



**5G;
NR;**

**Derivation of test tolerances and measurement uncertainty for
User Equipment (UE) conformance test cases
(3GPP TR 38.903 version 18.2.0 Release 18)**



Reference

RTR/TSGR-0538903vi20

Keywords

5G

ETSI

650 Route des Lucioles
F-06921 Sophia Antipolis Cedex - FRANCE

Tel.: +33 4 92 94 42 00 Fax: +33 4 93 65 47 16

Siret N° 348 623 562 00017 - APE 7112B
Association à but non lucratif enregistrée à la
Sous-Préfecture de Grasse (06) N° w061004871

Important notice

The present document can be downloaded from:

<https://www.etsi.org/standards-search>

The present document may be made available in electronic versions and/or in print. The content of any electronic and/or print versions of the present document shall not be modified without the prior written authorization of ETSI. In case of any existing or perceived difference in contents between such versions and/or in print, the prevailing version of an ETSI deliverable is the one made publicly available in PDF format at www.etsi.org/deliver.

Users of the present document should be aware that the document may be subject to revision or change of status.

Information on the current status of this and other ETSI documents is available at

<https://portal.etsi.org/TB/ETSIDeliverableStatus.aspx>

If you find errors in the present document, please send your comment to one of the following services:

<https://portal.etsi.org/People/CommitteeSupportStaff.aspx>

If you find a security vulnerability in the present document, please report it through our
Coordinated Vulnerability Disclosure Program:

<https://www.etsi.org/standards/coordinated-vulnerability-disclosure>

Notice of disclaimer & limitation of liability

The information provided in the present deliverable is directed solely to professionals who have the appropriate degree of experience to understand and interpret its content in accordance with generally accepted engineering or other professional standard and applicable regulations.

No recommendation as to products and services or vendors is made or should be implied.

No representation or warranty is made that this deliverable is technically accurate or sufficient or conforms to any law and/or governmental rule and/or regulation and further, no representation or warranty is made of merchantability or fitness for any particular purpose or against infringement of intellectual property rights.

In no event shall ETSI be held liable for loss of profits or any other incidental or consequential damages.

Any software contained in this deliverable is provided "AS IS" with no warranties, express or implied, including but not limited to, the warranties of merchantability, fitness for a particular purpose and non-infringement of intellectual property rights and ETSI shall not be held liable in any event for any damages whatsoever (including, without limitation, damages for loss of profits, business interruption, loss of information, or any other pecuniary loss) arising out of or related to the use of or inability to use the software.

Copyright Notification

No part may be reproduced or utilized in any form or by any means, electronic or mechanical, including photocopying and microfilm except as authorized by written permission of ETSI.

The content of the PDF version shall not be modified without the written authorization of ETSI.

The copyright and the foregoing restriction extend to reproduction in all media.

© ETSI 2024.
All rights reserved.

Intellectual Property Rights

Essential patents

IPRs essential or potentially essential to normative deliverables may have been declared to ETSI. The declarations pertaining to these essential IPRs, if any, are publicly available for **ETSI members and non-members**, and can be found in ETSI SR 000 314: "*Intellectual Property Rights (IPRs); Essential, or potentially Essential, IPRs notified to ETSI in respect of ETSI standards*", which is available from the ETSI Secretariat. Latest updates are available on the ETSI Web server (<https://ipr.etsi.org/>).

Pursuant to the ETSI Directives including the ETSI IPR Policy, no investigation regarding the essentiality of IPRs, including IPR searches, has been carried out by ETSI. No guarantee can be given as to the existence of other IPRs not referenced in ETSI SR 000 314 (or the updates on the ETSI Web server) which are, or may be, or may become, essential to the present document.

Trademarks

The present document may include trademarks and/or tradenames which are asserted and/or registered by their owners. ETSI claims no ownership of these except for any which are indicated as being the property of ETSI, and conveys no right to use or reproduce any trademark and/or tradename. Mention of those trademarks in the present document does not constitute an endorsement by ETSI of products, services or organizations associated with those trademarks.

DECT™, **PLUGTESTS™**, **UMTS™** and the ETSI logo are trademarks of ETSI registered for the benefit of its Members. **3GPP™** and **LTE™** are trademarks of ETSI registered for the benefit of its Members and of the 3GPP Organizational Partners. **oneM2M™** logo is a trademark of ETSI registered for the benefit of its Members and of the oneM2M Partners. **GSM®** and the GSM logo are trademarks registered and owned by the GSM Association.

Legal Notice

This Technical Report (TR) has been produced by ETSI 3rd Generation Partnership Project (3GPP).

The present document may refer to technical specifications or reports using their 3GPP identities. These shall be interpreted as being references to the corresponding ETSI deliverables.

The cross reference between 3GPP and ETSI identities can be found under <https://webapp.etsi.org/key/queryform.asp>.

Modal verbs terminology

In the present document "**should**", "**should not**", "**may**", "**need not**", "**will**", "**will not**", "**can**" and "**cannot**" are to be interpreted as described in clause 3.2 of the [ETSI Drafting Rules](#) (Verbal forms for the expression of provisions).

"**must**" and "**must not**" are **NOT** allowed in ETSI deliverables except when used in direct citation.

Contents

Intellectual Property Rights	2
Legal Notice	2
Modal verbs terminology.....	2
Foreword.....	10
Introduction	10
1 Scope	11
2 References	11
3 Definitions, symbols and abbreviations	12
3.1 Definitions	12
3.2 Symbols.....	12
3.3 Abbreviations	12
4 General Principles	13
4.1 Principle of Superposition	13
4.2 Sensitivity analysis	13
4.3 Statistical combination of uncertainties.....	13
4.4 Correlation between uncertainties	14
4.4.1 Uncorrelated uncertainties	14
4.4.2 Positively correlated uncertainties	15
4.4.3 Negatively correlated uncertainties.....	15
4.4.4 Treatment of uncorrelated uncertainties	16
4.4.5 Treatment of positively correlated uncertainties with adverse effect.....	16
4.4.6 Treatment of positively correlated uncertainties with beneficial effect	16
4.4.7 Treatment of negatively correlated uncertainties	16
5 Determination of Test System Uncertainties.....	17
5.1 General	17
5.2 Uncertainty figures	17
6 Determination of Test Tolerances	17
6.1 General	17
7 Grouping of test cases defined in TS 38.521-4	17
8 Grouping of test cases defined in TS 38.533.....	19
9 Grouping of test cases defined in TS 37.571-1	42
Annex A: Derivation documents for test tolerance	46
A.1 Void.....	46
A.2 Handling of common Test Tolerance topics for radiated test cases defined in TS 38.533	46
A.2.1 Angles of Arrival.....	46
A.2.1.1 Relevant core requirements.....	46
A.2.1.2 Modelling of variation within spherical coverage directions.....	47
A.2.1.3 Principles for Test Tolerance analysis	47
A.2.2 UE Fine beams and Rough beams.....	47
A.2.2.1 Relevant core requirements.....	47
A.2.2.2 Modelling of Fine beams and Rough beams.....	49
A.2.2.3 Principles for Test Tolerance analysis	49
A.2.3 UE internal noise.....	49
A.2.3.1 Relevant core requirements.....	49
A.2.3.2 Calculation method	50
A.2.3.3 Principles for Test Tolerance analysis	50
A.2.4 Calculation of Es/Iot at UE baseband.....	50
A.2.4.1 Relevant core requirements.....	50

A.2.4.2	Calculation method	51
A.2.4.3	Principles for Test Tolerance analysis	52
A.2.5	Calculation of Applied Io	52
A.2.5.1	Relevant core requirements.....	52
A.2.5.2	Calculation method.....	52
A.2.5.3	Principles for Test Tolerance analysis	53
A.2.6	UE Reported RSRP and UE gain	53
A.2.6.1	Relevant core requirements.....	53
A.2.6.2	Absolute RSRP	53
A.2.6.3	Relative RSRP, 2 levels on same cell, same Angle of Arrival.....	55
A.2.6.4	Relative RSRP, 2 intra-frequency cells, same Angle of Arrival	55
A.2.6.5	Relative RSRP, 2 inter-frequency cells, same Angle of Arrival	55
A.2.6.6	Relative RSRP, 2 cells, different Angles of Arrival	56
A.2.6.7	Principles for Test Tolerance analysis	56
A.2.7	Intra-frequency cells without AWGN, same Angle of Arrival.....	57
A.2.7.1	Test system	57
A.2.7.2	Calculation method for Es/Iot at UE baseband.....	57
A.2.7.3	Calculation method for Applied Io	58
A.2.7.4	Principles for Test Tolerance analysis	58
A.3	Test Tolerance analysis templates for radiated test cases awaiting completion.....	59
A.4	Design of radiated test cases defined in TS 38.533.....	59
A.4.1	Downlink considerations.....	59
A.4.1.1	Side conditions for Rx Beam Peak angle of arrival	59
A.4.1.2	Side conditions for Spherical Coverage angle of arrival.....	59
A.4.1.3	Test case design options to increase downlink dB range.....	60
Annex B:	Acceptable uncertainty of test system for test cases defined in TS	
	38.521-2 for radiative testing	62
B.1	Uncertainty budget calculation principle.....	62
B.1.1	Uncertainty budget calculation principle for DFF.....	62
B.1.2	Uncertainty budget calculation principle for IFF	63
B.1.3	Uncertainty budget calculation principle for NFFT	63
B.2	Measurement error contribution descriptions.....	63
B.2.1	Measurement error contribution descriptions for DFF.....	63
B.2.1.1	Positioning misalignment	63
B.2.1.2	Measure distance uncertainty.....	63
B.2.1.3	Quality of quiet zone.....	63
B.2.1.4	Mismatch	63
B.2.1.5	Standing Wave Between the DUT and measurement antenna.....	65
B.2.1.6	Uncertainty of the RF power measurement equipment.....	65
B.2.1.7	Phase curvature	66
B.2.1.8	Amplifier uncertainties	66
B.2.1.9	Random uncertainty	66
B.2.1.10	Influence of the XPD	67
B.2.1.11	Insertion loss Variation	71
B.2.1.12	RF leakage (from measurement antenna to receiver/transmitter)	71
B.2.1.13	Misalignment of positioning System	71
B.2.1.14	Uncertainty of the Network Analyzer	71
B.2.1.15	Uncertainty of the absolute gain of the calibration antenna.....	71
B.2.1.16	Positioning and pointing misalignment between the reference antenna and the measurement antenna	71
B.2.1.17	gNB emulator uncertainty.....	71
B.2.1.18	Phase centre offset of calibration	72
B.2.1.19	Quality of quiet zone for calibration process	72
B.2.1.20	Standing wave between reference calibration antenna and measurement antenna	72
B.2.1.21	Influence of the calibration antenna feed cable (Flexing cables, adapters, attenuators, connector repeatability)	73
B.2.1.22	Influence of TRP measurement grid	73
B.2.1.23	Influence of beam peak search grid	73
B.2.1.24	Systematic error due to TRP calculation/quadrature	73

B.2.1.25	Multiple measurement antenna uncertainty	73
B.2.1.26	DUT repositioning	73
B.2.1.27	Influence of noise	73
B.2.1.28	Systematic error related to beam peak search	74
B.2.1.29	Influence of spherical coverage grid.....	74
B.2.1.30	Systematic error related to EIS spherical coverage.....	74
B.2.1.31	Misalignment of DUT due to change of DUT orientation	74
B.2.1.32	Additional Impact of Interferer ACLR	74
B.2.1.33	Modulated Interferer uncertainty	74
B.2.1.34	Void	74
B.2.1.35	Influence of offset antenna for blocker signal.....	74
B.2.1.36	Uncertainty of the RF relative power measurement equipment.....	75
B.2.2	Measurement error contribution descriptions for IFF	75
B.2.2.1	Positioning misalignment	75
B.2.2.2	Measure distance uncertainty.....	75
B.2.2.3	Quality of Quiet Zone	76
B.2.2.4	Mismatch	77
B.2.2.5	Standing wave between DUT and measurement antenna	79
B.2.2.6	Uncertainty of the RF power measurement equipment.....	79
B.2.2.7	Phase Curvature	79
B.2.2.8	Amplifier Uncertainties	80
B.2.2.9	Random uncertainty	80
B.2.2.10	Influence of XPD	80
B.2.2.11	Insertion Loss Variation.....	81
B.2.2.12	RF leakage (from measurement antenna to receiver/transmitter)	81
B.2.2.13	Misalignment of positioning system	82
B.2.2.14	Uncertainty of the Network Analyzer.....	82
B.2.2.15	Uncertainty of the absolute gain of the calibration antenna.....	82
B.2.2.16	Positioning and pointing misalignment between the reference antenna and the measurement antenna	83
B.2.2.17	gNB emulator uncertainty.....	83
B.2.2.18	Phase centre offset of calibration	83
B.2.2.19	Quality of the Quiet Zone for Calibration Process.....	83
B.2.2.20	Standing wave between reference calibration antenna and measurement antenna	84
B.2.2.21	Influence of the calibration antenna feed cable (Flexing cables, adapters, attenuators, connector repeatability)	85
B.2.2.22	Influence of TRP measurement grid	85
B.2.2.23	Influence of beam peak search grid	85
B.2.2.24	Systematic error due to TRP calculation/quadrature	86
B.2.2.25	Multiple measurement antenna uncertainty	86
B.2.2.26	DUT repositioning	86
B.2.2.27	Influence of noise	87
B.2.2.28	Systematic error related to beam peak search	94
B.2.2.29	Influence of spherical coverage grid.....	95
B.2.2.30	Systematic error related to EIS spherical coverage.....	95
B.2.2.31	Misalignment of DUT due to change of DUT orientation	95
B.2.2.32	Additional Impact of Interferer ACLR	95
B.2.2.33	Modulated Interferer uncertainty	96
B.2.2.34	Void	96
B.2.2.35	Influence of offset antenna for blocker signal.....	96
B.2.2.36	Uncertainty of the RF relative power measurement equipment.....	96
B.2.3	Measurement error contribution descriptions for NTF.....	96
B.2.3.1	Axes Alignment	96
B.2.3.2	Measurement Distance uncertainty.....	97
B.2.3.3	Quality of the Quiet Zone	97
B.2.3.4	Mismatch	97
B.2.3.5	Multiple Reflections: Coupling Measurement Antenna and DUT.....	97
B.2.3.6	Uncertainty of the RF power measurement equipment.....	97
B.2.3.7	Phase curvature	97
B.2.3.8	Amplifier uncertainties	97
B.2.3.9	Random uncertainty	97
B.2.3.10	Influence of the XPD	97
B.2.3.11	NF to FF truncation.....	97

B.2.3.12	Probe Polarization Amplitude and Phase.....	97
B.2.3.13	Probe Array Uniformity (for multi-probe systems only).....	98
B.2.3.14	Uncertainty of the Network Analyzer.....	98
B.2.3.15	Uncertainty of the absolute gain of the calibration antenna.....	98
B.2.3.16	Phase Recovery Non-Linearity over signal bandwidth.....	98
B.2.3.17	Probe Pattern Effect.....	98
B.2.3.18	Phase centre offset of calibration.....	98
B.2.3.19	Quality of the Quiet Zone for Calibration Process.....	98
B.2.3.20	Phase Drift and Noise.....	98
B.2.3.21	Mismatch in the connection of the calibration antenna.....	98
B.2.3.22	Influence of TRP measurement grid.....	98
B.2.3.23	99
B.2.3.24	99
B.2.3.25	Leakage and Crosstalk.....	99
B.2.3.26	Systematic error due to TRP calculation/quadrature.....	99
B.2.3.27	Multiple measurement antenna uncertainty.....	99
B.2.3.28	DUT repositioning.....	99
B.2.3.29	Influence of noise.....	99
B.2.3.30	Uncertainty of the RF relative power measurement equipment.....	99
B.3	UE maximum output power.....	99
B.3.1	Uncertainty budget format and assessment for DFF.....	101
B.3.2	Uncertainty budget format and assessment for IFF.....	105
B.3.3	Uncertainty budget format and assessment for NFTF.....	123
B.4	UE maximum output power for modulation / channel bandwidth.....	124
B.4.1	Uncertainty budget format and assessment for DFF.....	125
B.4.2	Uncertainty budget format and assessment for IFF.....	126
B.4.3	Uncertainty budget format and assessment for NFTF.....	128
B.5	UE maximum output power with additional requirements.....	128
B.6	Configured transmitted power with Power Boost.....	129
B.6.1	Uncertainty budget format and assessment for DFF.....	129
B.6.2	Uncertainty budget format and assessment for IFF.....	131
B.6.3	Uncertainty budget format and assessment for NFTF.....	140
B.6a	UE Maximum Output Power – EIRP with UL Gaps.....	141
B.6a.1	Uncertainty budget format and assessment for DFF.....	141
B.6a.2	Uncertainty budget format and assessment for IFF.....	142
B.6a.3	Uncertainty budget format and assessment for NFTF.....	145
B.7	Minimum Output power.....	146
B.7.1	Uncertainty budget format and assessment for DFF.....	146
B.7.2	Uncertainty budget format and assessment for IFF.....	150
B.8	Transmit OFF power.....	162
B.8.1	Uncertainty budget format and assessment for DFF.....	162
B.8.2	Uncertainty budget format and assessment for IFF.....	165
B.9	ON/OFF time mask.....	171
B.9.1	ON power subtest.....	171
B.9.1.1	Uncertainty budget format and assessment for DFF.....	171
B.9.1.2	Uncertainty budget format and assessment for IFF.....	171
B.9.2	OFF power subtest.....	171
B.9.2.1	Uncertainty budget format and assessment for DFF.....	171
B.9.2.2	Uncertainty budget format and assessment for IFF.....	172
B.9a	Power control.....	178
B.9a.1	Absolute power tolerance.....	178
B.9a.2	Relative power control tolerance.....	178
B.9a.2.1	Uncertainty budget format and assessment for DFF.....	178
B.9a.2.2	Uncertainty budget format and assessment for IFF.....	179
B.9a.2.3	Uncertainty budget format and assessment for NFTF.....	180
B.9a.3	Aggregate Power control tolerance.....	181

B.9a.3.1	Uncertainty budget format and assessment for DFF	181
B.9a.3.2	Uncertainty budget format and assessment for IFF.....	182
B.9a.3.3	Uncertainty budget format and assessment for NFTF.....	183
B.10	Frequency error	184
B.10.1	Uncertainty budget format and assessment for DFF	184
B.10.2	Uncertainty budget format and assessment for IFF.....	185
B.11	Carrier leakage	185
B.11.1	Uncertainty budget format and assessment for DFF	185
B.11.2	Uncertainty budget format and assessment for IFF.....	189
B.12	Error Vector Magnitude	196
B.12.1	Uncertainty budget format and assessment for DFF	196
B.12.2	Uncertainty budget format and assessment for IFF.....	196
B.13 to B.14.....		199
B.15	Occupied bandwidth.....	199
B.15.1	Uncertainty budget format and assessment for DFF	199
B.15.2	Uncertainty budget format and assessment for IFF.....	199
B.16	Spectrum emission mask.....	199
B.16.1	Uncertainty budget format and assessment for DFF	200
B.16.2	Uncertainty budget format and assessment for IFF.....	203
B.17	Adjacent Channel Leakage Ratio.....	209
B.17.1	Uncertainty budget format and assessment for DFF	210
B.17.2	Uncertainty budget format and assessment for IFF.....	214
B.18	Spurious emissions.....	219
B.18.1	Uncertainty budget format and assessment for DFF	221
B.18.2	Uncertainty budget format and assessment for IFF.....	225
B.18.3	Uncertainty budget format and assessment for NFTF.....	257
B.18a	Beam correspondence - EIRP.....	257
B.18a.1	Uncertainty budget format and assessment for DFF.....	257
B.18a.2	Uncertainty budget format and assessment for IFF	258
B.18a.3	Uncertainty budget format and assessment for NFTF	259
B.19	Reference Sensitivity.....	260
B.19.1	Uncertainty budget format and assessment for DFF	261
B.19.2	Uncertainty budget format and assessment for IFF.....	261
B.20	274	
B.21	Adjacent Channel Selectivity	274
B.21.1	Uncertainty budget format and assessment for DFF	274
B.21.2	Uncertainty budget format and assessment for IFF.....	274
B.22	In-Band Blocking	284
B.22.1	Uncertainty budget format and assessment for DFF	284
B.22.2	Uncertainty budget format and assessment for IFF.....	284
B.23	285
B.24	285
B.25	Receiver spurious emissions	285
B.25.1	Uncertainty budget format and assessment for DFF	286
B.25.2	Uncertainty budget format and assessment for IFF.....	289
Annex C:	Acceptable uncertainty of test system for test cases defined in TS	
	38.521-3 for radiative testing	320
Annex D:	Acceptable uncertainty of test system for test cases defined in TS	
	38.521-4 for radiative testing	321

D.1	Uncertainty budget calculation principle.....	327
D.1.1	Uncertainty budget calculation principle for DNF.....	327
D.1.2	Uncertainty budget calculation principle for DFF.....	327
D.1.3	Uncertainty budget calculation principle for IFF.....	327
D.2	Measurement error contribution descriptions.....	327
D.2.1	Measurement error contribution descriptions for DNF.....	327
D.2.1.1	gNB emulator SNR uncertainty.....	327
D.2.1.2	gNB emulator Downlink EVM.....	327
D.2.1.3	gNB emulator fading model impairments.....	328
D.2.2	Measurement error contribution descriptions for DFF.....	328
D.2.2.1	gNB emulator SNR uncertainty.....	328
D.2.2.2	gNB emulator Downlink EVM.....	328
D.2.2.3	gNB emulator fading model impairments.....	328
D.2.3	Measurement error contribution descriptions for IFF.....	328
D.2.3.1	gNB emulator SNR uncertainty.....	328
D.2.3.2	gNB emulator Downlink EVM.....	328
D.2.3.3	gNB emulator fading model impairments.....	328
D.3	Assessment of testable DL SNR range and accuracy.....	328
D.3.1	Method and Parameters.....	328
D.3.2.1	SNR range for $SNR_{RP} - SNR_{BB} \leq 1\text{dB}$ for DFF.....	329
D.3.2.2	SNR range for $SNR_{RP} - SNR_{BB} \leq 1\text{dB}$ for IFF.....	329
D.4	Simulation results.....	333

Annex E: Acceptable uncertainty of test system for test cases defined in TS 38.533 for radiative testing.....336

E.1	Uncertainty budget calculation principle.....	336
E.1.1	Uncertainty budget calculation principle for DFF.....	336
E.1.2	Uncertainty budget calculation principle for IFF.....	337
E.2	Measurement error contribution descriptions.....	337
E.2.1	Measurement error contribution descriptions for DFF.....	337
E.2.1.1	gNB emulator SNR uncertainty.....	337
E.2.1.2	gNB emulator Downlink EVM.....	337
E.2.1.3	gNB emulator fading model impairments.....	337
E.2.2	Measurement error contribution descriptions for IFF.....	337
E.2.2.1	gNB emulator SNR uncertainty.....	337
E.2.2.2	gNB emulator Downlink EVM.....	337
E.2.2.3	gNB emulator fading model impairments.....	337
E.3	Uncertainty assessment for RRM MU quantities.....	338
E.3.1	Uncertainty assessment for DL AWGN absolute power or wanted DL signal absolute power.....	338
E.3.1.1	Uncertainty budget format and assessment for DFF test setup.....	338
E.3.1.2	Uncertainty budget format and assessment for Simplified DFF test setup.....	341
E.3.1.3	Uncertainty budget format and assessment for IFF test setup.....	341
E.3.1.4	Uncertainty budget format and assessment for Enhanced IFF test setup.....	344
E.3.1.5	Uncertainty budget format and assessment for IFF+DFF Hybrid test setup.....	347
E.3.2	Uncertainty assessment for DL applied SNR.....	347
E.3.3	Uncertainty assessment for DL Fading profile uncertainty.....	347
E.3.4	Uncertainty assessment for DL AWGN and signal flatness.....	347
E.3.5	Uncertainty assessment for UL absolute power measurement.....	347
E.3.5.1	Uncertainty budget format and assessment for DFF.....	347
E.3.5.2	TBD.....	350
E.3.5.3	Uncertainty budget format and assessment for IFF.....	350
E.3.5.4	Uncertainty budget format and assessment for Enhanced IFF test setup.....	352
E.3.5.5	Uncertainty budget format and assessment for IFF+DFF Hybrid test setup.....	354
E.3.6	Uncertainty assessment for UL relative power measurement.....	354
E.3.7	Uncertainty assessment for UL signal transmit timing relative to DL.....	354
E.3.8	Uncertainty assessment for Relative transmit timing accuracy during UE timing adjustment.....	354

Annex F: Applicable MTSU for Different QZ/Device Sizes354

Annex G: **Acceptable uncertainty of test system for test cases defined in TS
37.571-1 for radiative testing356**

Annex H: **Change history357**

History369

Foreword

This Technical Report has been produced by the 3rd Generation Partnership Project (3GPP).

The contents of the present document are subject to continuing work within the TSG and may change following formal TSG approval. Should the TSG modify the contents of the present document, it will be re-released by the TSG with an identifying change of release date and an increase in version number as follows:

Version x.y.z

where:

- x the first digit:
 - 1 presented to TSG for information;
 - 2 presented to TSG for approval;
 - 3 or greater indicates TSG approved document under change control.
- y the second digit is incremented for all changes of substance, i.e. technical enhancements, corrections, updates, etc.
- z the third digit is incremented when editorial only changes have been incorporated in the document.

Introduction

FFS

1 Scope

The present document specifies a general method used to derive Measurement Uncertainties and Test Tolerances for UE conformance tests. The acceptable uncertainties for each test case are documented and establish a system for relating the Test Tolerances to the measurement uncertainties of the Test System.

For UE radio transmitting and reception tests, only FR2 is considered in this document. For UE RRM and Demodulation tests, both FR1 and FR2 are considered in this document.

The test cases which have been analysed to determine Test Tolerances are included as .zip files.

The present document is applicable from Release 15 up to the release indicated on the front page of the present Terminal conformance specifications.

2 References

The following documents contain provisions which, through reference in this text, constitute provisions of the present document.

- References are either specific (identified by date of publication, edition number, version number, etc.) or non-specific.
- For a specific reference, subsequent revisions do not apply.
- For a non-specific reference, the latest version applies. In the case of a reference to a 3GPP document (including a GSM document), a non-specific reference implicitly refers to the latest version of that document *in the same Release as the present document*.

- [1] 3GPP TR 21.905: "Vocabulary for 3GPP Specifications".
- [2] 3GPP TR 36.903: " Evolved Universal Terrestrial Radio Access (E-UTRA) and Evolved Universal Terrestrial Radio Access Network (E-UTRAN); Derivation of test tolerances for Radio Resource Management (RRM) conformance tests".
- [3] 3GPP TS 36.904: " Evolved Universal Terrestrial Radio Access (E-UTRA) and Evolved Universal Terrestrial Radio Access Network (E-UTRAN); Derivation of test tolerances for User Equipment (UE) radio reception conformance tests".
- [4] ETSI ETR 273-1-2: "Improvement of radiated methods of measurement (using test sites) and evaluation of the corresponding measurement uncertainties; Part 1: Uncertainties in the measurement of mobile radio equipment characteristics; Sub-part 2: Examples and annexes".
- [5] 3GPP TS 36.521-1: "User Equipment (UE) conformance specification, Radio transmission and reception Part 1: conformance testing".
- [6] 3GPP TS 38.521-1: "NR; User Equipment (UE) conformance specification; Radio transmission and reception; Part 1: Range 1 Standalone".
- [7] 3GPP TS 38.521-2: "NR; User Equipment (UE) conformance specification; Radio transmission and reception; Part 2: Range 2 Standalone".
- [8] 3GPP TS 38.521-3: "NR; User Equipment (UE) conformance specification; Radio transmission and reception; Part 3: NR interworking between NR range1 + NR range2; and between NR and LTE".
- [9] 3GPP TS 38.521-4: "NR; User Equipment (UE) conformance specification; Radio transmission and reception; Part 4: Performance requirements".
- [10] 3GPP TS 38.533: "NR; User Equipment (UE) conformance specification; Radio Resource Management (RRM)".

- [11] ETSI TR 102 273-1-1 V1.2.1 (2001-12): "Electromagnetic compatibility and Radio spectrum Matters (ERM); Improvement on Radiated Methods of Measurement (using test site) and evaluation of the corresponding measurement uncertainties; Part 1: Uncertainties in the measurement of mobile radio equipment characteristics; Sub-part 1: Introduction".
- [12] 3GPP TR 25.914: "Measurement of Radio Performances for UMTS terminals in speech mode".
- [13] 3GPP TR 38.810: "Study on test methods for New Radio".
- [14] CTIA OTA Test Plan version 3.7, <https://www.ctia.org/>.
- [15] 3GPP TS 36.521-3: "User Equipment (UE) conformance specification, Radio transmission and reception Part 3: Radio Resource Management (RRM) conformance testing."
- [16] 3GPP TS 38.101-2: "User Equipment (UE) radio transmission and reception Part 2: Range 2 Standalone"
- [17] 3GPP TS 38.133: "Requirements for support of radio resource management"
- [18] 3GPP TS 38.508-1: "5GS; User Equipment (UE) conformance specification; Part 1: Common test environment"
- [19] 3GPP TS 38.101-4: "NR; User Equipment (UE) radio transmission and reception; Part 4: Performance requirements"
- [20] 3GPP TS 37.571-1: User Equipment (UE) conformance specification for UE positioning; Part 1: Conformance test specification.

3 Definitions, symbols and abbreviations

3.1 Definitions

For the purposes of the present document, the terms and definitions given in TR 21.905 [1] apply.

3.2 Symbols

For the purposes of the present document, the following symbols apply:

D DUT radiating aperture

3.3 Abbreviations

For the purposes of the present document, the abbreviations given in TR 21.905 [1] and the following apply. An abbreviation defined in the present document takes precedence over the definition of the same abbreviation, if any, in TR 21.905 [1].

AoA	Angle of Arrival
DFF	Direct Far Field
EIS	Effective Isotropic Sensitivity
EIRP	Effective (or equivalent) isotropic radiated power
FF	Far Field
FR1	Frequency Range 1
FR2	Frequency Range 2
FWA	Fixed Wireless Access
IFF	Indirect Far Field
MBW	Maximum Bandwidth
MU	Measurement Uncertainty
NFTF	Near Field To Far-field
NR	New Radio
SNR	Signal-to-Noise Ratio

TRP	Total Radiated Power
TT	Test Tolerance

4 General Principles

4.1 Principle of Superposition

For multi-cell tests there are several cells each generating various Physical channels. In general cells are combined along with AWGN, so the signal and noise seen by the UE may be determined by more than one cell.

Since several cells may contribute towards the overall power applied to the UE, a number of test system uncertainties affect the signal and noise seen by the UE. The aim of the superposition method is to vary each controllable parameter of the test system separately, and to establish its effect on the critical parameters as seen by the UE receiver. The superposition principle then allows the effect of each test system uncertainty to be added, to calculate the overall effect.

The contributing test system uncertainties shall form a minimum set for the superposition principle to be applicable.

4.2 Sensitivity analysis

A change in any one channel level or channel ratio generated at source does not necessarily have a 1:1 effect at the UE. The effect of each controllable parameter of the test system on the critical parameters as seen by the UE receiver shall therefore be established. As a consequence of the sensitivity scaling factors not necessarily being unity, the test system uncertainties cannot be directly applied as test tolerances to the critical parameters as seen by the UE.

EXAMPLE: In many of the tests described, the \hat{E}_s / I_{ot} is one of the critical parameters at the UE. Scaling factors are used to model the sensitivity of the \hat{E}_s / I_{ot} to each test system uncertainty. When the scaling factors have been determined, the superposition principle then allows the effect of each test system uncertainty to be added, to give the overall variability in the critical parameters as seen at the UE.

There are often constraints on several parameters at the UE. The aim of the sensitivity analysis, together with the acceptable test system uncertainties, is to ensure that the variability in each of these parameters is controlled within the limits necessary for the specification to apply. The test has then been conducted under valid conditions.

4.3 Statistical combination of uncertainties

The acceptable uncertainties of the test system are specified as the measurement uncertainty tolerance interval for a specific measurement that contains 95 % of the performance of a population of test equipment. In the RRM and UE radio transmission and reception conformance tests covered by the present document, the Test System shall enable the stimulus signals in the test case to be adjusted to within the specified range, with an uncertainty not exceeding the specified values.

The method given in the present document combines the acceptable uncertainties of the test system, to give the overall variability in the critical parameters as seen at the UE. Since the process does not add any new uncertainties, the method of combination should be chosen to maintain the same tolerance interval for the combined uncertainty as is already specified for the contributing test system uncertainties.

The basic principle for combining uncertainties is in accordance with ETR 273-1-2 [4]. In summary, the process requires 3 steps:

- Express the value of each contributing uncertainty as a one standard deviation figure, from knowledge of its numeric value and its distribution.
- Combine all the one standard deviation figures as root-sum-squares, to give the one standard deviation value for the combined uncertainty.
- Expand the combined uncertainty by a coverage factor, according to the tolerance interval required.

Provided that the contributing uncertainties have already been obtained using this method, using a coverage factor of 2, further stages of combination can be achieved by performing step b) alone, since steps a) and c) simply divide by 2 and multiply by 2 respectively.

The root-sum-squares method is therefore used to maintain the same tolerance interval for the combined uncertainty as is already specified for the contributing test system uncertainties. In some cases where correlation between contributing uncertainties has an adverse effect, the method is modified in accordance with clause 4.4.5 of the present document.

In each analysis, the uncertainties are assumed to be uncorrelated, and are added result root-sum-square unless otherwise stated.

The combination of uncertainties is performed using dB values for simplicity. It has been shown that using dB uncertainty values gives a slightly worse combined uncertainty result than using linear values for the uncertainties. The analysis method therefore errs on the safe side.

4.4 Correlation between uncertainties

The statistical (root-sum-square) addition of uncertainties is based on the assumption that the uncertainties are independent of each other. For realisable test systems, the uncertainties may not be fully independent. The validity of the method used to add uncertainties depends on both the type of correlation and on the way in which the uncertainties affect the test requirements.

Clauses 4.4.1 to 4.4.3 give examples to illustrate different types of correlation.

Clauses 4.4.4 to 4.4.7 show how the scenarios applicable to multi-cell RRM tests are treated.

4.4.1 Uncorrelated uncertainties

The graph shows an example of two test system uncertainties, A and B, which affect a test requirement. Each sample from a population of test systems has a specific value of error in parameter A, and a specific value of error in parameter B. Each dot on the graph represents a sample from a population of test systems, and is plotted according to its error values for parameters A and B.

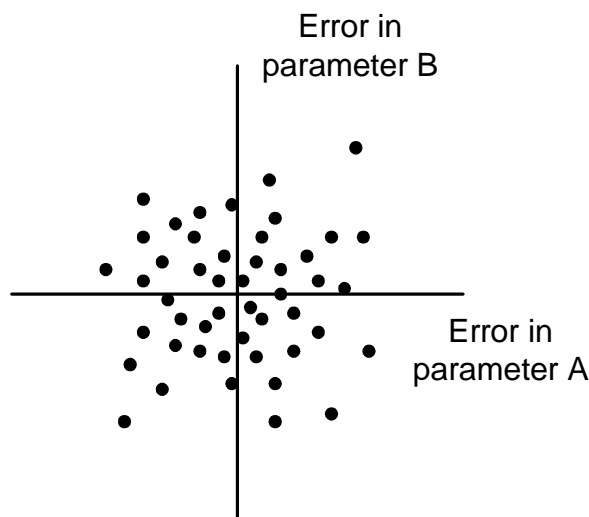

Figure 4.4.1-1: Example of two test system uncertainties affecting a test requirement

It can be seen that a positive value of error in parameter A, for example, is equally likely to occur with either a positive or a negative value of error in parameter B. This is expected when two parameters are uncorrelated, such as two uncertainties which arise from different and unrelated parts of the test system.

4.4.2 Positively correlated uncertainties

The graph shows an example of two test system uncertainties, A and B, which affect a test requirement. Each sample from a population of test systems has a specific value of error in parameter A, and a specific value of error in parameter B. Each dot on the graph represents a sample from a population of test systems, and is plotted according to its error values for parameters A and B.

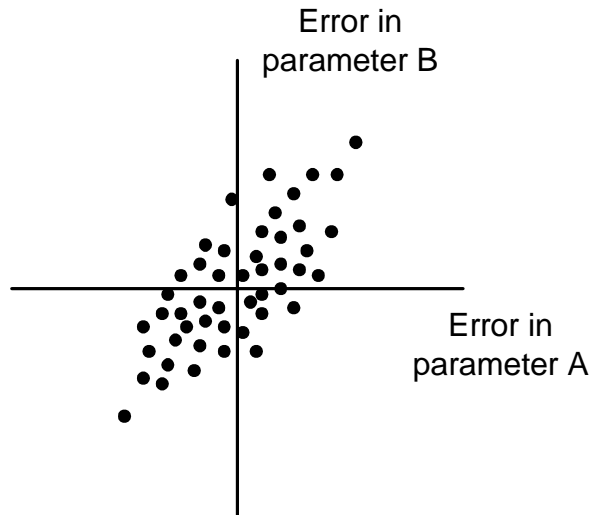

Figure 4.4.2-1: Example of two test system uncertainties affecting a test requirement

It can be seen that a positive value of error in parameter A, for example, is more likely to occur with a positive value of error in parameter B and less likely to occur with a negative value of error in parameter B. This can occur when the two uncertainties arise from similar parts of the test system, or when one component of the uncertainty affects both parameters in a similar way.

In an extreme case, if the error in parameter A and the error in parameter B came from the same sources of uncertainty, and no others, the dots would lie on a straight line of slope +1.

4.4.3 Negatively correlated uncertainties

The graph shows an example of two test system uncertainties, A and B, which affect a test condition. Each sample from a population of test systems has a specific value of error in parameter A, and a specific value of error in parameter B. Each dot on the graph represents a sample from a population of test systems, and is plotted according to its error values for parameters A and B.

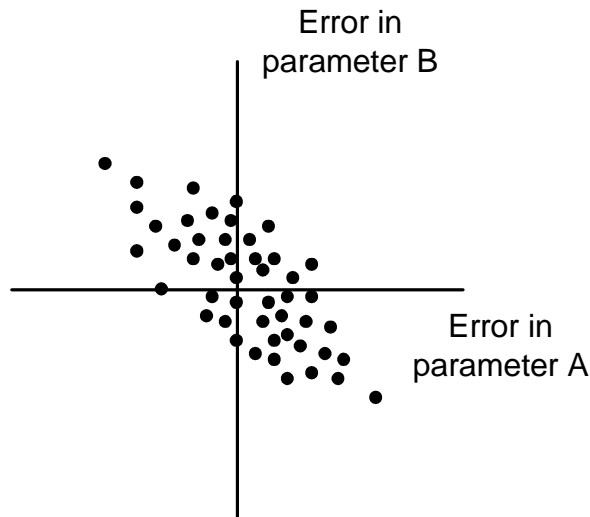

Figure 4.4.3-1: Example of two test system uncertainties affecting a test condition

It can be seen that a positive value of error in parameter A, for example, is more likely to occur with a negative value of error in parameter B and less likely to occur with a positive value of error in parameter B. This effect can theoretically occur, and is included for completeness, but is unlikely in a practical test system.

4.4.4 Treatment of uncorrelated uncertainties

If two uncertainties are uncorrelated, they are added statistically in the analysis. Provided that each uncertainty is already expressed as an expanded uncertainty with coverage factor 2, the contributing uncertainties are added root-sum-squares to give a combined uncertainty which also has coverage factor 2, and the 95% tolerance interval is maintained.

This is the default assumption.

4.4.5 Treatment of positively correlated uncertainties with adverse effect

If two test system uncertainties are positively correlated, and if they affect the value of a critical parameter in the same direction, the combined effect may be greater than predicted by adding the contributing uncertainties root-sum-squares.

In this scenario the two uncertainties are added worst-case in the analysis. Provided that each uncertainty is already expressed as an expanded uncertainty with coverage factor 2, the combined uncertainty will cover a 95% tolerance interval even when the two contributing uncertainties are fully correlated. If the two contributing uncertainties are less than fully correlated, the combined uncertainty will cover a tolerance interval greater than 95%.

4.4.6 Treatment of positively correlated uncertainties with beneficial effect

If two test system uncertainties are positively correlated, and if they affect the value of a critical parameter in opposite directions, the combined effect will be less than predicted by adding the contributing uncertainties root-sum-squares.

In this scenario the two uncertainties are added statistically in the analysis. Provided that each uncertainty is already expressed as an expanded uncertainty with coverage factor 2, the combined uncertainty will cover a 95% tolerance interval when the two contributing uncertainties are uncorrelated. If the two contributing uncertainties are positively correlated, the combined uncertainty will cover a tolerance interval greater than 95%.

4.4.7 Treatment of negatively correlated uncertainties

Negatively correlated uncertainties are excluded by the assumptions. This has been agreed as an acceptable restriction on practical test systems, as the mechanisms which produce correlation generally arise from similarities between two parts of the test system, and therefore produce positive correlation.

5 Determination of Test System Uncertainties

5.1 General

The uncertainty of a test system when making measurements reduces the ability of the test system to distinguish between conformant and non-conformant test subjects. The aim is therefore to minimise uncertainty, subject to a number of practical constraints:

- a) A vendor's test system should be reproducible in the required quantities.
- b) A choice of test systems should be available from different vendors.
- c) The uncertainties should allow reasonable freedom of test system implementation
- d) The test system can be run automatically
- e) The test system may include several radio access technologies
- f) It should be possible to maintain calibration of deployed test systems over reasonable spans of time and environmental conditions

In practice therefore within 3GPP the acceptable uncertainty of the test system is the smallest value that can be agreed between the test system vendors represented, consistent with the above constraints. The uncertainty will not therefore be as low as could be achieved, for example, by a national standards laboratory.

5.2 Uncertainty figures

The actual figures for the acceptable uncertainty of a test system are defined in Annex F of 38.521-1, Annex F of 38.521-2, Annex F of 38.521-3, Annex F of TS 38.521-4, Annex F of TS 38.533 and Annex C of 37.571-1. To avoid maintenance issues with figures in separate specifications, the uncertainties are not formally defined within the present document, but informative guidelines are provided in Annex B to Annex E of the present document.

6 Determination of Test Tolerances

6.1 General

The general principles given in the present document are applied to each test case, according to the applicable uncertainties and requirements to obtain a correct verdict.

The test cases which have been analysed to determine Test Tolerances are included in the present document as .zip files. The name of the zip file indicates the specification and the test cases covered.

Annex A gives the rationale for their inclusion.

7 Grouping of test cases defined in TS 38.521-4

Editor's note: intended to capture grouping of demodulation test cases.

Table 7-1: Grouping of FR1 test cases defined in Clause 5 of TS 38.521-4

Group	Test Case Numbers	.zip file name	Comments
PDSCH_Intercell_interference	5.2.2.1.15 5.2.2.2.16 5.2.3.1.15 5.2.3.2.16	"38.521-4 5.2.2.1.15 TT.zip"	"2 Interfering NR Cells, 2 sub-tests, Fading"

8 Grouping of test cases defined in TS 38.533

Table 8-1: Grouping of FR1 test cases defined in Clauses 4, 4A, 6, 8, 16 and 18 of TS 38.533

Group	Test Case Numbers	.zip file name	Comments
SCell_Activation_01	4.5.3.1 4.5.3.2 4.5.3.3 6.5.3.1 6.5.3.2 6.5.3.3	"38.533 4.5.3 +6.5.3 TT.zip"	"2 Inter Frequency NR Cells, 3 time periods, Various number of sub-tests, No fading"
SCell_Activation_02	4.5.3.5 6.5.3.4	"38.533 4.5.3.5 +6.5.3.4 TT.zip"	"2 Inter Frequency NR Cells, 2 time periods, Various number of sub-tests, No fading" Direct Scell activation configurations
PSCell_Activation	4.5.10.1	"38.533 4.5.10.1 TT.zip"	1 NR Cell, no fading
PSCell_Activation	5.5.12.1	"38.533 5.5.12.1 TT.zip"	1 NR Cell, no fading
SCell_Activation_03	6.5.3.5	"38.533 6.5.3.5 TT.zip"	"3 Cells with 2 Intra frequency and 3 rd cell with Inter Frequency NR FR1 Cells, Various number of sub-tests, No fading" direct Scell activation configurations
SCell_Activation_04	4.5.3.6 4.5.3.7 6.5.3.10 6.5.3.11	"38.533 4.5.3.6+4.5.3.7 +6.5.3.10+6.5.3.11 TT.zip"	"2 Inter Frequency NR Cells, 2 time periods, Various number of sub-tests, No fading" Fast Scell activation configurations
FastSCell_Activation	7.5.3.14	"38.533 7.5.3.14 TT.zip"	"2 Inter Frequency NR FR2 Cells, 2 time periods, No fading"
Intra_Freq_Meas_01	4.6.1.1 4.6.1.2 4.6.1.3 4.6.1.4 4.6.1.5 4.6.1.6 4.6.1.7 6.6.1.1 6.6.1.2 6.6.1.3 6.6.1.4 6.6.1.5 6.6.1.6 6.6.1.7 6.6.19.1 16.6.1.2 16.6.1.4 16.6.1.6 16.6.1.8 16.6.1.10 16.6.1.12 16.6.7.2	"38.533 4.6.1.1+4.6.1.2+4.6.1.3+4.6.1.4 TT v5.zip"	"2 Intra Frequency NR Cells, 2 time periods, Various number of sub-tests, No fading" Note: The spreadsheet "16.6.1.4-3" only applies to 30kHz SCS + 20MHz CBW RedCap test configurations.

Intra_Freq_MG_Enh	6.6.17.1 6.6.17.2	"38.533 6.6.17.1+6.6.17.2 TT.zip"	"2 Intra Frequency NR Cells, 3 time periods, Various number of sub-tests, No fading"
Intra_Freq_Meas_RedCap_1Rx_01	16.6.1.1 16.6.1.3 16.6.1.5 16.6.1.7 16.6.1.9 16.6.1.11 16.6.7.1	"38.533 16.6.1.1+16.6.1.3+16.6.1.5+16.6.1.7 TT.zip"	"2 Intra Frequency NR Cells, 2 time periods, Various number of sub-tests, No fading"
Intra_Freq_HST_Meas_01	4.6.1.8 6.6.1.8 6.6.19.4	"38.533 4.6.1.8+6.6.1.8 TT"	"3 NR cells on 2 channels (2 Intra Frequency NR Cells), 2 time periods, Various number of sub-tests, No fading"
Inter_Freq_Meas_01	4.6.2.1 4.6.2.2 4.6.2.5 4.6.2.6 4.6.2.9 6.6.2.1 6.6.2.2 6.6.2.5 6.6.2.6 6.6.2.12 6.6.19.2 16.6.2.2 16.6.2.4 16.6.2.6 16.6.2.8 16.6.2.10 16.6.2.12	"4.6.2.1+4.6.2.2+4.6.2.5+4.6.2.6 TT v4.zip"	"2 Inter Frequency NR Cells, 2 time periods, Various number of sub-tests, No fading" Note: The spreadsheet "16.6.2.2-3" only applies to 30kHz SCS + 20MHz CBW RedCap test configurations
Inter_Freq_MG_Enh	6.6.18.1 6.6.18.2	"6.6.18.1+6.6.18.2 TT.zip"	"3 Inter Frequency NR Cells, 2 time periods, Various number of sub-tests, No fading"
Intra_Reselection_01	6.1.1.1 16.1.1.2	38.533 6.1.1.1 + 16.1.1.2 TT	"2 Intra Frequency NR Cells, 3 time periods, No fading" The spreadsheet "16.1.1.2-3" only applies to 30kHz SCS + 20MHz CBW RedCap test configurations.
Inter_Reselection_01	6.1.1.2 6.1.1.8 16.1.1.4	38.533 6.1.1.2 + 16.1.1.4 TT	"2 Inter Frequency NR Cells, 3 time periods, No fading" The spreadsheet "16.1.1.4-3" only applies to 30kHz SCS + 20MHz CBW RedCap test configurations.

InterRAT_Higher_Reselection_01	6.1.2.1 16.1.2.2	38.533 6.1.2.1+16.1.2.2	"1 E-UTRAN Cell, 1 NR Cells, 3 time periods, No fading" The spreadsheet "16.1.2.2-3" only applies to 30kHz SCS + 20MHz CBW RedCap test configurations.
InterRAT_Lower_Reselection_01	6.1.2.2 6.1.2.3 6.1.2.5 16.1.2.4 16.1.2.6	38.533 6.1.2.2+6.1.2.3+6.1.2.5+16.1.2.4	"1 E-UTRAN Cell, 1 NR Cells, 2 time periods, No fading" The spreadsheet "16.1.2.4-3" only applies to 30kHz SCS + 20MHz CBW RedCap test configurations.
InterRAT_Lower_Reselection_02	6.1.2.4	"38.533 6.1.2.4 TT.zip"	"1 E-UTRAN Cell, 1 NR Cells, 2 time periods, No fading"
InterRAT_Known_Handover_01_1Rx	16.3.1.7	"38.533 16.3.1.7 TT.zip"	"1 E-UTRAN Cell, 1 NR Cells, 3 time periods, No fading"
InterRAT_Known_Handover_01	6.3.1.4 16.3.1.8	"38.533 6.3.1.4+16.3.1.8 TT v2.zip"	"1 E-UTRAN Cell, 1 NR Cells, 3 time periods, No fading" Note: The spreadsheet "16.3.1.8-3" only applies to 30kHz SCS + 20MHz CBW RedCap test configurations.
InterRAT_Unknown_Handover_01_1Rx	16.3.1.9	"38.533 16.3.1.9 TT.zip"	"1 E-UTRAN Cell, 1 NR Cells, 2 time periods, No fading"
InterRAT_Unknown_Handover_01	6.3.1.5 16.3.1.10	"38.533 6.3.1.5+16.3.1.10 TT.zip"	"1 E-UTRAN Cell, 1 NR Cells, 2 time periods, No fading" Note: The spreadsheet "16.3.1.10-3" only applies to 30kHz SCS + 20MHz CBW RedCap test configurations.
Intra_RRC_re-establishment_01	6.3.2.1.1 16.3.2.1.1 16.3.2.1.2	"38.533 6.3.2.1.1+16.3.2.1.1+16.3.2.1.2 TT.zip"	"2 Intra Frequency NR Cells, 3 time periods, No fading" Note: The spreadsheet "16.3.2.1.2-3" only applies to 30kHz SCS + 20MHz CBW RedCap test configurations.

Intra_SS-RSRP_Abs_Acc_01	4.7.1.1.1 6.7.1.1.1 16.7.1.2.1	"38.533 4.7.1.1.1+6.7.1.1.1+16.7.1.2.1 TT.zip"	"2 Intra-Frequency NR Cells, 3 Sub-tests, periodic reporting, No fading"
Intra_SS-RSRP_Rel_Acc_01	4.7.1.1.2 6.7.1.1.2 16.7.1.2.2	"38.533 4.7.1.1.2+6.7.1.1.2+16.7.1.2.2 TT.zip"	"2 Intra-Frequency NR Cells, 3 Sub-tests, periodic reporting, No fading"
Intra_SS-RSRP_Abs_Acc_01_RedCap_1Rx	16.7.1.1.1	"38.533 16.7.1.1.1 TT.zip"	2 Intra-Frequency NR Cells, 3 Sub-tests, periodic reporting, No fading"
Intra_SS-RSRP_Rel_Acc_01_RedCap_1Rx	16.7.1.1.2	38.533 16.7.1.1.2 TT.zip	"2 Intra-Frequency NR Cells, 3 Sub-tests, periodic reporting, No fading"
Inter_RRC_re-establishment_01	6.3.2.1.2 16.3.2.1.3 16.3.2.1.4	"38.533 6.3.2.1.2+16.3.2.1.3+16.3.2.1.4 TT.zip"	"2 Inter Frequency NR Cells, 3 time periods, No fading" Note: The spreadsheet "16.3.2.1.4-3" only applies to 30kHz SCS + 20MHz CBW RedCap test configurations.
Inter_RRC_redirection_01	6.3.2.3.1 16.3.2.3.1 16.3.2.3.2 18.2.2.1	"38.533 6.3.2.3.1+16.3.2.3.1+16.3.2.3.2+18.2.2.1 TT.zip"	"2 Inter Frequency NR Cells, 2 time periods, No fading" Note: The spreadsheet "16.3.2.3.2-3" only applies to 30kHz SCS + 20MHz CBW RedCap test configurations.
InterRAT_RRC_redirection_01	6.3.2.3.2 16.3.2.3.3 16.3.2.3.4	"38.533 6.3.2.3.2+16.3.2.3.3+16.3.2.3.4 TT.zip"	"1 E-UTRAN Cell, 1 NR Cells, 2 time periods, No fading" Note: The spreadsheet "16.3.2.3.4-3" only applies to 30kHz SCS + 20MHz CBW RedCap test configurations.

RLM_InSync_01	4.5.1.2 4.5.1.4 6.5.1.2 6.5.1.4 4.5.1.6 4.5.1.8 6.5.1.6 6.5.1.8 16.5.1.3 16.5.1.4 16.5.1.7 16.5.1.8 16.5.1.11 16.5.1.12 16.5.1.15 16.5.1.16	"38.533 4.5.1.2+4.5.1.4+6.5.1.2+6.5.1.4 TT v4.zip"	"1 NR Cell (1 E-UTRA Cell for NSA case), 1 sub-test, Fading, 5 Time Periods" Note: The spreadsheet "16.5.1.4-3" only applies to 30kHz SCS + 20MHz CBW RedCap test configurations.
RLM_Out_of_Sync_01	4.5.1.1 4.5.1.3 6.5.1.1 6.5.1.3 4.5.1.5 4.5.1.7 6.5.1.5 6.5.1.7 16.5.1.1 16.5.1.2 16.5.1.5 16.5.1.6 16.5.1.9 16.5.1.10 16.5.1.13 16.5.1.14	"38.533 4.5.1.1+4.5.1.3+6.5.1.1+6.5.1.3 TT v5.zip"	"1 NR Cell (1 E-UTRA Cell for NSA case), 1 sub-test, Fading, 3 Time Periods" Note: The spreadsheet "16.5.1.2-3" only applies to 30kHz SCS + 20MHz CBW RedCap test configurations.
UE_Timing_Advance_01	4.4.3.1 6.4.3.1 16.4.3.1 16.4.3.2	"38.533 4.4.3.1+6.4.3.1+16.4.3.1+16.4.3.2 TT.zip"	"1 NR Cell (1 E-UTRA Cell for NSA case), No Fading"
UE Transmit_Timing_01	4.4.1.1 6.4.1.1 16.4.1.1 16.4.1.2	"38.533 4.4.1.1+6.4.1.1+16.4.1.1+16.4.1.2 TT.zip"	"1 NR Cell (1 E-UTRA Cell for NSA case), 2 sub-tests, No Fading"
RRC_reconfiguration_delay_01	4.5.4.1 6.5.4.1	"38.533 4.5.4.1+6.5.1.1 TT.zip"	"1 E-UTRA Cell, 2 NR Cells", 3 Time Periods, No Fading"
Intra_Freq_HO_Known_Target	6.3.1.1 16.3.1.2	"38.533 6.3.1.1+16.3.1.2 TT.zip"	"2 Intra-Freq NR Cells, 3 Time Periods, No Fading" Note: The spreadsheet "16.3.1.2-3" only applies to 30kHz SCS + 20MHz CBW RedCap test configurations.
Intra_Freq_HO_Known_Target_1 Rx_RedCap	16.3.1.1	"38.533 16.3.1.1 TT.zip"	"2 Intra-Freq NR Cells, 3 Time Periods, No Fading"

Intra_Freq_HO_Unknown_Target	6.3.1.2 16.3.1.3 16.3.1.4	"38.533 6.3.1.2+16.3.1.4 TT.zip"	"2 Intra-Freq NR Cells, 2 Time Periods, No Fading" Note: The spreadsheet "16.3.1.4-3" only applies to 30kHz SCS + 20MHz CBW RedCap test configurations.
Inter_Freq_HO	6.3.1.3 16.3.1.5 16.3.1.6	"38.533 6.3.1.3+16.3.1.6 TT.zip"	"2 Inter-Freq NR Cells, 2 Time Periods, No Fading" Note: The spreadsheet "16.3.1.6-3" only applies to 30kHz SCS + 20MHz CBW RedCap test configurations.
InterRAT_Meas_01	6.6.3.1 6.6.3.2 6.6.19.3	"38.533 6.6.3.1+6.6.3.2 TT v2.zip"	"1 E-UTRAN Cell, 1 NR Cell, 2 time periods"
Interruption_Transition_01	4.5.2.1 4.5.2.2	"38.533 4.5.2.1+4.5.2.2 TT.zip"	"1 E-UTRAN Cell, 1 NR Cells, 1 time period, No fading"
Interruption_meas_NR_SCC_01	4.5.2.3 4.5.2.4 6.5.2.1	"38.533 4.5.2.3+4.5.2.4+6.5.2.1 TT.zip"	"1 E-UTRAN Cell, 2 NR Cells (2 NR Cells for SA case), 1 time period, No fading"
Interruption_meas_NR_SCC_01	4.5.2.5 4.5.2.6	"38.533 4.5.2.5+4.5.2.6 TT.zip"	"2 E-UTRAN Cell, 1 NR Cells, 1 time period, No fading"
Interruption_meas_NR_PSCell	4.5.2.10	"38.533 4.5.2.10 TT.zip"	"1 E-UTRAN Cell, 1 NR Cells, 1 time period, No fading"
Inter_SS-RSRP_Abs_Acc_01	4.7.1.2.1 6.7.1.2.1	"38.533 4.7.1.2.1+6.7.1.2.1 TT v3.zip"	"2 Inter-Frequency NR Cells, periodic reporting, No fading"
Inter_SS-RSRP_Rel_Acc_01	4.7.1.2.2 6.7.1.2.2	"38.533 4.7.1.2.2+6.7.1.2.2 TT v2.zip"	"2 Inter-Frequency NR Cells, periodic reporting, No fading"
Intra_SS-SINR_Acc_01	4.7.3.1 6.7.3.1	"38.533 4.7.3.1+6.7.3.1 TT.zip"	"2 Intra-Frequency NR Cells, periodic reporting, No fading"
SSB_Based_L1-RSRP-Meas	4.6.4.1 4.6.4.2 4.6.4.5 6.6.4.1 6.6.4.2 6.6.4.5 16.6.4.2 16.6.4.4	"38.533 4.6.4.1+4.6.4.2+6.6.4.1+6.6.4.2 TT v4.zip"	"1 NR Cell (1 E-UTRA Cell for NSA case), 2 time periods, No fading" Note: The spreadsheet "16.6.4.2-3" only applies to 30kHz SCS + 20MHz CBW RedCap test configurations.
SSB_Based_L1-RSRP-Meas_RedCap_1Rx	16.6.4.1 16.6.4.3	"38.533 16.6.4.1+16.6.4.3 TT.zip"	"1 NR Cell, 2 time periods, No fading"

CSI-RS_Based_L1-RSRP-Meas	4.6.4.3 4.6.4.4 6.6.4.3 6.6.4.4 16.6.4.5 16.6.4.6 16.6.4.7 16.6.4.8	"38.533 4.6.4.3+4.6.4.4+6.6.4.3+6.6.4.4 TT v5.zip"	"1 NR Cell (1 E- UTRA Cell for NSA case), one time period, No fading" Note: The spreadsheet "16.6.4.6-3" only applies to 30kHz SCS + 20MHz CBW RedCap test configurations.
CSI-RS_WithoutIMR_L1-SINR-Meas	4.6.7.1 6.6.8.1	"38.533 4.6.7.1+6.6.8.1 TT.zip"	"1 NR Cell (1 E- UTRA Cell for NSA case), one time period, No fading"
SSB_WithCSI-IM_L1-SINR-Meas	4.6.7.2 7.6.3.6	"38.533 4.6.7.2 TT.zip"	"1 E-UTRA Cell, 1 NR Cell, 2 time periods, No fading"
CSI-RS_WithCSI-IM_L1-SINR-Meas	4.7.7.3.1 6.7.9.3.1	"38.533 4.7.7.3.1+6.7.9.3.1 TT.zip"	"1 NR Cell (1 E- UTRA Cell for NSA case), one time period, No fading"
CSI-RS_WithCSI-IM_L1-SINR-Meas	4.7.7.3.2 6.7.9.3.2	"38.533 4.7.7.3.2+6.7.9.3.2 TT.zip"	"1 NR Cell (1 E- UTRA Cell for NSA case), one time period, No fading"
CSI-RS_Based_L1-SINR-Meas	4.7.7.1.1 6.7.7.9.1	"38.533 4.7.7.1.1+6.7.7.9.1 TT.zip"	"1 NR Cell (1 E- UTRA Cell for NSA case), one time period, No fading"
L1-SINR_Accuracy_3	7.7.6.2	"38.533 7.7.6.2 TT.zip"	1 NR FR2 Cell, 2 SSB and 2 CSI-RS, 1 subtests, 1 AoA in Rx peak and rough beam
L1-SINR_Accuracy_4	7.7.6.3	"38.533 7.7.6.3 TT.zip"	1 NR FR2 Cell, 2 CSI-RS and 2 CSI- IM, 1 subtest, 1 AoA in Rx peak and rough beam
CSI-RS_WithNZP_L1-SINR-Meas	4.6.7.3	"38.533 4.6.7.3 TT.zip"	"1 E-UTRA Cell, 1 NR Cell, one time period, No fading"
Intra_SS-RSRQ_Acc_01	4.7.2.1 6.7.2.1 16.7.2.2	"38.533 4.7.2.1+6.7.2.1+16.7.2.2 TT.zip"	"2 Intra-Frequency NR Cells, periodic reporting, No fading"
Intra_SS-RSRQ_Acc_01_RedCap_1Rx	16.7.2.1	"38.533 16.7.2.1 TT.zip"	"2 Intra-Frequency NR Cells, periodic reporting, No fading"
Inter_SS-RSRQ_Abs_Acc_01	4.7.2.2.1 6.7.2.2.1	"38.533 4.7.2.2.1+6.7.2.2.1 TT v2.zip"	"2 Inter-Frequency NR Cells, periodic reporting, No fading"
Inter_SS-RSRQ_Rel_Acc_01	4.7.2.2.2 6.7.2.2.2	"38.533 4.7.2.2.2+6.7.2.2.2 TT v2.zip"	"2 Inter-Frequency NR Cells, periodic reporting, No fading"
Inter_SS-SINR_Abs_Acc_01	4.7.3.2.1 6.7.3.2.1	"38.533 4.7.3.2.1+6.7.3.2.1 TT.zip"	"2 Inter-Frequency NR Cells, periodic reporting, No fading"
Inter_SS-SINR_Rel_Acc_01	4.7.3.2.2 6.7.3.2.2	"38.533 4.7.3.2.2+6.7.3.2.2 TT.zip"	"2 Inter-Frequency NR Cells, periodic reporting, No fading"

Inter_RAT_SS- RSRP_LTE_Serving_01	8.5.2.1.1.1	"38.533 8.5.2.1.1.1 TT.zip"	1 NR Cell, 1 LTE serving cell, periodic SS-RSRP reporting, No fading
Inter_RAT_SS- RSRQ_LTE_Serving_01	8.5.2.2.1	"38.533 8.5.2.2.1 TT.zip"	1 NR Cell, 1 LTE serving cell, periodic SS-RSRQ reporting, No fading
Inter_RAT_SS- SINR_LTE_Serving_01	8.5.2.3.1	"38.533 8.5.2.3.1 TT.zip"	1 NR Cell, 1 LTE serving cell, periodic SS-SINR reporting, No fading
L1-RSRP_Abs_Acc_01	4.7.4.1.1 6.7.4.1.1 4.7.4.2.1 6.7.4.2.1	"38.533 4.7.4.1.1+4.7.4.2.1+6.7.4.1.1+6.7.4.2.1 TT.zip"	1 NR Cell, periodic L1-RSRP reporting, No fading
L1-RSRP_Rel_Acc_01	4.7.4.1.2 6.7.4.1.2 4.7.4.2.2 6.7.4.2.2	"38.533 4.7.4.1.2+4.7.4.2.2+6.7.4.1.2+6.7.4.2.2 TT v2.zip"	1 NR Cell with 2 Beams, periodic L1-RSRP reporting, No fading
SSB_Based_BFR	4.5.5.1 4.5.5.2 6.5.5.1 6.5.5.2 16.5.2.2 16.5.2.4	"38.533 4.5.5.1+4.5.5.2+6.5.5.1+6.5.5.2 TT v4.zip"	"1 NR Cell (1 E-UTRA Cell for NSA case), 5 time periods, Fading" Note: The spreadsheet "16.5.2.2-3" only applies to 30kHz SCS + 20MHz CBW RedCap test configurations.
TRP specific SSB_Based_BFR	4.5.5.7	38.533 4.5.5.7 TT.zip	1 NR Cell 1 E-UTRA Cell PCell, 5 time periods, Fading"
SSB_Based_BFR_RedCap_1Rx_01	16.5.2.116 .5.2.3	"38.533 16.5.2.3 TT.zip"	"1 NR Cell (1 E-UTRA Cell for NSA case), 5 time periods, Fading"
CSI-RS_Based_BFR	4.5.5.3 4.5.5.4 6.5.5.3 6.5.5.4 16.5.2.5 16.5.2.6 16.5.2.7 16.5.2.8	"38.533 4.5.5.3+4.5.5.4+6.5.5.3+6.5.5.4 TT v3.zip"	"1 NR Cell (1 E-UTRA Cell for NSA case), 5 time periods, Fading" Note: The spreadsheet "16.5.2.6-3" only applies to 30kHz SCS + 20MHz CBW RedCap test configurations.
TRP specific CSI-RS_Based_BFR	6.5.5.7	"38.533 6.5.5.7 TT.zip"	"1 NR Cell (1 E-UTRA Cell for NSA case), 5 time periods, Fading"
CSI-RS_Based_BFD_SSB_Based_FR	4.5.5.5 4.5.5.6 6.5.5.5 6.5.5.6	For SSB refer to "38.533 4.5.5.1+4.5.5.2+6.5.5.1+6.5.5.2 TT v2.zip" For CSI-RS refer to "38.533 4.5.5.3+4.5.5.4+6.5.5.3+6.5.5.4 TT v2.zip"	"2 NR Cell (1 E-UTRA Cell for NSA case), 5 time periods, Fading"

TRP specific CSI-RS_Based_BFD_SSB_Based_FR	4.5.5.8	38.533 4.5.5.8 TT.zip	"2 NR Cell (1 E-UTRA Cell for NSA case), 5 time periods, Fading"
DCI_Based_BWP_Switch	4.5.6.1.1 4.5.6.1.2 6.5.6.1.1 6.5.6.1.2 16.5.3.1.1 16.5.3.1.2	"38.533 4.5.6.1.1+4.5.6.1.2+6.5.6.1.1+6.5.6.1.2 TT v2.zip"	"1 NR Cell (2NR Cells for Scell case, 1 E-UTRA Cell for NSA case), 3 time periods, No fading"
RRC_Based_BWP_Switch	4.5.6.2.1 6.5.6.2.1 5.5.6.3.1 16.5.3.2.1 16.5.3.2.2	"38.533 4.5.6.2.1+6.5.6.2.1+16.5.3.2.1+16.5.3.2.2 TT.zip"	"1 NR Cell (1 E-UTRA Cell for NSA case), 3 time periods, No fading"
Intra_RRC_re-establishment_without_timing	6.3.2.1.3 16.3.2.1.5 16.3.2.1.6	"38.533 6.3.2.1.3+16.3.2.1.5+16.3.2.1.6 TT.zip"	"2 Intra Frequency NR Cells, 3 time periods, No fading" Note: The spreadsheet "16.3.2.1.6-3" only applies to 30kHz SCS + 20MHz CBW RedCap test configurations.
InterRAT_re-selection_LTE_Serving	8.2.1.1	"38.533 8.2.1.1 TT.zip"	"1 NR Cell, 1 LTE serving cell, 3 time periods No fading"
InterRAT_HO_LTE_Serving	8.3.1.1 18.2.1.1	"38.533 8.3.1.1+18.2.1.1 TT.zip"	"1 NR Cell, 1 LTE serving cell, 3 time periods No fading" Note: The spreadsheet "18.2.1.1-3" only applies to 30kHz SCS + 20MHz CBW RedCap test configurations.
InterRAT_SFTD_Meas_LTE_Serving	8.4.1.1 8.4.1.2	"38.533 8.4.1.1+8.4.1.2 TT.zip"	"1 NR Cell, 1 LTE serving cell, 1 time period No fading"
InterRAT_Meas_LTE_Serving	8.4.2.1 8.4.2.2 8.4.2.3 8.4.2.4 18.3.1.1 18.3.1.2 18.3.1.3 18.3.1.4	"38.533 8.4.2.1+8.4.2.2+8.4.2.3+8.4.2.4 TT v3.zip"	"1 NR Cell, 1 LTE serving cell, 2 time periods, No Fading"
PSCell_Addition	4.5.7.1	"38.533 4.5.7.1 TT v2.zip"	1 NR Cell, no fading
PSCell_Addition_01	4.5.11.1	"38.533 4.5.11.1 TT.zip"	1 NR Cell, no fading
SFTD_Accuracy	4.7.5.1	"38.533 4.7.5.1 TT.zip"	1 E-UTRA Cell, 1 NR Cell, no fading
SSB_WithNZIP-IMR_L1-SINR-Meas	6.6.8.2	"38.533 6.6.8.2 TT.zip"	"1 NR Cell, 2 time periods, No fading"
CSI-RS_WithCSI-IM_L1-SINR-Meas	6.6.8.3	"38.533 6.6.8.3 TT.zip"	"1 NR Cell, one time period, No fading"
RLM_Out_of_Sync_PowerSaving_Enh	4.5.1.9 6.5.1.9	38.533 4.5.1.9+6.5.1.9 TT.zip	1 NR Cell (1 E-UTRA Cell for NSA case), 1 sub-test, Fading, 3 Time Periods
iRAT_E-UTRA_RSRP_Accuracy	6.7.5.1	"38.533 6.7.5.1 TT.zip"	1 E-UTRA Cell, 1 NR Cell, no fading

iRAT_E-UTRA_RSRQ_Accuracy	6.7.6.1	"38.533 6.7.6.1 TT.zip"	1 E-UTRA Cell, 1 NR Cell, no fading
iRAT_E-UTRA_RS-SINR_Accuracy	6.7.7.1	"38.533 6.7.7.1 TT.zip"	1 E-UTRA Cell, 1 NR Cell, no fading
InterRAT_SFTD_Meas_Accuracy_LTE_Serving	8.5.1.1	"38.533 8.5.1.1 TT.zip"	1 E-UTRA Cell, 1 NR Cell, no fading
Inter_Freq_HO_DAPS	6.3.1.9 6.3.1.10	"38.533 6.3.1.9+6.3.1.10 TT.zip"	"2 Inter-Freq NR Cells, 5 Time Periods, No Fading"
DL_Interruption_UL_Switching	4.5.8.1	"38.533 4.5.8.1 TT.zip"	1 E-UTRA Cell, 1 NR Cell, no fading
Intra_Reselection_Low_Mobility	6.1.1.3 16.1.1.6	38.533 6.1.1.3+16.1.1.6 TT	"2 Intra Frequency NR Cells, 2 time periods, No fading" The spreadsheet "16.1.1.6-3" only applies to 30kHz SCS + 20MHz CBW RedCap test configurations.
Intra_Reselection_Not_cell_edge	6.1.1.4	"38.533 6.1.1.4 TT.zip"	"2 Intra Frequency NR Cells, 2 time periods, No fading"
Inter_Reselection_Low_mobility	6.1.1.5 16.1.1.8	38.533 6.1.1.5+16.1.1.8 TT	"2 Inter Frequency NR Cells, 2 time periods, No fading" The spreadsheet "16.1.1.8-3" only applies to 30kHz SCS + 20MHz CBW RedCap test configurations.
Inter_Reselection_Not_cell_edge	6.1.1.6	"38.533 6.1.1.6 TT.zip"	"2 Inter Frequency NR Cells, 2 time periods, No fading"
Intra_Reselection_HST	6.1.1.7	"38.533 6.1.1.7 TT.zip"	"2 Intra Frequency NR Cells, 3 time periods, No fading"
InterRAT_HO_UTRA_FDD	6.3.1.6	"38.533 6.3.1.6 TT.zip"	"1 UTRA Cell, 1 NR Cell, 3 time periods, No fading"
InterRAT_Meas_UTRA_FDD	6.6.5.1	"38.533 6.6.5.1 TT.zip"	"1 UTRA Cell, 1 NR Cell, 2 time periods, No fading"
InterRAT_Meas_HST	6.6.3.3	"38.533 6.6.3.3 TT.zip"	1 E-UTRA Cell, 1 NR Cell, no fading
InterRAT_re-selection_LTE_Serving_HST	8.2.1.2	"38.533 8.2.1.2 TT.zip"	1 E-UTRA Cell, 1 NR Cell, no fading
InterRAT_Meas_LTE_Serving_HST	8.4.2.9	"38.533 8.4.2.9 TT.zip"	1 E-UTRA Cell, 1 NR Cell, no fading
Intra_Freq_HO_DAPS	6.3.1.7 6.3.1.8	"38.533 6.3.1.7+6.3.1.8 TT.zip"	"2 Intra-Freq NR Cells, 5 Time Periods, No Fading"
Inter_Freq_HO_DAPS	6.3.1.9 6.3.1.10	"38.533 6.3.1.9+6.3.1.10 TT.zip"	"2 Inter-Freq NR Cells, 5 Time Periods, No Fading"

Inter_Freq_HO_DAPS	6.3.1.11 6.3.1.12	"38.533 6.3.1.11+6.3.1.12 TT.zip"	"2 Inter-band Inter-Freq NR Cells, 5 Time Periods, No Fading"
Intra_Freq_CHO	6.3.3.1	"38.533 6.3.3.1 TT.zip"	"2 Intra-Freq NR Cells, 2 Time Periods, No Fading"
Inter_Freq_CHO	6.3.3.2	"38.533 6.3.3.2 TT.zip"	"2 Inter-Freq NR Cells, 2 Time Periods, No Fading"
Intra_Freq_CLI_SRS-RSRP	4.6.5.1 6.6.6.1	"38.533 4.6.5.1+6.6.6.1 TT.zip"	"1 E-UTRA Cell (clause 4 test only), 1 NR Cell, 1 Virtual UE, 2 Time Periods, no fading"
Intra_Freq_CLI_RSSI	4.6.5.2	"38.533 4.6.5.2 TT.zip"	"1 E-UTRA Cell, 1 NR Cell, 2 Time Periods, no fading"
Intra_Freq_CLI_SRS-RSRP_Accuracy	4.7.6.1 6.7.8.1	"38.533 4.7.6.1+6.7.8.1 TT.zip"	"1 E-UTRA Cell (clause 4 test only), 1 NR Cell, 1 Virtual UE, 1 Time Period, no fading"
DL_Interruption_UL_Switching_SA_01	6.5.7.1 6.5.7.2 6.5.7A.2 6.5.7A.1	"38.533 6.5.7.1+6.5.7.2+6.5.7A.1+6.5.7A.2 TT_v1.zip"	"2 NR Cells, 1 time period, no fading"
DL_Interruption_UL_Switching_SA_02	6.5.7B.2 6.5.7C.2	"38.533 6.5.7B.2 TT.zip"	"3 NR Cells, 1 time period, no fading"
DL_Interruption_UL_Switching_SA_03	6.5.7C.1 6.5.7B.1	"38.533 6.5.7B.1+6.5.7C.1 TT_v1.zip"	"3 NR Cells, 1 time period, no fading"
PRACH_01_1RX	16.3.2.2.1 16.3.2.2.3 16.3.2.2.5 16.3.2.2.7	"38.533 16.3.2.2.1+16.3.2.2.3+16.3.2.2.5+16.3.2.2.7 TT"	"1 NR Cell, PRACH measurements, no fading"
PRACH_01	4.3.2.2.1 4.3.2.2.2 6.3.2.2.1 6.3.2.2.2 16.3.2.2.2 16.3.2.2.4	"38.533 4.3.2.2.1+4.3.2.2.2+6.3.2.2.1+6.3.2.2.2 v2 TT.zip"	"1 NR Cell, PRACH measurements, no fading" Note: The spreadsheet "16.3.2.2.2-3" only applies to 30kHz SCS + 20MHz CBW RedCap test configurations.
PRACH_02	4.3.2.2.3 4.3.2.2.4 6.3.2.2.3 6.3.2.2.4 16.3.2.2.6 16.3.2.2.8	"38.533 4.3.2.2.3+4.3.2.2.4+6.3.2.2.3+6.3.2.2.4 TT v2.zip"	"1 NR Cell, PRACH measurements, no fading" Note: The spreadsheet "16.3.2.2.6-3" only applies to 30kHz SCS + 20MHz CBW RedCap test configurations.

Idle_CADC_meas	6.6.9.1	"38.533 6.6.9.1 TT.zip"	"2 NR Cells, 5 time periods, no fading"
CBW_change	6.5.8.1 16.5.4.1 16.5.4.2	"38.533 6.5.8.1+16.5.4.1+16.5.4.2 TT.zip"	"1 NR Cell, 1 time period, no fading"
NE-DC PSCell addition	4A.1.1.1	"38.533 4A.1.1.1 TT.zip"	"1 E-UTRA Cell, no fading"
NE-DC SFTD accuracy	4A.2.1.1	"38.533 4A.2.1.1 TT.zip"	"1 NR Cell, 1 E-UTRA Cell, no fading"
InterRAT_Idle_CADC_meas	6.6.15.1	"38.533 6.6.15.1 TT.zip"	"1 NR Cell, 1 E-UTRA Cell, 3 time periods, no fading"
InterRAT_LTE_Idle_CADC_meas	8.2.2.1	"38.533 8.2.2.1 TT.zip"	"1 E-UTRA Cell, 1 NR Cell, 3 time periods, no fading"
UE_Rx_Tx_difference_PDC_01	6.6.20.1 6.6.21.1	"38.533 6.6.20+6.6.21 TT.zip"	"1 NR Cell, 2 time periods, no fading"
Inter_Reselection_RedCap_1Rx	16.1.1.1	38.533 16.1.1.1 TT	"2 Intra Frequency NR Cells, 3 time periods, No fading, 1Rx RedCap UE"
Inter_Reselection_RedCap_1Rx	16.1.1.3	38.533 16.1.1.3 TT	"2 Inter Frequency NR Cells, 3 time periods, No fading, 1Rx RedCap UE"
Intra_Reselection_Low_Mobility_RedCap_1Rx	16.1.1.5	38.533 16.1.1.5 TT	"2 Intra Frequency NR Cells, 2 time periods, No fading, 1Rx RedCap UE"
Inter_Reselection_Low_mobility_RedCap_1Rx	16.1.1.7	38.533 16.1.1.7 TT	"2 Inter Frequency NR Cells, 2 time periods, No fading, 1Rx RedCap UE"
InterRAT_Higher_Reselection_RedCap_1Rx	16.1.2.1	38.533 16.1.2.1 TT	"1 E-UTRAN Cell, 1 NR Cells, 3 time periods, No fading, 1Rx RedCap UE"
InterRAT_Lower_Reselection_RedCap_1Rx	16.1.2.3	38.533 16.1.2.3 TT	"1 E-UTRAN Cell, 1 NR Cells, 2 time periods, No fading, 1Rx RedCap UE"
InterRAT_Lower_Reselection_RedCap_Relaxed_1Rx	16.1.2.5	38.533 16.1.2.5 TT	"1 E-UTRAN Cell, 1 NR Cells, 2 time periods, No fading, 1Rx RedCap UE"
Inter_Freq_Meas_01	16.6.2.1 16.6.2.3 16.6.2.5 16.6.2.7 16.6.2.9 16.6.2.11	38.533 16.6.2.1+16.6.2.3+16.6.2.5+16.6.2.7 TT	"2 Inter Frequency NR Cells, 2 time periods, Various number of sub-tests, No fading, 1Rx RedCap UE"
CG-SDT	6.2.1	38.533 6.2.1 TT	"1 NR Cell, 6 time periods, no fading"

Inter-RAT_Meas_RedCap_1Rx_01	16.6.3.1 16.6.3.3	38.533 16.6.3.1+16.6.3.3 TT	1 E-UTRA Cell, 1 NR Cell, no fading, 1Rx RedCap UE
Inter-RAT_Meas_RedCap_1Rx_02	16.6.3.2 16.6.3.4	38.533 16.6.3.2+16.6.3.4 TT	1 E-UTRA Cell, 1 NR Cell, no fading, 2Rx RedCap UE
UE_Specific_CBW_Change	4.5.9.1	"38.533 4.5.9.1 TT.zip"	"1 E-UTRA Cell and 1 NR Cell, 1 time period, no fading"

Table 8-2: Grouping of FR2 test cases defined in Clauses 5, 7, 8 and 17 of TS 38.533

Group	Test Case Numbers	.zip file name	Comments
Transmit_Timing_01	5.4.1.1 7.4.1.1	"38.533 5.4.1.1+7.4.1.1 TT.zip"	1 NR FR2 cell, no fading
Timing_Advance_01	5.4.3.1 7.4.3.1	"38.533 5.4.3.1+7.4.3.1 TT.zip"	1 NR FR2 cell, no fading
iRAT_meas_LTE_Serving	8.4.2.5 18.3.1.5	"38.533 8.4.2.5+18.3.1.5 TT.zip"	"1 NR FR2 cell, 1 E-UTRA serving cell, 2 time periods, No fading"
iRAT_meas_LTE_Serving_01	8.4.2.6 8.4.2.7 8.4.2.8 18.3.1.6 18.3.1.7 18.3.1.8	"38.533 8.4.2.6+8.4.2.7+8.4.2.8+18.3.1.6 TT.zip"	"1 NR FR2 cell, 1 E-UTRA serving cell, 2 time periods, No fading"
iRAT_SS-RSRP_01	8.5.2.1.2	"38.533 8.5.2.1.2 TT.zip"	"1 NR FR2 cell, 1 E-UTRA serving cell, 2 sub-tests, No fading"
iRAT_SS-RSRQ_01	8.5.2.2.2	"38.533 8.5.2.2.2 TT.zip"	"1 NR FR2 cell, 1 E-UTRA serving cell, 2 sub-tests, No fading"
iRAT_SS-SINR_01	8.5.2.3.2	"38.533 8.5.2.3.2 TT.zip"	"1 NR FR2 cell, 1 E-UTRA serving cell, 2 sub-tests, No fading"
Interruption_Transition_01	5.5.2.1 5.5.2.2	"38.533 5.5.2.1+5.5.2.2 TT.zip"	"1 E-UTRAN Cell, 1 NR FR2 Cell, 1 time period, No fading"
Interruption_meas_NR_SCC_01	5.5.2.3 5.5.2.4 7.5.2.1	"38.533 5.5.2.3+5.5.2.4+7.5.2.1 TT.zip"	1 E-UTRAN Cell, 2 NR Cells (2 NR Cells for SA case), 1 time period, No fading
SCell_Activation_01	5.5.3.1 5.5.3.7	"38.533 5.5.3.1 TT.zip"	"2 Inter Frequency NR FR2 Cells, 3 time periods, Various number of sub-tests, No fading"
SCell_Activation_02	7.5.3.3	"38.533 7.5.3.3 TT.zip"	"2 Inter Frequency NR FR2 Cells, 3 time periods, Various number of sub-tests, No fading"
SCell_Activation_02	7.5.3.4	"38.533 7.5.3.4 TT.zip"	"2 Inter Frequency NR FR2 Cells, 3 time periods, Various number of sub-tests, No fading" direct Scell activation configurations
SCell_Activation_03	7.5.3.5	"38.533 7.5.3.5 TT.zip"	"3 Cells with 2 Intra frequency and 3 rd cell with Inter Frequency NR FR2 Cells, 3 time periods, Various number of sub-tests, No fading" direct Scell activation with handover test case

SCell_Activation_04	5.5.3.8 7.5.3.13	"38.533 5.5.3.8+7.5.3.13 TT.zip"	"2 Inter Frequency NR FR2 Cells, 2 time periods, Various number of sub-tests, No fading" fast SCell activation configurations
Intra_Freq_Meas_01	5.6.1.1 5.6.1.3 7.6.1.1 7.6.1.3 7.6.16.1 17.6.1.1 17.6.1.3	"38.533 5.6.1.1+5.6.1.3+7.6.1.1+5.6.1.3 TT_v3.zip "	2 NR FR2 Cells (1 E-UTRA Cell for NSA case), 2 SSBs, 2 time periods, no fading, 2 AoAs, both are in EIS spherical coverage and rough beams
Intra_Freq_Meas_02	5.6.1.2 5.6.1.4 7.6.1.2 7.6.1.4 17.6.1.2 17.6.1.4	"38.533 5.6.1.2+5.6.1.4+7.6.1.2+5.6.1.4 TT.zip "	2 NR FR2 Cells (1 E-UTRA Cell for NSA case), 2 SSBs, 2 time periods, no fading, 1 AoA in Rx peak and rough beam
Inter_Freq_Meas_01	5.6.2.1 5.6.2.3 7.6.2.1 7.6.2.3 17.6.2.1 17.6.2.3	"38.533 5.6.2.1+5.6.2.3+7.6.2.1+7.6.2.3 TT v2.zip"	"2 Inter Frequency NR FR2 Cells, 2 time periods, Various number of sub-tests, No fading"
Inter_Freq_Meas_02	5.6.2.5 5.6.2.7 7.6.2.5 7.6.2.7	"38.533 5.6.2.5+5.6.2.7+7.6.2.5+7.6.2.7 TT.zip"	"2 Inter Frequency NR Cells (Cell 1 on FR1 and Cell 2 on FR2), 2 time periods, Various number of sub-tests, No fading"
Inter_Freq_Meas_03	5.6.2.6 5.6.2.8 7.6.2.6 7.6.2.8	"38.533 5.6.2.6+5.6.2.8+7.6.2.6+7.6.2.8 TT.zip"	"2 Inter Frequency NR Cells (Cell 1 on FR1 and Cell 2 on FR2), 2 time periods, Various number of sub-tests, No fading"
Inter_Freq_Meas_04	5.6.2.2 5.6.2.4 7.6.2.2 7.6.2.4 17.6.2.2 17.6.2.4	"38.533 5.6.2.2+5.6.2.4+7.6.2.2+7.6.2.4 TT.zip"	"2 Inter Frequency NR Cells (both on FR2), 2 time periods, Various number of sub-tests, No fading"
SSB_Based_L1-RSRP-Meas	5.6.3.1 5.6.3.2 7.6.3.1 7.6.3.2 17.6.3.1 17.6.3.2	"38.533 5.6.3.1+5.6.3.2+7.6.3.1+7.6.3.2 TT.zip"	"1 NR FR2 Cell (1 E-UTRA Cell for NSA case), 2 time periods, No fading"
SS-RSRP_01	5.7.1.1 7.7.1.1	"38.533 5.7.1.1+7.7.1.1 TT v2.zip"	"2 Intra-Frequency NR FR2 Cells, 2 sub-tests, No fading"
SS-RSRP_02	5.7.1.2 7.7.1.2	"38.533 5.7.1.2+7.7.1.2 TT v4.zip"	"2 Inter-Frequency NR FR2 Cells, 2 sub-tests, No fading"
SS-RSRP_03	5.7.1.3 7.7.1.3	"38.533 5.7.1.3+7.7.1.3 TT.zip"	"1 NR FR1 Cell, 1 NR FR2 Cell, 2 sub-tests, No fading"
SS-RSRQ_01	5.7.2.1 7.7.2.1	"38.533 5.7.2.1+7.7.2.1 TT.zip"	"2 Intra-Frequency NR FR2 Cells, 2 sub-tests, No fading"

SS-RSRQ_02	5.7.2.2 7.7.2.2	"38.533 5.7.2.2+7.7.2.2 TT.zip"	"2 Inter-Frequency NR FR2 Cells, 2 sub-tests, No fading"
SS-SINR_01	5.7.3.1 7.7.3.1	"38.533 5.7.3.1+7.7.3.1 TT.zip"	"2 Intra-Frequency NR FR2 Cells, 2 sub-tests, No fading"
SS-SINR_02	5.7.3.2 7.7.3.2	"38.533 5.7.3.2+7.7.3.2 TT v2.zip"	"2 Inter-Frequency NR FR2 Cells, 3 sub-tests, No fading"
CSI-RS_Based_L1-RSRP-Meas	5.6.3.3 5.6.3.4 7.6.3.3 7.6.3.4 17.6.3.3 17.6.3.4	"38.533 5.6.3.3+6.6.3.4+7.6.3.3+7.6.3.4 TT.zip"	"1 NR FR2 Cell (1 E-UTRA Cell for NSA case), 1 time period, No fading"
SSB_Based_BFD	5.5.5.1 5.5.5.2 5.5.5.5 7.5.5.1 7.5.5.2 7.5.5.5 17.5.2.5	"38.533 5.5.5.1+5.5.5.2+7.5.5.1+7.5.5.2 TT.zip "	"1 NR FR2 Cell (1 E-UTRA Cell for NSA case), 2 SSBs, 5 time periods, fading, 1AoA Rx peak, Rough beam"
CSI-RS Based BFD and BFR	5.5.5.3 5.5.5.4 7.5.5.3 7.5.5.4 17.5.2.3 17.5.2.4	"38.533 5.5.5.3+5.5.5.4+7.5.5.3+7.5.5.4 TT v2.zip"	"1 NR Cell (1 E-UTRA Cell for NSA case), 5 time periods, Fading"
CSI-RS Based SCell BFD and BFR	5.5.5.6 5.5.5.7 7.5.5.6 7.5.5.7	"38.533 5.5.5.3+5.5.5.4+7.5.5.3+7.5.5.4 TT v2.zip"	"2 NR Cell (1 E-UTRA Cell for NSA case), 5 time periods, Fading"
TRP specific CSI-RS Based BFD and BFR	5.5.5.8 7.5.5.9	"38.533 5.5.5.8+7.5.5.9 TT.zip"	"2 NR Cell (1 E-UTRA Cell for NSA case), 5 time periods, Fading"
SSB_Based_BFD_Relaxed_Meas	5.5.5.9	"38.533 5.5.5.9 TT.zip "	"1 NR FR2 Cell (1 E-UTRA Cell for NSA case), 2 SSBs, 5 time periods, fading, 1AoA Rx peak, Rough beam"
TRP specific SSB_Based_BFD	7.5.5.10	"38.533 7.5.5.10 TT.zip"	"2 NR FR2 Cell, 2 SSBs, 5 time periods, fading"
CSI-RS_WithoutIMR_L1-SINR-Meas	5.6.6.1 7.6.6.1	"38.533 5.6.6.1+7.6.6.1 TT.zip"	"1 NR Cell (1 E-UTRA Cell for NSA case), one time period, No fading"
CSI-RS_WithCSI-IM_L1-SINR-Meas	5.6.6.3	"38.533 5.6.6.3 TT.zip"	"1 E-UTRA Cell, 1 NR Cell, one time period, No fading"
Inter_Reselection_low_mobility	7.1.1.5 17.1.1.4	"38.533 7.1.1.5 TT.zip"	"2 NR FR2 Cells, 2 SSBs, 2 time periods, 1 AoA in Rx peak and rough beam"
CSI-RS_RLM_Out_of_Sync_02	5.5.1.7 7.5.1.7	"38.533 5.5.1.7+7.5.1.7 TT.zip"	"1 NR FR2 Cell (1 E-UTRA cell), 2 CSI-RSs, 3 time periods, 1AoA beam peak directions and rough beam, fading.

CSI-RS_RLM_InSync_02	5.5.1.8 7.5.1.8	"38.533 5.5.1.8+7.5.1.8 TT.zip"	1 NR FR2 Cell (1 E-UTRA cell), 2 CSI-RSs, 5 time periods, 1AoA in beam peak directions and rough beam, fading.
SSB_WithNZIP-IMR_L1-SINR-Meas	5.6.6.2	"38.533 5.6.6.2 TT.zip"	"1 E-UTRA Cell, 1 NR Cell, 2 time periods, No fading"
Inter_band_DAPS_HO	7.3.1.4 7.3.1.5	"38.533 7.3.1.4+7.3.1.5 TT.zip "	"1 NR FR2 Cell, 1 SSB, 5 time periods, 1 AoA in Rx peak and rough beam"
Intra_Freq_RRC_re-establishment_01	7.3.2.1.1 17.3.2.1.1	"38.533 7.3.2.1.1+17.3.2.1.1 TT"	"2 Intra Frequency NR Cells, 3 time periods, No fading"
Inter_Freq_RRC_re-establishment_01	7.3.2.1.2 17.3.2.1.2	"38.533 7.3.2.1.2+17.3.2.1.2 TT"	"2 Inter Frequency NR Cells, 3 time periods, No fading"
Intra_freq_HO	7.3.1.2	"38.533 7.3.1.2 TT.zip"	2 NR FR2 intra-frequency Cells, 2 time periods, no fading
Inter_freq_HO	7.3.1.3	"38.533 7.3.1.3+7.3.2.3.1 TT.zip"	2 NR FR2 inter-frequency Cells, 2 time periods, no fading
Inter_freq_redirection	7.3.2.3.1	"38.533 7.3.1.3+7.3.2.3.1 TT.zip"	2 NR FR2 inter-frequency Cells, 2 time periods, no fading
Intra_freq_CHO	7.3.3.1	"38.533 7.3.3.1 TT.zip "	2 NR FR2 Cells, 2 SSBs, 2 time periods, 1 AoA in Rx peak and rough beam
CSI-RS_RLM_Out_of_Sync_01	5.5.1.5 7.5.1.5	"38.533 5.5.1.5+7.5.1.5 TT.zip"	1 NR FR2 Cell (1 E-UTRA cell), 2 CSI-RSs, 3 time periods, 2AoA spherical coverage directions and rough beam, fading.
CSI-RS_RLM_InSync_01	5.5.1.6 7.5.1.6	"38.533 5.5.1.6+7.5.1.6 TT.zip"	1 NR FR2 Cell (1 E-UTRA cell), 2 CSI-RSs, 5 time periods, 2AoA in spherical coverage directions and rough beam, fading.
SSB_RLM_Out_of_Sync_02	5.5.1.10	"38.533 5.5.1.10 TT.zip"	1 NR FR2 Cell (1 E-UTRA cell), 3 time periods, 1AoA in Rx peak and rough beam, fading.
CSI-RS_WithNZIP_L1-SINR-Meas	7.6.6.3	"38.533 7.6.6.3 TT.zip"	"1 NR Cell, one time period, No fading"
L1-RSRP_Accuracy_1	5.7.4.1 7.7.4.1	"38.533 5.7.4.1+7.7.4.1 TT.zip"	1 NR FR2 Cell, 2 SSBs, 2 subtests, 1 AoA in Rx peak and rough beam
L1-RSRP_Accuracy_2	5.7.4.2 7.7.4.2	"38.533 5.7.4.2+7.7.4.2 TT.zip"	1 NR FR2 Cell, 2 CSI-RS, 2 subtests, 1 AoA in Rx peak and rough beam
SSB_WithCSI-IM_L1-SINR-Meas	7.6.6.2	"38.533 7.6.6.2 TT.zip"	"1 NR Cell, 2 time periods, No fading"

L1-SINR_Accuracy_1	5.7.6.1 7.7.6.1	"38.533 5.7.6.1+7.7.6.1 TT.zip"	1 NR FR2 Cell, 2 CSI-RSs, 1 subtest, 1 AoA in Rx peak and rough beam
L1-SINR_Accuracy_2	5.7.6.2	"38.533 5.7.6.2 TT.zip"	1 NR FR2 Cell, 2 SSB and 2 CSI-RS, 1 subtests, 1 AoA in Rx peak and rough beam
L1-SINR_Accuracy_3	5.7.6.3	"38.533 5.7.6.3 TT.zip"	1 NR FR2 Cell, 2 CSI-RS and 2 CSI-IM, 1 subtests, 1 AoA in Rx peak and rough beam
Inter_Reselection_not_at_cell_edge	7.1.1.6	"38.533 7.1.1.6 TT.zip"	"2 NR FR2 Cells, 2 SSBs, 2 time periods, 1 AoA in Rx peak and rough beam"
SSB_WithCSI-IM_L1-SINR-Meas	4.7.7.2 6.7.9.2	"38.533 4.7.7.2+6.7.9.2 TT.zip"	"1 NR Cell (1 E-UTRA Cell for NSA case), one time period, No fading"
Intra_Reselection	7.1.1.1 17.1.1.1	"38.533 7.1.1.1 TT.zip"	"2 NR FR2 Cells, 2 SSBs, 3 time periods, 1 AoA in Rx peak and rough beam"
Inter_Reselection	7.1.1.2 17.1.1.2	"38.533 7.1.1.2 TT.zip"	"2 NR FR2 Cells, 2 SSBs, 3 time periods, 1 AoA in Rx peak and rough beam"
CSI-RS_Based_L1-SINR-Meas	4.7.7.1.2 6.7.7.9.2	"38.533 4.7.7.1.2+6.7.9.1.2 TT.zip"	"1 NR Cell (1 E-UTRA Cell for NSA case), one time period, No fading"
RRC_Based_BWP_Switch	5.5.6.2.1 7.5.6.2.1 5.5.6.4.1	"38.533 5.5.6.2.1+7.5.6.2.1 TT.zip"	"1 NR Cell (1 E-UTRA Cell for NSA case), one time period, No fading"
TCI_State_Switch	7.5.8.1.1 7.5.8.2.1	"38.533 7.5.8.1.1+7.5.8.2.1 TT.zip"	1 NR FR2 Cell, 2 SSBs, 2 time periods, no fading, 2AoA in spherical coverage directions and rough beam
Intra_Freq_CLI_SRS-RSRP_Meas	5.6.4.1 7.6.4.1	"38.533 5.6.4.1+7.6.4.1 TT.zip"	Cell 1 and Neighbor Cell UE on f1, T1 and T2.
Intra_Freq_CLI_SRS-RSRP_Meas_Accu	5.7.5.1 7.7.5.1	"38.533 5.7.5.1+7.7.5.1 TT.zip"	Cell 1 and Neighbor Cell UE on f1, T1 and T2.
InterRAT_LTE_Idle_CADC_meas	8.2.2.2	"38.533 8.2.2.2 TT.zip"	"1 E-UTRA Cell, 1 NR Cell, 3 time periods, no fading"
UE_Rx_Tx_difference_PDC_02	7.6.13.1 7.6.13.2	"38.533 7.6.13.1 TT.zip"	"1 NR FR2 Cell, 2 time periods, no fading"
RRC_reconfiguration_delay_01	7.5.11.1	"38.533 7.5.11.1 TT.zip"	"2 NR Cells, 3 Time Periods, No Fading"
Intra_Reselection_not_at_cell_edge	7.1.1.4	"38.533 7.1.1.4 TT.zip"	"2 NR FR2 Cells, 2 SSBs, 2 time periods, 1 AoA in Rx peak and rough beam"
Intra_Reselection_low_mobility	7.1.1.3 17.1.1.3	"38.533 7.1.1.3 TT.zip"	"2 NR FR2 Cells, 2 SSBs, 2 time periods, 1 AoA in Rx peak and rough beam"

RLM_Out_of_Sync_01	5.5.1.1 7.5.1.1 17.5.1.1	38.533 5.5.1.1+7.5.1.1+17.5.1.1 TT.zip	1 NR FR2 Cell (1 E-UTRA cell), 2 SSBs, 3 time periods, 2AoA spherical coverage directions and rough beam, fading.
RLM_Out_of_Sync_02	5.5.1.3 7.5.1.3	38.533 5.5.1.3+7.5.1.3 TT.zip	1 NR FR2 Cell (1 E-UTRA cell), 2 SSBs, 3 time periods, 1AoA in Rx beam peak and rough beam, fading.
RLM_InSync_01	5.5.1.2 7.5.1.2 17.5.1.2	38.533 5.5.1.2+7.5.1.2+17.5.1.2 TT_v2.zip	1 NR FR2 Cell (1 E-UTRA cell), 2 SSBs, 5 time periods, 2AoA in spherical coverage directions and rough beam, fading.
RLM_InSync_02	5.5.1.4 7.5.1.4 17.5.1.4	38.533 5.5.1.4+7.5.1.4+17.5.1.4 TT.zip	1 NR FR2 Cell (1 E-UTRA cell), 2 SSBs, 5 time periods, 1AoA in Rx beam peak direction and rough beam, fading.
RRC_reconfiguration_delay_01	7.5.11.1	"38.533 7.5.11.1 TT.zip"	"2 NR Cells, 3 Time Periods, No Fading"
UE_Rx_Tx_difference_PDC_02	7.6.13.1	"38.533 7.6.13.1 TT.zip"	"1 NR FR2 Cell, 2 time periods, no fading"
MAC-CE_Based_Uplink_Spatial_Switch	5.5.9.1.1 7.5.9.1.1	"38.533 5.5.9.1.1+7.5.9.1.1 TT.zip"	"1 NR Cell, 2 time periods, no fading"
RRC_Based_Uplink_Spatial_Switch	5.5.9.2.1 7.5.9.2.1	"38.533 5.5.9.2.1+7.5.9.2.1 TT.zip"	"1 NR Cell, 2 time periods, no fading"
Unified_TCI_Switch_01	5.5.11.1 5.5.11.2 7.5.13.2	38.533 5.5.11.1 + 5.5.11.2 + 7.5.13.2 TT.zip	"1 NR Cell, 2 time periods, no fading"
Unified_TCI_Switch_02	5.5.11.3 7.5.13.1 7.5.13.3	38.533 5.5.11.3 + 7.5.13.1 + 7.5.13.3 TT.zip	"1 NR Cell, 2 time periods, no fading"
Conditional_PSCell_Add	5.5.13.1 7.5.12.1	"38.533 5.5.13.1+7.5.12.1 TT.zip"	"1 NR FR2 Cell (1 E-UTRA Cell for NSA case), 4 time periods, No fading"
PSCell_activate	7.5.14	"38.533 7.5.14 TT.zip"	"1 NR FR1 Cell, 1 NR FR2 Cell, 4 time periods, no fading"
Intra_Freq_Meas_03	7.6.14.1	"38.533 7.6.14.1 TT.zip "	2 NR FR2 Cells, 2 SSBs, 3 time periods, no fading, 2 AoAs, both are in EIS spherical coverage and rough beams
Intra_Freq_Meas_04	7.6.14.2	"38.533 7.6.14.2 TT.zip "	2 NR FR2 Cells, 2 SSBs, 3 time periods, no fading, 2 AoAs, both are in EIS spherical coverage and rough beams
Inter_Freq_Meas_05	7.6.15.1 7.6.15.2	"38.533 7.6.15.1+7.6.15.2 TT.zip"	"3 Inter Frequency NR FR2 Cells, 2 time periods, No fading, 2 AoAs, both are in EIS spherical coverage and rough beams"

Inter_Freq_Meas_07	7.6.16.2	"38.533 7.6.16.2 TT.zip"	"2 Inter Frequency NR Cells (both on FR2), 2 time periods, Various number of sub-tests, No fading"
Inter_Freq_Meas_08	7.6.16.3	"38.533 7.6.16.3 TT.zip"	"3 Inter Frequency NR Cells (2 frequencies in FR2), 2 time periods, No fading"

Table 8-3: Grouping of FR1 NR sidelink test cases defined in Clauses 9 of TS 38.533

Group	Test Case Numbers	.zip file name	Comments
SL_Timing_Accuracy_01	9.1.1.1	"38.533 9.1.1.1 TT.zip"	1 time period , no fading
SL_Timing_Accuracy_02	9.1.1.2	"38.533 9.1.1.2 TT.zip"	1 sidelink UE, 1 time period, no fading
SL_Timing_Accuracy_03	9.1.1.3	"38.533 9.1.1.3 TT.zip"	1 Cell, 1 time period, no fading
SL_SSB_Tx_01	9.1.2.1	"38.533 9.1.2.1 TT.zip"	1 Cell, 3 time periods, no fading"
SL_SSB_Tx_02	9.1.2.2	"38.533 9.1.2.2 TT.zip"	1 sidelink UE, 3 time periods, no fading"
SyncREF_Reselect_01	9.1.3.1	"38.533 9.1.3.1 TT.zip"	3 sidelink UEs, 3 time periods, no fading
SyncREF_Reselect_02	9.1.3.2	"38.533 9.1.3.2 TT.zip"	2 sidelink UEs, 3 time periods, no fading
SL-RSRP_01	9.1.4.1	"38.533 9.1.4.1 TT.zip"	50 sidelink UEs, 2 time periods, no fading
SL-RSRP_02	9.1.4.2	"38.533 9.1.4.2 TT.zip"	1 sidelink UE, 2 time periods, no fading"
SL-RSRP_03	9.1.4.3	"38.533 9.1.4.3 TT.zip"	130 sidelink UEs, 2 time periods, no fading"
SL-RSSI	9.1.5.1 9.1.5.2	"38.533 9.1.5.1+9.1.5.2 TT.zip"	4 sidelink UEs, 2 time periods, no fading"
WAN_Interruption	9.1.6.1	"38.533 9.1.6.1 TT.zip"	8 sidelink UEs, 3 time periods, no fading"

Table 8-4: Grouping of FR1 NR shared spectrum test cases defined in Clauses 10, 11, 12 and 13 of TS 38.533

Group	Test Case Numbers	.zip file name	Comments
NR-U_RLM_Out_of_Sync_01	10.3.1.2 11.4.1.2	"38.533 10.3.1.2+11.4.1.2 TT.zip"	"1 NR Cell under CCA (1 E-UTRA Cell for NSA case), 1 sub-test, Fading, 3 Time Periods,"
NR-U_RLM_In_Sync_01	10.3.1.3 11.4.1.3	"38.533 10.3.1.3+11.4.1.3 TT.zip"	"1 NR Cell under CCA (1 E-UTRA Cell for NSA case), 1 sub-test, Fading, 5 Time Periods,"
NR-U_SSB_Based_BFR_01	10.3.4.1 10.3.4.2 11.4.4.1 11.4.4.2	"38.533 10.3.4.1+10.3.4.2+11.4.4.1+11.4.4.2 TT.zip"	"1 NR Cell under CCA (1 E-UTRA Cell for NSA case), 1 sub-test, 5 time periods, Fading"
NR-U_BWP_Switch_01	10.3.5.1 11.4.5.1	"38.533 10.3.5.1+11.4.5.1 TT.zip"	"1 NR PCell (1 E-UTRAN Cell for NSA case), 2 time periods, no fading"
NR-U_BWP_Switch_02	10.3.5.2.1 10.3.5.2.2 11.4.5.2.1 11.4.5.2.2	"38.533 10.3.5.2.1+10.3.5.2.2+11.4.5.2.1+11.4.5.2.2 TT.zip"	"1 E-UTRAN Cell, 1 NR PCell, (1 NR SCell), 3 time periods, no fading"
NR-U_BWP_Switch_03	10.3.5.3.1 11.4.5.3.1	"38.533 10.3.5.3.1+11.4.5.3.1 TT.zip"	"1 NR PCell (1 E-UTRAN Cell for NSA case), 1 time period, no fading"

9 Grouping of test cases defined in TS 37.571-1

Table 9-1: Grouping of positioning test cases defined in TS 37.571-1

Group	Test Case Numbers	.zip file name	Comments
RSTD_reporting_1	14.2.1	"37.571-1 14.2.1 TT.zip"	3cells, RSTD reporting delay Single positioning frequency layer FR1
RSTD_Accuracy_1	14.3.1	"37.571-1 14.3.1 TT.zip"	RSTD accuracy Single positioning frequency layer FR1
RSTD_reporting_2	14.2.2	"37.571-1 14.2.2 TT.zip"	3 cells, 2 PFLs, reporting delay, FR1
RSTD_accuracy_2	14.3.2	"37.571-1 14.3.2 TT v2.zip"	3 cells, 2 PFLs, RSTD accuracy, FR1
RSTD_accuracy_3	14.3.3	"37.571-1 14.3.3 TT.zip"	RSTD accuracy Single positioning frequency layer FR2
RSTD_accuracy_4	14.3.4	"37.571-1 14.3.4 TT.zip"	RSTD accuracy Dual positioning frequency layer FR2
RSTD_reporting_3	14.2.3	"37.571-1 14.2.3 TT.zip"	3 cells, RSTD reporting delay Single positioning frequency layer FR2
RSTD_reporting_4	14.2.4	"37.571-1 14.2.4 TT.zip"	3 cells, RSTD reporting delay Dual positioning frequency layer FR2
PRP_reporting_1	16.2.3	"37.571-1 16.2.3 TT.zip"	PRP reporting delay, Single positioning frequency layer FR2
PRP_reporting_2	16.2.4	"37.571-1 16.2.4 TT.zip"	PRP reporting delay, Dual positioning frequency layer FR2
PRP_reporting_3	16.2.1	"37.571-1 16.2.1 TT.zip"	PRP reporting delay, Single positioning frequency layer FR1
PRP_reporting_4	16.2.2	"37.571-1 16.2.2 TT.zip"	PRP reporting delay,
PRP_reporting_5	16.2.7	"37.571-1 16.2.7 TT.zip"	PRP reporting delay, reduce number of samples, Single positioning frequency layer FR1
PRP_reporting_6	16.2.8	"37.571-1 16.2.8 TT.zip"	PRP reporting delay, without measurement gap, Single positioning frequency layer FR1
PRP_accuracy_1	16.3.1	"37.571-1 16.3.1 TT.zip"	PRP reporting accuracy, Single positioning frequency layer FR1
PRP_accuracy_1	16.3.2	"37.571-1 16.3.2 TT.zip"	PRP accuracy, Single positioning frequency layer FR2

PRP_accuracy_3	16.3.4	"37.571-1 16.3.4 TT.zip"	PRP accuracy, reduce number of samples Single positioning frequency layer FR2
UE_RxTxTimeDiff_reporting_1	15.2.1	"37.571-1 15.2.1 TT.zip"	UE Rx-Tx time difference reporting delay, Single positioning frequency layer FR1
UE_RxTxTimeDiff_reporting_2	15.2.2	"37.571-1 15.2.2 TT.zip"	UE Rx-Tx time difference reporting delay, Dual positioning frequency layer FR1
UE_RxTxTimeDiff_reporting_3	15.2.3	"37.571-1 15.2.3 TT.zip"	UE Rx-Tx time difference reporting delay, Single positioning frequency layer FR2
UE_RxTxTimeDiff_reporting_4	15.2.4	"37.571-1 15.2.4 TT.zip"	UE Rx-Tx time difference reporting delay, Dual positioning frequency layer FR2
UE_RxTxTimeDiff_reporting_5	15.2.8	"37.571-1 15.2.8 TT.zip"	UE Rx-Tx time difference reporting delay, reduce number of sample, Single positioning frequency layer FR2
UE_RxTxTimeDiff_reporting_6	15.2.9, 15.2.10	"37.571-1 15.2.9+15.2.10 TT.zip"	UE Rx-Tx time difference reporting delay, without MG, Single positioning frequency layer FR2
UE_RxTxTimeDiff_accuracy_1	15.3.1	"37.571-1 15.3.1 TT.zip"	UE Rx-Tx time difference accuracy, Single positioning frequency layer FR1
UE_RxTxTimeDiff_accuracy_2	15.3.2	"37.571-1 15.3.2 TT.zip"	UE Rx-Tx time difference accuracy, Single positioning frequency layer FR2
UE_RxTxTimeDiff_accuracy_3	15.3.5	"37.571-1 15.3.5 TT.zip"	UE Rx-Tx time difference accuracy, reduce number of samples Single positioning frequency layer FR2
UE_RxTxTimeDiff_accuracy_4	15.3.6	"37.571-1 15.3.6 TT.zip"	UE Rx-Tx time difference accuracy, Same RxTx TEG Single positioning frequency layer FR2

RSTD_reporting_5	14.2.8	"37.571-1 14.2.8 TT.zip"	3 cells, RSTD reporting delay, reduce number of samples, Single positioning frequency layer FR2
RSTD_reporting_6	14.2.9	"37.571-1 14.2.9 TT.zip"	3 cells, RSTD reporting delay, without MG, Single positioning frequency layer FR2
RSTD_reporting_7	14.2.10	"37.571-1 14.2.10 TT.zip"	3 cells, RSTD reporting delay, reduce number of samples, Single positioning frequency layer FR2
RSTD_accuracy_5	14.3.7	"37.571-1 14.3.7 TT.zip"	2 cells, RSTD accuracy, reduce number of samples, Single positioning frequency layer FR2
RSTD_accuracy_6	14.3.8	"37.571-1 14.3.8 TT.zip"	2 cells, RSTD accuracy, same Rx TEG, Single positioning frequency layer FR2

Annex A: Derivation documents for test tolerance

The documents (and spreadsheets where applicable) used to derive the test tolerances for each test case are included in the present document as zip files.

The aim is to provide a reference to completed test cases, so that test tolerances for similar test cases can be derived on a common basis. The information on test case grouping in clauses 7 and 8 can be used to identify similarities.

A.1 Void

A.2 Handling of common Test Tolerance topics for radiated test cases defined in TS 38.533

The basic principles of Test Tolerance analysis are the same for conducted testing and radiated testing, but for radiated testing additional topics are taken into account. This annex contains methods to handle common additional topics, to allow re-use and to avoid the need for each test case analysis to repeat the same detail.

Individual test case analyses are expected to follow the methods contained here where applicable, and to refer to relevant clauses in this Annex.

A.2.1 Angles of Arrival

A.2.1.1 Relevant core requirements

In FR2, the performance of the UE depends on the downlink signal angle of arrival, and is characterised by two parameters:

- Refsens: lowest signal level for a given demodulation performance in the UE Rx beam peak direction, specified in TS 38.101-2 [16] clause 7.3.2 according to UE Power class, Channel bandwidth and operating band
- EIS spherical coverage: lowest signal level for a given demodulation performance in a specified percentile of other directions, specified in TS 38.101-2 [16] clause 7.3.4 according to UE Power class, Channel bandwidth and operating band

As both of these requirements are defined in the context of a throughput requirement, the UE is assumed to be using fine beams. Note that for directions outside the specified percentile of spherical coverage directions, there are no requirements. Testing must therefore be carried out within the spherical coverage directions. For testing, direction is 3-dimensional, but the principle can be illustrated in a 2-dimensional diagram:

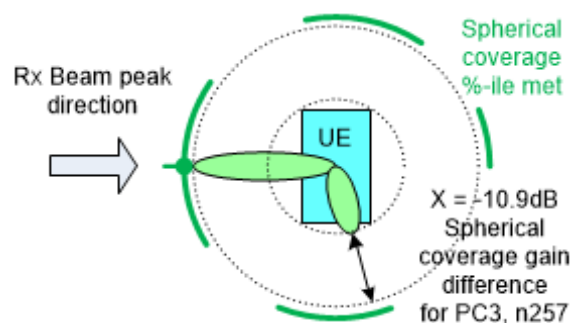

Figure A.2.1.1-1: UE Rx Beam-peak and spherical coverage directions, Fine beams

A.2.1.2 Modelling of variation within spherical coverage directions

Within the spherical coverage directions, a signal may be anywhere from near Rx Beam Peak (high gain direction, close to Refsens) to the worst of the allowed percentile (low gain direction, close to EIS spherical coverage requirement value). This is modelled by taking the midpoint of the Spherical coverage range as the nominal value, and then adding a variation of \pm (half the difference between Refsens and Spherical coverage).

UE Spherical coverage gain midpoint in dB is derived as $(\text{UE Refsens} - \text{UE Spherical coverage})/2$

Figure A.2.1.2-1 shows an example for UE Power class 3, Channel bandwidth 100MHz and operating band n257. In this example the UE Spherical coverage gain midpoint would be -5.45dB, as the gain is lower than in the Rx Beam peak direction. Variation about the midpoint is handled as a UE uncertainty.

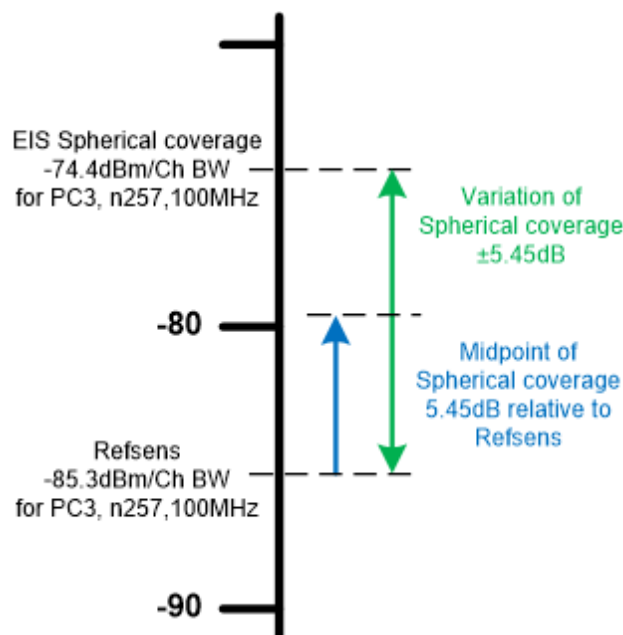

Figure A.2.1.2-1: Example modelling of variation within spherical coverage directions, Fine beams

A.2.1.3 Principles for Test Tolerance analysis

The following principles shall be followed in the test case analysis:

- The Angle of Arrival for each downlink signal shall be defined: either from UE Rx beam peak direction or from a direction within the EIS spherical coverage
- Variations over the EIS spherical coverage directions shall be included, using the method shown in A.2.1.2.

Variations over the EIS spherical coverage directions do not directly affect signals applied to the UE, but they do affect the SS-RSRP level measured by the UE, and the E_s/I_{ot} at UE baseband. Where the test case has requirements on UE baseband $E_s/I_{ot_{BB}}$, UE internal noise calculation is given in clause A.2.3, and calculation of E_s/I_{ot} at UE baseband is given in clauses A.2.4 and A.2.7.

A.2.2 UE Fine beams and Rough beams

A.2.2.1 Relevant core requirements

UE requirements such as Refsens in TS 38.101-2 [16], assume that the UE is using a fine beam which has higher antenna gain to give good demodulation performance. However, in some RRM scenarios where the UE is for example

searching for or measuring other cells, the UE uses rough beams which have lower antenna gain. The difference in gain is specified depending on the Angle of Arrival:

- The Gain difference Y between fine and rough beams in the UE Rx beam peak direction is specified in TS 38.133 [17] Table B.2.1.3.1-1 according to UE Power class
- The Gain difference Z between fine and rough beams in the UE Spherical coverage directions is specified in TS 38.133 [17] Table B.2.1.3.2-1 according to UE Power class

The Gain differences Y and Z are not dependent on Channel bandwidth or operating band. The concept is illustrated in Figures A.2.2.1-1 and A.2.2.1-2.

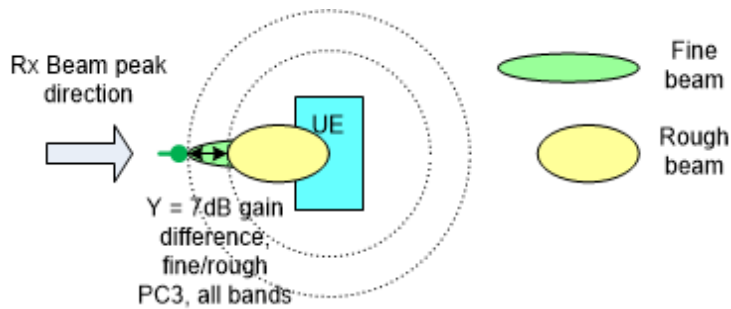

Figure A.2.2.1-1: Fine and rough beams, Rx Beam peak direction

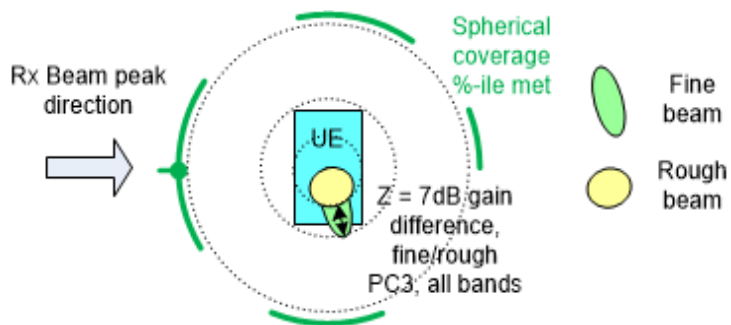

Figure A.2.2.1-2: Fine and rough beams, spherical coverage directions

When the Rx Beam Peak is selected and defined based on Fine Beams, the rough beam gain in that direction may be lower than the largest rough beam gain in another direction within Spherical Coverage. The term “D” is the maximum allowed rough beam gain reduction and is specified in TS 38.133 [17] Table B.2.1.5.3-1 for each power class. D parameter is applicable only to RSRP relative accuracy test cases.

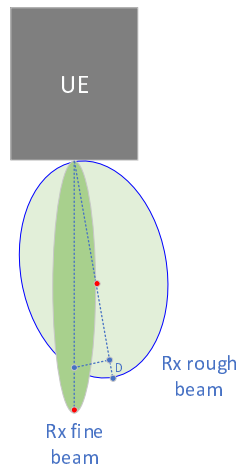

Figure A.2.2.1-3: Fine and rough beams alignment, Rx Beam peak direction

A.2.2.2 Modelling of Fine beams and Rough beams

Where the UE is assumed to use fine beams, the scenario is already covered in the Refsens and EIS spherical coverage requirements, and no further modifications are needed.

Where the UE is assumed to use rough beams, the effect is modelled as a reduction in gain of YdB or ZdB, according to the Angle of Arrival of each downlink signal. The reduction in gain translates to a higher UE internal noise seen at the Reference point where the downlink signals are applied. UE noise calculated from Refsens or from EIS spherical coverage requirements is increased by YdB or ZdB respectively. UE internal noise calculation is given in clause A.2.3.

A.2.2.3 Principles for Test Tolerance analysis

The following principles shall be followed in the test case analysis:

- The Type of beam assumed to be used by the UE for each downlink signal shall be defined: either Fine Beam or Rough Beam
- Where UE internal noise is relevant, and the UE is assumed to be using Rough Beams, it is increased by the value of Y or Z, selected according to UE Power class and Angle of Arrival.

UE internal noise calculation is given in clause A.2.3.

A.2.3 UE internal noise

A.2.3.1 Relevant core requirements

The relevant Core requirements are:

- Refsens or EIS spherical coverage, specified in TS 38.101-2 [16] clauses 7.3.2 and 7.3.4 respectively
- UE baseband SNR at which Refsens or EIS spherical coverage is specified, in TS 38.133 [17] clause B.2.1.3
- N_{RB} in channel BW at which Refsens or EIS spherical coverage is specified, in TS 38.101-2 [16] Table 5.3.2-1
- Gain difference between fine and rough beams, in TS 38.133 [17] clause B.2.1.3
- UE multi-band relaxation factors, in TS 38.101-2 [16] Table 6.2.1.3-4

A.2.3.2 Calculation method

For signals arriving from Rx Beam Peak direction:

$$\text{Noise in dBm/SCS} = \text{Refsens}_{\text{PC, band, Ch BW}} - \text{SNR}_{\text{Refsens}} - 10\text{Log}_{10}(\text{N}_{\text{RB_Ch BW, SCS}} \times 12) + Y_{\text{PC}} + \Sigma\text{MB}_P$$

where:

$\text{Refsens}_{\text{PC, band, Ch BW}}$ is the reference sensitivity value in dBm specified in TS 38.101-2 [16] clause 7.3.2 according to Power Class, Operating band and Channel bandwidth

$\text{SNR}_{\text{Refsens}}$ is the SNR used for simulation of Refsens and EIS spherical coverage, and is -1 dB

$\text{N}_{\text{RB_Ch BW, SCS}}$ is the number of PRBs specified in TS 38.101-2 [16] Table 5.3.2-1 according to Channel bandwidth and subcarrier spacing (not necessarily equal to the number of PRBs used in the test case)

12 is the number of subcarriers in a PRB

Y_{PC} is the gain difference in dB specified in TS 38.133 [17] Table B.2.1.3.1-1, according to Power Class, and is only applied when the UE is assumed to be using rough beams. Otherwise, use 0dB

ΣMB_P is the UE multi-band relaxation factor value in dB specified in TS 38.101-2 [16] clause 6.2.1

For signals arriving from Spherical coverage directions:

$$\text{Noise in dBm/SCS} = \text{EIS spherical coverage}_{\text{PC, band, Ch BW}} - \text{SNR}_{\text{Refsens}} - 10\text{Log}_{10}(\text{N}_{\text{RB_Ch BW, SCS}} \times 12) + Z_{\text{PC}} + \Sigma\text{MB}_S$$

where:

$\text{EIS spherical coverage}_{\text{PC, band, Ch BW}}$ is the EIS spherical coverage value in dBm specified in TS 38.101-2 [16] clause 7.3.4 according to Power Class, Operating band and Channel bandwidth

$\text{SNR}_{\text{Refsens}}$ is the SNR used for simulation of Refsens and EIS spherical coverage, and is -1 dB

$\text{N}_{\text{RB_Ch BW, SCS}}$ is the number of PRBs specified in TS 38.101-2 [16] Table 5.3.2-1 according to Channel bandwidth and subcarrier spacing (not necessarily equal to the number of PRBs used in the test case)

12 is the number of subcarriers in a PRB

Z_{PC} is the gain difference in dB specified in TS 38.133 [17] Table B.2.1.3.2-1, according to Power Class, and is only applied when the UE is assumed to be using rough beams. Otherwise, use 0dB

ΣMB_S is the UE multi-band relaxation factor value in dB specified in TS 38.101-2 [16] clause 6.2.1

The analysis spreadsheet converts dBm/SCS to linear power in pW/SCS for ease of further calculations.

A.2.3.3 Principles for Test Tolerance analysis

The following principles shall be followed in the test case analysis:

- Where the test case has requirements on UE baseband E_s/I_{otBB} , the Test Tolerance analysis should include UE internal noise in the calculation
- UE internal noise is calculated using the method in A.2.3.2

A.2.4 Calculation of E_s/I_{ot} at UE baseband

A.2.4.1 Relevant core requirements

Core requirements applicable to RRM test cases depend on the test purpose, and should be selected for each test case. For test cases where the UE makes a measurement, the following are relevant:

- Measurement Performance requirements are specified in TS 38.133 [17] clause 10, and side conditions such as Es/Iot are included in the core requirements for each measurement. For FR2, notes in tables clarify that Es/Iot is at UE baseband.
- Operating band specific conditions for RRM requirements are specified in TS 38.133 [17] Annex B, and side conditions such as Es/Iot are included for each measurement. For FR2, notes in tables clarify that Es/Iot is at UE baseband.

Other UE core requirements may also have conditions on Es/Iot.

A.2.4.2 Calculation method

An example is provided here for a scenario with applied AWGN and two intra-frequency cells. SSB Es/Iot at UE baseband is calculated for Cell 1. Interference to Cell 1 comes from the applied AWGN, from the UE internal noise, and from Cell 2. The values are chosen for illustration, and not taken from any specific test case.

Cell 1 SSB Es/Iot_{BB} = 10Log₁₀((Cell 1 SSB power) / (Applied AWGN power + UE internal noise + Cell 2 SSB power))

Where Applied AWGN power, UE internal noise, Cell 1 power and Cell 2 power are linear powers in W, per subcarrier.

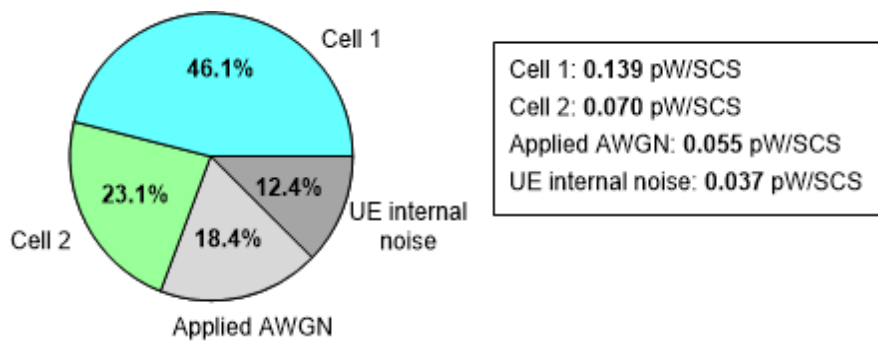

Figure A.2.4.2-1: Example Es/Iot_{BB} scenario, applied AWGN and two intra-frequency cells

In this case, the calculation gives Cell 1 SSB Es/Iot_{BB} = 10Log₁₀(0.139 / (0.055 + 0.037 + 0.070)) = **-0.67dB**

The main point is that the Es/Iot at UE baseband is lower than the applied Es/Iot, because the UE internal noise adds to the interference, and can be a significant contribution for the parameters used in some test cases.

The presence of UE internal noise also affects the calculation of Es/Iot sensitivity factors in the Test Tolerance analysis. The UE internal noise is a fixed (worst) value, being based on the UE minimum requirement, and is taken into account in the scaling which uses linear powers:

- Cell 1 SSB Es/Iot_{BB} sensitivity to applied AWGN absolute power = UE internal noise / (Applied AWGN power + UE internal noise + Cell 2 SSB power). In this example, (0.037 / (0.055 + 0.037 + 0.070)) = **+0.230**
- Cell 1 SSB Es/Iot_{BB} sensitivity to Cell 1 Es/Noc = **+1.000**
- Cell 1 SSB Es/Iot_{BB} sensitivity to Cell 2 Es/Noc = -Cell 2 SSB power / (Applied AWGN power + UE internal noise + Cell 2 SSB power). In this example, (0.070 / (0.055 + 0.037 + 0.070)) = **-0.429**

A positive sensitivity factor is used where an increase in the quantity produces an increase in Cell 1 SSB Es/Iot_{BB}, for example increasing Cell 1 Es/Noc. A negative sensitivity factor is used where an increase in the quantity produces a decrease in Cell 1 SSB Es/Iot_{BB}, for example increasing Cell 2 Es/Noc. The sensitivity factors are used to scale the uncertainties.

Where the uncertainties are uncorrelated, as here, they are added root-sum-square so the sign of the sensitivity factor does not have any effect. In special cases where the uncertainties are correlated, they may be added arithmetically and the sign affects the result, as in clause A.2.7.

A.2.4.3 Principles for Test Tolerance analysis

The following principles shall be followed in the test case analysis:

- UE internal noise is included in the interference when calculating E_s/I_{otBB}
- E_s/I_{otBB} sensitivity factors are calculated using the method in A.2.4.2

A.2.5 Calculation of Applied I_o

A.2.5.1 Relevant core requirements

Core requirements applicable to RRM test cases depend on the test purpose, and should be selected for each test case. For test cases where the UE makes a measurement, the following are relevant:

- Measurement Performance requirements are specified in TS 38.133 [17] clause 10, and side conditions such as I_o are included in the core requirements for each measurement. Normally the maximum I_o condition is specified in the channel bandwidth, whereas the minimum I_o condition is specified as a power density per subcarrier.

A.2.5.2 Calculation method

An example is provided here for a scenario with applied AWGN and two intra-frequency cells. I_o applied to the UE is the arithmetic sum of linear powers in the channel bandwidth. UE internal noise is not counted, as it is not applied to the UE. The values are chosen for illustration, and not taken from any specific test case.

$$\text{Channel } I_o = 10\text{Log}_{10}(\text{Applied AWGN power} + \text{Cell 1 power} + \text{Cell 2 power}) + 10\text{Log}_{10}(N_{RB_TC} \times 12)$$

where:

AWGN, Cell 1 power and Cell 2 power are linear powers in W, per subcarrier

N_{RB_TC} is the number of PRBs allocated in the test case (not necessarily equal to the number of PRBs in the channel bandwidth)

12 is the number of subcarriers in a PRB

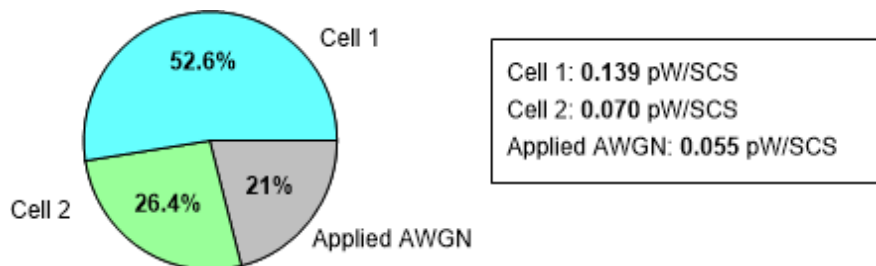

Figure A.2.5.2-1: Example I_o scenario, applied AWGN and two intra-frequency cells

With 24 PRBs allocated, the example gives $I_o = 10\text{Log}_{10}((0.055 + 0.139 + 0.070) \times 10^{-9}) + 10\text{Log}_{10}(24 \times 12) = -71.2\text{dBm}$

I_o sensitivity factors in the Test Tolerance analysis are based on linear powers:

- I_o sensitivity to applied AWGN absolute power = **+1.000**
- I_o sensitivity to Cell 1 $E_s/N_{oc} = \text{Cell 1 power} / (\text{Applied AWGN power} + \text{Cell 1 power} + \text{Cell 2 power})$. In this example, $(0.139 / (0.055 + 0.139 + 0.070)) = +0.527$
- I_o sensitivity to Cell 2 $E_s/N_{oc} = \text{Cell 2 power} / (\text{Applied AWGN power} + \text{Cell 1 power} + \text{Cell 2 power})$. In this example, $(0.070 / (0.055 + 0.139 + 0.070)) = +0.264$

All the sensitivity factors are positive, as an increase in the quantity produces an increase in I_o . The sensitivity factors are used to scale the uncertainties.

A.2.5.3 Principles for Test Tolerance analysis

The following principles shall be followed in the test case analysis:

- I_o is calculated using the method in A.2.5.2
- I_o sensitivity factors are calculated using the method in A.2.5.2

A.2.6 UE Reported RSRP and UE gain

A.2.6.1 Relevant core requirements

SS-RSRP is defined to be measured based on the combined signal from antenna elements corresponding to a given receiver branch. The reference point for requirement parameters from the UE perspective is the input of the UE antenna array. The UE gain “G” relates the combined signal from antenna elements corresponding to a given receiver branch to the reference point for requirement parameters.

For test cases where the UE reports a measured value, or compares a measured value to a signalled threshold, the UE Gain “G” affects the SS-RSRP level measured by the UE

- The UE Gain from the reference point (where test case parameters are specified) to the SS-RSRP measurement point is specified in TS 38.133 [17] clause B.2.1.5. As the UE gain “G” is specified for Rx Beam Peak angle of arrival, it does not include effects related to spherical coverage.
- Measurement Performance requirements are specified in TS 38.133 [17] clause 10, and include accuracy requirements as +/-dB values. For FR2, the accuracy is considered to apply at the combined signal from antenna elements corresponding to a given receiver branch, and does not include the UE gain “G”.

The specified range of UE Gain “G” allows the UE to use either Rough beams or Fine beams, so no further allowance is required for the parameters Y or Z in A.2.2.

In any specific direction, the UE gain G may be different depending on frequencies. The UE gain difference between inter-frequencies “Ginter” affects relative signal level values reported by the UE when measuring between different frequencies and is specified in TS 38.133 [17] Table B.2.1.5.2-1 for each power class. Ginter parameter is applicable only to RSRP relative accuracy test cases.

A.2.6.2 Absolute RSRP

An example is provided here for a scenario where the UE reports SS-RSRP for a signal arriving from a direction within the UE spherical coverage, to illustrate variation from both UE spherical coverage and variation from UE gain “G”.

$$\text{UE-measured SS-RSRP}_{\text{nom}} = \text{Applied SSB_RP} + \text{UE Spherical coverage gain midpoint} + \text{UE gain G midpoint}$$

where:

Applied SSB_RP is specified in the test case, either directly as E_s or derived from N_{oc} and E_s/N_{oc} , and is in dBm per subcarrier

UE Spherical coverage gain midpoint in dB is derived as $(\text{UE Refsens} - \text{UE Spherical coverage})/2$

UE gain G midpoint in dB is derived as $(\text{Min value of G} + \text{Max value of G})/2$

As an example for a UE power class 3 in band n257, measuring SS_RSRP from a spherical coverage direction, UE-measured $\text{SS-RSRP}_{\text{nom}} = \text{Applied SSB_RP} - 5.45\text{dB} + 5.0\text{dB}$.

Figure A.2.1.2-1 shows the derivation of UE Spherical coverage gain midpoint. Variation about the midpoint is handled as a UE uncertainty. For signals arriving from Rx Beam Peak direction, this gain is 0dB and does not vary.

Figure A.2.6.2-1 shows the derivation of UE gain G midpoint. Variation about the midpoint is handled as a UE uncertainty.

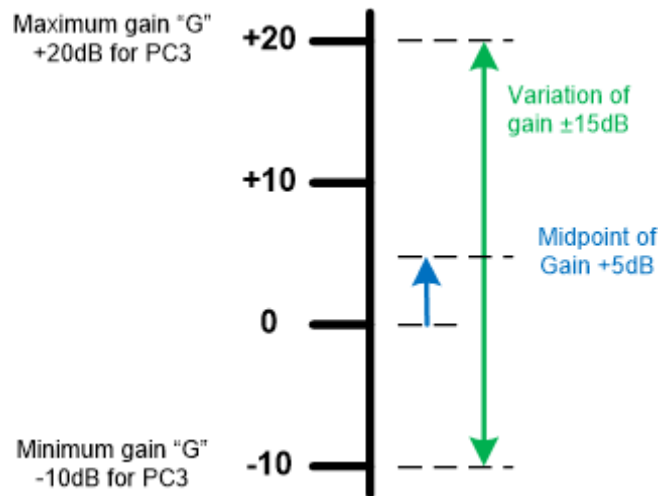

Figure A.2.6.2-1: Example modelling of UE Gain “G” variation

To calculate the range of valid SS-RSRP values that can be reported by the UE, contributions from Spherical coverage gain variation, UE gain variation and UE reporting accuracy are considered:

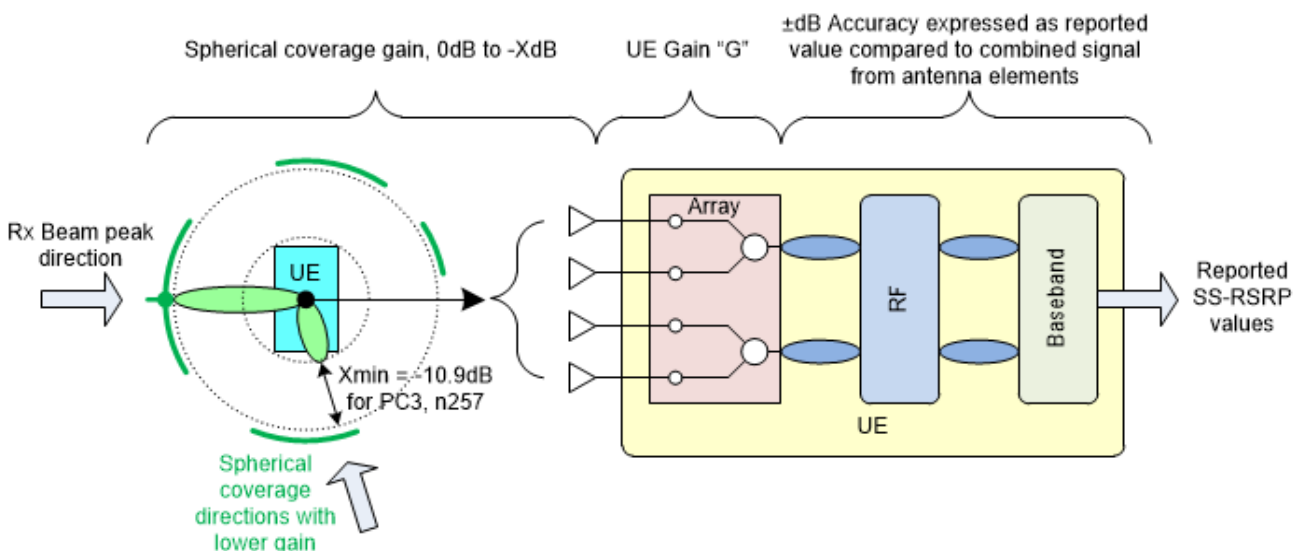

Figure A.2.6.2-2: modelling of contributions affecting SS-RSRP reported values

Reported SS-RSRP = UE measured SS-RSRP_{nom} ± Spherical coverage gain variation ± UE gain variation ± UE accuracy
 where:

UE measured SS-RSRP_{nom} is the nominal value derived from Applied SSB_RP, UE Spherical coverage gain midpoint and UE gain G midpoint

Spherical coverage gain variation is derived from Refsens and Spherical coverage, as shown in Figure A.2.1.2-1

UE gain variation is derived from Minimum and maximum values of G, as shown in Figure A.2.6.2-1

UE accuracy is the absolute accuracy from the core requirement referred to in A.2.6.1

As an example for a UE power class 3 in band n257, measuring SS_RSRP from a spherical coverage direction with applied $I_o > -70\text{dBm}$, the variation would be $(\pm 5.45\text{dB} \pm 15\text{dB} \pm 8\text{dB}) = \pm 28.45\text{dB}$

These variations are added arithmetically in the test case analysis, as each could be systematic and not random. For signals arriving from Rx Beam Peak direction, spherical coverage gain variation is 0dB.

A.2.6.3 Relative RSRP, 2 levels on same cell, same Angle of Arrival

An example is provided here for a scenario where the test case require the UE to report SS-RSRP for the same cell at two different levels, with the signal arriving from the same direction. The Angle of Arrival may be within the UE spherical coverage, or from Rx Beam peak direction.

$$\text{UE-measured SS-RSRP}_{1\text{nom}} = \text{Applied SSB_RP1} + \text{UE Spherical coverage gain midpoint} + \text{UE gain G midpoint}$$

$$\text{UE-measured SS-RSRP}_{2\text{nom}} = \text{Applied SSB_RP2} + \text{UE Spherical coverage gain midpoint} + \text{UE gain G midpoint}$$

$$\text{UE-measured SS-RSRP}_{2\text{nom}} - \text{UE-measured SS-RSRP}_{1\text{nom}} = \text{Applied SSB_RP2} - \text{Applied SSB_RP1}$$

where:

Applied SSB_RP1 and Applied SSB_RP2 are specified in the test case, either directly as Es or derived from Noc and Es/Noc, and are in dBm per subcarrier

It can be seen that UE Spherical coverage gain midpoint and UE gain G midpoint cancel out for this relative measurement, as they remain the same for a signal from the same Angle of Arrival.

$$\text{Reported SS-RSRP2} - \text{Reported SS-RSRP1} = \text{UE-measured SS-RSRP}_{2\text{nom}} - \text{UE-measured SS-RSRP}_{1\text{nom}} \pm \text{UE accuracy}$$

where:

UE accuracy is the relative accuracy from the core requirement referred to in A.2.6.1

A.2.6.4 Relative RSRP, 2 intra-frequency cells, same Angle of Arrival

An example is provided here for a scenario where the test case require the UE to report SS-RSRP for two different cells, with the signals arriving from the same direction. The Angle of Arrival may be within the UE spherical coverage, or from Rx Beam peak direction.

$$\text{UE-measured SS-RSRP}_{1\text{nom}} = \text{Applied SSB_RP1} + \text{UE Spherical coverage gain midpoint} + \text{UE gain G midpoint}$$

$$\text{UE-measured SS-RSRP}_{2\text{nom}} = \text{Applied SSB_RP2} + \text{UE Spherical coverage gain midpoint} + \text{UE gain G midpoint}$$

$$\text{UE-measured SS-RSRP}_{2\text{nom}} - \text{UE-measured SS-RSRP}_{1\text{nom}} = \text{Applied SSB_RP2} - \text{Applied SSB_RP1}$$

where:

Applied SSB_RP1 and Applied SSB_RP2 are specified in the test case, either directly as Es or derived from Noc and Es/Noc, and are in dBm per subcarrier

It can be seen that UE Spherical coverage gain midpoint and UE gain G midpoint cancel out for this relative measurement, as they are the same for signals from the same Angle of Arrival.

$$\text{Reported SS-RSRP2} - \text{Reported SS-RSRP1} = \text{UE-measured SS-RSRP}_{2\text{nom}} - \text{UE-measured SS-RSRP}_{1\text{nom}} \pm \text{UE accuracy}$$

where:

UE accuracy is the relative accuracy from the core requirement referred to in A.2.6.1

A.2.6.5 Relative RSRP, 2 inter-frequency cells, same Angle of Arrival

[FFS]

A.2.6.6 Relative RSRP, 2 cells, different Angles of Arrival

Examples are provided here for scenarios where the test case requires the UE to report SS-RSRP for two different cells, with the signals arriving from different directions.

For both Angles of Arrival from UE spherical coverage directions:

$$\text{UE-measured SS-RSRP}_{1_{\text{nom}}} = \text{Applied SSB_RP1} + \text{UE Spherical coverage gain midpoint} + \text{UE gain G midpoint}$$

$$\text{UE-measured SS-RSRP}_{2_{\text{nom}}} = \text{Applied SSB_RP2} + \text{UE Spherical coverage gain midpoint} + \text{UE gain G midpoint}$$

$$\text{UE-measured SS-RSRP}_{2_{\text{nom}}} - \text{UE-measured SS-RSRP}_{1_{\text{nom}}} = \text{Applied SSB_RP2} - \text{Applied SSB_RP1}$$

where:

Applied SSB_RP1 and Applied SSB_RP2 are specified in the test case, either directly as Es or derived from Noc and Es/Noc, and are in dBm per subcarrier

For the nominal values, UE Spherical coverage gain midpoint and UE gain G midpoint cancel out for this relative measurement. For the variations, UE gain variation cancels out as the same value affects both cells, but Spherical coverage gain variation applies separately to each Angle of Arrival.

$$\text{Reported SS-RSRP2} - \text{Reported SS-RSRP1} = \text{UE-measured SS-RSRP}_{2_{\text{nom}}} - \text{UE-measured SS-RSRP}_{1_{\text{nom}}} \pm \text{Spherical coverage gain variation}_{A_0A1} \pm \text{Spherical coverage gain variation}_{A_0A2} \pm \text{UE accuracy}$$

where:

Spherical coverage gain variation_{A₀A1} is derived from Refsens and Spherical coverage, as in Figure A.2.1.2-1

Spherical coverage gain variation_{A₀A2} is derived from Refsens and Spherical coverage, as in Figure A.2.1.2-1

UE accuracy is the relative accuracy from the core requirement referred to in A.2.6.1

For one Angle of Arrival from UE spherical coverage directions, and one from Rx Beam peak direction:

$$\text{UE-measured SS-RSRP}_{1_{\text{nom}}} = \text{Applied SSB_RP1} + \text{UE Spherical coverage gain midpoint} + \text{UE gain G midpoint}$$

$$\text{UE-measured SS-RSRP}_{2_{\text{nom}}} = \text{Applied SSB_RP2} + \text{UE gain G midpoint}$$

$$\text{UE-measured SS-RSRP}_{2_{\text{nom}}} - \text{UE-measured SS-RSRP}_{1_{\text{nom}}} = \text{Applied SSB_RP2} - \text{Applied SSB_RP1} - \text{UE Spherical coverage gain midpoint}$$

where:

Applied SSB_RP1 and Applied SSB_RP2 are specified in the test case, either directly as Es or derived from Noc and Es/Noc, and are in dBm per subcarrier

UE Spherical coverage gain midpoint in dB is derived as (UE Refsens - UE Spherical coverage)/2

For the nominal values, UE gain G midpoint cancels out for this relative measurement, but UE Spherical coverage gain midpoint applies to one Angle of Arrival. For the variations, UE gain variation cancels out as the same value affects both cells, but Spherical coverage gain variation applies to one Angle of Arrival.

$$\text{Reported SS-RSRP2} - \text{Reported SS-RSRP1} = \text{UE-measured SS-RSRP}_{2_{\text{nom}}} - \text{UE-measured SS-RSRP}_{1_{\text{nom}}} \pm \text{Spherical coverage gain variation}_{A_0A1} \pm \text{UE accuracy}$$

where:

Spherical coverage gain variation_{A₀A1} is derived from Refsens and Spherical coverage, as in Figure A.2.1.2-1

UE accuracy is the relative accuracy from the core requirement referred to in A.2.6.1

A.2.6.7 Principles for Test Tolerance analysis

The following principles shall be followed in the test case analysis:

- UE-measured SS-RSRP_{nom} is calculated using the relevant method in A.2.6.2 to A.2.6.6
- The range of SS-RSRP reported values is calculated using the relevant methods in A.2.6.2 to A.2.6.6

A.2.7 Intra-frequency cells without AWGN, same Angle of Arrival

A.2.7.1 Test system

In a practical test system running a test case where Intra-frequency cells come from the same Angle of Arrival, the level uncertainties for all cells will be highly correlated. If the test case has applied AWGN, it will specify Noc and Es/Noc, and the absolute uncertainty for applied AWGN will be the dominant contribution to the overall Es uncertainty for each cell. As AWGN is common to all cells on that frequency, the correlation is already included.

If the test case does not have applied AWGN, it will specify Es for each cell, with an absolute Es uncertainty for each cell. The method of handling the effect of correlation in the Test Tolerance analysis is given in A.2.7.2 and A.2.7.3.

A.2.7.2 Calculation method for Es/Iot at UE baseband

An example is provided here for a scenario with two intra-frequency cells, without applied AWGN. SSB Es/Iot at UE baseband is calculated for Cell 1. Interference to Cell 1 comes from the UE internal noise and from Cell 2. The values are chosen for illustration, and not taken from any specific test case.

$$\text{Cell 1 SSB Es/Iot}_{\text{BB}} = 10\text{Log}_{10}((\text{Cell 1 SSB power}) / (\text{UE internal noise} + \text{Cell 2 SSB power}))$$

Where UE internal noise, Cell 1 power and Cell 2 power are linear powers in W, per subcarrier.

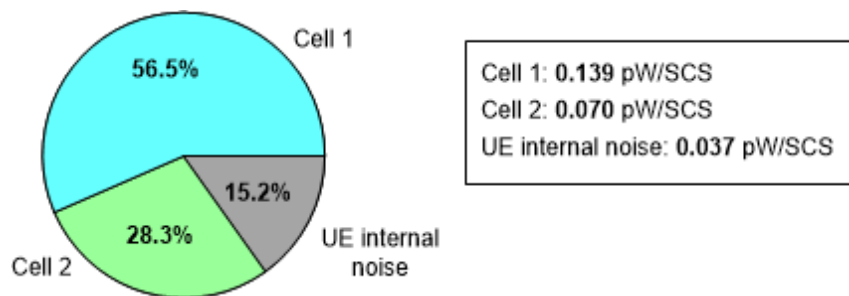

Figure A.2.7.2-1: Example Es/Iot_{BB} scenario, two intra-frequency cells

In this case, the calculation gives Cell 1 SSB Es/Iot_{BB} = 10Log₁₀(0.139 / (0.037 + 0.070)) = **1.14dB**

The presence of UE internal noise also affects the calculation of Es/Iot sensitivity factors in the Test Tolerance analysis. The UE internal noise is a fixed (worst) value, being based on the UE minimum requirement, and is taken into account in the scaling which uses linear powers:

- Cell 1 SSB Es/Iot_{BB} sensitivity to Cell 1 Es = **+1.000**
- Cell 1 SSB Es/Iot_{BB} sensitivity to Cell 2 Es = -Cell 2 SSB power / (UE internal noise + Cell 2 SSB power). In this example, (0.070 / (0.037 + 0.070)) = **-0.651**

A positive sensitivity factor is used where an increase in the quantity produces an increase in Cell 1 SSB Es/Iot_{BB}, for example increasing Cell 1 Es. A negative sensitivity factor is used where an increase in the quantity produces a decrease in Cell 1 SSB Es/Iot_{BB}, for example increasing Cell 2 Es. The sensitivity factors are used to scale the uncertainties.

Where the uncertainties are correlated, as here, they are added arithmetically and the sign affects the result. In this example, increasing Cell 1 Es increases the Cell 1 SSB Es/Iot_{BB}, but the correlated increase in Cell 2 Es decreases the Cell 1 SSB Es/Iot_{BB}. The overall effect is smaller, and depends on the ratios of linear powers.

A.2.7.3 Calculation method for Applied I_o

An example is provided here for a scenario with two intra-frequency cells, without applied AWGN. I_o applied to the UE is the arithmetic sum of linear powers in the channel bandwidth. UE internal noise is not counted, as it is not applied to the UE. The values are chosen for illustration, and not taken from any specific test case.

$$\text{Channel } I_o = 10\text{Log}_{10}(\text{Cell 1 power} + \text{Cell 2 power}) + 10\text{Log}_{10}(N_{\text{RB_TC}} \times 12)$$

where:

Cell 1 power and Cell 2 power are linear powers in W, per subcarrier

$N_{\text{RB_TC}}$ is the number of PRBs allocated in the test case (not necessarily equal to the number of PRBs in the channel bandwidth)

12 is the number of subcarriers in a PRB

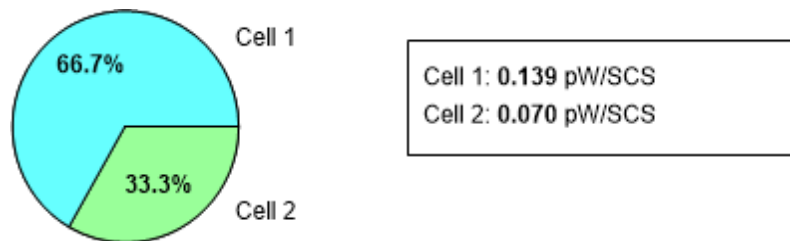

Figure A.2.7.3-1: Example I_o scenario, two intra-frequency cells

With 24 PRBs allocated, the example gives $I_o = 10\text{Log}_{10}((0.139 + 0.070) \times 10^{-9}) + 10\text{Log}_{10}(24 \times 12) = -72.2\text{dBm}$

I_o sensitivity factors in the Test Tolerance analysis are based on linear powers:

- I_o sensitivity to Cell 1 E_s = Cell 1 power / (Cell 1 power + Cell 2 power). In this example, $(0.139 / (0.139 + 0.070)) = +0.667$
- I_o sensitivity to Cell 2 E_s = Cell 2 power / (Cell 1 power + Cell 2 power). In this example, $(0.070 / (0.139 + 0.070)) = +0.333$

All the sensitivity factors are positive, as an increase in the quantity produces an increase in I_o . The sensitivity factors are used to scale the uncertainties.

Where the uncertainties are correlated, as here, they are added arithmetically, and the sign affects the result. In this example increasing Cell 1 E_s increases I_o , and the correlated increase in Cell 2 E_s also increases I_o . The overall effect of scaling adds up to 1, as expected.

A.2.7.4 Principles for Test Tolerance analysis

The following principles shall be followed in the test case analysis:

- For Intra-frequency cells from the same Angle of Arrival without AWGN, $E_s/I_{ot_{\text{BB}}}$ is calculated using the method in A.2.7.2.
- For Intra-frequency cells from the same Angle of Arrival without AWGN, $E_s/I_{ot_{\text{BB}}}$ sensitivity factors are calculated using the method in A.2.7.2.
- For Intra-frequency cells from the same Angle of Arrival without AWGN, I_o is calculated using the method in A.2.7.3.
- For Intra-frequency cells from the same Angle of Arrival without AWGN, I_o sensitivity factors are calculated using the method in A.2.7.3.

A.3 Test Tolerance analysis templates for radiated test cases awaiting completion

Test Tolerance analyses for Radiated testing listed below are not yet complete, but contain the main features for the test cases covered and can be used as templates. For each analysis, the missing aspects are listed.

The analysis documents (and spreadsheets where applicable) are included in the present document as zip files with “draft” at the end of the filename. When the test case analyses are complete, the draft versions and listing in this clause should be removed.

38.533 5.3.2.2.1+5.3.2.2.2+7.3.2.2.1+7.3.2.2.2 TT draft

Editor’s note: This test tolerance analysis is incomplete. The following aspects are missing:

- *Settable window for first preamble uplink power and the uplink calibration process*
- *Derivation of test requirement for absolute uplink power after uplink calibration process*
- *Derivation of test requirement for relative uplink power*
- *The uncertainty value and test requirement for PRACH timing are in [] and not yet finalised*
- *The results of the TT analysis are provisional until the corresponding MU values are agreed*

A.4 Design of radiated test cases defined in TS 38.533

The design of radiated test cases defined in TS 38.533 is more challenging than for conducted test cases, because the over-the-air path loss reduces the downlink power seen by the UE, and reduces the uplink power received by the test system.

The achievable downlink power in a practical test system is restricted, and there is less dB range between the lowest and highest power that can be applied within the UE Core requirement side conditions.

The range of uplink power that can be measured by a practical test system is also restricted, by signal-to-noise ratio considerations at the low end, and by the UE output power at the high end.

For both downlink and uplink, the achievable dB range is most restricted when the signal arrives from the UE Spherical coverage direction. In a test case it is further restricted by downlink power level uncertainty or uplink power measurement uncertainty, which are both larger for radiated signals than for conducted signals. This Annex considers the effect of restricted dB range on radiated RRM test case design.

A.4.1 Downlink considerations

A.4.1.1 Side conditions for Rx Beam Peak angle of arrival

Side conditions for Rx Beam Peak angle of arrival are less stringent than for Spherical Coverage angle of arrival. They are not directly analysed here, but the same principles apply as for Spherical Coverage in clause A.4.1.2.

A.4.1.2 Side conditions for Spherical Coverage angle of arrival

As an example, consider a test case where the UE makes measurements on the downlink signal, for example in Event-triggered reporting. Some side condition values are band-dependent, and also depend on whether the cell being measured is intra-frequency or inter-frequency. An adverse case is chosen for illustration:

- Spherical Coverage angle of arrival
- Inter-frequency
- UE Power Class 3

- Band n259
- Maximum multi-band relaxation
- Full RB allocation
- UE is required to make measurements, so side conditions apply

The scenario is however best case on two points:

- Applied Es only, without Noc (only UE internal noise)
- Only one cell on the frequency (no other intra-frequency cells)

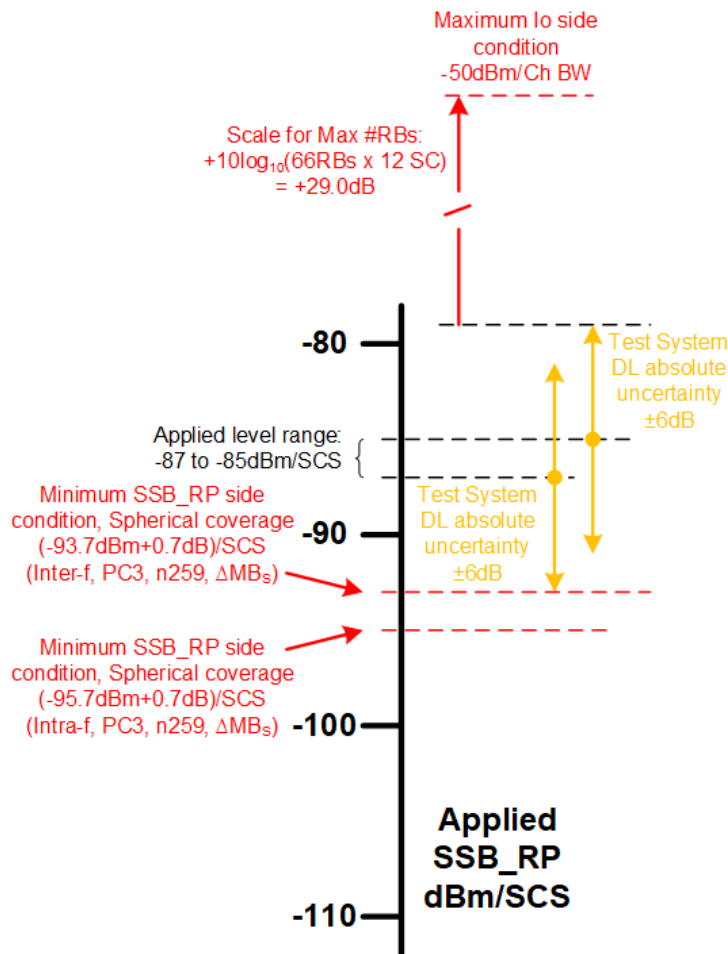

Figure A.4.1.2-1: Example side conditions when UE is making measurements

It can be seen that when uncertainties are taken into account (an indicative value of $\pm 6\text{dB}$ is used), the applied level range can be from -87dBm/SCS to -85dBm/SCS , a range of only 2dB . This is very restrictive for the test case design.

A.4.1.3 Test case design options to increase downlink dB range

A number of options are available to increase the dB range of the applied downlink signal, if necessary. For a specific test case, only some may be available, for example in a test case such as Radio Link Monitoring, it would not be possible to use applied Es only, because the test case relies on a well-defined SNR at the UE baseband.

Table A.4.1.3-1: Options to increase downlink dB range

Option	Applicability	Comments
Reduce number of allocated RBs	All Test cases	120kHz SSB SCS, use 24RBs 240kHz SSB SCS, use 48RBs Allocated RBs must include CORESET
Use applied Es only, without applied Noc	Test cases where Es/Iot_{BB} requirement is to be \geq defined value	Maximises Es contribution to I_o . Not suitable for test cases where Es/Iot_{BB} is intended as well-defined SNR.
If applied Noc is used, reduce margin above UE internal noise	Test cases where Es/Iot_{BB} requirement is to be \geq defined value	Not suitable for test cases where Es/Iot_{BB} is intended as well-defined SNR.
Use time-division multiplexing with SSB#0, SSB#1	Test cases using SSB#0, SSB#1	Avoids intra-frequency interference and degradation of Es/Iot_{BB}
Use Rx Beam Peak AoA instead of Spherical Coverage	Test cases where using Rx Beam Peak for one or both AoA, instead of Spherical Coverage, would provide adequate test coverage	Adequate test coverage may be achievable across several Test cases
Allow $I_o > -50dBm$	Test cases where measurement side conditions are not applicable	Test system may not be able to deliver $>-50dBm$
Restrict to 120kHz SSB SCS	Test cases with a 240kHz SSB SCS Configuration	Adequate test coverage of 120kHz and 240kHz SSB SCS may be achievable across several Test cases

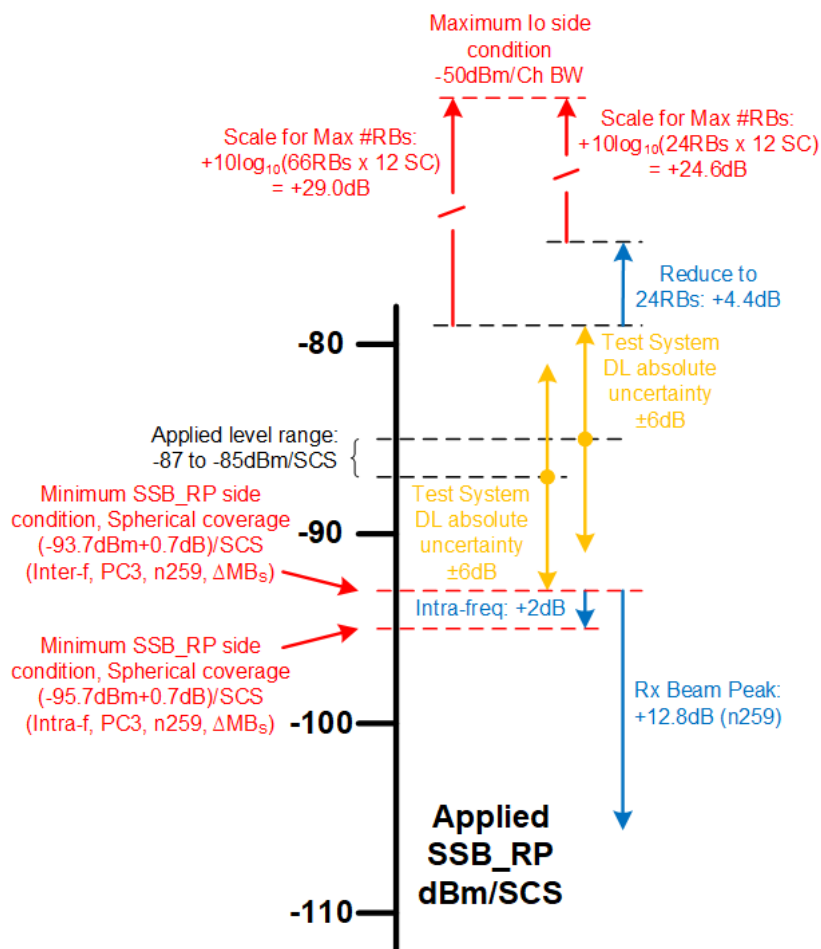

Figure A.4.1.3-1: Example illustration of selected options to increase downlink dB range

Annex B: Acceptable uncertainty of test system for test cases defined in TS 38.521-2 for radiative testing

This annex contains suggested uncertainties for each test case in TS 38.521-2.

B.1 Uncertainty budget calculation principle

Three permitted test methodologies, DFF, IFF and NFTF, have been identified for UE RF FR2 test cases defined in TS 38.521-2.

This Annex is deriving Total expanded Measurement Uncertainties per test case for each test methodology.

Threshold MU is equivalent to Total expanded uncertainty of the reference methodology which has been defined as IFF.

If the Total expanded Measurement Uncertainty per test case of a permitted test method is lower than or equal to the threshold MU, then that test method is applicable to the respective test cases defined in TS 38.521-2.

B.1.1 Uncertainty budget calculation principle for DFF

The uncertainty tables should be presented with two stages:

- Stage 1: the calibration of the absolute level of the DUT measurement results is performed by means of using a calibration antenna whose absolute gain is known at the frequencies of measurement
- Stage 2: the actual measurement with the DUT as either the transmitter or receiver is performed.

The MU budget should comprise the following headings:

- 1) The uncertainty source. Compile a complete list of the individual measurement uncertainty elements that contribute to a measurement
- 2) Determine the maximum value of each uncertainty
- 3) Determine the distribution of each uncertainty (rectangular, U-shaped, etc.),
- 4) Calculate (if necessary) the standard deviation of each uncertainty, u_i , (NOTE 1) for each uncertainty element,
- 5) Convert the units (if necessary) of each uncertainty element into the chosen unit, i.e., dB,
- 6) Combine ALL the standard uncertainties by the root-sum-squares method to derive the 'combined standard uncertainty',
- 7) Multiply the resulting combined standard uncertainty by an expansion factor ' k ' to derive the 'expanded uncertainty' for a given confidence level. All expanded uncertainties are quoted to 95% confidence level, so k is taken as 1.96. This gives 95% confidence that the true value is within 1.96 times the combined standard uncertainty of the measured value to derive the 'expanded uncertainty'.
- 8) Any systematic errors are added to the expanded uncertainty to derive the 'total expanded uncertainty', i.e.,

$$u_{c,\text{total expanded}} = u_{c,\text{expanded}} + u_{c,\text{systematic}} = 1.96 \sqrt{\sum u_i^2} + \sum u_{i,\text{systematic}}$$

NOTE 1: The standard deviation from a data set of N samples is defined as

$$u_i = \sqrt{\frac{1}{N-1} \sum_{k=1}^N |s_k - \bar{s}|^2}$$

where s_k are the respective sample results and \bar{S} the mean of all N samples. For an uncertainty u_i in dB, the dB values (instead of the linear powers) of s_k and \bar{S} are used.

B.1.2 Uncertainty budget calculation principle for IFF

The same as defined in B.1.1.

B.1.3 Uncertainty budget calculation principle for NFTF

The same as defined in B.1.1 with the exception of Stage 2, only the measurement of the DUT transmitter is performed.

B.2 Measurement error contribution descriptions

B.2.1 Measurement error contribution descriptions for DFF

B.2.1.1 Positioning misalignment

This contribution originates from the misalignment of the testing direction and the beam peak direction of the measurement antenna due to imperfect rotation operation. The pointing misalignment may happen in both azimuth and vertical directions and the effect of the misalignment depends highly on the beam width of the beam under test. The same level of misalignment results in a larger measurement error for a narrower beam.

B.2.1.2 Measure distance uncertainty

The cause of this uncertainty contributor is due to the reduction of distance between the measurement antenna and the DUT. If the distance of separation is $2D^2/\lambda$ based on D being the entire device size, then the phase variation is 22.5deg. Whether this is the minimum acceptable criteria of phase taper over the entire DUT is FFS and shall be assessed during final MU definition for the test method. Any reduction in the distance of separation increases the phase variation and creates an error which is DUT dependant. Determination of limit of the error shall be done during final MU definition for the test method.

B.2.1.3 Quality of quiet zone

The quality of the quiet zone procedure characterizes the quiet zone performance of the anechoic chamber, specifically the effect of reflections within the anechoic chamber including any positioners and support structures. The MU term additionally includes the amplitude variations effect of offsetting the directive antenna array inside a DUT from the centre of the quiet zone as well as the directivity MU, i.e., the variation of antenna gains in the different direct line-of-sight links. An additional MU term related to phase variation and phase ripple effects which depends on measurement distance is FFS, and shall be assessed during final MU definition for the test method. This might require an augmentation of the quality of the quiet zone validation procedure.

B.2.1.4 Mismatch

Mismatch uncertainty occurs when;

- Changing the signal path between the measurement and calibration procedure
- Evaluating the insertion loss of a signal path

The mismatch uncertainty for a system consisting of a generator, a load and a component in between is defined as

$$\text{Mismatch contribution (standard deviation)} = \frac{|\Gamma_{generator}| \cdot |\Gamma_{load}| \cdot |S_{21}| \cdot |S_{12}| \cdot 100}{\sqrt{2} \cdot 11.5} \text{ dB},$$

Where Γ denotes the reflection coefficient and S_{21} is the transmission coefficient, both in linear voltage ratios.

For a cascade of several components, the interactions between all components have to be evaluated. For example, for four devices in a row (shown in Figure B.2.1.4-1) the following contributions have to be accounted for: AB, BC, CD, ABC, BCD, ABCD. The term ABCD represents the interaction between A and D (generator and load) with the components B and C in between.

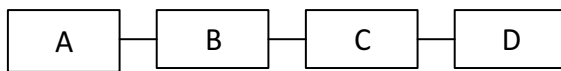

Figure B.2.1.4-1: Cascade of components

The combined mismatch uncertainty is given by the root sum square of the individual contributions:

$$\text{combined mismatch uncertainty} = \sqrt{(AB)^2 + (BC)^2 + (CD)^2 + (ABC)^2 + (BCD)^2 + (ABCD)^2}$$

In an optimized test procedure, the overall mismatch uncertainty is smaller when matching pairs of mismatches exist in the calibration and measurement stage since these pairs cancel each other out. Figure B.2.1.4-2 displays a calibration setup, where device D is replaced by device F. The mismatch contributions for this path are AB, BC, CE, ABC, BCE and ABCE. For a result based on the measurement and calibration stage, the mismatch contributions AB, BC, and ABC are matching pairs as they occur both in the measurement and calibration stage. Thus, they can be eliminated [11], and the system mismatch uncertainty is obtained as $\sqrt{(CD)^2 + (CE)^2 + (BCD)^2 + (BCE)^2 + (ABCD)^2 + (ABCE)^2}$

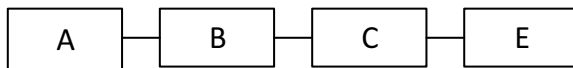

Figure B.2.1.4-2: Sketch of a calibration path

In the following, an example mismatch uncertainty calculation for a TX/RX patch from the measurement equipment to the measurement antenna is performed for a frequency of 43.5GHz. The example path under investigation consists of four SPDT switches, one SP6T switch and one DPDT switch and microwave cable interconnects with PC2.4 mm connectors. The attenuation and reflectance of typical components suitable for frequencies ranging up to 43.5 GHz have been considered in the calculation of the mismatch uncertainty.

Figure B1.1.4.4-3 shows a sample system setup for an EIRP/EIS test case with rather simple complexity of the switch box similar to a current sub 6GHz test setup. It should be noted that the switch unit is significantly less complex than a state-of-the-art switch unit currently used for conformance tests.

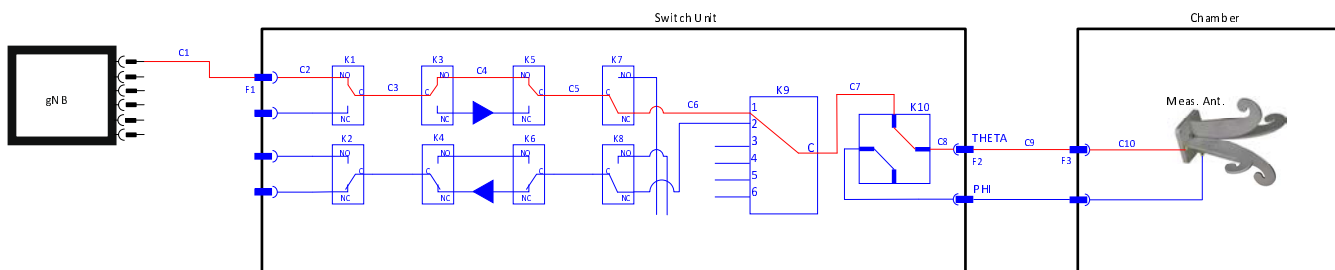

Figure B.2.1.4-3: Block Diagram of an EIRP/EIS test case with components from the gNB to the antenna (only portion of switch unit shown)

Table B.2.1.4-1: comprises the reflection and transmission properties of the components of the example path at a frequency of 43.5 GHz

Device / Component	VSWR	Transmission (dB)	Identifier in Figure B.2.1.4-3	Additional Comment/ Assumption
System Simulator	3.5		gNB	
Cable	1.5	-5.38	C1	Length: 1.5m Loss: 3.59dB/m
Cable	1.5	-0.61	C2, C3, C4, C5, C6, C7, C8	Length: 0.17m Loss: 3.59dB/m
Cable	1.5	-7.18	C9, C10	Length: 2.0m Loss: 3.59dB/m
Feedthrough	1.3	-0.66	F1, F2, F3	
SPDT switch	1.9	-1.10	K1, K3, K5, K7	
SP6T switch	2.2	-1.20	K9	
Transfer switch	2.0	-1.10	K10	
Antenna	2.0		Meas. Ant.	

The calculation of the overall mismatch uncertainty for a frequency of 43.5 GHz results in a value of 2.7 dB for the standard deviation, i.e., the expanded uncertainty is 5.3 dB.

Figure B.2.1.4-4 depicts a possible calibration for a part of the setup.

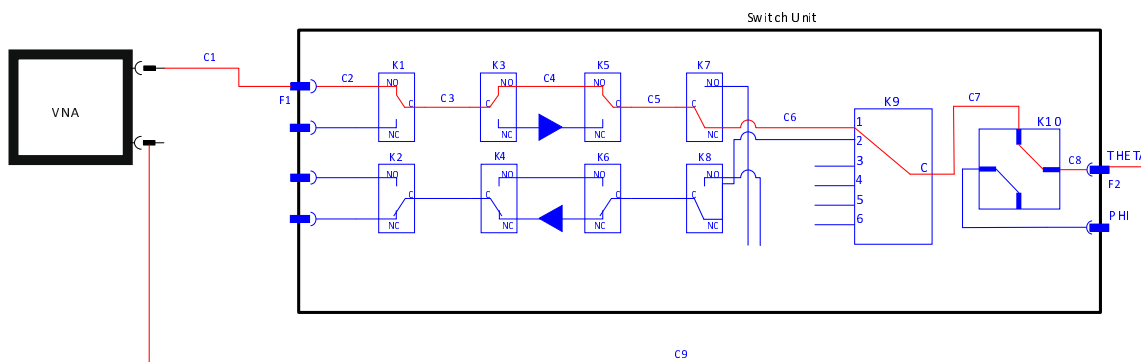

Figure B.2.1.4-4: Block Diagram of the calibration stage

For the VNA a return loss of 30 dB is assumed after a full two-port calibration. The calculation of the system mismatch uncertainty applying the elimination of matching pairs results in a value of 1.0 dB (standard deviation) with an expanded value of 1.9 dB.

Since the overall mismatch uncertainty value is already a standard deviation, which is RSS of values divided by the divisor ($\sqrt{2}$), the overall mismatch uncertainty value should be divided by actual divisor 1 when calculating total mismatch.

B.2.1.5 Standing Wave Between the DUT and measurement antenna

This uncertainty term is related to the amplitude ripple coming from the standing waves between the DUT and measurement antenna. If this term is not considered to be negligible one method to obtain this value is to slide the DUT $\lambda/4$ towards the measurement antenna while measuring the amplitude. The uncertainty term can be derived by performing the standard deviation on the results.

B.2.1.6 Uncertainty of the RF power measurement equipment

The receiving device is used to measure the received signal level in the EIRP tests as an absolute level. These receiving devices are spectrum analysers, communication analysers, or power meters. The uncertainty value will be indicated in the manufacturer's data sheet. It needs to be ensured that appropriate manufacturer's uncertainty contributions are

specified for the settings used such as bandwidth and absolute level. If a power meter is used zero offset, zero drift and measurement noise need to be included.

B.2.1.7 Phase curvature

This contribution originates from the finite far field measurement distance, which causes phase curvature across the antenna of UE/reference antenna. At a measurement distance of $2D^2/\lambda$ the phase curvature is 22.5 degrees. The impact of this factor shall be assessed during final MU definition for the test method.

B.2.1.8 Amplifier uncertainties

Any components in the setup can potentially introduce measurement uncertainty. It is then needed to determine the uncertainty contributors associated with the use of such components. For the case of external amplifiers, the following uncertainties should be considered but the applicability is contingent to the measurement implementation and calibration procedure.

- Stability
 - An uncertainty contribution comes from the output level stability of the amplifier. Even if the amplifier is part of the system for both measurement and calibration, the uncertainty due to the stability shall be considered. This uncertainty can be either measured or determined by the manufacturers' data sheet for the operating conditions in which the system will be required to operate.
- Linearity
 - An uncertainty contribution comes from the linearity of the amplifier since in most cases calibration and measurements are performed at two different input/output power levels. This uncertainty can be either measured or determined by the manufacturers' data sheet.
- Noise Figure
 - When the signal goes into an amplifier, noise is added so that the SNR at the output is reduced with regard to the SNR of the signal at the input. This added noise introduces error on the signal which affects the Error Rate of the receiver thus the EVM (Error Vector Magnitude). An uncertainty can be calculated through the following formula:

$$\varepsilon_{EVM} = 20 \log_{10} \left(1 + 10^{-\frac{SNR}{20}} \right)$$
 - Where SNR is the signal to noise ratio in dB at the signal level used during the sensitivity measurement.
- Mismatch
 - If the external amplifier is used for both stages, measurement and calibration the uncertainty contribution associated with it can be considered systematic and constant -> 0dB. If it is not the case, the mismatch uncertainty at its input and output shall be either measured or determined by the method described in [12].
- Gain
 - If the external amplifier is used for both stages, measurement and calibration the uncertainty contribution associated with it can be considered systematic and constant -> 0dB. If it is not the case, this uncertainty shall be considered.

B.2.1.9 Random uncertainty

This contribution is used to account for all the unknown, unquantifiable, etc. uncertainties associated with the measurements.

Random uncertainty MU contributions are normally distributed.

The random uncertainty term, by definition, cannot be measured, or even isolated completely. However, past system definitions provide an empirical basis for a value. Current LTE SISO OTA measurements have random uncertainty

contributions of ~0.2dB. A value of 0.5dB is suggested due to increased sensitivity to random effects in more complex, higher frequency NR test systems.

B.2.1.10 Influence of the XPD

This factor takes into account the uncertainty caused due to the finite cross polar discrimination (XPD) between the two polarization ports of the measurement probe. The XPD of the probe antenna shall be taken into account during final MU definition for the test method.

A typical probe antenna can have XPD of 30dB.

A transmission matrix and calibration setup as shown in Figure B.2.1.10-1 is considered here. Typically, a single-polarized reference antenna with known gain is placed at the centre of the quiet zone and the total attenuation, L , between the reference antenna terminal and the feed antenna terminals is determined as part of the range reference calibration procedure.

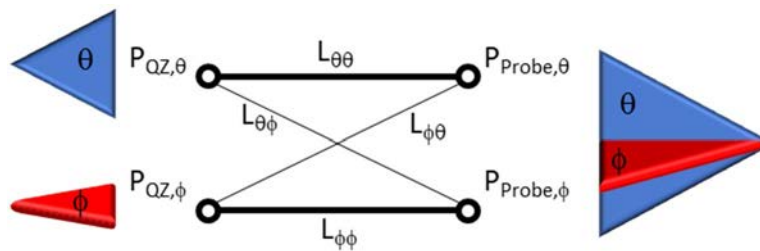

Figure B.2.1.10-1: Calibration Setup

Since the reference antenna is considered a single-polarized antenna, the XPD effect is negligible. Since the measurement probe is assumed to be a dual-linearly polarized antenna, leakage from one terminal/polarization to the other, i.e., XPD, needs to be considered.

The dual-linearly polarized measurement probe has two terminals corresponding to a set of orthogonal polarizations, θ and ϕ which match the orientations of the reference antenna. The most thorough calibration procedure would determine the path losses between the four different combinations of signal paths: $\theta\theta$, $\theta\phi$, $\phi\theta$, and $\phi\phi$, e.g., the power received by the measurement probe at the θ polarization/terminal, $P_{\text{Probe},\theta}$, is attenuated by $L_{\theta\theta}$ with respect to the power delivered to the reference antenna oriented in the ϕ polarization and placed in the centre of quiet zone, $P_{\text{QZ},\phi}$.

The most common calibration approach, however, is based on calibrating the polarization matched paths in Figure B.2.1.10-1 (thick solid lines), i.e., $\theta\theta$ and $\phi\phi$. In this case, as illustrated in Figure B.2.1.10-2, the normalized pathlosses $L_{\theta\theta}$ and $L_{\phi\phi}$ are 1 and the pathlosses of the crossed components become the XPD terms of the measurement probe:

$$\alpha_{\theta\phi} = 10^{\frac{\text{XPD}_{\theta\phi}}{10}} \quad (1.1)$$

and

$$\alpha_{\phi\theta} = 10^{\frac{\text{XPD}_{\phi\theta}}{10}} \quad (1.2)$$

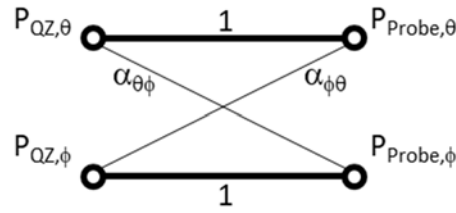

Figure B.2.1.10-2: Common calibration approach based on calibrating the polarization matched signal paths

In the remainder of this analysis, it is assumed that the leakage between the two polarization ports of the measurement probe is assumed to be the same, i.e., $XPD = XPD_{\theta\phi} = XPD_{\phi\theta}$ and $\alpha = \alpha_{\theta\phi} = \alpha_{\phi\theta}$.

The normalized powers at the measurement probe terminals can then be written as

$$P_{Probe,\theta} = P_{QZ,\theta} + \alpha P_{QZ,\phi} \tag{1.3}$$

$$P_{Probe,\phi} = P_{QZ,\phi} + \alpha P_{QZ,\theta} \tag{1.4}$$

The normalized ratio of total powers at measurement probe and the centre of the quiet zone is therefore

$$\frac{P_{Probe}}{P_{QZ}} = \frac{P_{Probe,\theta} + P_{Probe,\phi}}{P_{QZ,\theta} + P_{QZ,\phi}} = \frac{(P_{QZ,\theta} + P_{QZ,\phi})(1 + \alpha)}{P_{QZ,\theta} + P_{QZ,\phi}} = 1 + \alpha \tag{1.5}$$

This simple analysis shows that the XPD of the measurement probe introduces a small error of the total power measured by the measurement probe and that the conservation of measured powers is not guaranteed, i.e., the MU based on the XPD can be expressed as

$$MU_{XPD} [dB] = 10 \log_{10} (1 + \alpha) = 10 \log_{10} \left(1 + 10^{\frac{XPD}{10}} \right) \tag{1.6}$$

This XPD MU is tabulated for different levels of XPD in Table B.2.1.10-1.

Table B.2.1.10-1: XPD MU for different XPD values

XPD [dB]	MU _{XPD} [dB]
-20	0.043
-25	0.014
-30	0.004
-35	0.001
-40	0.000

When the range reference calibration is based on a full matrix-based approach, i.e., all signal paths are calibrated, the conservation of measured powers is guaranteed. As shown in Figure B.2.1.10-3, the polarization-matched signal paths take into account the leakage of power into the cross paths.

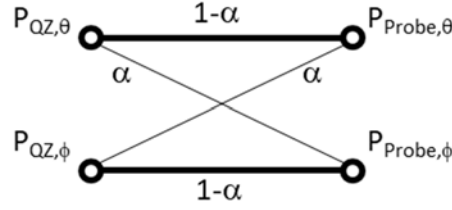

Figure B.2.1.10-3: Calibration approach based on calibrating all signal paths

The powers at the measurement probe can now be written as

$$P_{\text{Probe},\theta} = (1-\alpha)P_{\text{QZ},\theta} + \alpha P_{\text{QZ},\phi} \quad (1.7)$$

$$P_{\text{Probe},\phi} = (1-\alpha)P_{\text{QZ},\phi} + \alpha P_{\text{QZ},\theta} \quad (1.8)$$

The normalized ratio of total powers at measurement probe and the centre of the quiet zone is then

$$\frac{P_{\text{Probe}}}{P_{\text{QZ}}} = \frac{P_{\text{Probe},\theta} + P_{\text{Probe},\phi}}{P_{\text{QZ},\theta} + P_{\text{QZ},\phi}} = \frac{P_{\text{QZ},\theta} + P_{\text{QZ},\phi}}{P_{\text{QZ},\theta} + P_{\text{QZ},\phi}} = 1 \quad (1.9)$$

This simple analysis now shows that for a matrix-based calibration of all signal paths the XPD of the measurement probe no longer introduces any error and that the conservation of measured powers is guaranteed, i.e., the MU based on the XPD is 0dB.

The derivation of the XPD MU based on powers is a more straightforward and less complex approach than with electric fields as attempted in [2]. This annex shows that the same XPU MU result as derived in (1.5) can be derived using electric fields.

The corresponding signal paths are illustrated in Figure B.2.1.10-4.

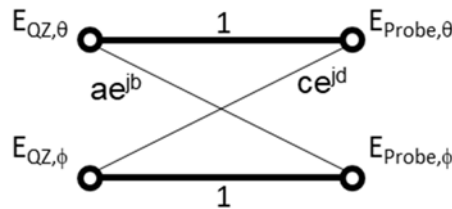

Figure B.2.1.10-4: Signal paths for electric fields (based on calibrating the polarization matched signal paths)

The normalized fields at the measurement probe terminals can then be written as

$$E_{\text{Probe},\theta} = E_{\text{QZ},\theta} + ce^{jd} E_{\text{QZ},\phi} \quad (1.10)$$

$$E_{\text{Probe},\phi} = E_{\text{QZ},\phi} + ae^{jb} E_{\text{QZ},\theta} \quad (1.11)$$

The transmission matrix can be defined as H

$$\begin{bmatrix} E_{\text{Probe},\theta} \\ E_{\text{Probe},\phi} \end{bmatrix} = H \begin{bmatrix} E_{\text{QZ},\theta} \\ E_{\text{QZ},\phi} \end{bmatrix} \quad (1.12)$$

$$H = \begin{bmatrix} 1 & ae^{jb} \\ ce^{jd} & 1 \end{bmatrix} \quad (1.13)$$

The total magnitude component of the electric field including coherence/interference terms at the probe is

$$\begin{aligned} E_{\text{Probe},T} &= \sqrt{|E_{\text{Probe},\theta}|^2 + |E_{\text{Probe},\phi}|^2} = \sqrt{|E_{\text{QZ},\theta} + ce^{jd} E_{\text{QZ},\phi}|^2 + |E_{\text{QZ},\phi} + ae^{jb} E_{\text{QZ},\theta}|^2} \\ &= \sqrt{\left[(E_{\text{QZ},\theta} + cE_{\text{QZ},\phi} \cos(d))^2 + (cE_{\text{QZ},\phi} \sin(d))^2 \right] + \left[(E_{\text{QZ},\phi} + aE_{\text{QZ},\theta} \cos(b))^2 + (aE_{\text{QZ},\theta} \sin(b))^2 \right]} \\ &= \sqrt{\left[E_{\text{QZ},\theta}^2 + 2cE_{\text{QZ},\theta}E_{\text{QZ},\phi} \cos(d) + c^2E_{\text{QZ},\phi}^2 \cos^2(d) + c^2E_{\text{QZ},\phi}^2 \sin^2(d) \right] +} \\ &= \sqrt{\left[E_{\text{QZ},\phi}^2 + 2aE_{\text{QZ},\theta}E_{\text{QZ},\phi} \cos(b) + a^2E_{\text{QZ},\theta}^2 \cos^2(b) + a^2E_{\text{QZ},\theta}^2 \sin^2(b) \right]} \\ &= \sqrt{E_{\text{QZ},\theta}^2 (1+a^2) + E_{\text{QZ},\phi}^2 (1+c^2) + 2E_{\text{QZ},\theta}E_{\text{QZ},\phi} (c \cos(d) + a \cos(b))} \end{aligned} \quad (1.14)$$

When it is assumed that leakage between the two polarization ports of the measurement probe is assumed to be the same, then $a=c=10^{\text{XPD}/20}$ in (1.14). Additionally, it has to be assumed that $d=b+\pi$ which guarantees the orthogonality between the two field vectors, i.e., the dot product between the vectors has to be zero. With these assumptions, Equation (1.14) will become

$$E_{\text{Probe},T} = \sqrt{(E_{\text{QZ},\theta}^2 + E_{\text{QZ},\phi}^2)(1+a^2)} \quad (1.15)$$

The normalized ratio of total powers at measurement probe and the centre of the quiet zone is therefore

$$\frac{P_{\text{Probe}}}{P_{\text{QZ}}} \propto \frac{E_{\text{Probe},T}^2}{E_{\text{QZ},T}^2} = 1 + a^2 = 1 + 10^{\frac{2\text{XPD}}{20}} = 1 + 10^{\frac{\text{XPD}}{10}} \quad (1.16)$$

The derived XPD MU based on electric fields which included the coherence/interference terms in (1.16) is the same as in (1.6).

The XPD of the measurement system shall be determined from the quality of quiet zone measurements, see clause O.2 of [7], at the 7 reference points, P1 through P7, specifically with reference AUT orientations $\gamma=\beta=0^\circ$ for distributed axes systems, Section O.2.6.1 [7], or reference AUT orientations $\beta=\alpha=0^\circ$ for combined-axes systems, Section O.2.6.2 [7]. Alternatively, it can be determined using a reference antenna optimized for XPD measurements and with the corresponding alignment to achieve optimal polarization matching between the reference and the measurement antenna.

The XPD for each reference point shall be calculated as the ratio of cross-polarized to co-polarized measured powers and the largest XPD from the 7 different reference points shall be used to determine the XPD MU, i.e.,

$$\text{MU}_{\text{XPD}} [\text{dB}] = 10 \log_{10} (1 + \alpha_{\text{max}}) = 10 \log_{10} \left(1 + 10^{\frac{\text{XPD}_{\text{max}}}{10}} \right) \quad (1-17)$$

where

$$\text{XPD}_{\text{max}} [\text{dB}] = 10 \log_{10} \left[\max \left(\left. \frac{P_{\text{cross-pol}}}{P_{\text{co-pol}}} \right|_{\text{P1}, \gamma_{\text{rot}}=0^\circ}, \left. \frac{P_{\text{cross-pol}}}{P_{\text{co-pol}}} \right|_{\text{P1}, \gamma_{\text{rot}}=90^\circ}, \dots, \left. \frac{P_{\text{cross-pol}}}{P_{\text{co-pol}}} \right|_{\text{P7}, \gamma_{\text{rot}}=0^\circ}, \left. \frac{P_{\text{cross-pol}}}{P_{\text{co-pol}}} \right|_{\text{P7}, \gamma_{\text{rot}}=90^\circ} \right) \right] \quad (1-18)$$

B.2.1.11 Insertion loss Variation

This uncertainty contribution comes from introducing an additional cable which is not present for both the calibration and DUT measurement. If the cables remain the same for the calibration and DUT measurement, then the contribution should be set to zero.

If an additional cable is added for one part of the test, the insertion loss must be accounted for in the measurement results. If the insertion loss is measured the uncertainty contribution will be the combined uncertainty related to the insertion loss measurement. The insertion loss can also be taken from the datasheet and assumed to have a rectangular distribution.

B.2.1.12 RF leakage (from measurement antenna to receiver/transmitter)

This contribution denotes noise leaking in to connector and cable(s) between measurement antenna and receiving/transmitting equipment. The contribution also includes the noise leakage between the connector and cable(s) between reference antenna and transmitting equipment for the calibration phase. This uncertainty contributor is contained in the contributor quality of quiet zone described in clause B.2.1.3 and its value therefore is set to zero.

B.2.1.13 Misalignment of positioning System

This contribution originates from uncertainty in sliding position and turn table angle/tilt accuracy. If the calibration antenna is aligned to the beam peak this contribution can be considered negligible and therefore set to zero.

B.2.1.14 Uncertainty of the Network Analyzer

This contribution originates from all uncertainties involved transmission magnitude measurement with a network analyser, for example: drift, frequency flatness, temperature variation from kit calibration to path losses measurement as well as interpolation of calibration data if test frequencies were not calibrated during path loss characterization. The uncertainty value will be indicated in the manufacturer's data sheet. It needs to be ensured that appropriate manufacturer's uncertainty contribution is specified for the absolute levels measured.

When an end-to-end system calibration approach is used, the absolute levels are related to the total system losses of the measurement path. When a split calibration approach is used, separate MU contributions need to be determined

- u_{cond} : transmission magnitude uncertainty for the conducted portion of the calibration; the absolute levels are related to the total system losses for the portion of the system calibrated
- u_{rad} : transmission magnitude uncertainty for the radiated portion of the calibration; the absolute levels are related to the total system losses for the portion of the system calibrated

The total MU of the network analyser for the split calibration is the RSS'ed value of u_{cond} and u_{rad} .

B.2.1.15 Uncertainty of the absolute gain of the calibration antenna

The calibration antenna only appears in Stage 2. Therefore, the gain uncertainty has to be taken into account. This uncertainty will come from a calibration report with traceability to a National Metrology Institute with measurement uncertainty budgets generated following the guidelines outlined in internationally accepted standards.

B.2.1.16 Positioning and pointing misalignment between the reference antenna and the measurement antenna

This contribution originates from reference antenna alignment and pointing error. In this measurement if the maximum gain direction of the reference antenna and the transmitting antenna are aligned to each other, this contribution can be considered negligible and therefore set to zero.

B.2.1.17 gNB emulator uncertainty

gNB emulator is used to drive a signal to the horn antenna (via multiple external components such as a switch box, an amplifier and a circulator, etc.) in sensitivity tests either as an absolute level or as a relative level. Receiving device

used is typically a UE/phablet/tablet/FWA. Generally there occurs uncertainty contribution from absolute level accuracy, non-linearity and frequency characteristic of the gNB emulator.

For practical reasons, in a case that a VNA is used as calibration equipment, gNB emulator is connected to the system after the calibration measurement (Stage 2) is performed by the VNA. Hence, the uncertainty on the absolute level of gNB emulator (transmitter device) cannot be assumed as systematic. This uncertainty should be calculated from the manufacturer's data in logs with a rectangular distribution, unless otherwise informed. Furthermore, the uncertainty of the non-linearity is included in the absolute level uncertainty.

B.2.1.18 Phase centre offset of calibration

Gain is defined at the phase centre of the antenna. If the phase centre of the calibration antenna is not aligned at the centre of the set up during the calibration, then there will be uncertainty related to the measurement distance.

The phase centre of a horn antenna moves with frequency along the taper length of the antenna therefore during the calibration the phase centre of all frequencies will not be aligned with the setup centre. The associated uncertainty term can be estimated using the following formula [14]:

$$\pm 20 \log_{10} \left(\frac{d_m - d_p}{d_m} \right)$$

$\pm 20 \log_{10}((\text{measurement distance} - d)/\text{measurement distance})$ [14]

Where d_m is the measurement distance and d_p is the maximum positional uncertainty. For a Horn antenna this is equal to 0.5 the length of the taper. This uncertainty is considered to have a rectangular distribution so the standard uncertainty is calculated by dividing the uncertainty by $\sqrt{3}$.

The same equation applies to log periodic antennas with d_m being 0.5 the length of the boom.

For a dipole antenna, given that the phase centre of the antenna is easily aligned with the centre of the set up the measurement uncertainty is zero.

If the calibration antenna (i.e. horn) is adjusted during the calibration to align the phase centre to the setup centre then this uncertainty term can be considered to be zero.

As an example a horn with a taper length of 50 mm, at 43.5 GHz and a measurement distance of 72.55 cm the uncertainty term is 0.62, with a rectangular distribution the standard uncertainty is 0.358 dB.

For DFF systems this uncertainty contribution must be included.

B.2.1.19 Quality of quiet zone for calibration process

During the calibration process the calibration antenna will be placed at the centre of the quiet zone. Therefore, only point P1 from the procedure outlined in B.2.1.3 needs to be considered for the quality of the quiet zone validation measurement.

For gain calibrations, the standard uncertainty of the EIRP results obtained following the method outlined in 2.10 shall be used. For efficiency calibrations, the standard uncertainty of the TRP result obtained following the method outlined in 2.9 shall be used.

B.2.1.20 Standing wave between reference calibration antenna and measurement antenna

This term comes from the amplitude ripple caused by the standing waves between the reference antenna and measurement antenna. This value can be captured by sliding ($\lambda/4$) the reference antenna towards the measurement antenna as the standing waves go in and out of phase causing a ripple in amplitude. The uncertainty term can be derived by performing the standard deviation on the results.

B.2.1.21 Influence of the calibration antenna feed cable (Flexing cables, adapters, attenuators, connector repeatability)

During the calibration measurement a cable (adapters, attenuators) is used to feed the calibration antenna. This uncertainty captures any influence the cable may have on the measurements result. This term can be assessed by repeating measurements while flexing the cables and rotary joints and using the largest difference between the results as the uncertainty. For some calibration test configurations this uncertainty can be considered to be zero.

B.2.1.22 Influence of TRP measurement grid

This contributor describes the uncertainty of the measured TRP value due to the finite number of measurement grid points.

B.2.1.23 Influence of beam peak search grid

This contributor describes the uncertainty of absolute TX power beam peak measurements, e.g., EIRP in beam peak direction, due to the finite number of measurement points in the beam peak search grid.

B.2.1.24 Systematic error due to TRP calculation/quadrature

When calculating TRP using different quadrature of constant step size data, a mean error shall be taken into account. The value of this contributor depends on the number of measurement grid points and the quadrature technique used.

No mean error has to be taken into account for constant density approach (using the charged particle or the golden spiral implementation) for non-sparse antenna arrays.

This measurement uncertainty contributor represents a systematic uncertainty and must not be root sum squared with contributors described by standard deviation.

B.2.1.25 Multiple measurement antenna uncertainty

This contributor describes the uncertainty caused by switching multiple measurement antennas either by mechanically or electrically to measure TRx spurious emission.

A frequency range of spurious tests (e.g. general spurious emission) is defined from 6 GHz to second harmonic of FR2 bands such as 80 GHz. Since that frequency range is quite wide, it is impossible to cover the whole range only by one measurement antenna. Therefore to provide a feature of the spurious emission measurement by FR2 test system, the system has to equip a capability to switch corresponding measurement antennas in an anechoic chamber. One of the mechanical antenna switching methods can be a structure of a slider. Then a repeatability of a bending loss of a feeder cable which is connected to the measurement antennas shall be taken into account. On the other hand for electrical antenna switching, since multiple antennas need to be aligned in a chamber with a different position, the quiet zone characteristics might receive an influence by a displacement from the ideal focal point. In a case of electrical switching system, if the measurement antenna configuration is the same for the quality of the quiet zone measurement and the DUT measurement, then this uncertainty term is encompassed in the quality of the quiet zone results.

B.2.1.26 DUT repositioning

This contributor describes the uncertainty due to a displacement of a DUT. The DUT may need to be re-positioned between measurements, for instance when the battery runs low in charge.

B.2.1.27 Influence of noise

This contributor describes an offset uncertainty factor caused by a noise floor especially in a case of low SNR. This contributor works as a bias to measured results only to a direction to increase values and thus this shall be included in the uncertainty budget table as a systematic uncertainty. The uncertainty value can be derived by the following equation.

$$\text{Influence of noise} = 10 * \log\left(1 + 10^{\left(\frac{SNR}{10}\right)}\right)$$

B.2.1.28 Systematic error related to beam peak search

When calculating beam peak search a systematic error shall be taken into account. The value of this contributor depends on the number of measurement grid points.

This measurement uncertainty contributor represents a systematic uncertainty and must not be root sum squared with contributors described by standard deviation.

B.2.1.29 Influence of spherical coverage grid

This contributor describes the uncertainty of spherical measurements, due to the finite number of measurement points in the spherical coverage grid.

B.2.1.30 Systematic error related to EIS spherical coverage

When calculating EIS spherical coverage, a mean error shall be taken into account. The value of this contributor depends on the DL power step size used for the EIS search and then number of measurement grid points.

This measurement uncertainty contributor represents a systematic uncertainty and must not be root sum squared with contributors described by standard deviation.

B.2.1.31 Misalignment of DUT due to change of DUT orientation

This contributor describes the uncertainty due to a mis-alignment of a DUT after a change of DUT orientations described in Tables J.2-1 through J.2-3 in [3] during spurious emission and spherical coverage measurements. This contribution is negligible with spherical coverage TC as far as the misalignment is within the accuracy of DUT re-positioning.

B.2.1.32 Additional Impact of Interferer ACLR

This contribution describes the effect of the interferer ACLR over the wanted signal channel when testing ACS and in-band blocking. Even if power is set perfectly in the configured transmission bandwidth, interferer power will leak in the wanted signal channel due to its ACLR.

B.2.1.33 Modulated Interferer uncertainty

Modulated Interferer is used to drive a signal to the horn antenna (via multiple external components such as a switch box, an amplifier and a circulator, etc.) in ACS and In-band Blocking tests either as an absolute level or as a relative level. Receiving device used is typically a UE/phablet/tablet/FWA. Generally, there occurs uncertainty contribution from absolute level accuracy, non-linearity and frequency characteristic of the interferer generator.

For practical reasons, in a case that a VNA is used as calibration equipment, Modulated Interferer is connected to the system after the calibration measurement (Stage 2) is performed by the VNA. Hence, the uncertainty on the absolute level of Modulated Interferer (transmitter device) cannot be assumed as systematic. This uncertainty should be calculated from the manufacturer's data in logs with a rectangular distribution, unless otherwise informed. Furthermore, the uncertainty of the non-linearity is included in the absolute level uncertainty.

B.2.1.34 Void

B.2.1.35 Influence of offset antenna for blocker signal

This MU term describes the additional uncertainty caused by using offset antenna for blocker signal for FR2 blocking test cases. The cause of additional MU using offset antenna is the difference of UE antenna's gain between beam peak direction and offset beam peak direction, which will cause the error for the ACS or IBB performance requirement which

is given by the power ratio of the wanted signal power and blocker signal power. Such difference of the UE antenna gain can be compensated by increasing the blocker signal power by the measured EIS difference at beam peak direction and at offset beam peak. Despite this compensation, there still is a residual error corresponding to the antenna gain difference due to different frequency of wanted and blocker signal. Table B.2.1.35-1 summarizes the residual error after compensation for various offset angle assumption.

Table B.2.1.35-1: Residual error when offset antenna is used for FR2 blocking test

offset angle[deg]	Mean error[dB]	Std.dev[dB]	Mean error[dB]	Std.dev[dB]
	2x8 Assumption		1x4 Assumption	
0	0.000	0.000	0.000	0.000
0.5	0.001	0.001	0.000	0.000
1	0.004	0.003	0.001	0.001
1.5	0.010	0.006	0.002	0.002
2	0.018	0.011	0.004	0.003
2.5	0.028	0.018	0.006	0.004
3	0.041	0.026	0.009	0.006
3.5	0.057	0.036	0.013	0.009
4	0.075	0.048	0.016	0.011
4.5	0.096	0.062	0.021	0.015
5	0.120	0.078	0.026	0.018
5.5	0.147	0.096	0.031	0.022
6	0.178	0.117	0.038	0.026
6.5	0.213	0.142	0.044	0.031
7	0.252	0.170	0.051	0.036

NOTE 1: For MU assessment of the test system, the MU values should be taken from the row corresponding to the test system's offset antenna angle.
NOTE 2: Mean error should be counted as systematic offset and Std.dev should be counted as a random uncertainty in the MU budget table.
NOTE 3: For PC3 UE testing, the values for 2x8 Assumption should be used.
NOTE 4: EIS step size used for compensation should be added as mean error.

B.2.1.36 Uncertainty of the RF relative power measurement equipment

The receiving device is used to measure the received signal level in the EIRP tests as a relative level. These receiving devices are spectrum analysers, communication analysers, or power meters. The uncertainty value will be indicated in the manufacturer's data sheet. Basically, the linearity and impact of the averaging time needs to be considered in this MU term.

B.2.2 Measurement error contribution descriptions for IFF

B.2.2.1 Positioning misalignment

See B.2.1.1.

The uncertainty value of positioning misalignment is estimated as below table and used across clause B.

Table B.2.2.1-1: Uncertainty value for positioning misalignment for IFF

Power class	Uncertainty value	Distribution of the probability	Divisor	Standard uncertainty (σ) [dB]
PC1, PC5	0.02	Normal	2.00	0.01
PC3	0.00	Normal	2.00	0.00
PC6	FFS	FFS	FFS	FFS

B.2.2.2 Measure distance uncertainty

See B.2.1.2. For IFF1 this can be considered to be zero.

The uncertainty value of measure distance uncertainty is estimated as below table and used across clause B.

Table B.2.2.2-1: Uncertainty value for measure distance uncertainty for IFF

Power class	Uncertainty value	Distribution of the probability	Divisor	Standard uncertainty (σ) [dB]
PC1, PC3, PC5, PC6	0.00	Rectangular	1.73	0.00

B.2.2.3 Quality of Quiet Zone

See B.2.1.3.

The uncertainty value of quality of quiet zone is estimated as below table and used across clause B.

Table B.2.2.3-1: Uncertainty value for quality of quiet zone for IFF

QZ size	Power class	Condition	Test case	Frequency range	Uncertainty value	Distribution of the probability	Divisor	Standard uncertainty (σ) [dB]		
All	All	All	ACLR (relative measurement)	FR2a, FR2b, FR2c	0.52	Actual	1.00	0.52		
≤30cm	PC1, PC3, PC5, PC6	NC	NOTE1	FR2a, FR2b	0.6	Actual	1.00	0.6		
				FR2c, FR2d	0.7	Actual	1.00	0.7		
			SE	6GHz to 12.75GHz	0.7	Actual	1.00	0.7		
				12.75GHz to 23.45GHz	0.6	Actual	1.00	0.6		
				23.45GHz to 40.8GHz	0.6	Actual	1.00	0.6		
				40.8GHz to 66GHz	0.6	Actual	1.00	0.6		
				66GHz to 87GHz	0.6	Actual	1.00	0.6		
		ETC	NOTE1	FR2a, FR2b, FR2c, FR2d	0.9	Actual	1.00	0.9		
		40cm	PC1, PC3, PC5, PC6	NC	NOTE1	FR2a, FR2b	0.7 (NOTE 2)	Actual	1.00	0.7
						FR2c, FR2d	0.8 (NOTE 2)	Actual	1.00	0.8
SE	6GHz to 12.75GHz				TBD	Actual	1.00	TBD		
	12.75GHz to 23.45GHz				TBD	Actual	1.00	TBD		
	23.45GHz to 40.8GHz				TBD	Actual	1.00	TBD		
	40.8GHz to 66GHz				TBD	Actual	1.00	TBD		
	66GHz to 87GHz				TBD	Actual	1.00	TBD		
ETC	NOTE1			FR2a, FR2b	TBD	Actual	1.00	TBD		

NOTE 1: The uncertainty in current row applies to maximum output power with EIRP and TRP, EIRP spherical coverage, MPR, configured output power with power boost, minimum output power, transmit OFF power, spectrum emission mask, reference sensitivity, adjacent selectivity, in-band blocking.

NOTE 2: For Uncertainty assessment in tables across clause B and MTSU calculation, QoQZ uncertainty value for QZ ≤ 30cm is used also for 40cm for FR2a through FR2c. The applicability to FR2d is FFS.

NOTE 3: Void

B.2.2.4 Mismatch

See B.2.1.4.

The uncertainty value of mismatch is estimated as below table and used across clause B.

Table B.2.2.4-2: Uncertainty value for mismatch for IFF

QZ size	Power class	Condition	Test case	Uncertainty value	Distribution of the probability	Divisor	Standard uncertainty (σ) [dB]		
Stage 2: DUT measurement									
<= 30cm	PC1, PC3, PC5, PC6	NC	Default (FR2a, FR2b)	1.30	Actual	1.00	1.30		
			Default (FR2c)	1.70	Actual	1.00	1.70		
			ACLR (relative measurement) (FR2a, FR2b)	1.84	Actual	1.00	1.84		
			ACLR (relative measurement) (FR2c)	2.4	Actual	1.00	2.4		
			Tx SE (6GHz to 12.75GHz)	1.5	Actual	1.00	1.5		
			Tx SE (12.75GHz to 23.45GHz)	1.5	Actual	1.00	1.5		
			Tx SE (23.45GHz to 40.8GHz)	1.4	Actual	1.00	1.4		
			Tx SE (40.8GHz to 66GHz)	2.3	Actual	1.00	2.3		
			Tx SE (66GHz to 87GHz)	2.3	Actual	1.00	2.3		
			Rx SE (6GHz to 12.75GHz)	1.6	Actual	1.00	1.6		
			Rx SE (12.75GHz to 23.45GHz)	1.6	Actual	1.00	1.6		
			Rx SE (23.45GHz to 40.8GHz)	1.5	Actual	1.00	1.5		
			Rx SE (40.8GHz to 66GHz)	2.3	Actual	1.00	2.3		
			Rx SE (66GHz to 87GHz)	2.3	Actual	1.00	2.3		
		ETC	Default (FR2a, FR2b)	1.30	Actual	1.00	1.30		
			Default (FR2c)	1.70	Actual	1.00	1.70		
			ACLR (relative measurement) (FR2a, FR2b)	1.84	Actual	1.00	1.84		
			ACLR (relative measurement) (FR2c)	2.4	Actual	1.00	2.4		
		Stage 1: Calibration measurement							
		<= 30cm	PC1, PC3, PC5, PC6	NC	All	0.00	U-shaped	1.41	0.00
ETC	All			0.00	U-shaped	1.41	0.00		

B.2.2.5 Standing wave between DUT and measurement antenna

See B.2.1.5.

The uncertainty value of standing wave between the DUT and measurement antenna is estimated as below table and used across clause B.

Table B.2.2.5-1: Uncertainty value for standing wave between the DUT and measurement antenna for IFF

Power class	Uncertainty value	Distribution of the probability	Divisor	Standard uncertainty (σ) [dB]
PC1, PC3, PC5, PC6	0.00	U-shaped	1.41	0.00

B.2.2.6 Uncertainty of the RF power measurement equipment

See B.2.1.6.

The uncertainty value of RF power measurement equipment is estimated as below table and used across clause B.

Table B.2.2.6-1: Uncertainty value for RF power measurement equipment for IFF

Power class	Test case	Frequency range	Uncertainty value	Distribution of the probability	Divisor	Standard uncertainty (σ) [dB]
PC1, PC3, PC5, PC6	MOP, MPR, Configured output power with power boost, SEM, ACLR	FR2a, FR2b	2.16	Normal	2.00	1.08
		FR2c	3.60	Normal	2.00	1.80
	Minimum output power, OFF power	FR2a, FR2b	2.50	Normal	2.00	1.25
		FR2c	3.60	Normal	2.00	1.80
	SE	6GHz to 12.75GHz	2.00	Normal	2.00	1.00
		12.75GHz to 23.45GHz	2.16	Normal	2.00	1.08
		23.45GHz to 40.8GHz	2.73	Normal	2.00	1.37
		40.8GHz to 66GHz	4.00	Normal	2.00	2.00
	66GHz to 87GHz	4.00	Normal	2.00	2.00	

B.2.2.7 Phase Curvature

See B.2.1.7. For IFF1 this can be considered to be zero.

The uncertainty value of phase curvature is estimated as below table and used across clause B.

Table B.2.2.7-1: Uncertainty value for phase curvature for IFF

Power class	Uncertainty value	Distribution of the probability	Divisor	Standard uncertainty (σ) [dB]
PC1, PC3, PC5, PC6	0.00	U-shaped	1.41	0.00

B.2.2.8 Amplifier Uncertainties

See B.2.1.8.

The uncertainty value of amplifier uncertainties is estimated as below table and used across clause B.

Table B.2.2.8-1: Uncertainty value for amplifier uncertainties for IFF

Power class	Test case	Uncertainty value	Distribution of the probability	Divisor	Standard uncertainty (σ) [dB]
Stage 2: DUT measurement					
PC1, PC5	Default	2.10	Normal	2.00	1.05
	Relative power tolerance	TBD	Rectangular	1.73	TBD
	SE (66GHz to 80GHz)	3.0	Normal	2.00	1.50
PC3	Default	2.10	Normal	2.00	1.05
	Relative power tolerance	0.5	Rectangular	1.73	0.29
	SE (66GHz to 87GHz)	3.0	Normal	2.00	1.50
PC6	Default	2.10	Normal	2.00	1.05
	Relative power tolerance	TBD	Rectangular	1.73	TBD
	SE (66GHz to 80GHz)	3.0	Normal	2.00	1.50
Stage 1: Calibration measurement					
PC1, PC3, PC5, PC6	Default	0.00	Normal	2.00	0.00

B.2.2.9 Random uncertainty

See B.2.1.9.

The uncertainty value of random uncertainty is estimated as below table and used across clause B.

Table B.2.2.9-1: Uncertainty value for random uncertainty for IFF

Power class	Uncertainty value	Distribution of the probability	Divisor	Standard uncertainty (σ) [dB]
PC1, PC3, PC5, PC6	0.5	Normal	2.00	0.25

B.2.2.10 Influence of XPD

See B.2.1.10.

The uncertainty value of influence of the XPD is estimated as below table and used across clause B.

Table B.2.2.10-2: Uncertainty value for influence of the XPD for IFF

QZ size	Power class	Test case	Frequency range	Uncertainty value	Distribution of the probability	Divisor	Standard uncertainty (σ) [dB]
All	All	ACLR	FR2a, FR2b, FR2c	0.00	U-shaped	1.41	0.00
≤30cm	PC1, PC3, PC5, PC6	Default	FR2a, FR2b, FR2c	0.01	U-shaped	1.41	0.00
		SE	6GHz to 12.75GHz	0.09	U-shaped	1.41	0.064
			12.75GHz to 23.45GHz	0.09	U-shaped	1.41	0.064
			23.45GHz to 40.8GHz	0.01	U-shaped	1.41	0.00
			40.8GHz to 66GHz	0.09	U-shaped	1.41	0.064
			66GHz to 87GHz	0.09	U-shaped	1.41	0.064
40cm	PC1, PC3, PC5, PC6	Default	FR2a, FR2b, FR2c	0.07 (NOTE 1)	U-shaped	1.41	0.02
		SE	6GHz to 12.75GHz	TBD	U-shaped	1.41	TBD
			12.75GHz to 23.45GHz	TBD	U-shaped	1.41	TBD
			23.45GHz to 40.8GHz	TBD	U-shaped	1.41	TBD
			40.8GHz to 66GHz	TBD	U-shaped	1.41	TBD
			66GHz to 87GHz	TBD	U-shaped	1.41	TBD

NOTE 1: For Uncertainty assessment in tables across clause B and MTSU calculation, influence of the XPD uncertainty value for QZ ≤ 30cm is used also for 40cm.

B.2.2.11 Insertion Loss Variation

See B.2.1.11.

The uncertainty value of insertion loss variation is estimated as below table and used across clause B.

Table B.2.2.11-1: Uncertainty value for insertion loss variation for IFF

Power class	Uncertainty value	Distribution of the probability	Divisor	Standard uncertainty (σ) [dB]
Stage 2: DUT measurement				
PC1, PC3, PC5, PC6	0.00	Rectangular	1.73	0.00
Stage 1: Calibration measurement				
PC1, PC3, PC5, PC6	0.00	Rectangular	1.73	0.00

B.2.2.12 RF leakage (from measurement antenna to receiver/transmitter)

See B.2.1.12.

The uncertainty value of RF leakage is estimated as below table and used across clause B.

Table B.2.2.12-1: Uncertainty value for RF leakage for IFF

Power class	Uncertainty value	Distribution of the probability	Divisor	Standard uncertainty (σ) [dB]
PC1, PC3, PC5, PC6	0.00	Actual	1.00	0.00

B.2.2.13 Misalignment of positioning system

See B.2.1.13.

The uncertainty value of misalignment of positioning system is estimated as below table and used across clause B.

Table B.2.2.13-1: Uncertainty value for misalignment of positioning system for IFF

Power class	Uncertainty value	Distribution of the probability	Divisor	Standard uncertainty (σ) [dB]
PC1, PC3, PC5, PC6	0.00	Normal	2.00	0.00

B.2.2.14 Uncertainty of the Network Analyzer

See B.2.1.14.

The uncertainty value of uncertainty of the network analyzer is estimated as below table and used across clause B.

Table B.2.2.14-1: Uncertainty value for uncertainty of the network analyser for IFF

Power class	Test case	Uncertainty value	Distribution of the probability	Divisor	Standard uncertainty (σ) [dB]
All	Default (6GHz to 40.8GHz)	1.50	Normal	2.00	0.75
	SE (40.8GHz to 87GHz)	1.70	Normal	2.00	0.85

B.2.2.15 Uncertainty of the absolute gain of the calibration antenna

See B.2.1.15.

The uncertainty value of uncertainty of the absolute gain of the calibration antenna is estimated as below table and used across clause B.

Table B.2.2.15-1: Uncertainty value for uncertainty of the absolute gain of the calibration antenna for IFF

Power class	Test case	Uncertainty value	Distribution of the probability	Divisor	Standard uncertainty (σ) [dB]
PC1, PC3, PC5, PC6	Default	0.60	Normal	2.00	0.30
	SE (40.8GHz to 66GHz)	1.70	Normal	2.00	0.85
	SE (66GHz to 87GHz)	1.70	Normal	2.00	0.85

B.2.2.16 Positioning and pointing misalignment between the reference antenna and the measurement antenna

See B.2.1.16.

The uncertainty value of positioning and pointing misalignment between the reference antenna and the measurement antenna is estimated as below table and used across clause B.

Table B.2.2.16-1: Uncertainty value for positioning and pointing misalignment between the reference antenna and the measurement antenna for IFF

Power class	Test case	Uncertainty value	Distribution of the probability	Divisor	Standard uncertainty (σ) [dB]
PC1, PC3, PC5, PC6	Default	0.01	Rectangular	1.73	0.00
	ACLR	0.00	Rectangular	1.73	0.00
	SE	0.05	Rectangular	1.73	0.03

B.2.2.17 gNB emulator uncertainty

See B.2.1.17.

The uncertainty value of gNB emulator uncertainty is estimated as below table and used across clause B.

Table B.2.2.17-1: Uncertainty value for gNB emulator uncertainty for IFF

Power class	Uncertainty value	Frequency range	Distribution of the probability	Divisor	Standard uncertainty (σ) [dB]
PC1, PC3, PC5, PC6	2.9	FR2a, FR2b	Normal	2.00	1.45
	3.6	FR2c	Normal	2.00	1.8

B.2.2.18 Phase centre offset of calibration

See B.2.1.18. For IFF1 this can be considered to be zero.

The uncertainty value of phase centre offset of calibration is estimated as below table and used across clause B.

Table B.2.2.18-1: Uncertainty value for phase centre offset of calibration for IFF

Power class	Uncertainty value	Distribution of the probability	Divisor	Standard uncertainty (σ) [dB]
PC1, PC3, PC5, PC6	0.00	Rectangular	1.73	0.00

B.2.2.19 Quality of the Quiet Zone for Calibration Process

See B.2.1.19.

The uncertainty value of quality of quiet zone for calibration process is estimated as below table and used across clause B.

Table B.2.2.19-1: Uncertainty value for quiet zone for calibration process for IFF

QZ size	Power class	Condition	Test case	Frequency range	Uncertainty value	Distribution of the probability	Divisor	Standard uncertainty (σ) [dB]
All	All	All	ACLR (relative measurement)	FR2a, FR2b, FR2c	0.32	Actual	1.00	0.32
≤ 30cm	PC1, PC3, PC5, PC6	NC	NOTE1	FR2a, FR2b	0.4	Actual	1.00	0.4
				FR2c, FR2d	0.5	Actual	1.00	0.5
			SE	6GHz to 12.75GHz	0.7	Actual	1.00	0.7
				12.75GHz to 23.45GHz	0.6	Actual	1.00	0.6
				23.45GHz to 40.8GHz	0.6	Actual	1.00	0.6
				40.8GHz to 66GHz	0.6	Actual	1.00	0.6
				66GHz to 87GHz	0.6	Actual	1.00	0.6
		ETC	NOTE1	FR2a, FR2b, FR2c, FR2d	0.6	Actual	1.00	0.6
		40cm	PC1, PC3, PC5, PC6	NC	NOTE1	FR2a, FR2b	0.4	Actual
FR2c, FR2d	0.5					Actual	1.00	0.5
SE	6GHz to 12.75GHz				TBD	Actual	1.00	TBD
	12.75GHz to 23.45GHz				TBD	Actual	1.00	TBD
	23.45GHz to 40.8GHz				TBD	Actual	1.00	TBD
	40.8GHz to 66GHz				TBD	Actual	1.00	TBD
	66GHz to 80GHz				TBD	Actual	1.00	TBD
ETC	NOTE 1			FR2a, FR2b, FR2c, FR2d	TBD	Actual	1.00	TBD
NOTE 1: The uncertainty in current row applies to maximum output power with EIRP and TRP, EIRP spherical coverage, MPR, configured output power with power boost, minimum output power, transmit OFF power, spectrum emission mask, reference sensitivity, adjacent selectivity, in-band blocking. NOTE 2: Void								

B.2.2.20 Standing wave between reference calibration antenna and measurement antenna

See B.2.1.20.

The uncertainty value of standing wave between reference calibration antenna and measurement antenna is estimated as below table and used across clause B.

Table B.2.2.20-1: Uncertainty value for standing wave between reference calibration antenna and measurement antenna for IFF

Power class	Uncertainty value	Distribution of the probability	Divisor	Standard uncertainty (σ) [dB]
PC1, PC3, PC5, PC6	0.00	U-shaped	1.41	0.00

B.2.2.21 Influence of the calibration antenna feed cable (Flexing cables, adapters, attenuators, connector repeatability)

See B.2.1.21.

The uncertainty value of influence of the calibration antenna feed cable is estimated as below table and used across clause B.

Table B.2.2.21-1: Uncertainty value for influence of the calibration antenna feed cable for IFF

Power class	Test case	Uncertainty value	Distribution of the probability	Divisor	Standard uncertainty (σ) [dB]
PC1, PC3, PC5, PC6	Default (FR2a,FR2b,FR2c)	0.14	Normal	2.00	0.07
	SE (40.8GHz to 66GHz)	0.28	Normal	2.00	0.14
	SE (66GHz to 87GHz)	0.28	Normal	2.00	0.14

B.2.2.22 Influence of TRP measurement grid

See B.2.1.22.

The uncertainty value of influence of TRP measurement grid is estimated as below table and used across clause B.

Table B.2.2.22-1: Uncertainty value for influence of TRP measurement grid for IFF

Power class	Test case	Uncertainty value	Distribution of the probability	Divisor	Standard uncertainty (σ) [dB]
PC1, PC5 (Note 1)	Default	0.25	Actual	1.00	0.25
	SE	0.25	Actual	1.00	0.25
PC3	Default	0.25	Actual	1.00	0.25
	SE	0.32	Actual	1.00	0.32
PC6	Default	FFS	FFS	FFS	FFS
	SE	FFS	FFS	FFS	FFS

Note 1: A finer measurement grid for SE (when compared to default) is required near the harmonic region, i.e., a constant-step size grid with 2522 unique grid points ($\Delta\theta=\Delta\phi=5^\circ$) or a constant-density grid with 1600 grid points.

B.2.2.23 Influence of beam peak search grid

See B.2.1.23.

The uncertainty value of influence of beam peak search grid is estimated as below table and used across clause B.

Table B.2.2.23-1: Uncertainty value for influence of beam peak search grid for IFF

Power class	Uncertainty value	Distribution of the probability	Divisor	Standard uncertainty (σ) [dB]
PC1, PC3, PC5, PC6	0.00	Actual	1.00	0.00

B.2.2.24 Systematic error due to TRP calculation/quadrature

See B.2.1.24.

The uncertainty value of systematic error due to TRP calculation/quadrature is estimated as below table and used across clause B.

Table B.2.2.24-1: Uncertainty value for systematic error due to TRP calculation/quadrature for IFF

Power class	Uncertainty value
PC1, PC3, PC5, PC6	0.00

B.2.2.25 Multiple measurement antenna uncertainty

See B.2.1.25.

The uncertainty value of multiple measurement antenna uncertainty is estimated as below table and used across clause B.

Table B.2.2.25-1: Uncertainty value for multiple measurement antenna uncertainty for IFF

Power class	Uncertainty value	Distribution of the probability	Divisor	Standard uncertainty (σ) [dB]
PC1, PC3, PC5, PC6	0.15	Actual	1.00	0.15

B.2.2.26 DUT repositioning

See B.2.1.26.

The uncertainty value of DUT repositioning is estimated as below table and used across clause B.

Table B.2.2.26-1: Uncertainty value for DUT repositioning for IFF

Power class	Test case	Uncertainty value	Distribution of the probability	Divisor	Standard uncertainty (σ) [dB]
PC1, PC5	TRP, spherical coverage	0.00	Rectangular	1.73	0.00
	EIRP, EIS	0.35	Rectangular	1.73	0.20
PC3	TRP, spherical coverage	0.00	Rectangular	1.73	0.00
	EIRP, EIS	0.08	Rectangular	1.73	0.05
PC6	TRP, spherical coverage	FFS	FFS	FFS	FFS
	EIRP, EIS	FFS	FFS	FFS	FFS

B.2.2.27 Influence of noise

See B.2.1.27.

The uncertainty value of influence of noise is estimated as below table and used across clause B.

Editor's Note: For ACLR, all applicable configurations need to be added.

Table B.2.2.27-1: Uncertainty value for influence of noise for PC3, SISO for IFF

Test case	Frequency range	Noise floor	Minimum requirement	Estimated SNR _{total} [dB/400MHz]	Relaxation	Influence of noise
MOP-EIRP	FR2a	N/A	20.7dBm/ChBW (22.4-1.7)	16.33 (NOTE 1)	0	0.1
	FR2b	N/A	18.9dBm/ChBW (20.6-1.7)	11.45 (NOTE 1)	0	0.3
	FR2c	N/A	18.2dBm/ChBW (18.7-0.5)	11.45 (NOTE 1)	0	0.3
MOP-TRP	FR2a	N/A	23dBm/ChBW	16.33 (NOTE 1)	0	0.1
	FR2b, FR2c	N/A	23dBm/ChBW	11.45 (NOTE 1)	0	0.3
MOP-Spherical	FR2a	N/A	9.75dBm/ChBW (Spherical – MBR= 11.5-1.75)	11.45 (NOTE 1)	0	0.3
	FR2b	N/A	7.6dBm/ChBW (Spherical – MBR=8-0.4)	6.37 (NOTE 1)	0	0.9
	FR2c	N/A	5.4dBm/ChBW (Spherical – MBR=5.8-0.4)	5.86 (NOTE 1)	0	1.0
MPR	FR2a	-7.6dBm/400MHz	7.65dBm/ChBW (EIRP-MPB-MPR-T(MPR)=22.4-0.75-9-5)	15.17 (NOTE 1)	0	0.13
	FR2b	-5.5dBm/400MHz	5.85dBm/ChBW (EIRP-MPB-MPR-T(MPR)=20.6-0.75-9-5)	11.30 (NOTE 1)	0	0.31
	FR2c	[-4.5]dBm/400MHz	4.2dBm/ChBW (EIRP-MPB-MPR-T(MPR)=18.7-0.5-9-5)	[8.70] (NOTE 1)	[0]	[0.55]
Configured output power with power boost	FR2a	N/A	21.7dBm/ChBW (22.4-1.7+1)	16.33 (NOTE 1)	0	0.1
	FR2b	N/A	19.9dBm/ChBW (20.6-1.7+1)	11.45 (NOTE 1)	0	0.3
Minimum output power	FR2a	-10.6dBm/400MHz	-13dBm	-2.54 (NOTE 1)	8.4	1.0 (with relaxation)
	FR2b	-5.5dBm/400MHz	-13dBm	-7.64 (NOTE 1)	13.5	1.0 (with relaxation)
	FR2c	[-4.5]dBm/400MHz	-13dBm	[-8.64] (NOTE 1)	[14.5]	[1.0] (with relaxation)
OFF power – TRP	FR2a	N/A	-35dBm/ChBW	-24.54 (NOTE 2)	30.4	1.0 (with relaxation)
	FR2b	N/A		<-24.54 (NOTE 2)	N/A	Propose not to test
OFF power – EIRP	FR2a	-7.6dBm/400MHz	-30dBm/ChBW	-22.54 (NOTE 2)	28.4	1.0 (with relaxation)
	FR2b	-5.5dBm/400MHz		-24.64 (NOTE 2)	30.5	1.0 (with relaxation)
Absolute power tolerance	Same as Minimum output power					
Relative power tolerance	FR2a	-13.6dBm/100MHz	-7.6dBm/100MHz	5.86 (NOTE 1)	0	1.0
	FR2b	-11.5dBm/100MHz	-5.5dBm/100MHz	5.86 (NOTE 1)	0	1.0

Aggregate power tolerance	Same as Relative power tolerance					
Aggregate power tolerance	FR2a	- 13.6dBm/100MHz	- 7.6dBm/100MHz	5.86 (NOTE 1)	0	1.0
	FR2b	- 11.5dBm/100MHz	- 5.5dBm/100MHz	5.86 (NOTE 1)	0	1.0
SEM	FR2a	N/A	-13dBm/1MHz	8.14 (NOTE 1)	0	0.62
	FR2b, FR2c	N/A		5.86 (NOTE 1)	0	1.0
ACLR (CP)	FR2a	-7.6dBm/400MHz	Highest testable MPR for 400MHz: 3dB 16.65dBm/ChBW (EIRP-MPB-MPR-T(MPR)=22.4-0.75-3-2) Actual lowest: 7.65dBm/ChBW (EIRP-MPB-MPR-T(MPR)=22.4-0.75-9-5)	22.86 (with 3dB MPR) (NOTE 1)	0	N/A
	FR2b	-5.5dBm/400MHz	Highest testable MPR for 400MHz: 2dB 16.35dBm/ChBW (EIRP-MPB-MPR-T(MPR)=20.6-0.75-2-1.5) Actual lowest: 5.85dBm/ChBW (EIRP-MPB-MPR-T(MPR)=20.6-0.75-9-5)	21.86 (with 2dB MPR) (NOTE 1)	0	N/A
ACLR (ACP)	FR2a	-7.6dBm/400MHz	Highest testable MPR for 400MHz: 3dB -0.35dBm/ChBW (EIRP-MPB-MPR-T(MPR)-ACLR=22.4-0.75-3-2-17) Actual lowest: -9.35 dBm/ChBW (EIRP-MPB-MPR-T(MPR)-ACLR=22.4-0.75-9-5-17)	5.86 (NOTE 1)	0	1.0

	FR2b	-5.5dBm/400MHz	Highest testable MPR for 400MHz: 2dB 0.35dBm/ChBW (EIRP-MPB-MPR-T(MPR)-ACLR=20.6-0.75-2-1.5-16) Actual lowest: -10.15 dBm/ChBW (EIRP-MPB-MPR-T(MPR)-ACLR=20.6-0.75-9-5-16)	5.86 (with 2dB MPR) (NOTE 1)	0	1.0
General Tx spurious	6GHz <=f<=23.45GHz	N/A	-13dBm/1MHz	10.0 (NOTE 1)	0	0.41
	23.45GHz<=f<=40GHz	N/A	-13dBm/1MHz	10.0 (NOTE 1)	0	
	40GHz<=f<=80GHz	N/A	-13dBm/1MHz	10.0 (NOTE 1)	0	
	80GHz<f<=87GHz	N/A	-13dBm/1MHz	6.8 (NOTE 1)	0	
Tx spurious Co-existence	n260 (Aggressor band : n257, n261)	-23	-2dBm/100MHz (-22dBm/MHz)	0.86 (NOTE 2)	5	1.0 (with relaxation)
	n257, n261 (Aggressor band : n260)	-27.7	-5dBm/100MHz (-25dBm/MHz)	2.56 (NOTE 2)	3.3	1.0 (with relaxation)
	23.6 GHz ≤ f ≤ 24.0GHz	-27.7	1dBm/200MHz (-22 dBm/MHz)	5.56 (NOTE 2)	0.3	1.0 (with relaxation)
	36 GHz ≤ f ≤ 37GHz	-23dBm/MHz	7dBm/1000MHz (-23dBm/MHz)	-0.14 (NOTE 2)	6	1.0 (with relaxation)
	57 GHz ≤ f ≤ 66GHz	N/A	2dBm/100MHz (-18dBm/MHz)	5.86 (NOTE 1)	0	1.0
Additional spurious emission	NS_202 (7.25GHz <=f <=12.75GHz)	-40 dBm/MHz	-10dBm/100MHz (-30 dBm/MHz)	10 (NOTE 1)	0	0.41
	NS_202 (12.75GHz <=f <=23.45GHz)	-23 dBm/MHz	-10dBm/100MHz (-30 dBm/MHz)	-7.14 (NOTE 2)	13	1.0 (with relaxation)
	NS_202 (23.6GHz <=f <=24.0GHz)	-27.7 dBm/MHz	1dBm/200MHz (-22 dBm/MHz)	5.56 (NOTE 2)	0.3	1.0 (with relaxation)
	NS_202 (23.45GHz <=f <=40.8GHz)	-23 dBm/MHz	-10dBm/100MHz (-30 dBm/MHz)	-7.14 (NOTE 2)	13	1.0 (with relaxation)
	NS_202 (40.8GHz <=f <=66GHz)	-23 dBm/MHz	-10dBm/100MHz (-30 dBm/MHz)	-7.14 (NOTE 2)	13	1.0 (with relaxation)
	NS_203 (23.6GHz <=f <=24.0GHz)	-27.7 dBm/MHz	+1dBm/200MHz (-22dBm/MHz)	5.56 (NOTE 2)	0.3	1.0 (with relaxation)
Rx spurious	6GHz <=f<=20GHz		-47dBm/1MHz	-2.2 (NOTE 3)	10.2	1.0 dB for 23.45~40.8GHz and 80~87 GHz, 0.64dB for 6~23.45 and 40.8~80 GHz.
	20GHz<=f<=40GHz		-47dBm/1MHz	-11.34 (NOTE 2)	17.2	
	40GHz<=f<=80GHz		-47dBm/1MHz	-25.1 (NOTE 3)	33.1	
	80GHz<f<=87GHz		-47dBm/1MHz	-27.1 (NOTE 2)	33.1	

NOTE 1: Estimated SNR is calculated based on agreed influence of noise.

NOTE 2: Estimated SNR is calculated based on agreed relaxation value: Estimated SNR = 6dB - relaxation.

NOTE 3: Estimated SNR is calculated based on agreed relaxation value: Estimated SNR = 8dB - relaxation.

Table B.2.2.27-1a: Uncertainty value for influence of noise for PC3, MIMO for IFF

Test case	Frequency range	Noise floor	Minimum requirement	Estimated SNR _{total} [dB/400MHz]	Relaxation	Influence of noise
MOP-EIRP	FR2a	N/A	22.4 dBm/ChBW	16.33 (NOTE 1)	0	0.1
	FR2b	N/A	20.6 dBm/ChBW	11.45 (NOTE 1)	0	0.3
	FR2c	N/A	18.7 dBm/ChBW	11.45 (NOTE 1)	0	0.3
MOP-TRP	FR2a	N/A	23 dBm/ChBW	16.33 (NOTE 1)	0	0.1
	FR2b, FR2c	N/A	23 dBm/ChBW	11.45 (NOTE 1)	0	0.3
MOP-Spherical	FR2a	N/A	11.5 dBm/ChBW	11.45 (NOTE 1)	0	0.3
	FR2b	N/A	8 dBm/ChBW	6.37 (NOTE 1)	0	0.9
Minimum output power	FR2a	-10.6dBm/400MHz	-10 dBm	-0.46 (NOTE 1)	5.4	1.0 (with relaxation)
	FR2b	-5.5dBm/400MHz	-10 dBm	-4.64 (NOTE 1)	10.5	1.0 (with relaxation)
OFF power – TRP	FR2a	N/A	-35dBm/ChBW	-24.54 (NOTE 2)	30.4	1.0 (with relaxation)
	FR2b	N/A		<-24.54 (NOTE 2)	N/A	Propose not to test

NOTE 1: Estimated SNR is calculated based on agreed influence of noise.

Table B.2.2.27-2: Uncertainty value for influence of noise for PC1, SISO for IFF

Test case	Frequency range	Relaxation [dB]	Influence of noise [dB]
MOP-EIRP	FR2a	0	0.13
	FR2b	0	0.2
MOP-TRP	FR2a	0	0.13
	FR2b	0	0.27
MOP-Spherical	FR2a	0	0.2
	FR2b	0	0.35
MPR	FR2a	0	0.13
	FR2b	0	0.3
Minimum output power	FR2a	0	0.3
	FR2b	0	0.6
OFF power – TRP	FR2a	Same as defined for PC3 in Table B.2.2.27-1	
	FR2b	Same as defined for PC3 in Table B.2.2.27-1	
SEM	FR2a	0	1.81 (NOTE 1, 2)
	FR2b	0	TBD
ACLR (ACP)	FR2a	0	0.95
	FR2b	0	0.95
General Tx spurious	6GHz <=f<12.75GHz	Same as defined for PC3 in Table B.2.2.27-1	
	12.75GHz<=f<66GHz	0	1.08 (NOTE 1, 3)
	66GHz<=f<=80GHz	Same as defined for PC3 in Table B.2.2.27-1	
Tx spurious Co-existence	n260 (Aggressor band : n257, n261)	5 (Same as PC3)	2.34 (NOTE 1, 4)
	n257, n261 (Aggressor band : n260)	3.3 (Same as PC3)	2.34 (NOTE 1, 4)
	23.6 GHz ≤ f ≤ 24.0GHz	0.3 (Same as PC3)	2.34 (NOTE 1, 4)
	57 GHz ≤ f ≤ 66GHz	Same as defined for PC3 in Table B.2.2.27-1	
Additional spurious emission	NS_202 (7.25GHz <=f <=12.75GHz)		
	NS_202 (12.75GHz <=f <=23.45GHz)	13 (Same as PC3)	2.34 (NOTE 1, 4)
	NS_202, NS_203 (23.6 GHz ≤ f ≤ 24.0GHz)	0.3 (Same as PC3)	2.34 (NOTE 1, 4)
	NS_202 (23.45GHz <=f <=40.8GHz)	13 (Same as PC3)	2.34 (NOTE 1, 4)
	NS_202 (40.8GHz <=f <=66GHz)	13 (Same as PC3)	2.34 (NOTE 1, 4)
Rx spurious	6GHz <=f<=20GHz	Same as defined for PC3 in Table B.2.2.27-1	
	20GHz<=f<=40GHz	Same as defined for PC3 in Table B.2.2.27-1	
	40GHz<=f<=80GHz	Same as defined for PC3 in Table B.2.2.27-1	

NOTE 1: values assuming up to 6% of grid points with EIRP > 43dBm.
NOTE 2: values assuming SNR = -7.9dB for points with EIRP > 43dBm / SNR = 8.14dB otherwise.
NOTE 3: values assuming SNR = -5dB for points with EIRP > 43dBm / SNR = 10dB otherwise.
NOTE 4: values assuming SNR = -9dB for points with EIRP > 43dBm / SNR = 6dB otherwise and considering the proposed relaxation.

Table B.2.2.27-2a: Uncertainty value for influence of noise for PC1, MIMO for IFF

Test case	Frequency range	Relaxation [dB]	Influence of noise [dB]
MOP-EIRP	FR2a	0	0.13
	FR2b	0	0.2
MOP-TRP	FR2a	0	0.13
	FR2b	0	0.27
MOP-Spherical	FR2a	0	0.2
	FR2b	0	0.35
Minimum output power	FR2a	0	0.15
	FR2b	0	0.3

Table B.2.2.27-3: Uncertainty value for influence of noise for PC5, SISO for IFF

Test case	Frequency range	Relaxation [dB]	Influence of noise [dB]
MOP-EIRP	FR2a	0	0.13
MOP-TRP	FR2a	0	0.13
MOP-Spherical	FR2a	0	0.2
MPR	FR2a	0	0.13
Minimum output power	FR2a	1.4dB for 400MHz 0dB otherwise	1
ACLR (ACP)	FR2a	0	0.95

Table B.2.2.27-3a: Uncertainty value for influence of noise for PC5, MIMO for IFF

Test case	Frequency range	Relaxation [dB]	Influence of noise [dB]
MOP-EIRP	FR2a	0	0.13
MOP-TRP	FR2a	0	0.13
MOP-Spherical	FR2a	0	0.2

Table B.2.2.27-4: Uncertainty value for influence of noise for PC6 for IFF

Test case	Frequency range	Relaxation	Influence of noise
MOP-EIRP	FR2a	FFS	FFS
MOP-TRP	FR2a	FFS	FFS
MOP-Spherical	FR2a	FFS	FFS
MPR	FR2a	FFS	FFS
Minimum output power	FR2a	FFS	FFS
OFF power – TRP	FR2a	FFS	
SEM	FR2a	FFS	FFS
ACLR (ACP)	FR2a	FFS	FFS
	12.75GHz<=f<66GHz	FFS	FFS
Tx spurious Co-existence	n260 (Aggressor band : n257, n261)	FFS	FFS
	n257, n261 (Aggressor band : n260)	FFS	FFS
	23.6 GHz ≤ f ≤ 24.0GHz	FFS	FFS
Additional spurious emission	23.6 GHz ≤ f ≤ 24.0GHz	FFS	FFS
	20GHz<=f<=40GHz	FFS	

B.2.2.28 Systematic error related to beam peak search

See B.2.1.28.

The uncertainty value of systematic error related to beam peak search is estimated as below table and used across clause B.

Table B.2.2.28-1: Uncertainty value for systematic error related to beam peak search for IFF

Power class	Uncertainty value
PC1, PC5	0.7
PC3	0.5
PC6	FFS

B.2.2.29 Influence of spherical coverage grid

See B.2.1.29.

The uncertainty value of influence of spherical coverage grid is estimated as below table and used across clause B.

Table B.2.2.29-1: Uncertainty value for influence of spherical coverage grid for IFF

Power class	Uncertainty value	Distribution of the probability	Divisor	Standard uncertainty (σ) [dB]
PC1, PC5	0.13	Actual	1.00	0.13
PC3	0.12	Actual	1.00	0.12
PC6	FFS	Actual	FFS	FFS

B.2.2.30 Systematic error related to EIS spherical coverage

See B.2.1.30.

The uncertainty value of systematic error related to EIS spherical coverage is estimated as below table and used across clause B.

Table B.2.2.30-1: Uncertainty value for systematic error related to EIS spherical coverage for IFF

Power class	Uncertainty value
PC1, PC5	DL power step size, 0.2
PC3	DL power step size, 0.2
PC6	DL power step size, 0.2

B.2.2.31 Misalignment of DUT due to change of DUT orientation

See B.2.1.31.

The uncertainty value of misalignment of DUT due to change of DUT orientation is estimated as below table and used across clause B.

Table B.2.2.31-1: Uncertainty value for misalignment of DUT due to change of DUT orientation for IFF

Power class	Uncertainty value	Distribution of the probability	Divisor	Standard uncertainty (σ) [dB]
PC1, PC5	0.10	Actual	1.00	0.10
PC3	0.10	Actual	1.00	0.10
PC6	0.10	Actual	1.00	0.10

B.2.2.32 Additional Impact of Interferer ACLR

See B.2.1.32.

The uncertainty value of additional Impact of Interferer ACLR is estimated as below table and used across clause B.

Table B.2.2.32-1: Uncertainty value for additional Impact of Interferer ACLR for IFF

Power class	Uncertainty value
PC1, PC3, PC5, PC6	0.7

B.2.2.33 Modulated Interferer uncertainty

See B.2.1.33.

The uncertainty value of modulated Interferer uncertainty is estimated as below table and used across clause B.

Table B.2.2.33-1: Uncertainty value for modulated Interferer uncertainty for IFF

Power class	Uncertainty value	Frequency range	Distribution of the probability	Divisor	Standard uncertainty (σ) [dB]
PC1, PC5	2.9	FR2a, FR2b	Normal	2.00	1.45
PC3	2.9	FR2a, FR2b	Normal	2.00	1.45
	3.6	FR2c	Normal	2.00	1.8
PC6	2.9	FR2a, FR2b	Normal	2.00	1.45

B.2.2.34 Void

B.2.2.35 Influence of offset antenna for blocker signal

See B.2.1.35.

B.2.2.36 Uncertainty of the RF relative power measurement equipment

See B.2.1.36.

The uncertainty value of uncertainty of the RF relative power measurement equipment is estimated as below table and used across clause B.

Table B.2.2.36-1: Uncertainty value for uncertainty of the RF relative power measurement equipment for IFF

Power class	Uncertainty value	Distribution of the probability	Divisor	Standard uncertainty (σ) [dB]
PC1	TBD	Normal	2	TBD
PC3	[0.4]	Normal	2	[0.2]
PC6	TBD	Normal	2	TBD

B.2.3 Measurement error contribution descriptions for NFTF

B.2.3.1 Axes Alignment

Includes the following mechanical alignment errors:

- The uncertainty related with the lateral displacement between the horizontal and vertical axes of the DUT positioner.
- The differences from 90° of the angle between the horizontal and vertical axes.
- The horizontal mis-pointing of the horizontal axis to the probe reference point for $\Theta=0^\circ$.

These mechanical errors can result in sampling the field on a non-ideal sphere. This uncertainty can be considered to have a normal distribution.

B.2.3.2 Measurement Distance uncertainty

See B.2.1.2.

B.2.3.3 Quality of the Quiet Zone

See B.2.1.3.

B.2.3.4 Mismatch

See B.2.1.4.

B.2.3.5 Multiple Reflections: Coupling Measurement Antenna and DUT

The multiple reflections occur when a portion of the transmitted signal is reflected from the receiving antenna back to the transmitting antenna and re-reflected by the transmitting antenna back to the receiving antenna. This uncertainty can be determined by multiple measurements of the DUT when at different distance from the probes. This uncertainty is assumed to have a U-shaped distribution.

B.2.3.6 Uncertainty of the RF power measurement equipment

See B.2.1.6.

B.2.3.7 Phase curvature

See B.2.1.7.

B.2.3.8 Amplifier uncertainties

See B.2.1.8.

B.2.3.9 Random uncertainty

See B.2.1.9.

B.2.3.10 Influence of the XPD

Refer to B.2.1.10. If the Probe Polarization Amplitude and Phase is measured and corrected for then this uncertainty term can be considered to be zero.

B.2.3.11 NF to FF truncation

The measured near field is expanded using a finite set of spherical modes. The number of modes is linked to number of samples. The filtering effect generated by the finite number of modes can improve measurement results by removing signals from outside the physical area of the DUT. Care must be taken in order to make sure the removed signals are not from the DUT itself. This term also includes the uncertainty related to the scan area truncation. This uncertainty is usually negligible. This uncertainty is assumed to have a normal distribution.

B.2.3.12 Probe Polarization Amplitude and Phase

The amplitude and phase of the probe polarization coefficients should be measured. This uncertainty is assumed to have a normal distribution.

B.2.3.13 Probe Array Uniformity (for multi-probe systems only)

This is the uncertainty due to the fact that different probes are used for each physical position. Different probes have different radiation patterns. Generally, the probe array is calibrated so that the uniformity of the probes is achieved. This uncertainty term must be considered if the amplitude and phase of each probe is not identical or corrected for. This uncertainty is assumed to have a normal distribution

B.2.3.14 Uncertainty of the Network Analyzer

See B.2.1.14.

B.2.3.15 Uncertainty of the absolute gain of the calibration antenna

See B.2.1.15.

B.2.3.16 Phase Recovery Non-Linearity over signal bandwidth

This uncertainty originates from the non-linearity of the phase recovery for wide band signal. The phase recovery can be due to either phase non-linearity of the receiver and/or the DUT itself. The method to quantify the non-linearities is not defined.

B.2.3.17 Probe Pattern Effect

The probe/s pattern/s is assumed to be known so that the DUT measurement in near field can be corrected when performing the near field to far field transform. If the probe pattern is known, then the uncertainty term is zero. There is no direct dependence between the DUT pattern and the probe pattern in near field measurements. This uncertainty is assumed to have a normal distribution.

B.2.3.18 Phase centre offset of calibration

See B.2.1.18.

B.2.3.19 Quality of the Quiet Zone for Calibration Process

See B.2.1.19.

B.2.3.20 Phase Drift and Noise

This uncertainty is due to the noise level and drift of the test range and should be determined or measured at the DUT location. The noise level is usually measured with a Spectrum Analyzer. This uncertainty is assumed to have a normal distribution.

B.2.3.21 Mismatch in the connection of the calibration antenna

See B.2.1.4.

B.2.3.22 Influence of TRP measurement grid

See B.2.1.22.

B.2.3.23

B.2.3.24

B.2.3.25 Leakage and Crosstalk

This uncertainty can be addressed by measurements on the actual system setup. The leakage and crosstalk cannot be separated from the random amplitude and phase errors so that the relative importance should be determined. This uncertainty is assumed to have a normal distribution.

B.2.3.26 Systematic error due to TRP calculation/quadrature

See B.2.1.24.

B.2.3.27 Multiple measurement antenna uncertainty

See B.2.1.25.

B.2.3.28 DUT repositioning

See B.2.1.26.

B.2.3.29 Influence of noise

See B.2.1.27.

B.2.3.30 Uncertainty of the RF relative power measurement equipment

See B.2.1.36.

B.3 UE maximum output power

Following tables summarize the MU threshold for EIRP and TRP measurements for UE maximum output power. The origin MU values for different test setups with varies parameters can be found in following clauses.

Table B.3-1: MU threshold for EIRP measurement for UE maximum output power

Power Class	Diversity	Frequency	MBW	Power (NOTE2)	Threshold MU value for NTC [dB] (NOTE1)	Threshold MU value for ETC [dB] (NOTE1)
PC3	SISO, MIMO	23.45GHz <= f <= 32.125GHz	BW <= 400MHz	P = Max Output Power	5.08	5.35
		32.125GHz < f <= 40.8GHz			5.28	5.55
		40.8GHz < f <= 44.3GHz			6.64	6.78
PC1	SISO, MIMO	23.45GHz <= f <= 32.125GHz	BW <= 400MHz	P = Max Output Power	5.33	5.60
		32.125GHz < f <= 40.8GHz			5.40	5.67
PC5	SISO, MIMO	23.45GHz <= f <= 32.125GHz	BW <= 400MHz	P = Max Output Power	5.33	5.60
NOTE 1: Total EIRP Expanded MU for IFF for Quiet Zone size ≤30cm in Table B.3.2-2 for PC3 UEs (NTC), in Table B.3.2-8 for PC3 UEs (ETC) and B.3.2-6 (NTC) and B.3.2-9 (ETC) for PC1 and PC5 UEs.						
NOTE 2: Max output power level for device with corresponding power class.						

Table B.3-2: MU threshold for TRP measurement for UE maximum output power

Power Class	Diversity	Frequency	MBW	Power (NOTE2)	Threshold MU value for NTC [dB] (NOTE 1)	Threshold MU value for ETC [dB] (NOTE 1)
PC3	SISO, MIMO	23.45GHz <= f <= 32.125GHz	BW <= 400MHz	P = Max Output Power	4.61	4.87
		32.125GHz < f <= 40.8GHz			4.81	5.07
		40.8GHz < f <= 44.3GHz			6.16	TBD
PC1	SISO, MIMO	23.45GHz <= f <= 32.125GHz	BW <= 400MHz	P = Max Output Power	4.64	4.90
		32.125GHz < f <= 40.8GHz			4.78	5.04
PC5	SISO, MIMO	23.45GHz <= f <= 32.125GHz	BW <= 400MHz	P = Max Output Power	4.64	4.90
NOTE 1: Total TRP Expanded MU for IFF for Quiet Zone size ≤ 30cm in Table B.3.2-2 for PC3 UEs (NTC), in Table B.3.2-8 for PC3 UEs (ETC) and B.3.2-6 (NTC) and B.3.2-9 (ETC) for PC1 and PC5 UEs.						
NOTE 2: Max output power level for device with corresponding power class.						

Table B.3-3: MU threshold for Spherical coverage measurement for UE maximum output power

Power Class	Diversity	Frequency	MBW	Power	Threshold MU value (NOTE 1)
PC3	SISO, MIMO	23.45GHz <= f <= 32.125GHz	BW <= 400MHz	P = TBD	4.78
		32.125GHz < f <= 40.8GHz			5.38
		40.8GHz < f <= 44.3GHz			6.84
PC1	SISO, MIMO	23.45GHz <= f <= 32.125GHz	BW <= 400MHz	P = TBD	4.69
		32.125GHz < f <= 40.8GHz			4.84
PC5	SISO, MIMO	23.45GHz <= f <= 32.125GHz	BW <= 400MHz	P = TBD	4.69
NOTE 1: Total Spherical coverage Expanded MU for IFF for Quiet Zone size ≤ 30cm in Tables B.3.2-4 for PC3 UEs and B.3.2-7 for PC1 and PC5 UEs					

B.3.1 Uncertainty budget format and assessment for DFF

The uncertainty contributions that may impact the overall MU value are listed in Table B.3.1-1.

Table B.3.1-1: Uncertainty contributions for EIRP and TRP measurement

UID	Description of uncertainty contribution	Details in annex
Stage 2: DUT measurement		
1	Positioning misalignment	B.2.1.1
2	Measure distance uncertainty	B.2.1.2
3	Quality of quiet zone	B.2.1.3
4	Mismatch	B.2.1.4
5	Standing Wave Between the DUT and measurement antenna	B.2.1.5
6	Uncertainty of the RF power measurement equipment	B.2.1.6
7	Phase curvature	B.2.1.7
8	Amplifier uncertainties	B.2.1.8
9	Random uncertainty	B.2.1.9
10	Influence of the XPD	B.2.1.10
11	Insertion Loss Variation	B.2.1.11
12	RF leakage (from measurement antenna to the receiver/transmitter)	B.2.1.12
13	Influence of TRP measurement grid	B.2.1.22
14	Influence of beam peak search grid	B.2.1.23
15	Multiple measurement antenna uncertainty	B.2.1.25
16	DUT repositioning	B.2.1.26
17	Influence of spherical coverage grid	B.2.1.29
Stage 1: Calibration measurement		
18	Mismatch	B.2.1.4
19	Amplifier uncertainties	B.2.1.8
20	Misalignment of positioning System	B.2.1.13
21	Uncertainty of the Network Analyzer	B.2.1.14
22	Uncertainty of the absolute gain of the calibration antenna	B.2.1.15
23	Positioning and pointing misalignment between the reference antenna and the measurement antenna	B.2.1.16
24	Phase centre offset of calibration antenna	B.2.1.18
25	Quality of quiet zone for calibration process	B.2.1.19
26	Standing wave between reference calibration antenna and measurement antenna	B.2.1.20
27	Influence of the calibration antenna feed cable	B.2.1.21
28	Insertion Loss Variation	B.2.1.11
Systematic uncertainties		
29	Systematic error due to TRP calculation/quadrature	B.2.1.24
30	Influence of noise	B.2.1.27
31	Systematic error related to beam peak search	B.2.1.28

The uncertainty assessment tables are organized as follows:

- For the purpose of uncertainty assessment, the radiating antenna aperture of the DUT is denoted as D

- The uncertainty assessment has been derived for the case of $D = [5 \text{ cm}]$, $f = \{22.65\text{GHz}, 31.1\text{GHz}, 45.1\text{GHz}\}$, $P = [\text{maximum output power}]$.
- The uncertainty assessment for EIRP and TRP is provided in Table B.3.1-2.

Table B.3.1-2: Uncertainty assessment for EIRP and TRP measurement (f=TBD, D=TBD)

UID	Uncertainty source	Uncertainty value	Distribution of the probability	Divisor	Standard uncertainty (σ) [dB]
Stage 2: DUT measurement					
1	Positioning misalignment				
2	Measure distance uncertainty				
3	Quality of quiet zone (NOTE 2)				
4	Mismatch (NOTE 3)				
5	Standing Wave Between the DUT and measurement antenna				
6	Uncertainty of the RF power measurement equipment (NOTE 4)				
7	Phase curvature				
8	Amplifier uncertainties				
9	Random uncertainty				
10	Influence of the XPD				
11	Insertion Loss Variation				
12	RF leakage (from measurement antenna to the receiver/transmitter)				
13	Influence of TRP measurement grid (NOTE 5)	0.25	Actual	1	0.25
14	Influence of beam peak search grid (NOTE 6)	0.0	Actual	1	0.0
15	Multiple measurement antenna uncertainty				
16	DUT repositioning				
17	Influence of spherical coverage grid (NOTE 8)	0.12	Actual	1	0.12
Stage 1: Calibration measurement					
18	Mismatch				
19	Amplifier uncertainties				
20	Misalignment of positioning System				
21	Uncertainty of the Network Analyzer				
22	Uncertainty of the absolute gain of the calibration antenna				
23	Positioning and pointing misalignment between the reference antenna and the measurement antenna				
24	Phase centre offset of calibration antenna				
25	Quality of quiet zone for calibration process (NOTE 2)				
26	Standing wave between reference calibration antenna and measurement antenna				
27	Influence of the calibration antenna feed cable				
28	Insertion Loss Variation				
Systematic uncertainties (NOTE 7)					Value
29	Systematic error due to TRP calculation/quadrature (NOTE 5)				0.00
30	Influence of noise				
31	Systematic error related to beam peak search (NOTE 6)				0.5
Total measurement uncertainty					Value
EIRP Expanded uncertainty (1.96 σ – confidence interval of 95 %) [dB]					TBD
TRP Expanded uncertainty (1.96 σ – confidence interval of 95 %) [dB]					TBD

NOTE 1:	The impact of phase variation on EIRP shall be taken into account during final MU definition for the test method.
NOTE 2:	The quality of quiet zone is different for EIRP and TRP in normal temperature conditions. For TRP, the standard uncertainty is FFS; for EIRP, the standard uncertainty of quiet zone is FFS.
NOTE 3:	The analysis was done only for the case of operating at max output power, in-band, non-CA.
NOTE 4:	The assessment assumes maximum DUT output power.
NOTE 5:	This contributor shall only be considered for TRP measurements.
NOTE 6:	This contributor shall only be considered for EIRP measurements.
NOTE 7:	In order to obtain the total measurement uncertainty, systematic uncertainties have to be added to the expanded root sum square of the standard deviations of the Stage 1 and Stage 2 contributors.
NOTE 8:	This contributor shall only be considered for spherical EIRP measurements

B.3.2 Uncertainty budget format and assessment for IFF

The uncertainty contributions that may impact the overall MU value are listed in Table B.3.2-1.

Table B.3.2-1: Uncertainty contributions for EIRP and TRP measurement

UID	Description of uncertainty contribution	Details in clause
Stage 2: DUT measurement		
1	Positioning misalignment	B.2.2.1
2	Measure distance uncertainty	B.2.2.2
3	Quality of Quiet Zone	B.2.2.3
4	Mismatch	B.2.2.4
5	Standing wave between the DUT and measurement antenna	B.2.2.5
6	Uncertainty of the RF power measurement equipment	B.2.2.6
7	Phase curvature	B.2.2.7
8	Amplifier uncertainties	B.2.2.8
9	Random uncertainty	B.2.2.9
10	Influence of the XPD	B.2.2.10
11	Insertion Loss Variation	B.2.2.11
12	RF leakage (from measurement antenna to the receiver/transmitter)	B.2.2.12
13	Influence of TRP measurement grid	B.2.2.22
14	Influence of beam peak search grid	B.2.2.23
15	Multiple measurement antenna uncertainty	B.2.2.25
16	DUT repositioning	B.2.2.26
17	Influence of spherical coverage grid	B.2.2.29
Stage 1: Calibration measurement		
18	Mismatch	B.2.2.4
19	Amplifier Uncertainties	B.2.2.8
20	Misalignment of positioning System	B.2.2.13
21	Uncertainty of the Network Analyzer	B.2.2.14
22	Uncertainty of the absolute gain of the calibration antenna	B.2.2.15
23	Positioning and pointing misalignment between the reference antenna and the measurement antenna	B.2.2.16
24	Phase centre offset of calibration antenna	B.2.2.18
25	Quality of quiet zone for calibration process	B.2.2.19
26	Standing wave between reference calibration antenna and measurement antenna	B.2.2.20
27	Influence of the calibration antenna feed cable	B.2.2.21
28	Insertion Loss Variation	B.2.1.11
Systematic uncertainties		
29	Systematic error due to TRP calculation/quadrature	B.2.2.24
30	Influence of noise	B.2.1.27
31	Systematic error related to beam peak search	B.2.2.28

The uncertainty assessment tables are organized as follows:

- For the purpose of uncertainty assessment, the radiating antenna aperture of the DUT is denoted as D

- The uncertainty assessment has been derived for the case of Quiet Zone size $\leq [30 \text{ cm}]$, $f = \{23.45\text{GHz}, 32.125\text{GHz}, 40.8\text{GHz}, 44.3\text{GHz}\}$, [$P = \text{maximum output power}$].
- The uncertainty assessment for EIRP and TRP in normal temperature conditions is provided in Table B.3.2-2 for PC3 UEs and in Table B.3.2-6 for PC1 and PC5 UEs.
- The uncertainty assessment for EIRP and TRP in extreme temperature conditions is provided in Table B.3.2-8 for PC3 UEs and in Table B.3.2-9 for PC1 and PC5 UEs.
- The uncertainty assessment for Spherical coverage is provided in Table B.3.2-4 for PC3 UEs in Table B.3.2-7 for PC1 and PC5 UEs.

Table B.3.2-2: Uncertainty assessment for EIRP and TRP measurement (f=23.45GHz, 32.125GHz, 40.8GHz, 44.3GHz, Quiet Zone size \leq 30 cm) for PC3 UEs and normal temperature condition

UID	Uncertainty source	Uncertainty value	Distribution of the probability	Divisor	Standard uncertainty (σ) [dB]
Stage 2: DUT measurement					
1	Positioning misalignment	0.00	Normal	2.00	0.00
2	Measure distance uncertainty	0.00	Rectangular	1.73	0.00
3	Quality of Quiet Zone (NOTE 1) (23.45GHz \leq f \leq 40.8GHz)	0.6	Actual	1.00	0.6
3	Quality of Quiet Zone (NOTE 1) (40.8GHz < f \leq 44.3GHz)	0.7	Actual	1.00	0.7
4	Mismatch (23.45GHz \leq f \leq 40.8GHz)	1.30	Actual	1.00	1.30
4	Mismatch (40.8GHz < f \leq 44.3GHz)	1.70	Actual	1.00	1.70
5	Standing wave between the DUT and measurement antenna	0.00	U-shaped	1.41	0.00
6	Uncertainty of the RF power measurement equipment (NOTE 3) (23.45GHz \leq f \leq 40.8GHz)	2.16	Normal	2.00	1.08
6	Uncertainty of the RF power measurement equipment (NOTE 3) (40.8GHz < f \leq 44.3GHz)	3.6	Normal	2.00	1.8
7	Phase curvature	0.00	U-shaped	1.41	0.00
8	Amplifier uncertainties	2.10	Normal	2.00	1.05
9	Random uncertainty	0.50	Normal	2.00	0.25
10	Influence of the XPD	0.01	U-shaped	1.41	0.00
11	Insertion Loss Variation	0.00	Rectangular	1.73	0.00
12	RF leakage (from measurement antenna to the receiver/transmitter)	0.00	Actual	1.00	0.00
13	Influence of TRP measurement grid (NOTE 4)	0.25	Actual	1	0.25
14	Influence of beam peak search grid (NOTE 5)	0.00	Actual	1	0.00
15	Multiple measurement antenna uncertainty (NOTE 9)	0.15	Actual	1	0.15
16	DUT repositioning	0.00 (NOTE 4) 0.08 (NOTE 5)	Rectangular	1.73	0.00 (NOTE 4) 0.05 (NOTE 5)
Stage 1: Calibration measurement					
17	Mismatch	0.00	U-shaped	1.41	0.00
18	Amplifier Uncertainties	0.00	Normal	2.00	0.00
19	Misalignment of positioning System	0.00	Normal	2.00	0.00
20	Uncertainty of the Network Analyzer (23.45GHz \leq f \leq 40.8GHz)	1.50	Normal	2.00	0.75
20	Uncertainty of the Network Analyzer (40.8GHz < f \leq 44.3GHz)	1.70	Normal	2.00	0.85
21	Uncertainty of the absolute gain of the calibration antenna	0.60	Normal	2.00	0.30
22	Positioning and pointing misalignment between the reference antenna and the measurement antenna	0.01	Rectangular	1.73	0.00
23	Phase centre offset of calibration antenna	0.00	Rectangular	1.73	0.00
24	Quality of quiet zone for calibration process (NOTE 1) (23.45GHz \leq f \leq 40.8GHz)	0.4	Actual	1.00	0.4
24	Quality of quiet zone for calibration process (NOTE 1) (40.8GHz < f \leq 44.3GHz)	0.5	Actual	1.00	0.5
25	Standing wave between reference calibration antenna and measurement antenna	0.00	U-shaped	1.41	0.00

26	Influence of the calibration antenna feed cable	0.14	Normal	2.00	0.07
27	Insertion Loss Variation	0.00	Rectangular	1.73	0.00
Systematic uncertainties (NOTE 6)					Value
28	Systematic error due to TRP calculation/quadrature (NOTE 4)				0.00
29	Influence of noise (23.45GHz <= f <= 32.125GHz)				0.1
29	Influence of noise (32.125GHz < f <= 40.8GHz)				0.3
29	Influence of noise (40.8GHz < f <= 44.3GHz)				0.3
30	Systematic error related to beam peak search (NOTE 5)				0.5
Total measurement uncertainty					Value
EIRP Expanded uncertainty (23.45GHz <= f <= 32.125GHz) (1.96σ - confidence interval of 95 %) [dB]					5.08
EIRP Expanded uncertainty (32.125GHz < f <= 40.8GHz) (1.96σ - confidence interval of 95 %) [dB]					5.28
EIRP Expanded uncertainty (40.8GHz < f <= 44.3GHz) (1.96σ - confidence interval of 95 %) [dB]					6.64
TRP Expanded uncertainty (23.45GHz <= f <= 32.125GHz) (1.96σ - confidence interval of 95 %) [dB]					4.61
TRP Expanded uncertainty (32.125GHz < f <= 40.8GHz) (1.96σ - confidence interval of 95 %) [dB]					4.81
TRP Expanded uncertainty (40.8GHz < f <= 44.3GHz) (1.96σ - confidence interval of 95 %) [dB]					6.16
NOTE 1: The quality of quiet zone is the same for EIRP and TRP. Value based on procedure defined in clause D.2 of TR 38.810 for Quiet Zone size less or equal to 30 cm.					
NOTE 2: The analysis was done only for the case of operating at max output power, in-band, non-CA and is valid for SISO and MIMO.					
NOTE 3: The assessment assumes maximum DUT output power.					
NOTE 4: This contributor shall only be considered for TRP measurements.					
NOTE 5: This contributor shall only be considered for EIRP measurements.					
NOTE 6: In order to obtain the total measurement uncertainty, systematic uncertainties have to be added to the expanded root sum square of the standard deviations of the Stage 1 and Stage 2 contributors.					
NOTE 7: Void.					
NOTE 8: Void					
NOTE 9: Applies to the system which has a structure of mechanical feed antenna positioning.					

Table B.3.2-3: Void

Table B.3.2-4: Uncertainty assessment for Spherical coverage measurement (f=23.45GHz, 32.125GHz, 40.8GHz, 44.3GHz, Quiet Zone size \leq 30 cm) for PC3 UEs and normal temperature condition

UID	Uncertainty source	Uncertainty value	Distribution of the probability	Divisor	Standard uncertainty (σ) [dB]
Stage 2: DUT measurement					
1	Positioning misalignment	0.00	Normal	2.00	0.00
2	Measure distance uncertainty	0.00	Rectangular	1.73	0.00
3	Quality of Quiet Zone (NOTE 1) (23.45GHz \leq f \leq 40.8GHz)	0.6	Actual	1.00	0.6
3	Quality of Quiet Zone (NOTE 1) (40.8GHz < f \leq 44.3GHz)	0.7	Actual	1.00	0.7
4	Mismatch (23.45GHz \leq f \leq 40.8GHz)	1.30	Actual	1.00	1.30
4	Mismatch (40.8GHz < f \leq 44.3GHz)	1.70	Actual	1.00	1.70
5	Standing wave between the DUT and measurement antenna	0.00	U-shaped	1.41	0.00
6	Uncertainty of the RF power measurement equipment (NOTE 3) (23.45GHz \leq f \leq 40.8GHz)	2.16	Normal	2.00	1.08
6	Uncertainty of the RF power measurement equipment (NOTE 3) (40.8GHz < f \leq 44.3GHz)	3.6	Normal	2.00	1.8
7	Phase curvature	0.00	U-shaped	1.41	0.00
8	Amplifier uncertainties	2.1	Normal	2.00	1.05
9	Random uncertainty	0.50	Normal	2.00	0.25
10	Influence of the XPD	0.01	U-shaped	1.41	0.00
11	Insertion Loss Variation	0.00	Rectangular	1.73	0.00
12	RF leakage (from measurement antenna to the receiver/transmitter)	0.00	Actual	1.00	0.00
13	Multiple measurement antenna uncertainty (NOTE 5)	0.15	Actual	1	0.15
14	DUT repositioning	0.00	Rectangular	1.73	0.00
15	Influence of spherical coverage grid	0.12	Actual	1	0.12
Stage 1: Calibration measurement					
16	Mismatch	0.00	U-shaped	1.41	0.00
17	Amplifier Uncertainties	0.00	Normal	2.00	0.00
18	Misalignment of positioning System	0.00	Normal	2.00	0.00
19	Uncertainty of the Network Analyzer (23.45GHz \leq f \leq 40.8GHz)	1.50	Normal	2.00	0.75
19	Uncertainty of the Network Analyzer (40.8GHz < f \leq 44.3GHz)	1.70	Normal	2.00	0.85
20	Uncertainty of the absolute gain of the calibration antenna	0.60	Normal	2.00	0.30
21	Positioning and pointing misalignment between the reference antenna and the measurement antenna	0.01	Rectangular	1.73	0.00
22	Phase centre offset of calibration antenna	0.00	Rectangular	1.73	0.00
23	Quality of quiet zone for calibration process (NOTE 1) (23.45GHz \leq f \leq 40.8GHz)	0.4	Actual	1.00	0.4
23	Quality of quiet zone for calibration process (NOTE 1) (40.8GHz < f \leq 44.3GHz)	0.5	Actual	1.00	0.5
24	Standing wave between reference calibration antenna and measurement antenna	0.00	U-shaped	1.41	0.00
25	Influence of the calibration antenna feed cable	0.14	Normal	2.00	0.07
26	Insertion Loss Variation	0.00	Rectangular	1.73	0.00
Systematic uncertainties (NOTE 4)					Value
27	Influence of noise (23.45GHz \leq f \leq 32.125GHz)				0.3

27	Influence of noise (32.125GHz < f <= 40.8GHz)	0.9
27	Influence of noise (40.8GHz < f <= 44.3GHz)	1.0
Total measurement uncertainty		Value
Spherical coverage Expanded uncertainty (23.45GHz <= f <= 32.125GHz) (1.96 σ - confidence interval of 95 %) [dB]		4.78
Spherical coverage Expanded uncertainty (32.125GHz < f <= 40.8GHz) (1.96 σ - confidence interval of 95 %) [dB]		5.38
Spherical coverage Expanded uncertainty (40.8GHz < f <= 44.3GHz) (1.96 σ - confidence interval of 95 %) [dB]		6.84
NOTE 1: The quality of quiet zone is the same for EIRP and TRP. Value based on procedure defined in clause D.2 of TR 38.810 for Quiet Zone size less or equal to 30 cm.		
NOTE 2: The analysis was done only for the case of operating at max output power, in-band, non-CA and is valid for SISO and MIMO.		
NOTE 3: The assessment assumes maximum DUT output power.		
NOTE 4: In order to obtain the total measurement uncertainty, systematic uncertainties have to be added to the expanded root sum square of the standard deviations of the Stage 1 and Stage 2 contributors.		
NOTE 5: Applies to the system which has a structure of mechanical feed antenna positioning.		

Table B.3.2-5: Void

Table B.3.2-6: Uncertainty assessment for EIRP and TRP measurement (f=23.45GHz, 32.125GHz, 40.8GHz, Quiet Zone size \leq 30 cm) for PC1 and PC5 UEs and normal temperature condition

UID	Uncertainty source	Uncertainty value	Distribution of the probability	Divisor	Standard uncertainty (σ) [dB]
Stage 2: DUT measurement					
1	Positioning misalignment	0.02	Normal	2.00	0.01
2	Measure distance uncertainty	0.00	Rectangular	1.73	0.00
3	Quality of Quiet Zone (NOTE 1)	0.6	Actual	1.00	0.6
4	Mismatch	1.30	Actual	1.00	1.30
5	Standing wave between the DUT and measurement antenna	0.00	U-shaped	1.41	0.00
6	Uncertainty of the RF power measurement equipment (NOTE 3)	2.16	Normal	2.00	1.08
7	Phase curvature	0.00	U-shaped	1.41	0.00
8	Amplifier uncertainties	2.10	Normal	2.00	1.05
9	Random uncertainty	0.50	Normal	2.00	0.25
10	Influence of the XPD	0.01	U-shaped	1.41	0.00
11	Insertion Loss Variation	0.00	Rectangular	1.73	0.00
12	RF leakage (from measurement antenna to the receiver/transmitter)	0.00	Actual	1.00	0.00
13	Influence of TRP measurement grid (NOTE 4)	0.25	Actual	1	0.25
14	Influence of beam peak search grid (NOTE 5)	0.00	Actual	1	0.00
15	Multiple measurement antenna uncertainty (NOTE 9)	0.15	Actual	1	0.15
16	DUT repositioning	0.00 (NOTE 4) 0.35 (NOTE 5)	Rectangular	1.73	0.00 (NOTE 4) 0.20 (NOTE 5)
Stage 1: Calibration measurement					
17	Mismatch	0.00	U-shaped	1.41	0.00
18	Amplifier Uncertainties	0.00	Normal	2.00	0.00
19	Misalignment of positioning System	0.00	Normal	2.00	0.00
20	Uncertainty of the Network Analyzer	1.50	Normal	2.00	0.75
21	Uncertainty of the absolute gain of the calibration antenna	0.60	Normal	2.00	0.30
22	Positioning and pointing misalignment between the reference antenna and the measurement antenna	0.01	Rectangular	1.73	0.00
23	Phase centre offset of calibration antenna	0.00	Rectangular	1.73	0.00
24	Quality of quiet zone for calibration process (NOTE 1)	0.4	Actual	1.00	0.4
25	Standing wave between reference calibration antenna and measurement antenna	0.00	U-shaped	1.41	0.00
26	Influence of the calibration antenna feed cable	0.14	Normal	2.00	0.07
27	Insertion Loss Variation	0.00	Rectangular	1.73	0.00
Systematic uncertainties (NOTE 6)					Value
28	Systematic error due to TRP calculation/quadrature (NOTE 4)				0.00
29	Influence of noise (23.45GHz \leq f \leq 32.125GHz)				0.13
29	Influence of noise (32.125GHz < f \leq 40.8GHz)				0.27 (NOTE 4) 0.20 (NOTE 5)
30	Systematic error related to beam peak search (NOTE 5)				0.7
Total measurement uncertainty					Value
EIRP Expanded uncertainty (23.45GHz \leq f \leq 32.125GHz) (1.96 σ - confidence interval of 95 %) [dB]					5.33
EIRP Expanded uncertainty (32.125GHz < f \leq 40.8GHz) (1.96 σ - confidence interval of 95 %) [dB]					5.40
TRP Expanded uncertainty (23.45GHz \leq f \leq 32.125GHz) (1.96 σ - confidence interval of 95 %) [dB]					4.64

TRP Expanded uncertainty (32.125GHz < f <= 40.8GHz) (1.96 σ - confidence interval of 95 %) [dB]	4.78
<p>NOTE 1: The quality of quiet zone is the same for EIRP and TRP. Value based on procedure defined in clause D.2 of TR 38.810 for Quiet Zone size less or equal to 30 cm.</p> <p>NOTE 2: The analysis was done only for the case of operating at max output power, in-band, non-CA and is valid for SISO and MIMO.</p> <p>NOTE 3: The assessment assumes maximum DUT output power.</p> <p>NOTE 4: This contributor shall only be considered for TRP measurements.</p> <p>NOTE 5: This contributor shall only be considered for EIRP measurements.</p> <p>NOTE 6: In order to obtain the total measurement uncertainty, systematic uncertainties have to be added to the expanded root sum square of the standard deviations of the Stage 1 and Stage 2 contributors.</p> <p>NOTE 7: Void.</p> <p>NOTE 8: Void</p> <p>NOTE 9: Applies to the system which has a structure of mechanical feed antenna positioning.</p>	

Table B.3.2-7: Uncertainty assessment for Spherical coverage measurement (f=23.45GHz, 32.125GHz, 40.8GHz, Quiet Zone size ≤ 30 cm) for PC1 and PC5 UEs and normal temperature condition

UID	Uncertainty source	Uncertainty value	Distribution of the probability	Divisor	Standard uncertainty (σ) [dB]
Stage 2: DUT measurement					
1	Positioning misalignment	0.02	Normal	2.00	0.01
2	Measure distance uncertainty	0.00	Rectangular	1.73	0.00
3	Quality of Quiet Zone (NOTE 1)	0.60	Actual	1.00	0.60
4	Mismatch	1.30	Actual	1.00	1.30
5	Standing wave between the DUT and measurement antenna	0.00	U-shaped	1.41	0.00
6	Uncertainty of the RF power measurement equipment (NOTE 3)	2.16	Normal	2.00	1.08
7	Phase curvature	0.00	U-shaped	1.41	0.00
8	Amplifier uncertainties	2.10	Normal	2.00	1.05
9	Random uncertainty	0.50	Normal	2.00	0.25
10	Influence of the XPD	0.01	U-shaped	1.41	0.00
11	Insertion Loss Variation	0.00	Rectangular	1.73	0.00
12	RF leakage (from measurement antenna to the receiver/transmitter)	0.00	Actual	1.00	0.00
13	Multiple measurement antenna uncertainty (NOTE 5)	0.15	Actual	1	0.15
14	DUT repositioning	0.00	Rectangular	1.73	0.00
15	Influence of spherical coverage grid	0.13	Actual	1	0.13
Stage 1: Calibration measurement					
16	Mismatch	0.00	U-shaped	1.41	0.00
17	Amplifier Uncertainties	0.00	Normal	2.00	0.00
18	Misalignment of positioning System	0.00	Normal	2.00	0.00
19	Uncertainty of the Network Analyzer	1.50	Normal	2.00	0.75
20	Uncertainty of the absolute gain of the calibration antenna	0.60	Normal	2.00	0.30
21	Positioning and pointing misalignment between the reference antenna and the measurement antenna	0.01	Rectangular	1.73	0.00
22	Phase centre offset of calibration antenna	0.00	Rectangular	1.73	0.00
23	Quality of quiet zone for calibration process (NOTE 1)	0.40	Actual	1.00	0.40
24	Standing wave between reference calibration antenna and measurement antenna	0.00	U-shaped	1.41	0.00
25	Influence of the calibration antenna feed cable	0.14	Normal	2.00	0.07
26	Insertion Loss Variation	0.00	Rectangular	1.73	0.00
Systematic uncertainties (NOTE 4)					Value
27	Influence of noise (23.45GHz ≤ f ≤ 32.125GHz)				0.20
27	Influence of noise (32.125GHz < f ≤ 40.8GHz)				0.35
Total measurement uncertainty					Value
Spherical coverage Expanded uncertainty (23.45GHz ≤ f ≤ 32.125GHz) (1.96 σ - confidence interval of 95 %) [dB]					4.69
Spherical coverage Expanded uncertainty (32.125GHz < f ≤ 40.8GHz) (1.96 σ - confidence interval of 95 %) [dB]					4.84
NOTE 1: The quality of quiet zone is the same for EIRP and TRP. Value based on procedure defined in clause D.2 of TR 38.810 for Quiet Zone size less or equal to 30 cm.					
NOTE 2: The analysis was done only for the case of operating at max output power, in-band, non-CA and is valid for SISO and MIMO.					
NOTE 3: The assessment assumes maximum DUT output power.					
NOTE 4: In order to obtain the total measurement uncertainty, systematic uncertainties have to be added to the expanded root sum square of the standard deviations of the Stage 1 and Stage 2 contributors.					
NOTE 5: Applies to the system which has a structure of mechanical feed antenna positioning.					

Table B.3.2-8: Uncertainty assessment for EIRP and TRP measurement (f=23.45GHz, 32.125GHz, 40.8GHz, 44.3GHz, Quiet Zone size \leq 30 cm) for PC3 UEs and extreme temperature condition

UID	Uncertainty source	Uncertainty value	Distribution of the probability	Divisor	Standard uncertainty (σ) [dB]
Stage 2: DUT measurement					
1	Positioning misalignment	0.00	Normal	2.00	0.00
2	Measure distance uncertainty	0.00	Rectangular	1.73	0.00
3	Quality of Quiet Zone (NOTE 1) (NOTE 8)	0.9	Actual	1.00	0.9
4	Mismatch (23.45GHz \leq f \leq 40.8GHz)	1.30	Actual	1.00	1.30
4	Mismatch (40.8GHz < f \leq 44.3GHz)	1.70	Actual	1.00	1.70
5	Standing wave between the DUT and measurement antenna	0.00	U-shaped	1.41	0.00
6	Uncertainty of the RF power measurement equipment (NOTE 3) (23.45GHz \leq f \leq 40.8GHz)	2.16	Normal	2.00	1.08
6	Uncertainty of the RF power measurement equipment (NOTE 3) (40.8GHz < f \leq 44.3GHz)	3.6	Normal	2.00	1.8
7	Phase curvature	0.00	U-shaped	1.41	0.00
8	Amplifier uncertainties	2.10	Normal	2.00	1.05
9	Random uncertainty	0.50	Normal	2.00	0.25
10	Influence of the XPD	0.01	U-shaped	1.41	0.00
11	Insertion Loss Variation	0.00	Rectangular	1.73	0.00
12	RF leakage (from measurement antenna to the receiver/transmitter)	0.00	Actual	1.00	0.00
13	Influence of TRP measurement grid (NOTE 4)	0.25	Actual	1	0.25
14	Influence of beam peak search grid (NOTE 5)	0.00	Actual	1	0.00
15	Multiple measurement antenna uncertainty (NOTE 7)	0.15	Actual	1	0.15
16	DUT repositioning	0.00 (NOTE 4) 0.08 (NOTE 5)	Rectangular	1.73	0.00 (NOTE 4) 0.05 (NOTE 5)
Stage 1: Calibration measurement					
17	Mismatch	0.00	U-shaped	1.41	0.00
18	Amplifier Uncertainties	0.00	Normal	2.00	0.00
19	Misalignment of positioning System	0.00	Normal	2.00	0.00
20	Uncertainty of the Network Analyzer (23.45GHz \leq f \leq 40.8GHz)	1.50	Normal	2.00	0.75
20	Uncertainty of the Network Analyzer (40.8GHz < f \leq 44.3GHz)	1.70	Normal	2.00	0.85
21	Uncertainty of the absolute gain of the calibration antenna	0.60	Normal	2.00	0.30
22	Positioning and pointing misalignment between the reference antenna and the measurement antenna	0.01	Rectangular	1.73	0.00
23	Phase centre offset of calibration antenna	0.00	Rectangular	1.73	0.00
24	Quality of quiet zone for calibration process (NOTE 1) (NOTE 8)	0.6	Actual	1.00	0.6
25	Standing wave between reference calibration antenna and measurement antenna	0.00	U-shaped	1.41	0.00
26	Influence of the calibration antenna feed cable	0.14	Normal	2.00	0.07
27	Insertion Loss Variation	0.00	Rectangular	1.73	0.00
Systematic uncertainties (NOTE 6)					Value
28	Systematic error due to TRP calculation/quadrature (NOTE 4)				0.00
29	Influence of noise (23.45GHz \leq f \leq 32.125GHz)				0.1

29	Influence of noise (32.125GHz < f <= 40.8GHz)	0.3
30	Systematic error related to beam peak search (NOTE 5)	0.5
Total measurement uncertainty		Value
EIRP Expanded uncertainty (23.45GHz <= f <= 32.125GHz) (1.96 σ - confidence interval of 95 %) [dB]		5.35
EIRP Expanded uncertainty (32.125GHz < f <= 40.8GHz) (1.96 σ - confidence interval of 95 %) [dB]		5.55
EIRP Expanded uncertainty (40.8GHz < f <= 44.3GHz) (1.96 σ - confidence interval of 95 %) [dB]		6.78
TRP Expanded uncertainty (23.45GHz <= f <= 32.125GHz) (1.96 σ - confidence interval of 95 %) [dB]		4.87
TRP Expanded uncertainty (32.125GHz < f <= 40.8GHz) (1.96 σ - confidence interval of 95 %) [dB]		5.07
TRP Expanded uncertainty (40.8GHz < f <= 44.3GHz) (1.96 σ - confidence interval of 95 %) [dB]		TBD
NOTE 1: The quality of quiet zone is the same for EIRP and TRP. Value based on procedure defined in clause D.2 of TR 38.810 for Quiet Zone size less or equal to 30 cm. The ETC QoQZ MU and ETC calibration path losses shall be applied to the NTC test cases if the ETC environment is used for NTC test cases.		
NOTE 2: The analysis was done only for the case of operating at max output power, in-band, non-CA and is valid for SISO and MIMO.		
NOTE 3: The assessment assumes maximum DUT output power.		
NOTE 4: This contributor shall only be considered for TRP measurements.		
NOTE 5: This contributor shall only be considered for EIRP measurements.		
NOTE 6: In order to obtain the total measurement uncertainty, systematic uncertainties have to be added to the expanded root sum square of the standard deviations of the Stage 1 and Stage 2 contributors.		
NOTE 7: Applies to the system which has a structure of mechanical feed antenna positioning.		
NOTE 8: For n259 in ETC, QoQZ MU factor only defined for EIRP.		

Table B.3.2-9: Uncertainty assessment for EIRP and TRP measurement (f=23.45GHz, 32.125GHz, 40.8GHz, Quiet Zone size \leq 30 cm) for PC1 and PC5 UEs and extreme temperature condition

UID	Uncertainty source	Uncertainty value	Distribution of the probability	Divisor	Standard uncertainty (σ) [dB]
Stage 2: DUT measurement					
1	Positioning misalignment	0.02	Normal	2.00	0.01
2	Measure distance uncertainty	0.00	Rectangular	1.73	0.00
3	Quality of Quiet Zone (NOTE 1)	0.90	Actual	1.00	0.90
4	Mismatch	1.30	Actual	1.00	1.30
5	Standing wave between the DUT and measurement antenna	0.00	U-shaped	1.41	0.00
6	Uncertainty of the RF power measurement equipment (NOTE 3)	2.16	Normal	2.00	1.08
7	Phase curvature	0.00	U-shaped	1.41	0.00
8	Amplifier uncertainties	2.10	Normal	2.00	1.05
9	Random uncertainty	0.50	Normal	2.00	0.25
10	Influence of the XPD	0.01	U-shaped	1.41	0.00
11	Insertion Loss Variation	0.00	Rectangular	1.73	0.00
12	RF leakage (from measurement antenna to the receiver/transmitter)	0.00	Actual	1.00	0.00
13	Influence of TRP measurement grid (NOTE 4)	0.25	Actual	1	0.25
14	Influence of beam peak search grid (NOTE 5)	0.00	Actual	1	0.00
15	Multiple measurement antenna uncertainty (NOTE 7)	0.15	Actual	1	0.15
16	DUT repositioning	0.00 (NOTE 4) 0.35 (NOTE 5)	Rectangular	1.73	0.00 (NOTE 4) 0.20 (NOTE 5)
Stage 1: Calibration measurement					
17	Mismatch	0.00	U-shaped	1.41	0.00
18	Amplifier Uncertainties	0.00	Normal	2.00	0.00
19	Misalignment of positioning System	0.00	Normal	2.00	0.00
20	Uncertainty of the Network Analyzer	1.50	Normal	2.00	0.75
21	Uncertainty of the absolute gain of the calibration antenna	0.60	Normal	2.00	0.30
22	Positioning and pointing misalignment between the reference antenna and the measurement antenna	0.01	Rectangular	1.73	0.00
23	Phase centre offset of calibration antenna	0.00	Rectangular	1.73	0.00
24	Quality of quiet zone for calibration process (NOTE 1)	0.60	Actual	1.00	0.60
25	Standing wave between reference calibration antenna and measurement antenna	0.00	U-shaped	1.41	0.00
26	Influence of the calibration antenna feed cable	0.14	Normal	2.00	0.07
27	Insertion Loss Variation	0.00	Rectangular	1.73	0.00
Systematic uncertainties (NOTE 6)					Value
28	Systematic error due to TRP calculation/quadrature (NOTE 4)				0.00
29	Influence of noise (23.45GHz \leq f \leq 32.125GHz)				0.13
29	Influence of noise (32.125GHz < f \leq 40.8GHz)				0.27 (NOTE 4) 0.20 (NOTE 5)
30	Systematic error related to beam peak search (NOTE 5)				0.7
Total measurement uncertainty					Value
EIRP Expanded uncertainty (23.45GHz \leq f \leq 32.125GHz) (1.96 σ - confidence interval of 95 %) [dB]					5.60
EIRP Expanded uncertainty (32.125GHz < f \leq 40.8GHz) (1.96 σ - confidence interval of 95 %) [dB]					5.67
TRP Expanded uncertainty (23.45GHz \leq f \leq 32.125GHz) (1.96 σ - confidence interval of 95 %) [dB]					4.90

TRP Expanded uncertainty (32.125GHz < f <= 40.8GHz) (1.96 σ - confidence interval of 95 %) [dB]	5.04
NOTE 1: The quality of quiet zone is the same for EIRP and TRP. Value based on procedure defined in clause D.2 of TR 38.810 for Quiet Zone size less or equal to 30 cm. The ETC QoQZ MU and ETC calibration path losses shall be applied to the NTC test cases if the ETC environment is used for NTC test cases.	
NOTE 2: The analysis was done only for the case of operating at max output power, in-band, non-CA and is valid for SISO and MIMO.	
NOTE 3: The assessment assumes maximum DUT output power.	
NOTE 4: This contributor shall only be considered for TRP measurements.	
NOTE 5: This contributor shall only be considered for EIRP measurements.	
NOTE 6: In order to obtain the total measurement uncertainty, systematic uncertainties have to be added to the expanded root sum square of the standard deviations of the Stage 1 and Stage 2 contributors.	
NOTE 7: Applies to the system which has a structure of mechanical feed antenna positioning.	

B.3.3 Uncertainty budget format and assessment for NFTF

The uncertainty contributions that may impact the overall MU value are listed in Table B.3.3-1.

Table B.3.3-1: Uncertainty contributions for EIRP and TRP measurement

UID	Description of uncertainty contribution	Details in paragraph
Stage 2: EIRP Near Field Radiation Pattern Measurement and EIRP Near Field DUT power measurement		
1	Axis Alignment	B.2.3.1
2	Measurement Distance Uncertainty	B.2.3.2
3	Quality of the Quiet Zone	B.2.3.3
4	Mismatch	B.2.3.4
5	Multiple Reflections: Coupling between Measurement Antenna and DUT	B.2.3.5
6	Uncertainty of the RF power measurement equipment	B.2.3.6
7	Phase curvature	B.2.3.7
8	Amplifier uncertainties	B.2.3.8
9	Random uncertainty	B.2.3.9
10	Influence of the XPD	B.2.3.10
11	NF to FF truncation	B.2.3.11
12	Probe Polarization Amplitude and Phase	B.2.3.12
13	Probe Array Uniformity (for multi-probe systems only)	B.2.3.13
14	Phase Recovery Non-Linearity over signal bandwidth	B.2.3.16
15	Probe Pattern Effect	B.2.3.17
16	Phase Drift and Noise	B.2.3.20
17	Leakage and Crosstalk	B.2.3.25
Stage 1: Calibration measurement		
18	Mismatch	B.2.3.4
19	Amplifier uncertainties	B.2.3.8
20	Uncertainty of the Network Analyzer	B.2.3.14
21	Uncertainty of the absolute gain of the calibration antenna	B.2.3.15
22	Phase centre offset of calibration	B.2.3.18
23	Quality of the Quiet Zone for Calibration Process	B.2.3.19
24	Mismatch in the connection of the calibration antenna	B.2.3.21

The uncertainty assessment table is organized as follows:

- For the purpose of uncertainty assessment, the radiating antenna aperture of the DUT is denoted as D
- The uncertainty assessment has been derived for the case of D = [5 cm], f = {22.65GHz, 31.1GHz, 45.1GHz}, P = [maximum output power].
- The uncertainty assessment for EIRP and TRP is provided in Table B.3.1-2.

Table B.3.3-2: Uncertainty assessment for EIRP and TRP measurement (f=TBD, D=TBD)

UID	Description of uncertainty contribution	Uncertainty Value	Distribution of the probability	Divisor	Standard uncertainty (σ) [dB]
Stage 2: EIRP Near Field Radiation Pattern Measurement and EIRP Near Field DUT power measurement					
1	Axis Alignment				
2	Measurement Distance Uncertainty				
3	Quality of the Quiet Zone				
4	Mismatch				
5	Multiple Reflections: Coupling between Measurement Antenna and DUT				
6	Uncertainty of the RF power measurement equipment				
7	Phase curvature				
8	Amplifier uncertainties				
9	Random uncertainty				
10	Influence of the XPD				
11	NF to FF truncation				
12	Probe Polarization Amplitude and Phase				
13	Probe Array Uniformity (for multi-probe systems only)				
14	Phase Recovery Non-Linearity over signal bandwidth				
15	Probe Pattern Effect				
16	Phase Drift and Noise				
17	Leakage and Crosstalk				
Stage 1: Calibration measurement					
18	Mismatch				
19	Amplifier uncertainties				
20	Uncertainty of the Network Analyzer				
21	Uncertainty of the absolute gain of the calibration antenna				
22	Phase centre offset of calibration				
23	Quality of the Quiet Zone for Calibration Process				
24	Mismatch in the connection of the calibration antenna				
EIRP Expanded uncertainty (1.96σ - confidence interval of 95 %) [dB]					
TRP Expanded uncertainty (1.96σ - confidence interval of 95 %) [dB]					
NOTE 1: The impact of phase variation on EIRP shall be taken into account during final MU definition for the test method.					
NOTE 2: The quality of quiet zone is different for EIRP and TRP. For TRP, the standard uncertainty is FFS; for EIRP FFS.					
NOTE 3: The analysis was done only for the case of operating at max output power, in-band, non-CA					
NOTE 4: The assessment assumes maximum DUT output power.					
NOTE 5: The Phase Recovery Non-Linearity over signal bandwidth is shall be taken into account during final MU definition for the test method.					

B.4 UE maximum output power for modulation / channel bandwidth

Following tables summarize the MU threshold for EIRP measurements for UE maximum output power for modulation / channel bandwidth (a.k.a Maximum Power Reduction/MPR). The origin MU values for different test setups with varies parameters can be found in following clauses.

Table B.4-1: MU threshold for EIRP measurement for UE maximum output power for modulation / channel bandwidth

Power Class	Frequency	MBW	Power (NOTE2)	Threshold MU value for NTC [dB] (NOTE1)	Threshold MU value for ETC [dB] (NOTE1)
PC3	23.45GHz <= f <= 32.125GHz	BW <= 400MHz	P = Max Output Power – MBR - MPR – T(MPR)	5.11	5.38
	32.125GHz < f <= 40.8GHz			5.29	5.56
	40.8GHz < f <= 44.3GHz			[6.89]	TBD
PC1	23.45GHz <= f <= 32.125GHz	BW <= 400MHz	P = Max Output Power – MPR – T(MPR)	5.33	5.60
	32.125GHz < f <= 40.8GHz			5.50	5.77
PC5	23.45GHz <= f <= 32.125GHz	BW <= 400MHz	P = Max Output Power – MPR – T(MPR)	5.33	5.60
NOTE 1: Total EIRP Expanded MU for IFF for Quiet Zone size ≤30cm in Table B.4.2-2 and Table B.4.2-3 for PC3 UEs and Table B.4.2-4 and Table B.4.2-5 for PC1 and PC5 UEs.					
NOTE 2: Max output power level for device with corresponding power class.					

B.4.1 Uncertainty budget format and assessment for DFF

The uncertainty contributions that may impact the overall MU value are listed in Table B.4.1-1.

Table B.4.1-1: Uncertainty contributions for EIRP measurement

UID	Description of uncertainty contribution	Details in annex
	Same as Table 3.1-1 for EIRP	

The uncertainty assessment tables are organized as follows:

- For the purpose of uncertainty assessment, the radiating antenna aperture of the DUT is denoted as D
- The uncertainty assessment has been derived for the case of D = 5 cm, f = {22.65GHz, 31.1GHz, 45.1GHz}, P = maximum output power – MBR - MPR – T(MPR).
- The uncertainty assessment for EIRP is provided in Table B.4.1-2.

Table B.4.1-2: Uncertainty assessment for EIRP measurement (f=TBD, D=TBD)

UID	Uncertainty source	Uncertainty value	Distribution of the probability	Divisor	Standard uncertainty (σ) [dB]
Stage 2: DUT measurement					
1 to 17	Same as Stage 2 of Table 3.1-2 for EIRP				
Stage 1: Calibration measurement					
18 to 28	Same as Stage 1 of Table 3.1-2 for EIRP				
Systematic uncertainties					Value
29	Systematic error due to TRP calculation/quadrature				N/A
30	Influence of noise				
31	Systematic error related to beam peak search				Same as Table 3.1-2
Total measurement uncertainty					Value
EIRP Expanded uncertainty (1.96 σ - confidence interval of 95 %) [dB]					TBD
TRP Expanded uncertainty (1.96 σ - confidence interval of 95 %) [dB]					TBD
NOTE 1: The assessment assumes maximum DUT output power – MBR - MPR – T(MPR)					

B.4.2 Uncertainty budget format and assessment for IFF

The uncertainty contributions that may impact the overall MU value are listed in Table B.4.2-1.

Table B.4.2-1: Uncertainty contributions for EIRP and TRP measurement

UID	Description of uncertainty contribution	Details in annex
	Same as Stage 2 of Table 3.2-1 for EIRP	

The uncertainty assessment tables are organized as follows:

- For the purpose of uncertainty assessment, the radiating antenna aperture of the DUT is denoted as D
- The uncertainty assessment has been derived for the case of Quiet Zone size ≤ 30 cm, $f = \{23.45\text{GHz}, 32.125\text{GHz}, 40.8\text{GHz}, 44.3\text{GHz}\}$, P = maximum output power – MPR – T(MPR).
- The uncertainty assessment for EIRP and TRP is provided in Table B.3.2-2 for PC3 UEs and in Table B.4.2-x for PC1 UEs.

Table B.4.2-2: Uncertainty assessment for EIRP measurement (f=23.45GHz, 32.125GHz, 40.8GHz, 44.3GHz, Quiet Zone size ≤ 30 cm) for PC3 UEs and normal temperature condition

UID	Uncertainty source	Uncertainty value	Distribution of the probability	Divisor	Standard uncertainty (σ) [dB]
Stage 2: DUT measurement					
1 to 16	Same as Stage 2 of Table B.3.2-2 for EIRP				
Stage 1: Calibration measurement					
17 to 27	Same as Stage 1 of Table B.3.2-2 for EIRP				
Systematic uncertainties					Value
28	Systematic error due to TRP calculation/quadrature				N/A
29	Influence of noise (23.45GHz ≤ f ≤ 32.125GHz)				0.13
29	Influence of noise (32.125GHz < f ≤ 40.8GHz)				0.31
29	Influence of noise (40.8GHz < f ≤ 44.3GHz)				[0.55]
30	Systematic error related to beam peak search				Same as Table B.3.2-2
Total measurement uncertainty					Value
EIRP Expanded uncertainty (23.45GHz ≤ f ≤ 32.125GHz) (1.96σ – confidence interval of 95 %) [dB]					5.11
EIRP Expanded uncertainty (32.125GHz < f ≤ 40.8GHz) (1.96σ – confidence interval of 95 %) [dB]					5.29
EIRP Expanded uncertainty (40.8GHz < f ≤ 44.3GHz) (1.96σ – confidence interval of 95 %) [dB]					[6.89]
NOTE 1: The assessment assumes maximum DUT output power – MBR - MPR – T(MPR)					

Table B.4.2-3: Uncertainty assessment for EIRP measurement (f=23.45GHz, 32.125GHz, 40.8GHz, Quiet Zone size ≤ 30 cm) for PC3 UEs and extreme temperature condition

UID	Uncertainty source	Uncertainty value	Distribution of the probability	Divisor	Standard uncertainty (σ) [dB]
Stage 2: DUT measurement					
1 to 16	Same as Stage 2 of Table B.3.2-8 for EIRP				
Stage 1: Calibration measurement					
17 to 27	Same as Stage 1 of Table B.3.2-8 for EIRP				
Systematic uncertainties					Value
28	Systematic error due to TRP calculation/quadrature				N/A
29	Influence of noise (23.45GHz ≤ f ≤ 32.125GHz)				0.13
29	Influence of noise (32.125GHz < f ≤ 40.8GHz)				0.31
30	Systematic error related to beam peak search				Same as Table B.3.2-8
Total measurement uncertainty					Value
EIRP Expanded uncertainty (23.45GHz ≤ f ≤ 32.125GHz) (1.96σ - confidence interval of 95 %) [dB]					5.38
EIRP Expanded uncertainty (32.125GHz < f ≤ 40.8GHz) (1.96σ - confidence interval of 95 %) [dB]					5.56
NOTE 1: The assessment assumes maximum DUT output power – MBR - MPR – T(MPR)					

Table B.4.2-4: Uncertainty assessment for EIRP measurement (f=23.45GHz, 32.125GHz, 40.8GHz, Quiet Zone size ≤ 30 cm) for PC1 and PC5 UEs and normal temperature condition

UID	Uncertainty source	Uncertainty value	Distribution of the probability	Divisor	Standard uncertainty (σ) [dB]
Stage 2: DUT measurement					
1 to 16	Same as Stage 2 of Table B.3.2-6 for EIRP				
Stage 1: Calibration measurement					
17 to 27	Same as Stage 1 of Table B.3.2-6 for EIRP				
Systematic uncertainties					Value
28	Systematic error due to TRP calculation/quadrature				N/A
29	Influence of noise (23.45GHz ≤ f ≤ 32.125GHz)				0.13
29	Influence of noise (32.125GHz < f ≤ 40.8GHz)				0.3
30	Systematic error related to beam peak search				Same as Table B.3.2-6
Total measurement uncertainty					Value
EIRP Expanded uncertainty (23.45GHz ≤ f ≤ 32.125GHz) (1.96σ - confidence interval of 95 %) [dB]					5.33
EIRP Expanded uncertainty (32.125GHz < f ≤ 40.8GHz) (1.96σ - confidence interval of 95 %) [dB]					5.50
NOTE 1: The assessment assumes maximum DUT output power – MPR – T(MPR)					

Table B.4.2-5: Uncertainty assessment for EIRP measurement (f=23.45GHz, 32.125GHz, 40.8GHz, Quiet Zone size ≤ 30 cm) for PC1 and PC5 UEs and extreme temperature condition

UID	Uncertainty source	Uncertainty value	Distribution of the probability	Divisor	Standard uncertainty (σ) [dB]
Stage 2: DUT measurement					
1 to 16	Same as Stage 2 of Table B.3.2-9 for EIRP				
Stage 1: Calibration measurement					
17 to 27	Same as Stage 1 of Table B.3.2-9 for EIRP				
Systematic uncertainties					Value
28	Systematic error due to TRP calculation/quadrature				N/A
29	Influence of noise (23.45GHz ≤ f ≤ 32.125GHz)				0.13
29	Influence of noise (32.125GHz < f ≤ 40.8GHz)				0.3
30	Systematic error related to beam peak search				Same as Table B.3.2-9
Total measurement uncertainty					Value
EIRP Expanded uncertainty (23.45GHz ≤ f ≤ 32.125GHz) (1.96σ - confidence interval of 95 %) [dB]					5.60
EIRP Expanded uncertainty (32.125GHz < f ≤ 40.8GHz) (1.96σ - confidence interval of 95 %) [dB]					5.77
NOTE 1: The assessment assumes maximum DUT output power – MPR – T(MPR)					

B.4.3 Uncertainty budget format and assessment for NFTF

FFS

B.5 UE maximum output power with additional requirements

FFS

B.6 Configured transmitted power with Power Boost

Following tables summarize the MU threshold for EIRP measurements for UE maximum output power. The origin MU values for different test setups with varies parameters can be found in following clauses.

Table B.6-1: MU threshold for EIRP measurement for Configured transmitted power with Power Boost

Power Class	Frequency	MBW	Power (NOTE2)	Threshold MU value for NTC [dB] (NOTE1)	Threshold MU value for ETC [dB] (NOTE1)
PC3	23.45GHz ≤ f ≤ 32.125GHz	BW ≤ 400MHz	P = Max Output Power	5.08	5.35
	32.125GHz < f ≤ 40.8GHz			5.28	5.55
PC1	23.45GHz ≤ f ≤ 32.125GHz	BW ≤ 400MHz	P = Max Output Power	FFS	FFS
	32.125GHz < f ≤ 40.8GHz			FFS	FFS
NOTE 1: Total EIRP Expanded MU for IFF for Quiet Zone size ≤30cm in Table B.6.2-2 for PC3 UEs (NTC), in Table B.6.2-8 for PC3 UEs (ETC) and B.6.2-6 for PC1 UEs.					
NOTE 2: Max output power level for device with corresponding power class.					

B.6.1 Uncertainty budget format and assessment for DFF

The uncertainty contributions that may impact the overall MU value are listed in Table B.6.1-1.

Table B.6.1-1: Uncertainty contributions for EIRP measurement

UID	Description of uncertainty contribution	Details in annex
Stage 2: DUT measurement		
1	Positioning misalignment	B.2.1.1
2	Measure distance uncertainty	B.2.1.2
3	Quality of quiet zone	B.2.1.3
4	Mismatch	B.2.1.4
5	Standing Wave Between the DUT and measurement antenna	B.2.1.5
6	Uncertainty of the RF power measurement equipment	B.2.1.6
7	Phase curvature	B.2.1.7
8	Amplifier uncertainties	B.2.1.8
9	Random uncertainty	B.2.1.9
10	Influence of the XPD	B.2.1.10
11	Insertion Loss Variation	B.2.1.11
12	RF leakage (from measurement antenna to the receiver/transmitter)	B.2.1.12
13	Influence of beam peak search grid	B.2.1.23
14	Multiple measurement antenna uncertainty	B.2.1.25
15	DUT repositioning	B.2.1.26
Stage 1: Calibration measurement		
16	Mismatch	B.2.1.4
17	Amplifier uncertainties	B.2.1.8
18	Misalignment of positioning System	B.2.1.13
19	Uncertainty of the Network Analyzer	B.2.1.14
20	Uncertainty of the absolute gain of the calibration antenna	B.2.1.15
21	Positioning and pointing misalignment between the reference antenna and the measurement antenna	B.2.1.16
22	Phase centre offset of calibration antenna	B.2.1.18
23	Quality of quiet zone for calibration process	B.2.1.19
24	Standing wave between reference calibration antenna and measurement antenna	B.2.1.20
25	Influence of the calibration antenna feed cable	B.2.1.21
26	Insertion Loss Variation	B.2.1.11
Systematic uncertainties		
27	Influence of noise	B.2.1.27
28	Systematic error related to beam peak search	B.2.1.28

The uncertainty assessment tables are organized as follows:

- For the purpose of uncertainty assessment, the radiating antenna aperture of the DUT is denoted as D
- The uncertainty assessment has been derived for the case of $D = [5 \text{ cm}]$, $f = \{22.65\text{GHz}, 31.1\text{GHz}, 45.1\text{GHz}\}$, $P = [\text{maximum output power}]$.
- The uncertainty assessment for EIRP is provided in Table B.6.1-2.

Table B.6.1-2: Uncertainty assessment for EIRP measurement (f=TBD, D=TBD)

UID	Uncertainty source	Uncertainty value	Distribution of the probability	Divisor	Standard uncertainty (σ) [dB]
Stage 2: DUT measurement					
1	Positioning misalignment				
2	Measure distance uncertainty				
3	Quality of quiet zone				
4	Mismatch (NOTE 2)				
5	Standing Wave Between the DUT and measurement antenna				
6	Uncertainty of the RF power measurement equipment (NOTE 3)				
7	Phase curvature				
8	Amplifier uncertainties				
9	Random uncertainty				
10	Influence of the XPD				
11	Insertion Loss Variation				
12	RF leakage (from measurement antenna to the receiver/transmitter)				
13	Influence of beam peak search grid	0.0	Actual	1	0.0
14	Multiple measurement antenna uncertainty				
15	DUT repositioning				
Stage 1: Calibration measurement					
16	Mismatch				
17	Amplifier uncertainties				
18	Misalignment of positioning System				
19	Uncertainty of the Network Analyzer				
20	Uncertainty of the absolute gain of the calibration antenna				
21	Positioning and pointing misalignment between the reference antenna and the measurement antenna				
22	Phase centre offset of calibration antenna				
23	Quality of quiet zone for calibration process				
24	Standing wave between reference calibration antenna and measurement antenna				
25	Influence of the calibration antenna feed cable				
26	Insertion Loss Variation				
Systematic uncertainties (NOTE 4)					Value
27	Influence of noise				
28	Systematic error related to beam peak search				0.5
Total measurement uncertainty					Value
EIRP Expanded uncertainty (1.96 σ - confidence interval of 95 %) [dB]					TBD
NOTE 1: The impact of phase variation on EIRP shall be taken into account during final MU definition for the test method.					
NOTE 2: The analysis was done only for the case of operating at max output power, in-band, non-CA.					
NOTE 3: The assessment assumes maximum DUT output power.					
NOTE 4: In order to obtain the total measurement uncertainty, systematic uncertainties have to be added to the expanded root sum square of the standard deviations of the Stage 1 and Stage 2 contributors.					

B.6.2 Uncertainty budget format and assessment for IFF

The uncertainty contributions that may impact the overall MU value are listed in Table B.6.2-1.

Table B.6.2-1: Uncertainty contributions for EIRP measurement

UID	Description of uncertainty contribution	Details in clause
Stage 2: DUT measurement		
1	Positioning misalignment	B.2.2.1
2	Measure distance uncertainty	B.2.2.2
3	Quality of Quiet Zone	B.2.2.3
4	Mismatch	B.2.2.4
5	Standing wave between the DUT and measurement antenna	B.2.2.5
6	Uncertainty of the RF power measurement equipment	B.2.2.6
7	Phase curvature	B.2.2.7
8	Amplifier uncertainties	B.2.2.8
9	Random uncertainty	B.2.2.9
10	Influence of the XPD	B.2.2.10
11	Insertion Loss Variation	B.2.2.11
12	RF leakage (from measurement antenna to the receiver/transmitter)	B.2.2.12
13	Influence of beam peak search grid	B.2.2.23
14	Multiple measurement antenna uncertainty	B.2.2.25
15	DUT repositioning	B.2.2.26
Stage 1: Calibration measurement		
16	Mismatch	B.2.2.4
17	Amplifier Uncertainties	B.2.2.8
18	Misalignment of positioning System	B.2.2.13
19	Uncertainty of the Network Analyzer	B.2.2.14
20	Uncertainty of the absolute gain of the calibration antenna	B.2.2.15
21	Positioning and pointing misalignment between the reference antenna and the measurement antenna	B.2.2.16
22	Phase centre offset of calibration antenna	B.2.2.18
23	Quality of quiet zone for calibration process	B.2.2.19
24	Standing wave between reference calibration antenna and measurement antenna	B.2.2.20
25	Influence of the calibration antenna feed cable	B.2.2.21
26	Insertion Loss Variation	B.2.1.11
Systematic uncertainties		
27	Influence of noise	B.2.1.27
28	Systematic error related to beam peak search	B.2.2.28

The uncertainty assessment tables are organized as follows:

- For the purpose of uncertainty assessment, the radiating antenna aperture of the DUT is denoted as D
- The uncertainty assessment has been derived for the case of Quiet Zone size $\leq [30 \text{ cm}]$, $f = \{23.45\text{GHz}, 32.125\text{GHz}, 40.8\text{GHz}\}$, $[P = \text{maximum output power}]$.
- The uncertainty assessment for EIRP is provided in Table B.6.2-2 for PC3 UEs and in Table B.6.2-6 for PC1 UEs.

Table B.6.2-2: Uncertainty assessment for EIRP measurement (f=23.45GHz, 32.125GHz, 40.8GHz, Quiet Zone size ≤ 30 cm) for PC3 UEs and normal temperature condition

UID	Uncertainty source	Uncertainty value	Distribution of the probability	Divisor	Standard uncertainty (σ) [dB]
Stage 2: DUT measurement					
1	Positioning misalignment	0.00	Normal	2.00	0.00
2	Measure distance uncertainty	0.00	Rectangular	1.73	0.00
3	Quality of Quiet Zone (NOTE 1)	0.6	Actual	1.00	0.6
4	Mismatch	1.30	Actual	1.00	1.30
5	Standing wave between the DUT and measurement antenna	0.00	U-shaped	1.41	0.00
6	Uncertainty of the RF power measurement equipment (NOTE 3)	2.16	Normal	2.00	1.08
7	Phase curvature	0.00	U-shaped	1.41	0.00
8	Amplifier uncertainties	2.10	Normal	2.00	1.05
9	Random uncertainty	0.50	Normal	2.00	0.25
10	Influence of the XPD	0.01	U-shaped	1.41	0.00
11	Insertion Loss Variation	0.00	Rectangular	1.73	0.00
12	RF leakage (from measurement antenna to the receiver/transmitter)	0.00	Actual	1.00	0.00
13	Influence of beam peak search grid	0.00	Actual	1	0.00
14	Multiple measurement antenna uncertainty (NOTE 5)	0.15	Actual	1	0.15
15	DUT repositioning	0.08	Rectangular	1.73	0.05
Stage 1: Calibration measurement					
16	Mismatch	0.00	U-shaped	1.41	0.00
17	Amplifier Uncertainties	0.00	Normal	2.00	0.00
18	Misalignment of positioning System	0.00	Normal	2.00	0.00
19	Uncertainty of the Network Analyzer	1.50	Normal	2.00	0.75
20	Uncertainty of the absolute gain of the calibration antenna	0.60	Normal	2.00	0.30
21	Positioning and pointing misalignment between the reference antenna and the measurement antenna	0.01	Rectangular	1.73	0.00
22	Phase centre offset of calibration antenna	0.00	Rectangular	1.73	0.00
23	Quality of quiet zone for calibration process (NOTE 1)	0.4	Actual	1.00	0.4
24	Standing wave between reference calibration antenna and measurement antenna	0.00	U-shaped	1.41	0.00
25	Influence of the calibration antenna feed cable	0.14	Normal	2.00	0.07
26	Insertion Loss Variation	0.00	Rectangular	1.73	0.00
Systematic uncertainties (NOTE 4)					Value
27	Influence of noise (23.45GHz ≤ f ≤ 32.125GHz)				0.1
27	Influence of noise (32.125GHz < f ≤ 40.8GHz)				0.3
28	Systematic error related to beam peak search				0.5
Total measurement uncertainty					Value
EIRP Expanded uncertainty (23.45GHz ≤ f ≤ 32.125GHz) (1.96σ - confidence interval of 95 %) [dB]					5.08
EIRP Expanded uncertainty (32.125GHz < f ≤ 40.8GHz) (1.96σ - confidence interval of 95 %) [dB]					5.28
NOTE 1: Value based on procedure defined in clause D.2 of TR 38.810 for Quiet Zone size less or equal to 30 cm.					
NOTE 2: The analysis was done only for the case of operating at max output power, in-band, non-CA.					
NOTE 3: The assessment assumes maximum DUT output power.					
NOTE 4: In order to obtain the total measurement uncertainty, systematic uncertainties have to be added to the expanded root sum square of the standard deviations of the Stage 1 and Stage 2 contributors.					
NOTE 5: Applies to the system which has a structure of mechanical feed antenna positioning.					

Table B.6.2-3: Uncertainty assessment for EIRP measurement (f=23.45GHz, 32.125GHz, 40.8GHz, Quiet Zone size ≤ 30 cm) for PC1 UEs and normal temperature condition

UID	Uncertainty source	Uncertainty value	Distribution of the probability	Divisor	Standard uncertainty (σ) [dB]
Stage 2: DUT measurement					
1	Positioning misalignment	0.02	Normal	2.00	0.01
2	Measure distance uncertainty	FFS	Rectangular	1.73	FFS
3	Quality of Quiet Zone (NOTE 1)	FFS	Actual	1.00	FFS
4	Mismatch	FFS	Actual	1.00	FFS
5	Standing wave between the DUT and measurement antenna	FFS	U-shaped	1.41	FFS
6	Uncertainty of the RF power measurement equipment (NOTE 3)	FFS	Normal	2.00	FFS
7	Phase curvature	FFS	U-shaped	1.41	FFS
8	Amplifier uncertainties	FFS	Normal	2.00	FFS
9	Random uncertainty	FFS	Normal	2.00	FFS
10	Influence of the XPD	FFS	U-shaped	1.41	FFS
11	Insertion Loss Variation	FFS	Rectangular	1.73	FFS
12	RF leakage (from measurement antenna to the receiver/transmitter)	FFS	Actual	1.00	FFS
13	Influence of beam peak search grid	0.00	Actual	1	0.00
14	Multiple measurement antenna uncertainty (NOTE 5)	FFS	Actual	1	FFS
15	DUT repositioning	0.35	Rectangular	1.73	0.20
Stage 1: Calibration measurement					
16	Mismatch	FFS	U-shaped	1.41	FFS
17	Amplifier Uncertainties	FFS	Normal	2.00	FFS
18	Misalignment of positioning System	FFS	Normal	2.00	FFS
19	Uncertainty of the Network Analyzer	FFS	Normal	2.00	FFS
20	Uncertainty of the absolute gain of the calibration antenna	FFS	Normal	2.00	FFS
21	Positioning and pointing misalignment between the reference antenna and the measurement antenna	FFS	Rectangular	1.73	FFS
22	Phase centre offset of calibration antenna	FFS	Rectangular	1.73	FFS
23	Quality of quiet zone for calibration process (NOTE 1)	FFS	Actual	1.00	FFS
24	Standing wave between reference calibration antenna and measurement antenna	FFS	U-shaped	1.41	FFS
25	Influence of the calibration antenna feed cable	FFS	Normal	2.00	FFS
26	Insertion Loss Variation	FFS	Rectangular	1.73	FFS
Systematic uncertainties (NOTE 4)					Value
27	Influence of noise (23.45GHz ≤ f ≤ 32.125GHz)				FFS
27	Influence of noise (32.125GHz < f ≤ 40.8GHz)				FFS
28	Systematic error related to beam peak search				0.7
Total measurement uncertainty					Value
EIRP Expanded uncertainty (23.45GHz ≤ f ≤ 32.125GHz) (1.96σ - confidence interval of 95 %) [dB]					FFS
EIRP Expanded uncertainty (32.125GHz < f ≤ 40.8GHz) (1.96σ - confidence interval of 95 %) [dB]					FFS
NOTE 1: Value based on procedure defined in clause D.2 of TR 38.810 for Quiet Zone size less or equal to 30 cm.					
NOTE 2: The analysis was done only for the case of operating at max output power, in-band, non-CA.					
NOTE 3: The assessment assumes maximum DUT output power.					
NOTE 4: In order to obtain the total measurement uncertainty, systematic uncertainties have to be added to the expanded root sum square of the standard deviations of the Stage 1 and Stage 2 contributors.					
NOTE 5: Applies to the system which has a structure of mechanical feed antenna positioning.					

Table B.6.2-4: Uncertainty assessment for EIRP measurement (f=23.45GHz, 32.125GHz, 40.8GHz, Quiet Zone size ≤ 30 cm) for PC3 UEs and extreme temperature condition

UID	Uncertainty source	Uncertainty value	Distribution of the probability	Divisor	Standard uncertainty (σ) [dB]
Stage 2: DUT measurement					
1	Positioning misalignment	0.00	Normal	2.00	0.00
2	Measure distance uncertainty	0.00	Rectangular	1.73	0.00
3	Quality of Quiet Zone (NOTE 1)	0.9	Actual	1.00	0.9
4	Mismatch	1.30	Actual	1.00	1.30
5	Standing wave between the DUT and measurement antenna	0.00	U-shaped	1.41	0.00
6	Uncertainty of the RF power measurement equipment (NOTE 3)	2.16	Normal	2.00	1.08
7	Phase curvature	0.00	U-shaped	1.41	0.00
8	Amplifier uncertainties	2.10	Normal	2.00	1.05
9	Random uncertainty	0.50	Normal	2.00	0.25
10	Influence of the XPD	0.01	U-shaped	1.41	0.00
11	Insertion Loss Variation	0.00	Rectangular	1.73	0.00
12	RF leakage (from measurement antenna to the receiver/transmitter)	0.00	Actual	1.00	0.00
13	Influence of beam peak search grid	0.00	Actual	1	0.00
14	Multiple measurement antenna uncertainty (NOTE 5)	0.15	Actual	1	0.15
15	DUT repositioning	0.08	Rectangular	1.73	0.05
Stage 1: Calibration measurement					
16	Mismatch	0.00	U-shaped	1.41	0.00
17	Amplifier Uncertainties	0.00	Normal	2.00	0.00
18	Misalignment of positioning System	0.00	Normal	2.00	0.00
19	Uncertainty of the Network Analyzer	1.50	Normal	2.00	0.75
20	Uncertainty of the absolute gain of the calibration antenna	0.60	Normal	2.00	0.30
21	Positioning and pointing misalignment between the reference antenna and the measurement antenna	0.01	Rectangular	1.73	0.00
22	Phase centre offset of calibration antenna	0.00	Rectangular	1.73	0.00
23	Quality of quiet zone for calibration process (NOTE 1)	0.6	Actual	1.00	0.6
24	Standing wave between reference calibration antenna and measurement antenna	0.00	U-shaped	1.41	0.00
25	Influence of the calibration antenna feed cable	0.14	Normal	2.00	0.07
26	Insertion Loss Variation	0.00	Rectangular	1.73	0.00
Systematic uncertainties (NOTE 4)					Value
27	Influence of noise (23.45GHz ≤ f ≤ 32.125GHz)				0.1
27	Influence of noise (32.125GHz < f ≤ 40.8GHz)				0.3
28	Systematic error related to beam peak search (NOTE 5)				0.5
Total measurement uncertainty					Value
EIRP Expanded uncertainty (23.45GHz ≤ f ≤ 32.125GHz) (1.96σ - confidence interval of 95 %) [dB]					5.35
EIRP Expanded uncertainty (32.125GHz < f ≤ 40.8GHz) (1.96σ - confidence interval of 95 %) [dB]					5.55
NOTE 1: Value based on procedure defined in clause D.2 of TR 38.810 for Quiet Zone size less or equal to 30 cm. The ETC QoQZ MU and ETC calibration path losses shall be applied to the NTC test cases if the ETC environment is used for NTC test cases.					
NOTE 2: The analysis was done only for the case of operating at max output power, in-band, non-CA.					
NOTE 3: The assessment assumes maximum DUT output power.					
NOTE 4: In order to obtain the total measurement uncertainty, systematic uncertainties have to be added to the expanded root sum square of the standard deviations of the Stage 1 and Stage 2 contributors.					
NOTE 5: Applies to the system which has a structure of mechanical feed antenna positioning.					

Table B.6.2-5: Uncertainty assessment for EIRP measurement (f=23.45GHz, 32.125GHz, 40.8GHz, Quiet Zone size ≤ 30 cm) for PC1 UEs and extreme temperature condition

UID	Uncertainty source	Uncertainty value	Distribution of the probability	Divisor	Standard uncertainty (σ) [dB]
Stage 2: DUT measurement					
1	Positioning misalignment	0.02	Normal	2.00	0.01
2	Measure distance uncertainty	FFS	Rectangular	1.73	FFS
3	Quality of Quiet Zone (NOTE 1)	FFS	Actual	1.00	FFS
4	Mismatch	FFS	Actual	1.00	FFS
5	Standing wave between the DUT and measurement antenna	FFS	U-shaped	1.41	FFS
6	Uncertainty of the RF power measurement equipment (NOTE 3)	FFS	Normal	2.00	FFS
7	Phase curvature	FFS	U-shaped	1.41	FFS
8	Amplifier uncertainties	FFS	Normal	2.00	FFS
9	Random uncertainty	FFS	Normal	2.00	FFS
10	Influence of the XPD	FFS	U-shaped	1.41	FFS
11	Insertion Loss Variation	FFS	Rectangular	1.73	FFS
12	RF leakage (from measurement antenna to the receiver/transmitter)	FFS	Actual	1.00	FFS
13	Influence of beam peak search grid	0.00	Actual	1	0.00
14	Multiple measurement antenna uncertainty (NOTE 5)	FFS	Actual	1	FFS
15	DUT repositioning	0.35	Rectangular	1.73	0.20
Stage 1: Calibration measurement					
16	Mismatch	FFS	U-shaped	1.41	FFS
17	Amplifier Uncertainties	FFS	Normal	2.00	FFS
18	Misalignment of positioning System	FFS	Normal	2.00	FFS
19	Uncertainty of the Network Analyzer	FFS	Normal	2.00	FFS
20	Uncertainty of the absolute gain of the calibration antenna	FFS	Normal	2.00	FFS
21	Positioning and pointing misalignment between the reference antenna and the measurement antenna	FFS	Rectangular	1.73	FFS
22	Phase centre offset of calibration antenna	FFS	Rectangular	1.73	FFS
23	Quality of quiet zone for calibration process (NOTE 1)	FFS	Actual	1.00	FFS
24	Standing wave between reference calibration antenna and measurement antenna	FFS	U-shaped	1.41	FFS
25	Influence of the calibration antenna feed cable	FFS	Normal	2.00	FFS
26	Insertion Loss Variation	FFS	Rectangular	1.73	FFS
Systematic uncertainties (NOTE 4)					Value
27	Influence of noise (23.45GHz ≤ f ≤ 32.125GHz)				FFS
27	Influence of noise (32.125GHz < f ≤ 40.8GHz)				FFS
28	Systematic error related to beam peak search				0.7
Total measurement uncertainty					Value
EIRP Expanded uncertainty (23.45GHz ≤ f ≤ 32.125GHz) (1.96σ - confidence interval of 95 %) [dB]					FFS
EIRP Expanded uncertainty (32.125GHz < f ≤ 40.8GHz) (1.96σ - confidence interval of 95 %) [dB]					FFS
NOTE 1: Value based on procedure defined in clause D.2 of TR 38.810 for Quiet Zone size less or equal to 30 cm.					
NOTE 2: The analysis was done only for the case of operating at max output power, in-band, non-CA.					
NOTE 3: The assessment assumes maximum DUT output power.					
NOTE 4: In order to obtain the total measurement uncertainty, systematic uncertainties have to be added to the expanded root sum square of the standard deviations of the Stage 1 and Stage 2 contributors.					
NOTE 5: Applies to the system which has a structure of mechanical feed antenna positioning.					

B.6.3 Uncertainty budget format and assessment for NFTF

The uncertainty contributions that may impact the overall MU value are listed in Table B.6.3-1.

Table B.6.3-1: Uncertainty contributions for EIRP measurement

UID	Description of uncertainty contribution	Details in paragraph
Stage 2: EIRP Near Field Radiation Pattern Measurement and EIRP Near Field DUT power measurement		
1	Axis Alignment	B.2.3.1
2	Measurement Distance Uncertainty	B.2.3.2
3	Quality of the Quiet Zone	B.2.3.3
4	Mismatch	B.2.3.4
5	Multiple Reflections: Coupling between Measurement Antenna and DUT	B.2.3.5
6	Uncertainty of the RF power measurement equipment	B.2.3.6
7	Phase curvature	B.2.3.7
8	Amplifier uncertainties	B.2.3.8
9	Random uncertainty	B.2.3.9
10	Influence of the XPD	B.2.3.10
11	NF to FF truncation	B.2.3.11
12	Probe Polarization Amplitude and Phase	B.2.3.12
13	Probe Array Uniformity (for multi-probe systems only)	B.2.3.13
14	Phase Recovery Non-Linearity over signal bandwidth	B.2.3.16
15	Probe Pattern Effect	B.2.3.17
16	Phase Drift and Noise	B.2.3.20
17	Leakage and Crosstalk	B.2.3.25
Stage 1: Calibration measurement		
18	Mismatch	B.2.3.4
19	Amplifier uncertainties	B.2.3.8
20	Uncertainty of the Network Analyzer	B.2.3.14
21	Uncertainty of the absolute gain of the calibration antenna	B.2.3.15
22	Phase centre offset of calibration	B.2.3.18
23	Quality of the Quiet Zone for Calibration Process	B.2.3.19
24	Mismatch in the connection of the calibration antenna	B.2.3.21

The uncertainty assessment table is organized as follows:

- For the purpose of uncertainty assessment, the radiating antenna aperture of the DUT is denoted as D
- The uncertainty assessment has been derived for the case of $D = [5 \text{ cm}]$, $f = \{22.65\text{GHz}, 31.1\text{GHz}, 45.1\text{GHz}\}$, $P = [\text{maximum output power}]$.
- The uncertainty assessment for EIRP is provided in Table B.6.1-2.

Table B.6.3-2: Uncertainty assessment for EIRP measurement (f=TBD, D=TBD)

UID	Description of uncertainty contribution	Uncertainty Value	Distribution of the probability	Divisor	Standard uncertainty (σ) [dB]
Stage 2: EIRP Near Field Radiation Pattern Measurement and EIRP Near Field DUT power measurement					
1	Axis Alignment				
2	Measurement Distance Uncertainty				
3	Quality of the Quiet Zone				
4	Mismatch				
5	Multiple Reflections: Coupling between Measurement Antenna and DUT				
6	Uncertainty of the RF power measurement equipment				
7	Phase curvature				
8	Amplifier uncertainties				
9	Random uncertainty				
10	Influence of the XPD				
11	NF to FF truncation				
12	Probe Polarization Amplitude and Phase				
13	Probe Array Uniformity (for multi-probe systems only)				
14	Phase Recovery Non-Linearity over signal bandwidth				
15	Probe Pattern Effect				
16	Phase Drift and Noise				
17	Leakage and Crosstalk				
Stage 1: Calibration measurement					
18	Mismatch				
19	Amplifier uncertainties				
20	Uncertainty of the Network Analyzer				
21	Uncertainty of the absolute gain of the calibration antenna				
22	Phase centre offset of calibration				
23	Quality of the Quiet Zone for Calibration Process				
24	Mismatch in the connection of the calibration antenna				
EIRP Expanded uncertainty (1.96σ - confidence interval of 95 %) [dB]					
NOTE 1: The impact of phase variation on EIRP shall be taken into account during final MU definition for the test method.					
NOTE 2: The analysis was done only for the case of operating at max output power, in-band, non-CA					
NOTE 3: The assessment assumes maximum DUT output power.					
NOTE 4: The Phase Recovery Non-Linearity over signal bandwidth shall be taken into account during final MU definition for the test method.					

B.6a UE Maximum Output Power – EIRP with UL Gaps

B.6a.1 Uncertainty budget format and assessment for DFF

The uncertainty contributions that may impact the overall MU value are listed in Table B.6a.1-1.

Table B.6a.1-1: Uncertainty contributions for P_{UMAX,f,c_GAP_ON} - P_{UMAX,f,c_GAP_OFF} measurement

UID	Description of uncertainty contribution	Details in annex
Stage 2: DUT measurement		
1	Uncertainty of the RF relative power measurement equipment	B.2.1.36
2	Amplifier uncertainties	B.2.1.8
Stage 1: Calibration measurement		
	N/A	
Systematic uncertainties		
3	Influence of noise	B.2.1.27

On top of uncertainty factors defined for P_{UMAX,f,c_GAP_ON} - P_{UMAX,f,c_GAP_OFF} measurement defined in table B.6a.1-1, for EIRP_{meas_peak} measurement, Table B.3.1-1 applies (only measurement uncertainty factors applicable to EIRP measurement).

The uncertainty assessment tables are organized as follows:

- For the purpose of uncertainty assessment, the radiating antenna aperture of the DUT is denoted as D
- The uncertainty assessment has been derived for the case of $D = [5 \text{ cm}]$, $f = \{22.65\text{GHz}, 31.1\text{GHz}, 45.1\text{GHz}\}$, $P = [\text{maximum output power}]$.
- The uncertainty assessment for UE Maximum Output Power – EIRP with UL Gaps is provided in Table B.6a.1-2.

Table B.6a.1-2: Uncertainty assessment for P_{UMAX,f,c_GAP_ON} - P_{UMAX,f,c_GAP_OFF} (f=TBD, D=TBD)

UID	Uncertainty source	Uncertainty value	Distribution of the probability	Divisor	Standard uncertainty (σ) [dB]
Stage 2: DUT measurement					
1	Uncertainty of the RF relative power measurement equipment	FFS	FFS	FFS	FFS
2	Amplifier uncertainties	FFS	FFS	FFS	FFS
Stage 1: Calibration measurement					
	N/A				
Systematic uncertainties (NOTE 1)					Value
3	Influence of noise				FFS
Total measurement uncertainty					Value
Relative EIRP Expanded uncertainty (1.96 σ - confidence interval of 95 %) [dB]					FFS

On top of uncertainty calculation defined for P_{UMAX,f,c_GAP_ON} - P_{UMAX,f,c_GAP_OFF} measurement defined in table B.3.1-2 for EIRP_{meas_peak} measurement, table B.3.1-2 applies respectively (only measurement uncertainty factors applicable to EIRP measurement).

B.6a.2 Uncertainty budget format and assessment for IFF

The uncertainty contributions that may impact the overall MU value are listed in Table B.6a.2-1.

Table B.6a.2-1: Uncertainty contributions for P_{UMAX,f,c_GAP_ON} - P_{UMAX,f,c_GAP_OFF} measurement

UID	Description of uncertainty contribution	Details in annex
Stage 2: DUT measurement		
1	Uncertainty of the RF relative power measurement equipment	B.2.2.36
2	Amplifier uncertainties	B.2.2.8
Stage 1: Calibration measurement		
	N/A	
Systematic uncertainties		
3	Influence of noise	B.2.2.27

On top of uncertainty factors defined for P_{UMAX,f,c_GAP_ON} - P_{UMAX,f,c_GAP_OFF} measurement defined in table B.6a.2-1, for $EIRP_{meas_peak}$ measurement, Table B.3.2-1 applies (only measurement uncertainty calculation applicable to EIRP measurement).

The uncertainty assessment tables are organized as follows:

- For the purpose of uncertainty assessment, the radiating antenna aperture of the DUT is denoted as D
- The uncertainty assessment has been derived for the case of Quiet Zone size $\leq [30 \text{ cm}]$, $f = \{23.45\text{GHz}, 32.125\text{GHz}, 40.8\text{GHz}\}$.
- The uncertainty assessment for UE Maximum Output Power – EIRP with UL Gaps is provided in Table B.6a.2-2 for PC3 UEs and in Table B.6a.2-3 for PC1 UEs.

Table B.6a.2-2: Uncertainty assessment for P_{UMAX,f,c_GAP_ON} - P_{UMAX,f,c_GAP_OFF} s measurement ($f=23.45\text{GHz}, 32.125\text{GHz}, 40.8\text{GHz}$, Quiet Zone size $\leq 30 \text{ cm}$) for PC3 UEs and normal temperature condition

UID	Uncertainty source	Uncertainty value	Distribution of the probability	Divisor	Standard uncertainty (σ) [dB]
Stage 2: DUT measurement					
1	Uncertainty of the RF relative power measurement equipment	0.4	Normal	2.00	0.2
2	Amplifier uncertainties	0.5	Rectangular	1.73	0.29
Stage 1: Calibration measurement					
	N/A				
Systematic uncertainties (NOTE 1)					Value
3	Influence of noise ($23.45\text{GHz} \leq f \leq 40.8\text{GHz}$)				1.0
Total measurement uncertainty					Value
EIRP Expanded uncertainty ($23.45\text{GHz} \leq f \leq 32.125\text{GHz}$) (1.96 σ - confidence interval of 95 %) [dB]					1.7
NOTE 1: Measurement uncertainties in this table assume absolute power measurements involved in the same relative power measurement are performed over the same RF path.					

Table B.6a.2-3: Uncertainty assessment for $P_{UMAX,f,c_GAP_ON} - P_{UMAX,f,c_GAP_OFF}$ measurement (f=23.45GHz, 32.125GHz, 40.8GHz, Quiet Zone size ≤ 30 cm) for PC3 UEs and extreme temperature condition

UID	Uncertainty source	Uncertainty value	Distribution of the probability	Divisor	Standard uncertainty (σ) [dB]
Stage 2: DUT measurement					
1	Uncertainty of the RF relative power measurement equipment	0.4	Normal	2.00	0.2
2	Amplifier uncertainties	[0.5]	Rectangular	1.73	[0.29]
Stage 1: Calibration measurement					
	N/A				
Systematic uncertainties (NOTE 1)					Value
3	Influence of noise (23.45GHz $\leq f \leq$ 40.8GHz)				1.0
Total measurement uncertainty					Value
	EIRP Expanded uncertainty (23.45GHz $\leq f \leq$ 32.125GHz) (1.96 σ - confidence interval of 95 %) [dB]				[1.7]
NOTE 1: Measurement uncertainties in this table assume absolute power measurements involved in the same relative power measurement are performed over the same RF path.					

Table B.6a.2-4: Uncertainty assessment for $P_{UMAX,f,c_GAP_ON} - P_{UMAX,f,c_GAP_OFF}$ measurement (f=23.45GHz, 32.125GHz, 40.8GHz, Quiet Zone size ≤ 30 cm) for PC1 UEs and normal temperature condition

UID	Uncertainty source	Uncertainty value	Distribution of the probability	Divisor	Standard uncertainty (σ) [dB]
Stage 2: DUT measurement					
1	Uncertainty of the RF power measurement equipment	FFS	Normal	2.0	FFS
2	Amplifier uncertainties	FFS	Rectangular	1.73	FFS
Stage 1: Calibration measurement					
	N/A				
Systematic uncertainties (NOTE 1)					Value
3	Influence of noise (23.45GHz $\leq f \leq$ 40.8GHz)				FFS
Total measurement uncertainty					Value
	Relative EIRP Expanded uncertainty (23.45GHz $\leq f \leq$ 32.125GHz) (1.96 σ - confidence interval of 95 %) [dB]				FFS

Table B.6a.2-5: Uncertainty assessment for $P_{UMAX,f,c_GAP_ON} - P_{UMAX,f,c_GAP_OFF}$ measurement (f=23.45GHz, 32.125GHz, 40.8GHz, Quiet Zone size ≤ 30 cm) for PC1 UEs and extreme temperature condition

UID	Uncertainty source	Uncertainty value	Distribution of the probability	Divisor	Standard uncertainty (σ) [dB]
Stage 2: DUT measurement					
1	Uncertainty of the RF power measurement equipment	FFS	Normal	2.0	FFS
2	Amplifier uncertainties	FFS	Rectangular	1.73	FFS
Stage 1: Calibration measurement					
	N/A				
Systematic uncertainties (NOTE 1)					Value
3	Influence of noise (23.45GHz $\leq f \leq$ 40.8GHz)				FFS
Total measurement uncertainty Table B.3.2-2					Value
	Relative EIRP Expanded uncertainty (23.45GHz $\leq f \leq$ 32.125GHz) (1.96 σ - confidence interval of 95 %) [dB]				FFS

On top of uncertainty calculation defined for $P_{UMAX,f,c_GAP_ON} - P_{UMAX,f,c_GAP_OFF}$ measurement defined in tables B.6a.2-2 (PC3-normal temperature conditions), B.6a.2-3 (PC3 extreme temperature conditions), B.6a.2-4 (PC1 normal temperature conditions) and B.6a.2-5 (PC1 extreme conditions), for $EIRP_{meas_peak}$ measurement, Tables B.3.2-2 (PC3 normal temperature conditions), B.3.2-8 (PC3 extreme temperature conditions), B.3.2-6 (PC1 normal temperature conditions) and B.3.2-9 (PC1 extreme temperature conditions) apply respectively (only measurement uncertainty calculation applicable to EIRP measurement).

B.6a.3 Uncertainty budget format and assessment for NFTF

The uncertainty contributions that may impact the overall MU value are listed in Table B.6a.3-1.

Table B.6a.3-1: Uncertainty contributions for $P_{UMAX,f,c_GAP_ON} - P_{UMAX,f,c_GAP_OFF}$ measurement

UID	Description of uncertainty contribution	Details in annex
Stage 2: DUT measurement		
1	Uncertainty of the RF relative power measurement equipment	B.2.3.30
2	Amplifier uncertainties	B.2.3.8
Stage 1: Calibration measurement		
	N/A	
Systematic uncertainties		
3	Influence of noise (23.45GHz <= f <= 40.8GHz)	B.2.3.29

On top of uncertainty factors defined for $P_{UMAX,f,c_GAP_ON} - P_{UMAX,f,c_GAP_OFF}$ measurement defined in table B.6a.3-1, for $EIRP_{meas_peak}$ measurement, Table B.3.3-1 applies (only measurement uncertainty calculation applicable to EIRP measurement).

The uncertainty assessment table is organized as follows:

- For the purpose of uncertainty assessment, the radiating antenna aperture of the DUT is denoted as D
- The uncertainty assessment has been derived for the case of $D = [5 \text{ cm}]$, $f = \{22.65\text{GHz}, 31.1\text{GHz}, 45.1\text{GHz}\}$, $P = [\text{maximum output power}]$.
- The uncertainty assessment for UE Maximum Output Power – EIRP with UL Gaps is provided in Table B.6a.3-2

Table B.6a.3-2: Uncertainty assessment for $P_{UMAX,f,c_GAP_ON} - P_{UMAX,f,c_GAP_OFF}$ measurement (f=TBD, D=TBD)

UID	Uncertainty source	Uncertainty value	Distribution of the probability	Divisor	Standard uncertainty (σ) [dB]
Stage 2: DUT measurement					
1	Uncertainty of the RF relative power measurement equipment	FFS	FFS	FFS	FFS
2	Amplifier uncertainties	FFS	FFS	FFS	FFS
Stage 1: Calibration measurement					
	N/A				
Systematic uncertainties (NOTE 1)					
3	Influence of noise (23.45GHz <= f <= 40.8GHz)				Value
Total measurement uncertainty					
Relative EIRP Expanded uncertainty (1.96 σ - confidence interval of 95 %) [dB]					
Value					
FFS					

On top of uncertainty calculation defined for $P_{UMAX,f,c_GAP_ON} - P_{UMAX,f,c_GAP_OFF}$ measurement defined in tables B.6a.3-2 for $EIRP_{meas_peak}$ measurement, Tables B.3.3-2 applies (only measurement uncertainty calculation applicable to EIRP measurement).

B.7 Minimum Output power

Following tables summarize the MU threshold for EIRP measurements for Minimum Output Power. The origin MU values for different test setups can be found in following clauses.

Table B.7-1: MU threshold for EIRP measurement for Minimum output power

Power Class	Diversity	Frequency	MBW	Power	Threshold MU value for NTC [dB] (NOTE1)	Threshold MU value For ETC [dB] (NOTE1)
PC1	SISO	$23.45\text{GHz} \leq f \leq 32.125\text{GHz}$	$BW \leq 400\text{MHz}$	P = Minimum Output Power	5.66	5.92
		$32.125\text{GHz} < f \leq 40.8\text{GHz}$			5.96	6.22
	MIMO	$23.45\text{GHz} \leq f \leq 32.125\text{GHz}$			5.51	5.77
		$32.125\text{GHz} < f \leq 40.8\text{GHz}$			5.66	5.92
PC3	SISO, MIMO	$23.45\text{GHz} \leq f \leq 32.125\text{GHz}$	$BW \leq 400\text{MHz}$	P = Minimum Output Power	6.15	6.41
		$32.125\text{GHz} < f \leq 40.8\text{GHz}$			6.15	6.41
		$40.8\text{GHz} < f \leq 44.3\text{GHz}$			[7.34]	TBD
PC5	SISO, MIMO	$23.45\text{GHz} \leq f \leq 32.125\text{GHz}$	$BW \leq 400\text{MHz}$	P = Minimum Output Power	6.36	6.62

NOTE 1: Total Expanded MU for IFF for Quiet Zone size $\leq 30\text{cm}$ in Table B.7.2-2 and Table B.7.2-5 for PC3 UEs and Table B.7.2-3 and Table B.7.2-6 for PC1 and PC5 UEs.

B.7.1 Uncertainty budget format and assessment for DFF

The uncertainty contributions that may impact the overall MU value are listed in Table B.7.1-1.

Table B.7.1-1: Uncertainty contributions for EIRP measurement

UID	Description of uncertainty contribution	Details in annex
Stage 2: DUT measurement		
1	Positioning misalignment	B.2.1.1
2	Measure distance uncertainty	B.2.1.2
3	Quality of quiet zone	B.2.1.3
4	Mismatch	B.2.1.4
5	Standing Wave Between the DUT and measurement antenna	B.2.1.5
6	Uncertainty of the RF power measurement equipment	B.2.1.6
7	Phase curvature	B.2.1.7
8	Amplifier uncertainties	B.2.1.8
9	Random uncertainty	B.2.1.9
10	Influence of the XPD	B.2.1.10
11	Insertion Loss Variation	B.2.1.11
12	RF leakage (from measurement antenna to the receiver/transmitter)	B.2.1.12
13	Influence of beam peak search grid	B.2.1.23
14	Multiple measurement antenna uncertainty	B.2.1.25
15	DUT repositioning	B.2.1.26
Stage 1: Calibration measurement		
16	Mismatch	B.2.1.4
17	Amplifier uncertainties	B.2.1.8
18	Misalignment of positioning System	B.2.1.13
19	Uncertainty of the Network Analyzer	B.2.1.14
20	Uncertainty of the absolute gain of the calibration antenna	B.2.1.15
21	Positioning and pointing misalignment between the reference antenna and the measurement antenna	B.2.1.16
22	Phase centre offset of calibration antenna	B.2.1.18
23	Quality of quiet zone for calibration process	B.2.1.19
24	Standing wave between reference calibration antenna and measurement antenna	B.2.1.20
25	Influence of the calibration antenna feed cable	B.2.1.21
26	Insertion Loss Variation	B.2.1.11
Systematic uncertainties		
27	Systematic error related to beam peak search	B.2.1.28
28	Influence of noise	B.2.1.27

The uncertainty assessment tables are organized as follows:

- For the purpose of uncertainty assessment, the radiating antenna aperture of the DUT is denoted as D
- The uncertainty assessment has been derived for the case of $D = [5 \text{ cm}]$, $f = \{23.45 \text{ GHz}, 32.125 \text{ GHz}, 40.8 \text{ GHz}, 44.3 \text{ GHz}\}$, $P = [\text{Minimum output power}]$.
- The uncertainty assessment for EIRP is provided in Table B.7.1-2.

Table B.7.1-2: Uncertainty assessment for EIRP measurement (f=TBD, D=TBD)

UID	Uncertainty source	Uncertainty value	Distribution of the probability	Divisor	Standard uncertainty (σ) [dB]
Stage 2: DUT measurement					
1	Positioning misalignment				
2	Measure distance uncertainty				
3	Quality of quiet zone (NOTE 2)				
4	Mismatch (NOTE 3)				
5	Standing Wave Between the DUT and measurement antenna				
6	Uncertainty of the RF power measurement equipment (NOTE 4)				
7	Phase curvature				
8	Amplifier uncertainties				
9	Random uncertainty				
10	Influence of the XPD				
11	Insertion Loss Variation				
12	RF leakage (from measurement antenna to the receiver/transmitter)				
13	Influence of beam peak search grid (NOTE 6)				
14	Multiple measurement antenna uncertainty				
15	DUT repositioning		Actual	1	
Stage 1: Calibration measurement					
16	Mismatch				
17	Amplifier uncertainties				
18	Misalignment of positioning System				
19	Uncertainty of the Network Analyzer				
20	Uncertainty of the absolute gain of the calibration antenna				
21	Positioning and pointing misalignment between the reference antenna and the measurement antenna				
22	Phase centre offset of calibration antenna				
23	Quality of quiet zone for calibration process (NOTE 2)				
24	Standing wave between reference calibration antenna and measurement antenna				
25	Influence of the calibration antenna feed cable				
26	Insertion Loss Variation				
EIRP Expanded uncertainty (1.96σ - confidence interval of 95 %) [dB]					
Systematic uncertainties (NOTE 7)					Value
27	Systematic error related to beam peak search				
28	Influence of noise				
Total measurement uncertainty					
EIRP total measurement uncertainty [dB]					
NOTE 1: The analysis was done only for the case of operating at Minimum output power, in-band, non-CA.					
NOTE 2: The assessment assumes DUT Minimum output power.					
NOTE 3: This contributor shall only be considered for EIRP measurements.					
NOTE 4: Void					
NOTE 5: In order to obtain the total measurement uncertainty, systematic uncertainties have to be added to the expanded root sum square of the standard deviations of the Stage 1 and Stage 2 contributors.					
NOTE 6: Void.					
NOTE 7: Void					
NOTE 8: Value based on procedure defined in Annex D.2 of TR 38.810 for Quiet Zone size less or equal to 30 cm.					
NOTE 9: Applies to the system which has a structure of mechanical feed antenna positioning.					

B.7.2 Uncertainty budget format and assessment for IFF

The uncertainty contributions that may impact the overall MU value are listed in Table B.7.2-1.

Table B.7.2-1: Uncertainty contributions for EIRP measurement

UID	Description of uncertainty contribution	Details in annex
Stage 2: DUT measurement		
1	Positioning misalignment	B.2.2.1
2	Measure distance uncertainty	B.2.2.2
3	Quality of Quiet Zone	B.2.2.3
4	Mismatch	B.2.2.4
5	Standing wave between the DUT and measurement antenna	B.2.2.5
6	Uncertainty of the RF power measurement equipment	B.2.2.6
7	Phase curvature	B.2.2.7
8	Amplifier uncertainties	B.2.2.8
9	Random uncertainty	B.2.2.9
10	Influence of the XPD	B.2.2.10
11	Insertion Loss Variation	B.2.2.11
12	RF leakage (from measurement antenna to the receiver/transmitter)	B.2.2.12
13	Influence of beam peak search grid	B.2.2.23
14	Multiple measurement antenna uncertainty	B.2.2.25
15	DUT repositioning	B.2.2.26
Stage 1: Calibration measurement		
16	Mismatch	B.2.2.4
17	Amplifier Uncertainties	B.2.2.8
18	Misalignment of positioning System	B.2.2.13
19	Uncertainty of the Network Analyzer	B.2.2.14
20	Uncertainty of the absolute gain of the calibration antenna	B.2.2.15
21	Positioning and pointing misalignment between the reference antenna and the measurement antenna	B.2.2.16
22	Phase centre offset of calibration antenna	B.2.2.18
23	Quality of quiet zone for calibration process	B.2.2.19
24	Standing wave between reference calibration antenna and measurement antenna	B.2.2.20
25	Influence of the calibration antenna feed cable	B.2.2.21
26	Insertion Loss Variation	B.2.2.11
Systematic uncertainties		
27	Systematic error related to beam peak search	B.2.2.28
28	Influence of noise	B.2.2.27

The uncertainty assessment tables are organized as follows:

- For the purpose of uncertainty assessment, the radiating antenna aperture of the DUT is denoted as D
- The uncertainty assessment has been derived for the case of Quiet Zone size ≤ 30 cm, $f = \{23.45\text{GHz}, 32.125\text{GHz}, 40.8\text{GHz}, 44.3\text{GHz}\}$, $P = \text{Minimum output power}$.
- The uncertainty assessment for EIRP is provided in Table B.7.2-2 for PC3 UEs and in Table B.7.2-3 for PC1 UEs.

Table B.7.2-2: Uncertainty assessment for EIRP measurement (f=23.45GHz, 32.125GHz, 40.8GHz, 44.3GHz, Quiet Zone size \leq 30 cm) for PC3 UEs and normal temperature condition

UID	Uncertainty source	Uncertainty value	Distribution of the probability	Divisor	Standard uncertainty (σ) [dB]
Stage 2: DUT measurement					
1	Positioning misalignment	0.00	Normal	2.00	0.00
2	Measure distance uncertainty	0.00	Rectangular	1.73	0.00
3	Quality of Quiet Zone (NOTE 8) (23.45GHz \leq f \leq 40.8GHz)	0.6	Actual	1.00	0.6
3	Quality of Quiet Zone (NOTE 8) (40.8GHz < f \leq 44.3GHz)	0.7	Actual	1.00	0.7
4	Mismatch (NOTE 1) (23.45GHz \leq f \leq 40.8GHz)	1.30	Actual	1.00	1.30
4	Mismatch (NOTE 1) (40.8GHz < f \leq 44.3GHz)	1.70	Actual	1.00	1.70
5	Standing wave between the DUT and measurement antenna	0.00	U-shaped	1.41	0.00
6	Uncertainty of the RF power measurement equipment (NOTE 2) (23.45GHz \leq f \leq 40.8GHz)	2.50	Normal	2.00	1.25
6	Uncertainty of the RF power measurement equipment (NOTE 2) (40.8GHz < f \leq 44.3GHz)	3.6	Normal	2.00	1.8
7	Phase curvature	0.00	U-shaped	1.41	0.00
8	Amplifier uncertainties	2.10	Normal	2.00	1.05
9	Random uncertainty	0.50	Normal	2.00	0.25
10	Influence of the XPD	0.01	U-shaped	1.41	0.00
11	Insertion Loss Variation	0.00	Rectangular	1.73	0.00
12	RF leakage (from measurement antenna to the receiver/transmitter)	0.00	Actual	1.00	0.00
13	Influence of beam peak search grid (NOTE 3)	0.00	Actual	1	0.00
14	Multiple measurement antenna uncertainty (NOTE 9)	0.15	Actual	1	0.15
15	DUT repositioning (NOTE 3)	0.08	Rectangular	1.73	0.05
Stage 1: Calibration measurement					
16	Mismatch	0.00	U-shaped	1.41	0.00
17	Amplifier Uncertainties	0.00	Normal	2.00	0.00
18	Misalignment of positioning System	0.00	Normal	2.00	0.00
19	Uncertainty of the Network Analyzer (23.45GHz \leq f \leq 40.8GHz)	1.50	Normal	2.00	0.75
19	Uncertainty of the Network Analyzer (40.8GHz < f \leq 44.3GHz)	1.70	Normal	2.00	0.85
20	Uncertainty of the absolute gain of the calibration antenna	0.60	Normal	2.00	0.30
21	Positioning and pointing misalignment between the reference antenna and the measurement antenna	0.01	Rectangular	1.73	0.00
22	Phase centre offset of calibration antenna	0.00	Rectangular	1.73	0.00
23	Quality of quiet zone for calibration process (NOTE 8) (23.45GHz \leq f \leq 40.8GHz)	0.4	Actual	1.00	0.4
23	Quality of quiet zone for calibration process (NOTE 8) (40.8GHz < f \leq 44.3GHz)	0.5	Actual	1.00	0.5
24	Standing wave between reference calibration antenna and measurement antenna	0.00	U-shaped	1.41	0.00
25	Influence of the calibration antenna feed cable	0.14	Normal	2.00	0.07
26	Insertion Loss Variation	0.00	Rectangular	1.73	0.00
Systematic uncertainties (NOTE 5)					Value

27	Systematic error related to beam peak search	0.5
28	Influence of noise (23.45GHz ≤ f ≤ 32.125GHz)	1.0
28	Influence of noise (32.125GHz < f ≤ 40.8GHz)	1.0
28	Influence of noise (40.8GHz < f ≤ 44.3GHz)	[1.0]
Total measurement uncertainty		Value
EIRP Expanded uncertainty (23.45GHz ≤ f ≤ 32.125GHz) (1.96σ - confidence interval of 95 %) [dB]		6.15
EIRP Expanded uncertainty (32.125GHz < f ≤ 40.8GHz) (1.96σ - confidence interval of 95 %) [dB]		6.15
EIRP Expanded uncertainty (40.8GHz < f ≤ 44.3GHz) (1.96σ - confidence interval of 95 %) [dB]		[7.34]
NOTE 1: The analysis was done only for the case of operating at Minimum output power, in-band, non-CA and is valid for SISO and MIMO.		
NOTE 2: The assessment assumes DUT Minimum output power.		
NOTE 3: This contributor shall only be considered for EIRP measurements.		
NOTE 4: Void		
NOTE 5: In order to obtain the total measurement uncertainty, systematic uncertainties have to be added to the expanded root sum square of the standard deviations of the Stage 1 and Stage 2 contributors.		
NOTE 6: Void.		
NOTE 7: Void		
NOTE 8: Value based on procedure defined in Annex D.2 of TR 38.810 for Quiet Zone size less or equal to 30 cm.		
NOTE 9: Applies to the system which has a structure of mechanical feed antenna positioning.		

Table B.7.2-3: Uncertainty assessment for EIRP measurement (f=23.45GHz, 32.125GHz, 40.8GHz, Quiet Zone size \leq 30 cm) for PC1 and PC5 UEs and normal temperature condition

UID	Uncertainty source	Uncertainty value	Distribution of the probability	Divisor	Standard uncertainty (σ) [dB]
Stage 2: DUT measurement					
1	Positioning misalignment	0.02	Normal	2.00	0.01
2	Measure distance uncertainty	0.00	Rectangular	1.73	0.00
3	Quality of Quiet Zone (NOTE 8)	0.60	Actual	1.00	0.60
4	Mismatch (NOTE 1)	1.30	Actual	1.00	1.30
5	Standing wave between the DUT and measurement antenna	0.00	U-shaped	1.41	0.00
6	Uncertainty of the RF power measurement equipment (NOTE 2)	2.50	Normal	2.00	1.25
7	Phase curvature	0.00	U-shaped	1.41	0.00
8	Amplifier uncertainties	2.10	Normal	2.00	1.05
9	Random uncertainty	0.50	Normal	2.00	0.25
10	Influence of the XPD	0.01	U-shaped	1.41	0.00
11	Insertion Loss Variation	0.00	Rectangular	1.73	0.00
12	RF leakage (from measurement antenna to the receiver/transmitter)	0.00	Actual	1.00	0.00
13	Influence of beam peak search grid (NOTE 3)	0.00	Actual	1	0.00
14	Multiple measurement antenna uncertainty (NOTE 9)	0.15	Actual	1	0.15
15	DUT repositioning (NOTE 3)	0.35	Rectangular	1.73	0.20
Stage 1: Calibration measurement					
16	Mismatch	0.00	U-shaped	1.41	0.00
17	Amplifier Uncertainties	0.00	Normal	2.00	0.00
18	Misalignment of positioning System	0.00	Normal	2.00	0.00
19	Uncertainty of the Network Analyzer	1.50	Normal	2.00	0.75
20	Uncertainty of the absolute gain of the calibration antenna	0.60	Normal	2.00	0.30
21	Positioning and pointing misalignment between the reference antenna and the measurement antenna	0.01	Rectangular	1.73	0.00
22	Phase centre offset of calibration antenna	0.00	Rectangular	1.73	0.00
23	Quality of quiet zone for calibration process (NOTE 8)	0.40	Actual	1.00	0.40
24	Standing wave between reference calibration antenna and measurement antenna	0.00	U-shaped	1.41	0.00
25	Influence of the calibration antenna feed cable	0.14	Normal	2.00	0.07
26	Insertion Loss Variation	0.00	Rectangular	1.73	0.00
Systematic uncertainties (NOTE 5)					Value
27	Systematic error related to beam peak search				0.7
28	Influence of noise (23.45GHz <= f <= 32.125GHz) (PC1) (SISO)				0.30
28	Influence of noise (23.45GHz <= f <= 32.125GHz) (PC1) (MIMO)				0.15
28	Influence of noise (23.45GHz <= f <= 32.125GHz) (PC5)				1.00
28	Influence of noise (32.125GHz < f <= 40.8GHz) (PC1) (SISO)				0.60
28	Influence of noise (32.125GHz < f <= 40.8GHz) (PC1) (MIMO)				0.30
Total measurement uncertainty					Value
EIRP Expanded uncertainty (23.45GHz <= f <= 32.125GHz) (1.96 σ - confidence interval of 95 %) [dB] (PC1) (SISO)					5.66
EIRP Expanded uncertainty (23.45GHz <= f <= 32.125GHz) (1.96 σ - confidence interval of 95 %) [dB] (PC1) (MIMO)					5.51
EIRP Expanded uncertainty (23.45GHz <= f <= 32.125GHz) (1.96 σ - confidence interval of 95 %) [dB] (PC5)					6.36
EIRP Expanded uncertainty (32.125GHz < f <= 40.8GHz) (1.96 σ - confidence interval of 95 %) [dB] (PC1) (SISO)					5.96
EIRP Expanded uncertainty (32.125GHz < f <= 40.8GHz) (1.96 σ - confidence interval of 95 %) [dB] (PC1) (MIMO)					5.66

NOTE 1: The analysis was done only for the case of operating at Minimum output power, in-band, non-CA and is valid for SISO and MIMO.

NOTE 2: The assessment assumes DUT Minimum output power.

NOTE 3: This contributor shall only be considered for EIRP measurements.

NOTE 4: Void

NOTE 5: In order to obtain the total measurement uncertainty, systematic uncertainties have to be added to the expanded root sum square of the standard deviations of the Stage 1 and Stage 2 contributors.

NOTE 6: Void.

NOTE 7: Void

NOTE 8: Value based on procedure defined in Annex D.2 of TR 38.810 for Quiet Zone size less or equal to 30 cm.

NOTE 9: Applies to the system which has a structure of mechanical feed antenna positioning.

NOTE: MU assessment in Table B.7.2-2 and Table B7.2-3 is based on the following relaxations for 400MHz BW:

Table B.7.2-4: Minimum output power requirement relaxation considered in MU assessment for 400 MHz EIRP measurement (f=23.45GHz, 32.125GHz, 40.8GHz, 44.3GHz, Quiet Zone size ≤ 30 cm)

Power Class	Diversity	Frequency Range	Relaxation (dB)
PC1	SISO	FR2a	0
		FR2b	0
PC2	SISO	FR2a	FFS
		FR2b	FFS
PC3	SISO	FR2a	8.4
		FR2b	13.5
		FR2c	[14.5]
PC3	MIMO	FR2a	5.4
		FR2b	10.5
		FR2c	FFS
PC4	SISO	FR2a	FFS
		FR2b	FFS
PC5	SISO, MIMO	FR2a	1.4

Table B.7.2-5: Uncertainty assessment for EIRP measurement (f=23.45GHz, 32.125GHz, 40.8GHz, Quiet Zone size \leq 30 cm) for PC3 UEs and extreme temperature condition

UID	Uncertainty source	Uncertainty value	Distribution of the probability	Divisor	Standard uncertainty (σ) [dB]
Stage 2: DUT measurement					
1	Positioning misalignment	0.00	Normal	2.00	0.00
2	Measure distance uncertainty	0.00	Rectangular	1.73	0.00
3	Quality of Quiet Zone (NOTE 8)	0.9	Actual	1.00	0.9
4	Mismatch (NOTE 1)	1.30	Actual	1.00	1.30
5	Standing wave between the DUT and measurement antenna	0.00	U-shaped	1.41	0.00
6	Uncertainty of the RF power measurement equipment (NOTE 2)	2.50	Normal	2.00	1.25
7	Phase curvature	0.00	U-shaped	1.41	0.00
8	Amplifier uncertainties	2.10	Normal	2.00	1.05
9	Random uncertainty	0.50	Normal	2.00	0.25
10	Influence of the XPD	0.01	U-shaped	1.41	0.00
11	Insertion Loss Variation	0.00	Rectangular	1.73	0.00
12	RF leakage (from measurement antenna to the receiver/transmitter)	0.00	Actual	1.00	0.00
13	Influence of beam peak search grid (NOTE 3)	0.00	Actual	1	0.00
14	Multiple measurement antenna uncertainty (NOTE 9)	0.15	Actual	1	0.15
15	DUT repositioning (NOTE 3)	0.08	Rectangular	1.73	0.05
Stage 1: Calibration measurement					
16	Mismatch	0.00	U-shaped	1.41	0.00
17	Amplifier Uncertainties	0.00	Normal	2.00	0.00
18	Misalignment of positioning System	0.00	Normal	2.00	0.00
19	Uncertainty of the Network Analyzer	1.50	Normal	2.00	0.75
20	Uncertainty of the absolute gain of the calibration antenna	0.60	Normal	2.00	0.30
21	Positioning and pointing misalignment between the reference antenna and the measurement antenna	0.01	Rectangular	1.73	0.00
22	Phase centre offset of calibration antenna	0.00	Rectangular	1.73	0.00
23	Quality of quiet zone for calibration process (NOTE 8)	0.6	Actual	1.00	0.6
24	Standing wave between reference calibration antenna and measurement antenna	0.00	U-shaped	1.41	0.00
25	Influence of the calibration antenna feed cable	0.14	Normal	2.00	0.07
26	Insertion Loss Variation	0.00	Rectangular	1.73	0.00
Systematic uncertainties (NOTE 5)					Value
27	Systematic error related to beam peak search				0.5
28	Influence of noise (23.45GHz <= f <= 32.125GHz)				1.0
28	Influence of noise (32.125GHz < f <= 40.8GHz)				1.0
Total measurement uncertainty					Value
EIRP Expanded uncertainty (23.45GHz <= f <= 32.125GHz) (1.96 σ - confidence interval of 95 %) [dB]					6.41
EIRP Expanded uncertainty (32.125GHz < f <= 40.8GHz) (1.96 σ - confidence interval of 95 %) [dB]					6.41

- | |
|---|
| <p>NOTE 1: The analysis was done only for the case of operating at Minimum output power, in-band, non-CA and is valid for SISO and MIMO.</p> <p>NOTE 2: The assessment assumes DUT Minimum output power.</p> <p>NOTE 3: This contributor shall only be considered for EIRP measurements.</p> <p>NOTE 4: Void</p> <p>NOTE 5: In order to obtain the total measurement uncertainty, systematic uncertainties have to be added to the expanded root sum square of the standard deviations of the Stage 1 and Stage 2 contributors.</p> <p>NOTE 6: Void.</p> <p>NOTE 7: Void</p> <p>NOTE 8: Value based on procedure defined in Annex D.2 of TR 38.810 for Quiet Zone size less or equal to 30 cm.</p> <p>NOTE 9: Applies to the system which has a structure of mechanical feed antenna positioning.</p> |
|---|

NOTE: MU assessment in Table B.7.2-5 is based on the relaxations for 400MHz BW in Table B.7.2-4.

Table B.7.2-6: Uncertainty assessment for EIRP measurement (f=23.45GHz, 32.125GHz, 40.8GHz, Quiet Zone size \leq 30 cm) for PC1 and PC5 UEs and extreme temperature condition

UID	Uncertainty source	Uncertainty value	Distribution of the probability	Divisor	Standard uncertainty (σ) [dB]
Stage 2: DUT measurement					
1	Positioning misalignment	0.02	Normal	2	0.01
2	Measure distance uncertainty	0.00	Rectangular	1.73	0.00
3	Quality of Quiet Zone (NOTE 8)	0.90	Actual	1	0.90
4	Mismatch (NOTE 1)	1.30	Actual	1	1.30
5	Standing wave between the DUT and measurement antenna	0.00	U-shaped	1.41	0.00
6	Uncertainty of the RF power measurement equipment (NOTE 2)	2.50	Normal	2	1.25
7	Phase curvature	0.00	U-shaped	1.41	0.00
8	Amplifier uncertainties	2.10	Normal	2	1.05
9	Random uncertainty	0.50	Normal	2	0.25
10	Influence of the XPD	0.01	U-shaped	1.41	0.00
11	Insertion Loss Variation	0.00	Rectangular	1.73	0.00
12	RF leakage (from measurement antenna to the receiver/transmitter)	0.00	Actual	1	0.00
13	Influence of beam peak search grid (NOTE 3)	0.00	Actual	1	0.00
14	Multiple measurement antenna uncertainty (NOTE 9)	0.15	Actual	1	0.15
15	DUT repositioning (NOTE 3)	0.35	Rectangular	1.73	0.20
Stage 1: Calibration measurement					
16	Mismatch	0.00	U-shaped	1.41	0.00
17	Amplifier Uncertainties	0.00	Normal	2	0.00
18	Misalignment of positioning System	0.00	Normal	2	0.00
19	Uncertainty of the Network Analyzer	1.50	Normal	2	0.75
20	Uncertainty of the absolute gain of the calibration antenna	0.60	Normal	2	0.30
21	Positioning and pointing misalignment between the reference antenna and the measurement antenna	0.01	Rectangular	1.73	0.00
22	Phase centre offset of calibration antenna	0.00	Rectangular	1.73	0.00
23	Quality of quiet zone for calibration process (NOTE 8)	0.60	Actual	1	0.60
24	Standing wave between reference calibration antenna and measurement antenna	0.00	U-shaped	1.41	0.00
25	Influence of the calibration antenna feed cable	0.14	Normal	2	0.07
26	Insertion Loss Variation	0.00	Rectangular	1.73	0.00
Systematic uncertainties (NOTE 5)					Value
27	Systematic error related to beam peak search				0.70
28	Influence of noise (23.45GHz <= f <= 32.125GHz) (PC1) (SISO)				0.30
28	Influence of noise (23.45GHz <= f <= 32.125GHz) (PC1) (MIMO)				0.15
28	Influence of noise (23.45GHz <= f <= 32.125GHz) (PC5)				1.00
28	Influence of noise (32.125GHz < f <= 40.8GHz) (PC1) (SISO)				0.60
28	Influence of noise (32.125GHz < f <= 40.8GHz) (PC1) (MIMO)				0.30
Total measurement uncertainty					Value
EIRP Expanded uncertainty (23.45GHz <= f <= 32.125GHz) (1.96 σ - confidence interval of 95 %) [dB] (PC1) (SISO)					5.92
EIRP Expanded uncertainty (23.45GHz <= f <= 32.125GHz) (1.96 σ - confidence interval of 95 %) [dB] (PC1) (MIMO)					5.75
EIRP Expanded uncertainty (23.45GHz <= f <= 32.125GHz) (1.96 σ - confidence interval of 95 %) [dB] (PC5)					6.62
EIRP Expanded uncertainty (32.125GHz < f <= 40.8GHz) (1.96 σ - confidence interval of 95 %) [dB] (PC1) (SISO)					6.22
EIRP Expanded uncertainty (32.125GHz < f <= 40.8GHz) (1.96 σ - confidence interval of 95 %) [dB] (PC1) (MIMO)					5.92

NOTE 1: The analysis was done only for the case of operating at Minimum output power, in-band, non-CA and is valid for SISO and MIMO.
 NOTE 2: The assessment assumes DUT Minimum output power.
 NOTE 3: This contributor shall only be considered for EIRP measurements.
 NOTE 4: Void
 NOTE 5: In order to obtain the total measurement uncertainty, systematic uncertainties have to be added to the expanded root sum square of the standard deviations of the Stage 1 and Stage 2 contributors.
 NOTE 6: Void.
 NOTE 7: Void
 NOTE 8: Value based on procedure defined in Annex D.2 of TR 38.810 for Quiet Zone size less or equal to 30 cm.
 NOTE 9: Applies to the system which has a structure of mechanical feed antenna positioning.

B.8 Transmit OFF power

Following tables summarize the MU threshold for TRP measurements for Transmit OFF power. The origin MU values for different test setups can be found in following clauses.

Table B.8-1: MU threshold for TRP measurement for Transmit OFF power

Power Class	Diversity	Frequency	MBW	Power	Threshold MU value (NOTE1)
PC3	SISO, MIMO	23.45GHz <= f <= 32.125GHz	BW <= 400MHz	P = Off Power	5.67
		32.125GHz < f <= 40.8GHz			N/A
PC1	SISO, MIMO	23.45GHz <= f <= 32.125GHz	BW <= 400MHz	P = Off Power	5.67
		32.125GHz < f <= 40.8GHz			N/A
NOTE 1: Total TRP Expanded MU for IFF for Quiet Zone size ≤ 30cm in Table B.8.2-2 for PC3 UEs and Table B.8.2-6 for PC1 UEs.					

Table B.8-2: Void

B.8.1 Uncertainty budget format and assessment for DFF

The uncertainty contributions that may impact the overall MU value are listed in Table B.8.1-1.

Table B.8.1-1: Uncertainty contributions for TRP measurement

UID	Description of uncertainty contribution	Details in annex
Stage 2: DUT measurement		
1	Positioning misalignment	B.2.1.1
2	Measure distance uncertainty	B.2.1.2
3	Quality of quiet zone	B.2.1.3
4	Mismatch	B.2.1.4
5	Standing Wave Between the DUT and measurement antenna	B.2.1.5
6	Uncertainty of the RF power measurement equipment	B.2.1.6
7	Phase curvature	B.2.1.7
8	Amplifier uncertainties	B.2.1.8
9	Random uncertainty	B.2.1.9
10	Influence of the XPD	B.2.1.10
11	Insertion Loss Variation	B.2.1.11
12	RF leakage (from measurement antenna to the receiver/transmitter)	B.2.1.12
13	Influence of TRP measurement grid	B.2.1.22
14	Influence of beam peak search grid	B.2.1.23
15	Multiple measurement antenna uncertainty	B.2.1.25
16	DUT repositioning	B.2.1.26
Stage 1: Calibration measurement		
17	Mismatch	B.2.1.4
18	Amplifier uncertainties	B.2.1.8
19	Misalignment of positioning System	B.2.1.13
20	Uncertainty of the Network Analyzer	B.2.1.14
21	Uncertainty of the absolute gain of the calibration antenna	B.2.1.15
22	Positioning and pointing misalignment between the reference antenna and the measurement antenna	B.2.1.16
23	Phase centre offset of calibration antenna	B.2.1.18
24	Quality of quiet zone for calibration process	B.2.1.19
25	Standing wave between reference calibration antenna and measurement antenna	B.2.1.20
26	Influence of the calibration antenna feed cable	B.2.1.21
27	Insertion Loss Variation	B.2.1.11
Systematic uncertainties		
28	Systematic error due to TRP calculation/quadrature	B.2.1.24
29	Influence of noise	B.2.1.27

The uncertainty assessment tables are organized as follows:

- For the purpose of uncertainty assessment, the radiating antenna aperture of the DUT is denoted as D
- The uncertainty assessment has been derived for the case of $D = [5 \text{ cm}]$, $f = \{23.45 \text{ GHz}, 32.125 \text{ GHz}, 40.8 \text{ GHz}\}$, $P = [\text{Off power}]$.
- The uncertainty assessment for TRP is provided in Table B.8.1-2.

Table B.8.1-2: Uncertainty assessment for TRP measurement (f=TBD, D=TBD)

UID	Uncertainty source	Uncertainty value	Distribution of the probability	Divisor	Standard uncertainty (σ) [dB]
Stage 2: DUT measurement					
1	Positioning misalignment				
2	Measure distance uncertainty				
3	Quality of quiet zone (NOTE 2)				
4	Mismatch (NOTE 3)				
5	Standing Wave Between the DUT and measurement antenna				
6	Uncertainty of the RF power measurement equipment (NOTE 4)				
7	Phase curvature				
8	Amplifier uncertainties				
9	Random uncertainty				
10	Influence of the XPD				
11	Insertion Loss Variation				
12	RF leakage (from measurement antenna to the receiver/transmitter)				
13	Influence of TRP measurement grid (NOTE 5)				
14	Influence of beam peak search grid (NOTE 6)				
15	Multiple measurement antenna uncertainty				
16	DUT repositioning		Actual	1	
Stage 1: Calibration measurement					
17	Mismatch				
18	Amplifier uncertainties				
19	Misalignment of positioning System				
20	Uncertainty of the Network Analyzer				
21	Uncertainty of the absolute gain of the calibration antenna				
22	Positioning and pointing misalignment between the reference antenna and the measurement antenna				
23	Phase centre offset of calibration antenna				
24	Quality of quiet zone for calibration process (NOTE 2)				
25	Standing wave between reference calibration antenna and measurement antenna				
26	Influence of the calibration antenna feed cable				
27	Insertion Loss Variation				
TRP Expanded uncertainty (1.96σ - confidence interval of 95 %) [dB]					
Systematic uncertainties (NOTE 7)					Value
28	Systematic error due to TRP calculation/quadrature (NOTE 5)				
29	Influence of noise				
Total measurement uncertainty					
TRP total measurement uncertainty [dB]					
NOTE 1: The impact of phase variation on EIRP is FFS.					
NOTE 2: The quality of quiet zone is different for EIRP and TRP. For TRP, the standard uncertainty is FFS; for EIRP, the standard uncertainty of quiet zone is FFS.					
NOTE 3: The analysis was done only for the case of operating at max output power, in-band, non-CA.					
NOTE 4: The assessment assumes maximum DUT output power.					
NOTE 5: This contributor shall only be considered for TRP measurements.					
NOTE 6: This contributor shall only be considered for EIRP measurements.					
NOTE 7: In order to obtain the total measurement uncertainty, systematic uncertainties have to be added to the expanded root sum square of the standard deviations of the Stage 1 and Stage 2 contributors.					

B.8.2 Uncertainty budget format and assessment for IFF

The uncertainty contributions that may impact the overall MU value are listed in Table B.8.2-1.

Table B.8.2-1: Uncertainty contributions for TRP measurement

UID	Description of uncertainty contribution	Details in annex
Stage 2: DUT measurement		
1	Positioning misalignment	B.2.2.1
2	Measure distance uncertainty	B.2.2.2
3	Quality of Quiet Zone	B.2.2.3
4	Mismatch	B.2.2.4
5	Standing wave between the DUT and measurement antenna	B.2.2.5
6	Uncertainty of the RF power measurement equipment	B.2.2.6
7	Phase curvature	B.2.2.7
8	Amplifier uncertainties	B.2.2.8
9	Random uncertainty	B.2.2.9
10	Influence of the XPD	B.2.2.10
11	Insertion Loss Variation	B.2.2.11
12	RF leakage (from measurement antenna to the receiver/transmitter)	B.2.2.12
13	Influence of TRP measurement grid	B.2.2.22
14	Influence of beam peak search grid	B.2.2.23
15	Multiple measurement antenna uncertainty	B.2.2.25
16	DUT repositioning	B.2.2.26
Stage 1: Calibration measurement		
17	Mismatch	B.2.2.4
18	Amplifier Uncertainties	B.2.2.8
19	Misalignment of positioning System	B.2.2.13
20	Uncertainty of the Network Analyzer	B.2.2.14
21	Uncertainty of the absolute gain of the calibration antenna	B.2.2.15
22	Positioning and pointing misalignment between the reference antenna and the measurement antenna	B.2.2.16
23	Phase centre offset of calibration antenna	B.2.2.18
24	Quality of quiet zone for calibration process	B.2.2.19
25	Standing wave between reference calibration antenna and measurement antenna	B.2.2.20
26	Influence of the calibration antenna feed cable	B.2.2.21
27	Insertion Loss Variation	B.2.2.11
Systematic uncertainties		
28	Systematic error due to TRP calculation/quadrature	B.2.2.24
29	Influence of noise	B.2.2.27

The uncertainty assessment tables are organized as follows:

- For the purpose of uncertainty assessment, the radiating antenna aperture of the DUT is denoted as D
- The uncertainty assessment has been derived for the case of Quiet Zone size ≤ 30 cm, $f = \{23.45\text{GHz}, 32.125\text{GHz}, 40.8\text{GHz}\}$, $P = \text{Off power}$.
- The uncertainty assessment for TRP is provided in Table B.8.2-2 for PC3 UEs and Table B.8.2-6 for PC1 UEs.

Table B.8.2-2: Uncertainty assessment for TRP measurement (f=23.45GHz, 32.125GHz, 40.8GHz, Quiet Zone size \leq 30 cm) for PC3 UEs

UID	Uncertainty source	Uncertainty value	Distribution of the probability	Divisor	Standard uncertainty (σ) [dB]
Stage 2: DUT measurement					
1	Positioning misalignment	0.00	Normal	2.00	0.00
2	Measure distance uncertainty	0.00	Rectangular	1.73	0.00
3	Quality of Quiet Zone (NOTE 8)	0.6	Actual	1.00	0.6
4	Mismatch (NOTE 1)	1.30	Actual	1.00	1.30
5	Standing wave between the DUT and measurement antenna	0.00	U-shaped	1.41	0.00
6	Uncertainty of the RF power measurement equipment (NOTE 2)	2.50	Normal	2.00	1.25
7	Phase curvature	0.00	U-shaped	1.41	0.00
8	Amplifier uncertainties	2.10	Normal	2.00	1.05
9	Random uncertainty	0.50	Normal	2.00	0.25
10	Influence of the XPD	0.01	U-shaped	1.41	0.00
11	Insertion Loss Variation	0.00	Rectangular	1.73	0.00
12	RF leakage (from measurement antenna to the receiver/transmitter)	0.00	Actual	1.00	0.00
13	Influence of TRP measurement grid (NOTE 3)	0.25	Actual	1	0.25
14	Influence of beam peak search grid	0.00	Actual	1	0.00
15	Multiple measurement antenna uncertainty (NOTE 9)	0.15	Actual	1	0.15
16	DUT repositioning	0.00	Rectangular	1.73	0.00
Stage 1: Calibration measurement					
17	Mismatch	0.00	U-shaped	1.41	0.00
18	Amplifier Uncertainties	0.00	Normal	2.00	0.00
19	Misalignment of positioning System	0.00	Normal	2.00	0.00
20	Uncertainty of the Network Analyzer	1.5	Normal	2.00	0.75
21	Uncertainty of the absolute gain of the calibration antenna	0.60	Normal	2.00	0.30
22	Positioning and pointing misalignment between the reference antenna and the measurement antenna	0.01	Rectangular	1.73	0.00
23	Phase centre offset of calibration antenna	0.00	Rectangular	1.73	0.00
24	Quality of quiet zone for calibration process (NOTE 8)	0.4	Actual	1.00	0.4
25	Standing wave between reference calibration antenna and measurement antenna	0.00	U-shaped	1.41	0.00
26	Influence of the calibration antenna feed cable	0.14	Normal	2.00	0.07
27	Insertion Loss Variation	0.00	Rectangular	1.73	0.00
Systematic uncertainties (NOTE 5)					Value
28	Systematic error due to TRP calculation/quadrature (NOTE 3)				0.0
29	Influence of noise (23.45GHz <= f <= 32.125GHz)				1.0
29	Influence of noise (32.125GHz < f <= 40.8GHz)				N/A
Total measurement uncertainty					Value
TRP Expanded uncertainty (23.45GHz <= f <= 32.125GHz) (1.96 σ - confidence interval of 95 %) [dB]					5.67
TRP Expanded uncertainty (32.125GHz < f <= 40.8GHz) (1.96 σ - confidence interval of 95 %) [dB]					N/A

- NOTE 1: The analysis was done only for the case of operating at TX OFF power, in-band, non-CA and is valid for SISO and MIMO.
- NOTE 2: The assessment assumes DUT Off power.
- NOTE 3: This contributor shall only be considered for TRP measurements.
- NOTE 4: Void
- NOTE 5: In order to obtain the total measurement uncertainty, systematic uncertainties have to be added to the expanded root sum square of the standard deviations of the Stage 1 and Stage 2 contributors.
- NOTE 6: Void.
- NOTE 7: Void
- NOTE 8: Value based on procedure defined in Annex D.2 of TR 38.810 for Quiet Zone size less or equal to 30 cm.
- NOTE 9: Applies to the system which has a structure of mechanical feed antenna positioning.

Table B.8.2-3: Void

Table B.8.2-4: Void

Table B.8.2-5: Void

Table B.8.2-6: Uncertainty assessment for TRP measurement ($f=23.45\text{GHz}$, 32.125GHz , 40.8GHz , Quiet Zone size $\leq 30\text{ cm}$) for PC1 UEs

UID	Uncertainty source	Uncertainty value	Distribution of the probability	Divisor	Standard uncertainty (σ) [dB]
Stage 2: DUT measurement					
1	Positioning misalignment	0.02	Normal	2.00	0.01
2	Measure distance uncertainty	0.00	Rectangular	1.73	0.00
3	Quality of Quiet Zone (NOTE 8)	0.6	Actual	1.00	0.6
4	Mismatch (NOTE 1)	1.30	Actual	1.00	1.30
5	Standing wave between the DUT and measurement antenna	0.00	U-shaped	1.41	0.00
6	Uncertainty of the RF power measurement equipment (NOTE 2)	2.50	Normal	2.00	1.25
7	Phase curvature	0.00	U-shaped	1.41	0.00
8	Amplifier uncertainties	2.10	Normal	2.00	1.05
9	Random uncertainty	0.50	Normal	2.00	0.25
10	Influence of the XPD	0.01	U-shaped	1.41	0.00
11	Insertion Loss Variation	0.00	Rectangular	1.73	0.00
12	RF leakage (from measurement antenna to the receiver/transmitter)	0.00	Actual	1.00	0.00
13	Influence of TRP measurement grid (NOTE 3)	0.25	Actual	1	0.25
14	Influence of beam peak search grid	0.00	Actual	1	0.00
15	Multiple measurement antenna uncertainty (NOTE 9)	0.15	Actual	1	0.15
16	DUT repositioning	0.00	Rectangular	1.73	0.00
Stage 1: Calibration measurement					
17	Mismatch	0.00	U-shaped	1.41	0.00
18	Amplifier Uncertainties	0.00	Normal	2.00	0.00
19	Misalignment of positioning System	0.00	Normal	2.00	0.00
20	Uncertainty of the Network Analyzer	1.5	Normal	2.00	0.75
21	Uncertainty of the absolute gain of the calibration antenna	0.60	Normal	2.00	0.30
22	Positioning and pointing misalignment between the reference antenna and the measurement antenna	0.01	Rectangular	1.73	0.00
23	Phase centre offset of calibration antenna	0.00	Rectangular	1.73	0.00
24	Quality of quiet zone for calibration process (NOTE 8)	0.4	Actual	1.00	0.4
25	Standing wave between reference calibration antenna and measurement antenna	0.00	U-shaped	1.41	0.00
26	Influence of the calibration antenna feed cable	0.14	Normal	2.00	0.07
27	Insertion Loss Variation	0.00	Rectangular	1.73	0.00
Systematic uncertainties (NOTE 5)					Value
28	Systematic error due to TRP calculation/quadrature (NOTE 3)				0.0
29	Influence of noise (23.45GHz <= f <= 32.125GHz)				1.0
29	Influence of noise (32.125GHz < f <= 40.8GHz)				N/A
Total measurement uncertainty					Value
TRP Expanded uncertainty (23.45GHz <= f <= 32.125GHz) (1.96 σ - confidence interval of 95 %) [dB]					5.67
TRP Expanded uncertainty (32.125GHz < f <= 40.8GHz) (1.96 σ - confidence interval of 95 %) [dB]					N/A

NOTE 1:	The analysis was done only for the case of operating at TX OFF power, in-band, non-CA and is valid for SISO and MIMO.
NOTE 2:	The assessment assumes DUT Off power.
NOTE 3:	This contributor shall only be considered for TRP measurements.
NOTE 4:	Void
NOTE 5:	In order to obtain the total measurement uncertainty, systematic uncertainties have to be added to the expanded root sum square of the standard deviations of the Stage 1 and Stage 2 contributors.
NOTE 6:	Void.
NOTE 7:	Void
NOTE 8:	Value based on procedure defined in Annex D.2 of TR 38.810 for Quiet Zone size less or equal to 30 cm.
NOTE 9:	Applies to the system which has a structure of mechanical feed antenna positioning.

NOTE: MU assessment in Table B.8.2-2 and Table B.8.2-6 for FR2a is based on the relaxation of 30.4dB for 400MHz BW.

B.9 ON/OFF time mask

B.9.1 ON power subtest

MU threshold for EIRP measurements in the ON power subtest in the Transmit ON/OFF time mask test case is specified in Table B.3-1. The origin MU values for different test setups can be found in following subclauses.

B.9.1.1 Uncertainty budget format and assessment for DFF

Uncertainty budget format and assessment for IFF for EIRP measurement is contained in clause B.3.1.

B.9.1.2 Uncertainty budget format and assessment for IFF

Uncertainty budget format and assessment for IFF for EIRP measurement is contained in clause B.3.2.

B.9.2 OFF power subtest

MU threshold for EIRP measurements in the OFF power subtest in the Transmit ON/OFF time mask test case. The origin MU values for different test setups can be found in following subclauses.

Table B.9.2-1: MU threshold for EIRP measurement for Transmit OFF power

Frequency	CBW	Power	Threshold MU value for NTC [dB] (NOTE1)	Threshold MU value for ETC [dB] (NOTE1)
23.45GHz ≤ f ≤ 32.125GHz	50MHz	P = Off Power	6.15	6.41
	100MHz			
	200MHz			
	400MHz			
32.125GHz < f ≤ 40.8GHz	50MHz	P = Off Power	6.15	6.41
	100MHz			
	200MHz			
	400MHz			

NOTE 1: Total Expanded MU for IFF for Quiet Zone size ≤ 30cm in Table B.8.2-4 for PC3 UEs

B.9.2.1 Uncertainty budget format and assessment for DFF

FFS

B.9.2.2 Uncertainty budget format and assessment for IFF

The uncertainty contributions that may impact the overall MU value are listed in Table B.9.2.2-1.

Table B.9.2.2-1: Uncertainty contributions for EIRP measurement

UID	Description of uncertainty contribution	Details in annex
Stage 2: DUT measurement		
1	Positioning misalignment	B.2.2.1
2	Measure distance uncertainty	B.2.2.2
3	Quality of Quiet Zone	B.2.2.3
4	Mismatch	B.2.2.4
5	Standing wave between the DUT and measurement antenna	B.2.2.5
6	Uncertainty of the RF power measurement equipment	B.2.2.6
7	Phase curvature	B.2.2.7
8	Amplifier uncertainties	B.2.2.8
9	Random uncertainty	B.2.2.9
10	Influence of the XPD	B.2.2.10
11	Insertion Loss Variation	B.2.2.11
12	RF leakage (from measurement antenna to the receiver/transmitter)	B.2.2.12
13	Influence of TRP measurement grid	B.2.2.22
14	Influence of beam peak search grid	B.2.2.23
15	Multiple measurement antenna uncertainty	B.2.2.25
16	DUT repositioning	B.2.2.26
Stage 1: Calibration measurement		
17	Mismatch	B.2.2.4
18	Amplifier Uncertainties	B.2.2.8
19	Misalignment of positioning System	B.2.2.13
20	Uncertainty of the Network Analyzer	B.2.2.14
21	Uncertainty of the absolute gain of the calibration antenna	B.2.2.15
22	Positioning and pointing misalignment between the reference antenna and the measurement antenna	B.2.2.16
23	Phase centre offset of calibration antenna	B.2.2.18
24	Quality of quiet zone for calibration process	B.2.2.19
25	Standing wave between reference calibration antenna and measurement antenna	B.2.2.20
26	Influence of the calibration antenna feed cable	B.2.2.21
27	Insertion Loss Variation	B.2.2.11
Systematic uncertainties		
28	Systematic error due to TRP calculation/quadrature	B.2.2.24
29	Influence of noise	B.2.2.27

The uncertainty assessment tables are organized as follows:

- For the purpose of uncertainty assessment, the radiating antenna aperture of the DUT is denoted as D
- The uncertainty assessment has been derived for the case of Quiet Zone size ≤ 30 cm, $f = \{23.45\text{GHz}, 32.125\text{GHz}, 40.8\text{GHz}\}$, P = Off power.

Table B.9.2.2-2: Uncertainty assessment for EIRP measurement (f=23.45GHz, 32.125GHz, 40.8GHz, Quiet Zone size \leq 30 cm) for PC3 UEs and normal temperature condition

UID	Uncertainty source	Uncertainty value	Distribution of the probability	Divisor	Standard uncertainty (σ) [dB]
Stage 2: DUT measurement					
1	Positioning misalignment	0.00	Normal	2.00	0.00
2	Measure distance uncertainty	0.00	Rectangular	1.73	0.00
3	Quality of Quiet Zone (NOTE 8)	0.6	Actual	1.00	0.6
4	Mismatch (NOTE 1)	1.30	Actual	1.00	1.30
5	Standing wave between the DUT and measurement antenna	0.00	U-shaped	1.41	0.00
6	Uncertainty of the RF power measurement equipment (NOTE 2)	2.50	Normal	2.00	1.25
7	Phase curvature	0.00	U-shaped	1.41	0.00
8	Amplifier uncertainties	2.10	Normal	2.00	1.05
9	Random uncertainty	0.50	Normal	2.00	0.25
10	Influence of the XPD	0.01	U-shaped	1.41	0.00
11	Insertion Loss Variation	0.00	Rectangular	1.73	0.00
12	RF leakage (from measurement antenna to the receiver/transmitter)	0.00	Actual	1.00	0.00
13	Influence of beam peak search grid (NOTE 3)	0.00	Actual	1	0.00
14	Multiple measurement antenna uncertainty (NOTE 9)	0.15	Actual	1	0.15
15	DUT repositioning (NOTE 3)	0.08	Rectangular	1.73	0.05
Stage 1: Calibration measurement					
16	Mismatch	0.00	U-shaped	1.41	0.00
17	Amplifier Uncertainties	0.00	Normal	2.00	0.00
18	Misalignment of positioning System	0.00	Normal	2.00	0.00
19	Uncertainty of the Network Analyzer	1.5	Normal	2.00	0.75
20	Uncertainty of the absolute gain of the calibration antenna	0.60	Normal	2.00	0.30
21	Positioning and pointing misalignment between the reference antenna and the measurement antenna	0.01	Rectangular	1.73	0.00
22	Phase centre offset of calibration antenna	0.00	Rectangular	1.73	0.00
23	Quality of quiet zone for calibration process (NOTE 8)	0.4	Actual	1.00	0.4
24	Standing wave between reference calibration antenna and measurement antenna	0.00	U-shaped	1.41	0.00
25	Influence of the calibration antenna feed cable	0.14	Normal	2.00	0.07
26	Insertion Loss Variation	0.00	Rectangular	1.73	0.00
Systematic uncertainties (NOTE 5)					Value
27	Systematic error related to beam peak search				0.5
28	Influence of noise (23.45GHz <= f <= 32.125GHz)				1
28	Influence of noise (32.125GHz < f <= 40.8GHz)				1
Total measurement uncertainty					Value
EIRP Expanded uncertainty (23.45GHz <= f <= 32.125GHz) (1.96 σ - confidence interval of 95 %) [dB]					6.15
EIRP Expanded uncertainty (32.125GHz < f <= 40.8GHz) (1.96 σ - confidence interval of 95 %) [dB]					6.15

- NOTE 1: The analysis was done only for the case of operating at TX OFF power, in-band, non-CA.
- NOTE 2: The assessment assumes DUT Off power.
- NOTE 3: This contributor shall only be considered for EIRP measurements.
- NOTE 4: Void
- NOTE 5: In order to obtain the total measurement uncertainty, systematic uncertainties have to be added to the expanded root sum square of the standard deviations of the Stage 1 and Stage 2 contributors.
- NOTE 6: Void.
- NOTE 7: Void
- NOTE 8: Value based on procedure defined in Annex D.2 of TR 38.810 for Quiet Zone size less or equal to 30 cm.
- NOTE 9: Applies to the system which has a structure of mechanical feed antenna positioning.

Table B.9.2.2-3: Uncertainty assessment for EIRP measurement (f=23.45GHz, 32.125GHz, 40.8GHz, Quiet Zone size \leq 30 cm) for PC3 UEs and extreme temperature condition

UID	Uncertainty source	Uncertainty value	Distribution of the probability	Divisor	Standard uncertainty (σ) [dB]
Stage 2: DUT measurement					
1	Positioning misalignment	0.00	Normal	2.00	0.00
2	Measure distance uncertainty	0.00	Rectangular	1.73	0.00
3	Quality of Quiet Zone (NOTE 8)	0.9	Actual	1.00	0.9
4	Mismatch (NOTE 1)	1.30	Actual	1.00	1.30
5	Standing wave between the DUT and measurement antenna	0.00	U-shaped	1.41	0.00
6	Uncertainty of the RF power measurement equipment (NOTE 2)	2.50	Normal	2.00	1.25
7	Phase curvature	0.00	U-shaped	1.41	0.00
8	Amplifier uncertainties	2.10	Normal	2.00	1.05
9	Random uncertainty	0.50	Normal	2.00	0.25
10	Influence of the XPD	0.01	U-shaped	1.41	0.00
11	Insertion Loss Variation	0.00	Rectangular	1.73	0.00
12	RF leakage (from measurement antenna to the receiver/transmitter)	0.00	Actual	1.00	0.00
13	Influence of beam peak search grid (NOTE 3)	0.00	Actual	1	0.00
14	Multiple measurement antenna uncertainty (NOTE 9)	0.15	Actual	1	0.15
15	DUT repositioning (NOTE 3)	0.08	Rectangular	1.73	0.05
Stage 1: Calibration measurement					
16	Mismatch	0.00	U-shaped	1.41	0.00
17	Amplifier Uncertainties	0.00	Normal	2.00	0.00
18	Misalignment of positioning System	0.00	Normal	2.00	0.00
19	Uncertainty of the Network Analyzer	1.5	Normal	2.00	0.75
20	Uncertainty of the absolute gain of the calibration antenna	0.60	Normal	2.00	0.30
21	Positioning and pointing misalignment between the reference antenna and the measurement antenna	0.01	Rectangular	1.73	0.00
22	Phase centre offset of calibration antenna	0.00	Rectangular	1.73	0.00
23	Quality of quiet zone for calibration process (NOTE 8)	0.6	Actual	1.00	0.6
24	Standing wave between reference calibration antenna and measurement antenna	0.00	U-shaped	1.41	0.00
25	Influence of the calibration antenna feed cable	0.14	Normal	2.00	0.07
26	Insertion Loss Variation	0.00	Rectangular	1.73	0.00
Systematic uncertainties (NOTE 5)					Value
27	Systematic error related to beam peak search				0.5
28	Influence of noise (23.45GHz <= f <= 32.125GHz)				1
28	Influence of noise (32.125GHz < f <= 40.8GHz)				1
Total measurement uncertainty					Value
EIRP Expanded uncertainty (23.45GHz <= f <= 32.125GHz) (1.96 σ - confidence interval of 95 %) [dB]					6.41
EIRP Expanded uncertainty (32.125GHz < f <= 40.8GHz) (1.96 σ - confidence interval of 95 %) [dB]					6.41

NOTE 1:	The analysis was done only for the case of operating at TX OFF power, in-band, non-CA.
NOTE 2:	The assessment assumes DUT Off power.
NOTE 3:	This contributor shall only be considered for EIRP measurements.
NOTE 4:	Void
NOTE 5:	In order to obtain the total measurement uncertainty, systematic uncertainties have to be added to the expanded root sum square of the standard deviations of the Stage 1 and Stage 2 contributors.
NOTE 6:	Void.
NOTE 7:	Void
NOTE 8:	Value based on procedure defined in Annex D.2 of TR 38.810 for Quiet Zone size less or equal to 30 cm.
NOTE 9:	Applies to the system which has a structure of mechanical feed antenna positioning.

NOTE: MU assessment in Table B.9.2.2-2 and Table B.9.2.2-3 is based on the relaxation in Table B.9.2.2-4.

Table B.9.2.2-4: Transmit OFF power (EIRP) requirement relaxation considered in MU assessment (f=23.45GHz, 32.125GHz, 40.8GHz, Quiet Zone size ≤ 30 cm)

Frequency	Power Class	Relaxation			
		CHBW 50MHz	CHBW 100MHz	CHBW 200MHz	CHBW 400MHz
23.45GHz <= f <= 32.125GHz	PC1	EIRP - 1dB	EIRP + 2dB	EIRP + 5dB	EIRP + 8dB
	PC2	FFS	FFS	FFS	FFS
	PC3	EIRP - 1dB	EIRP + 2dB	EIRP + 5dB	EIRP + 8dB
	PC4	FFS	FFS	FFS	FFS
32.125GHz <= f <= 40.8GHz	PC1	EIRP + 2dB	EIRP + 5dB	EIRP + 8dB	EIRP + 11dB
	PC2	FFS	FFS	FFS	FFS
	PC3	EIRP + 2dB	EIRP + 5dB	EIRP + 8dB	EIRP + 11dB
	PC4	FFS	FFS	FFS	FFS

NOTE: EIRP is the measured UE rms ON power level in ON/OFF time mask testing.

B.9a Power control

B.9a.1 Absolute power tolerance

B.9a.2 Relative power control tolerance

B.9a.2.1 Uncertainty budget format and assessment for DFF

The uncertainty contributions that may impact the overall MU value are listed in Table B.9a.2.1-1.

Table B.9a.2.1-1: Uncertainty contributions for EIRP relative power control tolerance measurement

UID	Description of uncertainty contribution	Details in annex
Stage 2: DUT measurement		
1	Uncertainty of the RF relative power measurement equipment	B.2.1.36
2	Amplifier uncertainties	B.2.1.8
3	Impact of frequency response	FFS
Stage 1: Calibration measurement		
	N/A	
Systematic uncertainties		
4	Influence of noise	B.2.1.27

The uncertainty assessment tables are organized as follows:

- For the purpose of uncertainty assessment, the radiating antenna aperture of the DUT is denoted as D

- The uncertainty assessment has been derived for the case of $D = [5 \text{ cm}]$, $f = \{22.65\text{GHz}, 31.1\text{GHz}, 45.1\text{GHz}\}$, $P = [\text{maximum output power}]$.
- The uncertainty assessment for EIRP relative power control tolerance is provided in Table B.9a.2.1-2.

Table B.9a.2.1-2: Uncertainty assessment for EIRP relative power control tolerance measurement (f=TBD, D=TBD)

UID	Uncertainty source	Uncertainty value	Distribution of the probability	Divisor	Standard uncertainty (σ) [dB]
Stage 2: DUT measurement					
1	Uncertainty of the RF relative power measurement equipment	FFS	FFS	FFS	FFS
2	Amplifier uncertainties	FFS	FFS	FFS	FFS
3	Impact of frequency response	FFS	FFS	FFS	FFS
Stage 1: Calibration measurement					
	N/A				
Systematic uncertainties (NOTE 1)					Value
4	Influence of noise				FFS
Total measurement uncertainty					Value
EIRP Expanded uncertainty (1.96 σ - confidence interval of 95 %) [dB]					FFS
NOTE 1: In order to obtain the total measurement uncertainty, systematic uncertainties have to be added to the expanded root sum square of the standard deviations of the Stage 1 and Stage 2 contributors.					

B.9a.2.2 Uncertainty budget format and assessment for IFF

The uncertainty contributions that may impact the overall MU value are listed in Table B.9a.2.2-1.

Table B.9a.2.2-1: Uncertainty contributions for EIRP relative power control tolerance measurement

UID	Description of uncertainty contribution	Details in annex
Stage 2: DUT measurement		
1	Uncertainty of the RF relative power measurement equipment	B.2.2.36
2	Amplifier uncertainties	B.2.2.8
3	Impact of frequency response	FFS
Stage 1: Calibration measurement		
	N/A	
Systematic uncertainties		
4	Influence of noise	B.2.2.27

The uncertainty assessment tables are organized as follows:

- For the purpose of uncertainty assessment, the radiating antenna aperture of the DUT is denoted as D
- The uncertainty assessment has been derived for the case of Quiet Zone size $\leq [30 \text{ cm}]$, $f = \{23.45\text{GHz}, 32.125\text{GHz}, 40.8\text{GHz}\}$.
- The uncertainty assessment for EIRP relative power control tolerance is provided in Table B.9a.2.2-2 for PC3 UEs and in Table B.9a.2.2-3 for PC1 UEs.

Table B.9a.2.2-2: Uncertainty assessment for EIRP relative power control tolerance measurement (f=23.45GHz, 32.125GHz, 40.8GHz, Quiet Zone size ≤ 30 cm) for PC3 UEs and normal temperature condition

UID	Uncertainty source	Uncertainty value	Distribution of the probability	Divisor	Standard uncertainty (σ) [dB]
Stage 2: DUT measurement					
1	Uncertainty of the RF relative power measurement equipment	[0.4]	Normal	2.00	[0.2]
2	Amplifier uncertainties	0.5	Rectangular	1.73	0.29
3	Impact of frequency response	FFS	FFS	FFS	FFS
Stage 1: Calibration measurement					
	N/A				
Systematic uncertainties (NOTE 1)					Value
4	Influence of noise (23.45GHz ≤ f ≤ 40.8GHz)				1.0
Total measurement uncertainty					Value
EIRP Expanded uncertainty (23.45GHz ≤ f ≤ 32.125GHz) (1.96σ - confidence interval of 95 %) [dB]					[1.7]
NOTE 1: In order to obtain the total measurement uncertainty, systematic uncertainties have to be added to the expanded root sum square of the standard deviations of the Stage 1 and Stage 2 contributors.					
NOTE 2: Power step size assumed ΔP = 1 dB.					
NOTE 3: Measurement uncertainties in this table assume absolute power measurements involved in the same relative power measurement are performed over the same RF path.					

Table B.9a.2.2-3: Uncertainty assessment for EIRP relative power control tolerance measurement (f=23.45GHz, 32.125GHz, 40.8GHz, Quiet Zone size ≤ 30 cm) for PC1 UEs and normal temperature condition

UID	Uncertainty source	Uncertainty value	Distribution of the probability	Divisor	Standard uncertainty (σ) [dB]
Stage 2: DUT measurement					
1	Uncertainty of the RF power measurement equipment	FFS	Normal	2.0	FFS
2	Amplifier uncertainties	FFS	Rectangular	1.73	FFS
3	Impact of frequency response	FFS	FFS	FFS	FFS
Stage 1: Calibration measurement					
	N/A				
Systematic uncertainties (NOTE 1)					Value
4	Influence of noise (23.45GHz ≤ f ≤ 40.8GHz)				FFS
Total measurement uncertainty					Value
EIRP Expanded uncertainty (23.45GHz ≤ f ≤ 32.125GHz) (1.96σ - confidence interval of 95 %) [dB]					FFS
NOTE 1: In order to obtain the total measurement uncertainty, systematic uncertainties have to be added to the expanded root sum square of the standard deviations of the Stage 1 and Stage 2 contributors.					

B.9a.2.3 Uncertainty budget format and assessment for NFTF

The uncertainty contributions that may impact the overall MU value are listed in Table B.9a.2.3-1.

Table B.9a.2.3-1: Uncertainty contributions for EIRP relative power control tolerance measurement

UID	Description of uncertainty contribution	Details in annex
Stage 2: DUT measurement		
1	Uncertainty of the RF relative power measurement equipment	B.2.3.30
2	Amplifier uncertainties	B.2.3.8
3	Impact of frequency response	FFS
Stage 1: Calibration measurement		
	N/A	
Systematic uncertainties		
4	Influence of noise	B.2.3.29

The uncertainty assessment table is organized as follows:

- For the purpose of uncertainty assessment, the radiating antenna aperture of the DUT is denoted as D
- The uncertainty assessment has been derived for the case of $D = [5 \text{ cm}]$, $f = \{22.65\text{GHz}, 31.1\text{GHz}, 45.1\text{GHz}\}$, $P = [\text{maximum output power}]$.
- The uncertainty assessment for EIRP relative power control tolerance is provided in Table B.9a.2.3-2

Table B.9a.2.3-2: Uncertainty assessment for EIRP relative power control tolerance measurement (f=TBD, D=TBD)

UID	Uncertainty source	Uncertainty value	Distribution of the probability	Divisor	Standard uncertainty (σ) [dB]
Stage 2: DUT measurement					
1	Uncertainty of the RF relative power measurement equipment	FFS	FFS	FFS	FFS
2	Amplifier uncertainties	FFS	FFS	FFS	FFS
3	Impact of frequency response	FFS	FFS	FFS	FFS
Stage 1: Calibration measurement					
	N/A				
Systematic uncertainties (NOTE 1)					Value
4	Influence of noise				FFS
Total measurement uncertainty					Value
EIRP Expanded uncertainty (1.96 σ - confidence interval of 95 %) [dB]					FFS
NOTE 1: In order to obtain the total measurement uncertainty, systematic uncertainties have to be added to the expanded root sum square of the standard deviations of the Stage 1 and Stage 2 contributors.					

B.9a.3 Aggregate Power control tolerance

B.9a.3.1 Uncertainty budget format and assessment for DFF

The uncertainty contributions that may impact the overall MU value are listed in Table B.9a.3.1-1.

Table B.9a.3.1-1: Uncertainty contributions for EIRP aggregate power control tolerance measurement

UID	Description of uncertainty contribution	Details in annex
Stage 2: DUT measurement		
1	Uncertainty of the RF relative power measurement equipment	B.2.1.36
Stage 1: Calibration measurement		
	N/A	
Systematic uncertainties		
2	Influence of noise	B.2.1.27

The uncertainty assessment tables are organized as follows:

- For the purpose of uncertainty assessment, the radiating antenna aperture of the DUT is denoted as D

- The uncertainty assessment has been derived for the case of $D = [5 \text{ cm}]$, $f = \{22.65\text{GHz}, 31.1\text{GHz}, 45.1\text{GHz}\}$, $P = [\text{maximum output power}]$.
- The uncertainty assessment for EIRP aggregate power control tolerance is provided in Table B.9a.3.1-2.

Table B.9a.3.1-2: Uncertainty assessment for EIRP aggregate power control tolerance measurement (f=TBD, D=TBD)

UID	Uncertainty source	Uncertainty value	Distribution of the probability	Divisor	Standard uncertainty (σ) [dB]
Stage 2: DUT measurement					
1	Uncertainty of the RF relative power measurement equipment	FFS	FFS	FFS	FFS
Stage 1: Calibration measurement					
	N/A				
Systematic uncertainties (NOTE 1)					Value
2	Influence of noise				FFS
Total measurement uncertainty					Value
EIRP Expanded uncertainty (1.96 σ - confidence interval of 95 %) [dB]					FFS
NOTE 1: In order to obtain the total measurement uncertainty, systematic uncertainties have to be added to the expanded root sum square of the standard deviations of the Stage 1 and Stage 2 contributors.					

B.9a.3.2 Uncertainty budget format and assessment for IFF

The uncertainty contributions that may impact the overall MU value are listed in Table B.9a.3.2-1.

Table B.9a.3.2-1: Uncertainty contributions for EIRP aggregate power control tolerance measurement

UID	Description of uncertainty contribution	Details in annex
Stage 2: DUT measurement		
1	Uncertainty of the RF relative power measurement equipment	B.2.2.36
Stage 1: Calibration measurement		
	N/A	
Systematic uncertainties		
2	Influence of noise	B.2.2.27

The uncertainty assessment tables are organized as follows:

- For the purpose of uncertainty assessment, the radiating antenna aperture of the DUT is denoted as D
- The uncertainty assessment has been derived for the case of Quiet Zone size $\leq [30 \text{ cm}]$, $f = \{23.45\text{GHz}, 32.125\text{GHz}, 40.8\text{GHz}\}$.
- The uncertainty assessment for EIRP aggregate power control tolerance is provided in Table B.9a.3.2-2 for PC3 UEs and in Table B.9a.3.2-3 for PC1 UEs.

Table B.9a.3.2-2: Uncertainty assessment for EIRP aggregate power control tolerance measurement (f=23.45GHz, 32.125GHz, 40.8GHz, Quiet Zone size ≤ 30 cm) for PC3 UEs and normal temperature condition

UID	Uncertainty source	Uncertainty value	Distribution of the probability	Divisor	Standard uncertainty (σ) [dB]
Stage 2: DUT measurement					
1	Uncertainty of the RF relative power measurement equipment	0.4	Normal	2.00	0.2
Stage 1: Calibration measurement					
	N/A				
Systematic uncertainties (NOTE 1)					Value
2	Influence of noise (23.45GHz ≤ f ≤ 40.8GHz)				1.0
Total measurement uncertainty					Value
EIRP Expanded uncertainty (23.45GHz ≤ f ≤ 32.125GHz) (1.96σ - confidence interval of 95 %) [dB]					1.4
NOTE 1: In order to obtain the total measurement uncertainty, systematic uncertainties have to be added to the expanded root sum square of the standard deviations of the Stage 1 and Stage 2 contributors.					
NOTE 2: Power step size assumed ΔP = 1 dB.					
NOTE 3: Measurement uncertainties in this table assume absolute power measurements involved in the same relative power measurement are performed over the same RF path.					

Table B.9a.3.2-3: Uncertainty assessment for EIRP aggregate power control tolerance measurement (f=23.45GHz, 32.125GHz, 40.8GHz, Quiet Zone size ≤ 30 cm) for PC1 UEs and normal temperature condition

UID	Uncertainty source	Uncertainty value	Distribution of the probability	Divisor	Standard uncertainty (σ) [dB]
Stage 2: DUT measurement					
1	Uncertainty of the RF power measurement equipment	FFS	Normal	2.0	FFS
Stage 1: Calibration measurement					
	N/A				
Systematic uncertainties (NOTE 1)					Value
2	Influence of noise (23.45GHz ≤ f ≤ 40.8GHz)				FFS
Total measurement uncertainty					Value
EIRP Expanded uncertainty (23.45GHz ≤ f ≤ 32.125GHz) (1.96σ - confidence interval of 95 %) [dB]					FFS
NOTE 1: In order to obtain the total measurement uncertainty, systematic uncertainties have to be added to the expanded root sum square of the standard deviations of the Stage 1 and Stage 2 contributors.					

B.9a.3.3 Uncertainty budget format and assessment for NFTF

The uncertainty contributions that may impact the overall MU value are listed in Table B.9a.3.3-1.

Table B.9a.3.3-1: Uncertainty contributions for EIRP aggregate power control tolerance measurement

UID	Description of uncertainty contribution	Details in annex
Stage 2: DUT measurement		
1	Uncertainty of the RF relative power measurement equipment	B.2.3.30
Stage 1: Calibration measurement		
	N/A	
Systematic uncertainties		
2	Influence of noise	B.2.3.29

The uncertainty assessment table is organized as follows:

- For the purpose of uncertainty assessment, the radiating antenna aperture of the DUT is denoted as D

- The uncertainty assessment has been derived for the case of $D = [5 \text{ cm}]$, $f = \{22.65\text{GHz}, 31.1\text{GHz}, 45.1\text{GHz}\}$, $P = [\text{maximum output power}]$.
- The uncertainty assessment for EIRP aggregate power control tolerance is provided in Table B.9a.3.3-2

Table B.9a.3.3-2: Uncertainty assessment for EIRP aggregate power control tolerance measurement (f=TBD, D=TBD)

UID	Uncertainty source	Uncertainty value	Distribution of the probability	Divisor	Standard uncertainty (σ) [dB]
Stage 2: DUT measurement					
1	Uncertainty of the RF relative power measurement equipment	FFS	FFS	FFS	FFS
Stage 1: Calibration measurement					
	N/A				
Systematic uncertainties (NOTE 1)					Value
2	Influence of noise				FFS
Total measurement uncertainty					Value
EIRP Expanded uncertainty (1.96 σ - confidence interval of 95 %) [dB]					FFS
NOTE 1: In order to obtain the total measurement uncertainty, systematic uncertainties have to be added to the expanded root sum square of the standard deviations of the Stage 1 and Stage 2 contributors.					

B.10 Frequency error

Following tables summarize the MU threshold for EIRP measurements for Frequency error. The origin MU values for different test setups can be found in following subclauses.

Table B.10-1: MU threshold for beam peak measurement for Frequency error

Power Class	Frequency	MBW	Power	Threshold MU value for NTC and ETC (NOTE1)
PC3	23.45GHz <= f <= 32.125GHz	BW <= 400MHz	P = Max Output Power	+/- 0.01 ppm
	32.125GHz < f <= 40.8GHz			+/- 0.01 ppm
	40.8GHz < f <= 44.3GHz			
PC1	23.45GHz <= f <= 32.125GHz	BW <= 400MHz	P = Max Output Power	+/- 0.01 ppm
	32.125GHz < f <= 40.8GHz			+/- 0.01 ppm
NOTE 1: Total Expanded MU for IFF for Quiet Zone size ≤ 30cm in section B.10.2				

B.10.1 Uncertainty budget format and assessment for DFF

+/- 0.01 ppm

- The uncertainty assessment has been derived for the case of $D = [5 \text{ cm}]$, $f = \{23.45 \text{ GHz}, 32.125 \text{ GHz}, 40.8 \text{ GHz}, 44.3\text{GHz}\}$, $P = [\text{Maximum output power}]$. This uncertainty has no dependency with extreme temperature conditions.

B.10.2 Uncertainty budget format and assessment for IFF

+/- 0.01 ppm

- The uncertainty assessment has been derived for the case of Quiet zone size \leq [30 cm], $f = \{23.45\text{GHz}, 32.125\text{GHz}, 40.8\text{GHz}, 44.3\text{GHz}\}$, $P = [\text{Maximum output power}]$.

B.11 Carrier leakage

Editor's Note: MU value analysis for PC1, 2 and 4 are not complete.

Following tables summarize the MU threshold for EIRP measurements for carrier leakage. The origin MU values for different test setups can be found in following subclauses.

Table B.11-1: MU threshold for EIRP measurement for carrier leakage

Power Class	Frequency	MBW	Power (NOTE2)	Threshold MU value for NTC [dB] (NOTE 1)
PC3	23.45GHz \leq f \leq 32.125GHz	BW \leq 400MHz	P = 0 + MU to 0 + (MU + Uplink power control window size) dBm	5.44
	32.125GHz < f \leq 40.8GHz			5.57
PC1	23.45GHz \leq f \leq 32.125GHz	BW \leq 400MHz	FFS	FFS
	32.125GHz < f \leq 40.8GHz			FFS
NOTE 1: Total Expanded MU for IFF for Quiet Zone size \leq 30cm in Table B.11.2-2 for PC3 UEs and FFS for PC1 UEs				

B.11.1 Uncertainty budget format and assessment for DFF

The uncertainty contributions that may impact the overall MU value are listed in Table B.11.1-1.

Table B.11.1-1: Uncertainty contributions for EIRP measurement

UID	Description of uncertainty contribution	Details in annex
Stage 2: DUT measurement		
1	Positioning misalignment	B.2.1.1
2	Measure distance uncertainty	B.2.1.2
3	Quality of quiet zone	B.2.1.3
4	Mismatch	B.2.1.4
5	Standing Wave Between the DUT and measurement antenna	B.2.1.5
6	Uncertainty of the RF power measurement equipment	B.2.1.6
7	Phase curvature	B.2.1.7
8	Amplifier uncertainties	B.2.1.8
9	Random uncertainty	B.2.1.9
10	Influence of the XPD	B.2.1.10
11	Insertion Loss Variation	B.2.1.11
12	RF leakage (from measurement antenna to the receiver/transmitter)	B.2.1.12
13	Influence of TRP measurement grid	B.2.1.22
14	Influence of beam peak search grid	B.2.1.23
15	Multiple measurement antenna uncertainty	B.2.1.25
16	DUT repositioning	B.2.1.26
Stage 1: Calibration measurement		
17	Mismatch	B.2.1.4
18	Amplifier uncertainties	B.2.1.8
19	Misalignment of positioning System	B.2.1.13
20	Uncertainty of the Network Analyzer	B.2.1.14
21	Uncertainty of the absolute gain of the calibration antenna	B.2.1.15
22	Positioning and pointing misalignment between the reference antenna and the measurement antenna	B.2.1.16
23	Phase centre offset of calibration antenna	B.2.1.18
24	Quality of quiet zone for calibration process	B.2.1.19
25	Standing wave between reference calibration antenna and measurement antenna	B.2.1.20
26	Influence of the calibration antenna feed cable	B.2.1.21
27	Insertion Loss Variation	B.2.1.11
Systematic uncertainties		
28	Systematic error due to TRP calculation/quadrature	B.2.1.24
29	Influence of noise	B.2.1.27

The uncertainty assessment tables are organized as follows:

- For the purpose of uncertainty assessment, the radiating antenna aperture of the DUT is denoted as D
- The uncertainty assessment has been derived for the case of $D = [5 \text{ cm}]$, $f = \{23.45 \text{ GHz}, 32.125 \text{ GHz}, 40.8 \text{ GHz}\}$, $P = [\text{Maximum output power}]$.
- The uncertainty assessment is provided in Table B.11.1-2.

Table B.11.1-2: Uncertainty assessment for EIRP measurement (f=TBD, D=TBD)

UID	Uncertainty source	Uncertainty value	Distribution of the probability	Divisor	Standard uncertainty (σ) [dB]
Stage 2: DUT measurement					
1	Positioning misalignment				
2	Measure distance uncertainty				
3	Quality of quiet zone (NOTE 2)				
4	Mismatch (NOTE 3)				
5	Standing Wave Between the DUT and measurement antenna				
6	Uncertainty of the RF power measurement equipment (NOTE 4)				
7	Phase curvature				
8	Amplifier uncertainties				
9	Random uncertainty				
10	Influence of the XPD				
11	Insertion Loss Variation				
12	RF leakage (from measurement antenna to the receiver/transmitter)				
13	Influence of TRP measurement grid (NOTE 5)				
14	Influence of beam peak search grid (NOTE 6)				
15	Multiple measurement antenna uncertainty				
16	DUT repositioning				
Stage 1: Calibration measurement					
17	Mismatch				
18	Amplifier uncertainties				
19	Misalignment of positioning System				
20	Uncertainty of the Network Analyzer				
21	Uncertainty of the absolute gain of the calibration antenna				
22	Positioning and pointing misalignment between the reference antenna and the measurement antenna				
23	Phase centre offset of calibration antenna				
24	Quality of quiet zone for calibration process (NOTE 2)				
25	Standing wave between reference calibration antenna and measurement antenna				
26	Influence of the calibration antenna feed cable				
27	Insertion Loss Variation				
EIRP Expanded uncertainty (1.96 σ - confidence interval of 95 %) [dB]					
Systematic uncertainties (NOTE 7)					Value
28	Systematic error due to TRP calculation/quadrature (NOTE 5)				
29	Influence of noise				
Total measurement uncertainty					
EIRP total measurement uncertainty [dB]					

NOTE 1:	The impact of phase variation on EIRP is FFS.
NOTE 2:	The quality of quiet zone is different for EIRP and TRP. For TRP, the standard uncertainty is FFS; for EIRP, the standard uncertainty of quiet zone is FFS.
NOTE 3:	The analysis was done only for the case of operating at 0dBm output power, in-band, non-CA.
NOTE 4:	The assessment assumes 0 dBm UE output power – carrier leakage requirement.
NOTE 5:	This contributor shall only be considered for TRP measurements.
NOTE 6:	This contributor shall only be considered for EIRP measurements.
NOTE 7:	In order to obtain the total measurement uncertainty, systematic uncertainties have to be added to the expanded root sum square of the standard deviations of the Stage 1 and Stage 2 contributors.
NOTE 8:	Void

B.11.2 Uncertainty budget format and assessment for IFF

The uncertainty contributions that may impact the overall MU value are listed in Table B.12.2-1.

Table B.11.2-1: Uncertainty contributions for EIRP measurement

UID	Description of uncertainty contribution	Details in clause
Stage 2: DUT measurement		
1	Positioning misalignment	B.2.2.1
2	Measure distance uncertainty	B.2.2.2
3	Quality of Quiet Zone	B.2.2.3
4	Mismatch	B.2.2.4
5	Standing wave between the DUT and measurement antenna	B.2.2.5
6	Uncertainty of the RF power measurement equipment	B.2.2.6
7	Phase curvature	B.2.2.7
8	Amplifier uncertainties	B.2.2.8
9	Random uncertainty	B.2.2.9
10	Influence of the XPD	B.2.2.10
11	Insertion Loss Variation	B.2.2.11
12	RF leakage (from measurement antenna to the receiver/transmitter)	B.2.2.12
13	Influence of TRP measurement grid	B.2.2.22
14	Influence of beam peak search grid	B.2.2.23
15	Multiple measurement antenna uncertainty	B.2.2.25
16	DUT repositioning	B.2.2.26
Stage 1: Calibration measurement		
17	Mismatch	B.2.2.4
18	Amplifier Uncertainties	B.2.2.8
19	Misalignment of positioning System	B.2.2.13
20	Uncertainty of the Network Analyzer	B.2.2.14
21	Uncertainty of the absolute gain of the calibration antenna	B.2.2.15
22	Positioning and pointing misalignment between the reference antenna and the measurement antenna	B.2.2.16
23	Phase centre offset of calibration antenna	B.2.2.18
24	Quality of quiet zone for calibration process	B.2.2.19
25	Standing wave between reference calibration antenna and measurement antenna	B.2.2.20
26	Influence of the calibration antenna feed cable	B.2.2.21
27	Insertion Loss Variation	B.2.2.11
Systematic uncertainties		
28	Systematic error due to TRP calculation/quadrature	B.2.2.24
29	Influence of noise	B.2.2.27

The uncertainty assessment tables are organized as follows:

- For the purpose of uncertainty assessment, the radiating antenna aperture of the DUT is denoted as D
- The uncertainty assessment has been derived for the case of Quiet Zone size ≤ 30 cm, $f = \{23.45\text{GHz}, 32.125\text{GHz}, 40.8\text{GHz}\}$, for PC3 with measured UE power in the range 0dBm + MU to 0dBm + MU + uplink power control window size, where

- MU is the test system uplink absolute power measurement uncertainty for minimum output power in Table B.7.2-2.
- Uplink power control window size = 1dB (UE power step size) + 5 dB (UE power step tolerance) + (Test system uplink relative power measurement uncertainty), where, the UE power step tolerance is specified in TS 38.101-1 [2], Table 6.3.4.3-1 and is 5dB for 1dB power step size, and the Test system uplink relative power measurement uncertainty is specified in Table F.1.2-1 in TS 38.521-2 for TC 6.4.2.2 with a value of 1.4 dB.
- The uncertainty assessment for EIRP is provided in Table B.17.2-2 for PC3 UEs and Table B.17.2-3 for PC1 UEs.

Table B.11.2-2: Uncertainty assessment for EIRP measurement (f=23.45GHz, 32.125GHz, 40.8GHz, Quiet Zone size \leq 30 cm) for PC3 UEs and normal temperature condition

UID	Uncertainty source	Uncertainty value	Distribution of the probability	Divisor	Standard uncertainty (σ) [dB]
Stage 2: DUT measurement					
1	Positioning misalignment	0.00	Normal	2.00	0.00
2	Measure distance uncertainty	0.00	Rectangular	1.73	0.00
3	Quality of Quiet Zone (NOTE 10)	0.52	Actual	1.00	0.52
4	Mismatch (NOTE 2)	1.84	Actual	1.00	1.84
5	Standing wave between the DUT and measurement antenna	0.00	U-shaped	1.41	0.00
6	Uncertainty of the RF power measurement equipment (NOTE 3, 7)	2.50	Normal	2.00	1.25
7	Phase curvature	0.00	U-shaped	1.41	0.00
8	Amplifier uncertainties	2.1	Normal	2.00	1.05
9	Random uncertainty	0.50	Normal	2.00	0.25
10	Influence of the XPD	0.00	U-shaped	1.41	0.00
11	Insertion Loss Variation	0.00	Rectangular	1.73	0.00
12	RF leakage (from measurement antenna to the receiver/transmitter)	0.00	Actual	1.00	0.00
13	Influence of TRP measurement grid (NOTE 4)	0.0	Actual	1	0.0
14	Influence of beam peak search grid (NOTE 5)	0.00	Actual	1	0.00
15	Multiple measurement antenna uncertainty (NOTE 9)	0.0	Actual	1	0.0
16	DUT repositioning (NOTE 4)	0.00	Rectangular	1.73	0.00
Stage 1: Calibration measurement					
17	Mismatch	0.00	U-shaped	1.41	0.00
18	Amplifier Uncertainties	0.00	Normal	2.00	0.00
19	Misalignment of positioning System	0.00	Normal	2.00	0.00
20	Uncertainty of the Network Analyzer	1.5	Normal	2.00	0.75
21	Uncertainty of the absolute gain of the calibration antenna	0.60	Normal	2.00	0.30
22	Positioning and pointing misalignment between the reference antenna and the measurement antenna	0.00	Rectangular	1.73	0.00
23	Phase centre offset of calibration antenna	0.00	Rectangular	1.73	0.00
24	Quality of quiet zone for calibration process (NOTE 10)	0.32	Actual	1.00	0.32
25	Standing wave between reference calibration antenna and measurement antenna	0.00	U-shaped	1.41	0.00
26	Influence of the calibration antenna feed cable	0.00	Normal	2.00	0.00
27	Insertion Loss Variation	0.00	Rectangular	1.73	0.00
EIRP Expanded uncertainty (1.96σ - confidence interval of 95 %) [dB]					5.24
Systematic uncertainties (NOTE 6)					Value
28	Systematic error due to TRP calculation/quadrature (NOTE 4)				0.00
29	Influence of noise ($23.45\text{GHz} \leq f \leq 32.125\text{GHz}$)				0.20
29	Influence of noise ($32.125\text{GHz} < f \leq 40.8\text{GHz}$)				0.33
30	Beam peak search				0.00
Total measurement uncertainty					Value
EIRP total measurement uncertainty ($23.45\text{GHz} \leq f \leq 32.125\text{GHz}$) [dB]					5.44
EIRP total measurement uncertainty ($32.125\text{GHz} < f \leq 40.8\text{GHz}$) [dB]					5.57

- NOTE 1: Void
- NOTE 2: The analysis was done only for the case of measured UE power in the range from 0dBm + MU to 0dBm + MU + uplink power control window size, in-band, non-CA.
- NOTE 3: The assessment assumes measured power in the range from 0dBm + MU – carrier leakage requirement to 0dBm + MU + uplink power control window – carrier leakage requirement.
- NOTE 4: This contributor shall only be considered for TRP measurements.
- NOTE 5: Void
- NOTE 6: In order to obtain the total measurement uncertainty, systematic uncertainties have to be added to the expanded root sum square of the standard deviations of the Stage 1 and Stage 2 contributors.
- NOTE 7: Void
- NOTE 8: Void
- NOTE 9: Applies to the system which has a structure of mechanical feed antenna positioning.
- NOTE 10: Defined as fixed value MU contributor.

Table B.11.2-3: Uncertainty assessment for EIRP measurement (f=23.45GHz, 32.125GHz, 40.8GHz, Quiet Zone size \leq 30 cm) for PC1 UEs and normal temperature condition

UID	Uncertainty source	Uncertainty value	Distribution of the probability	Divisor	Standard uncertainty (σ) [dB]
Stage 2: DUT measurement					
1	Positioning misalignment	0.02	Normal	2.00	0.01
2	Measure distance uncertainty	FFS	Rectangular	1.73	FFS
3	Quality of Quiet Zone (NOTE 10)	FFS	Actual	1.00	FFS
4	Mismatch (NOTE 2, NOTE 7)	FFS	Actual	1.00	FFS
5	Standing wave between the DUT and measurement antenna	FFS	U-shaped	1.41	FFS
6	Uncertainty of the RF power measurement equipment (NOTE 3, 7)	FFS	Normal	2.00	FFS
7	Phase curvature	FFS	U-shaped	1.41	FFS
8	Amplifier uncertainties	FFS	Normal	2.00	FFS
9	Random uncertainty	FFS	Normal	2.00	FFS
10	Influence of the XPD	FFS	U-shaped	1.41	FFS
11	Insertion Loss Variation	FFS	Rectangular	1.73	FFS
12	RF leakage (from measurement antenna to the receiver/transmitter)	FFS	Actual	1.00	FFS
13	Influence of TRP measurement grid (NOTE 4)	0.00	Actual	1	0.00
14	Influence of beam peak search grid (NOTE 5)	0.00	Actual	1	0.00
15	Multiple measurement antenna uncertainty (NOTE 9)	FFS	Actual	1	FFS
16	DUT repositioning (NOTE 4)	0.00	Rectangular	1.73	0.00
Stage 1: Calibration measurement					
17	Mismatch	FFS	U-shaped	1.41	FFS
18	Amplifier Uncertainties	FFS	Normal	2.00	FFS
19	Misalignment of positioning System	FFS	Normal	2.00	FFS
20	Uncertainty of the Network Analyzer	FFS	Normal	2.00	FFS
21	Uncertainty of the absolute gain of the calibration antenna	FFS	Normal	2.00	FFS
22	Positioning and pointing misalignment between the reference antenna and the measurement antenna	FFS	Rectangular	1.73	FFS
23	Phase centre offset of calibration antenna	FFS	Rectangular	1.73	FFS
24	Quality of quiet zone for calibration process (NOTE 10)	FFS	Actual	1.00	FFS
25	Standing wave between reference calibration antenna and measurement antenna	FFS	U-shaped	1.41	FFS
26	Influence of the calibration antenna feed cable	FFS	Normal	2.00	FFS
27	Insertion Loss Variation	FFS	Rectangular	1.73	FFS
TRP Expanded uncertainty (1.96σ - confidence interval of 95 %) [dB]					FFS
Systematic uncertainties (NOTE 6)					Value
28	Systematic error due to TRP calculation/quadrature (NOTE 4)				0.00
29	Influence of noise				FFS
30	Beam peak search				FFS
Total measurement uncertainty					Value
EIRP total measurement uncertainty [dB]					FFS

NOTE 1: Void
 NOTE 2: The analysis was done only for the case of measured UE power in the range from FFS to FFS, in-band, non-CA.
 NOTE 3: The assessment assumes measured power in the range from FFS to FFS.
 NOTE 4: This contributor shall only be considered for TRP measurements.
 NOTE 5: Void
 NOTE 6: In order to obtain the total measurement uncertainty, systematic uncertainties have to be added to the expanded root sum square of the standard deviations of the Stage 1 and Stage 2 contributors.
 NOTE 7: Void.
 NOTE 8: Void.
 NOTE 9: Applies to the system which has a structure of mechanical feed antenna positioning.
 NOTE 10: Defined as fixed value MU contributor.

B.12 Error Vector Magnitude

Following tables summarize the MU threshold for Error Vector Magnitude (EVM) measurements. The origin MU values for different test setups can be found in following subclauses.

Table B.12-1: MU threshold for beam peak measurement for Frequency error

Power Class	Frequency	MBW	Power	Threshold MU value for NTC and ETC (NOTE1)
PC3	23.45GHz <= f <= 32.125GHz	BW <= 400MHz	P = Max Output Power	PUSCH: Table B.12.2-1. Otherwise: FFS
	32.125GHz < f <= 40.8GHz			PUSCH: Table B.12.2-2. Otherwise: FFS
PC1	23.45GHz <= f <= 32.125GHz	BW <= 400MHz	P = Max Output Power	PUSCH: Table B.12.2-5 Otherwise: FFS
	32.125GHz < f <= 40.8GHz			FFS
NOTE 1: Total Expanded MU for IFF for Quiet Zone size ≤ 30cm in section B.10.2				

B.12.1 Uncertainty budget format and assessment for DFF

FFS

B.12.2 Uncertainty budget format and assessment for IFF

Table B.12.2-1: Measurement Uncertainty (MU) for PUSCH, PC3, FR2a (23.45GHz <= f <= 32.125GHz)

Test ID	Modulation	RB alloc.	50MHz	100MHz	200MHz	400MHz
1	DFT-s-OFDM PI/2 BPSK	Inner_Full	2.78%	3.85%	5.44%	7.69%
2	DFT-s-OFDM PI/2 BPSK	Outer_Full	3.10%	4.16%	5.88%	8.99%
3	DFT-s-OFDM QPSK	Inner_Full	2.78%	3.85%	5.44%	7.69%

4	DFT-s-OFDM QPSK	Outer_Full	3.10%	4.16%	5.88%	8.99%
5	DFT-s-OFDM 16 QAM	Inner_Full	3.31%	4.50%	6.36%	11.21%
6	DFT-s-OFDM 16 QAM	Outer_Full	3.60%	4.73%	6.68%	11.21%
7	DFT-s-OFDM 64 QAM	Inner_Full	4.26%	5.96%	8.41%	15.84%
8	DFT-s-OFDM 64 QAM	Outer_Full	5.01%	7.08%	9.99%	15.84%
9	CP-OFDM QPSK	Inner_Full	3.60%	4.73%	6.68%	11.89%
10	CP-OFDM QPSK	Outer_Full	3.71%	4.99%	7.07%	11.89%
11	CP-OFDM 16 QAM	Inner_Full	4.26%	5.96%	8.41%	15.84%
12	CP-OFDM 16 QAM	Outer_Full	4.26%	5.96%	8.41%	15.84%
13	CP-OFDM 64 QAM	Inner_Full	6.31%	8.91%	12.59%	21.13%
14	CP-OFDM 64 QAM	Outer_Full	6.31%	8.91%	12.59%	21.13%

Table B.12.2-2: Measurement Uncertainty (MU) for PUSCH, PC3, FR2b (32.125GHz < f <= 40.8GHz)

Test ID	Modulation	RB alloc.	50MHz	100MHz	200MHz	400MHz
1	DFT-s-OFDM PI/2 BPSK	Inner_Full	3.56%	4.83%	6.91%	9.65%
2	DFT-s-OFDM PI/2 BPSK	Outer_Full	4.15%	5.69%	8.11%	12.50%
3	DFT-s-OFDM QPSK	Inner_Full	3.56%	4.83%	6.91%	9.65%
4	DFT-s-OFDM QPSK	Outer_Full	4.15%	5.69%	8.11%	12.50%
5	DFT-s-OFDM 16 QAM	Inner_Full	4.54%	6.26%	8.91%	18.06%
6	DFT-s-OFDM 16 QAM	Outer_Full	5.09%	7.19%	10.15%	18.06%
7	DFT-s-OFDM 64 QAM	Inner_Full	6.78%	9.58%	13.54%	25.50%
8	DFT-s-OFDM 64 QAM	Outer_Full	8.06%	11.38%	16.09%	25.50%
9	CP-OFDM QPSK	Inner_Full	5.09%	7.19%	10.15%	19.13%
10	CP-OFDM QPSK	Outer_Full	5.39%	7.61%	10.75%	19.13%
11	CP-OFDM 16 QAM	Inner_Full	6.78%	9.58%	13.54%	25.50%
12	CP-OFDM 16 QAM	Outer_Full	6.78%	9.58%	13.54%	25.50%
13	CP-OFDM 64 QAM	Inner_Full	10.14%	14.33%	20.25%	34.01%
14	CP-OFDM 64 QAM	Outer_Full	10.14%	14.33%	20.25%	34.01%

- The uncertainty assessment has been derived for the case of Quiet zone size $\leq [30 \text{ cm}]$, $f = \{23.45\text{GHz}, 32.125\text{GHz}, 40.8\text{GHz}\}$, $P = [\text{Maximum output power}]$.
- Values above are calculated considering a TE noise floor assumption of -10.6 dBm/400 MHz for FR2a and -8.5 dBm/400 MHz for FR2b and additional TE measurement uncertainty (not related to TE noise floor) as shown in Table B.12-2-3 and Table B.12-2-4 added quadratically.

Table B.12.2-3: Additional TE EVM MU (not related to TE noise floor) for PUSCH, PC3, FR2a (23.45GHz <= f <= 32.125GHz)

Test ID	Modulation	RB alloc.	50MHz	100MHz	200MHz	400MHz
---------	------------	-----------	-------	--------	--------	--------

1	DFT-s-OFDM PI/2 BPSK	Inner_Full	2.50%	3.44%	4.86%	6.87%
2	DFT-s-OFDM PI/2 BPSK	Outer_Full	2.50%	3.26%	4.61%	6.58%
3	DFT-s-OFDM QPSK	Inner_Full	2.50%	3.44%	4.86%	6.87%
4	DFT-s-OFDM QPSK	Outer_Full	2.50%	3.26%	4.61%	6.58%
5	DFT-s-OFDM 16 QAM	Inner_Full	2.50%	3.29%	4.65%	6.45%
6	DFT-s-OFDM 16 QAM	Outer_Full	2.50%	3.01%	4.25%	6.45%
7	DFT-s-OFDM 64 QAM	Inner_Full	2.50%	3.43%	4.84%	9.12%
8	DFT-s-OFDM 64 QAM	Outer_Full	2.88%	4.07%	5.75%	9.12%
9	CP-OFDM QPSK	Inner_Full	2.50%	3.01%	4.25%	6.85%
10	CP-OFDM QPSK	Outer_Full	2.50%	3.16%	4.48%	6.85%
11	CP-OFDM 16 QAM	Inner_Full	2.50%	3.43%	4.84%	9.12%
12	CP-OFDM 16 QAM	Outer_Full	2.50%	3.43%	4.84%	9.12%
13	CP-OFDM 64 QAM	Inner_Full	3.63%	5.12%	7.25%	12.16%
14	CP-OFDM 64 QAM	Outer_Full	3.63%	5.12%	7.25%	12.16%

Table B.12.2-4: Additional TE EVM MU (not related to TE noise floor) for PUSCH, PC3, FR2b (32.125GHz < f <= 40.8GHz)

Test ID	Modulation	RB alloc.	50MHz	100MHz	200MHz	400MHz
1	DFT-s-OFDM PI/2 BPSK	Inner_Full	3.00%	4.00%	5.75%	8.00%
2	DFT-s-OFDM PI/2 BPSK	Outer_Full	3.00%	4.00%	5.75%	8.00%
3	DFT-s-OFDM QPSK	Inner_Full	3.00%	4.00%	5.75%	8.00%
4	DFT-s-OFDM QPSK	Outer_Full	3.00%	4.00%	5.75%	8.00%
5	DFT-s-OFDM 16 QAM	Inner_Full	3.00%	4.00%	5.75%	10.93%
6	DFT-s-OFDM 16 QAM	Outer_Full	3.08%	4.35%	6.14%	10.93%
7	DFT-s-OFDM 64 QAM	Inner_Full	4.10%	5.79%	8.19%	15.44%
8	DFT-s-OFDM 64 QAM	Outer_Full	4.87%	6.88%	9.73%	15.44%
9	CP-OFDM QPSK	Inner_Full	3.08%	4.35%	6.14%	11.58%
10	CP-OFDM QPSK	Outer_Full	3.26%	4.60%	6.50%	11.58%
11	CP-OFDM 16 QAM	Inner_Full	4.10%	5.79%	8.19%	15.44%
12	CP-OFDM 16 QAM	Outer_Full	4.10%	5.79%	8.19%	15.44%
13	CP-OFDM 64 QAM	Inner_Full	6.12%	8.66%	12.25%	20.59%
14	CP-OFDM 64 QAM	Outer_Full	6.12%	8.66%	12.25%	20.59%

Table B.12.2-5: Measurement Uncertainty (MU) for PUSCH, PC1, FR2a (23.45GHz <= f <= 32.125GHz)

50MHz	100MHz	200MHz	400MHz
2.48%	3.50%	4.95%	7.00%

- The uncertainty assessment has been derived for the case of Quiet zone size $\leq [30 \text{ cm}]$, $f = \{23.45\text{GHz}, 32.125\text{GHz}\}$, $P = [\text{Maximum output power}]$.
- Values above are calculated considering a TE noise floor assumption of -10.6 dBm/400 MHz for FR2a and additional TE measurement uncertainty (not related to TE noise floor) as shown in Table B.12-2-3 added quadratically.

Table B.12.2-6: Additional TE EVM MU (not related to TE noise floor) for PUSCH, PC1, FR2a (23.45GHz <= f <= 32.125GHz)

50MHz	100MHz	200MHz	400MHz
-------	--------	--------	--------

2.40%	3.39%	4.79%	6.68%
-------	-------	-------	-------

B.13 to B.14

B.15 Occupied bandwidth

Following tables summarize the MU threshold for EIRP measurements for Occupied bandwidth. The origin MU values for different test setups can be found in following subclauses.

Table B.15-1: MU threshold for beam peak measurement for Occupied bandwidth

Power Class	Frequency	Power	BW	Threshold MU value (NOTE1) [%CBW]
PC3, PC1	$23.45 \text{ GHz} \leq f \leq 32.125 \text{ GHz}$	P = Max Output Power	50 MHz	± 0.4
			100 MHz	± 0.4
			200 MHz	± 1.2
			400 MHz	± 1.2
	$32.125 \text{ GHz} < f \leq 40.8 \text{ GHz}$	P = Max Output Power	50 MHz	± 0.4
			100 MHz	± 0.4
			200 MHz	± 1.3
			400 MHz	± 1.3
PC3	$40.8 \text{ GHz} < f \leq 44.3 \text{ GHz}$	P = Max Output Power	50 MHz	TBD
			100 MHz	TBD
			200 MHz	TBD
			400 MHz	TBD
NOTE 1: Total Expanded MU for IFF for Quiet Zone size ≤ 30 cm.				

B.15.1 Uncertainty budget format and assessment for DFF

FFS

- The uncertainty assessment has been derived for the case of $D = [5 \text{ cm}]$, $f = \{23.45 \text{ GHz}, 32.125 \text{ GHz}, 40.8 \text{ GHz}\}$, $P = [\text{Maximum output power}]$.

B.15.2 Uncertainty budget format and assessment for IFF

FFS

- The uncertainty assessment has been derived for the case of Quiet Zone size $\leq 30 \text{ cm}$, $f = \{23.45 \text{ GHz}, 32.125 \text{ GHz}, 40.8 \text{ GHz}\}$, $P = \text{Maximum output power}$.

B.16 Spectrum emission mask

Following tables summarize the MU threshold for TRP measurements for Spectrum emission mask. The origin MU values for different test setups can be found in following subclauses.

Table B.16-1: MU threshold for TRP measurement for Spectrum emission mask

Power Class	Frequency	MBW	Power	Threshold MU value (NOTE 1)
PC3	23.45GHz <= f <= 32.125GHz	BW <= 400MHz	P = Max Output Power	5.13
	32.125GHz < f <= 40.8GHz			5.51
	40.8GHz < f <= 44.3GHz			6.86
PC1	23.45GHz <= f <= 32.125GHz	BW <= 400MHz	P = Max Output Power	6.32
	32.125GHz < f <= 40.8GHz			FFS
NOTE 1: Total Expanded MU for IFF for Quiet Zone size ≤ 30cm in Table B.16.2-2 for PC3 UEs and in Table B.16.2-4 for PC1 UEs				

B.16.1 Uncertainty budget format and assessment for DFF

The uncertainty contributions that may impact the overall MU value are listed in Table B.16.1-1.

Table B.16.1-1: Uncertainty contributions for TRP measurement

UID	Description of uncertainty contribution	Details in annex
Stage 2: DUT measurement		
1	Positioning misalignment	B.2.1.1
2	Measure distance uncertainty	B.2.1.2
3	Quality of quiet zone	B.2.1.3
4	Mismatch	B.2.1.4
5	Standing Wave Between the DUT and measurement antenna	B.2.1.5
6	Uncertainty of the RF power measurement equipment	B.2.1.6
7	Phase curvature	B.2.1.7
8	Amplifier uncertainties	B.2.1.8
9	Random uncertainty	B.2.1.9
10	Influence of the XPD	B.2.1.10
11	Insertion Loss Variation	B.2.1.11
12	RF leakage (from measurement antenna to the receiver/transmitter)	B.2.1.12
13	Influence of TRP measurement grid	B.2.1.22
14	Influence of beam peak search grid	B.2.1.23
15	Multiple measurement antenna uncertainty	B.2.1.25
16	DUT repositioning	B.2.1.26
Stage 1: Calibration measurement		
17	Mismatch	B.2.1.4
18	Amplifier uncertainties	B.2.1.8
19	Misalignment of positioning System	B.2.1.13
20	Uncertainty of the Network Analyzer	B.2.1.14
21	Uncertainty of the absolute gain of the calibration antenna	B.2.1.15
22	Positioning and pointing misalignment between the reference antenna and the measurement antenna	B.2.1.16
23	Phase centre offset of calibration antenna	B.2.1.18
24	Quality of quiet zone for calibration process	B.2.1.19
25	Standing wave between reference calibration antenna and measurement antenna	B.2.1.20
26	Influence of the calibration antenna feed cable	B.2.1.21
27	Insertion Loss Variation	B.2.1.11
Systematic uncertainties		
28	Systematic error due to TRP calculation/quadrature	B.2.1.24
29	Influence of noise	B.2.1.27

The uncertainty assessment tables are organized as follows:

- For the purpose of uncertainty assessment, the radiating antenna aperture of the DUT is denoted as D
- The uncertainty assessment has been derived for the case of $D = [5 \text{ cm}]$, $f = \{23.45 \text{ GHz}, 32.125 \text{ GHz}, 40.8 \text{ GHz}\}$, $P = [\text{Maximum output power}]$.
- The uncertainty assessment for TRP is provided in Table B.16.1-2.

Table B.16.1-2: Uncertainty assessment for TRP measurement (f=TBD, D=TBD)

UID	Uncertainty source	Uncertainty value	Distribution of the probability	Divisor	Standard uncertainty (σ) [dB]
Stage 2: DUT measurement					
1	Positioning misalignment				
2	Measure distance uncertainty				
3	Quality of quiet zone (NOTE 2)				
4	Mismatch (NOTE 3)				
5	Standing Wave Between the DUT and measurement antenna				
6	Uncertainty of the RF power measurement equipment (NOTE 4)				
7	Phase curvature				
8	Amplifier uncertainties				
9	Random uncertainty				
10	Influence of the XPD				
11	Insertion Loss Variation				
12	RF leakage (from measurement antenna to the receiver/transmitter)				
13	Influence of TRP measurement grid (NOTE 5)				
14	Influence of beam peak search grid (NOTE 6)				
15	Multiple measurement antenna uncertainty				
16	DUT repositioning				
Stage 1: Calibration measurement					
17	Mismatch				
18	Amplifier uncertainties				
19	Misalignment of positioning System				
20	Uncertainty of the Network Analyzer				
21	Uncertainty of the absolute gain of the calibration antenna				
22	Positioning and pointing misalignment between the reference antenna and the measurement antenna				
23	Phase centre offset of calibration antenna				
24	Quality of quiet zone for calibration process (NOTE 2)				
25	Standing wave between reference calibration antenna and measurement antenna				
26	Influence of the calibration antenna feed cable				
27	Insertion Loss Variation				
TRP Expanded uncertainty (1.96σ - confidence interval of 95 %) [dB]					
Systematic uncertainties (NOTE 7)					Value
28	Systematic error due to TRP calculation/quadrature (NOTE 5)				
29	Influence of noise				
Total measurement uncertainty					
TRP total measurement uncertainty [dB]					
NOTE 1: The impact of phase variation on EIRP is FFS.					
NOTE 2: The quality of quiet zone is different for EIRP and TRP. For TRP, the standard uncertainty is FFS; for EIRP, the standard uncertainty of quiet zone is FFS.					
NOTE 3: The analysis was done only for the case of operating at max output power, in-band, non-CA.					
NOTE 4: The assessment assumes maximum DUT output power.					
NOTE 5: This contributor shall only be considered for TRP measurements.					
NOTE 6: This contributor shall only be considered for EIRP measurements.					
NOTE 7: In order to obtain the total measurement uncertainty, systematic uncertainties have to be added to the expanded root sum square of the standard deviations of the Stage 1 and Stage 2 contributors.					

B.16.2 Uncertainty budget format and assessment for IFF

The uncertainty contributions that may impact the overall MU value are listed in Table B.16.2-1.

Table B.16.2-1: Uncertainty contributions for TRP measurement

UID	Description of uncertainty contribution	Details in clause
Stage 2: DUT measurement		
1	Positioning misalignment	B.2.2.1
2	Measure distance uncertainty	B.2.2.2
3	Quality of Quiet Zone	B.2.2.3
4	Mismatch	B.2.2.4
5	Standing wave between the DUT and measurement antenna	B.2.2.5
6	Uncertainty of the RF power measurement equipment	B.2.2.6
7	Phase curvature	B.2.2.7
8	Amplifier uncertainties	B.2.2.8
9	Random uncertainty	B.2.2.9
10	Influence of the XPD	B.2.2.10
11	Insertion Loss Variation	B.2.2.11
12	RF leakage (from measurement antenna to the receiver/transmitter)	B.2.2.12
13	Influence of TRP measurement grid	B.2.2.22
14	Influence of beam peak search grid	B.2.2.23
15	Multiple measurement antenna uncertainty	B.2.2.25
16	DUT repositioning	B.2.2.26
Stage 1: Calibration measurement		
17	Mismatch	B.2.2.4
18	Amplifier Uncertainties	B.2.2.8
19	Misalignment of positioning System	B.2.2.13
20	Uncertainty of the Network Analyzer	B.2.2.14
21	Uncertainty of the absolute gain of the calibration antenna	B.2.2.15
22	Positioning and pointing misalignment between the reference antenna and the measurement antenna	B.2.2.16
23	Phase centre offset of calibration antenna	B.2.2.18
24	Quality of quiet zone for calibration process	B.2.2.19
25	Standing wave between reference calibration antenna and measurement antenna	B.2.2.20
26	Influence of the calibration antenna feed cable	B.2.2.21
27	Insertion Loss Variation	B.2.2.11
Systematic uncertainties		
28	Systematic error due to TRP calculation/quadrature	B.2.2.24
29	Influence of noise	B.2.2.27

The uncertainty assessment tables are organized as follows:

- For the purpose of uncertainty assessment, the radiating antenna aperture of the DUT is denoted as D
- The uncertainty assessment has been derived for the case of Quiet Zone size $\leq [30 \text{ cm}]$, $f = \{23.45\text{GHz}, 32.125\text{GHz}, 40.8\text{GHz}, 44.3\text{GHz}\}$, $P = [\text{Maximum output power}]$.
- The uncertainty assessment for TRP is provided in Table B.16.2-2 for PC3 UEs and in Table B.16.2-4 for PC1 UEs.

Table B.16.2-2: Uncertainty assessment for TRP measurement (f=23.45GHz, 32.125GHz, 40.8GHz, 44.3GHz, Quiet Zone size \leq 30 cm) for PC3 UEs

UID	Uncertainty source	Uncertainty value	Distribution of the probability	Divisor	Standard uncertainty (σ) [dB]
Stage 2: DUT measurement					
1	Positioning misalignment	0.00	Normal	2.00	0.00
2	Measure distance uncertainty	0.00	Rectangular	1.73	0.00
3	Quality of Quiet Zone (NOTE 9) (23.45GHz \leq f \leq 40.8GHz)	0.6	Actual	1.00	0.6
3	Quality of Quiet Zone (NOTE 1) (40.8GHz < f \leq 44.3GHz)	0.7	Actual	1.00	0.7
4	Mismatch (NOTE 1) (23.45GHz \leq f \leq 40.8GHz)	1.30	Actual	1.00	1.30
4	Mismatch (40.8GHz < f \leq 44.3GHz)	1.70	Actual	1.00	1.70
5	Standing wave between the DUT and measurement antenna	0.00	U-shaped	1.41	0.00
6	Uncertainty of the RF power measurement equipment (NOTE 2) (23.45GHz \leq f \leq 40.8GHz)	2.16	Normal	2.00	1.08
6	Uncertainty of the RF power measurement equipment (NOTE 3) (40.8GHz < f \leq 44.3GHz)	3.6	Normal	2.00	1.8
7	Phase curvature	0.00	U-shaped	1.41	0.00
8	Amplifier uncertainties	2.1	Normal	2.00	1.05
9	Random uncertainty	0.50	Normal	2.00	0.25
10	Influence of the XPD	0.01	U-shaped	1.41	0.00
11	Insertion Loss Variation	0.00	Rectangular	1.73	0.00
12	RF leakage (from measurement antenna to the receiver/transmitter)	0.00	Actual	1.00	0.00
13	Influence of TRP measurement grid (NOTE 3)	0.25	Actual	1	0.25
14	Influence of beam peak search grid (NOTE 4)	0.00	Actual	1	0.00
15	Multiple measurement antenna uncertainty (NOTE 8)	0.15	Actual	1	0.15
16	DUT repositioning (NOTE 3)	0.00	Rectangular	1.73	0.00
Stage 1: Calibration measurement					
17	Mismatch	0.00	U-shaped	1.41	0.00
18	Amplifier Uncertainties	0.00	Normal	2.00	0.00
19	Misalignment of positioning System	0.00	Normal	2.00	0.00
20	Uncertainty of the Network Analyzer (23.45GHz \leq f \leq 40.8GHz)	1.50	Normal	2.00	0.75
20	Uncertainty of the Network Analyzer (40.8GHz < f \leq 44.3GHz)	1.70	Normal	2.00	0.85
21	Uncertainty of the absolute gain of the calibration antenna	0.60	Normal	2.00	0.30
22	Positioning and pointing misalignment between the reference antenna and the measurement antenna	0.01	Rectangular	1.73	0.00
23	Phase centre offset of calibration antenna	0.00	Rectangular	1.73	0.00
24	Quality of quiet zone for calibration process (NOTE 9) (23.45GHz \leq f \leq 40.8GHz)	0.4	Actual	1.00	0.4
24	Quality of quiet zone for calibration process (NOTE 9) (40.8GHz < f \leq 44.3GHz)	0.5	Actual	1.00	0.5
25	Standing wave between reference calibration antenna and measurement antenna	0.00	U-shaped	1.41	0.00
26	Influence of the calibration antenna feed cable	0.14	Normal	2.00	0.07
27	Insertion Loss Variation	0.00	Rectangular	1.73	0.00

Systematic uncertainties (NOTE 5)		Value
28	Systematic error due to TRP calculation/quadrature (NOTE 3)	0.00
29	Influence of noise (23.45GHz <= f <= 32.125GHz)	0.62
29	Influence of noise (32.125GHz < f <= 40.8GHz)	1.00
29	Influence of noise (40.8GHz < f <= 44.3GHz)	1.00
Total measurement uncertainty		Value
TRP total measurement uncertainty (23.45GHz <= f <= 32.125GHz) (1.96 σ - confidence interval of 95 %) [dB]		5.13
TRP total measurement uncertainty (32.125GHz < f <= 40.8GHz) (1.96 σ - confidence interval of 95 %) [dB]		5.51
TRP Expanded uncertainty (40.8GHz < f <= 44.3GHz) (1.96 σ - confidence interval of 95 %) [dB]		6.86
NOTE 1: The analysis was done only for the case of operating at max output power, in-band, non-CA.		
NOTE 2: The assessment assumes maximum DUT output power.		
NOTE 3: This contributor shall only be considered for TRP measurements.		
NOTE 4: This contributor shall only be considered for EIRP measurements.		
NOTE 5: In order to obtain the total measurement uncertainty, systematic uncertainties have to be added to the expanded root sum square of the standard deviations of the Stage 1 and Stage 2 contributors.		
NOTE 6: Values extracted from TR 38.810 v2.6.1 in square brackets pending for further analysis.		
NOTE 7: Void.		
NOTE 8: Applies to the system which has a structure of mechanical feed antenna positioning.		
NOTE 9: Value based on procedure defined in clause D.2 of TR 38.810 for Quiet Zone size less or equal to 30 cm.		

Table B.16.2-3: Void

Table B.16.2-4: Uncertainty assessment for TRP measurement (f=23.45GHz, 32.125GHz, 40.8GHz, Quiet Zone size \leq 30 cm) for PC1 UEs

UID	Uncertainty source	Uncertainty value	Distribution of the probability	Divisor	Standard uncertainty (σ) [dB]
Stage 2: DUT measurement					
1	Positioning misalignment	0.02	Normal	2.00	0.02
2	Measure distance uncertainty	0.00	Rectangular	1.73	0.00
3	Quality of Quiet Zone (NOTE 9)	0.60	Actual	1.00	0.60
4	Mismatch (NOTE 1)	1.30	Actual	1.00	1.30
5	Standing wave between the DUT and measurement antenna	0.00	U-shaped	1.41	0.00
6	Uncertainty of the RF power measurement equipment (NOTE 2)	2.16	Normal	2.00	1.08
7	Phase curvature	0.00	U-shaped	1.41	0.00
8	Amplifier uncertainties	2.10	Normal	2.00	1.05
9	Random uncertainty	0.50	Normal	2.00	0.25
10	Influence of the XPD	0.01	U-shaped	1.41	0.00
11	Insertion Loss Variation	0.00	Rectangular	1.73	0.00
12	RF leakage (from measurement antenna to the receiver/transmitter)	0.00	Actual	1.00	0.00
13	Influence of TRP measurement grid (NOTE 3)	0.25	Actual	1	0.25
14	Influence of beam peak search grid (NOTE 4)	0.00	Actual	1	0.00
15	Multiple measurement antenna uncertainty (NOTE 8)	0.15	Actual	1	0.15
16	DUT repositioning (NOTE 3)	0.00	Rectangular	1.73	0.00
Stage 1: Calibration measurement					
17	Mismatch	0.00	U-shaped	1.41	0.00
18	Amplifier Uncertainties	0.00	Normal	2.00	0.00
19	Misalignment of positioning System	0.00	Normal	2.00	0.00
20	Uncertainty of the Network Analyzer	1.50	Normal	2.00	0.75
21	Uncertainty of the absolute gain of the calibration antenna	0.60	Normal	2.00	0.30
22	Positioning and pointing misalignment between the reference antenna and the measurement antenna	0.01	Rectangular	1.73	0.00
23	Phase centre offset of calibration antenna	0.00	Rectangular	1.73	0.00
24	Quality of quiet zone for calibration process (NOTE 9)	0.40	Actual	1.00	0.40
25	Standing wave between reference calibration antenna and measurement antenna	0.00	U-shaped	1.41	0.00
26	Influence of the calibration antenna feed cable	0.14	Normal	2.00	0.07
27	Insertion Loss Variation	0.00	Rectangular	1.73	0.00
Systematic uncertainties (NOTE 5)					Value
28	Systematic error due to TRP calculation/quadrature (NOTE 3)				0.00
29	Influence of noise (23.45GHz <= f <= 32.125GHz)				1.81
29	Influence of noise (32.125GHz < f <= 40.8GHz)				FFS
Total measurement uncertainty					Value
TRP total measurement uncertainty (23.45GHz <= f <= 32.125GHz) (1.96 σ - confidence interval of 95 %) [dB]					6.32
TRP total measurement uncertainty (32.125GHz < f <= 40.8GHz) (1.96 σ - confidence interval of 95 %) [dB]					FFS

NOTE 1:	The analysis was done only for the case of operating at max output power, in-band, non-CA.
NOTE 2:	The assessment assumes maximum DUT output power.
NOTE 3:	This contributor shall only be considered for TRP measurements.
NOTE 4:	This contributor shall only be considered for EIRP measurements.
NOTE 5:	In order to obtain the total measurement uncertainty, systematic uncertainties have to be added to the expanded root sum square of the standard deviations of the Stage 1 and Stage 2 contributors.
NOTE 6:	Values extracted from TR 38.810 v2.6.1 in square brackets pending for further analysis.
NOTE 7:	Void.
NOTE 8:	Applies to the system which has a structure of mechanical feed antenna positioning.
NOTE 9:	Value based on procedure defined in clause D.2 of TR 38.810 for Quiet Zone size less or equal to 30 cm.

B.17 Adjacent Channel Leakage Ratio

Editor's Note: MU value analysis for PC1, 2 and 4 are not complete.

Following tables summarize the MU threshold for EIRP measurements for Adjacent Channel Leakage Ratio. The origin MU values for different test setups can be found in following subclauses.

Table B.17-1: MU threshold for TRP measurement for Adjacent Channel Leakage Ratio

Power Class	Frequency	MBW	Power	Threshold MU value (NOTE 1)
PC3	23.45GHz <= f <= 32.125GHz	BW <= 400MHz	P = Max Output Power	TBD
	32.125GHz < f <= 40.8GHz			TBD
	40.8GHz < f <= 44.3GHz			TBD
PC1	23.45GHz <= f <= 32.125GHz	BW <= 400MHz	P = Max Output Power	TBD
	32.125GHz < f <= 40.8GHz			TBD
PC5	23.45GHz <= f <= 32.125GHz	BW <= 400MHz	P = Max Output Power	TBD

NOTE 1: Total Expanded MU for IFF for a Quiet Zone size ≤ 30 cm in Table B.17.2-2 for PC3 UEs and B.17.2-3 for PC1 UEs.

Table B.17-1B: MU threshold for EIRP measurement for Adjacent Channel Leakage Ratio

Power Class	Frequency	CBW	Power	Threshold MU value for NTC and ETC (NOTE 1)
PC3	23.45GHz <= f <= 32.125GHz	50MHz	P = Max Output Power	5.63
		100MHz		6.09
		200MHz		6.09 (NOTE5)
		400MHz		6.09 (NOTE2)
	32.125GHz < f <= 40.8GHz	50MHz	P = Max Output Power	6.09 (NOTE7)
		100MHz		6.09 (NOTE6)
		200MHz		6.09 (NOTE3)
		400MHz		6.09 (NOTE4)
	40.8GHz < f <= 44.3GHz	50MHz	P = Max Output Power	TBD
		100MHz		TBD
		200MHz		TBD
		400MHz		TBD
PC1	23.45GHz <= f <= 32.125GHz	BW <= 400MHz	P = Max Output Power	6.04
	32.125GHz < f <= 40.8GHz	BW <= 400MHz	P = Max Output Power	6.04
PC5	23.45GHz <= f <= 32.125GHz	BW <= 400MHz	P = Max Output Power	6.04
NOTE 1: Total Expanded MU for IFF for a Quiet Zone size ≤ 30 cm in Table B.17.2-2 for PC3 UEs and Table B.17.2-3 for PC1 and PC5 UEs. NOTE 2: This value is based on the relaxation of (MPR – 3.0) dB for MPR > 3.0dB. NOTE 3: Not applicable for MPR > 3.5dB NOTE 4: Not applicable for MPR > 2.0dB NOTE 5: This value is based on the relaxation of (MPR – 5.0) dB for MPR > 5.0dB. NOTE 6: Not applicable for MPR > 5.0dB NOTE 7: Not applicable for MPR >7.5 dB				

B.17.1 Uncertainty budget format and assessment for DFF

The uncertainty contributions that may impact the overall MU value are listed in Table B.17.1-1.

Table B.17.1-1: Uncertainty contributions for EIRP measurement

UID	Description of uncertainty contribution	Details in annex
Stage 2: DUT measurement		
1	Positioning misalignment	B.2.1.1
2	Measure distance uncertainty	B.2.1.2
3	Quality of quiet zone	B.2.1.3
4	Mismatch	B.2.1.4
5	Standing Wave Between the DUT and measurement antenna	B.2.1.5
6	Uncertainty of the RF power measurement equipment	B.2.1.6
7	Phase curvature	B.2.1.7
8	Amplifier uncertainties	B.2.1.8
9	Random uncertainty	B.2.1.9
10	Influence of the XPD	B.2.1.10
11	Insertion Loss Variation	B.2.1.11
12	RF leakage (from measurement antenna to the receiver/transmitter)	B.2.1.12
13	Influence of TRP measurement grid	B.2.1.22
14	Influence of beam peak search grid	B.2.1.23
15	Multiple measurement antenna uncertainty	B.2.1.25
16	DUT repositioning	B.2.1.26
Stage 1: Calibration measurement		
17	Mismatch	B.2.1.4
18	Amplifier uncertainties	B.2.1.8
19	Misalignment of positioning System	B.2.1.13
20	Uncertainty of the Network Analyzer	B.2.1.14
21	Uncertainty of the absolute gain of the calibration antenna	B.2.1.15
22	Positioning and pointing misalignment between the reference antenna and the measurement antenna	B.2.1.16
23	Phase centre offset of calibration antenna	B.2.1.18
24	Quality of quiet zone for calibration process	B.2.1.19
25	Standing wave between reference calibration antenna and measurement antenna	B.2.1.20
26	Influence of the calibration antenna feed cable	B.2.1.21
27	Insertion Loss Variation	B.2.1.11
Systematic uncertainties		
28	Systematic error due to TRP calculation/quadrature	B.2.1.24
29	Influence of noise	B.2.1.27

The uncertainty assessment tables are organized as follows:

- For the purpose of uncertainty assessment, the radiating antenna aperture of the DUT is denoted as D
- The uncertainty assessment has been derived for the case of $D = [5 \text{ cm}]$, $f = \{23.45 \text{ GHz}, 32.125 \text{ GHz}, 40.8 \text{ GHz}, 44.3 \text{ GHz}\}$, $P = [\text{Maximum output power}]$.
- The uncertainty assessment for TRP is provided in Table B.17.1-2.

Table B.17.1-2: Uncertainty assessment for EIRP measurement (f=TBD, D=TBD)

UID	Uncertainty source	Uncertainty value	Distribution of the probability	Divisor	Standard uncertainty (σ) [dB]
Stage 2: DUT measurement					
1	Positioning misalignment				
2	Measure distance uncertainty				
3	Quality of quiet zone (NOTE 2)				
4	Mismatch (NOTE 3)				
5	Standing Wave Between the DUT and measurement antenna				
6	Uncertainty of the RF power measurement equipment (NOTE 4)				
7	Phase curvature				
8	Amplifier uncertainties				
9	Random uncertainty				
10	Influence of the XPD				
11	Insertion Loss Variation				
12	RF leakage (from measurement antenna to the receiver/transmitter)				
13	Influence of TRP measurement grid (NOTE 5)				
14	Influence of beam peak search grid (NOTE 6)				
15	Multiple measurement antenna uncertainty				
16	DUT repositioning				
Stage 1: Calibration measurement					
17	Mismatch				
18	Amplifier uncertainties				
19	Misalignment of positioning System				
20	Uncertainty of the Network Analyzer				
21	Uncertainty of the absolute gain of the calibration antenna				
22	Positioning and pointing misalignment between the reference antenna and the measurement antenna				
23	Phase centre offset of calibration antenna				
24	Quality of quiet zone for calibration process (NOTE 2)				
25	Standing wave between reference calibration antenna and measurement antenna				
26	Influence of the calibration antenna feed cable				
27	Insertion Loss Variation				
EIRP Expanded uncertainty (1.96σ - confidence interval of 95 %) [dB]					
Systematic uncertainties (NOTE 7)					Value
28	Systematic error due to TRP calculation/quadrature (NOTE 5)				
29	Influence of noise				
Total measurement uncertainty					
TRP total measurement uncertainty [dB]					
NOTE 1: The impact of phase variation on EIRP is FFS.					
NOTE 2: The quality of quiet zone is different for EIRP and TRP. For TRP, the standard uncertainty is FFS; for EIRP, the standard uncertainty of quiet zone is FFS.					
NOTE 3: The analysis was done only for the case of operating at max output power, in-band, non-CA.					
NOTE 4: The assessment assumes maximum DUT output power.					
NOTE 5: This contributor shall only be considered for TRP measurements.					
NOTE 6: This contributor shall only be considered for EIRP measurements.					
NOTE 7: In order to obtain the total measurement uncertainty, systematic uncertainties have to be added to the expanded root sum square of the standard deviations of the Stage 1 and Stage 2 contributors.					
NOTE 8: Void					

B.17.2 Uncertainty budget format and assessment for IFF

The uncertainty contributions that may impact the overall MU value are listed in Table B.17.2-1.

Table B.17.2-1: Uncertainty contributions for EIRP measurement

UID	Description of uncertainty contribution	Details in clause
Stage 2: DUT measurement		
1	Quality of Quiet Zone	B.2.2.3
2	Mismatch	B.2.2.4
3	Standing wave between the DUT and measurement antenna	B.2.2.5
4	Uncertainty of the RF power measurement equipment	B.2.2.6
5	Phase curvature	B.2.2.7
6	Amplifier uncertainties	B.2.2.8
7	Random uncertainty	B.2.2.9
8	Influence of the XPD	B.2.2.10
9	RF leakage (from measurement antenna to the receiver/transmitter)	B.2.2.12
10	Multiple measurement antenna uncertainty	B.2.2.25
Stage 1: Calibration measurement		
11	Mismatch	B.2.2.4
12	Amplifier Uncertainties	B.2.2.8
13	Misalignment of positioning System	B.2.2.13
14	Uncertainty of the Network Analyzer	B.2.2.14
15	Uncertainty of the absolute gain of the calibration antenna	B.2.2.15
16	Phase centre offset of calibration antenna	B.2.2.18
17	Quality of quiet zone for calibration process	B.2.2.19
18	Standing wave between reference calibration antenna and measurement antenna	B.2.2.20
19	Influence of the calibration antenna feed cable	B.2.2.21
20	Insertion Loss Variation	B.2.2.11
Systematic uncertainties		
21	Influence of noise	B.2.2.27

The uncertainty assessment tables are organized as follows:

- For the purpose of uncertainty assessment, the radiating antenna aperture of the DUT is denoted as D
- The uncertainty assessment has been derived for the case of Quiet Zone size ≤ 30 cm, $f = \{23.45\text{GHz}, 32.125\text{GHz}, 40.8\text{GHz}, 44.3\text{GHz}\}$, P = Maximum output power - MPR – MBR(Multi-band relaxation).
- The uncertainty assessment for EIRP is provided in Table B.17.2-2 for PC3 UEs and Table B.17.2-3 for PC1 UEs.

Table B.17.2-2: Uncertainty assessment for EIRP measurement (f=23.45GHz, 32.125GHz, 40.8GHz, 44.3GHz, Quiet Zone size \leq 30 cm) for PC3 UEs and normal and extreme temperature condition

UID	Uncertainty source	Uncertainty value	Distribution of the probability	Divisor	Standard uncertainty (σ) [dB]
Stage 2: DUT measurement					
1	Quality of Quiet Zone (NOTE 10)	0.52	Actual	1.00	0.52
2	Mismatch (NOTE 2) (23.45GHz \leq f \leq 40.8GHz)	1.84	Actual	1.00	1.84
2	Mismatch (NOTE 2) (40.8GHz < f \leq 44.3GHz)	2.40	Actual	1.00	2.40
3	Standing wave between the DUT and measurement antenna	0.00	U-shaped	1.41	0.00
4	Uncertainty of the RF power measurement equipment (NOTE 3, 7) (23.45GHz \leq f \leq 40.8GHz)	2.16	Normal	2.00	1.08
4	Uncertainty of the RF power measurement equipment (NOTE 3, 7) (40.8GHz < f \leq 44.3GHz)	3.6	Normal	2.00	1.8
5	Phase curvature	0.00	U-shaped	1.41	0.00
6	Amplifier uncertainties	2.1	Normal	2.00	1.05
7	Random uncertainty	0.50	Normal	2.00	0.25
8	Influence of the XPD	0.00	U-shaped	1.41	0.00
9	RF leakage (from measurement antenna to the receiver/transmitter)	0.00	Actual	1.00	0.00
10	Multiple measurement antenna uncertainty (NOTE 9)	0.0	Actual	1	0.0
Stage 1: Calibration measurement					
11	Mismatch	0.00	U-shaped	1.41	0.00
12	Amplifier Uncertainties	0.00	Normal	2.00	0.00
13	Misalignment of positioning System	0.00	Normal	2.00	0.00
14	Uncertainty of the Network Analyzer (23.45GHz \leq f \leq 40.8GHz)	1.5	Normal	2.00	0.75
14	Uncertainty of the Network Analyzer (40.8GHz < f \leq 44.3GHz)	1.7	Normal	2.00	0.85
15	Uncertainty of the absolute gain of the calibration antenna	0.60	Normal	2.00	0.30
16	Phase centre offset of calibration antenna	0.00	Rectangular	1.73	0.00
17	Quality of quiet zone for calibration process (NOTE 10)	0.32	Actual	1.00	0.32
18	Standing wave between reference calibration antenna and measurement antenna	0.00	U-shaped	1.41	0.00
19	Influence of the calibration antenna feed cable	0.00	Normal	2.00	0.00
20	Insertion Loss Variation	0.00	Rectangular	1.73	0.00
EIRP Expanded uncertainty (1.96 σ - confidence interval of 95 %) [dB] (23.45GHz \leq f \leq 40.8GHz)					5.09
EIRP Expanded uncertainty (1.96 σ - confidence interval of 95 %) [dB] (40.8GHz < f \leq 44.3GHz)					6.61
Systematic uncertainties (NOTE 6)					Value
21	Influence of noise				Table B.17.2-4
Total measurement uncertainty					Value
EIRP total measurement uncertainty [dB] (23.45GHz \leq f \leq 40.8GHz)					5.09 + Influence of Noise
EIRP total measurement uncertainty [dB] (40.8GHz < f \leq 44.3GHz)					6.61 + Influence of Noise

- NOTE 1: Void
- NOTE 2: The analysis was done only for the case of operating at max output power – MPR – MBR(Multi-band relaxation), in-band, non-CA.
- NOTE 3: The assessment assumes maximum DUT output power – MPR – MBR(Multi-band relaxation).
- NOTE 4: Void
- NOTE 5: Void
- NOTE 6: In order to obtain the total measurement uncertainty, systematic uncertainties have to be added to the expanded root sum square of the standard deviations of the Stage 1 and Stage 2 contributors.
- NOTE 7: Void
- NOTE 8: Void
- NOTE 9: Void
- NOTE 10: Defined as fixed value MU contributor.

Table B.17.2-3: Uncertainty assessment for EIRP measurement (f=23.45GHz, 32.125GHz, 40.8GHz, Quiet Zone size ≤ 30 cm) for PC1 and PC5 UEs

UID	Uncertainty source	Uncertainty value	Distribution of the probability	Divisor	Standard uncertainty (σ) [dB]
Stage 2: DUT measurement					
1	Quality of Quiet Zone (NOTE 10)	0.52	Actual	1.00	0.52
2	Mismatch (NOTE 2, NOTE 7)	1.84	Actual	1.00	1.84
3	Standing wave between the DUT and measurement antenna	0.00	U-shaped	1.41	0.00
4	Uncertainty of the RF power measurement equipment (NOTE 3, 7)	2.16	Normal	2.00	1.08
5	Phase curvature	0.00	U-shaped	1.41	0.00
6	Amplifier uncertainties	2.1	Normal	2.00	1.05
7	Random uncertainty	0.50	Normal	2.00	0.25
8	Influence of the XPD	0.00	U-shaped	1.41	0.00
9	RF leakage (from measurement antenna to the receiver/transmitter)	0.00	Actual	1.00	0.00
10	Multiple measurement antenna uncertainty (NOTE 9)	0.00	Actual	1	0.00
Stage 1: Calibration measurement					
11	Mismatch	0.00	U-shaped	1.41	0.00
12	Amplifier Uncertainties	0.00	Normal	2.00	0.00
13	Misalignment of positioning System	0.00	Normal	2.00	0.00
14	Uncertainty of the Network Analyzer	1.5	Normal	2.00	0.75
15	Uncertainty of the absolute gain of the calibration antenna	0.60	Normal	2.00	0.30
16	Phase centre offset of calibration antenna	0.00	Rectangular	1.73	0.00
17	Quality of quiet zone for calibration process (NOTE 10)	0.32	Actual	1.00	0.32
18	Standing wave between reference calibration antenna and measurement antenna	0.00	U-shaped	1.41	0.00
19	Influence of the calibration antenna feed cable	0.00	Normal	2.00	0.00
20	Insertion Loss Variation	0.00	Rectangular	1.73	0.00
EIRP Expanded uncertainty (1.96σ - confidence interval of 95 %) [dB]					5.09
Systematic uncertainties (NOTE 6)					Value
21	Influence of noise (23.45GHz ≤ f ≤ 32.125GHz)				0.95
21	Influence of noise (32.125GHz < f ≤ 40.8GHz)				0.95
Total measurement uncertainty					Value
EIRP total measurement uncertainty (23.45GHz ≤ f ≤ 32.125GHz) [dB]					6.04
EIRP total measurement uncertainty (32.125GHz < f ≤ 40.8GHz) [dB]					6.04
NOTE 1: Void					
NOTE 2: The analysis was done only for the case of operating at max output power, in-band, non-CA.					
NOTE 3: The assessment assumes maximum DUT output power.					
NOTE 4: Void					
NOTE 5: Void					
NOTE 6: In order to obtain the total measurement uncertainty, systematic uncertainties have to be added to the expanded root sum square of the standard deviations of the Stage 1 and Stage 2 contributors.					
NOTE 7: Values extracted from TR 38.810 v2.6.1 in square brackets pending for further analysis.					
NOTE 8: Void.					
NOTE 9: Void					
NOTE 10: Defined as fixed value MU contributor.					

Table B.17.2-4: Influence of noise measurement (f=23.45GHz, 32.125GHz, 40.8GHz, 44.3GHz, Quiet Zone size ≤ 30 cm) for PC3 UEs

	FR2a	FR2b	FR2c
ChBW (50MHz)	0.54	1.0 (NOTE 6)	TBD
ChBW (100MHz)	1.0	1.0 (NOTE 5)	TBD
ChBW (200MHz)	1.0 (NOTE 4)	1.0 (NOTE 2)	TBD
ChBW (400MHz)	1.0 (NOTE 1)	1.0 (NOTE 3)	TBD
NOTE 1: This value is based on the relaxation of (MPR – 3.0) dB for MPR > 3.0dB.			
NOTE 2: Not applicable for MPR > 3.5dB			
NOTE 3: Not applicable for MPR > 2.0dB			
NOTE 4: This value is based on the relaxation of (MPR – 5.0) dB for MPR > 5.0dB.			
NOTE 5: Not applicable for MPR > 5.0dB			
NOTE 6: Not applicable for MPR > 7.5dB			

B.18 Spurious emissions

Editor's Note:

- MU value analysis and offset value analysis for PC1, 2 and 4 are not complete.
- MU offset value analysis for PC2 and 4 are not complete.
- MU value analysis for various test setups in clause B.18.x is not complete for above 87 GHz.

Test procedure of general spurious emission comprises 2 stages: coarse TRP measurement and fine TRP measurement BW. Coarse TRP measurement is introduced to reduce the measurement time by applying sparser grids and/or wider measurement BW than fine TRP measurement while having offset dB more stringent test requirement in order not to cause additional misjudgement risk. For the frequency ranges for which coarse TRP measurement does not PASS, the measurement is continued with fine TRP measurement procedure.

Tables B.18-1, B.18-1a, B.18-1b summarizes the MU threshold for fine TRP measurements for General spurious emissions, spurious emission band UE co-existence and additional spurious emission, respectively. The origin MU values for fine TRP measurement for different test setups can be found in following subclauses.

Table B.18-1: MU threshold for TRP measurement for general spurious emission

Power Class	Frequency	In-band BW	In-band Power (NOTE2)	Threshold MU value [dB] (NOTE1)
PC3	6 GHz <= f <= 12.75 GHz	BW <= 400MHz	P = Max Output Power	5.29
	12.75 GHz <= f <= 23.45 GHz			5.25
	23.45 GHz <= f <= 40.8 GHz			5.41
	40.8 GHz <= f <= 66 GHz			7.42
	66 GHz <= f <= 80 GHz			7.72
	80 GHz < f <= 87 GHz			8.14
PC1	6 GHz <= f <= 12.75 GHz	BW <= 400MHz	P = Max Output Power	5.28
	12.75 GHz <= f <= 23.45 GHz			5.91
	23.45 GHz <= f <= 40.8 GHz			6.07
	40.8 GHz <= f <= 66 GHz			8.09
	66 GHz <= f <= 80 GHz			7.71
NOTE 1: Total EIRP Expanded MU for IFF for Quiet Zone size ≤ 30cm in Table B.18.2-3 to Table B.18.2-11 for PC3 UEs and in Table B.18.2-12 to Table B.18.2-16 for PC1 UEs.				
NOTE 2: Max output power level for device with corresponding power class.				

Table B.18-1a: MU threshold for TRP measurement for spurious emission band UE co-existence

Power Class	Frequency	In-band BW	In-band Power (NOTE2)	Threshold MU value [dB] (NOTE1)
PC3	n257, n260, n261	BW <= 400MHz	P = Max Output Power	6.00
	23.6 GHz < f <= 24.0 GHz			6.00
	36 GHz <= f <= 37 GHz			6.00
	57 GHz <= f <= 66 GHz			8.01
PC1	n257, n261	BW <= 400MHz	P = Max Output Power	7.32
	n260			7.32
	23.6 GHz < f <= 24.0 GHz			7.32
	57 GHz <= f <= 66 GHz			8.00
NOTE 1: Total EIRP Expanded MU for IFF for Quiet Zone size ≤ 30cm in Table B.18.2-3 to Table B.18.2-11 for PC3 UEs and in Table B.18.2-12 to Table B.18.2-16 for PC1 UEs.				
NOTE 2: Max output power level for device with corresponding power class.				

Table B.18-1b: MU threshold for TRP measurement for additional spurious emission

Power Class	Frequency	In-band BW	In-band Power (NOTE2)	Threshold MU value [dB] (NOTE1)
PC3	6 GHz \leq f \leq 12.75 GHz NS_202	BW \leq 400MHz	P = Max Output Power	5.29
	12.75 GHz \leq f \leq 23.45 GHz NS_202			5.84
	23.45 GHz \leq f \leq 40.8 GHz NS_202, NS_203			6.00
	40.8 GHz \leq f \leq 2nd harmonic of the upper frequency edge of the UL operating band NS_202			8.01
PC1	6 GHz \leq f \leq 12.75 GHz NS_202	BW \leq 400MHz	P = Max Output Power	5.28
	12.75 GHz \leq f \leq 23.45 GHz NS_202			7.16
	23.45 GHz \leq f \leq 40.8 GHz NS_202, NS_203			7.32
	40.8 GHz \leq f \leq 2nd harmonic of the upper frequency edge of the UL operating band NS_202			9.34
NOTE 1: Total EIRP Expanded MU for IFF for Quiet Zone size \leq 30cm in Table B.18.2-3 to Table B.18.2-11 for PC3 UEs and in Table B.18.2-12 to Table B.18-2.16 for PC1 UEs.				
NOTE 2: Max output power level for device with corresponding power class.				

B.18.1 Uncertainty budget format and assessment for DFF

The uncertainty contributions that may impact the overall MU value are listed in Table B.18.1-1.

Table B.18.1-1: Uncertainty contributions for TRP measurement

UID	Description of uncertainty contribution	Details in annex
Stage 2: DUT measurement		
1	Positioning misalignment	B.2.1.1
2	Measure distance uncertainty	B.2.1.2
3	Quality of quiet zone	B.2.1.3
4	Mismatch	B.2.1.4
5	Standing Wave Between the DUT and measurement antenna	B.2.1.5
6	Uncertainty of the RF power measurement equipment	B.2.1.6
7	Phase curvature	B.2.1.7
8	Amplifier uncertainties	B.2.1.8
9	Random uncertainty	B.2.1.9
10	Influence of the XPD	B.2.1.10
11	Insertion Loss Variation	B.2.1.11
12	RF leakage (from measurement antenna to the receiver/transmitter)	B.2.1.12
13	Influence of TRP measurement grid	B.2.1.22
14	Influence of beam peak search grid	B.2.1.23
15	Multiple measurement antenna uncertainty	B.2.1.25
16	DUT repositioning	B.2.1.26
Stage 1: Calibration measurement		
17	Mismatch	B.2.1.4
18	Amplifier uncertainties	B.2.1.8
19	Misalignment of positioning System	B.2.1.13
20	Uncertainty of the Network Analyzer	B.2.1.14
21	Uncertainty of the absolute gain of the calibration antenna	B.2.1.15
22	Positioning and pointing misalignment between the reference antenna and the measurement antenna	B.2.1.16
23	Phase centre offset of calibration antenna	B.2.1.18
24	Quality of quiet zone for calibration process	B.2.1.19
25	Standing wave between reference calibration antenna and measurement antenna	B.2.1.20
26	Influence of the calibration antenna feed cable	B.2.1.21
27	Insertion Loss Variation	B.2.1.11
Systematic uncertainties		
28	Systematic error due to TRP calculation/quadrature	B.2.1.24
29	Influence of noise	B.2.1.27

The uncertainty assessment tables are organized as follows:

- For the purpose of uncertainty assessment, the radiating antenna aperture of the DUT is denoted as D
- The uncertainty assessment has been derived for the case of $D = [5 \text{ cm}]$, $f = \{6 \text{ GHz to } 87 \text{ GHz}\}$, $P = [\text{Maximum output power}]$.
- The uncertainty assessment for TRP is provided in Table B.18.1-2 to B.18.1-xx

Table B.18.1-2: Uncertainty assessment for TRP measurement (f=TBD, D=TBD)

UID	Uncertainty source	Uncertainty value	Distribution of the probability	Divisor	Standard uncertainty (σ) [dB]
Stage 2: DUT measurement					
1	Positioning misalignment				
2	Measure distance uncertainty				
3	Quality of quiet zone (NOTE 2)				
4	Mismatch (NOTE 3)				
5	Standing Wave Between the DUT and measurement antenna				
6	Uncertainty of the RF power measurement equipment (NOTE 4)				
7	Phase curvature				
8	Amplifier uncertainties				
9	Random uncertainty				
10	Influence of the XPD				
11	Insertion Loss Variation				
12	RF leakage (from measurement antenna to the receiver/transmitter)				
13	Influence of TRP measurement grid (NOTE 5)				
14	Influence of beam peak search grid (NOTE 6)				
15	Multiple measurement antenna uncertainty				
16	DUT repositioning				
Stage 1: Calibration measurement					
17	Mismatch				
18	Amplifier uncertainties				
19	Misalignment of positioning System				
20	Uncertainty of the Network Analyzer				
21	Uncertainty of the absolute gain of the calibration antenna				
22	Positioning and pointing misalignment between the reference antenna and the measurement antenna				
23	Phase centre offset of calibration antenna				
24	Quality of quiet zone for calibration process (NOTE 2)				
25	Standing wave between reference calibration antenna and measurement antenna				
26	Influence of the calibration antenna feed cable				
27	Insertion Loss Variation				
TRP Expanded uncertainty (1.96σ - confidence interval of 95 %) [dB]					
Systematic uncertainties (NOTE 7)					Value
28	Systematic error due to TRP calculation/quadrature (NOTE 5)				
29	Influence of noise				
Total measurement uncertainty					
TRP total measurement uncertainty [dB]					
NOTE 1: The impact of phase variation on EIRP is FFS.					
NOTE 2: The quality of quiet zone is different for EIRP and TRP. For TRP, the standard uncertainty is FFS; for EIRP, the standard uncertainty of quiet zone is FFS.					
NOTE 3: The analysis was done only for the case of operating at max output power, in-band, non-CA.					
NOTE 4: The assessment assumes maximum DUT output power.					
NOTE 5: This contributor shall only be considered for TRP measurements.					
NOTE 6: This contributor shall only be considered for EIRP measurements.					
NOTE 7: In order to obtain the total measurement uncertainty, systematic uncertainties have to be added to the expanded root sum square of the standard deviations of the Stage 1 and Stage 2 contributors.					
NOTE 8: Void					

B.18.2 Uncertainty budget format and assessment for IFF

The uncertainty contributions that may impact the overall MU value are listed in Table B.18.2-1.

Table B.18.2-1: Uncertainty contributions for TRP measurement

UID	Description of uncertainty contribution	Details in clause
Stage 2: DUT measurement		
1	Positioning misalignment	B.2.2.1
2	Measure distance uncertainty	B.2.2.2
3	Quality of Quiet Zone	B.2.2.3
4	Mismatch	B.2.2.4
5	Standing wave between the DUT and measurement antenna	B.2.2.5
6	Uncertainty of the RF power measurement equipment	B.2.2.6
7	Phase curvature	B.2.2.7
8	Amplifier uncertainties	B.2.2.8
9	Random uncertainty	B.2.2.9
10	Influence of the XPD	B.2.2.10
11	Insertion Loss Variation	B.2.2.11
12	RF leakage (from measurement antenna to the receiver/transmitter)	B.2.2.12
13	Influence of TRP measurement grid	B.2.2.22
14	Influence of beam peak search grid	B.2.2.23
15	Multiple measurement antenna uncertainty	B.2.2.25
16	DUT repositioning	B.2.2.26
17	Misalignment of DUT due to change of DUT orientation	B.2.2.31
Stage 1: Calibration measurement		
18	Mismatch	B.2.2.4
19	Amplifier Uncertainties	B.2.2.8
20	Misalignment of positioning System	B.2.2.13
21	Uncertainty of the Network Analyzer	B.2.2.14
22	Uncertainty of the absolute gain of the calibration antenna	B.2.2.15
23	Positioning and pointing misalignment between the reference antenna and the measurement antenna	B.2.2.16
24	Phase centre offset of calibration antenna	B.2.2.18
25	Quality of quiet zone for calibration process	B.2.2.19
26	Standing wave between reference calibration antenna and measurement antenna	B.2.2.20
27	Influence of the calibration antenna feed cable	B.2.2.21
28	Insertion Loss Variation	B.2.2.11
Systematic uncertainties		
29	Systematic error due to TRP calculation/quadrature	B.2.2.24
30	Influence of noise	B.2.2.27

The uncertainty assessment tables are organized as follows:

- For the purpose of uncertainty assessment, the radiating antenna aperture of the DUT is denoted as D
- The uncertainty assessment has been derived for the case of Quiet zone size ≤ 30 cm, $f = \{6 \text{ GHz to } 87 \text{ GHz}\}$, $P = \text{Maximum output power}$.
- The uncertainty assessment for TRP is provided from Table B.18.2-2 to Table B.18.2-11 for PC3 UEs and from Table B.18.2-12 to Table B.18.2-16 for PC1 UEs.

Table B.18.2-2: Void

Table B.18.2-3: Uncertainty assessment for TRP measurement (f=6 GHz to 12.75GHz, Quiet Zone size \leq 30 cm) for PC3 UEs

UID	Uncertainty source	Uncertainty value	Distribution of the probability	Divisor	Standard uncertainty (σ) [dB]
Stage 2: DUT measurement					
1	Positioning misalignment	0.00	Normal	2.00	0.00
2	Measure distance uncertainty	0.00	Rectangular	1.73	0.00
3	Quality of Quiet Zone (NOTE 4)	0.70	Actual	1.00	0.70
4	Mismatch	1.50	Actual	1.00	1.50
5	Standing wave between the DUT and measurement antenna	0.00	U-shaped	1.41	0.00
6	Uncertainty of the RF power measurement equipment	2.00	Normal	2.00	1.00
7	Phase curvature	0.00	U-shaped	1.41	0.00
8	Amplifier uncertainties	2.1	Normal	2.00	1.05
9	Random uncertainty	0.5	Normal	2.00	0.25
10	Influence of the XPD	0.09	U-shaped	1.41	0.064
11	Insertion Loss Variation	0.00	Rectangular	1.73	0.00
12	RF leakage (from measurement antenna to the receiver/transmitter)	0.00	Actual	1.00	0.00
13	Influence of TRP measurement grid (NOTE 1)	0.32	Actual	1	0.32
14	Influence of beam peak search grid (NOTE 2)	N/A	Actual	1	N/A
15	Multiple measurement antenna uncertainty (NOTE 5)	0.15	Actual	1	0.15
16	DUT repositioning	0.00	Rectangular	1.73	0.00
17	Misalignment of DUT due to change of DUT orientation	0.10	Actual	1	0.10
Stage 1: Calibration measurement					
18	Mismatch	0.00	U-shaped	1.41	0.00
19	Amplifier Uncertainties	0.00	Normal	2.00	0.00
20	Misalignment of positioning System	0.00	Normal	2.00	0.00
21	Uncertainty of the Network Analyzer	1.50	Normal	2.00	0.75
22	Uncertainty of the absolute gain of the calibration antenna	0.60	Normal	2.00	0.30
23	Positioning and pointing misalignment between the reference antenna and the measurement antenna	0.05	Rectangular	1.73	0.03
24	Phase centre offset of calibration antenna	0.00	Rectangular	1.73	0.00
25	Quality of quiet zone for calibration process (NOTE 4)	0.70	Actual	1.00	0.70
26	Standing wave between reference calibration antenna and measurement antenna	0.00	U-shaped	1.41	0.00
27	Influence of the calibration antenna feed cable	0.14	Normal	2.00	0.07
28	Insertion Loss Variation	0.00	Rectangular	1.73	0.00
Expanded uncertainty (1.96σ - confidence interval of 95 %)					Value
TRP Expanded uncertainty (6 GHz < f <= 12.75 GHz) [dB] (a)					4.88
Systematic uncertainties (NOTE 3)					Value
29	Systematic error due to TRP calculation/quadrature (NOTE 1) (b)				0.0

30	General spurious emissions Influence of noise (c ₁) (6 GHz < f <= 12.75 GHz)	0.41
30	Additional spurious emissions Influence of noise (c ₂) NS_202 (6 GHz < f <= 12.75 GHz)	0.41
	Systematic error related to beam peak search (NOTE 2)	N/A
Total measurement uncertainty		Value
General spurious emissions Total measurement uncertainty (a)+(b)+(c ₁) [dB] (6 GHz < f <= 12.75 GHz)		5.29
Additional spurious emissions Total measurement uncertainty (a)+(b)+(c ₂) [dB] NS_202 (6 GHz < f <= 12.75 GHz)		5.29
<p>NOTE 1: This contributor shall only be considered for TRP measurements.</p> <p>NOTE 2: This contributor shall only be considered for EIRP measurements.</p> <p>NOTE 3: In order to obtain the total measurement uncertainty, systematic uncertainties have to be added to the expanded root sum square of the standard deviations of the Stage 1 and Stage 2 contributors.</p> <p>NOTE 4: Value based on procedure defined in clause D.2 of TR 38.810 for Quiet Zone size of less or equal to 30 cm.</p> <p>NOTE 5: Applies to the system which has a structure of mechanical feed antenna positioning.</p>		

Table B.18.2-4: Void

Table B.18.2-5: Uncertainty assessment for TRP measurement (f=12.75 GHz to 23.45 GHz, Quiet Zone size \leq 30 cm) for PC3 UEs

UID	Uncertainty source	Uncertainty value	Distribution of the probability	Divisor	Standard uncertainty (σ) [dB]
Stage 2: DUT measurement					
1	Positioning misalignment	0.00	Normal	2.00	0.00
2	Measure distance uncertainty	0.00	Rectangular	1.73	0.00
3	Quality of Quiet Zone (NOTE 4)	0.60	Actual	1.00	0.60
4	Mismatch	1.50	Actual	1.00	1.50
5	Standing wave between the DUT and measurement antenna	0.00	U-shaped	1.41	0.00
6	Uncertainty of the RF power measurement equipment	2.16	Normal	2.00	1.08
7	Phase curvature	0.00	U-shaped	1.41	0.00
8	Amplifier uncertainties	2.1	Normal	2.00	1.05
9	Random uncertainty	0.5	Normal	2.00	0.25
10	Influence of the XPD	0.09	U-shaped	1.41	0.064
11	Insertion Loss Variation	0.00	Rectangular	1.73	0.00
12	RF leakage (from measurement antenna to the receiver/transmitter)	0.00	Actual	1.00	0.00
13	Influence of TRP measurement grid (NOTE 1)	0.32	Actual	1	0.32
14	Influence of beam peak search grid (NOTE 2)	N/A	Actual	1	N/A
15	Multiple measurement antenna uncertainty (NOTE 5)	0.15	Actual	1	0.15
16	DUT repositioning	0.00	Rectangular	1.73	0.00
17	Misalignment of DUT due to change of DUT orientation	0.10	Actual	1	0.10
Stage 1: Calibration measurement					
18	Mismatch	0.00	U-shaped	1.41	0.00
19	Amplifier Uncertainties	0.00	Normal	2.00	0.00
20	Misalignment of positioning System	0.00	Normal	2.00	0.00
21	Uncertainty of the Network Analyzer	1.50	Normal	2.00	0.75
22	Uncertainty of the absolute gain of the calibration antenna	0.60	Normal	2.00	0.30
23	Positioning and pointing misalignment between the reference antenna and the measurement antenna	0.05	Rectangular	1.73	0.03
24	Phase centre offset of calibration antenna	0.00	Rectangular	1.73	0.00
25	Quality of quiet zone for calibration process (NOTE 4)	0.60	Actual	1.00	0.60
26	Standing wave between reference calibration antenna and measurement antenna	0.00	U-shaped	1.41	0.00
27	Influence of the calibration antenna feed cable	0.14	Normal	2.00	0.07
28	Insertion Loss Variation	0.00	Rectangular	1.73	0.00
Expanded uncertainty (1.96σ - confidence interval of 95 %)					Value
TRP Expanded uncertainty (12.75 GHz < f <= 23.45 GHz) [dB] (a)					4.84
Systematic uncertainties (NOTE 3)					Value
29	Systematic error due to TRP calculation/quadrature (NOTE 1) (b)				0.0

30	General spurious emissions Influence of noise (c_1) (12.75 GHz < f <= 23.45 GHz)	0.41
30	Additional spurious emissions Influence of noise (c_2) NS_202 (12.75 GHz < f <= 23.45 GHz)	1.0
31	Systematic error related to beam peak search (NOTE 2)	N/A
Total measurement uncertainty		Value
General spurious emissions Total measurement uncertainty (a)+(b)+(c ₁) [dB] (12.75 GHz < f <= 23.45 GHz)		5.25
Additional spurious emissions Total measurement uncertainty (a)+(b)+(c ₂) [dB] NS_202 (12.75 GHz < f <= 23.45 GHz)		5.84
NOTE 1: This contributor shall only be considered for TRP measurements.		
NOTE 2: This contributor shall only be considered for EIRP measurements.		
NOTE 3: In order to obtain the total measurement uncertainty, systematic uncertainties have to be added to the expanded root sum square of the standard deviations of the Stage 1 and Stage 2 contributors.		
NOTE 4: Value based on procedure defined in clause D.2 of TR 38.810 for Quiet Zone size of less or equal to 30 cm.		
NOTE 5: Applies to the system which has a structure of mechanical feed antenna positioning.		

Table B.18.2-6: Void

Table B.18.2-7: Uncertainty assessment for TRP measurement (f=23.45 GHz to 40.8 GHz, Quiet Zone size \leq 30 cm) for PC3 UEs

UID	Uncertainty source	Uncertainty value	Distribution of the probability	Divisor	Standard uncertainty (σ) [dB]
Stage 2: DUT measurement					
1	Positioning misalignment	0.00	Normal	2.00	0.00
2	Measure distance uncertainty	0.00	Rectangular	1.73	0.00
3	Quality of Quiet Zone (NOTE 4)	0.6	Actual	1.00	0.6
4	Mismatch	1.40	Actual	1.00	1.40
5	Standing wave between the DUT and measurement antenna	0.00	U-shaped	1.41	0.00
6	Uncertainty of the RF power measurement equipment	2.73	Normal	2.00	1.37
7	Phase curvature	0.00	U-shaped	1.41	0.00
8	Amplifier uncertainties	2.1	Normal	2.00	1.05
9	Random uncertainty	0.5	Normal	2.00	0.25
10	Influence of the XPD	0.01	U-shaped	1.41	0.00
11	Insertion Loss Variation	0.00	Rectangular	1.73	0.00
12	RF leakage (from measurement antenna to the receiver/transmitter)	0.00	Actual	1.00	0.00
13	Influence of TRP measurement grid (NOTE 1)	0.32	Actual	1	0.32
14	Influence of beam peak search grid (NOTE 2)	N/A	Actual	1	N/A
15	Multiple measurement antenna uncertainty (NOTE 5)	0.15	Actual	1	0.15
16	DUT repositioning	0.00	Rectangular	1.73	0.00
17	Misalignment of DUT due to change of DUT orientation	0.10	Actual	1	0.10
Stage 1: Calibration measurement					
18	Mismatch	0.00	U-shaped	1.41	0.00
19	Amplifier Uncertainties	0.00	Normal	2.00	0.00
20	Misalignment of positioning System	0.00	Normal	2.00	0.00
21	Uncertainty of the Network Analyzer	1.5	Normal	2.00	0.75
22	Uncertainty of the absolute gain of the calibration antenna	0.6	Normal	2.00	0.3
23	Positioning and pointing misalignment between the reference antenna and the measurement antenna	0.05	Rectangular	1.73	0.03
24	Phase centre offset of calibration antenna	0.00	Rectangular	1.73	0.00
25	Quality of quiet zone for calibration process (NOTE 4)	0.6	Actual	1.00	0.6
26	Standing wave between reference calibration antenna and measurement antenna	0.00	U-shaped	1.41	0.00
27	Influence of the calibration antenna feed cable	0.14	Normal	2.00	0.07
28	Insertion Loss Variation	0.00	Rectangular	1.73	0.00
Expanded uncertainty (1.96σ - confidence interval of 95 %)					Value
TRP Expanded uncertainty (23.45 GHz < f <= 40.8 GHz) [dB] (a)					5.00
Systematic uncertainties (NOTE 3)					Value
29	Systematic error due to TRP calculation/quadrature (NOTE 1) (b)				0.0

30	General spurious emissions Influence of noise (c ₁) (23.45 GHz < f <= 40.8 GHz)	0.41
30	Spurious emission band UE co-existence Influence of noise (c ₂) (f within NR Bands n257, n260 or n261)	1.0
30	Spurious emission band UE co-existence Influence of noise (c ₃) (36 GHz <= f <= 37 GHz)	1.0
30	Additional spurious emissions Influence of noise (c ₄) NS_202 (23.6 GHz < f <= 24.0 GHz)	1.0
30	Additional spurious emissions Influence of noise (c ₅) NS_202 (23.45 GHz < f <= 40.8 GHz)	1.0
30	Additional spurious emissions Influence of noise (c ₆) NS_203 (23.6 GHz < f <= 24.0 GHz)	1.0
30	Spurious emission band UE co-existence Influence of noise (c ₇) (23.6 GHz < f <= 24.0 GHz)	1.0
31	Systematic error related to beam peak search (NOTE 2)	N/A
Total measurement uncertainty		Value
General spurious emissions Total measurement uncertainty (a)+(b)+(c ₁) [dB] (23.45 GHz < f <= 40.8 GHz)		5.41
Spurious emission band UE co-existence Total measurement uncertainty (a)+(b)+(c ₂) [dB] (f within NR Bands n257, n260 or n261)		6.00
Spurious emission band UE co-existence Total measurement uncertainty (a)+(b)+(c ₃) [dB] (36 GHz <= f <= 37 GHz)		6.00
Additional spurious emissions Total measurement uncertainty (a)+(b)+(c ₄) [dB] NS_202 (23.6 GHz < f <= 24.0 GHz)		6.00
Additional spurious emissions Total measurement uncertainty (a)+(b)+(c ₅) [dB] NS_202 (23.45 GHz < f <= 40.8 GHz)		6.00
Additional spurious emissions Total measurement uncertainty (a)+(b)+(c ₆) [dB] NS_203 (23.6 GHz < f <= 24.0 GHz)		6.00
Spurious emission band UE co-existence Total measurement uncertainty (a)+(b)+(c ₇) [dB] (23.6 GHz < f <= 24.0 GHz)		6.00

<p>NOTE 1: This contributor shall only be considered for TRP measurements.</p> <p>NOTE 2: This contributor shall only be considered for EIRP measurements.</p> <p>NOTE 3: In order to obtain the total measurement uncertainty, systematic uncertainties have to be added to the expanded root sum square of the standard deviations of the Stage 1 and Stage 2 contributors.</p> <p>NOTE 4: Value based on procedure defined in clause D.2 of TR 38.810 for Quiet Zone size of less or equal to 30 cm.</p> <p>NOTE 5: Applies to the system which has a structure of mechanical feed antenna positioning.</p>
--

Table B.18.2-8: Void

Table B.18.2-9: Uncertainty assessment for TRP measurement (f= 40.8 GHz to 66 GHz, Quiet Zone size \leq 30 cm) for PC3 UEs

UID	Uncertainty source	Uncertainty value	Distribution of the probability	Divisor	Standard uncertainty (σ) [dB]
Stage 2: DUT measurement					
1	Positioning misalignment	0.0	Normal	2.00	0.0
2	Measure distance uncertainty	0.00	Rectangular	1.73	0.00
3	Quality of Quiet Zone (NOTE 4)	0.6	Actual	1.00	0.6
4	Mismatch	2.30	Actual	1.00	2.30
5	Standing wave between the DUT and measurement antenna	0.00	U-shaped	1.41	0.00
6	Uncertainty of the RF power measurement equipment	4.0	Normal	2.00	2.00
7	Phase curvature	0.00	U-shaped	1.41	0.00
8	Amplifier uncertainties	2.1	Normal	2.00	1.05
9	Random uncertainty	0.5	Normal	2.00	0.25
10	Influence of the XPD	0.09	U-shaped	1.41	0.064
11	Insertion Loss Variation	0.00	Rectangular	1.73	0.00
12	RF leakage (from measurement antenna to the receiver/transmitter)	0.00	Actual	1.00	0.00
13	Influence of TRP measurement grid (NOTE 1)	0.32	Actual	1	0.32
14	Influence of beam peak search grid (NOTE 2)	N/A	Actual	1	N/A
15	Multiple measurement antenna uncertainty (NOTE 5)	0.15	Actual	1	0.15
16	DUT repositioning	0.00	Rectangular	1.73	0.00
17	Misalignment of DUT due to change of DUT orientation	0.10	Actual	1	0.10
Stage 1: Calibration measurement					
18	Mismatch	0.00	U-shaped	1.41	0.00
19	Amplifier Uncertainties	0.00	Normal	2.00	0.00
20	Misalignment of positioning System	0.00	Normal	2.00	0.00
21	Uncertainty of the Network Analyzer	1.7	Normal	2.00	0.85
22	Uncertainty of the absolute gain of the calibration antenna	1.70	Normal	2.00	0.85
23	Positioning and pointing misalignment between the reference antenna and the measurement antenna	0.05	Rectangular	1.73	0.03
24	Phase centre offset of calibration antenna	0.00	Rectangular	1.73	0.00
25	Quality of quiet zone for calibration process (NOTE 4)	0.6	Actual	1.00	0.6
26	Standing wave between reference calibration antenna and measurement antenna	0.00	U-shaped	1.41	0.00
27	Influence of the calibration antenna feed cable	0.28	Normal	2.00	0.14
28	Insertion Loss Variation	0.00	Rectangular	1.73	0.00
Expanded uncertainty (1.96σ - confidence interval of 95 %)					Value
TRP Expanded uncertainty (40.8 GHz < f <= 66 GHz) [dB] (a)					7.01
Systematic uncertainties (NOTE 3)					Value
29	Systematic error due to TRP calculation/quadrature (NOTE 1) (b)				0.00

30	General spurious emissions Influence of noise (c_1) (40.8 GHz < f <= 66 GHz)	0.41
30	Spurious emission band UE co-existence Influence of noise (c_2) (57 GHz <= f <= 66 GHz)	1.0
30	Additional spurious emissions Influence of noise (c_3) NS_202 (40.8 GHz < f <= 2nd harmonic of the upper frequency edge of the UL operating band)	1.0
31	Systematic error related to beam peak search (NOTE 2)	N/A
Total measurement uncertainty		Value
General spurious emissions Total measurement uncertainty (a)+(b)+(c ₁) [dB] (40.8 GHz < f <= 66 GHz)		7.42
Spurious emission band UE co-existence Total measurement uncertainty (a)+(b)+(c ₂) [dB] (57 GHz <= f <= 66 GHz)		8.01
Additional spurious emissions Total measurement uncertainty (a)+(b)+(c ₃) [dB] NS_202 (40.8 GHz < f <= 2nd harmonic of the upper frequency edge of the UL operating band)		8.01
NOTE 1: This contributor shall only be considered for TRP measurements.		
NOTE 2: This contributor shall only be considered for EIRP measurements.		
NOTE 3: In order to obtain the total measurement uncertainty, systematic uncertainties have to be added to the expanded root sum square of the standard deviations of the Stage 1 and Stage 2 contributors.		
NOTE 4: Value based on procedure defined in clause D.2 of TR 38.810 for Quiet Zone size of less or equal to 30 cm.		
NOTE 5: Applies to the system which has a structure of mechanical feed antenna positioning.		
NOTE 6: Void		

Table B.18.2-10: Void

Table B.18.2-11: Uncertainty assessment for TRP measurement (f= 66 GHz to 87 GHz, Quiet Zone size \leq 30 cm) for PC3 UEs

UID	Uncertainty source	Uncertainty value	Distribution of the probability	Divisor	Standard uncertainty (σ) [dB]
Stage 2: DUT measurement					
1	Positioning misalignment	0.00	Normal	2.00	0.00
2	Measure distance uncertainty	0.00	Rectangular	1.73	0.00
3	Quality of Quiet Zone (NOTE 4)	0.6	Actual	1.00	0.6
4	Mismatch	2.30	Actual	1.00	2.30
5	Standing wave between the DUT and measurement antenna	0.00	U-shaped	1.41	0.00
6	Uncertainty of the RF power measurement equipment	4.00	Normal	2.00	2.00
7	Phase curvature	0.00	U-shaped	1.41	0.00
8	Amplifier uncertainties	3.0	Normal	2.00	1.50
9	Random uncertainty	0.5	Normal	2.00	0.25
10	Influence of the XPD	0.09	U-shaped	1.41	0.064
11	Insertion Loss Variation	0.00	Rectangular	1.73	0.00
12	RF leakage (from measurement antenna to the receiver/transmitter)	0.00	Actual	1.00	0.00
13	Influence of TRP measurement grid (NOTE 1)	0.32	Actual	1	0.32
14	Influence of beam peak search grid (NOTE 2)	N/A	Actual	1	N/A
15	Multiple measurement antenna uncertainty (NOTE 5)	0.15	Actual	1	0.15
16	DUT repositioning	0.00	Rectangular	1.73	0.00
17	Misalignment of DUT due to change of DUT orientation	0.10	Actual	1	0.10
Stage 1: Calibration measurement					
18	Mismatch	0.00	U-shaped	1.41	0.00
19	Amplifier Uncertainties	0.00	Normal	2.00	0.00
20	Misalignment of positioning System	0.00	Normal	2.00	0.00
21	Uncertainty of the Network Analyzer	1.70	Normal	2.00	0.85
22	Uncertainty of the absolute gain of the calibration antenna	1.70	Normal	2.00	0.85
23	Positioning and pointing misalignment between the reference antenna and the measurement antenna	0.05	Rectangular	1.73	0.03
24	Phase centre offset of calibration antenna	0.00	Rectangular	1.73	0.00
25	Quality of quiet zone for calibration process (NOTE 4)	0.60	Actual	1.00	0.60
26	Standing wave between reference calibration antenna and measurement antenna	0.00	U-shaped	1.41	0.00
27	Influence of the calibration antenna feed cable	0.28	Normal	2.00	0.14
28	Insertion Loss Variation	0.00	Rectangular	1.73	0.00
Expanded uncertainty (1.96σ - confidence interval of 95 %)					Value
TRP Expanded uncertainty (66 GHz < f <= 87 GHz) [dB] (a)					7.31
Systematic uncertainties (NOTE 3)					Value
29	Systematic error due to TRP calculation/quadrature (NOTE 1) (b)				0.00

30	General spurious emissions Influence of noise (c_1) (66 GHz < f <= 80 GHz)	0.41
30	General spurious emissions Influence of noise (c_1) (80 GHz < f <= 87 GHz)	0.83
31	Systematic error related to beam peak search (NOTE 2)	N/A
Total measurement uncertainty		Value
General spurious emissions Total measurement uncertainty (a)+(b)+(c ₁) [dB] (66 GHz < f <= 80 GHz)		7.72
General spurious emissions Total measurement uncertainty (a)+(b)+(c ₁) [dB] (80 GHz < f <= 87 GHz)		8.14
NOTE 1: This contributor shall only be considered for TRP measurements.		
NOTE 2: This contributor shall only be considered for EIRP measurements.		
NOTE 3: In order to obtain the total measurement uncertainty, systematic uncertainties have to be added to the expanded root sum square of the standard deviations of the Stage 1 and Stage 2 contributors.		
NOTE 4: Value based on procedure defined in clause D.2 of TR 38.810 for Quiet Zone size of less or equal to 30 cm.		
NOTE 5: Applies to the system which has a structure of mechanical feed antenna positioning.		

Table B.18.2-12: Uncertainty assessment for TRP measurement (f=6 GHz to 12.75GHz, Quiet Zone size \leq 30 cm) for PC1 UEs

UID	Uncertainty source	Uncertainty value	Distribution of the probability	Divisor	Standard uncertainty (σ) [dB]
Stage 2: DUT measurement					
1	Positioning misalignment	0.02	Normal	2.00	0.01
2	Measure distance uncertainty	0.00	Rectangular	1.73	0.00
3	Quality of Quiet Zone (NOTE 4)	0.70	Actual	1.00	0.70
4	Mismatch	1.50	Actual	1.00	1.50
5	Standing wave between the DUT and measurement antenna	0.00	U-shaped	1.41	0.00
6	Uncertainty of the RF power measurement equipment	2.00	Normal	2.00	1.00
7	Phase curvature	0.00	U-shaped	1.41	0.00
8	Amplifier uncertainties	2.1	Normal	2.00	1.05
9	Random uncertainty	0.5	Normal	2.00	0.25
10	Influence of the XPD	0.09	U-shaped	1.41	0.064
11	Insertion Loss Variation	0.00	Rectangular	1.73	0.00
12	RF leakage (from measurement antenna to the receiver/transmitter)	0.00	Actual	1.00	0.00
13	Influence of TRP measurement grid (NOTE 1)	0.25	Actual	1	0.25
14	Influence of beam peak search grid (NOTE 2)	N/A	Actual	1	N/A
15	Multiple measurement antenna uncertainty (NOTE 5)	0.15	Actual	1	0.15
16	DUT repositioning	0.00	Rectangular	1.73	0.00
17	Misalignment of DUT due to change of DUT orientation	0.10	Actual	1	0.10
Stage 1: Calibration measurement					
18	Mismatch	0.00	U-shaped	1.41	0.00
19	Amplifier Uncertainties	0.00	Normal	2.00	0.00
20	Misalignment of positioning System	0.00	Normal	2.00	0.00
21	Uncertainty of the Network Analyzer	1.5	Normal	2.00	0.75
22	Uncertainty of the absolute gain of the calibration antenna	0.60	Normal	2.00	0.30
23	Positioning and pointing misalignment between the reference antenna and the measurement antenna	0.05	Rectangular	1.73	0.03
24	Phase centre offset of calibration antenna	0.00	Rectangular	1.73	0.00
25	Quality of quiet zone for calibration process (NOTE 4)	0.70	Actual	1.00	0.70
26	Standing wave between reference calibration antenna and measurement antenna	0.00	U-shaped	1.41	0.00
27	Influence of the calibration antenna feed cable	0.14	Normal	2.00	0.07
28	Insertion Loss Variation	0.00	Rectangular	1.73	0.00
Expanded uncertainty (1.96σ - confidence interval of 95 %)					Value
TRP Expanded uncertainty (6 GHz < f <= 12.75 GHz) [dB] (a)					4.87
Systematic uncertainties (NOTE 3)					Value
29	Systematic error due to TRP calculation/quadrature (NOTE 1) (b)				0.00

30	General spurious emissions Influence of noise (c_1) (6 GHz < f <= 12.75 GHz)	0.41
30	Additional spurious emissions Influence of noise (c_2) NS_202 (6 GHz < f <= 12.75 GHz)	0.41
31	Systematic error related to beam peak search (NOTE 2)	N/A
Total measurement uncertainty		Value
General spurious emissions Total measurement uncertainty (a)+(b)+(c ₁) [dB] (6 GHz < f <= 12.75 GHz)		5.28
Additional spurious emissions Total measurement uncertainty (a)+(b)+(c ₂) [dB] NS_202 (6 GHz < f <= 12.75 GHz)		5.28
NOTE 1: This contributor shall only be considered for TRP measurements.		
NOTE 2: This contributor shall only be considered for EIRP measurements.		
NOTE 3: In order to obtain the total measurement uncertainty, systematic uncertainties have to be added to the expanded root sum square of the standard deviations of the Stage 1 and Stage 2 contributors.		
NOTE 4: Value based on procedure defined in clause D.2 of TR 38.810 for Quiet Zone size of less or equal to 30 cm.		
NOTE 5: Applies to the system which has a structure of mechanical feed antenna positioning.		

Table B.18.2-13: Uncertainty assessment for TRP measurement (f=12.75 GHz to 23.45 GHz, Quiet Zone size \leq 30 cm) for PC1 UEs

UID	Uncertainty source	Uncertainty value	Distribution of the probability	Divisor	Standard uncertainty (σ) [dB]
Stage 2: DUT measurement					
1	Positioning misalignment	0.02	Normal	2.00	0.01
2	Measure distance uncertainty	0.00	Rectangular	1.73	0.00
3	Quality of Quiet Zone (NOTE 4)	0.60	Actual	1.00	0.60
4	Mismatch	1.50	Actual	1.00	1.50
5	Standing wave between the DUT and measurement antenna	0.00	U-shaped	1.41	0.00
6	Uncertainty of the RF power measurement equipment	2.16	Normal	2.00	1.08
7	Phase curvature	0.00	U-shaped	1.41	0.00
8	Amplifier uncertainties	2.1	Normal	2.00	1.05
9	Random uncertainty	0.5	Normal	2.00	0.25
10	Influence of the XPD	0.09	U-shaped	1.41	0.064
11	Insertion Loss Variation	0.00	Rectangular	1.73	0.00
12	RF leakage (from measurement antenna to the receiver/transmitter)	0.00	Actual	1.00	0.00
13	Influence of TRP measurement grid (NOTE 1)	0.25	Actual	1	0.25
14	Influence of beam peak search grid (NOTE 2)	N/A	Actual	1	N/A
15	Multiple measurement antenna uncertainty (NOTE 5)	0.15	Actual	1	0.15
16	DUT repositioning	0.00	Rectangular	1.73	0.00
17	Misalignment of DUT due to change of DUT orientation	0.10	Actual	1	0.10
Stage 1: Calibration measurement					
18	Mismatch	0.00	U-shaped	1.41	0.00
19	Amplifier Uncertainties	0.00	Normal	2.00	0.00
20	Misalignment of positioning System	0.00	Normal	2.00	0.00
21	Uncertainty of the Network Analyzer	1.5	Normal	2.00	0.75
22	Uncertainty of the absolute gain of the calibration antenna	0.60	Normal	2.00	0.30
23	Positioning and pointing misalignment between the reference antenna and the measurement antenna	0.05	Rectangular	1.73	0.03
24	Phase centre offset of calibration antenna	0.00	Rectangular	1.73	0.00
25	Quality of quiet zone for calibration process (NOTE 4)	0.60	Actual	1.00	0.60
26	Standing wave between reference calibration antenna and measurement antenna	0.00	U-shaped	1.41	0.00
27	Influence of the calibration antenna feed cable	0.14	Normal	2.00	0.07
28	Insertion Loss Variation	0.00	Rectangular	1.73	0.00
Expanded uncertainty (1.96σ - confidence interval of 95 %)					Value
TRP Expanded uncertainty (12.75 GHz < f <= 23.45 GHz) [dB] (a)					4.83
Systematic uncertainties (NOTE 3)					Value
29	Systematic error due to TRP calculation/quadrature (NOTE 1) (b)				0.00

30	General spurious emissions Influence of noise (c_1) (12.75 GHz < f <= 23.45 GHz)	1.08
e30	Additional spurious emissions Influence of noise (c_2) NS_202 (12.75 GHz < f <= 23.45 GHz)	2.34
31	Systematic error related to beam peak search (NOTE 2)	N/A
Total measurement uncertainty		Value
General spurious emissions Total measurement uncertainty (a)+(b)+(c) [dB] (12.75 GHz < f <= 23.45 GHz)		5.91
Additional spurious emissions Total measurement uncertainty (a)+(b)+(c ₂) [dB] NS_202 (12.75 GHz < f <= 23.45 GHz)		7.16
NOTE 1: This contributor shall only be considered for TRP measurements.		
NOTE 2: This contributor shall only be considered for EIRP measurements.		
NOTE 3: In order to obtain the total measurement uncertainty, systematic uncertainties have to be added to the expanded root sum square of the standard deviations of the Stage 1 and Stage 2 contributors.		
NOTE 4: Value based on procedure defined in clause D.2 of TR 38.810 for Quiet Zone size of less or equal to 30 cm.		
NOTE 5: Applies to the system which has a structure of mechanical feed antenna positioning.		

Table B.18.2-14: Uncertainty assessment for TRP measurement (f=23.45 GHz to 40.8 GHz, Quiet Zone size \leq 30 cm) for PC1 UEs

UID	Uncertainty source	Uncertainty value	Distribution of the probability	Divisor	Standard uncertainty (σ) [dB]
Stage 2: DUT measurement					
1	Positioning misalignment	0.02	Normal	2.00	0.01
2	Measure distance uncertainty	0.00	Rectangular	1.73	0.00
3	Quality of Quiet Zone (NOTE 4)	0.6	Actual	1.00	0.6
4	Mismatch	1.40	Actual	1.00	1.40
5	Standing wave between the DUT and measurement antenna	0.00	U-shaped	1.41	0.00
6	Uncertainty of the RF power measurement equipment	2.73	Normal	2.00	1.37
7	Phase curvature	0.00	U-shaped	1.41	0.00
8	Amplifier uncertainties	2.1	Normal	2.00	1.05
9	Random uncertainty	0.5	Normal	2.00	0.25
10	Influence of the XPD	0.01	U-shaped	1.41	0.00
11	Insertion Loss Variation	0.00	Rectangular	1.73	0.00
12	RF leakage (from measurement antenna to the receiver/transmitter)	0.00	Actual	1.00	0.00
13	Influence of TRP measurement grid (NOTE 1)	0.25	Actual	1	0.25
14	Influence of beam peak search grid (NOTE 2)	N/A	Actual	1	N/A
15	Multiple measurement antenna uncertainty (NOTE 5)	0.15	Actual	1	0.15
16	DUT repositioning	0.00	Rectangular	1.73	0.00
17	Misalignment of DUT due to change of DUT orientation	0.10	Actual	1	0.10
Stage 1: Calibration measurement					
18	Mismatch	0.00	U-shaped	1.41	0.00
19	Amplifier Uncertainties	0.00	Normal	2.00	0.00
20	Misalignment of positioning System	0.00	Normal	2.00	0.00
21	Uncertainty of the Network Analyzer	1.5	Normal	2.00	0.75
22	Uncertainty of the absolute gain of the calibration antenna	0.6	Normal	2.00	0.3
23	Positioning and pointing misalignment between the reference antenna and the measurement antenna	0.05	Rectangular	1.73	0.03
24	Phase centre offset of calibration antenna	0.00	Rectangular	1.73	0.00
25	Quality of quiet zone for calibration process (NOTE 4)	0.6	Actual	1.00	0.6
26	Standing wave between reference calibration antenna and measurement antenna	0.00	U-shaped	1.41	0.00
27	Influence of the calibration antenna feed cable	0.14	Normal	2.00	0.07
28	Insertion Loss Variation	0.00	Rectangular	1.73	0.00
	Expanded uncertainty (1.96σ - confidence interval of 95 %)				Value
	TRP Expanded uncertainty (23.45 GHz < f <= 40.8 GHz) [dB] (a)				4.99
	Systematic uncertainties (NOTE 3)				Value
29	Systematic error due to TRP calculation/quadrature (NOTE 1) (b)				0.00

30	General spurious emissions Influence of noise (c ₁) (23.45 GHz < f <= 40.8 GHz)	1.08
30	Spurious emission band UE co-existence Influence of noise (c ₂) (f within NR Bands n257, n260 or n261)	2.34
30	Additional spurious emissions Influence of noise (c ₄) NS_202 (23.6 GHz < f <= 24.0 GHz)	2.34
30	Additional spurious emissions Influence of noise (c ₅) NS_202 (23.45 GHz < f <= 40.8 GHz)	2.34
30	Additional spurious emissions Influence of noise (c ₆) NS_203 (23.6 GHz < f <= 24.0 GHz)	2.34
30	Spurious emission band UE co-existence Influence of noise (c ₇) (23.6 GHz < f <= 24.0 GHz)	2.34
31	Systematic error related to beam peak search (NOTE 2)	N/A
Total measurement uncertainty		Value
General spurious emissions Total measurement uncertainty (a)+(b)+(c ₁) [dB] (23.45 GHz < f <= 40.8 GHz)		6.07
Spurious emission band UE co-existence Total measurement uncertainty (a)+(b)+(c ₂) [dB] (f within NR Bands n257, n260 or n261)		7.32
Additional spurious emissions Total measurement uncertainty (a)+(b)+(c ₄) [dB] NS_202 (23.6 GHz < f <= 24.0 GHz)		7.32
Additional spurious emissions Total measurement uncertainty (a)+(b)+(c ₅) [dB] NS_202 (23.45 GHz < f <= 40.8 GHz)		7.32
Additional spurious emissions Total measurement uncertainty (a)+(b)+(c ₆) [dB] NS_203 (23.6 GHz < f <= 24.0 GHz)		7.32
Spurious emission band UE co-existence Total measurement uncertainty (a)+(b)+(c ₇) [dB] (23.6 GHz < f <= 24.0 GHz)		7.32
NOTE 1: This contributor shall only be considered for TRP measurements.		
NOTE 2: This contributor shall only be considered for EIRP measurements.		
NOTE 3: In order to obtain the total measurement uncertainty, systematic uncertainties have to be added to the expanded root sum square of the standard deviations of the Stage 1 and Stage 2 contributors.		
NOTE 4: Value based on procedure defined in clause D.2 of TR 38.810 for Quiet Zone size of less or equal to 30 cm.		
NOTE 5: Applies to the system which has a structure of mechanical feed antenna positioning.		

Table B.18.2-15: Uncertainty assessment for TRP measurement (f= 40.8 GHz to 66 GHz, Quiet Zone size \leq 30 cm) for PC1 UEs

UID	Uncertainty source	Uncertainty value	Distribution of the probability	Divisor	Standard uncertainty (σ) [dB]
Stage 2: DUT measurement					
1	Positioning misalignment	0.02	Normal	2.00	0.01
2	Measure distance uncertainty	0.00	Rectangular	1.73	0.00
3	Quality of Quiet Zone (NOTE 4)	0.6	Actual	1.00	0.6
4	Mismatch	2.30	Actual	1.00	2.30
5	Standing wave between the DUT and measurement antenna	0.00	U-shaped	1.41	0.00
6	Uncertainty of the RF power measurement equipment	4.0	Normal	2.00	2.00
7	Phase curvature	0.00	U-shaped	1.41	0.00
8	Amplifier uncertainties	2.1	Normal	2.00	1.05
9	Random uncertainty	0.5	Normal	2.00	0.25
10	Influence of the XPD	0.09	U-shaped	1.41	0.064
11	Insertion Loss Variation	0.00	Rectangular	1.73	0.00
12	RF leakage (from measurement antenna to the receiver/transmitter)	0.00	Actual	1.00	0.00
13	Influence of TRP measurement grid (NOTE 1)	0.25	Actual	1	0.25
14	Influence of beam peak search grid (NOTE 2)	N/A	Actual	1	N/A
15	Multiple measurement antenna uncertainty (NOTE 5)	0.15	Actual	1	0.15
16	DUT repositioning	0.00	Rectangular	1.73	0.00
17	Misalignment of DUT due to change of DUT orientation	0.10	Actual	1	0.10
Stage 1: Calibration measurement					
18	Mismatch	0.00	U-shaped	1.41	0.00
19	Amplifier Uncertainties	0.00	Normal	2.00	0.00
20	Misalignment of positioning System	0.00	Normal	2.00	0.00
21	Uncertainty of the Network Analyzer	1.7	Normal	2.00	0.85
22	Uncertainty of the absolute gain of the calibration antenna	1.70	Normal	2.00	0.85
23	Positioning and pointing misalignment between the reference antenna and the measurement antenna	0.05	Rectangular	1.73	0.03
24	Phase centre offset of calibration antenna	0.00	Rectangular	1.73	0.00
25	Quality of quiet zone for calibration process (NOTE 4)	0.6	Actual	1.00	0.6
26	Standing wave between reference calibration antenna and measurement antenna	0.00	U-shaped	1.41	0.00
27	Influence of the calibration antenna feed cable	0.28	Normal	2.00	0.14
28	Insertion Loss Variation	0.00	Rectangular	1.73	0.00
	Expanded uncertainty (1.96σ - confidence interval of 95 %)				Value
	TRP Expanded uncertainty (40.8 GHz < f <= 66 GHz) [dB] (a)				7.00
	Systematic uncertainties (NOTE 3)				Value
29	Systematic error due to TRP calculation/quadrature (NOTE 1) (b)				0.00

30	General spurious emissions Influence of noise (c ₁) (40.8 GHz < f <= 66 GHz)	1.08
30	Spurious emission band UE co-existence Influence of noise (c ₂) (57 GHz <= f <= 66 GHz)	1
30	Additional spurious emissions Influence of noise (c ₃) NS_202 (40.8 GHz < f <= 2nd harmonic of the upper frequency edge of the UL operating band)	2.34
31	Systematic error related to beam peak search (NOTE 2)	N/A
Total measurement uncertainty		Value
General spurious emissions Total measurement uncertainty (a)+(b)+(c ₁) [dB] (40.8 GHz < f <= 66 GHz)		8.09
Spurious emission band UE co-existence Total measurement uncertainty (a)+(b)+(c ₂) [dB] (57 GHz <= f <= 66 GHz)		8.00
Additional spurious emissions Total measurement uncertainty (a)+(b)+(c ₃) [dB] NS_202 (40.8 GHz < f <= 2nd harmonic of the upper frequency edge of the UL operating band)		9.34
<p>NOTE 1: This contributor shall only be considered for TRP measurements.</p> <p>NOTE 2: This contributor shall only be considered for EIRP measurements.</p> <p>NOTE 3: In order to obtain the total measurement uncertainty, systematic uncertainties have to be added to the expanded root sum square of the standard deviations of the Stage 1 and Stage 2 contributors.</p> <p>NOTE 4: Value based on procedure defined in clause D.2 of TR 38.810 for Quiet Zone size of less or equal to 30 cm.</p> <p>NOTE 5: Applies to the system which has a structure of mechanical feed antenna positioning.</p> <p>NOTE 6: Void</p>		

Table B.18.2-16: Uncertainty assessment for TRP measurement (f= 66 GHz to 80 GHz, Quiet Zone size \leq 30 cm) for PC1 UEs

UID	Uncertainty source	Uncertainty value	Distribution of the probability	Divisor	Standard uncertainty (σ) [dB]
Stage 2: DUT measurement					
1	Positioning misalignment	0.02	Normal	2.00	0.01
2	Measure distance uncertainty	0.00	Rectangular	1.73	0.00
3	Quality of Quiet Zone (NOTE 4)	0.60	Actual	1.00	0.60
4	Mismatch	2.30	Actual	1.00	2.30
5	Standing wave between the DUT and measurement antenna	0.00	U-shaped	1.41	0.00
6	Uncertainty of the RF power measurement equipment	4.00	Normal	2.00	2.00
7	Phase curvature	0.00	U-shaped	1.41	0.00
8	Amplifier uncertainties	3.00	Normal	2.00	1.50
9	Random uncertainty	0.50	Normal	2.00	0.25
10	Influence of the XPD	0.09	U-shaped	1.41	0.06
11	Insertion Loss Variation	0.00	Rectangular	1.73	0.00
12	RF leakage (from measurement antenna to the receiver/transmitter)	0.00	Actual	1.00	0.00
13	Influence of TRP measurement grid (NOTE 1)	0.25	Actual	1	0.25
14	Influence of beam peak search grid (NOTE 2)	N/A	Actual	1	N/A
15	Multiple measurement antenna uncertainty (NOTE 5)	0.15	Actual	1	0.15
16	DUT repositioning	0.00	Rectangular	1.73	0.00
17	Misalignment of DUT due to change of DUT orientation	0.10	Actual	1	0.10
Stage 1: Calibration measurement					
18	Mismatch	0.00	U-shaped	1.41	0.00
19	Amplifier Uncertainties	0.00	Normal	2.00	0.00
20	Misalignment of positioning System	0.00	Normal	2.00	0.00
21	Uncertainty of the Network Analyzer	1.70	Normal	2.00	0.85
22	Uncertainty of the absolute gain of the calibration antenna	1.70	Normal	2.00	0.85
23	Positioning and pointing misalignment between the reference antenna and the measurement antenna	0.05	Rectangular	1.73	0.03
24	Phase centre offset of calibration antenna	0.00	Rectangular	1.73	0.00
25	Quality of quiet zone for calibration process (NOTE 4)	0.60	Actual	1.00	0.60
26	Standing wave between reference calibration antenna and measurement antenna	0.00	U-shaped	1.41	0.00
27	Influence of the calibration antenna feed cable	0.28	Normal	2.00	0.14
28	Insertion Loss Variation	0.00	Rectangular	1.73	0.00
Expanded uncertainty (1.96σ - confidence interval of 95 %)					Value
TRP Expanded uncertainty (66 GHz < f <= 80 GHz) [dB] (a)					7.30
Systematic uncertainties (NOTE 3)					Value
29	Systematic error due to TRP calculation/quadrature (NOTE 1) (b)				0

30	General spurious emissions Influence of noise (c ₁) (66 GHz < f ≤ 80 GHz)	0.41
31	Systematic error related to beam peak search (NOTE 2)	N/A
Total measurement uncertainty		Value
General spurious emissions Total measurement uncertainty (a)+(b)+(c ₁) [dB] (66 GHz < f ≤ 80 GHz)		7.71
NOTE 1: This contributor shall only be considered for TRP measurements.		
NOTE 2: This contributor shall only be considered for EIRP measurements.		
NOTE 3: In order to obtain the total measurement uncertainty, systematic uncertainties have to be added to the expanded root sum square of the standard deviations of the Stage 1 and Stage 2 contributors.		
NOTE 4: Value based on procedure defined in clause D.2 of TR 38.810 for Quiet Zone size of less or equal to 30 cm.		
NOTE 5: Applies to the system which has a structure of mechanical feed antenna positioning.		

NOTE: MU assessment for additional spurious in Table B.18.2-3 to Table B.18.2-16 is based on the following relaxations:

Table B.18.2-17: Transmitter Spurious emissions relaxation considered in MU assessment (Quiet Zone size ≤ 30 cm)

Power Class	Frequency	Relaxation
PC1	6 GHz < f ≤ 12.75 GHz	0 dB
	12.75 GHz < f ≤ 23.45 GHz	0 dB
	23.45GHz ≤ f ≤ 40.8GHz	0 dB
	40.8 GHz < f ≤ 66 GHz	0 dB
	66 GHz < f ≤ 80 GHz	0 dB
PC2	6 GHz < f ≤ 12.75 GHz	FFS
	12.75 GHz < f ≤ 23.45 GHz	FFS
	23.45GHz ≤ f ≤ 40.8GHz	FFS
	40.8 GHz < f ≤ 66 GHz	FFS
	66 GHz < f ≤ 87 GHz	FFS
PC3	6 GHz < f ≤ 12.75 GHz	0 dB
	12.75 GHz < f ≤ 23.45 GHz	0 dB
	23.45GHz ≤ f ≤ 40.8GHz	0 dB
	40.8 GHz < f ≤ 66 GHz	0 dB
	66 GHz < f ≤ 87 GHz	0 dB
PC4	6 GHz < f ≤ 12.75 GHz	FFS
	12.75 GHz < f ≤ 23.45 GHz	FFS
	23.45GHz ≤ f ≤ 40.8GHz	FFS
	40.8 GHz < f ≤ 66 GHz	FFS
	66 GHz < f ≤ 80 GHz	FFS

Table B.18.2-18: Spurious emissions band UE co-existence relaxation considered in MU assessment (Quiet Zone size ≤ 30 cm)

Power Class	Frequency	Relaxation
PC1	23.45GHz ≤ f ≤ 40.8GHz	3.3 dB (for protected bands n257, n261) 5 dB (for protected band n260) 0.3 dB (for 23.6 GHz ≤ f ≤ 24.0 GHz)
	40.8 GHz < f ≤ 66 GHz	0 dB (for 57.0 GHz ≤ f ≤ 66.0 GHz)
PC2	23.45GHz ≤ f ≤ 40.8GHz	FFS
	40.8 GHz < f ≤ 66 GHz	FFS
PC3	23.45GHz ≤ f ≤ 40.8GHz	3.3 dB (for protected bands n257, n261) 5 dB (for protected band n260) 0.3 dB (for 23.6 GHz ≤ f ≤ 24.0 GHz)
	40.8 GHz < f ≤ 66 GHz	6 dB (for 36.0 GHz ≤ f ≤ 37.0 GHz) 0 dB (for 57.0 GHz ≤ f ≤ 66.0 GHz)
PC4	23.45GHz ≤ f ≤ 40.8GHz	FFS
	40.8 GHz < f ≤ 66 GHz	FFS

Table B.18.2-19: Additional Spurious emissions relaxation considered in MU assessment (Quiet Zone size ≤ 30 cm)

Power Class	Frequency	Relaxation
PC1	6 GHz < f ≤ 12.75 GHz	0 dB (NS_202)
	12.75 GHz < f ≤ 23.45 GHz	13 dB (NS_202)
	23.45GHz ≤ f ≤ 40.8GHz	13 dB (whole frequency range for NS_202) 0.3 dB (for 23.6 GHz ≤ f ≤ 24.0 GHz for NS_202 & NS_203)
	40.8 GHz < f ≤ 66 GHz	13 dB (NS_202)
	66 GHz < f ≤ 80 GHz	FFS
PC2	6 GHz < f ≤ 12.75 GHz	FFS
	12.75 GHz < f ≤ 23.45 GHz	FFS
	23.45GHz ≤ f ≤ 40.8GHz	FFS
	40.8 GHz < f ≤ 66 GHz	FFS
	66 GHz < f ≤ 80 GHz	FFS
PC3	6 GHz < f ≤ 12.75 GHz	0 dB (NS_202)
	12.75 GHz < f ≤ 23.45 GHz	13 dB (NS_202)
	23.45GHz ≤ f ≤ 40.8GHz	13 dB (whole frequency range for NS_202) 0.3 dB (for 23.6 GHz ≤ f ≤ 24.0 GHz for NS_202 & NS_203)
	40.8 GHz < f ≤ 66 GHz	13 dB (NS_202)
PC4	6 GHz < f ≤ 12.75 GHz	FFS
	12.75 GHz < f ≤ 23.45 GHz	FFS
	23.45GHz ≤ f ≤ 40.8GHz	FFS
	40.8 GHz < f ≤ 66 GHz	FFS
	66 GHz < f ≤ 80 GHz	FFS

B.18.3 Uncertainty budget format and assessment for NFTF

FFS

B.18a Beam correspondence - EIRP

B.18a.1 Uncertainty budget format and assessment for DFF

The uncertainty contributions that may impact the overall MU value are listed in Table B.18a.1-1.

Table B.18a.1-1: Uncertainty contributions for Beam correspondence - EIRP measurement

UID	Description of uncertainty contribution	Details in annex
Stage 2: DUT measurement		
1	Uncertainty of the RF relative power measurement equipment	B.2.1.36
2	Amplifier uncertainties	B.2.1.8
Stage 1: Calibration measurement		
	N/A	
Systematic uncertainties		
3	Influence of noise	B.2.1.27

The uncertainty assessment tables are organized as follows:

- For the purpose of uncertainty assessment, the radiating antenna aperture of the DUT is denoted as D
- The uncertainty assessment has been derived for the case of $D = [5 \text{ cm}]$, $f = \{22.65\text{GHz}, 31.1\text{GHz}, 45.1\text{GHz}\}$, $P = [\text{maximum output power}]$.
- The uncertainty assessment for Beam correspondence - EIRP is provided in Table B.18a.1-2.

Table B.18a.1-2: Uncertainty assessment for Beam correspondence - EIRP measurement (f=TBD, D=TBD)

UID	Uncertainty source	Uncertainty value	Distribution of the probability	Divisor	Standard uncertainty (σ) [dB]
Stage 2: DUT measurement					
1	Uncertainty of the RF relative power measurement equipment	FFS	FFS	FFS	FFS
2	Amplifier uncertainties	FFS	FFS	FFS	FFS
Stage 1: Calibration measurement					
	N/A				
Systematic uncertainties (NOTE 1)					
3	Influence of noise				Value
Total measurement uncertainty					
Value					
EIRP Expanded uncertainty (1.96σ - confidence interval of 95 %) [dB]					FFS
NOTE 1: In order to obtain the total measurement uncertainty, systematic uncertainties have to be added to the expanded root sum square of the standard deviations of the Stage 1 and Stage 2 contributors.					

B.18a.2 Uncertainty budget format and assessment for IFF

The uncertainty contributions that may impact the overall MU value are listed in Table B.18a.2.-1.

Table B.18a.2-1: Uncertainty contributions for Beam correspondence - EIRP measurement

UID	Description of uncertainty contribution	Details in annex
Stage 2: DUT measurement		
1	Uncertainty of the RF relative power measurement equipment	B.2.2.36
2	Amplifier uncertainties	B.2.2.8
Stage 1: Calibration measurement		
	N/A	
Systematic uncertainties		
3	Influence of noise	B.2.2.27

The uncertainty assessment tables are organized as follows:

- For the purpose of uncertainty assessment, the radiating antenna aperture of the DUT is denoted as D
- The uncertainty assessment has been derived for the case of Quiet Zone size $\leq [30 \text{ cm}]$, $f = \{23.45\text{GHz}, 32.125\text{GHz}, 40.8\text{GHz}\}$.

- The uncertainty assessment for Beam Correspondence - EIRP is provided in Table B.18a.2-2.for PC3.

Table B.18a.2-2: Uncertainty assessment for Beam correspondence - EIRP measurement (f=23.45GHz, 32.125GHz, 40.8GHz, Quiet Zone size ≤ 30 cm) for PC3 UEs and normal temperature condition

UID	Uncertainty source	Uncertainty value	Distribution of the probability	Divisor	Standard uncertainty (σ) [dB]
Stage 2: DUT measurement					
1	Uncertainty of the RF relative power measurement equipment	0.4	Normal	2.00	[0.2]
2	Amplifier uncertainties	2.1	Rectangular	1.73	1.05
Stage 1: Calibration measurement					
	N/A				
Systematic uncertainties (NOTE 1)					Value
3	Influence of noise (23.45GHz ≤ f ≤ 32.125GHz)				0.58
3	Influence of noise (32.125GHz < f ≤ 40.8GHz)				1.71
Total measurement uncertainty					Value
EIRP Expanded uncertainty (23.45GHz ≤ f ≤ 32.125GHz) (1.96 σ - confidence interval of 95 %) [dB]					2.67
EIRP Expanded uncertainty (32.125GHz < f ≤ 40.8GHz) (1.96 σ - confidence interval of 95 %) [dB]					3.80
NOTE 1: In order to obtain the total measurement uncertainty, systematic uncertainties have to be added to the expanded root sum square of the standard deviations of the Stage 1 and Stage 2 contributors.					
NOTE 2: Power step size assumed to be no higher than 3.2 dB in 85% of the measurement grid points.					
NOTE 3: Measurement uncertainties in this table assume absolute power measurements involved in the same relative power measurement are performed over the same RF path.					

B.18a.3 Uncertainty budget format and assessment for NFTF

The uncertainty contributions that may impact the overall MU value are listed in Table B.18a.3-1.

Table B.18a.3-1: Uncertainty contributions for Beam correspondence - EIRP measurement

UID	Description of uncertainty contribution	Details in annex
Stage 2: DUT measurement		
1	Uncertainty of the RF relative power measurement equipment	B.2.3.30
2	Amplifier uncertainties	B.2.3.8
Stage 1: Calibration measurement		
	N/A	
Systematic uncertainties		
3	Influence of noise	B.2.3.29

The uncertainty assessment table is organized as follows:

- For the purpose of uncertainty assessment, the radiating antenna aperture of the DUT is denoted as D
- The uncertainty assessment has been derived for the case of D = [5 cm], f = {22.65GHz, 31.1GHz, 45.1GHz}, P = [maximum output power].
- The uncertainty assessment for Beam correspondence - EIRP is provided in Table B.18a.3-2

Table B.18a.3-2: Uncertainty assessment for Beam correspondence - EIRP measurement (f=TBD, D=TBD)

UID	Uncertainty source	Uncertainty value	Distribution of the probability	Divisor	Standard uncertainty (σ) [dB]
Stage 2: DUT measurement					
1	Uncertainty of the RF relative power measurement equipment	FFS	FFS	FFS	FFS
2	Amplifier uncertainties	FFS	FFS	FFS	FFS
Stage 1: Calibration measurement					
	N/A				
Systematic uncertainties (NOTE 1)					Value
3	Influence of noise				FFS
Total measurement uncertainty					Value
EIRP Expanded uncertainty (1.96 σ - confidence interval of 95 %) [dB]					FFS
NOTE 1: In order to obtain the total measurement uncertainty, systematic uncertainties have to be added to the expanded root sum square of the standard deviations of the Stage 1 and Stage 2 contributors.					

B.19 Reference Sensitivity

Following tables summarize the MU threshold for EIS measurements for Reference Sensitivity. The origin MU values for different test setups with varies parameters can be found in following subclauses.

Table B.19-1: MU threshold for EIS for Reference Sensitivity

Power Class	Frequency	MBW	Power	Threshold MU value for NTC (NOTE 1)	Threshold MU value for ETC (NOTE 1)
PC3	23.45GHz <= f <= 32.125GHz	BW <= 400MHz	P = Max Output Power	5.36	5.61
	32.125GHz < f <= 40.8GHz			5.36	5.61
	40.8GHz < f <= 44.3GHz			6.34	6.48
PC1	23.45GHz <= f <= 32.125GHz	BW <= 400MHz	P = Max Output Power	5.58	5.83
	32.125GHz < f <= 40.8GHz			5.58	5.83
PC5	23.45GHz <= f <= 32.125GHz	BW <= 400MHz	P = Max Output Power	5.58	5.83
NOTE 1: Total Expanded MU for IFF for Quiet Zone size \leq 30cm in Table B.19.2-2 for PC3 UEs (NTC), in Table B.19.2-4 for PC3 UEs (ETC), and Table B.19.2-3 for PC1 UEs					

Table B.19-2: MU threshold for Spherical coverage measurement for Reference Sensitivity

Power Class	Frequency	MBW	Power	Threshold MU value (NOTE 1)
PC3	23.45GHz <= f <= 32.125GHz	BW <= 400MHz	P = Max Output Power	5.07
	32.125GHz < f <= 40.8GHz			5.07
	40.8GHz < f <= 44.3GHz			6.04
PC1	23.45GHz <= f <= 32.125GHz	BW <= 400MHz	P = Max Output Power	5.07
	32.125GHz < f <= 40.8GHz			5.07
PC5	23.45GHz <= f <= 32.125GHz	BW <= 400MHz	P = Max Output Power	5.07
NOTE 1: Total Expanded MU for IFF for Quiet Zone size ≤ 30cm in Table B.19.2-2 for PC3 UEs and Table B.19.2-3 for PC1 UEs				

B.19.1 Uncertainty budget format and assessment for DFF

FFS

B.19.2 Uncertainty budget format and assessment for IFF

The uncertainty contributions that may impact the overall MU value are listed in Table B.19.2-1.

Table B.19.2-1: Uncertainty contributions for EIS measurement

UID	Description of uncertainty contribution	Details in clause
Stage 2: DUT measurement		
1	Positioning misalignment	B.2.2.1
2	Measure distance uncertainty	B.2.2.2
3	Quality of Quiet Zone	B.2.2.3
4	Mismatch	B.2.2.4
5	Standing wave between the DUT and measurement antenna	B.2.2.5
6	gNB emulator uncertainty	B.2.2.17
7	Phase curvature	B.2.2.7
8	Amplifier uncertainties	B.2.2.8
9	Random uncertainty	B.2.2.9
10	Influence of the XPD	B.2.2.10
11	Insertion Loss Variation	B.2.2.11
12	RF leakage (from measurement antenna to the receiver/transmitter)	B.2.2.12
13	Multiple measurement antenna uncertainty	B.2.2.25
14	DUT repositioning	B.2.2.26
15	Influence of spherical coverage grid	B.2.2.29
Stage 1: Calibration measurement		
16	Mismatch	B.2.2.4
17	Amplifier Uncertainties	B.2.2.8
18	Misalignment of positioning System	B.2.2.13
19	Uncertainty of the Network Analyzer	B.2.2.14
20	Uncertainty of the absolute gain of the calibration antenna	B.2.2.15
21	Positioning and pointing misalignment between the reference antenna and the measurement antenna	B.2.2.16
22	Phase centre offset of calibration antenna	B.2.2.18
23	Quality of quiet zone for calibration process	B.2.2.19
24	Standing wave between reference calibration antenna and measurement antenna	B.2.2.20
25	Influence of the calibration antenna feed cable	B.2.2.21
26	Insertion Loss Variation	B.2.2.11
Systematic uncertainties		
27	Systematic error related to beam peak search	B.2.2.28
28	Systematic error related to EIS spherical coverage	B.2.2.30

The uncertainty assessment tables are organized as follows:

- For the purpose of uncertainty assessment, the radiating antenna aperture of the DUT is denoted as D
- The uncertainty assessment has been derived for the case of Quiet Zone size $\leq [30 \text{ cm}]$, $f = \{23.45\text{GHz}, 32.125\text{GHz}, 40.8\text{GHz}, 44.3\text{GHz}\}$, $[P = \text{maximum output power}]$.
- The uncertainty assessment for EIS is provided in Table B.19.2-2 for PC3 UEs and Table B.19.2-3 for PC1 UEs.

Table B.19.2-2: Uncertainty assessment for EIS measurement (f=23.45GHz, 32.125GHz, 40.8GHz, 44.3GHz, Quiet Zone size \leq 30 cm) for PC3 UEs and normal temperature condition

UID	Uncertainty source	Uncertainty value	Distribution of the probability	Divisor	Standard uncertainty (σ) [dB]
Stage 2: DUT measurement					
1	Positioning misalignment	0.00	Normal	2.00	0.00
2	Measure distance uncertainty	0.00	Rectangular	1.73	0.00
3	Quality of Quiet Zone (NOTE 7) (23.45GHz \leq f \leq 40.8GHz)	0.6	Actual	1.00	0.6
3	Quality of Quiet Zone (NOTE 7) (40.8GHz < f \leq 44.3GHz)	0.7	Actual	1.00	0.7
4	Mismatch (23.45GHz \leq f \leq 40.8GHz)	1.30	Actual	1.00	1.30
4	Mismatch (40.8GHz < f \leq 44.3GHz)	1.70	Actual	1.00	1.70
5	Standing wave between the DUT and measurement antenna	0.00	U-shaped	1.41	0.00
6	gNB uncertainty on absolute level (23.45GHz \leq f \leq 40.8GHz)	2.9	Normal	2.00	1.45
6	gNB uncertainty on absolute level (40.8GHz < f \leq 44.3GHz)	3.6	Normal	2.00	1.8
7	Phase curvature	0.00	U-shaped	1.41	0.00
8	Amplifier uncertainties	2.1	Normal	2.00	1.05
9	Random uncertainty	0.50	Normal	2.00	0.25
10	Influence of the XPD	0.01	U-shaped	1.41	0.00
11	Insertion Loss Variation	0.00	Rectangular	1.73	0.00
12	RF leakage (from measurement antenna to the receiver/transmitter)	0.00	Actual	1.00	0.00
13	Multiple measurement antenna uncertainty (NOTE 6)	0.15	Actual	1.00	0.15
14	DUT repositioning	0.00 (NOTE 4) 0.08 (NOTE 5)	Rectangular	1.73	0.00 (NOTE 4) 0.05 (NOTE 5)
15	Influence of spherical coverage grid (NOTE 4)	0.12	Actual	1	0.12
Stage 1: Calibration measurement					
16	Mismatch	0.00	U-shaped	1.41	0.00
17	Amplifier Uncertainties	0.00	Normal	2.00	0.00
18	Misalignment of positioning System	0.00	Normal	2.00	0.00
19	Uncertainty of the Network Analyzer (23.45GHz \leq f \leq 40.8GHz)	1.50	Normal	2.00	0.75
19	Uncertainty of the Network Analyzer (40.8GHz < f \leq 44.3GHz)	1.70	Normal	2.00	0.85
20	Uncertainty of the absolute gain of the calibration antenna	0.60	Normal	2.00	0.30
21	Positioning and pointing misalignment between the reference antenna and the measurement antenna	0.01	Rectangular	1.73	0.00
22	Phase centre offset of calibration antenna	0.00	Rectangular	1.73	0.00
23	Quality of quiet zone for calibration process (NOTE 7) (23.45GHz \leq f \leq 40.8GHz)	0.4	Actual	1.00	0.4
23	Quality of quiet zone for calibration process (NOTE 7) (40.8GHz < f \leq 44.3GHz)	0.5	Actual	1.00	0.5
24	Standing wave between reference calibration antenna and measurement antenna	0.00	U-shaped	1.41	0.00
25	Influence of the calibration antenna feed cable	0.14	Normal	2.00	0.07
26	Insertion Loss Variation	0.00	Rectangular	1.73	0.00

Systematic uncertainties (NOTE 3)		Value
27	Systematic error related to beam peak search (NOTE 5)	0.5
28	Systematic error related to EIS spherical coverage (NOTE 4)	DL power step size, 0.2
Total measurement uncertainty		Value
EIS Expanded uncertainty (23.45GHz <= f <= 40.8GHz) (1.96 σ - confidence interval of 95 %) [dB]		5.36
EIS Expanded uncertainty (40.8GHz < f <= 44.3GHz) (1.96 σ - confidence interval of 95 %) [dB]		6.34
EIS Spherical coverage Expanded uncertainty (23.45GHz <= f <= 40.8GHz) (1.96 σ - confidence interval of 95 %) [dB]		5.07
EIS Spherical coverage Expanded uncertainty (40.8GHz < f <= 44.3GHz) (1.96 σ - confidence interval of 95 %) [dB]		6.04
NOTE 1: The analysis was done only for the case of operating at max output power, in-band, non-CA.		
NOTE 2: Void.		
NOTE 3: In order to obtain the total measurement uncertainty, systematic uncertainties have to be added to the expanded root sum square of the standard deviations of the Stage 1 and Stage 2 contributors.		
NOTE 4: This contributor shall only be considered for spherical EIS measurements.		
NOTE 5: This contributor shall only be considered for EIS measurements.		
NOTE 6: Applies to the system which has a structure of mechanical feed antenna positioning.		
NOTE 7: Value based on procedure defined in clause D.2 of TR 38.810 for Quiet Zone size less or equal to 30 cm.		

Table B.19.2-3: Uncertainty assessment for EIS measurement (f=23.45GHz, 32.125GHz, 40.8GHz, Quiet Zone size \leq 30 cm) for PC1 and PC5 UEs and normal temperature condition

UID	Uncertainty source	Uncertainty value	Distribution of the probability	Divisor	Standard uncertainty (σ) [dB]
Stage 2: DUT measurement					
1	Positioning misalignment	0.02	Normal	2.00	0.01
2	Measure distance uncertainty	0.00	Rectangular	1.73	0.00
3	Quality of Quiet Zone (NOTE 7)	0.6	Actual	1.00	0.6
4	Mismatch	1.30	Actual	1.00	1.30
5	Standing wave between the DUT and measurement antenna	0.00	U-shaped	1.41	0.00
6	gNB uncertainty on absolute level	2.9	Normal	2.00	1.45
7	Phase curvature	0.00	U-shaped	1.41	0.00
8	Amplifier uncertainties	2.1	Normal	2.00	1.05
9	Random uncertainty	0.50	Normal	2.00	0.25
10	Influence of the XPD	0.01	U-shaped	1.41	0.00
11	Insertion Loss Variation	0.00	Rectangular	1.73	0.00
12	RF leakage (from measurement antenna to the receiver/transmitter)	0.00	Actual	1.00	0.00
13	Multiple measurement antenna uncertainty (NOTE 6)	0.15	Actual	1.00	0.15
14	DUT repositioning	0.00 (NOTE 4) 0.35 (NOTE 5)	Rectangular	1.73	0.00 (NOTE 4) 0.20 (NOTE 5)
15	Influence of spherical coverage grid (NOTE 4)	0.13	Actual	1	0.13
Stage 1: Calibration measurement					
16	Mismatch	0.00	U-shaped	1.41	0.00
17	Amplifier Uncertainties	0.00	Normal	2.00	0.00
18	Misalignment of positioning System	0.00	Normal	2.00	0.00
19	Uncertainty of the Network Analyzer	1.50	Normal	2.00	0.75
20	Uncertainty of the absolute gain of the calibration antenna	0.60	Normal	2.00	0.30
21	Positioning and pointing misalignment between the reference antenna and the measurement antenna	0.01	Rectangular	1.73	0.00
22	Phase centre offset of calibration antenna	0.00	Rectangular	1.73	0.00
23	Quality of quiet zone for calibration process (NOTE 7)	0.4	Actual	1.00	0.4
24	Standing wave between reference calibration antenna and measurement antenna	0.00	U-shaped	1.41	0.00
25	Influence of the calibration antenna feed cable	0.14	Normal	2.00	0.07
26	Insertion Loss Variation	0.00	Rectangular	1.73	0.00
Systematic uncertainties (NOTE 3)					Value
27	Systematic error related to beam peak search (NOTE 5)				0.7
28	Systematic error related to EIS spherical coverage (NOTE 4)				DL power step size, 0.2
Total measurement uncertainty					Value
EIS Expanded uncertainty (1.96 σ - confidence interval of 95 %) [dB]					5.58
EIS Spherical coverage Expanded uncertainty (1.96 σ - confidence interval of 95 %) [dB]					5.07
NOTE 1: The analysis was done only for the case of operating at max output power, in-band, non-CA.					
NOTE 2: Void.					
NOTE 3: In order to obtain the total measurement uncertainty, systematic uncertainties have to be added to the expanded root sum square of the standard deviations of the Stage 1 and Stage 2 contributors.					
NOTE 4: This contributor shall only be considered for spherical EIS measurements.					
NOTE 5: This contributor shall only be considered for EIS measurements.					
NOTE 6: Applies to the system which has a structure of mechanical feed antenna positioning.					
NOTE 7: Value based on procedure defined in clause D.2 of TR 38.810 for Quiet Zone size less or equal to 30 cm.					

Table B.19.2-4: Uncertainty assessment for EIS measurement (f=23.45GHz, 32.125GHz, 40.8GHz, 44.3GHz, Quiet Zone size \leq 30 cm) for PC3 UEs and extreme temperature condition

UID	Uncertainty source	Uncertainty value	Distribution of the probability	Divisor	Standard uncertainty (σ) [dB]
Stage 2: DUT measurement					
1	Positioning misalignment	0.00	Normal	2.00	0.00
2	Measure distance uncertainty	0.00	Rectangular	1.73	0.00
3	Quality of Quiet Zone (NOTE 7)	0.9	Actual	1.00	0.9
4	Mismatch (23.45GHz \leq f \leq 40.8GHz)	1.30	Actual	1.00	1.30
4	Mismatch (40.8GHz < f \leq 44.3GHz)	1.70	Actual	1.00	1.70
5	Standing wave between the DUT and measurement antenna	0.00	U-shaped	1.41	0.00
6	gNB uncertainty on absolute level (23.45GHz \leq f \leq 40.8GHz)	2.9	Normal	2.00	1.45
6	gNB uncertainty on absolute level (40.8GHz < f \leq 44.3GHz)	3.6	Normal	2.00	1.8
7	Phase curvature	0.00	U-shaped	1.41	0.00
8	Amplifier uncertainties	2.1	Normal	2.00	1.05
9	Random uncertainty	0.50	Normal	2.00	0.25
10	Influence of the XPD	0.01	U-shaped	1.41	0.00
11	Insertion Loss Variation	0.00	Rectangular	1.73	0.00
12	RF leakage (from measurement antenna to the receiver/transmitter)	0.00	Actual	1.00	0.00
13	Multiple measurement antenna uncertainty (NOTE 6)	0.15	Actual	1.00	0.15
14	DUT repositioning	0.00 (NOTE 4) 0.08 (NOTE 5)	Rectangular	1.73	0.00 (NOTE 4) 0.05 (NOTE 5)
15	Influence of spherical coverage grid (NOTE 4)	0.12	Actual	1	0.12
Stage 1: Calibration measurement					
16	Mismatch	0.00	U-shaped	1.41	0.00
17	Amplifier Uncertainties	0.00	Normal	2.00	0.00
18	Misalignment of positioning System	0.00	Normal	2.00	0.00
19	Uncertainty of the Network Analyzer (23.45GHz \leq f \leq 40.8GHz)	1.50	Normal	2.00	0.75
19	Uncertainty of the Network Analyzer (40.8GHz < f \leq 44.3GHz)	1.70	Normal	2.00	0.85
20	Uncertainty of the absolute gain of the calibration antenna	0.60	Normal	2.00	0.30
21	Positioning and pointing misalignment between the reference antenna and the measurement antenna	0.01	Rectangular	1.73	0.00
22	Phase centre offset of calibration antenna	0.00	Rectangular	1.73	0.00
23	Quality of quiet zone for calibration process (NOTE 7)	0.6	Actual	1.00	0.6
24	Standing wave between reference calibration antenna and measurement antenna	0.00	U-shaped	1.41	0.00
25	Influence of the calibration antenna feed cable	0.14	Normal	2.00	0.07
26	Insertion Loss Variation	0.00	Rectangular	1.73	0.00
Systematic uncertainties (NOTE 3)					Value
27	Systematic error related to beam peak search (NOTE 5)				0.5
28	Systematic error related to EIS spherical coverage (NOTE 4)				DL power step size, 0.2
Total measurement uncertainty					Value
EIS Expanded uncertainty (23.45GHz \leq f \leq 40.8GHz) (1.96 σ - confidence interval of 95 %) [dB]					5.61

EIS Expanded uncertainty (40.8GHz < f <= 44.3GHz) (1.96 σ - confidence interval of 95%) [dB]	6.48
NOTE 1: The analysis was done only for the case of operating at max output power, in-band, non-CA.	
NOTE 2: Void.	
NOTE 3: In order to obtain the total measurement uncertainty, systematic uncertainties have to be added to the expanded root sum square of the standard deviations of the Stage 1 and Stage 2 contributors.	
NOTE 4: This contributor shall only be considered for spherical EIS measurements.	
NOTE 5: This contributor shall only be considered for EIS measurements.	
NOTE 6: Applies to the system which has a structure of mechanical feed antenna positioning.	
NOTE 7: Value based on procedure defined in clause D.2 of TR 38.810 for Quiet Zone size less or equal to 30 cm. The ETC QoQZ MU and ETC calibration path losses shall be applied to the NTC test cases if the ETC environment is used for NTC test cases.	

Table B.19.2-5: Uncertainty assessment for EIS measurement (f=23.45GHz, 32.125GHz, 40.8GHz, Quiet Zone size \leq 30 cm) for PC1 and PC5 UEs and extreme temperature condition

UID	Uncertainty source	Uncertainty value	Distribution of the probability	Divisor	Standard uncertainty (σ) [dB]
Stage 2: DUT measurement					
1	Positioning misalignment	0.02	Normal	2.00	0.01
2	Measure distance uncertainty	0.00	Rectangular	1.73	0.00
3	Quality of Quiet Zone (NOTE 7)	0.90	Actual	1.00	0.90
4	Mismatch	1.30	Actual	1.00	1.30
5	Standing wave between the DUT and measurement antenna	0.00	U-shaped	1.41	0.00
6	gNB uncertainty on absolute level	2.90	Normal	2.00	1.45
7	Phase curvature	0.00	U-shaped	1.41	0.00
8	Amplifier uncertainties	2.10	Normal	2.00	1.05
9	Random uncertainty	0.50	Normal	2.00	0.25
10	Influence of the XPD	0.01	U-shaped	1.41	0.00
11	Insertion Loss Variation	0.00	Rectangular	1.73	0.00
12	RF leakage (from measurement antenna to the receiver/transmitter)	0.00	Actual	1.00	0.00
13	Multiple measurement antenna uncertainty (NOTE 6)	0.15	Actual	1.00	0.15
14	DUT repositioning	0.00 (NOTE 4) 0.35(NOTE 5)	Rectangular	1.73	0.00 (NOTE 4) 0.20 (NOTE 5)
15	Influence of spherical coverage grid (NOTE 4)	0.13	Actual	1	0.13
Stage 1: Calibration measurement					
16	Mismatch	0.00	U-shaped	1.41	0.00
17	Amplifier Uncertainties	0.00	Normal	2.00	0.00
18	Misalignment of positioning System	0.00	Normal	2.00	0.00
19	Uncertainty of the Network Analyzer	1.50	Normal	2.00	0.75
20	Uncertainty of the absolute gain of the calibration antenna	0.60	Normal	2.00	0.30
21	Positioning and pointing misalignment between the reference antenna and the measurement antenna	0.01	Rectangular	1.73	0.00
22	Phase centre offset of calibration antenna	0.00	Rectangular	1.73	0.00
23	Quality of quiet zone for calibration process (NOTE 7)	0.60	Actual	1.00	0.60
24	Standing wave between reference calibration antenna and measurement antenna	0.00	U-shaped	1.41	0.00
25	Influence of the calibration antenna feed cable	0.14	Normal	2.00	0.07
26	Insertion Loss Variation	0.00	Rectangular	1.73	0.00
Systematic uncertainties (NOTE 3)					Value
27	Systematic error related to beam peak search (NOTE 5)				0.7
28	Systematic error related to EIS spherical coverage (NOTE 4)				DL power step size, 0.2
Total measurement uncertainty					Value
EIS Expanded uncertainty (1.96 σ - confidence interval of 95 %) [dB]					5.83
NOTE 1: The analysis was done only for the case of operating at max output power, in-band, non-CA.					
NOTE 2: Void.					
NOTE 3: In order to obtain the total measurement uncertainty, systematic uncertainties have to be added to the expanded root sum square of the standard deviations of the Stage 1 and Stage 2 contributors.					
NOTE 4: This contributor shall only be considered for spherical EIS measurements.					
NOTE 5: This contributor shall only be considered for EIS measurements.					
NOTE 6: Applies to the system which has a structure of mechanical feed antenna positioning.					
NOTE 7: Value based on procedure defined in clause D.2 of TR 38.810 for Quiet Zone size less or equal to 30 cm. The ETC QoQZ MU and ETC calibration path losses shall be applied to the NTC test cases if the ETC environment is used for NTC test cases.					

B.20

B.21 Adjacent Channel Selectivity

Following tables summarize the MU threshold for Adjacent Channel Selectivity measurement. The origin MU values for different test setups with varies parameters can be found in following subclauses.

Table B.21-1: MU threshold for Adjacent Channel Selectivity

Power Class	Frequency	MBW	Power	Threshold MU value (NOTE 1)
PC3	23.45GHz <= f <= 32.125GHz	BW <= 400MHz	P = Max Output Power	8.08
	32.125GHz < f <= 40.8GHz			8.08
	40.8GHz < f <= 44.3GHz			[9.46]
PC1	23.45GHz <= f <= 32.125GHz	BW <= 400MHz	P = Max Output Power	8.31
	32.125GHz < f <= 40.8GHz			8.31
PC5	23.45GHz <= f <= 32.125GHz	BW <= 400MHz	P = Max Output Power	8.31

NOTE 1: Total Expanded MU for IFF for Quiet Zone size ≤ 30cm in Table B.21.2-2 for PC3 UEs and Table B.21.2-3 for PC1 UEs.

B.21.1 Uncertainty budget format and assessment for DFF

FFS

B.21.2 Uncertainty budget format and assessment for IFF

The uncertainty contributions that may impact the overall MU value are listed in Table B.21.2-1.

Table B.21.2-1: Total Uncertainty contributions for Adjacent Channel Selectivity measurement

UID	Description of uncertainty contribution	Details in clause
Stage 2: DUT measurement (Wanted Signal contributions)		
1	Positioning misalignment	B.2.2.1
2	Measure distance uncertainty	B.2.2.2
3	Quality of Quiet Zone	B.2.2.3
4	Mismatch	B.2.2.4
5	Standing wave between the DUT and measurement antenna	B.2.2.5
6	gNB emulator uncertainty	B.2.2.17
7	Phase curvature	B.2.2.7
8	Amplifier uncertainties	B.2.2.8
9	Random uncertainty	B.2.2.9
10	Influence of the XPD	B.2.2.10
11	Insertion Loss Variation	B.2.2.11
12	RF leakage (from measurement antenna to the receiver/transmitter)	B.2.2.12
13	Multiple measurement antenna uncertainty	B.2.2.25
14	DUT repositioning	B.2.2.26
Stage 2: DUT measurement (Modulated Interferer Signal specific contributions)		
15	Positioning misalignment	B.2.2.1
16	Measure distance uncertainty	B.2.2.2
17	Quality of Quiet Zone	B.2.2.3
18	Mismatch	B.2.2.4
19	Standing wave between the DUT and measurement antenna	B.2.2.5
20	Modulated Interferer uncertainty	B.2.2.33
21	Phase curvature	B.2.2.7
22	Amplifier uncertainties	B.2.2.8
23	Random uncertainty	B.2.2.9
24	Influence of the XPD	B.2.2.10
25	Insertion Loss Variation	B.2.2.11
26	RF leakage (from measurement antenna to the receiver/transmitter)	B.2.2.12
27	Multiple measurement antenna uncertainty	B.2.2.25
28	DUT repositioning	B.2.2.26
29	Influence of offset antenna (Std.Dev)	B.2.2.35
Stage 1: Calibration measurement (Wanted Signal contributions)		
30	Mismatch	B.2.2.4
31	Amplifier Uncertainties	B.2.2.8
32	Misalignment of positioning System	B.2.2.13
33	Uncertainty of the Network Analyzer	B.2.2.14
34	Uncertainty of the absolute gain of the calibration antenna	B.2.2.15
35	Positioning and pointing misalignment between the reference antenna and the measurement antenna	B.2.2.16
36	Phase centre offset of calibration antenna	B.2.2.18
37	Quality of quiet zone for calibration process	B.2.2.19
38	Standing wave between reference calibration antenna and measurement antenna	B.2.2.20
39	Influence of the calibration antenna feed cable	B.2.2.21
40	Insertion Loss Variation	B.2.2.11
Stage 1: Calibration measurement (Modulated Interferer Signal contributions)		
41	Mismatch	B.2.2.4
42	Amplifier Uncertainties	B.2.2.8
43	Misalignment of positioning System	B.2.2.13
44	Uncertainty of the Network Analyzer	B.2.2.14
45	Uncertainty of the absolute gain of the calibration antenna	B.2.2.15
46	Positioning and pointing misalignment between the reference antenna and the measurement antenna	B.2.2.16
47	Phase centre offset of calibration antenna	B.2.2.18
48	Quality of quiet zone for calibration process	B.2.2.19
48	Standing wave between reference calibration antenna and measurement antenna	B.2.2.20
50	Influence of the calibration antenna feed cable	B.2.2.21
51	Insertion Loss Variation	B.2.2.11
Systematic uncertainties		
52	Systematic error related to beam peak search	B.2.2.28
53	Additional impact of interferer ACLR	B.2.2.32

54	Influence of offset antenna (mean error)	B.2.2.35
----	--	----------

The uncertainty assessment tables are organized as follows:

- For the purpose of uncertainty assessment, the radiating antenna aperture of the DUT is denoted as D
- The uncertainty assessment has been derived for the case of Quiet Zone size $\leq [30 \text{ cm}]$, $f = \{23.45\text{GHz}, 32.125\text{GHz}, 40.8\text{GHz}, 44.3\text{GHz}\}$, [$P = \text{maximum output power}$].
- The uncertainty assessment for ACS is provided in Table B.21.2-2 for PC3 UEs and Table B.21.2-3 for PC1 and PC5 UEs.

Table B.21.2-2: Uncertainty assessment for Adjacent Channel Selectivity measurement (f=23.45GHz, 32.125GHz, 40.8GHz, 44.3GHz, Quiet Zone size \leq 30 cm) for PC3 UEs

UID	Uncertainty source	Uncertainty value	Distribution of the probability	Divisor	Standard uncertainty (σ) [dB]
Stage 2: DUT measurement (Wanted Signal contributions)					
1	Positioning misalignment	0.00	Normal	2.00	0.00
2	Measure distance uncertainty	0.00	Rectangular	1.73	0.00
3	Quality of Quiet Zone (NOTE 4) (23.45GHz \leq f \leq 40.8GHz)	0.6	Actual	1.00	0.6
3	Quality of Quiet Zone (NOTE 4) (40.8GHz < f \leq 44.3GHz)	0.7	Actual	1.00	0.7
4	Mismatch (23.45GHz \leq f \leq 40.8GHz)	1.30	Actual	1.00	1.30
4	Mismatch (40.8GHz < f \leq 44.3GHz)	1.70	Actual	1.00	1.70
5	Standing wave between the DUT and measurement antenna	0.00	U-shaped	1.41	0.00
6	gNB uncertainty on absolute level (23.45GHz \leq f \leq 40.8GHz)	2.9	Normal	2.00	1.45
6	gNB uncertainty on absolute level (40.8GHz < f \leq 44.3GHz)	3.6	Normal	2.00	1.8
7	Phase curvature	0.00	U-shaped	1.41	0.00
8	Amplifier uncertainties	2.1	Normal	2.00	1.05
9	Random uncertainty	0.50	Normal	2.00	0.25
10	Influence of the XPD	0.01	U-shaped	1.41	0.00
11	Insertion Loss Variation	0.00	Rectangular	1.73	0.00
12	RF leakage (from measurement antenna to the receiver/transmitter)	0.00	Actual	1.00	0.00
13	Multiple measurement antenna uncertainty (NOTE 3)	0.15	Actual	1.00	0.15
14	DUT repositioning	0.08	Rectangular	1.73	0.05
Stage 2: DUT measurement (Modulated Interferer Signal specific contributions)					
15	Positioning misalignment	0.00	Normal	2.00	0.00
16	Measure distance uncertainty	0.00	Rectangular	1.73	0.00
17	Quality of Quiet Zone (NOTE 4) (23.45GHz \leq f \leq 40.8GHz)	0.6	Actual	1.00	0.6
17	Quality of Quiet Zone (NOTE 4) (40.8GHz < f \leq 44.3GHz)	0.7	Actual	1.00	0.7
18	Mismatch (23.45GHz \leq f \leq 40.8GHz)	1.30	Actual	1.00	1.30
18	Mismatch (40.8GHz < f \leq 44.3GHz)	1.70	Actual	1.00	1.70
19	Standing wave between the DUT and measurement antenna	0.00	U-shaped	1.41	0.00
20	Modulated Interferer uncertainty on absolute level (23.45GHz \leq f \leq 40.8GHz)	2.9	Normal	2.00	1.45
20	Modulated Interferer uncertainty on absolute level (40.8GHz < f \leq 44.3GHz)	3.6	Normal	2.00	1.8
21	Phase curvature	0.00	U-shaped	1.41	0.00
22	Amplifier uncertainties	2.1	Normal	2.00	1.05
23	Random uncertainty	0.50	Normal	2.00	0.25
24	Influence of the XPD	0.01	U-shaped	1.41	0.00
25	Insertion Loss Variation	0.00	Rectangular	1.73	0.00
26	RF leakage (from measurement antenna to the receiver/transmitter)	0.00	Actual	1.00	0.00
27	Multiple measurement antenna uncertainty (NOTE 3)	0.15	Actual	1.00	0.15
28	DUT repositioning	0.08	Rectangular	1.73	0.05
29	Influence of offset antenna (Std.Dev) (NOTE 5)	0.00	Normal	2.00	0.00
Stage 1: Calibration measurement (Wanted Signal contributions)					
30	Mismatch	0.00	U-shaped	1.41	0.00
31	Amplifier Uncertainties	0.00	Normal	2.00	0.00

32	Misalignment of positioning System	0.00	Normal	2.00	0.00
33	Uncertainty of the Network Analyzer (23.45GHz ≤ f ≤ 40.8GHz)	1.50	Normal	2.00	0.75
33	Uncertainty of the Network Analyzer (40.8GHz < f ≤ 44.3GHz)	1.70	Normal	2.00	0.85
34	Uncertainty of the absolute gain of the calibration antenna	0.60	Normal	2.00	0.30
35	Positioning and pointing misalignment between the reference antenna and the measurement antenna	0.01	Rectangular	1.73	0.00
36	Phase centre offset of calibration antenna	0.00	Rectangular	1.73	0.00
37	Quality of quiet zone for calibration process (NOTE 4) (23.45GHz ≤ f ≤ 40.8GHz)	0.4	Actual	1.00	0.4
37	Quality of quiet zone for calibration process (NOTE 4) (40.8GHz < f ≤ 44.3GHz)	0.5	Actual	1.00	0.5
38	Standing wave between reference calibration antenna and measurement antenna	0.00	U-shaped	1.41	0.00
39	Influence of the calibration antenna feed cable	0.14	Normal	2.00	0.07
40	Insertion Loss Variation	0.00	Rectangular	1.73	0.00
Stage 1: Calibration measurement (Modulated Interferer Signal contributions)					
41	Mismatch	0.00	U-shaped	1.41	0.00
42	Amplifier Uncertainties	0.00	Normal	2.00	0.00
43	Misalignment of positioning System	0.00	Normal	2.00	0.00
44	Uncertainty of the Network Analyzer (23.45GHz ≤ f ≤ 40.8GHz)	1.50	Normal	2.00	0.75
44	Uncertainty of the Network Analyzer (40.8GHz < f ≤ 44.3GHz)	1.70	Normal	2.00	0.85
45	Uncertainty of the absolute gain of the calibration antenna	0.60	Normal	2.00	0.30
46	Positioning and pointing misalignment between the reference antenna and the measurement antenna	0.01	Rectangular	1.73	0.00
47	Phase centre offset of calibration antenna	0.00	Rectangular	1.73	0.00
48	Quality of quiet zone for calibration process (NOTE 4) (23.45GHz ≤ f ≤ 40.8GHz)	0.4	Actual	1.00	0.4
48	Quality of quiet zone for calibration process (NOTE 4) (40.8GHz < f ≤ 44.3GHz)	0.5	Actual	1.00	0.5
48	Standing wave between reference calibration antenna and measurement antenna	0.00	U-shaped	1.41	0.00
50	Influence of the calibration antenna feed cable	0.14	Normal	2.00	0.07
51	Insertion Loss Variation	0.00	Rectangular	1.73	0.00
Systematic uncertainties (NOTE 2)					Value
52	Systematic error related to beam peak search				0.5
53	Additional impact of interferer ACLR				0.7
54	Influence of offset antenna (mean error) (NOTE 5)				0.00
Total measurement uncertainty					Value
ACS Expanded uncertainty (23.45GHz ≤ f ≤ 40.8GHz) (1.96σ - confidence interval of 95 %) [dB]					8.08

ACS Expanded uncertainty (40.8GHz < f <= 44.3GHz) (1.96 σ - confidence interval of 95 %) [dB]	[9.46]
NOTE 1: The analysis was done only for the case of operating at max output power, in-band, non-CA.	
NOTE 2: In order to obtain the total measurement uncertainty, systematic uncertainties have to be added to the expanded root sum square of the standard deviations of the Stage 1 and Stage 2 contributors.	
NOTE 3: Applies to the system which has a structure of mechanical feed antenna positioning.	
NOTE 4: Value based on procedure defined in clause D.2 of TR 38.810 for Quiet Zone size less or equal to 30 cm.	
NOTE 5: For MTSU derivation purpose, this value is set to 0.0 (no offset antenna case).	

Table B.21.2-3: Uncertainty assessment for Adjacent Channel Selectivity measurement (f=23.45GHz, 32.125GHz, 40.8GHz, Quiet Zone size \leq 30 cm) for PC1 and PC5 UEs

UID	Uncertainty source	Uncertainty value	Distribution of the probability	Divisor	Standard uncertainty (σ) [dB]
Stage 2: DUT measurement (Wanted Signal contributions)					
1	Positioning misalignment	0.02	Normal	2.00	0.01
2	Measure distance uncertainty	0.00	Rectangular	1.73	0.00
3	Quality of Quiet Zone (NOTE 4)	0.6	Actual	1.00	0.6
4	Mismatch	1.30	Actual	1.00	1.30
5	Standing wave between the DUT and measurement antenna	0.00	U-shaped	1.41	0.00
6	gNB uncertainty on absolute level	2.9	Normal	2.00	1.45
7	Phase curvature	0.00	U-shaped	1.41	0.00
8	Amplifier uncertainties	2.1	Normal	2.00	1.05
9	Random uncertainty	0.50	Normal	2.00	0.25
10	Influence of the XPD	0.01	U-shaped	1.41	0.00
11	Insertion Loss Variation	0.00	Rectangular	1.73	0.00
12	RF leakage (from measurement antenna to the receiver/transmitter)	0.00	Actual	1.00	0.00
13	Multiple measurement antenna uncertainty (NOTE 3)	0.15	Actual	1.00	0.15
14	DUT repositioning	0.35	Rectangular	1.73	0.20
Stage 2: DUT measurement (Modulated Interferer Signal specific contributions)					
15	Positioning misalignment	0.02	Normal	2.00	0.01
16	Measure distance uncertainty	0.00	Rectangular	1.73	0.00
17	Quality of Quiet Zone (NOTE 4)	0.6	Actual	1.00	0.6
18	Mismatch	1.30	Actual	1.00	1.30
19	Standing wave between the DUT and measurement antenna	0.00	U-shaped	1.41	0.00
20	Modulated Interferer uncertainty on absolute level	2.9	Normal	2.00	1.45
21	Phase curvature	0.00	U-shaped	1.41	0.00
22	Amplifier uncertainties	2.1	Normal	2.00	1.05
23	Random uncertainty	0.50	Normal	2.00	0.25
24	Influence of the XPD	0.01	U-shaped	1.41	0.00
25	Insertion Loss Variation	0.00	Rectangular	1.73	0.00
26	RF leakage (from measurement antenna to the receiver/transmitter)	0.00	Actual	1.00	0.00
27	Multiple measurement antenna uncertainty (NOTE 3)	0.15	Actual	1.00	0.15
28	DUT repositioning	0.35	Rectangular	1.73	0.20
29	Influence of offset antenna (Std.Dev) (NOTE 5)	0.00	Normal	2.00	0.00
Stage 1: Calibration measurement (Wanted Signal contributions)					
30	Mismatch	0.00	U-shaped	1.41	0.00
31	Amplifier Uncertainties	0.00	Normal	2.00	0.00
32	Misalignment of positioning System	0.00	Normal	2.00	0.00
33	Uncertainty of the Network Analyzer	1.50	Normal	2.00	0.75
34	Uncertainty of the absolute gain of the calibration antenna	0.60	Normal	2.00	0.30
35	Positioning and pointing misalignment between the reference antenna and the measurement antenna	0.01	Rectangular	1.73	0.00
36	Phase centre offset of calibration antenna	0.00	Rectangular	1.73	0.00
37	Quality of quiet zone for calibration process (NOTE 4)	0.4	Actual	1.00	0.4
38	Standing wave between reference calibration antenna and measurement antenna	0.00	U-shaped	1.41	0.00
39	Influence of the calibration antenna feed cable	0.14	Normal	2.00	0.07
40	Insertion Loss Variation	0.00	Rectangular	1.73	0.00

Stage 1: Calibration measurement (Modulated Interferer Signal contributions)					
41	Mismatch	0.00	U-shaped	1.41	0.00
42	Amplifier Uncertainties	0.00	Normal	2.00	0.00
43	Misalignment of positioning System	0.00	Normal	2.00	0.00
44	Uncertainty of the Network Analyzer	1.50	Normal	2.00	0.75
45	Uncertainty of the absolute gain of the calibration antenna	0.60	Normal	2.00	0.30
46	Positioning and pointing misalignment between the reference antenna and the measurement antenna	0.01	Rectangular	1.73	0.00
47	Phase centre offset of calibration antenna	0.00	Rectangular	1.73	0.00
48	Quality of quiet zone for calibration process (NOTE 4)	0.4	Actual	1.00	0.4
48	Standing wave between reference calibration antenna and measurement antenna	0.00	U-shaped	1.41	0.00
50	Influence of the calibration antenna feed cable	0.14	Normal	2.00	0.07
51	Insertion Loss Variation	0.00	Rectangular	1.73	0.00
Systematic uncertainties (NOTE 2)					Value
52	Systematic error related to beam peak search				0.7
53	Additional impact of interferer ACLR				0.7
54	Influence of offset antenna (mean error) (NOTE 5)				0.00
Total measurement uncertainty					Value
ACS Expanded uncertainty (1.96 σ - confidence interval of 95 %) [dB] (23.45GHz <= f <= 32.125GHz)					8.31
ACS Expanded uncertainty (1.96 σ - confidence interval of 95 %) [dB] (32.125GHz < f <= 40.8GHz)					8.31
NOTE 1: The analysis was done only for the case of operating at max output power, in-band, non-CA.					
NOTE 2: In order to obtain the total measurement uncertainty, systematic uncertainties have to be added to the expanded root sum square of the standard deviations of the Stage 1 and Stage 2 contributors.					
NOTE 3: Applies to the system which has a structure of mechanical feed antenna positioning.					
NOTE 4: Value based on procedure defined in clause D.2 of TR 38.810 for Quiet Zone size less or equal to 30 cm.					
NOTE 5: For MTSU derivation purpose, this value is set to 0.0 (no offset antenna case).					

B.22 In-Band Blocking

See B.21.

B.22.1 Uncertainty budget format and assessment for DFF

See B.21.1.

B.22.2 Uncertainty budget format and assessment for IFF

See B.21.2.

B.23

B.24

B.25 Receiver spurious emissions

Editor’s Note:

- MU value analysis and offset value analysis for PC1, 2 and 4 are not complete.
- MU value analysis for various test setups in subsection B.25.x is not complete for above 87 GHz for PC3
- Offset value analysis is not complete as it is derived from MU value analysis for above 87 GHz for PC3

Test procedure of general spurious emission comprises 2 stages: coarse TRP measurement and fine TRP measurement BW. Coarse TRP measurement is introduced to reduce the measurement time by applying sparser grids and/or wider measurement BW than fine TRP measurement while having offset dB more stringent test requirement in order not to cause additional misjudgement risk. For the frequency ranges for which coarse TRP measurement does not PASS, the measurement is continued with fine TRP measurement procedure.

Table B.25-1 summarizes the MU threshold for fine TRP measurements for General spurious emissions. The origin MU values for fine TRP measurement for different test setups can be found in following subclasses.

Table B.25-1: MU threshold for TRP measurement for Rx spurious emission

Power Class	Frequency	In-band BW	In-band Power (NOTE2)	Threshold MU value [dB] (NOTE1)
PC3	6 GHz ≤ f ≤ 12.75 GHz	BW ≤ 400MHz	P = Max Output Power	5.64
	12.75 GHz ≤ f ≤ 23.45 GHz			5.60
	23.45 GHz ≤ f ≤ 40.8 GHz			6.11
	40.8 GHz ≤ f ≤ 66 GHz			7.65
	66 GHz ≤ f ≤ 80 GHz			7.95
	80 GHz < f ≤ 87 GHz			8.31
PC1	6 GHz ≤ f ≤ 12.75 GHz	BW ≤ 400MHz	P = Max Output Power	5.63
	12.75 GHz ≤ f ≤ 23.45 GHz			5.59
	23.45 GHz ≤ f ≤ 40.8 GHz			6.10
	40.8 GHz ≤ f ≤ 66 GHz			7.64
	66 GHz ≤ f ≤ 80 GHz			7.95
NOTE 1: Total EIRP Expanded MU for IFF for Quiet Zone size ≤ 30cm in Table B.25.2-3 to Table B.25.2-11 for PC3 UEs and in Table B.25.2-12 to Table B.25.2-16 for PC1 UEs.				

Table B.25-2 provides valid coarse TRP measurement grids and corresponding offset dB value that may be used for UE general spurious emission test case. The offset value is derived as 95%-tile TRP measurement uncertainty including the effect from uncertainty due to Coarse TRP measurement grid, excluding influence of noise.

Table B.25-2: Coarse TRP measurement grids and offset values for UE Rx spurious emission

Power Class	Coarse TRP measurement grid	Frequency	Min Number of measurement points on the grid	Influence of coarse TRP measurement grid (dB)	Systematic error due to coarse TRP calculation/quadrature (dB)	Offset value (dB)
PC3	Constant density grid (charged particle based)	6 GHz ≤ f ≤ 12.75 GHz	35	0.94	0.09	5.38
		12.75 GHz ≤ f ≤ 23.45 GHz				5.35
		23.45 GHz ≤ f ≤ 40.8 GHz				5.49
		40.8 GHz ≤ f ≤ 66 GHz				7.31
		66 GHz ≤ f ≤ 87 GHz				7.61
	Constant step size grid	6 GHz ≤ f ≤ 12.75 GHz	62	0.97	0.2	5.51
		12.75 GHz ≤ f ≤ 23.45 GHz				5.48
		23.45 GHz ≤ f ≤ 40.8 GHz				5.62
		40.8 GHz ≤ f ≤ 66 GHz				7.43
		66 GHz ≤ f ≤ 87 GHz				7.73
PC1	Constant density grid (charged particle based)	6 GHz ≤ f ≤ 12.75 GHz	FFS	FFS	FFS	FFS
		12.75 GHz ≤ f ≤ 23.45 GHz				FFS
		23.45 GHz ≤ f ≤ 40.8 GHz				FFS
		40.8 GHz ≤ f ≤ 66 GHz				FFS
		66 GHz ≤ f ≤ 80 GHz				FFS
	Constant step size grid	6 GHz ≤ f ≤ 12.75 GHz	FFS	FFS	FFS	FFS
		12.75 GHz ≤ f ≤ 23.45 GHz				FFS
		23.45 GHz ≤ f ≤ 40.8 GHz				FFS
		40.8 GHz ≤ f ≤ 66 GHz				FFS
		66 GHz ≤ f ≤ 80 GHz				FFS

NOTE 1: Based on Total TRP Expanded MU for IFF for Quiet Zone size ≤ 30cm in Table B.25.2-3 to Table B.25.2-11, replacing “Influence of TRP measurement grid” and “Systematic error due to TRP calculation/quadrature” by the values for coarse TRP grid, and excluding “Influence of noise”.

B.25.1 Uncertainty budget format and assessment for DFF

The uncertainty contributions that may impact the overall MU value are listed in Table B.25.1-1.

Table B.25.1-1: Uncertainty contributions for TRP measurement

UID	Description of uncertainty contribution	Details in annex
Stage 2: DUT measurement		
1	Positioning misalignment	B.2.1.1
2	Measure distance uncertainty	B.2.1.2
3	Quality of quiet zone	B.2.1.3
4	Mismatch	B.2.1.4
5	Standing Wave Between the DUT and measurement antenna	B.2.1.5
6	Uncertainty of the RF power measurement equipment	B.2.1.6
7	Phase curvature	B.2.1.7
8	Amplifier uncertainties	B.2.1.8
9	Random uncertainty	B.2.1.9
10	Influence of the XPD	B.2.1.10
11	Insertion Loss Variation	B.2.1.11
12	RF leakage (from measurement antenna to the receiver/transmitter)	B.2.1.12
13	Influence of TRP measurement grid	B.2.1.22
14	Influence of beam peak search grid	B.2.1.23
15	Multiple measurement antenna uncertainty	B.2.1.25
16	DUT repositioning	B.2.1.26
Stage 1: Calibration measurement		
17	Mismatch	B.2.1.4
18	Amplifier uncertainties	B.2.1.8
19	Misalignment of positioning System	B.2.1.13
20	Uncertainty of the Network Analyzer	B.2.1.14
21	Uncertainty of the absolute gain of the calibration antenna	B.2.1.15
22	Positioning and pointing misalignment between the reference antenna and the measurement antenna	B.2.1.16
23	Phase centre offset of calibration antenna	B.2.1.18
24	Quality of quiet zone for calibration process	B.2.1.19
25	Standing wave between reference calibration antenna and measurement antenna	B.2.1.20
26	Influence of the calibration antenna feed cable	B.2.1.21
27	Insertion Loss Variation	B.2.1.11
Systematic uncertainties		
28	Systematic error due to TRP calculation/quadrature	B.2.1.24
29	Influence of noise	B.2.1.27

The uncertainty assessment tables are organized as follows:

- For the purpose of uncertainty assessment, the radiating antenna aperture of the DUT is denoted as D
- The uncertainty assessment has been derived for the case of $D = [5 \text{ cm}]$, $f = \{6 \text{ GHz to } 87 \text{ GHz}\}$, $P = [\text{Off power}]$.
- The uncertainty assessment for TRP is provided in Table B.25.1-2 to B.25.1-xx

Table B.25.1-2: Uncertainty assessment for TRP measurement (f=TBD, D=TBD)

UID	Uncertainty source	Uncertainty value	Distribution of the probability	Divisor	Standard uncertainty (σ) [dB]
Stage 2: DUT measurement					
1	Positioning misalignment				
2	Measure distance uncertainty				
3	Quality of quiet zone				
4	Mismatch (NOTE 1)				
5	Standing Wave Between the DUT and measurement antenna				
6	Uncertainty of the RF power measurement equipment (NOTE 2)				
7	Phase curvature				
8	Amplifier uncertainties				
9	Random uncertainty				
10	Influence of the XPD				
11	Insertion Loss Variation				
12	RF leakage (from measurement antenna to the receiver/transmitter)				
13	Influence of TRP measurement grid (NOTE 3)				
14	Influence of beam peak search grid (NOTE 4)				
15	Multiple measurement antenna uncertainty				
16	DUT repositioning				
Stage 1: Calibration measurement					
17	Mismatch				
18	Amplifier uncertainties				
19	Misalignment of positioning System				
20	Uncertainty of the Network Analyzer				
21	Uncertainty of the absolute gain of the calibration antenna				
22	Positioning and pointing misalignment between the reference antenna and the measurement antenna				
23	Phase centre offset of calibration antenna				
24	Quality of quiet zone for calibration process				
25	Standing wave between reference calibration antenna and measurement antenna				
26	Influence of the calibration antenna feed cable				
27	Insertion Loss Variation				
TRP Expanded uncertainty (1.96 σ - confidence interval of 95 %) [dB]					
Systematic uncertainties (NOTE 5)					Value
28	Systematic error due to TRP calculation/quadrature (NOTE 3)				
29	Influence of noise				
Total measurement uncertainty					
TRP total measurement uncertainty [dB]					
NOTE 1: The analysis was done only for the case of operating at max output power, in-band, non-CA.					
NOTE 2: The assessment assumes maximum DUT output power.					
NOTE 3: This contributor shall only be considered for TRP measurements.					
NOTE 4: This contributor shall only be considered for EIRP measurements.					
NOTE 5: In order to obtain the total measurement uncertainty, systematic uncertainties have to be added to the expanded root sum square of the standard deviations of the Stage 1 and Stage 2 contributors.					
NOTE 6: Void					

B.25.2 Uncertainty budget format and assessment for IFF

The uncertainty contributions that may impact the overall MU value are listed in Table B.25.2-1.

Table B.25.2-1: Uncertainty contributions for TRP measurement

UID	Description of uncertainty contribution	Details in clause
Stage 2: DUT measurement		
1	Positioning misalignment	B.2.2.1
2	Measure distance uncertainty	B.2.2.2
3	Quality of Quiet Zone	B.2.2.3
4	Mismatch	B.2.2.4
5	Standing wave between the DUT and measurement antenna	B.2.2.5
6	Uncertainty of the RF power measurement equipment	B.2.2.6
7	Phase curvature	B.2.2.7
8	Amplifier uncertainties	B.2.2.8
9	Random uncertainty	B.2.2.9
10	Influence of the XPD	B.2.2.10
11	Insertion Loss Variation	B.2.2.11
12	RF leakage (from measurement antenna to the receiver/transmitter)	B.2.2.12
13	Influence of TRP measurement grid	B.2.2.22
14	Influence of beam peak search grid	B.2.2.23
15	Multiple measurement antenna uncertainty	B.2.2.25
16	DUT repositioning	B.2.2.26
17	Misalignment of DUT due to change of DUT orientation	B.2.2.31
Stage 1: Calibration measurement		
18	Mismatch	B.2.2.4
19	Amplifier Uncertainties	B.2.2.8
20	Misalignment of positioning System	B.2.2.13
21	Uncertainty of the Network Analyzer	B.2.2.14
22	Uncertainty of the absolute gain of the calibration antenna	B.2.2.15
23	Positioning and pointing misalignment between the reference antenna and the measurement antenna	B.2.2.16
24	Phase centre offset of calibration antenna	B.2.2.18
25	Quality of quiet zone for calibration process	B.2.2.19
26	Standing wave between reference calibration antenna and measurement antenna	B.2.2.20
27	Influence of the calibration antenna feed cable	B.2.2.21
28	Insertion Loss Variation	B.2.2.11
Systematic uncertainties		
29	Systematic error due to TRP calculation/quadrature	B.2.2.24
30	Influence of noise	B.2.2.27

The uncertainty assessment tables are organized as follows:

- For the purpose of uncertainty assessment, the radiating antenna aperture of the DUT is denoted as D
- The uncertainty assessment has been derived for the case of Quiet Zone size ≤ 30 cm, $f = \{6 \text{ GHz to } 87 \text{ GHz}\}$, $P = \text{Receiver Spurious Core Requirement Level} + \text{Relaxation}$ (For n_{257} , 10.2dB for $6\text{GHz} \leq f < 20\text{GHz}$, 17.2 dB for $20\text{GHz} \leq f < 40\text{GHz}$, 33.1dB for $40\text{GHz} \leq f \leq 2^{\text{nd}}$ harmonic)
- The uncertainty assessment for TRP is provided from Table B.25.2-2 to Table B.25.2-11 for PC3 UEs and from Table B.25.2-12 to Table B.25.2-16 for PC1 UEs.

Table B.25.2-2: Void

Table B.25.2-3: Uncertainty assessment for TRP measurement (f=6 GHz to 12.75 GHz, Quiet Zone size ≤ 30 cm) for PC3 UEs

UID	Uncertainty source	Uncertainty value	Distribution of the probability	Divisor	Standard uncertainty (σ) [dB]
Stage 2: DUT measurement					
1	Positioning misalignment	0.00	Normal	2.00	0.00
2	Measure distance uncertainty	0.00	Rectangular	1.73	0.00
3	Quality of Quiet Zone (NOTE 4)	0.70	Actual	1.00	0.70
4	Mismatch	1.60	Actual	1.00	1.60
5	Standing wave between the DUT and measurement antenna	0.00	U-shaped	1.41	0.00
6	Uncertainty of the RF power measurement equipment	2.00	Normal	2.00	1.00
7	Phase curvature	0.00	U-shaped	1.41	0.00
8	Amplifier uncertainties	2.1	Normal	2.00	1.05
9	Random uncertainty	0.5	Normal	2.00	0.25
10	Influence of the XPD	0.09	U-shaped	1.41	0.064
11	Insertion Loss Variation	0.00	Rectangular	1.73	0.00
12	RF leakage (from measurement antenna to the receiver/transmitter)	0.00	Actual	1.00	0.00
13	Influence of TRP measurement grid (NOTE 1)	0.32	Actual	1	0.32
14	Influence of beam peak search grid (NOTE 2)	N/A	Actual	1	N/A
15	Multiple measurement antenna uncertainty (NOTE 5)	0.15	Actual	1	0.15
16	DUT repositioning	0.00	Rectangular	1.73	0.00
17	Misalignment of DUT due to change of DUT orientation	0.10	Actual	1	0.10
Stage 1: Calibration measurement					
18	Mismatch	0.00	U-shaped	1.41	0.00
19	Amplifier Uncertainties	0.00	Normal	2.00	0.00
20	Misalignment of positioning System	0.00	Normal	2.00	0.00
21	Uncertainty of the Network Analyzer	1.50	Normal	2.00	0.75
22	Uncertainty of the absolute gain of the calibration antenna	0.60	Normal	2.00	0.30
23	Positioning and pointing misalignment between the reference antenna and the measurement antenna	0.05	Rectangular	1.73	0.03
24	Phase centre offset of calibration antenna	0.00	Rectangular	1.73	0.00
25	Quality of quiet zone for calibration process (NOTE 4)	0.70	Actual	1.00	0.70
26	Standing wave between reference calibration antenna and measurement antenna	0.00	U-shaped	1.41	0.00
27	Influence of the calibration antenna feed cable	0.14	Normal	2.00	0.07
28	Insertion Loss Variation	0.00	Rectangular	1.73	0.00
Expanded uncertainty (1.96σ - confidence interval of 95 %)					Value
TRP Expanded uncertainty (6 GHz < f <= 12.75 GHz) [dB] (a)					5.00
Systematic uncertainties (NOTE 3)					Value
29	Systematic error due to TRP calculation/quadrature (NOTE 1) (b)				0.0
30	Influence of noise (6 GHz < f <= 12.75 GHz) (c)				0.64

31	Systematic error related to beam peak search (NOTE 2)	N/A
Total measurement uncertainty		Value
Total measurement uncertainty (a)+(b)+(c) [dB]		5.64
<p>NOTE 1: This contributor shall only be considered for TRP measurements.</p> <p>NOTE 2: This contributor shall only be considered for EIRP measurements.</p> <p>NOTE 3: In order to obtain the total measurement uncertainty, systematic uncertainties have to be added to the expanded root sum square of the standard deviations of the Stage 1 and Stage 2 contributors.</p> <p>NOTE 4: Value based on procedure defined in clause D.2 of TR 38.810 for Quiet Zone size of less or equal to 30 cm.</p> <p>NOTE 5: Applies to the system which has a structure of mechanical feed antenna positioning.</p>		

Table B.25.2-4: void

Table B.25.2-5: Uncertainty assessment for TRP measurement (f=12.75 GHz to 23.45 GHz, Quiet Zone size \leq 30 cm) for PC3 UEs

UID	Uncertainty source	Uncertainty value	Distribution of the probability	Divisor	Standard uncertainty (σ) [dB]
Stage 2: DUT measurement					
1	Positioning misalignment	0.00	Normal	2.00	0.00
2	Measure distance uncertainty	0.00	Rectangular	1.73	0.00
3	Quality of Quiet Zone (NOTE 4)	0.60	Actual	1.00	0.60
4	Mismatch	1.60	Actual	1.00	1.60
5	Standing wave between the DUT and measurement antenna	0.00	U-shaped	1.41	0.00
6	Uncertainty of the RF power measurement equipment	2.16	Normal	2.00	1.08
7	Phase curvature	0.00	U-shaped	1.41	0.00
8	Amplifier uncertainties	2.1	Normal	2.00	1.05
9	Random uncertainty	0.5	Normal	2.00	0.25
10	Influence of the XPD	0.09	U-shaped	1.41	0.064
11	Insertion Loss Variation	0.00	Rectangular	1.73	0.00
12	RF leakage (from measurement antenna to the receiver/transmitter)	0.00	Actual	1.00	0.00
13	Influence of TRP measurement grid (NOTE 1)	0.32	Actual	1	0.32
14	Influence of beam peak search grid (NOTE 2)	N/A	Actual	1	N/A
15	Multiple measurement antenna uncertainty (NOTE 5)	0.15	Actual	1	0.15
16	DUT repositioning	0.00	Rectangular	1.73	0.00
17	Misalignment of DUT due to change of DUT orientation	0.10	Actual	1	0.10
Stage 1: Calibration measurement					
18	Mismatch	0.00	U-shaped	1.41	0.00
19	Amplifier Uncertainties	0.00	Normal	2.00	0.00
20	Misalignment of positioning System	0.00	Normal	2.00	0.00
21	Uncertainty of the Network Analyzer	1.50	Normal	2.00	0.75
22	Uncertainty of the absolute gain of the calibration antenna	0.60	Normal	2.00	0.30
23	Positioning and pointing misalignment between the reference antenna and the measurement antenna	0.05	Rectangular	1.73	0.03
24	Phase centre offset of calibration antenna	0.00	Rectangular	1.73	0.00
25	Quality of quiet zone for calibration process (NOTE 4)	0.60	Actual	1.00	0.60
26	Standing wave between reference calibration antenna and measurement antenna	0.00	U-shaped	1.41	0.00
27	Influence of the calibration antenna feed cable	0.14	Normal	2.00	0.07
28	Insertion Loss Variation	0.00	Rectangular	1.73	0.00
Expanded uncertainty (1.96σ - confidence interval of 95 %)					Value
TRP Expanded uncertainty (12.75 GHz < f <= 23.45 GHz) [dB] (a)					4.96
Systematic uncertainties (NOTE 3)					Value
29	Systematic error due to TRP calculation/quadrature (NOTE 1) (b)				0.0
30	Influence of noise (12.75 GHz < f <= 23.45 GHz) (c)				0.64

31	Systematic error related to beam peak search (NOTE 2)	N/A
Total measurement uncertainty		Value
Total measurement uncertainty (a)+(b)+(c) [dB]		5.60
NOTE 1: This contributor shall only be considered for TRP measurements.		
NOTE 2: This contributor shall only be considered for EIRP measurements.		
NOTE 3: In order to obtain the total measurement uncertainty, systematic uncertainties have to be added to the expanded root sum square of the standard deviations of the Stage 1 and Stage 2 contributors.		
NOTE 4: Value based on procedure defined in clause D.2 of TR 38.810 for Quiet Zone size of less or equal to 30 cm.		
NOTE 5: Applies to the system which has a structure of mechanical feed antenna positioning.		

Table B.25.2-6: Void

Table B.25.2-7: Uncertainty assessment for TRP measurement (f=23.45 GHz to 40.8 GHz, Quiet Zone size \leq 30 cm) for PC3 UEs

UID	Uncertainty source	Uncertainty value	Distribution of the probability	Divisor	Standard uncertainty (σ) [dB]
Stage 2: DUT measurement					
1	Positioning misalignment	0.00	Normal	2.00	0.00
2	Measure distance uncertainty	0.00	Rectangular	1.73	0.00
3	Quality of Quiet Zone (NOTE 4)	0.6	Actual	1.00	0.6
4	Mismatch	1.50	Actual	1.00	1.50
5	Standing wave between the DUT and measurement antenna	0.00	U-shaped	1.41	0.00
6	Uncertainty of the RF power measurement equipment	2.73	Normal	2.00	1.37
7	Phase curvature	0.00	U-shaped	1.41	0.00
8	Amplifier uncertainties	2.1	Normal	2.00	1.05
9	Random uncertainty	0.5	Normal	2.00	0.25
10	Influence of the XPD	0.01	U-shaped	1.41	0.00
11	Insertion Loss Variation	0.00	Rectangular	1.73	0.00
12	RF leakage (from measurement antenna to the receiver/transmitter)	0.00	Actual	1.00	0.00
13	Influence of TRP measurement grid (NOTE 1)	0.32	Actual	1	0.32
14	Influence of beam peak search grid (NOTE 2)	N/A	Actual	1	N/A
15	Multiple measurement antenna uncertainty (NOTE 5)	0.15	Actual	1	0.15
16	DUT repositioning	0.00	Rectangular	1.73	0.00
17	Misalignment of DUT due to change of DUT orientation	0.10	Actual	1	0.10
Stage 1: Calibration measurement					
18	Mismatch	0.00	U-shaped	1.41	0.00
19	Amplifier Uncertainties	0.00	Normal	2.00	0.00
20	Misalignment of positioning System	0.00	Normal	2.00	0.00
21	Uncertainty of the Network Analyzer	1.5	Normal	2.00	0.75
22	Uncertainty of the absolute gain of the calibration antenna	0.6	Normal	2.00	0.3
23	Positioning and pointing misalignment between the reference antenna and the measurement antenna	0.05	Rectangular	1.73	0.03
24	Phase centre offset of calibration antenna	0.00	Rectangular	1.73	0.00
25	Quality of quiet zone for calibration process (NOTE 4)	0.6	Actual	1.00	0.6
26	Standing wave between reference calibration antenna and measurement antenna	0.00	U-shaped	1.41	0.00
27	Influence of the calibration antenna feed cable	0.14	Normal	2.00	0.07
28	Insertion Loss Variation	0.00	Rectangular	1.73	0.00
Expanded uncertainty (1.96σ - confidence interval of 95 %)					Value
TRP Expanded uncertainty (23.45 GHz < f <= 40.8 GHz) [dB] (a)					5.11
Systematic uncertainties (NOTE 3)					Value
29	Systematic error due to TRP calculation/quadrature (NOTE 1) (b)				0.0
30	Influence of noise (23.45 GHz < f <= 40.8 GHz) (c)				1.0

31	Systematic error related to beam peak search (NOTE 2)	N/A
Total measurement uncertainty		Value
Total measurement uncertainty (a)+(b)+(c) [dB]		6.11
<p>NOTE 1: This contributor shall only be considered for TRP measurements.</p> <p>NOTE 2: This contributor shall only be considered for EIRP measurements.</p> <p>NOTE 3: In order to obtain the total measurement uncertainty, systematic uncertainties have to be added to the expanded root sum square of the standard deviations of the Stage 1 and Stage 2 contributors.</p> <p>NOTE 4: Value based on procedure defined in clause D.2 of TR 38.810 for Quiet Zone size of less or equal to 30 cm.</p> <p>NOTE 5: Applies to the system which has a structure of mechanical feed antenna positioning.</p>		

Table B.25.2-8: Void

Table B.25.2-9: Uncertainty assessment for TRP measurement ($f = 40.8$ GHz to 66 GHz, Quiet Zone size ≤ 30 cm) for PC3 UEs

UID	Uncertainty source	Uncertainty value	Distribution of the probability	Divisor	Standard uncertainty (σ) [dB]
Stage 2: DUT measurement					
1	Positioning misalignment	0.0	Normal	2.00	0.0
2	Measure distance uncertainty	0.00	Rectangular	1.73	0.00
3	Quality of Quiet Zone (NOTE 4)	0.6	Actual	1.00	0.6
4	Mismatch	2.30	Actual	1.00	2.30
5	Standing wave between the DUT and measurement antenna	0.00	U-shaped	1.41	0.00
6	Uncertainty of the RF power measurement equipment	4.0	Normal	2.00	2.00
7	Phase curvature	0.00	U-shaped	1.41	0.00
8	Amplifier uncertainties	2.1	Normal	2.00	1.05
9	Random uncertainty	0.5	Normal	2.00	0.25
10	Influence of the XPD	0.09	U-shaped	1.41	0.064
11	Insertion Loss Variation	0.00	Rectangular	1.73	0.00
12	RF leakage (from measurement antenna to the receiver/transmitter)	0.00	Actual	1.00	0.00
13	Influence of TRP measurement grid (NOTE 1)	0.32	Actual	1	0.32
14	Influence of beam peak search grid (NOTE 2)	N/A	Actual	1	N/A
15	Multiple measurement antenna uncertainty (NOTE 5)	0.15	Actual	1	0.15
16	DUT repositioning	0.00	Rectangular	1.73	0.00
17	Misalignment of DUT due to change of DUT orientation	0.10	Actual	1	0.10
Stage 1: Calibration measurement					
18	Mismatch	0.00	U-shaped	1.41	0.00
19	Amplifier Uncertainties	0.00	Normal	2.00	0.00
20	Misalignment of positioning System	0.00	Normal	2.00	0.00
21	Uncertainty of the Network Analyzer	1.7	Normal	2.00	0.85
22	Uncertainty of the absolute gain of the calibration antenna	1.70	Normal	2.00	0.85
23	Positioning and pointing misalignment between the reference antenna and the measurement antenna	0.05	Rectangular	1.73	0.03
24	Phase centre offset of calibration antenna	0.00	Rectangular	1.73	0.00
25	Quality of quiet zone for calibration process (NOTE 4)	0.6	Actual	1.00	0.6
26	Standing wave between reference calibration antenna and measurement antenna	0.00	U-shaped	1.41	0.00
27	Influence of the calibration antenna feed cable	0.28	Normal	2.00	0.14
28	Insertion Loss Variation	0.00	Rectangular	1.73	0.00
Expanded uncertainty (1.96σ - confidence interval of 95 %)					Value
TRP Expanded uncertainty (40.8 GHz < f <= 66 GHz) [dB] (a)					7.01
Systematic uncertainties (NOTE 3)					Value
29	Systematic error due to TRP calculation/quadrature (NOTE 1) (b)				0.0
30	Influence of noise (40.8 GHz < f <= 66 GHz) (c)				0.64

31	Systematic error related to beam peak search (NOTE 2)	N/A
Total measurement uncertainty		Value
Total measurement uncertainty (a)+(b)+(c) [dB]		7.65
<p>NOTE 1: This contributor shall only be considered for TRP measurements.</p> <p>NOTE 2: This contributor shall only be considered for EIRP measurements.</p> <p>NOTE 3: In order to obtain the total measurement uncertainty, systematic uncertainties have to be added to the expanded root sum square of the standard deviations of the Stage 1 and Stage 2 contributors.</p> <p>NOTE 4: Value based on procedure defined in clause D.2 of TR 38.810 for Quiet Zone size of less or equal to 30 cm.</p> <p>NOTE 5: Applies to the system which has a structure of mechanical feed antenna positioning.</p>		

Table B.25.2-10: Void

Table B.25.2-11: Uncertainty assessment for TRP measurement (f= 66 GHz to 87 GHz, Quiet Zone size \leq 30 cm) for PC3 UEs

UID	Uncertainty source	Uncertainty value	Distribution of the probability	Divisor	Standard uncertainty (σ) [dB]
Stage 2: DUT measurement					
1	Positioning misalignment	0.00	Normal	2.00	0.00
2	Measure distance uncertainty	0.00	Rectangular	1.73	0.00
3	Quality of Quiet Zone (NOTE 4)	0.6	Actual	1.00	0.6
4	Mismatch	2.30	Actual	1.00	2.30
5	Standing wave between the DUT and measurement antenna	0.00	U-shaped	1.41	0.00
6	Uncertainty of the RF power measurement equipment	4.0	Normal	2.00	2.0
7	Phase curvature	0.00	U-shaped	1.41	0.00
8	Amplifier uncertainties	3.0	Normal	2.00	1.50
9	Random uncertainty	0.5	Normal	2.00	0.25
10	Influence of the XPD	0.09	U-shaped	1.41	0.064
11	Insertion Loss Variation	0.00	Rectangular	1.73	0.00
12	RF leakage (from measurement antenna to the receiver/transmitter)	0.00	Actual	1.00	0.00
13	Influence of TRP measurement grid (NOTE 1)	0.32	Actual	1	0.32
14	Influence of beam peak search grid (NOTE 2)	N/A	Actual	1	N/A
15	Multiple measurement antenna uncertainty (NOTE 5)	0.15	Actual	1	0.15
16	DUT repositioning	0.00	Rectangular	1.73	0.00
17	Misalignment of DUT due to change of DUT orientation	0.10	Actual	1	0.10
Stage 1: Calibration measurement					
18	Mismatch	0.00	U-shaped	1.41	0.00
19	Amplifier Uncertainties	0.00	Normal	2.00	0.00
20	Misalignment of positioning System	0.00	Normal	2.00	0.00
21	Uncertainty of the Network Analyzer	1.7	Normal	2.00	0.85
22	Uncertainty of the absolute gain of the calibration antenna	1.70	Normal	2.00	0.85
23	Positioning and pointing misalignment between the reference antenna and the measurement antenna	0.05	Rectangular	1.73	0.03
24	Phase centre offset of calibration antenna	0.00	Rectangular	1.73	0.00
25	Quality of quiet zone for calibration process (NOTE 4)	0.60	Actual	1.00	0.60
26	Standing wave between reference calibration antenna and measurement antenna	0.00	U-shaped	1.41	0.00
27	Influence of the calibration antenna feed cable	0.28	Normal	2.00	0.14
28	Insertion Loss Variation	0.00	Rectangular	1.73	0.00
Expanded uncertainty (1.96σ - confidence interval of 95 %)					Value
TRP Expanded uncertainty (66 GHz < f <= 87 GHz) [dB] (a)					7.31
Systematic uncertainties (NOTE 3)					Value
29	Systematic error due to TRP calculation/quadrature (NOTE 1) (b)				0.0
30	Influence of noise (66 GHz < f <= 80 GHz) (c)				0.64

30	Influence of noise ($80 \text{ GHz} < f \leq 87 \text{ GHz}$) (c)	1.00
31	Systematic error related to beam peak search (NOTE 2)	N/A
Total measurement uncertainty		Value
Total measurement uncertainty (a)+(b)+(c) [dB] ($66 \text{ GHz} < f \leq 80 \text{ GHz}$)		7.95
Total measurement uncertainty (a)+(b)+(c) [dB] ($80 \text{ GHz} < f \leq 87 \text{ GHz}$)		8.31
NOTE 1: This contributor shall only be considered for TRP measurements.		
NOTE 2: This contributor shall only be considered for EIRP measurements.		
NOTE 3: In order to obtain the total measurement uncertainty, systematic uncertainties have to be added to the expanded root sum square of the standard deviations of the Stage 1 and Stage 2 contributors.		
NOTE 4: Value based on procedure defined in clause D.2 of TR 38.810 for Quiet Zone size of less or equal to 30 cm.		
NOTE 5: Applies to the system which has a structure of mechanical feed antenna positioning.		

Table B.25.2-12: Uncertainty assessment for TRP measurement (f=6 GHz to 12.75 GHz, Quiet Zone size \leq 30 cm) for PC1 UEs

UID	Uncertainty source	Uncertainty value	Distribution of the probability	Divisor	Standard uncertainty (σ) [dB]
Stage 2: DUT measurement					
1	Positioning misalignment	0.02	Normal	2.00	0.01
2	Measure distance uncertainty	0.00	Rectangular	1.73	0.00
3	Quality of Quiet Zone (NOTE 4)	0.70	Actual	1.00	0.70
4	Mismatch	1.60	Actual	1.00	1.60
5	Standing wave between the DUT and measurement antenna	0.00	U-shaped	1.41	0.00
6	Uncertainty of the RF power measurement equipment	2.00	Normal	2.00	1.00
7	Phase curvature	0.00	U-shaped	1.41	0.00
8	Amplifier uncertainties	2.1	Normal	2.00	1.05
9	Random uncertainty	0.5	Normal	2.00	0.25
10	Influence of the XPD	0.09	U-shaped	1.41	0.064
11	Insertion Loss Variation	0.00	Rectangular	1.73	0.00
12	RF leakage (from measurement antenna to the receiver/transmitter)	0.00	Actual	1.00	0.00
13	Influence of TRP measurement grid (NOTE 1)	0.25	Actual	1	0.25
14	Influence of beam peak search grid (NOTE 2)	N/A	Actual	1	N/A
15	Multiple measurement antenna uncertainty (NOTE 5)	0.15	Actual	1	0.15
16	DUT repositioning	0.00	Rectangular	1.73	0.00
17	Misalignment of DUT due to change of DUT orientation	0.10	Actual	1	0.10
Stage 1: Calibration measurement					
18	Mismatch	0.00	U-shaped	1.41	0.00
19	Amplifier Uncertainties	0.00	Normal	2.00	0.00
20	Misalignment of positioning System	0.00	Normal	2.00	0.00
21	Uncertainty of the Network Analyzer	1.5	Normal	2.00	0.75
22	Uncertainty of the absolute gain of the calibration antenna	0.60	Normal	2.00	0.30
23	Positioning and pointing misalignment between the reference antenna and the measurement antenna	0.05	Rectangular	1.73	0.03
24	Phase centre offset of calibration antenna	0.00	Rectangular	1.73	0.00
25	Quality of quiet zone for calibration process (NOTE 4)	0.70	Actual	1.00	0.70
26	Standing wave between reference calibration antenna and measurement antenna	0.00	U-shaped	1.41	0.00
27	Influence of the calibration antenna feed cable	0.14	Normal	2.00	0.07
28	Insertion Loss Variation	0.00	Rectangular	1.73	0.00
Expanded uncertainty (1.96σ - confidence interval of 95 %)					Value
TRP Expanded uncertainty ([6] GHz < f <= [12.75] GHz) [dB] (a)					4.99
Systematic uncertainties (NOTE 3)					Value
29	Systematic error due to TRP calculation/quadrature (NOTE 1) (b)				0.00
30	Influence of noise (6 GHz < f <= 12.75 GHz) (c)				0.64

31	Systematic error related to beam peak search (NOTE 2)	N/A
Total measurement uncertainty		Value
Total measurement uncertainty (a)+(b)+(c) [dB]		5.63
<p>NOTE 1: This contributor shall only be considered for TRP measurements.</p> <p>NOTE 2: This contributor shall only be considered for EIRP measurements.</p> <p>NOTE 3: In order to obtain the total measurement uncertainty, systematic uncertainties have to be added to the expanded root sum square of the standard deviations of the Stage 1 and Stage 2 contributors.</p> <p>NOTE 4: Value based on procedure defined in clause D.2 of TR 38.810 for Quiet Zone size of less or equal to 30 cm.</p> <p>NOTE 5: Applies to the system which has a structure of mechanical feed antenna positioning.</p>		

Table B.25.2-13: Uncertainty assessment for TRP measurement (f=12.75 GHz to 23.45 GHz, Quiet Zone size \leq 30 cm) for PC1 UEs

UID	Uncertainty source	Uncertainty value	Distribution of the probability	Divisor	Standard uncertainty (σ) [dB]
Stage 2: DUT measurement					
1	Positioning misalignment	0.02	Normal	2.00	0.01
2	Measure distance uncertainty	0.00	Rectangular	1.73	0.00
3	Quality of Quiet Zone (NOTE 4)	0.60	Actual	1.00	0.60
4	Mismatch	1.60	Actual	1.00	1.60
5	Standing wave between the DUT and measurement antenna	0.00	U-shaped	1.41	0.00
6	Uncertainty of the RF power measurement equipment	2.16	Normal	2.00	1.08
7	Phase curvature	0.00	U-shaped	1.41	0.00
8	Amplifier uncertainties	2.1	Normal	2.00	1.05
9	Random uncertainty	0.5	Normal	2.00	0.25
10	Influence of the XPD	0.09	U-shaped	1.41	0.064
11	Insertion Loss Variation	0.00	Rectangular	1.73	0.00
12	RF leakage (from measurement antenna to the receiver/transmitter)	0.00	Actual	1.00	0.00
13	Influence of TRP measurement grid (NOTE 1)	0.25	Actual	1	0.25
14	Influence of beam peak search grid (NOTE 2)	N/A	Actual	1	N/A
15	Multiple measurement antenna uncertainty (NOTE 5)	0.15	Actual	1	0.15
16	DUT repositioning	0.00	Rectangular	1.73	0.00
17	Misalignment of DUT due to change of DUT orientation	0.10	Actual	1	0.10
Stage 1: Calibration measurement					
18	Mismatch	0.00	U-shaped	1.41	0.00
19	Amplifier Uncertainties	0.00	Normal	2.00	0.00
20	Misalignment of positioning System	0.00	Normal	2.00	0.00
21	Uncertainty of the Network Analyzer	1.5	Normal	2.00	0.75
22	Uncertainty of the absolute gain of the calibration antenna	0.60	Normal	2.00	0.30
23	Positioning and pointing misalignment between the reference antenna and the measurement antenna	0.05	Rectangular	1.73	0.03
24	Phase centre offset of calibration antenna	0.00	Rectangular	1.73	0.00
25	Quality of quiet zone for calibration process (NOTE 4)	0.60	Actual	1.00	0.60
26	Standing wave between reference calibration antenna and measurement antenna	0.00	U-shaped	1.41	0.00
27	Influence of the calibration antenna feed cable	0.14	Normal	2.00	0.07
28	Insertion Loss Variation	0.00	Rectangular	1.73	0.00
Expanded uncertainty (1.96σ - confidence interval of 95 %)					Value
TRP Expanded uncertainty (12.75 GHz < f <= 23.45 GHz) [dB] (a)					4.95
Systematic uncertainties (NOTE 3)					Value
29	Systematic error due to TRP calculation/quadrature (NOTE 1) (b)				0.00
30	Influence of noise (12.75 GHz < f <= 23.45 GHz) (c)				0.64

31	Systematic error related to beam peak search (NOTE 2)	N/A
Total measurement uncertainty		Value
Total measurement uncertainty (a)+(b)+(c) [dB]		5.59
<p>NOTE 1: This contributor shall only be considered for TRP measurements.</p> <p>NOTE 2: This contributor shall only be considered for EIRP measurements.</p> <p>NOTE 3: In order to obtain the total measurement uncertainty, systematic uncertainties have to be added to the expanded root sum square of the standard deviations of the Stage 1 and Stage 2 contributors.</p> <p>NOTE 4: Value based on procedure defined in clause D.2 of TR 38.810 for Quiet Zone size of less or equal to 30 cm.</p> <p>NOTE 5: Applies to the system which has a structure of mechanical feed antenna positioning.</p>		

Table B.25.2-14: Uncertainty assessment for TRP measurement (f=23.45 GHz to 40.8 GHz, Quiet Zone size \leq 30 cm) for PC1 UEs

UID	Uncertainty source	Uncertainty value	Distribution of the probability	Divisor	Standard uncertainty (σ) [dB]
Stage 2: DUT measurement					
1	Positioning misalignment	0.02	Normal	2.00	0.01
2	Measure distance uncertainty	0.00	Rectangular	1.73	0.00
3	Quality of Quiet Zone (NOTE 4)	0.6	Actual	1.00	0.6
4	Mismatch	1.50	Actual	1.00	1.50
5	Standing wave between the DUT and measurement antenna	0.00	U-shaped	1.41	0.00
6	Uncertainty of the RF power measurement equipment	2.73	Normal	2.00	1.37
7	Phase curvature	0.00	U-shaped	1.41	0.00
8	Amplifier uncertainties	2.1	Normal	2.00	1.05
9	Random uncertainty	0.5	Normal	2.00	0.25
10	Influence of the XPD	0.01	U-shaped	1.41	0.00
11	Insertion Loss Variation	0.00	Rectangular	1.73	0.00
12	RF leakage (from measurement antenna to the receiver/transmitter)	0.00	Actual	1.00	0.00
13	Influence of TRP measurement grid (NOTE 1)	0.25	Actual	1	0.25
14	Influence of beam peak search grid (NOTE 2)	N/A	Actual	1	N/A
15	Multiple measurement antenna uncertainty (NOTE 5)	0.15	Actual	1	0.15
16	DUT repositioning	0.00	Rectangular	1.73	0.00
17	Misalignment of DUT due to change of DUT orientation	0.10	Actual	1	0.10
Stage 1: Calibration measurement					
18	Mismatch	0.00	U-shaped	1.41	0.00
19	Amplifier Uncertainties	0.00	Normal	2.00	0.00
20	Misalignment of positioning System	0.00	Normal	2.00	0.00
21	Uncertainty of the Network Analyzer	1.5	Normal	2.00	0.75
22	Uncertainty of the absolute gain of the calibration antenna	0.6	Normal	2.00	0.3
23	Positioning and pointing misalignment between the reference antenna and the measurement antenna	0.05	Rectangular	1.73	0.03
24	Phase centre offset of calibration antenna	0.00	Rectangular	1.73	0.00
25	Quality of quiet zone for calibration process (NOTE 4)	0.6	Actual	1.00	0.6
26	Standing wave between reference calibration antenna and measurement antenna	0.00	U-shaped	1.41	0.00
27	Influence of the calibration antenna feed cable	0.14	Normal	2.00	0.07
28	Insertion Loss Variation	0.00	Rectangular	1.73	0.00
Expanded uncertainty (1.96σ - confidence interval of 95 %)					Value
TRP Expanded uncertainty (23.45 GHz < f <= 40.8 GHz) [dB] (a)					5.10
Systematic uncertainties (NOTE 3)					Value
29	Systematic error due to TRP calculation/quadrature (NOTE 1) (b)				0.00
30	Influence of noise (23.45 GHz < f <= 40.8 GHz) (c)				1.0

31	Systematic error related to beam peak search (NOTE 2)	N/A
Total measurement uncertainty		Value
Total measurement uncertainty (a)+(b)+(c) [dB]		6.10
<p>NOTE 1: This contributor shall only be considered for TRP measurements.</p> <p>NOTE 2: This contributor shall only be considered for EIRP measurements.</p> <p>NOTE 3: In order to obtain the total measurement uncertainty, systematic uncertainties have to be added to the expanded root sum square of the standard deviations of the Stage 1 and Stage 2 contributors.</p> <p>NOTE 4: Value based on procedure defined in clause D.2 of TR 38.810 for Quiet Zone size of less or equal to 30 cm.</p> <p>NOTE 5: Applies to the system which has a structure of mechanical feed antenna positioning.</p>		

Table B.25.2-15: Uncertainty assessment for TRP measurement (f= 40.8 GHz to 66 GHz, Quiet Zone size \leq 30 cm) for PC1 UEs

UID	Uncertainty source	Uncertainty value	Distribution of the probability	Divisor	Standard uncertainty (σ) [dB]
Stage 2: DUT measurement					
1	Positioning misalignment	0.02	Normal	2.00	0.01
2	Measure distance uncertainty	0.00	Rectangular	1.73	0.00
3	Quality of Quiet Zone (NOTE 4)	0.6	Actual	1.00	0.6
4	Mismatch	2.30	Actual	1.00	2.30
5	Standing wave between the DUT and measurement antenna	0.00	U-shaped	1.41	0.00
6	Uncertainty of the RF power measurement equipment	4.0	Normal	2.00	2.00
7	Phase curvature	0.00	U-shaped	1.41	0.00
8	Amplifier uncertainties	2.1	Normal	2.00	1.05
9	Random uncertainty	0.5	Normal	2.00	0.25
10	Influence of the XPD	0.09	U-shaped	1.41	0.064
11	Insertion Loss Variation	0.00	Rectangular	1.73	0.00
12	RF leakage (from measurement antenna to the receiver/transmitter)	0.00	Actual	1.00	0.00
13	Influence of TRP measurement grid (NOTE 1)	0.25	Actual	1	0.25
14	Influence of beam peak search grid (NOTE 2)	N/AN/A	Actual	1	N/AN/A
15	Multiple measurement antenna uncertainty (NOTE 5)	0.15	Actual	1	0.15
16	DUT repositioning	0.00	Rectangular	1.73	0.00
17	Misalignment of DUT due to change of DUT orientation	0.10	Actual	1	0.10
Stage 1: Calibration measurement					
18	Mismatch	0.00	U-shaped	1.41	0.00
19	Amplifier Uncertainties	0.00	Normal	2.00	0.00
20	Misalignment of positioning System	0.00	Normal	2.00	0.00
21	Uncertainty of the Network Analyzer	1.7	Normal	2.00	0.85
22	Uncertainty of the absolute gain of the calibration antenna	1.70	Normal	2.00	0.85
23	Positioning and pointing misalignment between the reference antenna and the measurement antenna	0.05	Rectangular	1.73	0.03
24	Phase centre offset of calibration antenna	0.00	Rectangular	1.73	0.00
25	Quality of quiet zone for calibration process (NOTE 4)	0.6	Actual	1.00	0.6
26	Standing wave between reference calibration antenna and measurement antenna	0.00	U-shaped	1.41	0.00
27	Influence of the calibration antenna feed cable	0.28	Normal	2.00	0.14
28	Insertion Loss Variation	0.00	Rectangular	1.73	0.00
Expanded uncertainty (1.96σ - confidence interval of 95 %)					Value
TRP Expanded uncertainty (40.8 GHz < f <= 66 GHz) [dB] (a)					7.00
Systematic uncertainties (NOTE 3)					Value
29	Systematic error due to TRP calculation/quadrature (NOTE 1) (b)				0.00
30	Influence of noise (40.8 GHz < f <= 66 GHz) (c)				0.64

31	Systematic error related to beam peak search (NOTE 2)	N/A
Total measurement uncertainty		Value
Total measurement uncertainty (a)+(b)+(c) [dB]		7.64
<p>NOTE 1: This contributor shall only be considered for TRP measurements.</p> <p>NOTE 2: This contributor shall only be considered for EIRP measurements.</p> <p>NOTE 3: In order to obtain the total measurement uncertainty, systematic uncertainties have to be added to the expanded root sum square of the standard deviations of the Stage 1 and Stage 2 contributors.</p> <p>NOTE 4: Value based on procedure defined in clause D.2 of TR 38.810 for Quiet Zone size of less or equal to 30 cm.</p> <p>NOTE 5: Applies to the system which has a structure of mechanical feed antenna positioning.</p>		

Table B.25.2-16: Uncertainty assessment for TRP measurement (f= 66 GHz to 80 GHz, Quiet Zone size ≤ 30 cm) for PC1 UEs

UID	Uncertainty source	Uncertainty value	Distribution of the probability	Divisor	Standard uncertainty (σ) [dB]
Stage 2: DUT measurement					
1	Positioning misalignment	0.02	Normal	2.00	0.01
2	Measure distance uncertainty	0.00	Rectangular	1.73	0.00
3	Quality of Quiet Zone (NOTE 4)	0.6	Actual	1.00	0.6
4	Mismatch	2.30	Actual	1.00	2.30
5	Standing wave between the DUT and measurement antenna	0.00	U-shaped	1.41	0.00
6	Uncertainty of the RF power measurement equipment	4.0	Normal	2.00	2.0
7	Phase curvature	0.00	U-shaped	1.41	0.00
8	Amplifier uncertainties	3.0	Normal	2.00	1.50
9	Random uncertainty	0.5	Normal	2.00	0.25
10	Influence of the XPD	0.09	U-shaped	1.41	0.064
11	Insertion Loss Variation	0.00	Rectangular	1.73	0.00
12	RF leakage (from measurement antenna to the receiver/transmitter)	0.00	Actual	1.00	0.00
13	Influence of TRP measurement grid (NOTE 1)	0.25	Actual	1	0.32
14	Influence of beam peak search grid (NOTE 2)	N/A	Actual	1	N/A
15	Multiple measurement antenna uncertainty (NOTE 5)	0.15	Actual	1	0.15
16	DUT repositioning	0.00	Rectangular	1.73	0.00
17	Misalignment of DUT due to change of DUT orientation	0.10	Actual	1	0.10
Stage 1: Calibration measurement					
18	Mismatch	0.00	U-shaped	1.41	0.00
19	Amplifier Uncertainties	0.00	Normal	2.00	0.00
20	Misalignment of positioning System	0.00	Normal	2.00	0.00
21	Uncertainty of the Network Analyzer	1.7	Normal	2.00	0.85
22	Uncertainty of the absolute gain of the calibration antenna	1.70	Normal	2.00	0.85
23	Positioning and pointing misalignment between the reference antenna and the measurement antenna	0.05	Rectangular	1.73	0.03
24	Phase centre offset of calibration antenna	0.00	Rectangular	1.73	0.00
25	Quality of quiet zone for calibration process (NOTE 4)	0.60	Actual	1.00	0.60
26	Standing wave between reference calibration antenna and measurement antenna	0.00	U-shaped	1.41	0.00
27	Influence of the calibration antenna feed cable	0.28	Normal	2.00	0.14
28	Insertion Loss Variation	0.00	Rectangular	1.73	0.00
Expanded uncertainty (1.96σ - confidence interval of 95 %)					Value
TRP Expanded uncertainty (66 GHz < f <= 80 GHz) [dB] (a)					7.31
Systematic uncertainties (NOTE 3)					Value
29	Systematic error due to TRP calculation/quadrature (NOTE 1) (b)				0.00
30	Influence of noise (66 GHz < f <= 80 GHz) (c)				0.64

31	Systematic error related to beam peak search (NOTE 2)	N/A
Total measurement uncertainty		Value
Total measurement uncertainty (a)+(b)+(c) [dB]		7.95
<p>NOTE 1: This contributor shall only be considered for TRP measurements.</p> <p>NOTE 2: This contributor shall only be considered for EIRP measurements.</p> <p>NOTE 3: In order to obtain the total measurement uncertainty, systematic uncertainties have to be added to the expanded root sum square of the standard deviations of the Stage 1 and Stage 2 contributors.</p> <p>NOTE 4: Value based on procedure defined in clause D.2 of TR 38.810 for Quiet Zone size of less or equal to 30 cm.</p> <p>NOTE 5: Applies to the system which has a structure of mechanical feed antenna positioning.</p>		

Annex C: Acceptable uncertainty of test system for test cases defined in TS 38.521-3 for radiative testing

FFS

Annex D: Acceptable uncertainty of test system for test cases defined in TS 38.521-4 for radiative testing

Editor's note: The MU tables in D-1, D-2, and D-3 serve as sample, consolidated baseline tables for demodulation test cases and can be removed once the MU tables customized for each TS 38.521-4 test case have been finalized.

This annex contains suggested uncertainties for each test case in TS 38.521-4.

The baseline MU table for Mode 1 (conditions with external noise) is shown in Table D-1 for baseband-combining implementation and in Table D-2 for external-combining implementation.

**Table D-1: Uncertainty Contributions for Mode 1 Demodulation Test Cases for PC1 and PC3
(Baseband-Combining Implementation)**

UID	Uncertainty source	Uncertainty value	Distribution of the probability	Divisor	Standard uncertainty (σ) [dB]
Signal-to-noise ratio uncertainty					
Stage 2: DUT measurement					
1	Positioning misalignment		N/A	N/A	
2	Measure distance uncertainty		N/A	N/A	
3	Quality of Quiet Zone		N/A	N/A	
4	Mismatch		N/A	N/A	
5	Standing wave between the DUT and measurement antenna		N/A	N/A	
6	gNB emulator SNR uncertainty	0.3	Note 3	1.96	0.153
7	Phase curvature		N/A	N/A	
8	Amplifier uncertainties		N/A	N/A	
9	Random uncertainty		N/A	N/A	
10	Influence of the XPD		N/A	N/A	
11	Insertion Loss Variation		N/A	N/A	
12	RF leakage (from measurement antenna to the receiver/transmitter)		N/A	N/A	
13	Multiple measurement antenna uncertainty		N/A	N/A	
14	DUT repositioning		N/A	N/A	
Stage 1: Calibration measurement					
15	Mismatch		N/A	N/A	
16	Amplifier Uncertainties		N/A	N/A	
17	Misalignment of positioning System		N/A	N/A	
18	Uncertainty of the Network Analyzer		N/A	N/A	
19	Uncertainty of the absolute gain of the calibration antenna		N/A	N/A	
20	Positioning and pointing misalignment between the reference antenna and the measurement antenna		N/A	N/A	
21	Phase centre offset of calibration antenna		N/A	N/A	
22	Quality of quiet zone for calibration process		N/A	N/A	
23	Standing wave between reference calibration antenna and measurement antenna		N/A	N/A	
24	Influence of the calibration antenna feed cable		N/A	N/A	
25	Insertion Loss Variation		N/A	N/A	
Total Signal-to-Noise ratio uncertainty					0.153
Other contributors affecting test result					
27	gNB emulator fading model impairments	0.5 for 1Tx 0.7 for 2Tx	Note 3	1.96	0.255 for 1Tx 0.357 for 2Tx
28	AWGN flatness and signal flatness, max deviation for any Resource Block, relative to average over BW_{Config} (Note 4)	3.6	Note 3	1.96	1.837
29	SNR uncertainty due to finite test time	0.3 for PDSCH and Doppler < 100 Hz 0.0 for PDSCH and Doppler \geq 100 Hz 0.4 for PDCCH	Note 3	1.96	0.153 for PDSCH and Doppler < 100 Hz 0.0 for PDSCH and Doppler \geq 100 Hz 0.204 for PDCCH
Systematic uncertainties					Value
26	Impact on non-ideal isolation between branches for the wireless cable mode				0.45 (Note 1) 0.60 (Note 2)
Overall system uncertainty					Value

	Note 5
<p>Note 1: applies to Rank 2 test cases for FR2a, FR2b, and FR2c</p> <p>Note 2: applies to Rank 1 test cases for FR2a, FR2b, and FR2c</p> <p>Note 3: Divisor of 1.96 is applied as the uncertainty value is based on 95% confidence level k=1.96.</p> <p>Note 4: AWGN flatness and signal flatness has x 0.25 effect on the required SNR. This sensitivity factor shall be considered in the calculation of the test case specific uncertainty.</p> <p>Note 5: Example calculation for fading conditions: Overall system uncertainty for fading conditions comprises five quantities: 1. Total Signal-to-noise ratio uncertainty 2. gNB emulator fading model impairments 3. Effect of AWGN flatness and signal flatness 4. SNR uncertainty due to finite test time 5. Impact on non-ideal isolation between branches for the wireless cable mode Items 1, 2, 3 and 4 are assumed to be uncorrelated so can be root sum squared. Item 5 is systematic and is added: AWGN flatness and signal flatness has x 0.25 effect on the required SNR, so use sensitivity factor of x 0.25 for the uncertainty contribution. Overall system uncertainty = 1.96 x SQRT (Total Signal-to-noise ratio uncertainty² + gNB emulator fading model impairments² + (0.25 x AWGN flatness and signal flatness)² + SNR uncertainty due to finite test time²) + Impact on non-ideal isolation between branches for the wireless cable model</p>	

Table D-1a: Overall system uncertainty for Mode 1 Demodulation Test Cases for PC1 and PC3 (Baseband-Combining Implementation)

Overall system uncertainty	Value
PDSCH 1Tx with Doppler < 100 Hz	1.71
PDSCH 2Tx with Doppler < 100 Hz, rank 1	1.82
PDSCH 2Tx with Doppler < 100 Hz, rank 2	1.67
PDSCH 1Tx with Doppler ≥ 100 Hz	1.67
PDSCH 2Tx with Doppler ≥ 100 Hz, rank 1	1.78
PDSCH 2Tx with Doppler ≥ 100 Hz, rank 2	1.63
PDCCH 1Tx, rank 1	1.74
PDCCH 2Tx, rank 1	1.84

Table D-2: Uncertainty Contributions for Mode 1 Demodulation Test Cases (External-Combining Implementation)

UID	Uncertainty source	Uncertainty value	Distribution of the probability	Divisor	Standard uncertainty (σ) [dB]
Signal-to-noise ratio uncertainty					
Stage 2: DUT measurement					
1	Positioning misalignment		[Normal]	[2.00]	
2	Measure distance uncertainty		[Rectangular]	[1.73]	
3	Quality of Quiet Zone		[Actual]	[1.00]	
4	Mismatch		[Actual]	[1.00]	
5	Standing wave between the DUT and measurement antenna		[U-shaped]	[1.41]	
6	gNB emulator SNR uncertainty		[Normal]	[2.00]	
7	Phase curvature		[U-shaped]	[1.41]	
8	Amplifier uncertainties		[Normal]	[2.00]	
9	Random uncertainty		[Normal]	[2.00]	
10	Influence of the XPD		[U-shaped]	[1.41]	
11	Insertion Loss Variation		[Rectangular]	[1.73]	
12	RF leakage (from measurement antenna to the receiver/transmitter)		[Actual]	[1.00]	
13	Multiple measurement antenna uncertainty		[Actual]	[1.00]	
14	DUT repositioning		[Rectangular]	[1.73]	
Stage 1: Calibration measurement					
15	Mismatch		[U-shaped]	[1.41]	
16	Amplifier Uncertainties		[Normal]	[2.00]	
17	Misalignment of positioning System		[Normal]	[2.00]	
18	Uncertainty of the Network Analyzer		[Normal]	[2.00]	
19	Uncertainty of the absolute gain of the calibration antenna		[Normal]	[2.00]	
20	Positioning and pointing misalignment between the reference antenna and the measurement antenna		[Rectangular]	[1.73]	
21	Phase centre offset of calibration antenna		[Rectangular]	[1.73]	
22	Quality of quiet zone for calibration process		[Actual]	[1.00]	
23	Standing wave between reference calibration antenna and measurement antenna		[U-shaped]	[1.41]	
24	Influence of the calibration antenna feed cable		[Normal]	[2.00]	
25	Insertion Loss Variation		[Rectangular]	[1.73]	
Systematic uncertainties					Value
26	Impact on non-ideal isolation between branches for the wireless cable mode				0.45 (Note 1) 0.60 (Note 2)
Total Signal-to-Noise ratio uncertainty					
Other contributors affecting test result					
27	gNB emulator fading model impairments		[Normal]	[2.00]	
28	AWGN flatness and signal flatness, max deviation for any Resource Block, relative to average over BW_{Config} (Note 3)		[Actual]	1.00	
29	Result variation due to finite test time		[Actual]	[1.00]	
<p>Note 1: applies to Rank 2 test cases for FR2a, FR2b, and FR2c</p> <p>Note 2: applies to Rank 1 test cases for FR2a, FR2b, and FR2c</p> <p>Note 3: AWGN flatness and signal flatness has x 0.25 effect on the required SNR. This sensitivity factor shall be considered in the calculation of the test case specific uncertainty.</p>					

The baseline MU table for Mode 2 (noise free conditions) is shown in Table D-3.

Table D-3: Uncertainty Contributions for Mode 2 Demodulation Test Cases

UID	Uncertainty source	Uncertainty value	Distribution of the probability	Divisor	Standard uncertainty (σ) [dB]
Stage 2: DUT measurement					
1	Positioning misalignment		[Normal]	[2.00]	
2	Measure distance uncertainty		[Rectangular]	[1.73]	
3	Quality of Quiet Zone		[Actual]	[1.00]	
4	Mismatch		[Actual]	[1.00]	
5	Standing wave between the DUT and measurement antenna		[U-shaped]	[1.41]	
6	gNB uncertainty on absolute level		[Normal]	[2.00]	
7	Phase curvature		[U-shaped]	[1.41]	
8	Amplifier uncertainties		[Normal]	[2.00]	
9	Random uncertainty		[Normal]	[2.00]	
10	Influence of the XPD		[U-shaped]	[1.41]	
11	Insertion Loss Variation		[Rectangular]	[1.73]	
12	RF leakage (from measurement antenna to the receiver/transmitter)		[Actual]	[1.00]	
13	Multiple measurement antenna uncertainty		[Actual]	[1.00]	
14	DUT repositioning		[Rectangular]	[1.73]	
Stage 1: Calibration measurement					
15	Mismatch		[U-shaped]	[1.41]	
16	Amplifier Uncertainties		[Normal]	[2.00]	
17	Misalignment of positioning System		[Normal]	[2.00]	
18	Uncertainty of the Network Analyzer		[Normal]	[2.00]	
19	Uncertainty of the absolute gain of the calibration antenna		[Normal]	[2.00]	
20	Positioning and pointing misalignment between the reference antenna and the measurement antenna		[Rectangular]	[1.73]	
21	Phase centre offset of calibration antenna		[Rectangular]	[1.73]	
22	Quality of quiet zone for calibration process		[Actual]	[1.00]	
23	Standing wave between reference calibration antenna and measurement antenna		[U-shaped]	[1.41]	
24	Influence of the calibration antenna feed cable		[Normal]	[2.00]	
25	Insertion Loss Variation		[Rectangular]	[1.73]	
Systematic uncertainties					Value
26	Systematic error related to beam peak search				
27	Impact on non-ideal isolation between branches for the wireless cable mode				0.45 (Note 1) 0.60 (Note 2)
Other contributors affecting test result					
28	Result variation due to finite test time		[Actual]	[1.00]	
Note 1: applies to Rank 2 test cases for FR2a, FR2b, and FR2c					
Note 2: applies to Rank 1 test cases for FR2a, FR2b, and FR2c					

D.1 Uncertainty budget calculation principle

D.1.1 Uncertainty budget calculation principle for DNF

The uncertainty tables cover the actual measurement using the DUT receiver. If applicable, any uncertainty arising from a calibration or alignment process before the measurements should also be included.

The MU budget should comprise of a minimum 5 headings:

- 1) The uncertainty source,
- 2) Uncertainty value,
- 3) Distribution of the probability,
- 4) Divisor based on distribution shape,
- 5) Calculated standard uncertainty (based on uncertainty value and divisor).

D.1.2 Uncertainty budget calculation principle for DFF

The same as defined in D.1.1.

D.1.3 Uncertainty budget calculation principle for IFF

The same as defined in D.1.1.

D.2 Measurement error contribution descriptions

D.2.1 Measurement error contribution descriptions for DNF

D.2.1.1 gNB emulator SNR uncertainty

This contribution originates from setting the ratio of signal and noise in the conducted part of the test system. It is estimated to be the same as for LTE conducted testing in TS 36.521-1 Annex F, which is ± 0.3 dB. The default for values in 36.521-1 Annex F is 95% confidence interval, normal distribution.

D.2.1.2 gNB emulator Downlink EVM

When simulations of demodulation performance are run, the downlink signal is modelled with a defined EVM, representing imperfections in the signal transmitted by the gNB. This EVM value is agreed across companies to align simulations, and is normally lower than the gNB EVM requirement, to represent “typical” conditions. The EVM used for simulations is therefore built in to the requirement points, normally specified as the SNR required to meet a specified throughput, with a defined modulation and Reference channel, under defined propagation conditions.

For a conformance test, the EVM defined for the simulations is taken as a maximum allowed value for the test system, as a worse gNB emulator EVM would make the signal harder to demodulate, and disadvantage the UE. In a test system the EVM cannot normally be set to a specific value, but is specified to be no higher than a defined value.

Following this approach, the uncertainty from gNB emulator Downlink EVM is a one-sided distribution, with beneficial effect. Without treating the positive and negative uncertainties separately, and as it would not make the SNR worse, the effective uncertainty is 0dB.

D.2.1.3 gNB emulator fading model impairments

This contribution originates from imperfections in the gNB emulator fading model, compared to the applied fading model. It is estimated to be the same as for LTE conducted testing in TS 36.521-1 Annex F, which is ± 0.5 dB. The default for values in 36.521-1 Annex F is 95% confidence interval, normal distribution.

D.2.2 Measurement error contribution descriptions for DFF

D.2.2.1 gNB emulator SNR uncertainty

See D.2.1.1.

D.2.2.2 gNB emulator Downlink EVM

See D.2.1.2.

D.2.2.3 gNB emulator fading model impairments

See D.2.1.3.

D.2.3 Measurement error contribution descriptions for IFF

The Measurement uncertainty contributions and uncertainty assessment are expected to be the same as for the Direct near field (DNF) setup in D.2.1.

D.2.3.1 gNB emulator SNR uncertainty

See D.2.1.1.

D.2.3.2 gNB emulator Downlink EVM

See D.2.1.2.

D.2.3.3 gNB emulator fading model impairments

See D.2.1.3.

D.3 Assessment of testable DL SNR range and accuracy

The signal and the noise provided by the test system are both attenuated by the over-the-air link loss. The UE noise then adds to the noise provided by the test system, hence degrading the SNR seen by the UE and potentially limiting the testable SNR range. The calculations and graphs in this clause allow this SNR degradation to be assessed over a range of scenarios.

For conducted tests, the noise provided by the test system can be set much higher than the UE noise and the SNR degradation is negligible. However for over-the-air test systems, the power that can realistically be delivered into the test system probe antenna is limited, so the test point is likely to be closer to the UE noise and a small SNR degradation is allowable.

D.3.1 Method and Parameters

The method is the same as in clause B.2.1.5.1 of TR 38.810 [13], but some values related to the test system are different. The calculation of noise level is described in clause 7.2.1.3 of TR 38.810 [13]. Under fading conditions the backoff is [17.71] dB instead of 13 dB when no fading applies.

D.3.2.1 SNR range for $SNR_{RP} - SNR_{BB} \leq 1\text{dB}$ for DFF

FFS

D.3.2.2 SNR range for $SNR_{RP} - SNR_{BB} \leq 1\text{dB}$ for IFF

Based on the method of setting the noise from the Test system to give a maximum of 1dB degradation in overall SNR between reference point and baseband, we can then work back through the signal chain to determine how high the SNR can be set. As the noise is set to a fixed level, the maximum SNR is set by the test system power amplifier and the channel bandwidth to be tested.

The SNR upper bound depends on the type of test system. For the Indirect Far field (IFF) setup the diagram below illustrates the principle, and is based on the “IFF 100MHz (n257, n258, n261)” tab of the accompanying spreadsheet.

The process works back through the signal chain, from left to right in the diagram.

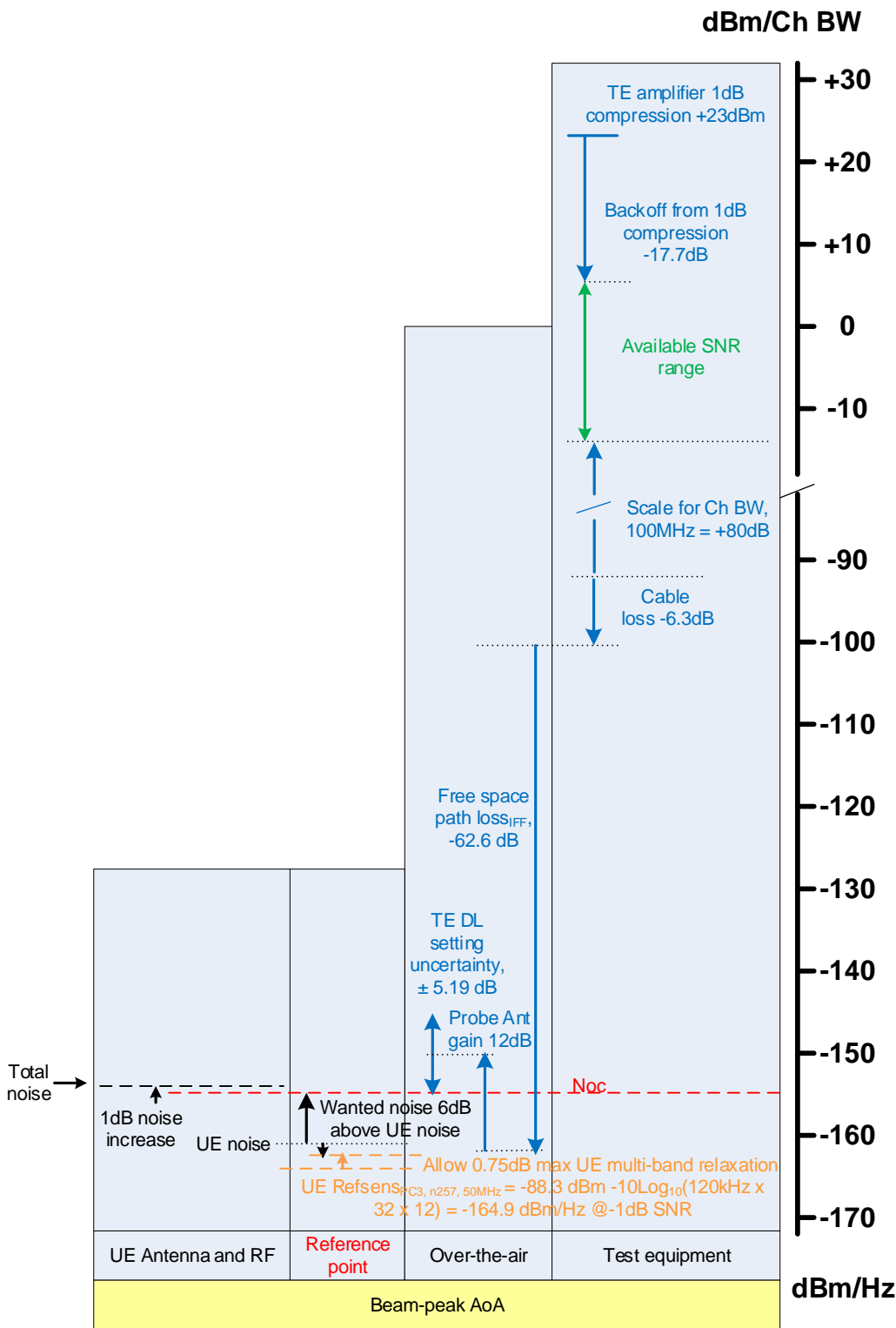

Figure D.3.2.2-1: Estimation of single band UE SNR range for Indirect far field (IFF) when no fading applies

The test equipment must supply at least the wanted noise level at the reference point. If the noise was lower, the degradation in SNR would be greater than 1dB, and may cause a conformant UE to fail.

For mode2 (noise free) scenarios, the expected SNR at the UE reference point is determined by the level of wanted signal power set by the TE above the UE REFSSENS point.

The accuracy of setting the signal and noise levels has been taken as ± 5.19 dB.

Inclusion of this contribution directly reduces the maximum SNR that can be measured by a test system for a given channel bandwidth.

To find the maximum SNR that can be measured by a test system with a specific Channel BW, the baseband SNR in the spreadsheet is increased until the value “Wanted signal + headroom, dBm/Ch BW” is just below the “Available DL power at CW 1dB compression at QZ, dBm” value. For fading conditions, the “Backoff from P1dB” with a value of -11.08 dB valid for modulations up to 64 QAM has been applied. In the case without fading with added noise, the “Backoff from P1dB” is [-13] dB valid for modulations up to 64 QAM. The resulting values for SNR_{BB} are given in Table D.3.2.2-1 for tests cases making use of fading, D.3.2.2-2 for test cases without fading with added Noise.

Single band UE values are obtained by setting the UE multi-band relaxation factor to 0 dB.

Table D.3.2.2-1: Predicted SNR_{BB} upper bound values for Indirect far field (IFF) with 30cm QZ, PC3, 100MHz CHBW, modulation up to 64 QAM under fading conditions

	Operating Band	Maximum SNR _{BB} (dB)		
		CHBW 50 MHz	CHBW 100 MHz	CHBW 200 MHz
Multi-band UE (Note)	n257	30.6	27.5	24.4
	n258	30.6	27.5	24.4
	n259	20.4	17.2	14.1
	n260	24.4	21.2	18.2
	n261	30.6	27.5	24.4
Note: For \sum MBp from TS 38.101-2 [16] Table 6.2.1.3-4 allow up to 0.75 dB in Rel-15.				

Table D.3.2.2-2: Predicted SNR_{BB} upper bound values for Indirect far field (IFF) with 30cm QZ, PC3, 100MHz CHBW, modulation up to 64 QAM when no fading conditions apply

	Operating Band	Maximum SNR _{BB} (dB)		
		CHBW 50 MHz	CHBW 100 MHz	CHBW 200 MHz
Multi-band UE (Note)	n257	[28.7]	[25.5]	[22.5]
	n258	[28.7]	[25.5]	[22.5]
	n259	[18.4]	[15.2]	[12.1]
	n260	[22.5]	[19.3]	[16.3]
	n261	[28.7]	[25.5]	[22.5]
Note: For \sum MBp from TS 38.101-2 [16] Table 6.2.1.3-4 allow up to 0.75 dB in Rel-15.				

For mode2 (noise free) scenarios, the maximum baseband SNR that can be achieved by a test system is calculated in the spreadsheet “Mode2 100MHz”. For other channel bandwidths the respective N_{RB} and EIS_{PC3, band} are to be used.

For the “Backoff from P1dB” a value of -13dB has been applied which is valid for modulations up to 64QAM. The resulting values for SNR_{BB} are given in D.3.2.2-3 for test cases without fading and without added noise.

Table D.3.2.2-3: Predicted SNR_{BB} upper bound values for Indirect far field (IFF) with 30cm QZ, PC3, 100MHz CHBW, modulation up to 64 QAM when no fading conditions and no added noise apply

	Operating Band	Maximum SNR _{BB} (dB)		
		CHBW 50 MHz	CHBW 100 MHz	CHBW 200 MHz
Multi-band UE (Note)	n257	[35.56]	[32.56]	[29.56]
	n258	[35.56]	[32.56]	[29.56]

	n259	[25.36]	[22.36]	[19.36]
	n260	[29.36]	[26.36]	[23.36]
	n261	[35.56]	[32.56]	[29.56]
Note1: For \sum MBp from TS 38.101-2 [16] Table 6.2.1.3-4 allow up to 0.75 dB in Rel-15.				

Note that these are UE baseband SNR values (SNR_{BB}), so the Reference point figures used in TS 38.101-4 [19] will be 1 dB higher.

Table D.3.2.2-4: Predicted SNR_{BB} upper bound values for Indirect far field (IFF) with 30cm QZ, PC3, 100MHz CHBW, modulation up to 256 QAM under fading conditions for DEMOD scenarios

Operating Band / Frequency	Maximum testable SNR_{BB} (dB)		
	CHBW 50 MHz	CHBW 100 MHz	CHBW 200 MHz
n257 mid	29.1	25.9	22.9
n258 mid	29.1	25.9	22.9
n259 mid	18.8	15.6	12.5
n260 mid	22.9	19.7	16.6
n261 mid	29.1	25.9	22.9

Table D.3.2.2-5: Predicted SNR_{BB} upper bound values for Indirect far field (IFF) with 30cm QZ, PC1, 100MHz CHBW, modulation up to 256 QAM under fading conditions for DEMOD scenarios

Operating Band / Frequency	Maximum testable SNR_{BB} (dB)		
	CHBW 50 MHz	CHBW 100 MHz	CHBW 200 MHz
n257 mid	39.0	35.9	32.9
n258 mid	39.0	35.9	32.9
n259 mid	TBD	TBD	TBD
n260 mid	32.4	29.3	26.3
n261 mid	39.0	35.9	32.9

Table D.3.2.2-6: Predicted SNR_{BB} upper bound values for Indirect far field (IFF) with 30cm QZ, PC3, 100MHz CHBW, modulation up to 256 QAM under fading conditions for CSI scenarios

Operating Band / Frequency	Maximum testable SNR_{BB} (dB)		
	CHBW 50 MHz	CHBW 100 MHz	CHBW 200 MHz
n257 mid	26.3	23.2	20.1
n258 mid	26.3	23.2	20.1
n259 mid	16.0	12.8	9.6
n260 mid	20.1	16.9	13.8
n261 mid	26.3	23.2	20.1

Table D.3.2.2-7: Predicted SNR_{BB} upper bound values for Indirect far field (IFF) with 30cm QZ, PC3, 100MHz CHBW, modulation up to 256 QAM with no fading conditions for CSI scenarios

Operating Band / Frequency	Maximum testable SNR_{BB} (dB)		
	CHBW 50 MHz	CHBW 100 MHz	CHBW 200 MHz
n257 mid	28.7	25.5	22.5
n258 mid	28.7	25.5	22.5
n259 mid	18.4	15.2	12.1
n260 mid	22.5	19.3	16.3
n261 mid	28.7	25.5	22.5

An example of SNR calculation for IFF method is provided in “38.521-4 Spreadsheet - Demod SNR range calculator.zip” file attached to the TR.

D.4 Simulation results

During the MU discussions to determine the maximum testable SNR for IFF setup with PC3 30cm QZ, it was found that using a conservative “backoff from P1 dB” value (where signal backoff and fading crest factor were considerably independently), caused most of the RAN4 defined test points to be untestable.

By simulating the CCDF of RAN4 defined signal waveform and faded signal waveform, it was concluded to consider the faded signal crest factor instead of independently adding signal crest factor and fading crest factor.

Figure D.4-1 below captures the CCDF of test 2-6 from table 7.2.2.2.1_1.4-2 of TS 38.521-4 which was considered as the scenario with highest faded signal crest factor for 64QAM.

For the simulation, actual signal corresponding to the RAN4 defined scenarios was generated and the appropriate fading profile as specified in the requirement was applied. Simulations were run for $4 \cdot 10^8$ samples.

In figure D.4-1, Hx denotes the actual RAN4 signal per Rx after fading is applied. The value in dB against each legend correspond to the computed PAPR for that signal and faded signal

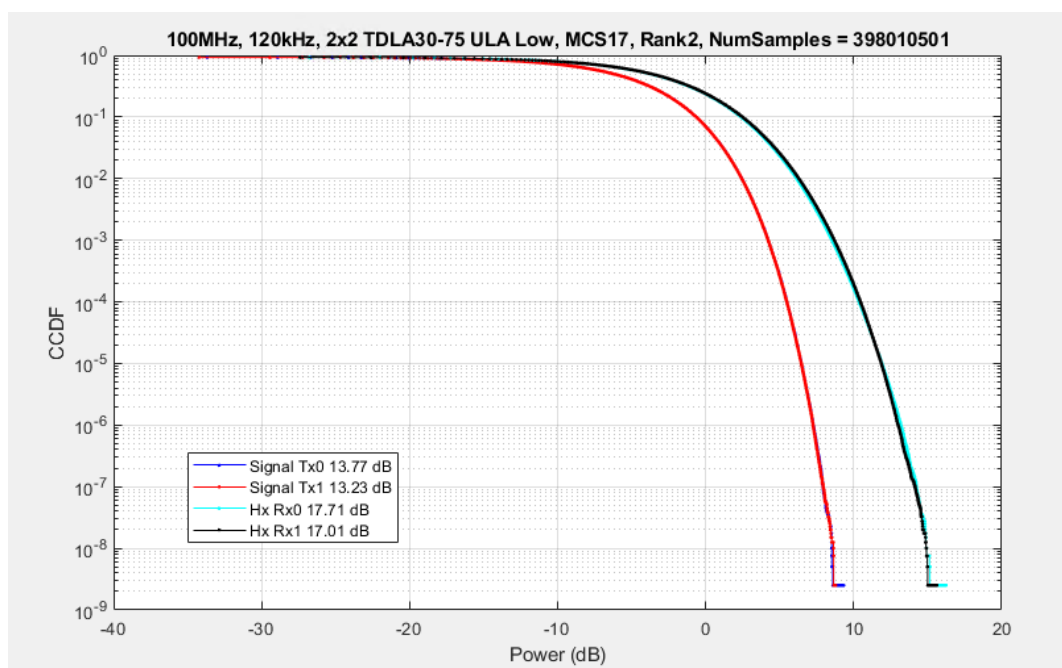

Figure D.4-1: CCDF of Test2-6 signal power and signal power after fading

Considering the max PAPR value of the faded signal allowed some more test points to be testable. In order to make more test points testable, higher probability of saturation of faded signal needed to be considered.

In order to determine how much faded signal clipping probability did not adversely impact the UE’s capability to successfully decode the PDSCH signal, simulations were run for most of the 64QAM and 256QAM test points defined in TS 38.521-4.

Two companies participated in providing the simulation results. Below tables and figures capture the simulation results from the 2 companies that was used to determine the faded signal clipping probability to be used for the “backoff from P1 dB” term.

Table D.4-1: Faded signal PAPR at different clipping probability for all test points defined in TS 38.521-4 (Company 1)

	Test#	Fading	MCS	Test SNR	numSamples	Mean Signal Pwr (Rx0/Rx1)	Mean Faded signal Pwr (Rx0/Rx1)	Signal PAPR (Rx0/Rx1)	Faded Signal PAPR (Rx0/Rx1)	Faded Signal PAPR at 1e-6 clipping prob	Faded Signal PAPR at 1e-4 clipping prob	Faded Signal PAPR at 1e-3 clipping prob	
1	1-1	TDLC60-300 Low	QPSK	1.4	1.23E+08	-4.44 -4.45	-1.39 -1.37	12.89 13.08	16.87 17.40				
2	1-2	TDLA30-300 Low	16QAM	3.6					leverage from 2-2				
3	1-3	TDLA30-300 XPL Med	64QAM	14.2	1.23E+08	-4.44 -4.45	-1.52 -1.39	13.04 13.15	17.78 18.20	15.72 16.21		8.24 8.4	
4	1-4	TDLD30-75 Low	256QAM	21.9	9.22E+07	-4.58 -4.59	-1.72 -1.60	13.31 13.29	17.0 16.24	15.08 14.82	12.62 12.5	10.96 10.84	
5	2-1	TDLA30-75 Low	QPSK	5.8					leverage from 2-6				
6	2-2	TDLA30-300 Low	16QAM	16	1.23E+08	-4.44 -4.45	-1.5 -1.43	12.95 12.96	16.37 16.52				
7	2-6	TDLA30-75 Low	64QAM	20.3	3.98E+08	-4.44	-1.54	13.77 13.23	17.77 17.01	14.73 14.54			
8	3-1	TDLA30-75 ULA Medium	16QAM	20.7	1.23E+08	-4.44 -4.45	-1.71 -1.78	12.95 12.96	16.03 16.48	14.19 14.55			
9	8.2.2.2.2	TDLA30-35 ULA High	256QAM	6/7, 12/13, 7/8, 20/21	9.22E+07	-4.59 -4.59	-1.70 -1.90	12.86 12.82	19.24 20.72	17.69 19.05	14.74 15.36	12.64 12.96	
10	8.3.2.2.1	TDLA30-35 Low	16QAM		1.23E+08	-4.45 -4.45	-1.86 -1.96	12.76 12.85	17.80 17.19	15.35 15.45			
11	8.4.2.2 Test1/2	TDLA30-35 Low	64QAM	0,16	1.23E+08	-4.45 -4.45	-1.86 -2.0	13.46 12.90	15.98 15.86				
12	8.4.2.2 Test3	TDLA30-35 XP High	64QAM	16	1.23E+08	-4.45 -4.45	-1.80 -2.07	13.25 13.27	16.99 18.05	15.57 15.54			
13	8.4.2.2 Test3	TDLA30-35 XP High	64QAM	16	1.23E+08	-4.45 -4.45	-1.86 -2.08	13.46 12.90	15.42 15.77				
14	8.2.2.2.1.1	AWGN only	64QAM	8/9, 14/15		Signal PAPR already available as part of other cases							

Table D.4-2: Throughput values for key test points at different faded signal clipping probabilities (Company 1)

Test#	Test SNR	Scenario	1E-06	1E-04	1E-03	1E-02
1-3	14.2	64QAM Demod	100%	100%	100%	100%
2-6	20.3	64QAM Demod	100%	100%	100%	100%
1-4	22	256QAM Demod	100%	100%	100%	83%
8.2.2.2.2	13	64QAM CSI	100%	100%	100%	98%
8.2.2.2.2	21	256QAM CSI	100%	100%	97%	85%

Note: All throughput values normalized to the no faded signal clipping case

Table D.4-3: Faded signal PAPR at different clipping probability for 256QAM test 1-4 (Company 2)

Clipping probability	PAPR (dB)
1e-6	15.43
1e-5	14.43
1e-4	13.18
1e-3	11.69
1e-2	9.79
1e-1	7.11

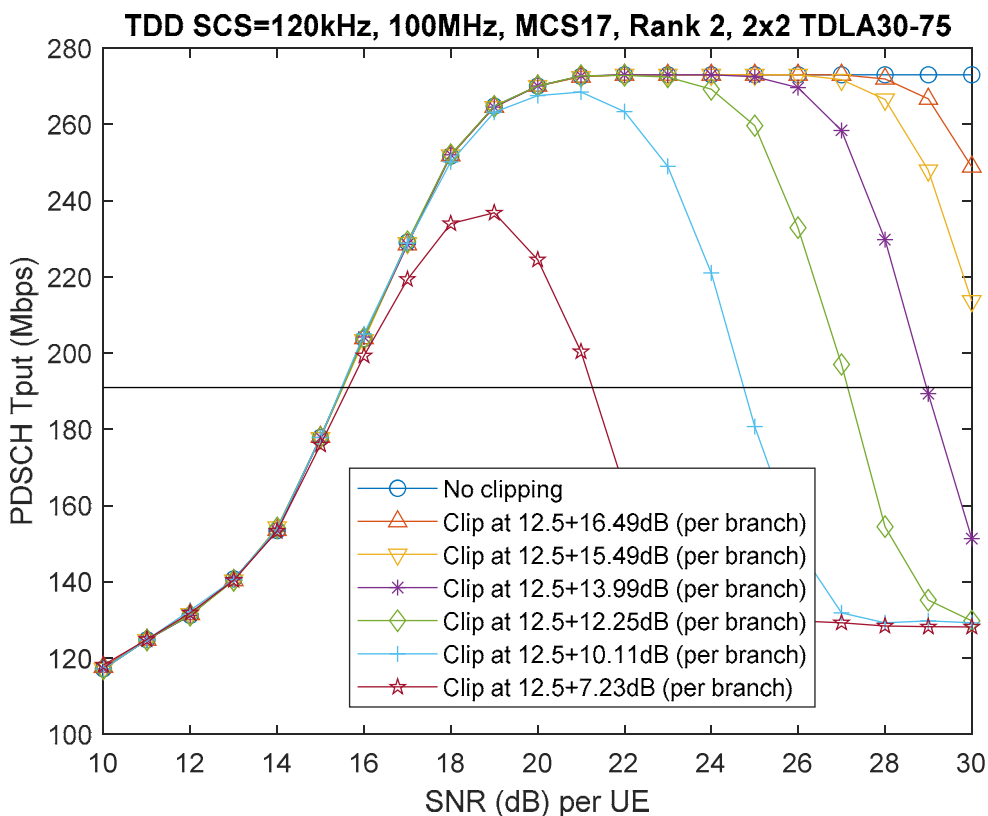

Figure D.4-2: Throughput vs SNR for 64QAM test 2-6 at different faded signal clipping probabilities (Company 2)

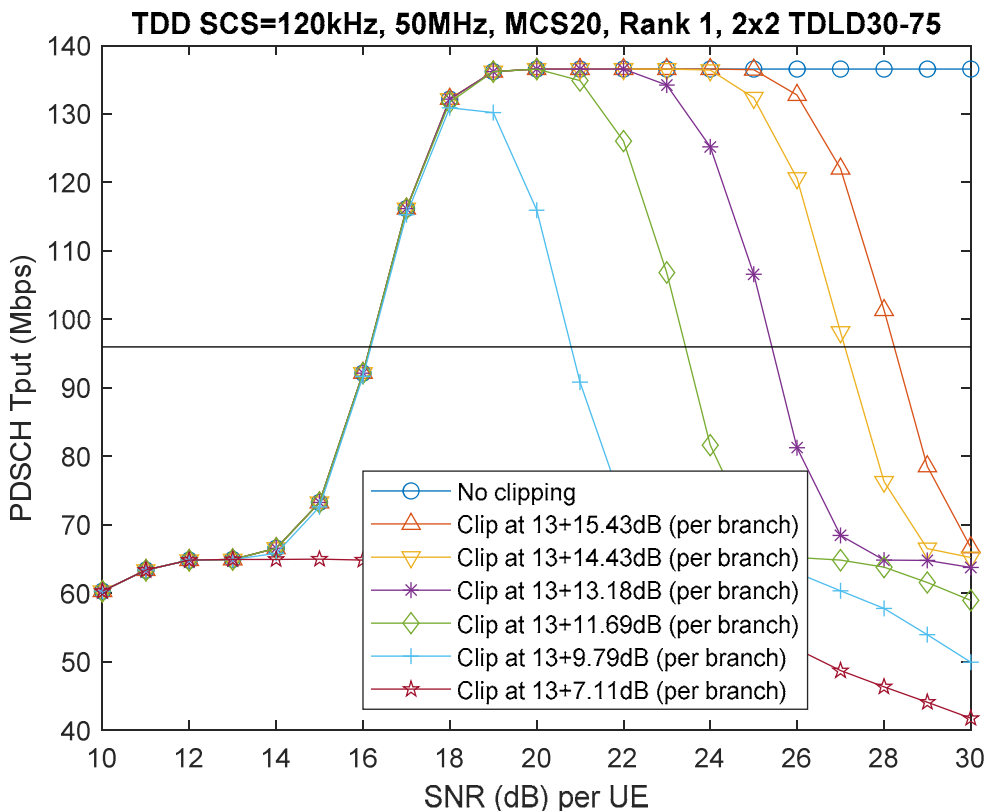

Figure D.4-3: Throughput vs SNR for 256QAM test at different faded signal clipping probabilities (Company 2)

Based on the above simulation results,

For 64QAM scenarios (both Demod and CSI), fading backoff margin of 11.08 dB corresponding to the 1e-3 faded signal clipping probability was considered.

For 256QAM Demod, fading backoff margin of 12.62 dB corresponding to 1e-3 fading signal clipping probability was considered.

For 256QAM CSI scenarios, fading backoff margin of 15.36 dB corresponding to 1e-4 fading signal clipping probability was considered.

Annex E: Acceptable uncertainty of test system for test cases defined in TS 38.533 for radiative testing

This annex contains suggested uncertainties for each test case or MU quantity in TS 38.533 [10].

E.1 Uncertainty budget calculation principle

E.1.1 Uncertainty budget calculation principle for DFF

The uncertainty tables cover the actual measurement using the DUT. In some cases, uncertainty may also arise from a calibration or alignment process before the measurements.

When a calibration process is used before the measurements, the uncertainty tables should be presented with two stages:

- Stage 1: the calibration of the absolute level of the DUT measurement results is performed by means of using a calibration antenna whose absolute gain is known at the frequencies of measurement
- Stage 2: the actual measurement with the DUT as either the transmitter or receiver is performed.

The MU budget should comprise of a minimum 5 headings:

- 1) The uncertainty source,
- 2) Uncertainty value,
- 3) Distribution of the probability,
- 4) Divisor based on distribution shape,
- 5) Calculated standard uncertainty (based on uncertainty value and divisor).

E.1.2 Uncertainty budget calculation principle for IFF

The same as defined in E.1.1.

E.2 Measurement error contribution descriptions

E.2.1 Measurement error contribution descriptions for DFF

All the measurement error contributions defined in Section B.2.1, with the following additions.

E.2.1.1 gNB emulator SNR uncertainty

See D.2.1.1.

E.2.1.2 gNB emulator Downlink EVM

See D.2.1.2.

E.2.1.3 gNB emulator fading model impairments

See D.2.1.3.

E.2.2 Measurement error contribution descriptions for IFF

All the measurement error contributions defined in Section B.2.2, with the following additions.

E.2.2.1 gNB emulator SNR uncertainty

See D.2.1.1.

E.2.2.2 gNB emulator Downlink EVM

See D.2.1.2.

E.2.2.3 gNB emulator fading model impairments

See D.2.1.3.

E.3 Uncertainty assessment for RRM MU quantities.

RRM measurement uncertainty analysis shall define the values for the following MU quantities:

- DL AWGN absolute power or wanted DL signal absolute power
- DL applied SNR
- DL Fading profile uncertainty
- DL AWGN and signal flatness
- UL absolute power measurement
- UL relative power measurement
- UL signal transmit timing relative to DL
- Relative transmit timing accuracy during UE timing adjustment

E.3.1 Uncertainty assessment for DL AWGN absolute power or wanted DL signal absolute power

Table E.3.1-1 summarizes the MU threshold for DL AWGN absolute power for RRM FR2 test cases. The origin MU values for different test setups with varies parameters can be found in following subclauses.

Table E.3.1-1: MU threshold for DL AWGN absolute power for RRM FR2

Power Class	Frequency	MBW	Power	Threshold MU value (NOTE 1)
PC3	23.45GHz <= f <= 32.125GHz	BW <= 400MHz	As configured in the test case	5.65 dB ²
	32.125GHz < f <= 40.8GHz			5.65 dB ²
PC1	23.45GHz <= f <= 32.125GHz	BW <= 400MHz	As configured in the test case	FFS
	32.125GHz < f <= 40.8GHz			FFS
NOTE 1: Total Expanded MU for IFF for Quiet Zone size ≤ 30cm in Table E.3.1.3-2 for PC3 UEs and Table FFS for PC1 UEs				
NOTE 2: If the TT analysis for a specific test case based on this MU value results in an unsolvable conflict, making the test case untestable, even after the alternative solutions listed in clause A.4 have been considered for the test case in TS 38.133 [6] Annex A, the TT analysis shall be repeated using a lower MU value, taking into account the lower values defined in this clause. The test case will be applicable for the subset of the test systems meeting this reduced MU Threshold.				

The types of test setup are defined in clause 7.1.3.2 of TS 38.508-1 [18]

E.3.1.1 Uncertainty budget format and assessment for DFF test setup

The uncertainty contributions that may impact the overall MU value are listed in Table E.3.1.1-1.

Table E.3.1.1-1: Uncertainty contributions for DL AWGN absolute power or wanted DL signal absolute power

UID	Description of uncertainty contribution	Details in annex
Stage 2: DUT measurement		
1	Positioning misalignment	B.2.1.1
2	Measure distance uncertainty	B.2.1.2
3	Quality of Quiet Zone	B.2.1.3
4	Mismatch	B.2.1.4
5	Standing wave between the DUT and measurement antenna	B.2.1.5
6	gNB emulator uncertainty	B.2.1.17
7	Phase curvature	B.2.1.7
8	Amplifier uncertainties	B.2.1.8
9	Random uncertainty	B.2.1.9
10	Influence of the XPD	B.2.1.10
11	Insertion Loss Variation	B.2.1.11
12	RF leakage (from measurement antenna to the receiver/transmitter)	B.2.1.12
13	Multiple measurement antenna uncertainty	B.2.1.25
14	DUT repositioning	B.2.1.26
Stage 1: Calibration measurement		
15	Mismatch	B.2.1.4
16	Amplifier Uncertainties	B.2.1.8
17	Misalignment of positioning System	B.2.1.13
18	Uncertainty of the Network Analyzer	B.2.1.14
19	Uncertainty of the absolute gain of the calibration antenna	B.2.1.15
20	Positioning and pointing misalignment between the reference antenna and the measurement antenna	B.2.1.16
21	Phase centre offset of calibration antenna	B.2.1.18
22	Quality of quiet zone for calibration process	B.2.1.19
23	Standing wave between reference calibration antenna and measurement antenna	B.2.1.20
24	Influence of the calibration antenna feed cable	B.2.1.21
25	Insertion Loss Variation	B.2.1.11
Systematic uncertainties		
26	Systematic error related to beam peak search	B.2.1.28

The uncertainty assessment tables are organized as follows:

- For the purpose of uncertainty assessment, the radiating antenna aperture of the DUT is denoted as D
- The uncertainty assessment has been derived for the case of Quiet Zone size $\leq [30 \text{ cm}]$, $f = \{23.45\text{GHz}, 32.125\text{GHz}, 40.8\text{GHz}\}$.
- The uncertainty assessment is applicable for 1AoA and 2AoA test cases
- The uncertainty assessment is provided in Table E.3.1.1-2.

Table E.3.1.1-2: Uncertainty assessment for DL AWGN absolute power or wanted DL signal absolute power (f=23.45GHz, 32.125GHz, 40.8GHz, Quiet Zone size ≤ 30 cm)

UID	Uncertainty source	Uncertainty value	Distribution of the probability	Divisor	Standard uncertainty (σ) [dB]
Stage 2: DUT measurement					
1	Positioning misalignment	0.00	Normal	2.00	0.00
2	Measure distance uncertainty	0.15	Rectangular	1.73	0.08
3	Quality of Quiet Zone (NOTE 4)	1.2	Actual	1.00	1.2
4	Mismatch	1.30	Actual	1.00	1.30
5	Standing wave between the DUT and measurement antenna	0.00	U-shaped	1.41	0.00
6	gNB uncertainty on absolute level	2.9	Normal	2.00	1.45
7	Phase curvature	0.00	U-shaped	1.41	0.00
8	Amplifier uncertainties	2.1	Normal	2.00	1.05
9	Random uncertainty	0.50	Normal	2.00	0.25
10	Influence of the XPD	0.06	U-shaped	1.41	0.043
11	Insertion Loss Variation	0.00	Rectangular	1.73	0.00
12	RF leakage (from measurement antenna to the receiver/transmitter)	0.00	Actual	1.00	0.00
13	Multiple measurement antenna uncertainty (NOTE 3)	0.15	Actual	1.00	0.15
14	DUT repositioning	0.08	Rectangular	1.73	0.05
Stage 1: Calibration measurement					
15	Mismatch	0.00	U-shaped	1.41	0.00
16	Amplifier Uncertainties	0.00	Normal	2.00	0.00
17	Misalignment of positioning System	0.00	Normal	2.00	0.00
18	Uncertainty of the Network Analyzer	0.73	Normal	2.00	0.37
19	Uncertainty of the absolute gain of the calibration antenna	0.60	Normal	2.00	0.30
20	Positioning and pointing misalignment between the reference antenna and the measurement antenna	0.01	Rectangular	1.73	0.00
21	Phase centre offset of calibration antenna	0.47	Rectangular	1.73	0.27
22	Quality of quiet zone for calibration process (NOTE 4)	0.4	Actual	1.00	0.4
23	Standing wave between reference calibration antenna and measurement antenna	0.00	U-shaped	1.41	0.00
24	Influence of the calibration antenna feed cable	0.14	Normal	2.00	0.07
25	Insertion Loss Variation	0.00	Rectangular	1.73	0.00
Systematic uncertainties (NOTE 2)					Value
26	Systematic error related to beam peak search				0.5
Total measurement uncertainty					Value
DL AWGN absolute power or wanted DL signal absolute power expanded uncertainty (1.96 σ - confidence interval of 95 %) [dB]					5.65
NOTE 1: The analysis was done only for the case of operating in-band, non-CA.					
NOTE 2: In order to obtain the total measurement uncertainty, systematic uncertainties have to be added to the expanded root sum square of the standard deviations of the Stage 1 and Stage 2 contributors.					
NOTE 3: Applies to the system which has a structure of mechanical feed antenna positioning.					
NOTE 4: Value based on procedure defined in Annex D.2 of TR 38.810 [13] for Quiet Zone size less or equal to 30 cm.					
NOTE 5: The values in this table have been derived for DL powers above and equal to REFSENS. The values might need to be revisited for power levels below REFSENS					

E.3.1.2 Uncertainty budget format and assessment for Simplified DFF test setup

[FFS]

E.3.1.3 Uncertainty budget format and assessment for IFF test setup

The uncertainty contributions that may impact the overall MU value are listed in Table E.3.1.3-1.

Table E.3.1.3-1: Uncertainty contributions for DL AWGN absolute power or wanted DL signal absolute power

UID	Description of uncertainty contribution	Details in annex
Stage 2: DUT measurement		
1	Positioning misalignment	B.2.2.1
2	Measure distance uncertainty	B.2.2.2
3	Quality of Quiet Zone	B.2.2.3
4	Mismatch	B.2.2.4
5	Standing wave between the DUT and measurement antenna	B.2.2.5
6	gNB emulator uncertainty	B.2.2.17
7	Phase curvature	B.2.2.7
8	Amplifier uncertainties	B.2.2.8
9	Random uncertainty	B.2.2.9
10	Influence of the XPD	B.2.2.10
11	Insertion Loss Variation	B.2.2.11
12	RF leakage (from measurement antenna to the receiver/transmitter)	B.2.2.12
13	Multiple measurement antenna uncertainty	B.2.2.25
14	DUT repositioning	B.2.2.26
Stage 1: Calibration measurement		
15	Mismatch	B.2.2.4
16	Amplifier Uncertainties	B.2.2.8
17	Misalignment of positioning System	B.2.2.13
18	Uncertainty of the Network Analyzer	B.2.2.14
19	Uncertainty of the absolute gain of the calibration antenna	B.2.2.15
20	Positioning and pointing misalignment between the reference antenna and the measurement antenna	B.2.2.16
21	Phase centre offset of calibration antenna	B.2.2.18
22	Quality of quiet zone for calibration process	B.2.2.19
23	Standing wave between reference calibration antenna and measurement antenna	B.2.2.20
24	Influence of the calibration antenna feed cable	B.2.2.21
25	Insertion Loss Variation	B.2.2.11
Systematic uncertainties		
26	Systematic error related to beam peak search	B.2.2.28

The uncertainty assessment tables are organized as follows:

- For the purpose of uncertainty assessment, the radiating antenna aperture of the DUT is denoted as D
- The uncertainty assessment has been derived for the case of Quiet Zone size $\leq [30 \text{ cm}]$, $f = \{23.45\text{GHz}, 32.125\text{GHz}, 40.8\text{GHz}\}$.
- The uncertainty assessment is applicable for 1AoA test cases- The uncertainty assessment is provided in Table E.3.1.3-2.

Table E.3.1.3-2: Uncertainty assessment for DL AWGN absolute power or wanted DL signal absolute power (f=23.45GHz, 32.125GHz, 40.8GHz, Quiet Zone size ≤ 30 cm)

UID	Uncertainty source	Uncertainty value	Distribution of the probability	Divisor	Standard uncertainty (σ) [dB]
Stage 2: DUT measurement					
1	Positioning misalignment	0.00	Normal	2.00	0.00
2	Measure distance uncertainty	0.00	Rectangular	1.73	0.00
3	Quality of Quiet Zone (NOTE 4)	0.6	Actual	1.00	0.6
4	Mismatch	1.30	Actual	1.00	1.30
5	Standing wave between the DUT and measurement antenna	0.00	U-shaped	1.41	0.00
6	gNB uncertainty on absolute level	2.9	Normal	2.00	1.45
7	Phase curvature	0.00	U-shaped	1.41	0.00
8	Amplifier uncertainties	2.1	Normal	2.00	1.05
9	Random uncertainty	0.50	Normal	2.00	0.25
10	Influence of the XPD	0.01	U-shaped	1.41	0.00
11	Insertion Loss Variation	0.00	Rectangular	1.73	0.00
12	RF leakage (from measurement antenna to the receiver/transmitter)	0.00	Actual	1.00	0.00
13	Multiple measurement antenna uncertainty (NOTE 3)	0.15	Actual	1.00	0.15
14	DUT repositioning	0.08	Rectangular	1.73	0.05
Stage 1: Calibration measurement					
15	Mismatch	0.00	U-shaped	1.41	0.00
16	Amplifier Uncertainties	0.00	Normal	2.00	0.00
17	Misalignment of positioning System	0.00	Normal	2.00	0.00
18	Uncertainty of the Network Analyzer	0.73	Normal	2.00	0.37
19	Uncertainty of the absolute gain of the calibration antenna	0.60	Normal	2.00	0.30
20	Positioning and pointing misalignment between the reference antenna and the measurement antenna	0.01	Rectangular	1.73	0.00
21	Phase centre offset of calibration antenna	0.00	Rectangular	1.73	0.00
22	Quality of quiet zone for calibration process (NOTE 4)	0.4	Actual	1.00	0.4
23	Standing wave between reference calibration antenna and measurement antenna	0.00	U-shaped	1.41	0.00
24	Influence of the calibration antenna feed cable	0.14	Normal	2.00	0.07
25	Insertion Loss Variation	0.00	Rectangular	1.73	0.00
Systematic uncertainties (NOTE 2)					Value
26	Systematic error related to beam peak search				0.5
Total measurement uncertainty					Value
DL AWGN absolute power expanded uncertainty (1.96 σ - confidence interval of 95 %) [dB]					5.19
NOTE 1: The analysis was done only for the case of operating in-band, non-CA.					
NOTE 2: In order to obtain the total measurement uncertainty, systematic uncertainties have to be added to the expanded root sum square of the standard deviations of the Stage 1 and Stage 2 contributors.					
NOTE 3: Applies to the system which has a structure of mechanical feed antenna positioning.					
NOTE 4: Value based on procedure defined in Annex D.2 of TR 38.810 [13] for Quiet Zone size less or equal to 30 cm.					
NOTE 5: The values in this table have been derived for DL powers above and equal to REFSENS. The values might need to be revisited for power levels below REFSENS					

Table E.3.1.3-3: Uncertainty assessment for DL AWGN absolute power or wanted DL signal absolute power (f=23.45GHz, 32.125GHz, Quiet Zone size ≤ 30 cm), PC1

UID	Uncertainty source	Uncertainty value	Distribution of the probability	Divisor	Standard uncertainty (σ) [dB]
Stage 2: DUT measurement					
1	Positioning misalignment	0.02	Normal	2.00	0.01
2	Measure distance uncertainty	0.00	Rectangular	1.73	0.00
3	Quality of Quiet Zone (NOTE 4)	0.6	Actual	1.00	0.6
4	Mismatch	1.30	Actual	1.00	1.30
5	Standing wave between the DUT and measurement antenna	0.00	U-shaped	1.41	0.00
6	gNB uncertainty on absolute level	2.9	Normal	2.00	1.45
7	Phase curvature	0.00	U-shaped	1.41	0.00
8	Amplifier uncertainties	[2.1]	Normal	2.00	[1.05]
9	Random uncertainty	0.50	Normal	2.00	0.25
10	Influence of the XPD	0.01	U-shaped	1.41	0.00
11	Insertion Loss Variation	0.00	Rectangular	1.73	0.00
12	RF leakage (from measurement antenna to the receiver/transmitter)	0.00	Actual	1.00	0.00
13	Multiple measurement antenna uncertainty (NOTE 3)	0.15	Actual	1.00	0.15
14	DUT repositioning	0.35	Rectangular	1.73	0.20
Stage 1: Calibration measurement					
15	Mismatch	0.00	U-shaped	1.41	0.00
16	Amplifier Uncertainties	0.00	Normal	2.00	0.00
17	Misalignment of positioning System	0.00	Normal	2.00	0.00
18	Uncertainty of the Network Analyzer	1.50	Normal	2.00	0.75
19	Uncertainty of the absolute gain of the calibration antenna	0.60	Normal	2.00	0.30
20	Positioning and pointing misalignment between the reference antenna and the measurement antenna	0.01	Rectangular	1.73	0.00
21	Phase centre offset of calibration antenna	0.00	Rectangular	1.73	0.00
22	Quality of quiet zone for calibration process (NOTE 4)	0.4	Actual	1.00	0.4
23	Standing wave between reference calibration antenna and measurement antenna	0.00	U-shaped	1.41	0.00
24	Influence of the calibration antenna feed cable	0.14	Normal	2.00	0.07
25	Insertion Loss Variation	0.00	Rectangular	1.73	0.00
Systematic uncertainties (NOTE 2)					Value
26	Systematic error related to beam peak search				0.7
Total measurement uncertainty					Value
DL AWGN absolute power expanded uncertainty (1.96 σ - confidence interval of 95 %) [dB]					[5.58]
NOTE 1: The analysis was done only for the case of operating in-band, non-CA.					
NOTE 2: In order to obtain the total measurement uncertainty, systematic uncertainties have to be added to the expanded root sum square of the standard deviations of the Stage 1 and Stage 2 contributors.					
NOTE 3: Applies to the system which has a structure of mechanical feed antenna positioning.					
NOTE 4: Value based on procedure defined in Annex D.2 of TR 38.810 [13] for Quiet Zone size less or equal to 30 cm.					
NOTE 5: The values in this table have been derived for DL powers above and equal to REFSENS. The values might need to be revisited for power levels below REFSENS					

E.3.1.4 Uncertainty budget format and assessment for Enhanced IFF test setup

The uncertainty contributions that may impact the overall MU value are listed in Table E.3.1.4-1.

Table E.3.1.4-1: Uncertainty contributions for DL AWGN absolute power or wanted DL signal absolute power

UID	Description of uncertainty contribution	Details in annex
Stage 2: DUT measurement		
1 to 14	See 1-14 of Table E.3.1.3-1	N/A
Stage 1: Calibration measurement		
15 to 25	See 15-25 of Table E.3.1.3-1	N/A
Systematic uncertainties		
26	See 26 of Table E.3.1.3-1	N/A

The uncertainty assessment tables are organized as follows:

- For the purpose of uncertainty assessment, the radiating antenna aperture of the DUT is denoted as D
- The uncertainty assessment has been derived for the case of Quiet Zone size $\leq [30 \text{ cm}]$, $f = \{23.45\text{GHz}, 32.125\text{GHz}, 40.8\text{GHz}\}$.
- The uncertainty assessment is applicable for 1AoA and 2AoA test cases
- The uncertainty assessment is provided in Table E.3.1.4-2.

Table E.3.1.4-2: Uncertainty assessment for fDL AWGN absolute power or wanted DL signal absolute power (f=23.45GHz, 32.125GHz, 40.8GHz, Quiet Zone size ≤ 30 cm)

UID	Uncertainty source	Uncertainty value	Distribution of the probability	Divisor	Standard uncertainty (σ) [dB]
Stage 2: DUT measurement					
1	Positioning misalignment	0.00	Normal	2.00	0.00
2	Measure distance uncertainty	0.00	Rectangular	1.73	0.00
3	Quality of Quiet Zone (NOTE 4)	0.7	Actual	1.00	0.7
4	Mismatch	1.30	Actual	1.00	1.30
5	Standing wave between the DUT and measurement antenna	0.00	U-shaped	1.41	0.00
6	gNB uncertainty on absolute level	2.9	Normal	2.00	1.45
7	Phase curvature	0.00	U-shaped	1.41	0.00
8	Amplifier uncertainties	2.1	Normal	2.00	1.05
9	Random uncertainty	0.50	Normal	2.00	0.25
10	Influence of the XPD	0.01	U-shaped	1.41	0.00
11	Insertion Loss Variation	0.00	Rectangular	1.73	0.00
12	RF leakage (from measurement antenna to the receiver/transmitter)	0.00	Actual	1.00	0.00
13	Multiple measurement antenna uncertainty (NOTE 3)	0.15	Actual	1.00	0.15
14	DUT repositioning	0.08	Rectangular	1.73	0.05
Stage 1: Calibration measurement					
17	Mismatch	0.00	U-shaped	1.41	0.00
18	Amplifier Uncertainties	0.00	Normal	2.00	0.00
19	Misalignment of positioning System	0.00	Normal	2.00	0.00
20	Uncertainty of the Network Analyzer	0.73	Normal	2.00	0.37
21	Uncertainty of the absolute gain of the calibration antenna	0.60	Normal	2.00	0.30
22	Positioning and pointing misalignment between the reference antenna and the measurement antenna	0.01	Rectangular	1.73	0.00
23	Phase centre offset of calibration antenna	0.00	Rectangular	1.73	0.00
24	Quality of quiet zone for calibration process (NOTE 4)	0.4	Actual	1.00	0.4
25	Standing wave between reference calibration antenna and measurement antenna	0.00	U-shaped	1.41	0.00
26	Influence of the calibration antenna feed cable	0.14	Normal	2.00	0.07
27	Insertion Loss Variation	0.00	Rectangular	1.73	0.00
Systematic uncertainties (NOTE 2)					Value
28	Systematic error related to beam peak search				0.5
Total measurement uncertainty					Value
DL AWGN absolute power expanded uncertainty (1.96 σ - confidence interval of 95 %) [dB]					5.25
NOTE 1: The analysis was done only for the case of operating in-band, non-CA.					
NOTE 2: In order to obtain the total measurement uncertainty, systematic uncertainties have to be added to the expanded root sum square of the standard deviations of the Stage 1 and Stage 2 contributors.					
NOTE 3: Applies to the system which has a structure of mechanical feed antenna positioning.					
NOTE 4: Value based on procedure defined in Annex M of TR 38.521-2 [7] for Quiet Zone size less or equal to 30 cm.					
NOTE 5: The values in this table have been derived for DL powers above and equal to REFSENS. The values might need to be revisited for power levels below REFSENS					

Table E.3.1.4-3: Uncertainty assessment for fDL AWGN absolute power or wanted DL signal absolute power (f=23.45GHz, 32.125GHz, Quiet Zone size ≤ 30 cm) for PC1

UID	Uncertainty source	Uncertainty value	Distribution of the probability	Divisor	Standard uncertainty (σ) [dB]
Stage 2: DUT measurement					
1	Positioning misalignment	0.02	Normal	2.00	0.02
2	Measure distance uncertainty	0.00	Rectangular	1.73	0.00
3	Quality of Quiet Zone (NOTE 4)	0.7	Actual	1.00	0.7
4	Mismatch	1.30	Actual	1.00	1.30
5	Standing wave between the DUT and measurement antenna	0.00	U-shaped	1.41	0.00
6	gNB uncertainty on absolute level	2.9	Normal	2.00	1.45
7	Phase curvature	0.00	U-shaped	1.41	0.00
8	Amplifier uncertainties	[2.1]	Normal	2.00	[1.05]
9	Random uncertainty	0.50	Normal	2.00	0.25
10	Influence of the XPD	0.01	U-shaped	1.41	0.00
11	Insertion Loss Variation	0.00	Rectangular	1.73	0.00
12	RF leakage (from measurement antenna to the receiver/transmitter)	0.00	Actual	1.00	0.00
13	Multiple measurement antenna uncertainty (NOTE 3)	0.15	Actual	1.00	0.15
14	DUT repositioning	0.35	Rectangular	1.73	0.20
Stage 1: Calibration measurement					
17	Mismatch	0.00	U-shaped	1.41	0.00
18	Amplifier Uncertainties	0.00	Normal	2.00	0.00
19	Misalignment of positioning System	0.00	Normal	2.00	0.00
20	Uncertainty of the Network Analyzer	1.50	Normal	2.00	0.75
21	Uncertainty of the absolute gain of the calibration antenna	0.60	Normal	2.00	0.30
22	Positioning and pointing misalignment between the reference antenna and the measurement antenna	0.01	Rectangular	1.73	0.00
23	Phase centre offset of calibration antenna	0.00	Rectangular	1.73	0.00
24	Quality of quiet zone for calibration process (NOTE 4)	0.4	Actual	1.00	0.4
25	Standing wave between reference calibration antenna and measurement antenna	0.00	U-shaped	1.41	0.00
26	Influence of the calibration antenna feed cable	0.14	Normal	2.00	0.07
27	Insertion Loss Variation	0.00	Rectangular	1.73	0.00
Systematic uncertainties (NOTE 2)					Value
28	Systematic error related to beam peak search				0.7
Total measurement uncertainty					Value
DL AWGN absolute power expanded uncertainty (1.96 σ - confidence interval of 95 %) [dB]					[5.65]
NOTE 1: The analysis was done only for the case of operating in-band, non-CA.					
NOTE 2: In order to obtain the total measurement uncertainty, systematic uncertainties have to be added to the expanded root sum square of the standard deviations of the Stage 1 and Stage 2 contributors.					
NOTE 3: Applies to the system which has a structure of mechanical feed antenna positioning.					
NOTE 4: Value based on procedure defined in Annex M of TR 38.521-2 [7] for Quiet Zone size less or equal to 30 cm.					
NOTE 5: The values in this table have been derived for DL powers above and equal to REFSSENS. The values might need to be revisited for power levels below REFSSENS					

E.3.1.5 Uncertainty budget format and assessment for IFF+DFF Hybrid test setup

For DFF probe, Uncertainty shall be evaluated using the Uncertainty budget format as specified in E.3.1.1.

For IFF probe, Uncertainty shall be evaluated using the Uncertainty budget format as specified in E.3.1.3.

The overall uncertainty of the IFF+DFF Hybrid test set up shall be calculated with the max(Total DFF probe MU, Total IFF probe MU).

E.3.2 Uncertainty assessment for DL applied SNR

E.3.3 Uncertainty assessment for DL Fading profile uncertainty

E.3.4 Uncertainty assessment for DL AWGN and signal flatness

E.3.5 Uncertainty assessment for UL absolute power measurement

Editor's Note : Applicability of MU in this section for 2AoA Test Cases needs to be reassessed once 2AoA Test Cases requiring UL power measurement is defined.

Following tables summarize the MU threshold for EIRP UL absolute power measurement in FR2 RRM test cases. The origin MU values for different test setups with varies parameters can be found in following clauses.

Table B.3.5-1: MU threshold for EIRP UL absolute power measurement

TBD

E.3.5.1 Uncertainty budget format and assessment for DFF

Editor's Note : Applicability of MU in this section for 2AoA Test Cases needs to be reassessed once 2AoA Test Cases requiring UL power measurement is defined.

The uncertainty contributions that may impact the overall MU value are listed in Table B.3.5.1-1.

Table B.3.5.1-1: Uncertainty contributions for EIRP UL absolute power measurement

UID	Description of uncertainty contribution	Details in annex
Stage 2: DUT measurement		
1	Positioning misalignment	B.2.1.1
2	Measure distance uncertainty	B.2.1.2
3	Quality of quiet zone	B.2.1.3
4	Mismatch	B.2.1.4
5	Standing Wave Between the DUT and measurement antenna	B.2.1.5
6	Uncertainty of the RF power measurement equipment	B.2.1.6
7	Phase curvature	B.2.1.7
8	Amplifier uncertainties	B.2.1.8
9	Random uncertainty	B.2.1.9
10	Influence of the XPD	B.2.1.10
11	Insertion Loss Variation	B.2.1.11
12	RF leakage (from measurement antenna to the receiver/transmitter)	B.2.1.12
13	Influence of beam peak search grid	B.2.1.23
14	Multiple measurement antenna uncertainty	B.2.1.25
15	DUT repositioning	B.2.1.26
Stage 1: Calibration measurement		
16	Mismatch	B.2.1.4
17	Amplifier uncertainties	B.2.1.8
18	Misalignment of positioning System	B.2.1.13
19	Uncertainty of the Network Analyzer	B.2.1.14
20	Uncertainty of the absolute gain of the calibration antenna	B.2.1.15
21	Positioning and pointing misalignment between the reference antenna and the measurement antenna	B.2.1.16
22	Phase centre offset of calibration antenna	B.2.1.18
23	Quality of quiet zone for calibration process	B.2.1.19
24	Standing wave between reference calibration antenna and measurement antenna	B.2.1.20
25	Influence of the calibration antenna feed cable	B.2.1.21
26	Insertion Loss Variation	B.2.1.11
Systematic uncertainties		
27	Influence of noise	B.2.1.27
28	Systematic error related to beam peak search	B.2.1.28

The uncertainty assessment tables are organized as follows:

- For the purpose of uncertainty assessment, the radiating antenna aperture of the DUT is denoted as D
- The uncertainty assessment has been derived for the case of Quiet Zone size ≤ 30 cm, $f = \{23.45\text{GHz}, 32.125\text{GHz}, 40.8\text{GHz}\}$.
- The uncertainty assessment is applicable for 1AoA and 2AoA test cases
- The uncertainty assessment is provided in Table B.3.5.1-2.

Table B.3.5.3-2: Uncertainty assessment for EIRP measurement (f=23.45GHz, 32.125GHz, 40.8GHz, Quiet Zone size ≤ 30 cm) for PC3 UEs and normal temperature condition

UID	Uncertainty source	Uncertainty value	Distribution of the probability	Divisor	Standard uncertainty (σ) [dB]
Stage 2: DUT measurement					
1	Positioning misalignment	0.00	Normal	2.00	0.00
2	Measure distance uncertainty	0.15	Rectangular	1.73	0.08
3	Quality of quiet zone (NOTE 1)	1.2	Actual	1.00	1.2
4	Mismatch	1.30	Actual	1.00	1.30
5	Standing Wave Between the DUT and measurement antenna	0.00	U-shaped	1.41	0.00
6	Uncertainty of the RF power measurement equipment (NOTE 2)	2.50	Normal	2.00	1.25
7	Phase curvature	0.00	U-shaped	1.41	0.00
8	Amplifier uncertainties	2.10	Normal	2.00	1.05
9	Random uncertainty	0.50	Normal	2.00	0.25
10	Influence of the XPD	0.06	U-shaped	1.41	0.043
11	Insertion Loss Variation	0.00	Rectangular	1.73	0.00
12	RF leakage (from measurement antenna to the receiver/transmitter)	0.00	Actual	1.00	0.00
13	Influence of beam peak search grid	0.00	Actual	1	0.00
14	Multiple measurement antenna uncertainty(NOTE 4)	0.15	Actual	1	0.15
15	DUT repositioning	0.08	Rectangular	1.73	0.05
Stage 1: Calibration measurement					
16	Mismatch	0.00	U-shaped	1.41	0.00
17	Amplifier uncertainties	0.00	Normal	2.00	0.00
18	Misalignment of positioning System	0.00	Normal	2.00	0.00
19	Uncertainty of the Network Analyzer	0.73	Normal	2.00	0.37
20	Uncertainty of the absolute gain of the calibration antenna	0.60	Normal	2.00	0.30
21	Positioning and pointing misalignment between the reference antenna and the measurement antenna	0.01	Rectangular	1.73	0.00
22	Phase centre offset of calibration antenna	0.47	Rectangular	1.73	0.27
23	Quality of quiet zone for calibration process (NOTE 1)	0.4	Actual	1.00	0.4
24	Standing wave between reference calibration antenna and measurement antenna	0.00	U-shaped	1.41	0.00
25	Influence of the calibration antenna feed cable	0.14	Normal	2.00	0.07
26	Insertion Loss Variation	0.00	Rectangular	1.73	0.00
Systematic uncertainties (NOTE 3)					Value
27	Influence of noise				TBD
28	Systematic error related to beam peak search				0.5
Total measurement uncertainty					Value
EIRP Expanded uncertainty (1.96 σ - confidence interval of 95 %) [dB]					TBD
NOTE 1: Value based on procedure defined in clause D.2 of TR 38.810 for Quiet Zone size less or equal to 30 cm.					
NOTE 2: The assessment assumes minimum output power level.					
NOTE 3: In order to obtain the total measurement uncertainty, systematic uncertainties have to be added to the expanded root sum square of the standard deviations of the Stage 1 and Stage 2 contributors.					
NOTE 4: Applies to the system which has a structure of mechanical feed antenna positioning.					

E.3.5.2 TBD

E.3.5.3 Uncertainty budget format and assessment for IFF

Editor's Note : Applicability of MU in this section for 2AoA Test Cases needs to be reassessed once 2AoA Test Cases requiring UL power measurement is defined.

The uncertainty contributions that may impact the overall MU value are listed in Table B.3.5.3-1.

Table E.3.5.3-1: Uncertainty contributions for EIRP UL absolute power measurement

UID	Description of uncertainty contribution	Details in clause
Stage 2: DUT measurement		
1	Positioning misalignment	B.2.2.1
2	Measure distance uncertainty	B.2.2.2
3	Quality of Quiet Zone	B.2.2.3
4	Mismatch	B.2.2.4
5	Standing wave between the DUT and measurement antenna	B.2.2.5
6	Uncertainty of the RF power measurement equipment	B.2.2.6
7	Phase curvature	B.2.2.7
8	Amplifier uncertainties	B.2.2.8
9	Random uncertainty	B.2.2.9
10	Influence of the XPD	B.2.2.10
11	Insertion Loss Variation	B.2.2.11
12	RF leakage (from measurement antenna to the receiver/transmitter)	B.2.2.12
13	Influence of beam peak search grid	B.2.2.23
14	Multiple measurement antenna uncertainty	B.2.2.25
15	DUT repositioning	B.2.2.26
Stage 1: Calibration measurement		
16	Mismatch	B.2.2.4
17	Amplifier Uncertainties	B.2.2.8
18	Misalignment of positioning System	B.2.2.13
19	Uncertainty of the Network Analyzer	B.2.2.14
20	Uncertainty of the absolute gain of the calibration antenna	B.2.2.15
21	Positioning and pointing misalignment between the reference antenna and the measurement antenna	B.2.2.16
22	Phase centre offset of calibration antenna	B.2.2.18
23	Quality of quiet zone for calibration process	B.2.2.19
24	Standing wave between reference calibration antenna and measurement antenna	B.2.2.20
25	Influence of the calibration antenna feed cable	B.2.2.21
26	Insertion Loss Variation	B.2.2.11
Systematic uncertainties		
27	Influence of noise	B.2.2.27
28	Systematic error related to beam peak search	B.2.2.28

The uncertainty assessment tables are organized as follows:

- For the purpose of uncertainty assessment, the radiating antenna aperture of the DUT is denoted as D
- The uncertainty assessment has been derived for the case of Quiet Zone size ≤ 30 cm, $f = \{23.45\text{GHz}, 32.125\text{GHz}, 40.8\text{GHz}\}$.
- The uncertainty assessment is applicable for 1AoA test cases
- The uncertainty assessment for EIRP is provided in Table B.3.5.3-2 for PC3 UEs

Table B.3.5.3-2: Uncertainty assessment for EIRP UL absolute power measurement (f=23.45GHz, 32.125GHz, 40.8GHz, Quiet Zone size ≤ 30 cm) for PC3 UEs and normal temperature condition

UID	Uncertainty source	Uncertainty value	Distribution of the probability	Divisor	Standard uncertainty (σ) [dB]
Stage 2: DUT measurement					
1	Positioning misalignment	0.00	Normal	2.00	0.00
2	Measure distance uncertainty	0.00	Rectangular	1.73	0.00
3	Quality of Quiet Zone (NOTE 1)	0.6	Actual	1.00	0.6
4	Mismatch	1.30	Actual	1.00	1.30
5	Standing wave between the DUT and measurement antenna	0.00	U-shaped	1.41	0.00
6	Uncertainty of the RF power measurement equipment (NOTE 2)	2.50	Normal	2.00	1.25
7	Phase curvature	0.00	U-shaped	1.41	0.00
8	Amplifier uncertainties	2.10	Normal	2.00	1.05
9	Random uncertainty	0.50	Normal	2.00	0.25
10	Influence of the XPD	0.01	U-shaped	1.41	0.00
11	Insertion Loss Variation	0.00	Rectangular	1.73	0.00
12	RF leakage (from measurement antenna to the receiver/transmitter)	0.00	Actual	1.00	0.00
13	Influence of beam peak search grid	0.00	Actual	1	0.00
14	Multiple measurement antenna uncertainty (NOTE 4)	0.15	Actual	1	0.15
15	DUT repositioning	0.08	Rectangular	1.73	0.05
Stage 1: Calibration measurement					
16	Mismatch	0.00	U-shaped	1.41	0.00
17	Amplifier Uncertainties	0.00	Normal	2.00	0.00
18	Misalignment of positioning System	0.00	Normal	2.00	0.00
19	Uncertainty of the Network Analyzer	0.73	Normal	2.00	0.37
20	Uncertainty of the absolute gain of the calibration antenna	0.60	Normal	2.00	0.30
21	Positioning and pointing misalignment between the reference antenna and the measurement antenna	0.01	Rectangular	1.73	0.00
22	Phase centre offset of calibration antenna	0.00	Rectangular	1.73	0.00
23	Quality of quiet zone for calibration process (NOTE 1)	0.4	Actual	1.00	0.4
24	Standing wave between reference calibration antenna and measurement antenna	0.00	U-shaped	1.41	0.00
25	Influence of the calibration antenna feed cable	0.14	Normal	2.00	0.07
26	Insertion Loss Variation	0.00	Rectangular	1.73	0.00
Systematic uncertainties (NOTE 3)					Value
27	Influence of noise (23.45GHz ≤ f ≤ 32.125GHz)				TBD
28	Systematic error related to beam peak search				0.5
Total measurement uncertainty					Value
EIRP Expanded uncertainty (1.96 σ - confidence interval of 95 %) [dB]					TBD
NOTE 1: Value based on procedure defined in clause D.2 of TR 38.810 for Quiet Zone size less or equal to 30 cm.					
NOTE 2: The assessment assumes minimum output power level.					
NOTE 3: In order to obtain the total measurement uncertainty, systematic uncertainties have to be added to the expanded root sum square of the standard deviations of the Stage 1 and Stage 2 contributors.					
NOTE 4: Applies to the system which has a structure of mechanical feed antenna positioning.					

E.3.5.4 Uncertainty budget format and assessment for Enhanced IFF test setup

Editor's Note : Applicability of MU in this section for 2AoA Test Cases needs to be reassessed once 2AoA Test Cases requiring UL power measurement is defined.

The uncertainty contributions that may impact the overall MU value are listed in Table E.3.5.4-1.

Table E.3.5.4-1: Uncertainty contributions for EIRP UL absolute power measurement

UID	Description of uncertainty contribution	Details in annex
Stage 2: DUT measurement		
1 to 15	See 1-15 of Table E.3.5.3-1	N/A
Stage 1: Calibration measurement		
16 to 26	See 16-26 of Table E.3.5.3-1	N/A
Systematic uncertainties		
27 to 28	See 27-28 of Table E.3.5.3-1	N/A

The uncertainty assessment tables are organized as follows:

- For the purpose of uncertainty assessment, the radiating antenna aperture of the DUT is denoted as D
- The uncertainty assessment has been derived for the case of Quiet Zone size ≤ 30 cm, $f = \{23.45\text{GHz}, 32.125\text{GHz}, 40.8\text{GHz}\}$.
- The uncertainty assessment is applicable for 1AoA and 2AoA test cases
- The uncertainty assessment is provided in Table E.3.5.4-2.

Table B.3.5.4-2: Uncertainty assessment for EIRP UL absolute power measurement (f=23.45GHz, 32.125GHz, 40.8GHz, Quiet Zone size ≤ 30 cm) for PC3 UEs and normal temperature condition

UID	Uncertainty source	Uncertainty value	Distribution of the probability	Divisor	Standard uncertainty (σ) [dB]
Stage 2: DUT measurement					
1	Positioning misalignment	0.00	Normal	2.00	0.00
2	Measure distance uncertainty	0.00	Rectangular	1.73	0.00
3	Quality of Quiet Zone (NOTE 1)	0.7	Actual	1.00	0.7
4	Mismatch	1.30	Actual	1.00	1.30
5	Standing wave between the DUT and measurement antenna	0.00	U-shaped	1.41	0.00
6	Uncertainty of the RF power measurement equipment (NOTE 2)	2.50	Normal	2.00	1.25
7	Phase curvature	0.00	U-shaped	1.41	0.00
8	Amplifier uncertainties	2.10	Normal	2.00	1.05
9	Random uncertainty	0.50	Normal	2.00	0.25
10	Influence of the XPD	0.01	U-shaped	1.41	0.00
11	Insertion Loss Variation	0.00	Rectangular	1.73	0.00
12	RF leakage (from measurement antenna to the receiver/transmitter)	0.00	Actual	1.00	0.00
13	Influence of beam peak search grid	0.00	Actual	1	0.00
14	Multiple measurement antenna uncertainty (NOTE 4)	0.15	Actual	1	0.15
15	DUT repositioning	0.08	Rectangular	1.73	0.05
Stage 1: Calibration measurement					
16	Mismatch	0.00	U-shaped	1.41	0.00
17	Amplifier Uncertainties	0.00	Normal	2.00	0.00
18	Misalignment of positioning System	0.00	Normal	2.00	0.00
19	Uncertainty of the Network Analyzer	0.73	Normal	2.00	0.37
20	Uncertainty of the absolute gain of the calibration antenna	0.60	Normal	2.00	0.30
21	Positioning and pointing misalignment between the reference antenna and the measurement antenna	0.01	Rectangular	1.73	0.00
22	Phase centre offset of calibration antenna	0.00	Rectangular	1.73	0.00
23	Quality of quiet zone for calibration process (NOTE 1)	0.4	Actual	1.00	0.4
24	Standing wave between reference calibration antenna and measurement antenna	0.00	U-shaped	1.41	0.00
25	Influence of the calibration antenna feed cable	0.14	Normal	2.00	0.07
26	Insertion Loss Variation	0.00	Rectangular	1.73	0.00
Systematic uncertainties (NOTE 3)					Value
27	Influence of noise (23.45GHz ≤ f ≤ 32.125GHz)				TBD
28	Systematic error related to beam peak search				0.5
Total measurement uncertainty					Value
EIRP Expanded uncertainty (1.96 σ - confidence interval of 95 %) [dB]					TBD
NOTE 1: Value based on procedure defined in clause D.2 of TR 38.810 for Quiet Zone size less or equal to 30 cm.					
NOTE 2: The assessment assumes minimum output power level.					
NOTE 3: In order to obtain the total measurement uncertainty, systematic uncertainties have to be added to the expanded root sum square of the standard deviations of the Stage 1 and Stage 2 contributors.					
NOTE 4: Applies to the system which has a structure of mechanical feed antenna positioning.					

E.3.5.5 Uncertainty budget format and assessment for IFF+DFF Hybrid test setup

For DFF probe, Uncertainty shall be evaluated using the Uncertainty budget format as specified in E.3.5.1.

For IFF probe, Uncertainty shall be evaluated using the Uncertainty budget format as specified in E.3.5.3.

The overall uncertainty of the IFF+DFF Hybrid test set up shall be calculated with the max(Total DFF probe MU, Total IFF probe MU).

E.3.6 Uncertainty assessment for UL relative power measurement

E.3.7 Uncertainty assessment for UL signal transmit timing relative to DL

E.3.8 Uncertainty assessment for Relative transmit timing accuracy during UE timing adjustment

Annex F: Applicable MTSU for Different QZ/Device Sizes

The applicability mapping between minimum QZ size, maximum device size and MTSU is outlined in Table F-1. The underlying assumptions for the mapping are as follows:

- The maximum device size ranges/limits follow the currently defined quiet zone sizes, i.e., 20cm, 30cm, 40cm, and 55cm [7], [18]
- The applicable MTSU follows the max device size, e.g., a max device size of 30cm to 40cm yields an MTSU of $MTSU_{40cm}$
- The applicable MTSU is the same regardless of whether a grey-box or black-box approach [7], [18] is selected to simplify the mapping and to prevent different test requirements for the same device depending on whether black or grey box is applied
- A maximum device size exceeding 55cm but with antenna separations of $\leq 55cm$ does not have an applicable MTSU given the lack of a larger QZ
- Devices with $>55cm$ maximum device size do not have an applicable MTSU given the lack of a larger QZ

Table F-1: Mapping between minimum QZ size, maximum device size, and applicable MTSU

Minimum QZ required to contain all active antennas within the quiet zone (optional vendor declaration)	Max Device Size	Applicable MTSU	Note
20cm	<20cm	MTSU _{30cm}	A system supporting a {20cm, 30cm, 40cm, 55cm} QZ can be used as long as the assessed MU with a {20cm, 30cm, 40cm, 55cm} QoQZ validation is \leq MTSU _{30cm}
20cm	20cm to 30cm	MTSU _{30cm}	A system supporting a {20cm, 30cm, 40cm, 55cm} QZ can be used as long as the assessed MU with a {20cm, 30cm, 40cm, 55cm} QoQZ validation is \leq MTSU _{30cm}
20cm	30cm to 40cm	MTSU _{40cm}	A system supporting a {20cm, 30cm, 40cm, 55cm} QZ can be used as long as the assessed MU with a {20cm, 30cm, 40cm, 55cm} QoQZ validation is \leq MTSU _{40cm}
20cm	40cm to 55cm	MTSU _{55cm}	A system supporting a {20cm, 30cm, 40cm, 55cm} QZ can be used as long as the assessed MU with a {20cm, 30cm, 40cm, 55cm} QoQZ validation is \leq MTSU _{55cm}
20cm	>55cm	Not applicable until larger QZ is defined	Pending larger QZ (exceeding 55cm) definition
30cm	\leq 30cm	MTSU _{30cm}	A system supporting a {30cm, 40cm, 55cm} QZ can be used as long as the assessed MU with a {30cm, 40cm, 55cm} QoQZ validation is \leq MTSU _{30cm}
30cm	30cm to 40cm	MTSU _{40cm}	A system supporting a {30cm, 40cm, 55cm} QZ can be used as long as the assessed MU with a {30cm, 40cm, 55cm} QoQZ validation is \leq MTSU _{40cm}
30cm	40cm to 55cm	MTSU _{55cm}	A system supporting a {30cm, 40cm, 55cm} QZ can be used as long as the assessed MU with a {30cm, 40cm, 55cm} QoQZ validation is \leq MTSU _{55cm}
30cm	>55cm	Not applicable until larger QZ is defined	Pending larger QZ (exceeding 55cm) definition
40cm	\leq 40cm	MTSU _{40cm}	A system supporting a {40cm, 55cm} QZ can be used as long as the assessed MU with a {40cm, 55cm} QoQZ validation is \leq MTSU _{40cm}
40cm	40cm to 55cm	MTSU _{55cm}	A system supporting a {40cm, 55cm} QZ can be used as long as the assessed MU with a {40cm, 55cm} QoQZ validation is \leq MTSU _{55cm}
40cm	>55cm	Not applicable until larger QZ is defined	Pending larger QZ (exceeding 55cm) definition
55cm	40cm to 55cm	MTSU _{55cm}	
55cm	>55cm	Not applicable until larger QZ is defined	Pending larger QZ (exceeding 55cm) definition
>55cm	>55cm	Not applicable until larger QZ is defined	Note: QZs exceeding 55cm cannot be declared due to lack of larger QZ definition

Annex G: Acceptable uncertainty of test system for test cases defined in TS 37.571-1 for radiative testing

This Annex is informative only, as the acceptable uncertainties of a test system are defined in Annex C of 37.571-1 [20].

Annex H: Change history

Change history							
Date	Meeting	TDoc	CR	R ev	Cat	Subject/Comment	New version
2017-09	RAN5 #76	R5-174706				Initial skeleton	0.0.1
2018-04	RAN5 #2-5G-NR-Adhoc	R5-182093				Implementation of pCRs to TS 38.903 V0.0.1	0.1.0
2018-05	RAN5#79	R5-182670				Editorial update of TR 38.903.	0.2.0
2018-09	RAN5#80	R5-185213				Making Measurement Uncertainty Terms Common between methods in TR 38.90	1.0.0
2018-09	RAN5#80	R5-185214				TP on Measurement Uncertainty Contributions in FR2	1.0.0
2018-09	RAN5#80	R5-185212				Adding MU values for EIRPTRP measurements with Near Field test range (NFTF) at mmWave	1.0.0
2018-09	RAN#81	-	-	-	-	raised to v15.0.0 with editorial changes only	15.0.0
2018-12	RAN#82	R5-187023	0010	-	F	Editorial update of Annex B	15.1.0
2018-12	RAN#82	R5-187024	0011	-	F	Addition of MU contribution for demodulation test cases	15.1.0
2018-12	RAN#82	R5-187025	0012	-	F	Addition of MU contribution for RRM test cases	15.1.0
2018-12	RAN#82	R5-187148	0013	-	F	General clauses updated for TR38.903	15.1.0
2018-12	RAN#82	R5-187848	0008	1	F	FR2 Spurious Emission measurement grids and offset values	15.1.0
2018-12	RAN#82	R5-188060	0019	1	F	Update of MU budget and contributor description to TR 38.903	15.1.0
2018-12	RAN#82	R5-188224	0009	1	F	Update MU budget in TR 38.903	15.1.0
2018-12	RAN#82	R5-188225	0016	1	F	Update of MU budget tables in TR 38.903	15.1.0
2018-12	RAN#82	R5-188226	0017	2	F	Addition of descriptions on new MU contributions	15.1.0
2019-03	RAN#83	R5-192476	0030	1	F	Addition of Test Tolerance analysis for FR1 PRACH Test cases	15.2.0
2019-03	RAN#83	R5-192504	0038	1	F	Addition of TT analysis for Transmit timing accuracy Tests	15.2.0
2019-03	RAN#83	R5-192505	0031	1	F	Addition common text for RRM	15.2.0
2019-03	RAN#83	R5-192534	0039	-	F	Addition of TT Analysis for Timing Advance Adjustment Accuracy 4.4.3.1	15.2.0
2019-03	RAN#83	R5-192671	0033	1	F	Addition of TT analysis for event triggered test cases	15.2.0
2019-03	RAN#83	R5-192679	0036	1	F	Addition of TT analysis for handover with known cell	15.2.0
2019-03	RAN#83	R5-192845	0029	1	F	CR to update TR 38.903	15.2.0
2019-06	RAN#84	R5-193799	0048	-	F	FR1 Test tolerance analysis for intra re-selection 6.1.1.1	15.3.0
2019-06	RAN#84	R5-193800	0049	-	F	FR1 Test tolerance analysis for inter re-selection 6.1.1.2	15.3.0
2019-06	RAN#84	R5-193801	0050	-	F	FR1 Test tolerance analysis for interRAT higher priority re-selection 6.1.2.1	15.3.0
2019-06	RAN#84	R5-193802	0051	-	F	FR1 Test tolerance analysis for interRAT lower priority re-selection 6.1.2.2	15.3.0
2019-06	RAN#84	R5-193803	0052	-	F	FR1 Test tolerance analysis for interRAT known handover 6.3.1.4	15.3.0
2019-06	RAN#84	R5-194027	0057	-	F	CR on spurious emission MU in FR2	15.3.0
2019-06	RAN#84	R5-194123	0058	-	F	Definition of MU terminologies in TR 38.903	15.3.0
2019-06	RAN#84	R5-195014	0054	1	F	FR1 Test tolerance analysis for EN-DC SCell activation 4.5.3.1-4.5.3.3	15.3.0
2019-06	RAN#84	R5-195015	0060	1	F	Test Tolerance analysis for Inter-Freq measurement Test Cases	15.3.0
2019-06	RAN#84	R5-195159	0059	1	F	CR to update TR 38.903 after RAN5#5-5G NR Adhoc	15.3.0
2019-06	RAN#84	R5-195181	0055	1	F	FR1 Test tolerance analysis for EN-DC measurement reporting 4.6.1.1-4.6.1.4	15.3.0
2019-06	RAN#84	-	-	-	-	Administrative release upgrade to match the release of 3GPP TS 38.521-1 which was upgraded at RAN#84 to Rel-16 due to Rel-16 relevant CR(s)	16.0.0
2019-09	RAN#85	R5-195583	0061	-	F	Update FR1 Test tolerance of 4.5.3.1-4.5.3.3 SCell activation	16.1.0
2019-09	RAN#85	R5-195584	0062	-	F	Update FR1 Test tolerance of 6.1.1.1 FR1 cell re-selection	16.1.0
2019-09	RAN#85	R5-195585	0063	-	F	Update FR1 Test tolerance of 6.1.1.2 FR1-FR1 cell re-selection	16.1.0
2019-09	RAN#85	R5-195586	0064	-	F	Update FR1 Test tolerance of 6.1.2.1 inter-RAT cell re-selection to higher priority	16.1.0
2019-09	RAN#85	R5-195587	0065	-	F	Update FR1 Test tolerance of 6.1.2.2 inter-RAT cell re-selection to lower priority	16.1.0
2019-09	RAN#85	R5-195588	0066	-	F	Update FR1 Test tolerance of 6.3.1.4 inter-RAT handover to known cell	16.1.0
2019-09	RAN#85	R5-195589	0067	-	F	Addition FR1 Test tolerance of 6.3.1.5 inter-RAT handover to unknown cell	16.1.0
2019-09	RAN#85	R5-195590	0068	-	F	Addition FR1 Test tolerance of 6.3.2.1.1 intra-freq RRC re-establishment	16.1.0
2019-09	RAN#85	R5-195591	0069	-	F	Addition FR1 Test tolerance of 6.3.2.1.2 inter-freq RRC re-establishment	16.1.0
2019-09	RAN#85	R5-195592	0070	-	F	Addition FR1 Test tolerance of 6.3.2.3.1 NR RRC redirection	16.1.0
2019-09	RAN#85	R5-195593	0071	-	F	Addition FR1 Test tolerance of 6.3.2.3.2 inter-RAT RRC redirection	16.1.0
2019-09	RAN#85	R5-197362	0072	1	F	FR1 Test Tolerance Analysis for SSB-based RLM IS Tests	16.1.0
2019-09	RAN#85	R5-197363	0073	1	F	FR1 Test Tolerance Analysis for SA Tx Timing Accuracy 6.4.1.1	16.1.0
2019-09	RAN#85	R5-197365	0083	1	F	TT_Analysis_ENDC_FR1_RLM_OOS	16.1.0
2019-09	RAN#85	R5-197369	0087	1	F	TT_Analysis_SA_FR1_TAAA	16.1.0
2019-09	RAN#85	R5-197494	0077	1	F	CR on DUT turnover and relations with QoQZ MU	16.1.0
2019-09	RAN#85	R5-197505	0081	1	F	Update of FR2 MUs in TR 38.903	16.1.0

2019-09	RAN#85	R5-197571	0078	1	F	TT Analysis for SS-RSRP FR1 tests	16.1.0
2019-09	RAN#85	R5-197625	0080	1	F	CR on FR2 OFF Power MU	16.1.0
2019-09	RAN#85	R5-197659	0076	2	F	CR on spurious emission MU in FR2	16.1.0
2019-12	RAN#86	R5-198260	0099	-	F	CR to 38.903 to define Reference Methodology for SE	16.2.0
2019-12	RAN#86	R5-198285	0100	-	F	FR1 Test tolerance analysis for interRAT measurement	16.2.0
2019-12	RAN#86	R5-198427	0101	-	F	Correction to uncertainty budget calculation principles	16.2.0
2019-12	RAN#86	R5-199070	0098	1	F	Editorial corrections to FR1 Test Tolerance files	16.2.0
2019-12	RAN#86	R5-199082	0104	2	F	FR1 Test Tolerance : Addition of TT Analysis for 6.3.1.1 NR SA FR1 Intra-Freq Handover	16.2.0
2019-12	RAN#86	R5-199083	0105	2	F	FR1 Test Tolerance : Addition of TT Analysis for 6.3.1.2 NR SA FR1 Intra-Freq Handover	16.2.0
2019-12	RAN#86	R5-199084	0106	2	F	FR1 Test Tolerance : Addition of TT Analysis for 6.3.1.3 NR SA FR1 Inter-Freq Handover	16.2.0
2019-12	RAN#86	R5-199091	0102	1	F	Update on FR2 MUs in 38.903	16.2.0
2019-12	RAN#86	R5-199092	0103	1	F	Update on FR2 Spurious MUs in 38.903	16.2.0
2019-12	RAN#86	R5-199362	0091	1	F	FR1 Test tolerance analysis for interruptions active and non-active	16.2.0
2019-12	RAN#86	R5-199363	0094	1	F	FR1 Test tolerance analysis for CSI-RS based RLM	16.2.0
2020-03	RAN#87	R5-200163	0107	-	F	Add Annex A.2 handling of common Test Tolerance Topics for FR2	16.3.0
2020-03	RAN#87	R5-200329	0112	-	F	CR to 38.903 on XPD Verification	16.3.0
2020-03	RAN#87	R5-200470	0114	-	F	FR1 Test tolerance analysis for interruptions deactivated NR SCC	16.3.0
2020-03	RAN#87	R5-200918	0116	1	F	Update to FR2 TRx Measurement Uncertainties	16.3.0
2020-03	RAN#87	R5-201037	0108	1	F	Test tolerance analysis inter-frequency SS-RSRP and intra-frequency SS-SINR	16.3.0
2020-03	RAN#87	R5-201038	0109	1	F	Test tolerance analysis SS-RSRQ and inter-frequency SS-SINR	16.3.0
2020-03	RAN#87	R5-201042	0110	1	F	Test Tolerance analysis for CSI-RS-Based L1-RSRP measurement test cases	16.3.0
2020-03	RAN#87	R5-201043	0111	1	F	Test Tolerance analysis for SSB-Based L1-RSRP measurement test cases	16.3.0
2020-06	RAN#88	R5-201662	0118	-	F	FR1 Test tolerance analysis for interruptions deactivated E-UTRAN SCC	16.4.0
2020-06	RAN#88	R5-203094	0119	1	F	FR1 Test tolerance analysis for SCell activation	16.4.0
2020-06	RAN#88	R5-202104	0124	-	F	Test tolerance correction for event triggered measurement test cases	16.4.0
2020-06	RAN#88	R5-202105	0125	-	F	Test tolerance correction for CSI-RS-based L1-RSRP measurement test cases	16.4.0
2020-06	RAN#88	R5-202702	0130	1	F	Test Tolerance analysis TC 4.5.4 and 6.5.4 RRC reconfiguration delay	16.4.0
2020-06	RAN#88	R5-202769	0127	1	F	CR to 38.903 to introduce baseline Demod MU tables	16.4.0
2020-06	RAN#88	R5-202915	0117	1	F	MU contributors for RRM FR2 TC 7.7.1.1	16.4.0
2020-06	RAN#88	R5-202916	0126	1	F	CR to 38.903 to introduce PC1 MU Tables	16.4.0
2020-06	RAN#88	R5-202917	0128	1	F	Update to FR2 Measurement Uncertainties	16.4.0
2020-06	RAN#88	R5-202938	0129	1	F	Addition of EIRP to Transmit OFF power MU analysis	16.4.0
2020-09	RAN#89	R5-203231	0131	-	F	TT analysis for RRM TC 8.5.2.1.1.1	16.5.0
2020-09	RAN#89	R5-203232	0132	-	F	TT analysis for RRM TC 8.5.2.2.1	16.5.0
2020-09	RAN#89	R5-203233	0133	-	F	TT analysis for RRM TC 8.5.2.3.1	16.5.0
2020-09	RAN#89	R5-203237	0134	-	F	TT analysis for RRM TC 4.7.4.1.1	16.5.0
2020-09	RAN#89	R5-203238	0135	-	F	TT analysis for RRM TC 4.7.4.1.2	16.5.0
2020-09	RAN#89	R5-203323	0140	-	F	Add Draft Test Tolerance analysis for FR2 Tx Timing Test cases	16.5.0
2020-09	RAN#89	R5-203324	0141	-	F	Add Draft Test Tolerance analysis for FR2 Inter-freq Event-trig Test cases	16.5.0
2020-09	RAN#89	R5-203325	0142	-	F	Add Draft Test Tolerance analysis for FR2 Intra-freq SS-RSRP Test case	16.5.0
2020-09	RAN#89	R5-203825	0149	-	F	Addition of FR1 Test tolerance analysis for 6.3.2.1.3 RRC Re-establishment	16.5.0
2020-09	RAN#89	R5-203826	0150	-	F	Update of grouping of test cases in clause 8	16.5.0
2020-09	RAN#89	R5-204190	0154	-	F	On Standard Deviation Definition in 38.903	16.5.0
2020-09	RAN#89	R5-204788	0138	1	F	Correction to the extreme conditions in TT analysis of 4.7.1.2.1	16.5.0
2020-09	RAN#89	R5-204887	0139	1	F	CR to update the DL AWGN absolute power for RRM test cases	16.5.0
2020-09	RAN#89	R5-204888	0143	1	F	Adjacent Channel Selectivity FR2 MU definition in 38.903	16.5.0
2020-09	RAN#89	R5-204889	0144	1	F	In-band Blocking FR2 MU definition in 38.903	16.5.0
2020-09	RAN#89	R5-204890	0153	1	F	CR to update MU in 38.903	16.5.0
2020-09	RAN#89	R5-204891	0155	1	F	FR2 Minimum output power measurement uncertainty	16.5.0
2020-09	RAN#89	R5-204945	0152	1	F	CR to 38.903 on some of the Transmit OFF power MU parameters	16.5.0
2020-09	RAN#89	R5-204946	0156	1	F	Update of AWGN flatness in TR 38.903	16.5.0
2020-09	RAN#89	R5-204947	0157	1	F	FR2 EIRP OFF power measurement uncertainty	16.5.0
2020-09	RAN#89	R5-205001	0145	1	F	Addition of FR1 Test tolerance analysis for DCI based BWP switch	16.5.0
2020-09	RAN#89	R5-205002	0146	1	F	Addition of FR1 Test tolerance analysis for RRC based BWP switch	16.5.0
2020-09	RAN#89	R5-205003	0147	1	F	Addition of FR1 Test tolerance analysis for SSB based BFR	16.5.0
2020-09	RAN#89	R5-205004	0148	1	F	Addition of FR1 Test tolerance analysis for CSI-RS based BFR	16.5.0
2020-12	RAN#90	R5-205628	0174	-	F	RRM FR2 DL AWGN absolute power MU	16.6.0
2020-12	RAN#90	R5-205704	0176	-	F	Update of demod MU	16.6.0
2020-12	RAN#90	R5-205831	0177	-	F	Editorial correction of clause 5.2	16.6.0

2020-12	RAN#90	R5-205949	0183	-	F	Update of grouping of test cases in clause 8	16.6.0
2020-12	RAN#90	R5-206809	0158	1	F	TT analysis for RRM 6.7.5.1	16.6.0
2020-12	RAN#90	R5-206810	0159	1	F	TT analysis for RRM 6.7.6.1	16.6.0
2020-12	RAN#90	R5-206811	0160	1	F	TT analysis for RRM 6.7.7.1	16.6.0
2020-12	RAN#90	R5-206812	0161	1	F	TT analysis for RRM 4.7.5.1	16.6.0
2020-12	RAN#90	R5-206813	0163	1	F	TT analysis for RRM 8.5.2.1.2	16.6.0
2020-12	RAN#90	R5-206814	0166	1	F	Add Draft Test Tolerance analysis for FR2 PRACH Test cases	16.6.0
2020-12	RAN#90	R5-206815	0178	1	F	Addition of FR1 TT analysis for inter-RAT cell reselection	16.6.0
2020-12	RAN#90	R5-206816	0179	1	F	Addition of FR1 TT analysis for inter-RAT handover	16.6.0
2020-12	RAN#90	R5-206817	0180	1	F	Addition of FR1 TT analysis for inter-RAT SFTD measurement	16.6.0
2020-12	RAN#90	R5-206818	0181	1	F	Addition of FR1 TT analysis for inter-RAT event-triggered reporting	16.6.0
2020-12	RAN#90	R5-206835	0184	1	F	CR to 38.903 on ETC Testing	16.6.0
2020-12	RAN#90	R5-206836	0185	1	F	CR to add DFF MU Tables in 38.903	16.6.0
2020-12	RAN#90	R5-206837	0187	1	F	Update FR2 TRx MU in 38.903	16.6.0
2020-12	RAN#90	R5-206838	0189	1	F	FR2 Time masks updates	16.6.0
2020-12	RAN#90	R5-206845	0164	1	F	TT analysis for RRM 8.5.2.2.2	16.6.0
2020-12	RAN#90	R5-206846	0167	1	F	Update Draft Test Tolerance analysis for FR2 Tx Timing Test cases	16.6.0
2020-12	RAN#90	R5-206847	0169	1	F	Add Draft Test Tolerance analysis FR2 RLM Peak Test cases	16.6.0
2020-12	RAN#90	R5-206848	0170	1	F	Add Draft Test Tolerance analysis for FR2 Intra-freq Event-trig Test cases	16.6.0
2020-12	RAN#90	R5-206849	0171	1	F	Update Draft Test Tolerance analysis for FR2 Inter-freq Event-trig Test cases	16.6.0
2020-12	RAN#90	R5-206850	0172	1	F	Update Draft Test Tolerance analysis for FR2 Intra-freq SS-RSRP Test case	16.6.0
2020-12	RAN#90	R5-206851	0173	1	F	Add Draft Test Tolerance analysis for FR2 Inter-freq SS-RSRP Test case	16.6.0
2020-12	RAN#90	R5-206852	0182	1	F	Update of FR1 TT analysis for 6.1.1.1 intra-freq cell re-selection	16.6.0
2020-12	RAN#90	R5-206911	0165	1	F	TT analysis for RRM 8.5.2.3.2	16.6.0
2021-03	RAN#91	R5-210431	0193	-	F	Test tolerance analysis for 7.4.3.1 and 5.4.3.1	16.7.0
2021-03	RAN#91	R5-210438	0195	-	F	Update TT analyses for FR2 iRAT measurement accuracy test cases	16.7.0
2021-03	RAN#91	R5-210445	0197	-	F	Update SS-RSRQ measurement accuracy TT analyses for SNR uncertainty change	16.7.0
2021-03	RAN#91	R5-210815	0203	-	F	Update Test Tolerance analyses for FR2 Tx Timing Test cases	16.7.0
2021-03	RAN#91	R5-210817	0204	-	F	Update Test Tolerance analyses for FR2 RLM Test cases	16.7.0
2021-03	RAN#91	R5-210818	0205	-	F	Update Test Tolerance analyses for FR2 Event-Trig Test cases	16.7.0
2021-03	RAN#91	R5-210819	0206	-	F	Update Test Tolerance analyses for FR2 SS-RSRP Test cases	16.7.0
2021-03	RAN#91	R5-210820	0207	-	F	Update Test Tolerance analyses for FR1 RLM Test cases	16.7.0
2021-03	RAN#91	R5-210846	0210	-	F	Update of grouping of test cases in clause 8	16.7.0
2021-03	RAN#91	R5-211175	0216	-	F	FR2 Minimum output power measurement uncertainty update	16.7.0
2021-03	RAN#91	R5-211191	0218	-	F	CR to 38.903 on PC1 Measurement Grid MUs	16.7.0
2021-03	RAN#91	R5-211642	0194	1	F	Test tolerance analysis for 4.5.7.1	16.7.0
2021-03	RAN#91	R5-211643	0196	1	F	Update SS-RSRP measurement accuracy TT analyses for SNR uncertainty change	16.7.0
2021-03	RAN#91	R5-211644	0199	1	F	Update RRM MU values for FR2	16.7.0
2021-03	RAN#91	R5-211645	0211	1	F	Update of FR1 TT for SCell activation	16.7.0
2021-03	RAN#91	R5-211646	0212	1	F	Update of FR1 TT for SSB based link recovery	16.7.0
2021-03	RAN#91	R5-211647	0213	1	F	Update of FR1 TT for CSI-RS based link recovery	16.7.0
2021-03	RAN#91	R5-211648	0214	1	F	Update of FR1 TT for RRC re-establishment	16.7.0
2021-03	RAN#91	R5-211649	0219	1	F	Update of Test Tolerance analysis for FR1 event triggered reporting test cases	16.7.0
2021-03	RAN#91	R5-211650	0220	1	F	Update of Test Tolerance analysis for FR1 SSB-based L1-RSRP test cases	16.7.0
2021-03	RAN#91	R5-211651	0221	1	F	Update of Test Tolerance analysis for FR1 CSI-RS based L1-RSRP test cases	16.7.0
2021-03	RAN#91	R5-211652	0224	1	F	Test Tolerance analysis for FR2 event triggered reporting test cases	16.7.0
2021-03	RAN#91	R5-211732	0202	1	F	Editorial correction to several MU factors	16.7.0
2021-03	RAN#91	R5-211892	0198	1	F	Correct 6.3.1.1 TT analysis	16.7.0
2021-03	RAN#91	R5-211930	0191	1	F	Adjacent Channel Selectivity FR2 MU definition in 38.903	16.7.0
2021-03	RAN#91	R5-211931	0192	1	F	In-band Blocking FR2 MU definition in 38.903	16.7.0
2021-03	RAN#91	R5-211932	0208	1	F	Update on FR2 Blocking Test MU	16.7.0
2021-03	RAN#91	R5-211933	0209	1	F	Update MU for FR2 RRM	16.7.0
2021-03	RAN#91	R5-211934	0215	1	F	Update FR2 MU and TT in 38.903	16.7.0
2021-03	RAN#91	R5-211935	0217	1	F	CR to 38.903 on ETC Testing	16.7.0
2021-03	RAN#91	R5-211936	0222	1	F	Update of demod SNR testability	16.7.0
2021-06	RAN#92	R5-212352	0230	-	F	ACS and IBB - FR2 MU definition in 38.903	16.8.0
2021-06	RAN#92	R5-213851	0228	1	F	Update of demod SNR testability	16.8.0
2021-06	RAN#92	R5-213852	0237	1	F	Measurement uncertainties for FR2 Relative and aggregate power tolerance	16.8.0
2021-06	RAN#92	R5-213940	0225	1	F	Update TT analysis for 5.7.1.1	16.8.0
2021-06	RAN#92	R5-213941	0226	1	F	New TT analysis for 5.7.2.1	16.8.0
2021-06	RAN#92	R5-213942	0227	1	F	New TT analysis for 5.7.3.1	16.8.0
2021-06	RAN#92	R5-213943	0235	1	F	Test Tolerance analysis for FR2 event triggered reporting test cases	16.8.0

2021-06	RAN#92	R5-213944	0236	1	F	Test Tolerance analysis for FR2 event triggered reporting test cases	16.8.0
2021-06	RAN#92	R5-213945	0239	1	F	Update of ACLR testability	16.8.0
2021-06	RAN#92	R5-214069	0234	1	F	Measurement Uncertainties updates for FR2 Extreme Testing Conditions	16.8.0
2021-06	RAN#92	R5-214114	0231	1	F	Add Test Tolerance analyses for FR2 RLM Test cases	16.8.0
2021-06	RAN#92	R5-214115	0232	1	F	Update and add Test Tolerance analysis for FR2 Intra-freq Event-trig Test cases	16.8.0
2021-06	RAN#92	R5-214116	0233	1	F	Update Test Tolerance analysis for FR2 Inter-freq SS-RSRP Test case	16.8.0
2021-09	RAN#93	R5-214189	0240	-	F	TT analysis for RRM test cases 5.7.2.2 and 7.7.2.2	16.9.0
2021-09	RAN#93	R5-214190	0241	-	F	TT analysis for RRM test cases 5.7.3.2 and 7.7.3.2	16.9.0
2021-09	RAN#93	R5-214919	0247	-	F	Update TT analysis for RRM test cases 5.7.1.2 and 7.7.1.2	16.9.0
2021-09	RAN#93	R5-215002	0248	-	F	TT analysis for LTE SA TC 8.5.1.1-SFTD accuracy	16.9.0
2021-09	RAN#93	R5-215330	0250	-	F	Correction to MU for spurious emission band UE co-existence	16.9.0
2021-09	RAN#93	R5-215433	0252	-	F	Correction of Test Tolerance analysis for FR2 event triggered reporting in DRX test cases	16.9.0
2021-09	RAN#93	R5-215834	0255	1	F	Introduction of MTSU mapping related to Max Device Size	16.9.0
2021-09	RAN#93	R5-216102	0242	1	F	Update of demod SNR testability	16.9.0
2021-09	RAN#93	R5-216103	0243	1	F	Add Test Tolerance analyses for EN-DC FR2 interruptions at transitions between active and non-active during DRX Test cases	16.9.0
2021-09	RAN#93	R5-216104	0244	1	F	Introducing EIRP UL Absolute Power MU for FR2 RRM	16.9.0
2021-09	RAN#93	R5-216105	0249	1	F	Correction of power control in 38.903	16.9.0
2021-09	RAN#93	R5-216117	0256	1	F	38.903 CR FR2 ETC MU updates for new ETC test cases	16.9.0
2021-09	RAN#93	R5-216362	0251	1	F	Correction of Test Tolerance analysis for FR2 event triggered reporting in non-DRX test cases	16.9.0
2021-09	RAN#93	R5-216363	0253	1	F	Test Tolerance analysis for FR2 SSB-based L1-RSRP measurement for beam reporting test cases	16.9.0
2021-12	RAN#94	R5-218208	0280	-	F	Correct TT analysis for TC 5.7.3.2 and 7.7.3.2	16.10.0
2021-12	RAN#94	R5-218242	0270	1	F	TT analysis for Mob_enh RRM TC 6.3.1.9+6.3.1.10	16.10.0
2021-12	RAN#94	R5-218262	0275	1	F	Test Tolerance analysis for FR2 CSI-RS based L1-RSRP measurement for beam reporting test cases	16.10.0
2021-12	RAN#94	R5-218295	0272	1	F	Addition of test tolerance analysis for test cases of EN-DC FR1 DL Interruptions at switching between two uplink carriers	16.10.0
2021-12	RAN#94	R5-218330	0261	1	F	TT analysis for PS RRM TC 6.1.1.3	16.10.0
2021-12	RAN#94	R5-218331	0262	1	F	TT analysis for PS RRM TC 6.1.1.4	16.10.0
2021-12	RAN#94	R5-218332	0263	1	F	TT analysis for PS RRM TC 6.1.1.5	16.10.0
2021-12	RAN#94	R5-218333	0264	1	F	TT analysis for PS RRM TC 6.1.1.6	16.10.0
2021-12	RAN#94	R5-218334	0273	1	F	Addition of test tolerance analysis for test cases of inter-RAT cell re-selection with relaxed measurement criterion	16.10.0
2021-12	RAN#94	R5-218337	0265	1	F	TT analysis for SRVCC RRM TC 6.3.1.6	16.10.0
2021-12	RAN#94	R5-218338	0266	1	F	TT analysis for SRVCC RRM TC 6.6.5.1	16.10.0
2021-12	RAN#94	R5-218353	0269	1	F	TT analysis for HST RRM TC 6.1.2.5	16.10.0
2021-12	RAN#94	R5-218354	0276	1	F	Test Tolerance analysis for SA FR1 - E-UTRAN event-triggered reporting in DRX for HST	16.10.0
2021-12	RAN#94	R5-218355	0277	1	F	Test Tolerance analysis for E-UTRA - NR FR1 Cell reselection tests for HST	16.10.0
2021-12	RAN#94	R5-218356	0278	1	F	Test Tolerance analysis for SA FR1 - E-UTRAN event-triggered reporting in DRX for HST	16.10.0
2021-12	RAN#94	R5-218394	0257	1	F	TT analysis for Mob_enh RRM TC 6.3.1.7+6.3.1.8	16.10.0
2021-12	RAN#94	R5-218395	0258	1	F	TT analysis for Mob_enh RRM TC 6.3.3.1	16.10.0
2021-12	RAN#94	R5-218396	0259	1	F	TT analysis for Mob_enh RRM TC 6.3.3.2	16.10.0
2021-12	RAN#94	R5-218397	0267	1	F	TT analysis for HST RRM TC 4.6.1.7+6.6.1.7	16.10.0
2021-12	RAN#94	R5-218398	0268	1	F	TT analysis for HST RRM TC 4.6.4.5+6.6.4.5	16.10.0
2021-12	RAN#94	R5-218402	0274	1	F	MU for Tx modulation quality test cases	16.10.0
2021-12	RAN#94	R5-218408	0279	1	F	38.903 Beam correspondence Measurement Uncertainties	16.10.0
2021-12	RAN#94	-	-	-	-	missing attachment file added	16.10.1
2022-03	RAN#95	R5-220281	0285	-	F	Test Tolerance analysis for FR1 CLI-RSSI measurement with non-DRX	16.11.0
2022-03	RAN#95	R5-220718	0289	-	F	TT analysis for FR2 SSB intra-freq measurement with DRX TCs	16.11.0
2022-03	RAN#95	R5-220994	0295	-	F	Addition of test tolerance analysis for 4.6.7.1 and 6.6.8.1 EN-DC and NR SA CSI-RS based L1-SINR measurement	16.11.0
2022-03	RAN#95	R5-220995	0296	-	F	Addition of test tolerance analysis for 4.6.7.2 EN-DC SSB based L1-SINR measurement	16.11.0
2022-03	RAN#95	R5-220996	0297	-	F	Addition of test tolerance analysis for 4.6.7.3 EN-DC CSI-RS based L1-SINR measurement	16.11.0
2022-03	RAN#95	R5-220997	0298	-	F	Addition of test tolerance analysis for 6.6.8.2 NR SA SSB based L1-SINR measurement	16.11.0
2022-03	RAN#95	R5-220998	0299	-	F	Addition of test tolerance analysis for 6.6.8.3 NR SA CSI-RS based L1-SINR measurement	16.11.0
2022-03	RAN#95	R5-221286	0302	-	F	Test Tolerance analysis for E-UTRA - NR FR1 Cell reselection tests for HST	16.11.0
2022-03	RAN#95	R5-221287	0303	-	F	Test Tolerance analysis for inter-frequency RRC re-establishment test case	16.11.0

2022-03	RAN#95	R5-221304	0305	-	F	Correction of clause 3	16.11.0
2022-03	RAN#95	R5-221629	0301	1	F	38.903 Beam correspondence Measurement Uncertainties	16.11.0
2022-03	RAN#95	R5-221644	0304	1	F	Test Tolerance analysis for inter-frequency RRC re-establishment test case	16.11.0
2022-03	RAN#95	R5-221647	0281	1	F	TT analysis for Mob_enh RRM TC 6.3.1.9+6.3.1.10	16.11.0
2022-03	RAN#95	R5-221648	0284	1	F	TT analysis for Mob_enh RRM TC 6.3.1.11+6.3.1.12	16.11.0
2022-03	RAN#95	R5-221649	0290	1	F	TT analysis for Mob_enh RRM TCs 7.3.1.4 and 7.3.1.5	16.11.0
2022-03	RAN#95	R5-221656	0294	1	F	Add Test Tolerance analyses for NR SA FR1 cell re-selection for UE configured with highSpeedMeasFlag-r16 Test cases	16.11.0
2022-03	RAN#95	R5-221743	0286	1	F	FR2 EVM MU definition in 38.903	16.11.0
2022-03	RAN#95	R5-221744	0287	1	F	TT analysis for FR2 SSB based BFD TCs	16.11.0
2022-03	RAN#95	R5-221745	0288	1	F	TT analysis for FR2 SSB intra-freq measurement without DRX TCs	16.11.0
2022-03	RAN#95	R5-221746	0292	1	F	Addition of summary table for MU factors	16.11.0
2022-03	RAN#95	R5-221747	0300	1	F	Update of predicted SNR upper bound for noise free SDR scenarios	16.11.0
2022-03	RAN#95	R5-221814	0291	1	F	TT analysis for Mob_enh RRM TCs 7.3.3.1	16.11.0
2022-03	RAN#95	R5-221840	0293	1	F	Addition of TT analysis for FR2 BFR test cases	16.11.0
2022-06	RAN#96	R5-223608	0306	1	F	Add Test Tolerance analyses for EN-DC FR2 RLM tests for PSCell configured with CSI-RS-based RLM RS in non-DRX	16.12.0
2022-06	RAN#96	R5-223609	0320	1	F	Test Tolerance analysis for FR2 CSI-RS based L1-RSRP measurement for beam reporting test cases	16.12.0
2022-06	RAN#96	R5-223708	0315	1	F	Addition of test tolerance analysis for 5.6.6.3	16.12.0
2022-06	RAN#96	R5-223709	0317	1	F	Addition of test tolerance analysis for 7.6.6.3	16.12.0
2022-06	RAN#96	R5-223865	0308	1	F	TT analysis for RRM test case 5.7.4.1 and 5.7.4.2	16.12.0
2022-06	RAN#96	R5-223866	0318	1	F	Test Tolerances for Intra-frequency SS-RSRP measurement accuracy tests in FR2	16.12.0
2022-06	RAN#96	R5-223883	0313	1	F	Addition of test tolerance analysis for 5.6.6.1 and 7.6.6.1	16.12.0
2022-06	RAN#96	R5-223884	0314	1	F	Addition of test tolerance analysis for 5.6.6.2	16.12.0
2022-06	RAN#96	R5-223885	0316	1	F	Addition of test tolerance analysis for 7.6.6.2	16.12.0
2022-09	RAN#97	R5-223964	0322	-	F	TT analysis for 5.7.1.3 and 7.7.1.3	16.13.0
2022-09	RAN#97	R5-223975	0324	-	F	TT analysis for 4.3.2.2.3	16.13.0
2022-09	RAN#97	R5-224412	0338	-	F	Introduction of NR positioning test cases information	16.13.0
2022-09	RAN#97	R5-224521	0341	-	F	TT analysis for NR SL RRM TC 9.1.1.1 - GNSS	16.13.0
2022-09	RAN#97	R5-224522	0342	-	F	TT analysis for NR SL RRM TC 9.1.1.2 - SyncRef UE	16.13.0
2022-09	RAN#97	R5-224523	0343	-	F	TT analysis for NR SL RRM TC 9.1.1.3 - gNB	16.13.0
2022-09	RAN#97	R5-224524	0344	-	F	TT analysis for NR SL RRM TC 9.1.2.1 - S-SSB Tx gNB	16.13.0
2022-09	RAN#97	R5-224525	0345	-	F	TT analysis for NR SL RRM TC 9.1.2.2 - S-SSB Tx SyncRef UE	16.13.0
2022-09	RAN#97	R5-224526	0346	-	F	TT analysis for NR SL RRM TC 9.1.3.1 - GNSS highest priority	16.13.0
2022-09	RAN#97	R5-224527	0347	-	F	TT analysis for NR SL RRM TC 9.1.3.2 - Cell highest priority	16.13.0
2022-09	RAN#97	R5-224528	0348	-	F	TT analysis for NR SL RRM TC 9.1.4.1 - resource selection	16.13.0
2022-09	RAN#97	R5-224529	0349	-	F	TT analysis for NR SL RRM TC 9.1.4.2 - resource pre-emption	16.13.0
2022-09	RAN#97	R5-224531	0351	-	F	TT analysis for NR SL RRM TC 9.1.5.x - CBR	16.13.0
2022-09	RAN#97	R5-224532	0352	-	F	TT analysis for NR SL RRM TC 9.1.6.1 - WAN interruption	16.13.0
2022-09	RAN#97	R5-224777	0365	-	F	Addition of TT information for 6.5.5.5 and 6.5.5.6	16.13.0
2022-09	RAN#97	R5-225137	0367	-	F	Test Tolerances for Intra-frequency SS-RSRP measurement accuracy tests in FR2	16.13.0
2022-09	RAN#97	R5-225612	0370	1	F	Test Tolerances for DL Interruptions at switching between two uplink carriers test cases	16.13.0
2022-09	RAN#97	R5-225616	0326	1	F	TT analysis for positioning test case 15.2.1 and 15.2.2	16.13.0
2022-09	RAN#97	R5-225618	0321	1	F	Add Test Tolerance analyses for EN-DC FR2 RLM tests for PSCell configured with CSI-RS-based RLM RS in DRX	16.13.0
2022-09	RAN#97	R5-225625	0329	1	F	Addition of test tolerance analysis for 4.7.7.1.2 and 6.7.9.1.2 FR1 L1-SINR relative measurement accuracy	16.13.0
2022-09	RAN#97	R5-225626	0333	1	F	Addition of test tolerance analysis for 7.7.6.2 NR FR2 L1-SINR measurement accuracy test	16.13.0
2022-09	RAN#97	R5-225627	0334	1	F	Addition of test tolerance analysis for 7.7.6.3 NR FR2 L1-SINR measurement accuracy test	16.13.0
2022-09	RAN#97	R5-225636	0366	1	F	TT analysis update for FR2 RLM test cases 5.5.1.x and 7.5.1.x	16.13.0
2022-09	RAN#97	R5-225637	0368	1	F	Test Tolerances for SSB based L1-RSRP measurement accuracy tests in FR2	16.13.0
2022-09	RAN#97	R5-225638	0369	1	F	Test Tolerances for FR2 CSI-RS based L1-RSRPSS-RSRP measurement accuracy tests in FR2	16.13.0
2022-09	RAN#97	R5-225663	0327	1	F	Measurement uncertainties for test case 6.2.4_1 Configured transmitted power with Power Boost	16.13.0
2022-09	RAN#97	R5-225671	0335	1	F	PC1 MU - definition for MOP in 38.903	16.13.0
2022-09	RAN#97	R5-225672	0336	1	F	PC1 MU - definition for REFSENS in 38.903	16.13.0
2022-09	RAN#97	R5-225673	0337	1	F	PC1 MU - General Update in 38.903 section B.2.2	16.13.0
2022-09	RAN#97	R5-225674	0359	1	F	Definition of PC1 MU	16.13.0
2022-09	RAN#97	R5-225675	0360	1	F	Update FR2 TRx MU in 38.903	16.13.0
2022-09	RAN#97	R5-225694	0328	1	F	Addition of test tolerance analysis for 4.7.7.1.1 and 6.7.9.1.1 EN-DC FR1 L1-SINR absolute accuracy tests	16.13.0
2022-09	RAN#97	R5-225695	0330	1	F	Addition of test tolerance analysis for 4.7.7.2 and 6.7.9.2 FR1 L1-SINR absolute measurement accuracy	16.13.0

2022-09	RAN#97	R5-225696	0331	1	F	Addition of test tolerance analysis for 4.7.7.3.1 and 6.7.9.3.1 FR1 L1-SINR absolute measurement accuracy	16.13.0
2022-09	RAN#97	R5-225697	0332	1	F	Addition of test tolerance analysis for 4.7.7.3.2 and 6.7.9.3.2 EN-DC FR1 L1-SINR absolute measurement accuracy	16.13.0
2022-09	RAN#97	R5-225854	0350	1	F	TT analysis for NR SL RRM TC 9.1.4.3 - resource re-evaluation	16.13.0
2022-09	RAN#97	R5-225860	0353	1	F	TT analysis for NR PS RRM TC 7.1.1.3 - intra-freq reselection low mobility	16.13.0
2022-09	RAN#97	R5-225861	0354	1	F	TT analysis for NR PS RRM TC 7.1.1.4 - intra-freq reselection not-at-cell-edge	16.13.0
2022-09	RAN#97	R5-225862	0355	1	F	TT analysis for NR PS RRM TC 7.1.1.5 - inter-freq reselection low mobility	16.13.0
2022-09	RAN#97	R5-225863	0356	1	F	TT analysis for NR PS RRM TC 7.1.1.6 - inter-freq reselection not-at-cell-edge	16.13.0
2022-09	RAN#97	R5-225867	0357	1	F	TT analysis for NR SA FR2 RRM TC 7.1.1.1 - intra-freq reselection	16.13.0
2022-09	RAN#97	R5-225868	0358	1	F	TT analysis for NR SA FR2 RRM TC 7.1.1.2 - inter-freq reselection	16.13.0
2022-09	RAN#97	R5-225873	0361	1	F	Addition of TT analysis for eMIMO L1-SINR test case 5.7.6.1 and 7.7.6.1	16.13.0
2022-09	RAN#97	R5-225874	0362	1	F	Addition of TT analysis for eMIMO L1-SINR test case 5.7.6.2	16.13.0
2022-09	RAN#97	R5-225875	0363	1	F	Addition of TT analysis for eMIMO L1-SINR test case 5.7.6.3	16.13.0
2022-09	RAN#97	R5-225879	0323	1	F	TT analysis for TS 37.571-1 TC 14.2.1	16.13.0
2022-09	RAN#97	R5-225880	0325	1	F	TT analysis for TS 37.571-1 TC 14.3.1	16.13.0
2022-12	RAN#98	R5-225939	0372	-	F	TT analysis for positioning test case 15.2.3	16.14.0
2022-12	RAN#98	R5-225940	0373	-	F	TT analysis for positioning test case 15.2.4	16.14.0
2022-12	RAN#98	R5-225941	0374	-	F	TT analysis for positioning test case 15.3.1	16.14.0
2022-12	RAN#98	R5-225942	0375	-	F	TT analysis for positioning test case 15.3.2	16.14.0
2022-12	RAN#98	R5-226101	0378	-	F	PC1 MU - definition for Frequency error in 38.903	16.14.0
2022-12	RAN#98	R5-226213	0408	-	F	TT analysis for Interruption TCs	16.14.0
2022-12	RAN#98	R5-226214	0409	-	F	TT analysis for SCell activation TCs	16.14.0
2022-12	RAN#98	R5-226375	0410	-	F	Test tolerance analysis for FR2 RRC-based DL active BWP switch	16.14.0
2022-12	RAN#98	R5-226534	0438	-	F	Update of MU for PC1 Demod	16.14.0
2022-12	RAN#98	R5-226642	0439	-	F	Capturing simulation results to derive the maximum testable SNR	16.14.0
2022-12	RAN#98	R5-227646	0440	2	F	PC1 update to Demod SNR range calculator	16.14.0
2022-12	RAN#98	R5-227821	0437	1	F	Update of MU for PC1 RRM	16.14.0
2022-12	RAN#98	R5-227822	0447	1	F	40cm QoQZ and XPD MU in 38.903	16.14.0
2022-12	RAN#98	R5-227841	0448	1	F	Test Tolerances for FR2 SRS-RSRP measurement in non-DRX	16.14.0
2022-12	RAN#98	R5-227842	0449	1	F	Test Tolerances for EN-DC FR2 SRS-RSRP measurement accuracy	16.14.0
2022-12	RAN#98	R5-227869	0441	1	F	Addition of TT analysis for 7.5.2.1	16.14.0
2022-12	RAN#98	R5-227967	0376	1	F	PC1 MU - definition for ACLR in 38.903	16.14.0
2022-12	RAN#98	R5-227968	0377	1	F	PC1 MU - definition for ACS in 38.903	16.14.0
2022-12	RAN#98	R5-227969	0380	1	F	PC1 MU - definition for MOP in 38.903	16.14.0
2022-12	RAN#98	R5-227970	0382	1	F	PC1 MU - definition for OFF power in 38.903	16.14.0
2022-12	RAN#98	R5-227971	0383	1	F	PC1 MU - definition for REFSENS in 38.903	16.14.0
2022-12	RAN#98	R5-227972	0384	1	F	PC1 MU - definition for SEM in 38.903	16.14.0
2022-12	RAN#98	R5-227973	0385	1	F	PC1 MU - General Update in 38.903 section B.2.2	16.14.0
2022-12	RAN#98	R5-227974	0443	1	F	Test Tolerances for Idle mode CA/DC measurement FR1 test case	16.14.0
2022-12	RAN#98	R5-227989	0442	1	F	Definition of PC1 MU	16.14.0
2022-12	RAN#98	R5-228009	0433	1	F	Update TT analysis for TC 14.2.1	16.14.0
2022-12	RAN#98	R5-228010	0434	1	F	Update TT analysis for TC 14.3.1	16.14.0
2022-12	RAN#98	R5-228011	0435	1	F	New TT analysis for TC 14.2.2	16.14.0
2022-12	RAN#98	R5-228012	0436	1	F	New TT analysis for TC 14.3.2	16.14.0
2022-12	RAN#98	R5-226428	0420	-	F	TT analysis for RedCap RRM TC 16.4.1.1 and 16.4.1.2 - Tx timing	17.0.0
2022-12	RAN#98	R5-226434	0426	-	F	TT analysis for RedCap RRM TC 17.3.2.1.1 - intra reestablish	17.0.0
2022-12	RAN#98	R5-226435	0427	-	F	TT analysis for RedCap RRM TC 17.3.2.1.2 - inter reestablish	17.0.0
2022-12	RAN#98	R5-226436	0428	-	F	TT analysis for RedCap RRM TC 17.5.1.1 - OOS non-DRX	17.0.0
2022-12	RAN#98	R5-226437	0429	-	F	TT analysis for RedCap RRM TC 17.5.1.2 - IS non-DRX	17.0.0
2022-12	RAN#98	R5-226438	0430	-	F	TT analysis for RedCap RRM TC 17.5.1.4 - IS DRX	17.0.0
2022-12	RAN#98	R5-226439	0431	-	F	TT analysis for RedCap RRM TC 17.6.1.1 - no gap non-DRX	17.0.0
2022-12	RAN#98	R5-227846	0411	1	F	TT analysis for RedCap RRM TC 16.3.1.8 - inter-RAT HO 2 Rx	17.0.0
2022-12	RAN#98	R5-227847	0412	1	F	TT analysis for RedCap RRM TC 16.3.1.10 - inter-RAT blind HO 2 Rx	17.0.0
2022-12	RAN#98	R5-227848	0413	1	F	TT analysis for RedCap RRM TC 16.3.2.1.2 - intra reestablish 2 Rx	17.0.0
2022-12	RAN#98	R5-227849	0414	1	F	TT analysis for RedCap RRM TC 16.3.2.1.4 - inter reestablish 2 Rx	17.0.0
2022-12	RAN#98	R5-227850	0415	1	F	TT analysis for RedCap RRM TC 16.3.2.1.6 - no timing reestablish 2 Rx	17.0.0
2022-12	RAN#98	R5-227851	0416	1	F	TT analysis for RedCap RRM TC 16.3.2.2.2 and 16.3.2.2.4 - 4 step RACH 2 Rx	17.0.0
2022-12	RAN#98	R5-227852	0417	1	F	TT analysis for RedCap RRM TC 16.3.2.2.6 and 16.3.2.2.8 - 2 step RACH 2 Rx	17.0.0
2022-12	RAN#98	R5-227853	0418	1	F	TT analysis for RedCap RRM TC 16.3.2.3.2 and 18.2.2.1 - NR redirection 2 Rx	17.0.0
2022-12	RAN#98	R5-227854	0419	1	F	TT analysis for RedCap RRM TC 16.3.2.3.4 - LTE redirection 2 Rx	17.0.0
2022-12	RAN#98	R5-227855	0421	1	F	TT analysis for RedCap RRM TC 16.5.1.2 - OOS SSB	17.0.0

2022-12	RAN#98	R5-227856	0422	1	F	TT analysis for RedCap RRM TC 16.5.1.4 and 16.5.1.8 - IS SSB	17.0.0
2022-12	RAN#98	R5-227857	0423	1	F	TT analysis for RedCap RRM TC 16.5.2.2 - SSB BFR	17.0.0
2022-12	RAN#98	R5-227858	0424	1	F	TT analysis for RedCap RRM TC 16.6.1.x - intra-freq	17.0.0
2022-12	RAN#98	R5-227859	0425	1	F	TT analysis for RedCap RRM TC 16.6.4.x - SSB L1-RSRP	17.0.0
2022-12	RAN#98	R5-227860	0432	1	F	TT analysis for RedCap RRM TC 18.2.1.1 - L2N HO	17.0.0
2023-03	RAN#99	R5-230030	0450	-	F	TT analysis for positioning test case 14.2.3	17.1.0
2023-03	RAN#99	R5-230031	0451	-	F	TT analysis for positioning test case 14.2.4	17.1.0
2023-03	RAN#99	R5-230033	0453	-	F	TT analysis for positioning test case 14.3.4	17.1.0
2023-03	RAN#99	R5-230034	0454	-	F	TT analysis for positioning test case 16.2.3	17.1.0
2023-03	RAN#99	R5-230180	0465	-	F	PC5 MU - definition for REFSENS test case in 38.903	17.1.0
2023-03	RAN#99	R5-230430	0469	-	F	Addition of test tolerance analysis for 5.5.3.1 EN-DC FR2 SCell activation and deactivation intra-band in non-DRX	17.1.0
2023-03	RAN#99	R5-230434	0471	-	F	Addition of test tolerance analysis for 8.4.2.6 and 8.4.2.7 and 8.4.2.8 NR Inter-RAT event triggered reporting tests for FR2 test cases	17.1.0
2023-03	RAN#99	R5-230517	0473	-	F	TT analysis for RedCap RRM TC 16.3.1.4 - intra unknown HO 2Rx	17.1.0
2023-03	RAN#99	R5-230518	0474	-	F	TT analysis for RedCap RRM TC 16.3.1.6 - inter unknown HO 2Rx	17.1.0
2023-03	RAN#99	R5-230519	0475	-	F	TT analysis for RedCap RRM TC 16.4.3.1 and 16.4.3.2 - TA	17.1.0
2023-03	RAN#99	R5-230520	0476	-	F	TT analysis for RedCap RRM TC 16.5.1.10 and 16.5.1.14 - OOS 2RX	17.1.0
2023-03	RAN#99	R5-230521	0477	-	F	TT analysis for RedCap RRM TC 16.5.1.12 and 16.5.1.16 - IS 2RX	17.1.0
2023-03	RAN#99	R5-230522	0478	-	F	TT analysis for RedCap RRM TC 16.5.2.6 and 16.5.2.8 - BFR 2RX	17.1.0
2023-03	RAN#99	R5-230523	0479	-	F	TT analysis for RedCap RRM TC 16.6.1.x - intra meas 2Rx	17.1.0
2023-03	RAN#99	R5-230524	0480	-	F	TT analysis for RedCap RRM TC 16.6.4.6 and 16.6.4.8 - CSI-RS L1-RSRP 2Rx	17.1.0
2023-03	RAN#99	R5-230525	0481	-	F	TT analysis for RedCap RRM TC 18.3.1.x - FR1 NR meas	17.1.0
2023-03	RAN#99	R5-230531	0482	-	F	TT analysis for RRM enhancement TC 6.5.8.1 - CBW change	17.1.0
2023-03	RAN#99	R5-230925	0491	-	F	New TT analysis for TC 4A.1.1.1	17.1.0
2023-03	RAN#99	R5-230926	0492	-	F	New TT analysis for TC 4A.2.1.1	17.1.0
2023-03	RAN#99	R5-231138	0494	-	F	TT analysis for RedCap RRM TC 16.1.1.4	17.1.0
2023-03	RAN#99	R5-231139	0495	-	F	TT analysis for RedCap RRM TC 16.1.1.6	17.1.0
2023-03	RAN#99	R5-231140	0496	-	F	TT analysis for RedCap RRM TC 16.1.1.8	17.1.0
2023-03	RAN#99	R5-231141	0497	-	F	TT analysis for RedCap RRM TC 16.1.2.2	17.1.0
2023-03	RAN#99	R5-231142	0498	-	F	TT analysis for RedCap RRM TC 16.1.2.4 and 16.1.2.6	17.1.0
2023-03	RAN#99	R5-231147	0499	-	F	TT analysis for Idle mode Inter-RAT CA/DC measurement test case 6.6.15.1	17.1.0
2023-03	RAN#99	R5-231148	0500	-	F	TT analysis for E-UTRA - NR Early Measurement Reporting for NR in FR1 test case 8.2.2.1	17.1.0
2023-03	RAN#99	R5-231345	0502	-	F	Max testable SNR table updates	17.1.0
2023-03	RAN#99	R5-231745	0501	1	F	TT analysis for E-UTRA - NR Early Measurement Reporting for NR in FR2 test case 8.2.2.2	17.1.0
2023-03	RAN#99	R5-231756	0452	1	F	TT analysis for positioning test case 14.3.3	17.1.0
2023-03	RAN#99	R5-231757	0455	1	F	TT analysis for positioning test case 16.2.4	17.1.0
2023-03	RAN#99	R5-231758	0490	1	F	Update TT analysis for TC 14.3.2	17.1.0
2023-03	RAN#99	R5-231762	0472	1	F	TT analysis for RedCap RRM TC 16.3.1.2 - intra known HO 2Rx	17.1.0
2023-03	RAN#99	R5-231763	0493	1	F	TT analysis for RedCap RRM TC 16.1.1.2	17.1.0
2023-03	RAN#99	R5-231765	0487	1	F	Addition of TT analysis for 7.3.1.2	17.1.0
2023-03	RAN#99	R5-231766	0488	1	F	Addition of TT analysis for 7.3.1.3 and 7.3.2.3.1	17.1.0
2023-03	RAN#99	R5-231784	0457	1	F	PC1 MU - definition for ACLR test case in 38.903	17.1.0
2023-03	RAN#99	R5-231785	0459	1	F	PC1 MU - definition for MOP test cases in 38.903	17.1.0
2023-03	RAN#99	R5-231786	0461	1	F	PC1 MU - definition for REFSENS test case in 38.903	17.1.0
2023-03	RAN#99	R5-231787	0463	1	F	PC1 MU - definition for Tx spurious test cases in 38.903	17.1.0
2023-03	RAN#99	R5-231788	0466	1	F	Definition of PC1 MU	17.1.0
2023-03	RAN#99	R5-231844	0460	1	F	PC1 MU - definition for MPR test case in 38.903	17.1.0
2023-03	RAN#99	R5-231849	0458	1	F	PC1 MU - definition for Min power test case in 38.903	17.1.0
2023-03	RAN#99	R5-231850	0464	1	F	PC1 MU - General Update in 38.903 test case section B.2.2	17.1.0
2023-03	RAN#99	R5-231899	0470	1	F	Addition of test tolerance analysis for 8.4.2.5 NR Inter-RAT event triggered reporting tests for FR2 test cases	17.1.0
2023-03	RAN#99	R5-231966	0467	1	F	Update of the uncertainty of the network analyzer	17.1.0
2023-03	RAN#99	R5-231968	0468	1	F	Update of PC1 MU	17.1.0
2023-06	RAN#100	R5-232078	0503	-	F	TT analysis for positioning test case 16.3.2	17.2.0
2023-06	RAN#100	R5-232164	0508	-	F	PC1 MU - definition for ACS Case 1 and IBB test cases in 38.903	17.2.0
2023-06	RAN#100	R5-232308	0513	-	F	Update of Test Tolerance analyses for EN-DC FR2 RLM tests for PSCell configured with CSI-RS-based RLM RS	17.2.0
2023-06	RAN#100	R5-232427	0514	-	F	TT analysis for TC 16.2.1	17.2.0
2023-06	RAN#100	R5-232428	0515	-	F	TT analysis for TC 16.2.2	17.2.0
2023-06	RAN#100	R5-232429	0516	-	F	TT analysis for TC 16.3.1	17.2.0
2023-06	RAN#100	R5-232483	0517	-	F	TT analysis for RedCap RRM TC 17.6.1.2 and 17.6.1.4 intraFreq one AoA	17.2.0
2023-06	RAN#100	R5-232484	0518	-	F	TT analysis for RedCap RRM TC 17.6.1.3 intraFreq two AoAs	17.2.0
2023-06	RAN#100	R5-232485	0519	-	F	TT analysis for RedCap RRM TC 17.6.3.1 and 17.6.3.2 SSB L1RSRP	17.2.0

2023-06	RAN#100	R5-232486	0520	-	F	TT analysis for RedCap RRM TC 17.6.3.3 and 17.6.3.4 CSIRS L1RSRP	17.2.0
2023-06	RAN#100	R5-232487	0521	-	F	TT analysis for RedCap RRM TC 18.3.1.5 interRAT nonPeak	17.2.0
2023-06	RAN#100	R5-232488	0522	-	F	TT analysis for RedCap RRM TC 18.3.1.x interRAT peak	17.2.0
2023-06	RAN#100	R5-232561	0523	-	F	Test Tolerance analysis of FR1 PDC test cases	17.2.0
2023-06	RAN#100	R5-232566	0524	-	F	Test Tolerance analysis of FR2 PDC test cases	17.2.0
2023-06	RAN#100	R5-232631	0525	-	F	Removal of Offsets in B.18	17.2.0
2023-06	RAN#100	R5-232657	0526	-	F	Addition of TT analysis for 4.6.5.1 and 6.6.6.1	17.2.0
2023-06	RAN#100	R5-232676	0529	-	F	Addition of TT analysis for test cases 6.6.3.1 and 6.6.3.2	17.2.0
2023-06	RAN#100	R5-232757	0530	-	F	Correction to test tolerance analysis for 5.6.6.1 and 7.6.6.1	17.2.0
2023-06	RAN#100	R5-233299	0538	-	F	Addition of TT analysis for NR SA FR2 BFD and BFR for RedCap	17.2.0
2023-06	RAN#100	R5-233632	0505	1	F	PC5 MU - definition for MOP test cases in 38.903	17.2.0
2023-06	RAN#100	R5-233633	0535	1	F	Updating for PC6 measurement error contribution descriptions for IFF	17.2.0
2023-06	RAN#100	R5-233639	0506	1	F	FR2 MUs - General Update in 38.903 section B.2.2	17.2.0
2023-06	RAN#100	R5-233640	0509	1	F	FR2 PC3 - Network Analyzer MU update in 38.903	17.2.0
2023-06	RAN#100	R5-233646	0527	1	F	Addition of TT analysis for 4.7.6.1 and 6.7.8.1	17.2.0
2023-06	RAN#100	R5-233653	0511	1	F	Grouping of test tolerance analysis for test Case 5.5.3.7 with 5.5.3.1	17.2.0
2023-06	RAN#100	R5-233659	0534	1	F	Test Tolerance analysis for HST event triggered test cases	17.2.0
2023-06	RAN#100	R5-233664	0504	1	F	TT analysis for FR2 UE UL carrier RRC reconfiguration delay test case	17.2.0
2023-06	RAN#100	R5-233695	0537	1	F	Editorial correction to Annex B	17.2.0
2023-06	RAN#100	R5-233750	0510	1	F	Addition of test tolerance analysis for test Case of 4.5.3.5 EN-DC FR1 direct SCell activation and test Case of 6.5.3.4 NR SA FR1 direct SCell activation	17.2.0
2023-09	RAN#101	R5-233966	0542	-	F	TT analysis for RRM test case 7.5.3.3 - SCell Activation and deactivation for SCell in FR2 inter-band in non-DR	17.3.0
2023-09	RAN#101	R5-233968	0543	-	F	Correction to Grouping of FR2 test case 7.5.11.1	17.3.0
2023-09	RAN#101	R5-233977	0545	-	F	PC5 MU definition in 38.903	17.3.0
2023-09	RAN#101	R5-233982	0547	-	F	Editorial correction Network Analyzer FR2 MU	17.3.0
2023-09	RAN#101	R5-234221	0548	-	F	Addition of missing group information for TS 37.571-1 UE Rx-Tx time difference positioning test cases	17.3.0
2023-09	RAN#101	R5-234339	0550	-	F	Test Tolerance analysis for FR2 PDC test case	17.3.0
2023-09	RAN#101	R5-234345	0551	-	F	Addition of test tolerance analysis for test Case of 6.5.3.5 NR SA FR1 direct SCell activation at handover	17.3.0
2023-09	RAN#101	R5-234346	0552	-	F	Addition of test tolerance analysis for test Case of 7.5.3.4 NR SA FR2 direct SCell activation	17.3.0
2023-09	RAN#101	R5-234347	0553	-	F	Addition of test tolerance analysis for test Case of 7.5.3.5 NR SA FR2 direct SCell activation at handover	17.3.0
2023-09	RAN#101	R5-234349	0554	-	F	Test Tolerances for NR SA FR1 DL interruptions at switching between two uplink carriers for 6.5.7A.2	17.3.0
2023-09	RAN#101	R5-234350	0555	-	F	Test Tolerances for NR SA FR1 DL interruptions at switching between two uplink bands for 6.5.7B.2	17.3.0
2023-09	RAN#101	R5-234387	0556	-	F	Update of Test Tolerance analysis for non-DRX SSB-based RLM In-sync tests in FR2	17.3.0
2023-09	RAN#101	R5-234389	0557	-	F	Update of Test Tolerance analyses for non-DRX CSI-RS-based RLM In-sync tests in FR2	17.3.0
2023-09	RAN#101	R5-234421	0561	-	F	TT analysis for RedCap RRM TC 16.5.1.x_RLM IS 1Rx	17.3.0
2023-09	RAN#101	R5-234422	0562	-	F	TT analysis for RedCap RRM TC 16.5.1.x_RLM OOS 1Rx	17.3.0
2023-09	RAN#101	R5-234423	0563	-	F	TT analysis for RedCap RRM TC 16.6.1.x_intraFreq 1Rx	17.3.0
2023-09	RAN#101	R5-234424	0564	-	F	TT analysis for RedCap RRM TC 16.6.4.1 and 16.6.4.3_SSB L1 RSRP 1Rx	17.3.0
2023-09	RAN#101	R5-234651	0567	-	F	Addition of TT analysis for test case 5.5.1.10	17.3.0
2023-09	RAN#101	R5-234663	0568	-	F	Addition of TTs for RedCap RLM OOS test cases 16.5.1.5 and 16.5.1.6	17.3.0
2023-09	RAN#101	R5-234665	0569	-	F	Addition of TTs for RedCap BFR test case 16.5.2.4	17.3.0
2023-09	RAN#101	R5-234666	0570	-	F	Addition of TTs for RedCap BFR test cases 16.5.2.3	17.3.0
2023-09	RAN#101	R5-234668	0571	-	F	Addition of TTs for RedCap BWP Switch test cases 16.5.3.1.1 and 16.5.3.1.2	17.3.0
2023-09	RAN#101	R5-234669	0572	-	F	Addition of TTs for RedCap BWP Switch test cases 16.5.3.2.1 and 16.5.3.2.2	17.3.0
2023-09	RAN#101	R5-234670	0573	-	F	Update to TT analysis for L2N latency test cases 8.4.2.x and 18.3.1.x	17.3.0
2023-09	RAN#101	R5-234678	0574	-	F	Addition of TT analysis for TCI state switch test cases 7.5.8.1.1 and 7.5.8.2.1	17.3.0
2023-09	RAN#101	R5-234882	0576	-	F	Addition of TT analysis for FeMIMO RRM TC 4.5.5.8	17.3.0
2023-09	RAN#101	R5-234966	0582	-	F	Test Tolerance for NR SA FR1 Cell reselection RedCap test case 16.1.1.5	17.3.0
2023-09	RAN#101	R5-234967	0583	-	F	Test Tolerance for NR SA FR1 Cell reselection RedCap test case 16.1.1.7	17.3.0
2023-09	RAN#101	R5-234969	0585	-	F	Test Tolerance for NR - E-UTRA FR1 Cell reselection RedCap test cases 16.1.2.3	17.3.0

2023-09	RAN#101	R5-234970	0586	-	F	Test Tolerance for NR - E-UTRA FR1 Cell reselection RedCap test case 16.1.2.5	17.3.0
2023-09	RAN#101	R5-235103	0587	-	F	TT analysis for FR1 Power saving Enh test cases 4.5.1.9 and 6.5.1.9	17.3.0
2023-09	RAN#101	R5-235104	0588	-	F	TT analysis for FR2 Power saving Enh test case 5.5.5.9	17.3.0
2023-09	RAN#101	R5-235461	0577	2	F	Addition of TT analysis for FeMIMO RRM TC 5.5.5.8& 7.5.5.9	17.3.0
2023-09	RAN#101	R5-235462	0579	2	F	Addition of TT analysis for FeMIMO RRM TC 7.5.5.10	17.3.0
2023-09	RAN#101	R5-235467	0549	2	F	Update to Demod SNR calculator for Agg BW up to 400MHz	17.3.0
2023-09	RAN#101	R5-235731	0560	1	F	TT analysis for RedCap RRM TC 16.3.1.x_intra and inter freq HO 1Rx	17.3.0
2023-09	RAN#101	R5-235732	0565	1	F	TT analysis for RedCap RRM TC 16.6.4.5 and 16.6.4.7_CSIRS L1 RSRP 1Rx	17.3.0
2023-09	RAN#101	R5-235736	0589	1	F	Addition of TT analysis grouping for test cases 5.5.9.1.1 and 7.5.9.1.1 to Table 8-2	17.3.0
2023-09	RAN#101	R5-235737	0590	1	F	Addition of TT analysis grouping for test cases 5.5.9.2.1 and 7.5.9.2.1 to Table 8-2	17.3.0
2023-09	RAN#101	R5-235740	0540	1	F	Addition of TT analysis for gap enhancement RRM test cases 6.6.18.1 and 6.6.18.2	17.3.0
2023-09	RAN#101	R5-235743	0566	1	F	TT analysis for FR1 L1 RSRP relative accuracy TCs	17.3.0
2023-09	RAN#101	R5-235751	0544	1	F	FR2c MU definition in 38.903	17.3.0
2023-09	RAN#101	R5-235920	0584	1	F	Test Tolerance for NR - E-UTRA FR1 Cell reselection RedCap test case 16.1.2.1	17.3.0
2023-09	RAN#101	R5-235921	0581	1	F	Test Tolerance for NR SA FR1 Cell reselection RedCap test case 16.1.1.3	17.3.0
2023-09	RAN#101	R5-235923	0575	1	F	Addition of TT analysis for FeMIMO RRM TC 4.5.5.7	17.3.0
2023-09	RAN#101	R5-235925	0578	1	F	Addition of TT analysis for FeMIMO RRM TC 6.5.5.7	17.3.0
2023-09	RAN#101	R5-235930	0541	1	F	Addition of TT analysis for NCSG RRM test cases 6.6.19.1,6.6.19.2, 6.6.19.3 and 6.6.19.4	17.3.0
2023-09	RAN#101	R5-235931	0539	1	F	Addition of TT analysis for MG_enh RRM test cases 6.6.17.1 and 6.6.17.2	17.3.0
2023-09	RAN#101	-	-	-	-	Administrative release upgrade to match the release of 3GPP TS 38.521-3 and TS 38.522 which were upgraded at RAN#101 to Rel-18 due to Rel-18 relevant CR(s)	18.0.0
2023-12	RAN#102	R5-236062	0598	-	F	PC5 MU - ACS Case 1 and IBB update in 38.903	18.1.0
2023-12	RAN#102	R5-236214	0602	-	F	Addition of Test Tolerances analysis for TC 6.5.7C.1	18.1.0
2023-12	RAN#102	R5-236215	0603	-	F	Addition of Test Tolerances analysis for TC 6.5.7C.2	18.1.0
2023-12	RAN#102	R5-236221	0604	-	F	Addition of test tolerances analysis for RedCap CGI identification test cases	18.1.0
2023-12	RAN#102	R5-236223	0605	-	F	Addition of Test Tolerances analysis for TC 7.6.3.6	18.1.0
2023-12	RAN#102	R5-236224	0606	-	F	Addition of test tolerance analysis for fast SCell activation test cases of 4.5.3.6, 4.5.3.7, 6.5.3.10, 6.5.3.11	18.1.0
2023-12	RAN#102	R5-236225	0607	-	F	Addition of test tolerance analysis for CPAC test cases of 4.5.11.1	18.1.0
2023-12	RAN#102	R5-236226	0608	-	F	Addition of test tolerance analysis for fast SCell activation test cases of 5.5.3.8 and 7.5.3.13	18.1.0
2023-12	RAN#102	R5-236250	0609	-	F	Removal of technical content in TR 38.903 v17.3.0 and substitution with pointer to the next Release	18.1.0
2023-12	RAN#102	R5-236391	0611	-	F	Addition of test tolerance analysis for 4.5.2.10 EN-DC FR1 interruptions due to RRM and RLM/BFD measurements on deactivated NR PSCell	18.1.0
2023-12	RAN#102	R5-236393	0612	-	F	Addition of test tolerance analysis for 4.5.10.1 EN-DC FR1 PSCell activation and deactivation delay	18.1.0
2023-12	RAN#102	R5-236395	0613	-	F	Addition of test tolerance analysis for 5.5.12.1 EN-DC FR2 PSCell activation and deactivation delay	18.1.0
2023-12	RAN#102	R5-236740	0615	-	F	TT analysis for RedCap RRM TC 16.3.1.9	18.1.0
2023-12	RAN#102	R5-236741	0616	-	F	TT analysis for RedCap RRM TC 16.3.2.1.1	18.1.0
2023-12	RAN#102	R5-236742	0617	-	F	TT analysis for RedCap RRM TC 16.3.2.1.3	18.1.0
2023-12	RAN#102	R5-236743	0618	-	F	TT analysis for RedCap RRM TC 16.3.2.1.5	18.1.0
2023-12	RAN#102	R5-236745	0620	-	F	TT analysis for RedCap RRM TC 16.3.2.3.1	18.1.0
2023-12	RAN#102	R5-236746	0621	-	F	TT analysis for RedCap RRM TC 16.3.2.3.3	18.1.0
2023-12	RAN#102	R5-236747	0622	-	F	TT analysis for RedCap RRM TC 16.5.2.x	18.1.0
2023-12	RAN#102	R5-236792	0624	-	F	Editorial correction for MU tables	18.1.0
2023-12	RAN#102	R5-236872	0627	-	F	Addition of test tolerance analysis for Conditional PSCell Addition FR2 test cases	18.1.0
2023-12	RAN#102	R5-236873	0628	-	F	Addition of test tolerance analysis for 7.5.14 PSCell activation	18.1.0
2023-12	RAN#102	R5-236989	0630	-	F	Test Tolerance for NR SA FR1 2Rx event triggered measurement RedCap test cases 16.6.2.x	18.1.0
2023-12	RAN#102	R5-236991	0632	-	F	Test Tolerance analysis correction for FR2 Inter-freq accuracy measurement test cases	18.1.0
2023-12	RAN#102	R5-237013	0633	-	F	Correction of UE gain parameters	18.1.0
2023-12	RAN#102	R5-237734	0599	1	F	FR2c MU definition in 38.903	18.1.0
2023-12	RAN#102	R5-237735	0623	1	F	Update for FR2c MU	18.1.0
2023-12	RAN#102	R5-237736	0639	1	F	Update of MU for FR2 UL MIMO	18.1.0
2023-12	RAN#102	R5-237791	0629	1	F	Test Tolerance for NR SA FR1 Cell reselection RedCap test case 16.1.1.1	18.1.0

2023-12	RAN#102	R5-237792	0631	1	F	Test Tolerance for NR SA FR1 1Rx event triggered measurement RedCap test cases 16.6.2.x	18.1.0
2023-12	RAN#102	R5-237796	0591	1	F	Addition of TT analysis for positioning test case 14.2.8	18.1.0
2023-12	RAN#102	R5-237797	0592	1	F	Addition of TT analysis for positioning test case 14.2.9	18.1.0
2023-12	RAN#102	R5-237798	0593	1	F	Addition of TT analysis for positioning test case 14.2.10	18.1.0
2023-12	RAN#102	R5-237799	0594	1	F	Addition of TT analysis for positioning test case 14.3.7	18.1.0
2023-12	RAN#102	R5-237800	0595	1	F	Addition of TT analysis for positioning test case 14.3.8	18.1.0
2023-12	RAN#102	R5-237801	0596	1	F	Addition of TT analysis for positioning test case 15.3.5	18.1.0
2023-12	RAN#102	R5-237802	0597	1	F	Addition of TT analysis for positioning test case 15.3.6	18.1.0
2023-12	RAN#102	R5-237812	0635	1	F	Addition of TTs for test case 7.5.1.5	18.1.0
2023-12	RAN#102	R5-237813	0636	1	F	Addition of TTs for test case 7.5.1.6	18.1.0
2023-12	RAN#102	R5-237814	0637	1	F	Addition of TTs for test case 7.5.1.7	18.1.0
2023-12	RAN#102	R5-237815	0638	1	F	Addition of TTs for test case 7.5.1.8	18.1.0
2023-12	RAN#102	R5-237928	0614	1	F	TT analysis for RedCap RRM TC 16.3.1.7	18.1.0
2023-12	RAN#102	R5-237929	0619	1	F	TT analysis for RedCap RRM TC 16.3.2.2.x	18.1.0
2023-12	RAN#102	R5-237952	0610	1	F	MU and TT analysis for unified TCI state switching	18.1.0
2023-12	RAN#102	R5-237956	0626	1	F	Addition of test tolerance analysis for 7.5.3.14 Fast SCell activation	18.1.0
2023-12	RAN#102	R5-237961	0634	1	F	Addition of TTs for test case 6.2.1	18.1.0
2024-03	RAN#103	R5-240129	0641	-	F	Addition of TT analysis for positioning test case 15.2.8	18.2.0
2024-03	RAN#103	R5-240131	0643	-	F	Addition of TT analysis for positioning test case 16.2.7	18.2.0
2024-03	RAN#103	R5-240132	0644	-	F	Addition of TT analysis for positioning test case 16.2.8	18.2.0
2024-03	RAN#103	R5-240133	0645	-	F	Addition of TT analysis for positioning test case 16.3.4	18.2.0
2024-03	RAN#103	R5-240373	0648	-	F	Test Tolerances for NR SA FR1 DL interruptions at switching between two uplink carriers for 6.5.7A.1	18.2.0
2024-03	RAN#103	R5-240374	0649	-	F	Test Tolerances for NR SA FR1 DL interruptions at switching between two uplink bands for 6.5.7B.1	18.2.0
2024-03	RAN#103	R5-240406	0651	-	F	FR2 MU - PC1 UL MIMO - Minimum output power test - 38.903	18.2.0
2024-03	RAN#103	R5-240735	0658	-	F	TT analysis for RedCap RRM test case 16.3.2.2.2 and 16.3.2.2.4	18.2.0
2024-03	RAN#103	R5-240736	0659	-	F	TT analysis for RedCap RRM test case 16.3.2.2.6 and 16.3.2.2.8	18.2.0
2024-03	RAN#103	R5-240737	0660	-	F	TT analysis for RedCap RRM test case 16.6.5.3	18.2.0
2024-03	RAN#103	R5-240738	0661	-	F	TT analysis for RedCap RRM test case 16.6.5.4	18.2.0
2024-03	RAN#103	R5-240739	0662	-	F	TT analysis for RedCap RRM test case 16.7.2.3.1	18.2.0
2024-03	RAN#103	R5-240741	0664	-	F	TT analysis for RedCap RRM test case 16.7.2.4.1	18.2.0
2024-03	RAN#103	R5-240742	0665	-	F	TT analysis for RedCap RRM test case 16.7.2.4.2	18.2.0
2024-03	RAN#103	R5-240743	0666	-	F	TT analysis for RedCap RRM test case 16.7.3.1 and 16.7.3.2	18.2.0
2024-03	RAN#103	R5-240747	0670	-	F	TT analysis for RedCap RRM test case 16.7.3.4.2	18.2.0
2024-03	RAN#103	R5-240748	0671	-	F	TT analysis for RedCap RRM test case 16.7.4.1.1	18.2.0
2024-03	RAN#103	R5-240749	0672	-	F	TT analysis for RedCap RRM test case 16.7.4.1.2	18.2.0
2024-03	RAN#103	R5-240752	0675	-	F	TT analysis for RedCap RRM test case 16.7.5.1	18.2.0
2024-03	RAN#103	R5-240753	0676	-	F	TT analysis for RedCap RRM test case 16.7.5.2	18.2.0
2024-03	RAN#103	R5-240754	0677	-	F	TT analysis for RedCap RRM test case 16.7.6.1	18.2.0
2024-03	RAN#103	R5-240755	0678	-	F	TT analysis for RedCap RRM test case 16.7.6.2	18.2.0
2024-03	RAN#103	R5-240787	0679	-	F	Addition of Test Tolerance for NR SA Event triggered reporting RedCap test cases	18.2.0
2024-03	RAN#103	R5-240788	0680	-	F	Test Tolerances for NR SA FR1 - E-UTRAN event-triggered reporting tests for 1 Rx RedCap UE	18.2.0
2024-03	RAN#103	R5-240789	0681	-	F	Test Tolerances for NR SA FR1 - E-UTRAN event-triggered reporting tests for 2 Rx RedCap UE	18.2.0
2024-03	RAN#103	R5-241150	0683	-	F	TT analysis for FR1 PDSCH with inter-cell interference test cases	18.2.0
2024-03	RAN#103	R5-241221	0685	-	F	Test Tolerance for NR SA FR1 SS-RSRP absolute measurement accuracy for RedCap 1 Rx UE test case 16.7.1.1.1	18.2.0
2024-03	RAN#103	R5-241222	0686	-	F	Test Tolerance for NR SA FR1 SS-RSRP relative measurement accuracy for 1 Rx UE test case 16.7.1.1.2	18.2.0
2024-03	RAN#103	R5-241223	0687	-	F	Test Tolerance for NR SA FR1 SS-RSRP absolute measurement accuracy for RedCap 2 Rx UE test case 16.7.1.2.1	18.2.0
2024-03	RAN#103	R5-241224	0688	-	F	Test Tolerance for NR SA FR1 SS-RSRP absolute measurement accuracy for RedCap 2 Rx UE test case 16.7.1.2.2	18.2.0
2024-03	RAN#103	R5-241225	0689	-	F	Test Tolerance for NR SA FR1 SS-RSRQ measurement accuracy UE test case 16.7.2.1	18.2.0
2024-03	RAN#103	R5-241226	0690	-	F	Test Tolerance NR SA FR1 SS-RSRQ measurement accuracy for 2 Rx UE test case 16.7.2.2	18.2.0
2024-03	RAN#103	R5-241337	0699	-	F	Addition of TT analysis grouping for test cases 4.5.9.1 to Table 8-1	18.2.0
2024-03	RAN#103	R5-241680	0653	1	F	Introduction of Test Tolerance analysis for FR2 SA event triggered reporting tests with Pre-MG	18.2.0
2024-03	RAN#103	R5-241681	0654	1	F	Introduction of Test Tolerance analysis for FR2 SA event triggered reporting tests with concurrent gaps	18.2.0
2024-03	RAN#103	R5-241682	0655	1	F	Introduction of Test Tolerance analysis for SA FR2 event triggered reporting tests with NCSG	18.2.0
2024-03	RAN#103	R5-241863	0650	1	F	FR2c MU definition in 38.903	18.2.0
2024-03	RAN#103	R5-241864	0652	1	F	CR to define FR2d QoQZ MUs and misc QoQZ MU corrections	18.2.0
2024-03	RAN#103	R5-241865	0682	1	F	Update for FR2c MU	18.2.0
2024-03	RAN#103	R5-241866	0702	1	F	Documentation of MU for n259	18.2.0

2024-03	RAN#103	R5-241881	0692	1	F	Addition of TTs for NR-U Test Cases 10.3.1.2 and 11.4.1.2	18.2.0
2024-03	RAN#103	R5-241882	0693	1	F	Addition of TTs for NR-U Test Cases 10.3.1.3 and 11.4.1.3	18.2.0
2024-03	RAN#103	R5-241883	0694	1	F	Addition of TTs for NR-U Test Cases 10.3.4.1, 10.3.4.2, 11.4.4.1 and 11.4.4.2	18.2.0
2024-03	RAN#103	R5-241884	0696	1	F	Addition of TTs for NR-U Test Cases 10.3.5.2.1, 10.3.5.2.2, 11.4.5.2.1 and 11.4.5.2.2	18.2.0
2024-03	RAN#103	R5-241885	0697	1	F	Addition of TTs for NR-U Test Cases 10.3.5.3.1 and 11.4.5.3.1	18.2.0
2024-03	RAN#103	R5-241887	0667	1	F	TT analysis for RedCap RRM test case 16.7.3.3.1	18.2.0
2024-03	RAN#103	R5-241888	0668	1	F	TT analysis for RedCap RRM test case 16.7.3.3.2	18.2.0
2024-03	RAN#103	R5-241889	0669	1	F	TT analysis for RedCap RRM test case 16.7.3.4.1	18.2.0
2024-03	RAN#103	R5-241890	0673	1	F	TT analysis for RedCap RRM test case 16.7.4.2.1 16.7.4.3.1 and 16.7.4.4.1	18.2.0
2024-03	RAN#103	R5-241891	0674	1	F	TT analysis for RedCap RRM test case 16.7.4.2.2 16.7.4.3.2 and 16.7.4.4.2	18.2.0
2024-03	RAN#103	R5-241892	0698	1	F	Update of TT analysis for 6.3.1.4 and 16.3.1.8	18.2.0
2024-03	RAN#103	R5-241894	0700	1	F	Addition of TT analysis grouping for test cases 5.5.6.3.1 to Table 8-2	18.2.0
2024-03	RAN#103	R5-241895	0701	1	F	Addition of TT analysis grouping for test cases 5.5.6.4.1 to Table 8-2	18.2.0
2024-03	RAN#103	R5-241900	0642	1	F	Addition of TT analysis for positioning test case 15.2.9 and 15.2.10	18.2.0
2024-03	RAN#103	R5-241902	0684	1	F	Correct of test tolerance analysis of EN-DC FR1 addition and release delay of known PSCell for test case 4.5.7.1	18.2.0
2024-03	RAN#103	R5-242000	0695	1	F	Addition of TTs for NR-U Test Cases 10.3.5.1 and 11.4.5.1	18.2.0
2024-03	RAN#103	R5-242029	0703	1	F	Measurement uncertainty definition for UE Maximum Output Power - EIRP with UL Gaps test case	18.2.0
2024-03	RAN#103	R5-242044	0663	1	F	TT analysis for RedCap RRM test case 16.7.2.3.2	18.2.0

History

Document history		
V18.2.0	May 2024	Publication