

ETSI TS 123 289 V18.9.0 (2024-07)



**5G;**  
**Mission Critical services over 5G System;**  
**Stage 2**  
**(3GPP TS 23.289 version 18.9.0 Release 18)**



---

**Reference**

RTS/TSGS-0623289v190

---

**Keywords**

5G

**ETSI**

---

650 Route des Lucioles  
F-06921 Sophia Antipolis Cedex - FRANCE

Tel.: +33 4 92 94 42 00 Fax: +33 4 93 65 47 16

Siret N° 348 623 562 00017 - APE 7112B  
Association à but non lucratif enregistrée à la  
Sous-Préfecture de Grasse (06) N° w061004871

---

**Important notice**

The present document can be downloaded from the  
ETSI [Search & Browse Standards application](#).

The present document may be made available in electronic versions and/or in print. The content of any electronic and/or print versions of the present document shall not be modified without the prior written authorization of ETSI. In case of any existing or perceived difference in contents between such versions and/or in print, the prevailing version of an ETSI deliverable is the one made publicly available in PDF format on [ETSI deliver](#).

Users should be aware that the present document may be revised or have its status changed,  
this information is available in the [Milestones listing](#).

If you find errors in the present document, please send your comments to  
the relevant service listed under [Committee Support Staff](#).

If you find a security vulnerability in the present document, please report it through our  
[Coordinated Vulnerability Disclosure \(CVD\)](#) program.

---

**Notice of disclaimer & limitation of liability**

The information provided in the present deliverable is directed solely to professionals who have the appropriate degree of experience to understand and interpret its content in accordance with generally accepted engineering or other professional standard and applicable regulations.

No recommendation as to products and services or vendors is made or should be implied.

No representation or warranty is made that this deliverable is technically accurate or sufficient or conforms to any law and/or governmental rule and/or regulation and further, no representation or warranty is made of merchantability or fitness for any particular purpose or against infringement of intellectual property rights.

In no event shall ETSI be held liable for loss of profits or any other incidental or consequential damages.

Any software contained in this deliverable is provided "AS IS" with no warranties, express or implied, including but not limited to, the warranties of merchantability, fitness for a particular purpose and non-infringement of intellectual property rights and ETSI shall not be held liable in any event for any damages whatsoever (including, without limitation, damages for loss of profits, business interruption, loss of information, or any other pecuniary loss) arising out of or related to the use of or inability to use the software.

---

**Copyright Notification**

No part may be reproduced or utilized in any form or by any means, electronic or mechanical, including photocopying and microfilm except as authorized by written permission of ETSI.

The content of the PDF version shall not be modified without the written authorization of ETSI.

The copyright and the foregoing restriction extend to reproduction in all media.

© ETSI 2024.  
All rights reserved.

---

# Intellectual Property Rights

## Essential patents

IPRs essential or potentially essential to normative deliverables may have been declared to ETSI. The declarations pertaining to these essential IPRs, if any, are publicly available for **ETSI members and non-members**, and can be found in ETSI SR 000 314: "*Intellectual Property Rights (IPRs); Essential, or potentially Essential, IPRs notified to ETSI in respect of ETSI standards*", which is available from the ETSI Secretariat. Latest updates are available on the ETSI Web server (<https://ipr.etsi.org/>).

Pursuant to the ETSI Directives including the ETSI IPR Policy, no investigation regarding the essentiality of IPRs, including IPR searches, has been carried out by ETSI. No guarantee can be given as to the existence of other IPRs not referenced in ETSI SR 000 314 (or the updates on the ETSI Web server) which are, or may be, or may become, essential to the present document.

## Trademarks

The present document may include trademarks and/or tradenames which are asserted and/or registered by their owners. ETSI claims no ownership of these except for any which are indicated as being the property of ETSI, and conveys no right to use or reproduce any trademark and/or tradename. Mention of those trademarks in the present document does not constitute an endorsement by ETSI of products, services or organizations associated with those trademarks.

**DECT™**, **PLUGTESTS™**, **UMTS™** and the ETSI logo are trademarks of ETSI registered for the benefit of its Members. **3GPP™** and **LTE™** are trademarks of ETSI registered for the benefit of its Members and of the 3GPP Organizational Partners. **oneM2M™** logo is a trademark of ETSI registered for the benefit of its Members and of the oneM2M Partners. **GSM®** and the GSM logo are trademarks registered and owned by the GSM Association.

---

# Legal Notice

This Technical Specification (TS) has been produced by ETSI 3rd Generation Partnership Project (3GPP).

The present document may refer to technical specifications or reports using their 3GPP identities. These shall be interpreted as being references to the corresponding ETSI deliverables.

The cross reference between 3GPP and ETSI identities can be found under <https://webapp.etsi.org/key/queryform.asp>.

---

# Modal verbs terminology

In the present document "**shall**", "**shall not**", "**should**", "**should not**", "**may**", "**need not**", "**will**", "**will not**", "**can**" and "**cannot**" are to be interpreted as described in clause 3.2 of the [ETSI Drafting Rules](#) (Verbal forms for the expression of provisions).

"**must**" and "**must not**" are **NOT** allowed in ETSI deliverables except when used in direct citation.

# Contents

Intellectual Property Rights .....	2
Legal Notice .....	2
Modal verbs terminology.....	2
Foreword.....	8
Introduction .....	9
1 Scope .....	10
2 References .....	10
3 Definitions of terms, symbols and abbreviations .....	11
3.1 Terms.....	11
3.2 Symbols.....	11
3.3 Abbreviations .....	11
4 MC system resource requirements .....	12
4.1 Multiple Access.....	12
4.1.1 General.....	12
4.1.2 Requirements .....	12
4.2 Session connectivity.....	12
4.2.1 General.....	12
4.2.2 Requirements .....	12
4.3 QoS characteristics .....	13
4.3.1 General.....	13
4.3.2 QoS requirements for general purposes.....	13
4.3.3 QoS requirements for Mission Critical Push to Talk.....	13
4.3.3.1 General .....	13
4.3.3.2 5QI values for MCPTT .....	13
4.3.3.3 Use of priorities.....	14
4.3.4 QoS requirements for Mission Critical Video .....	14
4.3.4.1 General .....	14
4.3.4.2 5QI values for MCVideo.....	14
4.3.4.3 Use of priorities.....	14
4.3.5 QoS requirements for Mission Critical Data.....	15
4.3.5.1 General .....	15
4.3.5.2 5QI values for MCData.....	15
4.3.5.3 Use of priorities.....	15
4.4 Network Slicing.....	15
4.4.1 General.....	15
4.4.2 Requirements .....	15
4.5 Use of public and non-public networks.....	16
4.5.1 General.....	16
4.5.2 Requirements .....	16
4.6 Migration.....	16
4.6.1 General.....	16
4.6.2 Public network utilization.....	16
4.6.3 Non-Public network utilization.....	17
4.7 Architectural aspects of MC services using MBS .....	18
4.7.1 General.....	18
4.7.2 General on-network architecture for use of MBS by MC services .....	18
4.7.3 Specific instantiations of on-network architecture for use of MBS by MC services .....	19
4.7.3.1 Instantiation without optional entities and associated interfaces.....	19
4.7.3.2 Instantiation without MBSF / MBSTF and associated interfaces .....	19
4.7.3.3 Instantiation without NEF and associated interfaces.....	20
4.7.4 Service layer-based interworking between eMBMS and MBS.....	20
4.7.5 Application layer based interworking between eMBMS and MBS .....	21
4.7.6 General architecture showcasing use of MBS by UE for MC services.....	22

4.8	Use of 5G ProSe UE-to-network relay .....	23
4.8.1	General.....	23
4.8.2	5G ProSe UE-to-network relay service requirements .....	24
4.9	EPS interworking .....	24
4.9.1	General.....	24
4.9.2	Requirements .....	24
5	MC system functional model .....	24
5.1	General .....	24
5.2	Description of the planes .....	25
5.3	Common functional model description .....	25
5.3.1	On-network functional model .....	25
5.3.2	Functional entities description .....	29
5.3.2.1	General .....	29
5.3.2.2	Application plane .....	29
5.3.2.3	Signalling control plane .....	29
5.3.3	Reference points .....	29
5.3.3.1	General reference point principle .....	29
5.3.3.2	Application plane .....	29
5.3.3.2.1	General .....	29
5.3.3.3	Signalling control plane .....	29
5.3.3.3.1	General .....	29
5.3.3.3.2	Reference point SIP-1 (between the signalling user agent and the SIP core) .....	29
5.3.3.3.3	Reference point SIP-2 (between the SIP core and the SIP AS) .....	30
5.3.3.3.4	Reference point SIP-3 (between the SIP core and SIP core) .....	30
5.3.3.3.5	Reference point HTTP-1 (between the HTTP client and the HTTP proxy) .....	30
5.3.3.3.6	Reference point HTTP-2 (between the HTTP proxy and the HTTP server) .....	30
5.3.3.3.7	Reference point HTTP-3 (between the HTTP proxy and HTTP proxy) .....	30
5.3.3.3.8	Reference point AAA-1 (between the SIP database and the SIP core) .....	30
5.3.3.3.9	Reference point AAA-2 (between the SIP core and Diameter proxy) .....	30
5.3.3.3.10	Reference points N5 and Rx (between the SIP core and the 5GS) .....	30
5.3.4	Off-network functional model .....	30
5.4	MCPTT functional model description .....	31
5.4.1	On-network functional model .....	31
5.5	MCVideo functional model description .....	32
5.5.1	On-network functional model .....	32
5.6	MCDATA functional model description .....	34
5.6.1	On-network functional model .....	34
6	Application of functional models and deployment scenarios .....	35
6.1	General .....	35
6.2	On-network architectural model .....	35
6.2.1	On-network architectural model diagram .....	35
6.2.2	Application services layer .....	36
6.2.2.1	Overview .....	36
6.2.2.2	Common services core .....	36
6.2.2.3	MC services .....	36
6.2.3	SIP core .....	36
6.2.4	5GS .....	36
6.2.5	UE 1 .....	37
6.2.6	UE 2 .....	37
6.3	Deployment scenarios .....	37
6.3.1	Administration of MC service, SIP core and 5GS .....	37
6.3.1.1	General .....	37
6.3.1.2	Common administration of all planes .....	37
6.3.1.3	MC service provider separate from SIP core and 5GS .....	38
6.3.1.4	MC service provider administers SIP core, separate from 5GS .....	38
6.3.1.5	SIP core partially administered by both PLMN operator and MC service provider .....	39
6.3.1.6	PLMN operator administers SIP core with SIP identities administered by MC service provider .....	40
6.3.2	Resource management of MC service sessions by SIP core and MC service server .....	41
6.3.2.1	General .....	41
6.3.2.2	Resource Management of MC service sessions by SIP core .....	41

6.3.2.3	Management of MC service sessions by MC service server .....	41
6.4	Involved business relationships .....	42
6.4.1	General .....	42
6.4.2	Public network and non-public network utilization .....	42
6.5	Off-network architectural model .....	43
6.5.1	Off-network architectural model diagram .....	43
6.5.2	UE 3 .....	43
6.5.3	UE 4 .....	43
7	MC procedures for 5GS .....	43
7.1	General .....	43
7.2	MC service resource management (on-network) .....	44
7.2.1	General .....	44
7.2.2	Request for unicast resources at session establishment .....	44
7.2.3	Request for unicast resources at session establishment from MC service server .....	45
7.2.3.1	General .....	45
7.2.3.2	Procedure .....	45
7.2.4	Request for modification of unicast resources .....	46
7.2.5	Request for media resources from MC service server .....	48
7.2.5.1	General .....	48
7.2.5.2	Procedure .....	48
7.3	MC service over 5G MBS .....	50
7.3.1	General .....	50
7.3.2	Information flows for 5G MBS .....	51
7.3.2.1	MBS session announcement .....	51
7.3.2.2	UE session join notification .....	54
7.3.2.3	MapGroupToSessionStream .....	54
7.3.2.4	Void .....	54
7.3.2.5	Void .....	54
7.3.2.6	Void .....	54
7.3.2.7	UnMapGroupFromSessionStream .....	54
7.3.2.8	Discover MBS Session request .....	55
7.3.2.9	Discover MBS Session response .....	55
7.3.2.10	MBS listening status report .....	56
7.3.2.11	MBS session de-announcement .....	56
7.3.2.12	MBS session de-announcement acknowledgement .....	56
7.3.2.13	Media distribution request .....	56
7.3.2.14	Media distribution response .....	57
7.3.2.15	Media distribution release .....	57
7.3.2.16	MBS session announcement acknowledgement .....	57
7.3.3	Procedures for usage of 5G MBS .....	57
7.3.3.1	MBS session creation and MBS session announcement .....	57
7.3.3.1.1	General .....	57
7.3.3.1.2	Procedure for pre-created MBS session and MBS session announcement .....	58
7.3.3.1.3	Procedure for dynamic MBS sessions .....	59
7.3.3.2	Request for updating MBS resources for group communications .....	61
7.3.3.2.1	General .....	61
7.3.3.2.2	Procedure for updating MBS resources without dynamic PCC rule .....	61
7.3.3.2.3	Procedure for updating MBS resources with dynamic PCC rule .....	63
7.3.3.3	MBS session deletion request .....	64
7.3.3.3.1	General .....	64
7.3.3.3.2	Procedure .....	65
7.3.3.4	Request to activate / de-activate multicast MBS sessions .....	66
7.3.3.4.1	General .....	66
7.3.3.4.2	Multicast MBS session activation procedure .....	66
7.3.3.4.3	Multicast MBS session de-activation procedure .....	67
7.3.3.5	MC service group media transmissions over 5G MBS sessions .....	68
7.3.3.5.1	General .....	68
7.3.3.5.2	Procedure .....	69
7.3.3.6	Application level control signalling over 5G MBS sessions .....	70
7.3.3.6.1	Description .....	70
7.3.3.6.2	Procedure .....	71

7.3.3.7	Multi-server MBS session coordination.....	72
7.3.3.7.1	General .....	72
7.3.3.7.2	Procedures .....	72
7.3.3.7.2.1	MBS Session coordination independent of media .....	72
7.3.3.7.2.2	MBS session coordination within one group call.....	74
7.3.3.8	Service continuity between 5G MBS delivery and unicast delivery .....	76
7.3.3.8.1	General .....	76
7.3.3.8.2	Service continuity for broadcast MBS session .....	77
7.3.3.8.2.1	General.....	77
7.3.3.8.2.2	Procedures.....	77
7.3.3.8.2.2.1	Service continuity from broadcast to unicast .....	77
7.3.3.8.2.2.2	Service continuity from unicast to broadcast .....	79
7.3.3.8.3	Service continuity for multicast MBS session.....	80
7.3.3.8.4	Path switch between MBS session and 5G ProSe UE-to-network relay .....	80
7.3.3.8.4.1	General.....	80
7.3.3.8.4.2	Path switch procedure from MBS session to a 5G ProSe UE-to-network relay .....	80
7.3.3.8.4.3	Path switch from a 5G ProSe UE-to-network relay to MBS session .....	82
7.3.3.9	MC service inter-system switching between 5G and LTE.....	83
7.3.3.9.1	General .....	83
7.3.3.9.2	Inter-system switching from 5G MBS session to LTE eMBMS bearer .....	83
7.3.3.9.3	Inter-system switching from 5G MBS session to LTE unicast bearer.....	85
7.3.3.9.4	Inter-system switching from LTE eMBMS to 5G MBS session .....	87
7.3.3.9.5	Inter-system switching from LTE eMBMS to 5G unicast PDU session .....	88
7.3.3.10	MBS transmission in MCPTT.....	90
7.3.3.10.1	General .....	90
7.3.3.10.2	Call connect and disconnect over MBS session procedures .....	90
7.3.3.10.3	Enhanced MCPTT group call setup procedure with 5MBS .....	92
7.3.3.10.4	Downlink media transmission with 5MBS.....	92
7.3.3.10.5	Switching between 5G MBS session, 5G unicast PDU session, LTE eMBMS bearer, and LTE unicast bearer for MCPTT.....	92
7.3.3.11	MBS transmission in MCVideo .....	93
7.3.3.11.1	General .....	93
7.3.3.11.2	Call connect and disconnect over MBS session procedures .....	93
7.3.3.11.3	Switching between 5G MBS session, 5G unicast PDU session, LTE eMBMS bearer, and LTE unicast bearer for MCVideo .....	95
7.3.3.11.4	DL media transmission with 5MBS for MCVideo .....	95
7.3.3.12	MBS transmission in MCDATA .....	96
7.3.3.12.1	General .....	96
7.3.3.12.2	Usage of MBS session for MCDATA.....	96
7.3.3.12.3	Switching between 5G MBS session, 5G unicast PDU session, LTE eMBMS bearer, and LTE unicast bearer for MCDATA .....	96
7.3.3.12.4	Group communication connect and disconnect over MBS session procedures.....	97
7.3.3.12.4.1	General.....	97
7.3.3.12.4.2	Procedure .....	97
7.3.3.12.4.2.1	Group communication connect over MBS session.....	97
7.3.3.12.4.2.2	Group communication disconnect from MBS session .....	98
7.3.3.12.5	Downlink media transmission with 5MBS .....	99
7.3.3.13	Use of FEC to protect 5G MBS transmissions .....	99
7.3.3.13.1	General .....	99
7.3.3.13.2	FEC encoding by the MBSTF .....	99
7.4	MC services over 5GS supporting EPS interworking .....	101
7.4.1	General.....	101
7.4.2	Inter-system mobility.....	101
7.4.3	Network notifications of EPS interworking related events.....	102
7.5	Enhancements for Location management over 5GS .....	103
7.5.1	General.....	103
7.5.2	Information flows for location information .....	103
7.5.2.1	General .....	103
7.5.2.2	Location reporting configuration .....	103
7.5.2.3	Location information report .....	104
7.5.3	Procedure .....	105
7.5.3.1	General .....	105

7.5.3.2	Event-triggered location reporting procedure .....	106
7.6	MC service over 5G ProSe .....	106
7.6.1	Off network group communication for MC service .....	106
7.6.2	Off-network private communication .....	106
7.6.3	Use of 5G ProSe UE-to-network relay .....	107
7.6.3.1	5G ProSe UE-to-network relay service authorization .....	107
7.6.3.2	UE-to-network relay MC service .....	107
<b>Annex A (normative):</b>	<b>Configuration data for MC services using 5GS .....</b>	<b>108</b>
A.1	General .....	108
A.2	Initial MC service UE configuration data .....	108
A.3	MC service user profile configuration data .....	108
A.4	MC service group configuration data .....	108
A.5	MC service configuration data .....	109
<b>Annex B (informative):</b>	<b>Service continuity for MC service .....</b>	<b>110</b>
B.1	Service continuity between on-network MC service and UE-to-network relay MC service .....	110
<b>Annex C (informative):</b>	<b>Change history .....</b>	<b>111</b>
History .....	History .....	114



---

# Foreword

This Technical Specification has been produced by the 3rd Generation Partnership Project (3GPP).

The contents of the present document are subject to continuing work within the TSG and may change following formal TSG approval. Should the TSG modify the contents of the present document, it will be re-released by the TSG with an identifying change of release date and an increase in version number as follows:

Version x.y.z

where:

- x the first digit:
  - 1 presented to TSG for information;
  - 2 presented to TSG for approval;
  - 3 or greater indicates TSG approved document under change control.
- y the second digit is incremented for all changes of substance, i.e. technical enhancements, corrections, updates, etc.
- z the third digit is incremented when editorial only changes have been incorporated in the document.

In the present document, modal verbs have the following meanings:

- shall** indicates a mandatory requirement to do something
- shall not** indicates an interdiction (prohibition) to do something

The constructions "shall" and "shall not" are confined to the context of normative provisions, and do not appear in Technical Reports.

The constructions "must" and "must not" are not used as substitutes for "shall" and "shall not". Their use is avoided insofar as possible, and they are not used in a normative context except in a direct citation from an external, referenced, non-3GPP document, or so as to maintain continuity of style when extending or modifying the provisions of such a referenced document.

- should** indicates a recommendation to do something
- should not** indicates a recommendation not to do something
- may** indicates permission to do something
- need not** indicates permission not to do something

The construction "may not" is ambiguous and is not used in normative elements. The unambiguous constructions "might not" or "shall not" are used instead, depending upon the meaning intended.

- can** indicates that something is possible
- cannot** indicates that something is impossible

The constructions "can" and "cannot" are not substitutes for "may" and "need not".

- will** indicates that something is certain or expected to happen as a result of action taken by an agency the behaviour of which is outside the scope of the present document
- will not** indicates that something is certain or expected not to happen as a result of action taken by an agency the behaviour of which is outside the scope of the present document
- might** indicates a likelihood that something will happen as a result of action taken by some agency the behaviour of which is outside the scope of the present document

**might not** indicates a likelihood that something will not happen as a result of action taken by some agency the behaviour of which is outside the scope of the present document

In addition:

**is** (or any other verb in the indicative mood) indicates a statement of fact

**is not** (or any other negative verb in the indicative mood) indicates a statement of fact

The constructions "is" and "is not" do not indicate requirements.

---

## Introduction

The use of 5GS to support MC services (i.e., MCPTT defined in 3GPP TS 23.379 [6], MCVideo defined in 3GPP TS 23.281 [4], MCDData defined in 3GPP TS 23.282 [5]) including common application plane and signalling plane entities is specified in the present document.

Each MC service supports several types of communications amongst the users (e.g. group communication, peer to peer communication). There are several general functions and entities (e.g. configuration, identity) which are used by the MC services. The general functional architecture to support MC services utilizes aspects of the IMS architecture specified in 3GPP TS 23.228 [2].

An MC service UE in the 5GS context obtains access to a MC service via 3GPP access (i.e., E-UTRA, 5G NR), wireless non-3GPP access (e.g. WLAN or Satellite) and/or wireline access using the 5GS architecture defined in 3GPP TS 23.501 [7]. Certain MC service functions such as dispatch and administrative functions can be supported using MC service UEs with 3GPP access and non-3GPP wireless/wireline access. External applications usage of MC services can be enabled via 3GPP access and/or non-3GPP access.

**NOTE:** Dispatch consoles and devices used by MC service administrators are considered as MC service UEs to support MC services.

---

# 1 Scope

The present document specifies the use of the 5G System (5GS) considering common functional architecture, procedures and information flows needed to support mission critical services encompassing the common services core architecture.

The corresponding service requirements applied in 3GPP TS 23.280 [3], 3GPP TS 22.179 [11], 3GPP TS 22.280 [12], 3GPP TS 22.281 [13] and 3GPP TS 22.282 [14] also apply here.

The corresponding MC service specific procedures and information flows are defined in 3GPP TS 23.379 [6], 3GPP TS 23.281[4], and 3GPP TS 23.282 [5].

The present document is applicable primarily to mission critical services using 3GPP access (5G NR and/or E-UTRA) and non-3GPP access (WLAN, Satellite and/or wireline) based on the 5GC architecture defined in 3GPP TS 23.501 [7], 3GPP TS 23.247 [15] and 3GPP TS 23.304 [17].

The common functional architecture to support mission critical services can be used for public safety applications and for general commercial applications e.g. utility companies and railways.

---

# 2 References

The following documents contain provisions which, through reference in this text, constitute provisions of the present document.

- References are either specific (identified by date of publication, edition number, version number, etc.) or non-specific.
- For a specific reference, subsequent revisions do not apply.
- For a non-specific reference, the latest version applies. In the case of a reference to a 3GPP document (including a GSM document), a non-specific reference implicitly refers to the latest version of that document *in the same Release as the present document*.

- [1] 3GPP TR 21.905: "Vocabulary for 3GPP Specifications".
- [2] 3GPP TS 23.228: "IP Multimedia Subsystem (IMS); Stage 2".
- [3] 3GPP TS 23.280: "Common functional architecture to support mission critical services; Stage 2".
- [4] 3GPP TS 23.281: "Functional architecture and information flows to support Mission Critical Video (MCVideo); Stage 2".
- [5] 3GPP TS 23.282: "Functional architecture and information flows to support Mission Critical Data (MCData); Stage 2".
- [6] 3GPP TS 23.379: "Functional architecture and information flows to support Mission Critical Push To Talk (MCPTT); Stage 2".
- [7] 3GPP TS 23.501: "System architecture for the 5G System (5GS)".
- [8] 3GPP TS 23.002: "Network Architecture".
- [9] 3GPP TS 23.503: "Policy and Charging Control Framework for the 5G System (5GS); Stage 2".
- [10] 3GPP TS 23.502: "Procedures for the 5G System (5GS)".
- [11] 3GPP TS 22.179: "Mission Critical Push to Talk (MCPTT); Stage 1".
- [12] 3GPP TS 22.280: "Mission Critical Services Common Requirements (MCCoRe); Stage 1".
- [13] 3GPP TS 22.281: "Mission Critical (MC) Video".
- [14] 3GPP TS 22.282: "Mission Critical (MC) Data".

- [15] 3GPP TS 23.247: "Architectural enhancements for 5G multicast-broadcast services; Stage 2".
- [16] 3GPP TS 23.468: "Group Communication System Enablers for LTE (GCSE\_LTE); Stage 2".
- [17] 3GPP TS 23.304: "Proximity based Service (ProSe) in the 5G System (5GS); Stage 2".
- [18] 3GPP TS 23.237: "IP Multimedia Subsystem (IMS) Service Continuity; Stage 2".
- [19] 3GPP TS 38.331: "NR; Radio Resource Control (RRC) protocol specification".
- [20] 3GPP TS 23.479: "UE MBMS APIs for Mission Critical Services".
- [21] 3GPP TS 26.502: "5G Multicast-Broadcast User Service Architecture".

---

## 3 Definitions of terms, symbols and abbreviations

### 3.1 Terms

For the purposes of the present document, the terms given in 3GPP TR 21.905 [1] and the following apply. A term defined in the present document takes precedence over the definition of the same term, if any, in 3GPP TR 21.905 [1].

For the purposes of the present document, the following terms given in 3GPP TS 23.280 [3] apply:

**MC service**  
**MC service user**  
**MC service UE**  
**MC system**  
**MC user**

For the purposes of the present document, the following terms given in 3GPP TS 23.247 [15] apply:

**MBS session**  
**Broadcast MBS session**  
**Multicast communication service**  
**Multicast MBS session**  
**Broadcast communication service**  
**MBS service area**

### 3.2 Symbols

Void.

### 3.3 Abbreviations

For the purposes of the present document, the abbreviations given in 3GPP TR 21.905 [1] and the following apply. An abbreviation defined in the present document takes precedence over the definition of the same abbreviation, if any, in 3GPP TR 21.905 [1].

NPN	Non-Public Network
PNI-NPN	Public Network Integrated Non-Public Network
SNPN	Stand-alone Non-Public Network
NID	Network Identifier

---

## 4 MC system resource requirements

### 4.1 Multiple Access

#### 4.1.1 General

5GS provides simultaneous integration of different access types 3GPP and non-3GPP (wireline and wireless), defined in 3GPP TS 23.501 [7]. Accordingly, this enables the MC service UE to be used under both stationary and non-stationary conditions.

With the convergence of multiple access technologies in 5GS, service features can be assigned agnostically without taking the access type into account for the MC service user.

#### 4.1.2 Requirements

With the use of 5GS, MC services shall be available via 3GPP access as well as via non-3GPP access. To enable access to the MC system, the use of the various access types shall be authorized by the 5GC. The simultaneous use of different access types (Access Traffic Steering, Switching and Splitting) is defined in 3GPP TS 23.501 [7] and its characteristics are subject to respective operators policy.

### 4.2 Session connectivity

#### 4.2.1 General

The access from 5GS to the MC service environment takes place via the Data Network (DN) in accordance with 3GPP TS 23.501 [7]. A Data Network Name (DNN) as part of the 5GS user profile allows access to the Data Network with up to 8 connectivity sessions (PDU sessions) each with up to 64 communication flows (QoS flows). Different data networks require different DNNs.

#### 4.2.2 Requirements

For MC service UEs who only utilize 5GS, a single DNN may be used for:

- for the SIP-1 reference point;
- for the HTTP-1 reference point; and
- for the CSC-1 reference point.

The DNN shall be made available to the MC service UE either via UE (pre)configuration or via initial UE configuration on a per HPLMN and optionally also per VPLMN basis.

NOTE 1: The Data Network access can also be shared with the "IMS" access taking into account the communication flow limits.

The MC service UE may exploit secondary authentication/authorization by a DN-AAA server during the establishment of session connectivity as specified in 3GPP TS 23.501 [7] using the Extensible Authentication Protocol (EAP) to access the DN identified by the MC service DNN. If required, DN access credentials shall be made available to the MC service UE via initial MC service UE configuration on a per DNN basis.

The DN connection to the DNN defined within the present subclause can be of PDU session type "IPv4", "IPv6", "IPv4v6", Ethernet or Unstructured (see 3GPP TS 23.501 [7]). If a DN connection to an DNN defined within the present subclause is of type "IPv4v6" then the MC service client shall use configuration data to determine whether to use IPv4 or IPv6.

NOTE 2: In accordance to 3GPP TS 23.501 [7], the use of PDU session type Ethernet and Unstructured has limited support in the Session and Service Continuity context.

For MC service UEs who utilize EPS and 5GS 3GPP TS 23.280 [3] clause 5.2.7 applies.

## 4.3 QoS characteristics

### 4.3.1 General

In 5GS, quality of service is enforced at QoS flow level and corresponding packets are classified and marked with an identifier in accordance with 3GPP TS 23.501 [7]. Every QoS flow is characterized by a QoS profile provided by the 5GC, and can be used for all connectivity types (PDU sessions) in accordance with 3GPP TS 23.501 [7].

5G QoS characteristics, standardized or non-standardized, are indicated through the 5QI value in accordance with 3GPP TS 23.501 [7]. Standardized 5QI values have a one-to-one mapping to a standardized combination of 5G QoS characteristics and non-standardized 5QI values allows a dynamic assignment of QoS parameter values.

NOTE 1: The use of non-standardized 5QI values can be subject for harmonisation within the individual user area.

The QoS parameter Allocation Retentions Priority (ARP) determines the priority level, the pre-emption capability and the pre-emption vulnerability of each QoS flow. ARP priority level defines the relative importance of a resource request to allow in deciding whether a new QoS Flow may be accepted or needs to be rejected in the case of resource limitations in accordance with 3GPP TS 23.501 [7].

NOTE 2: The use of ARP is regulated by the individual MC service.

The use of Multicast Broadcast Services (MBS) for MC services shall apply QoS handling as determined by 3GPP TS 23.247 [15].

### 4.3.2 QoS requirements for general purposes

The selection, deployment, initiation, and termination of QoS signalling and resource allocation shall consider the QoS mechanisms described in 3GPP TS 23.501 [7], 3GPP TS 23.502 [10], 3GPP TS 23.503 [9] and 3GPP TS 23.247 [15] for MBS.

MC system as well as MC service UE may share one DNN using multiple QoS flows for the settlement of MC services, application plane and signalling plane.

For the transport of SIP-1 reference point signalling, the standardized 5QI value of 69 in accordance with 3GPP TS 23.501 [7] shall be used.

For the transport of HTTP-1 reference point signalling, the standardized 5QI value of 8 in accordance with 3GPP TS 23.501 [7] or better shall be used.

MC services shall use standardized 5QI values or may use non-standardized 5QI values in accordance with 3GPP TS 23.501 [7].

When the MC system utilizes IMS services, at least one QoS flow shall be associated for IMS signalling. The generic mechanisms for interaction between QoS and session signalling applicable for the use of IMS in the 5GS context are defined in 3GPP TS 23.228 [2].

### 4.3.3 QoS requirements for Mission Critical Push to Talk

#### 4.3.3.1 General

The requirements listed here apply for the use of 5GS and replace the corresponding requirements in 3GPP TS 23.379 [6].

#### 4.3.3.2 5QI values for MCPTT

The MCPTT system may use the N5 reference point or Rx reference point for direct interaction with 5GS PCF to determine the required QoS flow parameters. Alternatively, the MCPTT system may use the N33 reference point for indirect interaction with 5GS NEF.

For the use of MBS, the MCPTT system may interact with the PCF/MB-SMF/NEF/MBSF to provide the corresponding QoS information.

A QoS flow (unicast or multicast/broadcast) for an MCPTT voice call and MCPTT-4/MCPTT-9 reference point signalling shall utilize 5QI value 65 in accordance with 3GPP TS 23.501 [7] and 3GPP TS 23.247 [15].

#### 4.3.3.3 Use of priorities

The QoS flow (unicast or multicast/broadcast) for an MCPTT emergency call shall have highest priority level among MCPTT call types. The QoS flow (unicast or multicast/broadcast) for MCPTT imminent peril call shall have higher priority level than one for a MCPTT call.

Depending on operators' policy, the MCPTT system may be able to request modification of the priority (ARP) of an established QoS flow (unicast or multicast/broadcast).

NOTE: Operators' policy takes into account regional/national requirements.

### 4.3.4 QoS requirements for Mission Critical Video

#### 4.3.4.1 General

The requirements listed here apply for the use of 5GS and replace the corresponding requirements in 3GPP TS 23.281 [4].

#### 4.3.4.2 5QI values for MCVideo

The MCVideo system may use the N5 reference point or Rx reference point for direct interaction with 5GS PCF to determine the required QoS flow parameters. Alternatively, the MCVideo system may use the N33 reference point for indirect interaction with 5GS NEF.

For the use of MBS, the MCVideo system may interact with the PCF/MB-SMF/NEF/MBSF to provide the corresponding QoS information.

Video media and control of the video media may use independent QoS flows (unicast or multicast/broadcast) and utilizes 5QI values depending on the MCVideo mode of the MCVideo call/session, as per table 4.3.4.2-1.

**Table 4.3.4.2-1: MCVideo mode associated 5QI values**

MCVideo mode	5QI value utilized (in accordance with 3GPP TS 23.501 [7])
Urgent real-time mode	67
Non-urgent real-time mode	67
Non real-time mode	4

For transmission and reception control signalling, the 5QI value 69 is recommended in accordance with 3GPP TS 23.501 [7] and 3GPP TS 23.247 [15].

#### 4.3.4.3 Use of priorities

The MCVideo audio media and video media may transmit over dedicated QoS flows (unicast or multicast/broadcast), in which case the priority for each QoS flow (unicast or multicast/broadcast) is determined by the operator policy.

MCVideo services shall be able to use ARP pre-emption capability and the pre-emption vulnerability of each individual QoS flow (unicast or multicast/broadcast) according to operators' policy. Depending on operators' policy, the MCVideo system may be able to request modification of the priority (ARP) of an established QoS flow (unicast or multicast/broadcast).

NOTE: Operator policy takes into account regional/national requirements.

## 4.3.5 QoS requirements for Mission Critical Data

### 4.3.5.1 General

The requirements listed here apply for the use of 5GS and replace the corresponding requirements in 3GPP TS 23.282 [5].

### 4.3.5.2 5QI values for MCDData

The MCDData system may use the N5 reference point or Rx reference point for direct interaction with 5GS PCF to determine the required QoS flow parameters. Alternatively, the MCDData system may use the N33 reference point for indirect interaction with 5GS NEF.

For the use of MBS, the MCDData system may interact with the PCF/MB-SMF/NEF/MBSF to provide the corresponding QoS information.

A QoS flow (unicast or multicast/broadcast) for MCDData media may utilize standardized 5QI value 70 or may utilize non-standardized 5QI values in accordance with 3GPP TS 23.501 [7] and 3GPP TS 23.247 [15].

### 4.3.5.3 Use of priorities

The QoS flows (unicast or multicast/broadcast) for MCDData emergency communications shall have highest priority level among MCDData communication types. The QoS flow (unicast or multicast/broadcast) for MCDData imminent peril call shall have higher priority level than one for a MCDData communication.

MCDData services shall be able to use ARP pre-emption capability and the pre-emption vulnerability of each individual QoS flow (unicast or multicast/broadcast) according to operators' policy.

NOTE: Operators' policy takes into account regional/national requirements.

## 4.4 Network Slicing

### 4.4.1 General

Network slicing in accordance with 3GPP TS 23.501 [7] can be used for several purposes such as to separate MC service users, UEs as well as applications in accordance with the various QoS requirements independent from 3GPP or non-3GPP access.

The corresponding slice information identifies a network slice across the 5G core, access network and the UE. In accordance with 3GPP TS 23.501 [7] standardized and non-standardized slice selection information can be used.

### 4.4.2 Requirements

For the use of network slicing in the MC service context, the following minimum requirements in accordance with 3GPP TS 23.501 [7] shall be considered:

One network slice shall be assigned per PDU session and may benefit from a dedicated transmission resource allocation.

The network slicing for MC services follows the concepts defined in 3GPP TS 23.501 [7]. The Initial MC service UE configuration shall contain at least one network slice identity (S-NSSAI). Those S-NSSAIs shall be considered as part of the Default Configured S-NSSAI(s), and should be utilized by the MC service UE to form the Requested S-NSSAI(s) at registration as specified in 3GPP TS 23.501 [7].

If the MC service UE requests a slice which is subject to Network Slice-Specific Authentication and Authorization, the corresponding aspects as well as the MC service UE behaviour are to be followed as described in 3GPP TS 23.501 [7], and 3GPP TS 23.502 [10]. The corresponding credentials per S-NSSAI can be configured in the initial MC service UE configuration or UE (pre-)configuration.



The use of network slices corresponding to non-standardized NSSAIs across PLMN boundaries requires harmonisation in order to guarantee their availability.

Initial MC service UE configuration data may contain information for the PDU session to be used for each MC service (including among others the S-NSSAI).

## 4.5 Use of public and non-public networks

### 4.5.1 General

MC services are service agnostic with respect to 5GS, i.e., the available service options are identical in both public networks (i.e. PLMN) and Non-Public Networks (NPNs). A Non-Public Network (NPN) can be deployed in organization defined premises and the 5G network services are provided to a defined set of users or organizations in accordance with 3GPP TS 23.501 [7].

### 4.5.2 Requirements

An MC system shall be able to utilize connectivity from public 5GS networks and non-public 5GS networks in accordance with 3GPP TS 23.501 [7].

## 4.6 Migration

### 4.6.1 General

For the migration of an MC service user the general assumptions in 3GPP TS 23.280 [3] clause 5.2.9.1 are applied.

### 4.6.2 Public network utilization

Migrated MC service users should utilize the home PLMN of the partner MC system to access MC services in the partner MC system, however, utilizing the home PLMN of the primary MC system is not precluded.

NOTE 1: The above recommendation ensures the security policy of the partner MC system and is not compromised, the expected 5QIs are used on the 5GS to ensure that service-level delay requirements are consistently met (which are especially at risk when the home PLMN of the primary MC system and the home PLMN of the partner MC system are far apart from a geographical point of view).

NOTE 2: Whether the home PLMN of partner MC systems or the home PLMN of the primary MC system is used to access MC services in partner MC systems is left to business agreements between MC service providers and is outside the scope of the present document.

NOTE 3: The MC service user's MCDATA message store will not be available when using the home PLMN of the partner MC system to access MC services in migration.

The MC service user profile enabled for migration shall be provisioned with configuration data that specifies which PLMNs supporting 5GS are to be selected when migrating to another MC system.

If the home PLMN of a partner MC system is different from the home PLMN of the primary MC system (i.e. migrating MC service users roam into the home PLMN of the partner MC system), then:

- 5GS-level roaming is required between the home PLMN of the primary MC system and home PLMN of the partner MC system;
- the home PLMN of the partner MC system needs to enable local break-out for the DNNs in accordance to subclause 4.2.2 that identify the DNs of the partner MC system; and
- the 5GS user profile of the home PLMN of the primary MC system used by the MC service users who are allowed to migrate to the partner MC system needs to be provisioned with, and local break-out enabled for, the DNNs proposed in subclause 4.2.2 that identify the DNs of the partner MC system.

If the home PLMN of the partner MC system and the home PLMN of the primary MC system are the same (i.e. migrating MC service users continue to use the home PLMN of their primary MC system), then:

- the 5GS user profile of the home PLMN of the primary MC system utilized by the MC service users who are allowed to migrate to the partner MC system needs to be provisioned with the DNNs specified in subclause 4.2.2 that identify the DNs of the partner MC system.

### 4.6.3 Non-Public network utilization

When the NPN is a PNI-NPN as described in 3GPP TS 23.501 [7], the requirements in clause 4.6.2 are applicable.

When the NPN is a SNPN as described in 3GPP TS 23.501 [7], the requirements may be different in the following options.

Option 1: The SNPN utilized by the primary MC system and the SNPN utilized by the partner MC system are the same (i.e., migrating MC service users continue to use the SNPN of their primary MC system.)

- the 5GS user profile of the SNPN of the primary MC system utilized by the MC service users who are allowed to migrate to the partner MC system needs to be provisioned with the DNNs specified in subclause 4.2.2 that identify the DNs of the partner MC system.

Option 2: The partner MC system and the primary MC system utilize different SNPNs.

- the migrated MC service users shall utilize the SNPN of the partner MC system to access MC service in the partner MC system.
- the 5GS user profile of the SNPN of the partner MC system used by the MC service users who are allowed to migrate to the partner MC system needs to be provisioned with the DNNs proposed in subclause 4.2.2 that identify the DNs of the partner MC system.
- the MC service UE shall have credentials to access the SNPN of the partner MC system. UE may access using credentials owned by a Credentials Holder separate from the SNPN of the partner MC system.

Option 3: The partner MC system utilizes the PLMN and the primary MC system utilize SNPN.

- the migrated MC service users should utilize the PLMN of the partner MC system to access MC service in the partner MC system.
- 5GS-level SNPN and PLMN interworking is required between the SNPN of the primary MC system and PLMN of the partner MC system if the migrated MC service users utilize the SNPN of the primary MC system to access MC service in the partner MC system.
- the 5GS user profile of the PLMN of the partner MC system used by the MC service users who are allowed to migrate to the partner MC system needs to be provisioned with the DNNs proposed in subclause 4.2.2 that identify the DNs of the partner MC system.

Option 4: The partner MC system utilizes the SNPN and the primary MC system utilize PLMN.

- the migrated MC service users should utilize the SNPN of the partner MC system to access MC service in the partner MC system.
- 5GS-level SNPN and PLMN interworking is required between the PLMN of the primary MC system and SNPN of the partner MC system if the migrated MC service users utilize the PLMN of the primary MC system to access MC service in the partner MC system.
- the MC service UE shall have credentials to access the SNPN of the partner MC system. UE may access using credentials owned by a Credentials Holder separate from the SNPN of the partner MC system.
- the 5GS user profile of the SNPN of the partner MC system used by the MC service users who are allowed to migrate to the partner MC system needs to be provisioned with the DNNs proposed in subclause 4.2.2 that identify the DNs of the partner MC system.

## 4.7 Architectural aspects of MC services using MBS

### 4.7.1 General

The main purpose of 5G Multicast-Broadcast Service (MBS) use by mission critical services is to provide efficient downlink delivery of user traffic in group calls and communications. The architectural figures in this clause are aligned with the 5GS architecture for MBS shown in Figure 5.1-2 of 3GPP TS 23.247 [15], which identifies both mandatory and optional functional entities and interfaces, in reference point representation, available for use by the MC services.

Multicast and broadcast communication services in 5G for MC group communications rely on the creation and establishment of MBS sessions to deliver user data in downlink. Shared and individual delivery from the MC service server to multiple MC users (i.e., users affiliated to a certain MC group) is supported either as point-to-point or point-to-multipoint over the radio. The MBS sessions are either broadcast or multicast type and consist of one or multiple QoS flows for different service requirements. For the broadcast MBS session or local MBS session, the MBS service area is configured with the MBS session.

NOTE 1: Support of MBS and specific session types is an implementation choice.

Within this arrangement, the MC service server decides whether to create broadcast or multicast MBS sessions to be associated with certain MC groups. The 5GC adaptively decides whether to deliver the MBS traffic from the MB-UPF in the form of shared delivery or individual delivery, where the latter is applicable to multicast MBS sessions only. The NG-RAN decides to utilize point-to-point or point-to-multipoint delivery methods applicable for shared delivery only. MBS provides reliability enhancements and minimizes loss of information, e.g., due to mobility and handover.

MBS group scheduling mechanism enables simultaneous reception of MBS and unicast user traffic by the MC service UEs. The UEs can receive broadcast MBS sessions irrespective of their RRC state (i.e., connected, inactive or idle) and multicast sessions only in RRC-CONNECTED and RRC-INACTIVE state.

The following capabilities (non-exhaustive list) provided by MBS could be used by MC service servers as described in 3GPP TS 23.247 [15]:

- MBS session creation;
- MBS session update;
- MBS session release;
- MBS session ID allocation;
- Transparent MBS Data forwarding;
- Dynamic PCC control for MBS session;
- UE's MBS assistance information provision.

### 4.7.2 General on-network architecture for use of MBS by MC services

Figure 4.7.2-1 presents a high-level architectural view of mission critical services when using MBS. The shown architecture is consistent with 3GPP TS 23.501 [7] and 3GPP TS 23.247 [15].

MC services use MBS control plane capabilities by initiating access via Nmb13, Nmb10 or N33. MBS user plane capabilities can be accessed via N6mb or Nmb8. MC service servers can initiate access to MBS PCC capabilities supported by PCF via N5 or N33. If the MC service server and the 5GS are in different trust domains with respect to MBS, N33 needs to be used to gain access to the MBS control plane capabilities and the PCC capabilities.

The 5G-GC1 reference point, which exists between the MC service client and the MC service server, is used for application layer signalling for the control of mission critical service delivery over MBS session. The functions of this reference point are defined in clause 7.3.

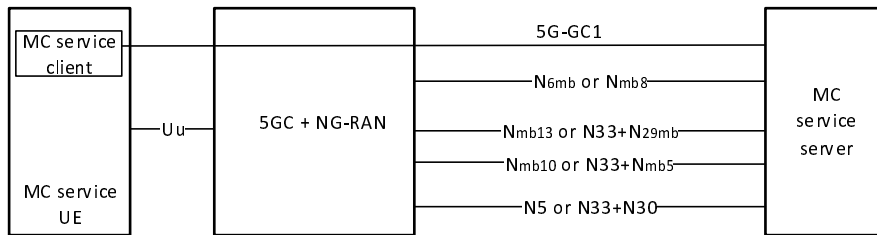

**Figure 4.7.2-1: Architectural view of a mission critical system when using MBS**

NOTE 1: Support of interfaces associated to 5GS optional entities (e.g. MBSF, MBSTF, NEF) is necessary only if features enabled by these entities are supported.

NOTE 2: When the MC service server uses MBS, the N5 reference point is used as described in the present document.

### 4.7.3 Specific instantiations of on-network architecture for use of MBS by MC services

#### 4.7.3.1 Instantiation without optional entities and associated interfaces

Figure 4.7.3.1-1 presents a high-level architectural view of mission critical services when using MBS without the presence or use of the optional entities (MBSF, MBSTF and NEF) and their associated interfaces. The shown architecture is a particularization of the general architecture shown in figure 4.7.3.1-1.

MC services use MBS control plane capabilities by initiating access via Nmb13. MBS user plane capabilities can be accessed via N6mb. MC service servers can initiate access to MBS PCC capabilities supported by PCF via N5.

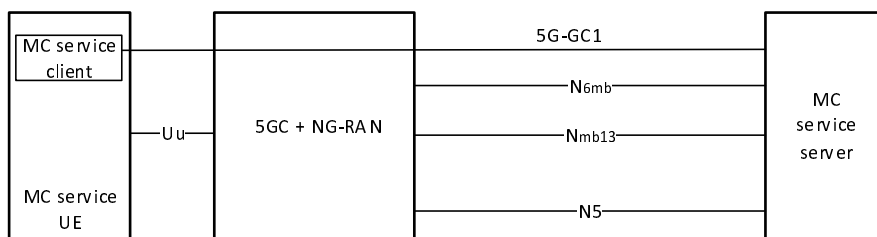
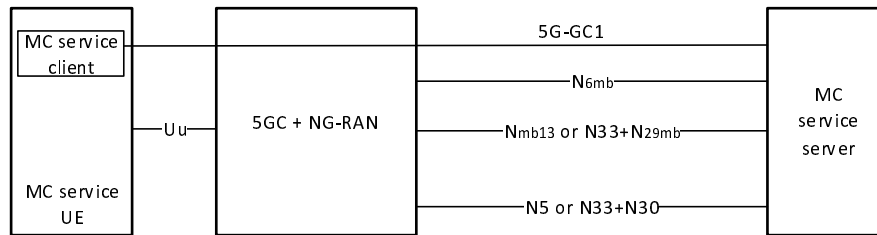

**Figure 4.7.3.1-1: Architectural view of a mission critical system when using MBS without optional MBS interfaces**

#### 4.7.3.2 Instantiation without MBSF / MBSTF and associated interfaces

Figure 4.7.3.2-1 presents a high-level architectural view of mission critical services when using MBS without the presence or use of the optional entities MBSF and MBSTF and their associated interfaces. The shown architecture is a particularization of the general architecture shown in figure 4.7.2-1.

MC services use MBS control plane capabilities by initiating access via Nmb13 or N33. MBS user plane capabilities can be accessed via N6mb. MC service servers can initiate access to MBS PCC capabilities supported by PCF via N5 or N33. If the MC service server and the 5GS are in different trust domains with respect to MBS, N33 needs to be used to gain access to the MBS control plane capabilities and the PCC capabilities.

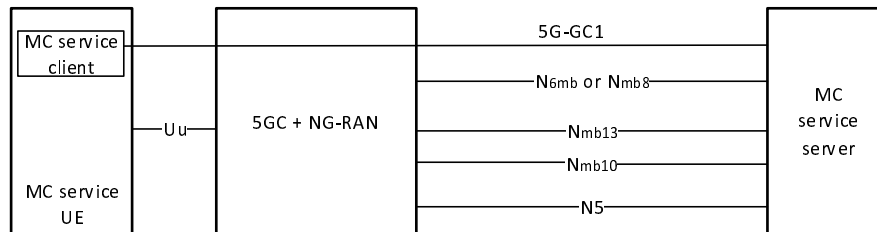

**Figure 4.7.3.2-1: Architectural view of a mission critical system when using MBS without optional MBSF/MBSTF entities and their associated interfaces**

### 4.7.3.3 Instantiation without NEF and associated interfaces

Figure 4.7.3.3-1 presents a high-level architectural view of mission critical services when using MBS without the presence or use of the optional entity NEF and its associated interfaces. The shown architecture is a particularization of the general architecture shown in figure 4.7.2-1.

MC services use MBS control plane capabilities by initiating access via Nmb13 or Nmb10. MBS user plane capabilities can be accessed via N6mb or Nmb8. MC service servers can initiate access to MBS PCC capabilities supported by PCF via N5.

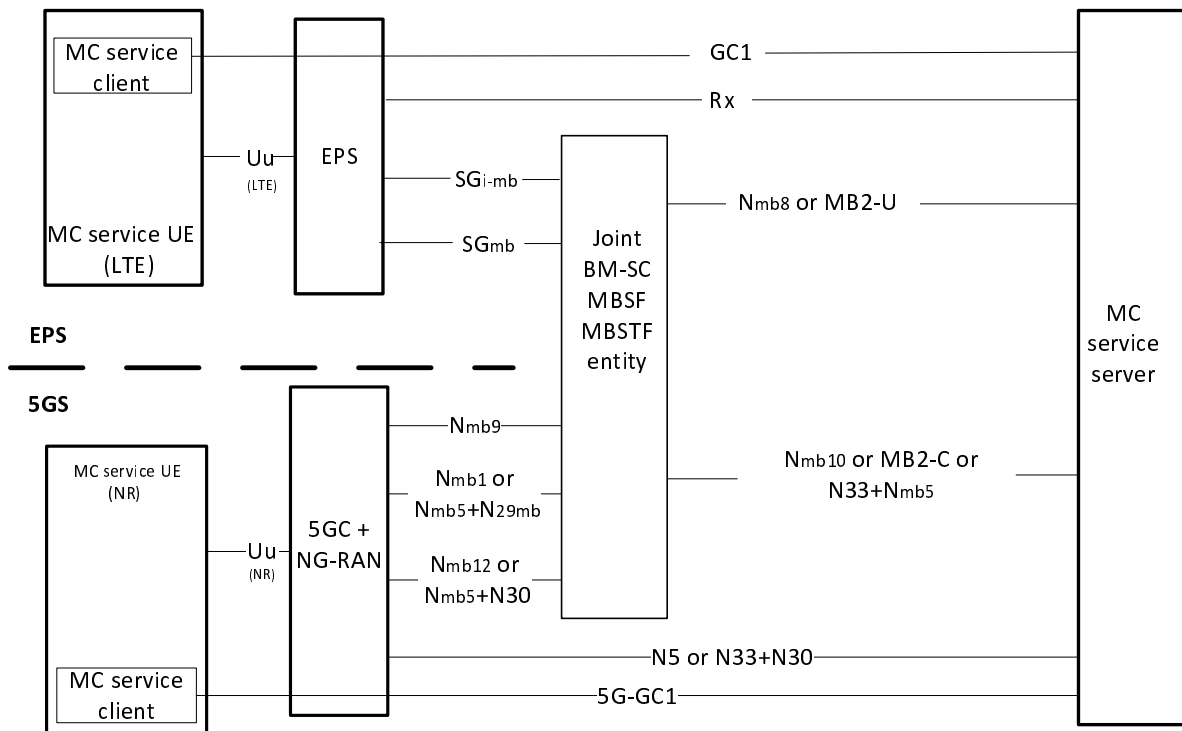

**Figure 4.7.3.3-1: Architectural view of a mission critical system when using MBS without optional NEF entity and its associated interfaces**

## 4.7.4 Service layer-based interworking between eMBMS and MBS

Figure 4.7.4-1 presents a high-level architectural view of mission critical services interworking between eMBMS and MBS at the service layer. The shown architecture is consistent with 3GPP TS 23.247 [15], subclauses 5.2, 6.8 and configurations 2 and 3 in Annex A.

The interworking between eMBMS and MBS for mission critical operation is enabled by the Joint BM-SC, MBSF and MBSTF functional entity. MC services can use control plane capabilities by accessing the Joint entity directly via MB2-C or Nmb10 or indirectly (using NEF) via N33+Nmb5. User plane traffic delivery is supported via MB2-U or Nmb8. If the MC service server and the 5GS are in different trust domains with respect to MBS, N33 needs to be used to gain access to the MBS PCC capabilities.



**Figure 4.7.4-1: Service layer-based mission critical interworking between eMBMS and MBS**

NOTE: Support of interfaces associated to 5GS optional entities (e.g., NEF) is necessary only if features enabled by these entities are supported.

### 4.7.5 Application layer based interworking between eMBMS and MBS

Figure 4.7.5-1 presents a high-level architectural view of mission critical services interworking between eMBMS and MBS at the application layer. The shown architecture does not use the MBSF/MBSTF entities defined in 3GPP TS 23.247 [15] and is inclusive of configuration 1 in Annex A of 3GPP TS 23.247 [15].

MC services initiate access to control plane capabilities via MB2-C (for eMBMS) and via Nmb13 or N33 (for MBS). User plane capabilities can be accessed via MB2-U (for eMBMS) and via N6mb (for MBS). MC service servers can initiate access to PCC capabilities via the Rx interface (for the PCRF in the EPS) and via the N5 or N33 interfaces (for the PCF in the 5GS). If the MC service server and the 5GS are in different trust domains with respect to MBS, N33 needs to be used to gain access to the MBS control plane capabilities and the PCC capabilities.

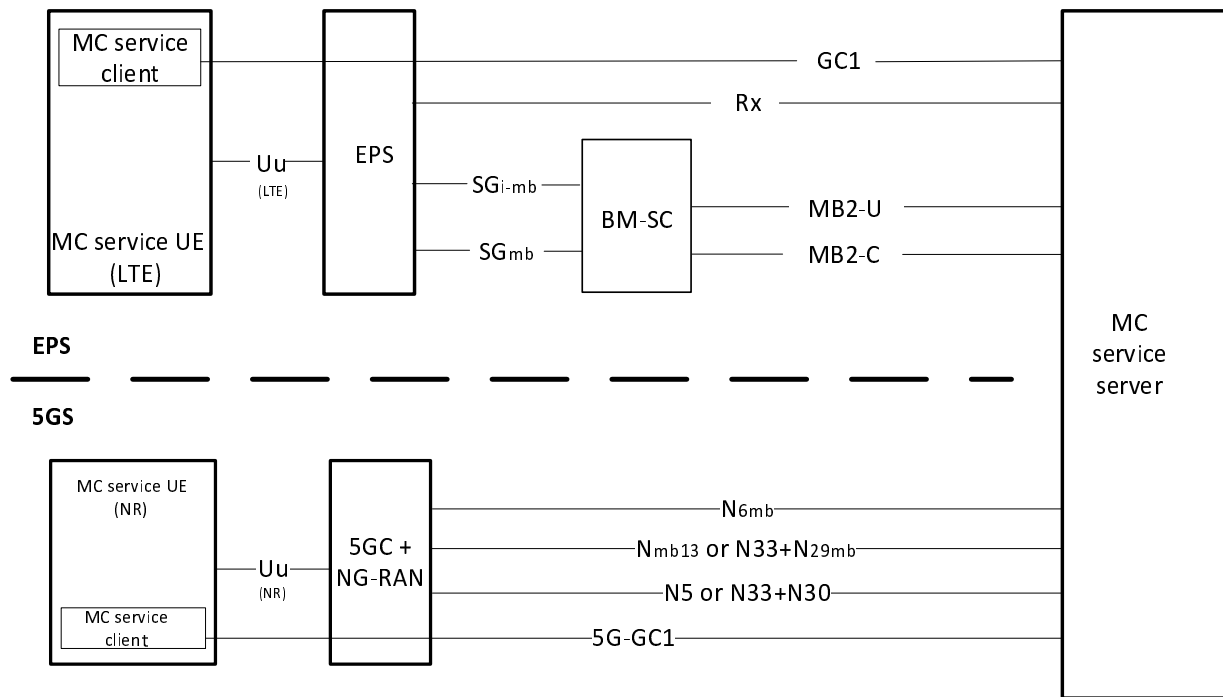
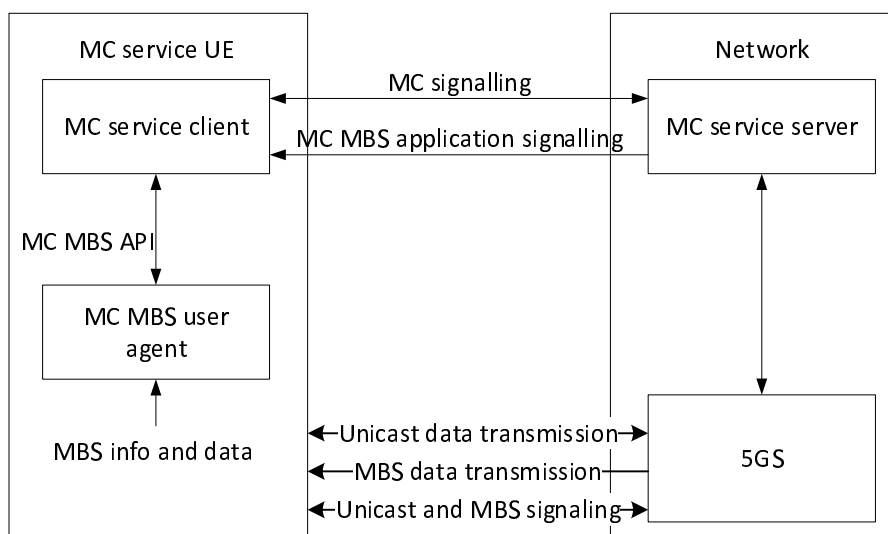

**Figure 4.7.5-1: Application layer-based mission critical interworking between eMBMS and MBS**

NOTE: Support of interfaces associated to 5GS optional entities (e.g., NEF) is necessary only if features enabled by these entities are supported.

### 4.7.6 General architecture showcasing use of MBS by UE for MC services

Figure 4.7.6-1 presents a high-level system architecture that shows how the MC service UEs support the delivery of mission critical services through MBS. Figure 4.7.6-2 shows the functional model used by the UE, highlighting the conceptual MC MBS API used for information transfer within the UE. The shown system architecture and functional model are analogous to the models described in 3GPP TS 23.479 [20] and consistent with 3GPP TS 23.501 [7] and 3GPP TS 23.247 [15].



**Figure 4.7.6-1: System architecture for MC MBS systems**

NOTE: The shown architecture does not consider MBS User Services, i.e., signalling with MBSF/MBSTF, which is described in 3GPP TS 26.502 [21].

The conceptual MC MBS API resides between the MC service client and the conceptual MC MBS user agent.

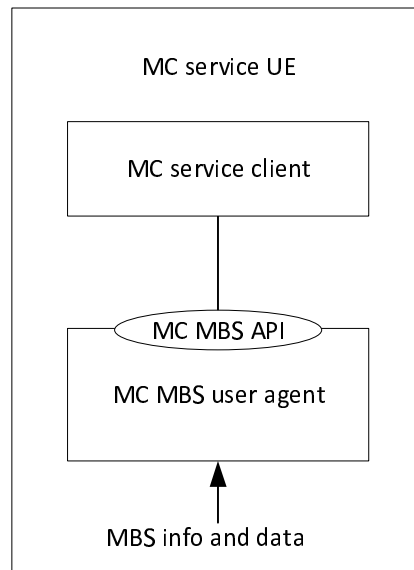

**Figure 4.7.6-2: Functional model highlighting the MC MBS API**

The MC service client uses information received from the MC service server through MC signalling (e.g., announcements) and through application-level signalling (e.g., mappings of MBS sessions and MBS subchannels to specific MC service groups) to communicate with the conceptual MC MBS user agent via the conceptual MC MBS API, in order to establish and update the proper communication context between the entities. Multiple MC service clients can be supported by the MC MBS user agent. The conceptual MC MBS user agent presents data and information received from the UE's lower layers to each MC service client according to the most recently established communication context. The functionalities of the MC service client and of the MC MBS user agent are described in clauses 4.3.2 and 4.3.3 of 3GPP TS 23.479 [20]. The information flows and procedures described in 3GPP TS 23.479 [20] apply, with the following clarifications:

- References to "MBMS" (meaning 4G "eMBMS") are understood to be references to 5G "MBS";
- Unless used as in "multicast IP address", the stand-alone term "multicast" is understood as "broadcast or multicast";
- References to "SAI" are understood to be references to "MBS service areas", e.g., cell id, tracking area id, MBS frequency selection area id, as specified in 3GPP TS 23.274 [15];
- References to (e)MBMS 4G "bearer" are understood to be references to 5G "MBS session" and references to 4G "TMGI" are understood to be references to 5G "MBS session ID"; and
- "Cell information", used in cell information responses and cell update notifications in 5G, contains not only the id of the cell the MC UE is being served by, but also the RRC state of the MC service UE in the cell (i.e., active, inactive, idle). 5G cell updates notify not only changes of the serving cell, but also changes of RRC state for the MC UE, within the same cell.

## 4.8 Use of 5G ProSe UE-to-network relay

### 4.8.1 General

The MC service shall support the capabilities for 5G ProSe UE-to-network relay. For this matter, 5G ProSe Layer-2 and 5G ProSe Layer-3 UE-to-network relaying techniques can be utilized, as described in 3GPP TS 23.304 [17]. The 5G ProSe Layer-3 UE-to-Network relaying technique may be done with or without the support of N3IWF, as described in 3GPP TS 23.304 [17].



A 5G ProSe UE-to-network relay supporting MC service UE provides means of connectivity and relaying of MC traffic to remote MC service UE(s). For this matter, the 5G ProSe UE-to-network Relay Discovery service allows the MC service remote UE to discover a potential UE-to-network relay UE supporting MC service in its proximity as described in 3GPP TS 23.304 [17]. Upon its discovery, the 5G ProSe Direct UE-to-network Relay Communication functionality is utilized to achieve communication to provide the MC service remote UE access to 5GS, and relay MC traffic via the UE-to-network relay UE over the NR PC5 reference point.

## 4.8.2 5G ProSe UE-to-network relay service requirements

In order to enable 5G ProSe UE-to-network relaying capabilities – whether based on Layer-3 or Layer-2 UE-to-network relaying techniques, the MC system provides the appropriate parameters and configurations to the MC service UE(s).

As defined in 3GPP TS 23.304 [17], among these parameters are: Relay Service Code(s) (RSCs) which can be associated to a certain MC service group, User Info, ProSe Layer-2 Group ID and ProSe Group IP multicast address. Moreover, the MC service group ID is resolved to the ProSe Layer-2 Group ID and ProSe Group IP multicast address, which are utilized within the 5G ProSe Relay Discovery and 5G ProSe Direct Communication procedures, as described in 3GPP TS 23.304 [17]. Furthermore, the RSCs are utilized to restrict the necessary UE-to-network relay service and related procedures within members of a certain MC service group.

Moreover, in case of 5G ProSe Layer-3 UE-to-network relay with the support of N3IWF, the UE-to-network relay is provisioned with policies and parameters, among others suitable RSC(s), in order to support N3IWF access, as defined in 3GPP TS 23.304 [17].

## 4.9 EPS interworking

### 4.9.1 General

Network deployments of MC services over 5GS may support interworking with EPS. EPS interworking aspects in 5G systems are specified in 3GPP TS 23.501 [7], 3GPP TS 23.502 [10], and 3GPP TS 23.503 [9].

### 4.9.2 Requirements

For MC services over a 5G system with EPS interworking, inter-system mobility between 5GC and EPC/E-UTRAN of MC service UEs shall be supported by the network based on the capabilities and procedures defined in 3GPP TS 23.501 [7], 3GPP TS 23.502 [10], and 3GPP TS 23.503 [9].

For the case that seamless session continuity is required for MC services, e.g. for MCPTT services, EPS interworking with N26 (interface between AMF in 5GC and MME in EPC) is required for inter-system change.

The MC system should be able to subscribe/unsubscribe to notification capabilities of specific events from the network related to EPS interworking. Thereby, the MC system can identify whether an MC service UE is registered on 5GS or EPS.

---

## 5 MC system functional model

### 5.1 General

The functional model for the MC services architecture is defined as a series of planes to allow for the breakdown of the architectural description. Each plane is expected to operate in an independent manner, providing services to the connected planes as and when requested by the connected plane, and requesting services from other planes as required.

In this context, each plane manages on its own behalf:

- a) Use of identities: Each plane is responsible for the privacy of that plane's own identities; and
- b) Security for that plane: It does not preclude a plane requesting security services from another plane, but that is a decision made within the plane, as to whether to use offered security services or mechanisms within the plane itself.

NOTE: Terminology such as client and server are not meant to imply specific physical implementation of a functional entity.

## 5.2 Description of the planes

The following planes are identified:

- a) application plane: The application plane provides all of the services (e.g. call control, floor control, video control, data control, conferencing of media, provision of tones and announcements) required by the user together with the necessary functions to support MC service. It uses the services of the signalling control plane to support those requirements.
- b) signalling control plane: The signalling control plane provides the necessary signalling support to establish the association of users involved in an MC service, such as an MCPTT call or other type of MC services. The signalling control plane also offers access to and control of services across MC services. The signalling control plane uses the services of session connectivity.

The corresponding session connectivity supporting these planes are defined for the use of 5GS within 3GPP TS 23.501 [7]. The associated resource control to support these planes is defined within 3GPP TS 23.503 [9].

## 5.3 Common functional model description

### 5.3.1 On-network functional model

Each MC service can be represented by an application plane functional model. The corresponding functional model across MC services may be similar but is described by the individual functional entities and reference points that belong to that MC service. Within the application plane for an MC service, a common set of functions as well as reference points is shared across MC services and is referred as the common services core.

Figure 5.3.1-1 shows the common functional model for the application plane for an MC system using 5GS.

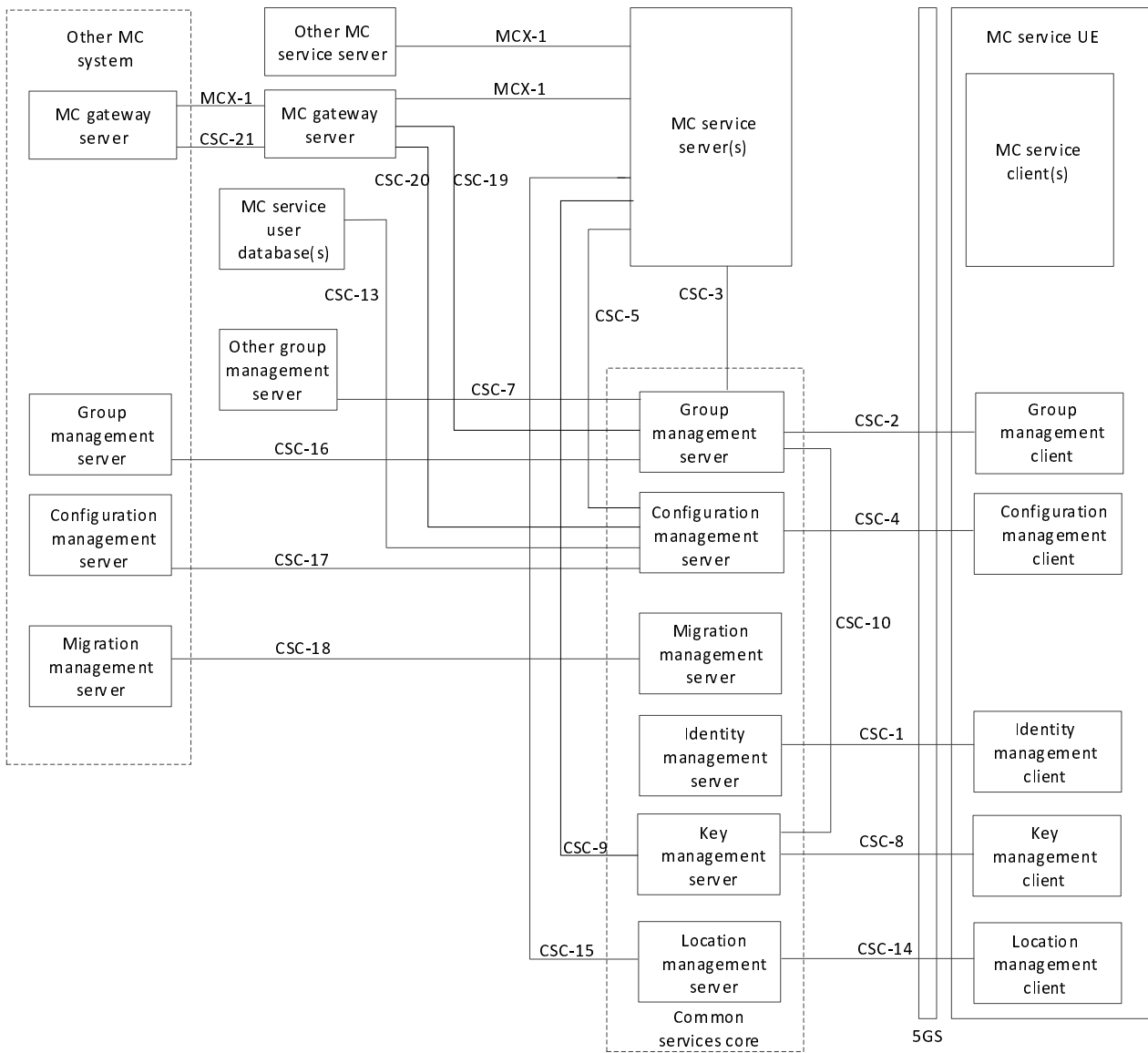

**Figure 5.3.1-1: Common functional model for application plane for an MC system**

The common services core functions and reference points shown in figure 5.3.1-1 are shared across each MC service.

Figure 5.3.1-2 shows the common functional model for the signalling control plane using 5GS.

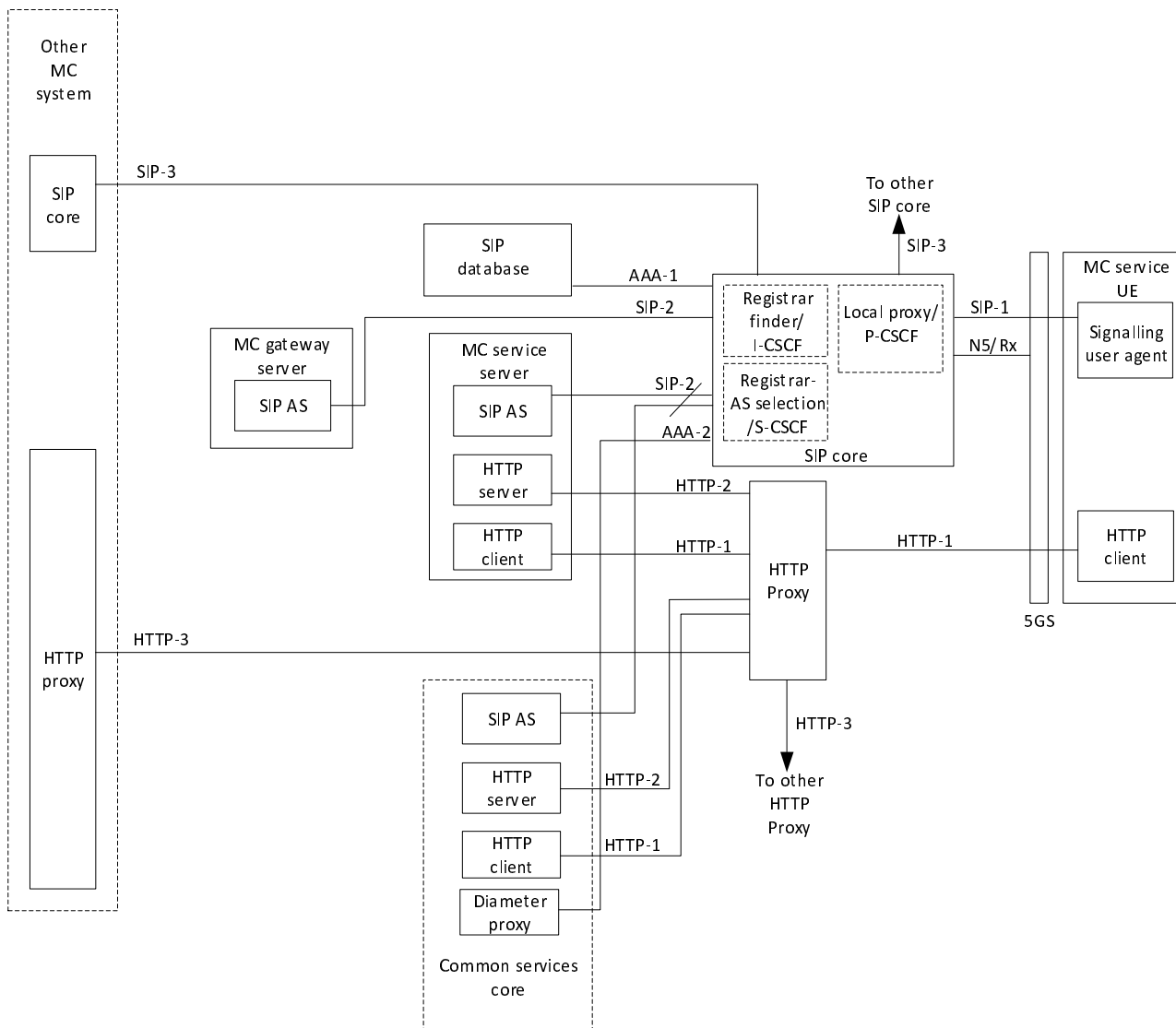
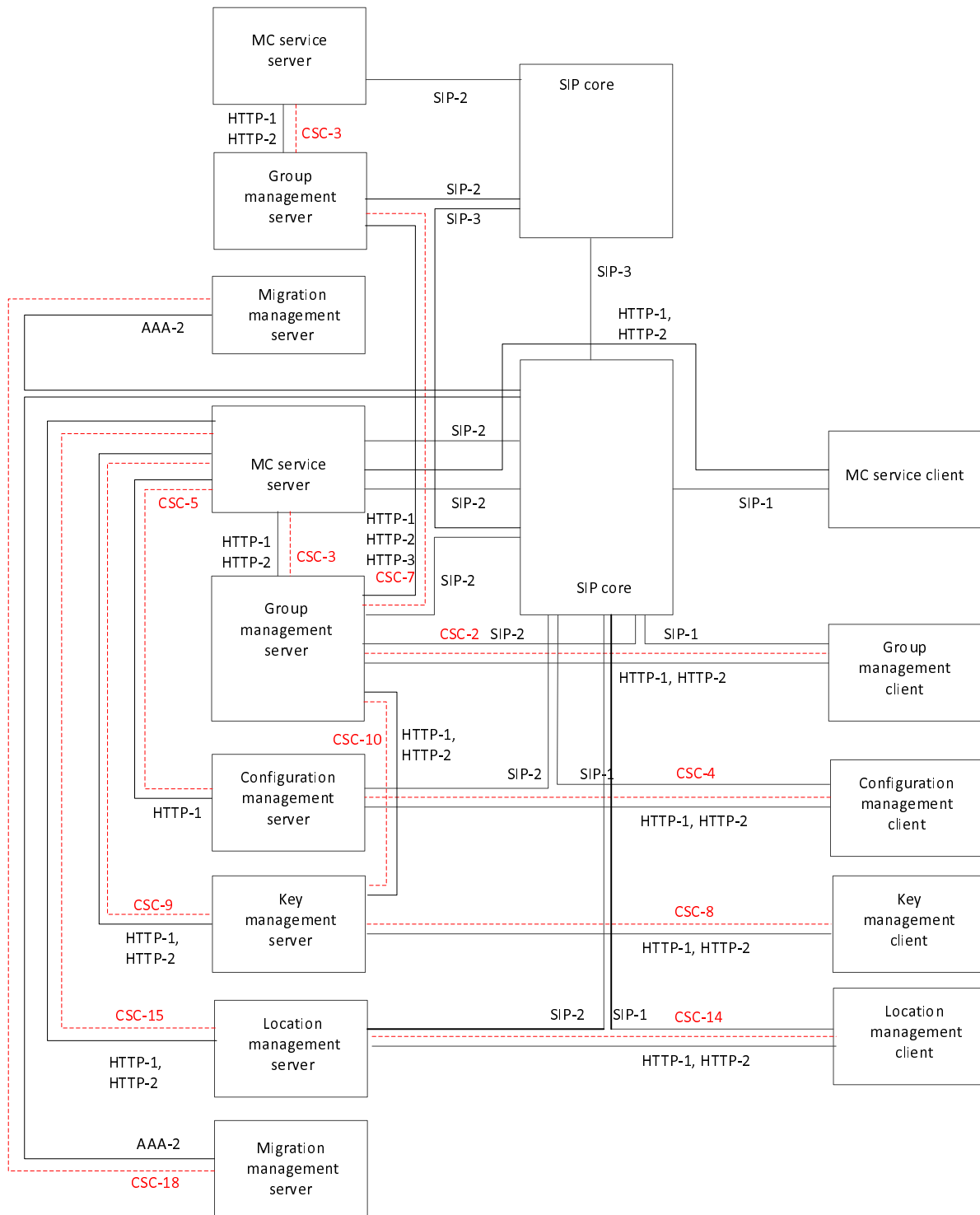

**Figure 5.3.1-2: Common functional model for signalling control plane**

In the model shown in figure 5.3.1-2, the SIP core may interact directly with 5GS via the N5 reference point or Rx reference point to control QoS on a per communication flow in accordance with 3GPP TS 23.501 [7].

NOTE 1: Indirect interaction between SIP core and 5GS Network Exposure Function using N33 reference point is not supported by 3GPP TS 23.002 [8].

Figure 5.3.1-3 shows the relationships between the reference points of the common application plane of an MC service server and the common signalling plane.



**Figure 5.3.1-3: Relationships between reference points of the common MC service application plane and signalling control planes**

NOTE 2: Application plane reference point CSC-7 makes use of SIP-2 reference point when the group management servers are connected by a single SIP core. Where they are joined by more than one SIP core, CSC-7 also makes use of the SIP-3 reference point.

NOTE 3: For simplicity, the HTTP proxy, which provides the interconnection between HTTP-1, HTTP-2 and HTTP-3 reference points, is not shown in figure 5.3.1-3.

NOTE 4: CSC-5, CSC-9, and CSC-15 make use of SIP-1 and SIP-2 reference points. For simplicity, this mapping relationship is not shown in figure 5.3.1-3.

## 5.3.2 Functional entities description

### 5.3.2.1 General

Each subclause is a description of a functional entity and does not imply a physical entity.

### 5.3.2.2 Application plane

The description of the application plane entities in 3GPP TS 23.280 [3] applies.

### 5.3.2.3 Signalling control plane

The description of the signalling control plane entities in 3GPP TS 23.280 [3] applies.

## 5.3.3 Reference points

### 5.3.3.1 General reference point principle

The protocols on any reference point that is exposed for MC service interoperability with other SIP core or other IMS entities in other systems shall be compatible with the protocols defined for the corresponding reference point defined in 3GPP TS 23.002 [8].

### 5.3.3.2 Application plane

#### 5.3.3.2.1 General

The definition of the application plane reference points in 3GPP TS 23.280 [3] applies.

### 5.3.3.3 Signalling control plane

#### 5.3.3.3.1 General

The reference points for the SIP and HTTP signalling are described in the following subclauses.

#### 5.3.3.3.2 Reference point SIP-1(between the signalling user agent and the SIP core)

The SIP-1 reference point, which exists between the signalling user agent and the SIP core for establishing a session in support of MC service, shall use the Gm reference point as defined in 3GPP TS 23.002 [8] (with necessary enhancements to support MC service requirements and profiled to meet the minimum requirements for support of MC services). The SIP-1 reference point fulfils the requirements of the 5G-GC1 reference point, and is used for:

- SIP registration (including the UE's capabilities, for example eMBMS capable, or MBS capable UE);
- authentication and security to the service layer;
- event subscription and event notification;
- overload control;
- MBS session management; e.g., MBS session announcement and de-announcement; and
- media negotiation.

NOTE 1: The reference point 5G-GC1 is defined within SA6, and outside of SA2 scope.

NOTE 2: Information related to the UE's MBS/eMBMS capabilities can be exchanged during either registration or service authorization procedure.

#### 5.3.3.3.3 Reference point SIP-2 (between the SIP core and the SIP AS)

The SIP-2 reference point, which exists between the SIP core and the SIP AS for establishing a session in support of MC service, shall use the ISC and Ma reference points as defined in 3GPP TS 23.002 [8]. The SIP-2 reference point is used for:

- notification to the MC service server(s) of SIP registration (including the UE's capabilities, for example eMBMS capable, or MBS capable UE) by the MC service UE;
- authentication and security to the service layer;
- event subscription and event notification;
- session management; and
- media negotiation.

NOTE: Information related to the UE's MBS/eMBMS capabilities can be exchanged during either registration or service authorization procedure.

#### 5.3.3.3.4 Reference point SIP-3 (between the SIP core and SIP core)

The description of the SIP-3 reference point in 3GPP TS 23.280 [3] applies.

#### 5.3.3.3.5 Reference point HTTP-1 (between the HTTP client and the HTTP proxy)

The description of the HTTP-1 reference point in 3GPP TS 23.280 [3] applies.

#### 5.3.3.3.6 Reference point HTTP-2 (between the HTTP proxy and the HTTP server)

The description of the HTTP-2 reference point in 3GPP TS 23.280 [3] applies.

#### 5.3.3.3.7 Reference point HTTP-3 (between the HTTP proxy and HTTP proxy)

The description of the HTTP-3 reference point in 3GPP TS 23.280 [3] applies.

#### 5.3.3.3.8 Reference point AAA-1 (between the SIP database and the SIP core)

The description of the AA1-1 reference point in 3GPP TS 23.280 [3] applies.

#### 5.3.3.3.9 Reference point AAA-2 (between the SIP core and Diameter proxy)

The description of the AA1-2 reference point in 3GPP TS 23.280 [3] applies.

#### 5.3.3.3.10 Reference points N5 and Rx (between the SIP core and the 5GS)

The N5 reference point and Rx reference point, which exist between the SIP core and the 5GS, are used for resource management of MC service sessions, e.g. QoS control, as defined in 3GPP TS 23.501 [7], 3GPP TS 23.502 [10] and 3GPP TS 23.503 [9].

### 5.3.4 Off-network functional model

The description of functional model for off-network operation in clause 7.3.2 of 3GPP TS 23.280 [3] applies.

The description of functional model for off-network operation of MCPTT service in clause 7.3.2 of 3GPP TS 23.379 [6] applies.

The description of functional model for off-network operation of MCVideo service in clause 6.1.2 of 3GPP TS 23.281 [4] applies.

The description of functional model for off-network operation of MCData service in clause 6.4.2 of 3GPP TS 23.282 [5] applies.

## 5.4 MCPTT functional model description

### 5.4.1 On-network functional model

Figure 5.4.1-1 shows the functional model for the application plane for an MCPTT system using the 5GS.

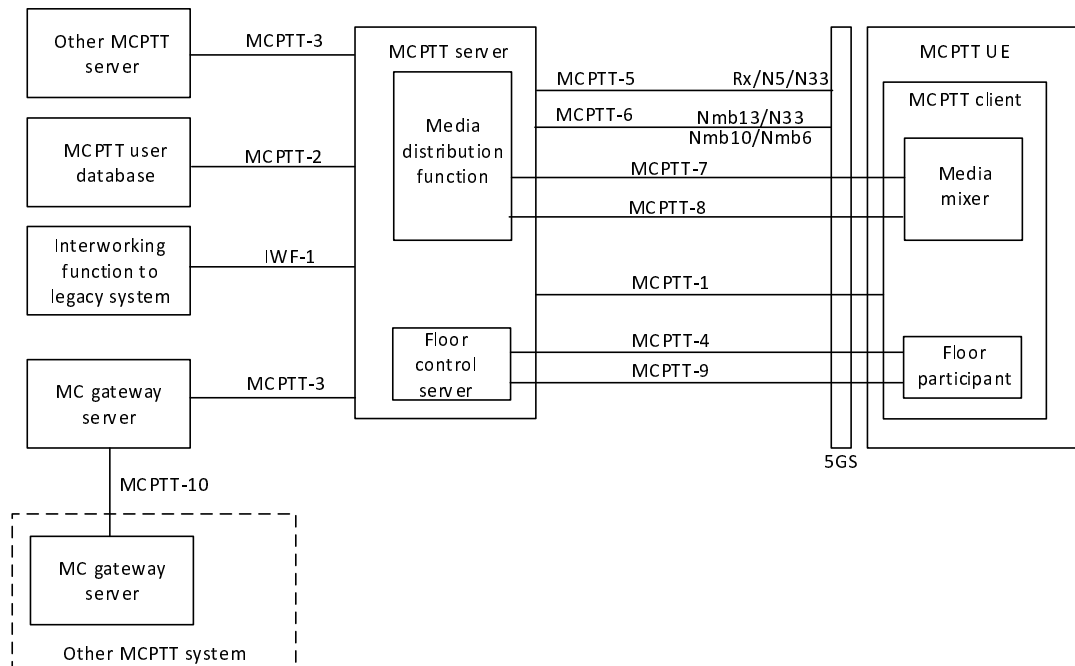

**Figure 5.4.1-1: MCPTT functional model for application plane**

In the functional model shown in figure 5.4.1-1, the following is considered:

- The description of the corresponding functional entities and reference points in 3GPP TS 23.379 [6] applies.
- MCPTT-1, uses the 5G-GC1 reference point as described in clause 4.7 and fulfils the requirements of the 5G-GC1 reference point for MCPTT.
- The description of the MCPTT-4 and MCPTT-7 reference points in 3GPP TS 23.379 [6] applies considering that it utilizes the N6 reference point defined in 3GPP TS 23.501 [7].
- The description of the MCPTT-5 reference point in 3GPP TS 23.379 [6] applies considering that it exists between the MCPTT server and the 5GS. It is used for resource management of MCPTT sessions, e.g. QoS control, and utilizes the N5 reference point or the Rx reference point or the N33 reference point as defined in 3GPP TS 23.501 [7], 3GPP TS 23.502 [10], 3GPP TS 23.503 [9] and 3GPP TS 23.247 [15].
- MCPTT-5, utilizing Rx reference point or N5 reference point, may be used when the MCPTT service provider directly interacts with operator's relevant 5GS network function for QoS control for both unicast PDU sessions and MBS sessions (if dynamic PCC is applicable).
- MCPTT-5, utilizing N33 reference point, may be used when the MCPTT service provider is limited by the operational agreement, i.e., indirect interaction with operator's 5GS network functions for QoS control.



- The MCPTT-6 reference point, which exists between the MCPTT server and the 5GS, is used to create an MBS session obtaining multicast or broadcast resources for MCPTT application usage.
- The MCPTT-6 reference point utilizes Nmb13 reference point when the MCPTT service provider and the PLMN operator have an operational agreement where QoS control is provided directly from the MCPTT service provider domain.
- The MCPTT-6 reference point utilizes Nmb10 reference point when MBSF is used.
- The MCPTT-6 reference point utilizes N33 reference point when the MCPTT service provider is limited by the operational agreement for QoS control, i.e. indirect interaction with operator's 5GS network functions for QoS control is only allowed.
- The MCPTT-6 reference point utilizes Nmb6 reference point when MCPTT service provider interacts with the Joint BM-SC, MBSF and MBSTF entity to facilitate interworking with LTE.
- For MCPTT-8 reference point, the reference point definition in 3GPP TS 23.379 [6] applies. The MCPTT-8 reference point utilizes the N6mb reference point according to 3GPP TS 23.247 [15].
- The MCPTT-8 reference point utilizes the Nmb8 reference point according to 3GPP TS 23.247 [15] when MBSTF is used.
- For interworking with LTE via Joint BM-SC, MBSF and MBSTF entity, the MCPTT-8 reference point utilizes the Nmb4 reference point according to 3GPP TS 23.247 [15].
- For MCPTT-9 reference point, the reference point definition in 3GPP TS 23.379 [6] applies. The MCPTT-9 reference point utilizes the N6mb reference point according to 3GPP TS 23.247 [15].
- The MCPTT-9 reference point utilizes the Nmb8 reference point according to 3GPP TS 23.247 [15] when MBSTF is used.
- For interworking with LTE via Joint BM-SC, MBSF and MBSTF entity, the MCPTT-9 reference point utilizes the Nmb4 reference point according to 3GPP TS 23.247 [15].

## 5.5 MCVideo functional model description

### 5.5.1 On-network functional model

Figure 5.5.1-1 shows the functional model for the application plane for an MCVideo system using the 5GS.

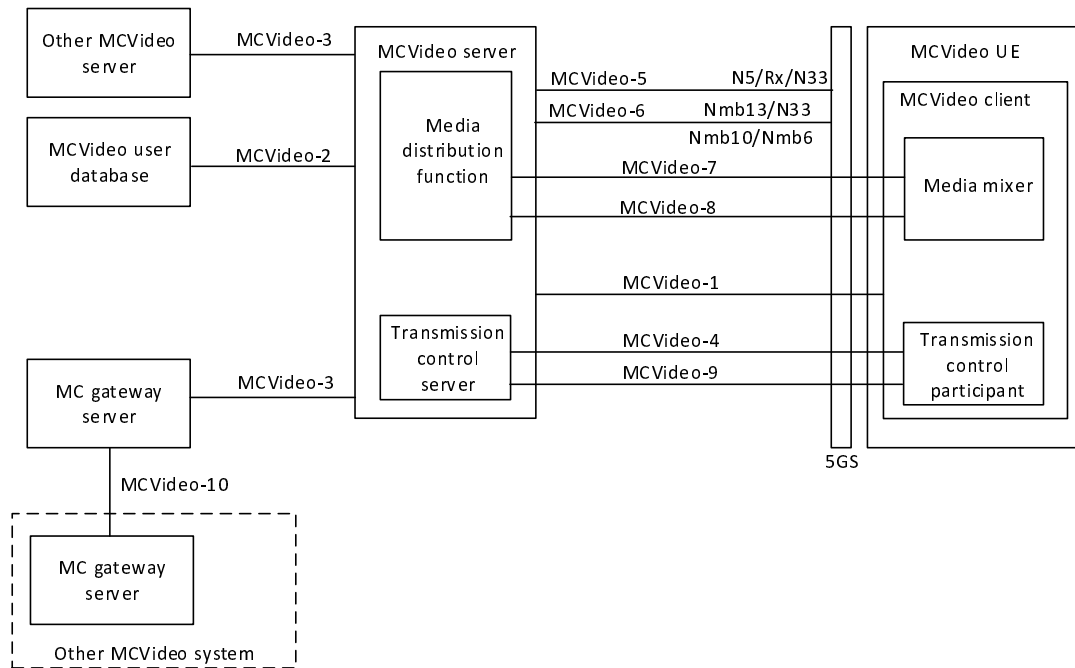

**Figure 5.5.1-1: MCVideo functional model for application plane**

In the functional model shown in figure 5.5.1-1, the following is considered:

- The description of the corresponding functional entities and reference points in 3GPP TS 23.281 [4] applies.
- MCVideo-1, uses the 5G-GC1 reference point as described in clause 4.7 and fulfils the requirements of the 5G-GC1 reference point for MCVideo.
- The description of the MCVideo-4 and MCVideo-7 reference points in 3GPP TS 23.281 [4] applies considering that it utilizes the N6 reference point defined in 3GPP TS 23.501 [7].
- The description of the MCVideo-5 reference point in 3GPP TS 23.281 [4] applies considering that it exists between the MCVideo server and the 5GS. It is used for resource management of MCVideo sessions, e.g. QoS control, and utilizes the N5 reference point or the Rx reference point or the N33 reference point as defined in 3GPP TS 23.501 [7], 3GPP TS 23.502 [10], 3GPP TS 23.503 [9] and 3GPP TS 23.247 [15].
- MCVideo-5, utilizing Rx reference point or N5 reference point, may be used when the MCVideo service provider directly interacts with operator's relevant 5GS network function for QoS control for both unicast PDU sessions and MBS sessions (if dynamic PCC is applicable).
- MCVideo-5, utilizing N33 reference point, may be used when the MCVideo service provider is limited by the operational agreement, i.e., indirect interaction with operator's 5GS network functions for QoS control.
- The MCVideo-6 reference point, which exists between the MCVideo server and the 5GS, is used to create an MBS session obtaining multicast or broadcast resources for MCVideo application usage.
- The MCVideo-6 reference point utilizes Nmb13 reference point when the MCVideo service provider and the PLMN operator have an operational agreement where QoS control is provided directly from the MCVideo service provider domain.
- The MCVideo-6 reference point utilizes Nmb10 reference point when MBSF is used.
- The MCVideo-6 reference point utilizes N33 reference point when the MCVideo service provider is limited by the operational agreement for QoS control, i.e. indirect interaction with operator's 5GS network functions for QoS control is only allowed.
- The MCVideo-6 reference point utilizes Nmb6 reference point when MCVideo service provider interacts with the Joint BM-SC, MBSF and MBSTF entity to facilitate interworking with LTE.
- For MCVideo-8 reference point, the reference point definition in 3GPP TS 23.281 [4] applies. The MCVideo-8 reference point utilizes the N6mb reference point according to 3GPP TS 23.247 [15].

- The MCVideo-8 reference point utilizes the Nmb8 reference point according to 3GPP TS 23.247 [15] when MBSTF is used.
- For interworking with LTE via Joint BM-SC, MBSF and MBSTF entity, the MCVideo-8 reference point utilizes the Nmb4 reference point according to 3GPP TS 23.247 [15].
- For MCVideo-9 reference point, the reference point definition in 3GPP TS 23.281 [4] applies. The MCVideo-9 reference point utilizes the N6mb reference point according to 3GPP TS 23.247 [15].
- The MCVideo-9 reference point utilizes the Nmb8 reference point according to 3GPP TS 23.247 [15] when MBSTF is used.
- For interworking with LTE via Joint BM-SC, MBSF and MBSTF entity, the MCVideo-9 reference point utilizes the Nmb4 reference point according to 3GPP TS 23.247 [15].

## 5.6 MCDATA functional model description

### 5.6.1 On-network functional model

Figure 5.6.1-1 shows the generic functional model for the application plane for an MCDATA system using the 5GS.

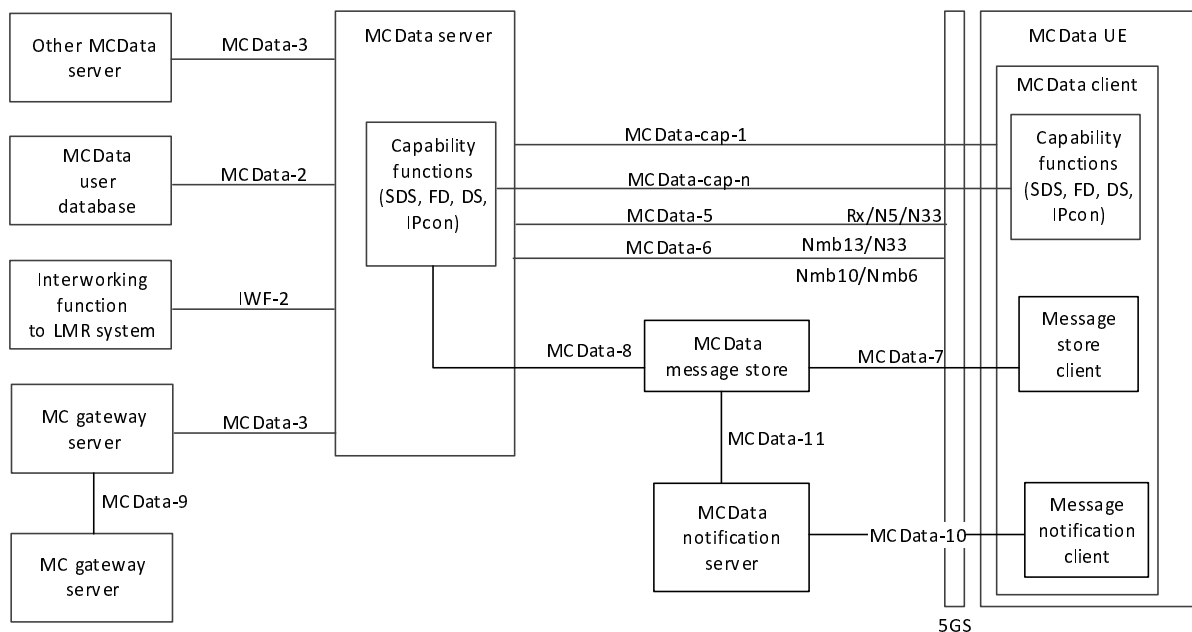

**Figure 5.6.1-1: Generic MCDATA functional model for application plane**

In the functional model shown in figure 5.6.1-1, the following is considered:

- The description of the corresponding functional entities and reference points in 3GPP TS 23.282 [5] applies.
- MCDATA-cap-1, uses the 5G-GC1 reference point as described in clause 4.7 and fulfils the requirements of the 5G-GC1 reference point for MCDATA.
- The description of the MCDATA-5 reference point in 3GPP TS 23.282 [5] applies considering that it exists between the MCDATA server and the 5GS. It is used for resource management of MCDATA sessions, e.g. QoS control, and utilizes the N5 reference point or the Rx reference point or the N33 reference point as defined in 3GPP TS 23.501 [7], 3GPP TS 23.502 [10], 3GPP TS 23.503 [9] and 3GPP TS 23.247 [15].
- MCDATA-5, utilizing Rx reference point or N5 reference point, may be used when the MCDATA service provider directly interacts with operator's relevant 5GS network function for QoS control for both unicast PDU sessions and MBS sessions (if dynamic PCC is applicable).

- MCDData-5, utilizing N33 reference point, may be used when the MCDData service provider is limited by the operational agreement, i.e., indirect interaction with operator's 5GS network functions for QoS control.
- The respective functional models supporting MCDData capabilities (e.g., SDS, FD, DS, IPcon) over unicast transmissions along with the corresponding reference points (i.e., MCDData-cap-1 to MCDData-cap-n) described in 3GPP TS 23.282 [5] also apply when the 5G system is used.
- The MCDData-6 reference point, which exists between the MCDData server and the 5GS, is used to create an MBS session obtaining multicast or broadcast resources for MCDData application usage.
- The MCDData-6 reference point utilizes Nmb13 reference point when the MCDData service provider and the PLMN operator have an operational agreement where QoS control is provided directly from the MCDData service provider domain.
- The MCDData-6 reference point utilizes Nmb10 reference point when MBSF is used.
- The MCDData-6 reference point utilizes N33 reference point when the MCDData service provider is limited by the operational agreement for QoS control, i.e. indirect interaction with operator's 5GS network functions for QoS control is only allowed.
- The MCDData-6 reference point utilizes Nmb6 reference point when MCDData service provider interacts with the Joint BM-SC, MBSF and MBSTF entity to facilitate interworking with LTE.
- The MCDData-6 reference point utilizes the Nmb8 reference point according to 3GPP TS 23.247 [15] when MBSTF is used.
- For interworking with LTE via Joint BM-SC, MBSF and MBSTF entity, the MCDData-6 reference point utilizes the Nmb4 reference point according to 3GPP TS 23.247 [15].
- The respective functional models supporting MCDData capabilities (e.g., SDS, FD, DS, IPcon) over eMBMS transmissions along with the corresponding reference points (i.e., MCDData-cap-1 to MCDData-cap-n) described in 3GPP TS 23.282 [5] also apply when the 5G MBS is used.

---

## 6 Application of functional models and deployment scenarios

### 6.1 General

This clause describes the application of the functional models described in clause 5. It also describes deployment scenarios that highlight some of the possible variations in the way that the functional models can be applied in different situations.

### 6.2 On-network architectural model

#### 6.2.1 On-network architectural model diagram

Figure 6.2.1-1 below is the on-network architectural model for the MC system solution, where the MC system provides one or more MC services via a single PLMN.

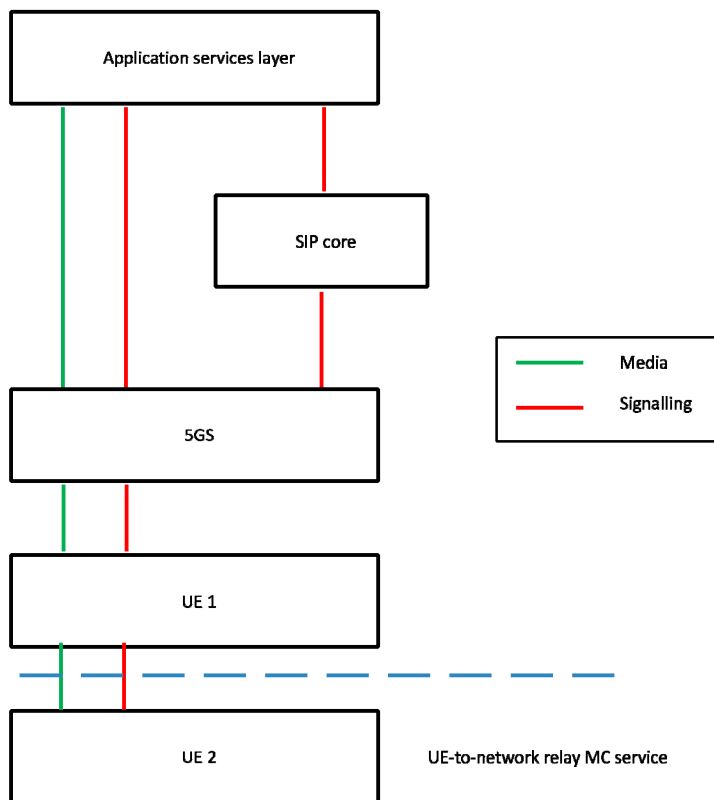

**Figure 6.2.1-1: On-network architectural model**

## 6.2.2 Application services layer

### 6.2.2.1 Overview

The application services layer includes application functions of one or more MC services and any required supporting functions grouped into common services core.

### 6.2.2.2 Common services core

Common services core is composed of the functional entities described in the common functional model in clause 5.3.

### 6.2.2.3 MC services

MC services are composed of the functional entities described in the corresponding MC service functional models in clause 5.

## 6.2.3 SIP core

The SIP core provides rendezvous (contact address binding and URI resolution) and service control (application service selection) functions, as described in clause 5.3.

## 6.2.4 5GS

The 5GS provides data connectivity and services with QoS control for the support of MC service sessions.

## 6.2.5 UE 1

UE 1 is an MC service UE in on-network mode supporting data connectivity and application(s) related to one or more MC services over the 5GS, or an UE that acts as 5G ProSe UE-to-network relay, or both of the above. It is composed of the corresponding MC service functional entities described in clause 5.

## 6.2.6 UE 2

UE 2 is a device using 5G ProSe UE-to-network relay, and supporting application(s) related to one or more MC services. It is composed of the corresponding MC service functional entities described in clause 5.

# 6.3 Deployment scenarios

## 6.3.1 Administration of MC service, SIP core and 5GS

### 6.3.1.1 General

This clause describes deployment scenarios in which different administration of MC service, SIP core and 5GS are described, together with the sensitivities of identities and other forms of signalling in those scenarios.

In each of these scenarios, the owner of the devices at each plane may be different from the organization that administers these devices. For example, the MC service provider may own some RAN components within the 5GS even when the 5GS is administered by the PLMN operator, and the MC service UE may be owned by an organization that is independent from PLMN and MC service providers.

### 6.3.1.2 Common administration of all planes

In this scenario, all planes (application services layer, SIP core and 5GS) are administered by the same party. This is illustrated in figure 6.3.1.2-1 below.

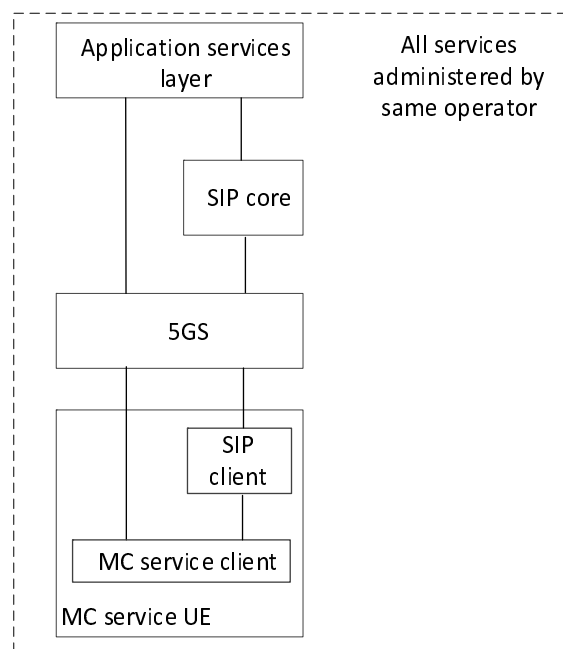

**Figure 6.3.1.2-1: Common administration of all services by one operator**

Although the identities in each plane are separate as described in 3GPP TS 23.280 [3], there is no particular sensitivity of identities and other information at the application plane, and these may be exposed to the SIP core and the 5GS.

All authorization and authentication mechanisms at each plane, i.e. the application services layer, SIP core and 5GS, shall be separate, but there may be no need for any restrictions in how these are stored and managed; for example the same entity could provide services to each of the application services layer, SIP core and 5GS.

### 6.3.1.3 MC service provider separate from SIP core and 5GS

In this scenario, as illustrated in figure 6.3.1.3-1, the MC service provider is separate and independent from the PLMN operator, and the MC service is administered independently of the 5GS and SIP core. The PLMN operator administers the 5GS and the SIP core.

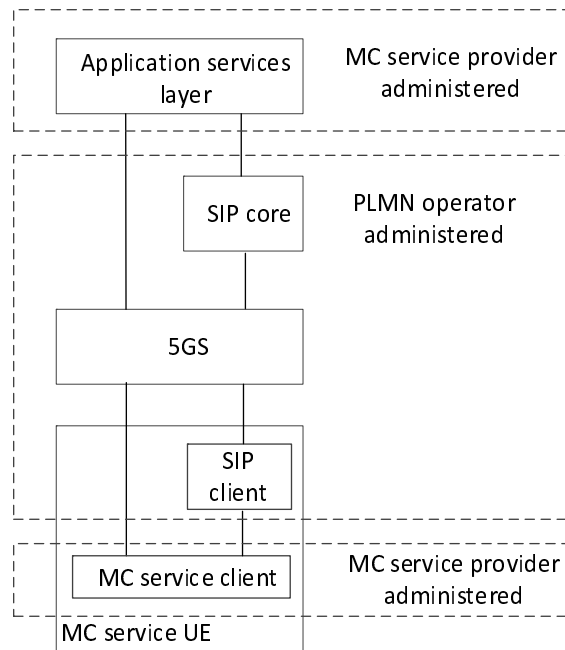

**Figure 6.3.1.3-1: MC service provider administers MC service separately from SIP core and 5GS**

The MC service provider may require that all application services layer identities and other sensitive information are hidden both from the SIP core and the 5GS.

When required by the MC service provider, all authentication and authorization mechanisms, including security roots, at the application services layer are hidden from and not available to the PLMN operator.

### 6.3.1.4 MC service provider administers SIP core, separate from 5GS

In this scenario, as illustrated in figure 6.3.1.4-1, the MC service provider administers the SIP core, and the MC services and SIP core are independent of the PLMN operator.

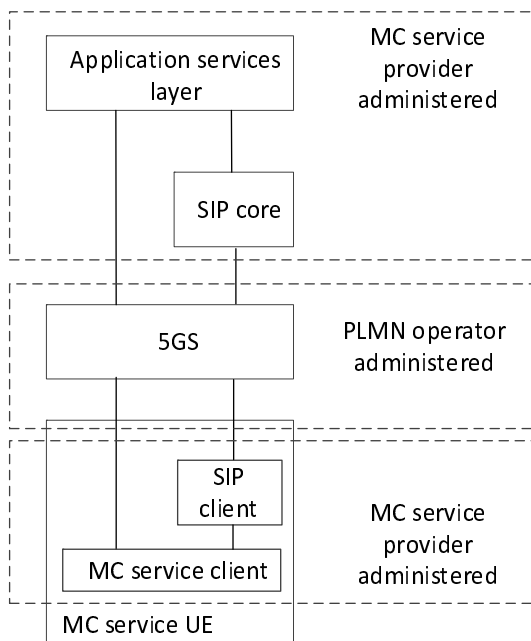

**Figure 6.3.1.4-1: MC service provider provision of SIP core, separate domain from 5GS**

The MC service provider may require that all identities and other sensitive information at the application services layer are hidden from the 5GS. The MC service provider need not hide the identities and signalling at the application services layer from the SIP core. However, the MC service provider may require that identities and other sensitive information between SIP core and SIP client in the MC service UE are also hidden from the 5GS.

All authentication and authorization mechanisms, including security roots, at both application services layer and at SIP signalling plane may need to be hidden from, and not available to, the PLMN operator.

### 6.3.1.5 SIP core partially administered by both PLMN operator and MC service provider

In this scenario, as illustrated in figure 6.3.1.5-1, the SIP core is partially administered by both parties, for example when the SIP core registrar is administered by the MC service provider, but the SIP core registrar finder and proxy is administered by the PLMN operator.

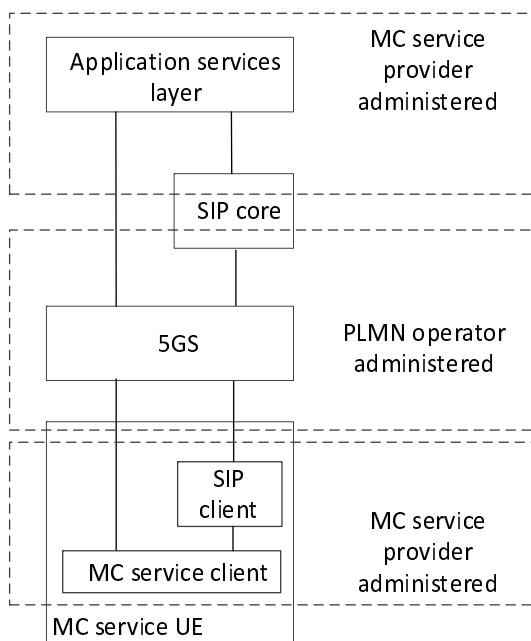

**Figure 6.3.1.5-1: MC service provider partial provision of SIP core, separate domain from 5GS**



The MC service provider may require that all identities and signalling at the application services layer are hidden from the 5GS, and may require identities and other sensitive information to be hidden from the PLMN operator administered part of the SIP core.

All authentication and authorization mechanisms, including security roots, at the application services layer may need to be hidden from, and not available to, the PLMN operator.

### 6.3.1.6 PLMN operator administers SIP core with SIP identities administered by MC service provider

In this scenario, the PLMN operator administers the SIP core. However, the identities used by the SIP core (IMPI and IMPU) for MC service UEs served by the MC service provider are provided from the SIP database of the MC service provider.

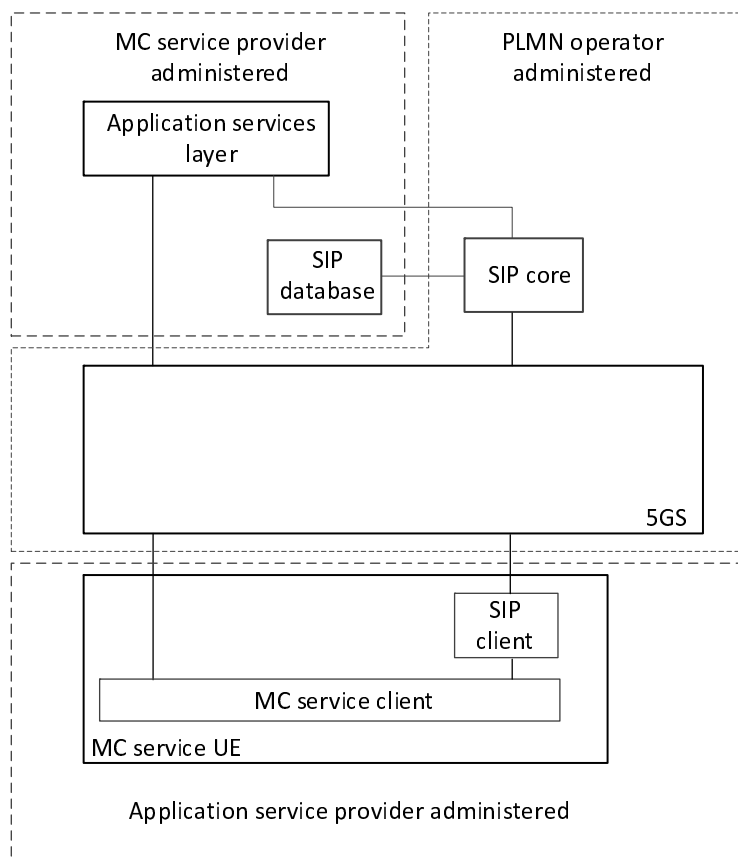

**Figure 6.3.1.6-1: MC service provider provides identities to PLMN operator SIP core**

The MC service provider may require that all identities and signalling at the application services layer are hidden from the SIP core and 5GS.

When required by the MC service provider, all authentication and authorization mechanisms, including security roots, at the application services layer may need to be hidden from, and not available to, the PLMN operator.

The security roots (authentication keys) required for access to the signalling control plane are not available to the PLMN operator as these are held in the MC service provider's SIP database. However, derived parameters e.g. authentication vectors are provided to the SIP core to allow signalling control plane authentication to take place.

## 6.3.2 Resource management of MC service sessions by SIP core and MC service server

### 6.3.2.1 General

This clause describes two different scenarios in which resource management of MC service sessions is performed via the Rx reference point, or N5 reference point, or N33 reference point as defined in 3GPP TS 23.501 [7], 3GPP TS 23.502 [10] and 3GPP TS 23.503 [9], by either the SIP core or the MC service server with the 5GS (PCF).

These may provide suitable models for each of the scenarios listed in clause 6.3.1. However, there is no direct correlation of any of the scenarios described in this clause to each of the scenarios described in clause 6.3.1.

### 6.3.2.2 Resource Management of MC service sessions by SIP core

In the scenario shown in figure 6.3.2.2-1, resource management of MC service sessions is performed by the SIP core.

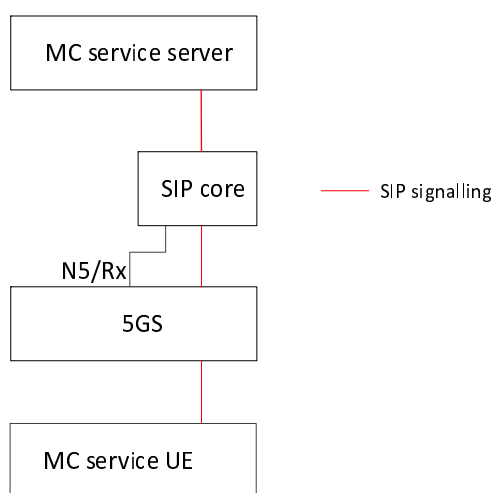

**Figure 6.3.2.2-1: Resource management of MC service sessions by SIP core**

### 6.3.2.3 Management of MC service sessions by MC service server

In the scenario shown in figure 6.3.2.3-1, resource management of MC service sessions is performed by the MC service server.

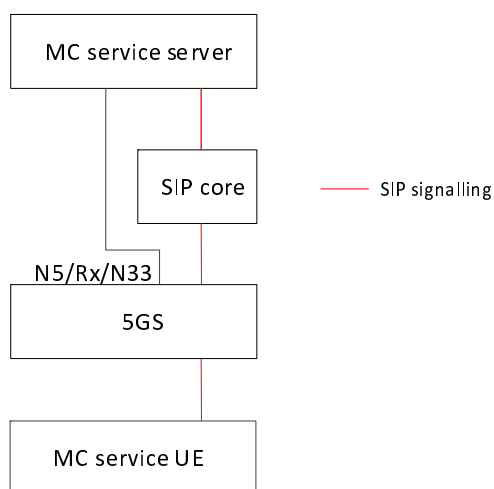

**Figure 6.3.2.3-1: Resource management of MC service sessions by MC service server**

## 6.4 Involved business relationships

### 6.4.1 General

For the relationship between the MC service provider, the MC service organization and the MC service user 3GPP TS 23.280 [3] clause 6 applies.

### 6.4.2 Public network and non-public network utilization

For the relationship between MC service provider and the utilization of public networks and/or non-public networks the following service arrangements apply:

- A home public network operator or a home non-public network operator can have service arrangements with multiple MC service providers.
- A MC service provider can have service arrangements with multiple home public network operators and/or home non-public network operators.
- As part of the service arrangement between the MC service provider and the home public network operator/home non-public network operator, the corresponding 5GS user profile can be provided which allows the MC service UEs to register to the home public network operator/home non-public network operator.
- The home PLMN operator can have PLMN roaming agreements with multiple visited PLMN operators and the visited PLMN operator can have PLMN roaming agreements with multiple home PLMN operators.

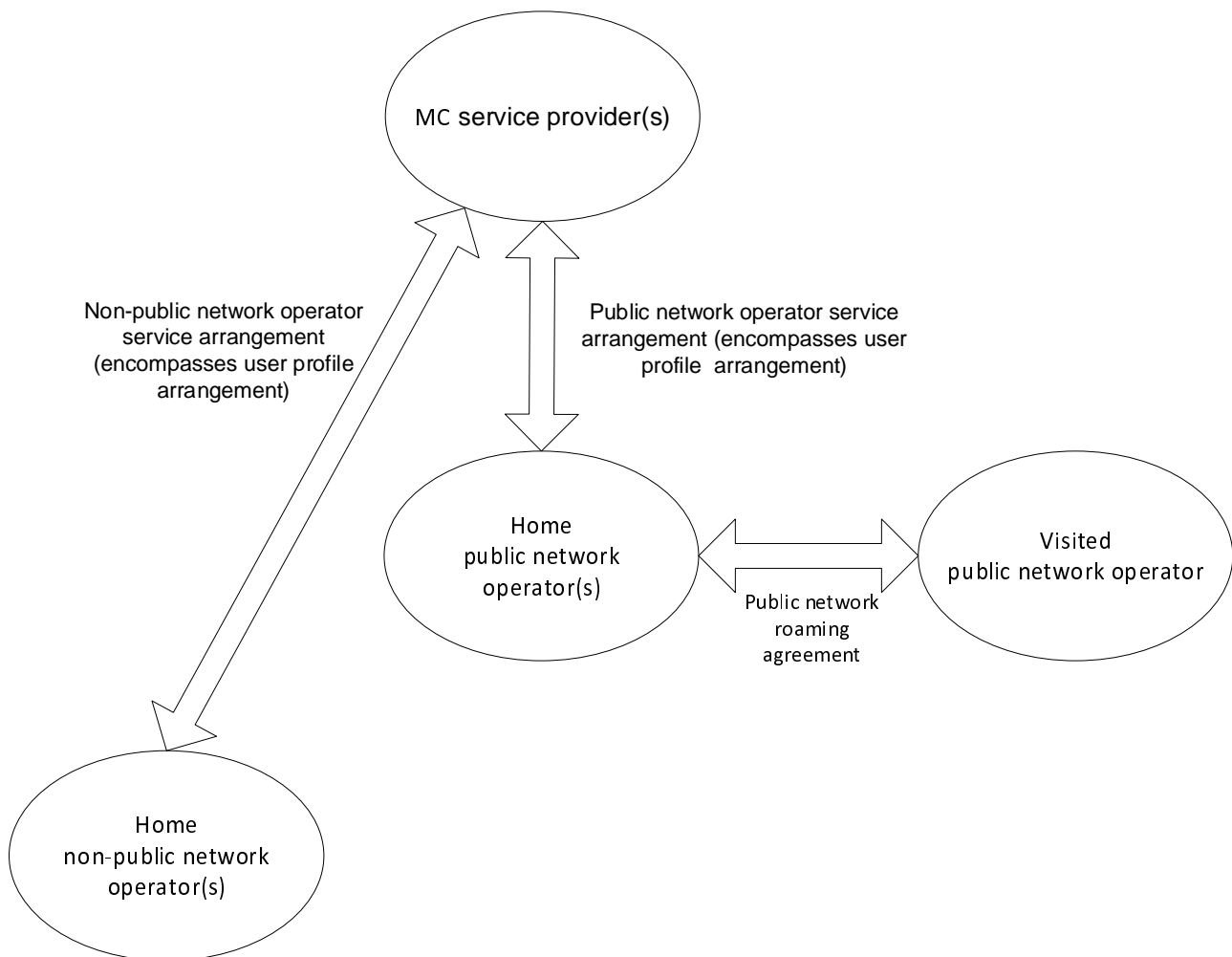
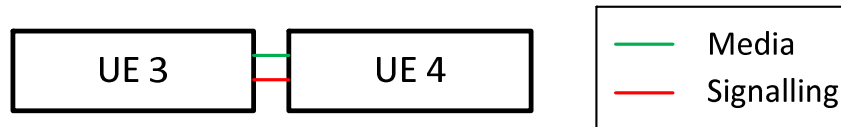

Figure 6.4.2-1: Business relationships for MC services

## 6.5 Off-network architectural model

### 6.5.1 Off-network architectural model diagram

Figure 6.5.1-1 shows the off-network architectural model for the MC system solution for 5G inter-UE communication, where no relay function is used.



**Figure 6.5.1-1: Off-network architectural model for 5G inter-UE communication where no relay function is used**

Figure 6.5.1-2 shows the off-network architectural model for the MC system solution for configuration management and group management. The description in clause 9.3.1 of 3GPP TS 23.280 [3] applies.

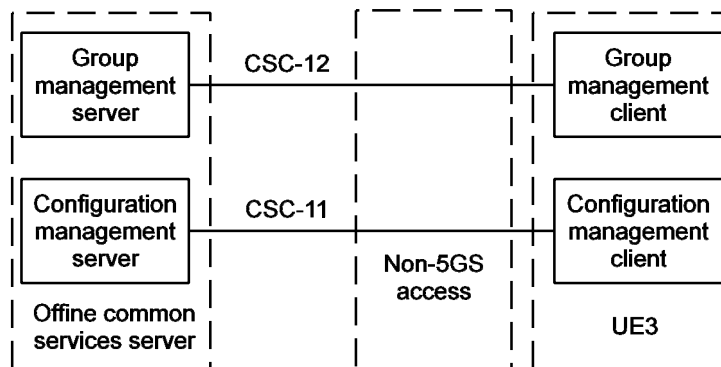

**Figure 6.5.1-2: Off-network architectural model for configuration management and group management**

### 6.5.2 UE 3

The UE 3 is a UE using 5G ProSe and supporting application(s) related to off-network MC service, and it is composed of the corresponding MC service functional entities described in clause 5.

### 6.5.3 UE 4

The UE 4 represents one or more UEs with the same functionality as UE 3.

### 6.5.4 Offline common services server

The offline common services server supports configuration applications related to MC service, and it is composed of the corresponding MC service functional entities described in clause 5.

---

## 7 MC procedures for 5GS

### 7.1 General

In this clause, only the procedures and information flows which are different from that over EPS are captured. The MC service specific procedures and information flows over 5GS remains the same as specified in TS 23.379 [6], TS 23.281[4], TS 23.282 [5] if not specially described in this clause.

## 7.2 MC service resource management (on-network)

### 7.2.1 General

These clauses specify the procedures for resource management for mission critical services. The procedures are utilized by the following MC services:

- MCPTT (as specified in 3GPP TS 23.379 [6]);
- MCVideo (as specified in 3GPP TS 23.281 [4]); and
- MCDData (as specified in 3GPP TS 23.282 [5]).

Session management, QoS model and QoS policy control are defined in 3GPP TS 23.501 [7], 3GPP TS 23.502 [10] and 3GPP TS 23.503 [9].

### 7.2.2 Request for unicast resources at session establishment

The procedure defined in this clause specifies how communication resources are requested from 5GS at session establishment. If concurrent sessions are used the MC service server may utilize the capability of resource sharing specified in 3GPP TS 23.503 [9]. The exchange of the QoS characteristics of the required resources takes place exclusively by means of direct interaction between SIP core and PCF using N5 reference point or Rx reference point and encompass media type, bandwidth, priority, application identifier and resource sharing information.

Establishment, modification or release of communication resources are managed according to 3GPP TS 23.502 [10]. The procedure is generic to any type of session establishment that requires communication resources.

Procedures in figure 7.1.2-1 show the signalling procedures for the requesting resource at session establishment.

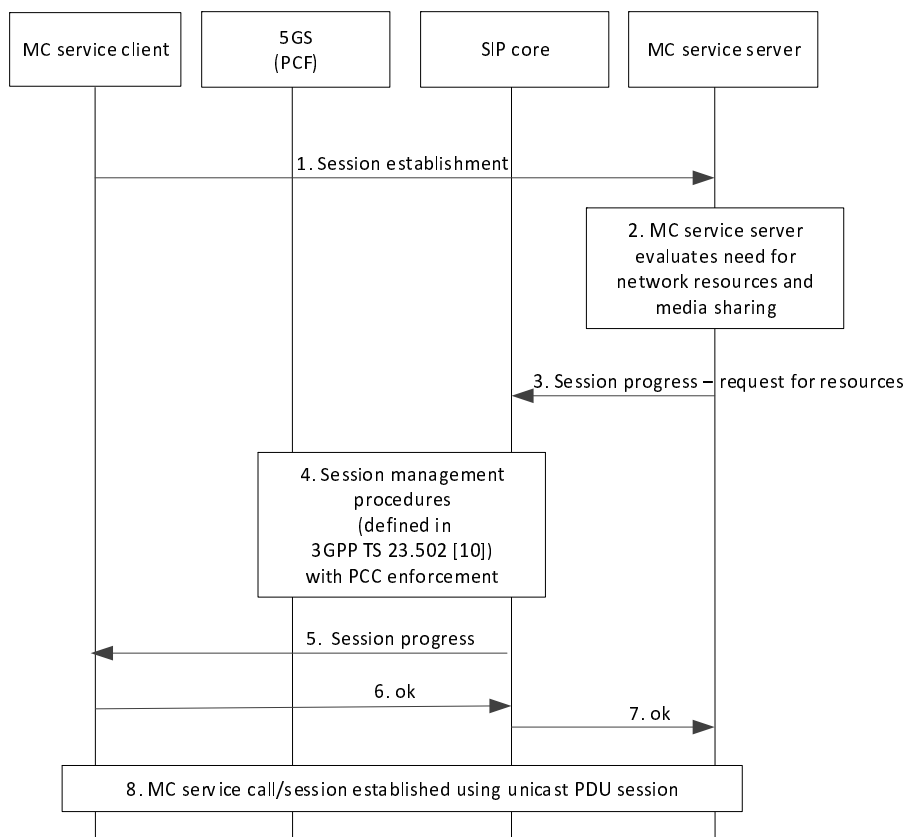

**Figure 7.2.2-1: Resource request at session establishment**

1. MC service client sends a call/session establishment request.

2. MC service server receives evaluates the need of communication resources and the use of media resource sharing.
3. MC service server sends a session progress request containing request for communication resources.
4. Session management procedures using PCF policy control enforcement (as defined in 3GPP TS 23.502 [10]) initiated from SIP core local inbound/outbound proxy using direct interaction between SIP core and PCF.
5. The SIP core local inbound/outbound proxy forwards the call control protocol request to the MC service client.
6. The MC service client acknowledges the session progress request with an OK message.
7. The SIP core local inbound/outbound proxy forwards the OK message to the MC service server.
8. The MC service call/session is established, and resources have been allocated.

## 7.2.3 Request for unicast resources at session establishment from MC service server

### 7.2.3.1 General

The procedure defined in this clause specifies how communication resources are requested from 5GS at session establishment from the MC service server. The required QoS characteristics for resources are sent directly to the PCF via the N5 reference point or Rx reference point from the MC service server. Alternatively, QoS characteristics for resources can be exchanged indirectly utilizing N33 reference point between MC service server and NEF. QoS characteristic information encompasses media type, bandwidth, priority, application identifier, resource sharing information and network slice information. If concurrent sessions are used, the MC service server may utilize the capability of resource sharing specified in 3GPP TS 23.503 [8].

For the request of communication resources by the MC service server via N5 reference point or Rx reference point, or N33 reference point, the MC service client provides to the MC service server the corresponding communication resource details (e.g. IP addresses and ports) of the MC service client and the corresponding media anchoring points.

This procedure is generic to any type of session establishment with the MC service server requesting network resources.

### 7.2.3.2 Procedure

Figure 7.2.3.2-1 describes the procedure for the request of resources at session establishment from the MC service server.

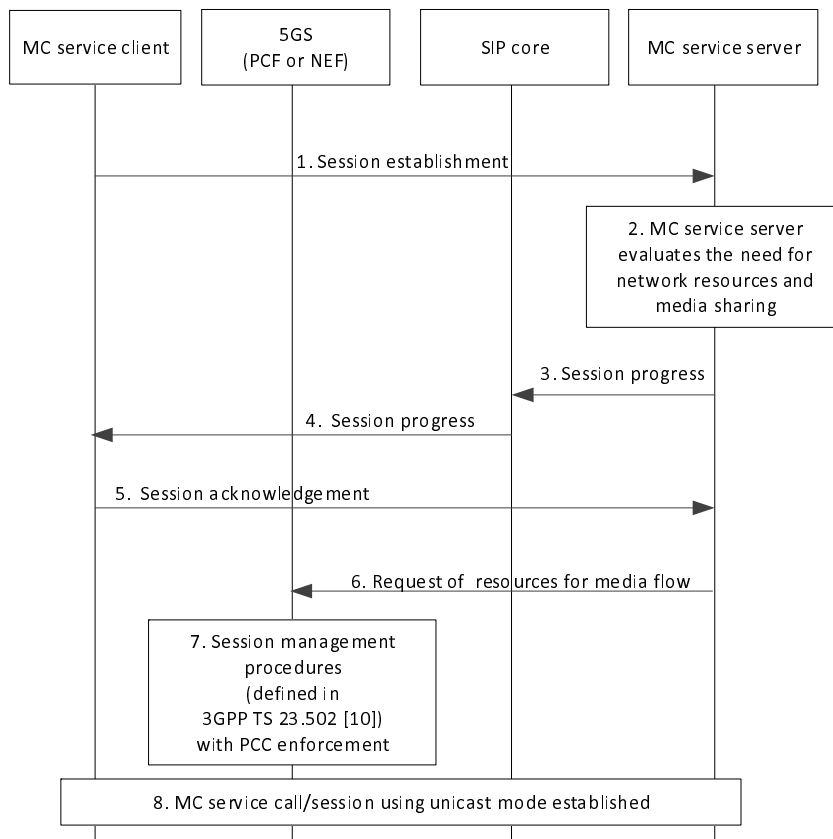

**Figure 7.2.3.2-1: Resource request at session establishment from the MC service server**

1. The MC service client sends a call/session establishment request. The request includes, apart from the SDP offer, access resource details, e.g. IP addresses and ports of the MC service client related to the media session.
2. The MC service server evaluates the need of communication resources and use of media resource sharing.
3. The MC service server sends a session progress request to the SIP core.

**NOTE:** The session progress request does not include a request for network communication resources to be performed by the SIP core.

4. The SIP core local inbound/outbound proxy forwards the session progress request to the MC service client.
5. The MC service client acknowledges the session establishment to the MC service server. This message contains the final negotiated media parameters, e.g. IP addresses and ports related to the media anchoring points received in the SDP answer from the SIP core.
6. To trigger resources allocation, the MC service server sends a request for communication resources to 5GS. For direct interaction, the resource allocation request is exchanged between MC service server and 5GS PCF using N5 reference point or Rx reference point. For indirect interaction, the resource allocation request is exchanged between MC service server and 5GS NEF using N33 reference point. The respective procedures are defined in 3GPP TS 23.502 [10]).
7. Session management procedures using PCF policy control enforcement (as defined in 3GPP TS 23.502 [10]) initiated from MC service server either directly via PCF or indirectly via NEF.
8. The MC service call/session is established, and resources have been allocated.

## 7.2.4 Request for modification of unicast resources

To modify an unicast media flow, the MC service server shall send a resource modification request containing the parameters to be modified, using the call control protocol via the SIP core to the UE. The exchange of the QoS characteristics of the concerned resources takes place exclusively by means of direct interaction between SIP core and PCF.

Possible scenarios when this procedure may be used are:

- Modify the allocation and retention priority for unicast resources;
- Release and resume resources in-between MC service calls when using the chat model; or
- Releasing resources for the media plane should give the option to allow the SIP session to either be torn down or continue.

Procedures in figure 7.2.4-1 are the signalling procedures for the modification of a unicast:

Pre-conditions:

- An MC service call or session is already in progress;

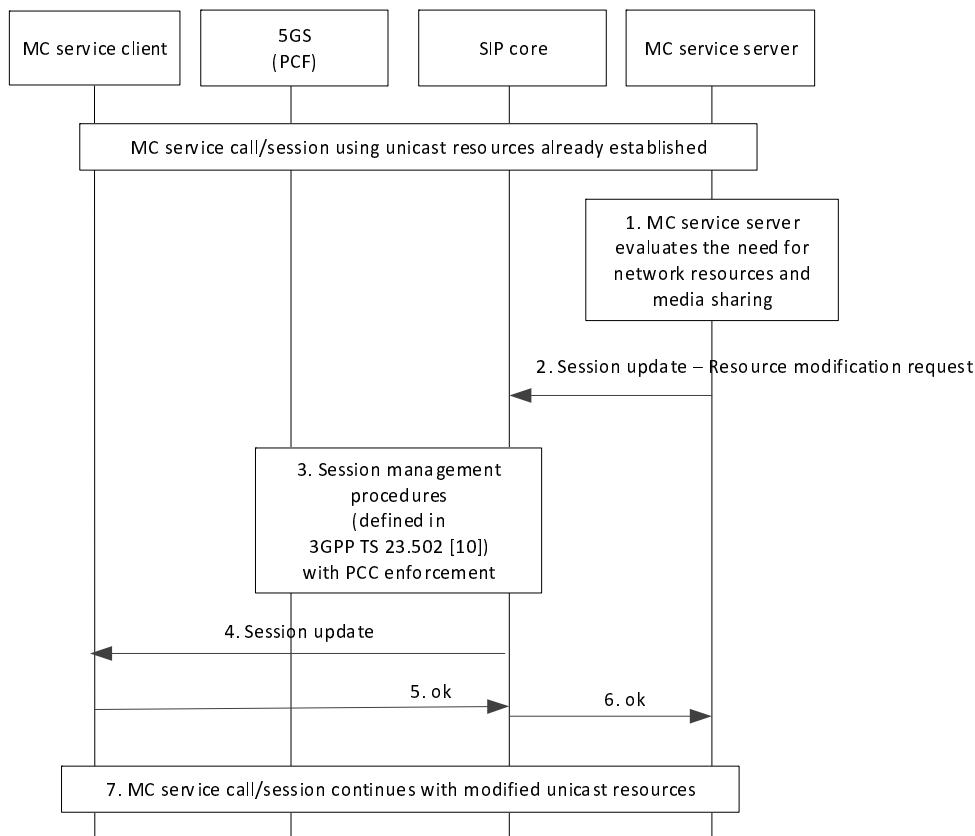

**Figure 7.2.4-1: Media flow modification request**

1. MC service server decides to modify the parameters of a unicast bearer (e.g. a request to upgrade the existing MC service call to an MC service emergency or imminent threat call).
2. MC service server sends a session update which includes a resource modification request containing the modified parameters of the unicast bearer.
3. Session management procedures using PCF policy control enforcement (as defined in 3GPP TS 23.502 [10]) initiated by the MC service server using direct interaction between SIP core and PCF.
4. The SIP core local inbound / outbound proxy forwards the session update request to the MC service client.
5. The MC service client acknowledges the call control protocol request with an OK message.
6. The SIP core local inbound / outbound proxy forwards the OK message to the MC service server.
7. The MC service call continues with the modified unicast resources.

**NOTE:** If multiple audio streams are sent to the UE, additional QoS flows could be required during an established session. Pre-allocation of additional QoS flows already at session establishment could be useful.



## 7.2.5 Request for media resources from MC service server

### 7.2.5.1 General

The procedure in this sub clause specifies how to request resources for floor control (or transmission control in MCVideo and MCDATA) and for the media plane can be handled independently. This procedure utilizes the N5 reference point or Rx reference point for direct interaction between MC service server and 5GS (PCF) and for direct interaction between SIP core and 5GS (PCF). Alternatively, resource requests for the media plane can be exchanged indirectly using N33 reference point between MC service server and NEF.

Resources for transmission control are requested at session establishment, in this case the IMS standard procedures using for direct interaction N5 reference point or Rx reference point as specified in 3GPP TS 23.228 [2] are used. The session description in this procedure shall encompass bandwidth information applicable for the transmission control traffic requirement. At group call setup the request for resources for the media plane is triggered. Either this request is sent directly from the MC service server to 5GS (PCF) or indirectly from the MC service server to 5GS (NEF).

The procedure is optional and is suitable when the procedures for pre-established sessions are used. It may also be used to setup and tear down the media plane used between consecutive group calls in one communication session using the chat call model.

### 7.2.5.2 Procedure

The figure 7.2.5.2-1 illustrates the procedure for resource allocation.

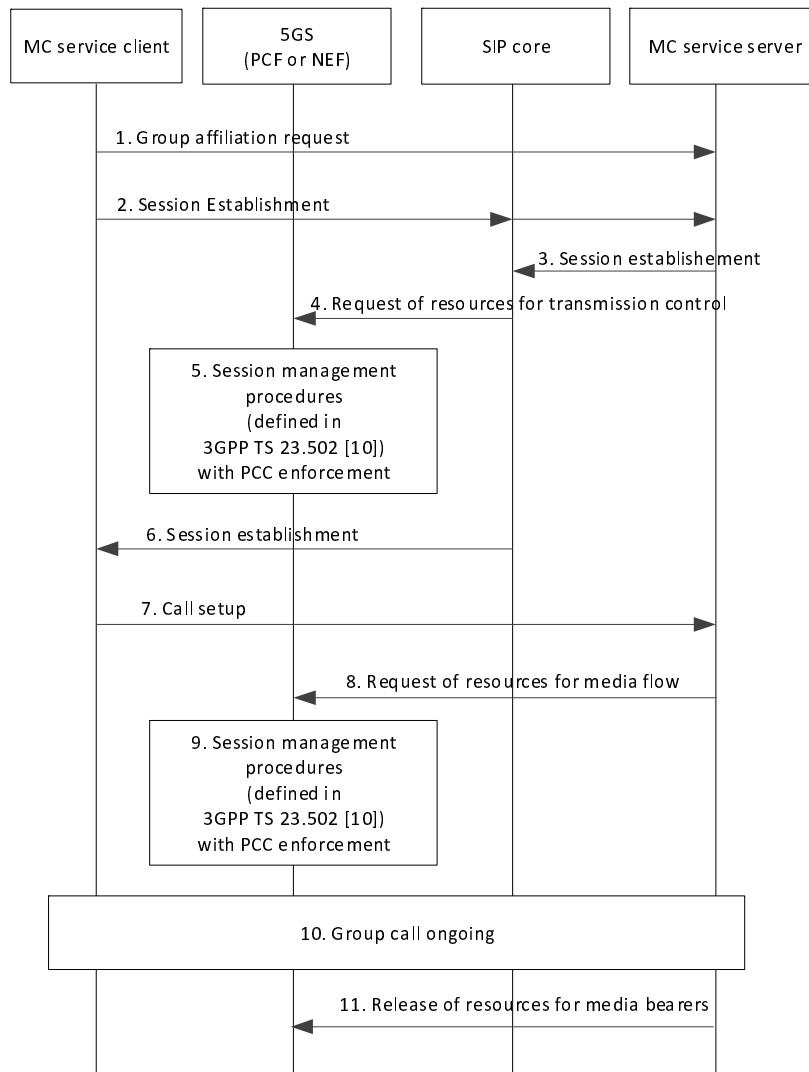

**Figure 7.2.5.2-1: Request of resources for transmission control and media plane**

1. The MC service client sends a request for group affiliation.
2. The MC service client sends a request to the MC service server for establishment of a communication session.
3. The MC service server answer the session establishment request and adjust the bandwidth information in the session description. The requested bandwidth shall be minimized to cover the bandwidth requirements for floor control signalling (or transmission control for MCVideo or MCDATA).
4. The SIP core request resources towards the 5GS according to the session establishment request.
5. Session management procedures using PCF policy control enforcement (as defined in 3GPP TS 23.502 [10]) initiated by the SIP Core.
6. The session establishment request is completed, and a response is sent towards the MC service client.
7. The MC service client sends a call setup message according to existing procedures.
8. The MC service server sends a request for resources for the media plane to 5GS, and the media plane is by that established. For direct interaction, the resource allocation request is exchanged between MC service server and 5GS PCF using N5 reference point or Rx reference point. For indirect interaction, the resource allocation request is exchanged between MC service server and 5GS NEF using N33 reference point. The respective procedures are defined in 3GPP TS 23.502 [10]). This request includes media description relevant for the media plane.

9. Session management procedures using PCF policy control enforcement (as defined in 3GPP TS 23.502 [10]) initiated by the MC service server either directly via PCF or indirectly via NEF.

10. Group call is ongoing on the group communication session.

11. The MC service server sends a release of media resources to 5GS, and the media plane is by that terminated.

NOTE 1: The resources for transmission control are retained.

NOTE 2: Step 7-11 can be repeated several times within the life cycle of one communication session.

## 7.3 MC service over 5G MBS

### 7.3.1 General

This subclause defines information flows and procedures for 5G MBS usage that applies to MC services. 5G MBS session can be used by any MC service for any MC service group.

The following subclauses specify the procedures and information flows for the usage of 5G MBS transmission that are utilized by the following MC services:

- MCPTT (as specified in 3GPP TS 23.379 [6]);
- MCVideo (as specified in 3GPP TS 23.281 [4]); and
- MCDData (as specified in 3GPP TS 23.282 [5]).

MC service specific pre-requisites and resultant behaviour by functional entities in performing these procedures are specified in the respective MC service TSs as listed above.

The first phase to utilize MBS sessions for MC service media transmission is to have the sessions created hence the network resources are reserved. The MC service server may consider the UE's capabilities and service related information e.g., UE's MBS capabilities, location, MBS listening status report sent by group members when it decides to create or use MBS sessions. The MC service server needs to interact with the 5GC for this matter. During the interaction, the necessary information related to the requested session is determined, e.g., MBS session mode (either a broadcast or a multicast session) and the required QoS profile. This interaction depends on the configuration option under consideration, i.e., whether the MC service server is in trusted domain (limited operations), and whether the session creation is done with or without a dynamic PCC rule.

NOTE 1: It is implementation specific whether the MC service server decides to use multicast or broadcast MBS sessions.

NOTE 2: It is implementation specific whether the MC service server decides to create (one or multiple) MBS sessions for MC media for MC group communications associated to a certain MC group or create (one or multiple) dynamic MBS sessions once the need has emerged, e.g., dynamic MBS sessions to be associated for an ad hoc group.

NOTE 3: It is implementation specific whether an MBS session is associated to one or multiple MC groups, and whether it is re-assigned to other MC groups.

NOTE 4: How the MC service server uses the UE's capabilities and service related information in order to create and use the MBS session is implementation specific.

The information elements describing the MBS session under consideration is then sent to the MC service clients via MBS session announcement, where the latter need to react according to the announced session mode.

If eMBMS and 5G MBS co-exist for MC services, the MC service server may decide to trigger the establishment of an eMBMS bearer to deliver the MC media associated to the MC service group communications, if the target MC service group(s) consists of members with eMBMS capable UE. As a result, the MC service server subsequently needs to send an eMBMS bearer announcement towards the clients camping on LTE.

NOTE 5: It is implementation specific whether the MC service server triggers an eMBMS bearer or a unicast bearer to serve MC service clients camping on LTE.

## 7.3.2 Information flows for 5G MBS

### 7.3.2.1 MBS session announcement

Table 7.3.2.1-1 provides the information elements during MBS session announcement, which are sent by the MC service server to the clients. The MBS session announcement includes information elements related to the announced MBS session. Optionally, it includes eMBMS related information elements, if eMBMS and 5G MBS co-exist.

**Table 7.3.2.1-1: MBS session announcement**

Information element	Status	Description
5G MBS session information	M	Providing the MBS session related information if MC service server decides to use 5G MBS session to deliver MC service group communication data
>MBS session ID	M	The identity of the MBS session used to deliver MC service group communication data. It is either TMGI for broadcast MBS and multicast MBS sessions, or source specific IP multicast address for multicast MBS session
>MBS session mode	M	Indicate the service type of the MBS session, either a multicast MBS session or a broadcast MBS session
>MC service group ID	O	Indicate the MC service group ID associated to the MBS session
>MBS related SDP information	M	SDP related to application-level control signalling or media to be transmitted over the MBS session (e.g., codec, protocol ID, FEC information, IP address and ports)
>List of MBS Service Area information (see NOTE 5)	O	For the case of local MBS services, it indicates either multicast service area identifier(s) for multicast MBS session, or broadcast service area identifier(s) for broadcast MBS session
>MBS session announcement acknowledgement	O	Indicate if the MC service server requires an acknowledgement to the MBS session announcement
>Multicast MBS session related information (see NOTE 1)	O	Additional information to be used by the MC service client to join the multicast MBS session such as PLMN ID of the default PLMN service provider, NID (for the case of SNPN deployments) in case of source specific IP multicast address, DNN, and SNSSAI of the PDU session associated with the multicast MBS session
> UE session join notification (see NOTE 2)	O	Indicate if the MC service server requires a notification from the MC service client once it has joined the multicast MBS session
>Monitoring state	O	Indicate if the MC service client is required to actively monitor the MBS session quality and report it to the MC service server. This is applicable for both multicast and broadcast eMBMS session.
>Frequency (see NOTE 3)	O	Identification of frequency associated with a broadcast MBS session, if multi carrier support is provided
>MBS Frequency Selection Area ID (MBS FSA ID) (see NOTE 3)	O	The frequency associated to a certain broadcast area, if multi carrier support is provided
eMBMS bearer information	O	Providing the 4G eMBMS bearer related information if MC service server decides to use 4G eMBMS additionally with 5G MBS session to deliver MC service group communication data
>TMGI (see NOTE 4)	M	TMGI information
>Alternative TMGI	O	A list of additional alternative TMGI may be included and used in roaming scenarios
>QCI	O	QCI information used by the ProSe UE-Network Relay to determine the ProSe Per-Packet Priority value to be applied for the multicast packets relayed to Remote UE over PC5
>List of service area identifier	M	A list of service area identifier for the applicable eMBMS broadcast area
>Frequency	O	Identification of frequency if multi carrier support is provided
>eMBMS related SDP information	M	SDP with media and floor control information applicable to groups that can use this eMBMS bearer (e.g., codec, protocol id, FEC information)
>Monitoring state	O	Indicate if the MC service client is required to actively monitor the eMBMS bearer quality and report it to the MC service server
>ROHC information	O	Indicate the usage of ROHC over the eMBMS bearer and provide the parameters of the ROHC channel to signal to the ROHC decoder

NOTE 1: Such information may be pre-configured in the MC service UE, or provided in any other implementation specific way  
 NOTE 2: It is applicable for multicast MBS session  
 NOTE 3: It is applicable for broadcast MBS session  
 NOTE 4: TMGI for 4G eMBMS bearer can be the same or different with 5G MBS session ID.  
 NOTE 5: Details of MBS service area information is defined in 3GPP TS 23.247 [15].

### 7.3.2.2 UE session join notification

Table 7.3.2.2-1 describes the information flow of UE session joining notification from the MC service client to the MC service server after successfully joining a certain multicast MBS session procedure as defined in 3GPP TS 23.247 [15].

**Table 7.3.2.2-1: UE session join notification**

Information element	Status	Description
MBS session ID(s)	M	The identity of the multicast MBS session(s) being joined. It is either TMGI or source specific IP multicast address.
MC service ID	M	Identity of the MC service user who is reporting the session status
MBS multicast joining status	M	The multicast listening status can be joined if successfully joined MBS session.

### 7.3.2.3 MapGroupToSessionStream

Table 7.3.2.3-1 defines the MapGroupToSessionStream to be sent from the MC service server to MC service clients to provide specific required information to receive the media related to a group communication within an MBS session. The MC service can either be MCPTT, MCVideo or MCDData services.

**Table 7.3.2.3-1: MapGroupToSessionStream**

Information element	Status	Description
MC service group ID	M	This element identifies the MC service group related to a group communication to be delivered over the MBS session. The MC service group ID is either MCPTT group ID, MCVideo group ID, or MCDData group ID.
Media stream identifier	M	This element identifies the media stream of the SDP used for the group communication within the MBS session. In case separate media streams are used for the audio and video media components in MCVideo services, separate identifiers can be used.
MBS session ID	O	The MBS session identifier if the MapGroupToSessionStream message is not sent on the same session as the MC media

7.3.2.4 Void

7.3.2.5 Void

7.3.2.6 Void

### 7.3.2.7 UnMapGroupFromSessionStream

Table 7.3.2.7-1 describes the information flow to disconnect an MC group communication call from a MBS session. It is sent from the MC service server to the MC service client, where the MC service can either be MCPTT, MCVideo or MCDData services.

**Table 7.3.2.7-1: UnMapGroupFromSessionStream**

Information element	Status	Description
MCPTT group ID	M	This element identifies the MC service group related to a group call to be dissociated over the MBS session. The MC service group ID is either MCPTT group ID, MCVideo group ID, or MCData group ID.
Media stream identifier	M	This element identifies the media stream of the SDP, which is no longer used for the group call within the MBS session. In case separate media streams are used for audio and video stream in MCVideo services, a separate identifier is optionally used to identify the audio stream, which is no longer used.
MBS session ID	O	Indicating the MBS session ID, if the information is sent over another MBS session or unicast path

### 7.3.2.8 Discover MBS Session request

The usage of Discover MBS Session request is similar to Discover Bearer request for eMBMS as it defined in 3GPP TS 23.280 [3].

Table 7.3.2.8-1 describes the information flow discover MBS session request from the MC service server to another MC service server (MBS session control role).

**Table 7.3.2.8-1: Discover MBS session request**

Information element	Status	Description
List of MBS service area information	O	A list of MBS service area information for the applicable MBS session service area.
Bandwidth	M	Maximum bandwidth required
5QI	O	Desired 5QI

NOTE: List of MBS service area information is optional and needed once it is applicable with the MBS session ID under consideration.

### 7.3.2.9 Discover MBS Session response

The usage of Discover MBS Session response is similar to Discover Bearer response for eMBMS as it defined in 3GPP TS 23.280 [3].

Table 7.3.2.9-1 describes the information flow discover MBS session response from an MC service server (MBS session control role) to the MC service server.

**Table 7.3.2.9-1: Discover MBS session response**

Information element	Status	Description
MBS Session ID(s)	M	List of MBS session IDs and related information
List of MBS service area information (see NOTE)	O	A list of MBS service area identifiers for the applicable MBS session service areas, corresponding to the listed MBS session IDs, over which the request was successful.
Frequency	O	Identification of the frequency if multi-carrier support is provided
5QI	O	Providing feedback related to the applicable 5QI information.
NOTE:		List of MBS service area information is optional and needed once it is applicable with the MBS session ID under consideration



### 7.3.2.10 MBS listening status report

Table 7.3.2.10-1 describes the information flow of MBS listening status report from the MC service client to the MC service server. The MBS listening status report is applicable to both broadcast and multicast MBS sessions.

**Table 7.3.2.10-1: MBS listening status report**

Information element	Status	Description
MBS session ID(s)	M	The identity of the MBS session(s) being monitored.
MC service ID	M	Identity of the MC service user who is reporting the session status. It may either be the MCPTT ID, MCVideo ID, or MCDATA ID.
MBS listening status	M	The listening status per MBS session ID.
MBS reception quality level	O	The reception quality level
Unicast listening status	O	The unicast listening status associated with the unicast delivery.
NOTE: The set of quality levels helps service continuity in broadcast and multicast scenarios. A reception quality level may help to make an efficient switching decision to unicast delivery. How these levels are used is implementation specific.		

### 7.3.2.11 MBS session de-announcement

Table 7.3.2.11-1 describes the information flow of an MBS session de-announcement sent from the MC service server to the MC service clients.

**Table 7.3.2.11-1: MBS session de-announcement.**

Information element	Status	Description
MBS session ID(s)	M	The identity of the MBS session(s) to be de-announced.
MBS session de-announcement acknowledgement	O	Indicate if the MC service server requires an acknowledgement to the MBS session de-announcement

### 7.3.2.12 MBS session de-announcement acknowledgement

Table 7.3.2.12-1 describes the information flow of an MBS session de-announcement acknowledgement message sent from the MC service clients to the MBS service server, to acknowledge the reception of the MBS session de-announcement.

**Table 7.3.2.12-1: MBS session de-announcement acknowledgement.**

Information element	Status	Description
MC service ID	M	The MC service identity of the MC service client, whose group is no longer associated to the MBS session(s)
MBS session ID(s)	M	The identity of the MBS session(s) to be de-announced.
MBS session de-announcement status	M	The de-announcement status per MBS session ID.

### 7.3.2.13 Media distribution request

Table 7.3.2.13-1 describes the information flow media distribution request from the MC Service server to an MC service server (5G MBS Session control role) that has a desired 5G MBS session.

The difference compared with the information flow defined in 3GPP TS 23.280 [3] is that in 5G MBS, the information element for QoS is 5QI.

**Table 7.3.2.13-1: Media distribution request**

Information element	Status	Description
MBS session ID	M	MBS session identifier
Bandwidth	M	Maximum bandwidth required
Separate floor control	M	Whether or not a separate session is required for floor control
SDP information	M	SDP with media and floor control information applicable to groups that can use this MBS session (e.g. codec, protocol id)
5QI	O	Desired 5QI
MC Group ID	O	The MC group id for when the request is sent for a specific group call

### 7.3.2.14 Media distribution response

Table 7.3.2.14-1 describes the information flow media distribution response from an MC Service server (5G MBS session control role) that has a desired 5G MBS session to the MC service server.

**Table 7.3.2.14-1: Media distribution response**

Information element	Status	Description
MBS session ID	M	MBS session identifier
Bandwidth	M	Maximum bandwidth required
SDP information	M	SDP with media and floor control information applicable to groups that can use this session (e.g. codec, protocol id)
5QI	O	Actual 5QI
Media stream identifier	O	This element identifies the media stream of the SDP used for the group call
Media distribution indicator	O	Indicates to the MC service server whether the media in the ongoing group communication should be sent or not

### 7.3.2.15 Media distribution release

Information flow for Media distribution release is reused without modification as specified in clause 10.7.2.10 of 3GPP TS 23.280 [3].

### 7.3.2.16 MBS session announcement acknowledgement

Table 7.3.2.16-1 describes the information flow of an MBS session announcement acknowledgement message sent from the MC service clients to the MBS service server, to acknowledge the reception of the MBS session announcement.

**Table 7.3.2.16-1: MBS session announcement acknowledgement.**

Information element	Status	Description
MC service ID	M	The MC service identity of the MC service client.
MBS session ID(s)	M	The identity of the MBS session(s) whose announcement information is received.

## 7.3.3 Procedures for usage of 5G MBS

### 7.3.3.1 MBS session creation and MBS session announcement

#### 7.3.3.1.1 General

The procedures in this clause describe how MBS session creation and MBS session announcement can be used for the transmission of MC service group communication data over either broadcast or multicast MBS sessions. The MBS

session can either be created with or without dynamic PCC rule, where the latter requires less interaction done by the MC service server towards the 5GC (either directly or via NEF).

### 7.3.3.1.2 Procedure for pre-created MBS session and MBS session announcement

Pre-conditions:

- The MC service server has decided to use an MBS session for MC service group communications associated to a certain MC service group based on transport only mode.
- The MC service server has performed MB-SMF discovery and selection either directly or indirectly, via NEF/MBSF, unless the corresponding information is locally configured.
- MC service clients 1 to n are attached to the 5GS, registered and affiliated to the same MC service group X.
- The MC service server is aware whether to request the creation of the MBS service server with or without dynamic PCC rule.

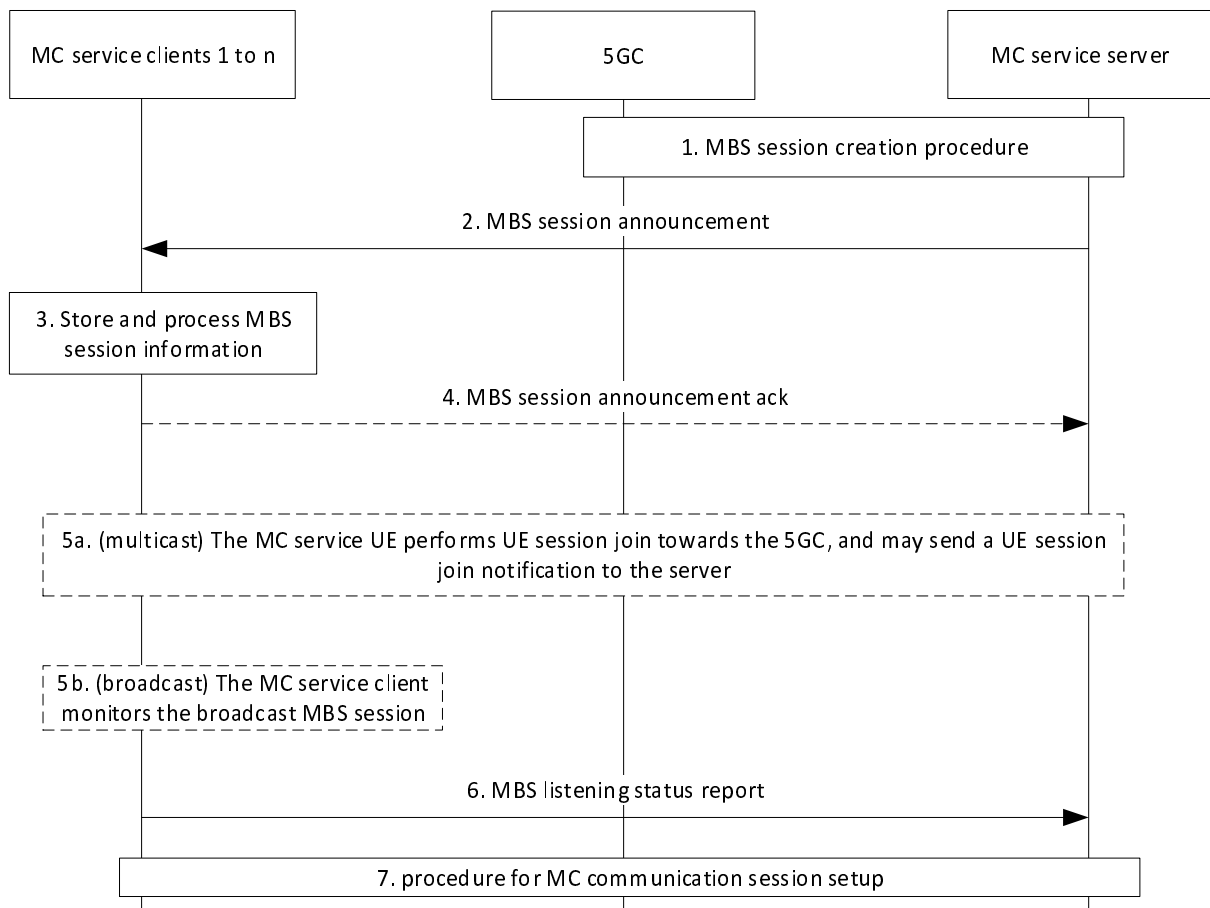

**Figure 7.3.3.1.2-1: Use of pre-created MBS session.**

1. The MC service server initiates an MBS session creation procedure towards the 5GC as described in 3GPP TS 23.247 [15]. The procedure starts once the MC service server initiates a TMGI allocation request (either directly to MB-SMF or indirectly via NEF). Upon the reception of the TMGI allocation response, the MC service server sends an MBS session creation request, including further information related to the MBS session, e.g., MBS session ID, MBS session mode and the QoS requirements if dynamic PCC rule is not considered. However, if dynamic PCC rule is considered, the MC service server defines these requirements at a later step, namely it sends an MBS authorization/policy create request towards PCF (either directly or to the NEF) indicating the QoS requirements.

NOTE 1: In case of LTE eMBMS and 5G MBS co-existence, the MC service server may trigger the establishment of eMBMS bearers as described in 3GPP TS 23.280 [3] (or it may establish a unicast bearer) based on the RAT capabilities supported by the affiliated members in the MC service group X. If MBSF and BM-SC are co-located, TMGI used by 4G eMBMS can be the same as the MBS session ID.

NOTE 2: For the case of multi carrier support for broadcast MBS sessions, the MC service server may indicate the frequencies within a broadcast MBS service area by providing the MBS frequency selection area ID(s) (MBS FSA ID(s)) to the MB-SMF, or indirectly, via NEF.

2. The MC service server provides the MC service clients affiliated to MC service group X with the information related to the created MBS session via the MBS session announcement. As described in table 7.3.2.1-1, the MBS session announcement includes information such as the MBS session ID, MBS session mode (broadcast or multicast service type) and SDP information related to the MBS session under consideration.

NOTE 3: The MC service server may send an MBS session announcement at an earlier step during the MBS session creation procedure towards the MC service clients once the MC group associated to the MBS session is known.

Optionally, the MC service server includes the information elements related to the established eMBMS bearer once the MC service server has determined the need, as indicated in table 7.3.2.1-1. The MC service clients which camp on LTE will subsequently react to the information elements related to the eMBMS bearer as described in 3GPP TS 23.280 [3].

3. MC service clients store and process the received MBS session information.

4. MC service clients may provide an MBS session announcement acknowledgment to the MC service server to indicate the reception of the corresponding MBS session announcement.

5. Based on the MBS session mode (either multicast or broadcast), the following actions take place:

5a. For multicast MBS sessions, MC service clients initiate a UE session join request towards the 5GC using the information provided via the MBS session announcement. Hence, upon the first successful UE session join request, the multicast is then established, and the radio resources are reserved, if the session is in an active state. The established session can either be in active or inactive state as indicated in 3GPP TS 23.247 [15]. The MC service clients sends a UE session join notification towards the server. If indicated in the MBS session announcement information, MC service clients report the monitoring state (i.e., the reception quality of the MBS session) back to the MC service server; or

5b. For broadcast MBS sessions, if the MC service client is accessing over 5G, the session is established as part of the session creation procedures as described in 3GPP TS 23.247 [15], and the network resources are reserved both in 5GC and NG-RAN. The MC service clients start monitoring the reception quality of the broadcast MBS session. If indicated in the MBS session announcement information, MC service clients report the monitoring state (i.e., the reception quality of the MBS session) back to the MC service server.

NOTE 4: It is implementation specific whether the MBS session reception quality level is determined per MBS session, per media stream or per MBS QoS flow level via e.g., measurements of radio level signals, such as the reference signals from the NG-RAN node(s), or packet loss.

6. The MC service clients provide a listening status notification related to the announced session (multicast or broadcast session) in the form of an MBS listening status report.

7. An MC service group communication setup takes place as specified in 3GPP TS 23.379 [6], 3GPP TS 23.281 [4], or 3GPP TS 23.282 [5]. The MC service server determines to use the pre-created MBS session for this group communication.

### 7.3.3.1.3 Procedure for dynamic MBS sessions

In this scenario, the group communication is already taken place and a unicast PDU session is utilized for MC DL transmission. When the MC service server decides to use an MBS session for the transmission under consideration, the MC service server interacts with 5GC to reserve the necessary network resources.

NOTE 1: The MC service server logic for determining when to create a dynamic MBS session is implementation specific.

The procedure in figure 7.3.3.1.3-1 shows one MC service client receiving the DL media. There might also be MC service clients in the same MC group communication session that receive the communication on an MBS session.

Pre-conditions:

- MC service client is attached to the 5GS, registered and affiliated to a certain MC service group X.
- The MC service server is aware whether to request the creation of the MBS service server with or without dynamic PCC rule.
- The MC service server has performed MB-SMF discovery and selection either directly or indirectly, via NEF/MBSF, unless the corresponding information is locally configured.
- No MBS session exists, or the existing multicast MBS session fails to satisfy the QoS requirements.

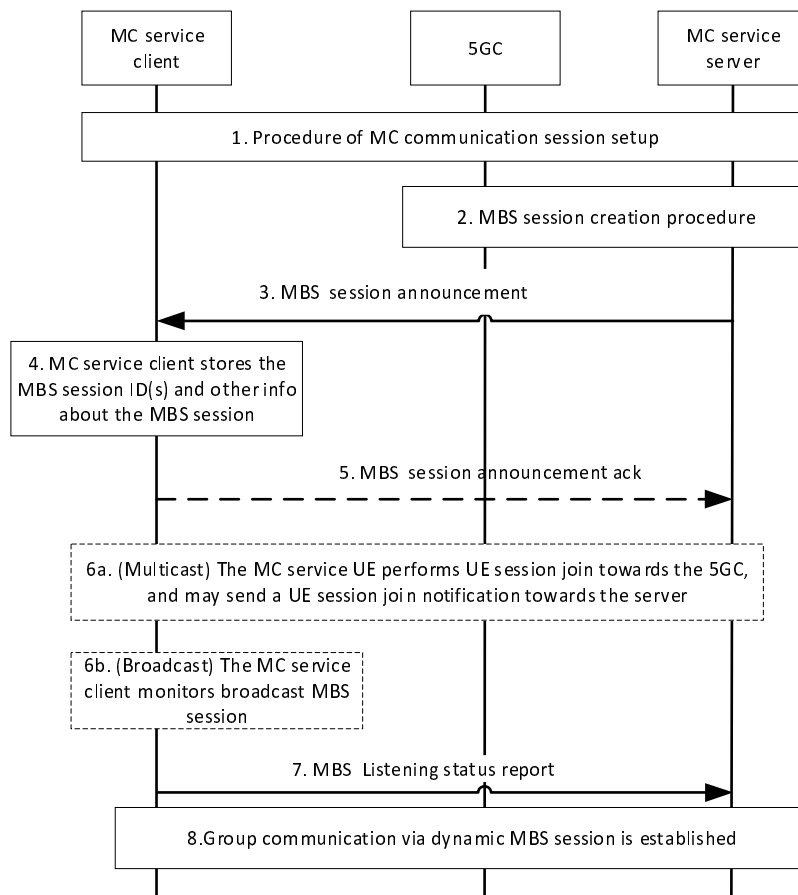

**Figure 7.3.3.1.3-1: Use of dynamic MBS session.**

1. An MC service group communication session is established as specified in 3GPP TS 23.379 [6], 3GPP TS 23.281 [4], or 3GPP TS 23.282 [5].
2. The MC service server decides to create an MBS session. The MBS session creation procedure takes place as described in clause 7.3.3.1.

**NOTE 2:** In case of LTE eMBMS and 5G MBS co-existence, the MC service server may trigger the establishment of eMBMS bearers as described in 3GPP TS 23.280 [3] (or it may establish a unicast bearer) based on the RAT capabilities supported by the affiliated members in the MC service group X. If MBSF and BM-SC are co-located, TMGI used by 4G eMBMS can be the same as the MBS session ID.

**NOTE 3:** For the case of multi carrier support for broadcast MBS sessions, the MC service server may indicate the frequencies within a broadcast MBS service area by providing the MBS frequency selection area ID(s) (MBS FSA ID(s)) to the MB-SMF, or indirectly, via NEF.

3. The MC service server provides the MC service client with the information related to the created MBS session via an MBS session announcement. As described in table 7.3.2.1-1, the session announcement includes

information such as the MBS session ID, MBS session mode (broadcast or multicast service type), and SDP information related to the MBS session.

Optionally, the MC service server includes the information elements related to the established eMBMS bearer once the MC service server has determined the need, as indicated in table 7.3.2.1-1. The MC service clients which camp on LTE will subsequently react to the information elements related to the eMBMS bearer as described in 3GPP TS 23.280 [3].

4. The MC service client stores the MBS session ID and other associated information.
  5. The MC service client may send an MBS session announcement ack back to the MC service server.
  6. Based on the MBS session mode (either multicast or broadcast), the following actions take place:
    - 6a. For multicast MBS sessions, MC service client initiates a UE session join request towards the 5GC using the information provided via the MBS session announcement. Hence, upon the first successful UE session join request, the multicast is then established, and the radio resources are reserved, if the session is in active state. The established session can either be in active or inactive state as indicated in 3GPP TS 23.247 [15]. The MC service client sends a UE session join notification towards the server. If indicated in the MBS session announcement information, MC service clients report the monitoring state (i.e., the reception quality of the MBS session) back to the MC service server; or
    - 6b. For broadcast MBS sessions, if the MC service client is accessing over 5G, the session is established as part of the session creation procedures as described in 3GPP TS 23.247 [15], and the network resources are reserved both in 5GC and NG-RAN. The MC service clients start monitoring the reception quality of the broadcast MBS session. If indicated in the MBS session announcement information, MC service clients report the monitoring state (i.e., the reception quality of the MBS session) back to the MC service server.
- NOTE 4: It is implementation specific whether the MBS session reception quality level is determined per MBS session, per media stream or per MBS QoS flow level via e.g., measurements of radio level signalling such as the reference signals from the NG-RAN node(s), packet loss.
7. The MC service clients provide a listening status notification related to the announced session (multicast or broadcast session) in the form of an MBS listening status report.
  8. An MC service group communication via dynamic MBS session is established.

### 7.3.3.2 Request for updating MBS resources for group communications

#### 7.3.3.2.1 General

The MC service server can create one or several MBS sessions based on certain service requirements (e.g., QoS profile), a certain service area, or the activity status of multicast MBS sessions. However, during the life cycle of the MBS sessions, the MC service server may need to update the sessions to meet emerging needs, including the service requirements, service area related parameters, etc..., as defined in 3GPP TS 23.247 [15].

In case of dynamic PCC rule, the MC service server needs to determine what aspects are needed to be updated (either service area related aspects/ multicast activation status, service requirements aspects, or both as described in 3GPP TS 23.247 [15]) in order to interact with the required entity in the 5GC either directly, (in case the MC service server is in trusted domain), or indirectly via NEF/MBSF.

#### 7.3.3.2.2 Procedure for updating MBS resources without dynamic PCC rule

The procedure shown in figure 7.3.3.2.2-1 presents an MBS session update procedure triggered by the MC service server (either directly to the MB-SMF, or indirectly via NEF/MBSF). Within the update request, either the service requirements, MBS service area, activity status of multicast MBS session, or all three are done, as indicated in 3GPP TS 23.247 [15].

Pre-conditions:

- The MC service clients 1 to n are attached to the 5GS, registered and affiliated to the same active MC service group.

- The MC service server has obtained the required information related to the MB-SMF, either locally configured or during initial session configuration.
- The MBS session is created with certain service requirements and optionally with a certain broadcast/multicast service area. The MBS session is announced to be associated with the MC service group for group communication purposes.

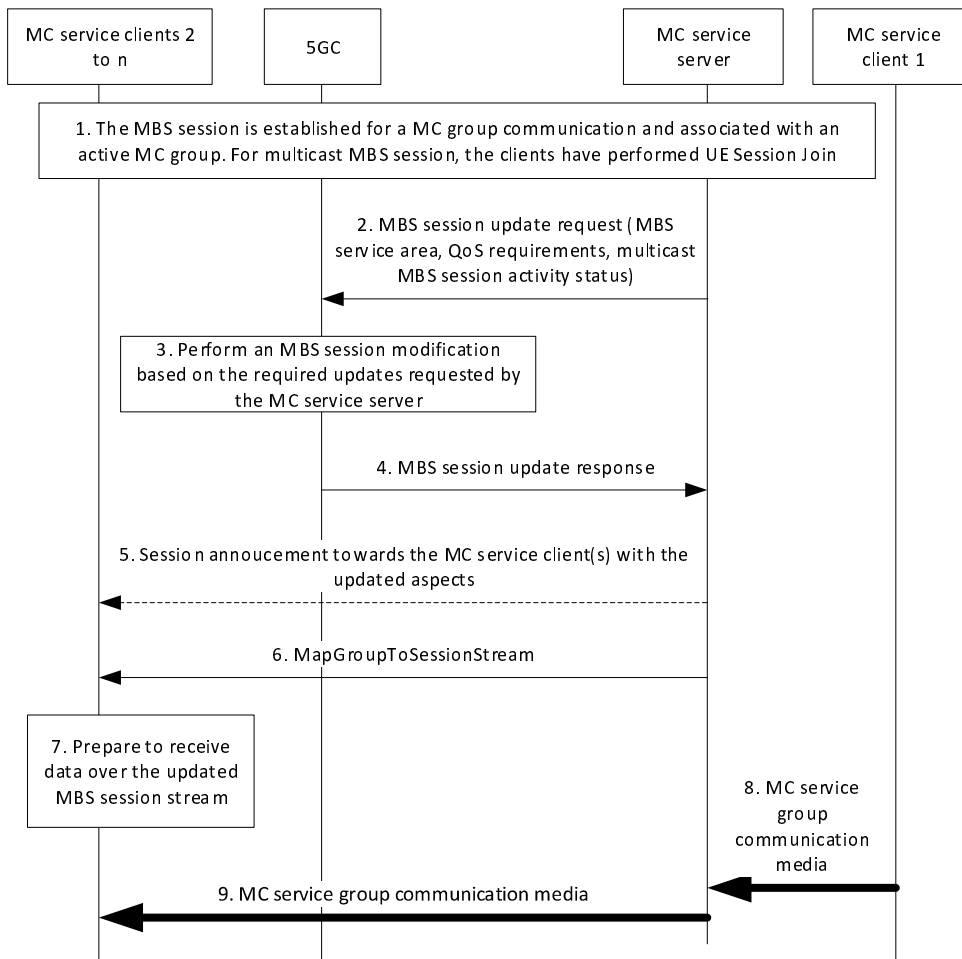

Figure 7.3.3.2.2-1: MBS session update without dynamic PCC.

1. An MBS session is established as described in in 3GPP TS 23.247 [15] (either a multicast or a broadcast session), and associated with a certain active MC group for group communication purposes. In the case of a multicast MBS session, the MC service clients have already joined the session.
2. The MC service server invokes an MBS session update request towards the 5GC (either directly to the MB-SMF or indirectly via NEF/MBSF) once the need has emerged to modify some aspects for the given MBS session under consideration. Hence, the MC service server sends the MBS session update request as described in 3GPP TS 23.247 [15] and either directly to the MB-SMF or indirectly via NEF/MBSF, indicating the MBS session ID to be updated. Along with the update request, the updated aspects are sent, which are either service requirements (required QoS), service area, or both. In case of multicast MBS sessions, the MC service server may as well update the status (active or inactive) of the multicast MBS session once needed within the update request.

NOTE 1: The updated service area information is required for local MBS and for broadcast MBS services.

3. Based on the needed requirements, the corresponding MBS session is accordingly modified, as indicated in 3GPP TS 23.247 [15]. The update may lead to QoS Flow(s) addition, modification, or removal.

4. The MC service server receives an MBS session update response as described in 3GPP TS 23.247 [15], once the requested modifications are performed, and the indicated MBS session is updated accordingly.
5. The MC service server may initiate a session announcement towards the MC service clients associated with the ongoing session in order to announce the updated information, if required, e.g., the updated service area or SDP information.

NOTE 2: The updated service area information is required for local MBS and for broadcast MBS services.

6. The MC service server sends an MapGroupToSessionStream over the configured MBS session providing the required information to receive the media related to the established MC service group communication.
7. The MC service clients process the received information over the MapGroupToSessionStream in order to receive the associated MC media over the specific MBS session stream.
8. MC service client 1 sends media to the MC service server over unicast to be distributed for the established group communication.
9. The MC service server distributes the MC media to the MC services clients 2 to n over the indicated streams.

#### 7.3.3.2.3 Procedure for updating MBS resources with dynamic PCC rule

The procedure shown in figure 7.3.3.2.3-1 presents an MBS session update procedure triggered by the MC service server to the 5GC, either directly or via NEF/MBSF. Based on the required updates to be done, the MC service server needs to interact with the MB-SMF to update the MBS service area and multicast activity status, with the PCF to update the required QoS requirements, or sequentially both to update all the above, as indicated in 3GPP TS 23.247 [15].

Pre-conditions:

- The MC service clients 1 to n are attached to the 5GS, registered and affiliated to the same active MC service group.
- The MC service server has obtained the required information related to the MB-SMF, either locally configured or during initial session configuration.
- The MBS session is created with certain service requirements and optionally with a certain broadcast/multicast service area. The MBS session is announced to be associated with the MC service group for group communication purposes.



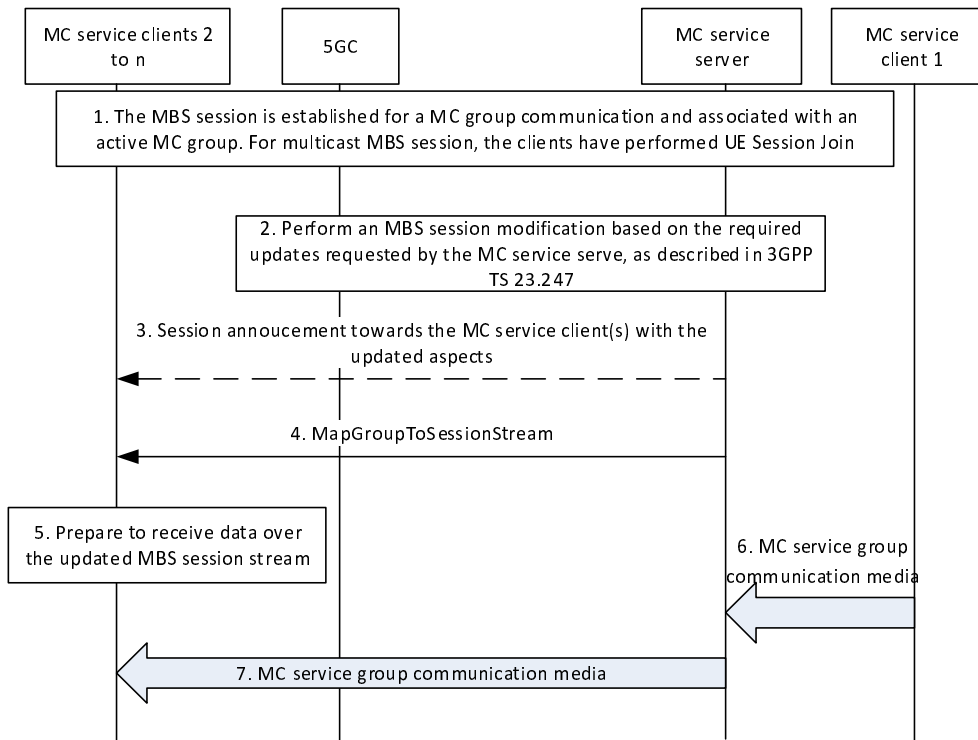

**Figure 7.3.3.2.3-1: MBS session update with dynamic PCC.**

1. An MBS session is established as described in 3GPP TS 23.247 [15] (either a multicast or a broadcast MBS session), and associated with a certain active MC group for group communication purposes. In the case of a multicast MBS session, the MC service clients have already joined the MBS session.
2. The MC service server, based on the update requirements (i.e., MBS service area and/or the multicast MBS session activity status as well as the service requirements), perform the MBS session update with PCC procedure towards the 5GS as described in 3GPP TS 23.247 [15] and/or the MBS session activate/deactivate procedure as described in clause 7.3.3.4.

NOTE 1: The updated service area information is required for local MBS and for broadcast MBS services.

3. The MC service server may initiate a MBS session announcement towards the MC service clients associated with the ongoing MBS session in order to announce the updated information if required, e.g., the updated service area or SDP information.

NOTE 2: The updated service area information is required for local MBS and for broadcast MBS services.

4. The MC service server sends an MapGroupToSessionStream over the MBS session providing the required information to receive the media related to the established MC service group communication.
5. The MC service clients process the received information over the MapGroupToSessionStream in order to receive the associated MC media over the specific MBS session stream.
6. MC service client 1 sends media to the MC service server over unicast to be distributed for the established group communication.
7. The MC service server distributes the MC media to the MC services clients 2 to n over the indicated streams.

### 7.3.3.3 MBS session deletion request

#### 7.3.3.3.1 General

The MC service server can decide to release a certain MBS session once it is no longer further utilized for the associated MC service group communication, e.g., the MC service group is no longer active, the MC media transmission is over and no further MC media to be delivered, group communication is terminated. The MBS session deletion procedure leads to releasing the network resources associated to that MBS session.

NOTE: It is up to implementation of MC service server to decide whether to release the MBS session or re-use it for subsequent group operations.

To delete the MBS session, the MC service server sends an MBS session deletion request to the 5GS providing the corresponding MBS session ID. The MBS session deletion request is sent to the MB-SMF (directly or via NEF/MBSF) when PCC is not used. However, if dynamic PCC rule is utilized, a policy authorization deletion request is initially sent to the PCF. Further details are provided in 3GPP TS 23.247 [15].

MC service server further informs the MC service client with the MBS session de-announcement, so that the MC client UE stops monitoring the broadcast MBS session or leaves the multicast MBS session. This procedure is applied for both broadcast MBS session and multicast MBS session.

### 7.3.3.3.2 Procedure

The procedure in figure 7.3.3.3.2-1 describes the MBS session deletion aspects for group communication.

Pre-conditions:

- MC service clients 1 to n are attached to the 5GS, registered and affiliated to the same active MC service group.
- An MBS session is configured to address the corresponding MC service group with certain service requirements and optionally with a certain broadcast/multicast service area. The session is announced and established for group communication purposes for the MC service group.

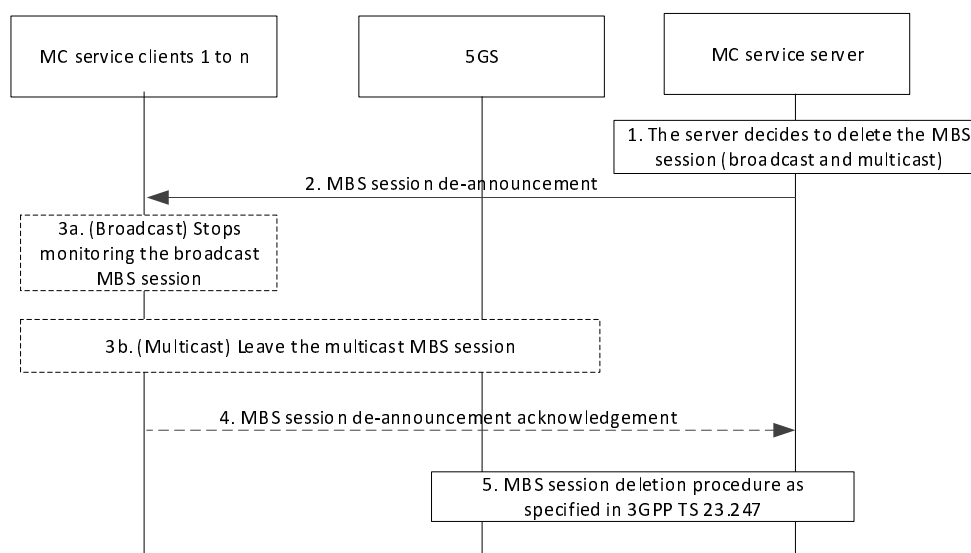

Figure 7.3.3.3.2-1: MBS session deletion procedure.

1. The MC service server decides to delete the MBS session for the associated MC group communication, either multicast or broadcast session.
2. The MC service server sends an MBS session de-announcement message with the MBS session ID towards the MC service client(s). Upon receiving the MBS session de-announcement message, either 3a or 3b is performed.
- 3a. If the MBS session identified by MBS session ID is a broadcast MBS session, the MC service client(s) stops monitoring the broadcast MBS session and removes the broadcast MBS session related information.
- 3b. If the MBS session identified by MBS session ID is a multicast MBS session, the joined MC service client(s) initiate an MBS session leave procedure to leave the indicated MBS session in order to release the respective network resources, as defined in 3GPP TS 23.247 [15].
4. Subsequently, the MC service clients may send an MBS session de-announcement acknowledgement message to the MC service server indicating the status of MBS session.
5. The MC service server initiates the MBS session deletion procedure with the 5GC (either directly or through NEF/MBSF) in order to stop using the configured MBS session and release the corresponding network

resources. The MC service server indicates within the MBS session release request the corresponding MBS session ID. The MBS session deletion procedure can either be with or without a dynamic PCC rule, as indicated in 3GPP TS 23.247 [15].

### 7.3.3.4 Request to activate / de-activate multicast MBS sessions

#### 7.3.3.4.1 General

In case of multicast MBS sessions, the members affiliated to a certain MC group need to initiate a UE session join request towards the 5GC in order to receive the MC media sent via the associated MBS session. The UE session join request enables the reservation of NG-RAN resources for the members of the MC group. However, it is not necessary that the MC media is delivered over the whole time the multicast MBS session is associated to the group under consideration. Therefore, the MC service server is able to efficiently utilize and control the reservation of radio resources based on the availability of MC data to be delivered via the activation and de-activation procedure. This presents more flexibility and efficient use of resources different from LTE.

The most suitable scenario to activate/de-activate a certain multicast MBS session is based on whether there is an MC group call, e.g., MCPTT group call, taking place over that associated MBS session to the MC group. In this manner, the MC service server can activate the associated multicast session once an MC group call takes place, then deactivate it once the MC group call is over. Whether the multicast session is activated (i.e., in an active state), or de-activated (in an inactive state), the MC group is associated to the multicast session and its members are within a UE session join.

The MBS session update request with the requested MBS session status is triggered by the MC service server either directly towards the MB-SMF or indirectly via NEF/MBSF.

**NOTE:** The activation of de-activation procedure may also be triggered by MB-SMF based on receiving notification from MB-UPF based on the availability of MC data to be transmitted.

#### 7.3.3.4.2 Multicast MBS session activation procedure

The procedure shown in figure 7.3.3.4.2-1 presents the multicast MBS session activation procedure triggered by the MC service server.

Pre-conditions:

- MC service clients are attached to the 5GS, registered and affiliated to the same MC service group X.
- The MC service server has directly performed (or via NEF/MBSF) an MB-SMF discovery and selection, unless the corresponding information is locally configured.
- The MC service server has decided to use a multicast MBS session for MC service group communications associated to MC service group X.
- The MBS session is created and announced to address MC group communication related to the associated MC service group X with certain service requirements and optionally with a certain service area.

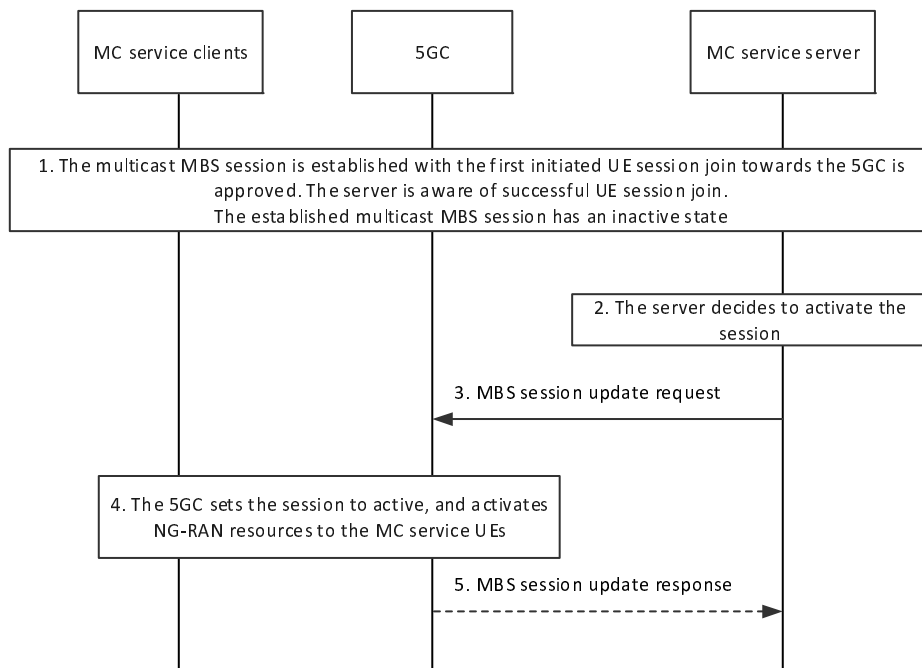

**Figure 7.3.3.4.2-1: Multicast MBS session activation procedure.**

1. The multicast MBS session is established as the first UE session join request, which is initiated by the first MC service UE towards 5GC, is granted. At this stage, the multicast MBS session is established with an inactive state.
2. The MC service server decides to activate the multicast MBS session as MC data is needed to be transmitted over the MBS session to the MC group X, as an MC group communication (e.g., MCPTT group call) is to take place over the associated MBS session.
3. The MC service sends an MBS session update request towards the 5GC, either directly to the MB-SMF or via NEF/MBSF, indicating the MBS session ID to be activated as described in 3GPP TS 23.247 [15].
4. The 5GC changes the MBS session status to "active" and finds the list of joined MC service UEs associated with the MBS session and activates the NG- RAN resources for MC data delivery as described in 3GPP TS 23.247 [15].
5. The 5GC may send an MBS session update response to the MC service server indicating that the requested multicast MBS session has been activated as described in 3GPP TS 23.247 [15].

#### 7.3.3.4.3 Multicast MBS session de-activation procedure

The procedure shown in figure 7.3.3.4.3-1 presents the multicast MBS session activation procedure triggered by the MC service server.

Pre-conditions:

- MC service clients are attached to the 5GS, registered and affiliated to the same MC service group X.
- The MC service server has directly performed (or via NEF/MBSF) an MB-SMF discovery and selection, unless the corresponding information is locally configured.
- A multicast MBS session is created and announced to address the corresponding MC service group with certain service requirements and optionally with a certain multicast service area.
- The MC service clients have already joined the multicast MBS session and are able to receive the MC data over the associated MBS session.

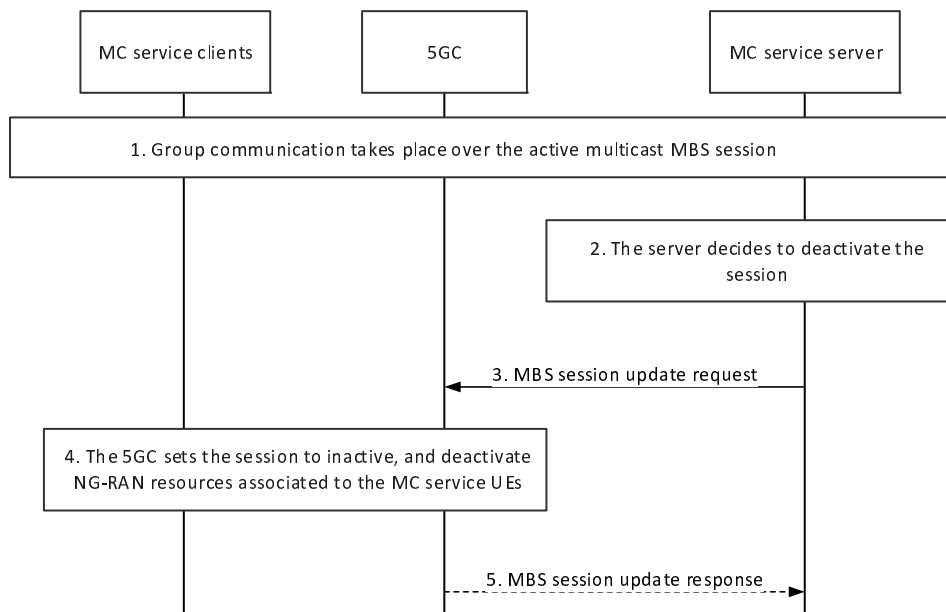

**Figure 7.3.3.4.3-1: Multicast MBS session deactivation procedure.**

1. The group communication associated with MC service group X takes place, and the corresponding MC data is delivered over the associated multicast MBS session, hence the MBS session has an active state.
2. The MC service server decides to deactivate the multicast MBS session, as no further MC data to be delivered to the associated group, as the MC group call is over, and no further MC media is to be delivered.
3. The MC service server sends an MBS session update request towards the 5GC, either directly to the MB-SMF or via NEF/MBSF, indicating the MBS session ID to be deactivated as described in 3GPP TS 23.247 [15].
4. The 5GC changes the MBS session state to "inactive" and deactivates the radio resources associated with the joined MC service UEs as described in 3GPP TS 23.247 [15].
5. The 5GC may send an MBS session update response to the server indicating that the requested multicast MBS session has been inactivated as described in 3GPP TS 23.247 [15].

### 7.3.3.5 MC service group media transmissions over 5G MBS sessions

#### 7.3.3.5.1 General

The MC service server can decide to configure an MBS session per MC service group to transmit the media related to the corresponding MC service group communications. Such group communications can comprise different service requirements. For that, multicast and broadcast MBS sessions need to be configured with multiple MBS QoS flows to address different service requirements, e.g., different required QoS, provided by the MC service server. For instance, application-level control messages or media associated to a group communication can comprise different QoS requirements. Also, different type of group communications can comprise different QoS requirements, e.g., emergency group calls should be handled with a higher priority than normal group calls.

The configuration of multiple MBS QoS flows to address different service requirements is associated to the assignment of different streams (e.g., different ports) within an MBS session.

The established multicast MBS session can either be in active or inactive state, where the former indicates the activation of radio resources hence transmitting the MC media to the associated MC service group, and the latter indicates their deactivation as no MC media is being transmitted. The MC service server may trigger the activation of multicast MBS sessions once the MC service group is established and active, as well as once the MC media is available for transmission. For this purpose, the MC service server sends a multicast MBS session activation request towards the 5GC indicating the MBS session ID to be activated.

Similar to the use of eMBMS, the MC service server shall provide the associated information between a specific group communication and the stream to be used within an MBS session. This information could be sent in advance in an MBS

session announcement or could be provided on demand in an additional signalling message for the MBS session, e.g., MapGroupToSessionStream (similar to the MapGroupToBearer in eMBMS).

### 7.3.3.5.2 Procedure

The procedure in figure 7.3.3.5.2-1 describes how media related to a specific group communication can be distributed over a configured MBS session which consist of multiple QoS flows, i.e. addressing different service requirements. The procedure is applicable for both the pre-created MBS session case as described in clause 7.3.3.1.2 and the dynamic MBS session case as described in clause 7.3.3.1.3. For simplicity, the figure 7.3.3.5.2-1 shows that the MBS session is pre-created prior to the group communication establishment.

Pre-conditions:

- MC service clients 1 to n are attached to the 5GS, registered and affiliated to the same MC service group X.
- The MC service server has decided to use an MBS session for MC service group communications associated to MC service group X.

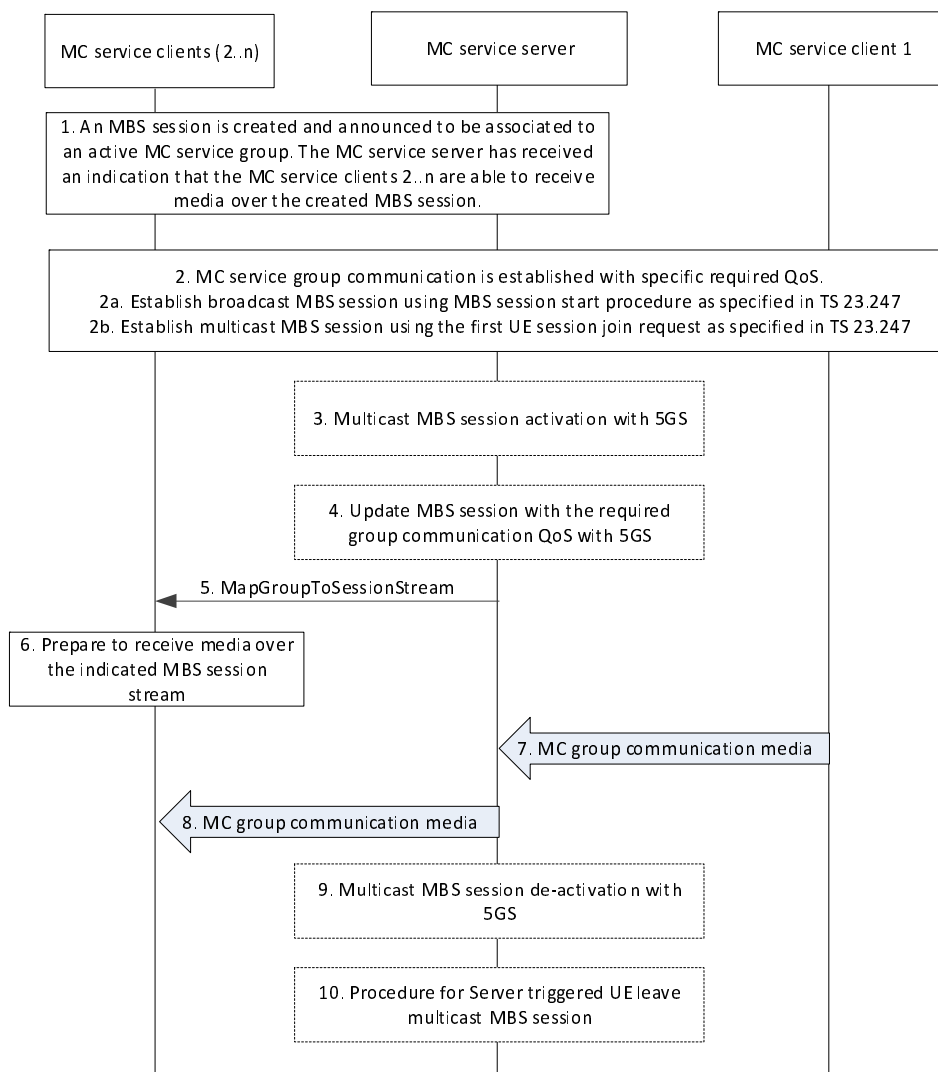

Figure 7.3.3.5.2-1: MC service group media transmission over MBS sessions

1. The MC service server creates a multicast or a broadcast MBS session targeting group communications associated to MC service group X, as being specified in 3GPP TS 23.247 [15]. Therefore, the MC service server can provide default service requirements to be addressed by the MBS session, e.g. associated to MC 5QIs and specific allocation and retention priority (ARP) to transmit the media associated to MC service group communications.

The MBS session is announced and received by MC service client 2 to n. The MC service server has identified that MC service clients 2 to n can receive media over the MBS sessions, e.g. based on a notification from the MC service clients indicating the successful join of the multicast MBS session or a monitoring report of the broadcast MBS session (similar to the listening status report used for eMBMS).

2. A new MC service group communication is established for the MC service group X consisting of a specific required QoS, e.g. an MC service emergency group communication. The group communication setup can be done over unicast.
  - 2a. For broadcast MBS sessions, the session is established upon sending a session start request as part of the MBS session creation procedure, which is described in 3GPP TS 23.247 [15].
  - 2b. For multicast MBS session, the session is established upon the acceptance of the first UE session join request initiated from the MC service UE towards the 5GS, as described in 3GPP TS 23.247 [15]. The multicast session can then have either an active or an inactive state.
  3. The MC service server may send a multicast MBS session activation request towards the 5GC in order to activate the multicast MBS session in case the session has an inactive state. For this purpose, the MC service server indicates the MBS session ID to be activated.
  4. Considering that the established group communication requires a specific QoS, e.g. an MC service emergency group communication which requires higher priority (i.e. better ARP), the MC service server requests an MBS session update to the 5GS to provide the new required QoS, if not done during the MBS session creation in step 1. The MBS session should then be updated and an additional QoS flow may be configured.
  5. The MC service server sends a MapGroupToSessionStream to MC service clients 2 to n over the configured MBS session providing the required stream information to receive the media related to the specific established MC service group communication within the MBS session.
  6. MC service clients process the MapGroupToSessionStream information to receive the related media over the specific MBS session stream.
  7. MC service client 1 sends media to the MC service server over unicast to be distributed for the established group communication.
  8. The MC service server distributes the media to MC service clients 2 to n over the indicated stream within the established MBS session.
- NOTE: The MC service server can stop the unicast delivery (if ongoing) towards the MC service clients considering the UE session join notification or the MBS listening status report.
9. The MC service server may send a multicast MBS session deactivation request towards the 5GC in order to deactivate the multicast MBS session. For this purpose, the MC service server indicates the MBS session ID to be deactivated.
  10. The MC service server may further trigger the UE to leave multicast MBS session.

### 7.3.3.6 Application level control signalling over 5G MBS sessions

#### 7.3.3.6.1 Description

The MC service server may use an 5G MBS session for application level control signalling. An 5G bearer for application level control signalling is typically used for the purposes beyond the benefit for using 5G for resource efficiency, e.g. for improved MC service performance (KPIs), handling of high load scenarios.

Similar to the usage of eMBMS, both broadcast and multicast 5MBS session for application level control signalling may be used to transmit the following messages,

- Transmission control (e.g. call setup and floor control)
- MBS session announcement for media sessions
- Group application paging
- Group dynamic data (e.g. status of the group)

- Group state (e.g. emergency alerts)

Similar to the usage of eMBMS bearer in 3GPP TS 23.280 [3], 5G MBS session for application level control signalling is created in a service area that is larger than the estimated service for media MBS session. The service area for the media sessions is mainly based on counting of group members in each defined service area. The MBS session for application level control signalling is also created with a QoS that is better than MBS media session since the packet loss requirements are much stricter.

The MC service client shall not send responses to group-addressed application level control signalling unless instructed or configured to respond.

### 7.3.3.6.2 Procedure

The procedure in figure 7.3.3.6.2-1 shows only one of the receiving MC service clients using an 5G MBS session.

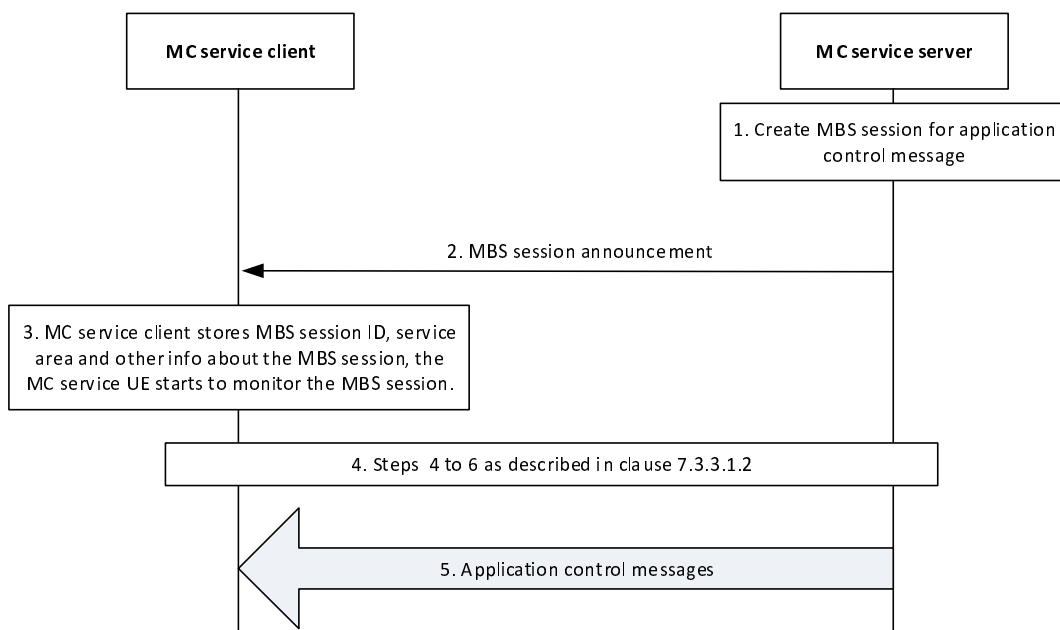

**Figure 7.3.3.6.2-1: Use of 5G MBS for application-level control signalling**

1. The MC service server determines to create MBS session for application-level control signalling, The creation of the 5G MBS session is done according to 3GPP TS 23.247 [15].
2. The MC service server passes the 5G MBS session info for the service description associated with the 5G MBS session to the MC service client. The MC service client obtains the MBS session ID, from the service description.

**NOTE:** For 5G MBS and 4G eMBMS co-existence, the eMBMS bearers activation and MBS session announcement are performed as specified in the procedure for pre-created MBS session and session announcement.

3. The MC service client stores the information associated with the MBS session ID. The MC service client uses the MBS session ID and other 5G MBS session related information to enable monitoring of the 5G MBS session by the MC service UE. In the case of multicast, UE may execute network layer multicast MBS joining as defined in 3GPP TS 23.247 [15].
4. Steps 4 to 6 defined in clause 7.3.3.1.2 are performed.
5. The MC service server transmits MC application control messages over the MBS session.



### 7.3.3.7 Multi-server MBS session coordination

#### 7.3.3.7.1 General

The motivation and principle of supporting Multi-server MBS session coordination is exactly similar to Multi-server eMBMS bearer coordination as described in 3GPP TS 23.280 [3].

NOTE: The procedures in clause 7.3.3.7.2 are only used when MBS session sharing between multiple MC service servers is required. It is implementation specific whether MBS session is shared amongst multiple MC service servers.

#### 7.3.3.7.2 Procedures

##### 7.3.3.7.2.1 MBS Session coordination independent of media

The procedure in this sub clause applies to both multicast and broadcast MBS session. The principle and pre-condition is similar with eMBMS bearer coordination as defined in 3GPP TS 23.280 [3].

This procedure is used when two or more MC service servers are serving users in the same area and are configured to share 5G MBS sessions for that specific area. The MC service servers may be of the same kind or different kind. The MC service servers are not participating in the same group call, which means that each MC service server transmit media independently of each other.

Pre-conditions:

- All MC service servers are configured with the contact information of those MC service servers that are configured to take the MBS session control role.

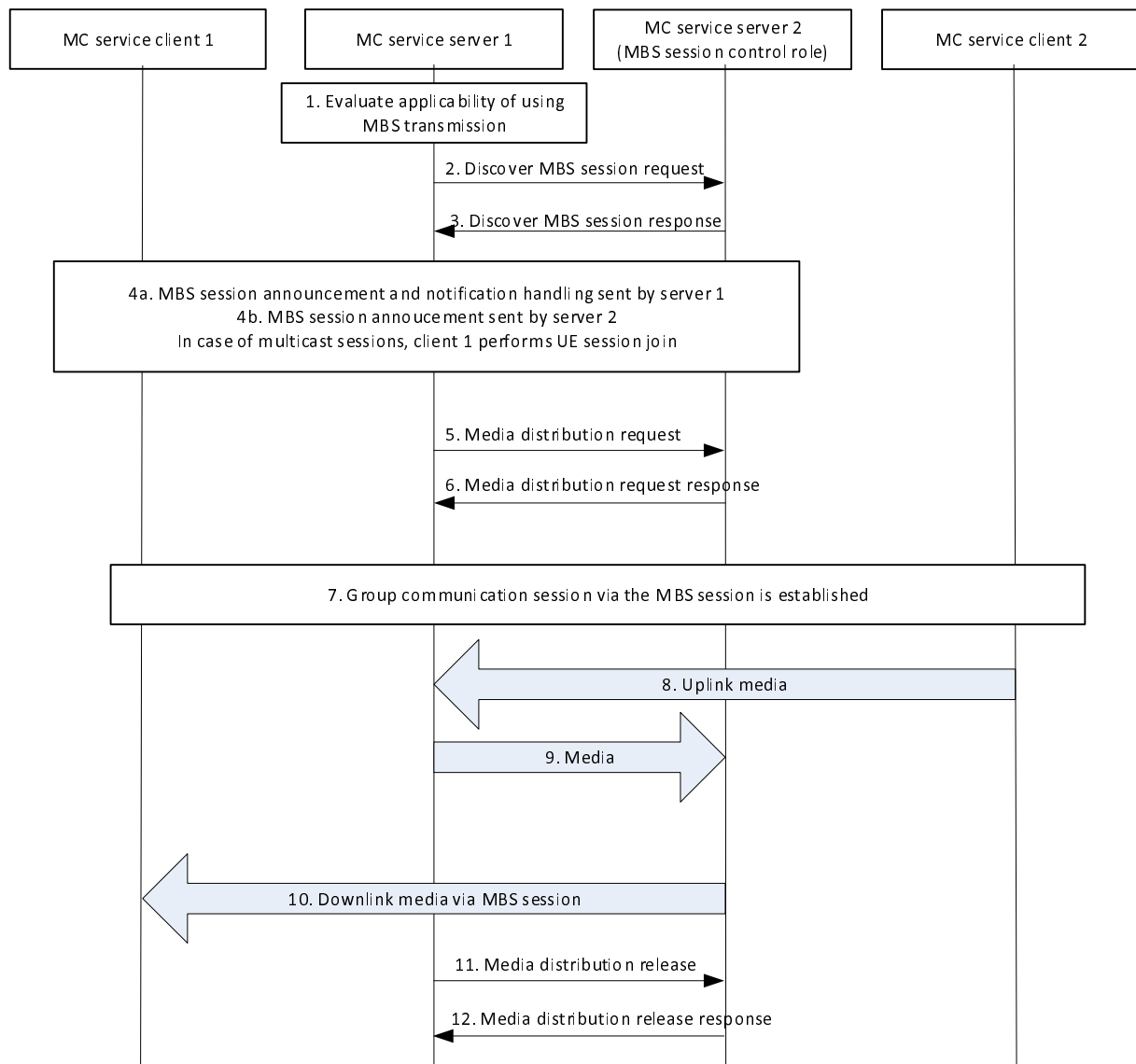

**Figure 7.3.3.7.2.1-1: Multiple server MBS procedure independent of media.**

1. The MC service server 1 evaluates whether MBS transmission is desired for each service area in which MC service group members are located, based upon the locations, affiliation status and other factors.
2. The MC service server 1 determines whether another MC service server has already established an MBS session with coverage for the MBS service area where MBS transmissions are desired. To do this, the MC service server 1 consults a pre-configured list of MC service servers and sends them a discover MBS session request. This request may be sent to several MC service servers.

**NOTE:** MC service servers of the same type can be configured to discover MBS sessions from a single server. The single server then becomes a centralized entity for MBS session control for the MC service. Similarly, all MC service servers of all types can be configured to discover MBS sessions from a single server. The single server then becomes a centralized MBS session controller for all MC services.

3. The MC service server 2 (MBS session control role) responds with a discover MBS session response indicating whether there is an MBS session available in the specific MBS service area with the requested bandwidth. The discover MBS session response message includes the MBS session ID of the MBS session that is shared between the MC service servers. If the MBS session of interest has insufficient bandwidth, the polling MC service server 1 may resort to unicast, or may allocate another MBS session for the congested area. If a duplicate MBS session is allocated for the same area, the MBS session should not be shared with other servers and may be torn down as soon as the congestion on the original MBS session clears up, in order to conserve resources.

For any MBS service areas not covered by another MC service server, the MC service server 1 prepares to distribute media to those MBS service areas by setting up an MBS session. The MBS session set up by the MC service server 1 may then become available for other MC service servers (controlling role) for other MC service groups.

4. 4a. The MC service server 1 performs the MBS session announcement towards MC client 1, as well as MBS notification handling, according to the relevant procedures specified in this specification. In case of multicast MBS sessions, the MC service UE subsequently initiates a UE session join towards 5GC, and may send a UE session join notification to MC service server 1 indicating it has successfully joined the multicast MBS session under consideration.  
  
4.b If the MC service server 2 is authorized to receive MBS related location information from the users utilizing the services from MC service server 1, the MC service server 2 may optionally do the MBS session announcement and handling of the notifications on behalf of MC service server 1. The notifications shall in this case be sent to both MC service server 1 and MC service server 2. In case of multicast MBS sessions, the MC service UE subsequently initiates a UE session join towards 5GC, and may send a UE session join notification to MC service server 2.
5. The MC service server 1 sends a media distribution request to the MC service server 2 (MBS session control role). The media distribution request is sent to reserve the specified capacity in the MBS session.
6. MC service server 2 (MBS session control role) sends a media distribution response to the MC service server 1 indicating whether the request can be supported and supplies details about the MBS session.
7. The MC service server 1 establishes a group communication session via the MBS session, informing MBS session connected MC service clients 1 and 2 that a group communication session is about to start on the MBS session. This step is equivalent to MapGroupToSessionStream.
8. MC service client 2 sends media on the uplink to the MC service server 1.
9. The MC service server 1 forwards the media to MC service server 2 (MBS session control role).
10. The MC service server 2 (MBS session control role) distributes the media to MC service client 1 with MBS capabilities over the MBS session.
11. The MC service server 1 sends a media distribution release request, informing the MC service server 2 (MBS session control role) to request the MC service server 2 (MBS session control role) to release the capacity that was reserved in step 5.
12. The MC service server 2 (MBS session control role) responds to the request by sending a media distribution release response.

#### 7.3.3.7.2.2 MBS session coordination within one group call

The procedure in this subclause applies to both multicast MBS session and broadcast MBS session.

The principle is similar to eMBMS bearer coordination within one group call as the following:

- It may be used when two MC service servers are serving users in the same area and are configured to share MBS sessions for that specific area. The MC service servers are of the same kind, and the MC service servers may participate in the same group call, and by that have a need to deliver the same content.

Pre-conditions:

- All MC service servers are configured with the contact information of those MC service servers that are configured to take the MBS session control role.

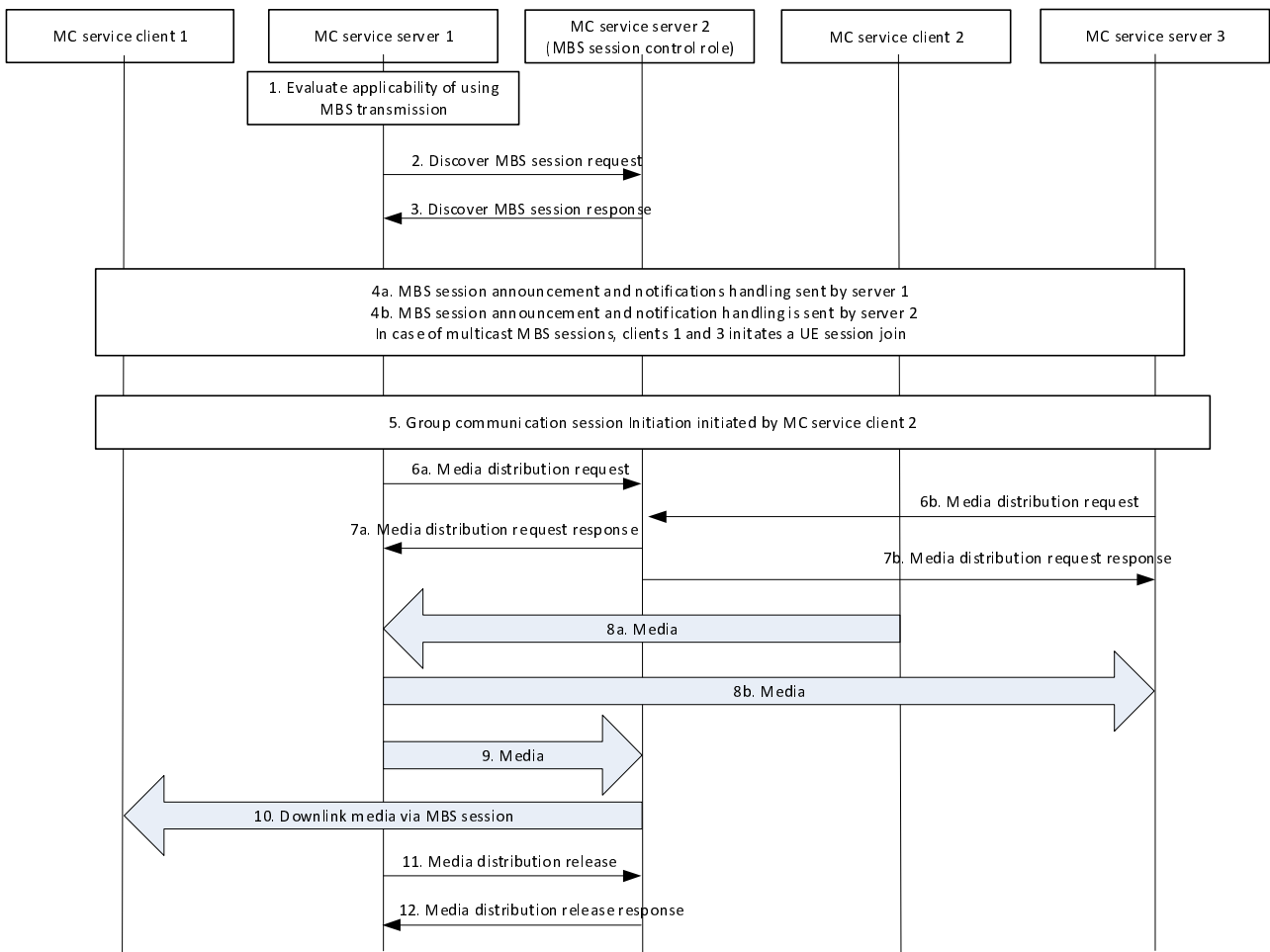

**Figure 7.3.3.7.2-1: Multiple server MBS procedure within one group call**

1. The MC service server 1 evaluates whether MBS based transmission is desired for each service area in which MC service group members are located, based upon the locations, affiliation status and other factors.
2. The MC service server 1 determines whether another MC service server has already established an MBS session with coverage for the MBS service area where MBS based transmission is desired. To do this, the MC service server 1 consults a pre-configured list of MC service servers and sends them a discover MBS session request. This request may be sent to several MC service servers.

NOTE 1: MC service servers of the same type can be configured to discover MBS sessions from a single server. The single server then becomes a centralized entity for MBS session control for the MC service. Similarly, all MC service servers of all types can be configured to discover MBS sessions from a single server. The single server then becomes a centralized MBS session controller for all MC services.

3. The MC service server 2 (MBS session control role) responds with a discover MBS session response indicating whether there is an MBS session available in the specific MBS service area with the requested bandwidth. The discover MBS session response message includes the ID of the MBS session that is shared between the MC service servers. If the MBS session of interest has insufficient bandwidth, the polling MC service server 1 may resort to unicast, or may allocate another MBS session for the congested area. If a duplicate MBS session is allocated for the same area, the MBS session should not be shared with other servers and may be torn down as soon as the congestion on the original MBS session clears up, in order to conserve resources.

For any MBS service areas not covered by another MC service server, the MC service server 1 prepares to distribute media to those MBS service areas by setting up a MBS session. The MBS session created by the MC service server 1 may then become available for other MC service servers (controlling role) for other MC service groups.

- 4a. The MC service server 1 performs the MBS session announcement as well as the MBS listening reporting according to the relevant procedures specified in this specification. In case of multicast MBS sessions, the MC

service UE(s) subsequently initiate a UE session join towards 5GC, and may send a UE session join notification to MC service server 1 indicating it has successfully joined the multicast MBS session under consideration.

- 4b. If the MC service server 2 is authorized to receive MBS related location information from the users utilizing the services from MC service server 1, the MC service server 2 may optionally do the MBS session announcement and handling the listening reports on behalf of MC service server 1. Listening reports shall in this case be sent to both MC service server 1 and MC service server 2. In case of multicast MBS sessions, the MC service UE(s) subsequently initiate a UE session join towards 5GC, and may send a UE session join notification to MC service server 2.

NOTE 2: Steps 1-4 are also performed by MC service server 3, but is not shown in the procedure to make it easier to read.

5. The MC service client 2 initiates a group call that is subject for MBS transmission. In this scenario there are more than one MC service server (i.e., MC service server 1 and MC service server 3) that serve MC service clients that are affiliated to the group, and by that should receive the media in the group call.
  - 6a. The MC service server 1 sends a media distribution request to the MC service server 2 (MBS session control role). The media distribution request includes the MC group identifier. This indicates that the media distribution request is used for this specific group call.
  - 6b. The MC service server 3 sends a media distribution request to the MC service server 2 (MBS session control role). The media distribution request includes the MC group identifier. This indicates that the media distribution request is used for this specific group call.
  - 7a. The MC service server 2 (MBS session control role) sends a media distribution response to the MC service server 1 indicating whether the request can be supported and supplies details about the MBS session. This also includes details on which media stream should be used for transmitting the media on the MBS session. This information is used in the MapGroupToSessionStream message sent by the MC service server when setting up the group call.
  - 7b. The MC service server 2 (MBS session control role) sends a media distribution response to the MC service server 3 indicating that the group call is already transmitted on the MBS session by another MC service server. Based on the information, the MC service server 3 could decide to not transmit media if media is already transmitted.
  - 8a. The media is sent from the MC service client 2 to MC service server 1, which is the participating server for the MC service group of the group call.
  - 8b. The media is forwarded to all MC service servers that are serving users that take part in the group call.
- NOTE 3: The figure above does not visualize the participating server for the MC service group and controlling server for the MC service group. The media is sent to all participating servers for the MC service group which are the servers that decide on unicast or MBS transmission.
9. The MC service server 1 forwards the media to MC service server 2 (MBS session control role).
  10. The MC service server 2 (MBS session control role) distributes the media to MC service client 1 with MBS capabilities via MBS session.
  11. The MC service server 1 sends a media distribution release request, to request the MC service server 2 (MBS session control role) to release the capacity that was reserved in step 5. The media distribution release request shall only be sent when the group call is terminated.
  12. The MC service server 2 (MBS session control role) responds to the request by sending a media distribution release response.

### 7.3.3.8 Service continuity between 5G MBS delivery and unicast delivery

#### 7.3.3.8.1 General

This clause addresses the issue of MC service media delivery over MBS session, specifically, to maintain the service continuity when switching between 5G MBS delivery and unicast delivery.

### 7.3.3.8.2 Service continuity for broadcast MBS session

#### 7.3.3.8.2.1 General

The MC service client reports the broadcast reception quality to the MC service server which is used to make the decision whether to use the unicast delivery to the MC service UE(s) which are suffering bad broadcast reception quality due to e.g., move out of the broadcast service area.

An MC service client monitors the broadcast MBS session to receive MC service media. Based on the received quality (e.g., radio level quality, RTP packet loss), the MC service client needs to inform the MC service server that the MC service client is able to receive the MC service media on the broadcast MBS session with sufficient quality or not.

This estimation of the broadcast reception quality may be dependent on, for example, the modulation and coding scheme (MCS) and measurements from the reference signals from the NG-RAN node(s), RTP packet loss, BLER of the received media.

#### 7.3.3.8.2.2 Procedures

##### 7.3.3.8.2.2.1 Service continuity from broadcast to unicast

The procedure in figure 7.3.3.8.2.2.1-1 illustrates the UE which is receiving media via broadcast MBS session is switched to unicast delivery because the UE suffers from bad broadcast reception quality due to e.g., moving out of the broadcast service area. It shows only one of the receiving MC service clients receiving the broadcast MBS session.

Pre-conditions:

1. The MC group communication is ongoing and the MC service media (e.g., DL media, application layer control signalling) is transmitted via broadcast MBS session.
2. The MC service client is receiving the MC service media (e.g., DL media, application layer control signalling) via the broadcast MBS session.
3. The MC service client(s) already have the associated information (e.g., SDP) to receive the unicast delivery during the group communication establishment phase.

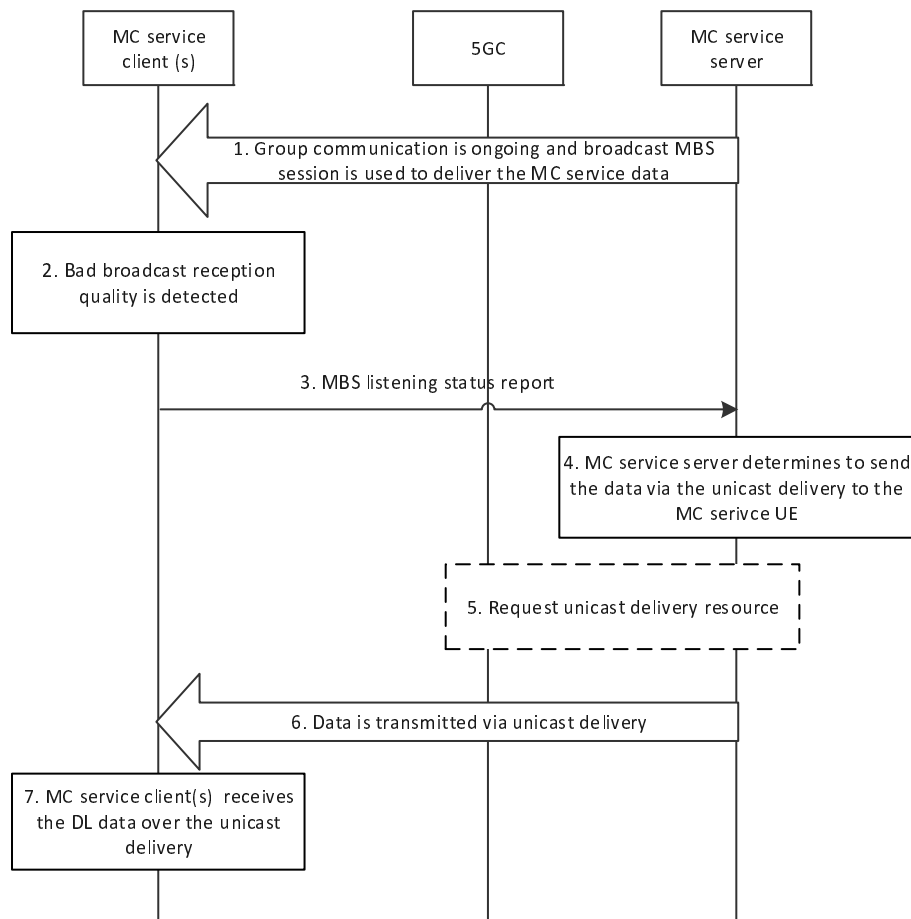

**Figure 7.3.3.8.2.2.1-1: Service continuity from broadcast to unicast**

1. An MC service group communication session is ongoing and the DL media is transmitted over broadcast MBS session.
2. The MC service client detects that it suffers bad broadcast reception due to e.g., moving out of the broadcast service area of the announced MBS session ID (i.e., TMGI). The MC service client may determine the broadcast reception quality by using the BLER of the received media. When no media is received, the quality estimation can consider the reference signals and the modulation and coding scheme (MCS).
3. The MC service client sends MBS listening status report which indicates the broadcast reception quality associated with the MBS session ID is not sufficient to receive media. The MC service client may also map the determined broadcast reception quality to a broadcast reception quality level. The broadcast reception quality level indicates at which specific broadcast reception quality level the MC service media has been received.

NOTE 1: It is implementation that the broadcast reception quality level can be determined per MBS session, per media stream or per MBS QoS flow level via e.g., measurements of radio level signalling such as the reference signals from the NG-RAN node(s), packet loss.

NOTE 2: The set of MBS reception quality levels and the mapping of the determined broadcast reception quality to those levels are implementation.

NOTE 3: The frequency of MC service UE sending listening reports can be limited to prevent signalling congestion. E.g., the MC service UE can stop monitoring the broadcast reception quality and send the MBS listening status report only once when it moves outside of the broadcast service area.

4. The MC service server based on the report from the participant, determines that the UE is not able to receive the media or the QoS requirements is not satisfied. The MC service server determines to send the MC service media (e.g., DL media, application layer control signalling) via the unicast delivery to the reported MC service client.
5. If the unicast QoS flow is not satisfied, the MC service server interacts with the 5GC to update the QoS requirements.

6. The MC service server sends the MC service media via the unicast delivery towards the MC service client which suffers bad broadcast reception quality.
7. The MC service client then receives the DL MC service via both broadcast MBS session and unicast delivery.

7.3.3.8.2.2.2 Service continuity from unicast to broadcast

The procedure in figure 7.3.3.8.2.2.2-1 illustrates the UE receiving media via unicast delivery being switched to broadcast MBS session as the UE enters the broadcast service area where the NG-RAN is broadcasting the MC service media of the ongoing group communication. The MC service client now is able to receive the broadcast media. Only one of the receiving MC service clients receiving the broadcast MBS session is shown.

Pre-conditions:

1. The MC group communication is ongoing and the MC service media (e.g., DL media, application layer control signalling) is transmitted via broadcast MBS session in the broadcast service areas.
2. The MC service client is receiving the MC service media (e.g., DL media, application layer control signalling) via the unicast delivery.
3. The MC service client has already received the broadcast MBS session announcement, MapGroupToSessionStream information and enters the broadcast service area.

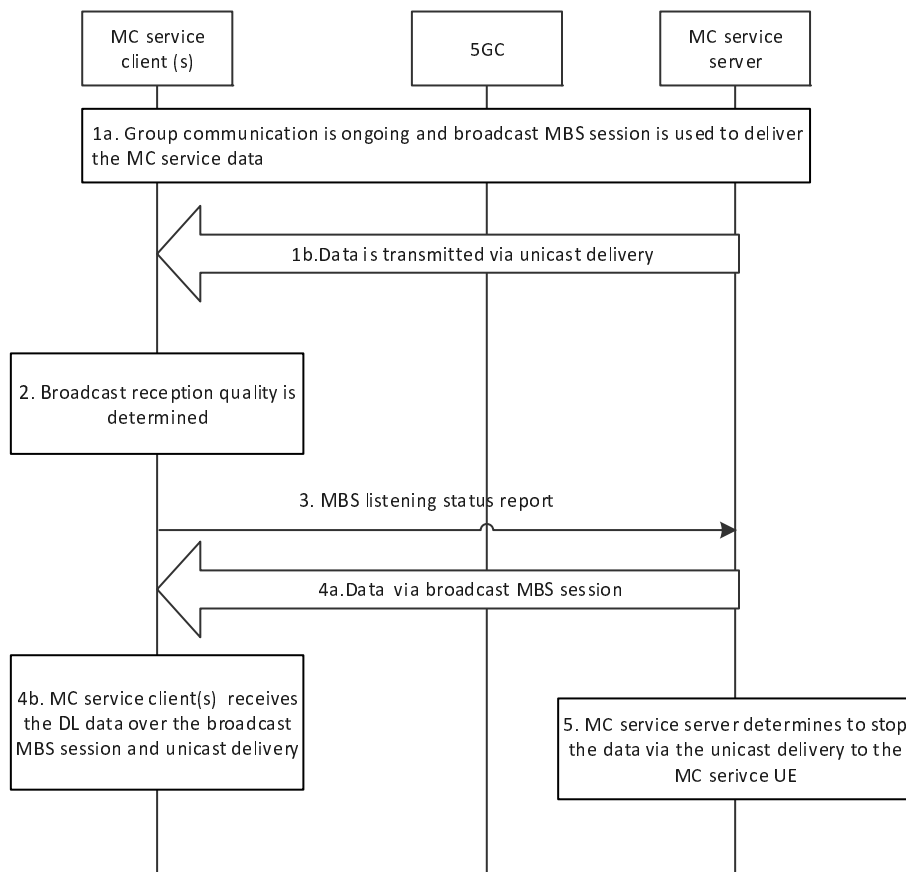

Figure 7.3.3.8.2.2.2-1: Service continuity from unicast to broadcast.

1. An MC service group communication session is ongoing and the broadcast MBS session is used to deliver the MC service media of the group communication. The MC service client is receiving the MC service media via the unicast delivery.
2. The MC service client detects that it is able to receive the broadcast media due to e.g., moving into the broadcast service area of the announced MBS session ID. The MC service client may determine the broadcast reception quality by using the BLER of the received media. When no media is received, the quality estimation can consider the reference signals and the modulation and coding scheme (MCS).



3. The MC service client sends MBS listening status report which indicates the broadcast reception quality associated with the MBS session ID is sufficient to receive media. The MC service client may also map the determined broadcast reception quality to a broadcast reception quality level. The broadcast reception quality level indicates at which specific broadcast reception quality level the MC service media has been received.

NOTE 1: The set of MBS reception quality levels and the mapping of the determined broadcast reception quality to those levels are implementation.

NOTE 2: It is implementation that the broadcast reception quality level can be determined per MBS session, per media stream or per MBS QoS flow level via e.g., measurements of radio level signals, such as the reference signals from the NG-RAN node(s), or packet loss.

4. Based on the MapGroupToSessionStream received before, the MC service client receives the DL MC service via both the broadcast MBS session and the unicast delivery.

NOTE 3: If any information about the broadcast MBS session stream has changed, the MC service server provides the MapGroupToSessionStream again.

5. The MC service server, based on the report from the participant, determines to stop sending the MC service media (e.g., DL media, application layer control signalling) via the unicast delivery to the reporting MC service client. After then, the MC service client receives the MC service media only via the broadcast MBS session.

### 7.3.3.8.3 Service continuity for multicast MBS session

#### 7.3.3.8.3.1 General

The MC service server may also switch between multicast and unicast by utilizing application layer mechanisms similar to switching between broadcast and unicast as specified in clause 7.3.3.8.2. If indicated in the MBS session announcement information, the MC service client reports the monitoring state (i.e., the reception quality of the MBS session) back to the MC service server.

NOTE: Once the MC service UE has successfully joined the multicast MBS session and started to receive the MC service media via the multicast MBS session, then the network mechanism specified in TS 23.247 [15] will deliver the media from the MC service server via the 5GC Individual MBS traffic delivery method or the 5GC Shared MBS traffic delivery method towards the MC service UE(s). The usage of 5GC Individual MBS traffic delivery method or the 5GC Shared MBS traffic delivery method is transparent to the MC service server.

### 7.3.3.8.4 Path switch between MBS session and 5G ProSe UE-to-network relay

#### 7.3.3.8.4.1 General

The MC service communications over 5G ProSe UE-to-network relay is supported for unicast delivery.

NOTE: In this release of the specification, service continuity is supported for unicast PDU session over 5G ProSe UE-to-network relay, however it is not yet supported for multicast/broadcast MBS sessions for MC service communications.

The path switch procedures for MC service communications between MBS session and 5G ProSe UE-to-network relay is specified in this clause.

The architecture of MC service utilizing IMS service continuity is specified in Annex B.

#### 7.3.3.8.4.2 Path switch procedure from MBS session to a 5G ProSe UE-to-network relay

This clause describes the procedures for path switch from MBS session to a 5G ProSe UE-to-network relay.

Figure 7.3.3.8.4.2-1 illustrates the path switch procedure from MBS session to a 5G ProSe UE-to-network relay.

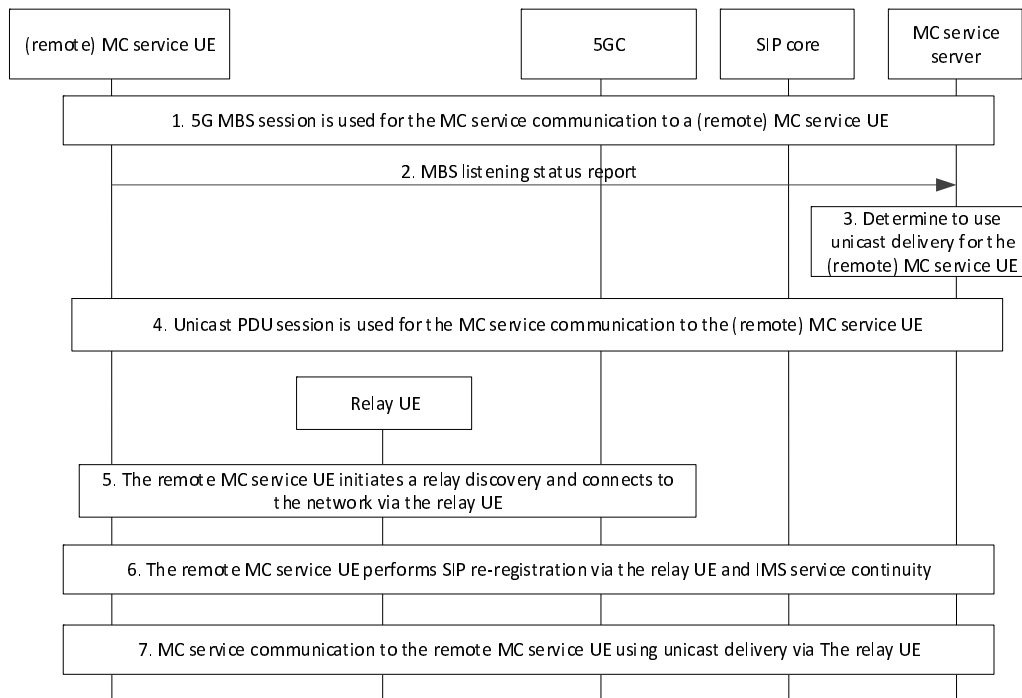

**Figure 7.3.3.8.4.2-1: Path switch from MBS session to a 5G ProSe UE-to-network relay.**

1. The DL media is transmitted over an MBS session to a (remote) MC service client.
2. The MC service client sends an MBS listening status report indicating that the MBS reception quality associated with the MBS session ID is not sufficient to receive media. The MC service client may also map the determined MBS reception quality to an MBS reception quality level. The MBS reception quality level indicates at which specific MBS reception quality level the MC service media has been received.
3. The MC service server based on the report from the MC service client determines that the (remote) MC service UE is unable to receive the media or the QoS requirements are not satisfied. The MC service server determines to send the MC service communications (e.g., DL media, application layer control signalling) via the unicast delivery to the reported MC service client.

4. The MC service server sends the DL media to the (remote) MC service UE over a unicast PDU session.

NOTE 1: Steps 2 to 4 may occur after step 6 if the MBS listening status report towards the MC service server has failed due to connection lost.

5. The remote MC service UE discovers and utilizes a 5G ProSe UE-to-network relay UE in its proximity once it has detected being out of the network coverage. This step applies to both 5G ProSe Layer-3 and Layer-2 UE-to-network relay.

NOTE 2: An NG-RAN based measurement report triggers the remote MC service UE to perform a 5G ProSe UE-to-Network relay discovery over PC5, as indicated in 3GPP TS 38.331 [19]. The remote MC service UE establishes a secure point-to-point link with the relay UE in its proximity over PC5. As part of this process the remote MC service UE is mutually authenticated at PC5 layer with either the relay or with the network as specified in 3GPP TS 23.304 [17].

6. For the case of 5G ProSe Layer-3 UE-to-network relay without the support of N3IWF, as described in 3GPP TS 23.304 [17], the remote MC service client performs SIP re-registration over the relay UE due to the change in IP address of the remote MC service UE and initiates IMS service continuity procedures as described in Annex B.

NOTE 3: For the case of 5G ProSe Layer-3 UE-to-Network relay with the support of N3IWF, the relay UE performs registration and authentication procedures towards the 5GC to support the remote MC service UE with an end-to-end confidentiality and IP address reservation requirements, as described in 3GPP TS 23.304 [17].

NOTE 4: For the case of 5G ProSe Layer-2 UE-to-network relay, the 5GC can provide the service continuity for the remote MC service UE with the UE's original IP address, as described in 3GPP TS 23.304 [17].

- The MC service server sends the MC service communications using the unicast delivery via the 5G ProSe MC service UE-to-Network relay UE towards the remote MC service client. The MC service client then receives the DL MC service communication via the relay UE.

#### 7.3.3.8.4.3 Path switch from a 5G ProSe UE-to-network relay to MBS session

This clause describes the procedure for path switch from a 5G ProSe UE-to-network relay to MBS session.

Figure 7.3.3.8.4.3-1 illustrates path switch from a 5G ProSe UE-to-network relay to MBS session.

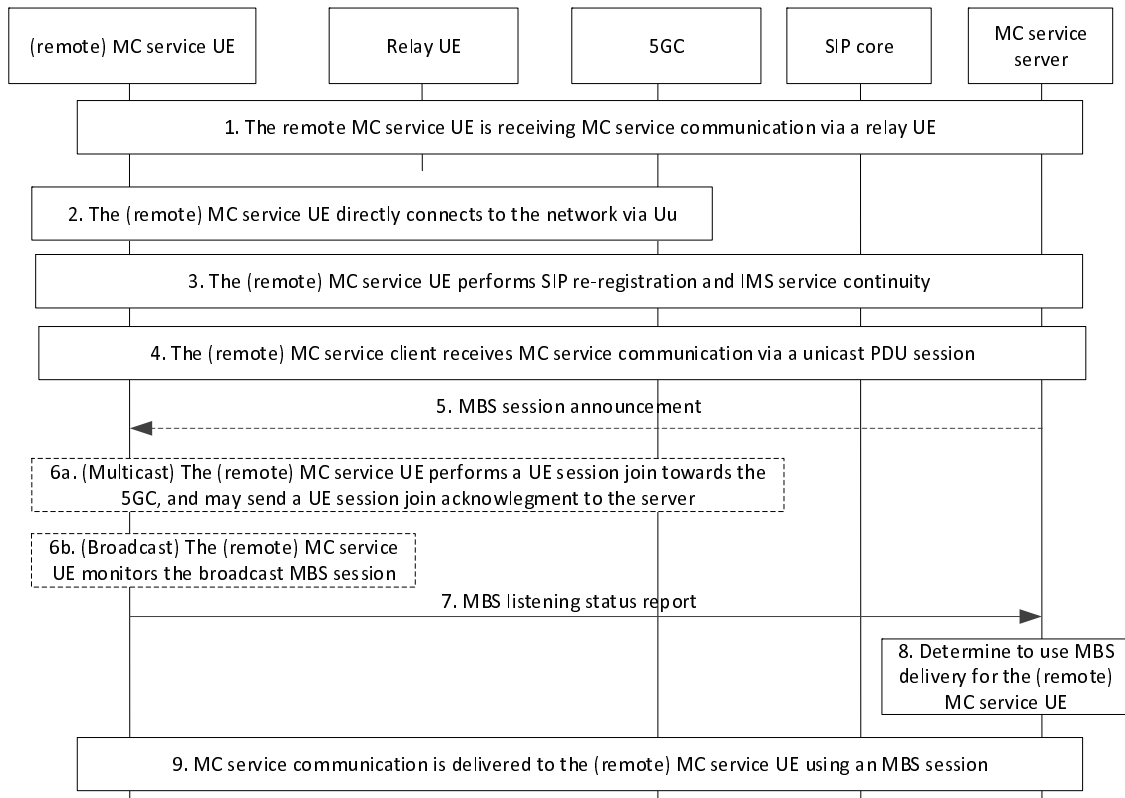

**Figure 7.3.3.8.4.3-1 Path switch from a 5G ProSe UE-to-network relay to MBS session.**

- The remote MC service client is receiving the MC service media using the unicast delivery via a 5G ProSe UE-to-Network relay UE. This step applies to both 5G ProSe Layer 3 and Layer 2 UE-to-network relay.
- Based on the (remote) MC service UE's path selection policies described in 3GPP TS 23.304 [17], and once the NG-RAN based measurement report discussed in 3GPP TS 38.331 [19] is triggered due to network coverage detection, the (remote) MC service UE connects to the network via the Uu-interface.

NOTE 1: The path selection policies may be pre-configured in the MC service UE or provided by the PCF, as defined in 3GPP TS 23.304 [17].

- For the case of 5G ProSe Layer-3 UE-to-network relay without the support of N3IWF, the (remote) MC service client performs SIP re-registration over Uu and initiates the IMS service continuity procedures as described in Annex B. Further, the MC service server sends MC service communications using unicast delivery which traverses over Uu to the remote MC service client.

NOTE 2: For the case of 5G ProSe Layer-3 UE-to-network relay via the support of N3IWF, the (remote) MC service UE performs registration procedures towards the 5GS to establish the necessary resources over the Uu-interface.

NOTE 3: For the case of 5G ProSe Layer-2 UE-to-network relay, the 5GC can provide the service continuity for the (remote) MC service UE with the UE's original IP address, as described in 3GPP TS 23.304 [17].

4. The MC service client receives the MC service communication over a unicast PDU session.
5. Optionally, the MC service server may send the MBS session announcement to the (remote) MC service client with the information of the MBS session.

NOTE 4: The information of the MBS session can be available at the (remote) MC service client due to a previous MC service signalling via the relay UE.

- 6a. If a multicast MBS session has been announced, the MC service UE performs a UE session join towards the 5GC using the MBS session information, and the MC service client may send a UE session join notification towards the server.
- 6b. If a broadcast MBS session has been announced, the MC service client start monitoring the reception quality of the broadcast MBS session.
7. The MC service client sends an MBS listening status report which indicates the MBS reception quality associated with the MBS session ID is sufficient to receive media.

NOTE 4: It is implementation specific whether the MBS session reception quality level is determined per MBS session, per media stream or per MBS QoS flow level via e.g., measurements of radio level signalling such as the reference signals from the NG-RAN node(s), packet loss.

8. Based on the report received from MC service client in step 7, the MC service server determines to stop sending the MC service communications (e.g., DL media, application layer control signalling) using the unicast delivery. Further, the MC server sends the MC service communications via the MBS session.
9. The MC service client receives the MC service communications from the MC service server via the MBS session.

### 7.3.3.9 MC service inter-system switching between 5G and LTE

#### 7.3.3.9.1 General

When working in transport only mode, the MC service server guides the MC service clients throughout the MC media transmission for switching between the LTE and 5G systems. For this purpose, the location management client sends location related information to the location management server, similar to the one defined in 3GPP TS 23.280 [3], which is triggered due to its location change – in this case due to Radio Access Technology (RAT) change, to inform the server hence the latter provides guidance related to how to receive the MC services after the location update.

The procedures cover both the deployment scenarios with/without MBSF/MBSTF. The procedures specify four inter-system switching related scenarios as follows:

1. Inter-system switching from 5G MBS session to LTE eMBMS bearer, as in 7.3.3.9.2
2. Inter-system switching from 5G MBS session to LTE unicast bearer, as in 7.3.3.9.3
3. Inter-system switching from LTE eMBMS to 5G MBS session, as in 7.3.3.9.4
4. Inter-system switching from LTE eMBMS to 5G unicast PDU session, as in 7.3.3.9.5

In all the inter-system switching related scenario described in 7.3.3.9.2, 7.3.3.9.3, 7.3.3.9.4 and 7.3.3.9.5, the functional entity that resides in 5GS may be NEF, or MBSF, or MB-SMF for session creation and together with PCF or PCC related interaction.

NOTE: There will be a service interrupt when the MC service server performs path switch between 5G and LTE bearers or sessions.

#### 7.3.3.9.2 Inter-system switching from 5G MBS session to LTE eMBMS bearer

The procedure provided in figure 7.3.3.9.2-1 describes how the MC service server handles inter-system switching when the MC service UE switches from 5G to LTE network, where the MC service server is able to provide the MC services to the clients over eMBMS bearer(s).

Pre-conditions:

- MC service clients are attached to the 5GS, registered and affiliated to the same MC service group X.
- The MC services can be provided via both 5GS and EPS.
- The MC service client(s) is within the eMBMS service area.
- It is assumed that the MC service client(s) has not received the eMBMS bearer announcement while camping in 5GS.

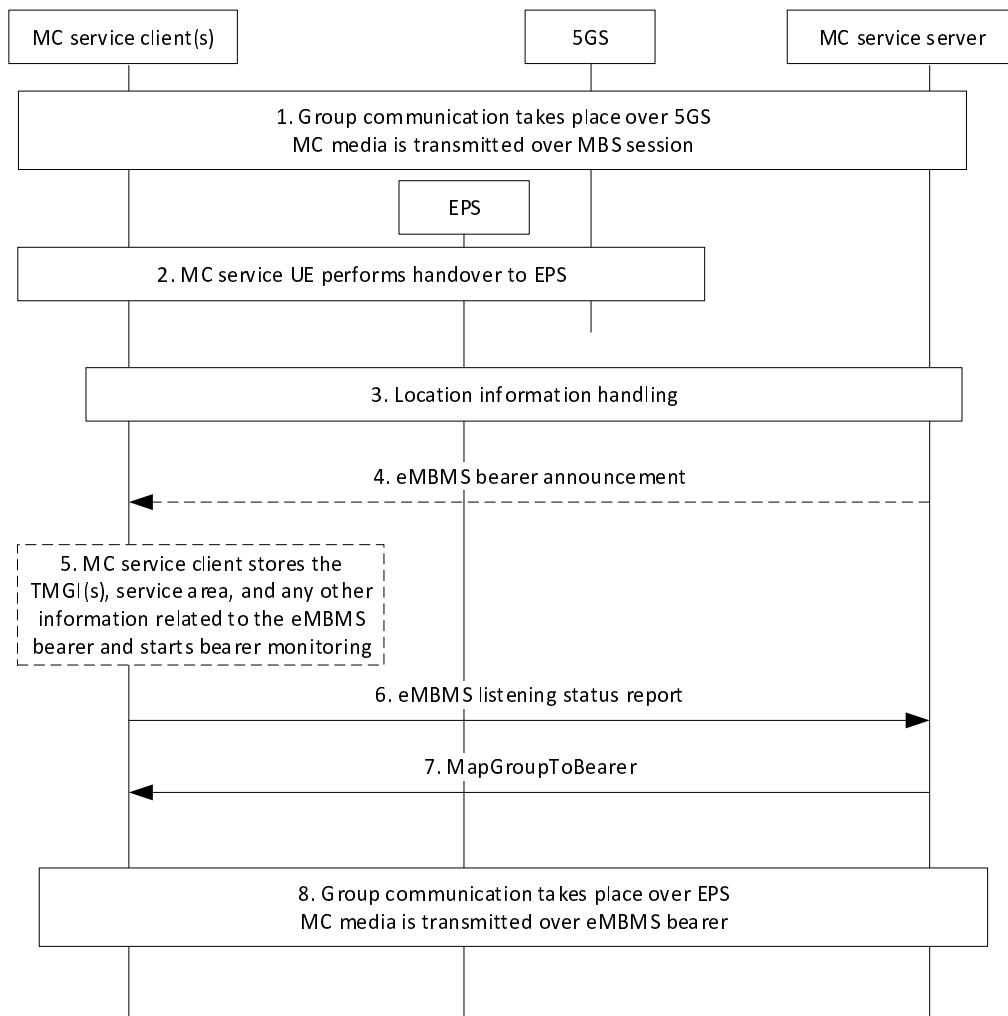

**Figure 7.3.3.9.2-1: Inter-system switching from 5G MBS session to LTE eMBMS bearer.**

1. An MC service group communication takes place, and the MC media is delivered over 5G MBS session (either broadcast or multicast session mode), which is associated to the MC service group X.
2. The MC service UE performs handover to EPS.
3. Location information handling can be based on location reports provided by the MC service client, where the MC service UE's location information is provided via the location management client, triggered by RAT change, to the location management server, where the latter provides the location information to the MC service server.

Also, location information handling can be based on notifications provided from the network to the MC service server related to 5GS supporting EPS interworking, as specified in 3GPP TS 23.501 [7], 3GPP TS 23.502 [10], and 3GPP TS 23.503 [9] and described in clause 7.4.3. For that, the MC service server can subscribe to receive

notifications of specific events from the network. For instance, the MC service server can subscribe to PCF related notifications (via N5 or Rx) for specific events, e.g., access network information notification and change of access type. Also, when SCEF+NEF is deployed, the MC service server can subscribe to SCEF+NEF related notifications for specific events, e.g., core network (CN) type change.

4. The MC service server analyses the location information and decides how to serve the client. If the MC service server decides to serve the client via eMBMS bearer, it may send an eMBMS bearer announcement as described in 3GPP TS 23.280 [3]. This step is optional as the bearer announcement related information could be sent in advance (implementation specific).
5. If not already available, the MC service client stores the announced TMGI(s), service area, and any relevant information to the eMBMS, which is delivered via the bearer announcement. As a result, the MC service client starts monitoring the bearer.
6. The MC service client sends an eMBMS listening status report to inform the server of its ability of receiving MC media over the specified bearer.
7. The MC server sends the necessary information related to receiving the MC media in the form of the MapGroupToBearer.
8. The MC service group communication takes place over EPS, and the MC media is transmitted over an eMBMS bearer.

#### 7.3.3.9.3 Inter-system switching from 5G MBS session to LTE unicast bearer

The procedure provided in figure 7.3.3.9.3-1 describes how the MC service server handles inter-system switching when the MC service UE switches from 5G to LTE network, where the MC service server is unable to provide the MC services to the client over eMBMS bearer.

Pre-conditions:

- MC service clients are attached to the 5GS, registered and affiliated to the same MC service group X.
- The MC services can be provided via both 5GS and EPS.

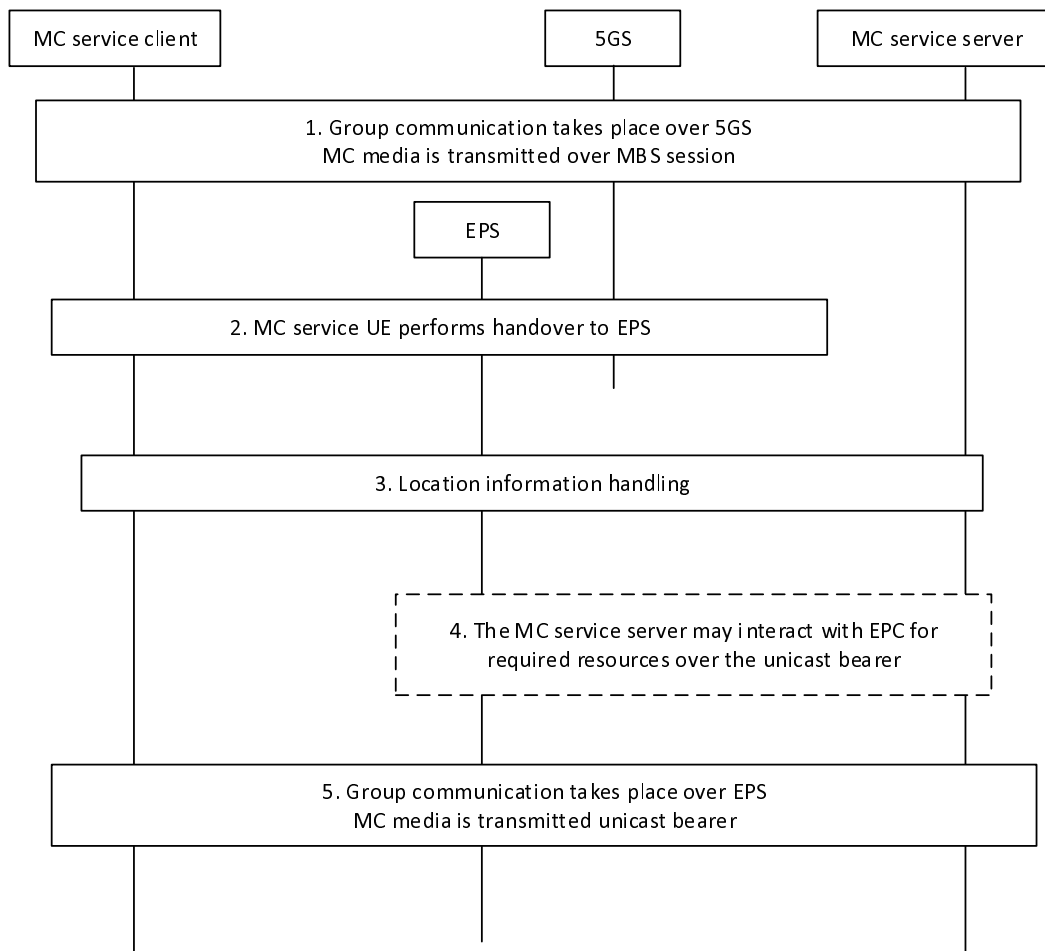

**Figure 7.3.3.9.3-1: Inter-system switching from 5G MBS session to LTE unicast bearer.**

1. An MC service group communication takes place, and the MC media is delivered over 5G MBS session (either broadcast or multicast session mode), which is associated to the MC service group X.
2. The MC service UE performs handover to EPS.
3. Location information handling can be based on location reports provided by the MC service client, where the MC service UE's location information is provided via the location management client, triggered by RAT change, to the location management server, where the latter provides the location information to the MC service server.

Also, location information handling can be based on notifications provided from the network to the MC service server related to 5GS supporting EPS interworking, as specified in 3GPP TS 23.501 [7], 3GPP TS 23.502 [10], and 3GPP TS 23.503 [9] and described in clause 7.4.3. For that, the MC service server can subscribe to receive notifications of specific events from the network. For instance, the MC service server can subscribe to PCF related notifications (via N5 or Rx) for specific events, e.g. access network information notification and change of access type. Also, when SCEF+NEF is deployed, the MC service server can subscribe to SCEF+NEF related notifications for specific events, e.g. core network (CN) type change.

4. The MC service server may interact with the EPC for providing the required media resources over the unicast bearer, if not already allocated.
5. The MC service group communication takes place over EPS, and the MC media is transmitted over a unicast bearer.

7.3.3.9.4 Inter-system switching from LTE eMBMS to 5G MBS session

The procedure provided in figure 7.3.3.9.4-1 describes how the MC service server handles inter-system switching when the MC service UE switches from LTE network to 5G, where the MC service server is able to provide the MC services to the client over 5G MBS sessions (either broadcast or multicast).

Pre-conditions:

- MC service clients are attached to the EPC and affiliated to the same MC service group X.
- The MC services can be provided via both 5GS and EPS.
- The MC service client(s) is within the service area (if the session is limited to an area), where the MBS session is configured.
- It is assumed that the MC service client(s) has not received the 5G MBS session announcement while camping in EPS.

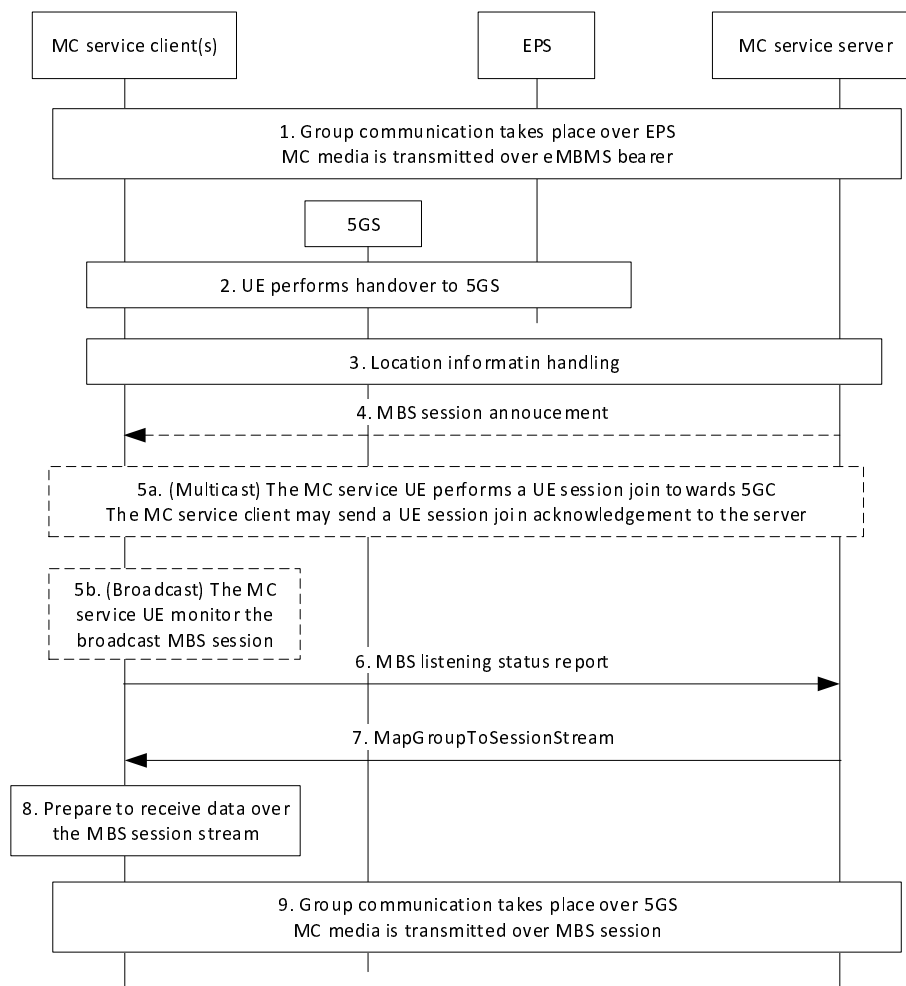

**Figure 7.3.3.9.4-1: Inter-system switching from LTE eMBMS bearer to 5G MBS sessions (either broadcast or multicast).**

1. An MC service group communication takes place, and the MC media is delivered over eMBMS bearer, which is associated to the MC service group X.
2. The MC service UE performs handover to 5GS.



3. Location information handling can be based on location reports provided by the MC service client, where the MC service UE's location information is provided via the location management client, triggered by RAT change, to the location management server, where the latter provides the location information to the MC service server.

Also, location information handling can be based on notifications provided from the network to the MC service server related to 5GS supporting EPS interworking, as specified in 3GPP TS 23.501 [7], 3GPP TS 23.502 [10], and 3GPP TS 23.503 [9] and described in clause 7.4.3. For that, the MC service server can subscribe to receive notifications of specific events from the network. For instance, the MC service server can subscribe to PCF related notifications (via N5 or Rx) for specific events, e.g., access network information notification and change of access type. Also, when SCEF+NEF is deployed, the MC service server can subscribe to SCEF+NEF related notifications for specific events, e.g., core network (CN) type change.

4. The MC service server analyses the location information and decides how to serve the client. If the MC service server decides to serve the client via 5G MBS session, it may send an MBS session announcement indicating information among others the session mode to serve the MC service client and the corresponding MBS session ID. This step is optional as the session announcement related information could be sent in advance (implementation specific).
5. The MC service UE acts according to the MBS session mode provided to receive the DL media.
  - 5a. In case of multicast MBS sessions, the MC service UE performs a UE session join towards the 5GC indicating the MBS session ID to join. It may as well send a UE session join acknowledgement to the MC service server.
  - 5b. In case of broadcast MBS sessions, the MC service UE starts monitoring the broadcast MBS session.
6. The MC service client sends an MBS listening status report to the server indicating its ability to receive media over the indicated MBS session.
7. The MC service server sends a MapGroupToSessionStream over the MBS session providing the required stream information to receive the media related to the group communication.
8. The MC service client processes the received information related to the MC media over the MBS session.
9. The MC service group communication takes place over 5GS, and the MC media is delivered over the broadcast or multicast MBS session.

#### 7.3.3.9.5 Inter-system switching from LTE eMBMS to 5G unicast PDU session

The procedure provided in figure 7.3.3.9.5-1 describes how the MC service server handles inter-system switching when the MC service UE switches from LTE network to 5G, where the MC service server is able to provide the MC services to the client over 5G MBS sessions (either broadcast or multicast).

Pre-conditions:

- MC service clients are attached to the EPC and affiliated to the same MC service group X.
- The MC services can be provided via both 5GS and EPS.

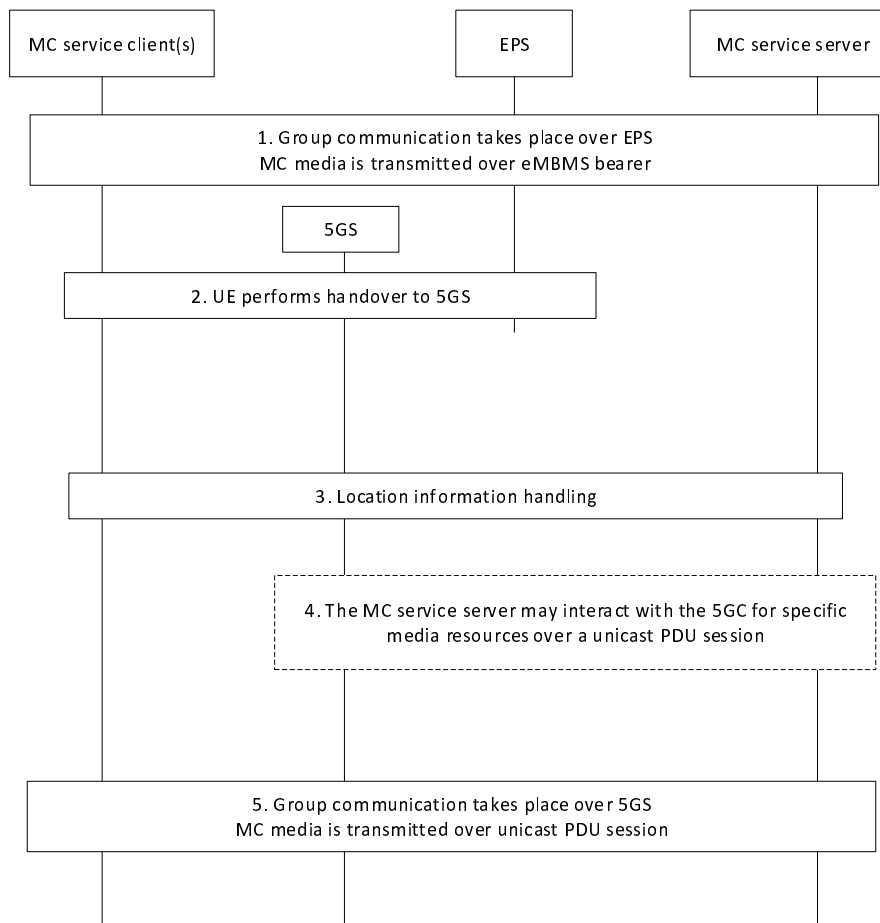

**Figure 7.3.3.9.5-1: Inter-system switching from LTE eMBMS bearer to 5G unicast PDU session.**

1. An MC service group communication takes place, and the MC media is delivered over eMBMS bearer, which is associated to the MC service group X.
2. The MC service UE performs handover to 5GS.
3. Location information handling can be based on location reports provided by the MC service client, where the MC service UE's location information is provided via the location management client, triggered by RAT change, to the location management server, where the latter provides the location information to the MC service server.

Also, location information handling can be based on notifications provided from the network to the MC service server related to 5GS supporting EPS interworking, as specified in 3GPP TS 23.501 [7], 3GPP TS 23.502 [10], and 3GPP TS 23.503 [9] and described in clause 7.4.3. For that, the MC service server can subscribe to receive notifications of specific events from the network. For instance, the MC service server can subscribe to PCF related notifications (via N5 or Rx) for specific events, e.g. access network information notification and change of access type. Also, when SCEF+NEF is deployed, the MC service server can subscribe to SCEF+NEF related notifications for specific events, e.g. core network (CN) type change.

4. The MC service server may interact with the 5GC to request media resources (if not already allocated) with specific requirements over unicast PDU session, as it is able to serve the MC service client via unicast PDU session, as described in clause 7.2.
5. The MC service group communication takes place over 5GS, and the MC media is delivered over unicast PDU session.

### 7.3.3.10 MBS transmission in MCPTT

#### 7.3.3.10.1 General

MCPTT server can determine to use 5G MBS for the transmission of downlink media for different types of MCPTT group calls.

The application layer signalling such as the floor control messages, application layer paging messages may be transmitted along with the MC media over the same MBS session however with different QoS requirements, or over other means such as unicast downlink or a different MBS session.

When using the procedures for pre-configured or dynamic MBS session establishment for MCPTT, the MCPTT server performs the procedure of call connect and disconnect over MBS session at the group communication session establishment phase.

#### 7.3.3.10.2 Call connect and disconnect over MBS session procedures

##### 7.3.3.10.2.1 General

MBS session can be used for MCPTT group calls. One MBS session may be not permanently associated to one specific group or group call.

**NOTE:** It is implementation-specific that one MBS session can be re-assigned to different groups, or is associated to only one group.

The procedure in clause 7.3.3.10.2 requires that the group session is setup before the media transmission starts. This eliminates the need for the receiving clients to continuously use a unicast session. Prior to this, the MBS session is activated and announced to the MCPTT clients.

##### 7.3.3.10.2.2 Procedure

###### 7.3.3.10.2.2.1 Group call connect over MBS session

Pre-conditions:

- The MCPTT clients 1 to n are attached to the 5GS, registered and affiliated to the same MCPTT group X.
- The MCPTT server has directly performed (or via NEF/MBSF) an MB-SMF discovery and selection, unless the corresponding information is locally configured.
- The MCPTT server has decided to use an MBS session for the MCPTT service group call associated with to the MCPTT group X.

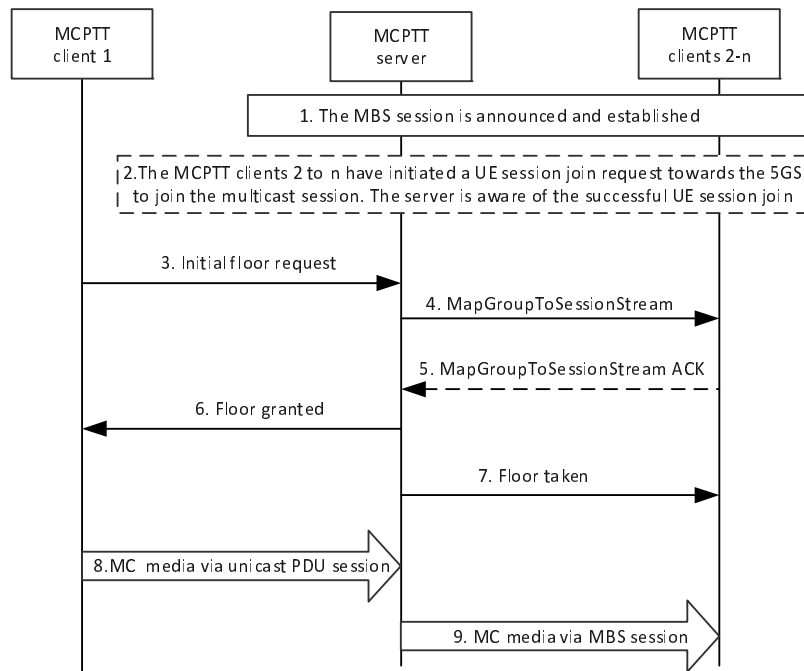

**Figure 7.3.3.10.2.2.1-1: Group call connect over broadcast and multicast MBS sessions.**

1. An MBS session is configured with the required QoS requirements announced and established.

**NOTE:** In case of broadcast MBS sessions, the session is established as part of session configuration procedures as described in 3GPP TS 23.247 [15]. In case of multicast MBS sessions, the session is established as specified in step 2.

2. In the case of multicast MBS sessions, the MCPTT UE initiates a UE session join towards the 5GS, based on the session information provided to the MCPTT UE during the session announcement step. This step is essential in order to receive the corresponding MC media. The multicast MBS session is hence established once the first initiated UE session join is accepted as indicated in 3GPP TS 23.247 [15].
3. MCPTT client 1 initiates a group call by sending an initial floor request over a unicast PDU session towards the MCPTT server.
4. The MCPTT server sends a MapGroupToSessionStream including the necessary stream information for the MCPTT clients 2 to n to receive the MC media related to the group call which is taken place within the associated MBS session.
5. The MCPTT clients 2 to n process the MapGroupToSessionStream information and may send a MapGroupToSessionStream Ack back to the MCPTT server if required.
6. The MCPTT server grants MCPTT client 1 the right to transmit media over the associated MBS session and sends a floor granted message to client 1 over a unicast PDU session.
7. A floor taken message is sent from the MCPTT server to MCPTT clients 2 to n indicating the MCPTT ID of the transmitting client, i.e., MCPTT client 1 and the associated MCPTT group ID. The floor taken message is transmitted over the associated MBS session.
8. MCPTT client 1 sends the MC media over uplink unicast PDU session towards the MCPTT server.
9. The MCPTT server sends the MC media over the indicated stream within the associated MBS session to the MCPTT clients 2 to n.

#### 7.3.3.10.2.2.2 Group call disconnect from MBS session

Figure 7.3.3.10.2.2.2-1 presents the procedure for a group communication call disconnect over broadcast and multicast MBS sessions.

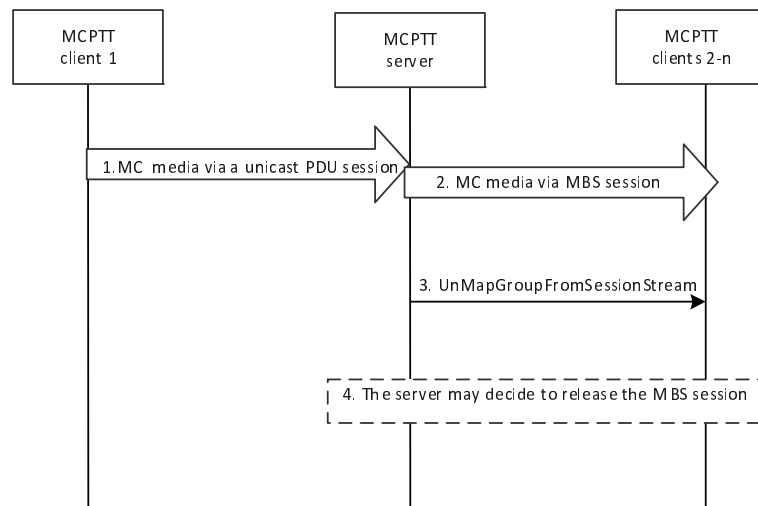

**Figure 7.3.3.10.2.2-1: Group call disconnect over broadcast and multicast MBS sessions.**

1. The MC group communication is taking place over the associated MBS session. MCPTT client 1 is sending the MC media over a unicast PDU session to the MCPTT server.
2. The MCPTT server sends the MC media over the associated MBS session to MCPTT clients 2 to n.
3. After the MC media transmission is over, i.e., no further media to be sent over the group communication, the MCPTT server sends an UnMapGroupFromSessionStream to de-associate the group call from the MBS session.
4. The MCPTT server may release the MBS session as described in clause 7.3.3.3.2.

### 7.3.3.10.3 Enhanced MCPTT group call setup procedure with 5MBS

Enhanced MCPTT group call setup procedure with eMBMS bearer is specified in clause 10.10.6 of 3GPP TS 23.379 [6]. When using mission critical services over 5G MBS, the application paging message transported over 5G MBS session should also be supported.

The related procedures and information flow is as specified in 3GPP TS 23.379 [6], with only difference of using of 5G MBS session for the transmission of application paging message.

### 7.3.3.10.4 Downlink media transmission with 5MBS

The MCPTT service shall support the procedure for using pre-created MBS session, or dynamic MBS session as specified clause 7.3.3.1.

MCPTT may use MBS session for the different types of MCPTT group calls. Both pre-arranged group calls and chat group calls can use the pre-created 5G MBS session for distributing the media.

Both the media packets as well as the floor control messages to the receiving users are sent on the 5G MBS session. Optionally a separate 5G MBS session could be used for the floor control messages.

### 7.3.3.10.5 Switching between 5G MBS session, 5G unicast PDU session, LTE eMBMS bearer, and LTE unicast bearer for MCPTT

The MCPTT service shall support the procedure for switching between 5G MBS session, 5G unicast PDU session, LTE eMBMS bearer and LTE unicast bearer as specified in clause 7.3.3.8 and clause 7.3.3.9 with the following clarifications:

- The MC service client is the MCPTT client;
- The MC service server is the MCPTT server; and

- The MC service ID is the MCPTT ID.

The MCPTT service shall use the MCPTT-1, MCPTT-4, MCPTT-7, MCPTT-8 and MCPTT-9 reference points for this procedure.

### 7.3.3.11 MBS transmission in MCVideo

#### 7.3.3.11.1 General

MCVideo server can determine to use 5G MBS for the transmission of DL link media for different types of MCVideo group calls.

The application layer signalling such as the transmit media request and transmit media granted messages, may be transmitted along with the MC media over the same MBS session however with different QoS requirements, or over other means such as unicast downlink or a different MBS session.

When using the procedures for pre-configured or dynamic MBS session establishment for MCVideo, the MCVideo server perform the procedure of call connect and disconnect over MBS session.

The MCVideo service shall support the procedure for using MBS sessions as specified clause 7.3.3.1 with the following clarifications:

- The MC service client is the MCVideo client;
- The MC service server is the MCVideo server; and
- The MC service ID is the MCVideo ID.

The MCVideo service shall use the MCVideo-1, MCVideo-8 and MCVideo-9 reference points for this procedure.

#### 7.3.3.11.2 Call connect and disconnect over MBS session procedures

##### 7.3.3.11.2.1 General

MBS session can be used for MCVideo group calls. One MBS session may not be permanently associated to one specific group or group call.

**NOTE:** It is implementation-specific that one MBS session can be re-assigned to different groups, or is associated to only one group.

The procedure in clause 7.3.3.11.2.2 requires that the group session is setup before the media transmission start. This eliminates the need for the receiving clients to continuously use a unicast session. Prior to this the MBS session is activated and announced to the MCVideo clients.

##### 7.3.3.11.2.2 Procedure

###### 7.3.3.11.2.2.1 Group call connect over MBS session

Figure 7.3.3.11.2.2.1-1 presents the procedure for a group communication, in specific, video call connect over either broadcast or multicast MBS sessions.

Pre-conditions:

- The MCVideo clients 1 to n are attached to the 5GS, registered and affiliated to the same MCVideo group X.
- The MCVideo server has directly performed (or via NEF/MBSF) an MB-SMF discovery and selection, unless the corresponding information is locally configured.
- The MCVideo server has decided to use an MBS session for the MCVideo services associated to the MCVideo group X.

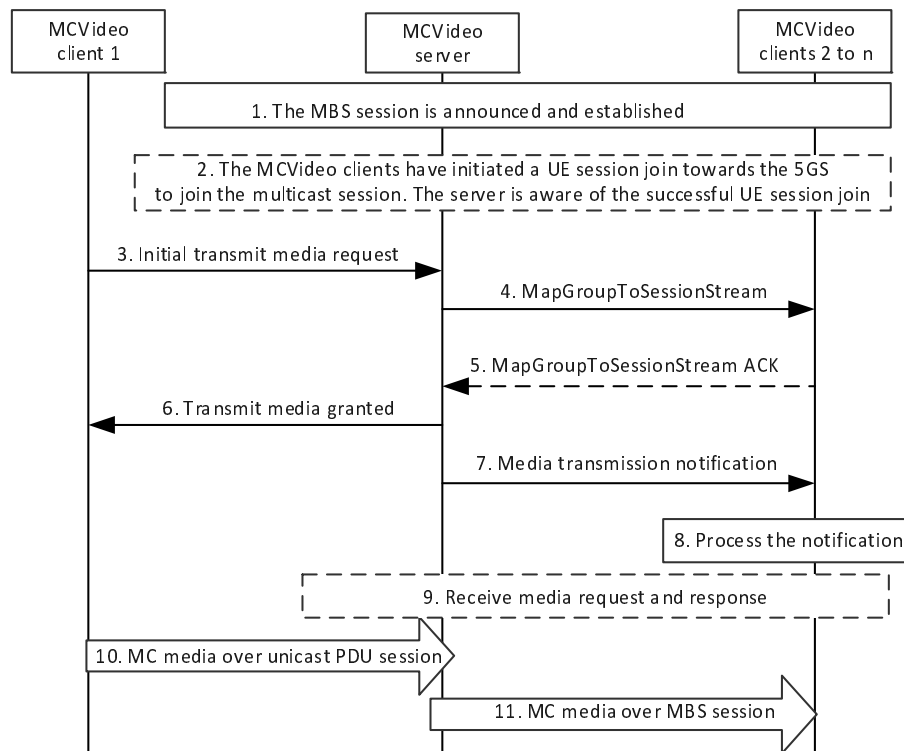

**Figure 7.3.3.11.2.2.1-1: Group call connect on MBS session**

1. An MBS session is configured with the required QoS requirements, announced and established.

**NOTE:** In case of broadcast MBS sessions, the session is established as part of session configuration procedures as described in 3GPP TS 23.247 [15]. In case of multicast MBS sessions, the session is established as specified in step 2.

2. In the case of multicast MBS sessions, the MCVideo UEs initiate a UE session join towards the 5GC based on the session information provided to the MCVideo UE during the session announcement step. This step is essential in order to receive the corresponding MC media. The multicast MBS session is hence established once the request of the first initiated UE session join is accepted as indicated in 3GPP TS 23.247 [15].
3. MCVideo client 1 initiates a MCVideo group communication, namely a video group call, by sending an initial transmit media request over a unicast PDU session towards the MCVideo server.
4. The MCVideo server sends a MapGroupToSessionStream including the necessary stream information for the MCVideo clients 2 to n to receive the MC media related to the group call which is taken place within the associated MBS session.
5. The MCVideo clients 2 to n process the MapGroupToSessionStream information and may send a MapGroupToSessionStream Ack back to the MCVideo server if required.
6. The MCVideo server grants MCVideo client 1 the right to transmit media over the associated MBS session and sends a transmit media granted message to client 1 over a unicast PDU session.
7. A media transmission notification message is sent from the MCVideo server to the MC clients 2 to n over the associated MBS session. It indicates the MCVideo ID of the transmitting client, i.e., MCVideo ID of service client 1 and the associated MC group ID.
8. MCVideo clients 2 to n process the notification message and get informed about the necessary information of the video group call.
9. The MCVideo clients 2 to n may send a receive media request to the MCVideo server, to indicate the reception of media over the associated MBS session. As a result, the MCVideo server sends a corresponding response message.
10. MCVideo client 1 sends the MC media over a unicast PDU session towards the MCVideo server.

- The MCVideo server sends the MC media over the indicated stream within the associated MBS session to the MCVideo clients 2 to n.

#### 7.3.3.11.2.2.2 Group call disconnect from MBS session

Figure 7.3.3.11.2.2-1 presents the procedure for a group call disconnect over broadcast and multicast MBS sessions.

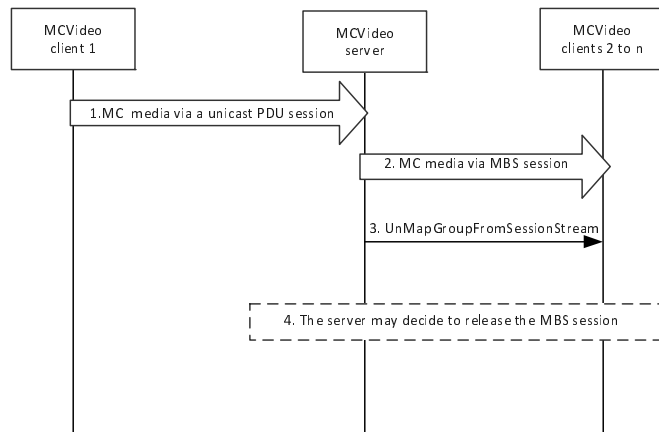

**Figure 7.3.3.11.2.2-1: Group call disconnect from MBS session**

- The MC group call is taking place over the associated MBS session. MCVideo client 1 is sending the MC media over a unicast PDU session to the MCVideo server.
- The MCVideo delivers the MC media over the associated broadcast or multicast MBS session to MCVideo clients 2 to n.
- After the MC media transmission is over, i.e., no further media to be sent over the group communication, the MCVideo server sends an `UnMapGroupFromSessionStream` to MCVideo clients 2 to n to indicate the de-association of the group call from the corresponding MBS session stream.
- The MCVideo server may release the MBS session as described in clause 7.3.3.3.2.

#### 7.3.3.11.3 Switching between 5G MBS session, 5G unicast PDU session, LTE eMBMS bearer, and LTE unicast bearer for MCVideo

The MCVideo service shall support the procedure for switching between 5G MBS session, 5G unicast PDU session, LTE eMBMS bearer and LTE unicast bearer as specified in clause 7.3.3.8 and clause 7.3.3.9 with the following clarifications:

- The MC service client is the MCVideo client;
- The MC service server is the MCVideo server; and
- The MC service ID is the MCVideo ID.

The MCVideo service shall use the MCVideo-1, MCVideo-4, MCVideo-7, MCVideo-8 and MCVideo-9 reference points for this procedure.

#### 7.3.3.11.4 DL media transmission with 5MBS for MCVideo

The MCVideo service shall support the procedure for using pre-created MBS session, or dynamic MBS session as specified clause 7.3.3.1.

MCVideo may use pre-created MBS session for the different types of MCVideo group calls. Both pre-arranged group calls and chat group calls can use the pre-created MBS session for distributing the media. The MBS session can be used by any group.



When using the pre-created MBS session for MCVideo, the MCVideo server may perform the procedure of call connect and disconnect over MBS as defined in clause 7.3.3.11.2 for the group communication session establishment step, or send map group communication to MBS session as defined in clause 7.3.2.4 after group communication session establishment.

MCVideo may also use dynamic MBS session for the different types of MCVideo group calls. Both pre-arranged group calls and chat group calls can use the dynamic MBS session for distributing the media.

When using the procedures for dynamic MBS session establishment for MCVideo, the MCVideo server perform the procedure of triggering MBS session configuration as defined in clause 7.3.3.1 and mapping group communication to MBS session as defined in defined in clause 7.3.2.4 at the group communication session establishment step.

Both the media packets as well as the transmission control messages to the receiving MCVideo clients are sent on the MBS session. Optionally a separate MBS session could be used for the transmission control messages.

### 7.3.3.12 MBS transmission in MCDData

#### 7.3.3.12.1 General

The procedures and information flows for Short data service and file distribution of MC Data group are defined in 3GPP TS 23.282 [5].

When using 5G MBS, MCDData server can determine to use either pre-created MBS session or dynamic MBS session as defined in clause 7.3.3.1 for the transmission of DL link media for different types of MCDData service capabilities.

MCDData may use the 5G MBS session for the MCDData features short data service and file distribution for MCDData group communication. The 5G MBS session can be used by any MCDData group.

Both the media packets as well as application level control signalling (e.g. transmission control) to the receiving users may be sent on the MBS session. Optionally, a separate MBS Session could be used for the application level control signalling (e.g. transmission control).

When MBSF/MBSTF are deployed in 5GS, MCDData server could also determine to use File distribution capabilities provided by MBSF/MBSTF for file distribution.

#### 7.3.3.12.2 Usage of MBS session for MCDData

The MCDData service shall support the procedure for using pre-created MBS session or dynamic MBS session as specified in Clause 7.3.3.1 with the following clarifications:

- The MC service client is the MCDData client;
- The MC service server is the MCDData server; and
- The MC service ID is the MCDData ID.

When using the procedures for pre-created or dynamic MBS session establishment for MCDData, the MCDData server performs the procedure of group communication connect and disconnect over MBS session at the group communication session establishment phase.

The MCDData service shall use the MCDData-SDS-1, MCDData-SDS-3, MCDData-FD-1, MCDData-FD-3, MCDData-DS-1 and MCDData-DS-3 reference points for this procedure.

#### 7.3.3.12.3 Switching between 5G MBS session, 5G unicast PDU session, LTE eMBMS bearer, and LTE unicast bearer for MCDData

The MCDData service shall support the procedure for switching between 5G MBS session, 5G unicast PDU session, LTE eMBMS bearer, and LTE unicast bearer or eMBMS bearer as specified in clause 7.3.3.8 and clause 7.3.3.9 with the following clarifications:

- The MC service client is the MCDData client;
- The MC service server is the MCDData server; and

- The MC service ID is the MCDData ID.

The MCDData service shall use the MCDData-SDS-1, MCDData-SDS-2, MCDData-SDS-3, MCDData-FD-1, MCDData FD-2, MCDData-FD-3, MCDData-DS-1, MCDData-DS-2 and MCDData-DS-3 reference points for this procedure.

### 7.3.3.12.4 Group communication connect and disconnect over MBS session procedures

#### 7.3.3.12.4.1 General

MBS session can be used for MCDData group communication. One MBS session may be not permanently associated to one specific group or group communication.

NOTE: It is implementation-specific that one MBS session can be re-assigned to different groups, or is associated to only one group.

The procedure in clause 7.3.3.12.4 requires that the group session is setup before the data transmission starts. This eliminates the need for the receiving clients to continuously use a unicast session. Prior to group session setup, the MBS session is activated and announced to the MCDData clients.

#### 7.3.3.12.4.2 Procedure

The procedure specified in this clause is applicable (for the group communication establishment) for Group standalone short data service using media plane as described in clause 7.4.2.6 in 3GPP TS 23.282 [5] and for Group short data service session as described in clause 7.4.2.7 in 3GPP TS 23.282 [5].

##### 7.3.3.12.4.2.1 Group communication connect over MBS session

Pre-conditions:

- The MCDData clients 1 to n are attached to the 5GS, registered and affiliated to the same MCDData group X.
- The MCDData server has directly performed (or via NEF/MBSF) an MB-SMF discovery and selection, unless the corresponding information is locally configured.
- The MCDData server has decided to use an MBS session for the MCDData service group communication associated with to the MCDData group X.

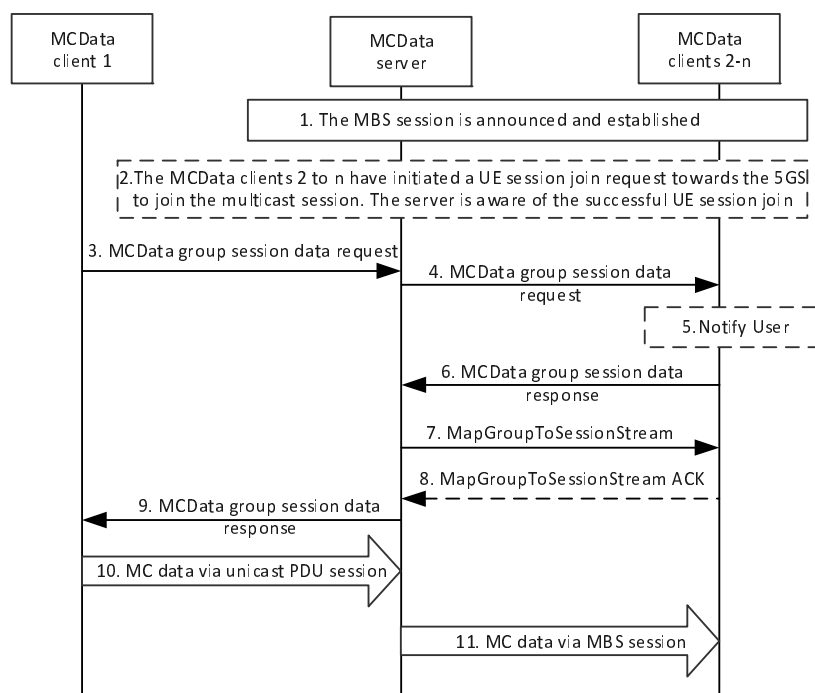

Figure 7.3.3.12.4.2.1-1: Group communication connect over broadcast and multicast MBS sessions.

1. An MBS session is configured with the required QoS requirements announced and established.

NOTE 1: In case of broadcast MBS sessions, the session is established as part of session configuration procedures as described in 3GPP TS 23.247 [15]. In case of multicast MBS sessions, the session is established as specified in step 2.

2. In the case of multicast MBS sessions, the MCDData UE initiates a UE session join towards the 5GS based on the session information provided to the MCDData UE during the session announcement step. This step 2 is essential in order to receive the corresponding MC media. The multicast MBS session is hence established once the first initiated UE session join is accepted as indicated in 3GPP TS 23.247 [15].
3. The MCDData client 1 initiates a group communication by sending a MCDData group data request over a unicast PDU session towards the MCDData server.
4. MCDData server initiates the MCDData group data request towards each MCDData clients 2 to n.
5. The receiving MCDData clients 2 to n optionally notify the user about the incoming MCDData session data request.
6. The receiving MCDData client 2 to n accept or reject the MCDData group data request and the corresponding result is in the MCDData group data response towards MCDData server.
7. The MCDData server sends a MapGroupToSessionStream including the necessary stream information for the MCDData clients 2 to n to receive the MC data related to the group communication which is taken place within the associated MBS session.
8. The MCDData clients 2 to n process the MapGroupToSessionStream information and may send a MapGroupToSessionStream Ack back to the MCDData server if required.
9. MCDData server forwards the MCDData group data response received from MCDData client 2 to n to the MCDData user initiating the MCDData session data request.

NOTE 2: The steps 4 to 6 and steps 7 to 8 can occur in any order, and prior to step 10 depending on the conditions to proceed with the data transmission.

10. MCDData client 1 sends the MC data over uplink unicast PDU session towards the MCDData server.
11. The MCDData server sends the MC data over the indicated stream within the associated MBS session to the MCDData clients 2 to n.

#### 7.3.3.12.4.2.2 Group communication disconnect from MBS session

Figure 7.3.3.12.4.2.2-1 presents the procedure for a group communication disconnect over broadcast and multicast MBS sessions.

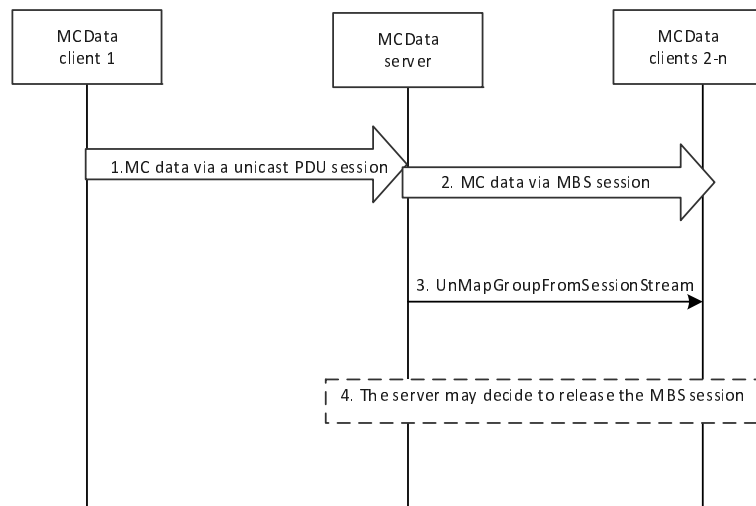

**Figure 7.3.3.12.4.2.2-1: Group communication disconnect over broadcast and multicast MBS sessions.**

1. The MC group communication is taking place over the associated MBS session. MCDData client 1 is sending the MC data over a unicast PDU session to the MCDData server.
2. The MCDData server sends the MC data over the associated MBS session to MCDData clients 2 to n.
3. After the MC data transmission is over, i.e., no further data to be sent over the group communication, the MCDData server sends an UnMapGroupFromSessionStream to de-associate the group communication from the MBS session.
4. The MCDData server may release the MBS session as described in clause 7.3.3.3.2.

### 7.3.3.12.5 Downlink media transmission with 5MBS

The MCDData service shall support the procedure for using pre-established MBS session, or dynamic MBS session as specified in clause 7.3.3.1.

MCDData may use MBS session for the different types of sub-services. Both SDS and FD can use the pre-established MBS session or dynamic MBS session for distributing the data.

### 7.3.3.13 Use of FEC to protect 5G MBS transmissions

#### 7.3.3.13.1 General

Application layer FEC can be used to recover the packet losses when delivering a MC service over 5G MBS, to reach its required level of QoS.

The support of FEC is optional for the MC service servers and MC service clients. FEC can be optionally applied by the MBSTF, if required by the MC service server (as specified in clause 7.3.3.13.2), or directly by the MC service server (as defined in 3GPP TS 23.280 [3]).

#### 7.3.3.13.2 FEC encoding by the MBSTF

In this procedure, depicted in figure 7.3.3.13.2-1, the MC service server asks the MBSF/MBSTF to apply FEC to a set of media, transported by a 5G MBS session, using the Setup FEC request.

This procedure can be applied when using pre-created MBS session and session announcement (as specified in clause 7.3.3.1.2) or using MBS session and session announcement (as specified in clause 7.3.3.1.3).

Pre-condition:

1. The MC service server has already configured and activated a 5G MBS session.

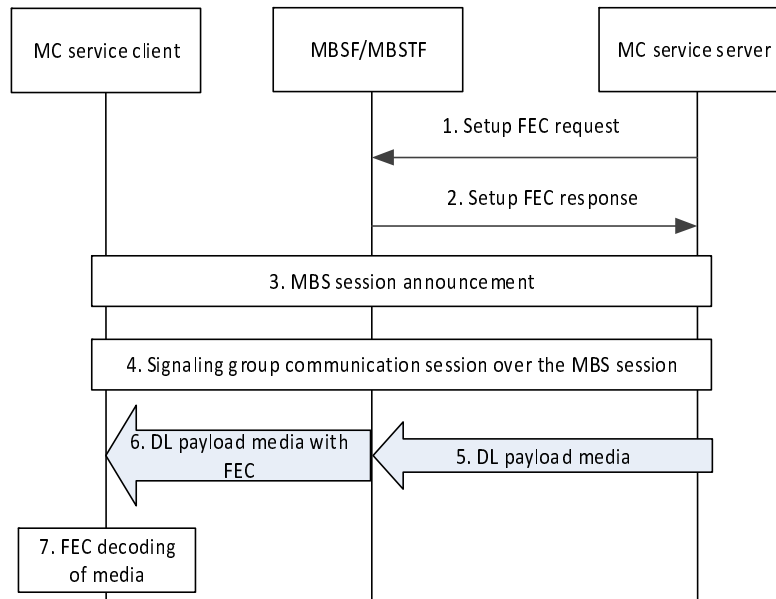

**Figure 7.3.3.13.2-1: Application of FEC by the MBSF-MBSTF**

1. The MC service server decides to set up FEC for a set of MC service media flows. It will send the FEC request to MBSF/MBSTF.

It includes the following elements: the MBS session ID of the MBS session transporting those media, the media descriptions (codecs, transport protocols, bitrates, destination IP addresses and ports), the identification of the FEC repair packet flow (IP destination and port), and an upper bound to the additional latency resulting due to FEC application. The MC Service server may perform this request several times to protect separately different sets of media transported within the same 5G MBS session.

2. If the MBSF can satisfy the request, the Setup FEC response includes a modified list of media information and FEC information. The response also includes an identifier of the corresponding FEC process instance, which can be used to release the application of FEC for these media flows.

NOTE 1: Source media packets may be modified by the application of FEC (e.g., addition of a footer or header), leading to a modification of the delivery protocol to be announced within the media information.

NOTE 2: The Release FEC request is not shown in the figure.

3. The MC service server announces the 5G MBS session to the MC service client with the MBS session announcement procedure, including the modified list of media information and FEC information within the SDP information.
4. When the MC service server decides to transmit the MC service media flow for a group communication, the MC service server sends to the group a message identifying the MC service media flow and the MBS session ID, such as the MapGroupToSessionStream message for MCPTT or MCVideo.
5. The MC service server sends the downlink media to the MBSTF over Nmb8.
6. The MBSTF performs FEC encoding of the downlink media in accordance with the announced FEC algorithm and parameters and delivers it over 5G MBS.
7. The MC service client performs FEC decoding of the encoded media flows in accordance with the announced FEC information and delivers the decoded flows to the media player.

## 7.4 MC services over 5GS supporting EPS interworking

### 7.4.1 General

MC services over a 5G system supporting EPS interworking are provided to 5GS/EPS capable MC service UEs as defined in 3GPP TS 23.501 [7], 3GPP TS 23.502 [10], and 3GPP TS 23.503 [9].

This clause describes procedures related to the support of MC services over a 5G system with EPS interworking.

### 7.4.2 Inter-system mobility

As specified in 3GPP TS 23.501 [7], a dedicated user plane anchor point, i.e. UPF + PGW-U function, is defined for interworking between 5GS and EPS. This enables that the network can directly handle PDU sessions (in 5GS) and PDN connections (in EPS) associated to MC service sessions of an MC service UE during inter-system change.

The inter-system change of an MC service UE will be transparent to the MC service server. The MC service server will continue interacting with the same control plane functions, e.g. PCF, and user plane function, e.g. UPF + PGW-U.

NOTE 1: For the case that seamless session continuity is required for MC services, e.g. for MCPTT services, EPS interworking with N26 (interface between AMF in 5GC and MME in EPC) is required for inter-system change, as described in 3GPP TS 23.501 [7].

The procedure in figure 7.4.2-1 describes in a high level inter-system mobility of 5GS/EPS capable MC service UEs with associated MC service sessions.

Pre-conditions:

- MC service UE is a 5GS/EPS capable UE.
- MC service UE is registered to a 5GS supporting EPS interworking for the support of MC services.

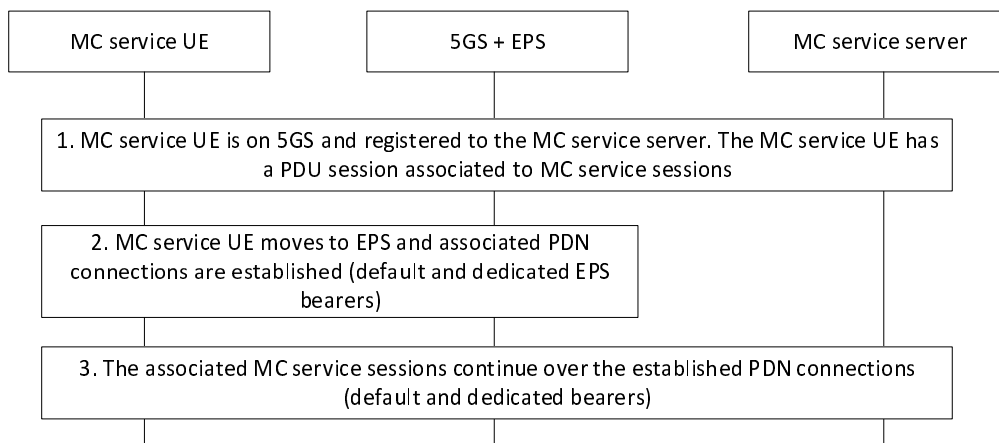

**Figure 7.4.2-1: MC services over 5GS with EPS interworking – Inter-system mobility**

1. MC service UE is registered to the MC service server over the 5GS. MC service UE has established a PDU session(s) associated to MC service sessions.
2. The 5GS supporting EPS interworking decides that the MC service UE should be handed over to EPS, e.g. due to radio conditions. 5GS handles associated PDU sessions of the MC service UE to establish corresponding PDN connections in EPS, i.e. required default and dedicated EPS bearers associated to MC service sessions.

NOTE 2: The interworking procedures with EPS are described in 3GPP TS 23.501 [7], 3GPP TS 23.502 [10], and 3GPP TS 23.503 [9].

- MC service UE is registered on EPS. MC services continue being provided to the MC service UE over EPS via the established PDN connections (default and dedicated bearers associated to corresponding MC service sessions) in step 2.

### 7.4.3 Network notifications of EPS interworking related events

In the case of MC services provided over a 5GS supporting EPS interworking, the MC service server may not be able to identify whether an MC service UE is registered on 5GS or EPS. Therefore, the MC service server can subscribe/unsubscribe to receive notifications of specific events from the network. These notifications can be related to PDU sessions/PDN connections to which MC service sessions are bounded or related to a specific MC service UE or group of MC service UEs.

Such notifications can be provided from the PCF (via N5 or Rx) for specific events, e.g. access network information notification and change of access type. If SCEF+NEF is deployed, notifications can also be provided from SCEF+NEF for specific events, e.g. core network (CN) type change. The specification of these event procedures are described in 3GPP TS 23.501 [7], 3GPP TS 23.502 [10], and 3GPP TS 23.503 [9].

The procedure in figure 7.4.3-1 describes a high level subscription/notification procedure between the MC service server and the network.

Pre-conditions:

- MC service UE is a 5GS/EPS capable UE.
- MC service UE is registered to a 5GS supporting EPS interworking for the support of MC services.

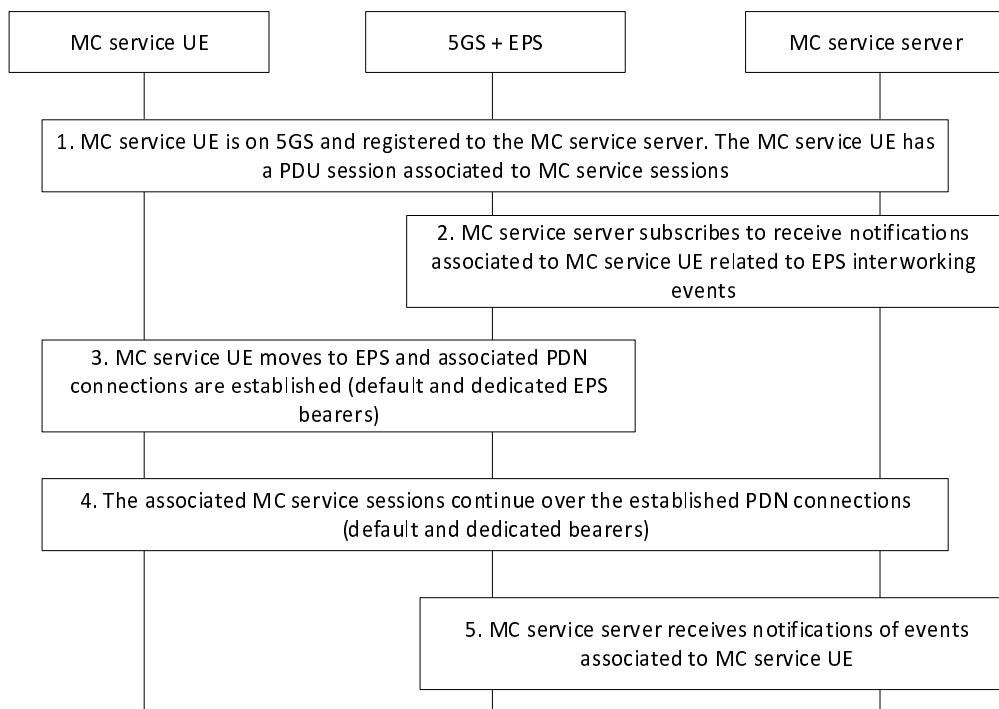

**Figure 7.4.3-1: Network notifications of EPS interworking related events**

- MC service UE is registered to the MC service server over the 5GS. MC service UE has established a PDU session(s) associated to MC service sessions.
- MC service server subscribes to receive notifications from the network associated to MC service UE related to EPS interworking events. For instance, the MC service server may subscribe to notifications of events from the PCF associated to the MC service UE, e.g. access network information notification and change of access type, as specified in 3GPP TS 23.503 [9].

If SCEF+NEF is deployed, the MC service server may also subscribe to notifications of events from SCEF+NEF associated to the MC service UE, e.g. CN type change, as specified in 3GPP TS 23.501 [7] and 3GPP TS 23.502 [10].

3. The 5GS supporting EPS interworking decides that the MC service UE should be handed over to EPS, e.g. due to radio conditions. 5GS handles associated PDU sessions of the MC service UE to establish corresponding PDN connections in EPS, i.e. required default and dedicated EPS bearers associated to MC service sessions.

NOTE 1: The interworking procedures with EPS are described in 3GPP TS 23.501 [7], 3GPP TS 23.502 [10], and 3GPP TS 23.503 [9].

4. MC service UE is registered on EPS. MC services continue being provided to the MC service UE over EPS via the established PDN connections (default and dedicated bearers associated to corresponding MC service sessions) in step 2.
5. The network provides notifications to the MC service server of subscribed events associated to the MC service UE.

NOTE 2: Step 5 can occur before or in parallel to step 4.

## 7.5 Enhancements for Location management over 5GS

### 7.5.1 General

In addition to the location management functions defined in 3GPP TS 23.280 [3], the location management system over 5GS shall support the following enhancement:

- Inter-system RAT changes event triggering and report as described in clause 7.3.3.9.1.
- Serving and neighbouring 5G NR Cell Global Identifiers (NCGI) as optional Location Information elements in the information flows of 3GPP TS 23.280 [3] clause 10.9.2.

### 7.5.2 Information flows for location information

#### 7.5.2.1 General

In this clause, only those information flows which requires enhancement to 3GPP TS 23.280 [3] for MC services over 5G specific are included.

#### 7.5.2.2 Location reporting configuration

Table 7.5.2.2-1 describes the information flow from the location management server to the location management client for the location reporting configuration.

Compared to that is defined in 3GPP TS 23.280 [3], the following changes are made:

- Allowing the location management server to configure location reporting by including inter-RAT trigger information.
- Adding a new NOTE 3 to clarify the usage of triggering event for inter-RAT changes



**Table 7.5.2.2-1: Location reporting configuration**

Information element	Status	Description
MC service ID	M	Identity of the MC service user to which the location reporting configuration is targeted.
Requested non-emergency location information	O (see NOTE 1)	Identifies what location information is requested, except for emergency or imminent peril calls or emergency alerts
Requested emergency location information	O (see NOTE 1)	Identifies what location information is requested, for emergency or imminent peril calls or emergency alerts
Triggering criteria in non-emergency cases	O (see NOTE 1 and NOTE 3)	Identifies when the location management client will send the location report in non-emergency cases
Handling criteria in not reporting location information cases	O	Identifies when the location management client will store location information (e.g. never, off-network, IOPS)
Triggering criteria in not reporting location information cases	O (see NOTE 2)	Identifies the causes when the location management client will generate location information
Minimum time between consecutive reports	O (see NOTE 1)	Defaults to 0 if absent and 0 for emergency calls, imminent peril calls and emergency alerts
Triggering criteria in emergency cases	O (see NOTE 1)	Identifies when the location management client will send the location report in emergency cases
<p>NOTE 1: If none of the information elements is present, this represents a cancellation for location reporting based on Triggering criteria in emergency and non-emergency cases, if configured.</p> <p>NOTE 2: If not present, location information is generated based on Triggering criteria in emergency and non-emergency cases, if configured.</p> <p>NOTE 3: Triggering criteria can contain the inter-RAT trigger information if the inter-system RAT changes information is expected from the LMC in case of LTE eMBMS and 5G MBS co-existence.</p>		

### 7.5.2.3 Location information report

Table 7.5.2.3-1 describes the information flow from the location management client to the location management server for the location information reporting.

Compared to that is defined in 3GPP TS 23.280 [3], the following changes are made:

- Allowing the location management client to report the the inter-RAT information in the location information report;
- Adding a new NOTE 5 to clarify the usage of triggering event for inter-RAT changes

**Table 7.5.2.3-1: Location information report (LMC – LMS)**

Information element	Status	Description
Set of MC service IDs	M	Set of identities of the reporting MC service user on the MC service UE (e.g. MCPPTT ID, MCVideo ID, MCData ID)
MC service ID (see NOTE 4)	O	Identity of the requesting MC service user.
Functional alias(es) (see NOTE 1)	O	Functional alias that corresponds to the reporting MC service ID.
MC service UE label	O	Generic name of the reporting MC service UE
Triggering event (see NOTE 3 and NOTE 5)	M	Identity of the event that triggered the sending of the report
Location Information (see NOTE 2 and NOTE 5)	M	Location information of the individual MC service user
<p>NOTE 1: Each functional alias corresponds to an individual MC service ID.</p> <p>NOTE 2: This may contain multiple sets of elements for the MC service user. The following elements shall accompany the location information elements: time of measurement and optional accuracy. The following location information elements shall be optional (configurable) present: longitude, latitude, speed, bearing, altitude, ECGL, eMBMS SAIs, MBS FSA ID(s), with at least one provided.</p> <p>NOTE 3: An on-demand request may be the triggering event.</p> <p>NOTE 4: In case of an on-demand request of an MC service user the MC service ID shall be provided. In case of an MC service server request or an event-triggered report, no MC service ID is provided.</p> <p>NOTE 5: Triggering event can contain the inter-RAT information if the inter-RAT changes information is expected from the LMC in case of LTE eMBMS and 5G MBS co-existence.</p>		

Table 7.5.2.3-2 describes the information flow from the location management server to the MC service server for location information reporting.

Compared to that is defined in 3GPP TS 23.280 [3], the following changes are made:

- Adding a new NOTE 4 to clarify the usage of triggering event for inter-RAT changes

**Table 7.5.2.3-2: Location information report (LMS – MC service server)**

Information element	Status	Description
Set of MC service IDs	M	Set of identities of the reporting MC service user on the MC service UE (e.g. MCPPTT ID, MCVideo ID, MCData ID)
Functional alias(es) (see NOTE 1)	O	Functional alias that corresponds to the MC service ID.
Triggering event (see NOTE 3 and NOTE 4)	M	Identity of the event that triggered the sending of the report
Location Information (see NOTE 2 and NOTE 4)	M	Location information of the individual MC service user
<p>NOTE 1: Each functional alias corresponds to an individual MC service ID.</p> <p>NOTE 2: This may contain multiple sets of elements for the MC service user. The following elements shall accompany the location information elements: time of measurement and optional accuracy. The following location information elements shall be optional (configurable) present: longitude, latitude, speed, bearing, altitude, ECGL, MBMS SAIs, MB FSA ID(s), with at least one provided.</p> <p>NOTE 3: An on-demand request may be the triggering event.</p> <p>NOTE 4: Triggering event can contain the inter-RAT information if the inter-RAT information is expected from the LMC in case of LTE eMBMS and 5G MBS co-existence.</p>		

## 7.5.3 Procedure

### 7.5.3.1 General

In this clause, only the procedure which requires enhancement to 3GPP TS 23.280 [3] for MC services over 5G specific are included.

### 7.5.3.2 Event-triggered location reporting procedure

NOTE 1: This procedure is valid for single MC system operation only.

The location management server provides location reporting configuration to the location management clients, indicating what information the location management server expects and what events will trigger the sending of this information to the location management server. For eMBMS and MBS co-existing, the MC service server needs to obtain the inter-RAT information. If the inter-RAT information report from the MC service UE is expected, the MC service server may obtain the inter-RAT information from the location management server, and the location management server then performs the procedure as described clause 10.9.3.1 in 3GPP TS 23.280 [3], clause 7.5.2.2 and 7.5.2.3. In addition to those trigger criteria defined in 3GPP TS 23.280 [3], the new inter-RAT triggers may include, the change of MBS FSA ID, inter-system RAT type changes. The location information report contains the inter-RAT information.

NOTE 2: How the location management client can identify or obtain information about the case that an inter-RAT change has occurred is implementation specific or out of the scope of this specification.

Similar to the usage of eMBMS bearer for transmitting of location reporting configuration defined in TS 23.280, the location reporting configuration message can also be sent over 5G MBS Session.

## 7.6 MC service over 5G ProSe

### 7.6.1 Off network group communication for MC service

The procedures and information flows used in 3GPP TS 23.280 [3], 3GPP TS 23.379 [6], 3GPP TS 23.281 [4], and 3GPP TS 23.282 [5] are reused for Off network group communication for MC service over 5G ProSe with following differences:

- Discovery Group ID is replaced by Application Layer Group ID, as specified in 3GPP TS 23.304 [17].
- The ProSe Layer-2 Group ID of the target MC service group may be used by the ProSe layer as the target group info;
- The Groupcast mode 5G ProSe Direct Communication procedure in clause 6.4.2 of 3GPP TS 23.304 [17] is utilized for the establishment of off-network group communication and the following media plane traffic exchanges.

### 7.6.2 Off-network private communication

The procedures and information flows used in 3GPP TS 23.280 [3], 3GPP TS 23.379 [6], 3GPP TS 23.281 [4], and 3GPP TS 23.282 [5] are reused for off-network private communication for MC service over 5G ProSe with following differences:

- PPPP (ProSe Per-Packet Priority) is replaced with PQI, as specified in 3GPP TS 23.304 [17].
- The ProSe discovery group ID is replaced with Application layer group ID which identifies a discovery group as specified in 3GPP TS 23.304 [17]. The Application layer group ID and the user info ID of the target MC service user are provisioned to the MC service client in the MC service user profile. The MC service client enables the ProSe layer to determine the IP address for the communication with the target MC service user by providing the Application layer group ID and user info ID of the target MC service user.
- Group Member Discovery procedure in 3GPP TS 23.304 [17] is utilized to enable for the call initiator to determine whether the called MC service user is in the proximity of the calling user prior to the establishment of an off-network private communication.
- The Unicast mode 5G ProSe Direct Communication procedure in 3GPP TS 23.304 [17] is utilized for the establishment of off-network private communication and the following media plane traffic exchanges.

## 7.6.3 Use of 5G ProSe UE-to-network relay

### 7.6.3.1 5G ProSe UE-to-network relay service authorization

The MC service shall support the capability for 5G ProSe UE-to-network relay to restrict the relayed group communication on a per group basis by using the relay service codes corresponding to the group.

5G ProSe (as specified in 3GPP TS 23.304 [17]) supports layer 2 UE-to-network relay and layer 3 UE-to-network relay. The procedure defined in clause 10.5 of 3GPP TS 23.280 [3] applies with the following differences:

- 5G ProSe UE-to-network relay is provisioned that each relay service code is offering layer 2 or layer 3 UE-to-Network Relay service.
- 5G ProSe remote UE is provisioned that each relay service code is offering layer 2 or layer 3 UE-to-Network Relay service.
- 5G ProSe Layer-3 UE-to-network relay is provisioned with suitable relay service codes to support access to N3IWF for the case of 5G ProSe Layer-3 UE-to-network relay with the support of N3IWF.

### 7.6.3.2 UE-to-network relay MC service

The 5G ProSe UE-to-network relay provides a layer 2 or layer 3 routing service (as specified in 3GPP TS 23.304 [17]) for a 5G ProSe remote UE, when the MC service user on the 5G ProSe remote UE requires to access the MC service via a 5G ProSe UE-to-network relay.

The application layer signalling for the MC service user on a 5G ProSe remote UE using a 5G ProSe UE-to-network relay are identical to the application layer signalling for the MC service user on an on-network UE.

---

# Annex A (normative): Configuration data for MC services using 5GS

## A.1 General

This Annex provides information about the static data needed for configuration of MC services encompassing the following category:

- Initial MC service UE configuration data (see subclause A.2).

Each parameter that can be configured online shall only be configured through one online reference point. Each parameter that can be configured offline shall only be configured through one offline reference point. The most recent configuration data made available to the MC service UE shall always overwrite previous configuration data, irrespective of whether the configuration data was provided via the online or offline mechanism.

---

## A.2 Initial MC service UE configuration data

The configuration data defined in 3GPP TS 23.280 [3] in Annex A.6 apply, with the following exceptions:

- DNN and the corresponding DN credentials instead of the PDN credentials shall be used, along with the S-NSSAI to be used for each MC service;
- The Default Configured slice(s) information may be pre-configured at the MC service UE and be utilized as defined in 3GPP TS 23.501 [7];

NOTE: It is up to UE implementation, whether an S-NSSAI value is included in the Requested NSSAI. If not included, the corresponding MC traffic could be handled according to the URSP rule with the "match all" Traffic descriptor.

- Additional MC network slice identification information may be provided for each S-NSSAI, e.g., the corresponding network slice credentials.

---

## A.3 MC service user profile configuration data

The configuration data defined in 3GPP TS 23.379 [6] in Annex A.3, apply, with the following exceptions:

- "MCPTT group ID" instead of the "ProSe discovery group ID" shall be used;

The configuration data defined in 3GPP TS 23.281 [4] in Annex A.3, apply, with the following exceptions:

- "MCVideo group ID" instead of the "ProSe discovery group ID" shall be used;

The configuration data defined in 3GPP TS 23.282 [5] in Annex A.3, apply, with the following exceptions:

- "MCData group ID" instead of the "Discovery group ID" shall be used;

---

## A.4 MC service group configuration data

The configuration data defined in 3GPP TS 23.379 [6] in Annex A.4, 3GPP TS 23.281 [4] in Annex A.4, 3GPP TS 23.282 [5] in Annex A.4, apply, with the following exceptions:

- "Default PQI (as specified in 3GPP TS 23.304 [17]) values" instead of "Default ProSe Per-Packet priority (as specified in 3GPP TS 23.303 [7]) values" shall be used;

---

## A.5 MC service configuration data

The configuration data defined in 3GPP TS 23.379 [6] in Annex A.5, 3GPP TS 23.281 [4] in Annex A.5, 3GPP TS 23.282 [5] in Annex A.5, apply, with the following exceptions:

- "Default PQI (as specified in 3GPP TS 23.304 [17]) values" instead of "Default ProSe Per-Packet priority (as specified in 3GPP TS 23.303 [7]) values" shall be used;

## Annex B (informative): Service continuity for MC service

### B.1 Service continuity between on-network MC service and UE-to-network relay MC service

This annex describes how 3GPP TS 23.237 [18] mechanisms for IMS service continuity can be used to provide service continuity between on-network MC service and UE-to-network relay MC service.

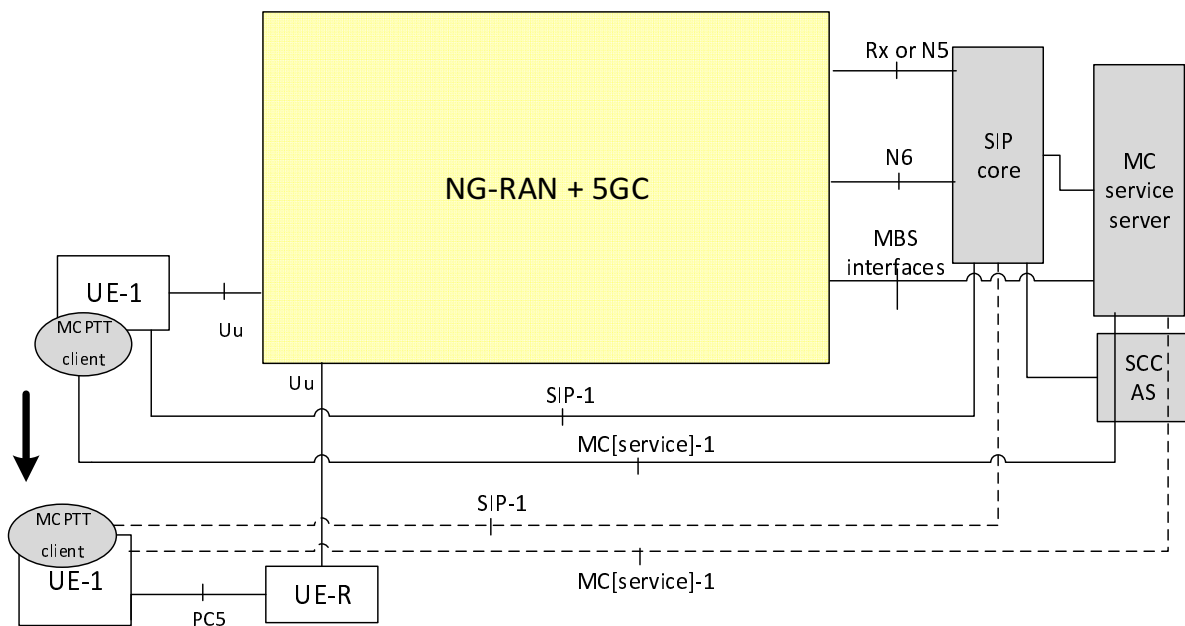

**Figure B.1-1: Service continuity from on-network to UE-to-network relay**

The details of MBS interfaces are specified in clause 4.7. The interaction between SIP core and 5GC is specified in 3GPP TS 23.228 [2]. The procedure for service continuity from on-network MCPTT service to UE-to-network relay MCPTT service is described in Annex B of 3GPP TS 23.280 [3].

As illustrated in figure B.1-1:

- Initially UE-1 has a direct connection to the network via 5GS (on-network MCPTT service). It is registered with the SIP core and is engaged in a SIP session with the MCPTT Application Server (solid lines SIP-1 and MC[service]-1 in figure B.1-1).
- When UE-1 realises that it is losing connection to the network, or after the connection to the network has been lost, UE-1 discovers a UE-to-network relay (UE-R) and establishes a PC5 connection with UE-R. UE-1 registers with the SIP core over the target access leg and enters UE-to-network relay MC service by transferring the media streams over the target leg (dashed lines SIP-1 and MC[service]-1 in figure B.1-1).
- The SIP session is anchored at a Service Centralisation and Continuity Application Server (SCC AS) before and after the handover, as described in 3GPP TS 23.237 [18].

## Annex C (informative): Change history



Change history							
Date	Meeting	TDoc	CR	Rev	Cat	Subject/Comment	New version
2020-10	SA6#39-BIS-e					Initial version.	0.0.0
2020-10						Implemented the following pCRs approved in SA6#39-BIS-e: S6-201792, S6-201981.	0.1.0
2020-11	SA6#40-e					Implemented the following pCRs approved in SA6#40-e: S6-202308, S6-202309.	0.2.0
2021-01	SA6#41-e					Implemented the following pCRs approved in SA6#41-e: S6-210197, S6-210199, S6-210214, S6-210216, S6-210217, S6-210218, S6-210219, S6-210333	0.3.0
2021-03	SA6#42-e					Implemented the following pCRs approved in SA6#42-e: S6-210553, S6-210650, S6-210686	0.4.0
2021-03	SA#91-e	SP-210176				Presentation for information at SA#91-e	1.0.0
2021-04	SA6#42-BIS-e					Implemented the following pCRs approved in SA6#42-BIS-e: S6-210953, S6-210954	1.1.0
2021-05						Editorial corrections	1.1.1
2021-06	SA6#43-e					Implemented the following pCRs approved in SA6#43-e: S6-211405, S6-211407, S6-211408, S6-211409, S6-211410	1.2.0
2021-06	SA#92-e	SP-210473				Presentation for approval at SA#92-e	2.0.0
2021-06	SA#92-e	SP-210473				MCC Editorial update for publication after TSG SA approval (SA#92)	17.0.0
2021-12	SA#94-e	SP-211526	0013	1	F	Corrections on network slicing	17.1.0
2021-12	SA#94-e	SP-211530	0004	2	B	MBS session release	18.0.0
2021-12	SA#94-e	SP-211530	0007	2	B	MC service media distribution over 5G MBS	18.0.0
2021-12	SA#94-e	SP-211530	0008	1	B	Call connect and disconnect over 5G MBS in MCPTT context	18.0.0
2021-12	SA#94-e	SP-211530	0009	1	B	Call connect and disconnect over 5G MBS in MCVideo context	18.0.0
2021-12	SA#94-e	SP-211530	0010	1	B	Service continuity between 5G MBS delivery and unicast delivery	18.0.0
2021-12	SA#94-e	SP-211530	0011	2	B	Architecture for MC/5MBS	18.0.0
2021-12	SA#94-e	SP-211530	0012	3	B	MBS architecture and functionalities	18.0.0
2021-12	SA#94-e	SP-211530	0014	1	B	Request for creation of MBS resources for group communications	18.0.0
2021-12	SA#94-e	SP-211530	0016		B	Request for updating MBS resources for group communications	18.0.0
2021-12	SA#94-e	SP-211530	0017	1	B	Request to activate or de-activate multicast MBS sessions	18.0.0
2021-12	SA#94-e	SP-211530	0020	1	B	MC service control signalling over 5G MBS	18.0.0
2021-12	SA#94-e	SP-211530	0021	2	B	Multi-server MBS session coordination	18.0.0
2021-12	SA#94-e	SP-211530	0022	2	B	Procedure for inter-system switching between eMBMS and 5G MBS	18.0.0
2022-03	SA#95-e	SP-220107	0023	1	C	Alignment of section 4.7 of 23.289 with latest version of 23.247 (v 17.1.0)	18.1.0
2022-03	SA#95-e	SP-220107	0024	1	F	Updating aspects related to the MBS resources update	18.1.0
2022-03	SA#95-e	SP-220107	0025	1	F	Alignment of some information flows within TS 23.289	18.1.0
2022-03	SA#95-e	SP-220108	0026	1	B	Use of 5G ProSe UE-to-network relay service for MC services	18.1.0
2022-03	SA#95-e	SP-220107	0027	1	F	Updating aspects and terminology related to MBS session creation and MC traffic transmission	18.1.0
2022-03	SA#95-e	SP-220107	0028	1	F	Updating the MBS session release related terminology and aspects	18.1.0
2022-03	SA#95-e	SP-220107	0029	1	F	Minor corrections to the procedures related to MBS session creation	18.1.0
2022-03	SA#95-e	SP-220107	0030		B	EPS interworking requirements	18.1.0
2022-03	SA#95-e	SP-220107	0031		B	MC services over 5GS supporting EPS interworking	18.1.0
2022-03	SA#95-e	SP-220107	0032		B	Network notifications for EPS interworking related events	18.1.0
2022-03	SA#95-e	SP-220107	0033		C	Update to inter-system switching between 5G MBS and eMBMS procedures	18.1.0
2022-03	SA#95-e	SP-220107	0034	2	C	Clean up of EPS-5GMBS interworking	18.1.0
2022-03	SA#95-e	SP-220107	0035	2	C	Clean up of switching between unicast and 5G MBS, between LTE eMBMS and 5G MBS	18.1.0
2022-03	SA#95-e	SP-220107	0036	1	C	Enhanced MCPTT group call setup procedure with 5MBS session	18.1.0
2022-03	SA#95-e	SP-220107	0037	1	C	Information flows for media distribution over 5MBS	18.1.0
2022-03	SA#95-e	SP-220107	0038	1	C	Description of 5G MBS usage for MCData	18.1.0
2022-03	SA#95-e	SP-220107	0039	1	C	Updates to usage of 5MBS for MCVideo	18.1.0
2022-03	SA#95-e	SP-220107	0040	1	F	Corrections to align with SA2 5G MBS specification	18.1.0
2022-03	SA#95-e	SP-220107	0041	1	C	Usage of FEC capabilities	18.1.0
2022-03	SA#95-e	SP-220108	0042	1	B	Architectural model over 5G ProSe	18.1.0
2022-03	SA#95-e	SP-220108	0043	1	B	Off-network functional model over 5G ProSe	18.1.0
2022-03	SA#95-e	SP-220108	0044		B	Off network group communication for MC service	18.1.0
2022-03	SA#95-e	SP-220108	0045	1	B	Off network private communication for MC service	18.1.0
2022-03	SA#95-e	SP-220108	0046	1	B	5G ProSe UE-to-network relay for MC service	18.1.0

2022-03	SA#95-e	SP-220108	0047	2	B	Service continuity with a 5G ProSe UE-to-network relay for MBMS	18.1.0
2022-06	SA#96	SP-220480	0048	1	C	Clarifications related to multi carrier support for MBS session creation and announcement	18.2.0
2022-06	SA#96	SP-220480	0049	1	B	Clarifications related to multi carrier support for MBS session update	18.2.0
2022-06	SA#96	SP-220479	0050	1	C	Update to service continuity procedure from an MBS session to 5G ProSe UE-to-network relay	18.2.0
2022-06	SA#96	SP-220479	0051	1	C	Update to service continuity procedure from 5G ProSe UE-to-network relay to an MBS session	18.2.0
2022-06	SA#96	SP-220479	0052	1	B	Requirements related to 5G ProSe Layer-3 relaying via N3IWF	18.2.0
2022-06	SA#96	SP-220476	0053		F	Corrections to the use of MC service system	18.2.0
2022-06	SA#96	SP-220480	0054		F	Corrections in MBS UE session join notification	18.2.0
2022-06	SA#96	SP-220480	0055		D	Small editorial corrections	18.2.0
2022-06	SA#96	SP-220480	0056	1	B	Update to 5G MBS service announcement	18.2.0
2022-06	SA#96	SP-220480	0057	1	F	Update to broadcast MBS sessions monitoring and the reception quality of the MBS session	18.2.0
2022-06	SA#96	SP-220480	0058		F	Resolve the EN about architecture and reference alignment in clause 4.7.1	18.2.0
2022-06	SA#96	SP-220480	0059	1	C	Resolve the EN in clause 5.2	18.2.0
2022-06	SA#96	SP-220480	0060	1	C	Resolve the EN on SA4 aspect	18.2.0
2022-06	SA#96	SP-220480	0064	3	F	Architectural and functional model for 5G MBS mission critical UE	18.2.0
2022-06	SA#96	SP-220480	0067	1	F	Rename "MBS service announcement" to "MBS session announcement" for self consistency in the spec	18.2.0
2022-06	SA#96	SP-220480	0068	2	B	Group communication connect and disconnect over 5G MBS for MCData	18.2.0
2022-06	SA#96	SP-220475	0069	1	A	Updating network slicing requirements for MC services	18.2.0
2022-06	SA#96	SP-220480	0071	1	C	Including MBS FSA ID into the location information report	18.2.0
2022-06	SA#96	SP-220480	0073		C	Removing unicast bearer status from eMBMS bearer information	18.2.0
2022-06	SA#96	SP-220480	0074		F	Add MBS service announcement acknowledge	18.2.0
2022-06	SA#96	SP-220480	0075	1	F	Clarification on GC1 in clause 4.7	18.2.0
2022-06	SA#96	SP-220480	0076	1	F	Format corrections to clause 7.3.2.9	18.2.0
2022-06	SA#96	SP-220480	0077	1	F	UE session join notification message name alignment	18.2.0
2022-06	SA#96	SP-220480	0078	1	F	Update to de-announcement	18.2.0
2022-09	SA#97-e	SP-220929	0079		F	Various textual fixes in 23.289 v 18.2.0	18.3.0
2022-09	SA#97-e	SP-220929	0080	1	C	Updating the general architecture of MBS system	18.3.0
2022-09	SA#97-e	SP-220929	0081	1	F	Clarification on MBS capable RAT usage	18.3.0
2022-09	SA#97-e	SP-220929	0082	1	F	Adding SCEF+NEF deployment option	18.3.0
2022-09	SA#97-e	SP-220929	0083	2	F	Clarification on MBS QoS	18.3.0
2022-09	SA#97-e	SP-220929	0084	2	F	Corrections to inter-RAT change report via LMC and LMS	18.3.0
2022-09	SA#97-e	SP-220929	0086	1	F	Message name corrections to clause 7.3.3.6.2	18.3.0
2022-09	SA#97-e	SP-220929	0087		F	Configurations for MC over 5G Prose	18.3.0
2022-09	SA#97-e	SP-220929	0088	1	F	Clarifications on UE's MBMS/MBS capabilities	18.3.0
2022-09	SA#97-e	SP-220929	0089	1	F	Adding references to 3GPP TS 26.502	18.3.0
2022-09	SA#97-e	SP-220929	0090	1	C	Correcting MBS session ID types	18.3.0
2022-09	SA#97-e	SP-220929	0091	1	F	Update the scope clause with reference to 5G network architecture specs	18.3.0
2022-12	SA#98-e	SP-221248	0092	1	F	N5 descriptions update for MBS	18.4.0
2022-12	SA#98-e	SP-221248	0093	1	F	Added additional subclause for switching from MBS session to unicast bearer for MCPTT	18.4.0
2022-12	SA#98-e	SP-221248	0094		F	Corrections to reference point usage in switching from MBS session to unicast bearer for MCData	18.4.0
2022-12	SA#98-e	SP-221248	0095		F	Title correction and use of group communication connect & disconnect clarification in MCData	18.4.0
2023-03	SA#99	SP-230291	0096	1	F	MBS session identity corrections	18.5.0
2023-03	SA#99	SP-230291	0097	2	F	Clarification on MBS service area in pre-conditions	18.5.0
2023-03	SA#99	SP-230291	0098	2	F	Clarification on the unicast delivery stop after MBS delivery	18.5.0
2023-03	SA#99	SP-230291	0100	1	F	Correction for usage of term MCX to MC service	18.5.0
2023-06	SA#100	SP-230703	0101	1	C	Add 5G NR Cell Global Identifier (NCGI) to Location Information Element	18.6.0
2023-09	SA#101	SP-231006	0104		F	Add 5G NR Cell Global Identifier (NCGI) to Location Information Element	18.7.0
2023-09	SA#101	SP-231006	0105	2	F	Resolve the ENs about NPN utilization	18.7.0
2023-09	SA#101	SP-231006	0107	2	F	Support of multicast MBS data reception in RRC inactive state	18.7.0
2024-03	SA#103	SP-240306	0113	1	F	Alignments of 23.289 Rel-18 with other specs	18.8.0
2024-06	SA#104	SP-240759	0118	1	F	Including NID in the MBS session announcement	18.9.0

---

# History

<b>Document history</b>		
V18.8.0	April 2024	Publication
V18.9.0	July 2024	Publication