

ETSI TS 123 333 V18.1.0 (2024-07)



**Digital cellular telecommunications system (Phase 2+) (GSM);
Universal Mobile Telecommunications System (UMTS);
LTE;
Multimedia Resource Function Controller (MRFC)
- Multimedia Resource Function Processor (MRFP)
Mp interface: Procedures descriptions
(3GPP TS 23.333 version 18.1.0 Release 18)**



Reference

RTS/TSGC-042333vi10

Keywords

GSM,LTE,UMTS

ETSI

650 Route des Lucioles
F-06921 Sophia Antipolis Cedex - FRANCE

Tel.: +33 4 92 94 42 00 Fax: +33 4 93 65 47 16

Siret N° 348 623 562 00017 - APE 7112B
Association à but non lucratif enregistrée à la
Sous-Préfecture de Grasse (06) N° w061004871

Important notice

The present document can be downloaded from the
ETSI [Search & Browse Standards application](#).

The present document may be made available in electronic versions and/or in print. The content of any electronic and/or print versions of the present document shall not be modified without the prior written authorization of ETSI. In case of any existing or perceived difference in contents between such versions and/or in print, the prevailing version of an ETSI deliverable is the one made publicly available in PDF format on [ETSI deliver](#).

Users should be aware that the present document may be revised or have its status changed,
this information is available in the [Milestones listing](#).

If you find errors in the present document, please send your comments to
the relevant service listed under [Committee Support Staff](#).

If you find a security vulnerability in the present document, please report it through our
[Coordinated Vulnerability Disclosure \(CVD\)](#) program.

Notice of disclaimer & limitation of liability

The information provided in the present deliverable is directed solely to professionals who have the appropriate degree of experience to understand and interpret its content in accordance with generally accepted engineering or other professional standard and applicable regulations.

No recommendation as to products and services or vendors is made or should be implied.

No representation or warranty is made that this deliverable is technically accurate or sufficient or conforms to any law and/or governmental rule and/or regulation and further, no representation or warranty is made of merchantability or fitness for any particular purpose or against infringement of intellectual property rights.

In no event shall ETSI be held liable for loss of profits or any other incidental or consequential damages.

Any software contained in this deliverable is provided "AS IS" with no warranties, express or implied, including but not limited to, the warranties of merchantability, fitness for a particular purpose and non-infringement of intellectual property rights and ETSI shall not be held liable in any event for any damages whatsoever (including, without limitation, damages for loss of profits, business interruption, loss of information, or any other pecuniary loss) arising out of or related to the use of or inability to use the software.

Copyright Notification

No part may be reproduced or utilized in any form or by any means, electronic or mechanical, including photocopying and microfilm except as authorized by written permission of ETSI.

The content of the PDF version shall not be modified without the written authorization of ETSI.

The copyright and the foregoing restriction extend to reproduction in all media.

© ETSI 2024.
All rights reserved.

Intellectual Property Rights

Essential patents

IPRs essential or potentially essential to normative deliverables may have been declared to ETSI. The declarations pertaining to these essential IPRs, if any, are publicly available for **ETSI members and non-members**, and can be found in ETSI SR 000 314: "*Intellectual Property Rights (IPRs); Essential, or potentially Essential, IPRs notified to ETSI in respect of ETSI standards*", which is available from the ETSI Secretariat. Latest updates are available on the ETSI Web server (<https://ipr.etsi.org/>).

Pursuant to the ETSI Directives including the ETSI IPR Policy, no investigation regarding the essentiality of IPRs, including IPR searches, has been carried out by ETSI. No guarantee can be given as to the existence of other IPRs not referenced in ETSI SR 000 314 (or the updates on the ETSI Web server) which are, or may be, or may become, essential to the present document.

Trademarks

The present document may include trademarks and/or tradenames which are asserted and/or registered by their owners. ETSI claims no ownership of these except for any which are indicated as being the property of ETSI, and conveys no right to use or reproduce any trademark and/or tradename. Mention of those trademarks in the present document does not constitute an endorsement by ETSI of products, services or organizations associated with those trademarks.

DECT™, **PLUGTESTS™**, **UMTS™** and the ETSI logo are trademarks of ETSI registered for the benefit of its Members. **3GPP™** and **LTE™** are trademarks of ETSI registered for the benefit of its Members and of the 3GPP Organizational Partners. **oneM2M™** logo is a trademark of ETSI registered for the benefit of its Members and of the oneM2M Partners. **GSM®** and the GSM logo are trademarks registered and owned by the GSM Association.

Legal Notice

This Technical Specification (TS) has been produced by ETSI 3rd Generation Partnership Project (3GPP).

The present document may refer to technical specifications or reports using their 3GPP identities. These shall be interpreted as being references to the corresponding ETSI deliverables.

The cross reference between 3GPP and ETSI identities can be found under <https://webapp.etsi.org/key/queryform.asp>.

Modal verbs terminology

In the present document "**shall**", "**shall not**", "**should**", "**should not**", "**may**", "**need not**", "**will**", "**will not**", "**can**" and "**cannot**" are to be interpreted as described in clause 3.2 of the [ETSI Drafting Rules](#) (Verbal forms for the expression of provisions).

"**must**" and "**must not**" are **NOT** allowed in ETSI deliverables except when used in direct citation.

Contents

Intellectual Property Rights	2
Legal Notice	2
Modal verbs terminology.....	2
Foreword.....	9
1 Scope	11
2 References	11
3 Definitions, symbols and abbreviations	14
3.1 Definitions	14
3.2 Symbols.....	14
3.3 Abbreviations	15
4 Architecture.....	16
5 Functional Requirements.....	17
5.1 General	17
5.2 Play Tone.....	17
5.3 Play Announcement	17
5.4 Text to Speech	18
5.5 Audio Record	18
5.6 DTMF Collection	19
5.7 Automatic Speech Recognition	19
5.8 Play Multimedia	20
5.8.1 General Play Multimedia	20
5.8.2 Play Message	20
5.9 Multimedia Record.....	21
5.9.1 General Multimedia Record.....	21
5.9.2 Message Record.....	21
5.10 Audio Conference.....	21
5.11 Multimedia Conference	22
5.11.1 General Multimedia Conferencing.....	22
5.11.2 Message Conferencing.....	22
5.11.3 Multi-stream Multiparty Conferencing Media Handling	23
5.11.3.1 Introduction	23
5.11.3.2 General MMCMH requirements	24
5.11.3.3 Negotiation in "dial-in" scenario.....	25
5.11.3.4 Negotiation in "dial-out" scenario.....	27
5.11.3.5 MMCMH handling at MRFP	30
5.12 Audio Transcoding	32
5.12.1 General.....	32
5.12.2 Handling of common codec parameters.....	32
5.12.3 Handling of the EVS speech codec.....	33
5.12.4 Handling of the IVAS speech codec	45
5.13 Video Transcoding	59
5.14 Floor Control Service Requirement.....	59
5.14.1 General.....	59
5.14.2 Architecture	59
5.14.3 Services Requirements.....	60
5.14.4 Information Flows	60
5.14.4.1 User requesting the Floor during a conference.....	60
5.14.4.2 User releasing the Floor during a conference.....	62
5.14.5 Requirements on Mp interface.....	62
5.14.5.1 Requirements for MRFP based FCS	62
5.15 Explicit Congestion Notification Service Requirement.....	63
5.15.1 General.....	63
5.16 Multimedia Priority Service (MPS) Support	63

5.17	Coordination of Video Orientation.....	64
5.18	Generic image attributes.....	65
5.19	Interactive Connectivity Establishment support.....	66
5.19.1	General.....	66
5.19.2	ICE lite.....	67
5.19.3	Full ICE.....	68
5.20	IMS Media Plane Security.....	70
5.20.1	General.....	70
5.20.2	End-to-end security for TCP-based media using TLS.....	70
5.20.3	Specific requirements for session based messaging (MSRP).....	71
5.20.4	Specific requirements for conferencing (BFCP).....	72
5.21	TCP bearer connection control.....	72
5.22	Support of Telepresence.....	73
5.22.1	General.....	73
5.22.2	Characteristics of the Telepresence support.....	73
5.22.3	CLUE data channel establishment.....	74
5.22.4	Release of CLUE data channel.....	75
5.22.5	CLUE transport between MRFC and MRFP.....	75
5.23	SDP Capability Negotiation (SDPCapNeg).....	76
5.24	Video Region-of-Interest (ROI).....	76
5.24.1	General.....	76
5.24.2	"Far End Camera Control" mode.....	77
5.24.3	"Predefined ROI" mode.....	78
5.24.4	"Arbitrary ROI" mode.....	79
5.25	Rate adaptation for media endpoints.....	80
5.26	RTCP Codec Control Commands and Indications.....	81
5.27	Delay Budget Information (DBI).....	82
6	MRFC-MRFP Procedures.....	83
6.1	Non-Call Related Procedures.....	83
6.1.1	General.....	83
6.1.2	MRFP Unavailable.....	83
6.1.3	MRFP Available.....	84
6.1.4	MRFP Recovery.....	85
6.1.5	MRFC Recovery.....	86
6.1.5.1	General.....	86
6.1.5.2	MRFC Restoration.....	86
6.1.6	MRFP Re-register.....	86
6.1.7	MRFP Re-registration Ordered by MRFC.....	87
6.1.8	Audit of MRFP.....	87
6.1.8.1	Audit of Value.....	87
6.1.8.2	Audit of Capability.....	87
6.1.9	MRFP Capability Change.....	88
6.1.10	MRFC Out of service.....	88
6.1.11	MRFP Resource Congestion Handling – Activate.....	88
6.1.12	MRFP Resource Congestion Handling -Indication.....	89
6.1.13	Hanging termination detection.....	89
6.2	Call Related Procedures.....	90
6.2.1	Play Tone Procedure.....	90
6.2.1.1	General.....	90
6.2.1.2	Send tone.....	90
6.2.1.3	Stop tone.....	90
6.2.1.4	Tone completed.....	90
6.2.1.5	Message sequence chart.....	90
6.2.2	Play Announcement Procedure.....	91
6.2.2.1	General.....	91
6.2.2.2	Start announcement.....	91
6.2.2.3	Stop announcement.....	92
6.2.2.4	Announcement completed.....	92
6.2.2.5	Message sequence chart.....	92
6.2.3	Text to Speech Procedure.....	93
6.2.3.1	General.....	93

6.2.3.2	Start TTS	93
6.2.3.3	Stop TTS	94
6.2.3.4	TTS Completed	94
6.2.3.5	Message sequence chart	94
6.2.4	Audio Record Procedure.....	95
6.2.4.1	General	95
6.2.4.2	Start audio record	95
6.2.4.3	Stop audio record	95
6.2.4.4	Audio record completed	95
6.2.4.5	Message sequence chart	95
6.2.5	DTMF Collection Procedure.....	96
6.2.6	Automatic Speech Recognition Procedure	97
6.2.6.1	General	97
6.2.6.2	Start ASR	97
6.2.6.3	Stop ASR	98
6.2.6.4	ASR Completed	98
6.2.6.5	Message sequence chart	98
6.2.7	Play Multimedia Procedure	99
6.2.7.1	General	99
6.2.7.2	H.248 context model	99
6.2.7.3	Start playing multimedia	100
6.2.7.4	Stop playing multimedia	100
6.2.7.5	Playing multimedia completed.....	100
6.2.7.6	Message sequence chart	100
6.2.7.7	Start playing message.....	101
6.2.7.8	Stop playing message	101
6.2.7.9	Playing message completed	102
6.2.7.10	Message sequence chart	102
6.2.8	Multimedia Record Procedure	102
6.2.8.1	General	102
6.2.8.2	H.248 context model	103
6.2.8.3	Start multimedia Record	103
6.2.8.4	Stop multimedia record	103
6.2.8.5	Multimedia record Completed	103
6.2.8.6	Message sequence chart	104
6.2.8.7	Start Message Record.....	104
6.2.8.8	Stop Message record	105
6.2.8.9	Message record Completed	105
6.2.8.10	Message sequence chart	105
6.2.9	Audio Conference Procedure.....	106
6.2.9.1	Context Model.....	106
6.2.9.2	Ad-hoc Conferences.....	106
6.2.9.2.1	General	106
6.2.9.2.2	Create Ad-hoc Audio Conference Procedure	106
6.2.9.2.3	Closure of Audio Conference Procedure	107
6.2.9.2.4	Add Subsequent User to Conference; Dial-out.....	107
6.2.9.2.5	Add subsequent user to conference; Dial-in	108
6.2.9.2.6	Remove Conference Participant Procedure	109
6.2.10	Multimedia Conference Procedures.....	110
6.2.10.1	Context Model.....	110
6.2.10.2	Ad-hoc Conferences.....	110
6.2.10.2.1	General	110
6.2.10.2.2	Create Ad-hoc Multimedia Conference Procedure.....	110
6.2.10.2.3	Closure of Multimedia Conference Procedure	111
6.2.10.2.4	Add Subsequent User to Conference; Dial-out.....	111
6.2.10.2.5	Add subsequent user to conference; Dial-in	112
6.2.10.2.6	Remove Conference Participant Procedure	113
6.2.10.2.7	Create Ad-hoc Multi-stream Multiparty Conference Procedure.....	114
6.2.10.2.7.1	Context Model	114
6.2.10.2.7.2	MMCMH conference establishment procedure using "dial-in" method	115
6.2.10.3	Message Conferencing.....	120
6.2.10.3.1	General	120

6.2.10.3.2	Messages Statistics	121
6.2.10.3.3	Message Filtering	123
6.2.11	Audio Transcoding Procedure	124
6.2.12	Video Transcoding Procedure.....	124
6.2.13	Floor Control	124
6.2.13.1	General	124
6.2.13.2	Floor Control within the MRFP	125
6.2.13.2.1	Floor Control Connection Establishment	125
6.2.13.2.2	Configure Conference and Floor Control Policy Indication	125
6.2.13.2.3	Floor Chair Designation	126
6.2.13.2.4	Floor Request Decision	127
6.2.13.2.5	Media Update and Confirmation	128
6.2.13.2.6	Floor Control Procedure	129
6.2.13.2.7	Floor Control Connection Release.....	129
6.2.13.2.8	Example Message sequence chart	129
6.2.14	Explicit Congestion Notification Support.....	131
6.2.14.1	General	131
6.2.14.2	Message sequence chart, Request ECN	131
6.2.14.3	Message sequence chart, Report ECN Failure Event.....	132
6.2.15	Multimedia Priority Service Congestion Control Procedures.....	132
6.2.15.1	General	132
6.2.15.2	MRFP Resource Congestion in ADD response, request is queued	133
6.2.15.3	MRFP Resource Congestion in ADD response, MRFC seizes new MRFP	133
6.2.15.4	MRFP Priority Resource Allocation	133
6.2.15.5	MRFP Priority User Data marking	134
6.2.16	Coordination of Video Orientation	134
6.2.17	Support of generic image attributes	135
6.2.17.1	General	135
6.2.17.2	Indication of generic image attributes	135
6.2.18	Interactive Connectivity Establishment Support.....	136
6.2.18.1	ICE lite	136
6.2.18.2	Full ICE.....	136
6.2.18.3	Connectivity check result notification (full ICE)	137
6.2.18.4	New peer reflexive candidate notification (full ICE)	138
6.2.19	End-to-end security for TCP based media using TLS	138
6.2.19.1	General	138
6.2.19.2	Specific procedures for session based messaging (MSRP)	138
6.2.19.2.1	IMS UE originating procedures ("dial-in" scenario) for e2e	138
6.2.19.2.2	IMS UE terminating procedures ("dial-out" scenario) for e2e	140
6.2.19.3	Specific procedures for Floor Control Service (BFCP)	142
6.2.19.3.1	IMS UE requesting e2e protected Floor control connection	142
6.2.19.4	TLS session establishment Failure Indication	144
6.2.20	TCP bearer connection control	144
6.2.20.1	TCP connection establishment	144
6.2.20.2	TCP connection establishment Failure Indication.....	146
6.2.21	Telepresence Procedures.....	146
6.2.21.1	CLUE data channel establishment	146
6.2.21.2	CLUE transport between MRFC and MRFP	148
6.2.22	Video Region-of-Interest (ROI).....	149
6.2.22.1	Video Region-of-Interest (ROI) using FECC.....	149
6.2.22.2	"Predefined ROI" mode	149
6.2.22.3	"Arbitrary ROI" mode.....	150
6.2.23	Rate adaptation for media endpoints.....	150
6.2.24	RTCP Codec Control Commands and Indications.....	153
6.2.25	Delay Budget Information (DBI).....	154
7	Charging.....	155
8	Messages/Procedures and contents	155
8.1	General	155
8.2	Send tone	156
8.3	Stop tone.....	156

8.4	Tone completed	157
8.5	Start announcement	157
8.6	Stop Announcement	158
8.7	Announcement Completed	158
8.8	Start audio record	158
8.9	Stop audio record.....	159
8.10	Audio record completed	159
8.11	Detect DTMF	160
8.12	Stop DTMF Detection	160
8.13	Report DTMF.....	161
8.14	Start playing multimedia	161
8.15	Stop playing multimedia	162
8.16	Playing multimedia completed	162
8.17	Start multimedia record	162
8.18	Stop multimedia record	163
8.19	Multimedia record completed.....	163
8.20	Reserve and Configure IMS Resources.....	165
8.21	Reserve IMS Resources Procedure.....	172
8.22	Configure IMS Resources Procedure	178
8.23	Release IMS Termination.....	183
8.24	Start TTS	183
8.25	Stop TTS	184
8.26	TTS Completed	184
8.27	Start ASR.....	184
8.28	Stop ASR.....	185
8.29	ASR completed	185
8.30	MRFP Out-of-Service or Maintenance Locked.....	186
8.31	MRFP Communication Up.....	186
8.32	MRFP Restoration	187
8.33	MRFC Restoration	187
8.34	MRFP Re-register.....	188
8.35	MRFC Re-registration Ordered by MRFC	188
8.36	Audit Value	189
8.37	Audit Capability	189
8.38	Capability Update.....	190
8.39	MRFC Out of Service.....	190
8.40	MRFP Resource Congestion Handling - Activate	191
8.41	MRFP Resource Congestion Handling - Indication	191
8.42	Command Reject	192
8.43	Termination heartbeat indication.....	192
8.44	Configure BFCP Termination	192
8.45	Configure Conference For Floor Control	193
8.46	Designate Floor Chair	194
8.47	Floor Request Decision	194
8.48	Report Floor Request Decision	195
8.49	Confirm Media Update.....	195
8.50	Configure Granted Quota	196
8.51	Report Message Statistics.....	196
8.52	Configure Filtering Rules	197
8.53	Start message record.....	198
8.54	Stop message record.....	198
8.55	Message record completed	198
8.56	Start playing message	199
8.57	Stop playing message	199
8.58	Playing message completed.....	200
8.59	Modify Media.....	200
8.60	ECN Failure Indication	201
8.61	ICE Connectivity Check Result Notification	202
8.62	ICE New Peer Reflexive Candidate Notification	202
8.63	Notify TCP connection establishment Failure Indication.....	203
8.64	Notify TLS session establishment Failure Indication.....	203
8.65	CLUE Message Send.....	204

8.66 CLUE Message Received Notification.....204

Annex A (informative): Change history205

History207

Foreword

This Technical Specification has been produced by the 3rd Generation Partnership Project (3GPP).

The contents of the present document are subject to continuing work within the TSG and may change following formal TSG approval. Should the TSG modify the contents of the present document, it will be re-released by the TSG with an identifying change of release date and an increase in version number as follows:

Version x.y.z

where:

- x the first digit:
 - 1 presented to TSG for information;
 - 2 presented to TSG for approval;
 - 3 or greater indicates TSG approved document under change control.
- y the second digit is incremented for all changes of substance, i.e. technical enhancements, corrections, updates, etc.
- z the third digit is incremented when editorial only changes have been incorporated in the document.

In the present document, modal verbs have the following meanings:

- shall** indicates a mandatory requirement to do something
- shall not** indicates an interdiction (prohibition) to do something

The constructions "shall" and "shall not" are confined to the context of normative provisions, and do not appear in Technical Reports.

The constructions "must" and "must not" are not used as substitutes for "shall" and "shall not". Their use is avoided insofar as possible, and they are not used in a normative context except in a direct citation from an external, referenced, non-3GPP document, or so as to maintain continuity of style when extending or modifying the provisions of such a referenced document.

- should** indicates a recommendation to do something
- should not** indicates a recommendation not to do something
- may** indicates permission to do something
- need not** indicates permission not to do something

The construction "may not" is ambiguous and is not used in normative elements. The unambiguous constructions "might not" or "shall not" are used instead, depending upon the meaning intended.

- can** indicates that something is possible
- cannot** indicates that something is impossible

The constructions "can" and "cannot" are not substitutes for "may" and "need not".

- will** indicates that something is certain or expected to happen as a result of action taken by an agency the behaviour of which is outside the scope of the present document
- will not** indicates that something is certain or expected not to happen as a result of action taken by an agency the behaviour of which is outside the scope of the present document
- might** indicates a likelihood that something will happen as a result of action taken by some agency the behaviour of which is outside the scope of the present document

might not indicates a likelihood that something will not happen as a result of action taken by some agency the behaviour of which is outside the scope of the present document

In addition:

is (or any other verb in the indicative mood) indicates a statement of fact

is not (or any other negative verb in the indicative mood) indicates a statement of fact

The constructions "is" and "is not" do not indicate requirements.

1 Scope

This specification describes the functional requirements and information flows that generate procedures between the Multimedia Resource Function Controller (MRFC) and the Multimedia Resource Function Processor (MRFP), the Mp Interface.

This specification is limited to information flows relevant to the Mp Interface; in order to define these procedures and make the functional requirements clear some triggers from an external interface may be described; these may be specified within the Mr interface for example or within an AS in which the MRFC function resides. However for the overall stage 2 procedures of IMS see 3GPP TS 23.228 [1].

The protocol on the Mp interface is defined to comply with ITU-T H.248.1 Gateway Control Protocol; see [3]. The goal of this specification is to provide the input to defining a formal Profile within the H.248 protocol toolbox specifically for the Mp application.

2 References

The following documents contain provisions which, through reference in this text, constitute provisions of the present document.

- References are either specific (identified by date of publication, edition number, version number, etc.) or non-specific.
- For a specific reference, subsequent revisions do not apply.
- For a non-specific reference, the latest version applies. In the case of a reference to a 3GPP document (including a GSM document), a non-specific reference implicitly refers to the latest version of that document *in the same Release as the present document*.

- [1] 3GPP TS 23.228: "IP Multimedia Subsystem (IMS); Stage 2".
- [2] 3GPP TS 23.002: "Network architecture".
- [3] ITU-T Recommendation H.248.1 (05/2002), Gateway control protocol: Version 2 + Corrigendum 1 (03/2004) and ITU-T Recommendation H.248.1 (09/2005), Gateway control protocol: Version 3 for Floor Control requirements.
- [4] 3GPP TS 24.147: "Conferencing using the IP Multimedia (IM) Core Network (CN) subsystem; Stage 3".
- [5] 3GPP TS 26.244: "Transparent end-to-end packet switched streaming service (PSS); 3GPP file format (3GP)".
- [6] 3GPP TR 21.905: "Vocabulary for 3GPP Specifications".
- [7] 3GPP TS 23.205: "Bearer independent circuit-switched core network; Stage 2".
- [8] Void.
- [9] 3GPP TS 29.163: "Interworking between the IP Multimedia (IM) Core Network (CN) subsystem and Circuit Switched (CS) networks".
- [10] IETF RFC 2833: "RTP Payload for DTMF Digits, Telephony Tones and Telephony Signals".
- [11] W3C Recommendation (September 2004): "Speech Synthesis Markup Language (SSML) Version 1.0".
- [12] W3C Recommendation (September 2004): "Speech Recognition Grammar Specification (SRGS) Version 1.0".
- [13] W3C Recommendation (September 2005): "Extensible MultiModal Annotation markup language (EMMA) (draft work in progress)".

- [14] 3GPP TS 32.260: "Telecommunication management; Charging management; IP Multimedia Subsystem (IMS) charging".
- [15] W3C Recommendation (November 2000): "Natural Language Semantics Markup Language (NLSML) for the Speech Interface Framework".
- [16] 3GPP TS 29.333: "Multimedia Resource Function Controller (MRFC) – Multimedia Resource Function Processor (MRFP) Mp Interface - Stage 3".
- [17] 3GPP TS 24.247: "Messaging service using the IP Multimedia (IM) Core Network (CN) subsystem - Stage 3".
- [18] IETF RFC 4975: "The Message Session Relay Protocol (MSRP)".
- [19] IETF RFC 4376: "Requirements for Floor Control Protocols".
- [20] IETF RFC 4582: "The Binary Floor Control Protocol (BFCP)".
- [21] IETF RFC 4583: "Session Description Protocol (SDP) Format for Binary Floor Control Protocol (BFCP) Streams".
- [22] 3GPP TS 26.140: "Multimedia Messaging Service; Media formats and codecs".
- [23] 3GPP TS 26.114: "IP Multimedia Subsystem (IMS); Multimedia Telephony; Media handling and interaction".
- [24] IETF RFC 3168: "The Addition of Explicit Congestion Notification (ECN) to IP".
- [25] IETF RFC 6679: "Explicit Congestion Notification (ECN) for RTP over UDP".
- [26] 3GPP TS 22.153: "Multimedia Priority Service".
- [27] IETF RFC 5285: "A General Mechanism for RTP Header Extensions".
- [28] IETF RFC 6236: "Negotiation of Generic Image Attributes in the Session Description Protocol (SDP)".
- [29] Void.
- [30] 3GPP TS 24.229: "IP Multimedia Call Control Protocol based on SIP and SDP".
- [31] 3GPP TS 33.328: "IMS Media Plane Security".
- [32] Void.
- [33] IETF RFC 6043: "MIKEY-TICKET: Ticket-Based Modes of Key Distribution in Multimedia Internet KEYing (MIKEY)".
- [34] IETF RFC 4279: "Pre-Shared Key Ciphersuites for Transport Layer Security (TLS)".
- [35] IETF RFC 4567: "Key Management Extensions for Session Description Protocol (SDP) and Real Time Streaming Protocol (RTSP)".
- [36] IETF RFC 4145: "TCP-Based Media Transport in the Session Description Protocol (SDP)".
- [37] IETF RFC 3830: "MIKEY: Multimedia Internet KEYing".
- [38] IETF RFC 793: "Transmission Control Protocol – DARPA Internet Program – Protocol Specification".
- [39] IETF RFC 8122: "Connection-Oriented Media Transport over the Transport Layer Security (TLS) Protocol in the Session Description Protocol (SDP)".
- [40] IETF RFC 6714: "Connection Establishment for Media Anchoring (CEMA) for the Message Session Relay Protocol (MSRP)".

- [41] 3GPP TS 23.334: "IMS Application Level Gateway (IMS-ALG) – IMS Access Gateway (IMS-AGW) interface: Procedures Descriptions".
- [42] 3GPP TS 26.441: "Codec for Enhanced Voice Services (EVS); General Overview".
- [43] 3GPP TS 26.445: "Codec for Enhanced Voice Services (EVS); Detailed Algorithmic Description".
- [44] IETF RFC 4566: "SDP: Session Description Protocol".
- [45] IETF RFC 4867: "RTP Payload Format and File Storage Format for the Adaptive Multi-Rate (AMR) and Adaptive Multi-Rate Wideband (AMR-WB) Audio Codecs".
- [46] IETF RFC 5746: "Transport Layer Security (TLS) Renegotiation Indication Extension".
- [47] 3GPP TS 33.310: "Network Domain Security (NDS); Authentication Framework (AF)".
- [48] IETF RFC 8841: "Session Description Protocol (SDP) Offer/Answer Procedures for Stream Control Transmission Protocol (SCTP) over Datagram Transport Layer Security (DTLS) Transport".
- [49] IETF RFC 8850: "Controlling Multiple Streams for Telepresence (CLUE) Protocol Data Channel".
- [50] IETF RFC 8864: "Negotiation Data Channels Using the Session Description Protocol (SDP)".
- [51] IETF RFC 6525: "Stream Control Transmission Protocol (SCTP) Stream Reconfiguration".
- [52] 3GPP TS 24.103: "Telepresence using the IP Multimedia (IM) Core Network (CN) Subsystem (IMS); Stage 3".
- [53] IETF RFC 5939: "Session Description Protocol (SDP) Capability Negotiation".
- [54] IETF RFC 4573: "MIME Type Registration for RTP Payload Format for H.224".
- [55] ITU-T Recommendation H.224 (01/2005): "A real time control protocol for simplex applications using the H.221 LSD/HSD/MLP channels".
- [56] ITU-T Recommendation H.281 (11/1994): "A far end camera control protocol for videoconferences using H.224".
- [57] IETF RFC 8853: "Using Simulcast in Session Description Protocol (SDP) and RTP Session".
- [58] IETF RFC 8851: "RTP Payload Format Restrictions".
- [59] IETF RFC 4796: "The Session Description Protocol (SDP) Content Attribute".
- [60] IETF RFC 4585: "Extended RTP Profile for Real-time Transport Control Protocol (RTCP)-Based Feedback (RTP/AVPF)".
- [61] IETF RFC 5104: "Codec Control Messages in the RTP Audio-Visual Profile with Feedback (AVPF)".
- [62] IETF RFC 7728: "RTP Stream Pause and Resume".
- [63] IETF RFC 3840: "Indicating User Agent Capabilities in the Session Initiation Protocol (SIP)".
- [64] IETF RFC 4574: "The Session Description Protocol (SDP) Label Attribute".
- [65] IETF RFC 8842: "Session Description Protocol (SDP) Offer/Answer Considerations for Datagram Transport Layer Security (DTLS) and Transport Layer Security (TLS)".
- [66] IETF RFC 8445: "Interactive Connectivity Establishment (ICE): A Protocol for Network Address Translator (NAT) Traversal".
- [67] IETF RFC 8839: "Session Description Protocol (SDP) Offer/Answer Procedures for Interactive Connectivity Establishment (ICE)".

- [68] 3GPP TS 26.250: "Codec for Immersive Voice and Audio Services; General overview".
- [69] 3GPP TS 26.253: "Codec for Immersive Voice and Audio Services; Detailed Algorithmic Description incl. RTP payload format and SDP parameter definitions".

3 Definitions, symbols and abbreviations

3.1 Definitions

For the purposes of the present document, the terms and definitions given in 3GPP TR 21.905 [6] and the following apply. A term defined in the present document takes precedence over the definition of the same term, if any, in 3GPP TR 21.905 [6].

- CLUE:** The acronym for "ControlLing mUltiple streams for tElepresence", which is the name of the IETF working group in which the requirements and protocol for telepresence are developed. CLUE-something refers to something that has been designed by the IETF CLUE working group, e.g. CLUE protocol and CLUE data channel.
- End-to-end security:** media protection between the IMS UE and the MRFP without being terminated by any intermediary node.
- Full ICE:** The full implementation of the Interactive Connectivity Establishment (ICE) specified in IETF RFC 8445 [66].
- ICE lite:** The lite implementation of the Interactive Connectivity Establishment (ICE) specified in IETF RFC 8445 [66].
- Media Gateway:** See Recommendation H.248.1 [3].
- Media Gateway Controller:** See Recommendation H.248.1 [3].
- Multimedia Resource Function Controller:** See 3GPP TS 23.228 [1].
- Multimedia Resource Function Processor:** See 3GPP TS 23.228 [1].

For the purposes of the present document, the following terms and definitions given in IETF RFC 3830 [37] apply:

- Crypto Session (CS)**
Initiator
Responder

For the purposes of the present document, the following terms and definitions given in IETF RFC 6043 [33] apply:

- Traffic-Encrypting Key (TEK)**
TEK Generation Key (TGK)
Ticket

For the purposes of the present document, the following terms and definitions given in 3GPP TS 26.114 [23] apply:

- Simulcast**
Simulcast stream
Simulcast format

3.2 Symbols

For the purposes of the present document, the following symbols apply:

- Mr** Interface between the MRFC and S-CSCF
Mp Interface between the MRFC and MRFP
Mb Interface between MRFP and the other bearer entity

3.3 Abbreviations

For the purposes of the present document, the abbreviations given in 3GPP TR 21.905 [6] and the following apply. An abbreviation defined in the present document takes precedence over the definition of the same abbreviation, if any, in 3GPP TR 21.905 [6].

AMR	Adaptive Multi-Rate
AMR-WB	Adaptive Multi-Rate - WideBand
AMR-WB IO	Adaptive Multi-Rate - WideBand Inter-operable Mode, included in the EVS and IVAS codecs
APP	APPLICATION-defined RTCP packet
ASR	Automatic Speech Recognition
BFCP	Binary Floor Control Protocol
CCM	Codec Control Messages
CS	Crypto Session
CVO	Coordination of Video Orientation
DBI	Delay Budget Information
DTMF	Dual Tone Multi Frequency
DTLS	Datagram Transport Layer Security
DTX	Discontinuous Transmission
e2e	End-to-end
ECN	Explicit Congestion Notification
ECN-CE	ECN Congestion Experienced
EVS	Enhanced Voice Services
EMMA	Extensible MultiModal Annotation markup language
FECC	Far End Camera Control
FIR	Full Intra Request
ICE	Interactive Connectivity Establishment
IP	Internet Protocol
IVAS	Immersive Voice and Audio Services
KMS	Key Management Service
MGC	Media Gateway Controller
MGW	Media Gateway
MIKEY	Multimedia Internet KEYing
MMCMH	Multi-stream Multiparty Conferencing Media Handling
MPS	Multimedia Priority Service
MRFC	Multimedia Resource Function Controller
MRFP	Multimedia Resource Function Processor
MSRP	Message Session Relay Protocol
NLSML	Natural Language Semantics Markup Language
PI	Processing Information
PSK	Pre-Shared Key
ROI	Region of Interest
RTCP	RTP Control Protocol
RTP	Real-time Transport Protocol
SCTP	Stream Control Transmission Protocol
SDP	Session Description Protocol
SDPCapNeg	SDP Capability Negotiation
SIP	Session Initiation Protocol
SRGS	Speech Recognition Grammar Specification
SSML	Speech Synthesis Markup Language
STUN	Session Traversal Utilities for NAT
TCP	Transmission Control Protocol
TEK	Traffic Encryption Key
TGK	TEK Generation Key
TLS	Transport Layer Security
TMMBN	Temporary Maximum Media Stream Bit Rate Notification
TMMBR	Temporary Maximum Media Stream Bit Rate Request
TP	TelePresence
TTS	Text to Speech
UDP	User Datagram Protocol
URN	Uniform Resource Name

4 Architecture

The architecture concerning the Multimedia Resource Function is presented in Figure 4.1 below.

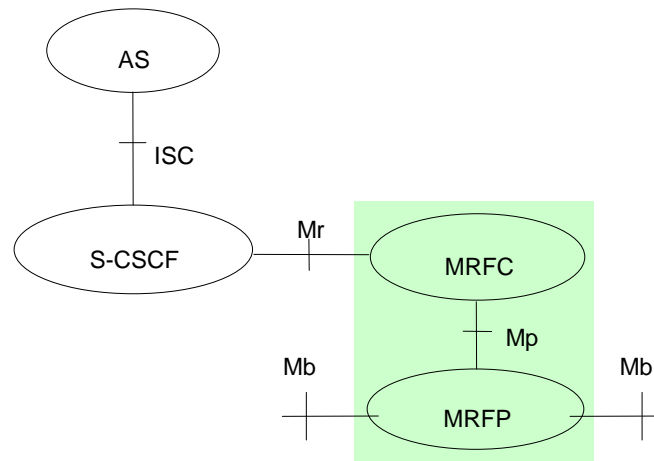

Figure 4.1: Architecture of MRF

The scope of this specification is limited to the area shown within the green shading.

The MRF is split into Multimedia Resource Function Controller (MRFC) and Multimedia Resource Function Processor (MRFP).

Tasks of the MRFC may consist of the following:

- Control the media stream resources in the MRFP.
- Interpret information coming from an AS and S-CSCF (e.g. session identifier) and control MRFP accordingly.
- Generation of CDRs.
- Advanced control of conferences (e.g. floor control)

Tasks of the MRFP may consist of the following:

- Control of the bearer on the Mb reference point.
- Provide resources to be controlled by the MRFC.
- Mixing of incoming media streams (e.g. for multiple parties).
- Media stream source (e.g. for multimedia announcements).
- Media stream processing (e.g. audio transcoding, media analysis).
- Manage access rights to shared resources in a conferencing environment (e.g. floor control).

The Mp reference point allows an MRFC to control media stream resources provided by an MRFP.

5 Functional Requirements

5.1 General

All functions are optional. Within a given function some components and procedures might be optional to still support the function but some will be required. Normative text in the following clauses thus describes requirements for support within an optional feature where it is desired to differentiate between optional and mandatory parts of the feature.

5.2 Play Tone

The MRFC shall request the MRFP to send tones to one, one of several, multiple or all parties connected in a call/session with a given tone identifier for each specific tone.

The MRFC may request the tone to be played continuously until requested to be stopped.

The MRFC may include in the request the length of time that the tone shall be played; the duration may be provisioned.

The MRFC may then request a notification from the MRFP when the tone is completed.

The MRFC may request DTMF detection while playing a tone.

The MRFC may request that upon DTMF detection the MRFP stops playing a tone.

5.3 Play Announcement

The function of playing announcement is to play audio media streams to the subscriber. The function can be used in services such as audio announcements, mail box services, play back recorded audio etc.

The MRFC shall request the MRFP to play announcements to one, one of several, multiple or all parties connected in a call/session.

The announcement may be referenced by identifiers that may be pre-configured, or dynamically obtained from the same MRFP for example due to Audio Record.

The MRFC shall request sequences of predefined fixed announcements within one request to the MRFP.

The MRFC may request announcements to be played in a loop until it commands the MRFP to stop.

The MRFC may request the MRFP to play an announcement for a fixed number of times.

The MRFC may request DTMF detection while playing an announcement.

The MRFC may request the MRFP to stop playing an announcement when a DTMF digit is detected.

The MRFC may request the MRFP to add the following variants to the announcements:

- Date/Day/Month
- Time
- Digits (the announcement may contain a number of digits to be controlled by the MRFC for example a telephone number)
- Money (currency)
- Integer (a value within the announcement that is controlled by the MRFC, e.g. "you are caller number 3 in the queue")
- Variants may have predefined default values for a given network.

The MRFC may request the MRFP to indicate when a specific announcement previously requested has been played successfully.

The MRFP shall indicate error cases such as announcement not played successfully.

5.4 Text to Speech

TTS (Text To Speech) is the process of automatic generation of speech output from text or annotated text input.

The MRFC shall request the MRFP to play the text to one, one of several, multiple or all parties connected in a call/session.

The text format shall comply with the SSML format as specified in [11].

The MRFC shall extract the SSML script from the VXML or other format XML script if received

If the received text is another format than SSML, the MRFC shall generate a SSML script that may include the basic SSML text and the language type.

The MRFC shall indicate to the MRFP the text-to-speech, by sending the SSML script or sending a URI reference to this SSML script.

If the MRFC indicates the SSML script to the MRFP, the SSML text is sent inline in a H.248 command of Mp; the size shall be limited to avoid the segmentation in the Mp interface. The MRFC may remove unnecessary elements, such as the comments element, from the SSML document, providing that the result is a Conforming Speech Synthesis Markup Language Fragment as described in clause 2.2.1 of SSML ref [11]. This is however outside the scope of the current Mp specification work. If the SSML script size pre-processed results in segmentation in the Mp interface, the URI reference should be used.

When the MRFC indicates the SSML script using an URI reference to the MRFP, two options can exist:

- the file (referenced by the URI) is located in the MRFP and it is a SSML text, hence the MRFP should play the text;
- the file (referenced by the URI) is located outside the MRFP; the MRFP may fetch the text and play it to the user otherwise the MRFP indicates an error.

The MRFP shall execute the basic SSML elements and may ignore the SSML elements not supported. The basic SSML elements include the root element "speak", language type and spoken text.

The MRFC may request the MRFP to play a text in a loop until it commands the MRFP to stop.

The MRFC may request the MRFP to play a text for a fixed number of times.

The MRFC may request DTMF detection while playing a text.

The MRFC may request the MRFP to stop playing a text when a DTMF digit is detected.

The MRFC may request the MRFP to indicate when a text has been played successfully.

The MRFP shall indicate error cases such as text not played successfully. Ignoring a non-supported SSML element shall not result in an error.

5.5 Audio Record

The function requirement of audio record is to record the audio media stream(s) and store it into a file. The function can be used in some services, such as the voice mail box service, conference service, etc.

The MRFC shall request the MRFP to start the audio record from one or all parties connected in a call/session. If it is to record one party in a call/session, only the input stream of the party is recorded. If it is to record all parties in a call/session, the mixed stream of all parties is recorded.

The MRFP file format shall comply with the 3GPP multimedia file formats as specified in the 3GPP TS 26.244[5].

The MRFC may request the MRFP to detect the DTMF digit while recording an audio.

The MRFC may request the MRFP to stop recording and still retain the recording file.

The MRFC may indicate to the MRFP the file format and the URI to store the recorded file or request the MRFP to return the record file URI.

The MRFC may indicate to the MRFP the maximum record time.

The MRFC shall request the MRFP to indicate the result and the cause of record completion when an audio has been recorded successfully.

The MRFP shall indicate error cases such as audio not recorded successfully.

The MRFC may indicate the MRFP to execute other functions, such as playing an announcement, when the MRFP is recording audio.

5.6 DTMF Collection

The MRFC shall request the MRFP to detect and report the DTMF digits.

The MRFP shall report DTMF Digits detected as RTP Telephony Events (see IETF RFC 2833 [10]) if the Telephony Event for DTMF Payload Type has been assigned to that interface. The MRFP shall report only single DTMF Digits.

5.7 Automatic Speech Recognition

ASR (Automatic Speech Recognition) function is that the recognizer processes the user input voice and may match that input against a target data to produce a recognition result that represents the detected input. In the IMS, the MRFP acts as the recognizer that is under control of the MRFC and finish the function of recognition.

The MRFC shall request the MRFP to start the automatic speech recognition.

The MRFC shall extract the SRGS recognition grammar script or URI from the VXML script if received or other format XML script if received.

The grammar format shall comply with the SRGS format as specified in W3C Recommendation [12].

The MRFC shall indicate the SRGS script or the SRGS URI to the MRFP using H.248 packages. If the SRGS script is sent inline, the size of the SRGS script shall be limited to avoid segmentation in the Mp interface.

The MRFC may indicate to the MRFP the recognition mode: Normal Recognition Mode or Hotword Recognition Mode.

- If the MRFC indicates the Normal Recognition Mode to the MRFP, the MRFP shall attempt to match all of the speech against a recognition grammar and returns a no-match status if the input fails to match or the method times out.
- If the MRFC indicates the Hot-word Recognition Mode to the MRFP, the MRFP shall look for a match against specific speech grammar and ignores speech that does not match. The recognition completes only for a successful match of the recognition grammar or if the subscriber cancels the request or if the recognition time elapses.

The MRFP shall execute the recognition against the SRGS grammar and may ignore SRGS elements which are not supported.

The MRFC may request DTMF detection while executing ASR.

The MRFC may request the MRFP to stop ASR when a DTMF digit is detected.

The MRFC may request the MRFP to indicate when a specific ASR has been completed successfully.

When ASR is completed successfully, the MRFP may notify the MRFC the recognition result.

The recognition result shall comply with a single recognition format (e.g. the EMMA format as specified in W3C Recommendation [13] or the NLSML format as specified in W3C Recommendation [15]).

NOTE: The mandatory recognition result format may be defined in Stage 3 specification 3GPP TS 29.333 [16]. The MRFP may notify the MRFC multiple recognition results that are mutually exclusive. Each result may be structured by multiple parts in time sequence with the input time, may include the text token that the value will correspond to tokens as defined by the SRGS grammar, may include the interpretation of application specific markup, may include the confidence score that represents the recognition quality.

The MRFP shall indicate error cases such as ASR not executed successfully.

5.8 Play Multimedia

5.8.1 General Play Multimedia

The function of playing multimedia is to play any combination of audio, video and messaging media streams (except for audio only play which is specified according to clause 5.2 or clause 5.3) to the subscriber. When playing combination of audio and video media stream(s), the media stream(s) shall be synchronized. The function can be used in the services, such as multimedia announcement, multimedia mail box service, etc.

The MRFC shall request MRFP to play multimedia to one, one of several, multiple or all parties connected in a call/session.

The multimedia to be played may be referenced by pre-configured identifiers or by reference to a file (location).

The MRFC shall request sequences of predefined fixed multimedia announcements within one request to the MRFP.

The MRFP multimedia of synchronized audio and video file format shall comply with the 3GPP multimedia file formats as specified in the 3GPP TS 26.244[5].

The MRFP may transcode the input codec into the session codec, if the multimedia file provides a different audio or video codec with the session codec.

The MRFC may request MRFP to play multimedia of synchronized audio and video in a loop until it commands the MRFP to stop.

The MRFC may request the MRFP to play multimedia of synchronized audio and video for a fixed number of times.

The MRFC may request DTMF detection while playing multimedia of synchronized audio and video.

The MRFC may request the MRFP to stop playing multimedia when a DTMF digit is detected.

The MRFC may indicate to the MRFP the multimedia file identifier and file format.

The MRFC may request the MRFP to indicate when a specific multimedia previously requested has been played successfully.

The MRFC may be able to decouple the play audio and play video request to the MRFP via separate sources for each media.

The MRFP shall indicate error cases such as multimedia not played successfully.

5.8.2 Play Message

The function specified in clause 5.8.1 for "General Play Multimedia" shall be followed. This clause describes the additional requirements to play the messaging media stream.

To detect DTMF digits is not required for message media stream.

To play message in a loop or in a loop with a fixed number of times is not required.

The MRFP message file formats shall comply with the file formats used inside MMS (Multimedia Messaging Service) as specified in the 3GPP TS 26.140 [22] in the current version.

5.9 Multimedia Record

5.9.1 General Multimedia Record

The function of the multimedia record is to record the any combination of audio, video and messaging media stream(s) (except for audio only record which are specified according to clause 5.5). When recording combination of audio and video media stream(s), the media stream(s) shall be synchronized and be stored into a multimedia file. The multimedia record function can be used in the services, such as multimedia mail box service, multimedia conference, etc.

The MRFC shall request the MRFP to start the multimedia record to one or all parties connected in a call/session. If it is to record one party in a call/session, only the input stream of the party shall be recorded.

If it is to record all parties in a call/session, the mixed stream of all parties shall be recorded. The MRFC may request the MRFP to detect the digit while recording a multimedia of synchronized audio and video.

The MRFP multimedia of synchronized audio and video file format shall comply with the 3GPP multimedia file formats as specified in the 3GPP TS 26.244[5].

The MRFC may request the MRFP to detect DTMF digits while recording multimedia of synchronized audio and video.

The MRFC may request the MRFP to stop recording and still retain the recording file.

The MRFC may indicate to the MRFP the file format and URI to store the recorded file or request the MRFP to return the URI.

The MRFC may indicate to the MRFP the maximum record time.

The MRFC may request the MRFP to indicate the result and the cause of record completion when a multimedia has been recorded successfully.

The MRFP shall indicate error cases such as multimedia not recorded successfully.

The MRFC may indicate the MRFP to execute other functions, such as playing an announcement, when the MRFP is recording multimedia.

5.9.2 Message Record

The function specified in clause 5.9.1 for "General Multimedia Record" shall be followed. This clause describes the additional requirements to record the messaging media stream.

The function of the message record is to record the messaging media stream(s) and store into a message file. The message record function can be used in the services, message conference, etc.

To detect DTMF digits is not required for message media stream.

The message file formats shall comply with the file formats used inside MMS (Multimedia Messaging Service) as specified in the 3GPP TS 26.140[22] in current version.

5.10 Audio Conference

Audio conferences allow users participating in the conference to communicate with all other participants simultaneously.

The details for conferencing within the IP Multimedia Core Network subsystem (IMS) are specified in 3GPP TS 24.147 [4].

The conference mixer is located in the MRFP.

The MRFC shall request the MRFP to create resources for an audio conference.

The MRFC shall create resources for users to join an existing conference, and to release resources for users to leave an existing conference.

The MRFC may request the MRFP to collect DTMF (according to clause 5.5), play tones (according to clause 5.1) or announcements (according to clause 5.2), or record the audio during the conference (according to 5.4).

The MRFP may support transcoding between different users.

5.11 Multimedia Conference

5.11.1 General Multimedia Conferencing

Multimedia conferences allow users participating in the conference to communicate with all other participants simultaneously using any combination of voice, video and messaging (except for audio only conferences which are specified according to clause 5.10).

The details for conferencing within the IP Multimedia Core Network subsystem (IMS) are specified in 3GPP TS 24.147 [4]. In addition, optional enhancements to support Multi-stream Multiparty Conferencing Media Handling are specified in 3GPP TS 26.114 [23] annex S.

The conference mixer is located in the MRFP.

The MRFC shall request the MRFP to create resources for a multimedia conference.

The MRFC shall create resources for users to join an existing conference, and to release resources for users to leave an existing conference.

The MRFC may indicate to the MRFP to collect the DTMF (according to clause 5.6), play multimedia (according to clause 5.8), or record the multimedia (according to clause 5.9) during the conference. It is not required to collect DTMF when creating messaging conference separately.

The MRFP may support audio transcoding between different users.

The MRFP may support video transcoding between different users.

The MRFC may indicate to the MRFP to modify the media attribute, including:

- To create a video stream or close a video stream.
- To create an audio stream or close an audio stream.
- To create a messaging stream or close a messaging stream.
- To modify the codec of audio or video.

5.11.2 Message Conferencing

Messaging conferences allow users participating in the conference to communicate with all other participants simultaneously using session based message. Message content shall be possible to carry different media including text, image, video and audio.

The details for messaging conference within the IP Multimedia Core Network subsystem (IMS) are specified in 3GPP TS 24.247 [17].

The MRFC shall request the MRFP to create resources for a messaging conference.

The MRFC shall request the MRFP to create resources for users to join an existing conference, and to release resources for users to leave an existing conference.

The MRFC may indicate the granted quotas and valid time to the MRFP. The granted quotas indicate the units specifying the number of messages or volume (size) of messages allowed to be received or sent by users. The valid time indicates the validity time of the granted service units.

The MRFP may report statistics information of messages according to the indication by the MRFC when the granted quota is reached or the valid time elapses even if the granted service units have not been consumed within the validity

time. The statistics information of messages may include any of the following received or sent by users in the conference:

- number of messages sent
- number of messages received
- volume (size) of messages sent
- volume (size) of messages received.

The MRFC may request the MRFP to report the statistics information of messages sent and/or received at the end of the session or during the session.

The MRFP may report the statistics information at the end of the session or during the session as requested by the MRFC. The statistics information of messages may include any of the following received or sent by users in the conference:

- number of messages sent
- number of messages received
- volume (size) of messages sent
- volume (size) of messages received

The MRFP shall utilize the Message Session Relay Protocol (MSRP) (see IETF RFC 4975 [18]) to transport messages carrying different media including text, images, video and audio. The Media types shall be MIME encoded.

The MRFC may request the MRFP to play messaging (according to clause 5.8) during the conference.

The MRFC may request the MRFP to support the message record (according to clause 5.9), including global storage of sessions and personal storage during the conference.

The MRFC may request the MRFP to filter the message of the recipient. If the filtering capabilities are supported:

- The MRFC shall request the MRFP to start/stop message filtering.
- The MRFC shall indicate the filtering criteria to the MRFP. The filtering criteria may include sender address, message size, message content type (e.g. video, audio), message content format (e.g. mpeg, jpeg) and message subject.
- The MRFC shall indicate the message treatments to the MRFP. The message treatments include block the delivery of the message content, store the message content and redirect the message to another address.
- The MRFP shall execute the message treatment when the criteria is reached.

5.11.3 Multi-stream Multiparty Conferencing Media Handling

5.11.3.1 Introduction

The MRFC and the MRFP may support the Multi-stream Multiparty Conferencing Media Handling (MMCMH) using "simulcast" and "RTP-level pause and resume" functionality as specified in 3GPP TS 26.114 [23] annex S.

Usage of simulcast RTP streams is negotiated via SDP offer/answer exchange through media level SDP attributes:

- simulcast stream description ("a=simulcast" attribute defined in IETF RFC 8853 [57]); and
- restriction identifier ("a=rid" attribute defined in IETF RFC 8851 [58]).

When using simulcast, the "a=rid" identification of simulcast formats shall be unique within a media clause ("m=" line). SDP simulcast negotiation decides which simulcast formats, if any, are sent between the conference participant and the MRFP.

Furthermore, the media level SDP attribute "a=content" (defined in IETF RFC 4796 [59]) is used to indicate content of RTP stream.

The main video SDP "m=" line is indicated by the "a=content:main" under that "m=" line. The screenshare video is indicated as a separate SDP video "m=" line, identified by "a=content:slides" under that "m=" line. The screenshare video "m=" line shall be listed after the main video "m=" line. The "thumbnail" video is defined as unidirectional video which can be offered under the main video "m=" line with a smaller resolution than a main video or as a separate "m=" line that is not the first video "m=" line in the SDP, and that is also not identified with any "a=content:main" or "a=content:slides".

NOTE: A typical use case for MMCMH is that each conference participant sends a main and a thumbnail video, and that receives one main video (depicting the current speaker) and thumbnail videos for all other or some of the conference participants. For the current speaker, the MRF typically passes the main video to everybody. For each other participant, the MRF typically passes a thumbnail video to all other participants.

The main audio SDP "m=" line shall be the first "m=" line in an SDP offer, to increase the probability that it is accepted by a non-MMCMH capable conference participant. Support for multiple, simultaneous audio streams is indicated in SDP as separate audio "m=" lines. The number of supported channels in multi-channel audio is indicated per audio stream through the SDP "m=" line <encoding parameters>, with the default being a single channel when <encoding parameters> is omitted. The additional audio "m=" lines shall be listed after the main audio "m=" line.

"RTP-level pause and resume" functionality shall be supported by conference participants supporting MMCMH feature. The following RTCP feedback "CCM PAUSE-RESUME" messages are defined in IETF RFC 7728 [62]:

- "PAUSE" message to request an RTP stream sender to pause an RTP stream;
- "RESUME" message to request an RTP stream sender to resume an RTP stream;
- "REFUSED" message to notify an RTP stream receiver that a pause or resume request is not accepted; and
- "PAUSED" message to inform an RTP stream receiver that an RTP stream is paused.

Usage of "RTP-level pause and resume" functionality is negotiated via SDP offer/answer exchange through an extension of RTCP feedback capability attribute "a=rtcp-fb" (defined in IETF RFC 4585 [60]) to include request for pause and resume, as specified in IETF RFC 7728 [62]. The use of the "RTP-level pause and resume" functionality can be restricted according to a "config" pause attribute (defined in IETF RFC 7728 [62]), including not using it at all if that is the SDP offer/answer negotiation outcome.

Floor Control function using BFCP (as specified in clause 5.14) to control main video and screenshare video shall be supported by conference participants supporting MMCMH feature.

Examples of media portions from possible SDP offers and SDP answers related to a multi-stream multiparty conference establishment using simulcast and RTP-level pause and resume signalling are given in 3GPP TS 26.114 [23] annex T.

If the MRFC and the MRFP support the MMCMH feature, the requirements and procedures in the following clauses apply.

5.11.3.2 General MMCMH requirements

The MRFC shall support separating simulcast formats through referencing separate RTP payload types for each simulcast format, i.e., using the "pt=" parameter on the "a=rid" line (IETF RFC 8851 [58]). The MRFC and the MRFP may support restrictions parameters defined in IETF RFC 8851 [58].

The MRFP:

- shall support sending at least two thumbnails;
- may support sending any number of additional thumbnails;
- shall support receiving at least one thumbnail-sized simulcast format of the main video;
- may support receiving also other simulcast formats;
- shall support the BFCP floor control server role as specified in clause 5.14;

- shall support the "RTP-level pause and resume" functionality corresponding to "config=2" (as defined in IETF RFC 7728 [62], i.e. sending of "PAUSE", "RESUME" and "PAUSED", and reception of "PAUSED" and "REFUSED" RTCP feedback "CCM PAUSE-RESUME" messages); and
- should support the full "RTP-level pause and resume" functionality corresponding to "config=1" (as defined in IETF RFC 7728 [62], i.e. sending and receiving of all RTCP feedback "CCM PAUSE-RESUME" messages).

5.11.3.3 Negotiation in "dial-in" scenario

If the MRFC receives an SDP offer containing:

- an "a=simulcast" attribute; and
- the corresponding "a=rid" lines with a "pt" parameter defining the simulcast stream identification,

under an "m=" line then, in accordance with local configuration and SDP simulcast negotiation results on other call legs, the MRFC shall:

NOTE 1: The local configuration and SDP simulcast negotiation results on other call legs is also used to determine the expected number of conference participants and the corresponding number of thumbnail video streams to be accepted.

- if the MRFC supports the "Compact Concurrent Codec Negotiation and Capabilities" function specified in 3GPP TS 26.114 [23], clause S.5.7 and received the session level "a=ccc_list" attribute (defined in 3GPP TS 26.114 [23], clause S.5.7.2) within the SDP offer, use the information from the received "a=ccc_list" attribute in addition to the local configuration and SDP simulcast negotiation results on other call leg when deciding which media stream configuration to select towards the conference participant and when requesting the MRFP to reserve resources towards this conference participant;
- select the payload types (codecs and codec configurations) that it accepts to use for the accepted "m=" lines;
- select simulcast formats i.e. the MRFC shall:
 - a) verify the "pt" parameter from the "a=rid" line against the list of payload types listed on the "m=" line:
 - 1) if payload type is not listed on the "m=" line, remove the payload type from the set of values in the "pt" parameter; and
 - 2) if no values are left in the "pt=" parameter after this processing, then remove the "a=rid" line;
 - b) if the "a=rid" line contains a restrictions parameter which the MRFC does not support and if the "direction" field is "recv", remove the "a=rid" line; and

NOTE 2: The MRFC does not need to understand every restriction parameter present in a "send" line. If a stream sender restricts the stream in a way that the receiver does not understand, this causes no issues with interoperability.

- c) change the directionality of the selected simulcast formats i.e. for the selected "a=simulcast" and "a=rid" attributes "send" from the received SDP offer becomes "recv" and "recv" becomes "send" in the SDP answer;
- if the "thumbnail" video descriptions are included in the SDP offer, based on the MRFP capabilities accept all or some of the offered the "thumbnail" video "m=" lines and change the directionality of the accepted "thumbnail" video "m=" lines from "recvonly" to "sendonly";
 - if a video "m=" line with the "a=content:slides" attribute is included in the SDP offer and if the MRFP supports the screenshare video, accept the screenshare video "m=" line;
 - when requesting the MRFP to configure resources towards the conference participant, for the accepted "m=" lines:
 - a) if the participant is the first conference participant, request the MRFP to create a new context and include a "MMCMH policy" information element to indicate to the MRFP that interconnection of video media streams with different StreamIDs is allowed in the context used for MMCMH and that the MRFP shall mix media streams autonomously based on policies for MMCMH. Within the "MMCMH policy" information element the MRFC:

- 1) shall indicate with the value "MMCMH basic policy" that the MRFP shall not send media streams received on a termination towards that termination and that the MRFP shall forward a received media stream of a particular media type (i.e. audio, main video or screenshare video) only towards outgoing media streams of the same media type. The MRFP shall select the video streams to be sent to a conference participant from among the videos received from the other conference participants in such a way that from each other conference participant at most one main video is sent to this conference participant and at most one screenshare video stream is sent to this conference participant;
- 2) may indicate with the value "Voice activity detected video" that the MRFP shall detect voice activity on audio streams and that the MRFP shall forward the main video received from the active speaker (i.e. from the media sender from which an audio stream is received where voice activity is currently detected) to all other conference participant;
- 3) may indicate with the value "Voice activity detected audio" that the MRFP shall detect voice activity on audio streams;
- 4) may indicate with the value "Mix audio" that the MRFP shall mix all the received audio streams from all other conference participants in the context and send the resulting audio stream(s) to each conference participant;
- 5) may indicate with the value "BFCP audio" that if the MRFP receives BFCP messages, the MRFP shall select received audio streams to forward or mix based on these BFCP messages;
- 6) may indicate with the value "BFCP video" that if the MRFP receives BFCP messages, the MRFP shall select received video streams to forward or mix based on these BFCP messages; and
- 7) may indicate with the value "BFCP screenshare" that if the MRFP receives BFCP messages, the MRFP shall select received screenshare streams to forward or mix based on these BFCP messages;

NOTE 3: A single context is used to handle all media types for an MMCMH conference.

- b) include all accepted media streams sent to or received from the conference participant into the same termination;
- c) include selected payload types for each accepted the "m=" line;
- d) include a "Simulcast desc" information element with the selected simulcast streams for the accepted "m=" line and request the MRFP to configure termination with a simulcast capability;
- e) include a "Simulcast format" information element with the accepted "a=rid" lines for the accepted "m=" line;
- f) if the "a=content" attribute was received in the SDP offer, include a "Stream content" information element to indicate content of stream;
- g) if the "a=rtcp-fb" line(s) with a "CCM" parameter (as defined in IETF RFC 5104 [61]) and a "pause" CCM parameter (as defined in IETF RFC 7728 [62]) was received in the SDP offer:
 - 1) include a "CCM pause-resume" information element to indicate to the MRFP which RTCP feedback "CCM PAUSE-RESUME" messages the MRFP may send to the conference participant;
 - 2) if a "nowait" pause attribute was received in the SDP offer, shall include a "nowait" pause attribute in the "CCM pause-resume" information element to indicate to the MRFP that exchange of the RTCP feedback "CCM PAUSE-RESUME" messages will be point-to-point and no hold-off period will therefore be necessary when resuming paused streams;
 - 3) include a "Autonomous request" information element to indicate that the MRFP is allowed to autonomously send RTCP feedback CCM PAUSE and RESUME messages; and
 - 4) include a "Autonomous response" information element to indicate that the MRFP is allowed to autonomously send RTCP feedback CCM PAUSED and REFUSED messages; and

NOTE 4: The MRFP will not send the RTCP feedback CCM REFUSED message if the "CCM pause-resume" information element contains the "config=2" pause attribute.

- h) if the BFCP media stream was included in the SDP offer, apply additional specific procedures for BFCP in clause 5.14.5;

- include the accepted simulcast streams in the SDP answer;
- include the "thumbnail" video "m=" lines in the SDP answer;
- include the screenshare video "m=" line in the SDP answer;
- if the "a=rtcp-fb" line with a "pause" CCM parameter was included in the SDP offer:
 - a) include the "a=rtcp-fb" line with a "pause" CCM parameter in the SDP answer;
 - b) if the "nowait" pause attribute was received in the SDP offer, include the "nowait" pause attribute in the SDP answer; and
 - c) if the MRFP does not support the full "RTP-level pause and resume" functionality corresponding to "config=1" include the "config" pause attribute in the SDP answer with the value set according to the MRFP capability ("config=2") and the SDP offer/answer rules specified in IETF RFC 7728 [62];
- if an offered BFCP media stream was accepted, include in the SDP answer:
 - a) an "a=floorctrl:s-only" attribute to indicate that the MRFP will act as a floor control server;
 - b) an "a=confid" attribute indicating the conference identity to be used by BFCP signalling;
 - c) an "a=userid" attribute indicating the user identity to be used by BFCP signalling;
 - d) "a=floorid" attribute line(s) containing the BFCP floor identity(ies) to be used to control accepted audio and/or video media streams;
 - e) "a=label" attribute line(s) indicating which of the accepted audio and/or video media streams will be BFCP controlled;

NOTE 5: The "a=floorctrl", "a=confid", "a=userid" and "a=floorid" attributes are defined in IETF RFC 4583 [21]. The "a=label" attribute is defined in IETF RFC 4574 [64].

- f) an "a=connection:new" attribute to request a new TCP connection; and
- g) an "a=setup" attribute to indicate which end point will act as a TCP client; and

NOTE 6: The "a= connection" and "a= setup" attributes are defined in IETF RFC 4145 [36].

NOTE 7: For the TCP support see clause 5.21.

- include in the SIP message containing the SDP answer an "isfocus" media feature tag, defined in IETF RFC 3840 [63].

If the MRFP supports the "Compact Concurrent Codec Negotiation and Capabilities" function specified in 3GPP TS 26.114 [23] and if the MRFC received the session level "a=ccc_list" attribute within the SDP offer, then when requesting the MRFP to configure resources towards the conference participant, the MRFC may provide to the MRFP a "Concurrent Codec Capabilities" information element to indicate the concurrent codec capabilities of the conference participant.

5.11.3.4 Negotiation in "dial-out" scenario

If the MRFC receives a trigger to add a new participant in the MMCMH conference, then in accordance with local configuration and SDP simulcast negotiation results on other call legs, the MRFC shall decide which media stream configuration to offer to a new conference participant. If the MRFC supports the "Compact Concurrent Codec Negotiation and Capabilities" function specified in 3GPP TS 26.114 [23], clause S.5.7 and received the "a=ccc_list" attribute (defined in 3GPP TS 26.114 [23], clause S.5.7.2) within the 200 (OK) final response to the OPTIONS request, the MRFC shall use the information from the received "a=ccc_list" attribute in addition to the local configuration and SDP simulcast negotiation results on other call legs when deciding which media stream configuration to offer to a new conference participant and when requesting the MRFP to reserve resources towards this conference participant. The MRFC:

- should offer an audio media stream as simulcasted media stream;
- should offer a main video media stream as simulcasted media stream;

- shall decide if a "screenshare" video media stream will be offered;
- shall decide the number of "thumbnail" video media streams that will be offered in a sending direction towards the conference participant;
- should offer a BFCP media stream to control the audio and the main video media streams, and, if a "screenshare" video media stream is offered, to control the "screenshare" video media stream and should assign separate floor identities for each of these streams;
- for each offered audio and video media stream, shall select the payload types (codecs and codec configurations);
- for each offered simulcasted media stream, shall select a simulcast configuration (the number of RTP media streams which will be offered in a sending and in a receiving direction towards the conference participant) i.e. shall create the "a=simulcast" attribute, and shall select the corresponding simulcast formats i.e. shall create the corresponding "a=rid" lines with the "pt" parameter defining the simulcast stream identification; and
- for each offered audio and video media stream, shall decide if the "RTP-level pause and resume" functionality corresponding to "config=1" or "config=2" (see figure 7 in IETF RFC 7728 [62]) will be offered.

The MRFC shall then, in accordance with the selected media stream configuration, request the MRFP to reserve resources towards the conference participant. The MRFC shall:

- if the participant is the first conference participant, request the MRFP to create a new context and include a "MMCMH policy" information element to indicate to the MRFP that interconnection of video media streams with different StreamIDs is allowed in the context used for MMCMH and that the MRFP shall mix RTP media streams autonomously based on the MMCMH policies. Within the "MMCMH policy" information element the MRFC:
 - a) shall indicate with the value "MMCMH basic policy" that the MRFP shall not send media streams received on a termination towards that termination and that the MRFP shall forward a received media stream of a particular media type (i.e. audio, main video or screenshare video) only towards outgoing media streams of the same media type. The MRFP shall select the video streams to be sent to a conference participant from among the videos received from the other conference participants in such a way that from each other conference participant at most one main video is sent to this conference participant and at most one screenshare video stream is sent to this conference participant;
 - b) may indicate with the value "Voice activity detected video" that the MRFP shall detect voice activity on audio streams and that the MRFP shall forward the main video received from the active speaker (i.e. from the media sender from which an audio stream is received where voice activity is currently detected) to all other conference participant;
 - c) may indicate with the value "Voice activity detected audio" that the MRFP shall detect voice activity on audio streams;
 - d) may indicate with the value "Mix audio" that the MRFP shall mix all the received audio streams from all other conference participants in the context and send the resulting audio stream(s) to each conference participant;
 - e) may indicate with the value "BFCP audio" that if the MRFP receives BFCP messages, the MRFP shall select received audio streams to forward or mix based on these BFCP messages;
 - f) may indicate with the value "BFCP video" that if the MRFP receives BFCP messages, the MRFP shall select received video streams to forward or mix based on these BFCP messages; and
 - g) may indicate with the value "BFCP screenshare" that if the MRFP receives BFCP messages, the MRFP shall select received screenshare streams to forward or mix based on these BFCP messages;
- include all offered media streams to that conference participant into the same termination;
- request the local IP address and the port for each offered audio and video media stream;
- include selected payload types for each offered audio and video media stream;
- include a "Stream content" information element with the value "main" for the main video media stream;

- if the "screenshare" video media stream is offered, include a "Stream content" information element with the value "slides";
- for each offered simulcast media stream:
 - a) include a "Simulcast desc" information element with the selected simulcast configuration (containing the "a=simulcast" attribute) and request the MRFP to configure the termination with the simulcast capability; and
 - b) include a "Simulcast format" information element with selected simulcast formats (the corresponding "a=rid" lines) to indicate to the MRFP the simulcast stream identification and which payload type to reserve for the particular simulcast format;
- for each audio and video media stream offered with the "RTP-level pause and resume" functionality:
 - a) include a "CCM pause-resume" information element to indicate to the MRFP which RTCP feedback "CCM PAUSE-RESUME" messages the MRFP may send to the end user;
 - b) include a "nowait" pause attribute in the "CCM pause-resume" information element to indicate to the MRFP that exchange of the RTCP feedback "CCM PAUSE-RESUME" messages will be point-to-point and no hold-off period will therefore be necessary when resuming paused streams;
 - c) include an "Autonomous request" information element to indicate that the MRFP is allowed to autonomously send RTCP feedback CCM PAUSE and RESUME messages; and
 - d) include an "Autonomous response" information element to indicate that the MRFP is allowed to autonomously send RTCP feedback CCM PAUSED and REFUSED messages; and

NOTE 1: The MRFP will not send the RTCP feedback CCM REFUSED message if the "CCM pause-resume" information element contains the "config=2" pause attribute.

- apply additional specific procedures for BFCP in clause 5.14.5.

Upon receipt of a confirmation from the MRFP about local IP address and port and reserved resources for each selected media stream, the MRFC shall include in the SIP request an "isfocus" media feature tag (defined in IETF RFC 3840 [63]), and the SDP offer with the selected audio, video and BFCP media streams. The MRFC shall include in the SDP offer:

- selected payload types for each offered audio and video media stream;
- an "a=content:main" attribute under the main video "m=" line;
- if the "screenshare" video media stream is offered, an "a=content: slides" attribute under the "screenshare" video "m=" line;
- for each offered simulcast media stream, an "a=simulcast" attribute and related "a=rid" attribute lines with a "pt" parameter defining the simulcast stream identification under the corresponding "m=" line;
- "a=label" attribute line(s) indicating which of the offered audio and/or video media streams will be BFCP controlled;

NOTE 2: The "a=label" attribute is defined in IETF RFC 4574 [64].

- for each offered "thumbnail" video media stream, an "a=sendonly" attribute under the corresponding "m=" line;
- for each offered audio and video media stream, an "a=rtcp-fb" line with a "pause" CCM parameter, a "nowait" pause attribute and a "config" pause attribute; and

NOTE 3: If the MRFP supports the full "RTP-level pause and resume" functionality, as defined in IETF RFC 7728 [62], the "config" pause attribute may be omitted.

- under BFCP over TCP "m=" line:
 - a) an "a=floorctrl:s-only" attribute to indicate that the MRFP will act as a floor control server;
 - b) an "a=confid" attribute indicating the conference identity to be used by BFCP signalling;
 - c) an "a=userid" attribute indicating the user identity to be used by BFCP signalling;

- d) "a=floorid" attribute line(s) containing the BFCP floor identity(ies) to be used to control offered audio and/or video media streams;

NOTE 4: The "a=floorctrl", "a=confid", "a=userid" and "a=floorid" attributes are defined in IETF RFC 4583 [21].

- e) an "a=connection:new" attribute to request a new TCP connection; and
- f) an "a=setup" attribute to negotiate which end point will act as a TCP client;

NOTE 5: The "a= connection" and "a= setup" attributes are defined in IETF RFC 4145 [36].

NOTE 6: For the TCP support see clause 5.21. The MRFC and the MRFP may support IMS media plane security and then procedures from clause 5.20 will be also applied.

Upon receipt of the corresponding SDP answer, the MRFC shall request the MRFP to modify termination towards the conference participant accordingly. The MRFC shall provide to the MRFP:

- the remote IP address and the port for each accepted media stream;
- payload types for each accepted audio and video media stream;
- for each accepted simulcast media stream:
 - a) the "Simulcast desc" information element with the accepted simulcast configuration (containing the "a=simulcast" attribute); and
 - b) the "Simulcast format" information element with accepted simulcast formats (the corresponding "a=rid" lines); and
- if the "a=rtcp-fb" line(s) with a "CCM" parameter and a "pause" CCM parameter was included in the SDP answer for the accepted audio or video media stream:
 - a) the "CCM pause-resume" information element;
 - b) if a "nowait" pause attribute was included in the SDP answer, the "nowait" pause attribute in the "CCM pause-resume" information element;
 - c) the "Autonomous request" information element; and
 - d) the "Autonomous response" information element.

If the MRFP supports the "Compact Concurrent Codec Negotiation and Capabilities" function specified in 3GPP TS 26.114 [23] and if the MRFC received the "a=ccc_list" attribute from the conference participant then when requesting the MRFP to modify termination towards the conference participant, the MRFC may provide to the MRFP a "Concurrent Codec Capabilities" information element to indicate the concurrent codec capabilities of the conference participant.

5.11.3.5 MMCMH handling at MRFP

Upon reception of a request from the MRFC to configure resources towards the conference participant, the MRFP:

- shall assign the requested resources:
 - a) shall configure termination to handle simulcast RTP streams; and
 - b) shall start monitoring voice activity for audio media streams when instructed by the MRFC;
- if "Concurrent Codec Capabilities" information element was received from the MRFC, shall store the concurrent codec capabilities of the conference participant i.e. the maximum number of concurrent encoders and decoders the conference participant can operate and take these constraints into account when selecting the media streams to/from a conference participant;
- shall select the media source (among the received RTP streams) to be sent as one of the RTP streams, and then among the available simulcast streams the MRFP shall select for the most appropriate one to be sent to the particular conference participant, as specified in IETF RFC 8853 [57]; and

- based on the value of the received "CCM pause-resume" information element, may send the RTCP "CCM PAUSE" messages towards the conference participant following the rules specified in IETF RFC 7728 [62].

Upon reception of a request from the MRFC to create a context with an "MMCMH policies" capability, the MRFP shall create that context and shall configure it according to value(s) received within the "MMCMH policy" information element. The MRFP shall handle media streams placed into the context as follows:

- The MRFP shall not send media streams received from a conference participant towards that conference participant.
- The MRFP shall forward a received media stream of a particular media type (i.e. audio, video or screenshare) only towards outgoing media streams of the same media type.

NOTE: The stream ID of a received media stream does not determine on which outgoing media streams the media are to be forwarded.

- The MRFP should forward the received audio stream of the active speaker (i.e. the audio stream where voice activity is detected) to all other conference participants. If simulcasted audio streams are received from the active speaker, the MRFP should select for each other conference participant an audio encoding among the received audio simulcast formats that is supported at the termination towards that participant to avoid transcoding.
- Alternatively, the MRFP may mix all the received audio streams from all other conference participants in the context and send the resulting audio stream(s) to a conference participant. If two audio streams were reserved towards a conference participant, the MRFP may distribute the received audio stream from each other conference participant in a specific way to render a stereo impression.
- The MRFP shall select the video streams to be sent to a conference participant from among the videos received from the other conference participants in such a way that:
 - a) from each other conference participant at most one main video is sent to this conference participant; and
 - b) at most one screenshare video stream is sent to this conference participant.

If simulcasted video streams are received from a participant, the MRFP should select for each other conference participant a video encoding among the received video simulcast formats that is supported at the termination towards that participant to avoid transcoding.

- The MRFP should forward the main video received from the active speaker (i.e. from the media sender from which an audio stream is received where voice activity is currently detected) to all other conference participant. If several video streams are simulcasted from the active speaker, the MRFP should select for each other conference participant the simulcast format that matches the configured encoding and resolution of the main video stream towards that conference participant to avoid transcoding.
- The MRFP should forward the main video of the previous speaker (i.e. received from the media sender from which an audio stream was received where the most recent past voice activity has been detected) to the active speaker (i.e. towards the media receiver associated with the media sender from which an audio stream is received where voice activity is currently detected). If several video streams are simulcasted from the previous speaker, the MRFP should select the simulcast format that matches the configured encoding and resolution of the main video stream towards the active speaker to avoid transcoding.
- The MRFP should forward received thumbnail video streams from the most recent previous speaker(s) (i.e. from the media sender(s) from which audio stream(s) was/were received where the most recent past voice activities have been detected). If several video streams are simulcasted from a previous speaker, the MRFP should select for each other conference participant the simulcast format that matches the configured encoding and resolution of a thumbnail video stream towards that conference participant to avoid transcoding.
- In order to avoid a too frequent switching of video images, the MRFP should wait for a short period when detecting voice activity from a new source before switching the video image.
- If the MRFC receives RTCP feedback about increased packet loss from a media receiver, the MRFP should reduce the number of video streams sent towards that media receiver and select only video streams with lower resolution (e.g. thumbnail video streams); the MRFP should select video streams received from the most recent speaker(s) (i.e. from the media sender(s) from which audio stream(s) are received where the most recent voice activities are or have been detected).

- If BFCP is configured at the MRFP and the MRFP receives BFCP messages, the MRFP should select received streams to forward or mix based on these BFCP messages.
- If the MRFP does not pass a received media stream to any conference participant, based on any of the criteria above, and the "RTP-level pause resume" capability was configured for that media stream, the MRFP should signal to the sender of that media stream to pause sending that media stream in accordance with IETF RFC 7728 [62].
- If the MRFP has previously signalled to a sender to pause sending a media stream and decides to pass that media stream to some conference participant(s), based on any of the criteria above, the MRFP shall signal to the sender to resume sending that media stream in accordance with IETF RFC 7728 [62].

5.12 Audio Transcoding

5.12.1 General

The MRFP shall support audio transcoding between streams of two Terminations within the same context where the streams are encoded differently, in accordance with standard H.248.1 principles, see ITU-T H.248.1 [3]. As minimum requirement the MRFP shall support the default 3GPP audio codec AMR (narrowband), and optionally any other audio codecs as specified in 3GPP TS 26.114 [23].

5.12.2 Handling of common codec parameters

Table 5.12.2.1 describes the MRFC handling of codec related parameters applicable to multiple codecs when the MRFC sends an SDP offer.

Table 5.12.2.1: MRFC handling of common codec parameters when the MRFC acts as offerer.

Parameter	Handling of common codec parameter in sent SDP offer	Handling of common codec parameter in received SDP answer
ptime (NOTE)	The MRFC may add the parameter with a value according to configured preferences to the SDP offer.	If the ptime parameter is included in the received SDP answer, the MRFC shall supply the parameter to the MRFP for the termination towards the answerer in the remote descriptor.
maxptime (NOTE)	The MRFC may add the parameter with a value according to the MRFP capabilities to the SDP offer.	If the maxptime parameter is included in the received SDP answer, the MRFC shall supply the parameter to the MRFP for the termination towards the answerer in the remote descriptor.
NOTE: This SDP attribute is defined in IETF RFC 4566 [44]. It applies to all codecs offered in an SDP media line.		

Table 5.12.2.2 describes the MRFC handling of codec related parameters applicable to multiple codecs when the MRFC receives an SDP offer.

Table 5.12.2.2: MRFC handling of common codec parameters when the MRFC acts as answerer.

Parameter	Handling of common codec parameter in received SDP offer	Handling of common codec parameter in sent SDP answer
ptime (NOTE)	If the ptime parameter is included in the received SDP offer, the MRFC shall supply the parameter to the MRFP for the termination towards the offerer in the remote descriptor.	The MRFC may add the ptime parameter with a value according to configured preferences to the SDP answer.
maxptime (NOTE)	If the maxptime parameter is included in the received SDP offer, the MRFC shall supply the parameter to the MRFP for the termination towards the offerer in the remote descriptor.	The MRFC may add the maxptime parameter with a value according to the MRFP capabilities to the SDP answer.
NOTE: This SDP attribute is defined in IETF RFC 4566 [44]. It applies to all codecs offered in an SDP media line.		

The MRFP handling of codec related parameters applicable to multiple codecs shall follow table 5.13.2.2 in 3GPP TS 23.334 [41].

5.12.3 Handling of the EVS speech codec

The Enhanced Voice Services (EVS) speech codec is defined in 3GPP TS 26.441 [42]. Its RTP payload type is defined in 3GPP TS 26.445 [43], and procedures for its usage as IMS Multimedia Telephony speech codec are defined in 3GPP TS 26.114 [23].

The MRFC and the MRFP may support transcoding to and from the EVS speech codec. If they do so, the procedures in the present clause apply.

Table 5.12.3.1 describes the MRFC handling of EVS codec parameters when the MRFC sends an SDP offer for an EVS payload type, and that EVS payload type is selected in the SDP answer. In addition, rules for the parameter handling in 3GPP TS 26.445 [43] shall apply.

Table 5.12.3.1: MRFC handling of EVS related SDP parameters when the MRFC adds the EVS payload type to the SDP offer it sends out.

Parameter	Handling for EVS payload type added to an SDP offer	Handling if offered EVS payload type is accepted in the SDP answer
evs-mode-switch (NOTE 1)	If the MRFC expects that interworking between AMR-WB and EVS is required, it shall include the evs-mode-switch with value 1. Otherwise, the MRFC shall not include the evs-mode-switch.	If the evs-mode-switch parameter is contained in the SDP answer, the MRFC shall forward this parameter to the MRFP for the termination towards the answerer in the remote descriptor.
hf-only (NOTE 1)	If the MRFC is configured to negotiate using only the header-full EVS RTP payload format, the MRFC shall include the hf-only parameter with a value 1.	If the hf-only parameter is contained in the SDP answer, the MRFC shall forward this parameter to the MRFP in the remote descriptor.
dtx (NOTE 1)	If the usage of DTX is not desired in the sending and receiving direction (e.g. due to DTX capabilities of expected codecs to transcode with), the MRFC shall include the dtx parameter with a value 0.	If the dtx parameter is contained in the SDP answer, the MRFC shall forward this parameter to the MRFP in the remote descriptor.
dtx-recv (NOTE 1)	If receiving DTX is not desired and the dtx parameter is not included, the MRFC shall include the dtx-recv parameter with a value 0. If both the dtx and dtx-recv parameters are included, those parameters shall have the same value; however, inclusion of the dtx-recv parameter is not required if the dtx parameter is included.	If the dtx-recv parameter is contained in the SDP answer, the MRFC shall forward this parameter to the MRFP in the remote descriptor.
br (NOTE 1)	If the MRFC desires the same bit rate range for the send and receive direction in EVS primary mode, and wants to restrict the bit rate range to match MRFP capabilities and possible configured policies, it shall supply the br parameter in the SDP offer it sends. Otherwise, the MRFC shall not include this parameter in the SDP offer. If the MRFC also supplies the bw, bw-send or bw-recv parameter, the value of the br parameter shall be compatible with the values of those parameters.	If the br parameter is contained in the SDP answer, the MRFC shall forward this parameter to the MRFP in the remote descriptor.
br-send (NOTE 1)	If the MRFC desires a different bit rate (range) for the send and receive direction in EVS primary mode, and wants to restrict the bit rate range for the send direction to match MRFP capabilities and possible configured policies, it shall supply the br-send parameter in the SDP offer it sends. Otherwise, the MRFC shall not include this parameter in the SDP offer. If the MRFC also supplies the bw or bw-send parameter, the value of the br-send parameter shall be compatible with the values of those parameters.	If the br-send parameter is contained in the SDP answer, the MRFC shall forward this parameter to the MRFP in the remote descriptor.
br-recv (NOTE 1)	If the MRFC desires a different bit rate (range) for the send and receive direction in EVS primary mode, and wants to restrict the bit rate range for the receive direction to match MRFP capabilities and possible configured policies, it shall supply the br-recv parameter in the SDP offer it sends. Otherwise, the MRFC shall not include this parameter in the SDP offer. If the MRFC also supplies the bw or bw-recv parameter, the value of the br-recv parameter shall be compatible with the values of those parameters.	If the br-recv parameter is contained in the SDP answer, the MRFC shall forward this parameter to the MRFP in the remote descriptor.

bw (NOTE 1)	If the MRFC desires the same sampling bandwidth(s) for the send and receive direction in EVS primary mode, and wants to restrict the sampling bandwidths to match MRFP capabilities, sampling bandwidths of expected codecs EVS will be transcoded to, and possible configured policies, it shall supply the bw parameter in the SDP offer it sends. Otherwise, the MRFC shall not include this parameter in the SDP offer.	If the bw parameter is contained in the SDP answer, the MRFC shall forward this parameter to the MRFP in the remote descriptor.
bw-send (NOTE 1)	If the MRFC desires different sampling bandwidths for the send and receive direction in EVS primary mode, and wants to restrict the sampling bandwidths in the send direction to match MRFP capabilities, sampling bandwidths of expected codecs EVS will be transcoded to and possible configured policies, it shall supply the bw-send parameter in the SDP offer it sends. Otherwise, the MRFC shall not include this parameter in the SDP offer.	If the bw-send parameter is contained in the SDP answer, the MRFC shall forward this parameter to the MRFP in the remote descriptor.
bw-recv (NOTE 1)	If the MRFC desires different sampling bandwidths for the send and receive direction in EVS primary mode, and wants to restrict the sampling bandwidths in the receive direction to match MRFP capabilities, sampling bandwidths of expected codecs EVS will be transcoded to, and possible configured policies, it shall supply the bw-recv parameter in the SDP offer it sends. Otherwise, the MRFC shall not include this parameter in the SDP offer.	If the bw-recv parameter is contained in the SDP answer, the MRFC shall forward this parameter to the MRFP in the remote descriptor.
cmr (NOTE 1)	If the MRFC desires to disable codec mode requests within the RTP payload of the EVS primary mode (due to the MRFP capabilities or policies), it shall include the cmr parameter with value -1 in the SDP offer it sends.	If the cmr parameter is contained in the SDP answer, the MRFC shall forward this parameter to the MRFP in the remote descriptor.
ch-aw-recv (NOTE 1)	The MRFC shall include the ch-aw-recv parameter in the SDP offer if it desires to control the channel-aware mode of EVS in the receive direction, e.g. to disable it with value -1. The MRFC shall consider the capabilities of the MRFP when it chooses an appropriate value.	If the ch-aw-recv parameter is contained in the SDP answer, the MRFC shall forward this parameter to the MRFP in the remote descriptor.
number of channels (NOTE 2)	The MRFC shall only include the "number of channels" parameter in the SDP offer if it desires to send or receive multiple channels. If the desired number of channels in the send and receive direction differs, the MRFC shall include the higher value. The MRFC should consider the number of channels of expected codecs EVS will be transcoded to.	If the "number of channels" parameter is contained in the SDP answer, the MRFC shall forward this parameter to the MRFP in the remote descriptor.
ch-send (NOTE 1)	The MRFC shall only include the ch-send parameter in the SDP offer if it desires to send multiple channels, with different numbers of channels in the send and receive direction. The MRFC should consider the number of channels of expected codecs EVS will be transcoded to.	If the ch-send parameter is contained in the SDP answer, the MRFC shall forward this parameter to the MRFP in the remote descriptor.
ch-recv (NOTE 1)	The MRFC shall only include the ch-recv parameter in the SDP offer if it desires to receive multiple channels, with different numbers of channels in the send and receive direction. The MRFC should consider the number of channels of expected codecs EVS will be transcoded to.	If the ch-recv parameter is contained in the SDP answer, the MRFC shall forward this parameter to the MRFP in the remote descriptor.

mode-set (NOTE 3)	The MRFC shall only include the mode-set parameter in the SDP offer if it desires to restrict the mode-set of AMR-WB IO mode. The MRFC should only restrict the mode-set if the expected codecs EVS will be interworked with is AMR-WB and has a restricted mode-set.	If the mode-set parameter is contained in the SDP answer, the MRFC shall forward this parameter to the MRFP in the remote descriptor.
mode-change-period (NOTE 3)	The MRFC shall only include the mode-change-period parameter with value 2 in the SDP offer if it desires to restrict the mode-change-period of received packets in AMR-WB IO mode. The MRFC should only restrict the mode-change-period if the expected codec EVS will be interworked with is AMR-WB and has such a restriction.	If the mode-change-period parameter is contained in the SDP answer, the MRFC shall forward this parameter to the MRFP in the remote descriptor.
mode-change-capability (NOTE 3)	The MRFC shall either include the mode-change-capability parameter with value 2 or omit the parameter in the SDP offer.	If the mode-change-capability parameter is contained in the SDP answer, the MRFC may forward this parameter to the MRFP in the remote descriptor.
mode-change-neighbor (NOTE 3)	The MRFC shall only include the mode-change-neighbor parameter in the SDP offer if it desires to restrict the mode-change within received packets of AMR-WB IO mode to neighboring modes. The MRFC should consider the mode-change-neighbor parameter of the expected codec EVS will be interworked with if this is AMR-WB.	If the mode-change-neighbor parameter is contained in the SDP answer, the MRFC shall forward this parameter to the MRFP in the remote descriptor.
max-red (NOTE 5)	The MRFC shall only include the max-red parameter in the SDP offer if it desires to restrict the maximum redundancy of received packets. MRFC shall consider the capabilities of the MRFP, and should consider a max-red parameter of the expected codec EVS will be interworked with if this is AMR-WB.	If the max-red parameter is contained in the SDP answer, the MRFC shall forward this parameter to the MRFP in the remote descriptor.
3gpp_mtsi_app_adapt (NOTE 4)	If the MRFP supports RTCP APP based adaptation messages defined in 3GPP TS 26.114 [23], and the MRFC has a policy to negotiate the usage of those messages, the MRFC shall include the 3gpp_mtsi_app_adapt SDP attribute indicating the supported APP messages in the SDP offer.	If the 3gpp_mtsi_app_adapt attribute is contained in the SDP answer, the MRFC shall forward this parameter to the MRFP in the remote descriptor.
<p>NOTE 1: This MIME parameter of the EVS RTP payload type is defined in 3GPP TS 26.445 [43]. It is encapsulated within the SDP "a=fmtp" attribute defined IETF RFC 4566 [44].</p> <p>NOTE 2: This number of channels are encoded as "encoding parameters" of the SDP "a=rtpmap" attribute defined in IETF RFC 4566 [44].</p> <p>NOTE 3: This MIME parameter of the EVS RTP payload type relates to AMR-WB IO mode and is defined in IETF RFC 4867 [45]. It is encapsulated within the SDP "a=fmtp" attribute defined IETF RFC 4566 [44].</p> <p>NOTE 4: This SDP attribute is defined in 3GPP TS 26.114 [23]. It applies to all codecs offered in an SDP media line. However, some values are specific to EVS.</p> <p>NOTE 5: This MIME parameter of the EVS RTP payload type is defined in IETF RFC 4867 [45]. It is encapsulated within the SDP "a=fmtp" attribute defined IETF RFC 4566 [44].</p>		

When receiving an SDP offer that contains an EVS codec payload type, the MRFC shall handle the EVS codec parameters as described in table 5.12.3.2. In addition, rules for the parameter handling in 3GPP TS 26.445 [43] shall apply.

Table 5.12.3.2: MRFC handling of EVS related SDP parameters when the MRFC receives the EVS payload type in an SDP offer.

Parameter	Handling of EVS payload type parameter received in the SDP offer	EVS payload type supplied in the SDP answer
evs-mode-switch (NOTE 1)	If the evs-mode-switch parameter is contained in the SDP offer and the MRFC selects the EVS payload type, the MRFC shall forward this parameter to the MRFP for the termination towards the offerer in the remote descriptor.	If the evs-mode-switch parameter is contained in the SDP offer, the MRFC shall include the evs-mode-switch parameter with unmodified value in the SDP answer. Otherwise, if the MRFC decides to interwork between AMR-WB and EVS, it shall include the evs-mode-switch with value 1. Otherwise, the MRFC shall not include the evs-mode-switch. If the MRFC supplies the evs-mode-switch in the SDP answer, it shall also supply it to the MRFP in the local descriptor for the termination towards the offerer with the same value.
hf-only (NOTE 1)	If the hf-only parameter is contained in the SDP offer and the MRFC selects the EVS payload type, the MRFC shall forward this parameter to the MRFP for the termination towards the offerer in the remote descriptor.	If the hf-only parameter is contained in the SDP offer, the MRFC shall include the hf-only parameter with unmodified value in the SDP answer. Otherwise, the MRFC may include the hf-only parameter with a value matching negotiated values of possible other EVS call legs in the conference. If the MRFC supplies the hf-only parameter in the SDP answer, it shall also supply it to the MRFP in the local descriptor for the termination towards the offerer with the same value.
dtx (NOTE 1)	If the dtx parameter is contained in the SDP offer and the MRFC selects the EVS payload type, the MRFC shall forward this parameter to the MRFP for the termination towards the offerer in the remote descriptor.	If the dtx parameter is contained in the SDP offer, the MRFC shall include the dtx parameter with unmodified value in the SDP answer. If the dtx parameter is not contained in the SDP offer and if a dtx-recv parameter is contained in the SDP offer, the MRFC may include the dtx parameter in the SDP answer, and the value of the dtx parameter shall then be identical to that of the dtx-recv parameter in the SDP offer (e.g, if that value matches negotiated values of possible other EVS call legs in the conference). If the dtx parameter is not contained in the SDP offer and if the dtx-recv parameter is not contained in the SDP offer the MRFC may include in the SDP answer the dtx parameter with a value matching negotiated values of possible other EVS call legs in the conference. If the MRFC supplies the dtx parameter in the SDP answer, it shall also supply it to the MRFP in the local descriptor for the termination towards the offerer with the same value.
dtx-recv (NOTE 1)	If the dtx-recv parameter is contained in the SDP offer and the MRFC selects the EVS payload type, the MRFC shall forward this parameter to the MRFP for the termination towards the offerer in the remote descriptor.	If no dtx parameter is included in the SDP answer and if the reception of DTX is not desired, the MRFC shall include in the SDP answer the dtx-recv parameter with a value 0. If both the dtx and dtx-recv parameters are included, those parameters shall have the same value; however, inclusion of the dtx-recv parameter is not required if the dtx parameter is included. If the MRFC supplies the dtx-recv parameter in the SDP answer, it should also supply it to the MRFP in the local descriptor for the termination towards the offerer with the same value.

<p>br (NOTE 1)</p>	<p>If the br parameter is contained in the SDP offer, the MRFC shall check if the MRFP supports the indicated bitrates, or a subset of them, in EVS primary mode in the send and receive direction. If the indicated bitrates, and even each subset of them, are not supported, the MRFC shall not select the EVS payload type. If the MRFC selects the EVS payload type, it shall forward this parameter to the MRFP for the termination towards the offerer in the remote descriptor.</p>	<p>If the br parameter is contained in the SDP offer, the MRFC shall select a bitrate value, which is either the received br value or a subset of it, based on MRFP capabilities, possible configured policies, and the negotiated br range of possible other EVS call legs in the conference, and shall include the br parameter with the selected value that is also supplied towards the MRFP in the SDP answer.</p> <p>Otherwise, if the MRFC desires the same bit rate range for the send and receive direction in EVS primary mode, and wants to restrict the bit rate range to match MRFP capabilities, possible configured policies, and the negotiated br range of possible other EVS call legs in the conference, the MRFC shall supply the br parameter in the SDP answer it sends.</p> <p>Otherwise, the MRFC shall not include this parameter in the answer.</p> <p>If the MRFC also supplies the bw, bw-send or bw-recv parameter, the value of the br parameter shall be compatible with the values of those parameters.</p> <p>If the MRFC supplies the br parameter in the SDP answer, it shall also supply to the MRFP the br parameter in the local descriptor for the termination towards the offerer with the same value.</p>
<p>br-send (NOTE 1)</p>	<p>If the br-send parameter is contained in the SDP offer, the MRFC shall check if the MRFP supports the indicated bitrates, or a subset of them, in EVS primary mode in the receive direction. If the indicated bitrates, and even each subset of them, are not supported, the MRFC shall not select the EVS payload type. If the MRFC selects the EVS payload type, it shall forward this parameter to the MRFP for the termination towards the offerer in the remote descriptor.</p>	<p>If the br-recv parameter is contained in the SDP offer, the MRFC shall select a bitrate value, which is either the received br-recv value or a subset of it, based on MRFP capabilities possible configured policies, and the negotiated br range of possible other EVS call legs in the conference, and the MRFC shall include the br-send parameter with the selected value that is also supplied towards the MRFP in the SDP answer.</p> <p>Otherwise, if the MRFC desires a different bit rate (range) for the send and receive direction in EVS primary mode, and wants to restrict the bit rate range for the send direction to match MRFP capabilities and possible configured policies, it shall supply the br-send parameter in the SDP answer it sends.</p> <p>Otherwise, the MRFC shall not include the br-send parameter in the SDP answer.</p> <p>If the MRFC also supplies the bw or bw-send parameter, the value of the br-send parameter shall be compatible with the values of those parameters.</p> <p>If the MRFC supplies the br-send parameter in the SDP answer, it shall also supply to the MRFP the br-send parameter in the local descriptor for the termination towards the offerer with the same value.</p>

br-recv (NOTE 1)	<p>If the br-recv parameter is contained in the SDP offer, the MRFC shall check if the MRFP supports the indicated bitrates, or a subset of them, in EVS primary mode in the send direction. If the indicated bitrates, and even each subset of them, are not supported, the MRFC shall not select the EVS payload type. If the MRFC selects the EVS payload type, it shall forward this parameter to the MRFP for the termination towards the offerer in the remote descriptor.</p>	<p>If the br-send parameter is contained in the SDP offer, the MRFC shall select a bitrate value, which is either the received br-send value or a subset of it, based on MRFP capabilities, possible configured policies, and the negotiated br range of possible other EVS call legs in the conference, and the MRFC shall include the br-recv parameter with the selected value that is also supplied towards the MRFP in the SDP answer.</p> <p>Otherwise, if the MRFC desires a different bit rate (range) for the send and receive direction in EVS primary mode, and wants to restrict the bit rate range for the receive direction to match MRFP capabilities and possible configured policies, it shall supply the br-recv parameter in the SDP answer it sends.</p> <p>Otherwise, the MRFC shall not include the br-recv parameter in the SDP answer.</p> <p>If the MRFC also supplies the bw or bw-recv parameter, the value of the br-recv parameter shall be compatible with the values of those parameters.</p> <p>If the MRFC supplies the br-recv parameter in the SDP answer, it shall also supply to the MRFP the br-recv parameter in the local descriptor for the termination towards the offerer with the same value.</p>
bw (NOTE 1)	<p>If the bw parameter is contained in the SDP offer, the MRFC shall check if the MRFP supports the indicated sampling bandwidth(s), or a subset of them, in EVS primary mode in the send and receive direction. If the indicated sampling bandwidth(s), and even each subset of them, are not supported, the MRFC shall not select the EVS payload type. If the MRFC selects the EVS payload type, it shall forward this parameter to the MRFP for the termination towards the offerer in the remote descriptor.</p>	<p>If the bw parameter is contained in the SDP offer, the MRFC shall select a sampling bandwidth value, which is either the received bw value or a subset of it, based on MRFP capabilities, possible configured policies, and the negotiated bw range of possible other EVS call legs in the conference, and the MRFC shall include the bw parameter with the selected value that is also supplied towards the MRFP in the SDP answer.</p> <p>Otherwise, if the MRFC desires the same sampling bandwidth(s) for the send and receive direction in EVS primary mode, and wants to restrict the sampling bandwidth(s) to match MRFP capabilities, possible configured policies, and the negotiated bw range of possible other EVS call legs in the conference, the MRFC shall supply the bw parameter in the SDP answer it sends.</p> <p>Otherwise, the MRFC shall not include this parameter in the SDP answer.</p> <p>If the MRFC also supplies the br, br-send or br-recv parameter, the value of the bw parameter shall be compatible with the values of those parameters.</p> <p>If the MRFC supplies the bw parameter in the SDP answer, it shall also supply to the MRFP the bw parameter in the local descriptor for the termination towards the offerer with the same value.</p>

<p>bw-send (NOTE 1)</p>	<p>If the bw-send parameter is contained in the SDP offer, the MRFC shall check if the MRFP supports the indicated sampling bandwidths, or a subset of them, in EVS primary mode in the receive direction. If the indicated sampling bandwidths, and even each subset of them, are not supported, the MRFC shall not select the EVS payload type. If the MRFC selects the EVS payload type, it shall forward this parameter to the MRFP for the termination towards the offerer in the remote descriptor.</p>	<p>If the bw-recv parameter is contained in the SDP offer, the MRFC shall select a sampling bandwidths value, which is either the received bw-recv value or a subset of it, based on MRFP capabilities, possible configured policies, and the negotiated bw range of possible other EVS call legs in the conference, and the MRFC shall include the bw-send parameter with the selected value in the SDP answer. Otherwise, if the MRFC desires different sampling bandwidths for the send and receive direction in EVS primary mode, and wants to restrict the sampling bandwidths for the send direction to match MRFP capabilities, possible configured policies, and the negotiated bw range of possible other EVS call legs in the conference, the MRFC shall supply the bw-send parameter in the SDP answer it sends. Otherwise, the MRFC shall not include the bw-send parameter in the SDP answer. If the MRFC also supplies the br or br-send parameter, the value of the bw-send parameter shall be compatible with the values of those parameters. If the MRFC supplies the bw-send parameter in the SDP answer, it shall also supply to the MRFP the bw-send parameter in the local descriptor for the termination towards the offerer with the same value.</p>
<p>bw-recv (NOTE 1)</p>	<p>If the br-recv parameter is contained in the SDP offer, the MRFC shall check if the MRFP supports the indicated sampling bandwidths, or a subset of them, in EVS primary mode in the send direction. If the indicated sampling bandwidths, and even each subset of them, are not supported, the MRFC shall not select the EVS payload type. If the MRFC selects the EVS payload type, it shall forward the bw-recv parameter to the MRFP for the termination towards the offerer in the remote descriptor.</p>	<p>If the bw-send parameter is contained in the SDP offer, the MRFC shall select a sampling bandwidths value, which is either the received bw-send value or a subset of it, based on MRFP capabilities, possible configured policies, and the negotiated bw range of possible other EVS call legs in the conference, and the MRFC shall include the bw-recv parameter with the selected value in the SDP answer. Otherwise, if the MRFC desires different sampling bandwidths for the send and receive direction in EVS primary mode, and wants to restrict the sampling bandwidths for the receive direction to match MRFP capabilities, possible configured policies, and the negotiated bw range of possible other EVS call legs in the conference, the MRFC shall supply the bw-recv parameter in the SDP answer it sends. Otherwise, the MRFC shall not include the bw-recv parameter in the SDP answer. If the MRFC also supplies the br or br-recv parameter, the value of the bw-recv parameter shall be compatible with the values of those parameters. If the MRFC supplies the bw-recv parameter in the SDP answer, it shall also supply it to the MRFP in the local descriptor for the termination towards the offerer with the same value.</p>

cmr (NOTE 1)	If the cmr parameter is contained in the SDP offer and the MRFC selects the EVS payload type, the MRFC shall forward this parameter to the MRFP for the termination towards the offerer in the remote descriptor.	If the cmr parameter is contained in the SDP offer, the MRFC shall include the cmr parameter with unmodified value in the SDP answer. Otherwise, if the MRFP desires to disable codec mode requests within the RTP payload of the EVS primary mode (due to the MRFP capabilities, possible configured policies, and the negotiated CMR mode of possible other EVS call legs in the conference, it shall include the cmr parameter with value -1 in the SDP answer it sends. If the MRFC supplies the cmr parameter in the SDP answer, it shall also supply it to the MRFP in the local descriptor for the termination towards the offerer with the same value.
ch-aw-recv (NOTE 1)	If the ch-aw-recv parameter is contained in the SDP offer the MRFC shall check if the MRFP supports the indicated mode in the send direction. If the indicated mode is not supported, the MRFC shall not select the EVS payload type. If the MRFC selects the EVS payload type, the MRFC shall forward this parameter to the MRFP for the termination towards the offerer in the remote descriptor.	If the MRFC desires to control the channel-aware mode of EVS in the receive direction, e.g. to disable it with value -1, it shall include the ch-aw-recv parameter in the SDP answer and shall also supply the ch-aw-recv parameter to the MRFP in the local descriptor for the termination towards the offerer with the same value. The MRFC shall consider the capabilities of the MRFP and the negotiated ch-aw-recv mode of possible other EVS call legs in the conference when it chooses an appropriate value.
number of channels (NOTE 2)	If the "number of channels" parameter is contained in the SDP offer, the MRFC shall check if the MRFP supports the indicated number of channels. If the indicated number of channels is not supported, the MRFC shall not select the EVS payload type. If the MRFC selects the EVS payload type, the MRFC shall forward this parameter to the MRFP for the termination towards the offerer in the remote descriptor.	If the "number of channels" parameter is contained in the SDP offer, the MRFC shall include the "number of channels" parameter with unmodified value in the SDP answer and shall also supply it to the MRFP in the local descriptor for the termination towards the offerer with the same value.
ch-send (NOTE 1)	If the ch-send parameter is contained in the SDP offer, the MRFC shall check if the MRFP supports the indicated number of channels in the receive direction. If the indicated number of channels is not supported, the MRFC shall not select the EVS payload type. If the MRFC selects the EVS payload type, the MRFC shall forward the ch-send parameter to the MRFP for the termination towards the offerer in the remote descriptor.	If the ch-recv parameter is contained in the SDP offer, the MRFC shall include the ch-send parameter with unmodified value in the SDP answer and shall also supply the ch-send parameter to the MRFP in the local descriptor for the termination towards the offerer with the same value.
ch-recv (NOTE 1)	If the ch-recv parameter is contained in the SDP offer, the MRFC shall check if the MRFP supports the indicated number of channels in the send direction. If the indicated number of channels is not supported, the MRFC shall not select the EVS payload type. If the MRFC selects the EVS payload type for transcoding, the MRFC shall forward the ch-recv parameter to the MRFP for the termination towards the offerer in the remote descriptor.	If the ch-send parameter is contained in the SDP offer, the MRFC shall include the ch-recv parameter with unmodified value in the SDP answer and shall also supply the ch-recv parameter to the MRFP in the local descriptor for the termination towards the offerer with the same value.

mode-set (NOTE 3)	If the mode-set parameter is contained in the SDP offer and the MRFC selects the EVS payload type, the MRFC shall forward this parameter to the MRFP for the termination towards the offerer in the remote descriptor.	If the mode-set parameter is contained in the SDP offer, the MRFC shall include the mode-set parameter with unmodified value in the SDP answer. Otherwise, if EVS or AMR-WB is used on possible other call legs in the conference, the MRFC should include the mode-set parameter with a value indicating the mode that was negotiated on those other call legs (or omit it if no restrictions applied before). If the MRFC supplies the mode-set parameter in the SDP answer, it shall also supply it to the MRFP in the local descriptor for the termination towards the offerer with the same value.
mode-change-period (NOTE 3)	If the mode-change-period parameter is contained in the SDP offer and the MRFC selects the EVS payload type, the MRFC shall forward this parameter to the MRFP for the termination towards the offerer in the remote descriptor.	If the MRFC selects the EVS payload type, the MRFC shall either include the mode-change-capability parameter with value 2 or omit it. If the MRFC supplies the mode-change-capability parameter in the SDP answer, it may also supply it to the MRFP in the local descriptor for the termination towards the offerer with the same value.
mode-change-capability (NOTE 3)	If the mode-change-capability parameter is contained in the SDP offer and the MRFC selects the EVS payload type, the MRFC may forward this parameter to the MRFP for the termination towards the offerer in the remote descriptor.	If EVS or AMR-WB is used on possible other EVS call legs in the conference, the MRFC should include the mode-change-capability parameter with a value indicating the mode that was negotiated on those other call legs (or omit it if no restrictions applied before). If the MRFC supplies the mode-change-capability parameter in the SDP answer, it may also supply it to the MRFP in the local descriptor for the termination towards the offerer with the same value.
mode-change-neighbor (NOTE 3)	If the mode-change-neighbor parameter is contained in the SDP offer and the MRFC selects the EVS payload type, the MRFC shall forward this parameter to the MRFP for the termination towards the offerer in the remote descriptor.	If EVS or AMR-WB was used on possible other EVS call legs in the conference, the MRFC should include the mode-change-neighbor parameter with a value indicating the mode that was negotiated on those other call legs (or omit it if no restrictions applied before). If the MRFC supplies the mode-change-neighbor parameter in the SDP answer, it shall also supply it to the MRFP in the local descriptor for the termination towards the offerer with the same value.
max-red (NOTE 5)	If the max-red parameter is contained in the SDP offer and the MRFC selects the EVS payload type, the MRFC shall forward this parameter to the MRFP for the termination towards the offerer in the remote descriptor.	The MRFC shall only include the max-red parameter in the SDP answer if it desires to restrict the maximum redundancy of received packets. When selecting the value of the max-red parameter, the MRFC shall consider the capabilities of the MRFP and, if EVS or AMR-WB is used on possible other EVS call legs in the conference, the redundancy that was negotiated on those call legs. If the MRFC supplies the max-red parameter in the SDP answer, it shall also supply it to the MRFP in the local descriptor for the termination towards the offerer with the same value.

3gpp_mtsi_app_adapt (NOTE 4)	If the 3gpp_mtsi_app_adapt parameter is contained in the SDP offer, and the MRFC selects the EVS payload type, the MRFC shall forward this parameter to the MRFP in the remote descriptor.	If the MRFP supports RTCP APP based adaptation messages defined in 3GPP TS 26.114 [23], and the MRFC has a policy to negotiate the usage of those messages, the MRFC shall include the 3gpp_mtsi_app_adapt SDP attribute indicating the allowed APP messages in the SDP answer. If EVS is used possible other EVS call legs in the conference, the MRFC should consider the negotiated RTCP APP packet types on those call legs in addition to the MRFP capabilities when selecting the allowed RTCP APP messages.
<p>NOTE 1: This MIME parameter of the EVS RTP payload type is defined in 3GPP TS 26.445 [43]. It is encapsulated within the SDP "a=fmtp" attribute defined IETF RFC 4566 [44].</p> <p>NOTE 2: This number of channels are encoded as "encoding parameters" of the SDP "a=rtpmap" attribute defined in IETF RFC 4566 [44].</p> <p>NOTE 3: This MIME parameter of the EVS RTP payload type relates to AMR-WB IO mode and is defined in IETF RFC 4867 [45]. It is encapsulated within the SDP "a=fmtp" attribute defined IETF RFC 4566 [44].</p> <p>NOTE 4: This SDP attribute is defined in 3GPP TS 26.114 [23]. It applies to all codecs offered in an SDP media line. However, some values are specific to EVS.</p> <p>NOTE 5: This MIME parameter of the EVS RTP payload type is defined in IETF RFC 4867 [45]. It is encapsulated within the SDP "a=fmtp" attribute defined IETF RFC 4566 [44].</p>		

The MRFP handling of EVS codec parameters shall follow table 5.13.3.3 in 3GPP TS 23.334 [41]. The MRFP should support transcoding of EVS with bandwidths (sampling rates) which are supported by codec the MRFP is capable to transcode EVS to/from (e.g. NB for AMR, and WB for AMR-WB).

5.12.4 Handling of the IVAS speech codec

The Immersive Voice and Audio Services (IVAS) speech codec is defined in 3GPP TS 26.250 [68]. Its RTP payload type is defined in 3GPP TS 26.263 [69], and procedures for its usage as IMS Multimedia Telephony speech codec are defined in 3GPP TS 26.114 [23].

The MRFC and the MRFP may support transcoding the IVAS speech codec to and from another (mono-format) codec (e.g. AMR-WB or EVS). If they do so, the MRFC and the MRFP shall support transcoding to and from the IVAS speech codec using the EVS Primary and AMRWB-IO modes, shall support transcoding from the IVAS speech codec using the IVAS Immersive mode (i.e. decoding the IVAS speech codec using the IVAS Immersive mode) and the MRFC and the MRFP may support transcoding to the IVAS speech codec using the IVAS Immersive mode, and the procedures in the present clause apply.

If the MRFC creates an SDP offer, the MRFC should not offer an IVAS payload type to avoid the need for transcoding between IVAS Immersive mode and another codec in this scenario. When receiving the SDP offer that contains the IVAS codec payload type, the MRFC shall handle the IVAS codec parameters as described in table 5.12.4.1 if the MRFC selects the IVAS payload type in the SDP answer. In addition, rules for the parameter handling in 3GPP TS 26.253 [69] shall apply.

Table 5.12.4.1: MRFC handling of IVAS related SDP parameters when the MRFC receives the IVAS payload type in an SDP offer and the MRFC selects the IVAS payload type in the SDP answer

Parameter	Handling of IVAS payload type parameter received in the SDP offer	IVAS payload type supplied in the SDP answer
ivas-mode-switch (NOTE 1)	If the ivas-mode-switch parameter is contained in the SDP offer and the MRFC selects the IVAS payload type, the MRFC shall forward this parameter to the MRFP for the termination towards the offerer in the remote descriptor.	If the ivas-mode-switch parameter is contained in the SDP offer, the MRFC shall include the ivas-mode-switch parameter with unmodified value in the SDP answer. Otherwise, if the MRFC decides to interwork between EVS or AMR-WB and IVAS using EVS Primary or AMR-WB IO mode, the MRFC shall include the ivas-mode-switch with value 1 in the SDP answer. Otherwise, the MRFC shall not include the ivas-mode-switch parameter in the SDP answer. If the MRFC supplies the ivas-mode-switch in the SDP answer, the MRFC shall also supply it to the MRFP in the local descriptor for the termination towards the offerer with the same value.
evs-mode-switch (NOTE 3)	If the evs-mode-switch parameter is contained in the SDP offer and the MRFC selects the IVAS payload type, the MRFC shall forward this parameter to the MRFP for the termination towards the offerer in the remote descriptor.	If the evs-mode-switch parameter is contained in the SDP offer, the MRFC shall include the evs-mode-switch parameter with unmodified value in the SDP answer. Otherwise, if the MRFC decides to interwork between AMR-WB or EVS using AMR-WB IO mode and IVAS using AMR-WB IO mode, the MRFC shall include the evs-mode-switch with value 1. Otherwise, the MRFC shall not include the evs-mode-switch. If the MRFC supplies the evs-mode-switch in the SDP answer, the MRFC shall also supply it to the MRFP in the local descriptor for the termination towards the offerer with the same value.
cmr (NOTE 1)	If the cmr parameter is contained in the SDP offer and the MRFC selects the IVAS payload type, the MRFC shall forward this parameter to the MRFP for the termination towards the offerer in the remote descriptor.	If the cmr parameter is contained in the SDP offer, the MRFC shall include the cmr parameter with unmodified value in the SDP answer. Otherwise, if the MRFP desires to disable codec mode requests within the IVAS RTP payload (due to the MRFP capabilities, possible configured policies, and the negotiated CMR mode of possible other IVAS call legs in the conference), the MRFC shall include the cmr parameter with value -1 in the SDP answer it sends. If the MRFC supplies the cmr parameter in the SDP answer, the MRFC shall also supply it to the MRFP in the local descriptor for the termination towards the offerer with the same value.
hf-only (NOTE 1, NOTE 6)	If the hf-only parameter set to value 1 is contained in the SDP offer and the MRFC selects the IVAS payload type, the MRFC shall forward this parameter to the MRFP for the termination towards the offerer in the remote descriptor.	If the hf-only parameter set to value 1 is contained in the SDP offer, the MRFC shall include the hf-only parameter with unmodified value in the SDP answer. If the MRFC supplies the hf-only parameter in the SDP answer, the MRFC shall also supply it to the MRFP in the local descriptor for the termination towards the offerer with the same value.

dtx (NOTE 1)	If the dtx parameter is contained in the SDP offer and the MRFC selects the IVAS payload type, the MRFC shall forward this parameter to the MRFP for the termination towards the offerer in the remote descriptor.	<p>If the dtx parameter is contained in the SDP offer, the MRFC shall include the dtx parameter with unmodified value in the SDP answer.</p> <p>If the dtx parameter is not contained in the SDP offer and if a dtx-recv parameter is contained in the SDP offer, the MRFC may include the dtx parameter in the SDP answer, and the value of the dtx parameter shall then be identical to that of the dtx-recv parameter in the SDP offer (e.g, if that value matches negotiated values of possible other IVAS call legs in the conference).</p> <p>If the dtx parameter is not contained in the SDP offer and if the dtx-recv parameter is not contained in the SDP offer the MRFC may include in the SDP answer the dtx parameter with a value matching negotiated values of possible other IVAS call legs in the conference.</p> <p>If the MRFC supplies the dtx parameter in the SDP answer, the MRFC shall also supply it to the MRFP in the local descriptor for the termination towards the offerer with the same value.</p>
dtx-recv (NOTE 1)	If the dtx-recv parameter is contained in the SDP offer and the MRFC selects the IVAS payload type, the MRFC shall forward this parameter to the MRFP for the termination towards the offerer in the remote descriptor.	<p>If no dtx parameter is included in the SDP answer and if the reception of DTX is not desired, the MRFC shall include in the SDP answer the dtx-recv parameter with a value 0.</p> <p>If both the dtx and dtx-recv parameters are included, those parameters shall have the same value; however, inclusion of the dtx-recv parameter is not required if the dtx parameter is included.</p> <p>If the MRFC supplies the dtx-recv parameter in the SDP answer, it should also supply it to the MRFP in the local descriptor for the termination towards the offerer with the same value.</p>
max-red (NOTE 2)	If the max-red parameter is contained in the SDP offer and the MRFC selects the IVAS payload type, the MRFC shall forward this parameter to the MRFP for the termination towards the offerer in the remote descriptor.	<p>The MRFC shall only include the max-red parameter in the SDP answer if the MRFC desires to restrict the maximum redundancy of received packets. When selecting the value of the max-red parameter, the MRFC shall consider the capabilities of the MRFP and, if the IVAS codec using AMR-WB IO mode is used on possible other IVAS call legs in the conference, the redundancy that was negotiated on those call legs.</p> <p>If the MRFC supplies the max-red parameter in the SDP answer, the MRFC shall also supply it to the MRFP in the local descriptor for the termination towards the offerer with the same value.</p>

<p>br (NOTE 3)</p>	<p>If the br parameter is contained in the SDP offer, the MRFC shall check if the MRFP supports the indicated bitrates, or a subset of them, in EVS primary mode in the send and receive direction. If the indicated bitrates, and even each subset of them, are not supported, the MRFC shall not select the IVAS payload type. If the MRFC selects the IVAS payload type, the MRFC shall forward this parameter to the MRFP for the termination towards the offerer in the remote descriptor.</p>	<p>If the br parameter is contained in the SDP offer, the MRFC shall select a bitrate value, which is either the received br value or a subset of it, based on MRFP capabilities, possible configured policies, and the negotiated br range of possible other IVAS call legs in the conference, and shall include the br parameter with the selected value that is also supplied towards the MRFP in the SDP answer. Otherwise, if the MRFC desires the same bit rate range for the send and receive direction in EVS primary mode and wants to restrict the bit rate range to match MRFP capabilities, possible configured policies, and the negotiated br range of possible other IVAS call legs in the conference, the MRFC shall supply the br parameter in the SDP answer it sends. Otherwise, the MRFC shall not include this parameter in the SDP answer. If the MRFC also supplies the bw, bw-send or bw-recv parameter, the value of the br parameter shall be compatible with the values of those parameters. If the MRFC supplies the br parameter in the SDP answer, the MRFC shall also supply to the MRFP the br parameter in the local descriptor for the termination towards the offerer with the same value.</p>
<p>br-send (NOTE 3)</p>	<p>If the br-send parameter is contained in the SDP offer, the MRFC shall check if the MRFP supports the indicated bitrates, or a subset of them, in EVS primary mode in the receive direction. If the indicated bitrates, and even each subset of them, are not supported, the MRFC shall not select the IVAS payload type. If the MRFC selects the IVAS payload type, the MRFC shall forward this parameter to the MRFP for the termination towards the offerer in the remote descriptor.</p>	<p>If the br-recv parameter is contained in the SDP offer, the MRFC shall select a bitrate value, which is either the received br-recv value or a subset of it, based on MRFP capabilities, possible configured policies, and the negotiated br range of possible other IVAS call legs in the conference, and the MRFC shall include the br-send parameter with the selected value that is also supplied towards the MRFP in the SDP answer. Otherwise, if the MRFC desires a different bit rate (range) for the send and receive direction in EVS primary mode and wants to restrict the bit rate range for the send direction to match MRFP capabilities and possible configured policies, the MRFC shall supply the br-send parameter in the SDP answer it sends. Otherwise, the MRFC shall not include the br-send parameter in the SDP answer. If the MRFC also supplies the bw or bw-send parameter, the value of the br-send parameter shall be compatible with the values of those parameters. If the MRFC supplies the br-send parameter in the SDP answer, the MRFC shall also supply to the MRFP the br-send parameter in the local descriptor for the termination towards the offerer with the same value.</p>

br-recv (NOTE 3)	<p>If the br-recv parameter is contained in the SDP offer, the MRFC shall check if the MRFP supports the indicated bitrates, or a subset of them, in EVS primary mode in the send direction. If the indicated bitrates, and even each subset of them, are not supported, the MRFC shall not select the IVAS payload type. If the MRFC selects the IVAS payload type, the MRFC shall forward this parameter to the MRFP for the termination towards the offerer in the remote descriptor.</p>	<p>If the br-send parameter is contained in the SDP offer, the MRFC shall select a bitrate value, which is either the received br-send value or a subset of it, based on MRFP capabilities, possible configured policies, and the negotiated br range of possible other IVAS call legs in the conference, and the MRFC shall include the br-recv parameter with the selected value that is also supplied towards the MRFP in the SDP answer.</p> <p>Otherwise, if the MRFC desires a different bit rate (range) for the send and receive direction in EVS primary mode and wants to restrict the bit rate range for the receive direction to match MRFP capabilities and possible configured policies, the MRFC shall supply the br-recv parameter in the SDP answer it sends.</p> <p>Otherwise, the MRFC shall not include the br-recv parameter in the SDP answer. If the MRFC also supplies the bw or bw-recv parameter, the value of the br-recv parameter shall be compatible with the values of those parameters.</p> <p>If the MRFC supplies the br-recv parameter in the SDP answer, the MRFC shall also supply to the MRFP the br-recv parameter in the local descriptor for the termination towards the offerer with the same value.</p>
bw (NOTE 3)	<p>If the bw parameter is contained in the SDP offer, the MRFC shall check if the MRFP supports the indicated sampling bandwidth(s), or a subset of them, in EVS primary mode in the send and receive direction. If the indicated sampling bandwidth(s), and even each subset of them, are not supported, the MRFC shall not select the IVAS payload type. If the MRFC selects the IVAS payload type, the MRFC shall forward this parameter to the MRFP for the termination towards the offerer in the remote descriptor.</p>	<p>If the bw parameter is contained in the SDP offer, the MRFC shall select a sampling bandwidth value, which is either the received bw value or a subset of it, based on MRFP capabilities, possible configured policies, and the negotiated bw range of possible other IVAS call legs in the conference, and the MRFC shall include the bw parameter with the selected value that is also supplied towards the MRFP in the SDP answer.</p> <p>Otherwise, if the MRFC desires the same sampling bandwidth(s) for the send and receive direction in EVS primary mode and wants to restrict the sampling bandwidth(s) to match MRFP capabilities, possible configured policies, and the negotiated bw range of possible other IVAS call legs in the conference, the MRFC shall supply the bw parameter in the SDP answer it sends.</p> <p>Otherwise, the MRFC shall not include this parameter in the SDP answer. If the MRFC also supplies the br, br-send or br-recv parameter, the value of the bw parameter shall be compatible with the values of those parameters.</p> <p>If the MRFC supplies the bw parameter in the SDP answer, the MRFC shall also supply to the MRFP the bw parameter in the local descriptor for the termination towards the offerer with the same value.</p>

<p>bw-send (NOTE 3)</p>	<p>If the bw-send parameter is contained in the SDP offer, the MRFC shall check if the MRFP supports the indicated sampling bandwidths, or a subset of them, in EVS primary mode in the receive direction. If the indicated sampling bandwidths, and even each subset of them, are not supported, the MRFC shall not select the IVAS payload type. If the MRFC selects the IVAS payload type, the MRFC shall forward this parameter to the MRFP for the termination towards the offerer in the remote descriptor.</p>	<p>If the bw-recv parameter is contained in the SDP offer, the MRFC shall select a sampling bandwidths value, which is either the received bw-recv value or a subset of it, based on MRFP capabilities, possible configured policies, and the negotiated bw range of possible other IVAS call legs in the conference, and the MRFC shall include the bw-send parameter with the selected value in the SDP answer. Otherwise, if the MRFC desires different sampling bandwidths for the send and receive direction in EVS primary mode and wants to restrict the sampling bandwidths for the send direction to match MRFP capabilities, possible configured policies, and the negotiated bw range of possible other IVAS call legs in the conference, the MRFC shall supply the bw-send parameter in the SDP answer it sends. Otherwise, the MRFC shall not include the br-send parameter in the SDP answer. If the MRFC also supplies the br or br-send parameter, the value of the bw-send parameter shall be compatible with the values of those parameters. If the MRFC supplies the bw-send parameter in the SDP answer, the MRFC shall also supply to the MRFP the bw-send parameter in the local descriptor for the termination towards the offerer with the same value.</p>
<p>bw-recv (NOTE 3)</p>	<p>If the bw-recv parameter is contained in the SDP offer, the MRFC shall check if the MRFP supports the indicated sampling bandwidths, or a subset of them, in EVS primary mode in the send direction. If the indicated sampling bandwidths, and even each subset of them, are not supported, the MRFC shall not select the IVAS payload type. If the MRFC selects the IVAS payload type, the MRFC shall forward the bw-recv parameter to the MRFP for the termination towards the offerer in the remote descriptor.</p>	<p>If the bw-send parameter is contained in the SDP offer, the MRFC shall select a sampling bandwidths value, which is either the received bw-send value or a subset of it, based on MRFP capabilities, possible configured policies, and the negotiated bw range of possible other IVAS call legs in the conference, and the MRFC shall include the bw-recv parameter with the selected value in the SDP answer. Otherwise, if the MRFC desires different sampling bandwidths for the send and receive direction in EVS primary mode and wants to restrict the sampling bandwidths for the receive direction to match MRFP capabilities, possible configured policies, and the negotiated bw range of possible other IVAS call legs in the conference, the MRFC shall supply the bw-recv parameter in the SDP answer it sends. Otherwise, the MRFC shall not include the bw-recv parameter in the SDP answer. If the MRFC also supplies the br or br-recv parameter, the value of the bw-recv parameter shall be compatible with the values of those parameters. If the MRFC supplies the bw-recv parameter in the SDP answer, the MRFC shall also supply it to the MRFP in the local descriptor for the termination towards the offerer with the same value.</p>

ch-aw-recv (NOTE 3)	If the ch-aw-recv parameter is contained in the SDP offer the MRFC shall check if the MRFP supports the indicated mode in the send direction. If the indicated mode is not supported, the MRFC shall not select the IVAS payload type. If the MRFC selects the IVAS payload type, the MRFC shall forward this parameter to the MRFP for the termination towards the offerer in the remote descriptor.	If the MRFC it desires to control the channel-aware mode of IVAS in EVS Primary mode in the receive direction, e.g., to disable it with value "-1", the MRFC shall include the ch-aw-recv parameter in the SDP answer and shall also supply the ch-aw-recv parameter to the MRFP in the local descriptor for the termination towards the offerer with the same value. The MRFC shall consider the capabilities of the MRFP and the negotiated ch-aw-recv mode of possible other IVAS call legs in the conference when the MRFC chooses an appropriate value.
mode-set (NOTE 4)	If the mode-set parameter is contained in the SDP offer and the MRFC selects the IVAS payload type, the MRFC shall forward this parameter to the MRFP for the termination towards the offerer in the remote descriptor.	If the mode-set parameter is contained in the SDP offer, the MRFC shall include the mode-set parameter with unmodified value in the SDP answer. Otherwise, if IVAS using AMR-WB IO mode or AMR-WB payload type is used on possible other call legs in the conference, the MRFC should include the mode-set parameter with a value indicating the mode that was negotiated on those other call legs (or omit it if no restrictions applied before). If the MRFC supplies the mode-set parameter in the SDP answer, the MRFC shall also supply it to the MRFP in the local descriptor for the termination towards the offerer with the same value.
mode-change-period (NOTE 4)	If the mode-change-period parameter is contained in the SDP offer and the MRFC selects the IVAS payload type, the MRFC shall forward this parameter to the MRFP for the termination towards the offerer in the remote descriptor.	If the MRFC selects the IVAS payload type, the MRFC shall either include the mode-change-capability parameter with value 2 or omit it. If the MRFC supplies the mode-change-capability parameter in the SDP answer, the MRFC may also supply it to the MRFP in the local descriptor for the termination towards the offerer with the same value.
mode-change-capability (NOTE 4)	If the mode-change-capability parameter is contained in the SDP offer and the MRFC selects the IVAS payload type, the MRFC may forward this parameter to the MRFP for the termination towards the offerer in the remote descriptor.	If IVAS using AMR-WB IO mode or AMR-WB payload type is used on possible other call legs, the MRFC should include the mode-change-capability parameter with a value indicating the mode that was negotiated on those other call legs (or omit it if no restrictions applied before). If the MRFC supplies the mode-change-capability parameter in the SDP answer, it may also supply it to the MRFP in the local descriptor for the termination towards the offerer with the same value.
mode-change-neighbor (NOTE 4)	If the mode-change-neighbor parameter is contained in the SDP offer and the MRFC selects the IVAS payload type, the MRFC shall forward this parameter to the MRFP for the termination towards the offerer in the remote descriptor.	If IVAS using AMR-WB IO mode or AMR-WB payload type is used on possible other call legs, the MRFC should include the mode-change-neighbor parameter with a value indicating the mode that was negotiated on those other call legs (or omit it if no restrictions applied before). If the MRFC supplies the mode-change-neighbor parameter in the SDP answer, the MRFC shall also supply it to the MRFP in the local descriptor for the termination towards the offerer with the same value.

<p>3gpp_mtsi_app_adapt (NOTE 5)</p>	<p>If the 3gpp_mtsi_app_adapt parameter is contained in the SDP offer, and the MRFC selects the IVAS payload type for transcoding, the MRFC shall forward this parameter to the MRFP in the remote descriptor.</p>	<p>If the MRFP supports RTCP APP based adaptation messages defined in 3GPP TS 26.114 [23], and the MRFC has a policy to negotiate the usage of those messages, the MRFC shall include the 3gpp_mtsi_app_adapt SDP attribute indicating the allowed APP messages in the SDP answer. If the IVAS is used possible on other IVAS call legs in the conference, the MRFC should consider the negotiated RTCP APP packet types on those call legs in addition to the MRFP capabilities when selecting the allowed RTCP APP messages.</p>
<p>ibr (NOTE 1)</p>	<p>If the ibr parameter is contained in the SDP offer, the MRFC shall check if the MRFP supports the indicated bitrates, or a subset of them, in the IVAS Immersive mode in the send and receive direction. If the indicated bitrates, and even each subset of them, are not supported, the MRFC shall not select the IVAS payload type. If the MRFC selects the IVAS payload type, the MRFC shall forward this parameter to the MRFP for the termination towards the offerer in the remote descriptor.</p>	<p>If the ibr parameter is contained in the SDP offer, the MRFC shall select a bitrate value, which is either the received ibr value or a subset of it, based on MRFP capabilities, possible configured policies, and the negotiated ibr range of possible other IVAS call legs in the conference, and shall include the ibr parameter with the selected value that is also supplied towards the MRFP, in the SDP answer. Otherwise, if the MRFC desires the same bit rate range for the send and receive direction in the IVAS Immersive mode and wants to restrict the bit rate range to match MRFP capabilities, possible configured policies, and the negotiated ibr range of possible other IVAS call legs in the conference, the MRFC shall supply the ibr parameter in the SDP answer it sends. Otherwise, the MRFC shall not include this parameter in the SDP answer. If the MRFC also supplies the ibw, ibw-send or ibw-recv parameter, the value of the ibr parameter shall be compatible with the values of those parameters. If the MRFC supplies the ibr parameter in the SDP answer, the MRFC shall also supply to the MRFP the ibr parameter in the local descriptor for the termination towards the offerer with the same value.</p>

<p>ibr-send (NOTE 1)</p>	<p>If the ibr-send parameter is contained in the SDP offer, the MRFC shall check if the MRFP supports the indicated bitrates, or a subset of them, in the IVAS Immersive mode in the receive direction. If the indicated bitrates, and even each subset of them, are not supported, the MRFC shall not select the IVAS payload type. If the MRFC selects the IVAS payload type, the MRFC shall forward this parameter to the MRFP for the termination towards the offerer in the remote descriptor.</p>	<p>If the ibr-recv parameter is contained in the SDP offer, the MRFC shall select a bitrate value, which is either the received ibr-recv value or a subset of it, based on MRFP capabilities, possible configured policies, and the negotiated ibr range of possible other IVAS call legs in the conference, and the MRFC shall include the ibr-send parameter with the selected value that is also supplied towards the MRFP in the SDP answer. Otherwise, if the MRFC desires a different bit rate (range) for the send and receive direction in the IVAS Immersive mode and wants to restrict the bit rate range for the send direction to match MRFP capabilities and possible configured policies, the MRFC shall supply the ibr-send parameter in the SDP answer it sends. Otherwise, the MRFC shall not include the ibr-send parameter in the SDP answer. If the MRFC also supplies the ibw or ibw-send parameter, the value of the ibr-send parameter shall be compatible with the values of those parameters. If the MRFC supplies the ibr-send parameter in the SDP answer, the MRFC shall also supply to the MRFP the ibr-send parameter in the local descriptor for the termination towards the offerer with the same value.</p>
<p>ibr-recv (NOTE 1)</p>	<p>If the ibr-recv parameter is contained in the SDP offer, the MRFC shall check if the MRFP supports the indicated bitrates, or a subset of them, in the IVAS Immersive mode in the send direction. If the indicated bitrates, and even each subset of them, are not supported, the MRFC shall not select the IVAS payload type. If the MRFC selects the IVAS payload type, the MRFC shall forward this parameter to the MRFP for the termination towards the offerer in the remote descriptor.</p>	<p>If the ibr-send parameter is contained in the SDP offer, the MRFC shall select a bitrate value, which is either the received ibr-send value or a subset of it, based on MRFP capabilities, possible configured policies, and the negotiated ibr range of possible other IVAS call legs in the conference, and the MRFC shall include the ibr-recv parameter with the selected value that is also supplied towards the MRFP in the SDP answer. Otherwise, if the MRFC desires a different bit rate (range) for the send and receive direction in the IVAS Immersive mode and wants to restrict the bit rate range for the receive direction to match MRFP capabilities and possible configured policies, the MRFC shall supply the ibr-recv parameter in the SDP answer it sends. Otherwise, the MRFC shall not include the ibr-recv parameter in the SDP answer. If the MRFC also supplies the ibw or ibw-recv parameter, the value of the ibr-recv parameter shall be compatible with the values of those parameters. If the MRFC supplies the ibr-recv parameter in the SDP answer, the MRFC shall also supply to the MRFP the ibr-recv parameter in the local descriptor for the termination towards the offerer with the same value.</p>

ibw (NOTE 1)	<p>If the ibw parameter is contained in the SDP offer, the MRFC shall check if the MRFP supports the indicated sampling bandwidth(s), or a subset of them, in the IVAS Immersive mode in the send and receive direction. If the indicated sampling bandwidth(s), and even each subset of them, are not supported, the MRFC shall not select the IVAS payload type. If the MRFC selects the IVAS payload type, the MRFC shall forward this parameter to the MRFP for the termination towards the offerer in the remote descriptor.</p>	<p>If the ibw parameter is contained in the SDP offer, the MRFC shall select a sampling bandwidth value, which is either the received ibw value or a subset of it, based on MRFP capabilities, possible configured policies, and the negotiated ibw range of possible other IVAS call legs in the conference, and the MRFC shall include the ibw parameter with the selected value that is also supplied towards the MRFP in the SDP answer.</p> <p>Otherwise, if the MRFC desires the same sampling bandwidth(s) for the send and receive direction in the IVAS Immersive mode and wants to restrict the sampling bandwidth(s) to match MRFP capabilities, possible configured policies, and the negotiated ibw range of possible other IVAS call legs in the conference, the MRFC shall supply the ibw parameter in the SDP answer it sends.</p> <p>Otherwise, the MRFC shall not include this parameter in the SDP answer.</p> <p>If the MRFC also supplies the ibr, ibr-send or ibr-recv parameter, the value of the ibw parameter shall be compatible with the values of those parameters.</p> <p>If the MRFC supplies the ibw parameter in the SDP answer, the MRFC shall also supply to the MRFP the ibw parameter in the local descriptor for the termination towards the offerer with the same value.</p>
ibw-send (NOTE 1)	<p>If the ibw-send parameter is contained in the SDP offer, the MRFC shall check if the MRFP supports the indicated sampling bandwidths, or a subset of them, in the IVAS Immersive mode in the receive direction. If the indicated sampling bandwidths, and even each subset of them, are not supported, the MRFC shall not select the IVAS payload type. If the MRFC selects the IVAS payload type, the MRFC shall forward this parameter to the MRFP for the termination towards the offerer in the remote descriptor.</p>	<p>If the ibw-recv parameter is contained in the SDP offer, the MRFC shall select a sampling bandwidths value, which is either the received ibw-recv value or a subset of it, based on MRFP capabilities, possible configured policies, and the negotiated ibw range of possible other IVAS call legs in the conference, and the MRFC shall include the ibw-send parameter with the selected value in the SDP answer.</p> <p>Otherwise, if the MRFC desires different sampling bandwidths for the send and receive direction in the IVAS Immersive mode and wants to restrict the sampling bandwidths for the send direction to match MRFP capabilities, possible configured policies, and the negotiated ibw range of possible other IVAS call legs in the conference, the MRFC shall supply the ibw-send parameter in the SDP answer it sends.</p> <p>Otherwise, the MRFC shall not include the ibr-send parameter in the SDP answer.</p> <p>If the MRFC also supplies the ibr or ibr-send parameter, the value of the ibw-send parameter shall be compatible with the values of those parameters.</p> <p>If the MRFC supplies the ibw-send parameter in the SDP answer, the MRFC shall also supply to the MRFP the ibw-send parameter in the local descriptor for the termination towards the offerer with the same value.</p>

ibw-recv (NOTE 1)	<p>If the ibw-recv parameter is contained in the SDP offer, the MRFC shall check if the MRFP supports the indicated sampling bandwidths, or a subset of them, in the IVAS Immersive mode in the send direction. If the indicated sampling bandwidths, and even each subset of them, are not supported, the MRFC shall not select the IVAS payload type.</p> <p>If the MRFC selects the IVAS payload type, the MRFC shall forward the ibw-recv parameter to the MRFP for the termination towards the offerer in the remote descriptor.</p>	<p>If the ibw-send parameter is contained in the SDP offer, the MRFC shall select a sampling bandwidths value, which is either the received ibw-send value or a subset of it, based on MRFP capabilities, possible configured policies, and the negotiated ibw range of possible other IVAS call legs in the conference, and the MRFC shall include the ibw-recv parameter with the selected value in the SDP answer.</p> <p>Otherwise, if the MRFC desires different sampling bandwidths for the send and receive direction in the IVAS Immersive mode and wants to restrict the sampling bandwidths for the receive direction to match MRFP capabilities, possible configured policies, and the negotiated ibw range of possible other IVAS call legs in the conference, the MRFC shall supply the ibw-recv parameter in the SDP answer it sends. Otherwise, the MRFC shall not include the ibw-recv parameter in the SDP answer.</p> <p>If the MRFC also supplies the ibr or ibr-recv parameter, the value of the ibw-recv parameter shall be compatible with the values of those parameters.</p> <p>If the MRFC supplies the ibw-recv parameter in the SDP answer, the MRFC shall also supply it to the MRFP in the local descriptor for the termination towards the offerer with the same value.</p>
cf (NOTE 1)	<p>If the cf parameter is contained in the SDP offer, the MRFC shall check if the MRFP supports the indicated IVAS coded-formats, or a subset of them, in the IVAS Immersive mode in the send and receive direction. The MRFC shall remove from the received list the IVAS coded-formats not supported by the MRFP. If none of the indicated IVAS coded-formats are supported, the MRFC shall not select the IVAS payload type.</p> <p>If the MRFC selects the IVAS payload type, the MRFC shall forward the cf parameter to the MRFP for the termination towards the offerer in the remote descriptor.</p>	<p>If the cf parameter is contained in the SDP offer, the MRFC shall select the list of the IVAS coded-formats, which is either the received list or a subset of it, based on MRFP capabilities and possible configured policies, and the MRFC shall include the cf parameter with the selected list in the SDP answer.</p> <p>If the MRFC supplies the cf parameter in the SDP answer, the MRFC shall also supply it to the MRFP in the local descriptor for the termination towards the offerer with the same value.</p>
cf-send (NOTE 1)	<p>If the cf-send parameter is contained in the SDP offer, the MRFC shall check if the MRFP supports the indicated IVAS coded-formats, or a subset of them, in the IVAS Immersive mode in the receive direction. The MRFC shall remove from the received list the IVAS coded-formats not supported by the MRFP. If none of the indicated IVAS coded-formats are supported, the MRFC shall not select the IVAS payload type.</p> <p>If the MRFC selects the IVAS payload type, the MRFC shall forward this parameter to the MRFP for the termination towards the offerer in the remote descriptor.</p>	<p>If the cf-recv parameter is contained in the SDP offer, the MRFC shall select the list of the IVAS coded-formats, which is either the received cf-recv list or a subset of it, based on MRFP capabilities and possible configured policies, and the MRFC shall include the cf-send parameter with the selected IVAS coded-formats in the SDP answer.</p> <p>If the MRFC supplies the cf-send parameter in the SDP answer, the MRFC shall also supply to the MRFP the cf-send parameter in the local descriptor for the termination towards the offerer with the same value.</p>

cf-recv (NOTE 1)	<p>If the cf-recv parameter is contained in the SDP offer, the MRFC shall check if the MRFP supports the indicated IVAS coded-formats, or a subset of them, in the IVAS Immersive mode in the send direction. The MRFC shall remove from the received list the IVAS coded-formats not supported by the MRFP. If none of the indicated IVAS coded-formats are supported, the MRFC shall not select the IVAS payload type. If the MRFC selects the IVAS payload type, the MRFC shall forward this parameter to the MRFP for the termination towards the offerer in the remote descriptor.</p>	<p>If the cf-send parameter is contained in the SDP offer, the MRFC shall select a list of the IVAS coded-formats, which is either the received cf-send list or a subset of it, based on MRFP capabilities and possible configured policies, and the MRFC shall include the cf-recv parameter with the selected IVAS coded-formats in the SDP answer.</p> <p>If the MRFC supplies the cf-recv parameter in the SDP answer, the MRFC shall also supply to the MRFP the cf-recv parameter in the local descriptor for the termination towards the offerer with the same value.</p>
pi-types (NOTE 1)	<p>If the pi-types parameter is contained in the SDP offer, the MRFC shall check if the MRFP supports the indicated PI data types, in the IVAS Immersive mode in the send and receive direction.</p> <p>The MRFC shall set the pi-types parameter based on the indicated value, MRFP capabilities and possible configured policies.</p> <p>If the MRFC selects the IVAS payload type, the MRFC shall forward the pi-types parameter to the MRFP for the termination towards the offerer in the remote descriptor.</p>	<p>If the pi-types parameter is contained in the SDP offer and the MRFC selects the IVAS payload type, the MRFC shall set the pi-types parameter based on the received value, MRFP capabilities and possible configured policies, and the MRFC shall include the pi-types parameter in the SDP answer.</p> <p>If none of the received PI data types are supported, the MRFC shall not include the pi-types parameter in the SDP answer.</p> <p>If the MRFC supplies the pi-types parameter in the SDP answer, the MRFC shall also supply it to the MRFP in the local descriptor for the termination towards the offerer with the same value.</p>
pi-types-send (NOTE 1)	<p>If the pi-types-send parameter is contained in the SDP offer, the MRFC shall check if the MRFP supports the received PI data types, in the IVAS Immersive mode in the receive direction. The MRFC shall set the pi-types-send parameter based on the received value, MRFP capabilities and possible configured policies.</p> <p>If the MRFC selects the IVAS payload type, the MRFC shall forward the pi-types-send parameter to the MRFP for the termination towards the offerer in the remote descriptor.</p>	<p>If the pi-types-recv parameter is contained in the SDP offer and the MRFC selects the IVAS payload type, the MRFC shall set the pi-types-send parameter based on the received value, MRFP capabilities and possible configured policies, and the MRFC shall include the pi-types-send parameter in the SDP answer.</p> <p>If none of the received PI data types are supported, the MRFC shall not include the pi-types-send parameter in the SDP answer.</p> <p>If the MRFC supplies the pi-types-send parameter in the SDP answer, the MRFC shall also supply it to the MRFP in the local descriptor for the termination towards the offerer with the same value.</p>
pi-types-recv (NOTE 1)	<p>If the pi-types-recv parameter is contained in the SDP offer, the MRFC shall check if the MRFP supports the received PI data types, in the IVAS Immersive mode in the send direction. The MRFC shall set the pi-types-recv parameter based on the received value, MRFP capabilities and possible configured policies.</p> <p>If the MRFC selects the IVAS payload type, the MRFC shall forward the pi-types-recv parameter to the MRFP for the termination towards the offerer in the remote descriptor.</p>	<p>If the pi-types-send parameter is contained in the SDP offer and the MRFC selects the IVAS payload type, the MRFC shall set the pi-types-recv parameter based on the received value, MRFP capabilities and possible configured policies, and the MRFC shall include the pi-types-recv parameter in the SDP answer.</p> <p>If none of the received PI data types are supported, the MRFC shall not include the pi-types-recv parameter in the SDP answer.</p> <p>If the MRFC supplies the pi-types-recv parameter in the SDP answer, the MRFC shall also supply it to the MRFP in the local descriptor for the termination towards the offerer with the same value.</p>

pi-br (NOTE 1)	<p>If the pi-br parameter is contained in the SDP offer, the MRFC shall check if the MRFP supports the indicated maximum bitrate, in the IVAS Immersive mode in the send and receive direction. If the indicated maximum bitrate is not supported, the MRFC shall set the pi-br parameter to the maximum bit rate supported by the MRFP for PI data.</p> <p>If the MRFC selects the IVAS payload type, the MRFC shall forward the pi-br parameter to the MRFP for the termination towards the offerer in the remote descriptor.</p>	<p>If the pi-br parameter is not contained in the SDP offer, the MRFC shall not supply the pi-br parameter in the SDP answer.</p> <p>Otherwise, if the pi-br parameter is contained in the SDP offer, the MRFC shall select the maximum bit rate value for PI data, based on the received value, MRFP capabilities and possible configured policies, and shall include the pi-br parameter with the selected value that is also supplied towards the MRFP, in the SDP answer.</p> <p>If the MRFC supplies the pi-br parameter in the SDP answer, the MRFC shall also supply it to the MRFP in the local descriptor for the termination towards the offerer with the same value.</p>
pi-br-send (NOTE 1)	<p>If the pi-br-send parameter is contained in the SDP offer, the MRFC shall check if the MRFP supports the indicated maximum bitrate, in the IVAS Immersive mode in the receive direction. If the indicated maximum bitrate is not supported, the MRFC shall set the pi-br-send parameter to the maximum bit rate supported by the MRFP for PI data.</p> <p>If the MRFC selects the IVAS payload type, the MRFC shall forward the pi-br-send parameter to the MRFP for the termination towards the offerer in the remote descriptor.</p>	<p>If the pi-br-recv parameter is contained in the SDP offer, the MRFC shall select the maximum bit rate value for PI data, based on the received value, MRFP capabilities and possible configured policies, and shall include the pi-br-send parameter with the selected value that is also supplied towards the MRFP, in the SDP answer.</p> <p>Otherwise, the MRFC shall not include this parameter in the SDP answer.</p> <p>If the MRFC supplies the pi-br-send parameter in the SDP answer, the MRFC shall also supply it to the MRFP in the local descriptor for the termination towards the offerer with the same value.</p>
pi-br-recv (NOTE 1)	<p>If the pi-br-recv parameter is contained in the SDP offer, the MRFC shall check if the MRFP supports the indicated maximum bitrate, in the IVAS Immersive mode in the send direction. If the indicated maximum bitrate is not supported, the MRFC shall set the pi-br-recv parameter to the maximum bit rate supported by the MRFP for PI data.</p> <p>If the MRFC selects the IVAS payload type, the MRFC shall forward the pi-br-recv parameter to the MRFP for the termination towards the offerer in the remote descriptor.</p>	<p>If the pi-br-send parameter is contained in the SDP offer, the MRFC shall select the maximum bit rate value for PI data, based on the received value, MRFP capabilities and possible configured policies, and shall include the pi-br-recv parameter with the selected value that is also supplied towards the MRFP, in the SDP answer.</p> <p>Otherwise, the MRFC shall not include this parameter in the SDP answer.</p> <p>If the MRFC supplies the pi-br-recv parameter in the SDP answer, the MRFC shall also supply it to the MRFP in the local descriptor for the termination towards the offerer with the same value.</p>
<p>NOTE 1: This MIME parameter of the IVAS RTP payload type is defined in 3GPP TS 26.253 [69]. It is encapsulated within the SDP "a=fmtp" attribute defined IETF RFC 4566 [44].</p> <p>NOTE 2: This MIME parameter of the IVAS RTP payload type is defined in IETF RFC 4867 [45]. It is encapsulated within the SDP "a=fmtp" attribute defined IETF RFC 4566 [44].</p> <p>NOTE 3: This MIME parameter of the IVAS RTP payload type relates to the EVS Primary mode and is defined in 3GPP TS 26.445 [43]. It is encapsulated within the SDP "a=fmtp" attribute defined IETF RFC 4566 [44].</p> <p>NOTE 4: This MIME parameter of the IVAS RTP payload type relates to the AMR-WB IO mode and is defined in IETF RFC 4867 [45]. It is encapsulated within the SDP "a=fmtp" attribute defined IETF RFC 4566 [44].</p> <p>NOTE 5: This SDP attribute is defined in 3GPP TS 26.114 [23]. It applies to all codecs offered in an SDP media line.</p> <p>NOTE 6: If present, the hf-only parameter shall be set to 1 as defined in clause A.4.1 of 3GPP TS 26.253 [69].</p>		

The MRFP handling of IVAS codec parameters shall follow table 5.13.5.2 in 3GPP TS 23.334 [41]. The MRFP should support transcoding of IVAS with bandwidths (sampling rates) which are supported by codec the MRFP is capable to transcode IVAS to/from (e.g., NB for AMR, and WB for AMR-WB).

5.13 Video Transcoding

The MRFP shall support video transcoding between streams of two Terminations within the same context where the streams are encoded differently, in accordance with standard H.248 principles, see ITU-T H.248.1 [3].

NOTE: 3GPP video codecs are specified in 3GPP TS 26.114 [23].

5.14 Floor Control Service Requirement

5.14.1 General

Floor control is a means to manage joint or exclusive access to shared resources in a (multiparty) conferencing environment. It enables applications or users to gain safe and mutually exclusive or non-exclusive input access to the shared object or resource. The "Floor" is an individual temporary access or manipulation permission for a specific shared resource (or group of resources) IETF RFC 4376 [19]. Floor control is an optional procedure; where "shall" is used it is meant that this is basic required functionality within the feature.

5.14.2 Architecture

The functional architecture concerning Floor control is presented in Figure 5.14.2.1 below.

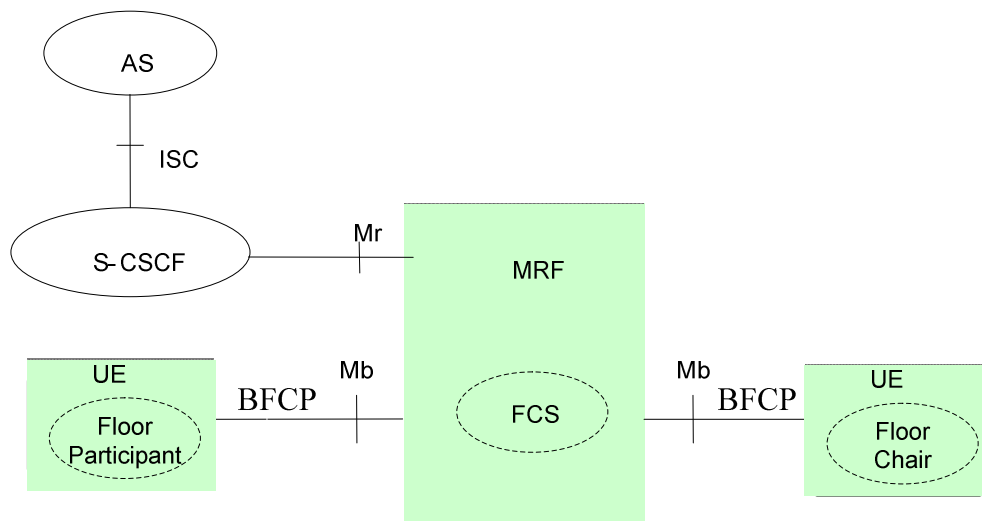

Figure 5.14.2.1: Functionality Architecture of Floor Control

The functional entities are described by solid line, and the roles are described by broken line.

The functional entities consist of the following:

- User Equipment (UE), a UE shall support the "Client" role of BFCP as specified by IETF RFC 4582 [20]. the Client may be a "Floor Participant" or "Floor Chair" .
- Media Resource Function (MRF), an MRF shall support the "Floor Control Server" role.

The roles consist of the following:

- Floor Participant, the Floor Participant shall support general Client operations and Floor Participant operations as described in IETF RFC 4582 [20].
- Floor Chair, the Floor Chair shall support Client operations and Floor Chair operations as described in IETF RFC 4582 [20].

- Floor Control Server, the Floor Control Server (FCS) shall support Floor Control Server operations as described in IETF RFC 4582 [20].

5.14.3 Services Requirements

The MRF shall support the Floor Control function, including: the "conference policy" related to Floor control and the communication between the Floor control functional entities (the Floor Participant, the Floor Chair and the Floor Control Server).

1. The MRF shall support the following Floor control policy related to Floor control:

- Whether the Floor control is in use or not.
- The algorithm to be used in granting the Floor.

The following algorithms shall be supported:

- FCFS (First Come First Served)

The following algorithms may be supported:

- Chair-Controlled
- The maximum number of users who can hold the Floor at the same time.
- To assign and modify the Floor Chair, if the Floor is Chair-controlled.

The MRF may support the following:

- Announcements/tones from network for indicating when a user gets and loses the hold of the Floor (note: announcement may also be text or indication in video)

2. The MRF, acting as FCS, shall support the communication with the Floor Participants and the Floor Chairs according to the BFCP protocol as described in IETF RFC 4582 [20] , providing:

- Communication between Floor Participant and FCS such that the participant shall be able to request/ modify /release a Floor for the Floor Participant himself or a third-party Floor Participant;
- Communication between Floor Chair and FCS such that the Chair shall be able to receive Floor requests and to grant/ reject/ revoke the Floor requests.

5.14.4 Information Flows

This clause covers the information flows between the UE and MRF.

5.14.4.1 User requesting the Floor during a conference

Figure 5.14.4.1.1 shows a Floor Participant requesting the Floor to obtain the right to talk during a conference. The UE#1 is a Floor Participant, the Floor of the "right to talk" is Chair-controlled and the UE#2 is the Floor Chair of the conference.

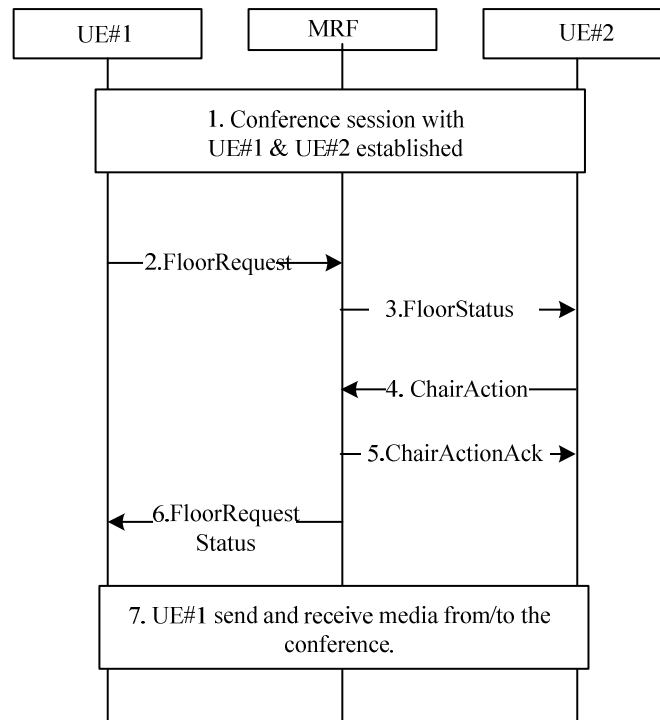

Figure 5.14.4.1.1: User requesting the Floor to obtain the right to talk during a conference

The details of the flows are as follows:

1. Conference session with UE#1 & UE#2 established

The UE#1 and UE#2 are participants of an existing conference. The BFCP connections between the participant and the MRF need to be established before the BFCP communication.

2. FloorRequest

The UE#1 requests the MRF for the Floor of the "right to talk". The message format is described in IETF RFC 4582 [20].

3. FloorStatus

The MRF notifies the UE#2 the Floor request from UE#1. The message format is described in IETF RFC 4582[20].

4. ChairAction

The UE#2 grants the Floor request and sends instruction to the MRF to action. The message format is described in IETF RFC 4582[20].

5. ChairActionAck

The MRF acknowledges the ChairAction message. The message format is described in IETF RFC 4582[20].

6. Floor RequestStatus

The MRF informs UE#1 about the status of their Floor requests. The message format is described in IETF RFC 4582[20].

7. UE#1 send and receive media (or audio) from/to the conference

Now the UE#1 has been granted the Floor of the "right to talk", it may send and receive the audio stream to the MRF.

5.14.4.2 User releasing the Floor during a conference

Figure 5.14.4.2.1 shows a Floor Participant requesting to release the Floor to give up the right to talk during a conference. The UE#1 is a Floor Participant and owns the Floor of the "right to talk", the Floor is Chair-controlled and the UE#2 is the Floor Chair of the conference.

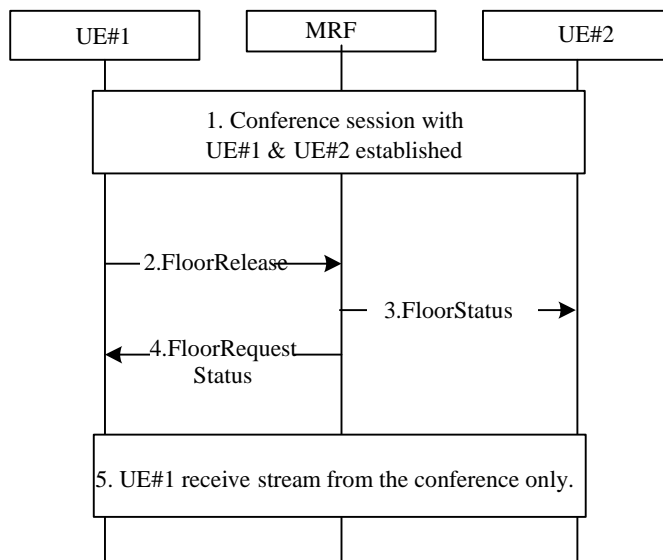

Figure 5.14.4.2.1: User releasing the Floor to give up the right to talk during a conference

The details of the flows are as follows:

1. Conference session with UE#1 & UE#2 established

The UE#1 and UE#2 are participants of an existing conference. The BFCP connections between the participant and the MRF need to be established before the BFCP communication.

2. FloorRelease

The UE#1 requests to release the MRF for the Floor of the "right to talk". The message format is described in IETF RFC 4582 [20].

3. FloorStatus

The MRF notifies the UE#2 the Floor release request from UE#1. The message format is described in IETF RFC 4582[20].

4. Floor RequestStatus

The MRF informs UE#1 about the status of the Floor release request. The message format is described in IETF RFC 4582[20].

5. UE#1 receive stream from the conference

Now the UE#1 has been revoked the right to talk, he may receive the audio stream from the MRF only.

5.14.5 Requirements on Mp interface

5.14.5.1 Requirements for MRFP based FCS

The MRFC shall indicate to the MRFP the Floor Control Policy:

- The algorithm to be used in granting the Floor.

- The FCFS algorithm shall be supported.
- The Chair-controlled algorithm may be supported.
- The maximum number of users who can hold the same Floor at the same time.
- To assign and modify the Floor Chair, if the Floor is Chair-controlled.
- The Floor media type shall be audio, video or a combination of one or more media type.
- The association between Floors and resources.

The MRFP shall maintain the state of the Floor(s), including which Floors exists, which terminations hold which Floors, and which termination is the Floor Chair, if the floor is Chair-controlled.

The MRFC may request the MRFP to establish a BFCP connection between the MRFP (FCS) and the Client (via Floor control Client Termination).

The MRFP shall support the communication with a Floor Participant such that the participant may request/ modify /release a Floor for the Floor Participant himself or a third-party Floor Participant according to the BFCP protocol [20].

The MRFP may support the communication with Floor Chair such that the Chair shall be able to receive Floor requests and to grant/ reject/ revoke the Floor according to the BFCP protocol [20].

The MRFP shall (if requested by the MRFC) report to the MRFC any requests to change the Floor holding status. The MRFC shall indicate to the MRFP to modify the Client's access right to the media according to the changes in Floor status.

The MRFC may request the MRFP to play tones (according to clause 5.1) or announcements (according to clause 5.2) for indicating when a Client gains or loses a Floor.

5.15 Explicit Congestion Notification Service Requirement

5.15.1 General

A MRFC/MRFP may support Multimedia Telephony using Explicit Congestion Notification see IETF RFC 3168 [24], and may act as an ECN endpoint to enable ECN with a local ECN-capable terminal within a local network that properly handles ECN-marked packets.

This requires that the MRFC performs the following:

- support SDP ability to negotiate ECN as described in 3GPP TS 26.114 [23].

This requires the MRFP to be capable of enabling end-to-end rate adaptation due to congestion between the local Multimedia Telephony terminal and the MRFP by performing the following towards the local Multimedia Telephony terminal:

- trigger rate adaptation request towards the Multimedia Telephony terminal when receiving incoming IMS media flow IP packets marked with ECN-CE;
- perform media adaptation (e.g. reduce media bit-rate) towards the Multimedia Telephony terminal when receiving from the latter an adaptation request;
- if requested by the MRFC, provide notification and an ECN failure event if ECN errors or packet losses occur.

5.16 Multimedia Priority Service (MPS) Support

The Multimedia Priority Service (MPS) is specified in 3GPP TS 22.153 [26]. The MRFC and MRFP may support the priority treatment of a call/session identified as an MPS call/session. If MPS is supported then upon receipt of the MPS priority information in the call control signalling:

- The MRFC shall recognise the call/session as having priority.

- The MRFC shall send the Priority information for a context to the MRFP to enable the priority treatment described below related to the MRFP.
- The MRFC shall apply priority handling to H.248 transactions related to priority calls/sessions when network resources are congested, e.g., preferential treatment in any queues or buffers.
- If the H.248 control association utilises a transport with the possibility for prioritisation, the MRFC may apply priority using the appropriate prioritisation procedures.
- If the MPS Priority service requires a specific MPS DSCP setting, the MRFC shall configure the MRFP to apply a specific MPS DSCP marking to the user data transport packets to indicate that the packets are of a higher priority than those for normal calls.
- If the MRFP receives an indication to apply a specific MPS DSCP marking to the user data transport packets, it shall apply this DSCP marking to the IP headers.

NOTE 1: Support of Diffserv procedures by the MRFP assumes an operator uses Diffserv for prioritising user plane traffic related to an MPS call/session.

- When the MRFC marks a Context with Priority information, the MRFP may use the Priority information for selecting resources for the media and signaling transport with priority. The following actions may be taken by the MRFP if it has reached a congested state:
 - i) seize priority reserved resources; or
 - ii) if resources are completely congested, indicate that in a Command Response error code.

NOTE 2: The Priority information can be used to derive Layer 2 QoS marking and trigger priority identification and priority treatment for other QoS technologies than Diffserv.

5.17 Coordination of Video Orientation

The MRFC and the MRFP may support the Coordination of Video Orientation (CVO) as defined in 3GPP TS 26.114 [23].

Upon receipt of an SDP offer containing the RTP header extension attribute(s) "a=extmap" as defined in IETF RFC 5285 [27] and if the "a=extmap" attribute indicates the CVO URN(s) (i.e. the CVO URN for a 2 bit granularity of rotation and/or the CVO URN for a higher granularity of rotation) as defined in 3GPP TS 26.114 [23], then:

- a) if the MRFC and the MRFP support the CVO feature, the MRFC shall:
 - include an "extended RTP header for CVO" information element when seizing resources in the MRFP to indicate the MRFP that it shall allow the RTP header extension for CVO to pass; and
 - select exactly one of the CVO related "a=extmap" attribute from the SDP offer and include the "a=extmap" attribute indicating selected CVO URN in the SDP answer that will be sent within the SIP signalling; or
- b) if the MRFP does not support the CVO feature the MRFC shall send the SDP answer without any CVO related "a=extmap" attribute within the SIP signalling.

NOTE 1: The UE supporting the CVO feature will not send the extended RTP headers for CVO if the UE did not receive any SDP answer with the CVO related "a=extmap" attribute.

When the MRFC selects one of the CVO related "a=extmap" attribute(s) from the SDP offer the MRFC shall take into consideration which CVO variant it has negotiated for CVO for other call leg(s) in the session.

If the MRFC and MRFP support the CVO feature then before sending an SDP offer, the MRFC shall:

- a) determine based on the local policy and the CVO negotiation results on other call legs if, and with which granularity to offer CVO; and
- b) if the MRFC determines to offer CVO:

- the MRFC shall include the "extended RTP header for CVO" information element when seizing resources in the MRFP to indicate the MRFP that it shall allow the RTP header extension for CVO to pass; and
- the MRFC shall include the CVO related "a=extmap" attribute in the SDP offer it sends within the SIP signalling.

If the MRFP does not support the CVO feature, the MRFC shall send the SDP offer without any CVO related "a=extmap" attribute within the SIP signalling.

NOTE 2: The UE supporting the CVO feature will not send the extended RTP headers for CVO if the UE did not receive any SDP offer with the CVO related "a=extmap" attribute.

If the MRFP supports the CVO feature and has been instructed to pass on the extended RTP header for CVO as described above then:

- if the MRFP does not apply video transcoding, it shall pass any received RTP CVO header extension to succeeding RTP streams; or
- if the MRFP applies video transcoding, it shall keep the video orientation unchanged during the transcoding and copy the received RTP CVO header extension into the succeeding RTP streams after transcoding the associated group of packets.

NOTE 3: IETF RFC 5285 [27] provides a framework for header extensions and can also be used for non-CVO related purposes. It is an implementation decision of the MRFP if it only passes CVO related RTP header extensions, or if it passes any RTP header extension when being instructed with the "extended RTP header for CVO" information element.

NOTE 4: The behaviour of the MRFP when being instructed with "an extended RTP header for CVO" information element may be variable due to the settings on the incoming and outgoing directions as listed in the table 5.17.1 and left further for implementation decision.

NOTE 5: Unknown IETF RFC 5285 [27] RTP header extensions are ignored by the destination RTP end system.

NOTE 6: In the conference scenarios when the picture mixing is needed, the MRFP can perform the video rotation of picture elements according to the received RTP CVO header extension for the associated pictures to achieve a consistent orientation for all of the components in the mixture collage.

Table 5.17.1: MRFP behaviour with different settings of "extended RTP header for CVO" information element in a particular direction

Connection Point A in incoming direction	Connection Point B in outgoing direction	MRFP behaviour on CVO processing
With CVO	With CVO	Received RTP CVO header extension is forwarded to the outgoing direction.
With CVO	No CVO	Received RTP CVO header extension is forwarded to the outgoing direction.
No CVO	With CVO	No RTP CVO header extension is forwarded since the source video does not contain any CVO information.

5.18 Generic image attributes

The MRFC and the MRFP may support the generic image attributes to negotiate the image size for sending and receiving video as required by 3GPP TS 26.114 [23].

If the MRFP and the MRFC support the negotiation of the image size and the MRFC receives an SDP offer with the media-level SDP image attribute(s) "a=imageattr", as defined in IETF RFC 6236 [28], and if the received image sizes are supported by the MRFP then the MRFC shall:

- include the generic image attribute parameters for the send and receive directions when seizing or modifying resources in the MRFP; and

- include the SDP image attribute "a=imageattr" indicating the supported image sizes in the SDP answer on the Mr interface.

NOTE 1: The image attribute may be used within the SDP capability negotiation framework and its use is then specified using the "a=acap" parameter.

NOTE 2: The MRFC not supporting the negotiation of the image size will ignore received generic image attributes and will return the SDP answer without any associated generic image attribute.

When sending the SDP body with image attribute(s) on the Mr interface the MRFC shall include in the "a=imageattr":

- "recv" keyword and corresponding image sizes which the MRFP supports in the receiving direction; and
- "send" keyword and corresponding image sizes which the MRFP supports in the sending direction.

If the MRFP and the MRFC support the negotiation of the image size and the MRFC sends an SDP offer for subsequent call leg in a conference, the MRFC should include the SDP image attribute(s) "a=imageattr", with image sizes as supported by the MRFP and negotiated at other call legs in the session.

If the MRFC receives an SDP answer containing the SDP image attribute "a=imageattr", it shall modify resources in the MRFP if needed by indicating the supported image sizes within the generic image attribute parameter.

If the MRFC supports the negotiation of the image size and if the MRFC sends on the Mr interface the SDP body (offer or answer) it shall adjust the image sizes to be the same for the call legs in the session.

If the MRFP does not support the negotiation of the image size the MRFC shall send on the Mr interface the SDP body (offer or answer) without any image attribute "a=imageattr".

If the MRFP is configured with different image sizes on the receive direction of one termination and the send direction of another interconnected termination, then it shall adjust the frame sizes accordingly when forwarding video media streams and use the image size as described in 3GPP TS 26.114 [23] when sending media.

NOTE 3: The relation between the negotiated image sizes and CVO are specified in 3GPP TS 26.114 [23].

NOTE 4: The generic image attribute includes information related to the send and receive capabilities of a single termination, and the adjustment of image sizes is typically based on the setting of two connected terminations in a single context.

5.19 Interactive Connectivity Establishment support

5.19.1 General

The MRFC and the MRFP may support Interactive Connectivity Establishment defined in IETF RFC 8445 [66] and IETF RFC 8839 [67], and 3GPP TS 24.229 [30] for NAT traversal as required by 3GPP TS 23.228 [1]. The present clause describes the requirements for MRFC and MRFP when the ICE procedures are supported.

Support of full ICE functionality is optional, but if ICE is supported, the MRFC and MRFP shall at least support ICE lite as specified in IETF RFC 8445 [66].

The MRFC and MRFP shall only use host candidates as local ICE candidates.

NOTE: MRFC and MRFP are not located behind a NAT from perspective of the ICE deployment model according to figure 1 in IETF RFC 8445 [66].

If ICE is supported, the MRFC shall perform separate ICE negotiation and procedures independently on each call leg (e.g. with each conference participant). Furthermore, the MRFC may be configured to apply ICE procedures only towards the access network side.

When the MRFC detects no ICE parameters in the received SDP, it shall not configure the MRFP to apply any ICE and STUN related procedures toward the call leg from where the SDP has been received.

Any MRFC supporting ICE shall advertise its support of incoming STUN continuity check procedures. An MRFC supporting full ICE procedures shall in addition advertise its support for originating STUN connectivity check procedures.

If the MRFP does not indicate the support of STUN procedures, or if the MRFC is configured not to apply ICE toward a call leg, the MRFC shall not configure the MRFP to apply STUN procedures.

5.19.2 ICE lite

If the MRFC is configured to use ICE lite, or supports only ICE lite, or controls an MRFP that only support ICE lite, the procedures in the present clause apply.

If the MRFC receives an initial SDP offer with ICE candidate information but no "a=ice-lite" attribute, the MRFC:

- shall request the MRFP for each media line where it decides to use ICE to reserve an ICE host candidate and provide its address information and a related ICE user name fragment and password;

NOTE 1: Requesting only one host candidate per m-line prevents that the MRFC will receive "a=remote-candidates" SDP attributes in a subsequent SDP. Requesting separate ufrag and password for each media line simplifies H.248 encoding.

- shall configure the MRFP to act as STUN server at the host candidate address, i.e. to answer STUN connectivity checks;
- may provide received remote ICE candidates and the received related ICE user name fragment and password to the MRFP;
- if an "a=ice-options" attribute with the value "ice2" was present in the received SDP offer, shall include the "a=ice-options" attribute with the value "ice2" in the SDP answer;
- shall include the host candidate and related ICE user name fragment and password received from the MRFP in the SDP answer; and
- shall include the "a=ice-lite" attribute in the SDP answer.

If the MRFC receives SDP offer with ICE candidate information and an "a=ice-lite" attribute, the MRFC shall not apply ICE towards that call leg and not include any ICE related SDP attributes in the SDP answer.

NOTE 2: This avoids that the ICE lite peer needs to send extra SDP offers to complete ICE procedures.

If the MRFC sends an SDP offer towards a call leg where ICE is to be applied, the MRFC:

- shall request the MRFP to reserve a host candidate for each media line where it decides to use ICE and provide its address information, user name fragment and password;
- shall configure the MRFP to act as STUN server at the host candidate address, i.e. to answer STUN connectivity checks;
- shall include the "a=ice-options" attribute with the value "ice2" in the SDP offer;
- shall include the host candidate provided by the MRFP and related ICE user name fragment and password in the SDP offer; and
- shall include the "a=ice-lite" attribute in the SDP offer.

If the MRFC then receives an SDP answer with candidate information from the call leg where ICE is to be applied, the MRFC may provide received remote ICE candidates and the received related ICE user name fragment and password to the MRFP.

After the initial SDP offer-answer exchange, the MRFC can receive a new offer from the peer that includes updated address and port information in the SDP "c=" line, "m=" line, or "a=rtcp" line SDP attributes. If the ICE user name fragment and password in the SDP offer differ from the ones received in the previous SDP (i.e. the peer restarts ICE), the MRFC shall apply the same procedures as for the initial SDP offer.

When receiving a request for a host candidate for a media line, the MRFP shall allocate one host candidate for that media line and send it to the MRFC within the reply. The IP address and port shall be the same as indicated separately as Local IP Resources. The MRFP shall also indicate that it supports ICE lite in the reply.

When receiving a request for an ICE user name fragment and password, the MRFP shall generate an ICE user name fragment and password and send it to the MRFC within the reply. The MRFP shall store the password and user name fragment to be able to authenticate incoming STUN binding request according to clause 7.2 of IETF RFC 8445 [66].

When receiving a request to act as STUN server, the MRFP shall be prepared to answer STUN binding request according to clause 7.2 of IETF RFC 8445 [66]. Once a STUN binding request with the "USE-CANDIDATE" flag has been received, the MRFP may send media towards the source of the binding request.

5.19.3 Full ICE

If the MRFC supports and is configured to use full ICE, and controls an MRFP that supports full ICE, the procedures in the present clause apply.

If the MRFC receives an initial SDP offer with ICE candidate information, the MRFC:

- shall request the MRFP for each media line where it decides to use ICE to reserve an ICE host candidate and provide its address information and a related ICE user name fragment and password;

NOTE: Requesting only one host candidate per m-line prevents that the MRFC will receive "a=remote-candidates" SDP attributes in a subsequent SDP. Requesting separate ufrag and password for each media line simplifies H.248 encoding.

- shall request the MRFP to provide the desired pacing value for connectivity checks (Ta timer value);
- shall configure the MRFP to act as STUN server at the host candidate address, i.e. to answer STUN connectivity checks;
- shall provide received remote ICE candidates and the received related ICE user name fragment and password to the MRFP;
- shall provide the remote pacing value to the MRFP as follows:
 - a) if the "a=ice-pacing" attribute was present in the received SDP answer, the received pacing value; or
 - b) otherwise the default pacing value of 50 ms;
- if an "a=ice-options" attribute with the value "ice2" was present in the received SDP offer, shall include the "a=ice-options" attribute with the value "ice2" in the SDP answer;
- shall include the "a=ice-pacing" attribute with the pacing value provided by the MRFP in the SDP answer;
- shall include the host candidate and related ICE user name fragment and password received from the MRFP in the SDP answer;
- shall determine the role of the MRFC in ICE (controlling or controlled) according to clause 6.1.1 of IETF RFC 8445 [66];
- shall configure the MRFP to perform connectivity checks in accordance with the determined ICE role;
- shall configure the MRFP to report connectivity check results; and
- shall configure the MRFP to report a new peer reflexive candidate if discovered during the connectivity check.

If the MRFC sends an SDP offer towards a call leg where ICE is to be applied, the MRFC:

- shall request the MRFP to reserve a host candidate for each media line where it decides to use ICE and provide its address information, ICE user name fragment and password;
- shall request the MRFP to provide the pacing value for connectivity checks;
- shall configure the MRFP to act as STUN server at the host candidate address, i.e. to answer STUN connectivity checks;
- shall include the "a=ice-options" attribute with the value "ice2" in the SDP offer;
- shall include the "a=ice-pacing" attribute with the pacing value provided by the MRFP in the SDP offer; and

- shall include the host candidate provided by the MRFP and related ICE user name fragment and password in the SDP offer.

If the MRFC then receives an SDP answer with candidate information from the call leg where ICE is to be applied, the MRFC:

- shall provide received remote ICE candidates and the received related ICE user name fragment and password to the MRFP;
- shall provide the remote pacing value to the MRFP as follows:
 - a) if the "a=ice-pacing" attribute was present in the received SDP answer, the received pacing value; or
 - b) otherwise the default pacing value of 50 ms;
- shall determine the role of the MRFC in ICE (controlling or controlled) according to clause 6.1.1 of IETF RFC 8445 [66];
- shall configure the MRFP to perform connectivity checks in accordance with the determined ICE role;
- shall configure the MRFP to report connectivity check results; and
- shall configure the MRFP to report a new peer reflexive candidate if discovered during the connectivity check.

When the MRFC is informed by the MRFP about new peer reflexive candidate(s) discovered by the connectivity checks, it shall configure the MRFP to perform additional connectivity checks for those candidates,

When the MRFC is informed by the MRFP about successful candidate pairs determined by the connectivity checks, the MRFC shall send a new SDP offer to its peer with contents according to clause 4.4.1 of IETF RFC 8839 [67] if it has the controlling role and the highest-priority candidate pair differs from the default candidates in previous SDP.

After the initial SDP offer-answer exchange, the MRFC can receive a new offer from the peer that includes updated address and port information in the SDP "c=" line, "m=" line, or "a=rtcp" line SDP attributes. If the ICE user name fragment and password in the SDP offer differ from the ones received in the previous SDP (i.e. the peer restarts ICE), the MRFC shall apply the same procedures as for the initial SDP offer.

When receiving a request for a host candidate for a media line, the MRFP shall allocate one host candidate for that media line and send it to the MRFC within the reply. The IP address and port shall be the same as indicated separately as Local IP Resources.

When receiving a request to provide a desired pacing value for connectivity checks (Ta timer value), the MRFP shall calculate Ta timer value based on the characteristics of the associated data or shall use the default value of 50 ms and provide it as desired Ta timer value. The MRFP shall compare the own desired Ta timer value with the Ta timer value provided by the MRFC and shall use the higher value for connectivity checks (as specified in IETF RFC 8445 [66]).

When receiving a request for an ICE user name fragment and password, the MRFP shall generate an ICE user name fragment and password and send it to the MRFC within the reply. The MRFP shall store the password and user name fragment to be able to authenticate incoming STUN binding request according to clause 7.3 of IETF RFC 8445 [66].

When receiving a request to act as STUN server, the MRFP shall be prepared to answer STUN binding request according to clause 7.3 of IETF RFC 8445 [66]. Once a STUN binding request with the "USE-CANDIDATE" flag has been received, the MRFP may send media towards the source of the binding request.

When receiving a request to perform connectivity checks and to report connectivity check results, the IMS AGW:

- shall compute ICE candidate pairs according to clause 6.1.2 of IETF RFC 8445 [66];
- shall schedule checks for the ICE candidate pairs according to clause 6.1.4 of IETF RFC 8445 [66];
- shall send STUN connectivity checks for the scheduled checks according to clause 7.2 of IETF RFC 8445 [66];
- shall inform the MRFC about successful candidate pairs determined by the connectivity checks;
- shall inform the MRFC about new peer reflexive candidate(s) discovered by the connectivity checks; and
- should send media using the highest priority candidate pair for which connectivity checks have been completed.

The MRFC and the MRFP shall check the conformance of the selected candidate pair with the media address information in SDP.

5.20 IMS Media Plane Security

5.20.1 General

The MRFC and the MRFP may support IMS media plane security as specified in 3GPP TS 33.328 [31]. They may support end-to-end security (e2e) for a TCP (see IETF RFC 793 [38]) based media using TLS and the Key Management Service (KMS). The e2e media security of TCP is based on the session keys negotiated via the TLS handshake protocol between the served UE and the MRFP as specified in 3GPP TS 33.328 [31].

E2e security for TCP based media using TLS and KMS is applicable for MSRP (see IETF RFC 4975 [18]; used in IMS session-based messaging conference) and BFCP (see IETF RFC 4582 [20]; used in IMS conferencing). The MRFC and the MRFP may support e2e security for MSRP, BFCP, or both protocols.

E2e protection of the MSRP and BFCP sessions is achieved through the KMS and a "ticket" concept:

- The session initiator requests keys and a ticket from the KMS. The ticket contains the keys in a protected format. The initiator then sends the ticket to the recipient.
- The recipient presents the ticket to the KMS and the KMS returns the keys on which the media security shall be based.

5.20.2 End-to-end security for TCP-based media using TLS

The e2e protection of the TCP based media relies on the usage of TLS according to the TLS profiles specified in Annex E of 3GPP TS 33.310 [47] and Annex M of 3GPP TS 33.328 [31].

The end-to-end security protection of session based messaging (MSRP) and conferencing (BFCP) is based on the pre-shared key ciphersuites for TLS (specified in IETF RFC 4279 [34] and with the profile defined in Annex H of 3GPP TS 33.328 [31]) and the MIKEY-TICKET mechanism (specified in IETF RFC 6043 [33] with the profiling of the tickets and procedures given in 3GPP TS 33.328 [31]).

The Pre-Shared Key (PSK) is the Traffic-Encrypting Key (TEK) associated with the Crypto Session (CS) that shall be used in the TLS handshake.

NOTE 1: The Security Parameters Index (SPI) in the CS points to a TEK Generation Key (TGK) that is used to derive the TEK for the crypto session using the CS ID (and some other parameters). The SPI could also point to a TEK directly.

If the MRFC and the MRFP support and are configured to use the e2e protection of the TCP based media using the pre-shared key ciphersuites for TLS and the MIKEY-TICKET mechanism, the following functional requirements apply.

The list of pre-shared key ciphersuites for TLS supported by the MRFP shall be preconfigured in the MRFC.

According to the TLS profile specified in Annex E of 3GPP TS 33.310 [47], the MRFP shall accept TLS renegotiation only if it is secured according to IETF RFC 5746 [46].

NOTE 2: IETF RFC 5746 [46] defines a "TLS secure renegotiation" procedure, which leaves the definition of a basic TLS renegotiation still open. H.248 based support to enable the MRFC to allow or not allow the MRFP to perform client initiated or server initiated TLS renegotiation is not addressed in the present release. The behaviour of the MRFP for "TLS session renegotiation" procedure is hence not further defined in the present release.

The MRFC acting as the session initiator shall:

- prepare the media security offer in the SDP body of the SIP INVITE request;
- include a single crypto session of type TLS in the TRANSFER_INIT message according to procedures specified in 3GPP TS 33.328 [31]; and

NOTE 3: Depending on the KMS and a local policy, the MRFC will either interact with the KMS to obtain keys and the MIKEY-TICKET ticket usable for the served UE or will create the ticket by itself. In the latter case, MIKEY-TICKET mode 3 as specified in IETF RFC 6043 [33] is used, and the MRFC will then perform all key and ticket generation functions otherwise performed by the KMS.

- insert in the SDP offer the SDP key management protocol attribute "a=key-mgmt" specified in IETF RFC 4567 [35] which indicates use of the MIKEY-TICKET ticket and contains the TRANSFER_INIT message.

Upon receipt of the SIP response with the SDP answer the MRFC shall check that the responder is authorized before completing the media security setup. If the MRFC notices that the other endpoint is not as expected, the MRFC shall abort the session setup. Otherwise the MRFC shall derive the PSK and shall send it to the MRFP.

Upon receipt of the SIP INVITE request with the SDP offer containing the media security offer and the SDP key management protocol attribute "a=key-mgmt" specified in IETF RFC 4567 [35] which indicates use of the MIKEY-TICKET ticket and contains the TRANSFER_INIT message the MRFC shall:

- check if it is authorized to resolve the ticket and if that is the case the MRFC interacts with the KMS to resolve the ticket and receive keys;
- include the MIKEY-TICKET response in the generated TRANSFER_RESP message;
- insert in the SDP answer the SDP key management protocol attribute "a=key-mgmt" specified in IETF RFC 4567 [35] which indicates use of the MIKEY-TICKET ticket and contains the TRANSFER_RESP message; and
- shall derive the PSK and shall send it to the MRFP.

The MRFC acting as the session initiator or the session responder shall:

- determine via SDP negotiation as specified in IETF RFC 4145 [36] if the MRFP needs to act as TCP client or server;
- request the MRFP to start the TCP connection establishment if the MRFP needs to act as TCP client;
- determine via SDP negotiation if the MRFP needs to act as TLS client or server as specified in the clauses below;

NOTE 4: The determination of the TLS client/server role relies on different rules for MSRP and BFCP.

- if the MRFP needs to act as TLS client, request the MRFP to start the TLS session setup once the TCP connection is established towards the served UE; and
- apply additional specific procedures specified for the MSRP in clause 5.20.3 or for the BFCP in clause 5.20.4.

The MRFP shall:

- upon request from the MRFC, start a TCP connection establishment by sending a TCP SYN;
- release the underlying TCP bearer connection as soon as the TLS session is released;
- be capable to support both the TLS server and TLS client roles;
- when being instructed to start the TLS session setup, act as a TLS client and establish the TLS session as soon as the underlying TCP bearer connection is established;
- uniquely associate the PSK received from the MRFC with the corresponding TCP based media stream;
- use the received PSK in the TLS handshake; and
- apply additional specific procedures specified for the MSRP in clause 5.20.3 or for the BFCP in clause 5.20.4.

5.20.3 Specific requirements for session based messaging (MSRP)

For the each MSRP media stream requiring e2e security, the MRFC shall:

- a) indicate "TCP/TLS/MSRP" as transport protocol when requesting resources from the MRFP; and
- b) determine via SDP negotiation if the MRFP needs to act as TLS client or TLS server as specified in IETF RFC 8122 [39] using the IETF RFC 4145 [36] "a=setup" SDP attribute as follows:
 - if the MRFC sends the "a=setup:active" SDP attribute in the SDP answer towards the UE, the MRFP shall act as TLS client;
 - if the MRFC sends the "a=setup:passive" SDP attribute in the SDP answer towards the UE, the MRFP shall act as TLS server;
 - if the MRFC receives the "a=setup:active" SDP attribute in the SDP answer from the UE, the MRFP shall act as TLS server; and
 - if the MRFC receives the "a=setup:passive" SDP attribute in the SDP answer from the UE, the MRFP shall act as TLS client.

NOTE: Since the "a=setup:" SDP attribute is used for the negotiation of the client/server roles for both protocols, TCP and TLS, then the assignment of a particular endpoint role (client or server) also applies for both protocols (e.g. the TLS server role assignment means also the TCP server role assignment).

The MRFP shall send the TLS protected MSRP packets to the served UE and shall accept the TLS protected MSRP packets from the served UE as requested by the MRFC.

5.20.4 Specific requirements for conferencing (BFCP)

For the each BFCP media stream requiring e2e security, the MRFC shall:

- a) indicate "TCP/TLS/BFCP" as transport protocol when requesting resources from the MRFP; and
- b) determine via SDP negotiation (see IETF RFC 4583 [21]) if the MRFP needs to act as TLS client or TLS server as follows:
 - if the MRFC receives an initial SDP offer from the served UE, the MRFP shall act as TLS server; or
 - if the MRFC sends an initial SDP offer towards the served UE, the MRFP shall act as TLS client.

The MRFP shall send the TLS protected BFCP packets to the served UE and shall accept the TLS protected BFCP packets from the served UE as requested by the MRFC.

5.21 TCP bearer connection control

If an MRFC and an MRFP support TCP as transport protocol (see IETF RFC 793 [38] and IETF RFC 4145 [36]), the following functional requirements apply.

NOTE 1: Support of TCP is required if the MRFC and the MRFP support the session based messaging (MSRP), (see IETF RFC 4975 [18]), and the conferencing using the floor control service (BFCP), (see IETF RFC 4582 [20]).

NOTE 2: It is assumed that these requirements also apply to pre-Release 12 MRFCs and MRFPs.

Upon reception of an SDP offer or an SDP answer containing a media line for a new TCP based media stream, the MRFC shall for that TCP based media stream:

- determine via SDP negotiation if the MRFP needs to act as TCP client or TCP server using the IETF RFC 4145 [36] "a=setup" SDP attribute as follows:
 - a) if the MRFC sends the "a=setup:active" SDP attribute in the SDP answer towards the conference participant, the MRFP shall act as TCP client;
 - b) if the MRFC sends the "a=setup:passive" SDP attribute in the SDP answer towards the conference participant, the MRFP shall act as TCP server;

- c) if the MRFC receives the "a=setup:active" SDP attribute in the SDP answer from the conference participant, the MRFP shall act as TCP server; and
- d) if the MRFC receives the "a=setup:passive" SDP attribute in the SDP answer from the conference participant, the MRFP shall act as TCP client;
- if no media security is applied, indicate "TCP/MSRP" (for session based messaging) or "TCP/BFCP" (for conferencing) as transport protocol to the MRFP;
- if media security is applied, indicate the transport protocol according to clause 5.20 to the MRFP;
- request the MRFP to allocate a TCP port at the termination towards the SDP offerer/answerer;
- indicate TCP port number from the received SDP offer/answer in the remote descriptor at the termination towards the SDP offerer/answerer;
- request the MRFP to start a TCP connection establishment if the MRFP needs to act as TCP client; and
- request the MRFP to report TCP connection establishment related failures.

Upon request from the MRFC to reserve and/or configure resources for TCP based media the MRFP shall:

- if being instructed to start TCP connection establishment at a given termination, start TCP connection establishment at that TCP termination by sending a TCP SYN message;
- if not being instructed to start TCP connection establishment at a given termination, answer any received TCP SYN message at a given termination with appropriate messages according to TCP procedures; and

NOTE 3: The MRFP will use the source IP address and TCP port of the received TCP SYN message as a destination address for the TCP SYN ACK message.

- report TCP connection establishment related failures to the MRFC.

5.22 Support of Telepresence

5.22.1 General

If the MRFC and the MRFP support telepresence, as specified in 3GPP TS 24.103 [52] and if the CLUE data channel used for telepresence is terminated in the MRFP, the following requirements and procedure apply.

5.22.2 Characteristics of the Telepresence support

The characteristics of the telepresence support by the MRFC and the MRFP are the following:

- 1) Regarding usage of CLUE data channel with respect to H.248 context/termination/stream model:
 - a) there is only one single H.248 termination for the telepresence bearer traffic of a single conference participant, which covers all telepresence media traffic flows and CLUE for control purposes;
 - b) there is only one CLUE data channel per conference participant (i.e., per H.248 termination);
 - c) the CLUE protocol including the underlying transport of a CLUE data channel, SCTP association, DTLS and lower layer protocols are modelled by a single H.248 stream; and
 - d) there is only one single CLUE data channel per SCTP association, hence a single SCTP stream only;
- 2) Regarding the transport protocol stack:
 - a) the L4 protocol is always "UDP";

NOTE 1: Any switchover to or alternative usage of "TCP" (due to possible NAT traversal issues) is out of scope. The option of DTLS-over-TCP is not supported (despite the fact that the CLUE data channel is based on the framework of WebRTC data channels).

- 3) For the protocol termination of SCTP in the MRFP:
 - a) the protocol parameter configuration for the SCTP is done via configuration management or default value settings, apart from the information elements (specified in clause 5.22.3) which are signalled between the MRFC and the MRFP using the SDP for SCTP;
- 4) Regarding the establishment procedures for DTLS and SCTP:
 - a) the establishment of a SCTP association is tightly coupled to the successful establishment of the underlying DTLS session/connection;
 - b) only an *immediate* SCTP establishment is supported;

NOTE 2: Hence, an *explicit information* element for triggering the sending of an outgoing SCTP establishment request is not required.

- c) the MRFP will immediately send an outgoing SCTP establishment request (SCTP INIT) when DTLS layer connectivity is available, if the MRFP did not already receive an incoming SCTP establishment request;
- 5) Regarding the procedure for closing the CLUE data channel:

NOTE 3: The closure procedure according to clause 3.2.7 of IETF RFC 8850 [49] is not supported (because the correspondent "SCTP reset message" cannot be explicitly triggered by the MRFC.

- a) the MRFP will deny during the SCTP association establishment phase the negotiation of SCTP extensions (such as the SCTP stream reset capability) in order to prevent their later usage for a closure procedure; and
 - b) a CLUE data channel is released by a removal of the H.248 stream endpoint or the subtraction of the H.248 termination, or a release procedure of the DTLS bearer session. All these triggers lead firstly to a SCTP shutdown procedure and then a subsequent DTLS bearer session release procedure;
- 6) security aspects:
 - a) incoming DTLS session/connection establishment request is not blocked; and
 - b) incoming SCTP association establishment request is not blocked.

5.22.3 CLUE data channel establishment

For establishing a CLUE data channel an SDP-based "SCTP over DTLS" data channel negotiation mechanism is used. SDP offer/answer transactions between the MRFC and the served TP UE are based on the SDP offer/answer procedure specified in IETF RFC 8841 [48] and IETF RFC 8842 [65]. The SDP describing an SCTP association over DTLS/UDP to be used to realize a CLUE data channel contains:

- "m=" line with "UDP/DTLS/SCTP" as transport protocol and UDP port;
- associated pair of "tls-id" SDP attribute values (the attribute values of the TP UE and the MRFC, see IETF RFC 8842 [65]);
- associated "sctp-port" and optional "max-message-size" attributes (see IETF RFC 8841 [48]); and
- associated "dcmapp" attribute (specified in IETF RFC 8864 [50]) with a "stream-id" parameter set to a value of the used SCTP stream and a subprotocol parameter set to "CLUE" as specified in IETF RFC 8850 [49].

For the media line with "UDP/DTLS/SCTP" as transport protocol to be set up for a CLUE data channel, the MRFC:

- shall send the remote UDP port and SCTP port to the MRFP;
- shall request the local UDP port and SCTP port from the MRFP;
- shall indicate the MRFP to start a DTLS bearer session establishment at the termination towards the SDP offerer, if the received SDP offerer contains an "a=setup:passive" SDP attribute;
- shall send the dcmapp-stream-id parameter that is contained in the received SDP offer, indicating the actual SCTP stream identifier with the SCTP association (over DTLS/UDP) used to realize the CLUE data channel;

- shall send the subprotocol value of "CLUE", indicating the protocol to be exchanged via the data channel;
- if the max-message-size parameter is contained in the received SDP offer, may forward the received max-message-size parameter, indicating to the MRFP the maximum message size the served TP UE is willing to accept;
- may request the maximum message size the MRFP is willing to accept;
- shall send the received TP UE certificate fingerprint to the MRFP that is then able to correlate the fingerprint within the CLUE data channel uniquely; and
- shall request the certificate fingerprint from the MRFP, for the "m=" line to be transported between the served TP UE and the MRFP using CLUE data channel.

For the media line with "UDP/DTLS/SCTP" as transport protocol to be set up for a CLUE data channel, the MRFP shall:

- allocate the local UDP port and SCTP port, and send them to the MRFC;
- when being instructed to start the DTLS bearer session setup, act as a DTLS client and establish the DTLS bearer session;
- if it is requested from the MRFC, set the maximum message size that is acceptable for the CLUE data channel and send it to the MRFC;
- upon request from the MRFC, select an own certificate for the CLUE data channel, and send the fingerprint of the own certificate to the MRFC;
- uniquely associate the certificate fingerprint received from the MRFC with the corresponding CLUE data channel, and subsequently use the certificate fingerprint to verify the establishment of the DTLS bearer session;
- if the verification of the remote certificate fingerprint during the DTLS bearer session establishment fails, regard the remote DTLS endpoint as not authenticated, terminate the DTLS bearer session and report the unsuccessful DTLS bearer session setup to the MRFC; and
- indicate the support of the required SCTP extensions (i.e. RE-CONFIG) and other SCTP considerations as defined in clause 3.2 of IETF RFC 8850 [49] at the start of the SCTP association.

5.22.4 Release of CLUE data channel

To close the CLUE data channel, the MRFC may instruct the MRFP to release the underlying communication (i.e., protocol stack UDP/DTLS/SCTP) for the CLUE data channel, which may result in triggering the release of the DTLS bearer session (which then will implicitly lead to a SCTP association shutdown procedure).

Regarding the SCTP reset, the MRFP shall provide a pre-configured (i.e., autonomous) behaviour by preventing "SCTP Stream Reconfiguration" procedures as specified in IETF RFC 6525[51], which results in:

- 1) for an outgoing direction: the MRFP shall not initiate any "Sender-Side Procedures for the RE-CONFIG Chunk", as specified in IETF RFC 6525[51]; and
- 2) for an incoming direction: the MRFP shall deny any SCTP re-configuration request (as part of "Receiver-Side Procedures for the RE-CONFIG Chunk", as specified in IETF RFC 6525[51]) in order to prevent possible later usage of SCTP stream reset requests.

5.22.5 CLUE transport between MRFC and MRFP

When the data channel is terminated in the MRFP for telepresence, CLUE messages (e.g. OPTIONS, ADVERTISEMENT, CONFIGURE etc.) are sent from the MRFC to the MRFP to be exchanged via the CLUE data channel between the MRFP and the TP UE.

When the MRFC requests the MRFP to establish a CLUE data channel the MRFC shall include a Notify CLUE Message Received Event information element to request the MRFP a reporting of the received CLUE message.

When a CLUE message needs to be sent to the TP UE the MRFC shall request the MRFP to send the CLUE message.

Upon reception of the request to send CLUE message from the MRFC containing the CLUE message content the MRFP shall send the CLUE message to the TP UE.

When a CLUE message is received from the TP UE, the MRFP shall send the content of the received CLUE message to the MRFC.

5.23 SDP Capability Negotiation (SDPCapNeg)

The SDP Capability Negotiation (SDPCapNeg) as specified in IETF RFC 5939 [53] is adopted as an optional functionality to negotiate capabilities and their associated configurations according to 3GPP TS 24.229 [30].

Upon receipt of an incoming SDP offer containing the attributes of SDP capability negotiation, e.g. offer AVPF and AVP together for the RTP profile negotiation using "a=tcap", "a=pcfg" and "a=acfg" attributes, the MRFC acting as the session responder shall make the decision on support of the alternative configurations based on the MRFC/MRFP capability as provision, and request the MRFP to reserve resources only for the configuration as selected. The MRFC then send the SDP answer indicating the selected configuration in the "a=acfg" attribute for actual configurations.

The MRFC acting as the session initiator may signal SDPCapNeg to the MRFP, e.g. the MRFC wildcard the supporting configurations from the MRFP in order to construct an SDP offer with the alternative configurations via SDPCapNeg attributes.

NOTE: The additional benefit of signalling SDPCapNeg between the MRFC and the MRFP is to check the resource availability for the corresponding configurations and to avoid the further session failure in case of inadequate resources for the configuration changes in the final confirmation. However, due to the extra resources reserved only during the call establishment phase, there is increased risk of call establishment failure.

In case the MRFC decides to request the MRFP to reserve resources for all of those configurations, the MRFC shall:

- use legacy SDP attributes as specified in IETF RFC 4566 [53] to do the mapping of actual and potential configurations with the H.248 ReserveGroup concept; or
- use SDP extensions for SDP capability negotiation as specified in IETF RFC 5939 [53], if supported by the MRFP.

Before using SDP extensions for SDP capability negotiation as specified in IETF RFC 5939 [53] towards the MRFP, the MRFC shall perform the necessary checks (i.e. through auditing or via prior provisioning) to ensure that the MRFP supports the syntax and capabilities requested. For an auditing the procedure in clause 6.1.8.1 is used with the "SDPCapNeg Supported Capabilities" as the object.

When receiving a request from the MRFC with information element "SDPCapNeg configuration" indicating the potential use of multiple configurations, the MRFP shall reserve resources for all of those configurations that it supports and shall send indicate the configurations for which it reserved resources in an "SDPCapNeg configuration" information element in the response. The MRFC shall update the SDP offer with SDPCapNeg configurations in the response from the MRFP and shall forward the SDP offer to the next hop.

On receipt of an SDP answer with SDPCapNeg, the MRFC shall request the MRFP to configure the resources for the selected configuration. If the MRFP previously reserved any temporary resources for configurations that were not selected, the MRFC shall also request the MRFP to release those resources.

5.24 Video Region-of-Interest (ROI)

5.24.1 General

The MRFC and the MRFP may support the video Region-of-Interest (ROI) as defined in 3GPP TS 26.114 [23]. Three modes are specified for supporting ROI, including "Far End Camera Control (FECC)", "Arbitrary ROI" and "Predefined ROI". The MRFC and the MRFP may independently support any of these modes.

For the forthcoming clauses on "Far End Camera Control (FECC)", "Arbitrary ROI" and "Predefined ROI", the MRF procedures allow for only a single ROI-sending client in a given conference to receive and act on ROI requests for a given ROI mode, but they allow for multiple ROI-receiving clients to issue and send ROI requests. Once the MRFC

successfully completes the ROI capability negotiation with the ROI-sending client, it offers the corresponding ROI capabilities to other ROI-receiving clients in the conference and instructs the MRFP to signal ROI request(s) to the ROI-sending client based on the ROI requests it receives from the ROI-receiving clients.

5.24.2 "Far End Camera Control" mode

The MRFC and MRFP may support the "Far End Camera Control" mode as specified in 3GPP TS 26.114 [23]. If the MRFC and MRFP support the "Far End Camera Control" mode, the MRFC and MRFP shall apply the procedures in the present clause.

Upon receipt of an SDP offer containing an "m=" line with a media type "application/h224", as defined by IETF RFC 4573 [54] which indicates support for FECC (ITU-T Recommendation H.281 [56]) using ITU-T Recommendation H.224 [55], the MRFC shall determine based on the local policy and the ROI negotiation results on other call legs whether to accept this "FECC" offer. If the "FECC" offer is accepted, the MRFC shall:

- include the "m=" and "a=" lines related to the "application/h224" media types (see the related SDP examples in annex A.4.2e of 3GPP TS 26.114 [23]) in the SDP answer that will be sent within the SIP signalling;
- request the MRFP to provide a separate IP/UDP/RTP transport for the "application/h224" media stream by setting the "m=" line media type to "application" and "RTP/AVP" or "RTP/AVPF" over UDP as transport protocol when reserving the transport resources, and forward transparently RTP/UDP packets (with the transparent (H.224)-PDU); and
- only one of the SDP offers containing "a=sendrecv" or "a=recvonly" capabilities shall be responded by the MRFC with an SDP answer with an indication of "a=sendonly" and other such SDP offers, if accepted, shall be responded by the MRFC with an SDP answer with an indication of "a=recvonly".
- request the MRFP to pass RTP flows from the terminations where the MRFC replied with "a=recvonly" in the SDP answer to the termination where the MRFC replied with "a=sendonly" in the SDP answer.

NOTE 1: There may be one media type "application/h224" "m=" line for each video "m=" line.

NOTE 2: The use of FECC itself is internal to the H.224 frame and is identified by the client ID field of the H.224 packet. The MRFC only indicates the use of IP/UDP/RTP. The use of FECC is signalled via H.224 by a MTSI client.

If the MRFP does not support the FECC feature or the MRFC determines that the "FECC" offer should not be accepted based on the local policy and the ROI negotiation results on other call legs, the MRFC shall send the SDP answer without any "m=" and "a=" lines related to the "application/h224" media types within the SIP signalling.

If the MRFC and MRFP support the FECC feature then before sending an SDP offer, the MRFC shall:

- a) determine based on the local policy and the FECC negotiation results on other call legs to offer FECC; and
- b) if the MRFC determines to offer FECC:
 - the MRFC shall include the "m=" and "a=" lines related to the "application/h224" media types in the SDP offer it sends within the SIP signalling; and
 - request the MRFP to provide a separate IP/UDP/RTP transport for the "application/h224" media stream by setting the "m=" line media type to "application" and "RTP/AVP" or "RTP/AVPF" over UDP as transport protocol when reserving the transport resources, and forward transparently RTP/UDP packets (with the transparent (H.224)-PDU)
 - only one of the SDP offers from the MRFC shall contain "a=sendonly" and remaining SDP offers from the MRFC shall contain "a=recvonly".
 - request the MRFP to pass RTP flows from the terminations where the MRFC indicated with "a=recvonly" in the SDP offer to the termination where the MRFC indicated with "a=sendonly" in the SDP offer.

If the MRFP does not support the FECC feature, the MRFC shall send the SDP offer without any FECC related SDP attributes within the SIP signalling.

5.24.3 "Predefined ROI" mode

The MRFC and MRFP may support the "Predefined ROI" mode as specified in 3GPP TS 26.114 [23]. If the MRFC and MRFP support the "Predefined ROI", the MRFC and MRFP shall apply the procedures in the present clause.

- Upon receipt of an SDP offer containing the predefined ROI attribute(s) "a=predefined_ROI" defined in 3GPP TS 26.114 [23], the MRFC shall determine based on the local policy and the ROI negotiation results on other call legs whether to accept this "Predefined ROI" offer. If the "Predefined ROI" offer is accepted, the MRFC shall include the accepted set of predefined ROIs in the SDP answer by indicating them using the "a=predefined_ROI" attributes that will be sent within the SIP signalling (see the related SDP examples in annex A.4.2e of 3GPP TS 26.114 [23]). The accepted set of predefined ROIs shall be based on the predefined ROIs offered by the client designated by the MRFC as the ROI-sending client. For the response to the ROI-sending client, the SDP answer from the MRFC shall not contain "a=predefined_ROI" attributes. If the MRFP does not support the Predefined ROI feature or the MRFC determines that the "Predefined ROI" offer should not be accepted based on the local policy and the ROI negotiation results on other call legs, the MRFC shall send the SDP answer without any "a=predefined_ROI" attributes within the SIP signalling.

Upon receipt of an SDP offer containing an "a=rtcp-fb" line with the "Predefined ROI" type expressed by the parameter "3gpp-roi-predefined", as described in 3GPP TS 26.114 [23], the MRFC shall determine based on the local policy and the ROI negotiation results on other call legs whether to accept this "Predefined ROI" offer. If the "Predefined ROI" offer is accepted, the MRFC shall:

- at the termination towards the ROI-sending client, include the "Predefined ROI Sent" information element when seizing resources in the MRFP to indicate to the MRFP that it shall signal RTCP "FB ROI" feedback message(s) related to predefined ROI on that termination and request the MRFP to assign the related resources for the corresponding RTCP control flow to convey pre-defined ROI information;
- at a termination towards an ROI-receiving client, include the "Predefined ROI Received" information element when seizing resources in the MRFP to indicate to the MRFP that it shall accept RTCP "FB ROI" feedback message(s) related to predefined ROI on that termination and request the MRFP to assign the related resources for the corresponding RTCP control flow to convey pre-defined ROI information; and
- include "a=rtcp-fb" lines related to the "3gpp-roi-predefined" parameter in the SDP answer that will be sent within the SIP signalling (see the related SDP examples in annex A.4.2e of 3GPP TS 26.114 [23]); and

NOTE: The RTCP control flow contains multiple RTCP packet types.

If the MRFP does not support the Predefined ROI feature or the MRFC determines that the "Predefined ROI" offer should not be accepted based on the local policy and the ROI negotiation results on other call legs, the MRFC shall send the SDP answer without any "a=rtcp-fb" lines related to the "3gpp-roi-predefined" parameter within the SIP signalling.

Upon receipt of an SDP offer containing "a=extmap" attribute(s), as defined in IETF RFC 5285 [27], and the "a=extmap" attribute(s) contain the pre-defined ROI URN(s) (i.e. the ROI URN for carriage of pre-defined region of interest information in the sent video stream is given by "urn:3gpp:predefined-roi-sent") as defined in 3GPP TS 26.114 [23], then the MRFC shall determine based on the local policy and the ROI negotiation results on other call legs whether to accept this "Predefined ROI" offer. If the "Predefined ROI" offer is accepted, the MRFC shall:

- include the "Extended RTP header for Sent ROI" information element when seizing resources in the MRFP to indicate to the MRFP that it shall allow the RTP header extension for predefined ROI to pass; and
- include "a=extmap" attributes containing the pre-defined ROI URN in the SDP answer that will be sent within the SIP signalling (see the related SDP examples in annex A.4.2e of 3GPP TS 26.114 [23]).

If the MRFP does not support the Predefined ROI feature or the MRFC determines that the "Predefined ROI" offer should not be accepted based on the local policy and the ROI negotiation results on other call legs, the MRFC shall send the SDP answer without any Predefined ROI related "a=extmap" attribute within the SIP signalling.

If the MRFC and MRFP support the Predefined ROI feature then before sending an SDP offer, the MRFC shall:

- a) determine based on the local policy and the Predefined ROI negotiation results on other call legs if, and with what configurations to offer Predefined ROI; and
- b) if the MRFC determines to offer Predefined ROI:

- at the termination towards the ROI sending client, the MRFC shall include the "Predefined ROI Sent" information element when seizing resources in the MRFP to indicate to the MRFP that it shall signal RTCP "FB ROI" feedback message(s) related to predefined ROI on that termination and request the MRFP to assign the related resources for the corresponding RTCP control flow to convey pre-defined ROI information;
- at a termination towards an ROI receiving client, the MRFC shall include the "Predefined ROI Received" information element when seizing resources in the MRFP to indicate to the MRFP that it shall accept RTCP "FB ROI" feedback message(s) related to predefined ROI on that termination and request the MRFP to assign the related resources for the corresponding RTCP control flow to convey pre-defined ROI information;
- the MRFC shall include "a=rtcp-fb" lines related to the "3gpp-roi-predefined" parameter along with the associated "a=predefined_ROI" attributes in the SDP offer it sends within the SIP signalling;
- the MRFC shall include the offered set of predefined ROIs by indicating them using the "a=predefined_ROI" attributes in the SDP offer it sends within the SIP signalling, where the offered set of predefined ROIs shall be based on the predefined ROIs offered by the client designated by the MRFC as the ROI-sending client.;
- the MRFC shall include the "extended RTP header for Sent ROI" information element for Predefined ROI when seizing resources in the MRFP to indicate the MRFP that it shall allow the RTP header extension for predefined ROI to pass; and
- the MRFC shall include the Predefined ROI related "a=extmap" attribute in the SDP offer it sends within the SIP signalling.

If the MRFP does not support the Predefined ROI feature, the MRFC shall send the SDP offer without any Predefined ROI related SDP attributes within the SIP signalling.

If the MRFP has been instructed to pass on the extended RTP header for predefined ROI as described above then:

- if the MRFP does not apply video transcoding, it shall pass any received RTP header extension for Predefined ROI to succeeding RTP streams; or
- if the MRFP applies video transcoding, it shall keep the predefined ROI information unchanged during the transcoding and copy the received RTP header extension for Predefined ROI to the succeeding outgoing RTP stream(s) after transcoding the associated group of packets.

5.24.4 "Arbitrary ROI" mode

The MRFC and MRFP may support the "Arbitrary ROI" mode as specified in 3GPP TS 26.114 [23]. If the MRFC and MRFP support the "Arbitrary ROI", the MRFC and MRFP shall apply the procedures in the present clause.

Upon receipt of an SDP offer containing an "a=rtcp-fb" line with the "Arbitrary ROI" type expressed by the parameter "3gpp-roi-arbitrary", as described in 3GPP TS 26.114 [23], the MRFC shall determine based on the local policy and the ROI negotiation results on other call legs whether to accept this "Arbitrary ROI" offer. If the "Arbitrary ROI" offer is accepted, the MRFC shall:

- at the termination towards the ROI-sending client, include the "Arbitrary ROI Sent" information element when seizing resources in the MRFP to indicate to the MRFP that it shall signal RTCP "FB ROI" feedback message(s) related to arbitrary ROI on that termination and request the MRFP to assign the related resources for the corresponding RTCP control flow to convey arbitrary ROI information;
- at a termination towards an ROI-receiving client, include the "Arbitrary ROI Received" information element when seizing resources in the MRFP to indicate to the MRFP that it shall accept RTCP "FB ROI" feedback message(s) related to arbitrary ROI on that termination and request the MRFP to assign the related resources for the corresponding RTCP control flow to convey arbitrary ROI information; and
- include "a=rtcp-fb" lines related to the "3gpp-roi-arbitrary" parameter in the SDP answer that will be sent within the SIP signalling (see the related SDP examples in annex A.4.2e of 3GPP TS 26.114 [23]).

NOTE: The RTCP control flow contains multiple RTCP packet types.

If the MRFP does not support the Arbitrary ROI feature or the MRFC determines that the "Arbitrary ROI" offer should not be accepted based on the local policy and the ROI negotiation results on other call legs, the MRFC shall send the SDP answer without any "a=rtcp-fb" lines related to the "3gpp-roi-arbitrary" parameter within the SIP signalling.

Upon receipt of an SDP offer containing "a=extmap" attribute(s), as defined in IETF RFC 5285 [27], and the "a=extmap" attribute(s) contain the arbitrary ROI URN(s) (i.e. the ROI URN for carriage of arbitrary region of interest information in the sent video stream is given by "urn:3gpp:roi-sent") as defined in 3GPP TS 26.114 [23], then the MRFC shall determine based on the local policy and the ROI negotiation results on other call legs whether to accept this "Arbitrary ROI" offer. If the "Arbitrary ROI" offer is accepted, the MRFC shall:

- include the "Extended RTP header for Sent ROI" information element when seizing resources in the MRFP to indicate to the MRFP that it shall allow the RTP header extension for arbitrary ROI to pass; and
- include "a=extmap" attributes containing the arbitrary ROI URN in the SDP answer that will be sent within the SIP signalling (see the related SDP examples in annex A.4.2e of 3GPP TS 26.114 [23]).

If the MRFP does not support the Arbitrary ROI feature or the MRFC determines that the "Arbitrary ROI" offer should not be accepted based on the local policy and the ROI negotiation results on other call legs, the MRFC shall send the SDP answer without any Arbitrary ROI related "a=extmap" attribute within the SIP signalling.

If the MRFC and MRFP support the Arbitrary ROI feature then before sending an SDP offer, the MRFC shall:

- a) determine based on the local policy and the Arbitrary ROI negotiation results on other call legs if, and with what configurations to offer Arbitrary ROI; and
- b) if the MRFC determines to offer Arbitrary ROI:
 - at the termination towards the ROI-sending client, the MRFC shall include the "Arbitrary ROI Sent" information element when seizing resources in the MRFP to indicate to the MRFP that it shall signal RTCP "FB ROI" feedback message(s) related to arbitrary ROI on that termination and request the MRFP to assign the related resources for the corresponding RTCP control flow to convey arbitrary ROI information;
 - at a termination towards an ROI-receiving client, the MRFC shall include the "Arbitrary ROI Received" information element when seizing resources in the MRFP to indicate to the MRFP that it shall accept RTCP "FB ROI" feedback message(s) related to arbitrary ROI on that termination and request the MRFP to assign the related resources for the corresponding RTCP control flow to convey arbitrary ROI information;
 - the MRFC shall include "a=rtcp-fb" lines related to the "3gpp-roi-arbitrary" parameter in the SDP offer it sends within the SIP signalling;
 - the MRFC shall include the "extended RTP header for Sent ROI" information element for Arbitrary ROI when seizing resources in the MRFP to indicate the MRFP that it shall allow the RTP header extension for arbitrary ROI to pass; and
 - the MRFC shall include the Arbitrary ROI related "a=extmap" attribute in the SDP offer it sends within the SIP signalling.

If the MRFP does not support the Arbitrary ROI feature, the MRFC shall send the SDP offer without any Arbitrary ROI related SDP attributes within the SIP signalling.

If the MRFP has been instructed to pass on the extended RTP header for arbitrary ROI as described above then:

- if the MRFP does not apply video transcoding, it shall pass any received RTP header extension for Arbitrary ROI to succeeding RTP streams; or
- if the MRFP applies video transcoding, it shall keep the arbitrary ROI information unchanged during the transcoding and copy the received RTP header extension for Arbitrary ROI to the succeeding outgoing RTP stream(s) after transcoding the associated group of packets.

5.25 Rate adaptation for media endpoints

If the MRFC and the MRFP support rate adaptation for media endpoints using the enhanced bandwidth negotiation mechanism defined in 3GPP TS 26.114 [23] the requirements and procedures in the present clause apply.

If the MRFC receives an SDP offer containing the SDP "a=bw-info" attribute(s), defined in clause 19 of 3GPP TS 26.114 [23] the MRFC shall:

- select the payload types (codecs and codec configurations) from the received SDP offer;

- if the received SDP offer contained the SDP "a=bw-info" attribute(s) for the selected codec:
 - a) construct appropriate SDP "a=bw-info" attribute(s) for the selected codec according to the rules in 3GPP TS 26.114 [23]; and

NOTE 1: The MRFP can modify the related SDP "a=bw-info" attribute(s) according to operator policies as specified in 3GPP TS 26.114 [23].

NOTE 2: The offer/answer negotiation is performed for each "a=bw-info" SDP attribute line, payload type, direction and bandwidth property individually.

- b) include the "Additional Bandwidth Properties" information element containing "a=bw-info" SDP attribute(s) in the remote descriptor describing bandwidths that will be used for the selected codec in the sending direction towards the preceding node when requesting the MRFP to reserve resources; and

NOTE 3: The included information corresponds to "a=bw-info" SDP attribute(s) in the sent SDP answer for the "send" or "sendrecv" direction.

- include the selected codec with the corresponding SDP "a=bw-info" attribute(s) in the SDP answer.

If the MRFC sends the SDP offer the MRFC shall include, in accordance with local configuration, for the each offered payload type appropriate bandwidth information in "a=bw-info" SDP attribute lines(s).

If the MRFC then receives the SDP answer with the SDP "a=bw-info" attribute(s) the MRFC shall, when requesting the MRFP to configure resources, include for the selected payload type the "Additional Bandwidth Properties" information element containing the "a=bw-info" SDP attribute(s) providing information for the selected codec in the remote descriptor about bandwidths that will be used for the selected codec in the sending direction towards the succeeding node.

NOTE 4: The included information corresponds to "a=bw-info" SDP attribute(s) in the received SDP answer for the "recv" or "sendrecv" direction.

The MRFP may use the "Additional Bandwidth Properties" information element indicating media bandwidth range for rate adaptation (i.e. to select an appropriate encoding and redundancy) when transcoding media streams.

5.26 RTCP Codec Control Commands and Indications

The MRFC and the MRFP may support signalling of "RTCP Codec Control Commands and Indications", as defined in 3GPP TS 26.114 [23] and IETF RFC 5104 [61].

NOTE 1: 3GPP TS 26.114 [23] specifies support of the following RTCP feedback codec control messages (CCM): "Full Intra Request (FIR)", "Temporary Maximum Media Stream Bit Rate Request (TMMBR)" and "Temporary Maximum Media Stream Bit Rate Notification (TMMBN)".

The RTCP FIR feedback message can be used by the MRFP supporting the Multi-stream Multiparty Conferencing Media Handling feature, as specified in clause 5.11.3, to request the media sender to send a decoder refresh point.

The RTCP TMMBR and TMMBN feedback messages can also be used in reaction to the Explicit Congestion Notification, as specified in clause 5.15.

Usage of the RTCP feedback "CCM" messages is negotiated via SDP offer/answer exchange through an extension (defined in IETF RFC 5104 [78]) of the RTCP feedback capability attribute "a=rtcp-fb" (defined in IETF RFC 4585 [60]).

NOTE 2: The SDP offer/answer negotiation is performed with a separate "a=rtcp-fb" attribute line for each CCM message type.

If the MRFC and the MRFP support the "RTCP Codec Control Commands and Indications" signalling, the MRFC and the MRFP shall apply the procedures in the present clause.

If the MRFC receives from a preceding node an SDP offer containing "a=rtcp-fb" line(s) with a "CCM" parameter and with "fir" and/or "tmmbr" CCM parameters (defined in IETF RFC 5104 [61]) under video "m=" line(s), the MRFC shall:

- when requesting the MRFP to configure resources towards the preceding node, include the "CCM BASE" information element with the "fir" and/or "tmnbr" CCM parameters to indicate that the MRFP shall be prepared to receive and is allowed to send the RTCP CCM "FIR" and/or "TMMBR/TMMBN" feedback messages; and
- include in the SDP answer, that will be sent to its preceding node, the "a=rtcp-fb" line(s) with the "fir" and/or "tmnbr" CCM parameters from the received SDP offer.

If the MRFC sends the SDP offer with video "m=" line(s) the MRFC shall include under the each offered video "m=" line the "a=rtcp-fb" attribute lines with the "CCM" parameter and with the "fir" and "tmnbr" CCM parameters.

If the MRFC then receives the SDP answer with the "a=rtcp-fb" line(s) with the "CCM" parameter and with the "fir" and/or "tmnbr" CCM parameters the MRFC shall, when requesting the MRFP to configure resources, include the "CCM BASE" information element with the "fir" and/or "tmnbr" CCM parameters to indicate that the MRFP shall be prepared to receive and is allowed to send the RTCP CCM "FIR" and/or "TMMBR/TMMBN" feedback messages.

The MRFP shall then assign resources for the requested RTCP control flow, and the MRFP:

- may send the RTCP FIR feedback message to request the media sender to send a decoder refresh point;
- may send the RTCP TMMBR feedback message to request the media sender to limit the maximum bit rate for a media stream to, or below, the provided value; and

NOTE 3: Trigger for sending of the RTCP TMMBR feedback message can be reception of RTP packets marked with ECN-CE, as described in clause 5.15.

- upon reception of the RTCP TMMBR feedback message shall adjust the sent media rate to the requested rate or lower and shall respond by sending the RTCP TMMBN feedback message.

5.27 Delay Budget Information (DBI)

The MRFP and the MRFC supporting Audio or Multimedia Conferencing, as specified in clauses 5.10 and 5.11, may support the "DBI" signalling as defined in 3GPP TS 26.114 [21].

The MRFP supporting Audio or Multimedia Conferencing, as specified in clause 5.10 and 5.11 may use RTCP feedback messages for "DBI" signalling (as defined in 3GPP TS 26.114 [23] clause 7.3.8) to exchange audio and video delay budget information with the conference participants as defined in 3GPP TS 26.114 [23].

Usage of the RTCP feedback messages for "DBI" signalling is negotiated via SDP offer/answer exchange through an extension of the RTCP feedback capability attribute "a=rtcp-fb" as defined in 3GPP TS 26.114 [23].

If the MRFC and the MRFP supports RTCP feedback messages for "DBI" signalling as defined in 3GPP TS 26.114 [23], the MRFC and the MRFP shall apply the procedures in the present clause.

If the MRFC receives from a preceding node an SDP offer containing "a=rtcp-fb" line(s) with a "3gpp-delay-budget" parameter (as defined in 3GPP TS 26.114 [23] clause 6.2.8) under audio "m=" line(s) or video "m=" line(s), the MRFC shall:

- when requesting the MRFP to configure resources towards the preceding node, include the "DBI" information element to indicate that the MRFP shall be prepared to receive and is allowed to send RTCP feedback messages for "DBI" signalling; and
- include in the SDP answer, that will be sent to its preceding node, the "a=rtcp-fb" line(s) with the "3gpp-delay-budget" parameter from the received SDP offer.

If the MRFC sends the SDP offer with audio or video "m=" line(s) the MRFC shall include under each offered audio or video "m=" line the "a=rtcp-fb" attribute line with the "3gpp-delay-budget" parameter.

If the MRFC then receives the SDP answer with the "a=rtcp-fb" line(s) with the "3gpp-delay-budget" parameter the MRFC shall, when requesting the MRFP to configure resources, include the "DBI" information element to indicate that the MRFP shall be prepared to receive and is allowed to send RTCP feedback messages for "DBI" signalling.

The MRFP shall then assign resources for the requested RTCP control flow and the MRFP:

- may send RTCP feedback messages for "DBI" signalling to report the available additional delay budget to the media sender by setting the "query parameter q" to '0' in the feedback control information as defined in

3GPP TS 26.114 [23] clause 7.3.8. The additional delay budget might be useful for the media sender to improve the reliability of its uplink transmissions in order to reduce packet loss.

- may send RTCP feedback messages for "DBI" signalling to request additional delay budget from the media receiver by setting the "query parameter q" to '1' in the feedback control information as defined in 3GPP TS 26.114 [23] clause 7.3.8. The message could be triggered by the the reception of an RTCP Receiver Report indicating high packet loss.
- upon reception of the RTCP feedback message for "DBI" signalling with the "query parameter q" set to '0' in the feedback control information (as defined in 3GPP TS 26.114 [23] clause 7.3.8), may use the additional delay budget to improve the reliability of its outgoing media stream in order to reduce packet loss observed by the media receiver.
- upon reception of the RTCP feedback message for "DBI" signalling with the "query parameter q" set to '1' in the feedback control information (as defined in 3GPP TS 26.114 [23] clause 7.3.8), may adjust the delay of the outgoing media stream, if possible.

NOTE: How the MRFP adapts the reliability of its outgoing media stream based on the available delay budget and observed packet loss is up to the implementation.

6 MRFC-MRFP Procedures

6.1 Non-Call Related Procedures

6.1.1 General

The non-call related procedures are based on corresponding procedures of 3GPP TS 23.205[7] when the MRFC takes the place of the MSC server and the MRFP takes the place of the MGW.

6.1.2 MRFP Unavailable

The MRFC recognises that the MRFP is unavailable in the following 4 cases:

1. The signalling connection is unavailable

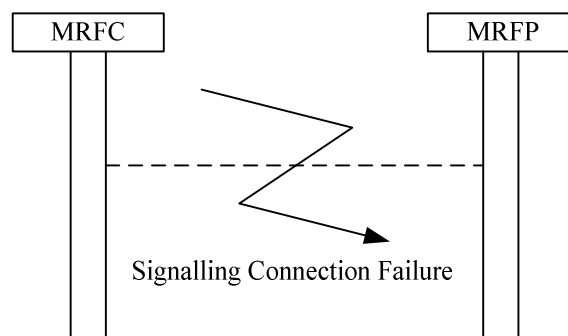

Figure 6.1.2.1: Signalling connection failure

2. The MRFP indicates the failure condition to all connected MRFCs

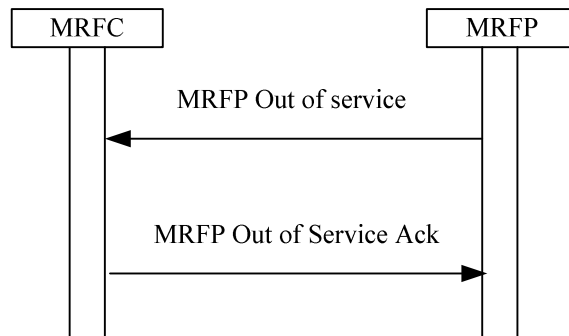

Figure 6.1.2.2: MRFP indicates the Failure/Maintenance locking

The failure indication indicates that the MRFP will soon go out of service and that no new connections should be established using this MRFP. The MRFP can choose between the "graceful" and the "forced" method. In the graceful method the connections are cleared when the corresponding calls are disconnected. In the forced method all connection are cleared immediately.

3. The MRFC recognises that the MRFP is not functioning correctly, e.g. because there is no reply on periodic sending of Audits. The periodic sending of Audits by MRFC should persist.
4. The MRFP indicates the maintenance locking condition to all concerned MRFCs.

The maintenance locking indication indicates that the MRFP is locked for new calls and that no new connections shall be established using this MRFP. The MRFP can choose between the "graceful" and the "forced" method. In the graceful method the connections are cleared when the corresponding calls are disconnected. In the forced method all connection are cleared immediately

In all of the above cases the MRFC shall prevent the usage of the MRFP until the MRFP has recovered or the communication with the MRFP is restored.

6.1.3 MRFP Available

The MRFC discovers that the MRFP is available when it receives an MRFP Communication Up message or an MRFP Restoration message. When the MRFC discovers that the MRFP is available the following shall occur:

1. Signalling recovery

The MRFP indicates to all connected MRFCs that the signalling connection is restored.

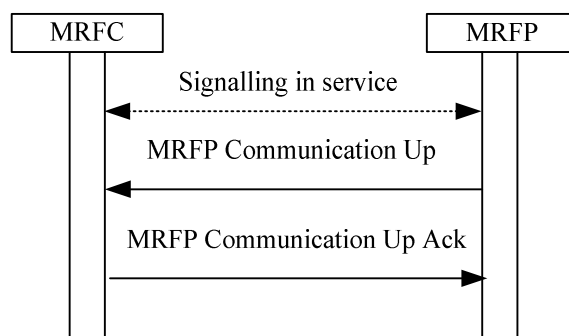

Figure 6.1.3.1: Communication goes up

2. MRFP restoration/maintenance unlocking indication.

The MRFP indicates to all connected MRFCs that normal operation has resumed.

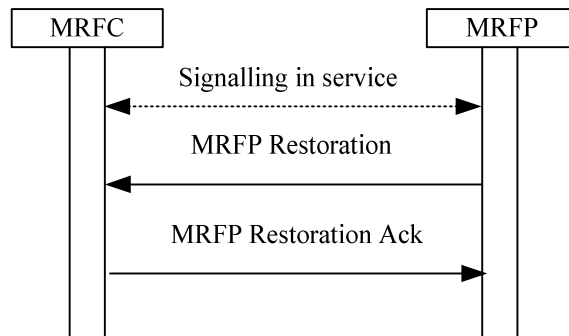

Figure 6.1.3.2: MRFP indicates recovery from a failure/or maintenance unlocking

NOTE: This procedure may be used after recovery from a signalling failure.

3. The MRFC recognises that the MRFP is now functioning correctly, e.g. because there is a reply on periodic sending of Audits.

After this the MRFC can use the MRFP. If none of 1,2, or 3 happens the MRFC can initiate the MRFC Ordered Re-register procedure.

6.1.4 MRFP Recovery

If the MRFP recovers from a failure, is maintenance unlocked, or it has been restarted, it registers to its known MRFCs using the MRFP Restoration procedure or the MRFP Registration procedure. The MRFP can indicate whether the Service has been restored or whether it has restarted with a cold or warm boot. The response sent to the MRFP indicates a signalling address to be used by the MRFP.

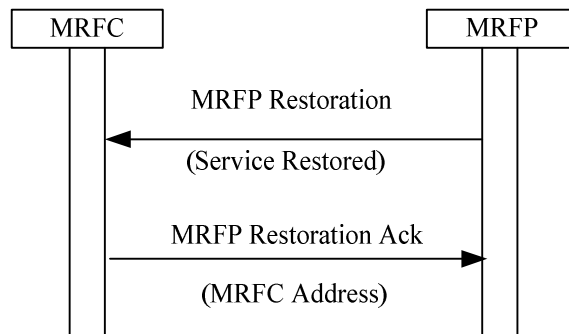

Figure 6.1.4.1: MRFP Restoration

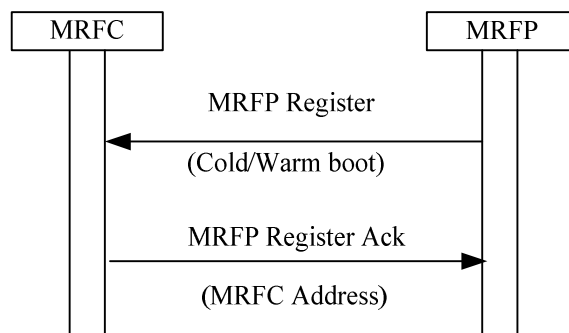

Figure 6.1.4.2 MRFP Registration

After the recovery the MRFC can use the MRFP.

6.1.5 MRFC Recovery

6.1.5.1 General

If an MRFP-unavailable condition is provoked by a failure/recovery action, the MRFC recovery sequence will, from an information flow point of view, look like MRFP unavailable and then MRFP available. If an MRFP-unavailable condition is not provoked, the MRFC recovery sequence will look like MRFP available.

After the information flow, the terminations affected by the recovery action are released.

6.1.5.2 MRFC Restoration

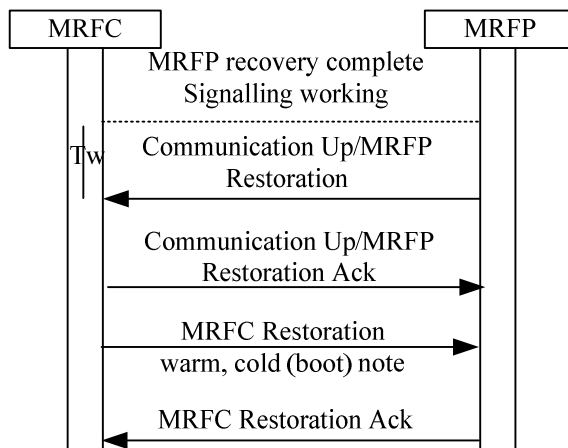

Figure 6.1.5.2.1: MRFC Restoration

NOTE: Normal release procedure may also be initiated.

After the recovery action is complete and it is possible to signal to the MRFP the MRFC starts a timer T_w . If recovery indications are not received (MRFP Communication Up or MRFP Restoration) from the MRFP during T_w an Audit is sent. If the MRFC receives a recovery indication or MRFP communication up indication, it shall acknowledge the indication before the MRFC Restoration may be sent or the release procedure is initiated.

6.1.6 MRFP Re-register

When the MRFC requests an MRFP to perform a registration (see clause 6.1.7), the MRFP performs a re-registration to the MRFC which is defined in the MRFC address.

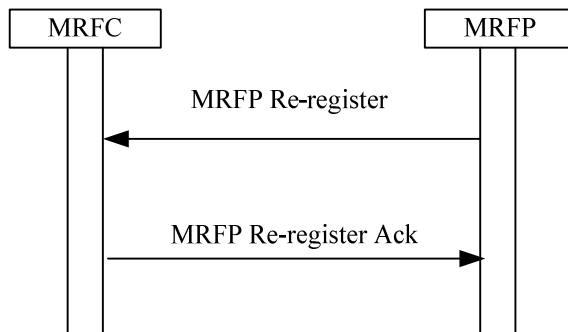

Figure 6.1.6.1: Re-registration of an MRFP

6.1.7 MRFP Re-registration Ordered by MRFC

If the MRFC knows that communication is possible, but the MRFP has not registered, the MRFC can order re-registration of the MRFP.

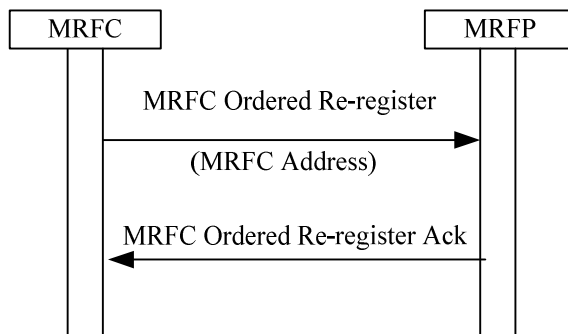

Figure 6.1.7.1: Re-registration ordered by the MRFC

If the re-registration request is accepted the MRFP uses the MRFP Re-register procedure to register with the MRFC.

6.1.8 Audit of MRFP

6.1.8.1 Audit of Value

The MRFC may request the MRFP to report the current values assigned to distinct objects in the MRFP.

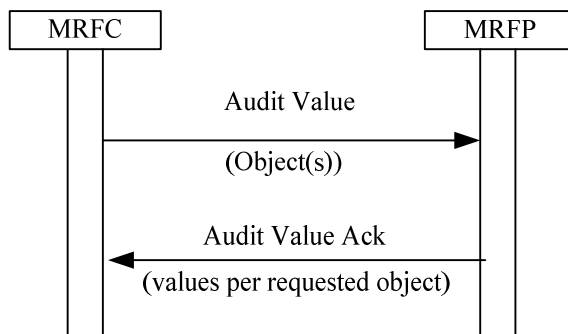

Figure 6.1.8.1.1: Audit Value

6.1.8.2 Audit of Capability

The MRFC may request the MRFP to report the capabilities of distinct objects in the MRFP.

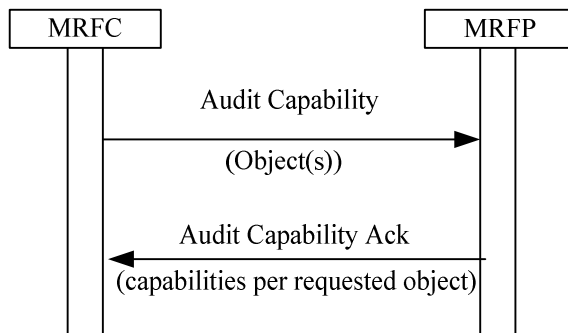

Figure 6.1.8.2.1: Audit Capability

6.1.9 MRFP Capability Change

The MRFP reports a change of capability of distinct objects in the MRFP.

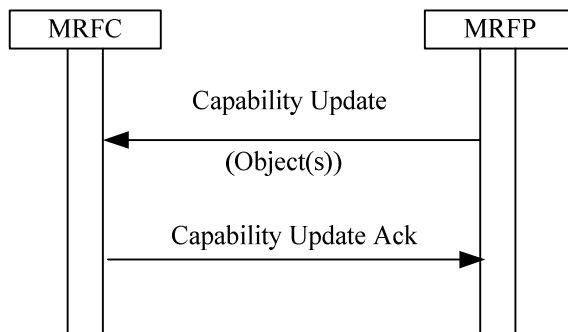

Figure 6.1.9.1: Capability Update

The MRFC can use the Audit Value and/or Audit Capability procedures to obtain further information, about the objects whose capabilities have changed.

6.1.10 MRFC Out of service

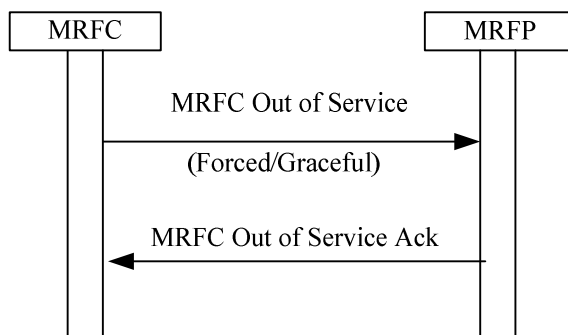

Figure 6.1.10.1: MRFC Out of Service

If an MRFC discovers that it wants to go out of service it starts an MRFC Out of Service procedure. The MRFC can indicate whether it requires the context to be cleared immediately (forced) or cleared when all terminations are released.(Graceful)

6.1.11 MRFP Resource Congestion Handling – Activate

When the MRFC requires that an MRFP congestion notification mechanism be applied in the MRFP, the MRFC shall use the MRFP Resource Congestion Handling - Activate procedure towards the MRFP.

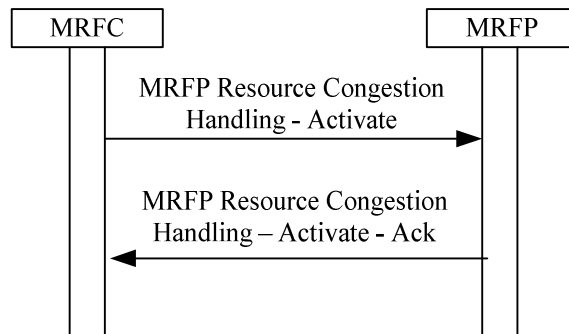

Figure 6.1.11.1: MRFP Resource Congestion Handling - Activate

6.1.12 MRFP Resource Congestion Handling -Indication

When the MRFC receives a load reduction notification from the MRFP via the MRFP Resource Congestion Handling - Indication procedure, the MRFC tries to reduce the processing load that the MRFC creates on the MRFP. The MRFP shall decide the actual level of traffic reduction.

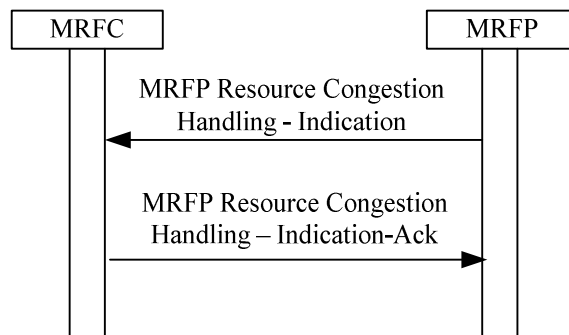

Figure 6.1.12.1: MRFP Resource Congestion Handling-Indication

6.1.13 Hanging termination detection

Whenever requesting new IP bearer terminations, the MRFC shall request the MRFP to periodically report termination heartbeat indications to detect hanging context and termination in the MRFP that may result e.g. from a loss of communication between the MRFC and the MRFP.

When the MRFC receives a termination heartbeat notification from the MRFP via the Termination heartbeat - Indication procedure, the MRFC shall return a Termination heartbeat -Indication Ack (without an error) if the context id / termination identity combination exists in the MRFC. If it does not exist, the MRFC shall return an error and shall correct the mismatch, e.g. by requesting the MRFP to subtract the indicated termination and to clear any associated context.

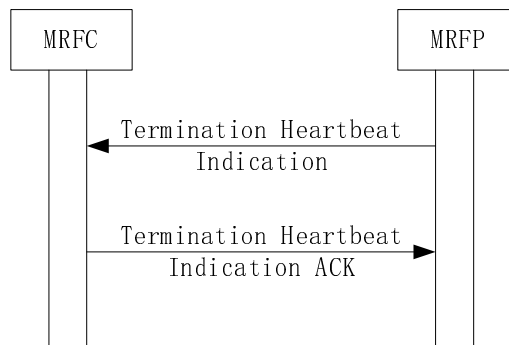

Figure 6.1.13.1: Termination heartbeat – Indication

6.2 Call Related Procedures

6.2.1 Play Tone Procedure

6.2.1.1 General

The following procedure assumes the IMS session has been established and the bearer is through-connected and the MRFC has received a trigger to play a tone and the MRFP selected for the call has the capabilities to provide tones.

NOTE: This procedure may also be ordered in combination with the session establishment procedure.

6.2.1.2 Send tone

After reception of a trigger to play a tone, the MRFC shall initiate the Send tone procedure. The MRFC may request the MRFP to send tone to one, multiple or all terminations in a context simultaneously with the tone identifier. The tone identifier may be a pre-configured identifier.

The MRFC may request the MRFP to send tone continuously until requested to be stopped. Alternatively, duration may be indicated or provisioned in the MRFP. When the duration elapses, the tone shall be stopped.

The MRFC may request the MRFP to detect DTMF digits, and may request the MRFP to stop sending tone when a DTMF digit is detected. For the second case, only the tone completion event is notified.

The MRFC may request the MRFP to detect the tone completion, and notify the completion event and cause to the MRFC. The tone is completed when either of the following has occurred;

- the duration has elapsed or:
- a DTMF digit is detected by the MRFP or:
- the sending tone is not successful.

6.2.1.3 Stop tone

On receipt of a trigger to stop a tone, the MRFC shall request the MRFP to stop the tone.

6.2.1.4 Tone completed

When a tone is completed, if the MRFC has requested the MRFP to notify the tone completion, the MRFP shall notify the tone completion event and the cause to the MRFC. The cause that the tone is completed may be that the duration has elapsed, a DTMF digit is detected by the MRFP, or that the tone is not successful. Then the MRFC may indicate to the AS that the tone has been stopped.

6.2.1.5 Message sequence chart

Figure 6.2.1.1 shows the message sequence chart example for sending tone.

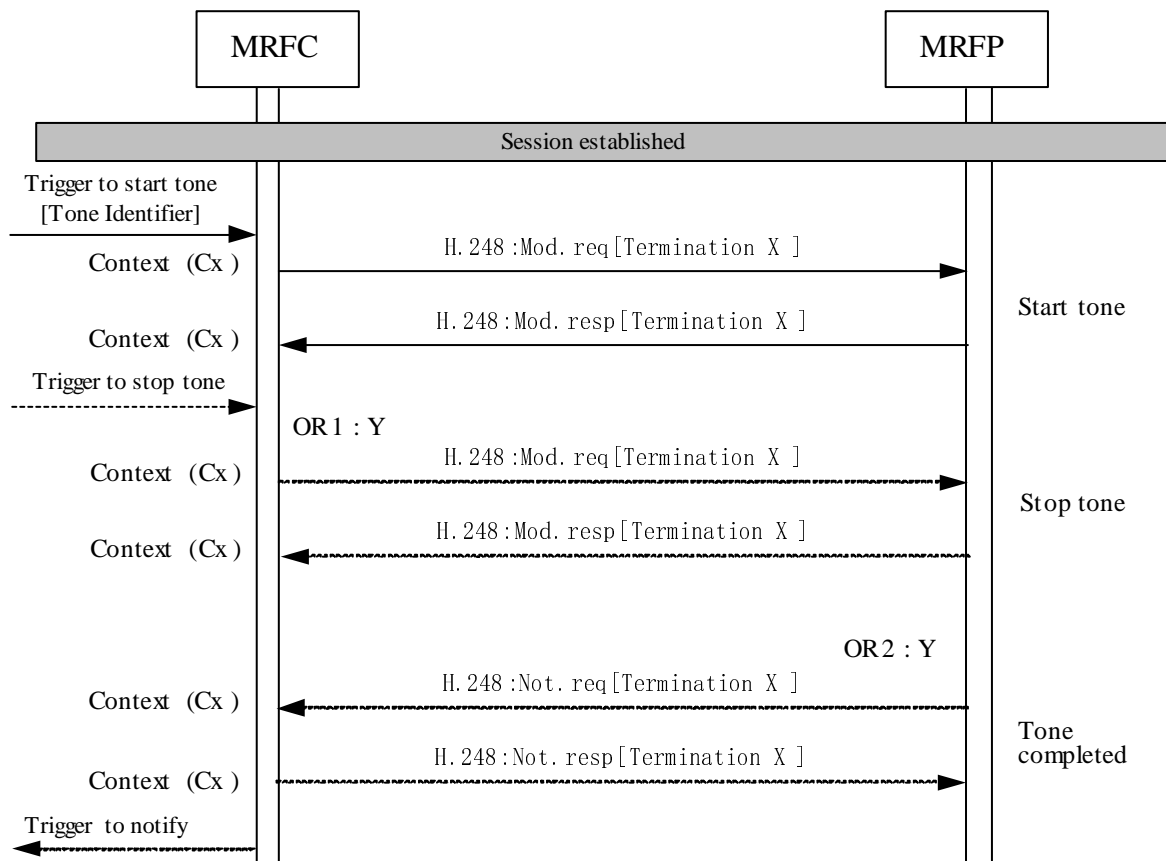

NOTE : OR 1:Stop the tone (Y:yes N:no)
 OR 2:Notification of completion required (Y:yes N: no)

Figure 6.2.1.1 Sending tone (message sequence chart)

6.2.2 Play Announcement Procedure

6.2.2.1 General

The following procedure assumes the IMS session has been established and the bearer is through-connected, and the MRFC has received a trigger to play announcement, and the MRFP selected for the call has the capabilities to provide announcement.

NOTE: This procedure may also be ordered in combination with the session establishment procedure.

6.2.2.2 Start announcement

After reception of a trigger to play the announcement, the MRFC should initiate the Start announcement procedure. The MRFC shall request the MRFP to play announcement to one, multiple or all terminations in a context with the announcement identifier. The announcement identifier may be a pre-configured identifier (such as a number).

If it is a sequence of announcements, the MRFC shall request the MRFP to play all the announcements with one request. The MRFC may request the MRFP to play the announcement in a loop continuously until requested to be stopped or in a loop with a fixed number of times. For the second case, if the fixed number of times is exhausted, the announcement is completed successfully.

If it is a variable announcement, the MRFC may indicate to the MRFP the following variants to the announcements:

- Date: A date variant is made up of three components: day, month and year. The MRFC shall indicate the date value and the date format to the MRFP, such as " day-month-year" or "year-month-day".

- Time: A time variant is made up of two components: hour and minute, The MRFC shall indicate the time value and the time format to the MRFP, such as "12-hours format" or "24-hours format".
- Digits (the announcement may contain a number of digits to be controlled by the MRFC for example a telephone number): a digits variant is made up of a sequence digit.
- Money (currency).
- Integer (a value within the announcement that is controlled by the MRFC, e.g. "you are caller number 3 in the queue"): an integer variant may be spoken as a cardinal or ordinal value. The MRFC shall indicate to the MRFP the value and type to be spoken.

The MRFC may request the MRFP to detect DTMF digit while playing an announcement, and may request the MRFP to stop playing an announcement when a DTMF digit is detected. For the latter case, only the announcement completion event is notified.

The MRFC may request the MRFP to detect the announcement completion, and notify the completion event and cause to the MRFC. The announcement is completed when either of the following has occurred;

- the announcement has been completed successfully or:
- a DTMF digit is detected by the MRFP or:
- the playing announcement is not successful.

6.2.2.3 Stop announcement

On receipt of a trigger to stop the announcement, the MRFC shall request the MRFP to stop the announcement.

6.2.2.4 Announcement completed

When an announcement is completed, if the MRFC has requested the MRFP to notify the announcement completion, the MRFP shall notify the announcement completion event and the cause to the MRFC. The cause that the announcement is completed may be the announcement has been completed successfully, or a DTMF digit is detected by the MRFP, or the playing announcement is not successful. Then the MRFC may indicate to the AS that the announcement has been stopped.

6.2.2.5 Message sequence chart

Figure 6.2.2.1 shows the message sequence chart example for playing announcement.

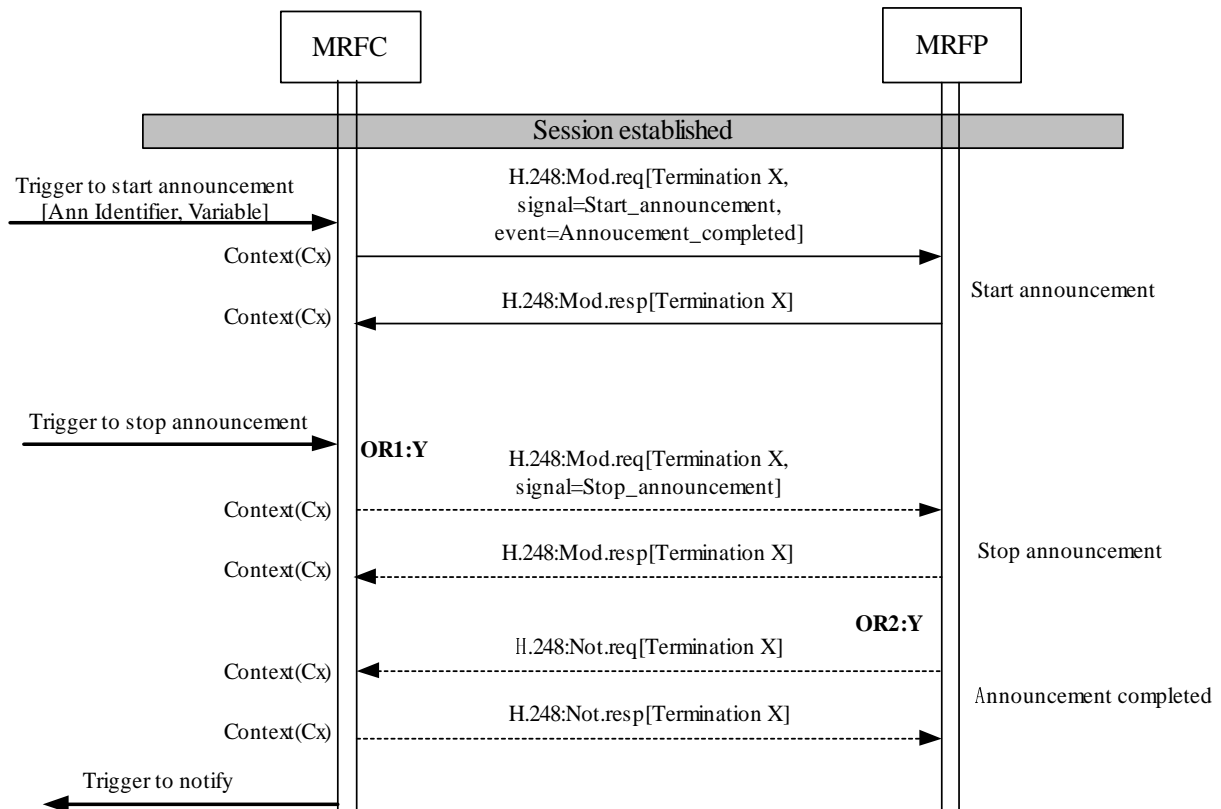

Note: OR1:Stop announcement (Y:yes, N:no)
 OR2:Notification of completion required(Y:yes, N:no)

Figure 6.2.2.1 Playing announcement (message sequence chart)

6.2.3 Text to Speech Procedure

6.2.3.1 General

The following procedure assumes the IMS session has been established and the bearer is through-connected, and the MRFC has received a trigger to play TTS, and the MRFP selected for the call has the capabilities to provide TTS.

NOTE: This procedure may also be ordered in combination with the session establishment procedure.

6.2.3.2 Start TTS

After reception of a trigger to play TTS, the MRFC should initiate the Start TTS procedure.

If the MRFC receives a VXML script, the MRFC shall extract the SSML script or the SSML file identifier from the VXML script. If the MRFC receives plain text, the MRFC shall generate a SSML script that includes this plain text (<speake>) and the language type (xml:lang) used the basic SSML format. If the size of the SSML script is larger than the transport capability of the Mp interface, the MRFC shall stop the Start TTS procedure and return error.

Then the MRFC shall indicate to the MRFP the SSML script or the SSML file identifier to play the SSML text to one, one of many, multiple or all terminations in a context. If the MRFP does not support an element of the SSML, the MRFP may ignore the element.

The MRFC may request the MRFP to play the TTS in a loop continuously until requested to be stopped or in a loop with a fixed number of times. For the second case, if the fixed number of times is exhausted, the TTS is completed successfully.

The MRFC may request the MRFP to detect DTMF digit while playing a TTS, and may request the MRFP to stop TTS when a DTMF digit is detected. For the second case, only the TTS completion event is notified.

The MRFC may request the MRFP to detect the TTS completion and notify the completion event and cause to the MRFC. The TTS is completed when either of the following has occurred;

- the TTS has been completed successfully or:
- a DTMF digit is detected by the MRFP or:
- the playing TTS is not successful.

6.2.3.3 Stop TTS

On receipt of a trigger to stop TTS, the MRFC shall request the MRFP to stop the TTS.

6.2.3.4 TTS Completed

When a TTS is completed, if the MRFC has requested the MRFP to notify the TTS completion, the MRFP shall notify the TTS completion event and the cause to the MRFC. The cause that the TTS is completed may be the TTS has been completed successfully, or a DTMF digit is detected by the MRFP, or the playing TTS is not successful. Then the MRFC may indicate to the AS that the TTS has been stopped.

6.2.3.5 Message sequence chart

Figure 6.2.3.5.1 shows the message sequence chart example for playing TTS.

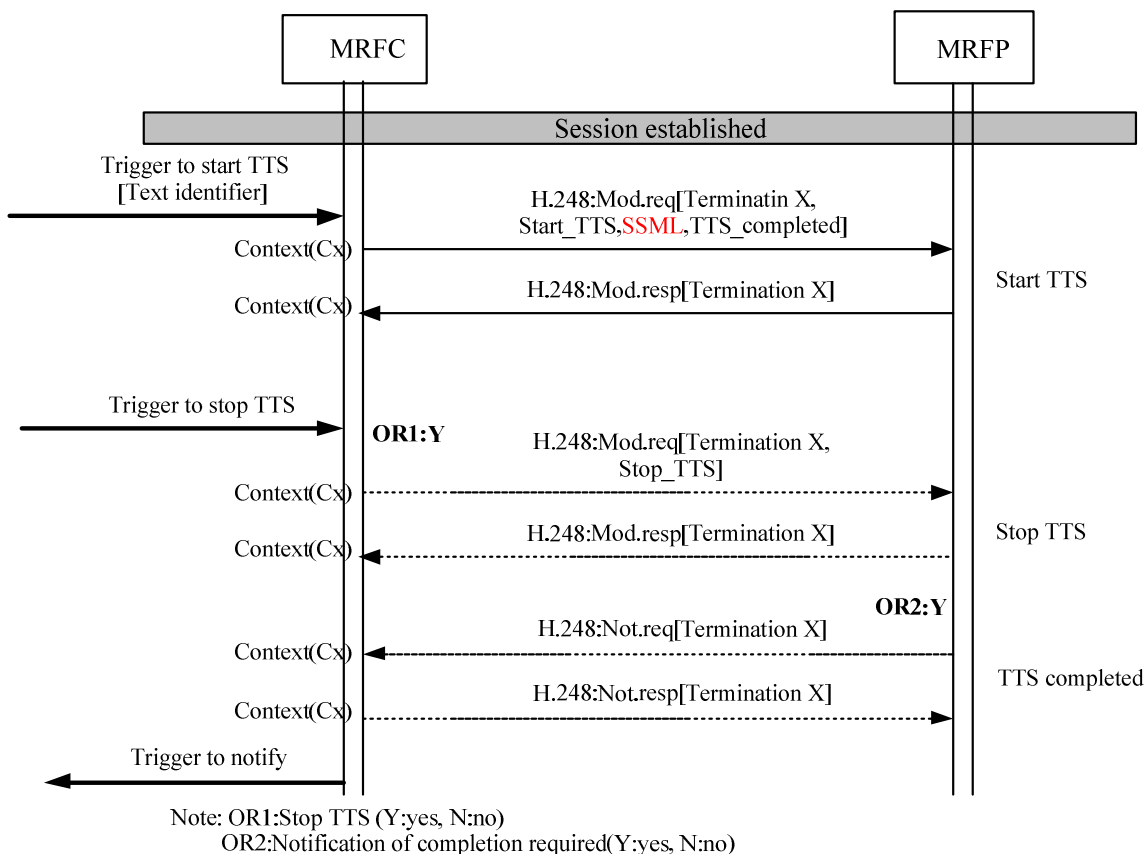

Figure 6.2.3.5.1 Playing TTS (message sequence chart)

6.2.4 Audio Record Procedure

6.2.4.1 General

The following procedure assumes the IMS session has been established and the bearer is through-connected, and the MRFC has received a trigger to record audio, and the MRFP selected for the call has the capabilities to provide audio record.

NOTE: This procedure may also be ordered in combination with the session establishment procedure.

6.2.4.2 Start audio record

After reception of a trigger to record audio, the MRFC should initiate the Start audio record procedure. The MRFC shall request the MRFP to record audio from one or all terminations in a context with the record file URI and record file format. If it is to record one party, only the input stream of the party is recorded. If it is to record all parties, the mixed stream of all parties is recorded.

When recording audio from all terminations in a context (for two-party sessions or a conference) the MRFC may request the MRFP to assign a new termination to record the audio in the context.

If other signals such as playing announcement are requested to be executed on the same termination as the termination to perform the recording the signals shall not override each other, e.g. the recording shall not be interrupted.

The record file URI can be generated by the AS/MRFC or by the MRFP. For the second case, the MRFC shall indicate the MRFP to generate the URI and return the generated URI to the MRFC. The record file format is the 3GPP multimedia file format, defined in the 3GPP TS 26.244[5], and only the audio track is used for the audio recording. The MRFC may indicate the maximum record time to the MRFP. When the maximum record time has elapsed, the MRFP shall stop the audio recording.

The MRFC may request the MRFP to detect the audio recording completion, and notify the completion event and cause to the MRFC. The audio recording is completed when either of the following has occurred;

- the maximum time period of audio recording has elapsed,
- no input is detected,
- DTMF digits are detected by the MRFP where the DTMF key sequence shall stop or cancel the audio recording ,
- the MRFC requests the MRFP to stop the audio recording, or:
- the audio recording is not successful.

6.2.4.3 Stop audio record

After reception of a trigger to stop audio record, the MRFC shall request the MRFP to stop the audio recording. If the audio recording termination is added, the MRFC shall request the MRFP to subtract it.

6.2.4.4 Audio record completed

When an audio recording is completed, if the audio recording is successful, the MRFP shall save the record file to the specified URI. If the audio recording is not successful, the MRFP shall delete the record file. If the MRFC has requested the MRFP to notify the audio recording completion, the MRFP shall notify the audio recording completion event and the cause to the MRFC. The cause of the audio recording completed may be no voice has been input during a specific period, the maximum record time has elapsed, a DTMF digit that represents to finish or cancel the audio recording is detected by the MRFP, or the audio recording is not successful. Then the MRFC may indicate to the AS that the audio record has been stopped.

6.2.4.5 Message sequence chart

Figure 6.2.4.1 shows the message sequence chart example for audio recording.

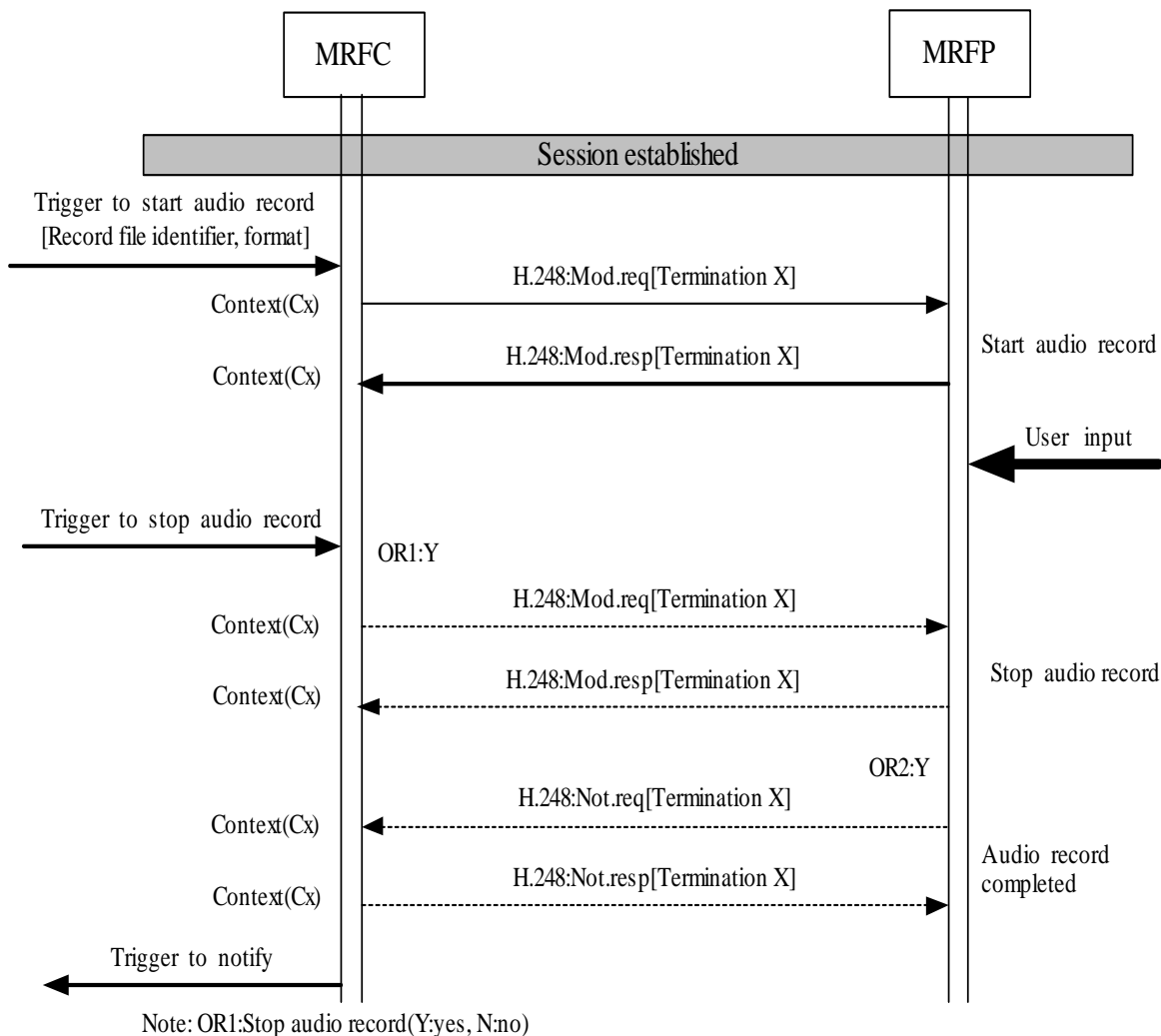

Figure 6.2.4.1 Audio record (message sequence chart)

6.2.5 DTMF Collection Procedure

On receipt of a request to detect DTMF Digits, the MRFC may command the MRFP to report DTMF Digits as defined in the Detect DTMF Procedure.

MRFC shall assign the RTP Payload Type for DTMF Telephony Events. When a DTMF Digit has been detected by the MRFP it shall report it to the MRFC.

When requested to detect DTMF the MRFP shall not forward the reported digit toward another connection.

An example sequence is shown in Figure 6.2.5.1.

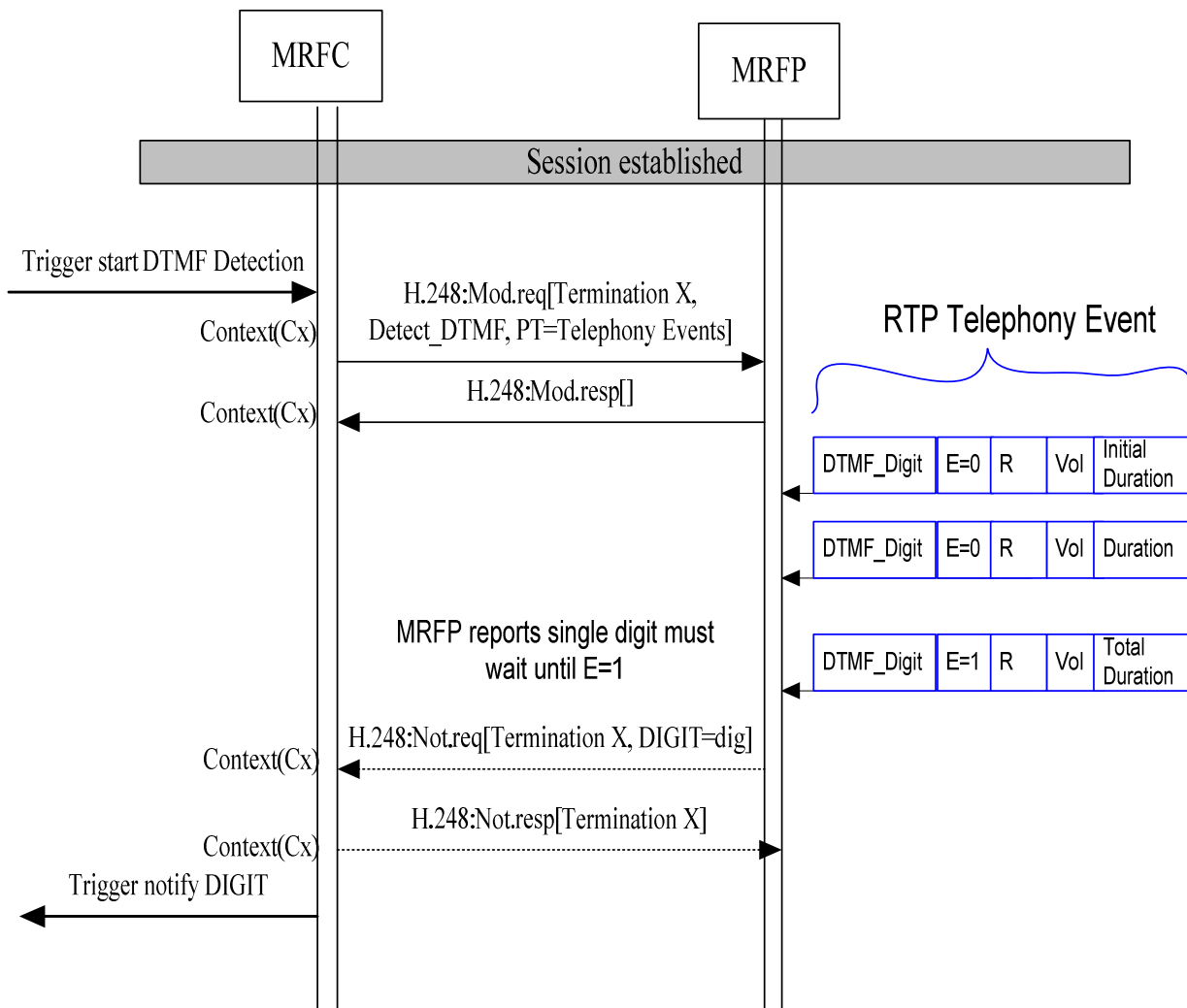

Figure 6.2.5.1 DTMF Telephony Event Detection

DTMF digit detection may be stopped by the MRFC sending the procedure Stop DTMF Detection. The MRFP, once it has acknowledged this request will no longer check for DTMF digits or report them to the MRFC.

6.2.6 Automatic Speech Recognition Procedure

6.2.6.1 General

The following procedure assumes the IMS session has been established and the bearer is through-connected, and the MRFC has received a trigger to play ASR, and the MRFP selected for the call has the capabilities to provide Automatic Speech Recognition.

NOTE: This procedure may also be ordered in combination with the session establishment procedure.

6.2.6.2 Start ASR

If the MRFC receives a request to initiate ASR, the MRFC shall extract the SRGS script or the SRGS URI from the received script.

If the size of the SRGS script is larger than the transport capability of the Mp interface, the MRFC shall terminate ASR procedure and return error.

Otherwise the MRFC initiates the Start ASR procedure; the MRFC shall indicate to the MRFP the SRGS script or the SRGS URI to play ASR to one termination in a context.

The MRFC may indicate to the MRFP the recognition mode: Normal Recognition Mode, Hotword Recognition Mode. If the MRFC indicate the Normal Recognition Mode to the MRFP, the MRFP shall match all of the speech against a recognition grammar and returns a no-match status if the input fails to match or the method times out. If the MRFC indicates the Hot-word Recognition Mode to the MRFP, the MRFP shall look for a match against specific speech grammar and ignores speech that does not match.

The MRFP shall recognize the subscriber's input speech stream according to the SRGS grammar, and output the result as the EMMA format.

If the MRFP does not support an element of the SRGS, the MRFP may ignore the element.

The MRFC may request the MRFP to detect DTMF digit while executing ASR, and may request the MRFP to stop ASR when a DTMF digits is detected. For the latter case, only the ASR result is notified.

The MRFC may request the MRFP to detect the ASR completion and notify the completion event and cause to the MRFC. The ASR is completed when either of the following has occurred;

- the ASR has been completed successfully,
- a DTMF digit is detected by the MRFP,
- the executing of ASR is not successful or
- the recognition time elapses.

6.2.6.3 Stop ASR

On receipt of a trigger to stop ASR, the MRFC shall request the MRFP to stop the ASR.

6.2.6.4 ASR Completed

When an ASR is completed, if the MRFC has requested the MRFP to notify the ASR completion, the MRFP shall notify the ASR result and the cause to the MRFC. The cause of the ASR completed may be that the ASR has been completed successfully, a DTMF digit is detected by the MRFP, or the executing ASR is not successful.

The MRFP shall generate the ASR result as the EMMA format. The EMMA result may include multiple recognition results that are mutually exclusive. Each result may be structured by multiple parts in time sequence with the input time. Each result may include the text token that the value will correspond to tokens as defined by the SRGS grammar. Each result may include the interpretation of application specific markup. Each result may include the confidence score that represents the recognition quality.

If the size of the EMMA script is larger than the transport capability of the Mp interface, the MRFP shall return the MRFC the ASR is not successful.

Then the MRFC may indicate to the AS that the ASR has been stopped and the ASR result.

6.2.6.5 Message sequence chart

Figure 6.2.6.5.1 shows the message sequence chart example for executing ASR.

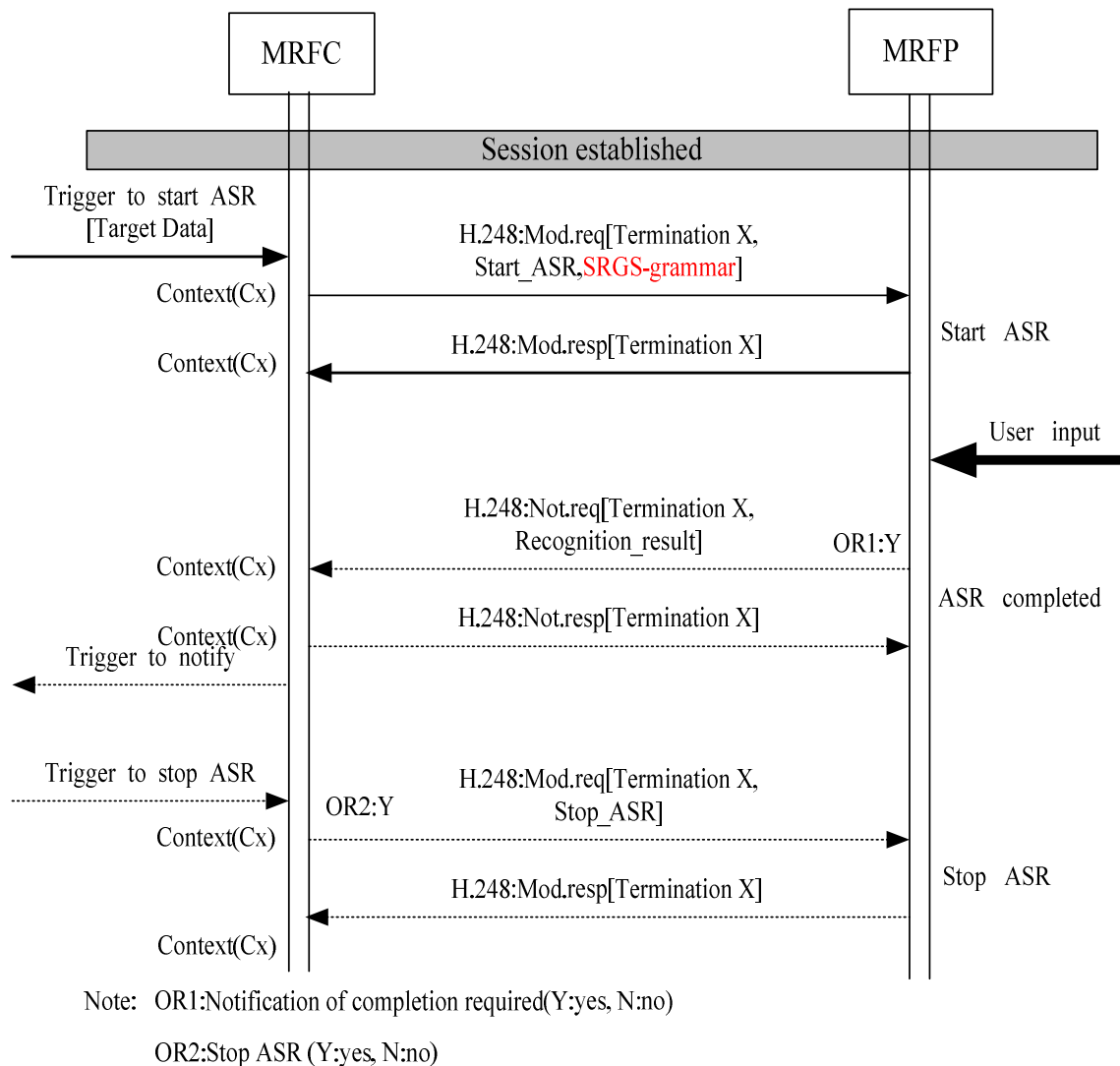

Figure 6.2.6.5.1 ASR (message sequence chart)

6.2.7 Play Multimedia Procedure

6.2.7.1 General

The following procedure assumes the IMS session has been established and the bearer is through-connected, and the MRFC has received a trigger to play multimedia, and the MRFP selected for the call has the capabilities to provide playing multimedia. The clauses 6.2.7.3- 6.2.7.6 specify the procedures to play the synchronized audio and video media stream(s). The clauses 6.2.7.aa- 6.2.7.dd describe the procedures for playing message.

NOTE: This procedure may also be ordered in combination with the session establishment procedure.

6.2.7.2 H.248 context model

The figure 6.2.7.1 shows the H.248 context model for playing multimedia. There may be up to three streams in the termination that is used for playing multimedia, which are any combination of audio, video and messaging media stream(s). The H.248 command can be processed in the termination to play multimedia and detect the playing multimedia completed event.

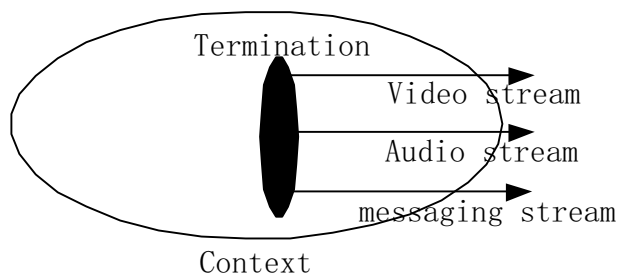

Figure 6.2.7.1: Playing Multimedia H.248 context model

6.2.7.3 Start playing multimedia

After reception of a trigger to play multimedia, the MRFC shall initiate the Start playing multimedia procedure.

If it is to play multimedia to one party, the multimedia shall be played in the external direction of the existing termination.

The MRFC shall indicate to the MRFP the multimedia identifier which may be a single identifier or list of identifiers. The MRFC may use a single identifier or separate identifiers per stream. If it is multiple identifiers, the MRFC shall request the MRFP to play all media in one request. If the identifier references a file, the file format shall be indicated. The multimedia file format is the 3GPP multimedia file format in current version. If the multimedia file provides different audio or video codec than the session codec, the MRFP shall transcode the input codec into the session codec.

The MRFC may request the MRFP to play the multimedia in a loop continuously until requested to be stopped or in a loop with a fixed number of times. For the latter case, if the fixed number of times is exhausted, the playing multimedia is completed successfully.

The MRFC may request the MRFP to detect DTMF digit while playing multimedia, and may request the MRFP to stop playing multimedia when DTMF digits is detected. For the latter case, only the multimedia completion is notified.

The MRFC may request the MRFP to detect the multimedia completion, and notify the completion event and cause to the MRFC. The play multimedia is completed when either of the following has occurred;

- the multimedia has been completed successfully,
- a DTMF digit is detected by the MRFP or:
- the playing multimedia is not successful.

6.2.7.4 Stop playing multimedia

After reception of a trigger to stop playing multimedia, the MRFC shall request the MRFP to stop playing multimedia.

6.2.7.5 Playing multimedia completed

When a playing multimedia is completed, if the MRFC has requested the MRFP to notify the playing multimedia completion, the MRFP shall notify the multimedia completion event and the cause to the MRFC. The cause of the playing multimedia completion may be the playing multimedia has been completed successfully, or a DTMF digit is detected by the MRFP, or the playing multimedia is not successful. Then the MRFC may indicate to the AS that the playing multimedia has been stopped.

6.2.7.6 Message sequence chart

Figure 6.2.7.2 shows the message sequence chart example for playing multimedia.

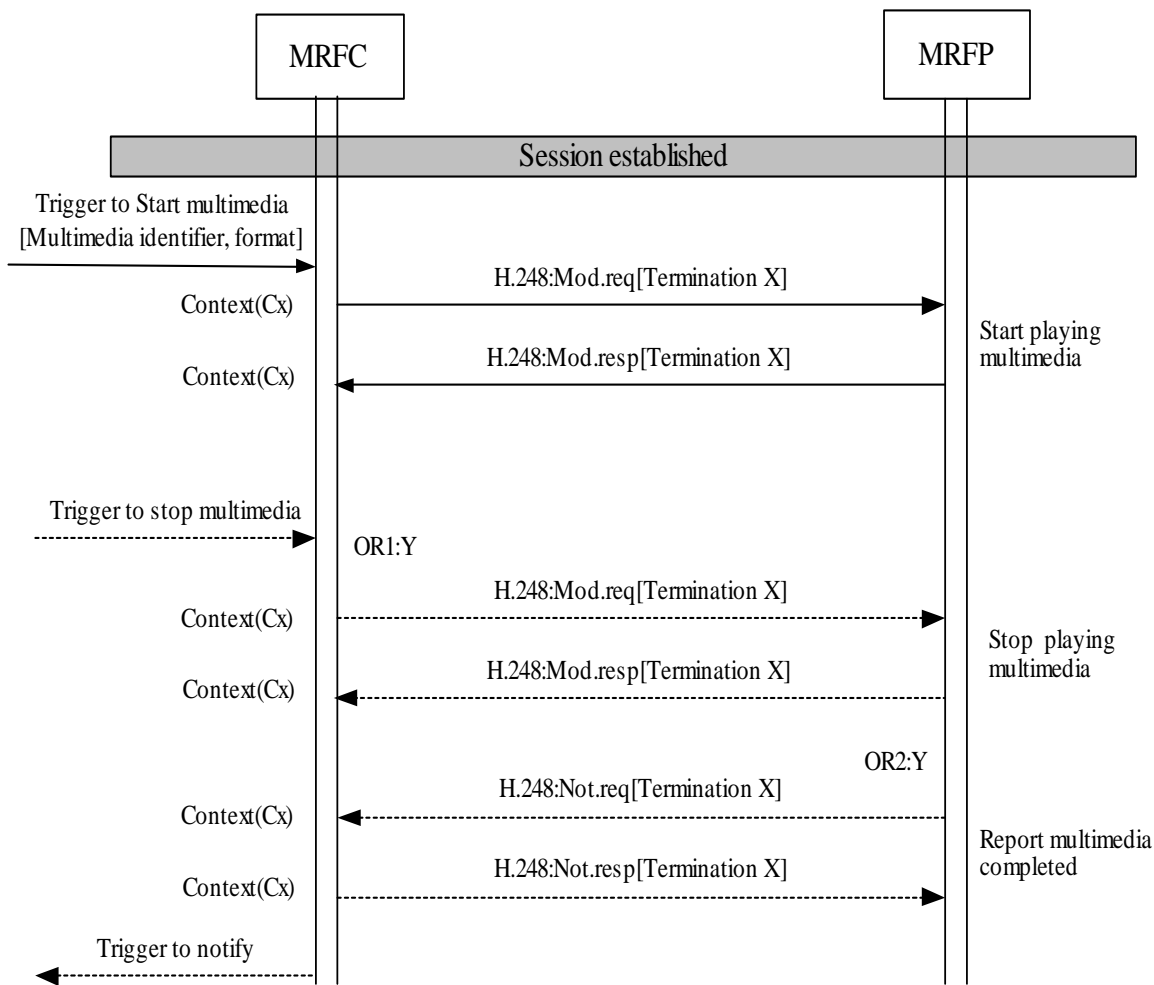

Note: OR1:Stop playing multimedia (Y:yes, N:no)

OR2:Notification of completion required(Y:yes, N:no)

Figure 6.2.7.2 Play multimedia (message sequence chart)

6.2.7.7 Start playing message

After reception of a trigger to play message, the MRFC shall initiate the Start playing message procedure.

If it is to play message to one party, the message shall be played in the external direction of the existing termination.

The MRFC shall indicate to the MRFP the message identifier which may be a single identifier or list of identifiers. The MRFC may use a single identifier or separate identifiers per stream. If it is message identifiers, the MRFC shall request the MRFP to play all media in one request. If the message references a file, the file message file formats shall comply with the file formats used inside MMS(Multimedia Messaging Service) as specified in the 3GPP TS 26.140 [22] in current version.

The MRFC may request the MRFP to notify the completion event and cause to the MRFC. The play message is completed when either of the following has occurred;

- the message has been completed successfully, or:
- the playing message is not successful.

6.2.7.8 Stop playing message

After reception of a trigger to stop playing message, the MRFC shall request the MRFP to stop playing message.

6.2.7.9 Playing message completed

When a playing message is completed, if the MRFC has requested the MRFP to notify the playing message completion, the MRFP shall notify the message completion event and the cause to the MRFC. The cause of the playing message completion may be the playing message has been completed successfully, or the playing message is not successful. Then the MRFC may indicate to the AS that the playing message has been stopped.

6.2.7.10 Message sequence chart

Figure 6.2.7.3 shows the message sequence chart example for playing message.

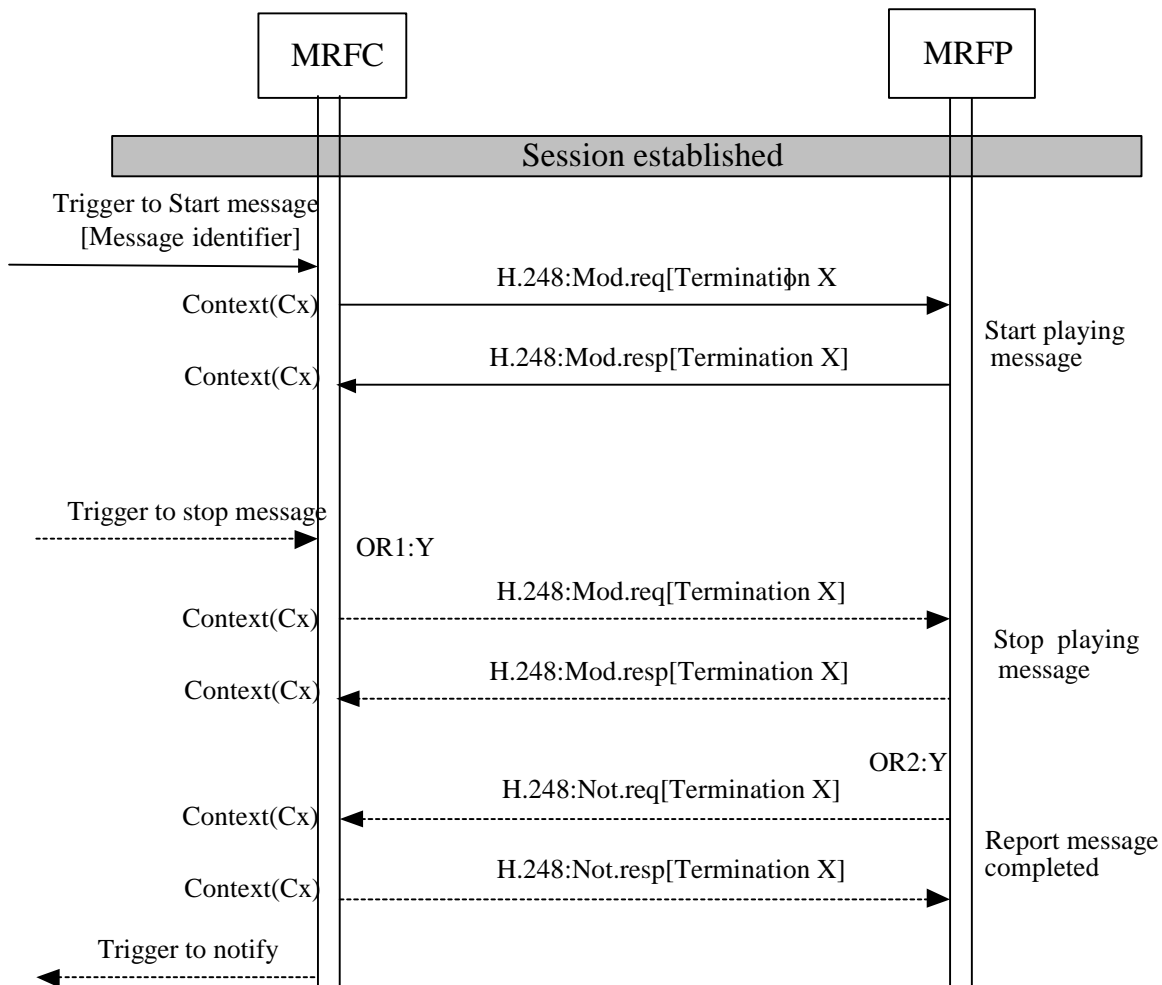

Note: OR1:Stop playing message (Y:yes, N:no)

OR2:Notification of completion required(Y:yes, N:no)

Figure 6.2.7.3 Play message (message sequence chart)

6.2.8 Multimedia Record Procedure

6.2.8.1 General

The following procedure assumes the IMS session has already been established and the bearer is through-connected, and the MRFC has received a trigger to record multimedia, and the MRFP selected for the call has the capabilities to provide multimedia record. The clauses 6.2.8.3- 6.2.8.6 specify the procedures to record the synchronized audio and video media stream(s). The clauses 6.2.8.aa- 6.2.8.dd describe the procedures for message record.

NOTE: This procedure may also be ordered in combination with the session establishment procedure.

6.2.8.2 H.248 context model

The figure 6.2.8.1 shows the H.248 context model for the multimedia record. The termination used for recording may have up to three streams, which are any combination of audio, video and messaging media stream(s). The H.248 command can be processed in the termination to record multimedia and detect the record multimedia completed event.

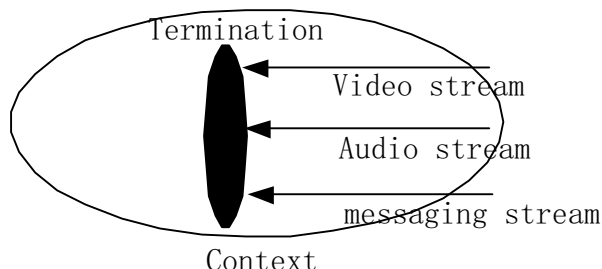

Figure 6.2.8.1: Multimedia Record Context Model

6.2.8.3 Start multimedia Record

After reception of a trigger to record multimedia, the MRFC shall initiate the Start multimedia record procedure.

If it is to record one party, only the input stream of the party is recorded. If it is to record all parties, the mixed stream of all parties is recorded.

When recording multimedia from all terminations in a context (for two-party sessions or a conference) the MRFC may request the MRFP to assign a new termination to record the multimedia in the context.

If other signals such as playing announcement are requested to be executed on the same termination as the termination to perform the recording the signals shall not override each other, e.g. the recording shall not be interrupted.

The MRFC shall indicate the record file URI and the record file format to the MRFP. The record file URI can be generated by the AS/MRFC or by the MRFP. For the second case, the MRFC shall indicate the MRFP to generate the URI and return the generated URI to the MRFC. The record file format is the 3GPP multimedia file format, defined in the 3GPP TS 26.244[5]. The MRFC may indicate the maximum record time to the MRFP, when this time has elapsed, the MRFP shall stop the multimedia recording.

The MRFC may request the MRFP to detect the multimedia recording completion, and notify the completion event and cause to the MRFC. The multimedia recording is completed when either of the following occurs;

- the maximum time period of multimedia recording has elapsed,
- a DTMF digit is detected by the MRFP where the DTMF key sequence shall stop or cancel the multimedia recording,
- DTMF digits are detected by the MRFP where the DTMF key sequence shall stop or cancel the audio recording,
- the MRFC requests the MRFP to stop the audio recording, or
- the media recording is not successful.

6.2.8.4 Stop multimedia record

After reception of a trigger to stop multimedia record, the MRFC shall request the MRFP to stop the multimedia recording. If the multimedia recording termination is added, the MRFC shall request the MRFP to subtract it.

6.2.8.5 Multimedia record Completed

When a multimedia recording is completed, if the multimedia recording is successful, the MRFP shall save the recorded content to the specified URI. If the multimedia recording is not successful, the MRFP shall discard the recorded content. If the MRFC has requested the MRFP to notify the multimedia recording completion, the MRFP shall notify the multimedia recording completion event to the MRFC. The cause of the multimedia recording completion may be that

the maximum record time has elapsed, a DTMF digit that represents to finish or cancel the multimedia recording is detected by the MRFP, or the multimedia recording is not successful. Then the MRFC may indicate to the AS that the multimedia record has been stopped.

6.2.8.6 Message sequence chart

Figure 6.2.8.2 shows the message sequence chart example for multimedia record.

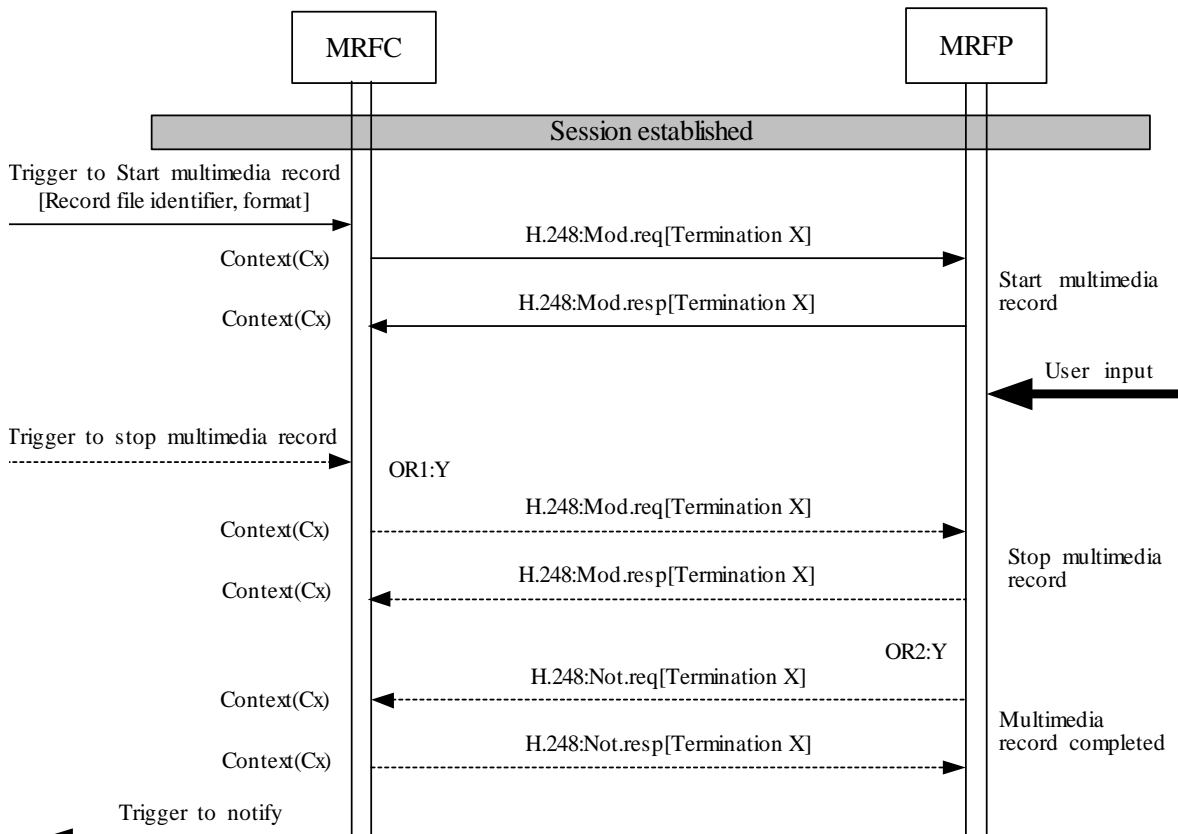

Note: OR1:Stop multimedia record(Y:yes, N:no)

OR2:Notification of completion required(Y:yes, N:no)

Figure 6.2.8.2 Multimedia record (message sequence chart)

6.2.8.7 Start Message Record

After reception of a trigger to record message, the MRFC shall initiate the Start message record procedure.

If it is to record one party, only the input stream of the party is recorded. If it is to record all parties, the message streams of all parties are recorded.

When recording message from all terminations in a context (for two-party sessions or a conference) the MRFC may request the MRFP to assign a new termination to record the message in the context.

If other signals such as playing announcement are requested to be executed on the same termination as the termination to perform the recording the signals shall not override each other, e.g. the recording shall not be interrupted.

The MRFC may indicate the record file URI and the record file format to the MRFP. The record file URI can be generated by the AS/MRFC or by the MRFP. For the second case, the MRFC shall indicate the MRFP to generate the URI and return the generated URI to the MRFC. The record file formats shall comply with the file formats used inside MMS(Multimedia Messaging Service) as specified in the 3GPP TS 26.140 [22] in the current version. The MRFC may indicate the maximum record time to the MRFP, when this time has elapsed, the MRFP shall stop the message recording.

The MRFC may request the MRFP to detect the message recording completion, and notify the completion event and cause to the MRFC. The message recording is completed when either of the following occurs;

- the maximum time period of message recording has elapsed,
- the MRFC requests the MRFP to stop the recording, or
- the media recording is not successful.

6.2.8.8 Stop Message record

After reception of a trigger to stop message record, the MRFC shall request the MRFP to stop the message recording. If the message recording termination is added, the MRFC shall request the MRFP to subtract it.

6.2.8.9 Message record Completed

When a message recording is completed, if the message recording is successful, the MRFP shall save the recorded content to the specified URI. If the message recording is not successful, the MRFP shall discard the recorded content. If the MRFC has requested the MRFP to notify the message recording completion, the MRFP shall notify the message recording completion event to the MRFC. The cause of the message recording completion may be that the maximum record time has elapsed, or the message recording is not successful. Then the MRFC may indicate to the AS that the message record has been stopped.

6.2.8.10 Message sequence chart

Figure 6.2.8.10.1 shows the message sequence chart example for message record.

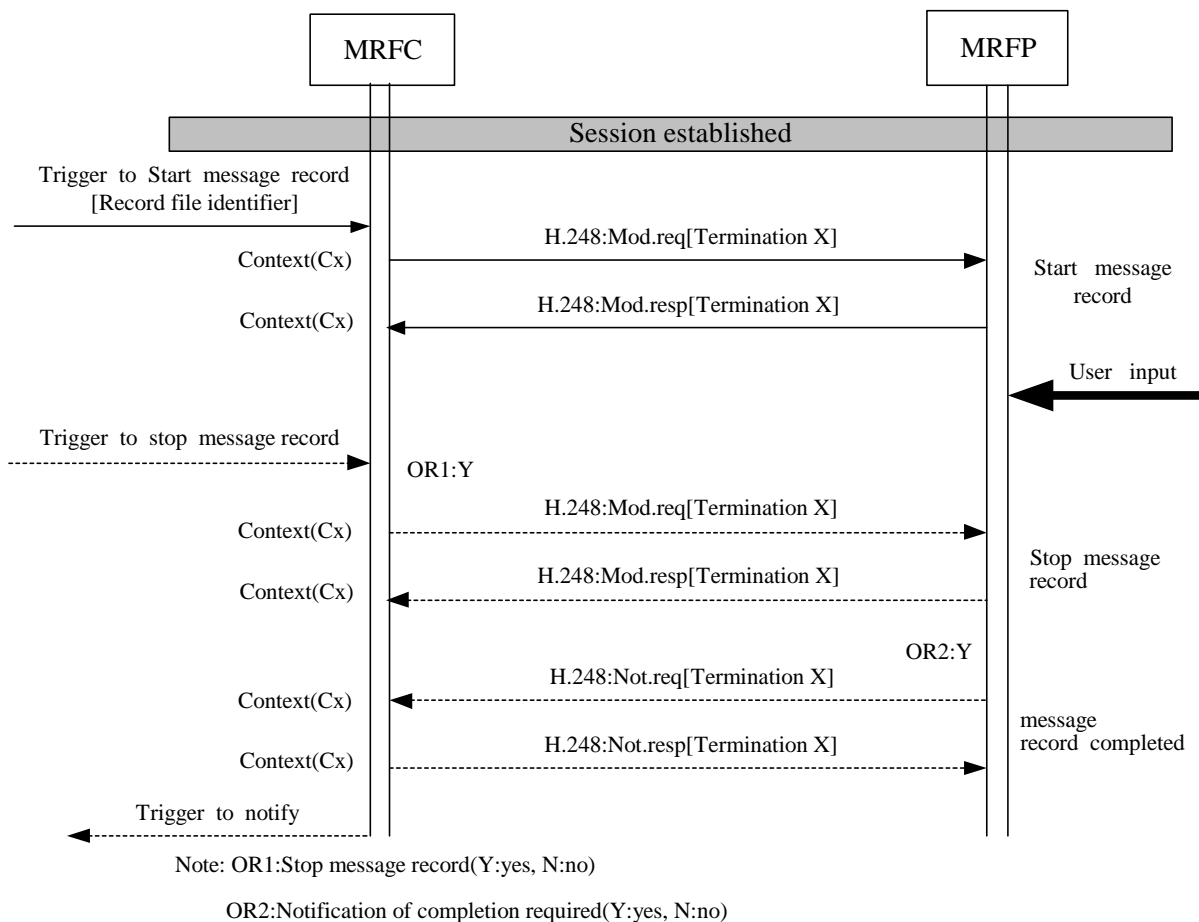

Figure 6.2.8.10.1 Message record (message sequence chart)

6.2.9 Audio Conference Procedure

6.2.9.1 Context Model

A conference consists of one context with terminations representing each user. The MRFP shall consider the context to represent an ad-hoc conference when three or more terminations have been through-connected.

6.2.9.2 Ad-hoc Conferences

6.2.9.2.1 General

An ad-hoc conference starts without any prior booking or reservation when a user initiates the conference, for further definition of ad-hoc conference, see 3GPP TS 24.147 [4]. Further participants can then be added to the conference without any prior reservation of resources, through either a method of "dial-out" where the conference calls the participant, or by a "dial-in" scenario where the end user calls the conference.

6.2.9.2.2 Create Ad-hoc Audio Conference Procedure

The MRFC receives a trigger to create an ad-hoc conference. The MRFC then initiates the "Reserve and Configure IMS Resources" procedure as specified in clause 8.20.

The MRFC:

Requests a new context and a new bearer termination including the Remote Connection Address.

The MRFP:

Creates a new context

Adds a new termination to the context and returns the Local Connection Address.

The MRFC:

Notifies the new user about the Local Connection Address.

Figure 6.2.9.1 shows the message sequence chart example for creating conference procedure.

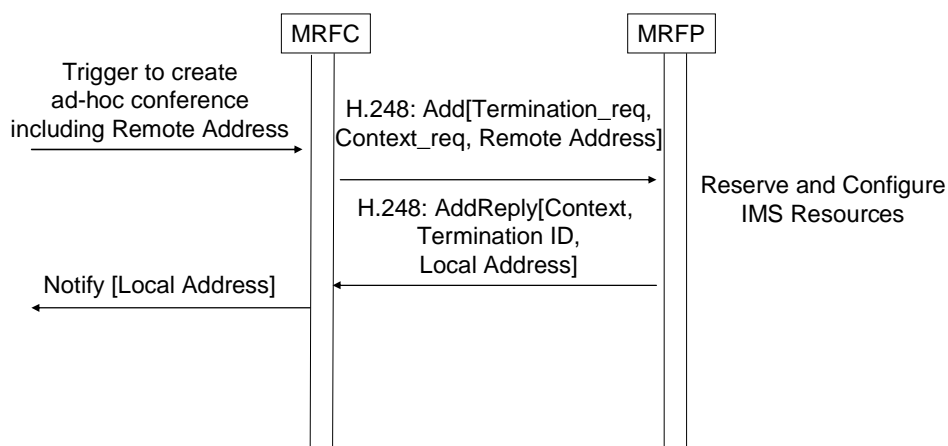

Figure 6.2.9.1 Create Ad-hoc conference

6.2.9.2.3 Closure of Audio Conference Procedure

The MRFP will in accordance with the general rules of H.248.1 delete the context when the last termination has been subtracted from the context.

6.2.9.2.4 Add Subsequent User to Conference; Dial-out

The MRFC receives a trigger to add a new bearer termination. The trigger does not contain connection address nor resources that the new participant can use. The MRFC adds a new bearer termination by initiating the "Reserve IMS Resources" procedure as specified in clause 8.21.

The MRFC:

Requests a bearer termination to be added to the existing context.

The MRFP:

Adds a bearer termination to the existing context and notifies the MRFC about its reserved resources and connection address.

The MRFC:

Sends a notification to the new user about the MRFP's resources and connection address.

The MRFC will then receive a trigger containing the new user's address and resources. The MRFC initiates the "Configure IMS resources" procedure as specified in clause 8.22.

The MRFC:

Requests that remote address and resources be configured to the termination

The MRFP:

Modifies the termination using the received data and confirms the action

The MRFC:

Notifies the new participant about the result

Figure 6.2.9.2 shows the message sequence chart example for dial-out procedure.

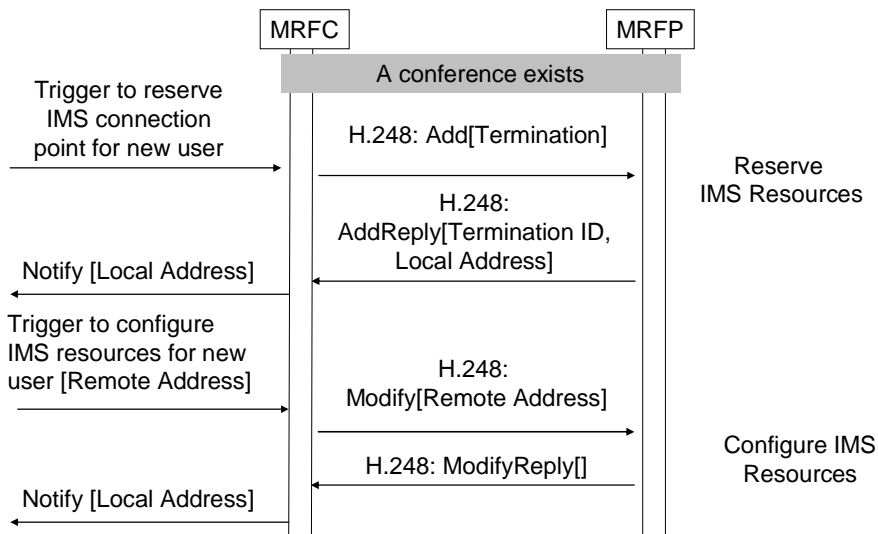

Figure 6.2.9.2 Procedure to add user in Dial-out scenario

6.2.9.2.5 Add subsequent user to conference; Dial-in

Precondition is that a conference exists. The MRFC receives a trigger to add a new user including Remote Connection Address. The MRFC then initiates the "Reserve and Configure IMS Resources" procedure as specified in clause 8.20.

The MRFC:

Requests a new bearer termination, including the Remote Connection Address, to be added to the existing context.

The MRFP:

Adds a new termination to the existing context and returns the Local Connection Address.

The MRFC notifies the new user about the Local Connection Address.

Figure 6.2.9.3 shows the message sequence chart example for dial-in procedure.

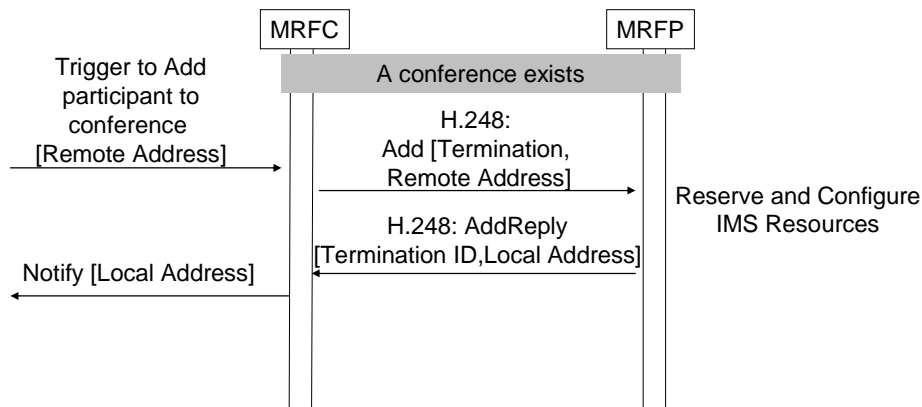

Figure 6.2.9.3 Procedure to add user in Dial-in scenario

6.2.9.2.6 Remove Conference Participant Procedure

When the MRFC receives a trigger that a user has left the conference, it initiates the "Release IMS termination" procedure as specified in clause 8.23.

The MRFC:

Requests that the termination is released.

The MRFP:

Releases the termination and informs the MRFC about the result.

Figure 6.2.9.4 shows the message sequence chart example for removing conference participant procedure.

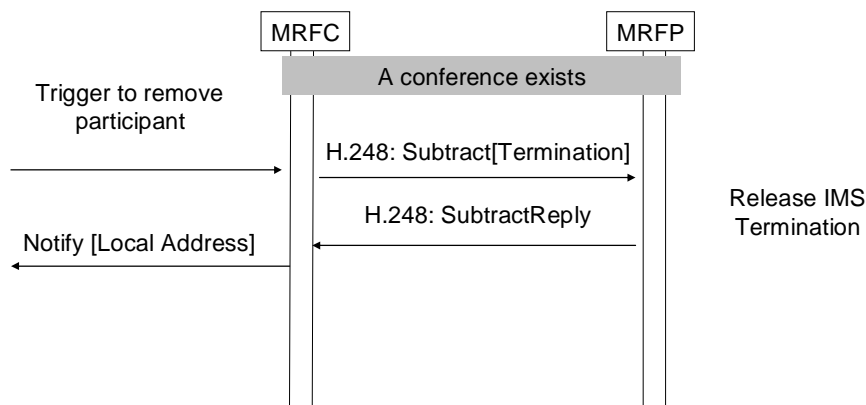

Figure 6.2.9.4 Procedure to remove conference participant

6.2.10 Multimedia Conference Procedures

6.2.10.1 Context Model

A conference consists of one context with terminations representing connections to the participants. Each termination shall support up to three streams, one for audio, one for messaging and one for video. The MRFP shall consider the context to represent an ad-hoc conference when three or more terminations have been through-connected.

It is possible for a user supporting only one media, represented by one stream, to join a conference. The user will then only participate in the part of the conference that is using the supported stream.

6.2.10.2 Ad-hoc Conferences

6.2.10.2.1 General

An ad-hoc conference starts without any prior booking or reservation when a user initiates the conference, for further definition of ad-hoc conference, see 3GPP TS 24.147 [4]. Further participants can then be added to the conference without any prior reservation of resources, through either a method of "dial-out" where the conference calls the participant, or by a "dial-in" scenario where the end user calls the conference.

6.2.10.2.2 Create Ad-hoc Multimedia Conference Procedure

The MRFC receives a trigger to create an ad-hoc conference. The MRFC then initiates the "Reserve and Configure IMS Resources" procedure as specified in clause 8.20, where the connection address and resources shall have multiple values for speech, messaging and video.

The MRFC:

Requests a new context and a new bearer termination including the Remote Connection Addresses.

The MRFP:

Creates a new context

Adds a new termination to the context and returns the Local Connection Address.

The MRFC:

Notifies the new user about the Local Connection Address.

Figure 6.2.10.1 shows the message sequence chart example for creating multimedia conference procedure.

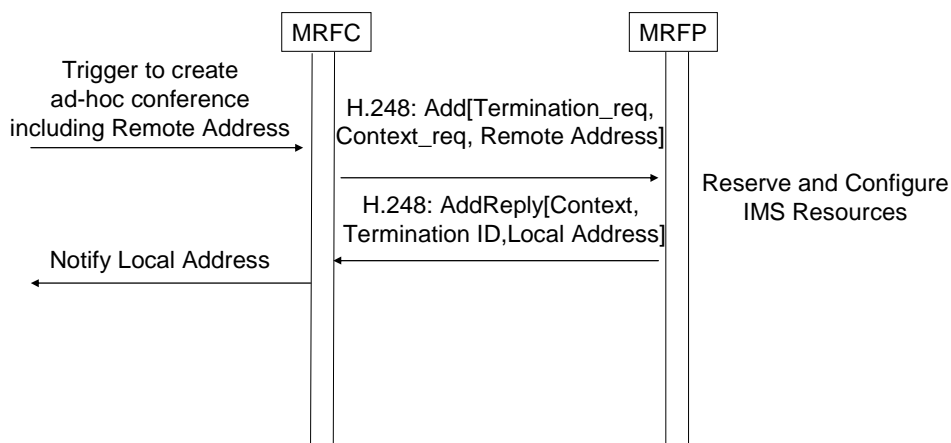

Figure 6.2.10.1 Create Ad-hoc conference

6.2.10.2.3 Closure of Multimedia Conference Procedure

The MRFP will in accordance with the general rules of H.248.1 delete the context when the last termination has been subtracted from the context..

6.2.10.2.4 Add Subsequent User to Conference; Dial-out

Precondition for this procedure is that a conference exists. The MRFC receives a trigger to add a new bearer termination. The trigger does not contain connection address nor resources that the new participant can use. The MRFC adds a new bearer termination by initiating the "Reserve IMS Resources" procedure as specified in clause 8.21 where the connection address and resources may have multiple values for speech, messaging and video.

The MRFC:

Requests a bearer termination to be added to the existing context.

The MRFP:

Adds a bearer termination to the existing context and notifies the MRFC about its reserved resources and connection address.

The MRFC:

Sends a notification to the new user about the MRFP's resources and connection address.

The MRFC will then receive a trigger containing the new user's address and resources. The MRFC initiates the "Configure IMS resources" procedure as specified in clause 8.22 where the connection address and resources may have multiple values for speech, messaging and video.

The MRFC:

Requests that remote address and resources be configured to the termination

The MRFP:

Modifies the termination using the received data and confirms the action

The MRFC:

Notifies the new participant about the result

Figure 6.2.10.2 shows the message sequence chart example for dial-out procedure of multimedia conference.

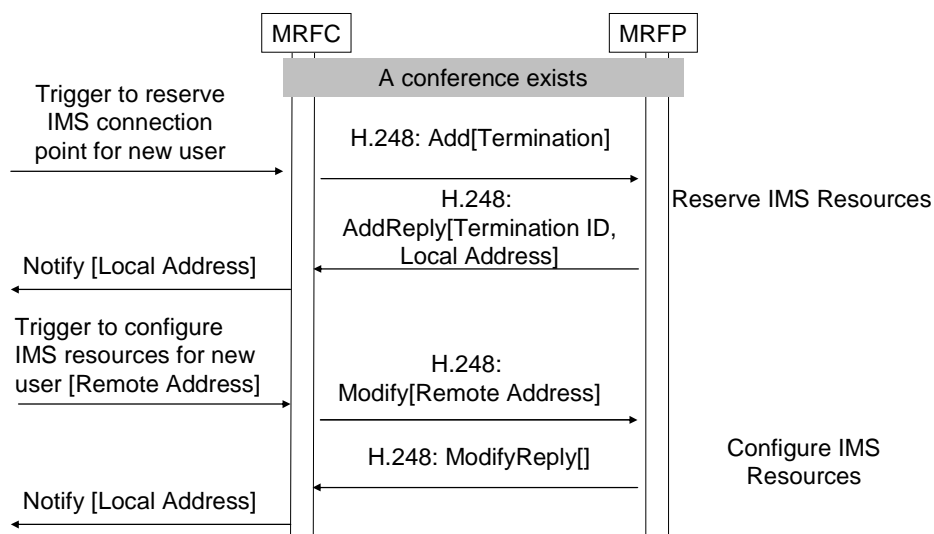

Figure 6.2.10.2 Procedure to add user in Dial-out scenario

6.2.10.2.5 Add subsequent user to conference; Dial-in

Precondition is that a conference exists. The MRFC receives a trigger to add a new user including Remote Connection Address. The MRFC then initiates the "Reserve and Configure IMS Resources" procedure as specified in clause 8.20 where the connection address and resources may have multiple values for speech, messaging and video.

The MRFC:

Requests a new bearer termination, including the Remote Connection Address, to be added to the existing context.

The MRFP:

Adds a new termination to the existing context and returns the Local Connection Address.

The MRFC notifies the new user about the Local Connection Address.

Figure 6.2.10.3 shows the message sequence chart example for dial-in procedure of multimedia conference.

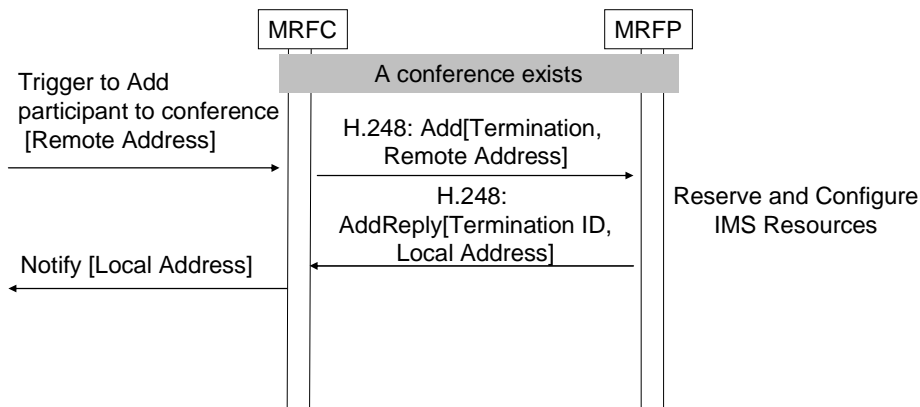

Figure 6.2.10.3 Procedure to add user in Dial-in scenario

6.2.10.2.6 Remove Conference Participant Procedure

When the MRFC receives a trigger that a user has left the conference, it initiates the "Release IMS termination" procedure as specified in clause 8.23.

The MRFC:

Requests that the termination is released.

The MRFP:

Releases the termination and informs the MRFC about the result.

Figure 6.2.10.4 shows the message sequence chart example for removing multimedia conference participant procedure.

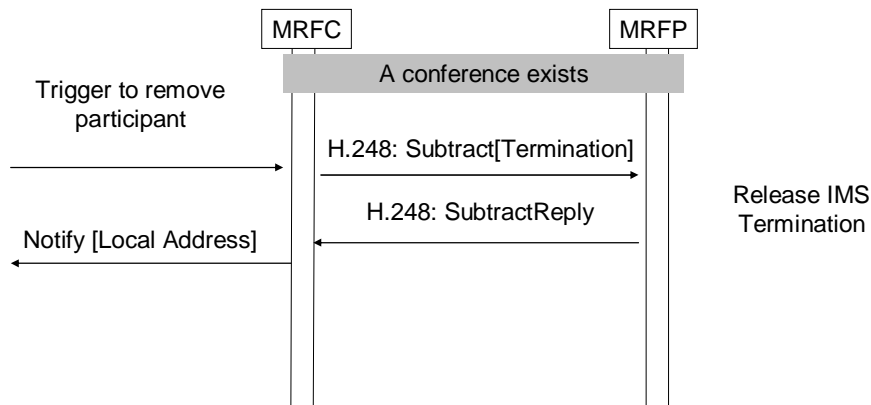

Figure 6.2.10.4 Procedure to remove conference participant

6.2.10.2.7 Create Ad-hoc Multi-stream Multiparty Conference Procedure

6.2.10.2.7.1 Context Model

Figure 6.2.10.2.7.1.1 shows an example of H.248 Context model for a multi-stream multiparty conference when the MRFC and the MRFP support the MMCHM feature and the floor control server functionality is embedded in the MRFP. Four users (A, B, C and D) participate in a conference and each user supports simulcast sending of a main video (one RTP video stream in high resolution and the other RTP video stream in low resolution), sending and receiving of a screenshare video, and a floor control using BFCP over TCP. In addition, the user A and the user D support receiving of one thumbnail video, and the user B and the user C support receiving of two thumbnail videos. The users A, B and C support simulcast sending of two audio RTP streams which are encoded using different codecs (e.g. one RTP audio stream is AMR-WB encoded and the other EVS encoded).

A conference consists of one context with terminations representing connections to the users. Each termination within the context supports: one audio media stream (S1), one video media stream for main video (S2), one video media stream for screenshare video (S3), one or more video media streams for thumbnail videos (S4 and S5), and one media stream for floor control protocol signalling (S6).

Video media streams S2 are configured with simulcast property and supports 3 simulcast RTP video streams: two simulcast RTP video streams (SC1 and SC3) with "recv" property and one RTP video stream (SC2) with "send" property towards the users. Video media streams S3 for screenshare video are configured with "sendrecv" property. Video media streams S4 and S5 for thumbnail videos are configured with "sendonly" property towards the users. In addition, video media streams S2, S3, S4 and S5 are configured with "RTP-level pause and resume" property.

In the example shown in figure 6.2.10.2.7.1.1 audio media streams S1 on terminations T2 and T3 are configured with:

- simulcast property and supports 3 simulcast RTP audio streams: two simulcast RTP audio streams (SC1 and SC3) with "recv" property and one RTP audio stream (SC2) with "send" property towards the users; and
- "RTP-level pause and resume" property.

Media stream S6 for floor control protocol signalling (BFCP over TCP) is configured with two separate floors: floor FL1 is used to control the audio and the main video (and thus associated with media streams S1 and S2) and floor FL2 is used to control the screenshare video (and thus associated with media stream S3).

The MMCMH interworking function (IWF) depicted in the context C1 symbolizes that the MRFP interworks media streams in that context according to the MMCMH policies defined in clause 5.11.3.5.

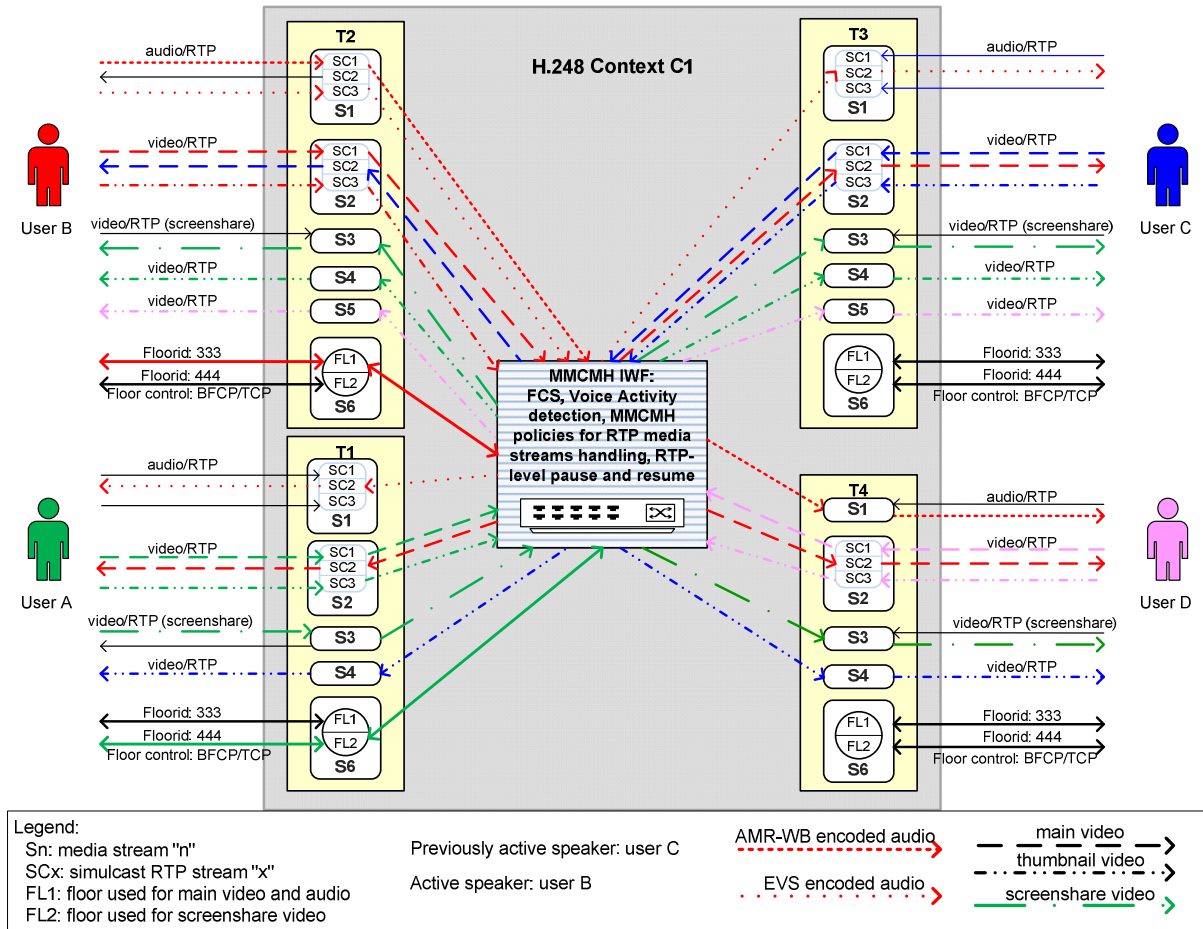

Figure 6.2.10.2.7.1.1: H.248 Context model for Multi-stream multiparty conference

6.2.10.2.7.2 MMCMH conference establishment procedure using "dial-in" method

The signalling flow shown in figures 6.2.10.2.7.2.1 and 6.2.10.2.7.2.2 gives an example for a multi-stream multiparty conference establishment ("dial-in" conference procedure) when "simulcast" and "RTP-level pause and resume" signalling for media endpoints are supported by the MRFC and the MRFP.

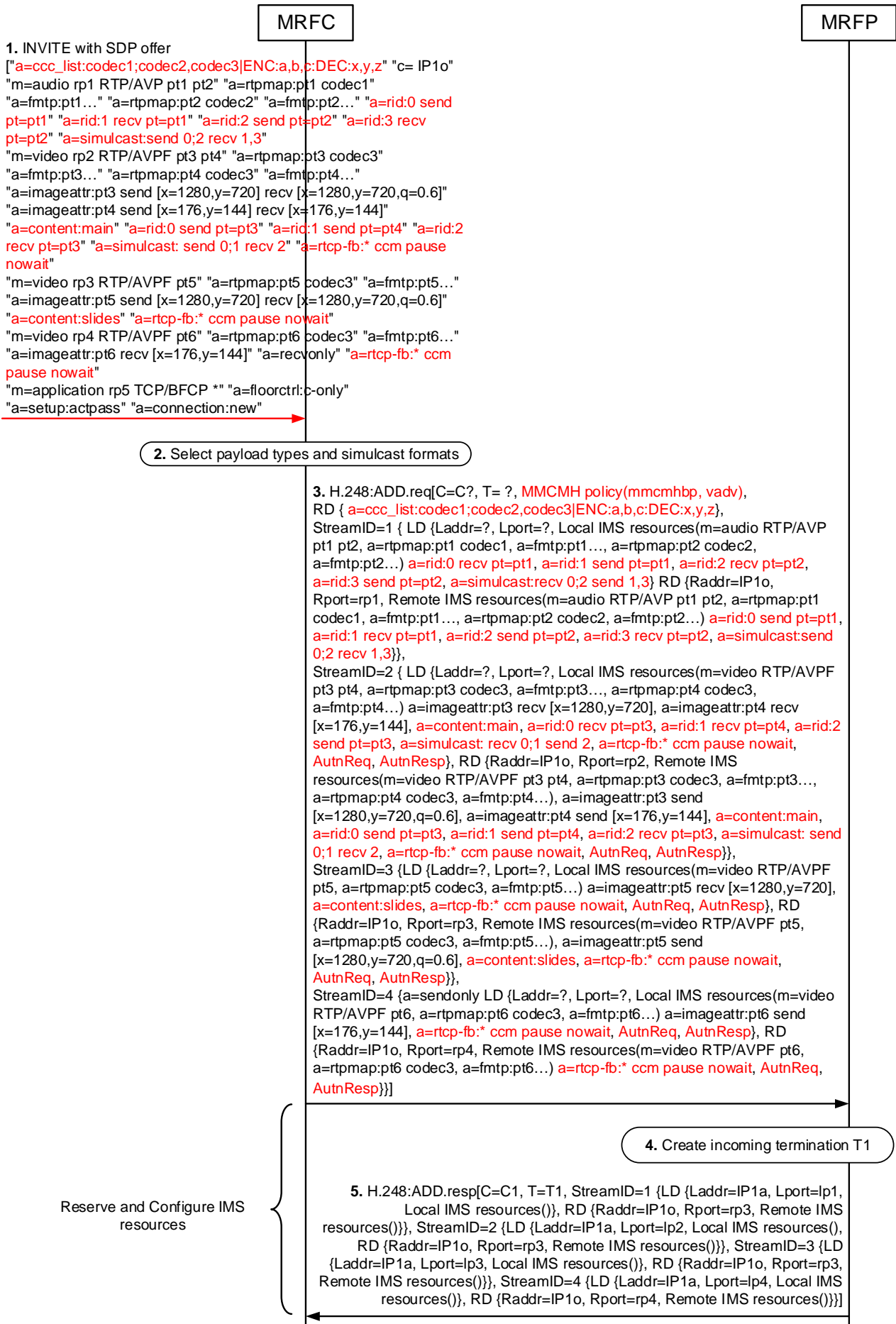

Figure 6.2.10.2.7.2.1: Multi-stream multiparty conference establishment ("dial-in" procedure) with support of "simulcast" and "RTP-level pause and resume"

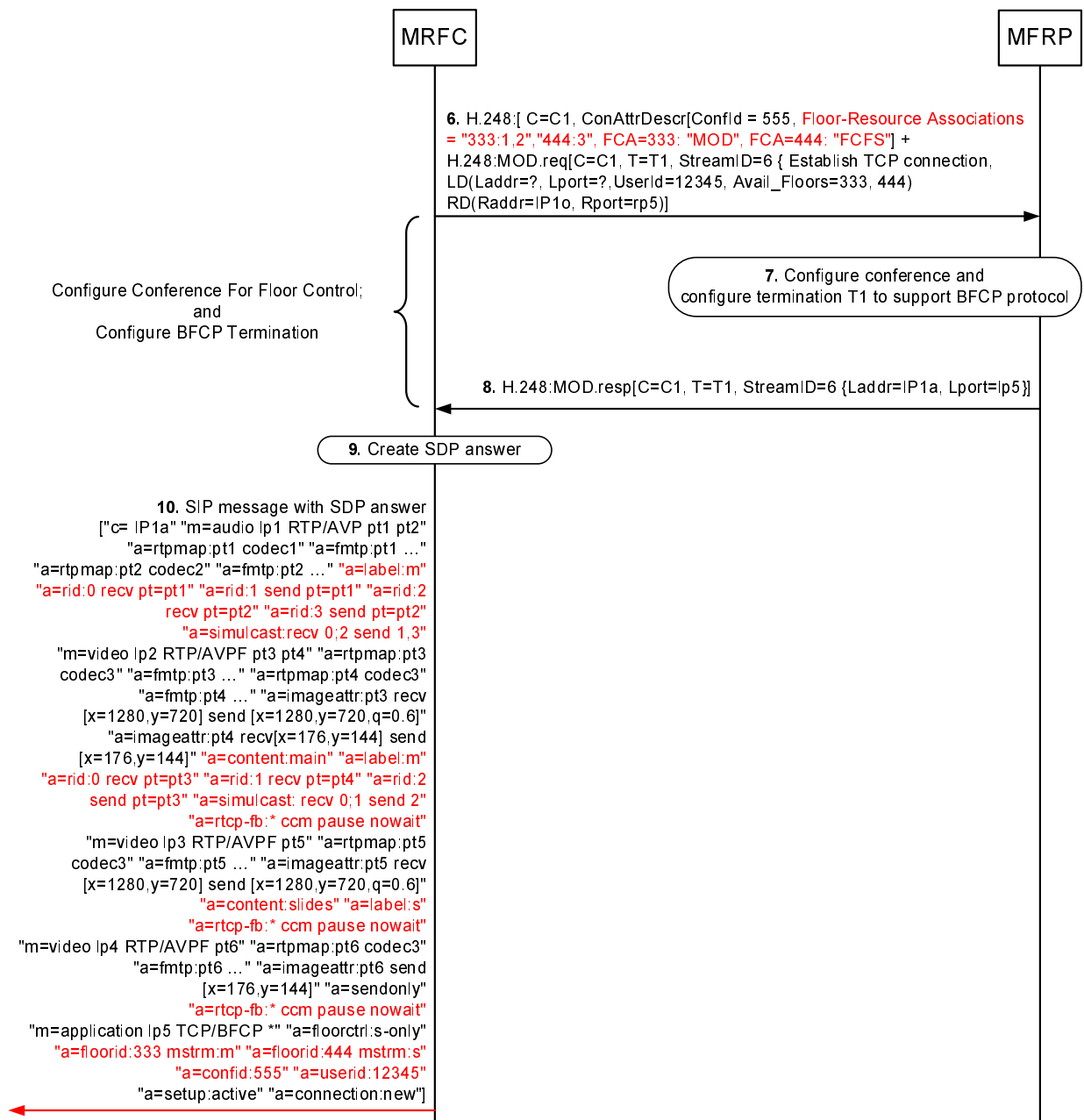

Figure 6.2.10.2.7.2.2: Multi-stream multiparty conference establishment ("dial-in" procedure) with support of "simulcast" and "RTP-level pause and resume" (message sequence chart continue)

This procedure is identical to that of clause 6.2.10.2.2 apart from the MRFC provides simulcast formats to the MRFP according to 3GPP TS 26.114 [23] annex S, IETF RFC 8853 [57] and IETF RFC 8851 [58], and "RTP-level pause and resume" signalling according to IETF RFC 7728 [62] for multi-stream multiparty conference media handling.

The procedure in the figures 6.2.10.2.7.2.1 and 6.2.10.2.7.2.2 is described step-by-step with an emphasis on the additional aspects for the MRFC and the MRFP of the multi-stream multiparty conference media handling.

1. The MRFC receives a trigger to create an ad-hoc MMCMH conference from the end user (e.g. user A from figure 6.2.10.2.7.1.1). The received SDP offer includes:
 - a) an audio "m=" line with the "a=simulcast" attribute and the corresponding "a=rid" lines with a "pt" parameter defining the simulcast stream identification (in this example simulcast sending of two audio RTP streams

- which are encoded using codec1 and codec2 [rid-id values 0 and 2], and reception of one RTP audio stream which may be decoded using codec1 or codec2 [rid-id values 1 or 3]);
- b) a video "m=" line with the "a=content:main" attribute, the "a=simulcast" attribute and the corresponding "a=rid" lines with a "pt" parameter defining the simulcast stream identification (in this example simulcast sending of RTP video stream in high resolution [rid-id value 0] and in low resolution [rid-id value 1], and reception of RTP video stream [rid-id value 2] in high resolution, the "a=rtcp-fb" line(s) with a "CCM" parameter, a "pause" CCM parameter and a "nowait" pause attribute;
 - c) a video "m=" line with the "a=content:slides" attribute indicating sending and receiving of a screenshare video;
 - d) a video "m=" line with the "a=imageattr" attribute indicating receiving of RTP video stream in low resolution;
 - e) a BFCP "m=" line indicating support of a floor control client role; and
 - f) a session level "a=ccc_list" attribute (defined in 3GPP TS 26.114 [23], clause S.5.7.2) with the concurrent codec capabilities of the conference participant.
2. Based on the local configuration and the received session level "a=ccc_list" SDP attribute the MRFC selects the payload type and simulcast formats from the received SDP offer for each accepted audio and video media stream and creates the corresponding media stream identities. The MRFC creates one media stream for floor control protocol signalling. In this example the MRFC creates:
- a) one audio media stream (StreamID = 1);
 - b) one video media stream for main video (StreamID = 2);
 - c) one video media stream for screenshare video (StreamID = 3);
 - d) one media stream for thumbnail video (StreamID = 4); and
 - e) one media stream for floor control using BFCP protocol signalling (StreamID = 6).
3. – 5. The MRFC uses the "Reserve and Configure IMS resources" procedure to request the MRFP to configure resources towards the user and for the accepted audio and video media streams (in this example StreamID values 1, 2, 3 and 4) the MRFC:
- a) if the user is the first conference participant, requests the MRFP to create a new context and includes a "MMCMH policy" information element to indicate to the MRFP that the context is used for MMCMH and that the MRFP shall mix RTP media streams autonomously based on the MMCMH policies specified in clause 5.11.3.5;
 - b) provides an IP address and port received from the user;
 - c) requests a local IP address and port;
 - d) includes selected payload types in "Local IMS resources" and "Remote IMS resources" information elements;
 - e) for the video media streams where the "a=content" attribute was received in the SDP offer, includes in the Local and Remote descriptors a "Stream content" information element with the received "a=content" attribute to indicate content of stream;
 - f) for the audio and video media streams with the simulcast streams includes in the Local and Remote descriptors a "Simulcast desc" information element (containing the "a=simulcast" attribute) with the selected simulcast streams and request the MRFP to configure termination with a simulcast capability;
 - g) for the audio and video media streams with the simulcast streams includes in the Local and Remote descriptors a "Simulcast format" information element with the accepted "a=rid" attribute lines;
 - h) for the audio and video media streams where the "a=rtcp-fb" line(s) with a "CCM" parameter was received in the SDP offer, includes in the Local and Remote descriptors:

- a "CCM pause-resume" information element to indicate to the MRFP which RTCP feedback "CCM PAUSE-RESUME" messages the MRFP may send to the end user;
 - if a "nowait" pause attribute was received in the SDP offer, include the "nowait" pause attribute in the "CCM pause-resume" information element to indicate to the MRFP that exchange of the RTCP feedback "CCM PAUSE-RESUME" messages will be point-to-point and no hold-off period will therefore be necessary when resuming paused streams;
 - an "Autonomous request" information element to indicate that the MRFP is allowed to autonomously send RTCP feedback CCM PAUSE and RESUME messages; and
 - an "Autonomous response" information element to indicate that the MRFP is allowed to autonomously send RTCP feedback CCM PAUSED and REFUSED messages; and
- i) for the video media streams where the "a=imageattr" attribute was received in the SDP offer, includes a "Generic image attribute" information element in accordance to procedure specified in clause 6.2.17; and
- j) includes in the Remote descriptor a "Concurrent Codec Capabilities" information element to indicate the concurrent codec capabilities of the conference participant.

Upon request from the MRFC, the MRFP creates:

- a) if the user is the first conference participant, a new context and configure it according to value(s) received within the "MMCMH policy" information element; and
- b) an incoming termination and configure it with the simulcast property.

The MRFP reserves resources for the received audio and media streams. In this example, the MRFP reserves the local IP address and port, and IMS resources (codecs and codec's configurations) for one audio media stream and for the three video media streams and provide the requested information to the MRFC. The MRFP configures termination:

- a) to receive the two simulcast audio RTP streams and to send one audio RTP stream and which are encoded using codec1 or codec2 (StreamID with value 1);
 - b) with the voice activity detection functionality;
 - c) to receive the two simulcast video RTP streams (one RTP video stream in high resolution and the other RTP video stream in low resolution) and to send one RTP video stream in high resolution and which are encoded using codec3 (StreamID with value 2); and
 - d) to support the full "RTP-level pause and resume" functionality corresponding to "config=1" on all audio and video media streams.
6. - 8. The MRFC uses the "Configure Conference For Floor Control" procedure (specified in clause 6.2.13.2.2) to request the MRFP to configure context C1 with a Floor Control Server property. The MRFC provides in a "Conference Identifier" information element the Conference Identity "555" to be used by BFCP floor control signalling, includes a "Floor-Resource Associations" information element to indicate to the MRFP that two floors will be used within the context C1:
- a) floor with identity "333" will be used to control the audio and the main video (and thus associated with StreamID with values 1 and 2); and
 - b) floor with identity "444" will be used to control the screenshare video (and thus associated with StreamID with value 3),

and includes a "Floor Control Algorithm" information element to indicate to the MRFP the algorithm used in granting the floor for each floor identity.

The MRFC uses the "Configure BFCP Termination" procedure to modify the termination to support BFCP over TCP media stream (StreamID with value 6) in accordance to procedure specified in clause 6.2.13.2.2. The MRFC provides an IP address and port received from the user and requests a local IP address and port from the MRFP. The MRFC includes an "User Identifier information" element indicating user identity and an "Available Floors" information element indicating the floor identities to be used for BFCP signalling.

If the MRFP needs to act as a TCP client, the MRFC requests the MRFP to start a TCP connection establishment with an "Establish TCP connection" information element. The MRFC includes a "Notify TCP connection establishment Failure Event" information element to request the MRFP to report an unsuccessful TCP connection set-up.

If the MRFC and the MRFP support IMS media plane security, they will apply additional procedures as specified in clause 6.2.19.3.

9. The MRFC inserts in the SDP answer the IP address and RTP port received from the MRFP for the accepted media streams and includes in the SDP answer:
 - if the simulcast streams were included in the SDP offer, the accepted simulcast streams;
 - if an "a=rtcp-fb" line with a "pause" CCM parameter was included in the SDP offer for the accepted media stream, an "a=rtcp-fb" line with a "pause" CCM parameter and "nowait" pause attribute;
 - an "a=floorctrl:s-only" to indicate that the MRFP will act as a floor control server;
 - an "a=confid" attribute indicating the conference identity to be used by BFCP signalling;
 - an "a=userid" attribute indicating the user identity to be used by BFCP signalling;
 - "a=floorid" attribute lines containing the BFCP floor identities ("333" which will be used to control main audio and main video media streams and "444" which will be used to control the screenshare video);
 - "a=label" attribute lines indicating which audio and video media streams will be BFCP controlled; and
 - an "a=setup:active" attribute to indicate that the MRFP will act as a TCP client.
10. The MRFC inserts in the SIP message (200 (OK) final response or 18x provisional response to the SIP INVITE request) an "isfocus" media feature tag and the SDP answer, and sends the SIP message towards the user.

6.2.10.3 Message Conferencing

The procedures specified in clauses 6.2.10.1- 6.2.10.6 for "General Multimedia Conferencing" shall be followed. The following clauses describe the additional requirements for the message conferencing.

6.2.10.3.1 General

For message conferencing, the Message Session Relay Protocol (MSRP) (see IETF RFC 4975 [18]) shall be used to transport messages. The message content may carry different media including text, image, video and audio. The Media types shall be MIME encoded. The TCP connection that the MSRP runs over shall be established when adding a new participant into the conference according to clause 6.2.20.

In order to manage the message conferencing, the following features may be supported:

- Message statistics.
- Message filtering.

An MRFC and an MRFP that support a session based messaging, as defined in IETF RFC 4975 [18], shall support the following procedures.

When receiving an SDP offer for a MSRP media, the MRFC:

- shall provide the value of the received "a=path" SDP attribute (defined in IETF RFC 4975 [18]) to the MRFP in the "MSRP URI Path" information element, as part of a remote descriptor;
- shall indicate "TCP/MSRP" or "TCP/TLS/MSRP" (if e2e media security is applied) as transport protocol to the MRFP;
- if the "a=msrp-cema" SDP attribute, as defined in IETF RFC 6714 [40], is not contained in the SDP offer, should use the IP address and port within the first entry of the "a=path" SDP attribute from the received SDP offer to configure the remote IP address and port at the MRFP;

NOTE 1: It is a normal MRFC procedure to configure the received SDP "c=" line and "m=" line IP address and TCP port information as the remote address and port at the MRFP. The SDP "c=" line and "m=" line address and port information will match the "a=path" address information unless there is an MSRP relay in the path.

- shall request the MRFP to allocate the IP address, TCP port and MSRP session-id and provide this information in the "MSRP URI Path" information element;
- shall include the "a=path" SDP attribute received from the MRFP in an SDP answer it sends; and
- if the SDP offer included the "a=msrp-cema" SDP attribute, shall include the "a=msrp-cema" SDP attribute in the SDP answer.

When sending an SDP offer for MSRP media, the MRFC:

- shall request the MRFP to allocate an IP address, TCP port and MSRP session-id and provide this information in the "MSRP URI Path" information element;
- shall indicate "TCP/MSRP" or "TCP/TLS/MSRP" (if e2e media security is applied) as transport protocol to the MRFP;
- shall include the value of the "MSRP URI Path" information element received from the MRFP in the "a=path" SDP attribute of the SDP offer it sends; and
- should include the "a=msrp-cema" SDP attribute in the SDP offer.

When receiving a corresponding SDP answer for MSRP media, the MRFC:

- shall provide the value of the received "a=path" SDP attribute to the MRFP in the "MSRP URI Path" information element; and
- if the "a=msrp-cema" SDP attribute is not contained in the SDP answer, should use the IP address and TCP port within the first entry of the "a=path" SDP attribute from the received SDP answer to configure the remote IP address and port at the MRFP.

When the MRFP is configured to handle MSRP media and is requested to allocate an IP address, TCP port and MSRP session-id, it shall provide this information in the "a=path" SDP attribute and shall store this information. When the MRFP then receives MSRP packets, it shall compare the session-id part of the received MSRP packets with the stored session-id.

NOTE 2: Comparing only the session-id, but not the address information, is in accordance with IETF draft-ietf-simple-msrp-sessmatch-10, but also compatible with peers using IETF RFC 4975 [18] without extensions or in combination with IETF RFC 6714 [40]. No procedures to indicate the method of session matching (according to IETF RFC 4975 [18] or IETF draft-ietf-simple-msrp-sessmatch-10) to the MRFP are defined.

The MRFP shall include MSRP URI(s) received in the "MSRP URI Path" information element from the MRFC in the "To-Path" header field of MSRP packets it sends.

6.2.10.3.2 Messages Statistics

The MRFP may report the statistics for the number of messages sent and/or received in two ways described as following.

1. The MRFC indicates quotas granted to the MRFP. The granted quotas indicate the units specifying the number of messages or volume of messages allowed to be received or sent by users. The MRFC may also indicate to the MRFP a valid time together with the granted quotas. The valid time indicates the time until the specific unit may be measured, after which the quota shall be reported, whether or not it has reached its granted quota. The MRFC initiates this via the "Configure Granted Quota" procedure as specified in clause 8.50. The quotas granted by MRFC may include any of the following:
 - Quota for number of messages sent
 - Quota for number of messages received

- Quota for volume (size) of messages sent
- Quota for volume (size) of messages received

When the quota granted is reached or the valid time elapses the MRFP shall report statistics information of messages according to the indication by the MRFC. The MRFP uses the "Report Message Statistics" procedure as specified in clause 8.51 to report the statistics of messages. The statistics of messages sent and/or received may include any of the following:

- number of messages sent
 - number of messages received
 - volume (size) of messages sent
 - volume (size) of messages received
 - reason for report i.e. quota reached or granted time elapsed
2. The MRFC requests the MRFP to report the statistics information of messages sent and/or received at the end of the session or during the session. In this case, the quotas or the valid time is not required, and the MRFP should report the statistics of message as requested by the MRFC. The statistics of messages are the same as described above.

Figure 6.2.10.3.2.1 shows the message sequence chart example for reporting message statistics.

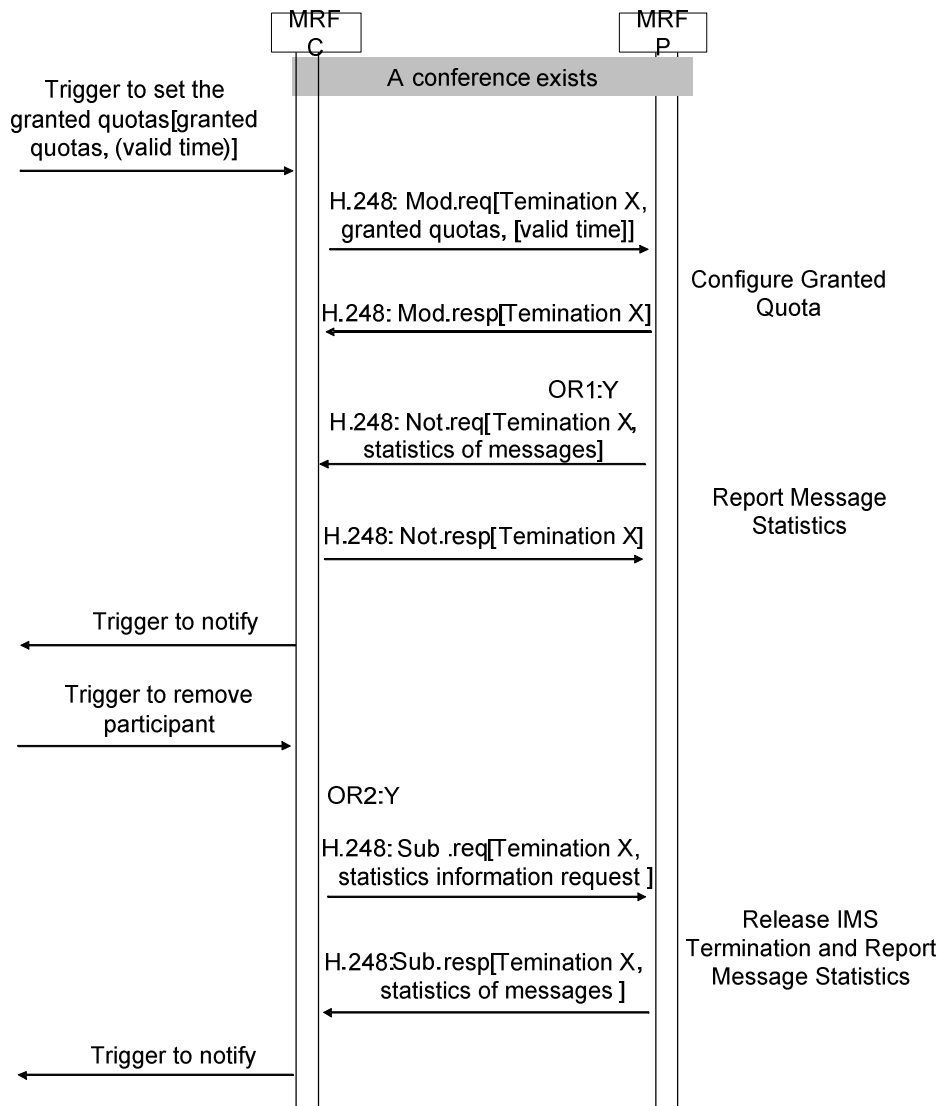

Note: OR1: granted quotas reached or valid time elapses. (Y:yes, N:no)
 OR2: remove the subscriber. (Y:yes, N:no)

Figure 6.2.10.3.2.1 Message statistics according to the granted quota

6.2.10.3.3 Message Filtering

When the MRFC receives the trigger to config the filtering rules, the MRFC may initiate the "Configure Filtering Rules" procedure as specified in clause 8.52 to set filtering rules in the MRFP. The filtering rule is composed of two parts: the criteria and the treatment of the filtered message. The MRFP should handle messages according to the filtering rules.

The MRFC may indicate to the MRFP the following criterias:

- Sender address
- Message size
- Message content type (e.g. video, audio)
- Message content format(e.g. mpeg, jpeg)
- Message subject

The MRFC may indicate to the MRFP the following message treatments:

Block the delivery of the message content

Store the message content

Redirect the message to another address

The MRFC may indicate to the MRFP the "store url" when messages storage is needed, or the MRFC may indicate the MRFP to allocate the "store url" and return the generated "store url" to the MRFC.

The MRFC may indicate to the MRFP the "redirect url" when messages redirection is needed.

Figure 6.2.10.3.3.1 shows the message sequence chart example to config the filtering rules.

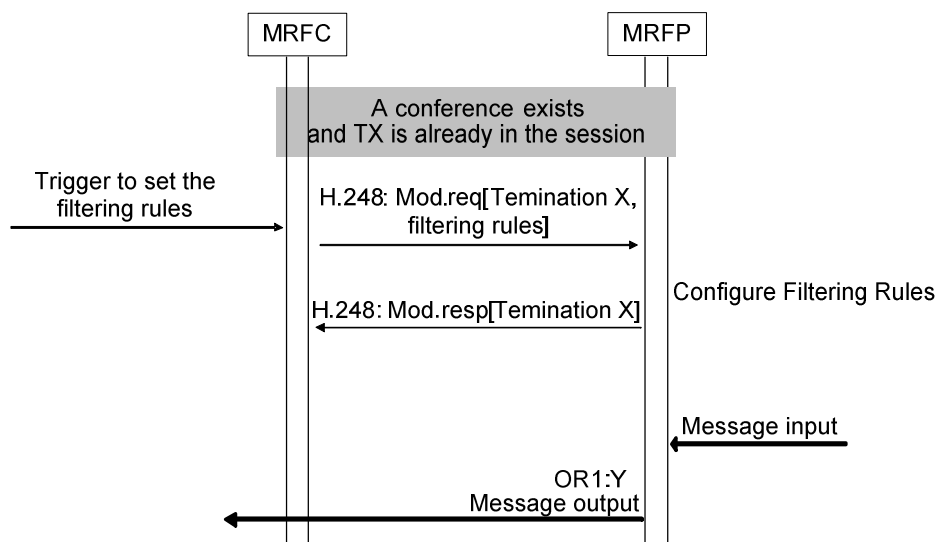

Note: OR1: The message is not filtered according to the filtering rules. (Y:yes, N:no)

Figure 6.2.10.3.3.1 Configure the filtering rules

6.2.11 Audio Transcoding Procedure

As transcoding is considered a basic feature of a MRFP, the MRFC does not explicitly request transcoding. It is expected that the MRFP determines when transcoding is applied, for example, when the MRFC specifies the audio codec to be applied for a given stream in a context, if there are any other audio terminations in the context and the stream modes permit data flow between these terminations and where the source encodings are not compatible then the MRFP transcodes the stream between these terminations.

6.2.12 Video Transcoding Procedure

As transcoding is considered a basic feature of an MRFP the MRFC does not explicitly request transcoding. It is expected that the MRFP determines when transcoding is applied, for example, when the MRFC specifies the video codec to be applied for a given stream in a context, if there are any other terminations supporting video in the context and the stream modes permit data flow between these terminations and where the source encodings are not compatible then the MRFP transcodes the stream between these terminations.

6.2.13 Floor Control

6.2.13.1 General

Floor control offers control of shared conference resources at the MRFP(s). Floor control protocol (BFCP) is used to convey the Floor control messages between the Floor Chair of the conference, the Floor Control Server, and the Floor Participants of the conference. All Floor control messages go via the Floor Control Server. Processing (granting or

rejecting) Floor control requests is done by the one or more Floor chairs or by the FCS itself, depending on the Floor Control Policy.

The location of the Floor Control Server may be in either the MRFC or the MRFP depending on the complexity/distribution of the conference. However when located in the MRFP, the MRFP shall forward the Floor request decision to the MRFC in order to execute the changes to the Floor Participant's granted permissions.

6.2.13.2 Floor Control within the MRFP

6.2.13.2.1 Floor Control Connection Establishment

The set of data to establish a BFCP connection shall be exchanged in accordance with IETF RFC 4583 [21]. A Floor control connection, which requires a BFCP/TCP protocol termination property, shall be established between the UE and the Floor Control Server, located in the MRFP. The MRFC shall initiate the "Configure BFCP Termination" procedure as specified in clause 8.44 to indicate to the MRFP the remote Floor control Client connection address and request the local Floor control Client connection address. The MRFP shall return the local Floor control Client connection address to the MRFC. The Floor control connection may be initiated by the UE or the MRFP (FCS).

- It is a prerequisite that the conference is configured using "Configure Conference for Floor Control" procedure as described in clause 6.2.13.2.2, which is used to set the common data of the conference for Floor control.

The combined sequence is shown in Figure 6.2.13.2.1.1

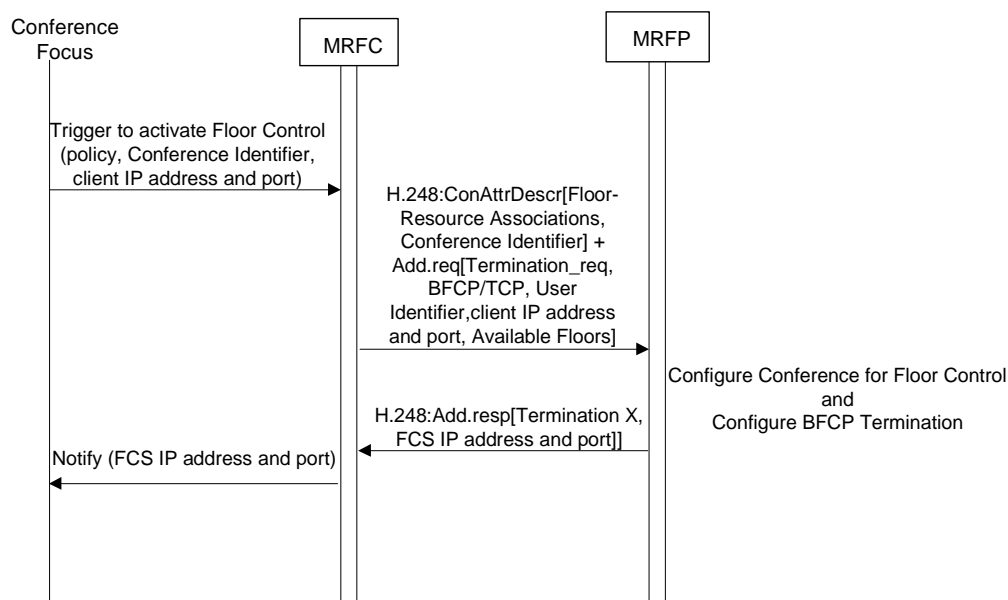

Figure 6.2.13.2.1.1: Combined procedures to Configure Conference and add a Floor Control Termination

6.2.13.2.2 Configure Conference and Floor Control Policy Indication

The "Configure Conference For Floor Control" procedure, specified in Clause 8.45 shall be used to set up a conference and to modify FCS properties such as the Floor Control Policy. The procedure defines common data for all BFCP users, these properties are defined on Context level.

The common data include:

- Floor-Resource Associations, which indicates the correlation between Floor ID and media properties for the MRFP to identify the Floor(s) when receiving BFCP requests and notifying the MRFC of decisions to change the floor permissions for a given user (termination).
- Conference Identifier, which indicates the Conference Identifier for the BFCP client to identify the conference when sending BFCP requests.

Floor Control Policy. This consists of:

- The Floor control algorithm to be used in granting the Floor, either:
 - The FCFS algorithm or
 - The chair-controlled algorithm.
- The maximum number of users who can hold the Floor at the same time.

Figure 6.2.13.2.2.1 shows the message sequence chart example for configuring a conference for Floor control.

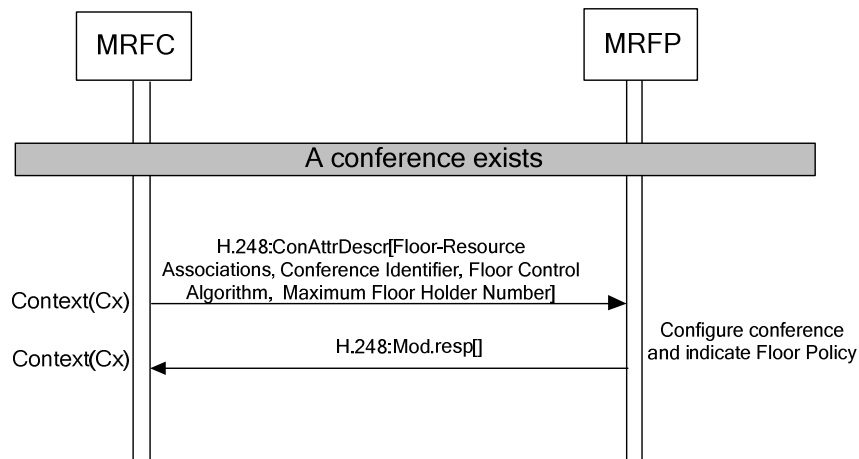

Figure 6.2.13.2.2.1 Procedure to Configure Conference for Floor Control

6.2.13.2.3 Floor Chair Designation

If the Floor Control Policy indicates that the conference is Chair-controlled, the MRFC shall indicate to the MRFP which termination represents the Floor Chair and which Floor(s) the Floor Chair controls using the "Designate Floor Chair" procedure as specified in clause 8.46.

The MRFC may also change the Floor Chair as needed using the "Designate Floor Chair" procedure as specified in clause 8.46.

NOTE: There may be one or more Floor Chairs in a conference. But one media stream can be controlled by only one chair.

It is a prerequisite that the conference is configured and the termination configured for BFCP using "Configure Conference for Floor Control" and "Configure BFCP Termination" procedures respectively.

NOTE: These procedures may be requested at same time.

Figure 6.2.13.2.3.1 shows the message sequence chart example for designating Floor Chair.

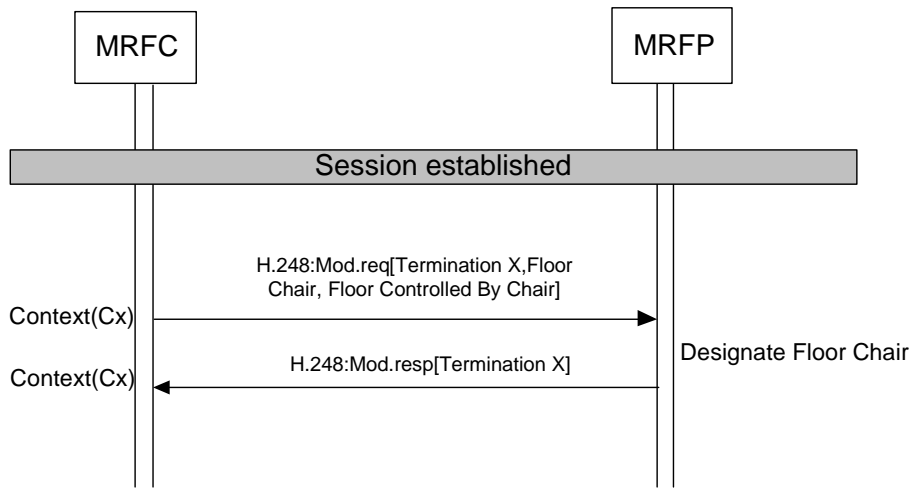

Figure 6.2.13.2.3.1 Procedure to designate Floor Chair

6.2.13.2.4 Floor Request Decision

The MRFC shall request the MRFP to notify the decision of Floor request using the "Floor Decision Request" procedure as specified in clause 8.47. The MRFP shall then notify the MRFC the outcome of the Floor Request, when the FCS has made the decision to change the status to "Granted", " Released " or " Revoked " (The status is defined as REQUEST-STATUS in IETF RFC 4582[20]), using the "Report Floor Status Decision" procedure as specified in clause 8.48.

The Floor Request Decision information is used by the MRFC to decide how to set the media properties of the associated Termination/Stream on the MRFP.

The MRFP shall indicate the Floor Identity or Identities to which the Floor decision is associated. The MRFP sends one notification per Floor decision for a given termination and only one notification per termination shall be outstanding at any time.

Figure 6.2.13.2.4.1 shows the message sequence chart example for requesting and reporting Floor Request decisions.

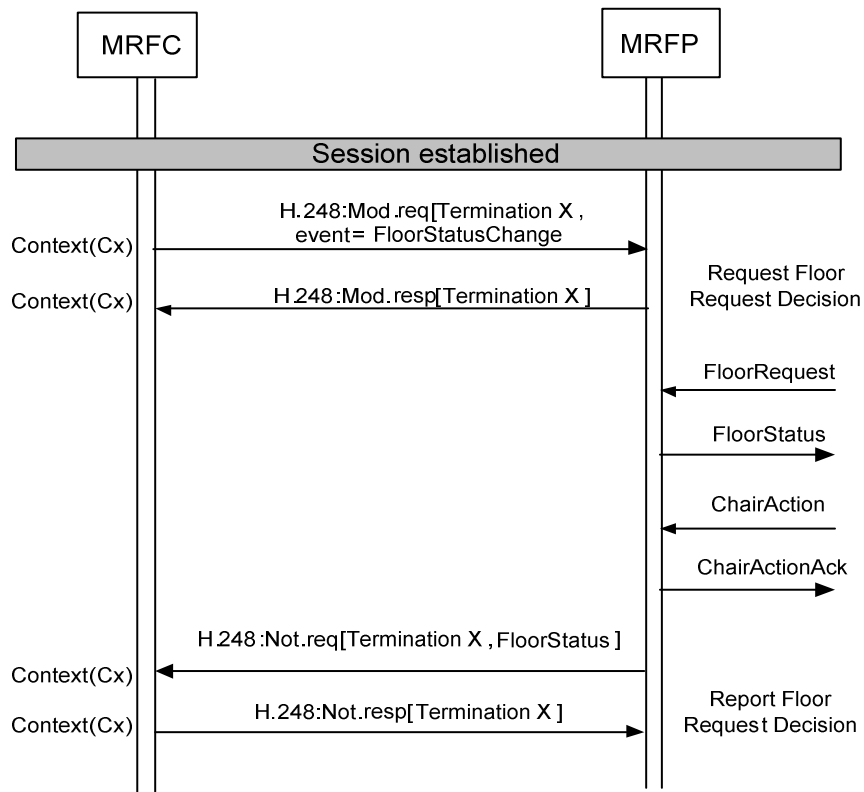

Figure 6.2.13.2.4.1 Procedure to request and report Floor Request decisions

6.2.13.2.5 Media Update and Confirmation

The MRFC modifies media properties associated with the Floor Request Decision received from the MRFP using the "Modify Media" procedure defined in Clause 8.59; this will be either adding permissions if the "status" was granted or removing the permissions if the "status" was revoked or released. The MRFC shall indicate to the MRFP when it has successfully modified the media properties based on the provided Floor Request Decisions notification using the "Confirm Media Update " procedure as specified in clause 8.49. The MRFP shall then modify the Floor status of the associated Client.

Figure 6.2.13.2.5.1 shows the message sequence chart example for modifying the media and confirming media update based on Floor Request status.

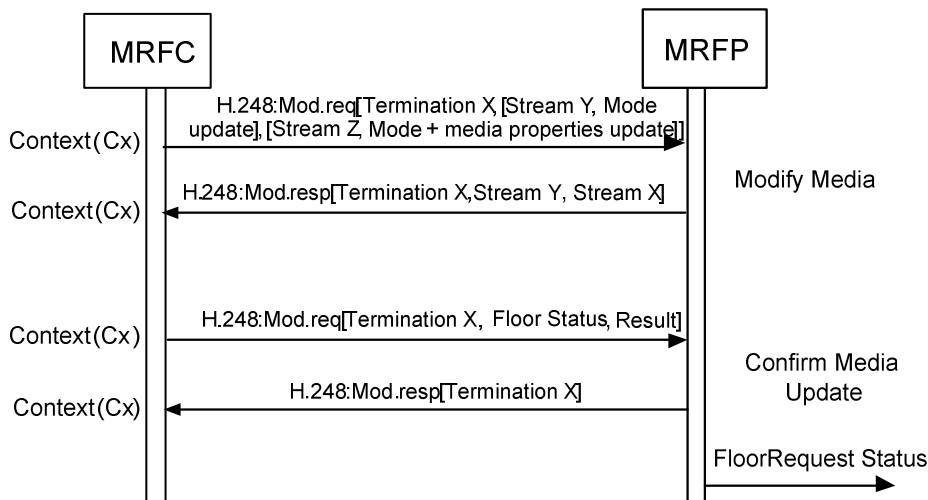

Figure 6.2.13.2.5.1 Procedures to modify the media and confirm media update

6.2.13.2.6 Floor Control Procedure

A Floor Participant may request one or more Floors by sending a BFCP request message to the MRFP (FCS).

The MRFP (FCS) informs the Floor Chair, if present, about a Floor Participant's Floor request via BFCP.

The Floor Chair sends to the MRFP (FCS) the decision to the Floor Participant's Floor requests. If the Floor is not Chair-controlled, the FCS located in the MRFP shall make the decision itself according to the Floor Control Algorithm.

The MRFP shall notify the MRFC the Floor change request decision via the "Report Floor Request Decision" procedure described in Clause 6.2.13.2.4.

The MRFC requests the MRFP to modify the media properties associated with the Floor Request decision as described in Clause 6.2.13.2.5.

The MRFC informs the MRFP that the requested media changes to satisfy the new Floor permissions have been completed using the "Confirm Media Update" procedure, see Clause 8.49.

The MRFC may request the MRFP to play tones or announcements for indicating when a user gains or loses Floor permissions.

6.2.13.2.7 Floor Control Connection Release

When the MRFC receives an indication that the Floor control connection is to be closed, the MRFC shall command the MRFP to release the Floor control connections.

The Floor control connection shall also be released by the MRFP when the termination for that connection is removed.

The Floor related BFCP signalling resources are released by the MRFP when the Floor control connection is released.

If a Floor Participant owns a Floor when releasing the Floor control connection, the MRFP(FCS) shall revoke the Floor permission.

6.2.13.2.8 Example Message sequence chart

Figure 6.2.13.1 shows the message sequence chart example for Floor control on a termination which is not the Floor Chair.

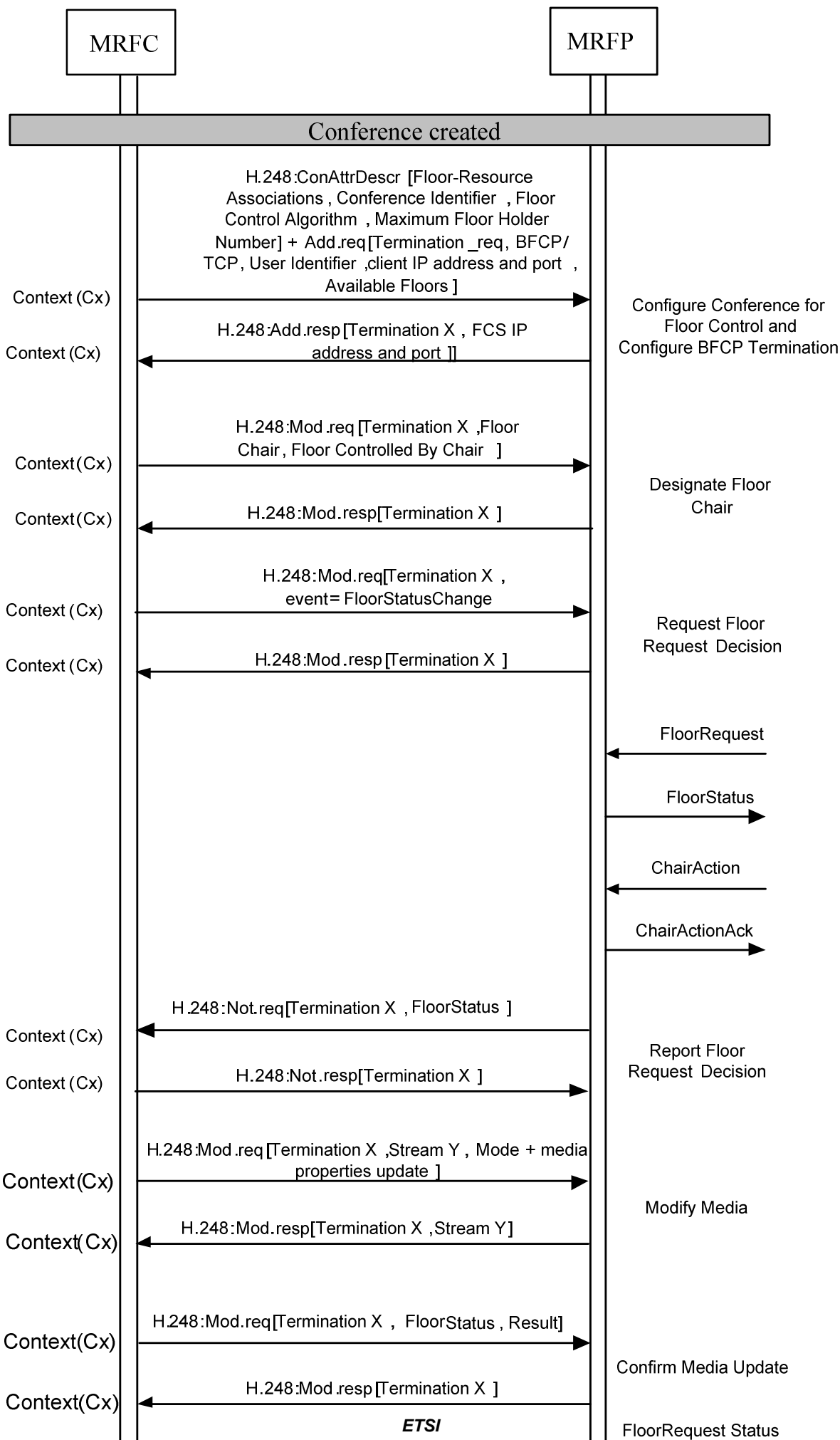

Figure 6.2.13.1 Floor control (message sequence chart)

6.2.14 Explicit Congestion Notification Support

6.2.14.1 General

If the MRFC receives a SDP Offer containing ECN negotiation, see IETF RFC 6679 [25], and the MRFC and MRFP support ECN and at least some of the initialisation methods offered within the "a=ecn-capable-rtp" attribute,

NOTE: Only the "leap" initialisation method is supported over the Mp interface in this release.

the MRFC shall:

- act as an end point for ECN;
- return a SDP Answer according to 3GPP TS 26.114 [23] and the capabilities of the MRFP, containing the "a=ecn-capable-rtp" attribute; and
- indicate to the MRFP that it shall apply the ECN procedures (according to 3GPP TS 26.114 [23]) and act as an ECT endpoint.

NOTE: ECN XR summary reports and RTCP AVPF ECN feedback message are not supported in this release.

When creating the SDP Offer the MRFC may initiate ECN negotiation (in accordance with 3GPP TS 26.114 [23]), indicating the capabilities of the MRFP.

If the MRFC receives the SDP Answer also containing ECN attributes (indicating successful ECN negotiation) then it shall indicate to the MRFP that it shall apply the ECN procedures (according to 3GPP TS 26.114 [23]) and act as an ECT endpoint.

The following ECN parameters are preconfigured in the MRFP:

- Initialisation = "leap";
- Mode = "setread";
- ECT Marking = ECT-0;
- Feedback is via Application Specific Adaptation Requests (i.e. Receiver Driven Congestion Control).

The MRFP should not send RTCP XR ECN summary reports.

The procedure to configure the MRFP for ECN may be combined with any other procedure requesting media resource from the MRFP.

6.2.14.2 Message sequence chart, Request ECN

Figure 6.2.14.2.1 shows the message sequence chart example for requesting Explicit Congestion Notification.

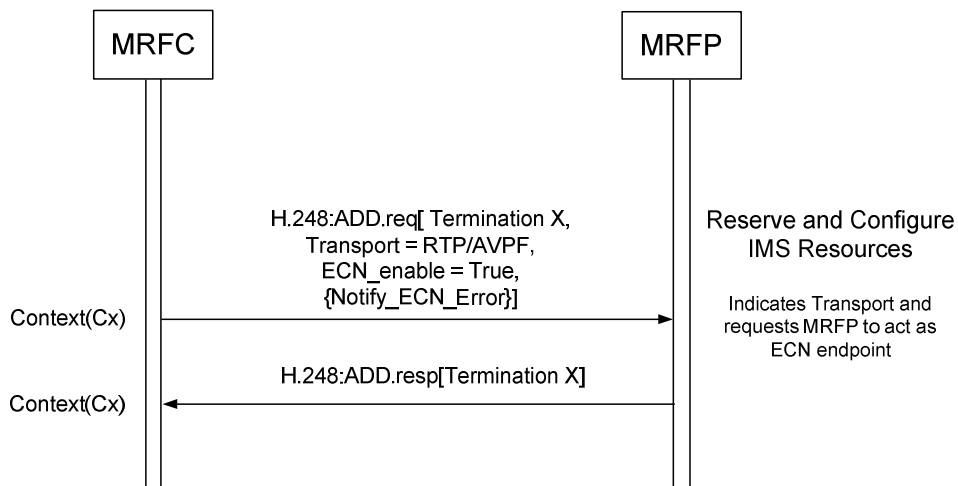

Figure 6.2.14.2.1: Procedure to Request ECN

Upon receipt of a request to apply Explicit Congestion Notification the MRFP shall set the ECN field of the IP header in accordance with 3GPP TS 26.114 [23] when sending any data packets.

Upon receipt of any IP headers indicating Congestion Experienced (ECN-CE) the MRFP shall trigger rate adaptation in accordance with 3GPP TS 26.114 [23].

6.2.14.3 Message sequence chart, Report ECN Failure Event

Figure 6.2.14.3.1 shows the message sequence chart example for ECN Failure Event.

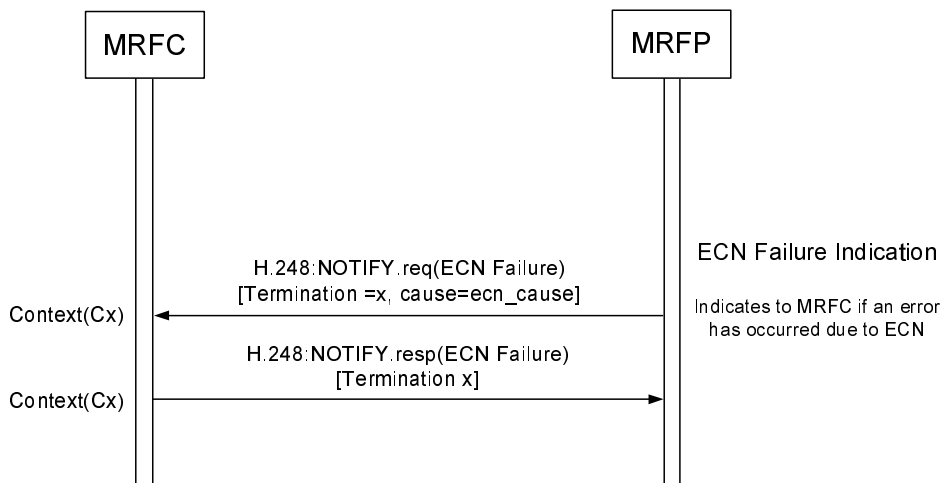

Figure 6.2.14.3.1: Procedure to Report ECN Failure

When the MRFC receives a Notification indicating that an error has occurred it may trigger a new SDP offer to remove ECN.

6.2.15 Multimedia Priority Service Congestion Control Procedures

6.2.15.1 General

The MRFC and MRFP may support the priority treatment of a call/session identified as an MPS call/session. This clause describes the Mp signalling procedures and their interactions with SIP signalling in the control plane and with user plane procedures to support the requirements for MPS. These Mp signalling procedures may or may not apply

depending on the network configuration (e.g. whether the MRFP is shared by multiple MRFCs or whether the MRFC controls multiple MRFPs for a given route – Media Gateway Group).

The MRFC can receive a SIP INVITE with MPS priority information (see 3GPP TS 23.228 [1], clause 5.21).

6.2.15.2 MRFP Resource Congestion in ADD response, request is queued

If the MRFC requests a resource via the Reserve and Configure IMS Resources procedure or Reserve IMS Resources procedure and receives an error indicating that the requested resource could not be seized (e.g. H.248 error code #510 "insufficient resources") and the MRFC does not have an alternative MRFP through which it can route the call/session, the MRFC queues the priority call/session and gives it priority over any further Reserve and Configure IMS Resources or Reserve IMS Resources procedures for lower priority calls/sessions towards this MRFP until the requested resource for this queued call/session is successfully seized. The example sequence is shown in Figure 6.2.15.2.1.

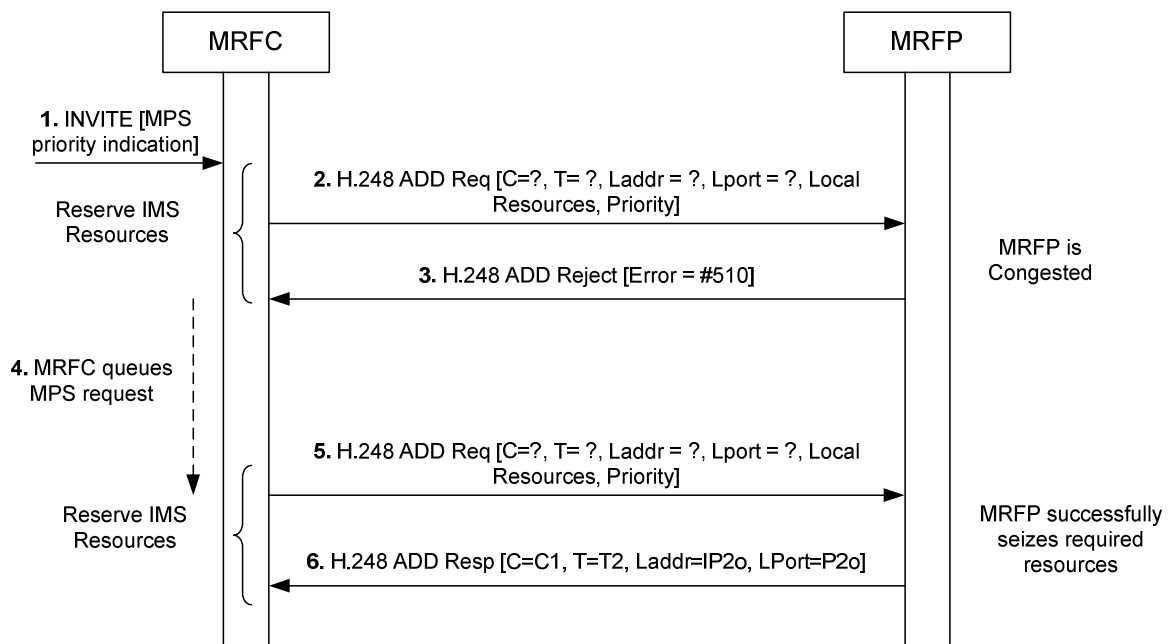

Figure 6.2.15.2.1: Request to Reserve MPS priority call resources when MRFP is congested

6.2.15.3 MRFP Resource Congestion in ADD response, MRFC seizes new MRFP

If the MRFC requests a resource via the Reserve and Configure IMS Resources procedure or Reserve IMS Resources procedure and receives an error indicating that the requested resources could not be seized due to congestion (e.g. H.248 error code #510 "insufficient resources") and Media Gateway Groups are implemented the MRFC seizes a new MRFP from the same Media Gateway Group before resorting to any queuing of the priority call/session (as described in 6.2.15.2) to enable the MPS call/session to proceed as early as possible.

6.2.15.4 MRFP Priority Resource Allocation

If the MRFP supports the Priority information (determined through provisioning or package profile), the MRFC requests a resource via the Reserve and Configure IMS Resources procedure or Reserve IMS Resources procedure and includes the Priority information. The MRFP may then provide priority allocation of resources once a congestion threshold is reached. The example sequence is shown in Figure 6.2.15.4.1. If the MRFP is completely congested it shall indicate this to the MRFC as described in 6.2.15.2.

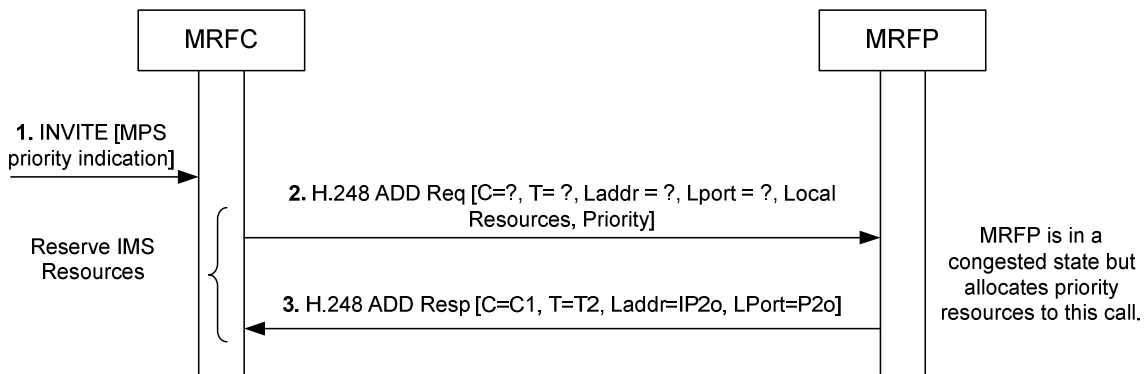

Figure 6.2.15.4.1: Request to reserve MPS priority call resources when MRFP is congested, priority resources are allocated

6.2.15.5 MRFP Priority User Data marking

The MRFC may request the streams associated to an MPS call/session to be marked with certain priority code point. The MRFP shall then mark each IP packet header accordingly. The example sequence is shown in Figure 6.2.15.5.1.

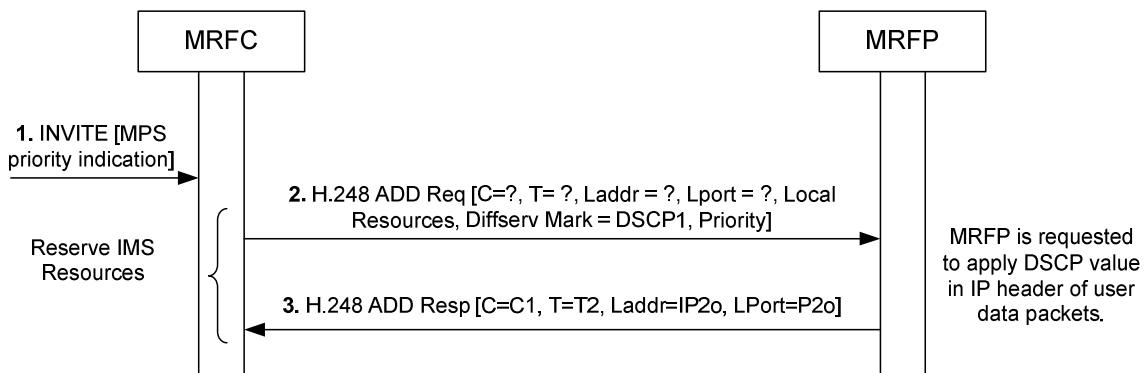

Figure 6.2.15.5.1: Request to reserve IMS resources and apply DSCP marking for MPS

The MRFP may also provide priority allocation for resources requested via a subsequent Configure IMS Resources procedure not including Priority information if the related context has been marked with priority information during the Reserve IMS Resources procedure or Reserve and Configure IMS Resources procedure.

6.2.16 Coordination of Video Orientation

Figure 6.2.16.1 shows the message sequence chart example for indicating extended RTP header for the Coordination of Video Orientation (CVO).

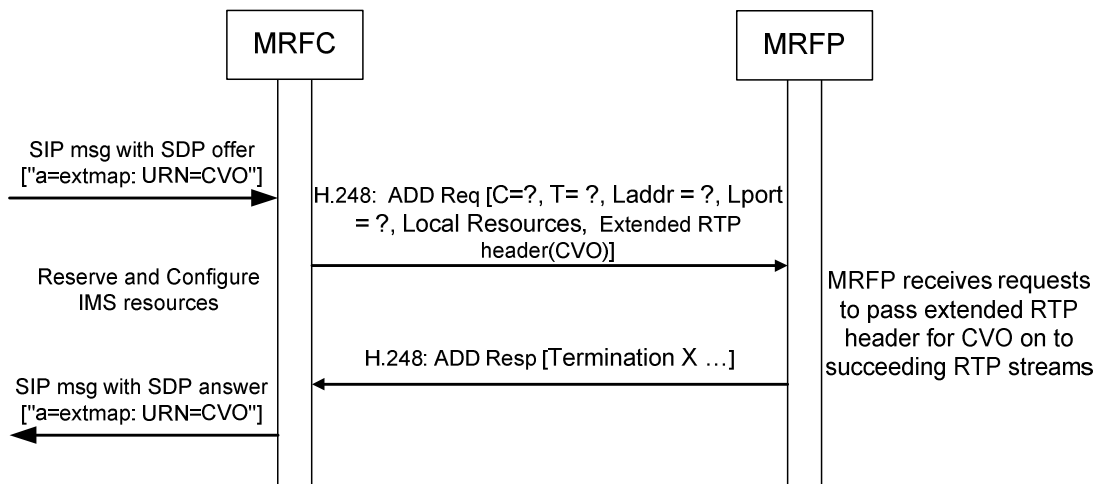

Figure 6.2.16.1: Procedure to indicate RTP extension header for CVO

When the MRFC requests the IMS resources from the MRFP, the MRFC may optionally request the MRFP to support the RTP header extension capability as defined in IETF RFC 5285 [27].

6.2.17 Support of generic image attributes

6.2.17.1 General

The MRFC and the MRFP may support the media-level SDP image attribute defined in IETF RFC 6236 [28] as required by 3GPP TS 26.114 [23].

If the MRFP and the MRFC support the negotiation of the image size and if the MRFC receives the SDP image attribute(s) "a=imageattr" then the MRFC may send the generic image attribute parameter to the MRFP when seizing or modifying a termination.

The list of image sizes per payload type supported by the MRFP shall be preconfigured in the MRFC. If the image sizes received within an SDP body on the Mr interface are not all supported by the MRFP then the MRFC shall only send the list of corresponding MRFP supported image sizes to the MRFP. If no image size is supported by the MRFP, the MRFC shall not send the generic image attribute parameter to the MRFP.

6.2.17.2 Indication of generic image attributes

The MRFC may include the generic image attributes to the MRFP. The example sequence is shown in figure 6.2.17.2.1.

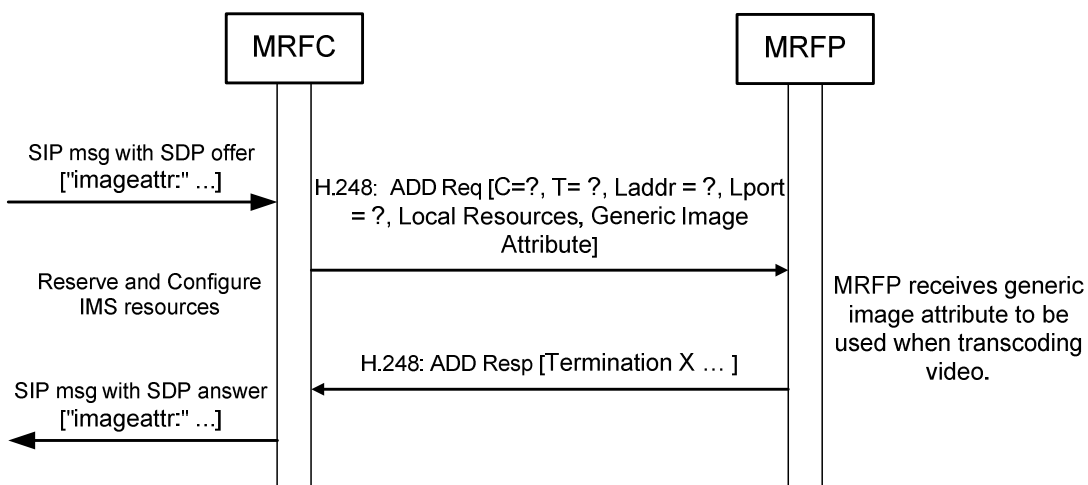

Figure 6.2.17.2.1: Request to reserve IMS resources with generic image attribute

6.2.18 Interactive Connectivity Establishment Support

6.2.18.1 ICE lite

Figure 6.2.18.1.1 shows a message sequence chart example for performing the ICE lite procedure towards the offerer.

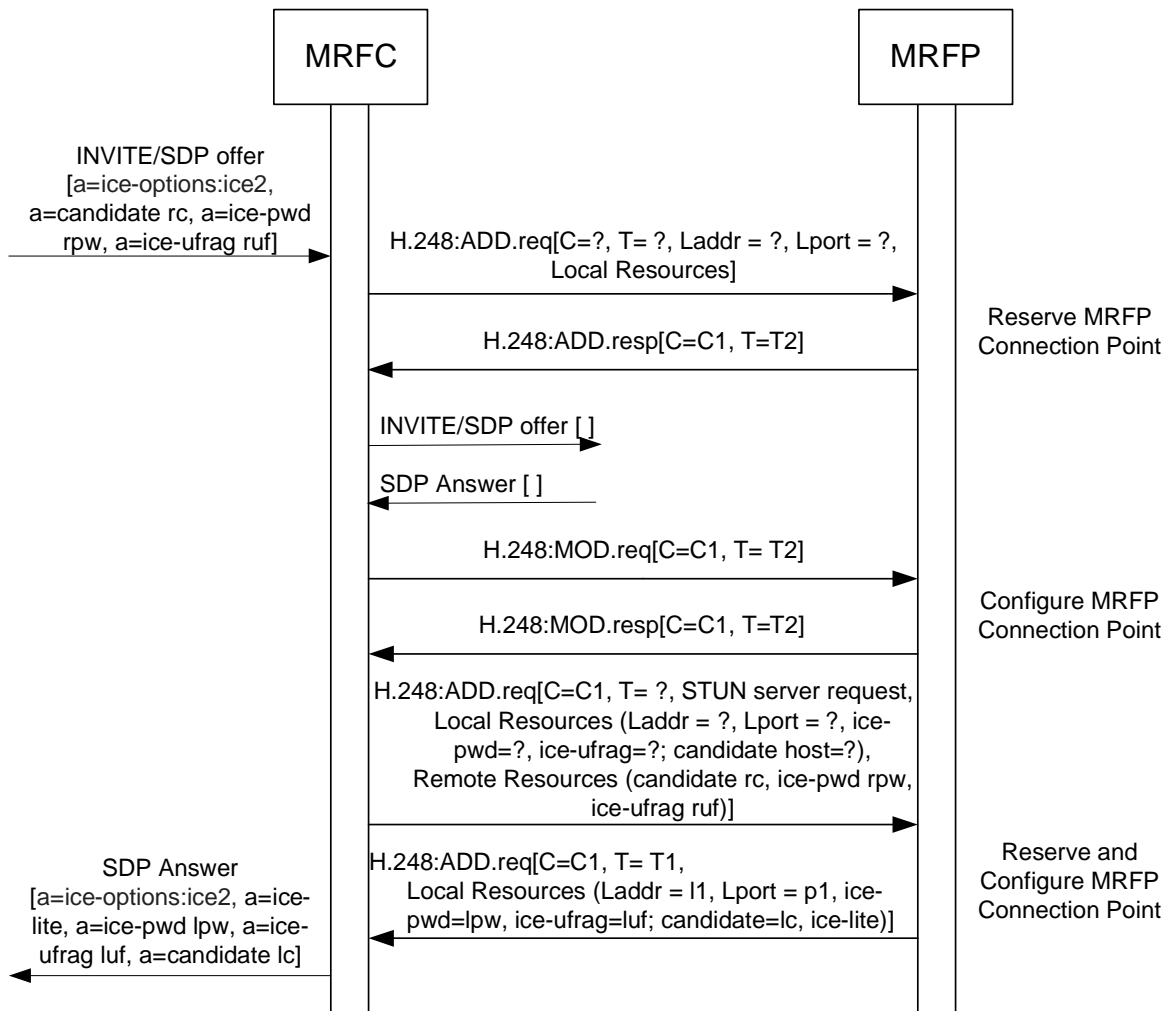

Figure 6.2.18.1: Procedure for interactive connectivity establishment using ICE lite towards the offerer

6.2.18.2 Full ICE

Figure 6.2.18.2.1 shows a message sequence chart example for performing the full ICE procedure towards the offerer.

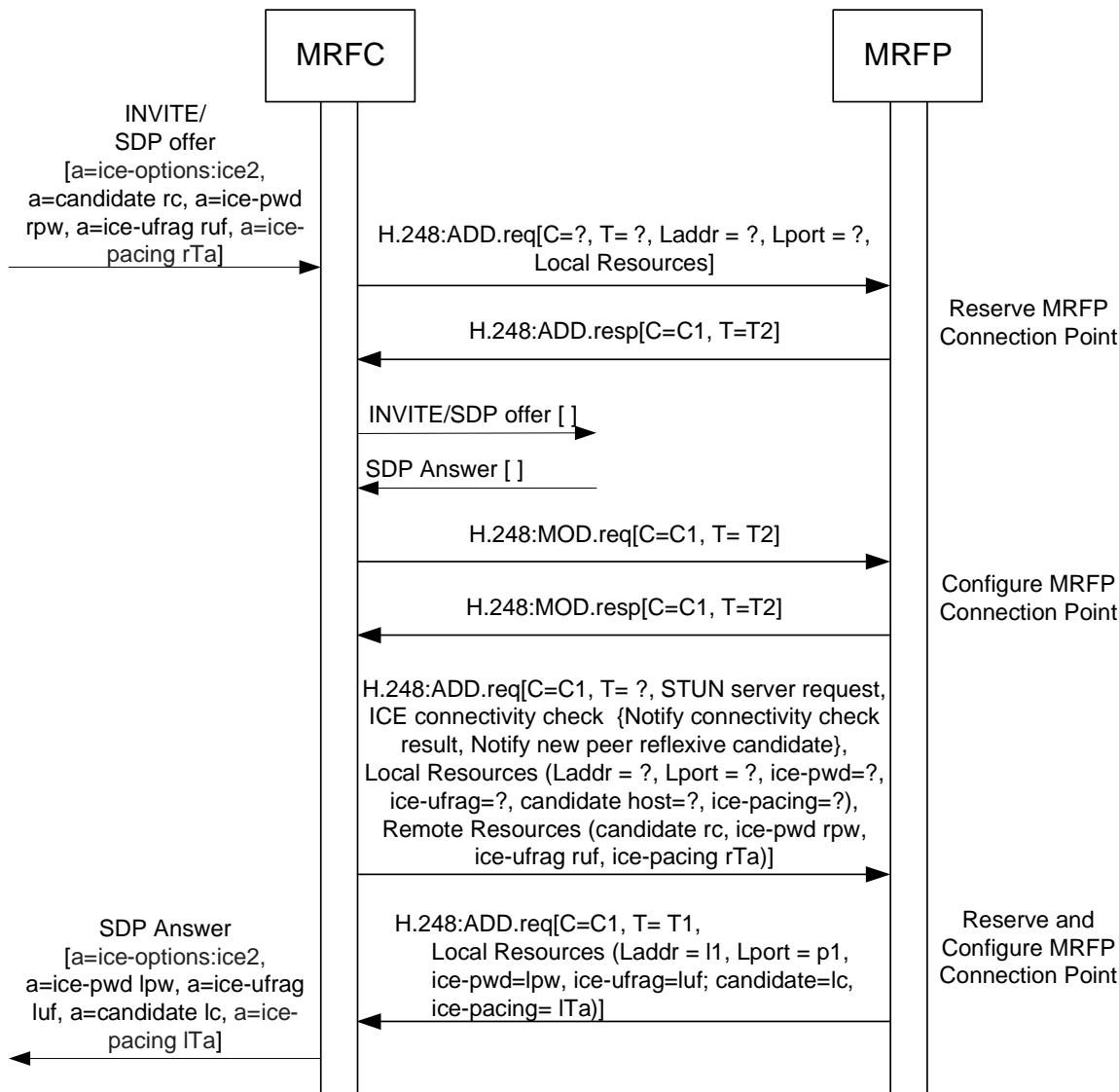

Figure 6.2.18.2.1: Procedure for interactive connectivity establishment using full ICE towards the offerer

6.2.18.3 Connectivity check result notification (full ICE)

Figure 6.2.18.3.1 shows the message sequence chart example for an ICE connectivity check result Event.

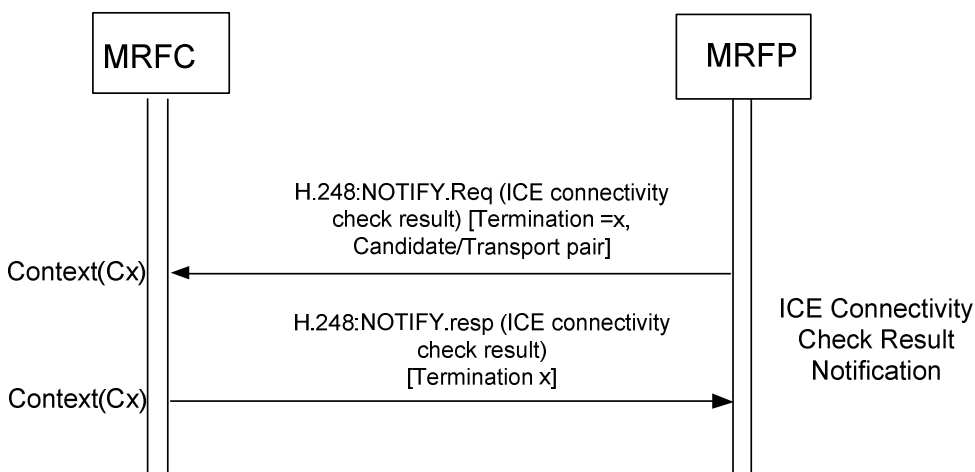

Figure 6.2.18.3.1: Procedure to report ICE connectivity check result

6.2.18.4 New peer reflexive candidate notification (full ICE)

Figure 6.2.18.4.1 shows the message sequence chart example for additional connectivity check when new peer reflexive candidate is discovered in full ICE.

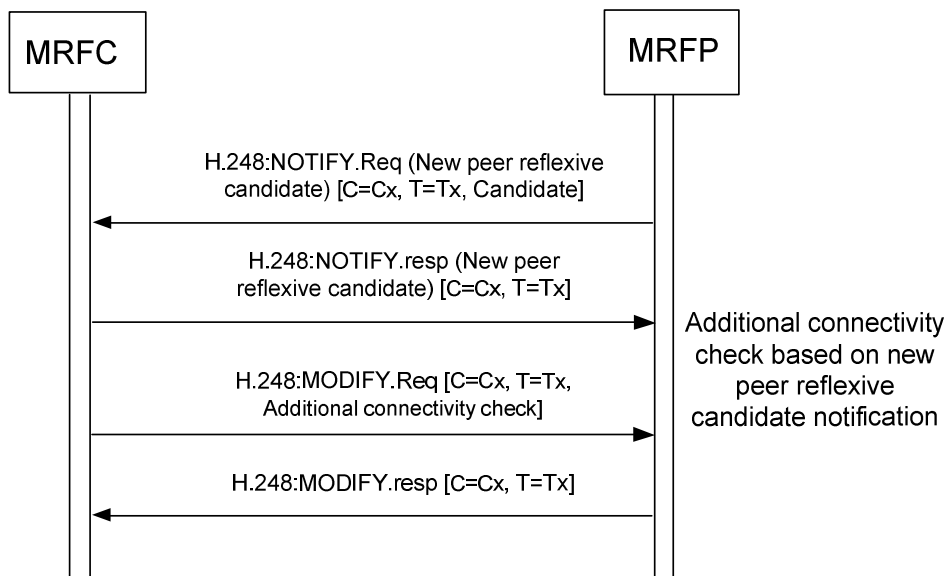

Figure 6.2.18.4.1: Procedure to perform additional connectivity check upon the report of new peer reflexive candidate

6.2.19 End-to-end security for TCP based media using TLS

6.2.19.1 General

The MRFC and the MFRP may support e2e protection of TCP based media using the pre-shared key ciphersuites for TLS (specified in IETF RFC 4279 [34]) and the MIKEY-TICKET mechanism (specified in IETF RFC 6043 [33] with the profiling of tickets and procedures given in 3GPP TS 33.328 [31]).

The following clauses describe extensions to the Mp signalling procedures and their interactions with SIP signalling in control plane and with user plane procedures if the e2e security for TCP based media using TLS and KMS is supported by the MRFC and the MFRP.

6.2.19.2 Specific procedures for session based messaging (MSRP)

6.2.19.2.1 IMS UE originating procedures ("dial-in" scenario) for e2e

Figure 6.2.19.2.1.1 shows a "dial-in" conference procedure for one MSRP session using TLS and KMS based security.

NOTE: In the shown example it is assumed that the UE-A and the MRFC/MRFP support IETF RFC 6714 [40].

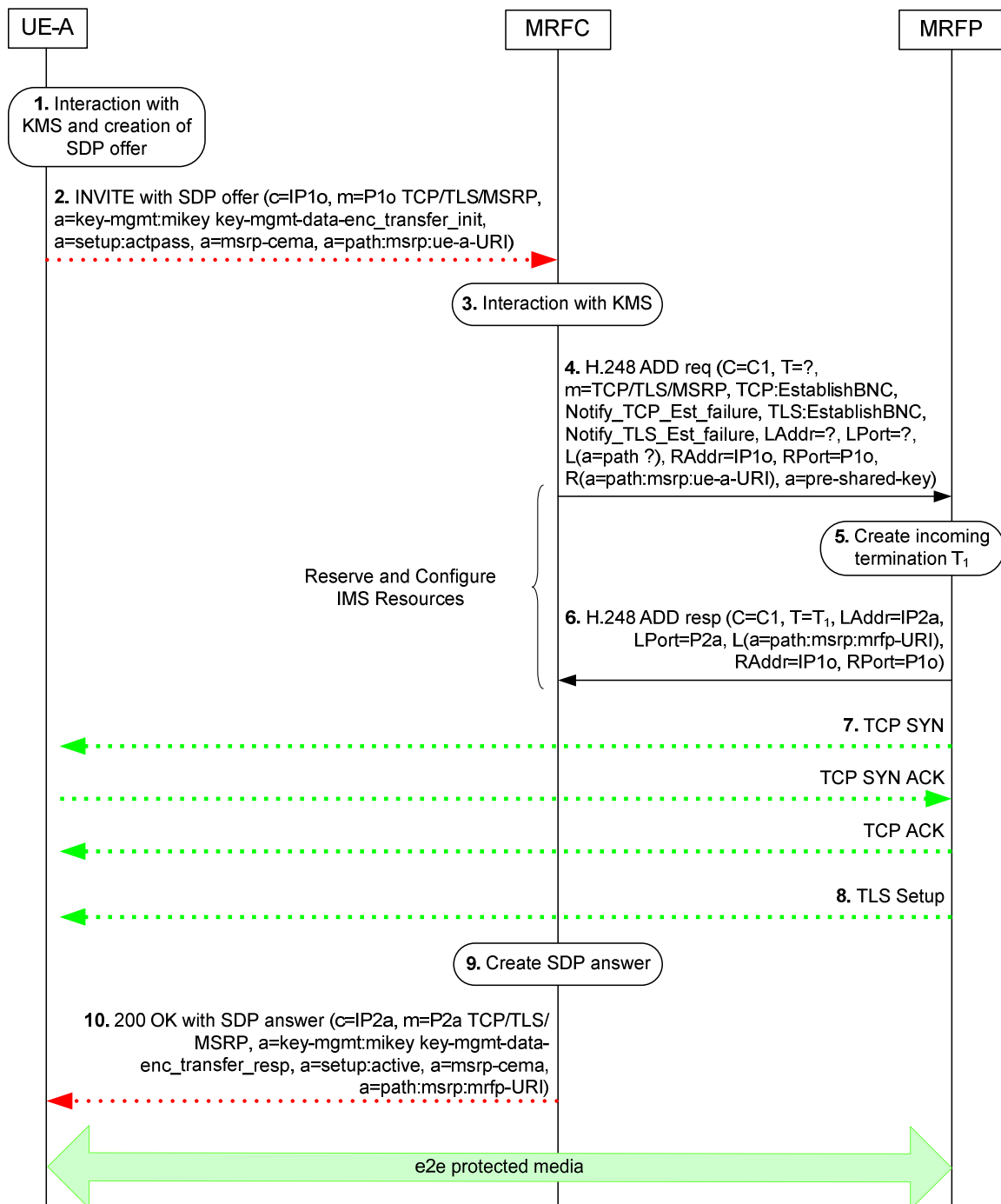

Figure 6.2.19.2.1.1: UE connecting into a messaging conference - example call flow for e2e case

The IMS UE-A and the MRFC perform an IMS conference session set-up according to 3GPP TS 23.228 [1], 3GPP TS 24.247 [17] and with modifications described in 3GPP TS 33.328 [31]. The procedure in the figure 6.2.19.2.1.1 for requesting e2e security for a media stream is described step-by-step with an emphasis on the additional aspects for the MRFC and the MRFP of the e2e media protection using TLS and KMS.

1. Depending on the KMS and a local policy, the IMS UE-A will either interact with the KMS to obtain keys and a MIKEY-TICKET ticket usable for the MRFC, or it will create the ticket by itself.

The IMS UE-A generates the TRANSFER_INIT message according to IETF RFC 6043 [33] containing the ticket associated with the MRFC. A single Crypto Session is included in the TRANSFER_INIT message as described in Annex H.3 of 3GPP TS 33.328 [31]. The protocol type in the Crypto Session is set to TLS.

The IMS UE-A creates an SDP offer with an MSRP based media over TLS transport protocol and inserts "a=setup:actpass" SDP attribute specified in IETF RFC 4145 [36] and key management protocol "a=key-mgmt"

SDP attribute specified in IETF RFC 4567 [35] which indicates use of the MIKEY-TICKET ticket and contains the TRANSFER_INIT message encapsulated in a keymgmt-data field.

2. The IMS UE-A sends the SIP INVITE request with the SDP offer.
3. Upon reception of the SIP INVITE request with the SDP offer containing a media stream that uses "TCP/TLS/MSRP" transport protocol, the MRFC checks for the presence of the key management protocol "a=key-mgmt" SDP attribute. If it indicates the usage of the MIKEY the MRFC extracts a key management data from a keymgmt-data field and "base64" decodes them to reconstruct the original TRANSFER_INIT message. The MRFC checks if it is authorized to resolve the ticket and if that is the case the MRFC interacts with the KMS to resolve the ticket and receive keys.
4. - 6. The MRFC uses the "Reserve And Configure IMS resources" procedure to request a termination for "TCP/TLS/MSRP" media. The MRFC provides an IP address and port received from the IMS UE-A and includes a Pre-Shared Key information element containing the derived PSK i.e. the Traffic-Encrypting Key associated with the Crypto Session that will be used by the MRFP in TLS handshake. The MRFC includes a Notify TCP connection establishment Failure Event information element to request the MRFP to report an unsuccessful TCP connection set-up and a Notify TLS session establishment Failure Event information element to request the MRFP to report an unsuccessful TLS session set-up. In accordance to the information in the "a=setup" SDP attribute that will be sent in an SDP answer the MRFC requests the MRFP to start a TCP connection establishment and to start a TLS session once the TCP connection is established.
7. The MRFP sends a TCP SYN message towards the IMS UE-A to establish a TCP connection. The IMS UE-A answers with a TCP SYN ACK message and the MRFP replies with a TCP ACK message, completing the TCP connection establishment.
8. Upon completion of the TCP connection establishment, the MRFP starts a TLS session establishment using the received Pre-Shared Key information element to set-up a TLS-PSK tunnel to protect MSRP messages.
9. The MRFC includes the MIKEY-TICKET response in the TRANSFER_RESP message created according to IETF RFC 6043 [33]. The MRFC inserts the key management protocol "a=key-mgmt" SDP attribute which indicates use of the MIKEY-TICKET ticket and contains the "base64" encoded TRANSFER_RESP message. The TRANSFER_RESP message includes the information required for the generation of keys.
10. The MRFC sends the SIP 200 (OK) final response (or 18x provisional response) to the SIP INVITE request with the SDP answer to the IMS UE-A.

After receiving the SIP 200 (OK) final response (or 18x provisional response) to the SIP INVITE request with the SDP answer the IMS UE-A extracts a key management data from the keymgmt-data field and "base64" decodes them to reconstruct the original TRANSFER-RESP message. The IMS UE-A verifies the TRANSFER-RESP message according to IETF RFC 6043 [33] and then verifies that the authenticated identity of the recipient corresponds to the policy for the MSRP session before completing the media security set-up.

6.2.19.2.2 IMS UE terminating procedures ("dial-out" scenario) for e2e

Figure 6.2.19.2.2.1 shows a "dial-out" conference procedure for one MSRP session using TLS and KMS based security.

NOTE: In the shown example it is assumed that the UE-B and the MRFC/MRFP support IETF RFC 6714 [40].

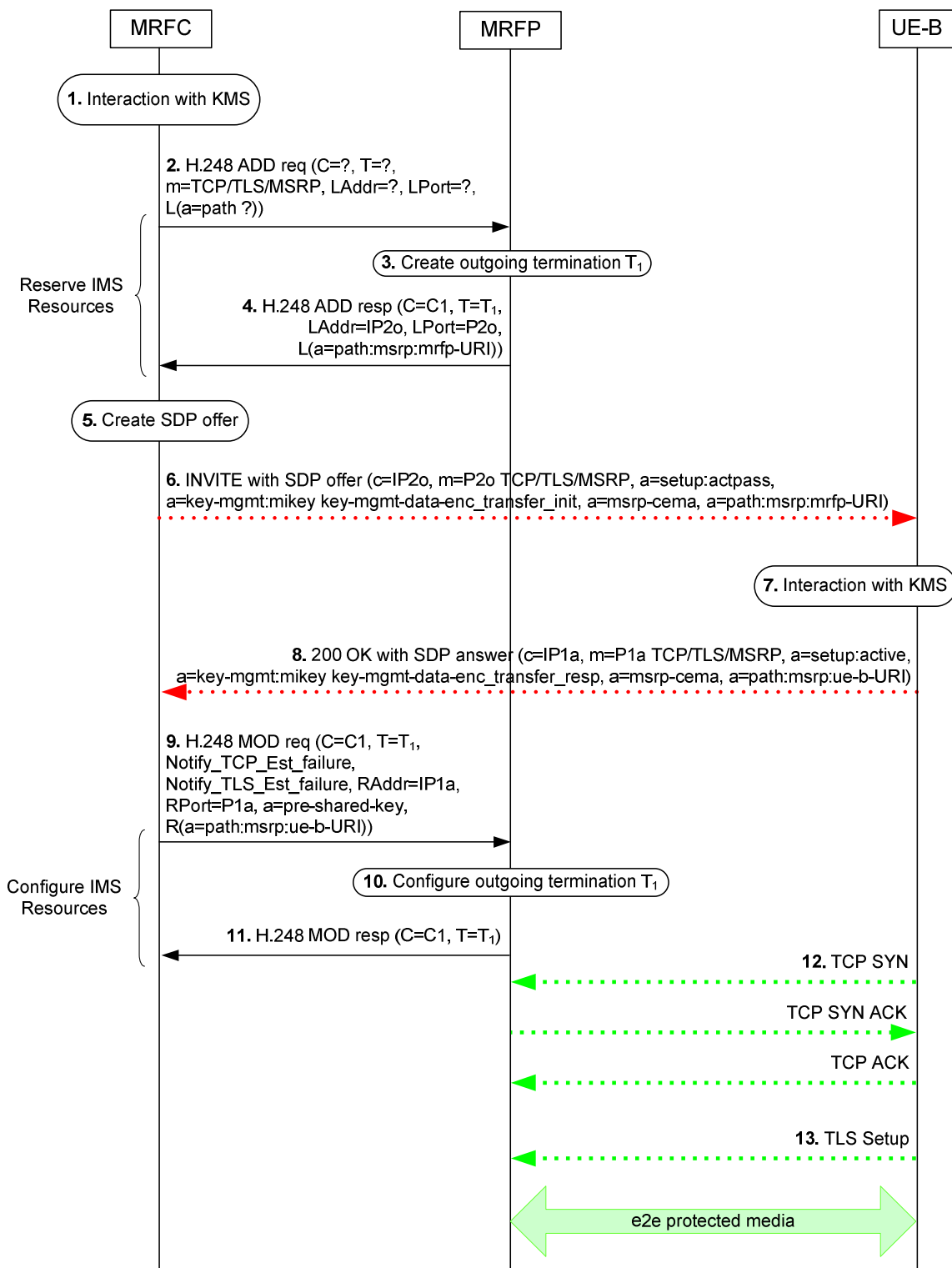

Figure 6.2.19.2.2.1: Terminating ("dial-out") example call flow for e2e case

The MRFC and the IMS UE-B performs an IMS "dial-out" conference session set-up according to 3GPP TS 23.228 [1], 3GPP TS 24.147 [4] and with modifications described in 3GPP TS 33.328 [31].

The procedure in the figure 6.2.19.2.2.1 for requesting e2e security for a media stream is described step-by-step with an emphasis on the additional aspects for the MRFC and the MRFP of the e2e media protection using TLS and KMS.

1. The MRFC receives a trigger to create an ad-hoc conference. Depending on the KMS and a local policy, the MRFC will either interact with the KMS to obtain keys and a MIKEY-TICKET ticket usable for the IMS UE-B, or it will create the ticket by itself. In the latter case, MIKEY-TICKET mode 3 as specified in

IETF RFC 6043 [33] is used, and the MRFC will then perform all key and ticket generation functions otherwise performed by the KMS.

The MRFC generates the TRANSFER_INIT message according to IETF RFC 6043 [33]. The identities of the initiator and the responder in the message are the KMS user identities derived from the URI's in the To and From header fields in the SIP INVITE request.

A single Crypto Session is included in the TRANSFER_INIT message as described in Annex H.3 of 3GPP TS 33.328 [31]. The protocol type in the Crypto Session is set to TLS.

2. - 4. The MRFC uses the "Reserve IMS resources" procedure to request a termination for "TCP/TLS/MSRP" media towards the IMS UE-B.
5. The MRFC creates an SDP offer with an MSRP based media over TLS transport protocol and inserts the "a=setup:actpass" SDP attribute specified in IETF RFC 4145 [36] and the key management protocol "a=key-mgmt" SDP attribute specified in IETF RFC 4567 [35] which indicates the use of the MIKEY-TICKET ticket and contains the TRANSFER_INIT message encapsulated in a keymgmt-data field.
6. The MRFC sends the SIP INVITE request with the SDP offer to the IMS UE-B.
7. Upon reception of the SIP INVITE request with the SDP offer containing a media stream that uses transport "TCP/TLS/MSRP", the IMS UE-B checks if it is authorized to resolve a ticket and if that is the case the IMS UE-B interacts with the KMS to resolve the ticket and receive keys.
8. The IMS UE-B includes the MIKEY-TICKET response in the TRANSFER_RESP message created according to IETF RFC 6043 [33]. The IMS UE-B inserts the key management protocol "a=key-mgmt" SDP attribute specified in IETF RFC 4567 [35].

The IMS UE-B sends the SIP 200 (OK) final response (or 18x provisional response) to the SIP INVITE request with an SDP answer.

9. - 11. After receiving the SIP 200 (OK) final response (or 18x provisional response) to the SIP INVITE request with the SDP answer the MRFC extracts a key management data from the keymgmt-data field and "base64" decodes them to reconstruct the original TRANSFER_RESP message. The MRFC verifies the TRANSFER_RESP message according to IETF RFC 6043 [33] and then verifies that the authenticated identity of the recipient corresponds to the policy for the MSRP session before completing the media security set-up.

The MRFC uses the "Configure IMS resources" procedure to configure a termination towards the IMS UE-B with an IP address and port received from the IMS UE-B and includes a Pre-Shared Key information element containing the derived PSK i.e. the Traffic-Encrypting Key associated with the Crypto Session that will be used by the MRFP in TLS handshake. The MRFC includes a Notify TCP connection establishment Failure Event information element to request reporting of an unsuccessful TCP connection set-up and a Notify TLS session establishment Failure Event information element to request reporting of an unsuccessful TLS session set-up.

12. The IMS UE-B sends a TCP SYN message towards the MRFP to establish a TCP connection. The MRFP answers with a TCP SYN ACK message and the IMS UE-B replies with a TCP ACK message, completing the TCP connection establishment.
13. Upon completion of the TCP connection establishment, the IMS UE-B starts a TLS session establishment using the received Pre-Shared Key information element to set-up a TLS-PSK tunnel to protect MSRP messages.

6.2.19.3 Specific procedures for Floor Control Service (BFCP)

6.2.19.3.1 IMS UE requesting e2e protected Floor control connection

Figure 6.2.19.3.1.1 shows a "dial-in" conference procedure for one BFCP session with an e2e media protection using TLS and KMS based security.

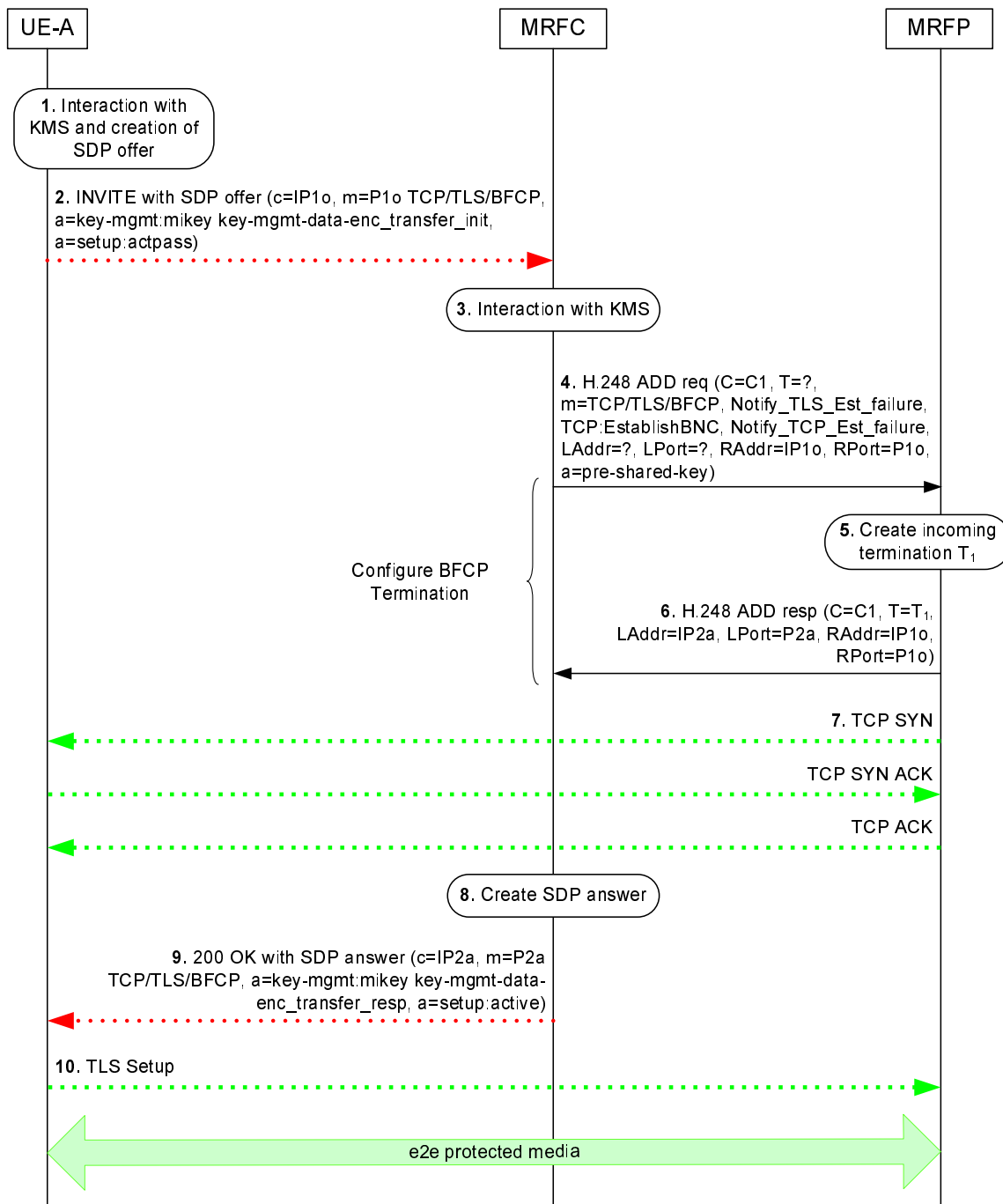

Figure 6.2.19.3.1.1: UE requesting Floor control connection with FCS/MRFP - example call flow for e2e case

The IMS UE-A wants to establish a Floor control connection with a Floor Control Server (FCS), located in the MRFP. The IMS UE-A and the MRFC perform a Floor control connection set-up according to 3GPP TS 23.228 [3], 3GPP TS 24.147 [21] and with modifications described in 3GPP TS 33.328 [2].

The procedure in the figure 6.2.19.3.1.1 for requesting e2e security of the Floor control connection is described step-by-step with an emphasis on the additional aspects for the MRFC and the MRFP of the e2e media protection using TLS and KMS.

1. As step 1 in clause 6.2.19.2.1.
2. As step 2 in clause 6.2.19.2.1 with the exception that SDP offer indicates "TCP/TLS/BFCP" as transport protocol.
3. As step 3 in clause 6.2.19.2.1.

- 4. - 6. The MRFC uses the "Configure BFCP Termination" procedure to request a termination for "TCP/TLS/BFCP" media. The MRFC provides an IP address and port received from the IMS UE-A and includes a Pre-Shared Key information element containing the derived PSK i.e. the Traffic-Encrypting Key associated with the Crypto Session that will be used by the MRFP in TLS handshake. The MRFC includes a Notify TCP connection establishment Failure Event information element to request the MRFP to report an unsuccessful TCP connection set-up and a Notify TLS session establishment Failure Event information element to request the MRFP to report an unsuccessful TLS session set-up. In accordance to the information in the "a=setup" SDP attribute that will be sent in an SDP answer the MRFC requests the MRFP to start a TCP connection establishment.
- 7. As step 7 in clause 6.2.19.2.1.
- 8. As step 9 in clause 6.2.19.2.1.
- 9. As step 10 in clause 6.2.19.2.1 with the exception that the SDP answer indicates "TCP/TLS/BFCP" as transport protocol.
- 10. Upon completion of the TCP connection establishment and the reception of the SDP answer with a key management data, the IMS UE-A starts a TLS session establishment, in accordance to IETF RFC 4583 [21], using the received PSK to set-up a TLS-PSK tunnel to protect MSRP messages.

6.2.19.4 TLS session establishment Failure Indication

The MRFP shall use a Notify TLS session establishment Failure Indication procedure to report TLS session establishment related failures.

The figure 6.2.19.4.1 shows the message sequence chart example when the MRFP reports an unsuccessful TLS session set-up to the MRFC.

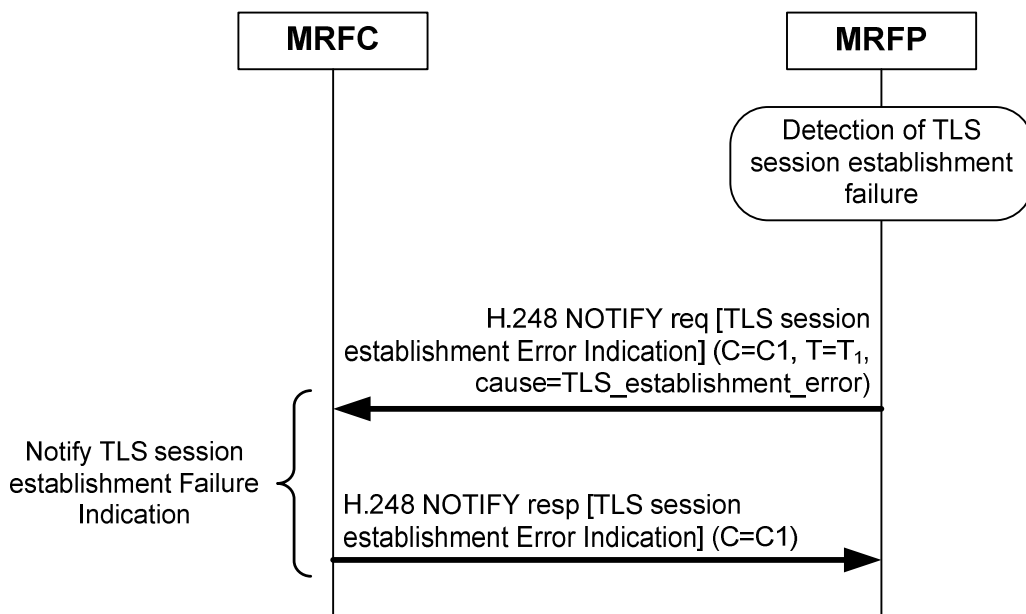
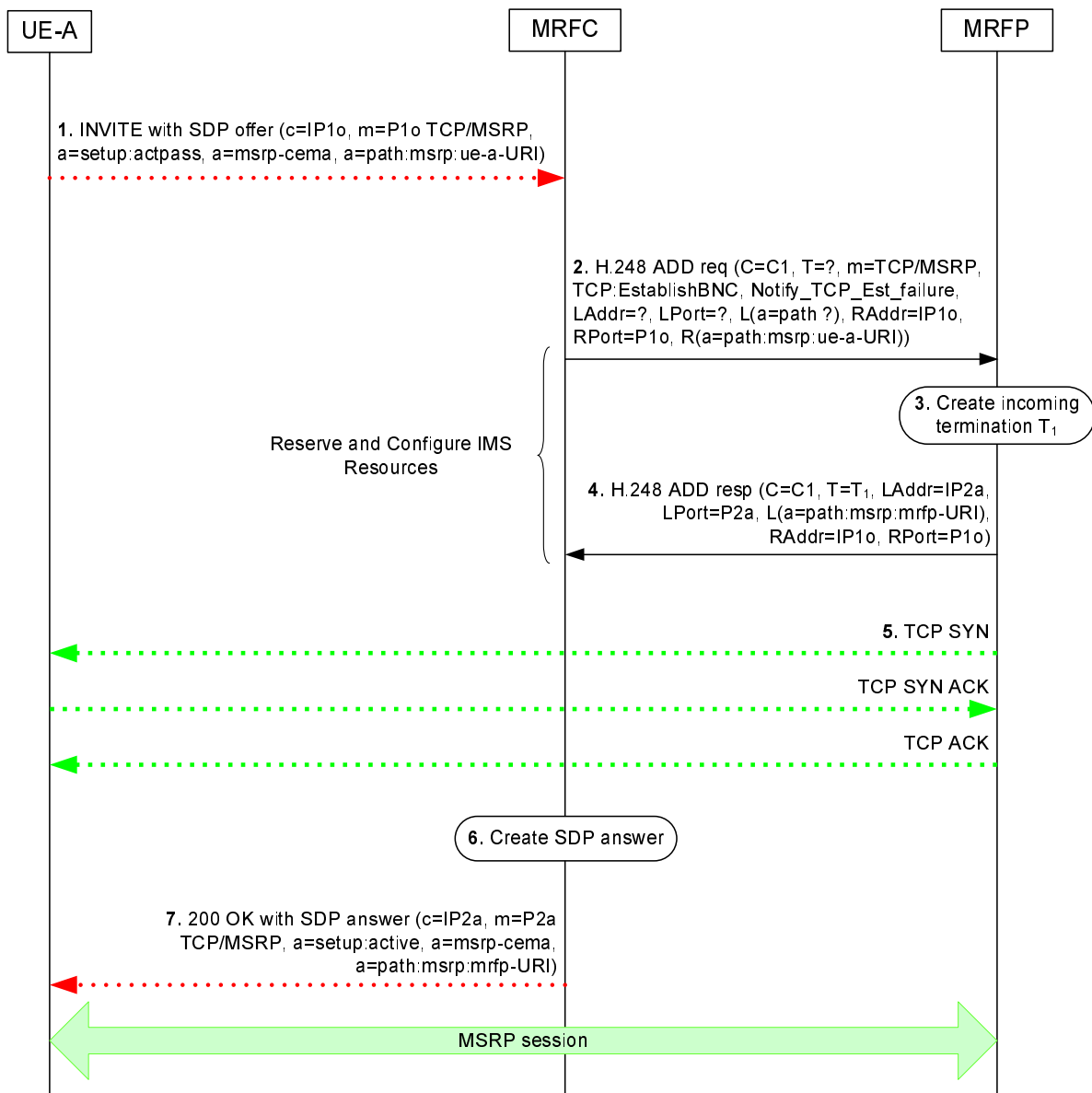

Figure 6.2.19.4.1: TLS session establishment Failure Indication

6.2.20 TCP bearer connection control

6.2.20.1 TCP connection establishment

Figure 6.2.20.1.1 shows an example call flow for a MSRP session set-up procedure, where the UE wants to join a messaging conference.



NOTE: In the shown example it is assumed that the UE-A and the MRFC/MRFP support IETF RFC 6714 [40].

Figure 6.2.20.1.1: UE connecting into a messaging conference

The IMS UE-A and the MRFC perform an IMS conference session set-up according to 3GPP TS 23.228 [1], 3GPP TS 24.247 [17] and 3GPP TS 24.147 [4]. The procedure in the figure 6.2.20.1.1 is described step-by-step with an emphasis on the additional aspects for the MRFC and the MRFP of the TCP connection establishment.

1. The IMS UE-A wants to join a messaging conference. For this purpose the IMS UE-A assigns a local TCP port number for the MSRP communication and builds an SDP offer containing the "a=setup:actpass" SDP attribute specified in IETF RFC 4145 [36].

The IMS UE-A sends the SIP INVITE request with the SDP offer.

2. - 4. Upon reception of the SIP INVITE request with the SDP offer containing a media stream that uses "TCP/MSRP" transport protocol, the MRFC uses the "Reserve And Configure IMS resources" procedure to request a termination for "TCP/MSRP" media. The MRFC provides an IP address and TCP port received from the IMS UE-A as part of a remote descriptor, requests the MRFP to allocate a local IP address and TCP port and includes a Notify TCP connection establishment Failure Event information element to request the MRFP to report an unsuccessful TCP connection set-up. In accordance to the information in the "a=setup" SDP attribute that will be sent in an SDP answer the MRFC requests the MRFP to start a TCP connection establishment.

5. The MRFP sends a TCP SYN message towards the IMS UE-A to establish a TCP connection. The IMS UE-A answers with a TCP SYN ACK message and the MRFP replies with a TCP ACK message, completing the TCP connection establishment.
6. The MRFC builds the SDP answer containing the "a=setup:active" SDP attribute and inserts the IP address and TCP port received from the MRFP.
7. The MRFC sends the 200 (OK) final response (or 18x provisional response) to the SIP INVITE request with the SDP answer for the MSRP session towards the IMS UE-A.

6.2.20.2 TCP connection establishment Failure Indication

The MRFP shall use a Notify TCP connection establishment Failure Indication procedure to report TCP connection establishment related failures.

The figure 6.2.20.2.1 shows the message sequence chart example when the MRFP reports an unsuccessful TCP connection set-up to the MRFC.

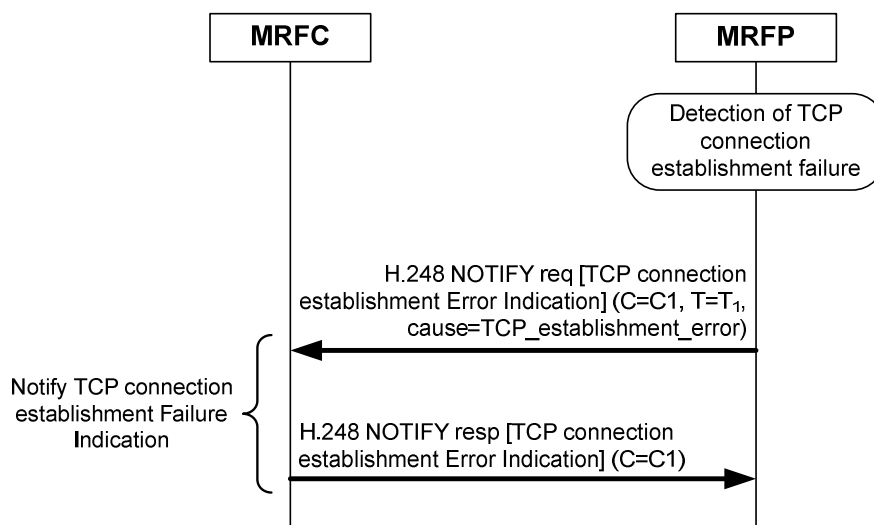

Figure 6.2.20.2.1: TCP connection establishment Failure Indication

6.2.21 Telepresence Procedures

6.2.21.1 CLUE data channel establishment

Figure 6.2.21.1.1 shows a message sequence chart example for CLUE data channel establishment procedure towards the SDP offerer (e.g. TP UE).

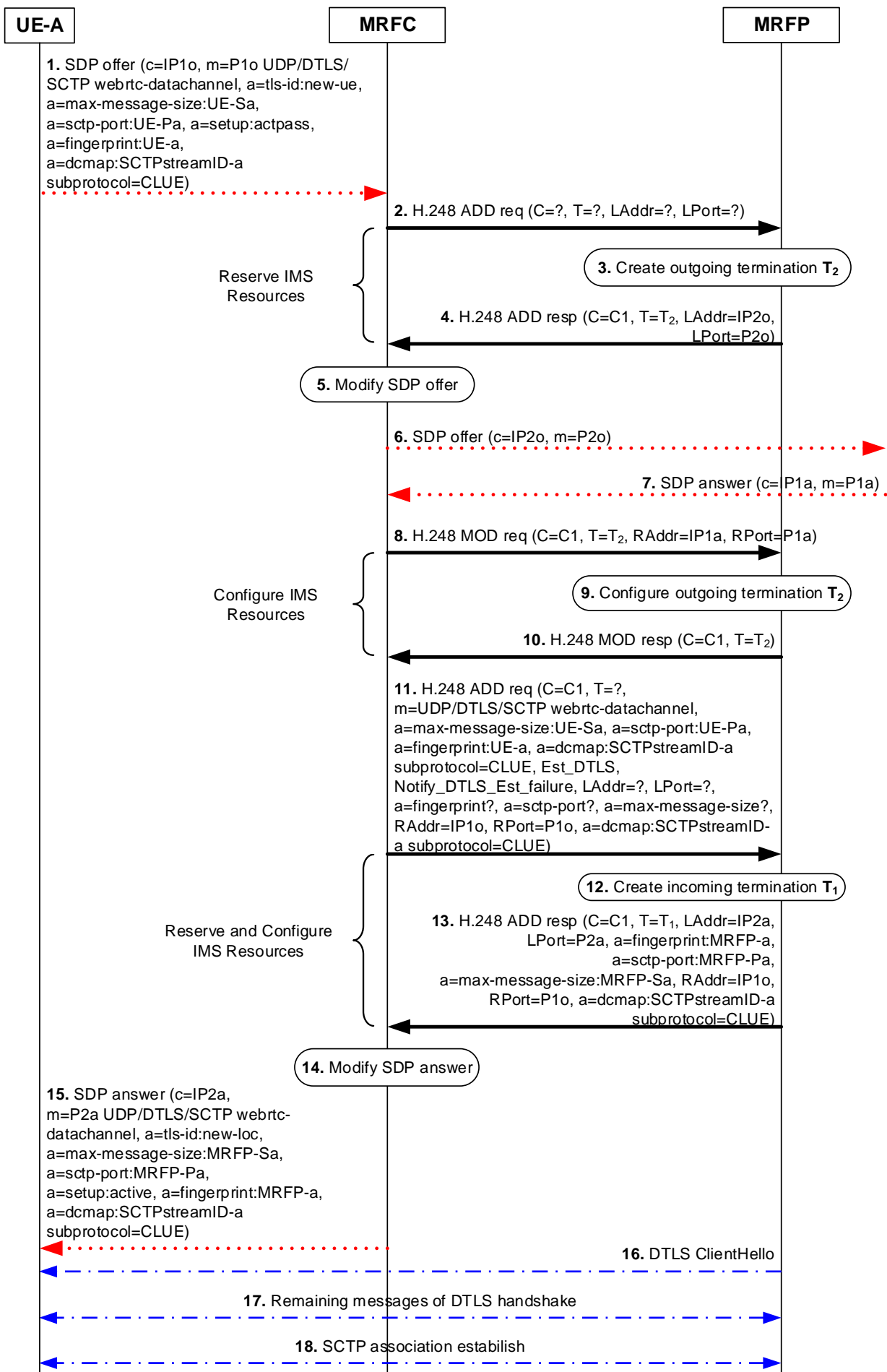
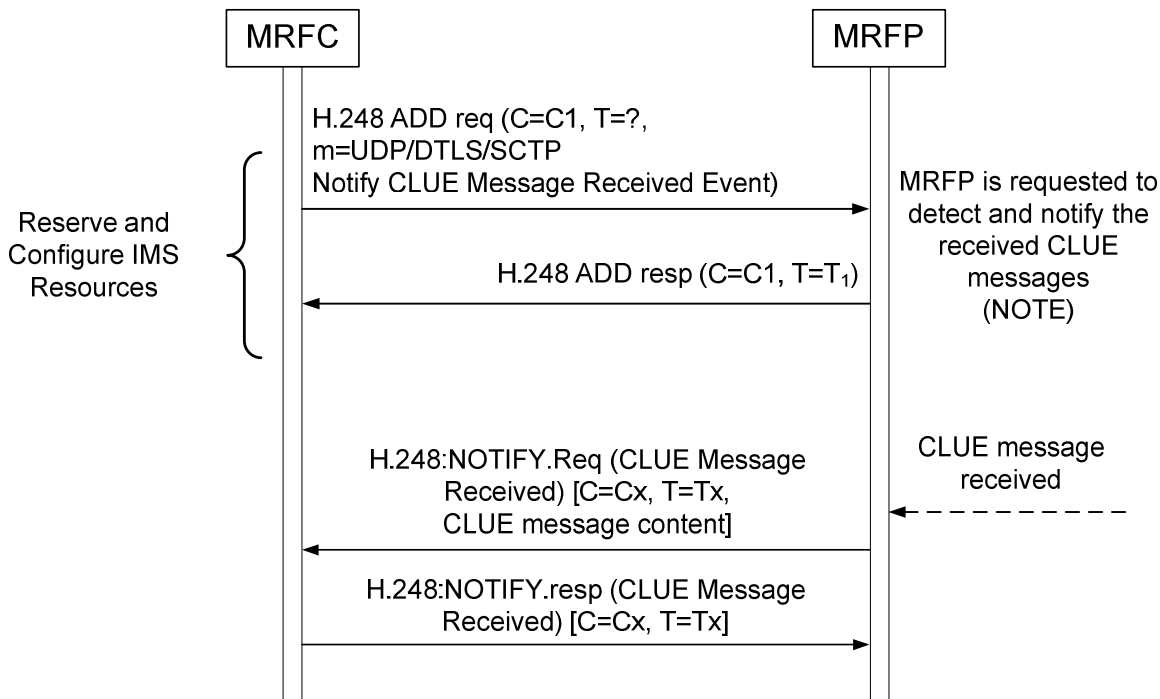

Figure 6.2.21.1.1: Procedure for CLUE data channel establishment towards the offerer

6.2.21.2 CLUE transport between MRFC and MRFP

Figure 6.2.21.2.1 shows a message sequence chart example for the initiation of CLUE message exchange procedure over Mp interface with the detection and notification of CLUE message received from the TP UE.



NOTE: Other IEs for Telepresence are shown in CLUE data channel establishment procedure.

Figure 6.2.21.2.1: Procedure for detection and notification of CLUE message received

Figure 6.2.21.2.2 shows a message sequence chart example for CLUE message carriage procedure towards the TP UE.

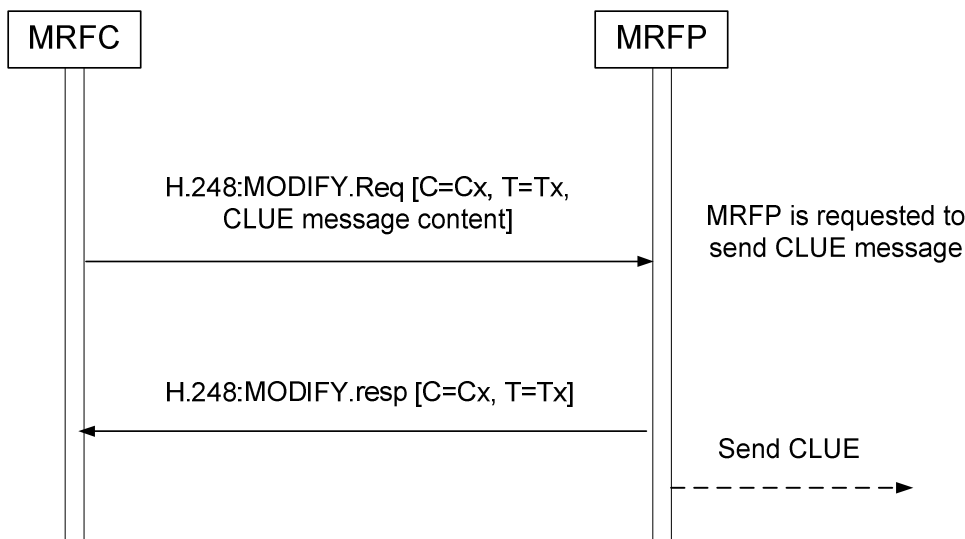

Figure 6.2.21.2.2: Procedure for sending CLUE message

6.2.22 Video Region-of-Interest (ROI)

6.2.22.1 Video Region-of-Interest (ROI) using FECC

Figure 6.2.22.1.1 shows the message sequence chart example for indicating Video Region-of-Interest (ROI) using FECC.

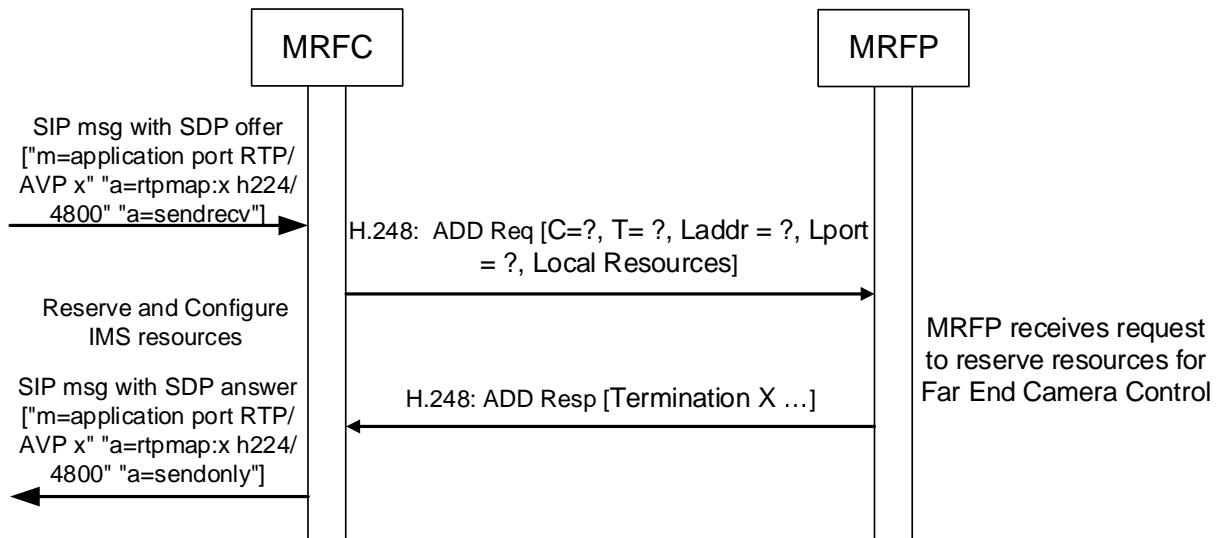

Figure 6.2.2.1.1: Procedure to indicate Video ROI using FECC

6.2.22.2 "Predefined ROI" mode

Figure 6.2.22.1 shows the message sequence chart example for indicating Predefined ROI mode.

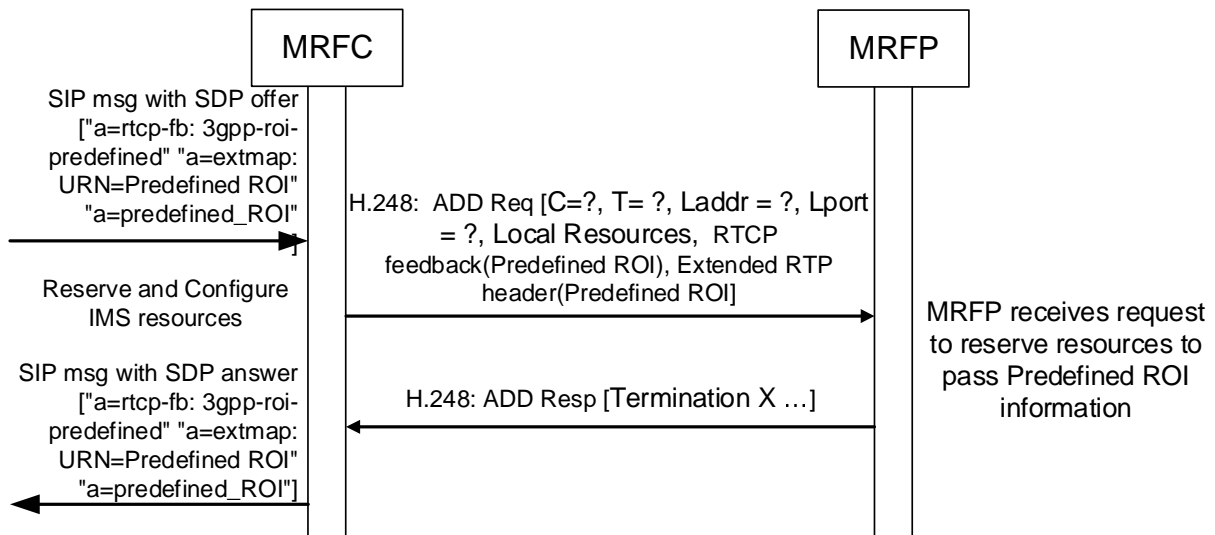

Figure 6.2.22.2.1: Procedure to indicate Predefined ROI mode

When the MRFC requests the IMS resources from the MRFP, the MRFC may optionally request the MRFP to support the RTCP feedback message capability for "Predefined ROI" type expressed by the parameter "3gpp-roi-predefined", as described in 3GPP TS 26.114 [23], media-level SDP predefined ROI attribute "a=predefined_ROI" defined in TS 26.114 [23] to negotiate the predefined ROI for sending and receiving video, and the RTP header extension capability for carriage of predefined ROI information as defined in IETF RFC 5285 [27] and 3GPP TS 26.114 [23].

6.2.22.3 "Arbitrary ROI" mode

Figure 6.2.22.3.1 shows the message sequence chart example for indicating Arbitrary ROI mode.

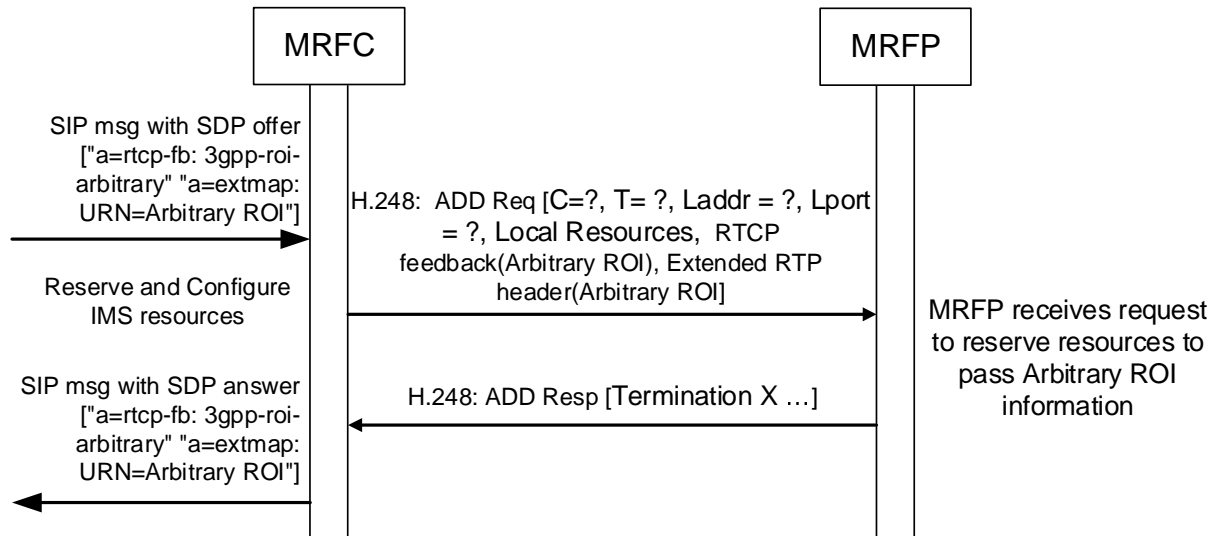

Figure 6.2.22.3.1: Procedure to indicate Arbitrary ROI mode

When the MRFC requests the IMS resources from the MRFP, the MRFC may optionally request the MRFP to support the RTCP feedback message capability for "Arbitrary ROI" type expressed by the parameter "3gpp-roi-arbitrary", as described in 3GPP TS 26.114 [23], and the RTP header extension capability for carriage of arbitrary ROI information as defined in IETF RFC 5285 [27] and 3GPP TS 26.114 [23].

6.2.23 Rate adaptation for media endpoints

The signalling flow shown in figure 6.2.23.1 gives an example for a multimedia conference establishment ("dial-in" conference procedure) when rate adaptation for media endpoints using the "a=bw-info" SDP attribute (defined in clause 19 of 3GPP TS 26.114 [23] to negotiate the additional bandwidth properties) is supported by the MRFC and the MRFP.

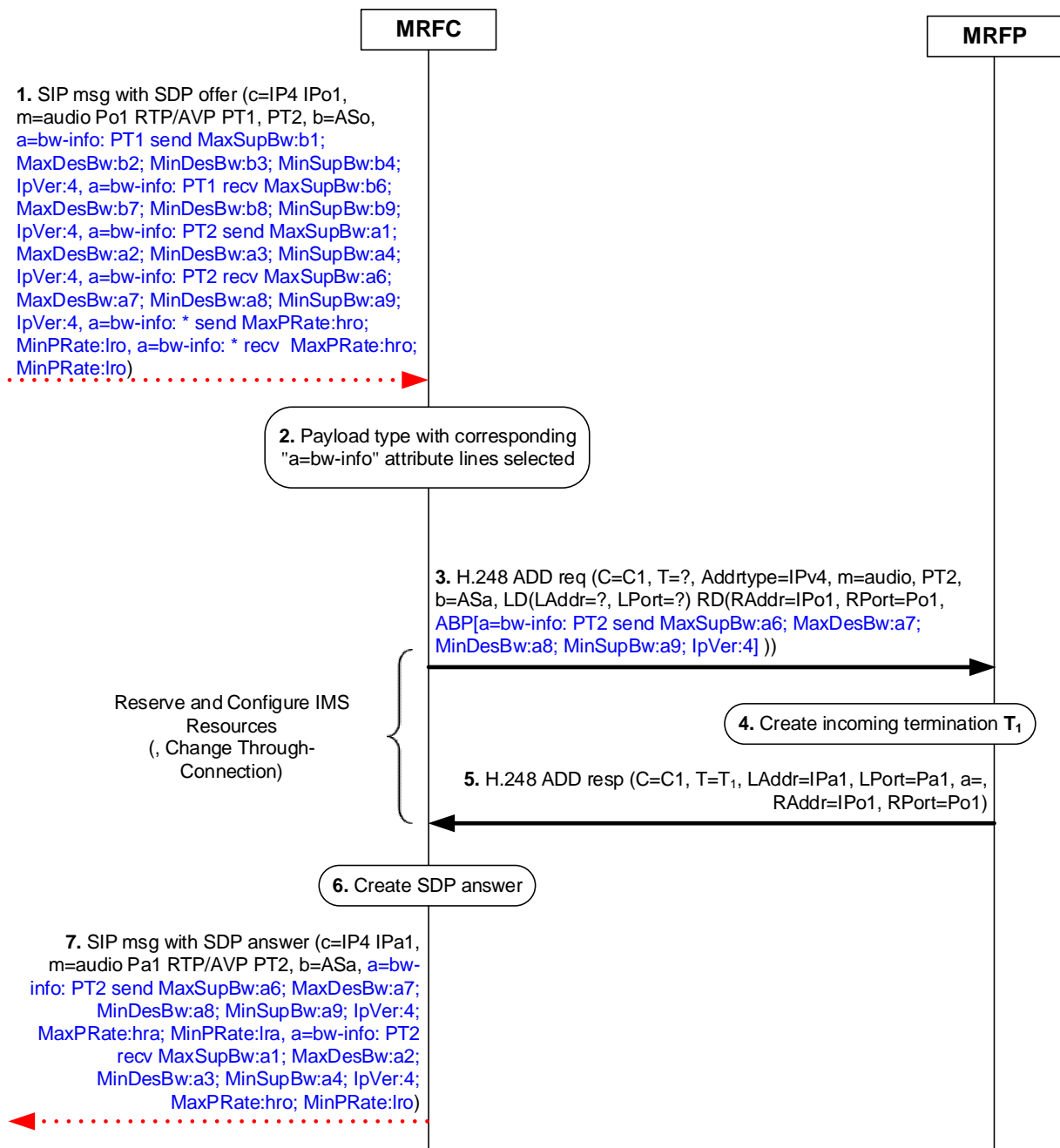

Figure 6.2.23.1: Multimedia conference establishment ("dial-in" procedure) with support of the enhanced bandwidth negotiation mechanism

The procedure in the figure 6.2.23.1 is described step-by-step with an emphasis on the additional aspects for the MRFC and the MRFP of the rate adaptation for media endpoints using the enhanced bandwidth negotiation mechanism.

1. The MRFC receives the SIP INVITE request with the SDP offer containing for the offered payload types "a=bw-info" SDP attribute lines.
2. The MRFC selects the payload type from the received SDP offer. The received SDP offer contained "a=bw-info" attribute(s) lines for the selected payload type.
3. – 5. The MRFC uses the "Reserve and Configure IMS resources" procedure to request media resources and for the selected payload type (codec and codec configurations) the MRFC provides to the MRFP the "Additional Bandwidth Properties" information element containing in the remote descriptor "a=bw-info" SDP attribute lines describing the bandwidth range which the MRFP will use in the sending direction towards the conference participant and which correspond to "a=bw-info" SDP attribute lines indicating receiving direction in the received SDP offer in step 1.

The encoder in the MRFP will use media bandwidth range for rate adaptation (i.e. to select an appropriate encoding and redundancy) when transcoding media streams.

6. The MRFC inserts in the SDP answer the IP address and RTP port received from the MRFP and for the selected payload type the "a=bw-info" SDP attribute lines.
7. The MRFC sends towards the conference participant the 200 (OK) final response (or 18x provisional response) to the SIP INVITE request with the SDP answer containing for the selected payload type "a=bw-info" SDP attribute lines.

The signalling flow shown in figure 6.2.23.2 gives an example for a multimedia conference establishment ("dial-out" conference procedure) when the rate adaptation for media endpoints using the enhanced bandwidth negotiation mechanism is supported by the MRFC and the MRFP.

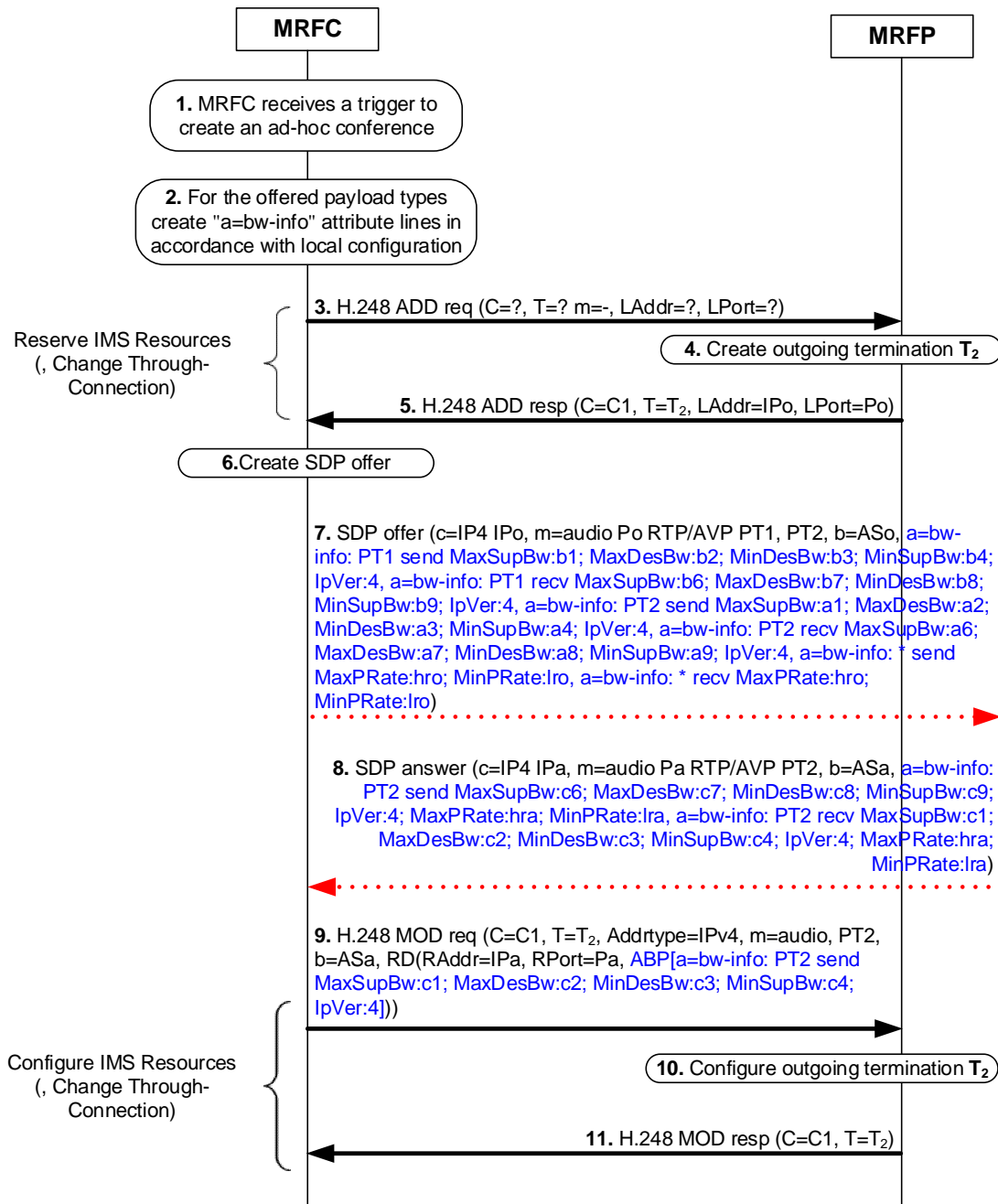

Figure 6.2.23.2: Multimedia conference establishment ("dial-out" procedure) with support of the enhanced bandwidth negotiation mechanism

The procedure in the figure 6.2.23.2 is described step-by-step with an emphasis on the additional aspects for the MRFC and the MRFP of the rate adaptation for media endpoints using the enhanced bandwidth negotiation mechanism.

1. The MRFC receives a trigger to create an ad-hoc conference.
2. Based on the local configuration the MRFC creates "a=bw-info" SDP attribute(s) for the offered payload types.
3. – 5. The MRFC uses the "Reserve IMS resources" procedure to request resources from the MRFP.
6. The MRFC inserts in the SDP offer the IP address and RTP port received from the MRFP and for the offered payload types the "a=bw-info" SDP attribute lines created in step 2.
7. The MRFC sends the SIP INVITE request with the SDP offer containing for the offered payload types "a=bw-info" SDP attribute lines towards the conference participant.
8. The MRFC receives the 200 (OK) final response (or 18x provisional response) to the SIP INVITE request with the SDP answer containing for the selected payload type "a=bw-info" SDP attribute lines.
9. – 11. The MRFC uses the "Configure IMS resources" procedure to configure media resources and for the selected payload type the MRFC provides to the MRFP the "Additional Bandwidth Properties" information element containing in the remote descriptor "a=bw-info" SDP attribute lines with the values received in step 8 describing the bandwidth range which the MRFP will use in the sending direction towards the conference participant and which correspond to "a=bw-info" SDP attribute lines indicating receiving direction in the received SDP answer in step 8.

The encoder in the MRFP will use media bandwidth range for rate adaptation (i.e. to select an appropriate encoding and redundancy) when transcoding media streams.

6.2.24 RTCP Codec Control Commands and Indications

Figure 6.2.24.1 shows the message sequence chart example for indicating "RTCP Codec Control Commands and Indications". The MRFC includes the "CCM BASE" information element in the Local and Remote descriptors to indicate that the MRFP shall be prepared to receive and is allowed to send the RTCP CCM "FIR" and "TMMBR/TMMBN" feedback messages (defined in IETF RFC 5104 [61]).

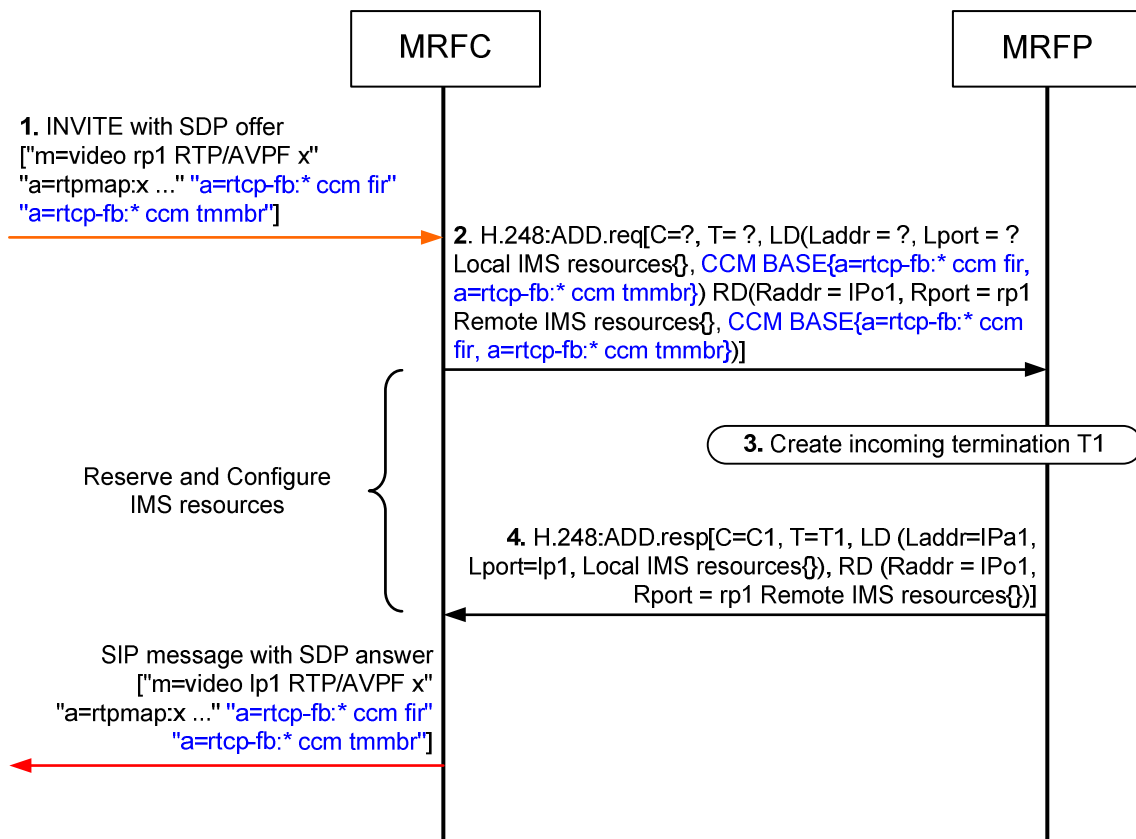

Figure 6.2.24.1: Procedure to indicate RTCP Codec Control Commands and Indications

6.2.25 Delay Budget Information (DBI)

Figure 6.2.25.1 shows a message sequence chart example for indicating "DBI" Signalling. The MRFC includes the "DBI" information element in the Local and Remote descriptors to indicate that the MRFP shall be prepared to receive and is allowed to send RTCP feedback messages for "DBI" as defined in 3GPP TS 26.114 [23].

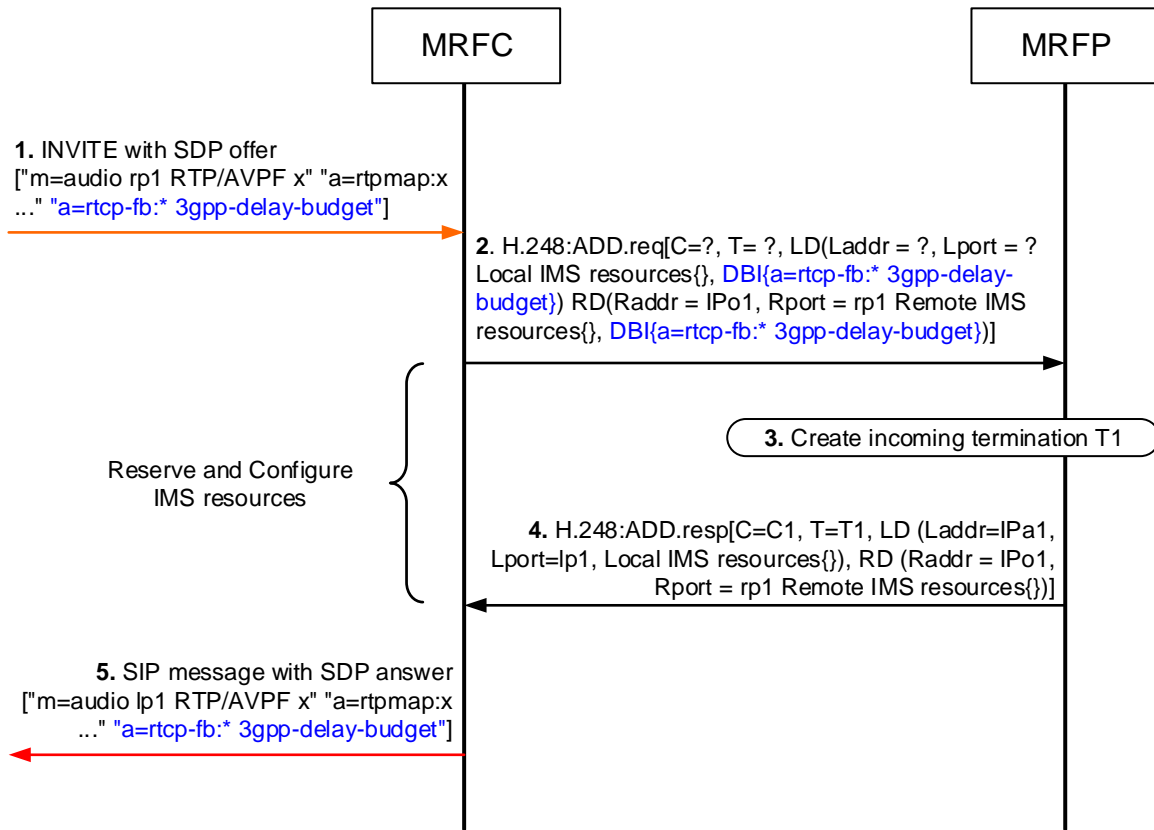

Figure 6.2.25.1: Procedure to support Delay Budget Information signalling

7 Charging

The charging is specified in 3GPP TS 32.260[14]; no requirements are identified for the Mp interface.

8 Messages/Procedures and contents

8.1 General

This clause describes logical signalling procedures between the MRFC and MRFP. The procedures within this clause are intended to be implemented using the standard H.248 procedure as defined in ITU recommendation H.248.1 [3] with appropriate parameter combinations.

8.2 Send tone

This procedure is used to send a tone.

Table 8.2.1: Procedures between MRFC and MRFP: Send Tone

Procedure	Initiated	Information element name	Information element required	Information element description
Send Tone MRFC		Context	M	This information element indicates the context for the bearer termination.
		Bearer Termination/Bearer Termination Request	M	This information element indicates the existing bearer termination or requests a new bearer termination where the tone is sent.
		Tone	M	This information element indicates the tone to be generated.
		Notify Tone Completion	O	This information element requests a notification of a completed tone.
		Tone Direction	O	This information element indicates the tone direction in the bearer termination.
		Tone Timing	O	This information element indicates the time for the tone.
		DTMF trigger	O	This information element indicates the MRFP to detect the DTMF and the MRFP should stop the tone when a DTMF digit is detected.
		Notify termination heartbeat	C	This information element requests termination heartbeat indications. This information element shall be included when requesting a new bearer termination.
Send Tone Ack	MRFP	Context	M	This information element indicates the context where the command was executed.
		Bearer Termination	M	This information element indicates the bearer termination where the command was executed.

NOTE This procedure may be combined with other procedures such as to ADD bearer connections.

8.3 Stop tone

This procedure is used to stop the tone.

Table 8.3.1: Procedures between MRFC and MRFP: Stop Tone

Procedure	Initiated	Information element name	Information element required	Information element description
Stop Tone	MRFC	Context	M	This information element indicates the context for the bearer termination.
		Bearer Termination	M	This information element indicates the bearer termination where the tone is stopped.
		Stop Tone	M	This information element requests that tone generation is stopped.
Stop Tone Ack	MRFP	Context	M	This information element indicates the context where the command was executed.
		Bearer Termination	M	This information element indicates the bearer termination where the command was executed.

8.4 Tone completed

This procedure is used to notify the completed tone.

Table 8.4.1: Procedures between MRFC and MRFP: Tone Completed

Procedure	Initiated	Information element name	Information element required	Information element description
Tone Completed	MRFP	Context	M	This information element indicates the context for the bearer termination.
		Bearer Termination	M	This information element indicates the bearer termination where the tone was completed.
		Tone Completed	M	This information element indicates completion of the tone.
		Cause	M	This information element indicates the cause of tone completion.
Tone Completed Ack	MRFC	Context	M	This information element indicates the context where the command was executed.
		Bearer Termination	M	This information element indicates the Bearer Termination where the command was executed.

8.5 Start announcement

This procedure is used to request to start announcement.

Table 8.5.1: Procedures between MRFC and MRFP: Start announcement

Procedure	Initiated	Information element name	Information element required	Information element description
Start announcement MRFC		Context	M	This information element indicates the context for the bearer termination.
		Bearer Termination/Bearer Termination Request	M	This information element indicates the existing bearer termination or requests a new bearer termination where the announcement is sent.
		Announcement identifier	M	This information element indicates the announcement or announcement list to be played.
		Audio file format	O	This information element indicates the audio file type, such as the 3GPP file type.
		Direction	O	This information element indicates the announcement direction in the bearer termination.
		Iterations	O	This information element indicates the number of times the announcement shall be played
		Variable List	O	This information element indicates the variable or variable list to be played.
		Notify Announcement Completed	O	This information element requests a notification of a completed announcement.
		DTMF stop announcement	O	This information element indicates whether the MRFP should stop the announcement when a DTMF digit is detected.
		Notify termination heartbeat	C	This information element requests termination heartbeat indications. This information element shall be included when requesting a new bearer termination.
	MRFP	Context	M	This information element indicates the context where the command was executed.

Start announcement Ack		Bearer Termination	M	This information element indicates the bearer termination where the command was executed.
------------------------	--	--------------------	---	---

NOTE This procedure may be combined with other procedures such as to ADD bearer connections.

8.6 Stop Announcement

This procedure is used to stop the announcement.

Table 8.6.1: Procedures between MRFC and MRFP: Stop Announcement

Procedure	Initiated	Information element name	Information element required	Information element description
Stop Announcement	MRFC	Context	M	This information element indicates the context for the bearer termination.
		Bearer Termination	M	This information element indicates the bearer termination where the announcement is stopped.
		Stop Announcement	M	This information element requests that announcement playing is stopped.
Stop Announcement Ack	MRFP	Context	M	This information element indicates the context where the command was executed.
		Bearer Termination	M	This information element indicates the bearer termination where the command was executed.

8.7 Announcement Completed

This procedure is used to notify the completed announcement.

Table 8.7.1: Procedures between MRFC and MRFP Announcement Completed

Procedure	Initiated	Information element name	Information element required	Information element description
Announcement Completed	MRFP	Context	M	This information element indicates the context for the bearer termination.
		Bearer Termination	M	This information element indicates the bearer termination where the announcement was completed.
		Announcement Completed	M	This information element indicates completion of the announcement.
		Cause	M	This information element indicates the cause of announcement completion.
Announcement Completed Ack	MRFC	Context	M	This information element indicates the context where the command was executed.
		Bearer Termination	M	This information element indicates the Bearer Termination where the command was executed.

8.8 Start audio record

This procedure is used to start the audio record.

Table 8.8.1: Procedures between MRFC and MRFP: Start audio record

Procedure	Initiated	Information element name	Information element required	Information element description
Start audio record MRFC		Context	M	This information element indicates the context for the bearer termination.

		Bearer Termination/Bearer Termination Request	M	This information element indicates the existing bearer termination or requests a new bearer termination where the audio is recorded.
		Record file Identifier	M	This information element indicates the record file Identifier or a request to the MRFP to create the record file Identifier.
		Record file Format	O	This information element indicates the audio record file format.
		Maximum Record Timer	O	This information element indicates the maximum allowable length of the recording
		Notify audio record Completed	O	This information element requests a notification of a completed audio record.
		Notify termination heartbeat	C	This information element requests termination heartbeat indications. This information element shall be included when requesting a new bearer termination.
Start audio record Ack	MRFP	Context	M	This information element indicates the context where the command was executed.
		Bearer Termination	M	This information element indicates the bearer termination where the command was executed.
		Record File identifier	O	This information element indicates the file identifier created by the MRFP if the MRFC request to create a file URI.

NOTE This procedure may be combined with other procedures such as to ADD bearer connections.

8.9 Stop audio record

This procedure is used to stop the audio record.

Table 8.9.1: Procedures between MRFC and MRFP: Stop audio record

Procedure	Initiated	Information element name	Information element required	Information element description
Stop audio record	MRFC	Context	M	This information element indicates the context for the bearer termination.
		Bearer Termination	M	This information element indicates the bearer termination where the audio record is stopped.
		Stop audio record	M	This information element requests that audio record is stopped.
Stop audio record Ack	MRFP	Context	M	This information element indicates the context where the command was executed.
		Bearer Termination	M	This information element indicates the bearer termination where the command was executed.

8.10 Audio record completed

This procedure is used to report the audio record completed.

Table 8.10.1: Procedures between MRFC and MRFP: Report audio record completed

Procedure	Initiated	Information element name	Information element required	Information element description
Audio Record Completed	MRFP	Context	M	This information element indicates the context for the bearer termination.
		Bearer Termination	M	This information element indicates the bearer termination where the audio record was completed.
		audio record Completed	M	This information element indicates the audio record completed.
		Cause	M	This information element indicates the return code of audio record.

Audio record Completed Ack	MRFC	Context	M	This information element indicates the context where the command was executed.
		Bearer Termination	M	This information element indicates the Bearer Termination where the command was executed.

8.11 Detect DTMF

This procedure is used to request detection of a DTMF digit.

Table 8.11.1: Procedures between MRFC and MRFP: Detect DTMF

Procedure	Initiated	Information element name	Information element required	Information element description
Detect DTMF	MRFC	Context	M	This information element indicates the context for the bearer termination.
		Bearer Termination/Bearer Termination Request	M	This information element indicates the existing bearer termination or requests a new bearer termination where the DTMF digit detection is requested.
		Start_DTMF_Detection	M	This information element requests MRFP to detect a DTMF digit.
Detect DTMF Ack	MRFP	Context	M	This information element indicates the context where the command was executed.
		Bearer Termination	M	This information element indicates the bearer termination where the command was executed.

NOTE This procedure may be combined with other procedures such as to ADD bearer connections.

8.12 Stop DTMF Detection

This procedure is used to stop detection of the DTMF digit.

Table 8.12.1: Procedures between MRFC and MRFP: Stop DTMF Detection

Procedure	Initiated	Information element name	Information element required	Information element description
Stop DTMF Detection	MRFC	Context	M	This information element indicates the context for the bearer termination.
		Bearer Termination	M	This information element indicates the bearer termination where the DTMF digit detection is stopped.
		Stop DTMF Detection	M	This information element requests that DTMF digit detection is stopped.
Stop DTMF Detection Ack	MRFP	Context	M	This information element indicates the context where the command was executed.
		Bearer Termination	M	This information element indicates the bearer termination where the command was executed.

8.13 Report DTMF

This procedure is used to report a detected DTMF digit.

Table 8.13.1: Procedures between MRFP and MRFC: Report DTMF

Procedure	Initiated	Information element name	Information element required	Information element description
Report DTMF	MRFP	Context	M	This information element indicates the context for the bearer termination.
		Bearer Termination	M	This information element indicates the bearer termination where the DTMF digit was detected.
		Digit	M	This information element reports the detected DTMF digit.
Report DTMF Ack	MRFC	Context	M	This information element indicates the context where the command was executed.
		Bearer Termination	M	This information element indicates the Bearer Termination where the command was executed.

8.14 Start playing multimedia

This procedure is used to start playing multimedia.

Table 8.14.1: Procedures between MRFC and MRFP: start playing multimedia

Procedure	Initiated	Information element name	Information element required	Information element description
Start playing multimedia MRFC		Context	M	This information element indicates the context for the bearer termination.
		Bearer Termination/Bearer Termination Request	M	This information element indicates the existing bearer termination or requests a new bearer termination where the multimedia is sent.
		Multimedia identifier	M	This information element indicates the multimedia or list of multimedia to be played. This may be a single identifier or one identifier per media type.
		Multimedia file format	O	This information element indicates the multimedia file type, such as the 3GP file type.
		Iterations	O	This information element indicates the number of times the multimedia shall be played
		Direction	O	This information element indicates the direction of the multimedia to be sent.
		Notify multimedia completed	O	This information element requests a notification when the playing multimedia is completed.
		DTMF stop multimedia	O	This information element indicates the MRFP to detect the DTMF digits and stop the playing multimedia when a pre-defined DTMF digit is detected.
		Notify termination heartbeat	C	This information element requests termination heartbeat indications. This information element shall be included when requesting a new bearer termination.

Start playing multimedia Ack	MRFP	Context	M	This information element indicates the context where the command was executed.
		Bearer Termination	M	This information element indicates the bearer termination where the command was executed.

NOTE This procedure may be combined with other procedures such as to ADD bearer connections.

8.15 Stop playing multimedia

This procedure is used to stop playing multimedia.

Table 8.15.1: Procedures between MRFC and MRFP: Stop playing multimedia

Procedure	Initiated	Information element name	Information element required	Information element description
Stop playing multimedia	MRFC	Context	M	This information element indicates the context for the bearer termination.
		Bearer Termination	M	This information element indicates the existing bearer termination.
		Stop playing multimedia	M	This information element requests that multimedia playing is stopped.
stop playing multimedia Ack	MRFP	Context	M	This information element indicates the context where the command was executed.
		Bearer Termination	M	This information element indicates the bearer termination where the command was executed.

8.16 Playing multimedia completed

This procedure is used to report the playing multimedia completed.

Table 8.16.1: Procedures between MRFC and MRFP: Report playing multimedia completed

Procedure	Initiated	Information element name	Information element required	Information element description
Report playing multimedia completed	MRFP	Context	M	This information element indicates the context for the bearer termination.
		Bearer Termination	M	This information element indicates the existing bearer termination.
		Playing Completed	M	This information element indicates completed of the multimedia play.
		Cause	M	This information element indicates the return code of playing multimedia.
Report playing multimedia completed ACK	MRFC	Context	M	This information element indicates the context where the command was executed.
		Bearer Termination	M	This information element indicates the bearer termination where the command was executed.

8.17 Start multimedia record

This procedure is used to start the multimedia record.

Table 8.17.1: Procedures between MRFC and MRFP: Start multimedia record

Procedure	Initiated	Information element name	Information element required	Information element description
-----------	-----------	--------------------------	------------------------------	---------------------------------

Start multimedia	Record MRFC	Context	M	This information element indicates the context for the bearer termination.
		Bearer Termination/Bearer Termination Request	M	This information element indicates the existing bearer termination or requests a new bearer termination where the multimedia is recorded.
		Multimedia file identifier	M	This information element indicates the multimedia record file identification or a request to the MRFP to create a file identifier.
		Multimedia file Format	O	This information element indicates the multimedia record file format.
		Maximum Record Timer	O	This information element indicates the maximum allowable length of the recording
		Notify multimedia record Completed	O	This information element requests a notification of a completed multimedia record.
		Notify termination heartbeat	C	This information element requests termination heartbeat indications. This information element shall be included when requesting a new bearer termination.
Start multimedia record Ack	MRFP	Context	M	This information element indicates the context where the command was executed.
		Bearer Termination	M	This information element indicates the bearer termination where the command was executed.
		File identifier	O	This information element indicates the file identification created by the MRFP if the MRFC request to create a file identifier.

NOTE This procedure may be combined with other procedures such as to ADD bearer connections.

8.18 Stop multimedia record

This procedure is used to stop the multimedia record.

Table 8.18.1: Procedures between MRFC and MRFP: Stop multimedia record

Procedure	Initiated	Information element name	Information element required	Information element description
Stop Multimedia Record	MRFC	Context	M	This information element indicates the context for the bearer termination.
		Bearer Termination	M	This information element indicates the existing bearer termination.
		Stop multimedia record	M	This information element requests that multimedia record is stopped.
Stop Multimedia record Ack	MRFP	Context	M	This information element indicates the context where the command is executed.
		Bearer Termination	M	This information element indicates the bearer termination where the command is executed.

8.19 Multimedia record completed

This procedure is used to report the multimedia record completed.

Table 8.19.1: Procedures between MRFC and MRFP: Report multimedia record completed

Procedure	Initiated	Information element name	Information element required	Information element description
Report multimedia record completed	MRFP	Context	M	This information element indicates the context for the bearer termination.
		Bearer Termination	M	This information element indicates the existing bearer termination.
		Multimedia record Completed	M	This information element indicates the multimedia record completed.
		Cause	M	This information element indicates the return code of multimedia record.
Report multimedia record completed ACK	MRFC	Context	M	This information element indicates the context where the command is executed.
		Bearer Termination	M	This information element indicates the bearer termination where the command is executed.

8.20 Reserve and Configure IMS Resources

This procedure is used to reserve multimedia-processing resources for an Mp interface connection; it is based on the procedure of the same name defined in 3GPP TS 29.163 [9].

Table 8.20.1: Procedures between MRFC and MRFP: Reserve and Configure IMS Resources

Procedure	Initiated	Information element name	Information element required	Information element description
Reserve and Configure IMS Resources	MRFC	Context/Context Request	M	This information element indicates the existing context or requests a new context for the bearer termination.
		Priority information	O	This information element requests the MRFP to apply priority treatment for the terminations and bearer connections in the specified context.
		IMSTermination Request	M	This information element indicates the existing bearer termination or requests a new IMS termination for the bearer to be established.
		Local IMS Resources	M	This information element indicates the resource(s) (i.e. codecs) for which the MRFP shall be prepared to receive user data. For terminations supporting any combination of video, audio and messaging this IE shall contain separate resources per stream.
		ReserveValue	O	This information element indicates if multiple local IMS resources are to be reserved
		Remote IMS Resources	M	This information element indicates the resource(s) (i.e. codecs) for which the MRFP shall send data. For terminations supporting any combination of video, audio and messaging this IE shall contain separate resources per stream.
		Local Connection Address Request	M	This information element requests an IP address and port number(s) on the MRFP that the remote end can send user plane data to. For terminations supporting any combination of video, audio and messaging this may contain multiple addresses.
		Remote Connection Address	M	This information element indicates the remote IP address and port number(s) that the MRFP can send user plane data to. For terminations supporting any combination of video, audio and messaging this may contain multiple addresses.
		Notify Released Bearer	O	This information element requests a notification of a released bearer.
		Notify termination heartbeat	C	This information element requests termination heartbeat indications. This information element shall be included when requesting a new bearer termination. Otherwise the information element is optional.
		ECN Enable	O	This information element requests the MRFP to apply ECN.
		ECN Initiation Method	C	This information element specifies the ECN Initiation method and requests the MRFP to perform IP header settings as an ECN endpoint. It may be included only if ECN is enabled.
Notify ECN Failure Event	C	This information element requests a notification if an ECN related error occurs It may be included only if ECN is enabled..		

		Diffserv Code Point	O	This information element requests the MRFP to apply a specific Diffserv Code Point to the IP headers.
		Extended RTP Header for CVO	O	This information element requests the MRFP to pass on the CVO extended RTP header as defined by IETF RFC 5285 [27].
		Generic Image Attributes	O	This information element indicates image attributes (e.g. image size) as defined by IETF RFC 6236 [28].
		STUN server request	O	This information element is present if MRFC requests the MRFP to answer STUN connectivity checks for ICE.
		ICE Connectivity Check	C	This information element requests the MRFP to perform ICE connectivity check as defined by IETF RFC 5245 [29]. It is only applicable for full ICE.
		Notify ICE Connectivity Check Result	C	This information element requests the MRFP to perform ICE connectivity check as defined by IETF RFC 8445 [66]. It is only applicable for full ICE.
		ICE password request	O	This information element is present if MRFC requests an ICE password.
		ICE Ufrag request	O	This information element is present if MRFC requests an ICE ufrag.
		ICE host candidate request	O	This information element is present if MRFC requests an ICE host candidate.
		ICE pacing request	O	This information element is present if MRFC requests a pacing value for connectivity checks (Ta timer value). It is only applicable for full ICE.
		ICE received candidate	O	This information element is present if MRFC indicates a received candidate for ICE.
		ICE received password	O	This information element is present if MRFC indicates a received password for ICE.
		ICE received Ufrag	O	This information element is present if MRFC indicates a received Ufrag for ICE.
		ICE received pacing	O	This information element is present if MRFC indicates a received pacing value for connectivity checks (Ta timer value). It is only applicable for full ICE.
		MSRP URI Path request	O	This information element requests the MSRP URI path information that the MRFP will insert in the MSRP message "From-Path" header field.
		MSRP URI Path	O	This information element provides the MSRP URI path information that the MRFP will insert in the MSRP message "To-Path" header field.
		Establish TCP connection	O	This information element requests the MRFP to take a TCP client role and to initiate a TCP connection establishment.
		Notify TCP connection establishment Failure Event	O	This information element requests a notification if a TCP connection establishment failure occurs.
		Establish (D)TLS session	O	This information element requests the MRFP to take a (D)TLS client role and to initiate a (D)TLS session establishment.
		Notify (D)TLS session establishment Failure Event	O	This information element requests a notification if a (D)TLS session establishment failure occurs.

		Pre-Shared Key	O	This information element is present if the MRFC wants that the media is protected using TLS tunnel established with MIKEY-TICKET procedures. It indicates the Traffic-Encrypting key associated with the Crypto Session that shall be used in TLS handshake.
		Allowed RTCP APP message types	O	This information element is present if the MRFC allows the MRFP to send RTCP APP packets of the indicated types. The MRFP shall not send other RTCP APP packets. If the parameter is not supplied, the MRFP shall not send any RTCP APP packets.
		Local certificate fingerprint Request	O	This information element is present if the MRFC requests the MRFP to establish the CLUE data channel. It requests the MRFP to provide a local certificate fingerprint.
		Remote certificate fingerprint	O	This information element is present if the MRFC requests the MRFP to establish the CLUE data channel. It indicates the remote certificate fingerprint.
		Local SCTP Port Request	O	This information element is present if the MRFC requests the MRFP to establish the CLUE data channel. It requests the MRFP to provide a local SCTP Port.
		Remote SCTP Port	O	This information element is present if the MRFC requests the MRFP to establish the CLUE data channel. It indicates the remote SCTP port.
		SCTP Stream ID	O	This information element is present if the MRFC requests the MRFP to establish the CLUE data channel. It indicates the the actual SCTP stream identifier to realize the CLUE data channel.
		Subprotocol ID	O	This information element is present if the MRFC requests the MRFP to establish the CLUE data channel. It indicates the protocol "CLUE" to exchange via the data channel.
		Local max message size Request	O	This information element is present if the MRFC requests the MRFP to establish the CLUE data channel. It requests the MRFP to provide a local max message size.
		Remote max message size	O	This information element is present if the MRFC requests the MRFP to establish the CLUE data channel. It indicates the remote max message size.
		Extended RTP Header for Sent ROI	O	This information element requests the MRFP to pass on the ROI extended RTP header for carriage of predefined and/or arbitrary ROI information as defined by IETF RFC 5285 [27] and 3GPP TS 26.114 [23].
		Predefined ROI Sent	O	This information element requests the MRFP to support the RTCP feedback message capability for "Predefined ROI" type toward the ROI-sending client, expressed by the parameter "3gpp-roi-predefined", as described in 3GPP TS 26.114 [23].
		Predefined ROI Received	O	This information element requests the MRFP to support the RTCP feedback message capability for "Predefined ROI" type toward the ROI-receiving clients, expressed by the parameter "3gpp-roi-predefined", as described in 3GPP TS 26.114 [23].

		Arbitrary ROI Sent		This information element requests the MRFP to support the RTCP feedback message capability for "Arbitrary ROI" type toward the ROI-sending client, expressed by the parameter "3gpp-roi-arbitrary", as described in 3GPP TS 26.114 [23].
		Arbitrary ROI Received		This information element requests the MRFP to support the RTCP feedback message capability for "Arbitrary ROI" type toward the ROI-receiving clients, expressed by the parameter "3gpp-roi-arbitrary", as described in 3GPP TS 26.114 [23].
		Notify CLUE Message Received Event	O	This information element requests a reporting of the received CLUE message.
		SDPCapNeg configuration	O	This information element provides SDPCapNeg configuration(s) using as "a=acap", "a=icap", "a=pcfg" and "a=acfg" SDP attributes.
		Additional Bandwidth Properties	O	This information element indicates additional bandwidth properties using "a=bw-info" SDP attribute(s) as defined by 3GPP TS 26.114 [23].
		CCM BASE	O	This information element indicates that the MRFP shall be prepared to receive and is allowed to send, respectively, the RTCP feedback "CCM FIR" and/or "CCM TMMBR" messages (defined in IETF RFC 5104 [61]) to the end user.
		MMCMH policy	O	This information element indicates that interconnection of video media streams with different stream identities (StreamIDs) is allowed in the context and that the MRFP shall handle incoming RTP media streams autonomously according to MMCMH policies defined in clause 5.11.3.5.
		Stream content	O	This information element indicates the content of the media stream as defined in IETF RFC 4796 [59].
		Simulcast desc	O	This information element requests the MRFP to configure a termination with a simulcast capability. For the indicated media stream, it contains the list of simulcast RTP streams using the "a=simulcast" attribute defined IETF RFC 8853 [57].
		Simulcast format	O	This information element indicates the identity and the format of the simulcast RTP stream using the "a=rid" attribute defined in IETF RFC 8851 [58].
		CCM pause-resume	O	This information element requests the MRFP to apply "RTP-level pause and resume" procedures as defined in IETF RFC 7728 [62] and indicates to the MRFP which RTCP feedback "CCM PAUSE-RESUME" messages the MRFP may send to the end user.
		Autonomous request	O	This information element indicates whether the MRFP is allowed to autonomously send RTCP feedback CCM PAUSE and RESUME messages.
		Autonomous response	O	This information element indicates whether the MRFP is allowed to autonomously send response to a CCM PAUSE and RESUME requests i.e. RTCP feedback CCM PAUSED and REFUSED messages.

		Concurrent Codec Capabilities	O	This information element indicates the concurrent codec capabilities of an MMCMH conference participant in a compact representation using the "a=ccc_list" SDP attribute defined in 3GPP TS 26.114 [23].
		DBI	O	This information element indicates that the MRFP shall be prepared to receive and is allowed to send, respectively, the RTCP feedback messages for "DBI" signalling (as defined in 3GPP TS 26.114 [23] clause 7.3.8).
Reserve and Configure IMS Resources Ack	MRFP	Context	M	This information element indicates the context where the command was executed.
		IMSTermination	M	This information element indicates the Bearer Termination where the command was executed.
		Local IMS Resources	M	This information element indicates the resource(s) (i.e. codecs) for which the MRFP shall be prepared to receive user data. For terminations supporting any combination of video, audio and messaging this IE shall contain separate resources per stream.
		Remote IMS Resources	M	This information element indicates the resource(s) (i.e. codecs) for which the MRFP shall send data. For terminations supporting any combination of video, audio and messaging this IE shall contain separate resources per stream.
		Local Connection Address	M	This information element indicates the IP address and port number(s) the MRFP shall receive user plane data from IMS. For terminations supporting any combination of video, audio and messaging this may contain multiple addresses.
		Remote Connection Address	M	This information element indicates the remote IP address and port number(s) that the MRFP can send user plane data to. For terminations supporting any combination of video, audio and messaging this may contain multiple addresses.
		ICE password	C	This information element shall be present only if it was contained in the request. It indicates the ICE password assigned by the MRFP.
		ICE Ufrag	C	This information element shall be present only if it was contained in the request. It indicates the ICE Ufrag assigned by the MRFP.
		ICE host candidate	C	This information element shall be present only if it was contained in the request. It indicates the ICE host candidate assigned by the MRFP.
		ICE pacing	C	This information element shall be present only if it was contained in the request. It indicates a desired pacing value for connectivity checks (Ta timer value).

		ICE lite indication	C	This information element shall be present only if an ICE host candidate request was contained in the request, and the MRFP supports ICE lite, but not full ICE. It indicates that the MRFP only supports ICE lite.
		MSRP URI Path	C	This information element may be present only if the MSRP URI Path request was contained in the request. This information element provides the MSRP URI path information that the MRFP will insert in the MSRP message "From-Path" header field.
		Local certificate fingerprint	C	This information element may be present only if the Local certificate fingerprint Request was contained in the request. It indicates the local certificate fingerprint.
		Local SCTP Port	C	This information element may be present only if the Local SCTP Port Request was contained in the request. It indicates the local SCTP Port.
		SCTP Stream ID	C	This information element shall be present if it was contained in the request. It indicates the SCTP stream identifier that the MRFP used to realize the CLUE data channel.
		Subprotocol ID	C	This information element shall be present if it was contained in the request. It indicates the the protocol "CLUE" to exchange via the data channel.
		Local max message size	C	This information element may be present only if the Local max message size Request was contained in the request. It indicates the local max message size.
		SDPCapNeg configuration	C	This information element shall be present only if it was contained in the request. It provides SDPCapNeg configuration(s) using as "a=acap", "a=tcap", "a=pcfng" and "a=acfg" SDP attributes.

8.21 Reserve IMS Resources Procedure

This procedure is used to reserve local connection addresses and local resources in MRFP; it is based on the procedure of the same name defined in 3GPP TS 29.163 [9].

Table 8.21.1: Procedures between MRFC and MRFP: Reserve IMS Resources

Procedure	Initiated	Information element name	Information element required	Information element description
Reserve IMS Resources	MRFC	Context /Context Request	M	This information element indicates the existing context or requests a new context for the bearer termination.
		Priority information	O	This information element requests the MRFP to apply priority treatment for the terminations and bearer connections in the specified context.
		IMS Termination Request	M	This information element requests a new bearer termination
		Local IMS Resources	M	This information element indicates the resource(s) (i.e. codecs) for which the MRFP shall be prepared to receive user data. For terminations supporting any combination of video, audio and messaging this IE shall contain separate resources per stream.
		ReserveValue	O	This information element indicates if multiple local IMS resources are to be reserved.
		Local Connection Address Request	M	This information element requests an IP address and port number(s) on the MRFP that the remote end can send user plane data to. For terminations supporting any combination of video, audio and messaging this may contain multiple addresses.
		Notify Released Bearer	O	This information element requests a notification of a released bearer.
		Notify termination heartbeat	M	This information element requests termination heartbeat indications.
		ECN Enable	O	This information element requests the MRFP to apply ECN.
		ECN Initiation Method	C	This information element specifies the ECN Initiation method and requests the MRFP to perform IP header settings as an ECN endpoint. It may be included only if ECN is enabled.
		Notify ECN Failure Event	C	This information element requests a notification if an ECN related error occurs. It may be included only if ECN is enabled.
		Diffserv Code Point	O	This information element requests the MRFP to apply a specific Diffserv Code Point to the IP headers.
		Extended RTP Header for CVO	O	This information element requests the MRFP to pass on the CVO extended RTP header as defined by IETF RFC 5285 [27].
		Generic Image Attributes	O	This information element indicates image attributes (e.g. image size) as defined by IETF RFC 6236 [28].
		ICE password request	O	This information element is present if MRFC requests an ICE password.
		ICE Ufrag request	O	This information element is present if MRFC requests an ICE ufrag.
ICE host candidate request	O	This information element is present if MRFC requests an ICE host candidate.		
ICE pacing request	O	This information element is present if MRFC requests a pacing value for connectivity checks (Ta timer value). It is only applicable for full ICE.		

		STUN server request	O	This information element is present if MRFC requests the MRFP to answer STUN connectivity checks for ICE.
		MSRP URI Path request	O	This information element requests the MSRP URI path information that the MRFP will insert in the MSRP message "From-Path" header field.
		Notify TCP connection establishment Failure Event	O	This information element requests a notification if a TCP connection establishment failure occurs.
		Local certificate fingerprint Request	O	This information element is present if the MRFC requests the MRFP to establish the CLUE data channel. It requests the MRFP to provide a local certificate fingerprint.
		Local SCTP Port Request	O	This information element is present if the MRFC requests the MRFP to establish the CLUE data channel. It requests the MRFP to provide a local SCTP Port.
		SCTP Stream ID	O	This information element is present if the MRFC requests the MRFP to establish the CLUE data channel. It indicates the the actual SCTP stream identifier to realize the CLUE data channel.
		Subprotocol ID	O	This information element is present if the MRFC requests the MRFP to establish the CLUE data channel. It indicates the the protocol "CLUE" to exchange via the data channel.
		Local max message size Request	O	This information element is present if the MRFC requests the MRFP to establish the CLUE data channel. It requests the MRFP to provide a local max message size.
		Extended RTP Header for Sent ROI	O	This information element requests the MRFP to pass on the ROI extended RTP header for carriage of predefined and/or arbitrary ROI information as defined by IETF RFC 5285 [27] and 3GPP TS 26.114 [23].
		Predefined ROI Sent	O	This information element requests the MRFP to support the RTCP feedback message capability for "Predefined ROI" type toward the ROI-sending client, expressed by the parameter "3gpp-roi-predefined", as described in 3GPP TS 26.114 [23].
		Predefined ROI Received	O	This information element requests the MRFP to support the RTCP feedback message capability for "Predefined ROI" type toward the ROI-receiving clients, expressed by the parameter "3gpp-roi-predefined", as described in 3GPP TS 26.114 [23].
		Arbitrary ROI Sent	O	This information element requests the MRFP to support the RTCP feedback message capability for "Arbitrary ROI" type toward the ROI-sending client, expressed by the parameter "3gpp-roi-arbitrary", as described in 3GPP TS 26.114 [23].

		Arbitrary ROI Received	O	This information element requests the MRFP to support the RTCP feedback message capability for "Arbitrary ROI" type toward the ROI-receiving clients, expressed by the parameter "3gpp-roi-arbitrary", as described in 3GPP TS 26.114 [23].
		Notify CLUE Message Received Event	O	This information element requests a reporting of the received CLUE message.
		SDPCapNeg configuration	O	This information element provides SDPCapNeg configuration(s) using as "a=acap", "a=tcap", "a=pcfg" and "a=acfg" SDP attributes.
		MMCMH policy	O	This information element indicates that interconnection of video media streams with different stream identities (StreamIDs) is allowed in the context and that the MRFP shall handle incoming RTP media streams autonomously according to MMCMH policies defined in clause 5.11.3.5.
		Stream content	O	This information element indicates the content of the media stream as defined in IETF RFC 4796 [59].
		Simulcast desc	O	This information element requests the MRFP to configure a termination with a simulcast capability. For the indicated media stream, it contains the list of simulcast RTP streams using the "a=simulcast" attribute defined IETF RFC 8853 [57].
		Simulcast format	O	This information element indicates the identity and the format of the simulcast RTP stream using the "a=rid" attribute defined in IETF RFC 8851 [58].
		CCM pause-resume	O	This information element requests the MRFP to apply "RTP-level pause and resume" procedures as defined in IETF RFC 7728 [62] and indicates to the MRFP which RTCP feedback "CCM PAUSE-RESUME" messages the MRFP may send to the end user.
		Autonomous request	O	This information element indicates whether the MRFP is allowed to autonomously send RTCP feedback CCM PAUSE and RESUME messages.
		Autonomous response	O	This information element indicates whether the MRFP is allowed to autonomously send response to a CCM PAUSE and RESUME requests i.e. RTCP feedback CCM PAUSED and REFUSED messages.
Reserve IMS Resources Ack	MRFP	Context	M	This information element indicates the context where the command was executed.
		Bearer Termination	M	This information element indicates the Bearer Termination where the command was executed.
		Local IMS Resources	M	This information element indicates the resource(s) (i.e. codecs) for which the MRFP shall be prepared to receive user data For terminations supporting any combination of video, audio and messaging this IE shall contain separate resources per stream.

		Local Connection Address	M	<p>This information element indicates the IP address and port number(s) the MRFP shall receive user plane data from IMS.</p> <p>For terminations supporting any combination of video, audio and messaging this may contain multiple addresses.</p>
		ICE password	C	This information element shall be present only if it was contained in the request. It indicates the ICE password assigned by the MRFP.
		ICE Ufrag	C	This information element shall be present only if it was contained in the request. It indicates the ICE Ufrag assigned by the MRFP.
		ICE host candidate	C	This information element shall be present only if it was contained in the request. It indicates the ICE host candidate assigned by the MRFP.
		ICE pacing	C	This information element shall be present only if it was contained in the request. It indicates a desired pacing value for connectivity checks (Ta timer value).
		ICE lite indication	C	This information element shall be present only if an ICE host candidate request was contained in the request, and the MRFP supports ICE lite, but not full ICE. It indicates that the MRFP only supports ICE lite.
		MSRP URI Path	C	This information element may be present only if the MSRP URI Path request was contained in the request. This information element provides the MSRP URI path information that the MRFP will insert in the MSRP message "From-Path" header field.
		Local certificate fingerprint	C	This information element may be present only if the Local certificate fingerprint Request was contained in the request. It indicates the local certificate fingerprint.
		Local SCTP Port	C	This information element may be present only if the Local SCTP Port Request was contained in the request. It indicates the local SCTP Port.
		SCTP Stream ID	C	This information element shall be present if it was contained in the request. It indicates the SCTP stream identifier that the MRFP used to realize the CLUE data channel.
		Subprotocol ID	C	This information element shall be present if it was contained in the request. It indicates the the protocol "CLUE" to exchange via the data channel.
		Local max message size	C	This information element may be present only if the Local max message size Request was contained in the request. It indicates the local max message size.

		SDPCapNeg configuration	C	This information element shall be present only if it was contained in the request. It provides SDPCapNeg configuration(s) using as "a=acap", "a=tcap", "a=pcfg" and "a=acfg" SDP attributes.
--	--	-------------------------	---	--

8.22 Configure IMS Resources Procedure

This procedure is used to select multimedia-processing resources for an Mp interface connection; it is based on the procedure of the same name defined in 3GPP TS 29.163 [9].

Table 8.22.1: Procedures between MRFC and MRFP: Configure IMS Resources Procedure

Procedure	Initiated	Information element name	Information element required	Information element description
Configure IMS Resources	MRFC	Context	M	This information element indicates the context for the bearer termination.
		IMS Termination	M	This information element indicates the existing bearer termination.
		Local IMS Resources	O	This information element indicates the resource(s) (i.e. codecs) for which the MRFP shall be prepared to receive user data. For terminations supporting any combination of video, audio and messaging this IE shall contain separate resources per stream.
		Remote IMS Resources	M	This information element indicates the resource(s) (i.e. codecs) for which the MRFP shall send data. For terminations supporting any combination of video, audio and messaging this IE shall contain separate resources per stream.
		Local Connection Address	O	This information element indicates the IP address and port number(s) on the MRFP that the IMS user can send user plane data to. For terminations supporting video any combination of video, audio and messaging may contain multiple addresses.
		Remote Connection Address	M	This information element indicates the remote IP address and port number(s) that the MRFP can send user plane data to. For terminations supporting any combination of video, audio and messaging this may contain multiple addresses.
		Notify termination heartbeat	O	This information element requests termination heartbeat indications.
		ECN Enable	O	This information element requests the MRFP to apply ECN procedures.
		ECN Initiation Method	C	This information element specifies the ECN Initiation method and requests the MRFP to perform IP header settings as an ECN endpoint. It may be included if ECN is enabled.
		Notify ECN Failure Event	C	This information element requests a notification if an ECN related error occurs. It may be included if ECN is enabled.
		Extended RTP Header for CVO	O	This information element requests the MRFP to pass on the CVO extended RTP header as defined by IETF RFC 5285 [27].
Generic Image Attributes	O	This information element indicates image attributes (e.g. image size) as defined by IETF RFC 6236 [28].		

		ICE Connectivity Check	C	This information element requests the MRFP to perform ICE connectivity check as defined by IETF RFC 8445 [66]. It is only applicable for full ICE.
		Notify ICE Connectivity Check Result	C	This information element requests a notification of ICE connectivity check result. It is only applicable for full ICE.
		Notify New Peer Reflexive Candidate	C	This information element requests a notification of new peer reflexive candidate was discovered during a connectivity check. It is only applicable for full ICE.
		Additional ICE Connectivity Check	C	This information element requests the MRFP to perform additional ICE connectivity check as defined by IETF RFC 8445 [66]. It is only applicable for full ICE.
		ICE received candidate	O	This information element is present if MRFC indicates a received candidate for ICE.
		ICE received password	O	This information element is present if MRFC indicates a received password for ICE.
		ICE received Ufrag	O	This information element is present if MRFC indicates a received Ufrag for ICE.
		ICE received pacing	O	This information element is present if MRFC indicates a received pacing value for connectivity checks (Ta timer value). It is only applicable for full ICE.
		MSRP URI Path	O	This information element provides the MSRP URI path information that the MRFP will insert in the MSRP message "To-Path" header field.
		Establish TCP connection	O	This information element requests the MRFP to take a TCP client role and to initiate a TCP connection establishment.
		Notify TCP connection establishment Failure Event	O	This information element requests a notification if a TCP connection establishment failure occurs.
		Establish (D)TLS session	O	This information element requests the MRFP to take a (D)TLS client role and to initiate a (D)TLS session establishment.
		Notify (D)TLS session establishment Failure Event	O	This information element requests a notification if a (D)TLS session establishment failure occurs.
		Pre-Shared Key	O	This information element is present if the MRFC wants that the media is protected using TLS tunnel established with MIKEY-TICKET procedures. It indicates the Traffic-Encrypting key associated with the Crypto Session that shall be used in TLS handshake.
		Allowed RTCP APP message types	O	This information element is present if the MRFC allows the MRFP to send RTCP APP packets of the indicated types. The MRFP shall not send other RTCP APP packets. If the parameter is not supplied, the MRFP shall not send any RTCP APP packets.

		Extended RTP Header for Sent ROI	O	This information element requests the MRFP to pass on the ROI extended RTP header for carriage of predefined and/or arbitrary ROI information as defined by IETF RFC 5285 [27] and 3GPP TS 26.114 [23].
		Predefined ROI Sent	O	This information element requests the MRFP to support the RTCP feedback message capability for "Predefined ROI" type toward the ROI-sending client, expressed by the parameter "3gpp-roi-predefined", as described in 3GPP TS 26.114 [23].
		Predefined ROI Received	O	This information element requests the MRFP to support the RTCP feedback message capability for "Predefined ROI" type toward the ROI-receiving clients, expressed by the parameter "3gpp-roi-predefined", as described in 3GPP TS 26.114 [23].
		Arbitrary ROI Sent	O	This information element requests the MRFP to support the RTCP feedback message capability for "Arbitrary ROI" type toward the ROI-sending client, expressed by the parameter "3gpp-roi-arbitrary", as described in 3GPP TS 26.114 [23].
		Arbitrary ROI Received	O	This information element requests the MRFP to support the RTCP feedback message capability for "Arbitrary ROI" type toward the ROI-receiving clients, expressed by the parameter "3gpp-roi-arbitrary", as described in 3GPP TS 26.114 [23].
		Remote certificate fingerprint	O	This information element is present if the MRFC requests the MRFP to establish the CLUE data channel. It indicates the remote certificate fingerprint.
		Remote sctp port	O	This information element is present if the MRFC requests the MRFP to establish the CLUE data channel. It indicates the remote SCTP port.
		Remote max message size	O	This information element is present if the MRFC requests the MRFP to establish the CLUE data channel. It indicates the remote max message size.
		SDPCapNeg configuration	O	This information element provides SDPCapNeg configuration(s) using as "a=acap", "a=tcap", "a=pcfg" and "a=acfg" SDP attributes.
		Additional Bandwidth Properties	O	This information element indicates additional bandwidth properties using "a=bw-info" SDP attribute(s) as defined by 3GPP TS 26.114 [23].
		CCM BASE	O	This information element indicates that the MRFP shall be prepared to receive and is allowed to send, respectively, the RTCP feedback "CCM FIR" and/or "CCM TMMBR" messages (defined in IETF RFC 5104 [61]) to the end user.
		Stream content	O	This information element indicates the content of the media stream as defined in IETF RFC 4796 [59].

		Simulcast desc	O	This information element requests the MRFP to configure a termination with a simulcast capability. For the indicated media stream, it contains the list of simulcast RTP streams using the "a=simulcast" attribute defined IETF RFC 8853 [57].
		Simulcast format	O	This information element indicates the identity and the format of the simulcast RTP stream using the "a=rid" attribute defined in IETF RFC 8851 [58].
		CCM pause-resume	O	This information element requests the MRFP to apply "RTP-level pause and resume" procedures as defined in IETF RFC 7728 [62] and indicates to the MRFP which RTCP feedback "CCM PAUSE-RESUME" messages the MRFP may send to the end user.
		Autonomous request	O	This information element indicates whether the MRFP is allowed to autonomously send RTCP feedback CCM PAUSE and RESUME messages.
		Autonomous response	O	This information element indicates whether the MRFP is allowed to autonomously send response to a CCM PAUSE and RESUME requests i.e. RTCP feedback CCM PAUSED and REFUSED messages.
		Concurrent Codec Capabilities	O	This information element indicates the concurrent codec capabilities of an MMCMH conference participant in a compact representation using the "a=ccc_list" SDP attribute defined in 3GPP TS 26.114 [23].
		DBI	O	This information element indicates that the MRFP shall be prepared to receive and is allowed to send, respectively, the RTCP feedback messages for "DBI" signalling (as defined in 3GPP TS 26.114 [23] clause 7.3.8).
Configure IMS Resources Ack	MRFP	Context	M	This information element indicates the context where the command was executed.
		IMS Termination	M	This information element indicates the Bearer Termination where the command was executed.
		Local IMS Resources	O	This information element indicates the resource(s) (i.e. codecs) for which the MRFP shall be prepared to receive user data For terminations supporting any combination of video, audio and messaging this IE shall contain separate resources per stream.
		Remote IMS Resources	M	This information element indicates the resource(s) (i.e. codecs) for which the MRFP shall send data. For terminations supporting any combination of video, audio and messaging this IE shall contain separate resources per stream.
		Local Connection Address	O	This information element indicates the IP address and port number(s) on the MRFP that the IMS user can send user plane data to. For terminations supporting any combination of video, audio and messaging this may contain multiple addresses.

		Remote Connection Address	M	This information element indicates the remote IP address and port number(s) that the MRFP can send user plane data to. For terminations supporting any combination of video, audio and messaging this may contain multiple addresses.
--	--	---------------------------	---	--

8.23 Release IMS Termination

This procedure is used to release a termination towards the IMS and free all related resources; it is based on the procedure of the same name defined in 3GPP TS 29.163 [9].

Table 8.23.1: Procedures between MRFC and MRFP: Release IMS Termination

Procedure	Initiated	Information element name	Information element required	Information element description
Release IMS Termination	MRFC	Context	M	This information element indicates the existing context for the bearer termination.
		Bearer Termination	M	This information element indicates the bearer termination to be released.
Release IMS Termination Ack	MRFP	Context	M	This information element indicates the context where the command was executed.
		Bearer Termination	M	This information element indicates the Bearer Termination where the command was executed.

8.24 Start TTS

This procedure is used to request to start TTS.

Table 8.24.1: Procedures between MRFC and MRFP: Start TTS

Procedure	Initiated	Information element name	Information element required	Information element description
Start TTS	MRFC	Context	M	This information element indicates the context for the bearer termination.
		Bearer Termination/Bearer Termination Request	M	This information element indicates the existing bearer termination or requests a new bearer termination where the TTS is sent.
		Direction	O	This information element indicates the direction of the TTS to be sent.
		Notify TTS Completed	O	This information element requests a notification of a completed TTS.
		DTMF stop TTS	O	This information element indicates the MRFP to detect the DTMF digits and stop the TTS when a pre-defined DTMF digit is detected.
		SSML	M	This information element indicates the text to be spoken as SSML script.
		Iterations	O	This information element indicates the number of times the TTS shall be played.
		Notify termination heartbeat	C	This information element requests termination heartbeat indications. This information element shall be included when requesting a new bearer termination.

Start TTS Ack	MRFP	Context	M	This information element indicates the context where the command was executed.
		Bearer Termination	M	This information element indicates the bearer termination where the command was executed.

NOTE This procedure may be combined with other procedures such as to ADD bearer connections.

8.25 Stop TTS

This procedure is used to stop TTS.

Table 8.25.1: Procedures between MRFC and MRFP: Stop TTS

Procedure	Initiated	Information element name	Information element required	Information element description
Stop TTS	MRFC	Context	M	This information element indicates the context for the bearer termination.
		Bearer Termination	M	This information element indicates the bearer termination where the TTS is stopped.
		Stop TTS	M	This information element requests that TTS is stopped.
Stop TTS Ack	MRFP	Context	M	This information element indicates the context where the command was executed.
		Bearer Termination	M	This information element indicates the bearer termination where the command was executed.

8.26 TTS Completed

This procedure is used to report the TTS result.

Table 8.26.1: Procedures between MRFC and MRFP: TTS Completed

Procedure	Initiated	Information element name	Information element required	Information element description
TTS Completed	MRFP	Context	M	This information element indicates the context for the bearer termination.
		Bearer Termination	M	This information element indicates the bearer termination where the TTS is requested.
		TTS Completed	M	This information element indicates completed of the TTS.
		Cause	M	This information element indicates the return code of TTS.
TTS Completed Ack	MRFC	Context	M	This information element indicates the context where the command was executed.
		Bearer Termination	M	This information element indicates the Bearer Termination where the command was executed.

8.27 Start ASR

This procedure is used to request to start ASR.

Table 8.27.1: Procedures between MRFC and MRFP: Start ASR

Procedure	Initiated	Information element name	Information element required	Information element description
Start ASR	MRFC	Context	M	This information element indicates the context for the bearer termination.
		Bearer Termination/Bearer Termination Request	M	This information element indicates the existing bearer termination or requests a new bearer termination where the ASR is requested.

		Recognition Mode	O	This information element indicates the recognition mode: Normal Recognition Mode, Hotword Recognition Mode.
		Notify ASR completion	O	This information element requests a notification of a completed ASR.
		DTMF stop ASR	O	This information element indicates the MRFP to detect the DTMF digits and stop the ASR when a pre-defined DTMF digit is detected.
		SRGS Grammar	M	This information element indicates the SRGS format grammar as script or URI.
		Notify termination heartbeat	C	This information element requests termination heartbeat indications. This information element shall be included when requesting a new bearer termination.
Start ASR Ack	MRFP	Context	M	This information element indicates the context where the command was executed.
		Bearer Termination	M	This information element indicates the bearer termination where the command was executed.

NOTE This procedure may be combined with other procedures such as to ADD bearer connections.

8.28 Stop ASR

This procedure is used to stop ASR.

Table 8.28.1: Procedures between MRFC and MRFP: Stop ASR

Procedure	Initiated	Information element name	Information element required	Information element description
Stop ASR	MRFC	Context	M	This information element indicates the context for the bearer termination.
		Bearer Termination	M	This information element indicates the bearer termination where the ASR is stopped.
		Stop ASR	M	This information element requests that ASR is stopped.
Stop ASR Ack	MRFP	Context	M	This information element indicates the context where the command was executed.
		Bearer Termination	M	This information element indicates the bearer termination where the command was executed.

8.29 ASR completed

This procedure is used to report the ASR result.

Table 8.29.1: Procedures between MRFC and MRFP: ASR completed

Procedure	Initiated	Information element name	Information element required	Information element description
ASR completed	MRFP	Context	M	This information element indicates the context for the bearer termination.
		Bearer Termination	M	This information element indicates the bearer termination where the ASR is requested.
		ASR Completed	M	This information element indicates completed of the ASR.
		Cause	M	This information element indicates the return code of ASR.
		Recognition Result	O	This information element reports the ASR result.
		Text Token	O	This information element indicates a text token correspond to tokens as defined by the SRGS grammar. The ASR may return multiple results.
		Result Interpretation	O	This information element indicates interpretation of application specific for each result.

		Confidence Score	O	This information indicates the quality of the input for each result. The confidence score is a number in the range from 0.0 to 1.0 inclusive.
		Input Time	O	This information indicates the time of the speech input for each result.
ASR completed Ack	MRFC	Context	M	This information element indicates the context where the command was executed.
		Bearer Termination	M	This information element indicates the Bearer Termination where the command was executed.

8.30 MRFP Out-of-Service or Maintenance Locked

This procedure is used to indicate that the MRFP will go out of service or is maintenance locked.

Table 8.30.1: Procedures between MRFC and MRFP: MRFP Out-of-Service

Procedure	Initiated	Information element name	Information element required	Information element description
MRFP Out-of-Service	MRFP	Context	M	This information element indicates the context for the command.
		Root Termination	M	This information element indicates the root termination for the command.
		Reason	M	This information element indicates the reason for service change.
		Method	M	This information element indicates the method for service change.
MRFP Out-of-Service Ack	MRFC	Context	M	This information element indicates the context where the command was executed.
		Root Termination	M	This information element indicates the root termination where the command was executed.

8.31 MRFP Communication Up

This procedure is used to indicate that the MRFP is back in service.

Table 8.31.1: Procedures between MRFC and MRFP: MRFP Communication Up

Procedure	Initiated	Information element name	Information element required	Information element description
MRFP Communication Up	MRFP	Context	M	This information element indicates the context for the command.
		Root Termination	M	This information element indicates the root termination for the command.
		Reason	M	This information element indicates the reason for service change.
		Method	M	This information element indicates the method for service change.
MRFP Communication Up Ack	MRFC	Context	M	This information element indicates the context where the command was executed.
		Root Termination	M	This information element indicates the root termination where the command was executed.

8.32 MRFP Restoration

This procedure is used to indicate the MRFP failure or recovery.

Table 8.32.1: Procedures between MRFC and MRFP: MRFP Restoration

Procedure	Initiated	Information element name	Information element required	Information element description
MRFP Restoration	MRFP	Context	M	This information element indicates the context for the command.
		Root Termination	M	This information element indicates the root termination for the command.
		Reason	M	This information element indicates the reason for the service change.
		Method	M	This information element indicates the method for service change.
MRFP Restoration Ack	MRFC	Context	M	This information element indicates the context where the command was executed.
		Root Termination	M	This information element indicates the root termination where the command was executed.

8.33 MRFC Restoration

This procedure is used to indicate the MRFC failure or recovery.

Table 8.33.1: Procedures between MRFC and MRFP: MRFC Restoration

Procedure	Initiated	Information element name	Information element required	Information element description
MRFC Restoration	MRFC	Context	M	This information element indicates the context for the command.
		Root Termination	M	This information element indicates the root termination for the command.
		Reason	M	This information element indicates the reason for the service change.
		Method	M	This information element indicates the method for service change.
MRFC Restoration Ack	MRFP	Context	M	This information element indicates the context where the command was executed.
		Root Termination	M	This information element indicates the root termination where the command was executed.

8.34 MRFP Re-register

This procedure is used to re-register the MRFP.

Table 8.34.1: Procedures between MRFC and MRFP: MRFP Re-register

Procedure	Initiated	Information element name	Information element required	Information element description
MRFP Re-register	MRFP	Context	M	This information element indicates the context for the command.
		Root Termination	M	This information element indicates the root termination for the command.
		Reason	M	This information element indicates the reason for the service change.
		Method	M	This information element indicates the method for service change.
		Protocol Version	M	This information element indicates the protocol version for Mp interface requested by the MRFP.
		Service Change Profile	M	This information element indicates the profile for the Mp interface requested by the MRFP.
MRFP Re-register Ack	MRFC	Context	M	This information element indicates the context where the command was executed.
		Root Termination	M	This information element indicates the root termination where the command was executed.
		Protocol Version	O	This information element indicates the protocol version for Mp interface supported by the MRFC.
		Service Change Profile	O	This information element indicates the profile for the Mp interface supported by the MRFC.

8.35 MRFC Re-registration Ordered by MRFC

This procedure is used by the MRFC to request the MRFP to register itself.

Table 8.35.1: Procedures between MRFC and MRFP: MRFC Ordered Re-register

Procedure	Initiated	Information element name	Information element required	Information element description
MRFC Ordered Re-register	MRFC	Context	M	This information element indicates the context for the command.
		Root Termination	M	This information element indicates the root termination for the command.
		Reason	M	This information element indicates the reason for the service change.
		MRFC Address	O	This information element indicates the MRFC signalling address.
MRFC Ordered Re-register Ack	MRFP	Context	M	This information element indicates the context where the command was executed.
		Root Termination	M	This information element indicates the root termination where the command was executed.

8.36 Audit Value

This procedure is used to audit values of different object(s).

Table 8.36.1: Procedures between MRFC and MRFP: Audit Value

Procedure	Initiated	Information element name	Information element required	Information element description
Audit Value	MRFC	Context	M	This information element indicates the context for the command.
		Bearer Termination	M	This information element indicates the bearer termination(s) for the command.
		Object(s)	M	This information element indicates the object(s) to be audited.
Audit Value Ack	MRFP	Context	M	This information element indicates the context where the command was executed.
		Bearer Termination	M	This information element indicates the bearer termination where the command was executed.
		Value(s)	M	This information element indicates the value(s) of the object(s).

8.37 Audit Capability

This procedure is used to audit capabilities of different object(s).

Table 8.37.1: Procedures between MRFC and MRFP: Audit Capability

Procedure	Initiated	Information element name	Information element required	Information element description
Audit Capability	MRFC	Context	M	This information element indicates the context for the command.
		Bearer Termination	M	This information element indicates the bearer termination(s) for the command.
		Object(s)	M	This information element indicates the object(s) which capability is requested.
Audit Capability Ack	MRFP	Context	M	This information element indicates the context where the command was executed.
		Bearer Termination	M	This information element indicates the bearer termination where the command was executed.
		Capabilities(s)	M	This information element indicates the capabilities of the object(s).

8.38 Capability Update

This procedure is used to indicate update of an object capability.

Table 8.38.1: Procedures between MRFC and MRFP: Capability Update

Procedure	Initiated	Information element name	Information element required	Information element description
Capability Update	MRFP	Context	M	This information element indicates the context for the command.
		Bearer Termination	M	This information element indicates the bearer termination(s) for the command.
		Reason	M	This information element indicates the reason for service change.
		Method	M	This information element indicates the method for service change.
Capability Update Ack	MRFC	Context	M	This information element indicates the context where the command was executed.
		Bearer Termination	M	This information element indicates the bearer termination where the command was executed.

8.39 MRFC Out of Service

This procedure is used to indicate that MRFC has gone out of service.

Table 8.39.1: Procedures between MRFC and MRFP: MRFC Out of Service

Procedure	Initiated	Information element name	Information element required	Information element description
MRFC Out of Service	MRFC	Context	M	This information element indicates the context for the command.
		Root Termination	M	This information element indicates the root termination for the command.
		Reason	M	This information element indicates the reason for the service change.
		Method	M	This information element indicates the method for service change.
MRFC Out of Service Ack	MRFP	Context	M	This information element indicates the context where the command was executed.
		Root Termination	M	This information element indicates the root termination where the command was executed.

8.40 MRFP Resource Congestion Handling - Activate

This procedure is used to activate the congestion handling mechanism.

Table 8.40.1: Procedures between MRFC and MRFP: MRFP Resource Congestion Handling - Activate

Procedure	Initiated	Information element name	Information element required	Information element description
MRFP Resource Congestion Handling – Activate	MRFC	Context	M	This information element indicates that all context are applicable for the root termination.
		Root Termination	M	This information element indicates that root termination is where the congestion mechanism is activated.
		Congestion Activate	M	This information element requests to activate the congestion mechanism.
MRFP Resource Congestion Handling - Activate Ack	MRFP	Context	M	This information element indicates that all context are where the command was executed.
		Root Termination	M	This information element indicates that root termination is where the command was executed.

8.41 MRFP Resource Congestion Handling - Indication

This procedure is used to inform the MRFC that traffic restriction is advised.

Table 8.41.1: Procedures between MRFC and MRFP: MRFP Resource Congestion Handling - Indication

Procedure	Initiated	Information element name	Information element required	Information element description
MRFP Resource Congestion Handling - Indication	MRFP	Context	M	This information element indicates all context are applicable for the root termination.
		Root Termination	M	This information element indicates that root termination is where the congestion mechanism was activated.
		Reduction	M	This information element indicates the load percentage to be reduced.
MRFP Resource Congestion Handling - Indication Ack	MRFC	Context	M	This information element indicates all context are where the command was executed.
		Root Termination	M	This information element indicates that root termination is where the command was executed.

8.42 Command Reject

This command is used to reject the received command request. It may be used as response to any of the procedures.

Table 8.42.1: Procedures between (G)MSC server and MGW: Command Reject

Procedure	Initiated	Information element name	Information element required	Information element description
Command Reject	Both	Context	M	This information element indicates the context where the command was rejected.
		Bearer Termination	M	This information element indicates the bearer termination where the command was rejected.
		Error	M	This information element indicates the error that caused command rejection.

8.43 Termination heartbeat indication

This procedure is used to report indication of hanging termination.

Table 8.43.1: Procedures between MRFC and MRFP: Hanging termination indication

Procedure	Initiated	Information element name	Information element required	Information element description
Termination heartbeat indication	MRFP	Context	M	This information element indicates the context for the bearer termination.
		Bearer Termination	M	This information element indicates the bearer termination for which the termination heartbeat is reported.
		Termination heartbeat	M	Hanging Termination event, as defined in 3GPP TS 29.333 [16].
Termination heartbeat indication Ack	MRFC	Context	M	This information element indicates the context where the command was executed.
		Bearer Termination	M	This information element indicates the Bearer Termination where the command was executed.

8.44 Configure BFCP Termination

This procedure is used to configure a termination to support BFCP protocol

Table 8.44.1: Procedures between MRFC and MRFP: Configure BFCP Termination

Procedure	Initiated	Information element name	Information element required	Information element description
Configure BFCP Termination	MRFC	Context	M	This information element indicates the context for the bearer termination.
		Bearer Termination	M	This information element indicates the existing bearer termination or requests a new bearer termination.
		Local BFCP Connection Address Request	M	This information element requests an IP address and port number(s) on the MRFP to serve BFCP/TCP protocol
		Remote BFCP Connection Address	M	This information element indicates the remote IP address and port number(s) that the MRFP can send BFCP/TCP to.

		User Identifier	M	This information element indicates the user Identifier to identify the BFCP client when receiving BFCP requests.
		Available Floors	M	This information Element defines the list of Floor Ids that may be requested (via BFCP) to be used by the client represented by this termination.
		Establish TCP connection	O	This information element requests the MRFP to take a TCP client role and to initiate a TCP connection establishment.
		Notify TCP connection establishment Failure Event	O	This information element requests a notification if a TCP connection establishment failure occurs.
		Notify TLS session establishment Failure Event	O	This information element requests a notification if a TLS session establishment failure occurs.
		Pre-Shared Key	O	This information element is present if the MRFC wants that the media is protected using TLS tunnel established with MIKEY-TICKET procedures. It indicates the Traffic-Encrypting key associated with the Crypto Session that shall be used in TLS handshake.
Configure BFCP Termination Ack	MRFP	Context	M	This information element indicates the context where the command was executed.
		Bearer Termination	M	This information element indicates the Bearer Termination where the command was executed.
NOTE: The above procedure may be combined with other procedures in ADD or MOD commands.				

8.45 Configure Conference For Floor Control

This procedure is used to configure or modify a conference for floor control and indicate the Floor policy for a conference.

Table 8.45.1: Procedures between MRFC and MRFP: Configure Conference For Floor Control

Procedure	Initiated	Information element name	Information element required	Information element description
Indicate Floor Policy	MRFC	Context	M	This information element indicates the context for the bearer termination.
		Conference Identifier	M	This information element indicates the Identifier for the conference for BFCP purposes.

		Floor-Resource Associations	M	This information element indicates the resource associated with specific Floor Ids for the MRFP to identify the Floor(s) when receiving BFCP requests.
		Floor Control Algorithm	M	This information element indicates for a specific floor, the algorithm to be used in granting the Floor.
		Maximum Floor Holder Number	M	This information element indicates for a specific floor, the maximum number of users who can hold the same Floor at the same time.
Indicate Floor Policy Ack	MRFP	Context	M	This information element indicates the context where the command was executed.
NOTE: The above procedure applies to a context instead of a termination. The H.248v3 shall be supported. The procedure may be combined with other procedures in ADD or MOD commands.				

8.46 Designate Floor Chair

This procedure is used to designate a Floor Chair to a conference.

Table 8.46.1: Procedures between MRFC and MRFP: Designate Floor Chair

Procedure	Initiated	Information element name	Information element required	Information element description
Designate Floor Chair	MRFC	Context	M	This information element indicates the context for the bearer termination.
		Bearer Termination/Bearer Termination Request	M	This information element indicates the existing bearer termination.
		Floor Chair	M	This information element indicates that the termination represents a Floor Chair in accordance with BFCP [20].
		Floor Controlled By Chair	O	This information element indicates the Floor(s) the Floor Chair controls.
Designate Floor Chair Ack	MRFP	Context	M	This information element indicates the context where the command was executed.
		Bearer Termination	M	This information element indicates the bearer termination where the command was executed.

8.47 Floor Request Decision

This procedure is used to request the MRFP to report the Floor request decision.

Table 8.47.1: Procedures between MRFC and MRFP: Floor Request Decision

Procedure	Initiated	Information element name	Information element required	Information element description
Floor Request Decision	MRFC	Context	M	This information element indicates the context for the bearer termination.
		Bearer Termination/Bearer Termination Request	M	This information element indicates the existing bearer termination.
		Notify Floor Request Decision	M	This information element requests MRFP to notify the decision of the FCS to Floor requests.

Floor Request Decision Ack	MRFP	Context	M	This information element indicates the context where the command was executed.
		Bearer Termination	M	This information element indicates the bearer termination where the command was executed.

8.48 Report Floor Request Decision

This procedure is used to report the Floor request status .

Table 8.48.1: Procedures between MRFP and MRFC: Report Floor Request Decision

Procedure	Initiated	Information element name	Information element required	Information element description
Report Floor Request Decision	MRFP	Context	M	This information element indicates the context for the bearer termination.
		Bearer Termination	M	This information element indicates the bearer termination to which the Floor request is associated.
		Floor Request Status	M	This information element reports the Floor Id or Floor Ids to which the Floor Request is associated and the Floor request status of specific Floor or Floors..
Report Floor Request Decision Ack	MRFC	Context	M	This information element indicates the context where the command was executed.
		Bearer Termination	M	This information element indicates the Bearer Termination where the command was executed.

8.49 Confirm Media Update

This procedure is used to indicate whether the media properties associated with a Floor Request have been modified successfully or not..

Table 8.49.1: Procedures between MRFC and MRFP: Confirm Media Update

Procedure	Initiated	Information element name	Information element required	Information element description
Confirm Media Update	MRFC	Context	M	This information element indicates the context for the bearer termination.
		Bearer Termination	M	This information element indicates the existing bearer termination to which the floor request is associated.
		Floor Request Status	M	This information element indicates the Floor Id or Ids and requested status to which the Confirm Media Result applies..
		Result	M	This information element indicates whether the media properties associated with a Floor Request have been modified successfully or not.
Confirm Media Update Ack	MRFP	Context	M	This information element indicates the context where the command was executed.
		Bearer Termination	M	This information element indicates the bearer termination where the command was executed.

8.50 Configure Granted Quota

This procedure is used to configure the granted quota.

Table 8.50.1: Procedures between MRFC and MRFP: Configure Granted Quota

Procedure	Initiated	Information element name	Information element required	Information element description
Configure Granted Quota	MRFC	Context	M	This information element indicates the context for the bearer termination.
		Bearer Termination	M	This information element indicates the bearer termination to configure the granted quotas.
		Quota for number of messages sent	O	This information element indicates the quota for the number of messages sent.
		Quota for number of messages received	O	This information element indicates the quota for the number of messages received.
		Quota for volume of messages sent	O	This information element indicates the quota for the volume of messages sent.
		Quota for volume of messages received	O	This information element indicates the quota for the volume of messages received.
		Valid Time	O	This information element indicates the valid time for collecting message statistics, upon expiry the MRFP shall report the current message statistics.
Configure Granted Quota Ack	MRFP	Context	M	This information element indicates the context where the command was executed.
		Bearer Termination	M	This information element indicates the Bearer Termination where the command was executed.

8.51 Report Message Statistics

This procedure is used to report statistics for the sent and received messages.

Table 8.51.1: Procedures between MRFP and MRFC: Report Message Statistics

Procedure	Initiated	Information element name	Information element required	Information element description
Report Message Statistics	MRFP	Context	M	This information element indicates the context for the bearer termination.
		Bearer Termination	M	This information element indicates the bearer termination to report statistics.
		Number of messages sent	O	This information element indicates the number of messages sent.
		Number of messages received	O	This information element indicates the number of messages received.
		Volume of messages sent	O	This information element indicates the volume of messages sent.
		Volume of messages received	O	This information element indicates the volume of messages received.
		Reason For Report	M	Indicates reason for the report (e.g. expiry of time, granted quotas reached)

Report Message Statistics Ack	MRFC	Context	M	This information element indicates the context where the command was executed.
		Bearer Termination	M	This information element indicates the Bearer Termination where the command was executed.

8.52 Configure Filtering Rules

This procedure is used to configure the filtering rules.

Table 8.52.1: Procedures between MRFC and MRFP: Configure Filtering Rules

Procedure	Initiated	Information element name	Information element required	Information element description
Configure Filtering Rules	MRFC	Context	M	This information element indicates the context for the bearer termination.
		Bearer Termination	M	This information element indicates the bearer termination to config the filtering rules.
		Sender address	O	This information element indicates the filtering criteria of sender address.
		Message size	O	This information element indicates the filtering criteria of message size.
		Message content type	O	This information element indicates the filtering criteria of message content type.
		Message content format	O	This information element indicates the filtering criteria of message content format.
		Message subject	O	This information element indicates the filtering criteria of message subject.
		Message treatment	O	This information element indicates to the MRFP the message treatment when the filtering criteria is reached. The message treatment can be: Block the delivery of the message content. Store the message content Redirect the message to another address.
		Store URL	O	This information element indicates the store URL.
		Redirect URL	O	This information element indicates the redirect URL.
Configure Filtering Rules Ack	MRFP	Context	M	This information element indicates the context where the command was executed.
		Bearer Termination	M	This information element indicates the Bearer Termination where the command was executed.
		Store URL	O	This information element indicates the store URL.

8.53 Start message record

This procedure is used to start the message record.

Table 8.53.1: Procedures between MRFC and MRFP: Start message record

Procedure	Initiated	Information element name	Information element required	Information element description
Start message Record	MRFC	Context	M	This information element indicates the context for the bearer termination.
		Bearer Termination/Bearer Termination Request	M	This information element indicates the existing bearer termination or requests a new bearer termination where the message is recorded.
		Message file identifier	M	This information element indicates the message record file identification. The MRFC may also request the MRFP to create file identifier.
		Maximum Record Timer	O	This information element indicates the maximum allowable length of time of the recording
		Notify message record Completed	O	This information element requests a notification of a completed message record.
Start message record Ack	MRFP	Context	M	This information element indicates the context where the command was executed.
		Bearer Termination	M	This information element indicates the bearer termination where the command was executed.
		File identifier	O	This information element indicates the file identification created by the MRFP if the MRFC request to create a file identifier.

NOTE This procedure may be combined with other procedures such as to ADD bearer connections.

8.54 Stop message record

This procedure is used to stop the message record.

Table 8.54.1: Procedures between MRFC and MRFP: Stop message record

Procedure	Initiated	Information element name	Information element required	Information element description
Stop Message Record	MRFC	Context	M	This information element indicates the context for the bearer termination.
		Bearer Termination	M	This information element indicates the existing bearer termination.
		Stop message record	M	This information element requests that message record is stopped.
Stop Message record Ack	MRFP	Context	M	This information element indicates the context where the command is executed.
		Bearer Termination	M	This information element indicates the bearer termination where the command is executed.

8.55 Message record completed

This procedure is used to report the message record completed.

Table 8.55.1: Procedures between MRFC and MRFP: Report message record completed

Procedure	Initiated	Information element name	Information element required	Information element description
Report message record completed	MRFP	Context	M	This information element indicates the context for the bearer termination.
		Bearer Termination	M	This information element indicates the existing bearer termination.
		Message record Completed	M	This information element indicates the message record completed.
		Cause	M	This information element indicates the return code of message record.
Report message record completed ACK	MRFC	Context	M	This information element indicates the context where the command is executed.
		Bearer Termination	M	This information element indicates the bearer termination where the command is executed.

8.56 Start playing message

This procedure is used to start playing message.

Table 8.56.1: Procedures between MRFC and MRFP: start playing message

Procedure	Initiated	Information element name	Information element required	Information element description
Start playing message	MRFC	Context	M	This information element indicates the context for the bearer termination.
		Bearer Termination/Bearer Termination Request	M	This information element indicates the existing bearer termination or requests a new bearer termination where the message is sent.
		Message identifier	M	This information element indicates the message or list of message to be played. This may be a single identifier or one identifier per media type.
		Direction	O	This information element indicates the direction of the message to be sent.
		Notify message completed	O	This information element requests a notification when the playing message is completed.
		Notify termination heartbeat	C	This information element requests termination heartbeat indications. This information element shall be included when requesting a new bearer termination.
Start playing message Ack	MRFP	Context	M	This information element indicates the context where the command was executed.
		Bearer Termination	M	This information element indicates the bearer termination where the command was executed.

NOTE This procedure may be combined with other procedures such as to ADD bearer connections.

8.57 Stop playing message

This procedure is used to stop playing message.

Table 8.57.1: Procedures between MRFC and MRFP: Stop playing message

Procedure	Initiated	Information element name	Information element required	Information element description
Stop playing message	MRFC	Context	M	This information element indicates the context for the bearer termination.

		Bearer Termination	M	This information element indicates the existing bearer termination.
		Stop playing message	M	This information element requests that message playing is stopped.
Stop playing message Ack	MRFP	Context	M	This information element indicates the context where the command was executed.
		Bearer Termination	M	This information element indicates the bearer termination where the command was executed.

8.58 Playing message completed

This procedure is used to report the playing message completed.

Table 8.58.1: Procedures between MRFC and MRFP: Report playing message completed

Procedure	Initiated	Information element name	Information element required	Information element description
Report playing message completed	MRFP	Context	M	This information element indicates the context for the bearer termination.
		Bearer Termination	M	This information element indicates the existing bearer termination.
		Playing Completed	M	This information element indicates completed of the message play.
		Cause	M	This information element indicates the return code of playing message.
Report playing message completed ACK	MRFC	Context	M	This information element indicates the context where the command was executed.
		Bearer Termination	M	This information element indicates the bearer termination where the command was executed.

8.59 Modify Media

This procedure is used to modify the media and stream properties for a given Floor Request (as indicated by the Report Floor Request Decision, Clause 8.48).

Table 8.59.1: Procedures between MRFC and MRFP: Modify Media

Procedure	Initiated	Information element name	Information element required	Information element description
Modify Media	MRFC	Context	M	This information element indicates the existing context for the bearer termination or requests a new context for the bearer termination.
		Bearer Termination	M	This information element indicates the existing bearer termination to which the floor request is associated.
		Stream	M	This information element indicates the existing stream to which the floor request is associated
		Stream Mode	M	Stream mode properties associated to the floor request.
		Media Properties	M	Media properties associated to the floor request
Modify Media Ack	MRFP	Context	M	This information element indicates the context where the command was executed.
		Bearer Termination	M	This information element indicates the bearer termination where the command was executed.

8.60 ECN Failure Indication

This procedure is used to indicate an ECN related Error.

Table 8.60.1: Procedures between MRFC and MRFP: ECN Failure indication

Procedure	Initiated	Information element name	Information element required	Information element description
ECN Failure Indication	MRFP	Context	M	This information element indicates the context for the bearer termination.
		Bearer Termination	M	This information element indicates the existing bearer termination.
		ECN Failure Indication	M	This information element indicates an ECN failure event.
ECN Failure Indication ACK	MRFC	Context	M	This information element indicates the context where the command is executed.
		Bearer Termination	M	This information element indicates the bearer termination where the command is executed.

8.61 ICE Connectivity Check Result Notification

This procedure is used to report ICE connectivity check result for Full ICE (see clause 6.2.18.3).

Table 8.61.1: Procedures between MRFC and MRFP: ICE Connectivity Check Result Notification

Procedure	Initiated	Information element name	Information element required	Information element description
ICE Connectivity Check Result Notification	MRFP	Context	M	This information element indicates the context for the bearer termination.
		Bearer Termination	M	This information element indicates the bearer termination for which the ICE Connectivity Check Result is reported.
		ICE Connectivity Check Result	M	This information element indicates an ICE Connectivity Check Result event.
ICE Connectivity Check Result Notification Ack	MRFC	Context	M	This information element indicates the context where the command was executed.
		Bearer Termination	M	This information element indicates the bearer termination where the command was executed.

8.62 ICE New Peer Reflexive Candidate Notification

This procedure is used to report ICE new peer reflexive candidate for Full ICE (see clause 6.2.18.4).

Table 8.62.1: Procedures between MRFC and MRFP: ICE New Peer Reflexive Candidate Notification

Procedure	Initiated	Information element name	Information element required	Information element description
ICE New Peer Reflexive Candidate Notification	MRFP	Context	M	This information element indicates the context for the bearer termination.
		Bearer Termination	M	This information element indicates the bearer termination for which the ICE New Peer Reflexive Candidate is reported.
		ICE New Peer Reflexive Candidate	M	This information element indicates an ICE New Peer Reflexive Candidate event.
ICE New Peer Reflexive Candidate Notification Ack	MRFC	Context	M	This information element indicates the context where the command was executed.
		Bearer Termination	M	This information element indicates the bearer termination where the command was executed.

8.63 Notify TCP connection establishment Failure Indication

This procedure is used to report TCP connection establishment failures.

Table 8.63.1: Procedures between MRFC and MRFP: TCP connection establishment Failure Indication

Procedure	Initiated	Information element name	Information element required	Information element description
TCP connection establishment Failure Indication	MRFP	Context	M	This information element indicates the context for the bearer termination.
		Bearer Termination	M	This information element indicates the bearer termination for which a TCP connection establishment failure is reported.
		TCP connection establishment Error Indication	M	This information element indicates a TCP connection establishment failure event.
TCP connection establishment Failure Indication Ack	MRFC	Context	M	This information element indicates the context where the command was executed.
		Bearer Termination	M	This information element indicates the bearer termination where the command was executed.

8.64 Notify TLS session establishment Failure Indication

This procedure is used to report TLS session establishment failures.

Table 8.64.1: Procedures between MRFC and MRFP: TLS session establishment Failure Indication

Procedure	Initiated	Information element name	Information element required	Information element description
TLS session establishment Failure Indication	MRFP	Context	M	This information element indicates the context for the bearer termination.
		Bearer Termination	M	This information element indicates the bearer termination for which a TLS session establishment failure is reported.
		TLS session establishment Error Indication	M	This information element indicates a TLS session establishment failure event.
TLS session establishment Failure Indication Ack	MRFC	Context	M	This information element indicates the context where the command was executed.
		Bearer Termination	M	This information element indicates the bearer termination where the command was executed.

8.65 CLUE Message Send

This procedure is used in a telepresence session by the MRFC to request the MRFP to send a CLUE message (see clause 6.2.21.2).

Table 8.65.1: Procedures between MRFC and MRFP: CLUE Message Send

Procedure	Initiated	Information element name	Information element required	Information element description
CLUE Message Send	MRFC	Context	M	This information element indicates the context for the bearer termination.
		Bearer Termination	M	This information element indicates the bearer termination for which the CLUE information is reported.
		CLUE Message Content	M	This information element indicates the CLUE message content to send.
CLUE Message Send Ack	MRFP	Context	M	This information element indicates the context where the command was executed.
		Bearer Termination	M	This information element indicates the bearer termination where the command is executed.

8.66 CLUE Message Received Notification

This procedure is used in a telepresence session by the MRFP to report the received CLUE message to the MRFC (see clause 6.2.21.2).

Table 8.66.1: Procedures between MRFC and MRFP: CLUE Message Received Notification

Procedure	Initiated	Information element name	Information element required	Information element description
CLUE Message Received Notification	MRFP	Context	M	This information element indicates the context for the bearer termination.
		Bearer Termination	M	This information element indicates the bearer termination for which the CLUE information is reported.
		CLUE Message Content	M	This information element indicates a content of the received CLUE message.
CLUE Message Received Notification Ack	MRFC	Context	M	This information element indicates the context where the command was executed.
		Bearer Termination	M	This information element indicates the bearer termination where the command is executed.

Annex A (informative): Change history

Date	TSG #	TSG Doc.	CR	Rev	Cat	Subject/Comment	New
2006-05	CT4#31					Draft Skeleton	0.1.0
2006-07	CT4#31					Approval of the ad-hoc meeting TDs: C4-060934, C4-060935, C4-060938, C4-060939, C4-060940, C4-060963, C4-060964, C4-060965, C4-060966, C4-060967, C4-060968.	0.2.0
2006-09	CT4#32					Approval of the meeting TDs: C4-061324,C4-061474,C4-601475,C4-061476, C4-061477,C4-061478	0.3.0
2006-11	CT4#33					Approval of the meeting TDs: C4-061797, C4-061798, C4-061799, C4-061801, C4-061802, C4-061804, C4-061805, C4-061806, C4-061594,C4-061646	0.4.0
2006-11						Sent to CT#34 information	1.0.0
2007-02	CT4#34					Approval of the meeting TDs: C4-070282, C4-070285, C4-070357, C4-070246, C4-070290, C4-070056, C4-070291, C4070358	1.1.0
2007-03	CT#35	CP-070037				Sent to CT#35 for approval	2.0.0
2007-03	CT#35	CP-070261				Chapter numbering corrected	2.1.0
2007-03	CT#35					Approved as v7.0.0	7.0.0
2007-06	CT#36	CP-070472	0002	1		Clarify the TTS requirement	7.1.0
			0003	3		Alignment of procedures and normative text	
			0005	5		Clarify ASR function requirement	
			0004	1		Correction to DTMF handling	
			0007	1		Multimedia Play	
			0010	1		Remove editor notes	
			0011	1		Correction of Play Announcement	
			0012	1		Addition of Non-call Related procedures to chapter 8	
2007-09	CT#37	CP-070539	0013	1		Remove option to signal max number of participants in conference	7.2.0
			0014	2		Removal of floor control functions	
			0015	2		Correction of stop audio and multimedia record procedures	
			0017	2		Clarify recording requirement and procedure	
2007-12	CT#38	CP-070745	0020			Maximum Number of Participants in a conference	7.3.0
			0021			Clarification of Topology Handling During a Recording	
			0022			Amend iterations parameter in start TTS procedure	
			0023			Clarification of record file storage	
			0024	1		Clean-up of hanging contexts and terminations	
			0025			Eliminate the duplicate definitions on the ASR completion scenario	
			0027	1		Implementation of multiple signals played simultaneously	
			0028	1		Clarification of the connection address and port	
2008-03	CT#39	CP-080021	0030	1		Introduction of support for Messaging on Mp Interface	8.0.0
			0031	1		Alignment of IMS resources procedures' title	
			0032			Mandatory use termination heartbeat	
			0034	2		Clarify floor control requirement	
2008-03	CT#39				Corrupted table structure fixed in tables: 8.17.1, 8.20.1, 8.21.1, 8.22.1, 8.24.1, 8.27.1 by MCC	8.0.1	
2008-06	CT#40	CP-080263	0035	1		Clarify messaging conference requirements	8.1.0
			0038	1		Clarify floor control requirements and procedures	
			0039	1		Introduction of procedure for Messaging Conference	
2008-09	CT#41	CP-080465	0041	2		Clarification of message storage requirement and procedure	8.2.0
			0042	2		Clarification of playing messaging requirement and procedure	
			0044	1		Improvement of Floor control procedures	
2008-12	CT#42	CP-080694	0045			Remove Editor's Note on Message File Format	8.3.0
2009-12	-	-	-	-		Update to Rel-9 version (MCC)	9.0.0
2010-12	CT#50	CP-100685	0048	3		Support of ECN	10.0.0
2011-03	CT#51	CP-110058	0049	2		ECN Support in Mp Interface	10.1.0
2011-06	CT#52	CP-110368	0050	1		Adding ECN IEs to Connection Point procedures	10.2.0
2011-12	CT#54	CP-110789	0051	1		ECN Improvements	10.3.0
2012-06	CT#56	CP-120226	0055	1		Reference update: draft-ietf-avtcore-ecn-for-rtp	10.4.0
2012-11						Change history table corrected	11.0.1
2012-12	CT#58	CP-120723	0059	-		Reference update: RFC 6679	11.1.0
			0060	1		Additional Text for Support of Multimedia Priority Service (MPS) over Mp Interface	
2013-09	CT#61	CP-130452	0061	3		Introduction of support for Coordination of Video Orientation (CVO)	12.0.0
			0062	3		Introduction of support for Generic Image Attribute/signalling of image size	
2013-12	CT#62	CP-130619	0063	2		CVO handling in MRF	12.1.0
			0067	1		Correction of CVO description	
			0064	1		Usage of generic image attributes	
			0068	1		Correction of Image Size description	
2014-06	CT#64	CP-140248	0069	2		ICE support for MRF in Mp interface	12.2.0
2014-09	CT#65	CP-140504	0070	2		Mp requirements for e2e media security	12.3.0
2014-12	CT#66	CP-140786	0074	1		Generic procedure to support session based messaging (MSRP)	12.4.0

		CP-140786	0075	1		TCP bearer connection control	
		CP-140786	0076	1		E2e media security procedures for TCP based media (MSRP, BFCP) using TLS and KMS	
		CP-140788	0077	2		Adding support for EVS codec	
2015-03	CT#67	CP-150030	0078	1		TLS session renegotiation on the Mp interface	12.5.0
		CP-150026	0079	3		Support of CLUE bearer level signalling	
		CP-150026	0080	2		CLUE carriage over Mp interface	
2015-06	CT#68	CP-150259	0081	1		EVS corrections	12.6.0
		CP-150260	0082	2		Bearer Termination in ICE Acknowledgements	
		CP-150255	0083	1		IETF Updates on IMS Telepresenc	
		CP-150258	0084	-		3GPP TLS profile reference	
2015-12	CT#70	CP-150755	0088	3		Reference update: IETF drafts	12.7.0
2015-12	CT#70	CP-150786	0086	6		Support of SDP capability negotiation	13.0.0
		CP-150783	0087	6		Support for Video Enhancements by Region-of-Interest Information Signalling	
2016-03	CT#71	CP-160015	0093	1		Corrections to EVS AMR-WB IO mode-change-capability MIME parameter handling	13.1.0
		CP-160048	0090	1		Removal of references to TS 26.235	
		CP-160034	0091	1		Support of enhanced bandwidth negotiation mechanism for MTSI sessions	
2016-06	CT#72	CP-160229	0094	-		Rate adaptation clarification	13.2.0
2016-06	CT#72	CP-160229	0095	-		Clarifications related to the rate adaptation for media endpoints	13.2.0
2016-07						Version number number corrected	13.2.1
2016-12	CT#74	CP-160647	0098	1		Handling of dtx and dtx-recv MIME parameters in SDP offer/answer	13.3.0
2016-12	CT#74	CP-160684	0096	2		Support of multi-party multimedia conference using simulcast	14.0.0
2017-03	CT#75	CP-170023	0106	-		RFC 4572 obsoleted by draft-ietf-mmusic-4572-update	14.1.0
2017-03	CT#75	CP-170051	0101	3		MMCMH conference establishment procedure	14.1.0
2017-03	CT#75	CP-170051	0102	2		MMCMH "dial-out" conference establishment requirements	14.1.0
2017-03	CT#75	CP-170051	0103	2		Including new MMCMH related IEs in procedures in clause 8	14.1.0
2017-03	CT#75	CP-170033	0107	-		Correcting reference identity for RFC 6714	14.1.0
2017-03	CT#75	CP-170051	0104	2		MMCMH Updates	14.1.0
2017-03	CT#75	CP-170051	0108	1		RTCP Codec Control Commands and Indications	14.1.0
2017-06	CT#76	CP-171015	0110	-		Reference update: RFC 8122	14.2.0
2017-06	CT#76	CP-171013	0110	-		Reference update: draft-ietf-clue-datachannel	14.2.0
2017-06	CT#76	CP-171037	0114	2		Support of "Compact Concurrent Codec Negotiation and Capabilities"	14.2.0
2017-06	CT#76	CP-171014	0117	-		Reference update: draft-ietf-mmusic-sctp-sdp	14.2.0
2017-06	CT#76	CP-171037	0118	-		Reference update: MMCMH related IETF drafts	14.2.0
2017-06	CT#76	CP-171037	0119	1		Removal IE for voice activity detection and "MMCMH policies" clarification	14.2.0
2017-12	CT#78	CP-173014	0121	-		Reference update: draft-ietf-mmusic-dtls-sdp	14.3.0
2018-06	CT#80	-	-	-		Update to Rel-15 version (MCC)	15.0.0
2019-06	CT#84	CP-191053	0122	2		Update Mp interface procedures for DBI	16.0.0
2020-12	CT#90e	CP-203024	0128	-		Reference update: telepresence related IETF drafts	16.1.0
2020-12	CT#90e	CP-203025	0131	-		Reference update: MMCMH related IETF drafts	16.1.0
2021-03	CT#91e	CP-210064	0136	-		Reference update: RFC 8841, RFC 8850 and RFC 8864	16.2.0
2021-03	CT#91e	CP-210065	0140	-		Reference update: RFC 8842	16.2.0
2021-03	CT#91e	CP-210067	0143	-		Reference update: RFC 8851 and RFC 8853	16.2.0
2021-12	CT#94e	CP-213104	0144	-	B	Alignment with SA3 supported TLS profiles	17.0.0
2022-03	CT#95e	CP-220052	0145	1	B	Update of IETF references for ICE	17.1.0
2024-03	-	-	-	-		Update to Rel-18 version (MCC)	18.0.0
2024-06	CT#104	CP-241037	0146	1	B	Adding support for IVAS codec	18.1.0

History

Document history		
V18.0.0	May 2024	Publication
V18.1.0	July 2024	Publication