

ETSI TS 124 483 V18.4.0 (2024-09)



**LTE;
Mission Critical Services (MCS) Management Object (MO)
(3GPP TS 24.483 version 18.4.0 Release 18)**



Reference

RTS/TSGC-0124483vi40

Keywords

LTE

ETSI

650 Route des Lucioles
F-06921 Sophia Antipolis Cedex - FRANCE

Tel.: +33 4 92 94 42 00 Fax: +33 4 93 65 47 16

Siret N° 348 623 562 00017 - APE 7112B
Association à but non lucratif enregistrée à la
Sous-Préfecture de Grasse (06) N° w061004871

Important notice

The present document can be downloaded from:

<https://www.etsi.org/standards-search>

The present document may be made available in electronic versions and/or in print. The content of any electronic and/or print versions of the present document shall not be modified without the prior written authorization of ETSI. In case of any existing or perceived difference in contents between such versions and/or in print, the prevailing version of an ETSI deliverable is the one made publicly available in PDF format at www.etsi.org/deliver.

Users of the present document should be aware that the document may be subject to revision or change of status.

Information on the current status of this and other ETSI documents is available at

<https://portal.etsi.org/TB/ETSIDeliverableStatus.aspx>

If you find errors in the present document, please send your comment to one of the following services:

<https://portal.etsi.org/People/CommitteeSupportStaff.aspx>

If you find a security vulnerability in the present document, please report it through our
Coordinated Vulnerability Disclosure Program:

<https://www.etsi.org/standards/coordinated-vulnerability-disclosure>

Notice of disclaimer & limitation of liability

The information provided in the present deliverable is directed solely to professionals who have the appropriate degree of experience to understand and interpret its content in accordance with generally accepted engineering or other professional standard and applicable regulations.

No recommendation as to products and services or vendors is made or should be implied.

No representation or warranty is made that this deliverable is technically accurate or sufficient or conforms to any law and/or governmental rule and/or regulation and further, no representation or warranty is made of merchantability or fitness for any particular purpose or against infringement of intellectual property rights.

In no event shall ETSI be held liable for loss of profits or any other incidental or consequential damages.

Any software contained in this deliverable is provided "AS IS" with no warranties, express or implied, including but not limited to, the warranties of merchantability, fitness for a particular purpose and non-infringement of intellectual property rights and ETSI shall not be held liable in any event for any damages whatsoever (including, without limitation, damages for loss of profits, business interruption, loss of information, or any other pecuniary loss) arising out of or related to the use of or inability to use the software.

Copyright Notification

No part may be reproduced or utilized in any form or by any means, electronic or mechanical, including photocopying and microfilm except as authorized by written permission of ETSI.

The content of the PDF version shall not be modified without the written authorization of ETSI.

The copyright and the foregoing restriction extend to reproduction in all media.

© ETSI 2024.
All rights reserved.

Intellectual Property Rights

Essential patents

IPRs essential or potentially essential to normative deliverables may have been declared to ETSI. The declarations pertaining to these essential IPRs, if any, are publicly available for **ETSI members and non-members**, and can be found in ETSI SR 000 314: "*Intellectual Property Rights (IPRs); Essential, or potentially Essential, IPRs notified to ETSI in respect of ETSI standards*", which is available from the ETSI Secretariat. Latest updates are available on the ETSI Web server (<https://ipr.etsi.org/>).

Pursuant to the ETSI Directives including the ETSI IPR Policy, no investigation regarding the essentiality of IPRs, including IPR searches, has been carried out by ETSI. No guarantee can be given as to the existence of other IPRs not referenced in ETSI SR 000 314 (or the updates on the ETSI Web server) which are, or may be, or may become, essential to the present document.

Trademarks

The present document may include trademarks and/or tradenames which are asserted and/or registered by their owners. ETSI claims no ownership of these except for any which are indicated as being the property of ETSI, and conveys no right to use or reproduce any trademark and/or tradename. Mention of those trademarks in the present document does not constitute an endorsement by ETSI of products, services or organizations associated with those trademarks.

DECT™, **PLUGTESTS™**, **UMTS™** and the ETSI logo are trademarks of ETSI registered for the benefit of its Members. **3GPP™** and **LTE™** are trademarks of ETSI registered for the benefit of its Members and of the 3GPP Organizational Partners. **oneM2M™** logo is a trademark of ETSI registered for the benefit of its Members and of the oneM2M Partners. **GSM®** and the GSM logo are trademarks registered and owned by the GSM Association.

Legal Notice

This Technical Specification (TS) has been produced by ETSI 3rd Generation Partnership Project (3GPP).

The present document may refer to technical specifications or reports using their 3GPP identities. These shall be interpreted as being references to the corresponding ETSI deliverables.

The cross reference between 3GPP and ETSI identities can be found under <https://webapp.etsi.org/key/queryform.asp>.

Modal verbs terminology

In the present document "**shall**", "**shall not**", "**should**", "**should not**", "**may**", "**need not**", "**will**", "**will not**", "**can**" and "**cannot**" are to be interpreted as described in clause 3.2 of the [ETSI Drafting Rules](#) (Verbal forms for the expression of provisions).

"**must**" and "**must not**" are **NOT** allowed in ETSI deliverables except when used in direct citation.

Contents

Intellectual Property Rights	2
Legal Notice	2
Modal verbs terminology.....	2
Foreword.....	44
1 Scope	45
2 References	46
3 Definitions and abbreviations.....	47
3.1 Definitions	47
3.2 Abbreviations	47
3.3 Symbols.....	47
3.4 Management Object design and representation guidelines.....	48
4 MCPTT UE configuration MO	48
4.1 General	48
4.2 MCPTT UE configuration MO parameters	49
4.2.1 General.....	49
4.2.2 Node: <x>	49
4.2.3 /<x>/Name	49
4.2.4 /<x>/Ext/	50
4.2.5 /<x>/Common.....	50
4.2.6 /<x>/Common/PrivateCall.....	50
4.2.7 /<x>/Common/PrivateCall/MaxCallIN10.....	50
4.2.8 /<x>/Common/MCPTTGroupCall.....	51
4.2.9 /<x>/Common/MCPTTGroupCall/MaxCallIN4.....	51
4.2.10 /<x>/Common/MCPTTGroupCall/MaxTransmissionN5.....	51
4.2.11 /<x>/Common/MCPTTGroupCall/PrioritizedMCPTTGroup.....	51
4.2.12 /<x>/Common/MCPTTGroupCall/PrioritizedMCPTTGroup/<x>.....	51
4.2.13 /<x>/Common/MCPTTGroupCall/PrioritizedMCPTTGroup/<x>/ MCPTTGroupID	52
4.2.14 /<x>/Common/MCPTTGroupCall/PrioritizedMCPTTGroup/<x>/ MCPTTGroupPriorityHierarchy	52
4.2.15 /<x>/OnNetwork.....	52
4.2.16 /<x>/OnNetwork/RelayService	52
4.2.17 /<x>/OnNetwork/IPv6Preferred	53
4.2.18 /<x>/OnNetwork/RelayedMCPTTGroup	53
4.2.19 /<x>/OnNetwork/RelayedMCPTTGroup/<x>.....	53
4.2.20 /<x>/OnNetwork/RelayedMCPTTGroup/<x>/MCPTTGroupID	53
4.2.21 /<x>/OnNetwork/RelayedMCPTTGroup/<x>/RelayServiceCode	54
5 MCPTT user profile MO.....	54
5.1 General	54
5.2 MCPTT user profile MO parameters.....	58
5.2.1 General.....	58
5.2.2 Node: <x>	58
5.2.3 /<x>/Name	58
5.2.4 /<x>/Ext/	58
5.2.5 /<x>/<x>.....	59
5.2.6 /<x>/<x>/Common	59
5.2.7 /<x>/<x>/Common/MCPTTUserID	59
5.2.7A /<x>/<x>/Common/MCPTTUserProfileIndex	59
5.2.7B /<x>/<x>/Common/MCPTTUserProfileName	60
5.2.7C /<x>/<x>/Common/PreSelectedIndication	60
5.2.8 /<x>/<x>/Common/UserAliases	60
5.2.8A /<x>/<x>/Common/UserAliases/<x>	60
5.2.8B /<x>/<x>/Common/UserAliases/<x>/UserAlias	61
5.2.9 /<x>/<x>/Common/AuthorisedAlias	61
5.2.10 /<x>/<x>/Common/ParticipantType.....	61

5.2.11	/<x>/<x>/Common/Organization	61
5.2.12	/<x>/<x>/Common/PrivateCall	62
5.2.13	/<x>/<x>/Common/PrivateCall/Authorised	62
5.2.14	/<x>/<x>/Common/PrivateCall/AuthorisedAny.....	62
5.2.15	/<x>/<x>/Common/PrivateCall/UserList	62
5.2.16	/<x>/<x>/Common/PrivateCall/UserList/<x>	62
5.2.16A	/<x>/<x>/Common/PrivateCall/UserList/<x>/Entry	63
5.2.17	/<x>/<x>/Common/PrivateCall/UserList/<x>/Entry/MCPTTID	63
5.2.18	/<x>/<x>/Common/PrivateCall/UserList/<x>/Entry/DiscoveryGroupID	63
5.2.18A	/<x>/<x>/Common/PrivateCall/UserList/<x>/Entry/ApplicationLayerGroupID.....	63
5.2.19	/<x>/<x>/Common/PrivateCall/UserList/<x>/Entry/UserInfoID.....	64
5.2.19A	/<x>/<x>/Common/PrivateCall/UserList/<x>/Entry/DisplayName	64
5.2.19B	/<x>/<x>/Common/PrivateCall/UserList/<x>/Entry/PrivateCallKMSURI.....	64
5.2.20	/<x>/<x>/Common/PrivateCall/ManualCommence	64
5.2.21	/<x>/<x>/Common/PrivateCall/AutoCommence	65
5.2.22	/<x>/<x>/Common/PrivateCall/AutoAnswer.....	65
5.2.23	/<x>/<x>/Common/PrivateCall/FailRestrict.....	65
5.2.24	/<x>/<x>/Common/PrivateCall/AllowedMediaProtection	65
5.2.25	/<x>/<x>/Common/PrivateCall/AllowedFloorControlProtection	66
5.2.26	/<x>/<x>/Common/PrivateCall/EmergencyCall	66
5.2.27	/<x>/<x>/Common/PrivateCall/EmergencyCall/Authorised.....	66
5.2.28	/<x>/<x>/Common/PrivateCall/EmergencyCall/CancelPriority	67
5.2.29	/<x>/<x>/Common/PrivateCall/EmergencyCall/MCPTTPrivateRecipient.....	67
5.2.29A	/<x>/<x>/Common/PrivateCall/EmergencyCall/MCPTTPrivateRecipient/Entry.....	67
5.2.29B	/<x>/<x>/Common/PrivateCall/EmergencyCall/MCPTTPrivateRecipient/Entry/ID	67
5.2.29C	/<x>/<x>/Common/PrivateCall/EmergencyCall/MCPTTPrivateRecipient/Entry/DiscoveryGroupID	68
5.2.29C1	/<x>/<x>/Common/PrivateCall/EmergencyCall/ MCPTTPrivateRecipient/Entry/ApplicationLayerGroupID	68
5.2.29D	/<x>/<x>/Common/PrivateCall/EmergencyCall/MCPTTPrivateRecipient/Entry/UserInfoID	68
5.2.29E	/<x>/<x>/Common/PrivateCall/EmergencyCall/MCPTTPrivateRecipient/Entry/DisplayName.....	68
5.2.29F	/<x>/<x>/Common/PrivateCall/EmergencyCall/MCPTTPrivateRecipient/Entry/Usage.....	69
5.2.30	/<x>/<x>/Common/MCPTTGroupCall	69
5.2.31	/<x>/<x>/Common/MCPTTGroupCall/MaxSimultaneousCallsN6	69
5.2.32	/<x>/<x>/Common/MCPTTGroupCall/EmergencyCall	69
5.2.33	/<x>/<x>/Common/MCPTTGroupCall/EmergencyCall/Enabled	70
5.2.34	/<x>/<x>/Common/MCPTTGroupCall/EmergencyCall/MCPTTGroupInitiation	70
5.2.34A	/<x>/<x>/Common/MCPTTGroupCall/EmergencyCall/MCPTTGroupInitiation/Entry	70
5.2.34B	/<x>/<x>/Common/MCPTTGroupCall/EmergencyCall/MCPTTGroupInitiation/Entry/GroupID	70
5.2.34C	/<x>/<x>/Common/MCPTTGroupCall/EmergencyCall/ MCPTTGroupInitiation/Entry/DisplayName	71
5.2.34D	/<x>/<x>/Common/MCPTTGroupCall/EmergencyCall/MCPTTGroupInitiation/Entry/Usage	71
5.2.35	/<x>/<x>/Common/MCPTTGroupCall/EmergencyCall/CancelMCPTTGroup.....	71
5.2.36	/<x>/<x>/Common/MCPTTGroupCall/ImminentPerilCall	72
5.2.37	/<x>/<x>/Common/MCPTTGroupCall/ImminentPerilCall/Authorised.....	72
5.2.38	/<x>/<x>/Common/MCPTTGroupCall/ImminentPerilCall/Cancel	72
5.2.39	/<x>/<x>/Common/MCPTTGroupCall/ImminentPerilCall/MCPTTGroupInitiation	72
5.2.39A	/<x>/<x>/Common/MCPTTGroupCall/ImminentPerilCall/MCPTTGroupInitiation/Entry	73
5.2.39B	/<x>/<x>/Common/MCPTTGroupCall/ImminentPerilCall/MCPTTGroupInitiation/Entry/GroupID	73
5.2.39C	/<x>/<x>/Common/MCPTTGroupCall/ImminentPerilCall/MCPTTGroupInitiation/DisplayName	73
5.2.39D	/<x>/<x>/Common/MCPTTGroupCall/ImminentPerilCall/MCPTTGroupInitiation/Entry/Usage	73
5.2.40	/<x>/<x>/Common/MCPTTGroupCall/EmergencyAlert.....	74
5.2.41	/<x>/<x>/Common/MCPTTGroupCall/EmergencyAlert/Authorised.....	74
5.2.42	/<x>/<x>/Common/MCPTTGroupCall/EmergencyAlert/Cancel.....	74
5.2.43	Void	74
5.2.43A	/<x>/<x>/Common/MCPTTGroupCall/EmergencyAlert/Entry	74
5.2.43B	/<x>/<x>/Common/MCPTTGroupCall/EmergencyAlert/Entry/ID.....	75
5.2.43C	Void	75
5.2.43D	/<x>/<x>/Common/MCPTTGroupCall/EmergencyAlert/Entry/DisplayName	75
5.2.43E	/<x>/<x>/Common/MCPTTGroupCall/EmergencyAlert/Entry/Usage.....	75
5.2.43F	/<x>/<x>/Common/MCPTTGroupCall/Priority	76
5.2.44	Void	76
5.2.45	/<x>/<x>/Common/MCPTTGroupBroadcast.....	76

5.2.46	/<x>/<x>/Common/MCPTTGroupBroadcast/Authorised	76
5.2.47	/<x>/<x>/Common/UserBroadcast.....	76
5.2.48	/<x>/<x>/Common/UserBroadcast/Authorised	77
5.2.48A	/<x>/<x>/OnNetwork	77
5.2.48B1	/<x>/<x>/OnNetwork/MCPTTGroupList.....	77
5.2.48B2	/<x>/<x>/OnNetwork/MCPTTGroupList/<x>	77
5.2.48B3	/<x>/<x>/OnNetwork/MCPTTGroupList/<x>/Entry	77
5.2.48B4	/<x>/<x>/OnNetwork/MCPTTGroupList/<x>/Entry/ MCPTTGroupID	78
5.2.48B4A	/<x>/<x>/OnNetwork/MCPTTGroupList/<x>/Entry/ RulesForAffiliation.....	78
5.2.48B4A0	/<x>/<x>/OnNetwork/MCPTTGroupList/<x>/Entry/ RulesForAffiliation/<x>	78
5.2.48B4A1	/<x>/<x>/OnNetwork/MCPTTGroupList/<x>/Entry/ RulesForAffiliation/<x>/ListOfLocationCriteria.....	78
5.2.48B4A2	/<x>/<x>/OnNetwork/MCPTTGroupList/<x>/Entry/ RulesForAffiliation/<x>/ListOfLocationCriteria/<x>	79
5.2.48B4A3	/<x>/<x>/OnNetwork/MCPTTGroupList/<x>/Entry/ RulesForAffiliation/<x>/ListOfLocationCriteria/<x>/Entry	79
5.2.48B4A4	/<x>/<x>/OnNetwork/MCPTTGroupList/<x>/Entry/ RulesForAffiliation/<x>/ListOfLocationCriteria/<x>/Entry/ EnterSpecificArea.....	79
5.2.48B4A5	/<x>/<x>/OnNetwork/MCPTTGroupList/<x>/Entry/ RulesForAffiliation/<x>/ListOfLocationCriteria/<x>/Entry/ EnterSpecificArea/PolygonArea.....	79
5.2.48B4A6	/<x>/<x>/OnNetwork/MCPTTGroupList/<x>/Entry/ RulesForAffiliation/<x>/ListOfLocationCriteria/<x>/Entry/ EnterSpecificArea/PolygonArea/<x>	80
5.2.48B4A7	/<x>/<x>/OnNetwork/MCPTTGroupList/<x>/Entry/ RulesForAffiliation/<x>/ListOfLocationCriteria/<x>/Entry/ EnterSpecificArea/PolygonArea/<x>/PointCoordinateType	80
5.2.48B4A8	/<x>/<x>/OnNetwork/MCPTTGroupList/<x>/Entry/ RulesForAffiliation/<x>/ListOfLocationCriteria/<x>/Entry/ EnterSpecificArea/PolygonArea/<x>/PointCoordinateType/ Longitude.....	80
5.2.48B4A9	/<x>/<x>/OnNetwork/MCPTTGroupList/<x>/Entry/ RulesForAffiliation/<x>/ListOfLocationCriteria/<x>/Entry/ EnterSpecificArea/PolygonArea/<x>/PointCoordinateType/ Latitude.....	81
5.2.48B4A10	/<x>/<x>/OnNetwork/MCPTTGroupList/<x>/Entry/ RulesForAffiliation/<x>/ListOfLocationCriteria/<x>/Entry/ EnterSpecificArea/EllipsoidArcArea.....	81
5.2.48B4A11	/<x>/<x>/OnNetwork/MCPTTGroupList/<x>/Entry/ RulesForAffiliation/<x>/ListOfLocationCriteria/<x>/Entry/ EnterSpecificArea/EllipsoidArcArea/Center	81
5.2.48B4A12	/<x>/<x>/OnNetwork/MCPTTGroupList/<x>/Entry/ RulesForAffiliation/<x>/ListOfLocationCriteria/<x>/Entry/ EnterSpecificArea/EllipsoidArcArea/Center/ PointCoordinateType.....	82
5.2.48B4A13	/<x>/<x>/OnNetwork/MCPTTGroupList/<x>/Entry/ RulesForAffiliation/<x>/ListOfLocationCriteria/<x>/Entry/ EnterSpecificArea/EllipsoidArcArea/Center/ PointCoordinateType/Longitude	82
5.2.48B4A14	/<x>/<x>/OnNetwork/MCPTTGroupList/<x>/Entry/ RulesForAffiliation/<x>/ListOfLocationCriteria/<x>/Entry/ EnterSpecificArea/EllipsoidArcArea/Center/ PointCoordinateType/Latitude	82
5.2.48B4A15	/<x>/<x>/OnNetwork/MCPTTGroupList/<x>/Entry/ RulesForAffiliation/<x>/ListOfLocationCriteria/<x>/Entry/ EnterSpecificArea/EllipsoidArcArea/Radius.....	83
5.2.48B4A16	/<x>/<x>/OnNetwork/MCPTTGroupList/<x>/Entry/ RulesForAffiliation/<x>/ListOfLocationCriteria/<x>/Entry/ EnterSpecificArea/EllipsoidArcArea/OffsetAngle	83
5.2.48B4A17	/<x>/<x>/OnNetwork/MCPTTGroupList/<x>/Entry/ RulesForAffiliation/<x>/ListOfLocationCriteria/<x>/Entry/ EnterSpecificArea/EllipsoidArcArea/IncludedAngle	83
5.2.48B4A18	/<x>/<x>/OnNetwork/MCPTTGroupList/<x>/Entry/ RulesForAffiliation/<x>/ListOfLocationCriteria/<x>/Entry/ EnterSpecificArea/Speed.....	83
5.2.48B4A19	/<x>/<x>/OnNetwork/MCPTTGroupList/<x>/Entry/ RulesForAffiliation/<x>/ListOfLocationCriteria/<x>/Entry/ EnterSpecificArea/Speed/MinimumSpeed	84
5.2.48B4A20	/<x>/<x>/OnNetwork/MCPTTGroupList/<x>/Entry/ RulesForAffiliation/<x>/ListOfLocationCriteria/<x>/Entry/ EnterSpecificArea/Speed/MaximumSpeed.....	84

5.2.48B4A21	/<x>/<x>/OnNetwork/MCPTTGroupList/<x>/Entry/ RulesForAffiliation/<x>/ListOfLocationCriteria/<x>/Entry/ EnterSpecificArea/Heading	84
5.2.48B4A22	/<x>/<x>/OnNetwork/MCPTTGroupList/<x>/Entry/ RulesForAffiliation/<x>/ListOfLocationCriteria/<x>/Entry/ EnterSpecificArea/Heading/MinimumHeading	85
5.2.48B4A23	/<x>/<x>/OnNetwork/MCPTTGroupList/<x>/Entry/ RulesForAffiliation/<x>/ListOfLocationCriteria/<x>/Entry/ EnterSpecificArea/Heading/MaximumHeading	85
5.2.48B4A24	/<x>/<x>/OnNetwork/MCPTTGroupList/<x>/Entry/ RulesForAffiliation/<x>/ListOfLocationCriteria/<x>/Entry/ ExitSpecificArea.....	85
5.2.48B4A25	/<x>/<x>/OnNetwork/MCPTTGroupList/<x>/Entry/ RulesForAffiliation/<x>/ListOfLocationCriteria/<x>/Entry/ ExitSpecificArea/PolygonArea.....	86
5.2.48B4A26	/<x>/<x>/OnNetwork/MCPTTGroupList/<x>/Entry/ RulesForAffiliation/<x>/ListOfLocationCriteria/<x>/Entry/ ExitSpecificArea/PolygonArea/<x>	86
5.2.48B4A27	/<x>/<x>/OnNetwork/MCPTTGroupList/<x>/Entry/ RulesForAffiliation/<x>/ListOfLocationCriteria/<x>/Entry/ ExitSpecificArea/PolygonArea/<x>/PointCoordinateType	86
5.2.48B4A28	/<x>/<x>/OnNetwork/MCPTTGroupList/<x>/Entry/ RulesForAffiliation/<x>/ListOfLocationCriteria/<x>/Entry/ ExitSpecificArea/PolygonArea/<x>/PointCoordinateType/ Longitude	87
5.2.48B4A29	/<x>/<x>/OnNetwork/MCPTTGroupList/<x>/Entry/ RulesForAffiliation/<x>/ListOfLocationCriteria/<x>/Entry/ ExitSpecificArea/PolygonArea/<x>/PointCoordinateType/ Latitude.....	87
5.2.48B4A30	/<x>/<x>/OnNetwork/MCPTTGroupList/<x>/Entry/ RulesForAffiliation/<x>/ListOfLocationCriteria/<x>/Entry/ ExitSpecificArea/EllipsoidArcArea.....	87
5.2.48B4A31	/<x>/<x>/OnNetwork/MCPTTGroupList/<x>/Entry/ RulesForAffiliation/<x>/ListOfLocationCriteria/<x>/Entry/ ExitSpecificArea/EllipsoidArcArea/Center	88
5.2.48B4A32	/<x>/<x>/OnNetwork/MCPTTGroupList/<x>/Entry/ RulesForAffiliation/<x>/ListOfLocationCriteria/<x>/Entry/ ExitSpecificArea/EllipsoidArcArea/Center/PointCoordinateType.....	88
5.2.48B4A33	/<x>/<x>/OnNetwork/MCPTTGroupList/<x>/Entry/ RulesForAffiliation/<x>/ListOfLocationCriteria/<x>/Entry/ ExitSpecificArea/EllipsoidArcArea/Center/ PointCoordinateType/Longitude	88
5.2.48B4A34	/<x>/<x>/OnNetwork/MCPTTGroupList/<x>/Entry/ RulesForAffiliation/<x>/ListOfLocationCriteria/<x>/Entry/ ExitSpecificArea/EllipsoidArcArea/Center/ PointCoordinateType/Latitude	89
5.2.48B4A35	/<x>/<x>/OnNetwork/MCPTTGroupList/<x>/Entry/ RulesForAffiliation/<x>/ListOfLocationCriteria/<x>/Entry/ ExitSpecificArea/EllipsoidArcArea/Radius.....	89
5.2.48B4A36	/<x>/<x>/OnNetwork/MCPTTGroupList/<x>/Entry/ RulesForAffiliation/<x>/ListOfLocationCriteria/<x>/Entry/ ExitSpecificArea/EllipsoidArcArea/OffsetAngle	89
5.2.48B4A37	/<x>/<x>/OnNetwork/MCPTTGroupList/<x>/Entry/ RulesForAffiliation/<x>/ListOfLocationCriteria/<x>/Entry/ ExitSpecificArea/EllipsoidArcArea/IncludedAngle	90
5.2.48B4A38	/<x>/<x>/OnNetwork/MCPTTGroupList/<x>/Entry/ RulesForAffiliation/<x>/ListOfLocationCriteria/<x>/Entry/ ExitSpecificArea/Speed.....	90
5.2.48B4A39	/<x>/<x>/OnNetwork/MCPTTGroupList/<x>/Entry/ RulesForAffiliation/<x>/ListOfLocationCriteria/<x>/Entry/ ExitSpecificArea/Speed/MinimumSpeed	90
5.2.48B4A40	/<x>/<x>/OnNetwork/MCPTTGroupList/<x>/Entry/ RulesForAffiliation/<x>/ListOfLocationCriteria/<x>/Entry/ ExitSpecificArea/Speed/MaximumSpeed.....	91
5.2.48B4A41	/<x>/<x>/OnNetwork/MCPTTGroupList/<x>/Entry/ RulesForAffiliation/<x>/ListOfLocationCriteria/<x>/Entry/ ExitSpecificArea/Heading	91
5.2.48B4A42	/<x>/<x>/OnNetwork/MCPTTGroupList/<x>/Entry/ RulesForAffiliation/<x>/ListOfLocationCriteria/<x>/Entry/ ExitSpecificArea/Heading/MinimumHeading	91
5.2.48B4A43	/<x>/<x>/OnNetwork/MCPTTGroupList/<x>/Entry/ RulesForAffiliation/<x>/ListOfLocationCriteria/<x>/Entry/ ExitSpecificArea/Heading/MaximumHeading	92

5.2.48B4A44	/<x>/<x>/OnNetwork/MCPTTGroupList/<x>/Entry/ RulesForAffiliation/<x>/ListOfActiveFunctionalAliases	92
5.2.48B4A45	/<x>/<x>/OnNetwork/MCPTTGroupList/<x>/Entry/ RulesForAffiliation/<x>/ListOfActiveFunctionalAliases/<x>	92
5.2.48B4A46	/<x>/<x>/OnNetwork/MCPTTGroupList/<x>/Entry/ RulesForAffiliation/<x>/ListOfActiveFunctionalAliases/<x>/Entry	92
5.2.48B4A47	/<x>/<x>/OnNetwork/MCPTTGroupList/<x>/Entry/ RulesForAffiliation/<x>/ListOfActiveFunctionalAliases/<x>/Entry/FunctionalAlias	93
5.2.48B4B	/<x>/<x>/OnNetwork/MCPTTGroupList/<x>/Entry/ RulesForDeaffiliation	93
5.2.48B4B0	/<x>/<x>/OnNetwork/MCPTTGroupList/<x>/Entry/ RulesForDeaffiliation/<x>	93
5.2.48B4B1	/<x>/<x>/OnNetwork/MCPTTGroupList/<x>/Entry/ RulesForDeaffiliation/<x>/ListOfLocationCriteria	93
5.2.48B4B2	/<x>/<x>/OnNetwork/MCPTTGroupList/<x>/Entry/ RulesForDeaffiliation/<x>/ListOfLocationCriteria/<x>	94
5.2.48B4B3	/<x>/<x>/OnNetwork/MCPTTGroupList/<x>/Entry/ RulesForDeaffiliation/<x>/ListOfLocationCriteria/<x>/Entry	94
5.2.48B4B4	/<x>/<x>/OnNetwork/MCPTTGroupList/<x>/Entry/ RulesForDeaffiliation/<x>/ListOfLocationCriteria/<x>/Entry/ EnterSpecificArea	94
5.2.48B4B5	/<x>/<x>/OnNetwork/MCPTTGroupList/<x>/Entry/ RulesForDeaffiliation/<x>/ListOfLocationCriteria/<x>/Entry/ EnterSpecificArea/PolygonArea	94
5.2.48B4B6	/<x>/<x>/OnNetwork/MCPTTGroupList/<x>/Entry/ RulesForDeaffiliation/<x>/ListOfLocationCriteria/<x>/Entry/ EnterSpecificArea/PolygonArea/<x>	95
5.2.48B4B7	/<x>/<x>/OnNetwork/MCPTTGroupList/<x>/Entry/ RulesForDeaffiliation/<x>/ListOfLocationCriteria/<x>/Entry/ EnterSpecificArea/PolygonArea/<x>/PointCoordinateType	95
5.2.48B4B8	/<x>/<x>/OnNetwork/MCPTTGroupList/<x>/Entry/ RulesForDeaffiliation/<x>/ListOfLocationCriteria/<x>/Entry/ EnterSpecificArea/PolygonArea/<x>/PointCoordinateType/ Longitude	95
5.2.48B4B9	/<x>/<x>/OnNetwork/MCPTTGroupList/<x>/Entry/ RulesForDeaffiliation/<x>/ListOfLocationCriteria/<x>/Entry/ EnterSpecificArea/PolygonArea/<x>/PointCoordinateType/ Latitude	96
5.2.48B4B10	/<x>/<x>/OnNetwork/MCPTTGroupList/<x>/Entry/ RulesForDeaffiliation/<x>/ListOfLocationCriteria/<x>/Entry/ EnterSpecificArea/EllipsoidArcArea	96
5.2.48B4B11	/<x>/<x>/OnNetwork/MCPTTGroupList/<x>/Entry/ RulesForDeaffiliation/<x>/ListOfLocationCriteria/<x>/Entry/ EnterSpecificArea/EllipsoidArcArea/Center	96
5.2.48B4B12	/<x>/<x>/OnNetwork/MCPTTGroupList/<x>/Entry/ RulesForDeaffiliation/<x>/ListOfLocationCriteria/<x>/Entry/ EnterSpecificArea/EllipsoidArcArea/Center/PointCoordinateType	97
5.2.48B4B13	/<x>/<x>/OnNetwork/MCPTTGroupList/<x>/Entry/ RulesForDeaffiliation/<x>/ListOfLocationCriteria/<x>/Entry/ EnterSpecificArea/EllipsoidArcArea/Center/ PointCoordinateType/Longitude	97
5.2.48B4B14	/<x>/<x>/OnNetwork/MCPTTGroupList/<x>/Entry/ RulesForDeaffiliation/<x>/ListOfLocationCriteria/<x>/Entry/ EnterSpecificArea/EllipsoidArcArea/Center/ PointCoordinateType/Latitude	97
5.2.48B4B15	/<x>/<x>/OnNetwork/MCPTTGroupList/<x>/Entry/ RulesForDeaffiliation/<x>/ListOfLocationCriteria/<x>/Entry/ EnterSpecificArea/EllipsoidArcArea/Radius	98
5.2.48B4B16	/<x>/<x>/OnNetwork/MCPTTGroupList/<x>/Entry/ RulesForDeaffiliation/<x>/ListOfLocationCriteria/<x>/Entry/ EnterSpecificArea/EllipsoidArcArea/OffsetAngle	98
5.2.48B4B17	/<x>/<x>/OnNetwork/MCPTTGroupList/<x>/Entry/ RulesForDeaffiliation/<x>/ListOfLocationCriteria/<x>/Entry/ EnterSpecificArea/EllipsoidArcArea/IncludedAngle	98
5.2.48B4B18	/<x>/<x>/OnNetwork/MCPTTGroupList/<x>/Entry/ RulesForDeaffiliation/<x>/ListOfLocationCriteria/<x>/Entry/ EnterSpecificArea/Speed	98
5.2.48B4B19	/<x>/<x>/OnNetwork/MCPTTGroupList/<x>/Entry/ RulesForDeaffiliation/<x>/ListOfLocationCriteria/<x>/Entry/ EnterSpecificArea/Speed/MinimumSpeed	99
5.2.48B4B20	/<x>/<x>/OnNetwork/MCPTTGroupList/<x>/Entry/ RulesForDeaffiliation/<x>/ListOfLocationCriteria/<x>/Entry/ EnterSpecificArea/Speed/MaximumSpeed	99

5.2.48B4B21	/<x>/<x>/OnNetwork/MCPTTGroupList/<x>/Entry/ RulesForDeaffiliation/<x>/ListOfLocationCriteria/<x>/Entry/ EnterSpecificArea/Heading	99
5.2.48B4B22	/<x>/<x>/OnNetwork/MCPTTGroupList/<x>/Entry/ RulesForDeaffiliation/<x>/ListOfLocationCriteria/<x>/Entry/ EnterSpecificArea/Heading/MinimumHeading	100
5.2.48B4B23	/<x>/<x>/OnNetwork/MCPTTGroupList/<x>/Entry/ RulesForDeaffiliation/<x>/ListOfLocationCriteria/<x>/Entry/ EnterSpecificArea/Heading/MaximumHeading	100
5.2.48B4B24	/<x>/<x>/OnNetwork/MCPTTGroupList/<x>/Entry/ RulesForDeaffiliation/<x>/ListOfLocationCriteria/<x>/Entry/ ExitSpecificArea	100
5.2.48B4B25	/<x>/<x>/OnNetwork/MCPTTGroupList/<x>/Entry/ RulesForDeaffiliation/<x>/ListOfLocationCriteria/<x>/Entry/ ExitSpecificArea/PolygonArea	101
5.2.48B4B26	/<x>/<x>/OnNetwork/MCPTTGroupList/<x>/Entry/ RulesForDeaffiliation/<x>/ListOfLocationCriteria/<x>/Entry/ ExitSpecificArea/PolygonArea/<x>	101
5.2.48B4B27	/<x>/<x>/OnNetwork/MCPTTGroupList/<x>/Entry/ RulesForDeaffiliation/<x>/ListOfLocationCriteria/<x>/Entry/ ExitSpecificArea/PolygonArea/<x>/PointCoordinateType	101
5.2.48B4B28	/<x>/<x>/OnNetwork/MCPTTGroupList/<x>/Entry/ RulesForDeaffiliation/<x>/ListOfLocationCriteria/<x>/Entry/ ExitSpecificArea/PolygonArea/<x>/PointCoordinateType/ Longitude	102
5.2.48B4B29	/<x>/<x>/OnNetwork/MCPTTGroupList/<x>/Entry/ RulesForDeaffiliation/<x>/ListOfLocationCriteria/<x>/Entry/ ExitSpecificArea/PolygonArea/<x>/PointCoordinateType/ Latitude	102
5.2.48B4B30	/<x>/<x>/OnNetwork/MCPTTGroupList/<x>/Entry/ RulesForDeaffiliation/<x>/ListOfLocationCriteria/<x>/Entry/ ExitSpecificArea/EllipsoidArcArea	102
5.2.48B4B31	/<x>/<x>/OnNetwork/MCPTTGroupList/<x>/Entry/ RulesForDeaffiliation/<x>/ListOfLocationCriteria/<x>/Entry/ ExitSpecificArea/EllipsoidArcArea/Center	103
5.2.48B4B32	/<x>/<x>/OnNetwork/MCPTTGroupList/<x>/Entry/ RulesForDeaffiliation/<x>/ListOfLocationCriteria/<x>/Entry/ ExitSpecificArea/EllipsoidArcArea/Center/PointCoordinateType	103
5.2.48B4B33	/<x>/<x>/OnNetwork/MCPTTGroupList/<x>/Entry/ RulesForDeaffiliation/<x>/ListOfLocationCriteria/<x>/Entry/ ExitSpecificArea/EllipsoidArcArea/Center/PointCoordinateType/ Longitude	103
5.2.48B4B34	/<x>/<x>/OnNetwork/MCPTTGroupList/<x>/Entry/ RulesForDeaffiliation/<x>/ListOfLocationCriteria/<x>/Entry/ ExitSpecificArea/EllipsoidArcArea/Center/PointCoordinateType/ Latitude	104
5.2.48B4B35	/<x>/<x>/OnNetwork/MCPTTGroupList/<x>/Entry/ RulesForDeaffiliation/<x>/ListOfLocationCriteria/<x>/Entry/ ExitSpecificArea/EllipsoidArcArea/Radius	104
5.2.48B4B36	/<x>/<x>/OnNetwork/MCPTTGroupList/<x>/Entry/ RulesForDeaffiliation/<x>/ListOfLocationCriteria/<x>/Entry/ ExitSpecificArea/EllipsoidArcArea/OffsetAngle	104
5.2.48B4B37	/<x>/<x>/OnNetwork/MCPTTGroupList/<x>/Entry/ RulesForDeaffiliation/<x>/ListOfLocationCriteria/<x>/Entry/ ExitSpecificArea/EllipsoidArcArea/IncludedAngle	105
5.2.48B4B38	/<x>/<x>/OnNetwork/MCPTTGroupList/<x>/Entry/ RulesForDeaffiliation/<x>/ListOfLocationCriteria/<x>/Entry/ ExitSpecificArea/Speed	105
5.2.48B4B39	/<x>/<x>/OnNetwork/MCPTTGroupList/<x>/Entry/ RulesForDeaffiliation/<x>/ListOfLocationCriteria/<x>/Entry/ ExitSpecificArea/Speed/MinimumSpeed	105
5.2.48B4B40	/<x>/<x>/OnNetwork/MCPTTGroupList/<x>/Entry/ RulesForDeaffiliation/<x>/ListOfLocationCriteria/<x>/Entry/ ExitSpecificArea/Speed/MaximumSpeed	106
5.2.48B4B41	/<x>/<x>/OnNetwork/MCPTTGroupList/<x>/Entry/ RulesForDeaffiliation/<x>/ListOfLocationCriteria/<x>/Entry/ ExitSpecificArea/Heading	106
5.2.48B4B42	/<x>/<x>/OnNetwork/MCPTTGroupList/<x>/Entry/ RulesForDeaffiliation/<x>/ListOfLocationCriteria/<x>/Entry/ ExitSpecificArea/Heading/MinimumHeading	106
5.2.48B4B43	/<x>/<x>/OnNetwork/MCPTTGroupList/<x>/Entry/ RulesForDeaffiliation/<x>/ListOfLocationCriteria/<x>/Entry/ ExitSpecificArea/Heading/MaximumHeading	107

5.2.48B4B44	/<x>/<x>/OnNetwork/MCPTTGroupList/<x>/Entry/ RulesForDeaffiliation/<x>/ListOfActiveFunctionalAliases	107
5.2.48B4B45	/<x>/<x>/OnNetwork/MCPTTGroupList/<x>/Entry/ RulesForDeaffiliation/<x>/ListOfActiveFunctionalAliases/<x>	107
5.2.48B4B46	/<x>/<x>/OnNetwork/MCPTTGroupList/<x>/Entry/ RulesForDeaffiliation/<x>/ListOfActiveFunctionalAliases/<x>/Entry	107
5.2.48B4B47	/<x>/<x>/OnNetwork/MCPTTGroupList/<x>/Entry/ RulesForDeaffiliation/<x>/ListOfActiveFunctionalAliases/<x>/Entry/FunctionalAlias	108
5.2.48B5	/<x>/<x>/OnNetwork/MCPTTGroupList/<x>/Entry/DisplayName	108
5.2.48B6	/<x>/<x>/OnNetwork/MCPTTGroupList/<x>/Entry/ ManualDeaffiliationNotAllowedIfAffiliationRulesAreMet	108
5.2.48B7	/<x>/<x>/OnNetwork/MCPTTGroupList/<x>/Entry/RelativePresentationPriority	108
5.2.48B8	/<x>/<x>/OnNetwork/MCPTTGroupList/<x>/Entry/GMSServID	109
5.2.48B9	/<x>/<x>/OnNetwork/MCPTTGroupList/<x>/Entry/IDMSTokenEndPoint	109
5.2.48B10	/<x>/<x>/OnNetwork/MCPTTGroupList/<x>/Entry/GroupKMSURI	109
5.2.48C1	/<x>/<x>/OnNetwork/ImplicitAffiliations	109
5.2.48C2	/<x>/<x>/OnNetwork/ImplicitAffiliations/<x>	109
5.2.48C3	/<x>/<x>/OnNetwork/ImplicitAffiliations/<x>/Entry	110
5.2.48C4	/<x>/<x>/OnNetwork/ImplicitAffiliations/<x>/Entry/MCPTTGroupID	110
5.2.48C5	/<x>/<x>/OnNetwork/ImplicitAffiliations/<x>/Entry/DisplayName	110
5.2.48D	/<x>/<x>/OnNetwork/AllowedRegroup	110
5.2.48E	/<x>/<x>/OnNetwork/AllowedPresenceStatus	111
5.2.48F	/<x>/<x>/OnNetwork/AllowedPresence	111
5.2.48G	/<x>/<x>/OnNetwork/EnabledParticipation	111
5.2.48H	/<x>/<x>/OnNetwork/AllowedTransmission	111
5.2.48I	/<x>/<x>/OnNetwork/AllowedManualSwitch	112
5.2.48J	/<x>/<x>/OnNetwork/PrivateCall	112
5.2.48K	/<x>/<x>/OnNetwork/PrivateCall/EmergencyAlert	112
5.2.48L	/<x>/<x>/OnNetwork/PrivateCall/EmergencyAlert/Entry	112
5.2.48M	/<x>/<x>/OnNetwork/PrivateCall/EmergencyAlert/Entry/ID	113
5.2.48N	/<x>/<x>/OnNetwork/PrivateCall/EmergencyAlert/Entry/DisplayName	113
5.2.48O	/<x>/<x>/OnNetwork/PrivateCall/EmergencyAlert/Entry/Usage	113
5.2.48P	/<x>/<x>/OnNetwork/PrivateCall/AllowedCallbackRequest	113
5.2.48Q	/<x>/<x>/OnNetwork/PrivateCall/AllowedCallbackCancelRequest	114
5.2.48R	/<x>/<x>/OnNetwork/PrivateCall/AllowedRemoteInitiatedAmbientListening	114
5.2.48S	/<x>/<x>/OnNetwork/PrivateCall/AllowedLocallyInitiatedAmbientListening	114
5.2.48T	/<x>/<x>/OnNetwork/PrivateCall/AllowedRequestFirstToAnswerCall	114
5.2.48T1	/<x>/<x>/OnNetwork/PrivateCall/AllowedCallTransfer	115
5.2.48T2	/<x>/<x>/OnNetwork/PrivateCall/AllowedCallTransferAny	115
5.2.48T3	/<x>/<x>/OnNetwork/PrivateCall/AllowedCallForwardManualInput	115
5.2.48U1	/<x>/<x>/OnNetwork/RemoteGroupSelection	116
5.2.48U2	/<x>/<x>/OnNetwork/RemoteGroupSelection/<x>	116
5.2.48U3	/<x>/<x>/OnNetwork/RemoteGroupSelection/<x>/Entry	116
5.2.48U4	/<x>/<x>/OnNetwork/RemoteGroupSelection/<x>/Entry/MCPTTID	116
5.2.48U5	/<x>/<x>/OnNetwork/RemoteGroupSelection/<x>/Entry/DisplayName	116
5.2.48V1	Void	117
5.2.48V2	Void	117
5.2.48V3	Void	117
5.2.48V4	Void	117
5.2.48V5	Void	117
5.2.48V6	Void	117
5.2.48V7	Void	117
5.2.48V8	Void	117
5.2.48V9	Void	117
5.2.48V10	Void	117
5.2.48V11	Void	117
5.2.48V12	Void	117
5.2.48V13	Void	117
5.2.48V14	Void	117
5.2.48V15	Void	117
5.2.48V16	Void	117
5.2.48V17	Void	117

5.2.48W1	/<x>/<x>/OnNetwork/AllowedRequestRemoteInitPrivateCall	117
5.2.48W2	/<x>/<x>/OnNetwork/AllowedRequestRemoteInitGroupCall	118
5.2.48W3	/<x>/<x>/OnNetwork/FunctionalAliasList	118
5.2.48W4	/<x>/<x>/OnNetwork/FunctionalAliasList/<x>	118
5.2.48W5	/<x>/<x>/OnNetwork/FunctionalAliasList/<x>/Entry	118
5.2.48W6	/<x>/<x>/OnNetwork/FunctionalAliasList/<x>/Entry/ FunctionalAlias	119
5.2.48W6A	/<x>/<x>/OnNetwork/FunctionalAliasList/<x>/Entry/ LocationCriteriaForActivation	119
5.2.48W6A0	/<x>/<x>/OnNetwork/FunctionalAliasList/<x>/Entry/ LocationCriteriaForActivation/<x>	119
5.2.48W6A1	/<x>/<x>/OnNetwork/FunctionalAliasList/<x>/Entry/ LocationCriteriaForActivation/<x>/EnterSpecificArea	119
5.2.48W6A2	/<x>/<x>/OnNetwork/FunctionalAliasList/<x>/Entry/ LocationCriteriaForActivation/<x>/EnterSpecificArea/ PolygonArea	120
5.2.48W6A3	/<x>/<x>/OnNetwork/FunctionalAliasList/<x>/Entry/ LocationCriteriaForActivation/<x>/EnterSpecificArea/ PolygonArea/<x>	120
5.2.48W6A3A	/<x>/<x>/OnNetwork/FunctionalAliasList/<x>/Entry/ LocationCriteriaForActivation/<x>/EnterSpecificArea/ PolygonArea/<x>/PointCoordinateType	120
5.2.48W6A4	/<x>/<x>/OnNetwork/FunctionalAliasList/<x>/Entry/ LocationCriteriaForActivation/<x>/EnterSpecificArea/ PolygonArea/<x>/PointCoordinateType/Longitude	121
5.2.48W6A5	/<x>/<x>/OnNetwork/FunctionalAliasList/<x>/Entry/ LocationCriteriaForActivation/<x>/EnterSpecificArea/ PolygonArea/<x>/PointCoordinateType/Latitude	121
5.2.48W6A6	/<x>/<x>/OnNetwork/FunctionalAliasList/<x>/Entry/ LocationCriteriaForActivation/<x>/EnterSpecificArea/ EllipsoidArcArea	121
5.2.48W6A7	/<x>/<x>/OnNetwork/FunctionalAliasList/<x>/Entry/ LocationCriteriaForActivation/<x>/EnterSpecificArea/ EllipsoidArcArea/Center	122
5.2.48W6A7A	/<x>/<x>/OnNetwork/FunctionalAliasList/<x>/Entry/ LocationCriteriaForActivation/<x>/EnterSpecificArea/ EllipsoidArcArea/Center/PointCoordinateType	122
5.2.48W6A8	/<x>/<x>/OnNetwork/FunctionalAliasList/<x>/Entry/ LocationCriteriaForActivation/<x>/EnterSpecificArea/ EllipsoidArcArea/Center/PointCoordinateType/Longitude	122
5.2.48W6A9	/<x>/<x>/OnNetwork/FunctionalAliasList/<x>/Entry/ LocationCriteriaForActivation/<x>/EnterSpecificArea/ EllipsoidArcArea/Center/PointCoordinateType/Latitude	123
5.2.48W6A10	/<x>/<x>/OnNetwork/FunctionalAliasList/<x>/Entry/ LocationCriteriaForActivation/<x>/ EnterSpecificArea/EllipsoidArcArea/Radius	123
5.2.48W6A11	/<x>/<x>/OnNetwork/FunctionalAliasList/<x>/Entry/ LocationCriteriaForActivation/<x>/ EnterSpecificArea/EllipsoidArcArea/OffsetAngle	123
5.2.48W6A12	/<x>/<x>/OnNetwork/FunctionalAliasList/<x>/ Entry/LocationCriteriaForActivation/<x>/ EnterSpecificArea/EllipsoidArcArea/IncludedAngle	124
5.2.48W6A12A/<x>/<x>/OnNetwork/FunctionalAliasList/<x>/Entry/ LocationCriteriaForActivation/<x>/EnterSpecificArea/Speed	124
5.2.48W6A12B	/<x>/<x>/OnNetwork/FunctionalAliasList/<x>/Entry/ LocationCriteriaForActivation/<x>/EnterSpecificArea/Speed/ MinimumSpeed	124
5.2.48W6A12C	/<x>/<x>/OnNetwork/FunctionalAliasList/<x>/Entry/ LocationCriteriaForActivation/<x>/EnterSpecificArea/Speed/ MaximumSpeed	125
5.2.48W6A12D/<x>/<x>/OnNetwork/FunctionalAliasList/<x>/Entry/ LocationCriteriaForActivation/<x>/EnterSpecificArea/Heading	125
5.2.48W6A12E	/<x>/<x>/OnNetwork/FunctionalAliasList/<x>/Entry/ LocationCriteriaForActivation/<x>/EnterSpecificArea/Heading/ MinimumHeading	125
5.2.48W6A12F	/<x>/<x>/OnNetwork/FunctionalAliasList/<x>/Entry/ LocationCriteriaForActivation/<x>/EnterSpecificArea/Heading/ MaximumHeading	126
5.2.48W6A13	/<x>/<x>/OnNetwork/FunctionalAliasList/<x>/Entry/ LocationCriteriaForActivation/<x>/ ExitSpecificArea	126
5.2.48W6A14	/<x>/<x>/OnNetwork/FunctionalAliasList/<x>/Entry/ LocationCriteriaForActivation/<x>/ ExitSpecificArea/PolygonArea	126
5.2.48W6A15	/<x>/<x>/OnNetwork/FunctionalAliasList/<x>/Entry/ LocationCriteriaForActivation/<x>/ ExitSpecificArea/PolygonArea/<x>	127
5.2.48W6A15A/<x>/<x>/OnNetwork/FunctionalAliasList/<x>/Entry/ LocationCriteriaForActivation/<x>/ExitSpecificArea/ PolygonArea/<x>/PointCoordinateType	127

5.2.48W6A16	<x><x>/OnNetwork/FunctionalAliasList/<x>/Entry/ LocationCriteriaForActivation/<x>/ExitSpecificArea/PolygonArea/<x>/PointCoordinateType/Longitude.....	127
5.2.48W6A17	<x><x>/OnNetwork/FunctionalAliasList/<x>/Entry/ LocationCriteriaForActivation/<x>/ExitSpecificArea/PolygonArea/<x>/PointCoordinateType/Latitude.....	128
5.2.48W6A18	<x><x>/OnNetwork/FunctionalAliasList/<x>/Entry/ LocationCriteriaForActivation/<x>/ExitSpecificArea/EllipsoidArcArea.....	128
5.2.48W6A19	<x><x>/OnNetwork/FunctionalAliasList/<x>/Entry/ LocationCriteriaForActivation/<x>/ExitSpecificArea/EllipsoidArcArea/Center.....	128
5.2.48W6A19A<x><x>/OnNetwork/FunctionalAliasList/<x>/Entry/ LocationCriteriaForActivation/<x>/ExitSpecificArea/EllipsoidArcArea/Center/PointCoordinateType.....	128
5.2.48W6A20	<x><x>/OnNetwork/FunctionalAliasList/<x>/Entry/ LocationCriteriaForActivation/<x>/ExitSpecificArea/EllipsoidArcArea/Center/PointCoordinateType/ Longitude.....	129
5.2.48W6A21	<x><x>/OnNetwork/FunctionalAliasList/<x>/Entry/ LocationCriteriaForActivation/<x>/ExitSpecificArea/EllipsoidArcArea/Center/PointCoordinateType/ Latitude.....	129
5.2.48W6A22	<x><x>/OnNetwork/FunctionalAliasList/<x>/Entry/ LocationCriteriaForActivation/<x>/ExitSpecificArea/EllipsoidArcArea/Radius.....	129
5.2.48W6A23	<x><x>/OnNetwork/FunctionalAliasList/<x>/Entry/ LocationCriteriaForActivation/<x>/ExitSpecificArea/EllipsoidArcArea/OffsetAngle.....	130
5.2.48W6A24	<x><x>/OnNetwork/FunctionalAliasList/<x>/Entry/ LocationCriteriaForActivation/<x>/ExitSpecificArea/EllipsoidArcArea/IncludedAngle.....	130
5.2.48W6A24A<x><x>/OnNetwork/FunctionalAliasList/<x>/Entry/ LocationCriteriaForActivation/<x>/ExitSpecificArea/Speed.....	130
5.2.48W6A24B	<x><x>/OnNetwork/FunctionalAliasList/<x>/Entry/ LocationCriteriaForActivation/<x>/ExitSpecificArea/Speed/ MinimumSpeed.....	131
5.2.48W6A24C	<x><x>/OnNetwork/FunctionalAliasList/<x>/Entry/ LocationCriteriaForActivation/<x>/ExitSpecificArea/Speed/ MaximumSpeed.....	131
5.2.48W6A24D<x><x>/OnNetwork/FunctionalAliasList/<x>/Entry/ LocationCriteriaForActivation/<x>/ExitSpecificArea/Heading.....	131
5.2.48W6A24E	<x><x>/OnNetwork/FunctionalAliasList/<x>/Entry/ LocationCriteriaForActivation/<x>/ExitSpecificArea/Heading/ MinimumHeading.....	132
5.2.48W6A24F	<x><x>/OnNetwork/FunctionalAliasList/<x>/Entry/ LocationCriteriaForActivation/<x>/ExitSpecificArea/Heading/ MaximumHeading.....	132
5.2.48W6B	<x><x>/OnNetwork/FunctionalAliasList/<x>/Entry/ LocationCriteriaForDeactivation.....	132
5.2.48W6B0	<x><x>/OnNetwork/FunctionalAliasList/<x>/Entry/ LocationCriteriaForDeactivation/<x>.....	132
5.2.48W6B1	<x><x>/OnNetwork/FunctionalAliasList/<x>/Entry/ LocationCriteriaForDeactivation/<x>/EnterSpecificArea.....	133
5.2.48W6B2	<x><x>/OnNetwork/FunctionalAliasList/<x>/Entry/ LocationCriteriaForDeactivation/<x>/EnterSpecificArea/ PolygonArea.....	133
5.2.48W6B3	<x><x>/OnNetwork/FunctionalAliasList/<x>/Entry/ LocationCriteriaForDeactivation/<x>/EnterSpecificArea/ PolygonArea/<x>.....	133
5.2.48W6B3A	<x><x>/OnNetwork/FunctionalAliasList/<x>/Entry/ LocationCriteriaForDeactivation/<x>/EnterSpecificArea/ PolygonArea/<x>/PointCoordinateType ...	134
5.2.48W6B4	<x><x>/OnNetwork/FunctionalAliasList/<x>/Entry/ LocationCriteriaForDeactivation/<x>/EnterSpecificArea/ PolygonArea/<x>/PointCoordinateType/Longitude.....	134
5.2.48W6B5	<x><x>/OnNetwork/FunctionalAliasList/<x>/Entry/ LocationCriteriaForDeactivation/<x>/EnterSpecificArea/ PolygonArea/<x>/PointCoordinateType/Latitude.....	134
5.2.48W6B6	<x><x>/OnNetwork/FunctionalAliasList/<x>/Entry/ LocationCriteriaForDeactivation/<x>/EnterSpecificArea/ EllipsoidArcArea.....	135
5.2.48W6B7	<x><x>/OnNetwork/FunctionalAliasList/<x>/Entry/ LocationCriteriaForDeactivation/<x>/EnterSpecificArea/ EllipsoidArcArea/Center.....	135
5.2.48W6B7A	<x><x>/OnNetwork/FunctionalAliasList/<x>/Entry/ LocationCriteriaForDeactivation/<x>/EnterSpecificArea/ EllipsoidArcArea/Center/PointCoordinateType.....	135
5.2.48W6B8	<x><x>/OnNetwork/FunctionalAliasList/<x>/Entry/ LocationCriteriaForDeactivation/<x>/EnterSpecificArea/ EllipsoidArcArea/Center/PointCoordinateType/Longitude.....	136
5.2.48W6B9	<x><x>/OnNetwork/FunctionalAliasList/<x>/Entry/ LocationCriteriaForDeactivation/<x>/EnterSpecificArea/ EllipsoidArcArea/Center/PointCoordinateType/Latitude.....	136

5.2.48W6B10	/<x>/<x>/OnNetwork/FunctionalAliasList/<x>/Entry/ LocationCriteriaForDeactivation/<x>/EnterSpecificArea/ EllipsoidArcArea/Radius	136
5.2.48W6B11	/<x>/<x>/OnNetwork/FunctionalAliasList/<x>/Entry/ LocationCriteriaForDeactivation/<x>/EnterSpecificArea/ EllipsoidArcArea/OffsetAngle	137
5.2.48W6B12	/<x>/<x>/OnNetwork/FunctionalAliasList/<x>/Entry/ LocationCriteriaForDeactivation/<x>/EnterSpecificArea/ EllipsoidArcArea/IncludedAngle.....	137
5.2.48W6B12A	/<x>/<x>/OnNetwork/FunctionalAliasList/<x>/Entry/ LocationCriteriaForDeactivation/<x>/EnterSpecificArea/Speed	137
5.2.48W6B12B	/<x>/<x>/OnNetwork/FunctionalAliasList/<x>/Entry/ LocationCriteriaForDeactivation/<x>/EnterSpecificArea/Speed/ MinimumSpeed.....	138
5.2.48W6B12C	/<x>/<x>/OnNetwork/FunctionalAliasList/<x>/Entry/ LocationCriteriaForDeactivation/<x>/EnterSpecificArea/Speed/ MaximumSpeed	138
5.2.48W6B12D	/<x>/<x>/OnNetwork/FunctionalAliasList/<x>/Entry/ LocationCriteriaForDeactivation/<x>/EnterSpecificArea/Heading.....	138
5.2.48W6B12E	/<x>/<x>/OnNetwork/FunctionalAliasList/<x>/Entry/ LocationCriteriaForDeactivation/<x>/EnterSpecificArea/Heading/ MinimumHeading	139
5.2.48W6B12F	/<x>/<x>/OnNetwork/FunctionalAliasList/<x>/Entry/ LocationCriteriaForDeactivation/<x>/EnterSpecificArea/Heading/ MaximumHeading.....	139
5.2.48W6B13	/<x>/<x>/OnNetwork/FunctionalAliasList/<x>/Entry/ LocationCriteriaForDeactivation/<x>/ExitSpecificArea	139
5.2.48W6B14	/<x>/<x>/OnNetwork/FunctionalAliasList/<x>/Entry/ LocationCriteriaForDeactivation/<x>/ExitSpecificArea/ PolygonArea	140
5.2.48W6B15	/<x>/<x>/OnNetwork/FunctionalAliasList/<x>/Entry/ LocationCriteriaForDeactivation/<x>/ExitSpecificArea/ PolygonArea/<x>	140
5.2.48W6B15A	/<x>/<x>/OnNetwork/FunctionalAliasList/<x>/Entry/ LocationCriteriaForDeactivation/<x>/ExitSpecificArea/ PolygonArea/<x>/PointCoordinateType	140
5.2.48W6B16	/<x>/<x>/OnNetwork/FunctionalAliasList/<x>/Entry/ LocationCriteriaForDeactivation/<x>/ExitSpecificArea/ PolygonArea/<x>/PointCoordinateType/Longitude	141
5.2.48W6B17	/<x>/<x>/OnNetwork/FunctionalAliasList/<x>/Entry/ LocationCriteriaForDeactivation/<x>/ExitSpecificArea/ PolygonArea/<x>/PointCoordinateType/Latitude	141
5.2.48W6B18	/<x>/<x>/OnNetwork/FunctionalAliasList/<x>/Entry/ LocationCriteriaForDeactivation/<x>/ExitSpecificArea/ EllipsoidArcArea	141
5.2.48W6B19	/<x>/<x>/OnNetwork/FunctionalAliasList/<x>/Entry/ LocationCriteriaForDeactivation/<x>/ExitSpecificArea/ EllipsoidArcArea/Center	142
5.2.48W6B19A	/<x>/<x>/OnNetwork/FunctionalAliasList/<x>/Entry/ LocationCriteriaForDeactivation/<x>/ExitSpecificArea/ EllipsoidArcArea/Center/PointCoordinateType	142
5.2.48W6B20	/<x>/<x>/OnNetwork/FunctionalAliasList/<x>/Entry/ LocationCriteriaForDeactivation/<x>/ExitSpecificArea/ EllipsoidArcArea/Center/PointCoordinateType/Longitude	142
5.2.48W6B21	/<x>/<x>/OnNetwork/FunctionalAliasList/<x>/Entry/ LocationCriteriaForDeactivation/<x>/ExitSpecificArea/ EllipsoidArcArea/Center/PointCoordinateType/Latitude	143
5.2.48W6B22	/<x>/<x>/OnNetwork/FunctionalAliasList/<x>/Entry/ LocationCriteriaForDeactivation/<x>/ExitSpecificArea/ EllipsoidArcArea/Radius	143
5.2.48W6B23	/<x>/<x>/OnNetwork/FunctionalAliasList/<x>/Entry/ LocationCriteriaForDeactivation/<x>/ExitSpecificArea/ EllipsoidArcArea/OffsetAngle	143
5.2.48W6B24	/<x>/<x>/OnNetwork/FunctionalAliasList/<x>/Entry/ LocationCriteriaForDeactivation/<x>/ExitSpecificArea/ EllipsoidArcArea/IncludedAngle	144
5.2.48W6B24A	/<x>/<x>/OnNetwork/FunctionalAliasList/<x>/Entry/ LocationCriteriaForDeactivation/<x>/ExitSpecificArea/Speed	144
5.2.48W6B24B	/<x>/<x>/OnNetwork/FunctionalAliasList/<x>/Entry/ LocationCriteriaForDeactivation/<x>/ExitSpecificArea/Speed/ MinimumSpeed.....	144
5.2.48W6B24C	/<x>/<x>/OnNetwork/FunctionalAliasList/<x>/Entry/ LocationCriteriaForDeactivation/<x>/ExitSpecificArea/Speed/ MaximumSpeed	145
5.2.48W6B24D	/<x>/<x>/OnNetwork/FunctionalAliasList/<x>/Entry/ LocationCriteriaForDeactivation/<x>/ExitSpecificArea/Heading	145
5.2.48W6B24E	/<x>/<x>/OnNetwork/FunctionalAliasList/<x>/Entry/ LocationCriteriaForDeactivation/<x>/ExitSpecificArea/Heading/ MinimumHeading	145

5.2.48W6B24F	/<x>/<x>/OnNetwork/FunctionalAliasList/<x>/Entry/ LocationCriteriaForDeactivation/<x>/ExitSpecificArea/Heading/ MaximumHeading.....	146
5.2.48W6C	/<x>/<x>/OnNetwork/FunctionalAliasList/<x>/Entry/ ManualDeactivationNotAllowedIfLocationCriteriaMet	146
5.2.48W7	/<x>/<x>/OnNetwork/FunctionalAliasList/<x>/Entry/ DisplayName	146
5.2.48W7A	/<x>/<x>/OnNetwork/FunctionalAliasList/<x>/Entry/ MaxSimultaneousEmergencyGroupCalls	146
5.2.48W7B	/<x>/<x>/OnNetwork/FunctionalAliasList/<x>/Entry/ FAsAllowedToCall.....	147
5.2.48W7C	/<x>/<x>/OnNetwork/FunctionalAliasList/<x>/Entry/ FAsAllowedToCall/<x>	147
5.2.48W7D	/<x>/<x>/OnNetwork/FunctionalAliasList/<x>/Entry/ FAsAllowedToCall/<x>/Entry	147
5.2.48W7E	/<x>/<x>/OnNetwork/FunctionalAliasList/<x>/Entry/ FAsAllowedToCall/<x>/Entry/FunctionalAlias	147
5.2.48W8	/<x>/<x>/OnNetwork/AllowedQueryFunctionalAliasOtherUser	148
5.2.48W9	/<x>/<x>/OnNetwork/AllowedTakeoverFunctionalAliasOtherUser.....	148
5.2.48W10	/<x>/<x>/OnNetwork/AllowedLocationInfoWhenTalking	148
5.2.48W11	/<x>/<x>/OnNetwork/AllowedFunctionalAliasGroupBinding	148
5.2.48W12	/<x>/<x>/OnNetwork/MCPTTAdhocGroup	149
5.2.48W12A	/<x>/<x>/OnNetwork/MCPTTAdhocGroup/EmergencyAlert.....	149
5.2.48W12A1	/<x>/<x>/OnNetwork/MCPTTAdhocGroup/EmergencyAlert/ Authorised	149
5.2.48W12A2	/<x>/<x>/OnNetwork/MCPTTAdhocGroup/EmergencyAlert/ Cancel	149
5.2.48W12A3	/<x>/<x>/OnNetwork/MCPTTAdhocGroup/EmergencyAlert/ AuthRecvParticipantInfo	150
5.2.48W12A4	/<x>/<x>/OnNetwork/MCPTTAdhocGroup/EmergencyAlert/ AuthSetupAdhocGroupCall.....	150
5.2.48W12B	/<x>/<x>/OnNetwork/MCPTTAdhocGroup/AdhocGroupCall.....	150
5.2.48W12B1	/<x>/<x>/OnNetwork/MCPTTAdhocGroup/AdhocGroupCall/ Authorised	151
5.2.48W12B2	/<x>/<x>/OnNetwork/MCPTTAdhocGroup/AdhocGroupCall/ AuthorisedParticipation.....	151
5.2.48W12B3	/<x>/<x>/OnNetwork/MCPTTAdhocGroup/AdhocGroupCall/ AuthInitEmergencyCall.....	151
5.2.48W12B4	/<x>/<x>/OnNetwork/MCPTTAdhocGroup/AdhocGroupCall/ AuthInitImminentPerilCall.....	151
5.2.48W12B5	/<x>/<x>/OnNetwork/MCPTTAdhocGroup/AdhocGroupCall/ AuthRecvCallParticipantInfo	152
5.2.48W12B6	/<x>/<x>/OnNetwork/MCPTTAdhocGroup/AdhocGroupCall/ AuthModifyCallParticipantInfo	152
5.2.48X	/<x>/<x>/OnNetwork/AuthorisedIncomingAny.....	152
5.2.48Y1	/<x>/<x>/OnNetwork/UserList.....	153
5.2.48Y2	/<x>/<x>/OnNetwork/UserList/<x>	153
5.2.48Y3	/<x>/<x>/OnNetwork/UserList/<x>/Entry	153
5.2.48Y4	/<x>/<x>/OnNetwork/UserList/<x>/Entry/MCPTTID.....	153
5.2.48Y5	/<x>/<x>/OnNetwork/UserList/<x>/Entry/PrivateCallKMSURI.....	153
5.2.48Z	/<x>/<x>/OnNetwork/AuthorisedReceiveNonAcknowledged	154
5.2.49	/<x>/<x>/OffNetwork.....	154
5.2.50	/<x>/<x>/OffNetwork/Authorised	154
5.2.51	/<x>/<x>/OffNetwork/MCPTTGroupInfo.....	154
5.2.52	/<x>/<x>/OffNetwork/MCPTTGroupInfo/<x>	155
5.2.52A	/<x>/<x>/OffNetwork/MCPTTGroupInfo/<x>/Entry	155
5.2.53	/<x>/<x>/OffNetwork/MCPTTGroupInfo/<x>/Entry/MCPTTGroupID	155
5.2.53A	/<x>/<x>/OffNetwork/MCPTTGroupInfo/<x>/Entry/DisplayName	155
5.2.53B	/<x>/<x>/OffNetwork/MCPTTGroupInfo/<x>/Entry/ RelativePresentationPriority	155
5.2.53C	/<x>/<x>/OffNetwork/MCPTTGroupInfo/<x>/Entry/ GMSServID	156
5.2.53D	/<x>/<x>/OffNetwork/MCPTTGroupInfo/<x>/Entry/ IDMSTokenEndPoint	156
5.2.53E	/<x>/<x>/OffNetwork/MCPTTGroupInfo/<x>/Entry/GroupKMSURI	156
5.2.54	/<x>/<x>/OffNetwork/AllowedListen	156
5.2.55	/<x>/<x>/OffNetwork/AllowedTransmission	157
5.2.56	/<x>/<x>/OffNetwork/EmergencyCallChange.....	157
5.2.57	/<x>/<x>/OffNetwork/ImminentPerilCallChange	157
5.2.58	/<x>/<x>/OffNetwork/UserInfoID	158
5.2.58A1	Void	159
5.2.58A2	Void	159
5.2.58A3	Void	159
5.2.58A4	Void	159
5.2.58A5	Void	159
5.2.58A6	Void	159
5.2.58A7	Void	159
5.2.58A8	Void	159
5.2.58A9	Void	159
5.2.58A10	Void	159
5.2.58A11	Void	159

5.2.58A12	Void	159
5.2.58A13	Void	159
5.2.58A14	Void	159
5.2.58A15	Void	159
5.2.58A16	Void	159
5.2.58A17	Void	159
5.2.59	/<x>/Status	159
6	MCS group configuration MO	160
6.1	General.....	160
6.2	MCS group configuration MO parameters.....	163
6.2.1	General.....	163
6.2.2	Node: <x>	163
6.2.3	/<x>/Name	164
6.2.4	/<x>/Ext	164
6.2.5	/<x>/<x>	164
6.2.6	/<x>/<x>/Common	164
6.2.7	/<x>/<x>/Common/MCPTTGroupID.....	165
6.2.8	/<x>/<x>/Common/MCPTTGroupAlias	165
6.2.9	/<x>/<x>/Common/MCPTTGroupMemberList	165
6.2.10	/<x>/<x>/Common/MCPTTGroupMemberList/<x>.....	165
6.2.11	/<x>/<x>/Common/MCPTTGroupMemberList/<x>/MCPTTID	166
6.2.12	/<x>/<x>/Common/MCPTTGroupMemberList/<x>/UserPriority	166
6.2.13	/<x>/<x>/Common/MCPTTGroupMemberList/<x>/ParticipantType	166
6.2.14	Void	166
6.2.15	/<x>/<x>/Common/MCPTTGroupOwner	166
6.2.16	/<x>/<x>/Common/PreferredVoiceCodec.....	167
6.2.17	/<x>/<x>/Common/MCPTTGroupLevel.....	167
6.2.18	/<x>/<x>/Common/UserLevel.....	167
6.2.19	/<x>/<x>/Common/AllowedEmergencyCall.....	168
6.2.20	/<x>/<x>/Common/AllowedImminentPerilCall	168
6.2.21	/<x>/<x>/Common/AllowedEmergencyAlert	168
6.2.22	/<x>/<x>/Common/MediaProtectionRequired	168
6.2.22A	/<x>/<x>/Common/PreconfiguredGroupUseOnly	169
6.2.23	/<x>/<x>/Common/FloorControlProtectionRequired.....	169
6.2.23A	/<x>/<x>/Common/MediaProtectionSecurityMaterial	169
6.2.23B	/<x>/<x>/Common/MCData.....	170
6.2.23C	/<x>/<x>/Common/MCData/MediaProtectionRequired	170
6.2.23D	/<x>/<x>/Common/MCData/TxControlProtectionRequired	170
6.2.23E	/<x>/<x>/Common/MCData/MediaProtectionSecurityMaterial	170
6.2.23F	/<x>/<x>/Common/MCData/AllowedSDS	171
6.2.23G	/<x>/<x>/Common/MCData/AllowedFD.....	171
6.2.23H	/<x>/<x>/Common/MCData/AllowedConvMgmt	171
6.2.23I	/<x>/<x>/Common/MCData/AllowedTxControl	171
6.2.23J	/<x>/<x>/Common/MCData/AllowedRxControl	172
6.2.23K	/<x>/<x>/Common/MCData/AllowedEnhSvc	172
6.2.23L	/<x>/<x>/Common/MCData/EnhSvcOpValues	172
6.2.23M	/<x>/<x>/Common/MCData/EnhSvcOpValues/<x>.....	172
6.2.23N	/<x>/<x>/Common/MCData/EnhSvcOpValues/<x>/ EnhSvcOpValue	173
6.2.23NA	/<x>/<x>/Common/MCData/EnhSvcOpValues/<x>/ EnhSvcOpID	173
6.2.23O	/<x>/<x>/Common/MCData/AllowedTransmitDataInGroup	173
6.2.23P	/<x>/<x>/Common/MCData/MaxDataSingleRequest.....	173
6.2.23Q	/<x>/<x>/Common/MCData/MaxTimeSingleRequest.....	174
6.2.23R	/<x>/<x>/Common/MCVideo	174
6.2.23S	/<x>/<x>/Common/MCVideo/MediaProtectionRequired	174
6.2.23T	/<x>/<x>/Common/MCVideo/TxControlProtectionRequired.....	174
6.2.23U	/<x>/<x>/Common/MCVideo/MediaProtectionSecurityMaterial	175
6.2.23V	/<x>/<x>/Common/MCVideo/AllowedAudioCodecs.....	175
6.2.23W	/<x>/<x>/Common/MCVideo/AllowedAudioCodecs/<x>	175
6.2.23X	/<x>/<x>/Common/MCVideo/AllowedAudioCodecs/<x>/ AudioCodec	175
6.2.23Y	/<x>/<x>/Common/MCVideo/AllowedVideoCodecs	176
6.2.23Z	/<x>/<x>/Common/MCVideo/AllowedVideoCodecs/<x>.....	176

6.2.23AA	<x><x>/Common/MCVideo/AllowedVideoCodecs/<x>/ VideoCodec.....	176
6.2.23AB	<x><x>/Common/MCVideo/AllowedVideoResolutions	176
6.2.23AC	<x><x>/Common/MCVideo/AllowedVideoResolutions/<x>.....	176
6.2.23AD	<x><x>/Common/MCVideo/AllowedVideoResolutions/<x>/ VideoResolution.....	177
6.2.23AE	<x><x>/Common/MCVideo/AllowedVideoFrameRates	177
6.2.23AF	<x><x>/Common/MCVideo/AllowedVideoFrameRates/<x>	177
6.2.23AG	<x><x>/Common/MCVideo/AllowedVideoFrameRates/<x>/ FrameRate.....	177
6.2.23AH	<x><x>/Common/MCVideo/AllowedUrgentRealTimeMode.....	178
6.2.23AI	<x><x>/Common/MCVideo/AllowedNonUrgentRealTimeMode.....	178
6.2.23AJ	<x><x>/Common/MCVideo/AllowedNonRealTimeMode	178
6.2.23AK	<x><x>/Common/MCVideo/ActiveNonRealTimeMode	178
6.2.23AL	<x><x>/Common/MCVideo/MaxTransmitMembers.....	179
6.2.24	<x><x>/OffNetwork.....	179
6.2.25	<x><x>/OffNetwork/MCPTTGroupParameter	179
6.2.26	<x><x>/OffNetwork/MCPTTGroupParameter/<x>.....	179
6.2.27	<x><x>/OffNetwork/MCPTTGroupParameter/<x>/ ProSeLayer2GroupID	180
6.2.28	<x><x>/OffNetwork/MCPTTGroupParameter/<x>/ IPMulticastAddress	180
6.2.29	<x><x>/OffNetwork/MCPTTGroupParameter/<x>/ RelayServiceCode	180
6.2.30	<x><x>/OffNetwork/MCPTTGroupParameter/<x>/IPVersions.....	180
6.2.31	<x><x>/OffNetwork/EmergencyCallCancel	181
6.2.32	<x><x>/OffNetwork/ImminentPerilCallCancel	181
6.2.33	<x><x>/OffNetwork/HangTime.....	181
6.2.34	<x><x>/OffNetwork/MaxDuration	181
6.2.34A	<x><x>/OffNetwork/QueueUsage	182
6.2.35	<x><x>/OffNetwork/DefaultPPPP.....	182
6.2.36	<x><x>/OffNetwork/DefaultPPPP/MCPTTGroupCallSignalling	182
6.2.37	<x><x>/OffNetwork/DefaultPPPP/MCPTTGroupCallMedia.....	183
6.2.38	<x><x>/OffNetwork/DefaultPPPP/ MCPTTEmergencyGroupCallSignalling	183
6.2.39	<x><x>/OffNetwork/DefaultPPPP/ MCPTTEmergencyGroupCallMedia.....	183
6.2.40	<x><x>/OffNetwork/DefaultPPPP/ MCPTTImminentPerilGroupCallSignalling.....	184
6.2.41	<x><x>/OffNetwork/DefaultPPPP/ MCPTTImminentPerilGroupCallMedia.....	184
6.2.41A	<x><x>/OffNetwork/DefaultPQI	184
6.2.41B	<x><x>/OffNetwork/DefaultPQI/MCPTTGroupCallSignalling	184
6.2.41C	<x><x>/OffNetwork/DefaultPQI/MCPTTGroupCallMedia	185
6.2.41D	<x><x>/OffNetwork/DefaultPQI/ MCPTTEmergencyGroupCallSignalling	185
6.2.41E	<x><x>/OffNetwork/DefaultPQI/ MCPTTEmergencyGroupCallMedia	185
6.2.41F	<x><x>/OffNetwork/DefaultPQI/ MCPTTImminentPerilGroupCallSignalling	186
6.2.41G	<x><x>/OffNetwork/DefaultPQI/ MCPTTImminentPerilGroupCallMedia	186
6.2.42	<x><x>/OffNetwork/MCData.....	186
6.2.43	<x><x>/OffNetwork/MCData/DefaultPPPP	187
6.2.44	<x><x>/OffNetwork/MCData/DefaultPPPP/ MCDataGroupCallSignalling	187
6.2.45	<x><x>/OffNetwork/MCData/DefaultPPPP/ MCDataGroupCallMedia	187
6.2.45A	<x><x>/OffNetwork/MCData/DefaultPQI.....	187
6.2.45B	<x><x>/OffNetwork/MCData/DefaultPQI/ MCDataGroupCallSignalling.....	188
6.2.45C	<x><x>/OffNetwork/MCData/DefaultPQI/ MCDataGroupCallMedia	188
6.2.46	<x><x>/OffNetwork/MCVideo.....	188
6.2.47	<x><x>/OffNetwork/MCVideo/ArbitrationApproach	188
6.2.48	<x><x>/OffNetwork/MCVideo/MaxTransmissions	189
6.2.49	<x><x>/OffNetwork/MCVideo/DefaultPPPP	189
6.2.50	<x><x>/OffNetwork/MCVideo/DefaultPPPP/ MCVideoGroupCallSignalling	189
6.2.51	<x><x>/OffNetwork/MCVideo/DefaultPPPP/ MCVideoGroupCallMedia	190
6.2.52	<x><x>/OffNetwork/MCVideo/DefaultPPPP/ MCVideoEmergencyGroupCallSignalling	190
6.2.53	<x><x>/OffNetwork/MCVideo/DefaultPPPP/ MCVideoEmergencyGroupCallMedia	190
6.2.54	<x><x>/OffNetwork/MCVideo/DefaultPPPP/ MCVideoImminentPerilGroupCallSignalling	191
6.2.55	<x><x>/OffNetwork/MCVideo/DefaultPPPP/ MCVideoImminentPerilGroupCallMedia	191
6.2.55A	<x><x>/OffNetwork/MCVideo/DefaultPQI	191
6.2.55B	<x><x>/OffNetwork/MCVideo/DefaultPQI/ MCVideoGroupCallSignalling	191
6.2.55C	<x><x>/OffNetwork/MCVideo/DefaultPQI/ MCVideoGroupCallMedia	192
6.2.55D	<x><x>/OffNetwork/MCVideo/DefaultPQI/ MCVideoEmergencyGroupCallSignalling	192
6.2.55E	<x><x>/OffNetwork/MCVideo/DefaultPQI/ MCVideoEmergencyGroupCallMedia	192
6.2.55F	<x><x>/OffNetwork/MCVideo/DefaultPQI/ MCVideoImminentPerilGroupCallSignalling	193
6.2.55G	<x><x>/OffNetwork/MCVideo/DefaultPQI/ MCVideoImminentPerilGroupCallMedia	193

6.2.56	/<x>/<x>/OffNetwork/MCVideo/MaxDuration	193
6.2.57	/<x>/<x>/OffNetwork/MCVideo/EmergencyCallCancel	194
6.2.58	/<x>/<x>/OffNetwork/MCVideo/ImminentPerilCallCancel	194
7	MCPTT service configuration MO	194
7.1	General	194
7.2	MCPTT service configuration MO parameters	195
7.2.1	General	195
7.2.2	Node: <x>	196
7.2.3	/<x>/Name	196
7.2.4	/<x>/Ext/	196
7.2.5	/<x>/Common	196
7.2.6	/<x>/Common/BroadcastMCPTTGroupCall	197
7.2.7	/<x>/Common/BroadcastMCPTTGroupCall/ NumLevelGroupHierarchy	197
7.2.8	/<x>/Common/BroadcastMCPTTGroupCall/ NumLevelUserHierarchy	197
7.2.9	/<x>/Common/MinLengthAliasID	197
7.2.10	/<x>/OffNetwork	198
7.2.11	/<x>/OffNetwork/PrivateCall	198
7.2.12	/<x>/OffNetwork/PrivateCall/MaxDuration	198
7.2.13	/<x>/OffNetwork/PrivateCall/HangTime	198
7.2.14	/<x>/OffNetwork/PrivateCall/CancelTimeout	198
7.2.15	/<x>/OffNetwork/EmergencyCall	199
7.2.16	/<x>/OffNetwork/EmergencyCall/MCPTTGroupTimeout	199
7.2.17	/<x>/OffNetwork/NumLevelHierarchy	199
7.2.18	/<x>/OffNetwork/TransmitTimeout	199
7.2.19	/<x>/OffNetwork/TransmissionWarning	200
7.2.20	/<x>/OffNetwork/HangTimeWarning	200
7.2.21	/<x>/OffNetwork/DefaultPPPP	200
7.2.22	/<x>/OffNetwork/DefaultPPPP/MCPTTPrivateCallSignalling	200
7.2.23	/<x>/OffNetwork/DefaultPPPP/MCPTTPrivateCallMedia	201
7.2.24	/<x>/OffNetwork/DefaultPPPP/ MCPTTEmergencyPrivateCallSignalling	201
7.2.25	/<x>/OffNetwork/DefaultPPPP/MCPTTEmergencyPrivateCallMedia	201
7.2.25A	/<x>/OffNetwork/DefaultPQI	202
7.2.25B	/<x>/OffNetwork/DefaultPQI/MCPTTPrivateCallSignalling	202
7.2.25C	/<x>/OffNetwork/DefaultPQI/MCPTTPrivateCallMedia	202
7.2.25D	/<x>/OffNetwork/DefaultPQI/ MCPTTEmergencyPrivateCallSignalling	202
7.2.25E	/<x>/OffNetwork/DefaultPQI/MCPTTEmergencyPrivateCallMedia	203
7.2.26	/<x>/OffNetwork/LogMetadata	203
7.2.27	/<x>/OnNetwork	203
7.2.28	/<x>/OnNetwork/MCPTTAdhocGroup	204
7.2.29	/<x>/OnNetwork/MCPTTAdhocGroup/GroupCall	204
7.2.30	/<x>/OnNetwork/MCPTTAdhocGroup/GroupCall/ AllowAdhocGroupCall	204
7.2.31	/<x>/OnNetwork/MCPTTAdhocGroup/GroupCall/MaxNoParticipants	204
7.2.32	/<x>/OnNetwork/MCPTTAdhocGroup/GroupCall/HangTime	204
7.2.33	/<x>/OnNetwork/MCPTTAdhocGroup/GroupCall/ MaxDurationOfCall	205
8	MCS UE initial configuration MO	205
8.1	General	205
8.2	MCS UE initial configuration MO parameters	210
8.2.1	General	210
8.2.2	Node: <x>	210
8.2.3	/<x>/Name	210
8.2.4	/<x>/Ext/	210
8.2.5	/<x>/DefaultUserProfile	211
8.2.6	/<x>/DefaultUserProfile/UserID	211
8.2.7	/<x>/DefaultUserProfile/UserProfileIndex	211
8.2.8	/<x>/OnNetwork	211
8.2.9	/<x>/OnNetwork/GMSURI	212
8.2.9A	/<x>/OnNetwork/GroupCreationXUI	212
8.2.9B	/<x>/OnNetwork/GMSXCAPRootURI	212
8.2.9C	/<x>/OnNetwork/CMSXCAPRootURI	212
8.2.10	/<x>/OnNetwork/Timers	213

8.2.11	/<x>/OnNetwork/Timers/T100	213
8.2.12	/<x>/OnNetwork/Timers/T101	213
8.2.13	/<x>/OnNetwork/Timers/T103	213
8.2.14	/<x>/OnNetwork/Timers/T104	214
8.2.15	/<x>/OnNetwork/Timers/T132	214
8.2.16	/<x>/OnNetwork/HPLMN	214
8.2.17	/<x>/OnNetwork/HPLMN/PLMN	214
8.2.18	/<x>/OnNetwork/HPLMN/Service	215
8.2.19	/<x>/OnNetwork/HPLMN/Service/MCPTTToConRef	215
8.2.20	/<x>/OnNetwork/HPLMN/Service/MCPTTToConRef/<x>	215
8.2.21	/<x>/OnNetwork/HPLMN/Service/MCPTTToConRef/<x>/ConRef	215
8.2.22	/<x>/OnNetwork/HPLMN/Service/MCCommonCoreToConRef	215
8.2.23	/<x>/OnNetwork/HPLMN/Service/MCCommonCoreToConRef/<x>	216
8.2.24	/<x>/OnNetwork/HPLMN/Service/MCCommonCoreToConRef/<x>/ConRef	216
8.2.25	/<x>/OnNetwork/HPLMN/Service/MCIDMTToConRef	216
8.2.26	/<x>/OnNetwork/HPLMN/Service/MCIDMTToConRef/<x>	216
8.2.27	/<x>/OnNetwork/HPLMN/Service/MCIDMTToConRef/<x>/ConRef	217
8.2.27A1	/<x>/OnNetwork/HPLMN/Service/MCPTTRefSNSSAI	217
8.2.27A2	/<x>/OnNetwork/HPLMN/Service/MCPTTRefSNSSAI/<x>	217
8.2.27A3	/<x>/OnNetwork/HPLMN/Service/MCPTTRefSNSSAI/<x>/RefSNSSAI	217
8.2.27A4	/<x>/OnNetwork/HPLMN/Service/MCCommonCoreRefSNSSAI	217
8.2.27A5	/<x>/OnNetwork/HPLMN/Service/MCCommonCoreRefSNSSAI/<x>	218
8.2.27A6	/<x>/OnNetwork/HPLMN/Service/MCCommonCoreRefSNSSAI/<x>/RefSNSSAI	218
8.2.27A7	/<x>/OnNetwork/HPLMN/Service/MCIdMRefSNSSAI	218
8.2.27A8	/<x>/OnNetwork/HPLMN/Service/MCIdMRefSNSSAI/<x>	218
8.2.27A9	/<x>/OnNetwork/HPLMN/Service/MCIdMRefSNSSAI/<x>/RefSNSSAI	219
8.2.27A10	/<x>/OnNetwork/HPLMN/Service/MCDataRefSNSSAI	219
8.2.27A11	/<x>/OnNetwork/HPLMN/Service/MCDataRefSNSSAI/<x>	219
8.2.27A12	/<x>/OnNetwork/HPLMN/Service/MCDataRefSNSSAI/<x>/RefSNSSAI	219
8.2.27A13	/<x>/OnNetwork/HPLMN/Service/MCVideoRefSNSSAI	220
8.2.27A14	/<x>/OnNetwork/HPLMN/Service/MCVideoRefSNSSAI/<x>	220
8.2.27A15	/<x>/OnNetwork/HPLMN/Service/MCVideoRefSNSSAI/<x>/RefSNSSAI	220
8.2.28	/<x>/OnNetwork/HPLMN/VPLMN	220
8.2.28A	/<x>/OnNetwork/HPLMN/VPLMN/<x>	220
8.2.29	/<x>/OnNetwork/HPLMN/VPLMN/<x>/PLMN	221
8.2.30	/<x>/OnNetwork/HPLMN/VPLMN/<x>/Service	221
8.2.31	/<x>/OnNetwork/HPLMN/VPLMN/<x>/Service/MCPTTToConRef	221
8.2.32	/<x>/OnNetwork/HPLMN/VPLMN/<x>/Service/MCPTTToConRef/<x>	221
8.2.33	/<x>/OnNetwork/HPLMN/VPLMN/<x>/Service/MCPTTToConRef/<x>/ConRef	222
8.2.34	/<x>/OnNetwork/HPLMN/VPLMN/<x>/Service/MCCommonCoreToConRef	222
8.2.35	/<x>/OnNetwork/HPLMN/VPLMN/<x>/Service/MCCommonCoreToConRef/<x>	222
8.2.36	/<x>/OnNetwork/HPLMN/VPLMN/<x>/Service/MCCommonCoreToConRef/<x>/ConRef	222
8.2.37	/<x>/OnNetwork/HPLMN/VPLMN/<x>/Service/MCIDMTToConRef	223
8.2.38	/<x>/OnNetwork/HPLMN/VPLMN/<x>/Service/MCIDMTToConRef/<x>	223
8.2.39	/<x>/OnNetwork/HPLMN/VPLMN/<x>/Service/MCIDMTToConRef/<x>/ConRef	223
8.2.39A1	/<x>/OnNetwork/HPLMN/VPLMN/<x>/Service/MCPTTRefSNSSAI	223
8.2.39A2	/<x>/OnNetwork/HPLMN/VPLMN/<x>/Service/MCPTTRefSNSSAI/<x>	224
8.2.39A3	/<x>/OnNetwork/HPLMN/VPLMN/<x>/Service/MCPTTRefSNSSAI/<x>/RefSNSSAI	224
8.2.39A4	/<x>/OnNetwork/HPLMN/VPLMN/<x>/Service/MCCommonCoreRefSNSSAI	224
8.2.39A5	/<x>/OnNetwork/HPLMN/VPLMN/<x>/Service/MCCommonCoreRefSNSSAI/<x>	224
8.2.39A6	/<x>/OnNetwork/HPLMN/VPLMN/<x>/Service/MCCommonCoreRefSNSSAI/<x>/RefSNSSAI	225
8.2.39A7	/<x>/OnNetwork/HPLMN/VPLMN/<x>/Service/MCIdMRefSNSSAI	225
8.2.39A8	/<x>/OnNetwork/HPLMN/VPLMN/<x>/Service/MCIdMRefSNSSAI/<x>	225
8.2.39A9	/<x>/OnNetwork/HPLMN/VPLMN/<x>/Service/MCIdMRefSNSSAI/<x>/RefSNSSAI	225
8.2.39A10	/<x>/OnNetwork/HPLMN/VPLMN/<x>/Service/MCDataRefSNSSAI	226
8.2.39A11	/<x>/OnNetwork/HPLMN/VPLMN/<x>/Service/MCDataRefSNSSAI/<x>	226
8.2.39A12	/<x>/OnNetwork/HPLMN/VPLMN/<x>/Service/MCDataRefSNSSAI/<x>/RefSNSSAI	226
8.2.39A13	/<x>/OnNetwork/HPLMN/VPLMN/<x>/Service/MCVideoRefSNSSAI	226
8.2.39A14	/<x>/OnNetwork/HPLMN/VPLMN/<x>/Service/MCVideoRefSNSSAI/<x>	227
8.2.39A15	/<x>/OnNetwork/HPLMN/VPLMN/<x>/Service/MCVideoRefSNSSAI/<x>/RefSNSSAI	227
8.2.40	/<x>/OnNetwork/AppServerInfo	227
8.2.41	/<x>/OnNetwork/AppServerInfo/IDMSAuthEndpoint	227

8.2.41A	/<x>/OnNetwork/AppServerInfo/IDMSTokenEndpoint	228
8.2.41B	/<x>/OnNetwork/AppServerInfo/HTTPProxy	228
8.2.42	/<x>/OnNetwork/AppServerInfo/GMS	228
8.2.43	/<x>/OnNetwork/AppServerInfo/CMS	228
8.2.44	/<x>/OnNetwork/AppServerInfo/KMS	228
8.2.44A	/<x>/OnNetwork/AppServerInfo/TLSTunnelAuthMethod	229
8.2.44B	/<x>/OnNetwork/AppServerInfo/TLSTunnelAuthMethod/Mutual	229
8.2.44C	/<x>/OnNetwork/AppServerInfo/TLSTunnelAuthMethod/X509	229
8.2.44D	/<x>/OnNetwork/AppServerInfo/TLSTunnelAuthMethod/Key	229
8.2.44E	/<x>/OnNetwork/IntegrityProtection	230
8.2.44F	/<x>/OnNetwork/ConfidentialityProtection	230
8.2.44G1	/<x>/OnNetwork/MCPTTServiceDetails	230
8.2.44G2	/<x>/OnNetwork/MCPTTServiceDetails/IPv6Required	230
8.2.44G3	/<x>/OnNetwork/MCPTTServiceDetails/ServerURI	231
8.2.44G3A	/<x>/OnNetwork/MCPTTServiceDetails/PDUSessionType	231
8.2.44G3A1	Void	231
8.2.44G3A2	Void	231
8.2.44G3A3	Void	231
8.2.44G3A4	Void	231
8.2.44G3A5	Void	231
8.2.44G3A6	Void	231
8.2.44G3A7	Void	231
8.2.44G3A8	Void	231
8.2.44G4	/<x>/OnNetwork/MCVideoServiceDetails	231
8.2.44G5	/<x>/OnNetwork/MCVideoServiceDetails/IPv6Required	232
8.2.44G6	/<x>/OnNetwork/MCVideoServiceDetails/ServerURI	232
8.2.44G6A	/<x>/OnNetwork/MCVideoServiceDetails/PDUSessionType	232
8.2.44G6A1	Void	233
8.2.44G6A2	Void	233
8.2.44G6A3	Void	233
8.2.44G6A4	Void	233
8.2.44G6A5	Void	233
8.2.44G6A6	Void	233
8.2.44G6A7	Void	233
8.2.44G6A8	Void	233
8.2.44G7	/<x>/OnNetwork/MCDataServiceDetails	233
8.2.44G8	/<x>/OnNetwork/MCDataServiceDetails/IPv6Required	233
8.2.44G9	/<x>/OnNetwork/MCDataServiceDetails/ServerURI	233
8.2.44G9A	/<x>/OnNetwork/MCDataServiceDetails/PDUSessionType	234
8.2.44G9A1	Void	235
8.2.44G9A2	Void	235
8.2.44G9A3	Void	235
8.2.44G9A4	Void	235
8.2.44G9A5	Void	235
8.2.44G9A6	Void	235
8.2.44G9A7	Void	235
8.2.44G9A8	Void	235
8.2.44G10	Void	235
8.2.44G11	Void	235
8.2.44G12	Void	235
8.2.44G13	Void	235
8.2.44G14	Void	235
8.2.44G15	Void	235
8.2.44G16	Void	235
8.2.44G17	Void	235
8.2.44G18	Void	235
8.2.44G19	Void	235
8.2.44G20	Void	235
8.2.44G21	Void	235
8.2.44G22	Void	235
8.2.44G23	Void	235
8.2.44G24	Void	235

8.2.44G25	Void	236
8.2.44G26	/<x>/OnNetwork/MCCommonCoreServiceDetails	236
8.2.44G27	/<x>/OnNetwork/MCCommonCoreServiceDetails/IPv6Required	236
8.2.44G28	/<x>/OnNetwork/MCCommonCoreServiceDetails/ServerURI	236
8.2.44G29	/<x>/OnNetwork/MCCommonCoreServiceDetails/ PDUSessionType	236
8.2.44G30	/<x>/OnNetwork/MCIdMServiceDetails	237
8.2.44G31	/<x>/OnNetwork/MCIdMServiceDetails/IPv6Required	237
8.2.44G32	/<x>/OnNetwork/MCIdMServiceDetails/ServerURI	237
8.2.44G33	/<x>/OnNetwork/MCIdMServiceDetails/PDUSessionType	237
8.2.44H	/<x>/OnNetwork/DNInfo	237
8.2.44H1	/<x>/OnNetwork/DNInfo/<x>	238
8.2.44H2	/<x>/OnNetwork/DNInfo/<x>/DNN	238
8.2.44H3	/<x>/OnNetwork/DNInfo/<x>/DNAAAServer	238
8.2.44H4	/<x>/OnNetwork/DNInfo/<x>/PapParameters	238
8.2.44H5	/<x>/OnNetwork/DNInfo/<x>/PapParameters/UserName	239
8.2.44H6	/<x>/OnNetwork/DNInfo/<x>/PapParameters/PassWord	239
8.2.44H7	/<x>/OnNetwork/DNInfo/<x>/ChapParameters	239
8.2.44H8	/<x>/OnNetwork/DNInfo/<x>/ChapParameters/UserName	239
8.2.44H9	/<x>/OnNetwork/DNInfo/<x>/ChapParameters/PassWord	239
8.2.44H10	/<x>/OnNetwork/DNInfo/<x>/Credentials	240
8.2.44H11	/<x>/OnNetwork/DNInfo/<x>/Credentials/ID	240
8.2.44H12	/<x>/OnNetwork/SNSSAIInfo	240
8.2.44H13	/<x>/OnNetwork/SNSSAIInfo/<x>	240
8.2.44H14	/<x>/OnNetwork/SNSSAIInfo/<x>/NSSAAServer	240
8.2.44H15	/<x>/OnNetwork/SNSSAIInfo/<x>/SNSSAI	241
8.2.44H16	/<x>/OnNetwork/SNSSAIInfo/<x>/SNSSAI/Credentials	241
8.2.44H17	/<x>/OnNetwork/SNSSAIInfo/<x>/SNSSAI/Credentials/ID	241
8.2.45	/<x>/OffNetwork	241
8.2.46	/<x>/OffNetwork/Timers	241
8.2.47	/<x>/OffNetwork/Timers/TFG1	242
8.2.48	/<x>/OffNetwork/Timers/TFG2	242
8.2.49	/<x>/OffNetwork/Timers/TFG3	242
8.2.50	/<x>/OffNetwork/Timers/TFG4	242
8.2.51	/<x>/OffNetwork/Timers/TFG5	243
8.2.52	/<x>/OffNetwork/Timers/TFG11	243
8.2.53	/<x>/OffNetwork/Timers/TFG12	243
8.2.54	/<x>/OffNetwork/Timers/TFG13	244
8.2.54A	/<x>/OffNetwork/Timers/TFG14	244
8.2.55	/<x>/OffNetwork/Timers/TFP1	244
8.2.56	/<x>/OffNetwork/Timers/TFP2	244
8.2.57	/<x>/OffNetwork/Timers/TFP3	245
8.2.58	/<x>/OffNetwork/Timers/TFP4	245
8.2.59	/<x>/OffNetwork/Timers/TFP5	245
8.2.60	/<x>/OffNetwork/Timers/TFP6	245
8.2.61	/<x>/OffNetwork/Timers/TFP7	246
8.2.61A	/<x>/OffNetwork/Timers/TFP9	246
8.2.62	/<x>/OffNetwork/Timers/TFB1	246
8.2.63	/<x>/OffNetwork/Timers/TFB2	247
8.2.64	/<x>/OffNetwork/Timers/TFB3	247
8.2.65	/<x>/OffNetwork/Timers/T201	247
8.2.66	/<x>/OffNetwork/Timers/T203	247
8.2.67	/<x>/OffNetwork/Timers/T204	248
8.2.68	/<x>/OffNetwork/Timers/T205	248
8.2.69	Void	248
8.2.70	/<x>/OffNetwork/Timers/T233	248
8.2.71	/<x>/OffNetwork/Timers/TFE1	248
8.2.72	/<x>/OffNetwork/Timers/TFE2	249
8.2.73	/<x>/OffNetwork/Counters	249
8.2.74	/<x>/OffNetwork/Counters/CFP1	249
8.2.75	/<x>/OffNetwork/Counters/CFP3	249
8.2.76	/<x>/OffNetwork/Counters/CFP4	250
8.2.77	/<x>/OffNetwork/Counters/CFP6	250

8.2.78	/<x>/OffNetwork/Counters/CFG11	250
8.2.79	/<x>/OffNetwork/Counters/CFG12	250
8.2.80	/<x>/OffNetwork/Counters/C201	251
8.2.81	/<x>/OffNetwork/Counters/C204	251
8.2.82	/<x>/OffNetwork/Counters/C205	251
9	MCDData UE configuration MO	251
9.1	General.....	251
9.2	MCDData UE configuration MO parameters	253
9.2.1	General.....	253
9.2.2	Node: <x>	253
9.2.3	/<x>/Name	253
9.2.4	/<x>/Ext/	253
9.2.5	/<x>/Common	253
9.2.6	/<x>/Common/MCDDataGroupTxns	254
9.2.7	/<x>/Common/MCDDataGroupTxns/MaxSDSNc4.....	254
9.2.8	/<x>/Common/MCDDataGroupTxns/SDSPresentationPriority	254
9.2.9	/<x>/Common/MCDDataGroupTxns/SDSPresentationPriority/<x>	254
9.2.10	/<x>/Common/MCDDataGroupTxns/SDSPresentationPriority/ <x>/MCDDataGroupID	255
9.2.11	/<x>/Common/MCDDataGroupTxns/SDSPresentationPriority/ <x>/MCDDataGroupPriorityHierarchy	255
9.2.12	/<x>/Common/MCDDataGroupTxns/MaxFDNc4	255
9.2.13	/<x>/Common/MCDDataGroupTxns/FDPresentationPriority	255
9.2.14	/<x>/Common/MCDDataGroupTxns/FDPresentationPriority/<x>.....	256
9.2.15	/<x>/Common/MCDDataGroupTxns/FDPresentationPriority/ <x>/MCDDataGroupID	256
9.2.16	/<x>/Common/MCDDataGroupTxns/FDPresentationPriority/ <x>/MCDDataGroupPriorityHierarchy....	256
9.2.17	/<x>/Common/MCDDataGroupTxns/ConversationPresentationPriority	256
9.2.18	/<x>/Common/MCDDataGroupTxns/ ConversationPresentationPriority/<x>	257
9.2.19	/<x>/Common/MCDDataGroupTxns/ ConversationPresentationPriority/<x>/MCDDataGroupID	257
9.2.20	/<x>/Common/MCDDataGroupTxns/ ConversationPresentationPriority/<x>/ MCDDataGroupPriorityHierarchy.....	257
9.2.21	/<x>/Common/MCDDataGroupTxns/MaxTCNc4	257
9.2.22	/<x>/Common/MCDDataGroupTxns/MaxTCNc5	258
9.2.23	/<x>/Common/MCDDataGroupTxns/DataPresentationPriority	258
9.2.24	/<x>/Common/MCDDataGroupTxns/DataPresentationPriority/ <x>	258
9.2.25	/<x>/Common/MCDDataGroupTxns/DataPresentationPriority/ <x>/MCDDataGroupID	258
9.2.26	/<x>/Common/MCDDataGroupTxns/DataPresentationPriority/ <x>/MCDDataGroupPriorityHierarchy	259
9.2.27	/<x>/Common/MCDDataGroupTxns/MaxRCNc4.....	259
9.2.28	/<x>/Common/MCDDataGroupTxns/MaxRCNc5	259
9.2.28A	/<x>/Common/MCDDataSDSCharset.....	259
9.2.29	/<x>/OnNetwork.....	260
9.2.30	/<x>/OnNetwork/RelayService.....	260
9.2.31	/<x>/OnNetwork/IPv6Preferred.....	260
9.2.32	/<x>/OnNetwork/RelayedMCDDataGroup.....	260
9.2.33	/<x>/OnNetwork/RelayedMCDDataGroup/<x>	261
9.2.34	/<x>/OnNetwork/RelayedMCDDataGroup/<x>/MCDDataGroupID	261
9.2.35	/<x>/OnNetwork/RelayedMCDDataGroup/<x>/RelayServiceCode.....	261
10	MCDData user profile MO.....	261
10.1	General.....	261
10.2	MCDData user profile MO parameters.....	264
10.2.1	General.....	264
10.2.2	Node: <x>	264
10.2.3	/<x>/Name	265
10.2.4	/<x>/Ext/	265
10.2.5	/<x>/<x>	265
10.2.6	/<x>/<x>/Common	265
10.2.7	/<x>/<x>/Common/MCDDataUserID.....	266
10.2.8	/<x>/<x>/Common/MCDDataUserProfileIndex	266
10.2.9	/<x>/<x>/Common/MCDDataUserProfileName.....	266
10.2.9A	/<x>/<x>/Common/MCDDataUserIDKMSURI	266

10.2.10	/<x>/<x>/Common/PreSelectedIndication	267
10.2.11	/<x>/<x>/Common/UserAliases	267
10.2.12	/<x>/<x>/Common/UserAliases/<x>	267
10.2.13	/<x>/<x>/Common/UserAliases/<x>UserAlias	267
10.2.14	/<x>/<x>/Common/AuthorisedAlias	268
10.2.15	/<x>/<x>/Common/ParticipantType	268
10.2.16	/<x>/<x>/Common/Organization	268
10.2.16A	/<x>/<x>/Common/OnetoOne	268
10.2.16B	/<x>/<x>/Common/OnetoOne/UserList	269
10.2.16C	/<x>/<x>/Common/OnetoOne/UserList/<x>	269
10.2.16D	/<x>/<x>/Common/OnetoOne/UserList/<x>/Entry	269
10.2.16E	/<x>/<x>/Common/OnetoOne/UserList/<x>/Entry/MCDataID	269
10.2.16F	/<x>/<x>/Common/OnetoOne/UserList/<x>/Entry/DiscoveryGroupID	269
10.2.16F1	/<x>/<x>/Common/OnetoOne/UserList/<x>/Entry/ ApplicationLayerGroupID	270
10.2.16G	/<x>/<x>/Common/OnetoOne/UserList/<x>/Entry/UserInfoID	270
10.2.16H	/<x>/<x>/Common/OnetoOne/UserList/<x>/Entry/ MCDataIDKMSURI	270
10.2.16I	/<x>/<x>/Common/OnetoOne/UserList/<x>/Entry/DisplayName	270
10.2.16J	/<x>/<x>/Common/OnetoOne/UserList/<x>/Entry/IPInformation	271
10.2.16K	/<x>/<x>/Common/OnetoOne/UserList/<x>/Entry/ IPInformation/<x>	271
10.2.16L	/<x>/<x>/Common/OnetoOne/UserList/<x>/Entry/ IPInformation/<x>/Entry	271
10.2.16M	/<x>/<x>/Common/OnetoOne/UserList/<x>/Entry/ IPInformation/<x>/Entry/IPv4Information	271
10.2.16N	/<x>/<x>/Common/OnetoOne/UserList/<x>/Entry/ IPInformation/<x>/Entry/IPv6Information	272
10.2.16O	/<x>/<x>/Common/OnetoOne/UserList/<x>/Entry/ IPInformation/<x>/Entry/FQDN	272
10.2.17	/<x>/<x>/Common/FileDistribution	272
10.2.18	/<x>/<x>/Common/FileDistribution/CancelList	272
10.2.19	/<x>/<x>/Common/FileDistribution/CancelList/<x>	272
10.2.20	/<x>/<x>/Common/FileDistribution/CancelList/<x>/Entry	273
10.2.21	/<x>/<x>/Common/FileDistribution/CancelList/<x>/Entry/MCDataID	273
10.2.21A	/<x>/<x>/Common/FileDistribution/CancelList/<x>/Entry/ MCDataIDKMSURI	273
10.2.22	/<x>/<x>/Common/FileDistribution/CancelList/<x>/Entry/ DisplayName	273
10.2.23	/<x>/<x>/Common/TxRxControl	274
10.2.24	/<x>/<x>/Common/TxRxControl/AuthorisedTransmit	274
10.2.25	/<x>/<x>/Common/TxRxControl/MaxData1To1	274
10.2.26	/<x>/<x>/Common/TxRxControl/MaxTime1To1	274
10.2.27	/<x>/<x>/Common/TxRxControl/ReleaseList	275
10.2.28	/<x>/<x>/Common/TxRxControl/ReleaseList/<x>	275
10.2.29	/<x>/<x>/Common/TxRxControl/ReleaseList/<x>/Entry	275
10.2.30	/<x>/<x>/Common/TxRxControl/ReleaseList/<x>/Entry/MCDataID	275
10.2.31	/<x>/<x>/Common/TxRxControl/ReleaseList/<x>/Entry/ DisplayName	276
10.2.32	/<x>/<x>/Common/MCDataGroupBroadcast	276
10.2.33	/<x>/<x>/Common/MCDataGroupBroadcast/Authorised	276
10.2.34	/<x>/<x>/Common/UserBroadcast	276
10.2.35	/<x>/<x>/Common/UserBroadcast/Authorised	276
10.2.36	/<x>/<x>/Common/GroupEmergencyAlert	277
10.2.37	/<x>/<x>/Common/GroupEmergencyAlert/Entry	277
10.2.38	/<x>/<x>/Common/GroupEmergencyAlert/Entry/ID	277
10.2.39	/<x>/<x>/Common/GroupEmergencyAlert/Entry/DisplayName	277
10.2.40	/<x>/<x>/Common/GroupEmergencyAlert/Entry/Usage	278
10.2.41	/<x>/<x>/Common/AllowedActivateAlert	278
10.2.42	/<x>/<x>/Common/AllowedCancelAlert	278
10.2.42A	/<x>/<x>/Common/AllowedEmergencyPrivateCall	278
10.2.42B	/<x>/<x>/Common/AllowedCancelEmergencyPrivateCall	279
10.2.43	/<x>/<x>/OnNetwork	279
10.2.44	/<x>/<x>/OnNetwork/MCDataGroupList	279
10.2.45	/<x>/<x>/OnNetwork/MCDataGroupList/<x>	279
10.2.46	/<x>/<x>/OnNetwork/MCDataGroupList/<x>/Entry	280
10.2.47	/<x>/<x>/OnNetwork/MCDataGroupList/<x>/Entry/MCDataGroupID	280
10.2.48	/<x>/<x>/OnNetwork/MCDataGroupList/<x>/Entry/DisplayName	280
10.2.49	Void	280
10.2.50	Void	280
10.2.51	/<x>/<x>/OnNetwork/MCDataGroupList/<x>/Entry/GMSServID	280
10.2.52	Void	281

10.2.53	Void	281
10.2.54	/<x>/<x>/OnNetwork/MCDataGroupList/<x>/Entry/ IdMSTokenEndPoint	281
10.2.54A	/<x>/<x>/OnNetwork/MCDataGroupList/<x>/Entry/ GroupKMSURI	281
10.2.55	/<x>/<x>/OnNetwork/MCDataGroupList/<x>/Entry/ RelativePresentationPriority	281
10.2.55A	/<x>/<x>/OnNetwork/MCDataGroupList/<x>/Entry/ RulesForAffiliation	282
10.2.55A0	/<x>/<x>/OnNetwork/MCDataGroupList/<x>/Entry/ RulesForAffiliation/<x>	282
10.2.55A1	/<x>/<x>/OnNetwork/MCDataGroupList/<x>/Entry/ RulesForAffiliation/<x>/ListOfLocationCriteria/	282
10.2.55A2	/<x>/<x>/OnNetwork/MCDataGroupList/<x>/Entry/ RulesForAffiliation/<x>/ListOfLocationCriteria/<x>	282
10.2.55A3	/<x>/<x>/OnNetwork/MCDataGroupList/<x>/Entry/ RulesForAffiliation/<x>/ListOfLocationCriteria/<x>/Entry	283
10.2.55A4	/<x>/<x>/OnNetwork/MCDataGroupList/<x>/Entry/ RulesForAffiliation/<x>/ListOfLocationCriteria/<x>/Entry/ EnterSpecificArea	283
10.2.55A5	/<x>/<x>/OnNetwork/MCDataGroupList/<x>/Entry/ RulesForAffiliation/<x>/ListOfLocationCriteria/<x>/Entry/ EnterSpecificArea/PolygonArea	283
10.2.55A6	/<x>/<x>/OnNetwork/MCDataGroupList/<x>/Entry/ RulesForAffiliation/<x>/ListOfLocationCriteria/<x>/Entry/ EnterSpecificArea/PolygonArea/<x>	283
10.2.55A7	/<x>/<x>/OnNetwork/MCDataGroupList/<x>/Entry/ RulesForAffiliation/<x>/ListOfLocationCriteria/<x>/Entry/ EnterSpecificArea/PolygonArea/<x>/PointCoordinateType	284
10.2.55A8	/<x>/<x>/OnNetwork/MCDataGroupList/<x>/Entry/ RulesForAffiliation/<x>/ListOfLocationCriteria/<x>/Entry/ EnterSpecificArea/PolygonArea/<x>/PointCoordinateType/ Longitude	284
10.2.55A9	/<x>/<x>/OnNetwork/MCDataGroupList/<x>/Entry/ RulesForAffiliation/<x>/ListOfLocationCriteria/<x>/Entry/ EnterSpecificArea/PolygonArea/<x>/PointCoordinateType/ Latitude	284
10.2.55A10	/<x>/<x>/OnNetwork/MCDataGroupList/<x>/Entry/ RulesForAffiliation/<x>/ListOfLocationCriteria/<x>/Entry/ EnterSpecificArea/EllipsoidArcArea	285
10.2.55A11	/<x>/<x>/OnNetwork/MCDataGroupList/<x>/Entry/ RulesForAffiliation/<x>/ListOfLocationCriteria/<x>/Entry/ EnterSpecificArea/EllipsoidArcArea/Center	285
10.2.55A12	/<x>/<x>/OnNetwork/MCDataGroupList/<x>/Entry/ RulesForAffiliation/<x>/ListOfLocationCriteria/<x>/Entry/ EnterSpecificArea/EllipsoidArcArea/Center/PointCoordinateType	285
10.2.55A13	/<x>/<x>/OnNetwork/MCDataGroupList/<x>/Entry/ RulesForAffiliation/<x>/ListOfLocationCriteria/<x>/Entry/ EnterSpecificArea/EllipsoidArcArea/Center/PointCoordinateType/ Longitude	286
10.2.55A14	/<x>/<x>/OnNetwork/MCDataGroupList/<x>/Entry/ RulesForAffiliation/<x>/ListOfLocationCriteria/<x>/Entry/ EnterSpecificArea/EllipsoidArcArea/Center/PointCoordinateType/ Latitude	286
10.2.55A15	/<x>/<x>/OnNetwork/MCDataGroupList/<x>/Entry/ RulesForAffiliation/<x>/ListOfLocationCriteria/<x>/Entry/ EnterSpecificArea/EllipsoidArcArea/Radius	286
10.2.55A16	/<x>/<x>/OnNetwork/MCDataGroupList/<x>/Entry/ RulesForAffiliation/<x>/ListOfLocationCriteria/<x>/Entry/ EnterSpecificArea/EllipsoidArcArea/OffsetAngle	287
10.2.55A17	/<x>/<x>/OnNetwork/MCDataGroupList/<x>/Entry/ RulesForAffiliation/<x>/ListOfLocationCriteria/<x>/Entry/ EnterSpecificArea/EllipsoidArcArea/IncludedAngle	287
10.2.55A18	/<x>/<x>/OnNetwork/MCDataGroupList/<x>/Entry/ RulesForAffiliation/<x>/ListOfLocationCriteria/<x>/Entry/ EnterSpecificArea/Speed	287
10.2.55A19	/<x>/<x>/OnNetwork/MCDataGroupList/<x>/Entry/ RulesForAffiliation/<x>/ListOfLocationCriteria/<x>/Entry/ EnterSpecificArea/Speed/MinimumSpeed	287
10.2.55A20	/<x>/<x>/OnNetwork/MCDataGroupList/<x>/Entry/ RulesForAffiliation/<x>/ListOfLocationCriteria/<x>/Entry/ EnterSpecificArea/Speed/MaximumSpeed	288
10.2.55A21	/<x>/<x>/OnNetwork/MCDataGroupList/<x>/Entry/ RulesForAffiliation/<x>/ListOfLocationCriteria/<x>/Entry/ EnterSpecificArea/Heading	288

10.2.55A22	/<x>/<x>/OnNetwork/MCDataGroupList/<x>/Entry/ RulesForAffiliation/<x>/ListOfLocationCriteria/<x>/Entry/ EnterSpecificArea/Heading/MinimumHeading	288
10.2.55A23	/<x>/<x>/OnNetwork/MCDataGroupList/<x>/Entry/ RulesForAffiliation/<x>/ListOfLocationCriteria/<x>/Entry/ EnterSpecificArea/Heading/MaximumHeading	289
10.2.55A24	/<x>/<x>/OnNetwork/MCDataGroupList/<x>/Entry/ RulesForAffiliation/<x>/ListOfLocationCriteria/<x>/Entry/ ExitSpecificArea.....	289
10.2.55A25	/<x>/<x>/OnNetwork/MCDataGroupList/<x>/Entry/ RulesForAffiliation/<x>/ListOfLocationCriteria/<x>/Entry/ ExitSpecificArea/PolygonArea.....	289
10.2.55A26	/<x>/<x>/OnNetwork/MCDataGroupList/<x>/Entry/ RulesForAffiliation/<x>/ListOfLocationCriteria/<x>/Entry/ ExitSpecificArea/PolygonArea/<x>	290
10.2.55A27	/<x>/<x>/OnNetwork/MCDataGroupList/<x>/Entry/ RulesForAffiliation/<x>/ListOfLocationCriteria/<x>/Entry/ ExitSpecificArea/PolygonArea/<x>/PointCoordinateType	290
10.2.55A28	/<x>/<x>/OnNetwork/MCDataGroupList/<x>/Entry/ RulesForAffiliation/<x>/ListOfLocationCriteria/<x>/Entry/ ExitSpecificArea/PolygonArea/<x>/PointCoordinateType/ Longitude.....	290
10.2.55A29	/<x>/<x>/OnNetwork/MCDataGroupList/<x>/Entry/ RulesForAffiliation/<x>/ListOfLocationCriteria/<x>/Entry/ ExitSpecificArea/PolygonArea/<x>/PointCoordinateType/ Latitude.....	291
10.2.55A30	/<x>/<x>/OnNetwork/MCDataGroupList/<x>/Entry/ RulesForAffiliation/<x>/ListOfLocationCriteria/<x>/Entry/ ExitSpecificArea/EllipsoidArcArea.....	291
10.2.55A31	/<x>/<x>/OnNetwork/MCDataGroupList/<x>/Entry/ RulesForAffiliation/<x>/ListOfLocationCriteria/<x>/Entry/ ExitSpecificArea/EllipsoidArcArea/Center	291
10.2.55A32	/<x>/<x>/OnNetwork/MCDataGroupList/<x>/Entry/ RulesForAffiliation/<x>/ListOfLocationCriteria/<x>/Entry/ ExitSpecificArea/EllipsoidArcArea/Center/PointCoordinateType	291
10.2.55A33	/<x>/<x>/OnNetwork/MCDataGroupList/<x>/Entry/ RulesForAffiliation/<x>/ListOfLocationCriteria/<x>/Entry/ ExitSpecificArea/EllipsoidArcArea/Center/PointCoordinateType/ Longitude	292
10.2.55A34	/<x>/<x>/OnNetwork/MCDataGroupList/<x>/Entry/ RulesForAffiliation/<x>/ListOfLocationCriteria/<x>/Entry/ ExitSpecificArea/EllipsoidArcArea/Center/PointCoordinateType/ Latitude.....	292
10.2.55A35	/<x>/<x>/OnNetwork/MCDataGroupList/<x>/Entry/ RulesForAffiliation/<x>/ListOfLocationCriteria/<x>/Entry/ ExitSpecificArea/EllipsoidArcArea/Radius.....	292
10.2.55A36	/<x>/<x>/OnNetwork/MCDataGroupList/<x>/Entry/ RulesForAffiliation/<x>/ListOfLocationCriteria/<x>/Entry/ ExitSpecificArea/EllipsoidArcArea/OffsetAngle	293
10.2.55A37	/<x>/<x>/OnNetwork/MCDataGroupList/<x>/Entry/ RulesForAffiliation/<x>/ListOfLocationCriteria/<x>/Entry/ ExitSpecificArea/EllipsoidArcArea/IncludedAngle	293
10.2.55A38	/<x>/<x>/OnNetwork/MCDataGroupList/<x>/Entry/ RulesForAffiliation/<x>/ListOfLocationCriteria/<x>/Entry/ ExitSpecificArea/Speed	293
10.2.55A39	/<x>/<x>/OnNetwork/MCDataGroupList/<x>/Entry/ RulesForAffiliation/<x>/ListOfLocationCriteria/<x>/Entry/ ExitSpecificArea/Speed/MinimumSpeed	293
10.2.55A40	/<x>/<x>/OnNetwork/MCDataGroupList/<x>/Entry/ RulesForAffiliation/<x>/ListOfLocationCriteria/<x>/Entry/ ExitSpecificArea/Speed/MaximumSpeed.....	294
10.2.55A41	/<x>/<x>/OnNetwork/MCDataGroupList/<x>/Entry/ RulesForAffiliation/<x>/ListOfLocationCriteria/<x>/Entry/ ExitSpecificArea/Heading	294
10.2.55A42	/<x>/<x>/OnNetwork/MCDataGroupList/<x>/Entry/ RulesForAffiliation/<x>/ListOfLocationCriteria/<x>/Entry/ ExitSpecificArea/Heading/MinimumHeading	294
10.2.55A43	/<x>/<x>/OnNetwork/MCDataGroupList/<x>/Entry/ RulesForAffiliation/<x>/ListOfLocationCriteria/<x>/Entry/ ExitSpecificArea/Heading/MaximumHeading	295
10.2.55A44	/<x>/<x>/OnNetwork/MCDataGroupList/<x>/Entry/ RulesForAffiliation/<x>/ListOfActiveFunctionalAliases.....	295

10.2.55A45	/<x>/<x>/OnNetwork/MCDataGroupList/<x>/Entry/ RulesForAffiliation/<x>/ListOfActiveFunctionalAliases/<x>	295
10.2.55A46	/<x>/<x>/OnNetwork/MCDataGroupList/<x>/Entry/ RulesForAffiliation/<x>/ListOfActiveFunctionalAliases/<x>/Entry	295
10.2.55A47	/<x>/<x>/OnNetwork/MCDataGroupList/<x>/Entry/ RulesForAffiliation/<x>/ListOfActiveFunctionalAliases/<x>/Entry/FunctionalAlias	296
10.2.55B	/<x>/<x>/OnNetwork/MCDataGroupList/<x>/Entry/ RulesForDeaffiliation	296
10.2.55B0	/<x>/<x>/OnNetwork/MCDataGroupList/<x>/Entry/ RulesForDeaffiliation/<x>	296
10.2.55B1	/<x>/<x>/OnNetwork/MCDataGroupList/<x>/Entry/ RulesForDeaffiliation/<x>/ListOfLocationCriteria/	296
10.2.55B2	/<x>/<x>/OnNetwork/MCDataGroupList/<x>/Entry/ RulesForDeaffiliation/<x>/ListOfLocationCriteria/<x>	297
10.2.55B3	/<x>/<x>/OnNetwork/MCDataGroupList/<x>/Entry/ RulesForDeaffiliation/<x>/ListOfLocationCriteria/<x>/Entry	297
10.2.55B4	/<x>/<x>/OnNetwork/MCDataGroupList/<x>/Entry/ RulesForDeaffiliation/<x>/ListOfLocationCriteria/<x>/Entry/ EnterSpecificArea	297
10.2.55B5	/<x>/<x>/OnNetwork/MCDataGroupList/<x>/Entry/ RulesForDeaffiliation/<x>/ListOfLocationCriteria/<x>/Entry/ EnterSpecificArea/PolygonArea	297
10.2.55B6	/<x>/<x>/OnNetwork/MCDataGroupList/<x>/Entry/ RulesForDeaffiliation/<x>/ListOfLocationCriteria/<x>/Entry/ EnterSpecificArea/PolygonArea/<x>	298
10.2.55B7	/<x>/<x>/OnNetwork/MCDataGroupList/<x>/Entry/ RulesForDeaffiliation/<x>/ListOfLocationCriteria/<x>/Entry/ EnterSpecificArea/PolygonArea/<x>/PointCoordinateType	298
10.2.55B8	/<x>/<x>/OnNetwork/MCDataGroupList/<x>/Entry/ RulesForDeaffiliation/<x>/ListOfLocationCriteria/<x>/Entry/ EnterSpecificArea/PolygonArea/<x>/PointCoordinateType/ Longitude	298
10.2.55B9	/<x>/<x>/OnNetwork/MCDataGroupList/<x>/Entry/ RulesForDeaffiliation/<x>/ListOfLocationCriteria/<x>/Entry/ EnterSpecificArea/PolygonArea/<x>/PointCoordinateType/ Latitude	299
10.2.55B10	/<x>/<x>/OnNetwork/MCDataGroupList/<x>/Entry/ RulesForDeaffiliation/<x>/ListOfLocationCriteria/<x>/Entry/ EnterSpecificArea/EllipsoidArcArea	299
10.2.55B11	/<x>/<x>/OnNetwork/MCDataGroupList/<x>/Entry/ RulesForDeaffiliation/<x>/ListOfLocationCriteria/<x>/Entry/ EnterSpecificArea/EllipsoidArcArea/Center	299
10.2.55B12	/<x>/<x>/OnNetwork/MCDataGroupList/<x>/Entry/ RulesForDeaffiliation/<x>/ListOfLocationCriteria/<x>/Entry/ EnterSpecificArea/EllipsoidArcArea/Center/PointCoordinateType	300
10.2.55B13	/<x>/<x>/OnNetwork/MCDataGroupList/<x>/Entry/ RulesForDeaffiliation/<x>/ListOfLocationCriteria/<x>/Entry/ EnterSpecificArea/EllipsoidArcArea/Center/PointCoordinateType/ Longitude	300
10.2.55B14	/<x>/<x>/OnNetwork/MCDataGroupList/<x>/Entry/ RulesForDeaffiliation/<x>/ListOfLocationCriteria/<x>/Entry/ EnterSpecificArea/EllipsoidArcArea/Center/PointCoordinateType/ Latitude	300
10.2.55B15	/<x>/<x>/OnNetwork/MCDataGroupList/<x>/Entry/ RulesForDeaffiliation/<x>/ListOfLocationCriteria/<x>/Entry/ EnterSpecificArea/EllipsoidArcArea/Radius	301
10.2.55B16	/<x>/<x>/OnNetwork/MCDataGroupList/<x>/Entry/ RulesForDeaffiliation/<x>/ListOfLocationCriteria/<x>/Entry/ EnterSpecificArea/EllipsoidArcArea/OffsetAngle	301
10.2.55B17	/<x>/<x>/OnNetwork/MCDataGroupList/<x>/Entry/ RulesForDeaffiliation/<x>/ListOfLocationCriteria/<x>/Entry/ EnterSpecificArea/EllipsoidArcArea/IncludedAngle	301
10.2.55B18	/<x>/<x>/OnNetwork/MCDataGroupList/<x>/Entry/ RulesForDeaffiliation/<x>/ListOfLocationCriteria/<x>/Entry/ EnterSpecificArea/Speed	301
10.2.55B19	/<x>/<x>/OnNetwork/MCDataGroupList/<x>/Entry/ RulesForDeaffiliation/<x>/ListOfLocationCriteria/<x>/Entry/ EnterSpecificArea/Speed/MinimumSpeed	302
10.2.55B20	/<x>/<x>/OnNetwork/MCDataGroupList/<x>/Entry/ RulesForDeaffiliation/<x>/ListOfLocationCriteria/<x>/Entry/ EnterSpecificArea/Speed/MaximumSpeed	302

10.2.55B21	/<x>/<x>/OnNetwork/MCDataGroupList/<x>/Entry/ RulesForDeaffiliation/<x>/ListOfLocationCriteria/<x>/Entry/ EnterSpecificArea/Heading	302
10.2.55B22	/<x>/<x>/OnNetwork/MCDataGroupList/<x>/Entry/ RulesForDeaffiliation/<x>/ListOfLocationCriteria/<x>/Entry/ EnterSpecificArea/Heading/MinimumHeading	303
10.2.55B23	/<x>/<x>/OnNetwork/MCDataGroupList/<x>/Entry/ RulesForDeaffiliation/<x>/ListOfLocationCriteria/<x>/Entry/ EnterSpecificArea/Heading/MaximumHeading	303
10.2.55B24	/<x>/<x>/OnNetwork/MCDataGroupList/<x>/Entry/ RulesForDeaffiliation/<x>/ListOfLocationCriteria/<x>/Entry/ ExitSpecificArea	303
10.2.55B25	/<x>/<x>/OnNetwork/MCDataGroupList/<x>/Entry/ RulesForDeaffiliation/<x>/ListOfLocationCriteria/<x>/Entry/ ExitSpecificArea/PolygonArea	304
10.2.55B26	/<x>/<x>/OnNetwork/MCDataGroupList/<x>/Entry/ RulesForDeaffiliation/<x>/ListOfLocationCriteria/<x>/Entry/ ExitSpecificArea/PolygonArea/<x>... ..	304
10.2.55B27	/<x>/<x>/OnNetwork/MCDataGroupList/<x>/Entry/ RulesForDeaffiliation/<x>/ListOfLocationCriteria/<x>/Entry/ ExitSpecificArea/PolygonArea/<x>/PointCoordinateType	304
10.2.55B28	/<x>/<x>/OnNetwork/MCDataGroupList/<x>/Entry/ RulesForDeaffiliation/<x>/ListOfLocationCriteria/<x>/Entry/ ExitSpecificArea/PolygonArea/<x>/PointCoordinateType/ Longitude.....	305
10.2.55B29	/<x>/<x>/OnNetwork/MCDataGroupList/<x>/Entry/ RulesForDeaffiliation/<x>/ListOfLocationCriteria/<x>/Entry/ ExitSpecificArea/PolygonArea/<x>/PointCoordinateType/ Latitude.....	305
10.2.55B30	/<x>/<x>/OnNetwork/MCDataGroupList/<x>/Entry/ RulesForDeaffiliation/<x>/ListOfLocationCriteria/<x>/Entry/ ExitSpecificArea/EllipsoidArcArea ...	305
10.2.55B31	/<x>/<x>/OnNetwork/MCDataGroupList/<x>/Entry/ RulesForDeaffiliation/<x>/ListOfLocationCriteria/<x>/Entry/ ExitSpecificArea/EllipsoidArcArea/Center	306
10.2.55B32	/<x>/<x>/OnNetwork/MCDataGroupList/<x>/Entry/ RulesForDeaffiliation/<x>/ListOfLocationCriteria/<x>/Entry/ ExitSpecificArea/EllipsoidArcArea/Center/PointCoordinateType	306
10.2.55B33	/<x>/<x>/OnNetwork/MCDataGroupList/<x>/Entry/ RulesForDeaffiliation/<x>/ListOfLocationCriteria/<x>/Entry/ ExitSpecificArea/EllipsoidArcArea/Center/PointCoordinateType/ Longitude	306
10.2.55B34	/<x>/<x>/OnNetwork/MCDataGroupList/<x>/Entry/ RulesForDeaffiliation/<x>/ListOfLocationCriteria/<x>/Entry/ /ExitSpecificArea/EllipsoidArcArea/Center/PointCoordinateType/ Latitude	307
10.2.55B35	/<x>/<x>/OnNetwork/MCDataGroupList/<x>/Entry/ RulesForDeaffiliation/<x>/ListOfLocationCriteria/<x>/Entry/ ExitSpecificArea/EllipsoidArcArea/Radius	307
10.2.55B36	/<x>/<x>/OnNetwork/MCDataGroupList/<x>/Entry/ RulesForDeaffiliation/<x>/ListOfLocationCriteria/<x>/Entry/ ExitSpecificArea/EllipsoidArcArea/OffsetAngle	307
10.2.55B37	/<x>/<x>/OnNetwork/MCDataGroupList/<x>/Entry/ RulesForDeaffiliation/<x>/ListOfLocationCriteria/<x>/Entry/ ExitSpecificArea/EllipsoidArcArea/IncludedAngle	308
10.2.55B38	/<x>/<x>/OnNetwork/MCDataGroupList/<x>/Entry/ RulesForDeaffiliation/<x>/ListOfLocationCriteria/<x>/Entry/ ExitSpecificArea/Speed.....	308
10.2.55B39	/<x>/<x>/OnNetwork/MCDataGroupList/<x>/Entry/ RulesForDeaffiliation/<x>/ListOfLocationCriteria/<x>/Entry/ ExitSpecificArea/Speed/MinimumSpeed	308
10.2.55B40	/<x>/<x>/OnNetwork/MCDataGroupList/<x>/Entry/ RulesForDeaffiliation/<x>/ListOfLocationCriteria/<x>/Entry/ ExitSpecificArea/Speed/MaximumSpeed	309
10.2.55B41	/<x>/<x>/OnNetwork/MCDataGroupList/<x>/Entry/ RulesForDeaffiliation/<x>/ListOfLocationCriteria/<x>/Entry/ ExitSpecificArea/Heading.....	309
10.2.55B42	/<x>/<x>/OnNetwork/MCDataGroupList/<x>/Entry/ RulesForDeaffiliation/<x>/ListOfLocationCriteria/<x>/Entry/ ExitSpecificArea/Heading/MinimumHeading	309
10.2.55B43	/<x>/<x>/OnNetwork/MCDataGroupList/<x>/Entry/ RulesForDeaffiliation/<x>/ListOfLocationCriteria/<x>/Entry/ ExitSpecificArea/Heading/MaximumHeading	310

10.2.55B44	/<x>/<x>/OnNetwork/MCDataGroupList/<x>/Entry/ RulesForDeaffiliation/<x>/ListOfActiveFunctionalAliases	310
10.2.55B45	/<x>/<x>/OnNetwork/MCDataGroupList/<x>/Entry/ RulesForDeaffiliation/<x>/ListOfActiveFunctionalAliases/<x>.....	310
10.2.55B46	/<x>/<x>/OnNetwork/MCDataGroupList/<x>/Entry/ RulesForDeaffiliation/<x>/ListOfActiveFunctionalAliases/<x>/Entry.....	310
10.2.55B47	/<x>/<x>/OnNetwork/MCDataGroupList/<x>/Entry/ RulesForDeaffiliation/<x>/ListOfActiveFunctionalAliases/<x>/Entry/ FunctionalAlias	311
10.2.55B48	/<x>/<x>/OnNetwork/MCDataGroupList/<x>/Entry/ ManualDeaffiliationNotAllowedIfAffiliationRulesAreMet	311
10.2.55C	/<x>/<x>/OnNetwork/MCDataGroupList/<x>/Entry/ AllowStoreGroupCommInMsgstore	311
10.2.56	/<x>/<x>/OnNetwork/ImplicitAffiliations	311
10.2.57	/<x>/<x>/OnNetwork/ImplicitAffiliations/<x>	312
10.2.58	/<x>/<x>/OnNetwork/ImplicitAffiliations/<x>/Entry	312
10.2.59	/<x>/<x>/OnNetwork/ImplicitAffiliations/<x>/Entry/MCDataGroupID	312
10.2.60	/<x>/<x>/OnNetwork/ImplicitAffiliations/<x>/Entry/DisplayName	312
10.2.61	/<x>/<x>/OnNetwork/PresenceStatus	312
10.2.62	/<x>/<x>/OnNetwork/PresenceStatus/<x>	313
10.2.63	/<x>/<x>/OnNetwork/PresenceStatus/<x>/Entry	313
10.2.64	/<x>/<x>/OnNetwork/PresenceStatus/<x>/Entry/MCDataID	313
10.2.65	/<x>/<x>/OnNetwork/PresenceStatus/<x>/Entry/DisplayName	313
10.2.66	/<x>/<x>/OnNetwork/RemoteGroupChange.....	314
10.2.67	/<x>/<x>/>/OnNetwork/RemoteGroupChange/<x>.....	314
10.2.68	/<x>/<x>/OnNetwork/RemoteGroupChange/<x>/Entry	314
10.2.69	/<x>/<x>/OnNetwork/RemoteGroupChange/<x>/Entry/MCDataID	314
10.2.70	/<x>/<x>/OnNetwork/RemoteGroupChange/<x>/Entry/DisplayName	314
10.2.71	/<x>/<x>/OnNetwork/MaxAffiliationsN2.....	315
10.2.72	/<x>/<x>/OnNetwork/ConversationManagement	315
10.2.73	/<x>/<x>/OnNetwork/ConversationManagement/GroupHangTime	315
10.2.74	/<x>/<x>/OnNetwork/ConversationManagement/ GroupHangTime/<x>.....	315
10.2.75	/<x>/<x>/OnNetwork/ConversationManagement/ GroupHangTime/<x>/Entry.....	315
10.2.76	/<x>/<x>/OnNetwork/ConversationManagement/ GroupHangTime/<x>/Entry/MCDataGroupID.....	316
10.2.77	/<x>/<x>/OnNetwork/ConversationManagement/ GroupHangTime/<x>/Entry/DisplayName.....	316
10.2.78	/<x>/<x>/OnNetwork/ConversationManagement/ GroupHangTime/<x>/Entry/HangTime.....	316
10.2.79	/<x>/<x>/OnNetwork/ConversationManagement/ DeliveredDisposition	317
10.2.80	/<x>/<x>/OnNetwork/ConversationManagement/ DeliveredDisposition/<x>.....	317
10.2.81	/<x>/<x>/OnNetwork/ConversationManagement/ DeliveredDisposition/<x>/Entry.....	317
10.2.82	/<x>/<x>/OnNetwork/ConversationManagement/ DeliveredDisposition/<x>/Entry/MCDataID.....	317
10.2.83	/<x>/<x>/OnNetwork/ConversationManagement/ DeliveredDisposition/<x>/Entry/DisplayName.....	318
10.2.84	/<x>/<x>/OnNetwork/ConversationManagement/ReadDisposition.....	318
10.2.85	/<x>/<x>/OnNetwork/ConversationManagement/ReadDisposition/ <x>	318
10.2.86	/<x>/<x>/OnNetwork/ConversationManagement/ReadDisposition/ <x>/Entry	318
10.2.87	/<x>/<x>/OnNetwork/ConversationManagement/ReadDisposition/ <x>/Entry/MCDataID	319
10.2.88	/<x>/<x>/OnNetwork/ConversationManagement/ReadDisposition/ <x>/Entry/DisplayName	319
10.2.89	/<x>/<x>/OnNetwork/OneToOneEmergencyAlert	319
10.2.90	/<x>/<x>/OnNetwork/OneToOneEmergencyAlert/Entry	319
10.2.91	/<x>/<x>/OnNetwork/OneToOneEmergencyAlert/Entry/ID	319
10.2.92	/<x>/<x>/OnNetwork/OneToOneEmergencyAlert/Entry/ DisplayName.....	320
10.2.93	/<x>/<x>/OnNetwork/OneToOneEmergencyAlert/Entry/Usage	320
10.2.94	/<x>/<x>/OnNetwork/AllowedRegroup.....	320
10.2.95	/<x>/<x>/OnNetwork/AllowedPresenceStatus.....	320
10.2.96	/<x>/<x>/OnNetwork/AllowedPresence	321
10.2.97	/<x>/<x>/OnNetwork/AllowedManualSwitch	321
10.2.97A	/<x>/<x>/OnNetwork/MCDataContentServerURI.....	321
10.2.97B	/<x>/<x>/OnNetwork/FunctionalAliasList.....	322
10.2.97B1	/<x>/<x>/OnNetwork/FunctionalAliasList/<x>	322
10.2.97B2	/<x>/<x>/OnNetwork/FunctionalAliasList/<x>/Entry	322
10.2.97B3	/<x>/<x>/OnNetwork/FunctionalAliasList/<x>/Entry/ FunctionalAlias.....	322
10.2.97B3A	/<x>/<x>/OnNetwork/FunctionalAliasList/<x>/ Entry/DisplayName	322
10.2.97B3B	/<x>/<x>/OnNetwork/FunctionalAliasList/<x>/Entry/ LocationCriteriaForActivation.....	323
10.2.97B3B0	/<x>/<x>/OnNetwork/FunctionalAliasList/<x>/Entry/ LocationCriteriaForActivation/<x>	323

10.2.97B3B1	<x>/<x>/OnNetwork/FunctionalAliasList/<x>/Entry/ LocationCriteriaForActivation/<x>/EnterSpecificArea	323
10.2.97B3B2	<x>/<x>/OnNetwork/FunctionalAliasList/<x>/Entry/ LocationCriteriaForActivation/<x>/EnterSpecificArea/ PolygonArea	323
10.2.97B3B3	<x>/<x>/OnNetwork/FunctionalAliasList/<x>/Entry/ LocationCriteriaForActivation/<x>/EnterSpecificArea/ PolygonArea/<x>	324
10.2.97B3B4	<x>/<x>/OnNetwork/FunctionalAliasList/<x>/Entry/ LocationCriteriaForActivation/<x>/EnterSpecificArea/ PolygonArea/<x>/PointCoordinateType	324
10.2.97B3B5	<x>/<x>/OnNetwork/FunctionalAliasList/<x>/Entry/ LocationCriteriaForActivation/<x>/EnterSpecificArea/ PolygonArea/<x>/PointCoordinateType/Longitude	324
10.2.97B3B6	<x>/<x>/OnNetwork/FunctionalAliasList/<x>/Entry/ LocationCriteriaForActivation/<x>/EnterSpecificArea/ PolygonArea/<x>/PointCoordinateType/Latitude	325
10.2.97B3B7	<x>/<x>/OnNetwork/FunctionalAliasList/<x>/Entry/ LocationCriteriaForActivation/<x>/EnterSpecificArea/ EllipsoidArcArea	325
10.2.97B3B8	<x>/<x>/OnNetwork/FunctionalAliasList/<x>/Entry/ LocationCriteriaForActivation/<x>/EnterSpecificArea/ EllipsoidArcArea/Center	325
10.2.97B3B9	<x>/<x>/OnNetwork/FunctionalAliasList/<x>/Entry/ LocationCriteriaForActivation/<x>/EnterSpecificArea/ EllipsoidArcArea/Center/PointCoordinateType	325
10.2.97B3B10	<x>/<x>/OnNetwork/FunctionalAliasList/<x>/Entry/ LocationCriteriaForActivation/<x>/EnterSpecificArea/ EllipsoidArcArea/Center/PointCoordinateType/Longitude	326
10.2.97B3B11	<x>/<x>/OnNetwork/FunctionalAliasList/<x>/Entry/ LocationCriteriaForActivation/<x>/EnterSpecificArea/ EllipsoidArcArea/Center/PointCoordinateType/Latitude	326
10.2.97B3B12	<x>/<x>/OnNetwork/FunctionalAliasList/<x>/Entry/ LocationCriteriaForActivation/<x>/EnterSpecificArea/ EllipsoidArcArea/Radius	326
10.2.97B3B13	<x>/<x>/OnNetwork/FunctionalAliasList/<x>/Entry/ LocationCriteriaForActivation/<x>/EnterSpecificArea/ EllipsoidArcArea/OffsetAngle	327
10.2.97B3B14	<x>/<x>/OnNetwork/FunctionalAliasList/<x>/Entry/ LocationCriteriaForActivation/<x>/EnterSpecificArea/ EllipsoidArcArea/IncludedAngle	327
10.2.97B3B15	<x>/<x>/OnNetwork/FunctionalAliasList/<x>/Entry/ LocationCriteriaForActivation/<x>/EnterSpecificArea/Speed	327
10.2.97B3B16	<x>/<x>/OnNetwork/FunctionalAliasList/<x>/Entry/ LocationCriteriaForActivation/<x>/EnterSpecificArea/Speed/ MinimumSpeed	328
10.2.97B3B17	<x>/<x>/OnNetwork/FunctionalAliasList/<x>/Entry/ LocationCriteriaForActivation/<x>/EnterSpecificArea/Speed/ MaximumSpeed	328
10.2.97B3B18	<x>/<x>/OnNetwork/FunctionalAliasList/<x>/Entry/ LocationCriteriaForActivation/<x>/EnterSpecificArea/Heading	328
10.2.97B3B19	<x>/<x>/OnNetwork/FunctionalAliasList/<x>/Entry/ LocationCriteriaForActivation/<x>/EnterSpecificArea/Heading/ MinimumHeading	329
10.2.97B3B20	<x>/<x>/OnNetwork/FunctionalAliasList/<x>/Entry/ LocationCriteriaForActivation/<x>/EnterSpecificArea/Heading/ MaximumHeading	329
10.2.97B3B21	<x>/<x>/OnNetwork/FunctionalAliasList/<x>/Entry/ LocationCriteriaForActivation/<x>/ExitSpecificArea	329
10.2.97B3B22	<x>/<x>/OnNetwork/FunctionalAliasList/<x>/ Entry/LocationCriteriaForActivation/<x>/ExitSpecificArea/ PolygonArea	330
10.2.97B3B23	<x>/<x>/OnNetwork/FunctionalAliasList/<x>/Entry/ LocationCriteriaForActivation/<x>/ExitSpecificArea/ PolygonArea/<x>	330
10.2.97B3B24	<x>/<x>/OnNetwork/FunctionalAliasList/<x>/Entry/ LocationCriteriaForActivation/<x>/ExitSpecificArea/ PolygonArea/<x>/PointCoordinateType	330
10.2.97B3B25	<x>/<x>/OnNetwork/FunctionalAliasList/<x>/Entry/ LocationCriteriaForActivation/<x>/ExitSpecificArea/ PolygonArea/<x>/PointCoordinateType/Longitude	330
10.2.97B3B26	<x>/<x>/OnNetwork/FunctionalAliasList/<x>/Entry/ LocationCriteriaForActivation/<x>/ExitSpecificArea/ PolygonArea/<x>/PointCoordinateType/Latitude	331
10.2.97B3B27	<x>/<x>/OnNetwork/FunctionalAliasList/<x>/Entry/ LocationCriteriaForActivation/<x>/ExitSpecificArea/ EllipsoidArcArea	331

10.2.97B3B28	<x>/<x>/OnNetwork/FunctionalAliasList/<x>/Entry/ LocationCriteriaForActivation/<x>/ExitSpecificArea/ EllipsoidArcArea/Center	331
10.2.97B3B29	<x>/<x>/OnNetwork/FunctionalAliasList/<x>/Entry/ LocationCriteriaForActivation/<x>/ExitSpecificArea/ EllipsoidArcArea/Center/PointCoordinateType	332
10.2.97B3B30	<x>/<x>/OnNetwork/FunctionalAliasList/<x>/Entry/ LocationCriteriaForActivation/<x>/ExitSpecificArea/ EllipsoidArcArea/Center/PointCoordinateType/Longitude	332
10.2.97B3B31	<x>/<x>/OnNetwork/FunctionalAliasList/<x>/Entry/ LocationCriteriaForActivation/<x>/ExitSpecificArea/ EllipsoidArcArea/Center/PointCoordinateType/Latitude	332
10.2.97B3B32	<x>/<x>/OnNetwork/FunctionalAliasList/<x>/Entry/ LocationCriteriaForActivation/<x>/ExitSpecificArea/ EllipsoidArcArea/Radius	333
10.2.97B3B33	<x>/<x>/OnNetwork/FunctionalAliasList/<x>/Entry/ LocationCriteriaForActivation/<x>/ExitSpecificArea/ EllipsoidArcArea/OffsetAngle	333
10.2.97B3B34	<x>/<x>/OnNetwork/FunctionalAliasList/<x>/Entry/ LocationCriteriaForActivation/<x>/ExitSpecificArea/ EllipsoidArcArea/IncludedAngle	333
10.2.97B3B35	<x>/<x>/OnNetwork/FunctionalAliasList/<x>/Entry/ LocationCriteriaForActivation/<x>/ExitSpecificArea/ Speed	334
10.2.97B3B36	<x>/<x>/OnNetwork/FunctionalAliasList/<x>/Entry/ LocationCriteriaForActivation/<x>/ExitSpecificArea/ Speed/ MinimumSpeed	334
10.2.97B3B37	<x>/<x>/OnNetwork/FunctionalAliasList/<x>/Entry/ LocationCriteriaForActivation/<x>/ExitSpecificArea/ Speed/ MaximumSpeed	334
10.2.97B3B38	<x>/<x>/OnNetwork/FunctionalAliasList/<x>/Entry/ LocationCriteriaForActivation/<x>/ExitSpecificArea/ Heading	334
10.2.97B3B39	<x>/<x>/OnNetwork/FunctionalAliasList/<x>/Entry/ LocationCriteriaForActivation/<x>/ExitSpecificArea/ Heading/ MinimumHeading	335
10.2.97B3B40	<x>/<x>/OnNetwork/FunctionalAliasList/<x>/Entry/ LocationCriteriaForActivation/<x>/ExitSpecificArea/ Heading/ MaximumHeading	335
10.2.97B3C	<x>/<x>/OnNetwork/FunctionalAliasList/<x>/Entry/ LocationCriteriaForDeactivation	335
10.2.97B3C0	<x>/<x>/OnNetwork/FunctionalAliasList/<x>/Entry/ LocationCriteriaForDeactivation/<x>	336
10.2.97B3C1	<x>/<x>/OnNetwork/FunctionalAliasList/<x>/Entry/ LocationCriteriaForDeactivation/<x>/EnterSpecificArea	336
10.2.97B3C2	<x>/<x>/OnNetwork/FunctionalAliasList/<x>/Entry/ LocationCriteriaForDeactivation/<x>/EnterSpecificArea/ PolygonArea	336
10.2.97B3C3	<x>/<x>/OnNetwork/FunctionalAliasList/<x>/Entry/ LocationCriteriaForDeactivation/<x>/EnterSpecificArea/ PolygonArea/<x>	336
10.2.97B3C4	<x>/<x>/OnNetwork/FunctionalAliasList/<x>/Entry/ LocationCriteriaForDeactivation/<x>/EnterSpecificArea/ PolygonArea/<x>/PointCoordinateType ...	337
10.2.97B3C5	<x>/<x>/OnNetwork/FunctionalAliasList/<x>/Entry/ LocationCriteriaForDeactivation/<x>/EnterSpecificArea/ PolygonArea/<x>/PointCoordinateType/Longitude	337
10.2.97B3C6	<x>/<x>/OnNetwork/FunctionalAliasList/<x>/Entry/ LocationCriteriaForDeactivation/<x>/EnterSpecificArea/ PolygonArea/<x>/PointCoordinateType/Latitude	337
10.2.97B3C7	<x>/<x>/OnNetwork/FunctionalAliasList/<x>/Entry/ LocationCriteriaForDeactivation/<x>/EnterSpecificArea/ EllipsoidArcArea	338
10.2.97B3C8	<x>/<x>/OnNetwork/FunctionalAliasList/<x>/Entry/ LocationCriteriaForDeactivation/<x>/EnterSpecificArea/ EllipsoidArcArea/Center	338
10.2.97B3C9	<x>/<x>/OnNetwork/FunctionalAliasList/<x>/Entry/ LocationCriteriaForDeactivation/<x>/EnterSpecificArea/ EllipsoidArcArea/Center/PointCoordinateType	338
10.2.97B3C10	<x>/<x>/OnNetwork/FunctionalAliasList/<x>/Entry/ LocationCriteriaForDeactivation/<x>/EnterSpecificArea/ EllipsoidArcArea/Center/PointCoordinateType/Longitude	339
10.2.97B3C11	<x>/<x>/OnNetwork/FunctionalAliasList/<x>/Entry/ LocationCriteriaForDeactivation/<x>/EnterSpecificArea/ EllipsoidArcArea/Center/PointCoordinateType/Latitude	339
10.2.97B3C12	<x>/<x>/OnNetwork/FunctionalAliasList/<x>/Entry/ LocationCriteriaForDeactivation/<x>/EnterSpecificArea/ EllipsoidArcArea/Radius	339
10.2.97B3C13	<x>/<x>/OnNetwork/FunctionalAliasList/<x>/Entry/ LocationCriteriaForDeactivation/<x>/EnterSpecificArea/ EllipsoidArcArea/OffsetAngle	340

10.2.97B3C14	/<x>/<x>/OnNetwork/FunctionalAliasList/<x>/Entry/ LocationCriteriaForDeactivation/<x>/EnterSpecificArea/ EllipsoidArcArea/IncludedAngle	340
10.2.97B3C15	/<x>/<x>/OnNetwork/FunctionalAliasList/<x>/Entry/ LocationCriteriaForDeactivation/<x>/EnterSpecificArea/Speed	340
10.2.97B3C16	<x>/<x>/OnNetwork/FunctionalAliasList/<x>/Entry/ LocationCriteriaForDeactivation/<x>/EnterSpecificArea/Speed/ MinimumSpeed.....	341
10.2.97B3C17	<x>/<x>/OnNetwork/FunctionalAliasList/<x>/Entry/ LocationCriteriaForDeactivation/<x>/EnterSpecificArea/Speed/ MaximumSpeed	341
10.2.97B3C18	<x>/<x>/OnNetwork/FunctionalAliasList/<x>/Entry/ LocationCriteriaForDeactivation/<x>/EnterSpecificArea/Heading.....	341
10.2.97B3C19	<x>/<x>/OnNetwork/FunctionalAliasList/<x>/Entry/ LocationCriteriaForDeactivation/<x>/EnterSpecificArea/Heading/ MinimumHeading	342
10.2.97B3C20	<x>/<x>/OnNetwork/FunctionalAliasList/<x>/Entry/ LocationCriteriaForDeactivation/<x>/EnterSpecificArea/Heading/ MaximumHeading.....	342
10.2.97B3C21	<x>/<x>/OnNetwork/FunctionalAliasList/<x>/Entry/ LocationCriteriaForDeactivation/<x>/ExitSpecificArea	342
10.2.97B3C22	<x>/<x>/OnNetwork/FunctionalAliasList/<x>/Entry/ LocationCriteriaForDeactivation/<x>/ExitSpecificArea/ PolygonArea	343
10.2.97B3C23	<x>/<x>/OnNetwork/FunctionalAliasList/<x>/Entry/ LocationCriteriaForDeactivation/<x>/ExitSpecificArea/ PolygonArea/<x>.....	343
10.2.97B3C24	<x>/<x>/OnNetwork/FunctionalAliasList/<x>/Entry/ LocationCriteriaForDeactivation/<x>/ExitSpecificArea/ PolygonArea/<x>/PointCoordinateType	343
10.2.97B3C25	<x>/<x>/OnNetwork/FunctionalAliasList/<x>/Entry/ LocationCriteriaForDeactivation/<x>/ExitSpecificArea/ PolygonArea/<x>/PointCoordinateType/Longitude	344
10.2.97B3C26	<x>/<x>/OnNetwork/FunctionalAliasList/<x>/Entry/ LocationCriteriaForDeactivation/<x>/ExitSpecificArea/ PolygonArea/<x>/PointCoordinateType/Latitude	344
10.2.97B3C27	<x>/<x>/OnNetwork/FunctionalAliasList/<x>/Entry/ LocationCriteriaForDeactivation/<x>/ExitSpecificArea/ EllipsoidArcArea	344
10.2.97B3C28	<x>/<x>/OnNetwork/FunctionalAliasList/<x>/Entry/ LocationCriteriaForDeactivation/<x>/ExitSpecificArea/ EllipsoidArcArea/Center	345
10.2.97B3C29	<x>/<x>/OnNetwork/FunctionalAliasList/<x>/Entry/ LocationCriteriaForDeactivation/<x>/ExitSpecificArea/ EllipsoidArcArea/Center/PointCoordinateType	345
10.2.97B3C30	<x>/<x>/OnNetwork/FunctionalAliasList/<x>/Entry/ LocationCriteriaForDeactivation/<x>/ExitSpecificArea/ EllipsoidArcArea/Center/PointCoordinateType/Longitude	345
10.2.97B3C31	<x>/<x>/OnNetwork/FunctionalAliasList/<x>/Entry/ LocationCriteriaForDeactivation/<x>/ExitSpecificArea/ EllipsoidArcArea/Center/PointCoordinateType/Latitude	346
10.2.97B3C32	<x>/<x>/OnNetwork/FunctionalAliasList/<x>/Entry/ LocationCriteriaForDeactivation/<x>/ExitSpecificArea/ EllipsoidArcArea/Radius	346
10.2.97B3C33	<x>/<x>/OnNetwork/FunctionalAliasList/<x>/Entry/ LocationCriteriaForDeactivation/<x>/ExitSpecificArea/ EllipsoidArcArea/OffsetAngle	346
10.2.97B3C34	<x>/<x>/OnNetwork/FunctionalAliasList/<x>/Entry/ LocationCriteriaForDeactivation/<x>/ExitSpecificArea/ EllipsoidArcArea/IncludedAngle	347
10.2.97B3C35	<x>/<x>/OnNetwork/FunctionalAliasList/<x>/Entry/ LocationCriteriaForDeactivation/<x>/ExitSpecificArea/Speed	347
10.2.97B3C36	<x>/<x>/OnNetwork/FunctionalAliasList/<x>/Entry/ LocationCriteriaForDeactivation/<x>/ExitSpecificArea/Speed/ MinimumSpeed.....	347
10.2.97B3C37	<x>/<x>/OnNetwork/FunctionalAliasList/<x>/Entry/ LocationCriteriaForDeactivation/<x>/ExitSpecificArea/Speed/ MaximumSpeed	348
10.2.97B3C38	<x>/<x>/OnNetwork/FunctionalAliasList/<x>/Entry/ LocationCriteriaForDeactivation/<x>/ExitSpecificArea/Heading.....	348
10.2.97B3C39	<x>/<x>/OnNetwork/FunctionalAliasList/<x>/Entry/ LocationCriteriaForDeactivation/<x>/ExitSpecificArea/Heading/ MinimumHeading	348
10.2.97B3C40	<x>/<x>/OnNetwork/FunctionalAliasList/<x>/Entry/ LocationCriteriaForDeactivation/<x>/ExitSpecificArea/Heading/ MaximumHeading.....	349
10.2.97B3D	<x>/<x>/OnNetwork/FunctionalAliasList/<x>/Entry/ ManualDeactivationNotAllowedIfLocationCriteriaMet.....	349
10.2.97B4	<x>/<x>/OnNetwork/FunctionalAliasList/<x>/Entry/ MaxSimultaneousEmergencyGroupCalls.....	349

10.2.97C	/<x>/<x>/OnNetwork/AllowedQueryFunctionalAliasOtherUser.....	349
10.2.97D	/<x>/<x>/OnNetwork/AllowedTakeoverFunctionalAliasOtherUser.....	350
10.2.97E	/<x>/<x>/OnNetwork/MessageStoreHostname.....	350
10.2.97F	/<x>/<x>/OnNetwork/AuthorisedIncomingAny	350
10.2.97G	/<x>/<x>/OnNetwork/IncomingUserList	350
10.2.97G1	/<x>/<x>/OnNetwork/IncomingUserList/<x>.....	351
10.2.97G2	/<x>/<x>/OnNetwork/IncomingUserList/<x>/Entry	351
10.2.97G3	/<x>/<x>/OnNetwork/IncomingUserList/<x>/Entry/MCDataID.....	351
10.2.97G4	/<x>/<x>/OnNetwork/IncomingUserList/<x>/Entry/ MCDataDKMSURI	351
10.2.97H	/<x>/<x>/OnNetwork/AllowedFunctionalAliasGroupBinding	352
10.2.97I	/<x>/<x>/OnNetwork/AllowStoreCommsInMsgstore	352
10.2.97J	/<x>/<x>/OnNetwork/AllowStorePrivateCommsInMsgstore	352
10.2.97K	/<x>/<x>/OnNetwork/MCDataAdhocGroup.....	353
10.2.97K1	/<x>/<x>/OnNetwork/MCDataAdhocGroup/EmergencyAlert	353
10.2.97K2	/<x>/<x>/OnNetwork/MCDataAdhocGroup/EmergencyAlert/ Authorised.....	353
10.2.97K3	/<x>/<x>/OnNetwork/MCDataAdhocGroup/EmergencyAlert/ Cancel	353
10.2.97K4	/<x>/<x>/OnNetwork/MCDataAdhocGroup/EmergencyAlert/ AuthRecvParticipantInfo	354
10.2.97K5	/<x>/<x>/OnNetwork/MCDataAdhocGroup/EmergencyAlert/ AuthSetupAdhocGroupComn.....	354
10.2.97K6	/<x>/<x>/OnNetwork/MCDataAdhocGroup/AdhocGroupComn	354
10.2.97K7	/<x>/<x>/OnNetwork/MCDataAdhocGroup/AdhocGroupComn/ Authorised	354
10.2.97K8	/<x>/<x>/OnNetwork/MCDataAdhocGroup/AdhocGroupComn/ AuthorisedParticipation	355
10.2.97K9	/<x>/<x>/OnNetwork/MCDataAdhocGroup/AdhocGroupComn/ AuthInitEmergencyComn.....	355
10.2.97K10	/<x>/<x>/OnNetwork/MCDataAdhocGroup/AdhocGroupComn/ AuthInitImminentPerilComn	355
10.2.97K11	/<x>/<x>/OnNetwork/MCDataAdhocGroup/AdhocGroupComn/ AuthRecvComnParticipantInfo	356
10.2.97K12	/<x>/<x>/OnNetwork/MCDataAdhocGroup/AdhocGroupComn/ AuthModifyComnParticipantInfo.....	356
10.2.98	/<x>/<x>/OffNetwork.....	356
10.2.99	/<x>/<x>/OffNetwork/Authorised.....	356
10.2.100	/<x>/<x>/OffNetwork/MCDataGroupList	357
10.2.101	/<x>/<x>/OffNetwork/MCDataGroupList/<x>.....	357
10.2.102	/<x>/<x>/OffNetwork/MCDataGroupList/<x>/Entry	357
10.2.103	/<x>/<x>/OffNetwork/MCDataGroupList/<x>/Entry/MCDataGroupID	357
10.2.104	/<x>/<x>/OffNetwork/MCDataGroupList/<x>/Entry/DisplayName	358
10.2.105	Void	358
10.2.106	Void	358
10.2.107	/<x>/<x>/OffNetwork/MCDataGroupList/<x>/Entry/GMSServID.....	358
10.2.108	Void	358
10.2.109	Void	358
10.2.110	/<x>/<x>/OffNetwork/MCDataGroupList/<x>/Entry/ IdMSTokenEndPoint.....	358
10.2.110A	/<x>/<x>/OffNetwork/MCDataGroupList/<x>/Entry/ GroupKMSURI	358
10.2.111	/<x>/<x>/OffNetwork/MCDataGroupList/<x>/Entry/ RelativePresentationPriority.....	359
10.2.112	/<x>/<x>/OffNetwork/UserInfoID	359
10.2.113	Void	360
10.2.114	Void	360
10.2.115	Void	360
10.2.116	Void	360
10.2.117	Void	360
10.2.118	Void	360
10.2.119	Void	360
10.2.120	Void	360
10.2.121	/<x>/Status.....	360
11	MCData service configuration MO.....	360
11.1	General	360
11.2	MCData service configuration MO parameters.....	361
11.2.1	General.....	361
11.2.2	Node: <x>	361
11.2.3	/<x>/Name	361
11.2.4	/<x>/Ext/.....	362
11.2.5	/<x>/Common.....	362
11.2.6	/<x>/Common/TxRxControl	362
11.2.7	/<x>/Common/TxRxControl/TimeTempDataWaiting	362
11.2.8	/<x>/Common/TxRxControl/TimePeriodicAnnouncement	363

11.2.9	/<x>/OffNetwork	363
11.2.10	/<x>/OffNetwork/DefaultPPPP	363
11.2.11	/<x>/OffNetwork/DefaultPPPP/MCDataOneToOneCallSignalling	363
11.2.12	/<x>/OffNetwork/DefaultPPPP/MCDataOneToOneCallMedia	364
11.2.12A	/<x>/OffNetwork/DefaultPQI	364
11.2.12B	/<x>/OffNetwork/DefaultPQI/MCDataOneToOneCallSignalling	364
11.2.12C	/<x>/OffNetwork/DefaultPQI/MCDataOneToOneCallMedia	364
11.2.13	/<x>/OnNetwork	365
11.2.14	/<x>/OnNetwork/NotificationServers	365
11.2.15	/<x>/OnNetwork/NotificationServers/<x>	365
11.2.16	/<x>/OnNetwork/NotificationServers/<x>/NotificationServer	365
11.2.17	/<x>/OnNetwork/MCDataAdhocGroup	365
11.2.18	/<x>/OnNetwork/MCDataAdhocGroup/GroupComn	366
11.2.19	/<x>/OnNetwork/MCDataAdhocGroup/GroupComn/ AllowAdhocGroupComn	366
11.2.20	/<x>/OnNetwork/MCDataAdhocGroup/GroupComn/ MaxNoParticipants	366
11.2.21	/<x>/OnNetwork/MCDataAdhocGroup/GroupComn/ HangTime	366
11.2.22	/<x>/OnNetwork/MCDataAdhocGroup/GroupComn/ MaxDurationOfComn	367
12	MCVideo UE configuration MO	367
12.1	General	367
12.2	MCVideo UE configuration MO parameters	368
12.2.1	General	368
12.2.2	Node: <x>	368
12.2.3	/<x>/Name	368
12.2.4	/<x>/Ext/	369
12.2.5	/<x>/Common	369
12.2.5A	/<x>/Common/PrivateCall	369
12.2.5B	/<x>/Common/PrivateCall/MaxCallNc10	369
12.2.6	/<x>/Common/MCVideoGroupCall	370
12.2.7	/<x>/Common/MCVideoGroupCall/MaxCallNc4	370
12.2.8	/<x>/Common/MCVideoGroupCall/MaxTransmissionNc5	370
12.2.9	/<x>/Common/MCVideoGroupCall/PrioritizedMCVideoGroup	370
12.2.10	/<x>/Common/MCVideoGroupCall/PrioritizedMCVideoGroup/<x>	370
12.2.11	/<x>/Common/MCVideoGroupCall/PrioritizedMCVideoGroup/<x>/ MCVideoGroupID	371
12.2.12	/<x>/Common/MCVideoGroupCall/PrioritizedMCVideoGroup/<x>/ MCVideoGroupPriorityHierarchy	371
12.2.13	/<x>/OnNetwork	371
12.2.14	/<x>/OnNetwork/RelayService	371
12.2.15	/<x>/OnNetwork/IPv6Preferred	372
12.2.16	/<x>/OnNetwork/RelayedMCVideoGroup	372
12.2.17	/<x>/OnNetwork/RelayedMCVideoGroup/<x>	372
12.2.18	/<x>/OnNetwork/RelayedMCVideoGroup/<x>/MCVideoGroupID	372
12.2.19	/<x>/OnNetwork/RelayedMCVideoGroup/<x>/RelayServiceCode	373
13	MCVideo user profile MO	373
13.1	General	373
13.2	MCVideo user profile MO parameters	376
13.2.1	General	376
13.2.2	Node: <x>	376
13.2.3	/<x>/Name	376
13.2.4	/<x>/Ext/	377
13.2.5	/<x>/<x>	377
13.2.6	/<x>/<x>/Common	377
13.2.7	/<x>/<x>/Common/MCVideoUserID	377
13.2.8	/<x>/<x>/Common/MCVideoUserProfileIndex	378
13.2.9	/<x>/<x>/Common/MCVideoUserProfileName	378
13.2.10	/<x>/<x>/Common/PreSelectedIndication	378
13.2.11	/<x>/<x>/Common/UserAliases	378
13.2.12	/<x>/<x>/Common/UserAliases/<x>	379
13.2.13	/<x>/<x>/Common/UserAliases/<x>/UserAlias	379
13.2.14	Void	379
13.2.15	/<x>/<x>/Common/ParticipantType	379

13.2.16	/<x>/<x>/Common/Organization	379
13.2.17	/<x>/<x>/Common/MCVideoGroupBroadcast	379
13.2.18	/<x>/<x>/Common/MCVideoGroupBroadcast/Authorised	380
13.2.19	/<x>/<x>/Common/UserBroadcast.....	380
13.2.20	/<x>/<x>/Common/UserBroadcast/Authorised	380
13.2.21	Void	381
13.2.22	Void	381
13.2.23	Void	381
13.2.24	Void	381
13.2.25	Void	381
13.2.26	Void	381
13.2.27	Void	381
13.2.28	Void	381
13.2.29	/<x>/<x>/Common/AllowedActivateAlert.....	381
13.2.30	/<x>/<x>/Common/AllowedCancelAlert	381
13.2.31	Void	382
13.2.32	Void	382
13.2.33	Void	382
13.2.34	Void	382
13.2.35	Void	382
13.2.36	Void	382
13.2.37	Void	382
13.2.38	Void	382
13.2.38A	/<x>/<x>/Common/MCVideoGroupCall	382
13.2.38A1	/<x>/<x>/Common/MCVideoGroupCall/EmergencyAlert	382
13.2.38A2	/<x>/<x>/Common/MCVideoGroupCall/EmergencyAlert/ Authorised	382
13.2.38A3	/<x>/<x>/Common/MCVideoGroupCall/EmergencyAlert/Cancel	383
13.2.38A4	/<x>/<x>/Common/MCVideoGroupCall/EmergencyAlert/Entry	383
13.2.38A5	/<x>/<x>/Common/MCVideoGroupCall/EmergencyAlert/Entry/ID.....	383
13.2.38A6	/<x>/<x>/Common/MCVideoGroupCall/EmergencyAlert/ Entry/DisplayName	383
13.2.38A7	/<x>/<x>/Common/MCVideoGroupCall/EmergencyAlert/ Entry/Usage	383
13.2.38B	/<x>/<x>/Common/MCVideoGroupCall/EmergencyCall.....	384
13.2.38C	/<x>/<x>/Common/MCVideoGroupCall/EmergencyCall/Enabled.....	384
13.2.38D	/<x>/<x>/Common/MCVideoGroupCall/EmergencyCall/ CancelMCVideoGroup	384
13.2.38D1	/<x>/<x>/Common/MCVideoGroupCall/EmergencyCall/ MCVideoGroupInitiation	385
13.2.38D2	/<x>/<x>/Common/MCVideoGroupCall/EmergencyCall/ MCVideoGroupInitiation/Entry	385
13.2.38D3	/<x>/<x>/Common/MCVideoGroupCall/EmergencyCall/ MCVideoGroupInitiation/Entry/GroupID....	385
13.2.38D4	/<x>/<x>/Common/MCVideoGroupCall/EmergencyCall/ MCVideoGroupInitiation/Entry/DisplayName.....	385
13.2.38D5	/<x>/<x>/Common/MCVideoGroupCall/EmergencyCall/ MCVideoGroupInitiation/Entry/Usage	386
13.2.38E	/<x>/<x>/Common/MCVideoGroupCall/ImminentPerilCall.....	386
13.2.38F	/<x>/<x>/Common/MCVideoGroupCall/ImminentPerilCall/ Authorised	386
13.2.38G	/<x>/<x>/Common/MCVideoGroupCall/ImminentPerilCall/Cancel.....	387
13.2.38G1	/<x>/<x>/Common/MCVideoGroupCall/ImminentPerilCall/ MCVideoGroupInitiation	387
13.2.38G2	/<x>/<x>/Common/MCVideoGroupCall/ImminentPerilCall/ MCVideoGroupInitiation/Entry	387
13.2.38G3	/<x>/<x>/Common/MCVideoGroupCall/ImminentPerilCall/ MCVideoGroupInitiation/Entry/GroupID	387
13.2.38G4	/<x>/<x>/Common/MCVideoGroupCall/ImminentPerilCall/ MCVideoGroupInitiation/DisplayName.....	388
13.2.38G5	/<x>/<x>/Common/MCVideoGroupCall/ImminentPerilCall/ MCVideoGroupInitiation/Entry/Usage ...	388
13.2.38G6	/<x>/<x>/Common/MCVideoGroupCall/Priority	388
13.2.38G7	/<x>/<x>/Common/MCVideoGroupCall/MaxSimultaneousCallsN6	389
13.2.38H	/<x>/<x>/Common/PrivateCall	389
13.2.38H1	Void	389
13.2.38H2	Void	389
13.2.38H3	Void	389
13.2.38H4	Void	389
13.2.38H5	Void	389
13.2.38H6	Void	389
13.2.38I	/<x>/<x>/Common/PrivateCall/Authorised	389
13.2.38I1	/<x>/<x>/Common/PrivateCall/AuthorisedAny.....	389
13.2.38I2	/<x>/<x>/Common/PrivateCall/UserList	390

13.2.38I3	/<x>/<x>/Common/PrivateCall/UserList/<x>.....	390
13.2.38I4	/<x>/<x>/Common/PrivateCall/UserList/<x>/Entry.....	390
13.2.38I5	/<x>/<x>/Common/PrivateCall/UserList/<x>/Entry/MCVideoID.....	390
13.2.38I6	/<x>/<x>/Common/PrivateCall/UserList/<x>/Entry/DiscoveryGroupID.....	391
13.2.38I6A	/<x>/<x>/Common/PrivateCall/UserList/<x>/Entry/ApplicationLayerGroupID.....	391
13.2.38I7	/<x>/<x>/Common/PrivateCall/UserList/<x>/Entry/UserInfoID.....	391
13.2.38I8	/<x>/<x>/Common/PrivateCall/UserList/<x>/Entry/DisplayName.....	391
13.2.38I9	/<x>/<x>/Common/PrivateCall/UserList/<x>/Entry/PrivateCallKMSURI.....	392
13.2.38J	/<x>/<x>/Common/PrivateCall/ManualCommence.....	392
13.2.38K	/<x>/<x>/Common/PrivateCall/AutoCommence.....	392
13.2.38L	/<x>/<x>/Common/PrivateCall/FailRestrict.....	392
13.2.38M	Void.....	393
13.2.38N	/<x>/<x>/Common/PrivateCall/AllowedMediaProtection.....	393
13.2.38O	/<x>/<x>/Common/PrivateCall/EmergencyCall.....	393
13.2.38P	/<x>/<x>/Common/PrivateCall/EmergencyCall/Authorised.....	393
13.2.38Q	/<x>/<x>/Common/PrivateCall/EmergencyCall/CancelPriority.....	394
13.2.38R	/<x>/<x>/Common/PrivateCall/EmergencyCall/MCVideoPrivateRecipient.....	394
13.2.38S	/<x>/<x>/Common/PrivateCall/EmergencyCall/MCVideoPrivateRecipient/Entry.....	394
13.2.38T	/<x>/<x>/Common/PrivateCall/EmergencyCall/MCVideoPrivateRecipient/Entry/ID.....	394
13.2.38U	/<x>/<x>/Common/PrivateCall/EmergencyCall/ MCVideoPrivateRecipient/Entry/DiscoveryGroupID.....	395
13.2.38U1	/<x>/<x>/Common/PrivateCall/EmergencyCall/ MCVideoPrivateRecipient/Entry/ApplicationLayerGroupID.....	395
13.2.38V	/<x>/<x>/Common/PrivateCall/EmergencyCall/MCVideoPrivateRecipient/Entry/UserInfoID.....	395
13.2.38W	/<x>/<x>/Common/PrivateCall/EmergencyCall/MCVideoPrivateRecipient/Entry/DisplayName.....	395
13.2.38X	/<x>/<x>/Common/PrivateCall/EmergencyCall/MCVideoPrivateRecipient/Entry/Usage.....	396
13.2.38Y	/<x>/<x>/Common/PrivateCall/AutoAnswer.....	396
13.2.39	/<x>/<x>/OnNetwork.....	396
13.2.40	/<x>/<x>/OnNetwork/MCVideoGroupList.....	397
13.2.41	/<x>/<x>/OnNetwork/MCVideoGroupList/<x>.....	397
13.2.42	/<x>/<x>/OnNetwork/MCVideoGroupList/<x>/Entry.....	397
13.2.43	/<x>/<x>/OnNetwork/MCVideoGroupList/<x>/Entry/MCVideoGroupID.....	397
13.2.43A	/<x>/<x>/OnNetwork/MCVideoGroupList/<x>/Entry/RulesForAffiliation.....	398
13.2.43A0	/<x>/<x>/OnNetwork/MCVideoGroupList/<x>/Entry/RulesForAffiliation/<x>.....	398
13.2.43A1	/<x>/<x>/OnNetwork/MCVideoGroupList/<x>/Entry/ RulesForAffiliation/<x>/ListOfLocationCriteria.....	398
13.2.43A2	/<x>/<x>/OnNetwork/MCVideoGroupList/<x>/Entry/ RulesForAffiliation/<x>/ListOfLocationCriteria/<x>.....	398
13.2.43A3	/<x>/<x>/OnNetwork/MCVideoGroupList/<x>/Entry/ RulesForAffiliation/<x>/ListOfLocationCriteria/<x>/Entry.....	399
13.2.43A4	/<x>/<x>/OnNetwork/MCVideoGroupList/<x>/Entry/ RulesForAffiliation/<x>/ListOfLocationCriteria/<x>/Entry/EnterSpecificArea.....	399
13.2.43A5	/<x>/<x>/OnNetwork/MCVideoGroupList/<x>/Entry/ RulesForAffiliation/<x>/ListOfLocationCriteria/<x>/Entry/EnterSpecificArea/PolygonArea.....	399
13.2.43A6	/<x>/<x>/OnNetwork/MCVideoGroupList/<x>/Entry/ RulesForAffiliation/<x>/ListOfLocationCriteria/<x>/Entry/EnterSpecificArea/PolygonArea/<x>.....	399
13.2.43A7	/<x>/<x>/OnNetwork/MCVideoGroupList/<x>/Entry/ RulesForAffiliation/<x>/ListOfLocationCriteria/<x>/Entry/ EnterSpecificArea/PolygonArea/<x>/PointCoordinateType.....	400
13.2.43A8	/<x>/<x>/OnNetwork/MCVideoGroupList/<x>/Entry/ RulesForAffiliation/<x>/ListOfLocationCriteria/<x>/Entry/ EnterSpecificArea/PolygonArea/<x>/PointCoordinateType/Longitude.....	400
13.2.43A9	/<x>/<x>/OnNetwork/MCVideoGroupList/<x>/Entry/ RulesForAffiliation/<x>/ListOfLocationCriteria/<x>/Entry/ EnterSpecificArea/PolygonArea/<x>/PointCoordinateType/Latitude.....	400
13.2.43A10	/<x>/<x>/OnNetwork/MCVideoGroupList/<x>/Entry/ RulesForAffiliation/<x>/ListOfLocationCriteria/<x>/Entry/EnterSpecificArea/EllipsoidArcArea.....	401
13.2.43A11	/<x>/<x>/OnNetwork/MCVideoGroupList/<x>/Entry/ RulesForAffiliation/<x>/ListOfLocationCriteria/<x>/Entry/ EnterSpecificArea/EllipsoidArcArea/Center.....	401

13.2.43A12	/<x>/<x>/OnNetwork/MCVideoGroupList/<x>/Entry/ RulesForAffiliation/<x>/ListOfLocationCriteria/<x>/Entry/ EnterSpecificArea/EllipsoidArcArea/Center/PointCoordinateType.....	401
13.2.43A13	/<x>/<x>/OnNetwork/MCVideoGroupList/<x>/Entry/ RulesForAffiliation/<x>/ListOfLocationCriteria/<x>/Entry/ EnterSpecificArea/EllipsoidArcArea/Center/PointCoordinateType/ Longitude	402
13.2.43A14	/<x>/<x>/OnNetwork/MCVideoGroupList/<x>/Entry/ RulesForAffiliation/<x>/ListOfLocationCriteria/<x>/Entry/ EnterSpecificArea/EllipsoidArcArea/Center/PointCoordinateType/ Latitude	402
13.2.43A15	/<x>/<x>/OnNetwork/MCVideoGroupList/<x>/Entry/ RulesForAffiliation/<x>/ListOfLocationCriteria/<x>/Entry/ EnterSpecificArea/EllipsoidArcArea/Radius.....	402
13.2.43A16	/<x>/<x>/OnNetwork/MCVideoGroupList/<x>/Entry/ RulesForAffiliation/<x>/ListOfLocationCriteria/<x>/Entry/ EnterSpecificArea/EllipsoidArcArea/OffsetAngle	403
13.2.43A17	/<x>/<x>/OnNetwork/MCVideoGroupList/<x>/Entry/ RulesForAffiliation/<x>/ListOfLocationCriteria/<x>/Entry/ EnterSpecificArea/EllipsoidArcArea/IncludedAngle	403
13.2.43A18	/<x>/<x>/OnNetwork/MCVideoGroupList/<x>/Entry/ RulesForAffiliation/<x>/ListOfLocationCriteria/<x>/Entry/ EnterSpecificArea/Speed.....	403
13.2.43A19	/<x>/<x>/OnNetwork/MCVideoGroupList/<x>/Entry/ RulesForAffiliation/<x>/ListOfLocationCriteria/<x>/Entry/ EnterSpecificArea/Speed/MinimumSpeed	403
13.2.43A20	/<x>/<x>/OnNetwork/MCVideoGroupList/<x>/Entry/ RulesForAffiliation/<x>/ListOfLocationCriteria/<x>/Entry/ EnterSpecificArea/Speed/MaximumSpeed.....	404
13.2.43A21	/<x>/<x>/OnNetwork/MCVideoGroupList/<x>/Entry/ RulesForAffiliation/<x>/ListOfLocationCriteria/<x>/Entry/ EnterSpecificArea/Heading	404
13.2.43A22	/<x>/<x>/OnNetwork/MCVideoGroupList/<x>/Entry/ RulesForAffiliation/<x>/ListOfLocationCriteria/<x>/Entry/ EnterSpecificArea/Heading/MinimumHeading.....	404
13.2.43A23	/<x>/<x>/OnNetwork/MCVideoGroupList/<x>/Entry/ RulesForAffiliation/<x>/ListOfLocationCriteria/<x>/Entry/ EnterSpecificArea/Heading/MaximumHeading	405
13.2.43A24	/<x>/<x>/OnNetwork/MCVideoGroupList/<x>/Entry/ RulesForAffiliation/<x>/ListOfLocationCriteria/<x>/Entry/ ExitSpecificArea.....	405
13.2.43A25	/<x>/<x>/OnNetwork/MCVideoGroupList/<x>/Entry/ RulesForAffiliation/<x>/ListOfLocationCriteria/<x>/Entry/ ExitSpecificArea/PolygonArea.....	405
13.2.43A26	/<x>/<x>/OnNetwork/MCVideoGroupList/<x>/Entry/ RulesForAffiliation/<x>/ListOfLocationCriteria/<x>/Entry/ ExitSpecificArea/PolygonArea/<x>	406
13.2.43A27	/<x>/<x>/OnNetwork/MCVideoGroupList/<x>/Entry/ RulesForAffiliation/<x>/ListOfLocationCriteria/<x>/Entry/ ExitSpecificArea/PolygonArea/<x>/PointCoordinateType	406
13.2.43A28	/<x>/<x>/OnNetwork/MCVideoGroupList/<x>/Entry/ RulesForAffiliation/<x>/ListOfLocationCriteria/<x>/Entry/ ExitSpecificArea/PolygonArea/<x>/PointCoordinateType/ Longitude	406
13.2.43A29	/<x>/<x>/OnNetwork/MCVideoGroupList/<x>/Entry/ RulesForAffiliation/<x>/ListOfLocationCriteria/<x>/Entry/ ExitSpecificArea/PolygonArea/<x>/PointCoordinateType/ Latitude.....	407
13.2.43A30	/<x>/<x>/OnNetwork/MCVideoGroupList/<x>/Entry/ RulesForAffiliation/<x>/ListOfLocationCriteria/<x>/Entry/ ExitSpecificArea/EllipsoidArcArea.....	407
13.2.43A31	/<x>/<x>/OnNetwork/MCVideoGroupList/<x>/Entry/ RulesForAffiliation/<x>/ListOfLocationCriteria/<x>/Entry/ ExitSpecificArea/EllipsoidArcArea/Center	407
13.2.43A32	/<x>/<x>/OnNetwork/MCVideoGroupList/<x>/Entry/ RulesForAffiliation/<x>/ListOfLocationCriteria/<x>/Entry/ ExitSpecificArea/EllipsoidArcArea/Center/PointCoordinateType.....	407
13.2.43A33	/<x>/<x>/OnNetwork/MCVideoGroupList/<x>/Entry/ RulesForAffiliation/<x>/ListOfLocationCriteria/<x>/Entry/ ExitSpecificArea/EllipsoidArcArea/Center/PointCoordinateType/ Longitude	408

13.2.43A34	/<x>/<x>/OnNetwork/MCVideoGroupList/<x>/Entry/ RulesForAffiliation/<x>/ListOfLocationCriteria/<x>/Entry/ ExitSpecificArea/EllipsoidArcArea/Center/PointCoordinateType/ Latitude	408
13.2.43A35	/<x>/<x>/OnNetwork/MCVideoGroupList/<x>/Entry/ RulesForAffiliation/<x>/ListOfLocationCriteria/<x>/Entry/ ExitSpecificArea/EllipsoidArcArea/Radius.....	408
13.2.43A36	/<x>/<x>/OnNetwork/MCVideoGroupList/<x>/Entry/ RulesForAffiliation/<x>/ListOfLocationCriteria/<x>/Entry/ ExitSpecificArea/EllipsoidArcArea/OffsetAngle	409
13.2.43A37	/<x>/<x>/OnNetwork/MCVideoGroupList/<x>/Entry/ RulesForAffiliation/<x>/ListOfLocationCriteria/<x>/Entry/ ExitSpecificArea/EllipsoidArcArea/IncludedAngle	409
13.2.43A38	/<x>/<x>/OnNetwork/MCVideoGroupList/<x>/Entry/ RulesForAffiliation/<x>/ListOfLocationCriteria/<x>/Entry/ ExitSpecificArea/Speed	409
13.2.43A39	/<x>/<x>/OnNetwork/MCVideoGroupList/<x>/Entry/ RulesForAffiliation/<x>/ListOfLocationCriteria/<x>/Entry/ ExitSpecificArea/Speed/MinimumSpeed	409
13.2.43A40	/<x>/<x>/OnNetwork/MCVideoGroupList/<x>/Entry/ RulesForAffiliation/<x>/ListOfLocationCriteria/<x>/Entry/ ExitSpecificArea/Speed/MaximumSpeed.....	410
13.2.43A41	/<x>/<x>/OnNetwork/MCVideoGroupList/<x>/Entry/ RulesForAffiliation/<x>/ListOfLocationCriteria/<x>/Entry/ ExitSpecificArea/Heading	410
13.2.43A42	/<x>/<x>/OnNetwork/MCVideoGroupList/<x>/Entry/ RulesForAffiliation/<x>/ListOfLocationCriteria/<x>/Entry/ ExitSpecificArea/Heading/MinimumHeading	410
13.2.43A43	/<x>/<x>/OnNetwork/MCVideoGroupList/<x>/Entry/ RulesForAffiliation/<x>/ListOfLocationCriteria/<x>/Entry/ ExitSpecificArea/Heading/MaximumHeading	411
13.2.43A44	/<x>/<x>/OnNetwork/MCVideoGroupList/<x>/Entry/ RulesForAffiliation/<x>/ListOfActiveFunctionalAliases.....	411
13.2.43A45	/<x>/<x>/OnNetwork/MCVideoGroupList/<x>/Entry/ RulesForAffiliation/<x>/ListOfActiveFunctionalAliases/<x>	411
13.2.43A46	/<x>/<x>/OnNetwork/MCVideoGroupList/<x>/Entry/ RulesForAffiliation/<x>/ListOfActiveFunctionalAliases/<x>/Entry	411
13.2.43A47	/<x>/<x>/OnNetwork/MCVideoGroupList/<x>/Entry/ RulesForAffiliation/<x>/ListOfActiveFunctionalAliases/<x>/Entry/ FunctionalAlias.....	412
13.2.43B	/<x>/<x>/OnNetwork/MCVideoGroupList/<x>/Entry/ RulesForDeaffiliation	412
13.2.43B0	/<x>/<x>/OnNetwork/MCVideoGroupList/<x>/Entry/ RulesForDeaffiliation/<x>	412
13.2.43B1	/<x>/<x>/OnNetwork/MCVideoGroupList/<x>/Entry/ RulesForDeaffiliation/<x>/ListOfLocationCriteria	412
13.2.43B2	/<x>/<x>/OnNetwork/MCVideoGroupList/<x>/Entry/ RulesForDeaffiliation/<x>/ListOfLocationCriteria/<x>	413
13.2.43B3	/<x>/<x>/OnNetwork/MCVideoGroupList/<x>/Entry/ RulesForDeaffiliation/<x>/ListOfLocationCriteria/<x>/Entry.....	413
13.2.43B4	/<x>/<x>/OnNetwork/MCVideoGroupList/<x>/Entry/ RulesForDeaffiliation/<x>/ListOfLocationCriteria/<x>/Entry/ EnterSpecificArea	413
13.2.43B5	/<x>/<x>/OnNetwork/MCVideoGroupList/<x>/Entry/ RulesForDeaffiliation/<x>/ListOfLocationCriteria/<x>/Entry/ EnterSpecificArea/PolygonArea	413
13.2.43B6	/<x>/<x>/OnNetwork/MCVideoGroupList/<x>/Entry/ RulesForDeaffiliation/<x>/ListOfLocationCriteria/<x>/Entry/ EnterSpecificArea/PolygonArea/<x>....	414
13.2.43B7	/<x>/<x>/OnNetwork/MCVideoGroupList/<x>/Entry/ RulesForDeaffiliation/<x>/ListOfLocationCriteria/<x>/Entry/ EnterSpecificArea/PolygonArea/<x>/PointCoordinateType	414
13.2.43B8	/<x>/<x>/OnNetwork/MCVideoGroupList/<x>/Entry/ RulesForDeaffiliation/<x>/ListOfLocationCriteria/<x>/Entry/ EnterSpecificArea/PolygonArea/<x>/PointCoordinateType/ Longitude.....	414
13.2.43B9	/<x>/<x>/OnNetwork/MCVideoGroupList/<x>/Entry/ RulesForDeaffiliation/<x>/ListOfLocationCriteria/<x>/Entry/ EnterSpecificArea/PolygonArea/<x>/PointCoordinateType/ Latitude.....	415
13.2.43B10	/<x>/<x>/OnNetwork/MCVideoGroupList/<x>/Entry/ RulesForDeaffiliation/<x>/ListOfLocationCriteria/<x>/Entry/ EnterSpecificArea/EllipsoidArcArea	415

13.2.43B11	/<x>/<x>/OnNetwork/MCVideoGroupList/<x>/Entry/ RulesForDeaffiliation/<x>/ListOfLocationCriteria/<x>/Entry/ EnterSpecificArea/EllipsoidArcArea/Center	415
13.2.43B12	/<x>/<x>/OnNetwork/MCVideoGroupList/<x>/Entry/ RulesForDeaffiliation/<x>/ListOfLocationCriteria/<x>/Entry/ EnterSpecificArea/EllipsoidArcArea/Center/PointCoordinateType	416
13.2.43B13	/<x>/<x>/OnNetwork/MCVideoGroupList/<x>/Entry/ RulesForDeaffiliation/<x>/ListOfLocationCriteria/<x>/Entry/ EnterSpecificArea/EllipsoidArcArea/Center/PointCoordinateType/ Longitude	416
13.2.43B14	/<x>/<x>/OnNetwork/MCVideoGroupList/<x>/Entry/ RulesForDeaffiliation/<x>/ListOfLocationCriteria/<x>/Entry/ EnterSpecificArea/EllipsoidArcArea/Center/PointCoordinateType/ Latitude	416
13.2.43B15	/<x>/<x>/OnNetwork/MCVideoGroupList/<x>/Entry/ RulesForDeaffiliation/<x>/ListOfLocationCriteria/<x>/Entry/ EnterSpecificArea/EllipsoidArcArea/Radius	417
13.2.43B16	/<x>/<x>/OnNetwork/MCVideoGroupList/<x>/Entry/ RulesForDeaffiliation/<x>/ListOfLocationCriteria/<x>/Entry/ EnterSpecificArea/EllipsoidArcArea/OffsetAngle	417
13.2.43B17	/<x>/<x>/OnNetwork/MCVideoGroupList/<x>/Entry/ RulesForDeaffiliation/<x>/ListOfLocationCriteria/<x>/Entry/ EnterSpecificArea/EllipsoidArcArea/IncludedAngle	417
13.2.43B18	/<x>/<x>/OnNetwork/MCVideoGroupList/<x>/Entry/ RulesForDeaffiliation/<x>/ListOfLocationCriteria/<x>/Entry/ EnterSpecificArea/Speed	417
13.2.43B19	/<x>/<x>/OnNetwork/MCVideoGroupList/<x>/Entry/ RulesForDeaffiliation/<x>/ListOfLocationCriteria/<x>/Entry/ EnterSpecificArea/Speed/MinimumSpeed	418
13.2.43B20	/<x>/<x>/OnNetwork/MCVideoGroupList/<x>/Entry/ RulesForDeaffiliation/<x>/ListOfLocationCriteria/<x>/Entry/ EnterSpecificArea/Speed/MaximumSpeed	418
13.2.43B21	/<x>/<x>/OnNetwork/MCVideoGroupList/<x>/Entry/ RulesForDeaffiliation/<x>/ListOfLocationCriteria/<x>/Entry/ EnterSpecificArea/Heading	418
13.2.43B22	/<x>/<x>/OnNetwork/MCVideoGroupList/<x>/Entry/ RulesForDeaffiliation/<x>/ListOfLocationCriteria/<x>/Entry/ EnterSpecificArea/Heading/MinimumHeading	419
13.2.43B23	/<x>/<x>/OnNetwork/MCVideoGroupList/<x>/Entry/ RulesForDeaffiliation/<x>/ListOfLocationCriteria/<x>/Entry/ EnterSpecificArea/Heading/MaximumHeading	419
13.2.43B24	/<x>/<x>/OnNetwork/MCVideoGroupList/<x>/Entry/ RulesForDeaffiliation/<x>/ListOfLocationCriteria/<x>/Entry/ ExitSpecificArea	419
13.2.43B25	/<x>/<x>/OnNetwork/MCVideoGroupList/<x>/Entry/ RulesForDeaffiliation/<x>/ListOfLocationCriteria/<x>/Entry/ ExitSpecificArea/PolygonArea	420
13.2.43B26	/<x>/<x>/OnNetwork/MCVideoGroupList/<x>/Entry/ RulesForDeaffiliation/<x>/ListOfLocationCriteria/<x>/Entry/ ExitSpecificArea/PolygonArea/<x>	420
13.2.43B27	/<x>/<x>/OnNetwork/MCVideoGroupList/<x>/Entry/ RulesForDeaffiliation/<x>/ListOfLocationCriteria/<x>/Entry/ ExitSpecificArea/PolygonArea/<x>/PointCoordinateType	420
13.2.43B28	/<x>/<x>/OnNetwork/MCVideoGroupList/<x>/Entry/ RulesForDeaffiliation/<x>/ListOfLocationCriteria/<x>/Entry/ ExitSpecificArea/PolygonArea/<x>/PointCoordinateType/ Longitude	421
13.2.43B29	/<x>/<x>/OnNetwork/MCVideoGroupList/<x>/Entry/ RulesForDeaffiliation/<x>/ListOfLocationCriteria/<x>/Entry/ ExitSpecificArea/PolygonArea/<x>/PointCoordinateType/ Latitude	421
13.2.43B30	/<x>/<x>/OnNetwork/MCVideoGroupList/<x>/Entry/ RulesForDeaffiliation/<x>/ListOfLocationCriteria/<x>/Entry/ ExitSpecificArea/EllipsoidArcArea	421
13.2.43B31	/<x>/<x>/OnNetwork/MCVideoGroupList/<x>/Entry/ RulesForDeaffiliation/<x>/ListOfLocationCriteria/<x>/Entry/ ExitSpecificArea/EllipsoidArcArea/Center	422
13.2.43B32	/<x>/<x>/OnNetwork/MCVideoGroupList/<x>/Entry/ RulesForDeaffiliation/<x>/ListOfLocationCriteria/<x>/Entry/ ExitSpecificArea/EllipsoidArcArea/Center/PointCoordinateType	422

13.2.43B33	/<x>/<x>/OnNetwork/MCVideoGroupList/<x>/Entry/ RulesForDeaffiliation/<x>/ListOfLocationCriteria/<x>/Entry/ ExitSpecificArea/EllipsoidArcArea/Center/PointCoordinateType/ Longitude	422
13.2.43B34	/<x>/<x>/OnNetwork/MCVideoGroupList/<x>/Entry/ RulesForDeaffiliation/<x>/ListOfLocationCriteria/<x>/Entry/ ExitSpecificArea/EllipsoidArcArea/Center/PointCoordinateType/ Latitude	423
13.2.43B35	/<x>/<x>/OnNetwork/MCVideoGroupList/<x>/Entry/ RulesForDeaffiliation/<x>/ListOfLocationCriteria/<x>/Entry/ ExitSpecificArea/EllipsoidArcArea/Radius.....	423
13.2.43B36	/<x>/<x>/OnNetwork/MCVideoGroupList/<x>/Entry/ RulesForDeaffiliation/<x>/ListOfLocationCriteria/<x>/Entry/ ExitSpecificArea/EllipsoidArcArea/OffsetAngle	423
13.2.43B37	/<x>/<x>/OnNetwork/MCVideoGroupList/<x>/Entry/ RulesForDeaffiliation/<x>/ListOfLocationCriteria/<x>/Entry/ ExitSpecificArea/EllipsoidArcArea/IncludedAngle	424
13.2.43B38	/<x>/<x>/OnNetwork/MCVideoGroupList/<x>/Entry/ RulesForDeaffiliation/<x>/ListOfLocationCriteria/<x>/Entry/ ExitSpecificArea/Speed	424
13.2.43B39	/<x>/<x>/OnNetwork/MCVideoGroupList/<x>/Entry/ RulesForDeaffiliation/<x>/ListOfLocationCriteria/<x>/Entry/ ExitSpecificArea/Speed/MinimumSpeed	424
13.2.43B40	/<x>/<x>/OnNetwork/MCVideoGroupList/<x>/Entry/ RulesForDeaffiliation/<x>/ListOfLocationCriteria/<x>/Entry/ ExitSpecificArea/Speed/MaximumSpeed.....	425
13.2.43B41	/<x>/<x>/OnNetwork/MCVideoGroupList/<x>/Entry/ RulesForDeaffiliation/<x>/ListOfLocationCriteria/<x>/Entry/ ExitSpecificArea/Heading.....	425
13.2.43B42	/<x>/<x>/OnNetwork/MCVideoGroupList/<x>/Entry/ RulesForDeaffiliation/<x>/ListOfLocationCriteria/<x>/Entry/ ExitSpecificArea/Heading/MinimumHeading	425
13.2.43B43	/<x>/<x>/OnNetwork/MCVideoGroupList/<x>/Entry/ RulesForDeaffiliation/<x>/ListOfLocationCriteria/<x>/Entry/ ExitSpecificArea/Heading/MaximumHeading	426
13.2.43B44	/<x>/<x>/OnNetwork/MCVideoGroupList/<x>/Entry/ RulesForDeaffiliation/<x>/ListOfActiveFunctionalAliases	426
13.2.43B45	/<x>/<x>/OnNetwork/MCVideoGroupList/<x>/Entry/ RulesForDeaffiliation/<x>/ListOfActiveFunctionalAliases/<x>	426
13.2.43B46	/<x>/<x>/OnNetwork/MCVideoGroupList/<x>/Entry/ RulesForDeaffiliation/<x>/ListOfActiveFunctionalAliases/<x>/Entry.....	426
13.2.43B47	/<x>/<x>/OnNetwork/MCVideoGroupList/<x>/Entry/ RulesForDeaffiliation/<x>/ListOfActiveFunctionalAliases/<x>/Entry/ FunctionalAlias	427
13.2.43C	/<x>/<x>/OnNetwork/MCVideoGroupList/<x>/Entry/ ManualDeaffiliationNotAllowedIfAffiliationRulesAreMet	427
13.2.44	/<x>/<x>/OnNetwork/MCVideoGroupList/<x>/Entry/DisplayName	427
13.2.45	Void	427
13.2.46	Void	427
13.2.47	/<x>/<x>/OnNetwork/MCVideoGroupList/<x>/Entry/GMSServID	427
13.2.48	Void	428
13.2.49	Void	428
13.2.50	/<x>/<x>/OnNetwork/MCVideoGroupList/<x>/Entry/ IdMSTokenEndPoint	428
13.2.50A	Void	428
13.2.50B	Void	428
13.2.50C	Void	428
13.2.50D	/<x>/<x>/OnNetwork/MCVideoGroupList/<x>/Entry/ GroupKMSURI.....	428
13.2.51	/<x>/<x>/OnNetwork/MCVideoGroupList/<x>/Entry/ RelativePresentationPriority	428
13.2.52	/<x>/<x>/OnNetwork/ImplicitAffiliations	429
13.2.53	/<x>/<x>/OnNetwork/ImplicitAffiliations/<x>.....	429
13.2.54	/<x>/<x>/OnNetwork/ImplicitAffiliations/<x>/Entry.....	429
13.2.55	/<x>/<x>/OnNetwork/ImplicitAffiliations/<x>/Entry/MCVideoGroupID	429
13.2.56	/<x>/<x>/OnNetwork/ImplicitAffiliations/<x>/Entry/DisplayName.....	429
13.2.57	/<x>/<x>/OnNetwork/PresenceStatus	430
13.2.58	/<x>/<x>/OnNetwork/PresenceStatus/<x>.....	430
13.2.59	/<x>/<x>/OnNetwork/PresenceStatus/<x>/Entry.....	430
13.2.60	/<x>/<x>/OnNetwork/PresenceStatus/<x>/Entry/MCVideoGroupID	430

13.2.61	/<x>/<x>/OnNetwork/PresenceStatus/<x>/Entry/DisplayName	430
13.2.62	Void	431
13.2.63	Void	431
13.2.64	Void	431
13.2.65	Void	431
13.2.66	Void	431
13.2.67	/<x>/<x>/OnNetwork/MaxAffiliationsN2	431
13.2.68	/<x>/<x>/OnNetwork/AllowedRegroup	431
13.2.69	/<x>/<x>/OnNetwork/AllowedPresenceStatus	431
13.2.70	/<x>/<x>/OnNetwork/AllowedPresence	432
13.2.71	/<x>/<x>/OnNetwork/AllowedManualSwitch	432
13.2.72	Void	432
13.2.73	/<x>/<x>/OnNetwork/MaxSimultaneousVideoStreams	432
13.2.74	/<x>/<x>/OnNetwork/MaxSimultaneousVideoStreams/MaxStreams	432
13.2.75	Void	433
13.2.76	Void	433
13.2.77	Void	433
13.2.78	Void	433
13.2.79	Void	433
13.2.80	Void	433
13.2.81	Void	433
13.2.82	Void	433
13.2.83	Void	433
13.2.84	Void	433
13.2.85	Void	433
13.2.86	Void	433
13.2.87	Void	433
13.2.87A	/<x>/<x>/OnNetwork/EnabledParticipation	433
13.2.87A1	/<x>/<x>/OnNetwork/AllowedRemoteInitiatedAmbientViewing	433
13.2.87A2	/<x>/<x>/OnNetwork/AllowedLocallyInitiatedAmbientViewing	434
13.2.87A3	/<x>/<x>/OnNetwork/FunctionalAliasList	434
13.2.87A4	/<x>/<x>/OnNetwork/FunctionalAliasList/<x>	434
13.2.87A5	/<x>/<x>/OnNetwork/FunctionalAliasList/<x>/Entry	434
13.2.87A6	/<x>/<x>/OnNetwork/FunctionalAliasList/<x>/Entry/ FunctionalAlias	435
13.2.87A6A	/<x>/<x>/OnNetwork/FunctionalAliasList/<x>/Entry/ LocationCriteriaForActivation	435
13.2.87A6A0	/<x>/<x>/OnNetwork/FunctionalAliasList/<x>/Entry/ LocationCriteriaForActivation/<x>	435
13.2.87A6A1	/<x>/<x>/OnNetwork/FunctionalAliasList/<x>/Entry/ LocationCriteriaForActivation/<x>/EnterSpecificArea	435
13.2.87A6A2	/<x>/<x>/OnNetwork/FunctionalAliasList/<x>/Entry/ LocationCriteriaForActivation/<x>/EnterSpecificArea/PolygonArea	436
13.2.87A6A3	/<x>/<x>/OnNetwork/FunctionalAliasList/<x>/Entry/ LocationCriteriaForActivation/<x>/EnterSpecificArea/ PolygonArea/<x>	436
13.2.87A6A3A	/<x>/<x>/OnNetwork/FunctionalAliasList/<x>/Entry/ LocationCriteriaForActivation/<x>/EnterSpecificArea/ PolygonArea/<x>/PointCoordinateType	436
13.2.87A6A4	/<x>/<x>/OnNetwork/FunctionalAliasList/<x>/Entry/ LocationCriteriaForActivation/<x>/EnterSpecificArea/ PolygonArea/<x>/PointCoordinateType/Longitude	436
13.2.87A6A5	/<x>/<x>/OnNetwork/FunctionalAliasList/<x>/Entry/ LocationCriteriaForActivation/<x>/EnterSpecificArea/ PolygonArea/<x>/PointCoordinateType/Latitude	437
13.2.87A6A6	/<x>/<x>/OnNetwork/FunctionalAliasList/<x>/Entry/ LocationCriteriaForActivation/<x>/EnterSpecificArea/ EllipsoidArcArea	437
13.2.87A6A7	/<x>/<x>/OnNetwork/FunctionalAliasList/<x>/Entry/ LocationCriteriaForActivation/<x>/EnterSpecificArea/ EllipsoidArcArea/Center	437
13.2.87A6A7A	/<x>/<x>/OnNetwork/FunctionalAliasList/<x>/Entry/ LocationCriteriaForActivation/<x>/EnterSpecificArea/ EllipsoidArcArea/Center/PointCoordinateType	438
13.2.87A6A8	/<x>/<x>/OnNetwork/FunctionalAliasList/<x>/Entry/ LocationCriteriaForActivation/<x>/EnterSpecificArea/ EllipsoidArcArea/Center/PointCoordinateType/Longitude	438

13.2.87A6A9	/<x>/<x>/OnNetwork/FunctionalAliasList/<x>/Entry/ LocationCriteriaForActivation/<x>/EnterSpecificArea/ EllipsoidArcArea/Center/PointCoordinateType/Latitude	438
13.2.87A6A10	/<x>/<x>/OnNetwork/FunctionalAliasList/<x>/Entry/ LocationCriteriaForActivation/<x>/EnterSpecificArea/ EllipsoidArcArea/Radius	439
13.2.87A6A11	/<x>/<x>/OnNetwork/FunctionalAliasList/<x>/Entry/ LocationCriteriaForActivation/<x>/EnterSpecificArea/ EllipsoidArcArea/OffsetAngle	439
13.2.87A6A12	/<x>/<x>/OnNetwork/FunctionalAliasList/<x>/Entry/ LocationCriteriaForActivation/<x>/EnterSpecificArea/ EllipsoidArcArea/IncludedAngle	439
13.2.87A6A12A	/<x>/<x>/OnNetwork/FunctionalAliasList/<x>/Entry/ LocationCriteriaForActivation/<x>/EnterSpecificArea/Speed	440
13.2.87A6A12B	/<x>/<x>/OnNetwork/FunctionalAliasList/<x>/Entry/ LocationCriteriaForActivation/<x>/EnterSpecificArea/Speed/ MinimumSpeed.....	440
13.2.87A6A12C	/<x>/<x>/OnNetwork/FunctionalAliasList/<x>/Entry/ LocationCriteriaForActivation/<x>/EnterSpecificArea/Speed/ MaximumSpeed	440
13.2.87A6A12D	/<x>/<x>/OnNetwork/FunctionalAliasList/<x>/Entry/ LocationCriteriaForActivation/<x>/EnterSpecificArea/Heading	440
13.2.87A6A12E	/<x>/<x>/OnNetwork/FunctionalAliasList/<x>/Entry/ LocationCriteriaForActivation/<x>/EnterSpecificArea/Heading/ MinimumHeading	441
13.2.87A6A12F	/<x>/<x>/OnNetwork/FunctionalAliasList/<x>/Entry/ LocationCriteriaForActivation/<x>/EnterSpecificArea/Heading/ MaximumHeading	441
13.2.87A6A13	/<x>/<x>/OnNetwork/FunctionalAliasList/<x>/Entry/ LocationCriteriaForActivation/<x>/ExitSpecificArea	441
13.2.87A6A14	/<x>/<x>/OnNetwork/FunctionalAliasList/<x>/Entry/ LocationCriteriaForActivation/<x>/ExitSpecificArea/PolygonArea	442
13.2.87A6A15	/<x>/<x>/OnNetwork/FunctionalAliasList/<x>/ Entry/LocationCriteriaForActivation/<x>/ExitSpecificArea/ PolygonArea/<x>	442
13.2.87A6A15A	/<x>/<x>/OnNetwork/FunctionalAliasList/<x>/Entry/ LocationCriteriaForActivation/<x>/ExitSpecificArea/PolygonArea/ <x>/PointCoordinateType	442
13.2.87A6A16	/<x>/<x>/OnNetwork/FunctionalAliasList/<x>/Entry/ LocationCriteriaForActivation/<x>/ExitSpecificArea/PolygonArea/ <x>/PointCoordinateType/Longitude	442
13.2.87A6A17	/<x>/<x>/OnNetwork/FunctionalAliasList/<x>/Entry/ LocationCriteriaForActivation/<x>/ExitSpecificArea/PolygonArea/ <x>/PointCoordinateType/Latitude	443
13.2.87A6A18	/<x>/<x>/OnNetwork/FunctionalAliasList/<x>/Entry/ LocationCriteriaForActivation/<x>/ExitSpecificArea/ EllipsoidArcArea	443
13.2.87A6A19	/<x>/<x>/OnNetwork/FunctionalAliasList/<x>/Entry/ LocationCriteriaForActivation/<x>/ExitSpecificArea/ EllipsoidArcArea/Center	443
13.2.87A6A19A	/<x>/<x>/OnNetwork/FunctionalAliasList/<x>/Entry/ LocationCriteriaForActivation/<x>/ExitSpecificArea/ EllipsoidArcArea/Center/PointCoordinateType.....	444
13.2.87A6A20	/<x>/<x>/OnNetwork/FunctionalAliasList/<x>/Entry/ LocationCriteriaForActivation/<x>/ExitSpecificArea/ EllipsoidArcArea/Center/PointCoordinateType/Longitude	444
13.2.87A6A21	/<x>/<x>/OnNetwork/FunctionalAliasList/<x>/Entry/ LocationCriteriaForActivation/<x>/ExitSpecificArea/ EllipsoidArcArea/Center/PointCoordinateType/Latitude	444
13.2.87A6A22	/<x>/<x>/OnNetwork/FunctionalAliasList/<x>/Entry/ LocationCriteriaForActivation/<x>/ExitSpecificArea/ EllipsoidArcArea/Radius.....	445
13.2.87A6A23	/<x>/<x>/OnNetwork/FunctionalAliasList/<x>/Entry/ LocationCriteriaForActivation/<x>/ExitSpecificArea/ EllipsoidArcArea/OffsetAngle	445
13.2.87A6A24	/<x>/<x>/OnNetwork/FunctionalAliasList/<x>/Entry/ LocationCriteriaForActivation/<x>/ExitSpecificArea/ EllipsoidArcArea/IncludedAngle	445
13.2.87A6A24A	/<x>/<x>/OnNetwork/FunctionalAliasList/<x>/Entry/ LocationCriteriaForActivation/<x>/ExitSpecificArea/Speed	446
13.2.87A6A24B	/<x>/<x>/OnNetwork/FunctionalAliasList/<x>/Entry/ LocationCriteriaForActivation/<x>/ExitSpecificArea/Speed/ MinimumSpeed.....	446
13.2.87A6A24C	/<x>/<x>/OnNetwork/FunctionalAliasList/<x>/Entry/ LocationCriteriaForActivation/<x>/ExitSpecificArea/Speed/ MaximumSpeed	446
13.2.87A6A24D	/<x>/<x>/OnNetwork/FunctionalAliasList/<x>/Entry/ LocationCriteriaForActivation/<x>/ExitSpecificArea/Heading	446

13.2.87A6A24E	/<x>/<x>/OnNetwork/FunctionalAliasList/<x>/Entry/ LocationCriteriaForActivation/<x>/ExitSpecificArea/Heading/ MinimumHeading	447
13.2.87A6A24F	/<x>/<x>/OnNetwork/FunctionalAliasList/<x>/Entry/ LocationCriteriaForActivation/<x>/ExitSpecificArea/Heading/ MaximumHeading	447
13.2.87A6B	/<x>/<x>/OnNetwork/FunctionalAliasList/<x>/Entry/ LocationCriteriaForDeactivation	447
13.2.87A6B0	/<x>/<x>/OnNetwork/FunctionalAliasList/<x>/Entry/ LocationCriteriaForDeactivation/<x>.....	448
13.2.87A6B1	/<x>/<x>/OnNetwork/FunctionalAliasList/<x>/Entry/ LocationCriteriaForDeactivation/<x>/EnterSpecificArea	448
13.2.87A6B2	/<x>/<x>/OnNetwork/FunctionalAliasList/<x>/Entry/ LocationCriteriaForDeactivation/<x>/EnterSpecificArea/ PolygonArea	448
13.2.87A6B3	/<x>/<x>/OnNetwork/FunctionalAliasList/<x>/Entry/ LocationCriteriaForDeactivation/<x>/EnterSpecificArea/ PolygonArea/<x>	448
13.2.87A6B3A	/<x>/<x>/OnNetwork/FunctionalAliasList/<x>/Entry/ LocationCriteriaForDeactivation/<x>/EnterSpecificArea/ PolygonArea/<x>/PointCoordinateType.....	449
13.2.87A6B4	/<x>/<x>/OnNetwork/FunctionalAliasList/<x>/Entry/ LocationCriteriaForDeactivation/<x>/EnterSpecificArea/ PolygonArea/<x>/PointCoordinateType/Longitude	449
13.2.87A6B5	/<x>/<x>/OnNetwork/FunctionalAliasList/<x>/Entry/ LocationCriteriaForDeactivation/<x>/EnterSpecificArea/ PolygonArea/<x>/PointCoordinateType/Latitude	449
13.2.87A6B6	/<x>/<x>/OnNetwork/FunctionalAliasList/<x>/Entry/ LocationCriteriaForDeactivation/<x>/EnterSpecificArea/ EllipsoidArcArea	450
13.2.87A6B7	/<x>/<x>/OnNetwork/FunctionalAliasList/<x>/Entry/ LocationCriteriaForDeactivation/<x>/EnterSpecificArea/ EllipsoidArcArea/Center.....	450
13.2.87A6B7A	/<x>/<x>/OnNetwork/FunctionalAliasList/<x>/Entry/ LocationCriteriaForDeactivation/<x>/EnterSpecificArea/ EllipsoidArcArea/Center/PointCoordinateType.....	450
13.2.87A6B8	/<x>/<x>/OnNetwork/FunctionalAliasList/<x>/Entry/ LocationCriteriaForDeactivation/<x>/EnterSpecificArea/ EllipsoidArcArea/Center/PointCoordinateType/Longitude	451
13.2.87A6B9	/<x>/<x>/OnNetwork/FunctionalAliasList/<x>/Entry/ LocationCriteriaForDeactivation/<x>/EnterSpecificArea/ EllipsoidArcArea/Center/PointCoordinateType/Latitude	451
13.2.87A6B10	/<x>/<x>/OnNetwork/FunctionalAliasList/<x>/Entry/ LocationCriteriaForDeactivation/<x>/EnterSpecificArea/ EllipsoidArcArea/Radius	451
13.2.87A6B11	/<x>/<x>/OnNetwork/FunctionalAliasList/<x>/Entry/ LocationCriteriaForDeactivation/<x>/EnterSpecificArea/ EllipsoidArcArea/OffsetAngle.....	452
13.2.87A6B12	/<x>/<x>/OnNetwork/FunctionalAliasList/<x>/Entry/ LocationCriteriaForDeactivation/<x>/EnterSpecificArea/ EllipsoidArcArea/IncludedAngle.....	452
13.2.87A6B12A	/<x>/<x>/OnNetwork/FunctionalAliasList/<x>/Entry/ LocationCriteriaForDeactivation/<x>/EnterSpecificArea/Speed.....	452
13.2.87A6B12B	/<x>/<x>/OnNetwork/FunctionalAliasList/<x>/Entry/ LocationCriteriaForDeactivation/<x>/EnterSpecificArea/Speed/ MinimumSpeed	453
13.2.87A6B12C	/<x>/<x>/OnNetwork/FunctionalAliasList/<x>/Entry/ LocationCriteriaForDeactivation/<x>/EnterSpecificArea/Speed/ MaximumSpeed	453
13.2.87A6B12D	/<x>/<x>/OnNetwork/FunctionalAliasList/<x>/Entry/ LocationCriteriaForDeactivation/<x>/EnterSpecificArea/Heading	453
13.2.87A6B12E	/<x>/<x>/OnNetwork/FunctionalAliasList/<x>/Entry/ LocationCriteriaForDeactivation/<x>/EnterSpecificArea/Heading/ MinimumHeading.....	454
13.2.87A6B12F	/<x>/<x>/OnNetwork/FunctionalAliasList/<x>/Entry/ LocationCriteriaForDeactivation/<x>/EnterSpecificArea/Heading/ MaximumHeading	454
13.2.87A6B13	/<x>/<x>/OnNetwork/FunctionalAliasList/<x>/Entry/ LocationCriteriaForDeactivation/<x>/ExitSpecificArea	454
13.2.87A6B14	/<x>/<x>/OnNetwork/FunctionalAliasList/<x>/Entry/ LocationCriteriaForDeactivation/<x>/ExitSpecificArea/ PolygonArea	454
13.2.87A6B15	/<x>/<x>/OnNetwork/FunctionalAliasList/<x>/Entry/ LocationCriteriaForDeactivation/<x>/ExitSpecificArea/ PolygonArea/<x>	455
13.2.87A6B15A	/<x>/<x>/OnNetwork/FunctionalAliasList/<x>/Entry/ LocationCriteriaForDeactivation/<x>/ExitSpecificArea/ PolygonArea/<x>/PointCoordinateType...	455

13.2.87A6B16	/<x>/<x>/OnNetwork/FunctionalAliasList/<x>/Entry/ LocationCriteriaForDeactivation/<x>/ExitSpecificArea/ PolygonArea/<x>/PointCoordinateType/Longitude	455
13.2.87A6B17	/<x>/<x>/OnNetwork/FunctionalAliasList/<x>/Entry/ LocationCriteriaForDeactivation/<x>/ExitSpecificArea/ PolygonArea/<x>/PointCoordinateType/Latitude	456
13.2.87A6B18	/<x>/<x>/OnNetwork/FunctionalAliasList/<x>/Entry/ LocationCriteriaForDeactivation/<x>/ExitSpecificArea/ EllipsoidArcArea	456
13.2.87A6B19	/<x>/<x>/OnNetwork/FunctionalAliasList/<x>/Entry/ LocationCriteriaForDeactivation/<x>/ExitSpecificArea/ EllipsoidArcArea/Center	456
13.2.87A6B19A	/<x>/<x>/OnNetwork/FunctionalAliasList/<x>/Entry/ LocationCriteriaForDeactivation/<x>/ExitSpecificArea/ EllipsoidArcArea/Center/PointCoordinateType.....	457
13.2.87A6B20	/<x>/<x>/OnNetwork/FunctionalAliasList/<x>/Entry/ LocationCriteriaForDeactivation/<x>/ExitSpecificArea/ EllipsoidArcArea/Center/PointCoordinateType/Longitude	457
13.2.87A6B21	/<x>/<x>/OnNetwork/FunctionalAliasList/<x>/Entry/ LocationCriteriaForDeactivation/<x>/ExitSpecificArea/ EllipsoidArcArea/Center/PointCoordinateType/Latitude	457
13.2.87A6B22	/<x>/<x>/OnNetwork/FunctionalAliasList/<x>/Entry/ LocationCriteriaForDeactivation/<x>/ExitSpecificArea/ EllipsoidArcArea/Radius	458
13.2.87A6B23	/<x>/<x>/OnNetwork/FunctionalAliasList/<x>/Entry/ LocationCriteriaForDeactivation/<x>/ExitSpecificArea/ EllipsoidArcArea/OffsetAngle.....	458
13.2.87A6B24	/<x>/<x>/OnNetwork/FunctionalAliasList/<x>/Entry/ LocationCriteriaForDeactivation/<x>/ExitSpecificArea/ EllipsoidArcArea/IncludedAngle.....	458
13.2.87A6B24A	/<x>/<x>/OnNetwork/FunctionalAliasList/<x>/Entry/ LocationCriteriaForDeactivation/<x>/ExitSpecificArea/Speed.....	459
13.2.87A6B24B	/<x>/<x>/OnNetwork/FunctionalAliasList/<x>/Entry/ LocationCriteriaForDeactivation/<x>/ExitSpecificArea/Speed/ MinimumSpeed	459
13.2.87A6B24C	/<x>/<x>/OnNetwork/FunctionalAliasList/<x>/Entry/ LocationCriteriaForDeactivation/<x>/ExitSpecificArea/Speed/ MaximumSpeed	459
13.2.87A6B24D	/<x>/<x>/OnNetwork/FunctionalAliasList/<x>/Entry/ LocationCriteriaForDeactivation/<x>/ExitSpecificArea/Heading	459
13.2.87A6B24E	/<x>/<x>/OnNetwork/FunctionalAliasList/<x>/Entry/ LocationCriteriaForDeactivation/<x>/ExitSpecificArea/Heading/ MinimumHeading.....	460
13.2.87A6B24F	/<x>/<x>/OnNetwork/FunctionalAliasList/<x>/Entry/ LocationCriteriaForDeactivation/<x>/ExitSpecificArea/Heading/ MaximumHeading.....	460
13.2.87A6C	/<x>/<x>/OnNetwork/FunctionalAliasList/<x>/Entry/ ManualDeactivationNotAllowedIfLocationCriteriaMet	460
13.2.87A7	/<x>/<x>/OnNetwork/FunctionalAliasList/<x>/Entry/DisplayName	461
13.2.87A7A	/<x>/<x>/OnNetwork/FunctionalAliasList/<x>/Entry/ MaxSimultaneousEmergencyGroupCalls	461
13.2.87A7B	/<x>/<x>/OnNetwork/FunctionalAliasList/<x>/Entry/ FAsAllowedToCall.....	461
13.2.87A7C	/<x>/<x>/OnNetwork/FunctionalAliasList/<x>/Entry/ FAsAllowedToCall/<x>	461
13.2.87A7D	/<x>/<x>/OnNetwork/FunctionalAliasList/<x>/Entry/ FAsAllowedToCall/<x>/Entry	462
13.2.87A7E	/<x>/<x>/OnNetwork/FunctionalAliasList/<x>/Entry/ FAsAllowedToCall/<x>/Entry/FunctionalAlias	462
13.2.87A8	/<x>/<x>/OnNetwork/AllowedQueryFunctionalAliasOtherUser	462
13.2.87A9	/<x>/<x>/OnNetwork/AllowedTakeoverFunctionalAliasOtherUser	462
13.2.87A10	/<x>/<x>/OnNetwork/AllowedFunctionalAliasGroupBinding	463
13.2.87B	/<x>/<x>/OnNetwork/AuthorisedIncomingAny.....	463
13.2.87C	/<x>/<x>/OnNetwork/IncomingUserList.....	463
13.2.87C1	/<x>/<x>/OnNetwork/IncomingUserList/<x>	463
13.2.87C2	/<x>/<x>/OnNetwork/IncomingUserList/<x>/Entry	464
13.2.87C3	/<x>/<x>/OnNetwork/IncomingUserList/<x>/Entry/MCVideoID	464
13.2.87C4	/<x>/<x>/OnNetwork/IncomingUserList/<x>/Entry/ MCVideoIDKMSURI	464
13.2.87D	/<x>/<x>/OnNetwork/PrivateCall.....	464
13.2.87E	/<x>/<x>/OnNetwork/PrivateCall/EmergencyAlert	465
13.2.87F	/<x>/<x>/OnNetwork/PrivateCall/EmergencyAlert/Entry	465
13.2.87G	/<x>/<x>/OnNetwork/PrivateCall/EmergencyAlert/Entry/ID.....	465
13.2.87H	/<x>/<x>/OnNetwork/PrivateCall/EmergencyAlert/Entry/ DisplayName	465
13.2.87I	/<x>/<x>/OnNetwork/PrivateCall/EmergencyAlert/Entry/Usage	465
13.2.87J	/<x>/<x>/OnNetwork/RemoteGroupSelection.....	466

13.2.87K	/<x>/<x>/OnNetwork/RemoteGroupSelection/<x>	466
13.2.87L	/<x>/<x>/OnNetwork/RemoteGroupSelection/<x>/Entry	466
13.2.87M	/<x>/<x>/OnNetwork/RemoteGroupSelection/<x>/Entry/ MCVideoID	466
13.2.87N	/<x>/<x>/OnNetwork/RemoteGroupSelection/<x>/Entry/ DisplayName	467
13.2.87O1	/<x>/<x>/OnNetwork/MCVideoAdhocGroup	467
13.2.87O1A	/<x>/<x>/OnNetwork/MCVideoAdhocGroup/EmergencyAlert	467
13.2.87O1A1	/<x>/<x>/OnNetwork/MCVideoAdhocGroup/EmergencyAlert/ Authorised	467
13.2.87O1A2	/<x>/<x>/OnNetwork/MCVideoAdhocGroup/EmergencyAlert/ Cancel	468
13.2.87O1A3	/<x>/<x>/OnNetwork/MCVideoAdhocGroup/EmergencyAlert/ AuthRecvParticipantInfo	468
13.2.87O1A4	/<x>/<x>/OnNetwork/MCVideoAdhocGroup/EmergencyAlert/ AuthSetupAdhocGroupCall	468
13.2.87O1B	/<x>/<x>/OnNetwork/MCVideoAdhocGroup/AdhocGroupCall	469
13.2.87O1B1	/<x>/<x>/OnNetwork/MCVideoAdhocGroup/AdhocGroupCall/ Authorised	469
13.2.87O1B2	/<x>/<x>/OnNetwork/MCVideoAdhocGroup/AdhocGroupCall/ AuthorisedParticipation	469
13.2.87O1B3	/<x>/<x>/OnNetwork/MCVideoAdhocGroup/AdhocGroupCall/ AuthInitEmergencyCall	469
13.2.87O1B4	/<x>/<x>/OnNetwork/MCVideoAdhocGroup/AdhocGroupCall/ AuthInitImminentPerilCall	470
13.2.87O1B5	/<x>/<x>/OnNetwork/MCVideoAdhocGroup/AdhocGroupCall/ AuthRecvCallParticipantInfo	470
13.2.87O1B6	/<x>/<x>/OnNetwork/MCVideoAdhocGroup/AdhocGroupCall/ AuthModifyCallParticipantInfo	470
13.2.88	/<x>/<x>/OffNetwork	471
13.2.89	/<x>/<x>/OffNetwork/Authorised	471
13.2.90	/<x>/<x>/OffNetwork/MCVideoGroupList	471
13.2.91	/<x>/<x>/OffNetwork/MCVideoGroupList/<x>	471
13.2.92	/<x>/<x>/OffNetwork/MCVideoGroupList/<x>/Entry	471
13.2.93	/<x>/<x>/OffNetwork/MCVideoGroupList/<x>/Entry/ MCVideoGroupID	472
13.2.94	/<x>/<x>/OffNetwork/MCVideoGroupList/<x>/Entry/DisplayName	472
13.2.95	Void	472
13.2.96	Void	472
13.2.97	/<x>/<x>/OffNetwork/MCVideoGroupList/<x>/Entry/GMSServID	472
13.2.98	Void	473
13.2.99	Void	473
13.2.100	/<x>/<x>/OffNetwork/MCVideoGroupList/<x>/Entry/ IdMSTokenEndPoint	473
13.2.100A	Void	473
13.2.100B	Void	473
13.2.100C	/<x>/<x>/OffNetwork/MCVideoGroupList/<x>/Entry/ GroupKMSURI	473
13.2.101	/<x>/<x>/OffNetwork/MCVideoGroupList/<x>/Entry/ RelativePresentationPriority	473
13.2.102	/<x>/<x>/OffNetwork/UserInfoID	474
13.2.102A	/<x>/<x>/OffNetwork/EmergencyCallChange	474
13.2.102B	/<x>/<x>/OffNetwork/ImminentPerilCallChange	474
13.2.103	/<x>/Status	474
14	MCVideo service configuration MO	475
14.1	General	475
14.2	MCVideo service configuration MO parameters	476
14.2.1	General	476
14.2.2	Node: <x>	476
14.2.3	/<x>/Name	476
14.2.4	/<x>/Ext/	476
14.2.5	/<x>/Common	476
14.2.6	/<x>/Common/BroadcastMCVideoGroupCall	477
14.2.7	/<x>/Common/BroadcastMCVideoGroupCall/ NumLevelGroupHierarchy	477
14.2.8	/<x>/Common/BroadcastMCVideoGroupCall/ NumLevelUserHierarchy	477
14.2.9	/<x>/Common/MinLengthAliasID	477
14.2.10	/<x>/OffNetwork	478
14.2.11	/<x>/OffNetwork/DefaultPPPP	478
14.2.12	/<x>/OffNetwork/DefaultPPPP/MCVideoPrivateCallSignalling	478
14.2.13	/<x>/OffNetwork/DefaultPPPP/MCVideoPrivateCallMedia	478
14.2.14	/<x>/OffNetwork/DefaultPPPP/ MCVideoEmergencyPrivateCallSignalling	479
14.2.15	/<x>/OffNetwork/DefaultPPPP/ MCVideoEmergencyPrivateCallMedia	479
14.2.15A	/<x>/OffNetwork/DefaultPQI	479
14.2.15B	/<x>/OffNetwork/DefaultPQI/MCVideoPrivateCallSignalling	480
14.2.15C	/<x>/OffNetwork/DefaultPQI/MCVideoPrivateCallMedia	480
14.2.15D	/<x>/OffNetwork/DefaultPQI/ MCVideoEmergencyPrivateCallSignalling	480
14.2.15E	/<x>/OffNetwork/DefaultPQI/ MCVideoEmergencyPrivateCallMedia	480

14.2.16	/<x>/OffNetwork/PrivateCall	481
14.2.17	/<x>/OffNetwork/PrivateCall/MaxDuration.....	481
14.2.18	/<x>/OffNetwork/NumLevelHierarchy	481
14.2.19	/<x>/OnNetwork.....	481
14.2.20	/<x>/OnNetwork/MCVideoAdhocGroup	482
14.2.21	/<x>/OnNetwork/MCVideoAdhocGroup/GroupCall	482
14.2.22	/<x>/OnNetwork/MCVideoAdhocGroup/GroupCall/ AllowAdhocGroupCall	482
14.2.23	/<x>/OnNetwork/MCVideoAdhocGroup/GroupCall/ MaxNoParticipants	482
14.2.24	/<x>/OnNetwork/MCVideoAdhocGroup/GroupCall/ HangTime	483
14.2.25	/<x>/OnNetwork/MCVideoAdhocGroup/GroupCall/ MaxDurationOfCall	483
Annex A (informative):	MCPTT UE configuration MO DDF	484
Annex B (informative):	MCPTT user profile MO DDF	485
Annex C (informative):	MCS group configuration MO DDF	486
Annex D (informative):	MCPTT service configuration MO DDF	487
Annex E (informative):	MCS UE initial configuration MO DDF	488
Annex F (informative):	MCVideo UE configuration MO DDF	489
Annex G (informative):	MCVideo user profile configuration MO DDF	490
Annex H (informative):	MCVideo service configuration MO DDF	491
Annex I (informative):	MCDData UE configuration MO DDF	492
Annex J (informative):	MCDData user profile configuration MO DDF	493
Annex K (informative):	MCDData service configuration MO DDF.....	494
Annex L (normative):	MO specific concepts for the support of mission critical services over 5GS	495
L.1	General	495
L.2	Aspects not applicable to 5GS.....	495
L.3	5GS specific aspects not applicable to EPS	495
L.4	Mapping of EPS-specific terms to 5GS	495
Annex M (informative):	Change history	496
History		500

Foreword

This Technical Specification has been produced by the 3rd Generation Partnership Project (3GPP).

The contents of the present document are subject to continuing work within the TSG and may change following formal TSG approval. Should the TSG modify the contents of the present document, it will be re-released by the TSG with an identifying change of release date and an increase in version number as follows:

Version x.y.z

where:

- x the first digit:
 - 1 presented to TSG for information;
 - 2 presented to TSG for approval;
 - 3 or greater indicates TSG approved document under change control.
- y the second digit is incremented for all changes of substance, i.e. technical enhancements, corrections, updates, etc.
- z the third digit is incremented when editorial only changes have been incorporated in the document.

1 Scope

The present document defines a number of Mission Critical Services (MCSs) Management Objects (MO) that are configured for the UE for the operation of MCSs. The management objects are compatible with OMA Device Management protocol specifications, version 1.2 and upwards, and is defined using the OMA DM Device Description Framework as described in the Enabler Release Definition OMA OMA-ERELD_DM-V1_2 [2].

MCSs are services that require preferential handling compared to normal telecommunication services, e.g. in support of police or fire brigade.

MCSs can be used for public safety applications and also for general commercial applications (e.g., utility companies and railways).

The present document is applicable to an UE supporting on-line, off-line or both on-line and off-line configuration of the configuration management client.

The present document is applicable to an UE supporting off-line configuration of the group management client.

The parameters defined by the management objects in the present document are configured in the UE using on-line configuration over the CSC-4 reference point and using off-line configuration over the CSC-11 and CSC-12 reference points. Other specifications define how these parameters are used in the operation of MCSs, and whether they are applicable to on-network operation or off-network operation, or both:

- 3GPP TS 24.379 [7];
- 3GPP TS 24.380 [8];
- 3GPP TS 24.481 [9];
- 3GPP TS 24.482 [11];
- 3GPP TS 24.484 [12];
- 3GPP TS 24.282 [16];
- 3GPP TS 24.582 [17];
- 3GPP TS 24.281 [18]; and
- 3GPP TS 24.581 [19].

The common network operation means both on-network operation and off-network operation in the present document.

The following management objects are defined in the present document:

- MCPTT UE configuration MO;
- MCPTT user profile MO;
- MCS group configuration MO;
- MCPTT service configuration MO;
- MCS UE initial configuration MO;
- MCDData UE configuration MO;
- MCDData user profile MO;
- MCDData service configuration MO;
- MCVideo UE configuration MO;
- MCVideo user profile MO; and
- MCVideo service configuration MO.

The MOs listed above define repositories of data in the ME.

2 References

The following documents contain provisions which, through reference in this text, constitute provisions of the present document.

- References are either specific (identified by date of publication, edition number, version number, etc.) or non-specific.
- For a specific reference, subsequent revisions do not apply.
- For a non-specific reference, the latest version applies. In the case of a reference to a 3GPP document (including a GSM document), a non-specific reference implicitly refers to the latest version of that document *in the same Release as the present document*.

- [1] 3GPP TR 21.905: "Vocabulary for 3GPP Specifications".
- [2] OMA OMA-ERELD-DM-V1_2-20070209-A: "Enabler Release Definition for OMA Device Management, Version 1.2".
- [3] OMA OMA-TS-DM_Protocol-V1_2: "OMA Device Management Protocol".
- [4] OMA OMA-TS-XDM_Group-V1_1-20120403-A: "Group XDM Specification".
- [5] 3GPP TS 23.003: "Numbering, addressing and identification".
- [6] 3GPP TS 23.303: "Proximity-based Services (ProSe); Stage 2".
- [7] 3GPP TS 24.379: "Mission Critical Push To Talk (MCPTT) call control Protocol specification".
- [8] 3GPP TS 24.380: "Mission Critical Push To Talk (MCPTT) media plane control Protocol specification".
- [9] 3GPP TS 24.481: "Mission Critical Services (MCS) group management Protocol specification".
- [10] 3GPP TS 31.102: "Characteristics of the USIM Application".
- [11] 3GPP TS 24.482: "Mission Critical Services (MCS) identity management Protocol specification".
- [12] 3GPP TS 24.484: "Mission Critical Services (MCS) configuration management Protocol specification".
- [13] IETF RFC 4566 (July 2006): "Session Description Protocol".
- [14] Void.
- [15] 3GPP TS 23.179: "Functional architecture and information flows to support mission critical communication services; Stage 2".
- [16] 3GPP TS 24.282: "Mission Critical Data (MCData) signalling control Protocol specification".
- [17] 3GPP TS 24.582: "Mission Critical Data (MCData) media plane control Protocol specification".
- [18] 3GPP TS 24.281: "Mission Critical Video (MCVideo) signalling control Protocol specification".
- [19] 3GPP TS 24.581: "Mission Critical Video (MCVideo) media plane control Protocol specification".
- [20] 3GPP TS 33.180: "Security of the mission critical service".
- [21] 3GPP TS 23.032: "Universal Geographical Area Description (GAD)".
- [22] OMA OMA-TS-DM_StdObj-V1_2-20070209-A: "OMA Device Management Standardized Objects", http://www.openmobilealliance.org/release/DM/V1_2-20070209-A/OMA-TS-DM_StdObj-V1_2-20070209-A.pdf.

- [23] 3GPP TS 23.501: "System Architecture for the 5G System; Stage 2".
- [24] IETF RFC 3748 (June 2004): "Extensible Authentication Protocol (EAP)".
- [25] 3GPP TS 23.304: "Proximity based Services (ProSe) in the 5G System (5GS)".
- [26] 3GPP TS 24.554: "Proximity-services (ProSe) in 5G System (5GS) protocol aspects; Stage 3".
- [27] IANA: Character Sets, <https://www.iana.org/assignments/character-sets/character-sets.xhtml>.

3 Definitions and abbreviations

3.1 Definitions

For the purpose of the present document, the following terms and definitions given in 3GPP TS 23.179 [15] apply:

Pre-selected MCPTT user profile

3.2 Abbreviations

For the purposes of the present document, the abbreviations given in 3GPP TR 21.905 [1] and the following apply. An abbreviation defined in the present document takes precedence over the definition of the same abbreviation, if any, in 3GPP TR 21.905 [1].

5GS	5G System
ACL	Access Control List
APN	Access Point Name
CMS	Configuration Management Server
DDF	Device Description Framework
DM	Device Management
DNN	Data Network Name
EPS	Evolved Packet System
GMS	Group Management Server
MCS	Mission Critical Service
MCSs	Mission Critical Services
MCPTT	Mission Critical Push To Talk
ME	Mobile Equipment
MO	Management Object
OMA	Open Mobile Alliance
PQI	PC5 5QI
ProSe	Proximity-based Services
RFC	Request For Comments
S-NSSAI	Single Network Slice Selection Assistance Information
URI	Uniform Resource Identifier
URN	Uniform Resource Name
XCAP	XML Configuration Access Protocol
XML	eXtensible Markup Language
XUI	XCAP Unique Identifier

3.3 Symbols

For the purposes of the present document, the following symbols apply to all the figures:

?	zero or one occurrences
*	zero or more occurrences
+	one or more occurrences

If none of these characters is used the default occurrence is exactly once.

3.4 Management Object design and representation guidelines

All the Management Objects (MOs) defined in the present document are compatible with OMA OMA-TS-DM_Protocol-V1_2 [3].

All figures are informative and the design principles of OMA OMA-TS-DM_StdObj-V1_2 [22] are applied with the following differences:

- interior nodes are represented as rectangles with solid border;
- leaf nodes are represented without any border;
- un-named nodes are represented by less than and a greater than characters containing a lower-case or an uppercase character, e.g. <x>, <X>;
- a stadium with solid border is used for informative text i.e. to point to a figure describing the contents of an MO; and
- named nodes that share the same contents can refer to the same figure to represent their MO contents.

A representative example is shown in figure 3.4.1.

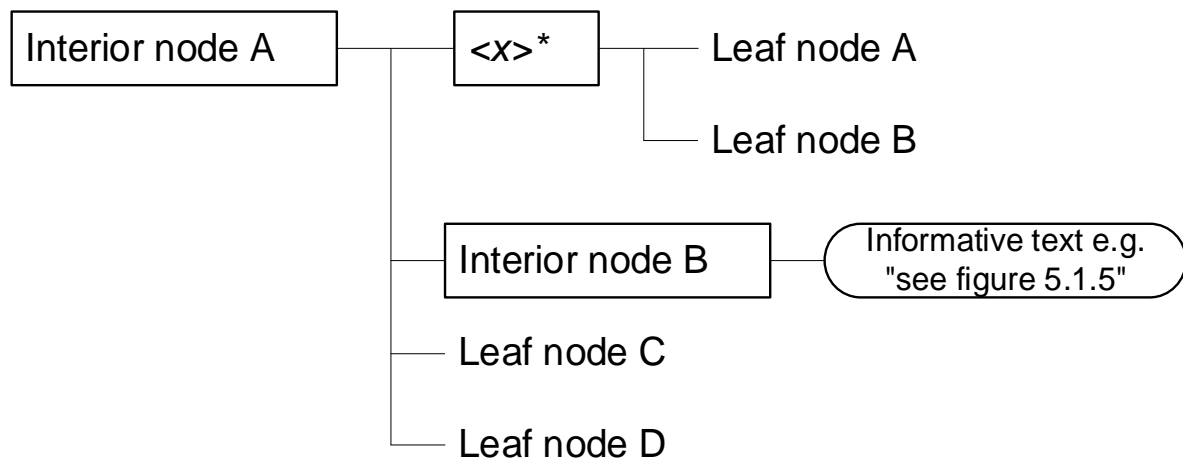

Figure 3.4.1: The MO graphical notation

4 MCPTT UE configuration MO

4.1 General

The MCPTT UE configuration Management Object (MO) is used to configure MCPTT Client behaviour for the on-network or off-network MCPTT Service. The MCPTT UE configuration parameters may be stored in the ME, or in the USIM as specified in 3GPP TS 31.102 [10], or in both the ME and the USIM. If both the ME and the USIM contain the same parameters, the values stored in the USIM shall take precedence.

The Management Object Identifier is: urn:oma:mo:ext-3gpp-MCPTT-UE-configuration:1.0.

Protocol compatibility: This MO is compatible with OMA OMA DM 1.2 [3].

The OMA DM ACL property mechanism (see OMA OMA-ERELED-DM-V1_2 [2]) may be used to grant or deny access rights to OMA DM servers in order to modify nodes and leaf objects of the MCPTT UE configuration MO.

The following nodes and leaf objects are possible under the MCPTT UE configuration node as described in figure 4.1.1.

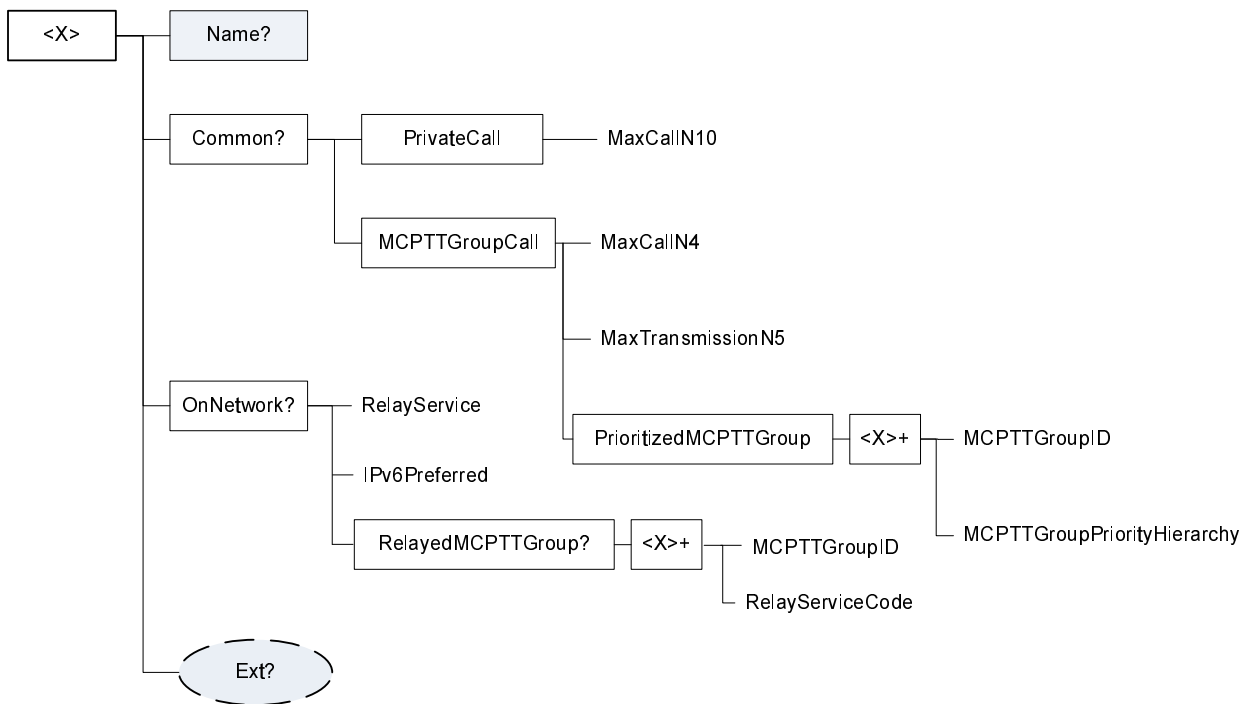

Figure 4.1.1: The MCPTT UE configuration MO

4.2 MCPTT UE configuration MO parameters

4.2.1 General

This clause describes the parameters for the MCPTT UE configuration Management Object (MO).

4.2.2 Node: <x>

Table 4.2.2.1: Node: <x>

<x>

Status	Occurrence	Format	Min. Access Types
Required	OneOrMore	node	Get

This interior node acts as a placeholder for the MCPTT UE configuration Management Object (MO).

For the MCPTT UE configuration MO, the namespace specific string is: "urn:oma:mo:oma-dm-mcptt-ue-configuration:1.0"

- Values: N/A

4.2.3 /<x>/Name

Table 4.2.3.1: /<x>/Name

Name

Status	Occurrence	Format	Min. Access Types
Required	ZeroOrOne	chr	Get

The Name leaf is a name for the MCPTT UE configuration settings.

- Values: <User displayable name>

4.2.4 /<x>/Ext/

Table 4.2.4.1: /<x>/Ext/

Ext

Status	Occurrence	Format	Min. Access Types
Optional	ZeroOrOne	node	Get, Replace

The Ext is an interior node for where the vendor specific information about the MCPTT UE configuration MO is being placed.

Usually the vendor extension is identified by vendor specific name under the ext node and contains the vendor meaning application vendor, device vendor etc. The tree structure under the vendor identified is not defined and can therefore include one or more un-standardized sub-trees.

- Values: N/A

4.2.5 /<x>/Common

Table 4.2.5.1: /<x>/Common

Common

Status	Occurrence	Format	Min. Access Types
Required	ZeroOrOne	node	Get, Replace

This interior node represents a container for the common network operation which means both on-network operation and off-network operation.

4.2.6 /<x>/Common/PrivateCall

Table 4.2.6.1: /<x>/Common/PrivateCall

Common/PrivateCall

Status	Occurrence	Format	Min. Access Types
Required	One	node	Get, Replace

This interior node is a placeholder for the private call configuration.

4.2.7 /<x>/Common/PrivateCall/MaxCallN10

Table 4.2.7.1: /<x>/Common/PrivateCall/MaxCallN10

Common/PrivateCall/MaxCallN10

Status	Occurrence	Format	Min. Access Types
Required	One	int	Get, Replace

This leaf node indicates the maximum number of private calls.

- Values: 0-255

4.2.8 `<x>/Common/MCPTTGroupCall`

Table 4.2.8.1: `<x>/Common/MCPTTGroupCall`

Common/MCPTTGroupCall

Status	Occurrence	Format	Min. Access Types
Required	One	node	Get, Replace

This interior node is a placeholder for the MCPTT group call configuration.

4.2.9 `<x>/Common/MCPTTGroupCall/MaxCallN4`

Table 4.2.9.1: `<x>/Common/MCPTTGroupCall/MaxCallN4`

Common/MCPTTGroupCall/MaxCallN4

Status	Occurrence	Format	Min. Access Types
Required	One	int	Get, Replace

This leaf node indicates the maximum number of simultaneous group calls.

- Values: 0-255

4.2.10 `<x>/Common/MCPTTGroupCall/MaxTransmissionN5`

Table 4.2.10.1: `<x>/Common/MCPTTGroupCall/MaxTransmissionN5`

Common/MCPTTGroupCall/MaxTransmissionN5

Status	Occurrence	Format	Min. Access Types
Required	One	int	Get, Replace

This leaf node indicates the maximum number of transmissions in a group.

- Values: 0-255

4.2.11 `<x>/Common/MCPTTGroupCall/PrioritizedMCPTTGroup`

Table 4.2.11.1: `<x>/Common/MCPTTGroupCall/PrioritizedMCPTTGroup`

Common/MCPTTGroupCall/PrioritizedMCPTTGroup

Status	Occurrence	Format	Min. Access Types
Required	One	node	Get, Replace

This interior node is a placeholder for the prioritized MCPTT group call configuration.

4.2.12 `<x>/Common/MCPTTGroupCall/PrioritizedMCPTTGroup/<x>`

Table 4.2.12.1: `<x>/Common/MCPTTGroupCall/PrioritizedMCPTTGroup/<x>`

Common/MCPTTGroupCall/PrioritizedMCPTTGroup `<x>`

Status	Occurrence	Format	Min. Access Types
Required	OneOrMore	node	Get, Replace

This interior node is a placeholder for one or more prioritized MCPTT group call configuration.

4.2.13 /<x>/Common/MCPTTGroupCall/PrioritizedMCPTTGroup/<x>/MCPTTGroupID

Table 4.2.13.1: /<x>/Common/MCPTTGroupCall/PrioritizedMCPTTGroup/<x>/MCPTTGroupID

Common/MCPTTGroupCall/PrioritizedMCPTTGroup/<x>/MCPTTGroupID

Status	Occurrence	Format	Min. Access Types
Required	One	chr	Get, Replace

This leaf node indicates the associated MCPTT group ID.

The value is a "uri" attribute specified in OMA OMA-TS-XDM_Group-V1_1 [4].

4.2.14 /<x>/Common/MCPTTGroupCall/PrioritizedMCPTTGroup/<x>/MCPTTGroupPriorityHierarchy

Table 4.2.14.1: /<x>/Common/MCPTTGroupCall/PrioritizedMCPTTGroup/<x>/MCPTTGroupPriorityHierarchy

Common/MCPTTGroupCall/PrioritizedMCPTTGroup/<x>/MCPTTGroupPriorityHierarchy

Status	Occurrence	Format	Min. Access Types
Required	One	int	Get, Replace

This leaf node indicates the requested presentation priority of group call.

- Values: 0-7

The group with the lowest MCPTTGroupPriorityHierarchy value shall be considered as the group having the lowest priority among the groups.

4.2.15 /<x>/OnNetwork

Table 4.2.15.1: /<x>/OnNetwork

OnNetwork

Status	Occurrence	Format	Min. Access Types
Required	ZeroOrOne	node	Get, Replace

This interior node represents a container for on-network operation.

4.2.16 /<x>/OnNetwork/RelayService

Table 4.2.16.1: /<x>/OnNetwork/RelayService

OnNetwork/RelayService

Status	Occurrence	Format	Min. Access Types
Required	One	bool	Get, Replace

This leaf node indicates the authorisation to use a relay service.

When set to "true" the MCPTT group is allowed to use a relay service.

When set to "false" the MCPTT group is not allowed to use a relay service.

4.2.17 /<x>/OnNetwork/IPv6Preferred

Table 4.2.17.1: /<x>/OnNetwork/IPv6Preferred

OnNetwork/IPv6Preferred

Status	Occurrence	Format	Min. Access Types
Required	One	bool	Get, Replace

This leaf node indicates whether IPv6 is preferred over IPv4 for on-network operation when the MCPTT UE has both IPv4 and IPv6 host configuration.

If the MCPTT UE has both IPv4 and IPv6 host configuration and:

- if IPv6Preferred is set to "true" then the UE uses IPv6 for all on-network signalling and media; otherwise
- if IPv6Preferred is set to "false" then the UE uses IPv4 for all on-network signalling and media.

4.2.18 /<x>/OnNetwork/RelayedMCPTTGroup

Table 4.2.18.1: /<x>/OnNetwork/RelayedMCPTTGroup

OnNetwork/RelayedMCPTTGroup

Status	Occurrence	Format	Min. Access Types
Optional	ZeroOrOne	node	Get, Replace

This interior node is a placeholder for the allowed relayed MCPTT groups.

4.2.19 /<x>/OnNetwork/RelayedMCPTTGroup/<x>

Table 4.2.19.1: /<x>/OnNetwork/RelayedMCPTTGroup/<x>

OnNetwork/RelayedMCPTTGroup/<x>

Status	Occurrence	Format	Min. Access Types
Required	OneOrMore	node	Get, Replace

This interior node is a placeholder for one or more allowed relayed MCPTT groups.

4.2.20 /<x>/OnNetwork/RelayedMCPTTGroup/<x>/MCPTTGroupID

Table 4.2.20.1: /<x>/OnNetwork/RelayedMCPTTGroup/<x>/MCPTTGroupID

OnNetwork/RelayedMCPTTGroup/<x>/MCPTTGroupID

Status	Occurrence	Format	Min. Access Types
Required	One	chr	Get, Replace

This leaf node indicates the associated MCPTT group ID.

The value is a "uri" attribute specified in OMA OMA-TS-XDM_Group-V1_1 [4].

4.2.21 /<x>/OnNetwork/RelayedMCPTTGroup/<x>/RelayServiceCode

Table 4.2.21.1: /<x>/OnNetwork/RelayedMCPTTGroup/<x>/RelayServiceCode

OnNetwork/RelayedMCPTTGroup/<x>/RelayServiceCode

Status	Occurrence	Format	Min. Access Types
Required	One	chr	Get, Replace

This leaf node indicates the connectivity service that the ProSe UE-to-network relay provides to public safety applications as specified in 3GPP TS 23.303 [6].

5 MCPTT user profile MO

5.1 General

The MCPTT user profile configuration Management Object (MO) is used to configure the MCPTT Client behaviour for the on-network or off-network MCPTT Service. The MCPTT user profile configuration parameters may be stored in the ME, or in the USIM as specified in 3GPP TS 31.102 [10], or in both the ME and the USIM. If both the ME and the USIM contain the same parameters, the values stored in the USIM shall take precedence.

The Management Object Identifier is: urn:oma:mo:ext-3gpp-MCPTT-user-profile:1.0.

Protocol compatibility: This MO is compatible with OMA OMA DM 1.2 [3].

The OMA DM ACL property mechanism (see OMA OMA-ERELD-DM-V1_2 [2]) may be used to grant or deny access rights to OMA DM servers in order to modify nodes and leaf objects of the MCPTT user profile MO.

The following nodes and leaf objects are possible under the MCPTT user profile node as described in figure 5.1.1, figure 5.1.2, figure 5.1.3, figure 5.1.4, figure 5.1.5, figure 5.1.6, figure 5.1.7, figure 5.1.8, and figure 5.1.9.

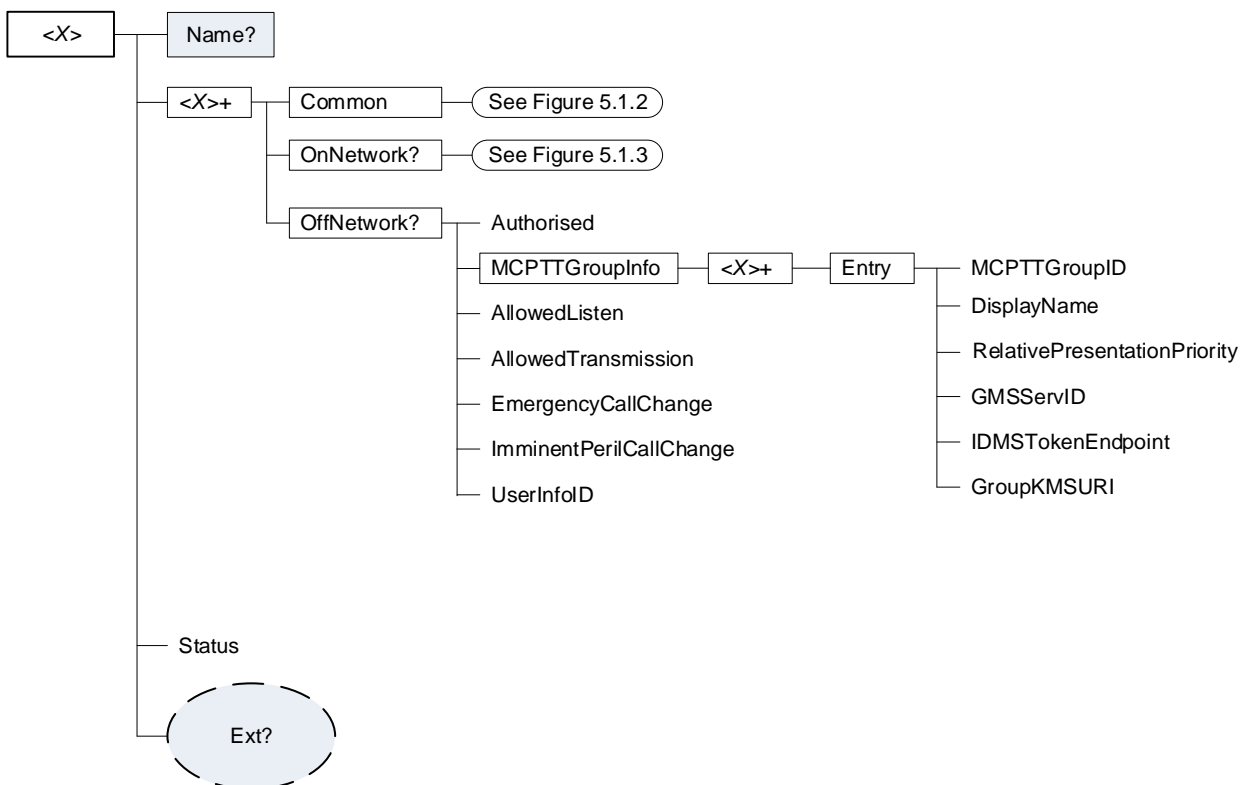

Figure 5.1.1: The MCPTT user profile MO (1 of 3)

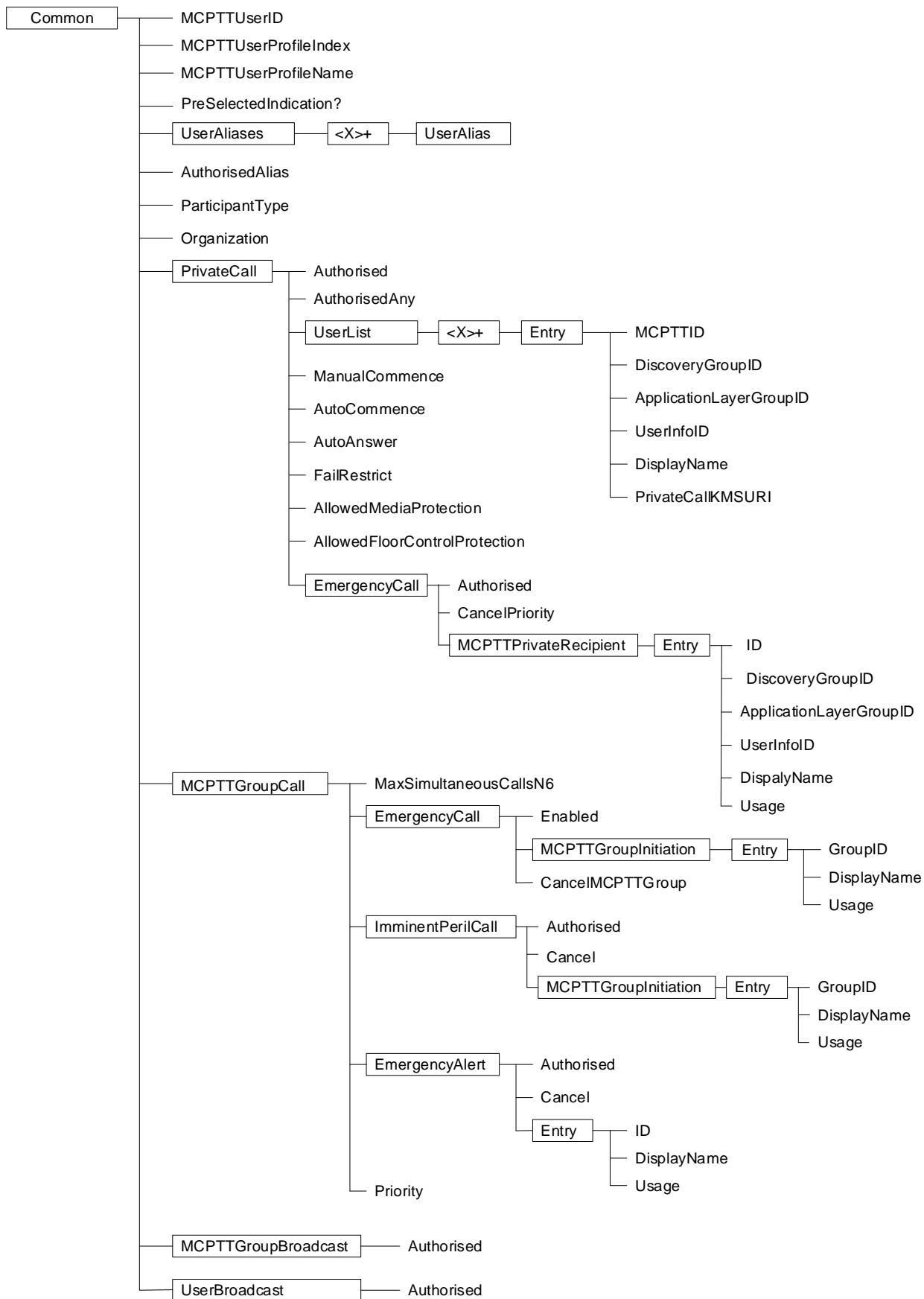

Figure 5.1.2: The MCPTT user profile MO (2 of 3)

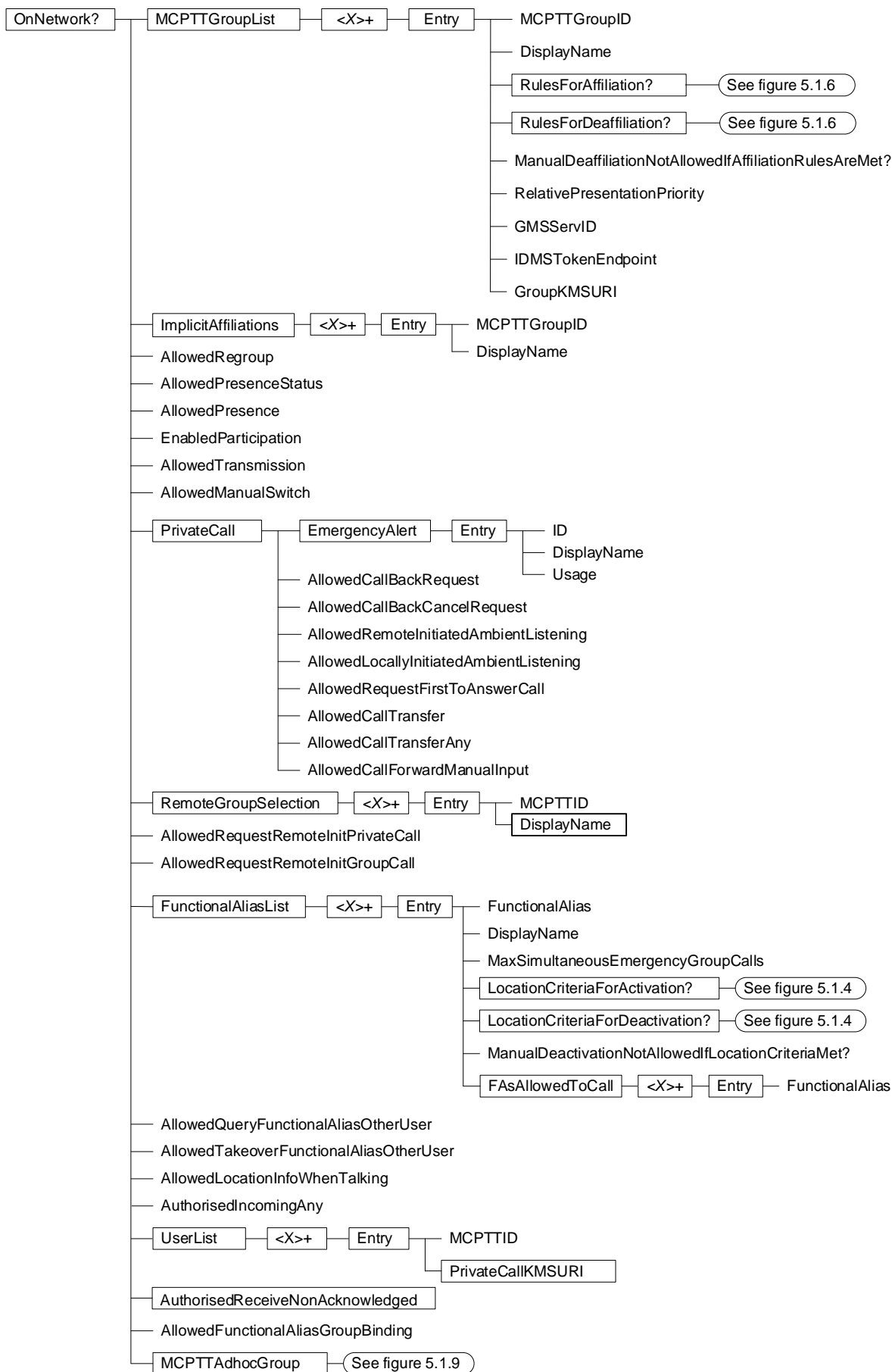
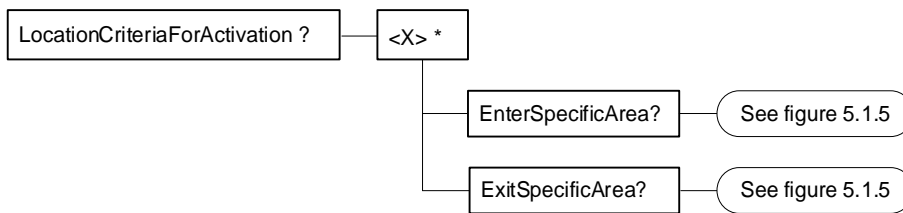

Figure 5.1.3: The MCPTT user profile MO (3 of 3)



NOTE 1: The LocationCriteriaForDeactivation MO contents are identical.

NOTE 2: This figure is referenced by figures 5.1.3, 10.1.2 and 13.1.2.

Figure 5.1.4: LocationCriteriaForActivation MO contents

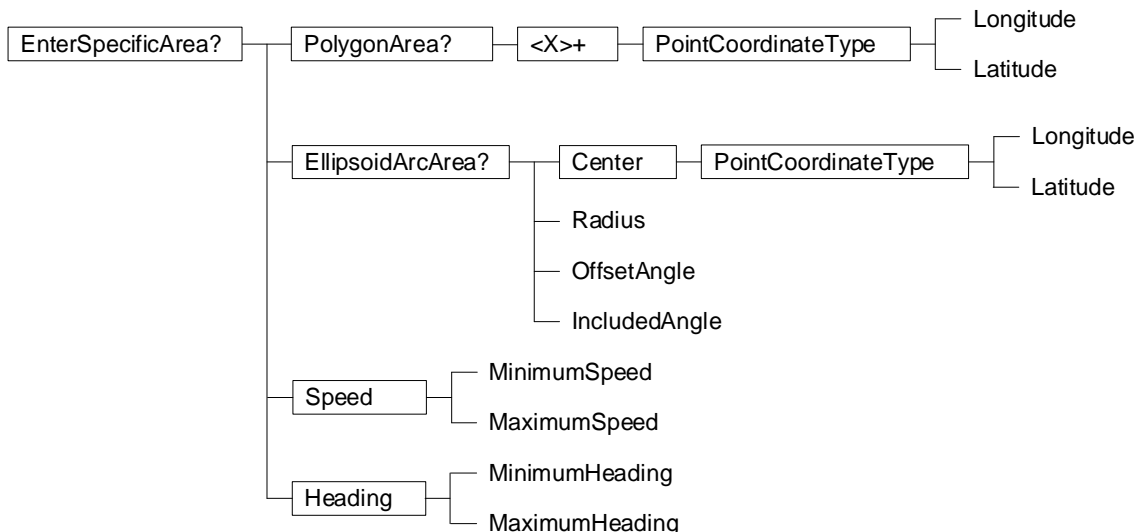

NOTE: The ExitSpecificArea MO contents are identical.

Figure 5.1.5: EnterSpecificArea MO contents

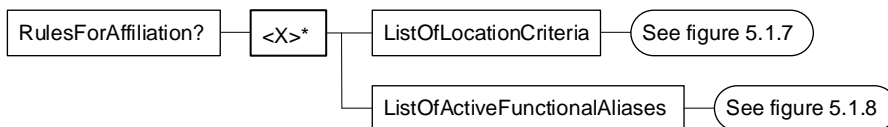

NOTE 1: The RulesForDeaffiliation MO contents are identical.

NOTE 2: This figure is referenced by figures 5.1.3, 10.1.2 and 13.1.2.

Figure 5.1.6: RulesForAffiliation MO contents

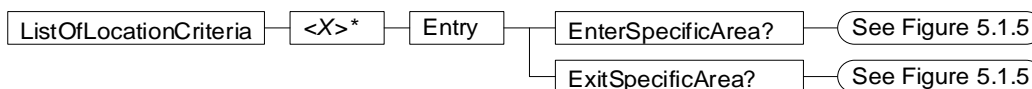

Figure 5.1.7: ListOfLocationCriteria MO contents

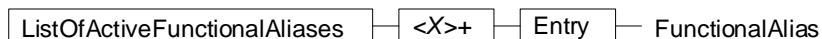

Figure 5.1.8: ListOfActiveFunctionalAliases MO contents

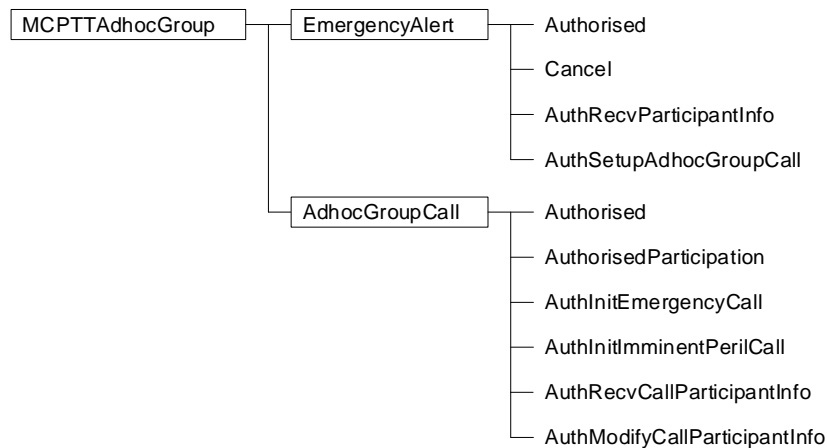

Figure 5.1.9: MCPTTAdhocGroup MO contents

5.2 MCPTT user profile MO parameters

5.2.1 General

This clause describes the parameters for the MCPTT user profile Management Object (MO).

5.2.2 Node: <x>

Table 5.2.2.1: Node: <x>

<x>

Status	Occurrence	Format	Min. Access Types
Required	OneOrMore	node	Get

This interior node acts as a placeholder for the MCPTT user profile Management Object (MO).

For the MCPTT user profile MO, the namespace specific string is: "urn:oma:mo:oma-dm-mcptt-user-profile:1.0"

- Values: N/A

5.2.3 /<x>/Name

Table 5.2.3.1: /<x>/Name

Name

Status	Occurrence	Format	Min. Access Types
Required	ZeroOrOne	chr	Get

The Name leaf is a name for the MCPTT user profile settings.

- Values: <User displayable name>

5.2.4 /<x>/Ext/

Table 5.2.4.1: /<x>/Ext/

Ext

Status	Occurrence	Format	Min. Access Types
Optional	ZeroOrOne	node	Get, Replace

The Ext is an interior node for where the vendor specific information about the MCPTT user profile MO is being placed.

Usually the vendor extension is identified by vendor specific name under the ext node and contains the vendor meaning application vendor, device vendor etc. The tree structure under the vendor identified is not defined and can therefore include one or more un-standardized sub-trees.

- Values: N/A

5.2.5 /<x>/<x>

Table 5.2.5.1: /<x>/<x>

<x>

Status	Occurrence	Format	Min. Access Types
Required	OneOrMore	node	Get, Replace

This interior node represents a container for on-network operation and off-network operation.

5.2.6 /<x>/<x>/Common

Table 5.2.6.1: /<x>/<x>/Common

<x>/Common

Status	Occurrence	Format	Min. Access Types
Required	One	node	Get, Replace

This interior node represents a container for the common network operation which means both on-network operation and off-network operation.

5.2.7 /<x>/<x>/Common/MCPTTUserID

Table 5.2.7.1: /<x>/<x>/Common/MCPTTUserID

<x>/Common/MCPTTUserID

Status	Occurrence	Format	Min. Access Types
Required	One	chr	Get, Replace

This leaf node indicates an MCPTT user identity (MCPTT ID) which is a globally unique identifier within the MCPTT service that represents the MCPTT user.

5.2.7A /<x>/<x>/Common/MCPTTUserProfileIndex

Table 5.2.7A.1: /<x>/<x>/Common/MCPTTUserProfileIndex

<x>/Common/MCPTTUserProfileIndex

Status	Occurrence	Format	Min. Access Types
Required	One	int	Get, Replace

This leaf node indicates an index for the particular MCPTT user profile.

- Values: 0-255

5.2.7B /<x>/<x>/Common/MCPTTUserProfileName

Table 5.2.7B.1: /<x>/<x>/Common/MCPTTUserProfileName

<x>/Common/MCPTTUserProfileName

Status	Occurrence	Format	Min. Access Types
Optional	One	chr	Get, Replace

This leaf node indicates a profile name for the particular MCPTT user profile.

5.2.7C /<x>/<x>/Common/PreSelectedIndication

Table 5.2.7C.1: /<x>/<x>/Common/PreSelectedIndication

<x>/Common/PreSelectedIndication

Status	Occurrence	Format	Min. Access Types
Optional	ZeroOrOne	null	Get, Replace

This leaf node indicates that this MCPTT user profile MO is designated to be the pre-selected MCPTT user profile as defined by 3GPP TS 23.179 [15]

- Values: null

When this leaf node is present, this MCPTT user profile MO is designated as the pre-selected MCPTT user profile.

When this leaf node is absent, this MCPTT user profile MO is not designated as the pre-selected MCPTT user profile.

If more than one MCPTT user profile MO is specified for the MCPTT user, then only one MCPTT user profile MO for the MCPTT user shall contain the <x>/Common/PreSelectedIndication leaf node.

If there is only one MCPTT user profile MO specified for the MCPTT user, then it is optional to include the <x>/Common/PreSelectedIndication leaf node.

5.2.8 /<x>/<x>/Common/UserAliases

Table 5.2.8.1: /<x>/<x>/Common/UserAliases

<x>/Common/UserAliases

Status	Occurrence	Format	Min. Access Types
Required	One	node	Get, Replace

This interior node is a placeholder for a list of aliases of an MCPTT user.

5.2.8A /<x>/<x>/Common/UserAliases/<x>

Table 5.2.8A.1: /<x>/<x>/Common/UserAliases/<x>

<x>/Common/UserAliases/<x>

Status	Occurrence	Format	Min. Access Types
Required	OneOrMore	node	Get, Replace

This interior node is a placeholder for one or more aliases of an MCPTT user.

5.2.8B /<x>/<x>/Common/UserAliases/<x>/UserAlias

Table 5.2.8B.1: /<x>/<x>/Common/UserAliases/<x>/UserAlias

<x>/Common/UserAliases/<x>/UserAlias

Status	Occurrence	Format	Min. Access Types
Required	One	chr	Get, Replace

This leaf node indicates an alphanumeric alias of the MCPTT user.

5.2.9 /<x>/<x>/Common/AuthorisedAlias

Table 5.2.9.1: /<x>/<x>/Common/AuthorisedAlias

<x>/Common/AuthorisedAlias

Status	Occurrence	Format	Min. Access Types
Optional	One	bool	Get, Replace

This leaf node indicates authorisation to create and delete aliases of other MCPTT users and their associated MCPTT user profiles.

When set to "true" the MCPTT user is authorised to create and delete aliases of other MCPTT users and their associated MCPTT user profiles.

When set to "false" the MCPTT user is not authorised to create and delete aliases of other MCPTT user and their associated MCPTT user profiles. This is the default if this leaf node is not present.

5.2.10 /<x>/<x>/Common/ParticipantType

Table 5.2.10.1: /<x>/<x>/Common/ParticipantType

<x>/Common/ParticipantType

Status	Occurrence	Format	Min. Access Types
Required	One	chr	Get, Replace

This leaf node indicates the participant type of the MCPTT user.

The ParticipantType means the functional category of the participant (e.g., first responder, second responder, dispatch, dispatch supervisor), typically defined by the MCPTT administrators.

5.2.11 /<x>/<x>/Common/Organization

Table 5.2.11.1: /<x>/<x>/Common/Organization

<x>/Common/Organization

Status	Occurrence	Format	Min. Access Types
Required	One	chr	Get, Replace

This leaf node indicates the organization an MCPTT user belongs to.

5.2.12 /<x>/<x>/Common/PrivateCall

Table 5.2.12.1: /<x>/<x>/Common/PrivateCall

<x>/Common/PrivateCall

Status	Occurrence	Format	Min. Access Types
Required	One	node	Get, Replace

This interior node is a placeholder for the MCPTT private call configuration.

5.2.13 /<x>/<x>/Common/PrivateCall/Authorised

Table 5.2.13.1: /<x>/<x>/Common/PrivateCall/Authorised

<x>/Common/PrivateCall/Authorised

Status	Occurrence	Format	Min. Access Types
Required	One	bool	Get, Replace

This leaf node indicates the authorisation to make a MCPTT private call.

When set to "true" the MCPTT user is allowed to make a MCPTT private call.

When set to "false" the MCPTT user is not allowed to make a MCPTT private call.

5.2.14 /<x>/<x>/Common/PrivateCall/AuthorisedAny

Table 5.2.14.1: /<x>/<x>/Common/PrivateCall/AuthorisedAny

<x>/Common/PrivateCall/AuthorisedAny

Status	Occurrence	Format	Min. Access Types
Required	One	bool	Get, Replace

This leaf node indicates the authorisation to make a MCPTT private call to any MCPTT user.

When set to "true" any MCPTT user is authorised to make an MCPTT private call to any MCPTT user.

When set to "false" any MCPTT user is not authorised to make an MCPTT private call to any MCPTT user.

5.2.15 /<x>/<x>/Common/PrivateCall/UserList

Table 5.2.15.1: /<x>/<x>/PrivateCall/UserList

<x>/Common/PrivateCall/UserList

Status	Occurrence	Format	Min. Access Types
Required	One	node	Get, Replace

This interior node is a placeholder for a list of MCPTT user(s) who can be called in a MCPTT private call.

5.2.16 /<x>/<x>/Common/PrivateCall/UserList/<x>

Table 5.2.16.1: /<x>/<x>/Common/PrivateCall/UserList/<x>

<x>/Common/PrivateCall/UserList/<x>

Status	Occurrence	Format	Min. Access Types

Optional	OneOrMore	node	Get, Replace
----------	-----------	------	--------------

This interior node is a placeholder for one or more list of MCPTT users who can be called in a MCPTT private call.

5.2.16A /<x>/<x>/Common/PrivateCall/UserList/<x>/Entry

Table 5.2.16A.1: /<x>/<x>/Common/PrivateCall/UserList/<x>/Entry

<x>/Common/PrivateCall/UserList/<x>/Entry

Status	Occurrence	Format	Min. Access Types
Required	One	node	Get, Replace

This interior node is a placeholder for one or more MCPTT users who can be called in a private call.

5.2.17 /<x>/<x>/Common/PrivateCall/UserList/<x>/Entry/MCPTTID

Table 5.2.17.1: /<x>/<x>/Common/PrivateCall/UserList/<x>/Entry/MCPTTID

<x>/Common/PrivateCall/UserList/<x>/Entry/MCPTTID

Status	Occurrence	Format	Min. Access Types
Optional	One	chr	Get, Replace

This leaf node indicates an MCPTT user identity (MCPTT ID) which is a globally unique identifier within the MCPTT service that represents the MCPTT user.

The value is a "uri" attribute specified in OMA OMA-TS-XDM_Group-V1_1 [4].

5.2.18 /<x>/<x>/Common/PrivateCall/UserList/<x>/Entry/DiscoveryGroupID

Table 5.2.18.1: /<x>/<x>/Common/PrivateCall/UserList/<x>/Entry/DiscoveryGroupID

<x>/Common/PrivateCall/UserList/<x>/Entry/DiscoveryGroupID

Status	Occurrence	Format	Min. Access Types
Optional	One	int	Get, Replace

This leaf node indicates a discovery group ID as specified in 3GPP TS 23.303 [6].

The value is used as the discovery group ID in the ProSe discovery procedures as specified in 3GPP TS 23.303 [6].

5.2.18A /<x>/<x>/Common/PrivateCall/UserList/<x>/Entry/ApplicationLayerGroupID

Table 5.2.18A.1: /<x>/<x>/Common/PrivateCall/UserList/<x>/Entry/ApplicationLayerGroupID

<x>/Common/PrivateCall/UserList/<x>/Entry/ApplicationLayerGroupID

Status	Occurrence	Format	Min. Access Types
Optional	One	int	Get, Replace

This leaf node indicates an application layer group ID as specified in 3GPP TS 23.304 [25].

The value is used as the application layer group ID in the ProSe discovery procedures as specified in 3GPP TS 23.304 [25].

5.2.19 /<x>/<x>/Common/PrivateCall/UserList/<x>/Entry/UserInfoID

Table 5.2.19.1: /<x>/<x>/Common/PrivateCall/UserList/<x>/Entry/UserInfoID

<x>/Common/PrivateCall/UserList/<x>/Entry/UserInfoID

Status	Occurrence	Format	Min. Access Types
Optional	One	int	Get, Replace

This leaf node indicates a ProSe user info ID as specified in 3GPP TS 23.303 [6].

5.2.19A /<x>/<x>/Common/PrivateCall/UserList/<x>/Entry/DisplayName

Table 5.2.19A.1: /<x>/<x>/Common/PrivateCall/UserList/<x>/Entry/DisplayName

<x>/Common/PrivateCall/UserList/<x>/Entry/DisplayName

Status	Occurrence	Format	Min. Access Types
Optional	One	chr	Get, Replace

This leaf node contains a human readable name.

5.2.19B /<x>/<x>/Common/PrivateCall/UserList/<x>/Entry/PrivateCallKMSURI

Table 5.2.19B.1: /<x>/<x>/Common/PrivateCall/UserList/<x>/Entry/PrivateCallKMSURI

<x>/Common/PrivateCall/UserList/<x>/Entry/PrivateCallKMSURI

Status	Occurrence	Format	Min. Access Types
Optional	One	chr	Get, Replace

This leaf node indicates the identity (URI) of the KMS associated with the MCPTTID. If the value is empty, the KMS leaf node present in the MCS UE initial configuration MO is used.

5.2.20 /<x>/<x>/Common/PrivateCall/ManualCommence

Table 5.2.20.1: /<x>/<x>/Common/PrivateCall/ManualCommence

<x>/Common/PrivateCall/ManualCommence

Status	Occurrence	Format	Min. Access Types
Required	One	bool	Get, Replace

This leaf node indicates the authorisation to make a MCPTT private call with manual commencement.

When set to "true" the MCPTT user is authorised to make a MCPTT private call in manual commencement mode.

When set to "false" the MCPTT user is not authorised to make a MCPTT private call in manual commencement mode.

5.2.21 /<x>/<x>/Common/PrivateCall/AutoCommence

Table 5.2.21.1: /<x>/<x>/Common/PrivateCall/AutoCommence

<x>/Common/PrivateCall/AutoCommence

Status	Occurrence	Format	Min. Access Types
Required	One	bool	Get, Replace

This leaf node indicates the authorisation to make a MCPTT private call with automatic commencement.

When set to "true" the MCPTT user is authorised to make a MCPTT private call in automatic commencement mode.

When set to "false" the MCPTT user is not authorised to make a MCPTT private call in automatic commencement mode.

5.2.22 /<x>/<x>/Common/PrivateCall/AutoAnswer

Table 5.2.22.1: /<x>/<x>/Common/PrivateCall/AutoAnswer

<x>/Common/PrivateCall/AutoAnswer

Status	Occurrence	Format	Min. Access Types
Required	One	bool	Get, Replace

This leaf node indicates the authorisation of MCPTT user to force automatic answer for a MCPTT private call.

When set to "true" the MCPTT user is authorised to force automatic answer for a MCPTT private call.

When set to "false" the MCPTT user is not authorised to force automatic answer for a MCPTT private call.

5.2.23 /<x>/<x>/Common/PrivateCall/FailRestrict

Table 5.2.23.1: /<x>/<x>/Common/PrivateCall/FailRestrict

<x>/Common/PrivateCall/FailRestrict

Status	Occurrence	Format	Min. Access Types
Required	One	bool	Get, Replace

This leaf node indicates the authorisation to restrict the provision of a notification of call failure reason for a MCPTT private call.

When set to "true" the MCPTT user is authorised to restrict notification of call failure reason for MCPTT private call.

When set to "false" the MCPTT user is not authorised to restrict notification of call failure reason for MCPTT private call.

5.2.24 /<x>/<x>/Common/PrivateCall/AllowedMediaProtection

Table 5.2.24.1: /<x>/<x>/Common/PrivateCall/AllowedMediaProtection

<x>/Common/PrivateCall/AllowedMediaProtection

Status	Occurrence	Format	Min. Access Types
Required	One	bool	Get, Replace

This leaf node indicates authorisation to protect confidentiality and integrity of media for MCPTT private calls.

When set to "true" the MCPTT user is authorised to protect confidentiality and integrity of media for MCPTT private calls.

When set to "false" the MCPTT user is not authorised to protect confidentiality and integrity of media for MCPTT private calls.

The default value is set to "true".

5.2.25 `/Common/PrivateCall/AllowedFloorControlProtection`

Table 5.2.25.1: `/Common/PrivateCall/AllowedFloorControlProtection`

`<x>/Common/PrivateCall/AllowedFloorControlProtection`

Status	Occurrence	Format	Min. Access Types
Required	One	bool	Get, Replace

This leaf node indicates authorisation to protect confidentiality and integrity of floor control signalling for MCPTT private calls.

When set to "true" the MCPTT user is authorised to protect confidentiality and integrity of floor control signalling for MCPTT private calls.

When set to "false" the MCPTT user is not authorised to protect confidentiality and integrity of floor control signalling for MCPTT private calls.

The default value is set to "true".

5.2.26 `/Common/PrivateCall/EmergencyCall`

Table 5.2.26.1: `/Common/PrivateCall/EmergencyCall`

`<x>/Common/PrivateCall/EmergencyCall`

Status	Occurrence	Format	Min. Access Types
Required	One	node	Get, Replace

This interior node is a placeholder for the MCPTT emergency call policy.

5.2.27 `/Common/PrivateCall/EmergencyCall/Authorised`

Table 5.2.27.1: `/Common/PrivateCall/EmergencyCall/Authorised`

`<x>/Common/PrivateCall/EmergencyCall/Authorised`

Status	Occurrence	Format	Min. Access Types
Required	One	bool	Get, Replace

This leaf node indicates the authorisation to make an MCPTT emergency private call.

When set to "true" the MCPTT user is authorised to make an MCPTT emergency private call.

When set to "false" the MCPTT user is not authorised to make an MCPTT emergency private call.

5.2.28 /<x>/<x>/Common/PrivateCall/EmergencyCall/CancelPriority

Table 5.2.28.1: /<x>/<x>/Common/PrivateCall/EmergencyCall/CancelPriority

<x>/Common/PrivateCall/EmergencyCall/CancelPriority

Status	Occurrence	Format	Min. Access Types
Required	One	bool	Get, Replace

This leaf node indicates the authorisation to cancel emergency priority in an MCPTT emergency private call by an authorised MCPTT user.

When set to "true" the MCPTT user is authorised to cancel an emergency priority in an MCPTT private call.

When set to "false" the MCPTT user is not authorised to cancel an emergency priority in an MPCTT private call.

5.2.29 /<x>/<x>/Common/PrivateCall/EmergencyCall/MCPTTPrivateRecipient

Table 5.2.29.1: /<x>/<x>/Common/PrivateCall/EmergencyCall/MCPTTPrivateRecipient

<x>/Common/PrivateCall/EmergencyCall/MCPTTPrivateRecipient

Status	Occurrence	Format	Min. Access Types
Optional	One	node	Get, Replace

This interior node is a placeholder for the MCPTT private recipient for an MCPTT emergency private call.

5.2.29A /<x>/<x>/Common/PrivateCall/EmergencyCall/MCPTTPrivateRecipient/Entry

Table 5.2.29A.1: /<x>/<x>/Common/PrivateCall EmergencyCall/MCPTTPrivateRecipient/Entry

<x>/Common/PrivateCall/EmergencyCall/MCPTTPrivateRecipient/Entry

Status	Occurrence	Format	Min. Access Types
Required	One	node	Get, Replace

This interior node is a placeholder for the details of the MCPTT private recipient for an MCPTT emergency private call.

5.2.29B /<x>/<x>/Common/PrivateCall/EmergencyCall/MCPTTPrivateRecipient/Entry/ID

Table 5.2.29B.1: /<x>/<x>/Common/PrivateCall/EmergencyCall/MCPTTPrivateRecipient/Entry/ID

<x>/Common/PrivateCall/EmergencyCall/MCPTTPrivateRecipient/Entry/ID

Status	Occurrence	Format	Min. Access Types
Optional	One	chr	Get, Replace

This leaf node indicates the MCPTT private recipient used upon certain criteria on initiation of an MCPTT emergency private call.

5.2.29C /<x>/<x>/Common/PrivateCall/EmergencyCall/ MCPTTPrivateRecipient/Entry/DiscoveryGroupID

**Table 5.2.29C.1: /<x>/<x>/Common/PrivateCall/EmergencyCall/MCPTTPrivateRecipient/Entry/
DiscoveryGroupID**

<x>/Common/PrivateCall/EmergencyCall/MCPTTPrivateRecipient/Entry/DiscoveryGroupID

Status	Occurrence	Format	Min. Access Types
Optional	One	int	Get, Replace

This leaf node indicates the discovery group ID as specified in 3GPP TS 23.303 [6].

5.2.29C1 /<x>/<x>/Common/PrivateCall/EmergencyCall/ MCPTTPrivateRecipient/Entry/ApplicationLayerGroupID

**Table 5.2.29C1.1: /<x>/<x>/Common/PrivateCall/EmergencyCall/MCPTTPrivateRecipient/Entry/
ApplicationLayerGroupID**

<x>/Common/PrivateCall/EmergencyCall/MCPTTPrivateRecipient/Entry/ApplicationLayerGroupID

Status	Occurrence	Format	Min. Access Types
Optional	One	int	Get, Replace

This leaf node indicates an application layer group ID as specified in 3GPP TS 23.304 [25].

5.2.29D /<x>/<x>/Common/PrivateCall/EmergencyCall/ MCPTTPrivateRecipient/Entry/UserInfoID

**Table 5.2.29D.1: /<x>/<x>/Common/PrivateCall/EmergencyCall/MCPTTPrivateRecipient/Entry/
UserInfoID**

<x>/Common/PrivateCall/EmergencyCall/MCPTTPrivateRecipient/Entry/UserInfoID

Status	Occurrence	Format	Min. Access Types
Optional	One	int	Get, Replace

This leaf node indicates a ProSe user info ID as specified in 3GPP TS 23.303 [6].

The "UserInfoID" element identifies the MCPTT private recipient when making an off-network private call.

5.2.29E /<x>/<x>/Common/PrivateCall/EmergencyCall/ MCPTTPrivateRecipient/Entry/DisplayName

**Table 5.2.29E.1: /<x>/<x>/Common/PrivateCall/EmergencyCall/MCPTTPrivateRecipient/Entry/
DisplayName**

<x>/Common/PrivateCall/EmergencyCall/MCPTTPrivateRecipient/Entry/DisplayName

Status	Occurrence	Format	Min. Access Types
Optional	One	chr	Get, Replace

This leaf node contains a human readable name that corresponds to the MCPTT private recipient ID.

5.2.29F /<x>/<x>/Common/PrivateCall/EmergencyCall/MCPTTPrivateRecipient/Entry/Usage

Table 5.2.29F.1: /<x>/<x>/Common/PrivateCall/EmergencyCall/MCPTTPrivateRecipient/Entry/Usage

<x>/Common/PrivateCall/EmergencyCall/MCPTTPrivateRecipient/Entry/Usage

Status	Occurrence	Format	Min. Access Types
Required	One	chr	Get, Replace

This leaf node indicates the criteria to determine when initiation of an MCPTT emergency private call uses the MCPTT private recipient ID.

The valid values are 'LocallyDetermined' and 'UsePreConfigured'.

When set to 'LocallyDetermined' then if the MCPTT user selects an MCPTT ID then use that MCPTT ID for the MCPTT emergency private call, if the MCPTT user does not select a MCPTT ID then use the MCPTT ID identified by the MCPTT private recipient ID in clause 5.2.29B for an on-network MCPTT emergency private call.

When set to 'UsePreConfigured' then use the MCPTT ID identified by the MCPTT private recipient ID in clause 5.2.29B for an on-network MCPTT emergency private call.

When set to 'LocallyDetermined' then if the MCPTT user selects an MCPTT user then use the UserInfoID that corresponds to that MCPTT user for the MCPTT emergency private call, if the MCPTT user does not select a MCPTT user then use the User Info ID identified by the UserInfoID in clause 5.2.29D for an off-network MCPTT emergency private call.

When set to 'UsePreConfigured' then use the User Info ID identified by the UserInfoID in clause 5.2.29D for an off-network MCPTT emergency private call.

5.2.30 /<x>/<x>/Common/MCPTTGroupCall

Table 5.2.30.1: /<x>/<x>/Common/MCPTTGroupCall

<x>/Common/MCPTTGroupCall

Status	Occurrence	Format	Min. Access Types
Required	One	node	Get, Replace

This interior node is a placeholder for the MCPTT group call configuration.

5.2.31 /<x>/<x>/Common/MCPTTGroupCall/MaxSimultaneousCallsN6

Table 5.2.31.1: /<x>/<x>/Common/MCPTTGroupCall/MaxSimultaneousCallsN6

<x>/Common/MCPTTGroupCall/MaxSimultaneousCallsN6

Status	Occurrence	Format	Min. Access Types
Required	One	int	Get, Replace

This leaf node indicates the maximum number of simultaneously received MCPTT group calls (N6).

5.2.32 /<x>/<x>/Common/MCPTTGroupCall/EmergencyCall

Table 5.2.32.1: /<x>/<x>/Common/MCPTTGroupCall/EmergencyCall

<x>/Common/MCPTTGroupCall/EmergencyCall

Status	Occurrence	Format	Min. Access Types

Required	One	node	Get, Replace
----------	-----	------	--------------

This interior node is a placeholder for the MCPTT emergency call policy.

5.2.33 /<x>/<x>/Common/MCPTTGroupCall/EmergencyCall/Enabled

Table 5.2.33.1: /<x>/<x>/Common/MCPTTGroupCall/EmergencyCall/Enabled

<x>/Common/MCPTTGroupCall/EmergencyCall/Enabled

Status	Occurrence	Format	Min. Access Types
Optional	One	bool	Get, Replace

This leaf node indicates the authorisation to make an MCPTT emergency group call functionality enabled for MCPTT user.

When set to "true" the MCPTT user is authorised to make an MCPTT emergency group call functionality enabled.

When set to "false" the MCPTT user is not authorised to make an MCPTT emergency group call functionality enabled.

5.2.34 /<x>/<x>/Common/MCPTTGroupCall/EmergencyCall/MCPTTGroupInitiation

Table 5.2.34.1: /<x>/<x>/Common/MCPTTGroupCall/EmergencyCall/MCPTTGroupInitiation

<x>/Common/MCPTTGroupCall/EmergencyCall/MCPTTGroupInitiation

Status	Occurrence	Format	Min. Access Types
Required	One	node	Get, Replace

This interior node is a placeholder for the group used on initiation of an MCPTT emergency group call.

5.2.34A /<x>/<x>/Common/MCPTTGroupCall/EmergencyCall/MCPTTGroupInitiation/Entry

Table 5.2.34A.1: /<x>/<x>/Common/MCPTTGroupCall/EmergencyCall/MCPTTGroupInitiation/Entry

<x>/Common/MCPTTGroupCall/EmergencyCall/MCPTTGroupInitiation/Entry

Status	Occurrence	Format	Min. Access Types
Required	One	node	Get, Replace

This interior node is a placeholder for the details of the group used on initiation of an MCPTT emergency group call.

5.2.34B /<x>/<x>/Common/MCPTTGroupCall/EmergencyCall/MCPTTGroupInitiation/Entry/GroupID

Table 5.2.34BA.1: /<x>/<x>/Common/MCPTTGroupCall/EmergencyCall/MCPTTGroupInitiation/Entry/GroupID

<x>/Common/MCPTTGroupCall/EmergencyCall/MCPTTGroupInitiation/Entry/GroupID

Status	Occurrence	Format	Min. Access Types
Optional	One	chr	Get, Replace

This leaf node indicates the group used upon certain criteria on initiation of an MCPTT emergency group call.

5.2.34C /<x>/<x>/Common/MCPTTGroupCall/EmergencyCall/MCPTTGroupInitiation/Entry/DisplayName

Table 5.2.34C.1: /<x>/<x>/Common/MCPTTGroupCall/EmergencyCall/MCPTTGroupInitiation/Entry/DisplayName

<x>/Common/MCPTTGroupCall/EmergencyCall/MCPTTGroupInitiation/Entry/DisplayName

Status	Occurrence	Format	Min. Access Types
Optional	One	chr	Get, Replace

This leaf node contains a human readable name that corresponds to the Group ID.

5.2.34D /<x>/<x>/Common/MCPTTGroupCall/EmergencyCall/MCPTTGroupInitiation/Entry/Usage

Table 5.2.34D.1: /<x>/<x>/Common/MCPTTGroupCall/EmergencyCall/MCPTTGroupInitiation/Entry/Usage

<x>/Common/MCPTTGroupCall/EmergencyCall/MCPTTGroupInitiation/Entry/Usage

Status	Occurrence	Format	Min. Access Types
Required	One	chr	Get, Replace

This leaf node indicates the criteria to determine when initiation of an MCPTT emergency group call uses the GroupID.

The valid values are 'UseCurrentlySelectedGroup' and 'DedicatedGroup'.

When set to 'UseCurrentlySelectedGroup' then if the MCPTT user has currently selected an MCPTT group then use that MCPTT group for an on-network MCPTT emergency group call, if the MCPTT user does not have a currently selected MCPTT group then use the MCPTT group identified by the GroupID in clause 5.2.34B for an MCPTT emergency group call.

When set to 'DedicatedGroup' then use the MCPTT group identified by the GroupID in clause 5.2.34B for an MCPTT emergency group call.

5.2.35 /<x>/<x>/Common/MCPTTGroupCall/EmergencyCall/CancelMCPTTGroup

Table 5.2.35.1: /<x>/<x>/Common/MCPTTGroupCall/EmergencyCall/CancelMCPTTGroup

<x>/Common/MCPTTGroupCall/EmergencyCall/CancelMCPTTGroup

Status	Occurrence	Format	Min. Access Types
Required	One	bool	Get, Replace

This leaf node indicates the authorisation to cancel an in progress MCPTT emergency group call associated with a group.

When set to "true" the MCPTT user is authorised to cancel a MCPTT emergency group call.

When set to "false" the MCPTT user is not authorised to cancel a MCTT emergency group call.

5.2.36 /<x>/<x>/Common/MCPTTGroupCall/ImminentPerilCall

Table 5.2.36.1: /<x>/<x>/Common/MCPTTGroupCall/ImminentPerilCall

<x>/Common/MCPTTGroupCall/ImminentPerilCall

Status	Occurrence	Format	Min. Access Types
Required	One	node	Get, Replace

This interior node is a placeholder for the MCPTT imminent peril call policy.

5.2.37 /<x>/<x>/Common/MCPTTGroupCall/ImminentPerilCall/Authorised

Table 5.2.37.1: /<x>/<x>/Common/MCPTTGroupCall/ImminentPerilCall/Authorised

<x>/Common/MCPTTGroupCall/ImminentPerilCall/Authorised

Status	Occurrence	Format	Min. Access Types
Required	One	bool	Get, Replace

This leaf node indicates the authorisation to make an Imminent Peril group call.

When set to "true" the MCPTT user is authorised to create an MCPTT imminent peril group call.

When set to "false" the MCPTT user is not authorised to create an MCPTT imminent peril group call.

5.2.38 /<x>/<x>/Common/MCPTTGroupCall/ImminentPerilCall/Cancel

Table 5.2.38.1: /<x>/<x>/Common/MCPTTGroupCall/ImminentPerilCall/Cancel

<x>/Common/MCPTTGroupCall/ImminentPerilCall/Cancel

Status	Occurrence	Format	Min. Access Types
Required	One	bool	Get, Replace

This leaf node indicates the authorisation for in-progress MCPTT imminent peril cancelation.

When set to "true" the MCPTT user is authorised to cancel an MCPTT imminent peril call.

When set to "false" the MCPTT user is not authorised to cancel an MCPTT imminent peril call.

5.2.39 /<x>/<x>/Common/MCPTTGroupCall/ImminentPerilCall/MCPTTGroupInitiation

Table 5.2.39.1: /<x>/<x>/Common/MCPTTGroupCall/ImminentPerilCall/MCPTTGroupInitiation

<x>/Common/MCPTTGroupCall/ImminentPerilCall/MCPTTGroupInitiation

Status	Occurrence	Format	Min. Access Types
Optional	One	node	Get, Replace

This interior node is a placeholder for the group used on initiation of an MCPTT imminent peril group call.

5.2.39A /<x>/<x>/Common/MCPTTGroupCall/ImminentPerilCall/MCPTTGroupInitiation/Entry

Table 5.2.39A.1: /<x>/<x>/Common/MCPTTGroupCall/ImminentPerilCall/MCPTTGroupInitiation/Entry

<x>/Common/MCPTTGroupCall/ImminentPerilCall/MCPTTGroupInitiation/Entry

Status	Occurrence	Format	Min. Access Types
Required	One	node	Get, Replace

This interior node is a placeholder for the details of the group used on initiation of an imminent peril call.

5.2.39B /<x>/<x>/Common/MCPTTGroupCall/ImminentPerilCall/MCPTTGroupInitiation/Entry/GroupID

Table 5.2.39B.1: /<x>/<x>/Common/MCPTTGroupCall/ImminentPerilCall/MCPTTGroupInitiation/Entry/GroupID

<x>/Common/MCPTTGroupCall/ImminentPerilCall/MCPTTGroupInitiation/Entry/GroupID

Status	Occurrence	Format	Min. Access Types
Required	One	chr	Get, Replace

This leaf node indicates the group used upon certain criteria on initiation of an MCPTT imminent peril group call.

5.2.39C /<x>/<x>/Common/MCPTTGroupCall/ImminentPerilCall/MCPTTGroupInitiation/DisplayName

Table 5.2.39C.1: /<x>/<x>/Common/MCPTTGroupCall/ImminentPerilCall/MCPTTGroupInitiation/Entry/DisplayName

<x>/Common/MCPTTGroupCall/ImminentPerilCall/MCPTTGroupInitiation/Entry/DisplayName

Status	Occurrence	Format	Min. Access Types
Optional	One	chr	Get, Replace

This leaf node contains a human readable name that corresponds to the Group ID.

5.2.39D /<x>/<x>/Common/MCPTTGroupCall/ImminentPerilCall/MCPTTGroupInitiation/Entry/Usage

Table 5.2.39D.1: /<x>/<x>/Common/MCPTTGroupCall/ImminentPerilCall/MCPTTGroupInitiation/Entry/Usage

<x>/Common/MCPTTGroupCall/ImminentPerilCall/MCPTTGroupInitiation/Entry/Usage

Status	Occurrence	Format	Min. Access Types
Required	One	chr	Get, Replace

This leaf node indicates the criteria to determine when initiation of an MCPTT imminent peril group call uses the GroupID.

The valid values are 'UseCurrentlySelectedGroup' and 'DedicatedGroup'.

When set to 'UseCurrentlySelectedGroup' then if the MCPTT user has currently selected an MCPTT group then use that MCPTT group for an on-network MCPTT imminent peril group call, if the MCPTT user does not have a currently

selected MCPTT group then use the MCPTT group identified by the GroupID in clause 5.2.39B for an MCPTT imminent peril group call.

When set to 'DedicatedGroup' then use the MCPTT group identified by the GroupID in clause 5.2.39B for an MCPTT imminent peril group call.

5.2.40 /<x>/<x>/Common/MCPTTGroupCall/EmergencyAlert

Table 5.2.40.1: /<x>/<x>/Common/MCPTTGroupCall/EmergencyAlert

<x>/Common/MCPTTGroupCall/EmergencyAlert

Status	Occurrence	Format	Min. Access Types
Required	One	node	Get, Replace

This interior node is a placeholder for the MCPTT emergency alert policy.

5.2.41 /<x>/<x>/Common/MCPTTGroupCall/EmergencyAlert/Authorised

Table 5.2.41.1: /<x>/<x>/Common/MCPTTGroupCall/EmergencyAlert/Authorised

<x>/Common/MCPTTGroupCall/EmergencyAlert/Authorised

Status	Occurrence	Format	Min. Access Types
Required	One	bool	Get, Replace

This leaf node indicates the authorisation to activate an MCPTT emergency alert.

When set to "true" the MCPTT user is authorised to make an MCPTT emergency alert.

When set to "false" the MCPTT user is not authorised to make an MCPTT emergency alert.

5.2.42 /<x>/<x>/Common/MCPTTGroupCall/EmergencyAlert/Cancel

Table 5.2.42.1: /<x>/<x>/Common/MCPTTGroupCall/EmergencyAlert/Cancel

<x>/Common/MCPTTGroupCall/EmergencyAlert/Cancel

Status	Occurrence	Format	Min. Access Types
Required	One	bool	Get, Replace

This leaf node indicates the authorisation to cancel an MCPTT emergency alert.

When set to "true" the MCPTT user is authorised to cancel an MCPTT emergency alert.

When set to "false" the MCPTT user is not authorised to cancel an MCPTT emergency alert.

5.2.43 Void

5.2.43A /<x>/<x>/Common/MCPTTGroupCall/EmergencyAlert/Entry

Table 5.2.43A.1: /<x>/<x>/Common/MCPTTGroupCall/EmergencyAlert/Entry

<x>/Common/MCPTTGroupCall/EmergencyAlert/Entry

Status	Occurrence	Format	Min. Access Types
Required	One	node	Get, Replace

This interior node is a placeholder for the details of the MCPTT group of an MCPTT emergency alert.

5.2.43B /<x>/<x>/Common/MCPTTGroupCall/EmergencyAlert/Entry/ID

Table 5.2.43B.1: /<x>/<x>/Common/MCPTTGroupCall/EmergencyAlert/Entry/ID

<x>/Common/MCPTTGroupCall/EmergencyAlert/Entry/ID

Status	Occurrence	Format	Min. Access Types
Required	One	chr	Get, Replace

This leaf node indicates the MCPTT group used upon certain criteria on initiation of an MCPTT emergency alert.

5.2.43C Void

5.2.43D /<x>/<x>/Common/MCPTTGroupCall/EmergencyAlert/Entry/DisplayName

Table 5.2.43D.1: /<x>/<x>/Common/MCPTTGroupCall/EmergencyAlert/Entry/DisplayName

<x>/Common/MCPTTGroupCall/EmergencyAlert/Entry/DisplayName

Status	Occurrence	Format	Min. Access Types
Optional	One	chr	Get, Replace

This leaf node contains a human readable name that corresponds to the ID.

5.2.43E /<x>/<x>/Common/MCPTTGroupCall/EmergencyAlert/Entry/Usage

Table 5.2.43E.1: /<x>/<x>/Common/MCPTTGroupCall/EmergencyAlert/Entry/Usage

<x>/Common/MCPTTGroupCall/EmergencyAlert/Entry/Usage

Status	Occurrence	Format	Min. Access Types
Required	One	chr	Get, Replace

This leaf node indicates the criteria to determine when initiation of an MCPTT emergency alert uses the ID.

The valid values are 'LocallyDetermined', 'UseCurrentlySelectedGroup', 'UsePreConfigured' and 'DedicatedGroup'.

When set to 'LocallyDetermined' then if the MCPTT user selects an MCPTT ID then use that MCPTT ID for an on-network MCPTT emergency alert, if the MCPTT user does not select a MCPTT ID then use the MCPTT ID identified by the ID in clause 5.2.43B for an on-network MCPTT emergency alert.

When set to 'UseCurrentlySelectedGroup' then if the MCPTT user has currently selected an MCPTT group then use that MCPTT group for an on-network MCPTT emergency alert, if the MCPTT user does not have a currently selected MCPTT group then use the MCPTT group identified by the ID in clause 5.2.43B for an MCPTT emergency alert.

When set to 'UsePreConfigured' then use the ID identified by the ID in clause 5.2.43B for an on-network MCPTT emergency alert.

When set to 'DedicatedGroup' then use the MCPTT group identified by the ID in clause 5.2.43B for an MCPTT emergency alert.

5.2.43F /<x>/<x>/Common/MCPTTGroupCall/Priority

Table 5.2.43F.1: /<x>/<x>/Common/MCPTTGroupCall/Priority

<x>/Common/MCPTTGroupCall/Priority

Status	Occurrence	Format	Min. Access Types
Required	One	int	Get, Replace

This leaf node indicates the priority of the MCPTT group calls.

- Values: 0-255

The MCPTT group call with the lowest Priority value shall be considered as the MCPTT group call having the lowest level among the MCPTT group calls.

5.2.44 Void

5.2.45 /<x>/<x>/Common/MCPTTGroupBroadcast

Table 5.2.45.1: /<x>/<x>/Common/MCPTTGroupBroadcast

<x>/Common/MCPTTGroupBroadcast

Status	Occurrence	Format	Min. Access Types
Required	One	node	Get, Replace

This interior node is a placeholder for the group-broadcast group policy.

5.2.46 /<x>/<x>/Common/MCPTTGroupBroadcast/Authorised

Table 5.2.46.1: /<x>/<x>/Common/MCPTTGroupBroadcast/Authorised

<x>/Common/MCPTTGroupBroadcast/Authorised

Status	Occurrence	Format	Min. Access Types
Required	One	bool	Get, Replace

This leaf node indicates the authorisation to create a group-broadcast group.

When set to "true" the MCPTT user is authorised to create a group-broadcast group.

When set to "false" the MCPTT user is not authorised to create a group-broadcast group.

5.2.47 /<x>/<x>/Common/UserBroadcast

Table 5.2.47.1: /<x>/<x>/Common/UserBroadcast

<x>/Common/UserBroadcast

Status	Occurrence	Format	Min. Access Types
Required	One	node	Get, Replace

This interior node is a placeholder for the user-broadcast group policy.

5.2.48 /<x>/<x>/Common/UserBroadcast/Authorised

Table 5.2.48.1: /<x>/<x>/Common/UserBroadcast/Authorised

<x>/Common/UserBroadcast/Authorised

Status	Occurrence	Format	Min. Access Types
Required	One	bool	Get, Replace

This leaf node indicates the authorisation to create a user-broadcast group.

When set to "true" the MCPTT user is authorised to create a user-broadcast group.

When set to "false" the MCPTT user is not authorised to create a user-broadcast group.

5.2.48A /<x>/<x>/OnNetwork

Table 5.2.48A.1: /<x>/<x>/OnNetwork

<x>/OnNetwork

Status	Occurrence	Format	Min. Access Types
Required	ZeroOrOne	node	Get, Replace

This interior node represents a container for on-network operation.

5.2.48B1 /<x>/<x>/OnNetwork/MCPTTGroupList

Table 5.2.48B1.1: /<x>/<x>/OnNetwork/MCPTTGroupList

<x>/OnNetwork/MCPTTGroupList

Status	Occurrence	Format	Min. Access Types
Required	One	node	Get, Replace

This interior node is a placeholder for the list of on-network MCPTT groups that the MCPTT user is allowed to affiliate to.

5.2.48B2 /<x>/<x>/OnNetwork/MCPTTGroupList/<x>

Table 5.2.48B2.1: /<x>/<x>/OnNetwork/MCPTTGroupList/<x>

<x>/OnNetwork/MCPTTGroupList/<x>

Status	Occurrence	Format	Min. Access Types
Required	OneOrMore	node	Get, Replace

This interior node is a placeholder for one or more list of on-network MCPTT groups that the MCPTT user is allowed to affiliate to.

5.2.48B3 /<x>/<x>/OnNetwork/MCPTTGroupList/<x>/Entry

Table 5.2.48B3.1: /<x>/<x>/OnNetwork/MCPTTGroupList/<x>/Entry

<x>/OnNetwork/MCPTTGroupList/<x>/Entry

Status	Occurrence	Format	Min. Access Types
Optional	One	node	Get, Replace

This interior node is a placeholder for the details of the on-network MCPTT groups that the MCPTT user is allowed to affiliate to.

5.2.48B4/ <x>/<x>/OnNetwork/MCPTTGroupList/<x>/Entry/ MCPTTGroupID

Table 5.2.48B4.1: /<x>/<x>/OnNetwork/MCPTTGroupList/<x>/Entry/MCPTTGroupID

<x>/OnNetwork/MCPTTGroupList/<x>/Entry/MCPTTGroupID

Status	Occurrence	Format	Min. Access Types
Required	One	chr	Get, Replace

This leaf node indicates the MCPTT group ID for the on-network MCPTT group that the MCPTT user is allowed to affiliate to.

The value is a "uri" attribute specified in OMA OMA-TS-XDM_Group-V1_1 [4].

5.2.48B4A /<x>/<x>/OnNetwork/MCPTTGroupList/<x>/Entry/ RulesForAffiliation

Table 5.2.48B4A.1: /<x>/<x>/OnNetwork/MCPTTGroupList/<x>/Entry/RulesForAffiliation

<x>/OnNetwork/MCPTTGroupList/<x>/Entry/RulesForAffiliation

Status	Occurrence	Format	Min. Access Types
Optional	ZeroOrOne	node	Get, Replace

This interior node is a placeholder for the rules that control automatic affiliation.

5.2.48B4A0 /<x>/<x>/OnNetwork/MCPTTGroupList/<x>/Entry/ RulesForAffiliation/<x>

Table 5.2.48B4A0.1: /<x>/<x>/OnNetwork/MCPTTGroupList/<x>/Entry/RulesForAffiliation/<x>

<x>/OnNetwork/MCPTTGroupList/<x>/Entry/RulesForAffiliation/<x>

Status	Occurrence	Format	Min. Access Types
Optional	ZeroOrMore	node	Get, Replace

This interior node is a placeholder for the zero or more rules that control automatic affiliation.

5.2.48B4A1 /<x>/<x>/OnNetwork/MCPTTGroupList/<x>/Entry/ RulesForAffiliation/<x>/ListOfLocationCriteria

Table 5.2.48B4A1.1: /<x>/<x>/OnNetwork/MCPTTGroupList/<x>/Entry/RulesForAffiliation/<x>/ListOfLocationCriteria

<x>/OnNetwork/MCPTTGroupList/<x>/Entry/RulesForAffiliation/<x>/ListOfLocationCriteria

Status	Occurrence	Format	Min. Access Types
Optional	One	node	Get, Replace

This interior node is a placeholder for the location portion of the rules that control automatic affiliation.

5.2.48B4A2 /<x>/<x>/OnNetwork/MCPTTGroupList/<x>/Entry/ RulesForAffiliation/<x>/ListOfLocationCriteria/<x>

**Table 5.2.48B84A2.1: /<x>/<x>/OnNetwork/MCPTTGroupList/<x>/Entry/RulesForAffiliation/<x>/
ListOfLocationCriteria/<x>**

<x>/OnNetwork/MCPTTGroupList/<x>/Entry/RulesForAffiliation/<x>/ListOfLocationCriteria/<x>

Status	Occurrence	Format	Min. Access Types
Optional	ZeroOrMore	node	Get, Replace

This interior node is a placeholder for the location portion of the rules that control automatic affiliation.

5.2.48B4A3 /<x>/<x>/OnNetwork/MCPTTGroupList/<x>/Entry/ RulesForAffiliation/<x>/ListOfLocationCriteria/<x>/Entry

**Table 5.2.48B4A3.1: /<x>/<x>/OnNetwork/MCPTTGroupList/<x>/Entry/RulesForAffiliation/<x>/
ListOfLocationCriteria/<x>/Entry**

<x>/OnNetwork/MCPTTGroupList/<x>/Entry/RulesForAffiliation/<x>/ListOfLocationCriteria/<x>/Entry

Status	Occurrence	Format	Min. Access Types
Optional	One	node	Get, Replace

This interior node is a placeholder for the location portion of the rules that control automatic affiliation.

5.2.48B4A4 /<x>/<x>/OnNetwork/MCPTTGroupList/<x>/Entry/ RulesForAffiliation/<x>/ListOfLocationCriteria/<x>/Entry/ EnterSpecificArea

**Table 5.2.48B4A4.1: /<x>/<x>/OnNetwork/MCPTTGroupList/<x>/Entry/RulesForAffiliation/<x>/
ListOfLocationCriteria/<x>/Entry/EnterSpecificArea**

<x>/OnNetwork/MCPTTGroupList/<x>/Entry/RulesForAffiliation/<x>/ListOfLocationCriteria/<x>/Entry/EnterSpe
cificArea

Status	Occurrence	Format	Min. Access Types
Optional	ZeroOrOne	node	Get, Replace

This interior node contains a geographical area which when entered by the MC service UE triggers evaluation of the rules.

5.2.48B4A5 /<x>/<x>/OnNetwork/MCPTTGroupList/<x>/Entry/ RulesForAffiliation/<x>/ListOfLocationCriteria/<x>/Entry/ EnterSpecificArea/PolygonArea

**Table 5.2.48B4A5.1: /<x>/<x>/OnNetwork/MCPTTGroupList/<x>/Entry/RulesForAffiliation/<x>/
ListOfLocationCriteria/<x>/Entry/EnterSpecificArea/PolygonArea**

<x>/OnNetwork/MCPTTGroupList/<x>/Entry/RulesForAffiliation/<x>/ListOfLocationCriteria/<x>/Entry/EnterSpe
cificArea/PolygonArea

Status	Occurrence	Format	Min. Access Types
Optional	ZeroOrOne	node	Get, Replace

This interior node contains a geographical area described by a polygon.

5.2.48B4A6 /<x>/<x>/OnNetwork/MCPTTGroupList/<x>/Entry/ RulesForAffiliation/<x>/ListOfLocationCriteria/<x>/Entry/ EnterSpecificArea/PolygonArea/<x>

**Table 5.2.48B4A6.1: /<x>/<x>/OnNetwork/MCPTTGroupList/<x>/Entry/RulesForAffiliation/<x>/
ListOfLocationCriteria/<x>/Entry/EnterSpecificArea/PolygonArea/<x>**

<x>/OnNetwork/MCPTTGroupList/<x>/Entry/RulesForAffiliation/<x>/ListOfLocationCriteria/<x>/Entry/EnterSpe
cificArea/PolygonArea/<x>

Status	Occurrence	Format	Min. Access Types
Required	OneOrN	node	Get, Replace

This interior node contains the coordinates of the corners which define a polygon. The occurrence of this leaf node is "3 to 15" as per 3GPP TS 23.032 [21].

5.2.48B4A7 /<x>/<x>/OnNetwork/MCPTTGroupList/<x>/Entry/ RulesForAffiliation/<x>/ListOfLocationCriteria/<x>/Entry/ EnterSpecificArea/PolygonArea/<x>/PointCoordinateType

**Table 5.2.48B4A7.1: /<x>/<x>/OnNetwork/MCPTTGroupList/<x>/Entry/RulesForAffiliation/<x>/
ListOfLocationCriteria/<x>/Entry/EnterSpecificArea/PolygonArea/<x>/PointCoordinateType**

<x>/OnNetwork/MCPTTGroupList/<x>/Entry/RulesForAffiliation/<x>/ListOfLocationCriteria/<x>/Entry/EnterSpe
cificArea/PolygonArea/<x>/PointCoordinateType

Status	Occurrence	Format	Min. Access Types
Required	One	node	Get, Replace

This interior node contains the type of the coordinates.

5.2.48B4A8 /<x>/<x>/OnNetwork/MCPTTGroupList/<x>/Entry/ RulesForAffiliation/<x>/ListOfLocationCriteria/<x>/Entry/ EnterSpecificArea/PolygonArea/<x>/PointCoordinateType/ Longitude

**Table 5.2.48B4A8.1: /<x>/<x>/OnNetwork/MCPTTGroupList/<x>/Entry/RulesForAffiliation/<x>/
ListOfLocationCriteria/<x>/Entry/EnterSpecificArea/PolygonArea/<x>/PointCoordinateType/
Longitude**

<x>/OnNetwork/MCPTTGroupList/<x>/Entry/RulesForAffiliation/<x>/ListOfLocationCriteria/<x>/Entry/EnterSpe
cificArea/PolygonArea/<x>/PointCoordinateType/Longitude

Status	Occurrence	Format	Min. Access Types
Required	One	int	Get, Replace

This leaf node contains the longitudinal coordinate of a corner.

5.2.48B4A9 /<x>/<x>/OnNetwork/MCPTTGroupList/<x>/Entry/
RulesForAffiliation/<x>/ListOfLocationCriteria/<x>/Entry/
EnterSpecificArea/PolygonArea/<x>/PointCoordinateType/
Latitude

**Table 5.2.48B4A9.1: /<x>/<x>/OnNetwork/MCPTTGroupList/<x>/Entry/RulesForAffiliation/<x>/
ListOfLocationCriteria/<x>/Entry/EnterSpecificArea/PolygonArea/<x>/PointCoordinateType/
Latitude**

<x>/OnNetwork/MCPTTGroupList/<x>/Entry/RulesForAffiliation/<x>/ListOfLocationCriteria/<x>/Entry/EnterSpe
cificArea/PolygonArea/<x>/PointCoordinateType/Latitude

Status	Occurrence	Format	Min. Access
Required	One	int	Get, Replace

This leaf node contains the latitudinal coordinate of a corner.

5.2.48B4A10 /<x>/<x>/OnNetwork/MCPTTGroupList/<x>/Entry/
RulesForAffiliation/<x>/ListOfLocationCriteria/<x>/Entry/
EnterSpecificArea/EllipsoidArcArea

**Table 5.2.48B4A10.1: /<x>/<x>/OnNetwork/MCPTTGroupList/<x>/Entry/RulesForAffiliation/<x>/
ListOfLocationCriteria/<x>/Entry/EnterSpecificArea/EllipsoidArcArea**

<x>/OnNetwork/MCPTTGroupList/<x>/Entry/RulesForAffiliation/<x>/ListOfLocationCriteria/<x>/Entry/EnterSpe
cificArea/EllipsoidArcArea

Status	Occurrence	Format	Min. Access Types
Optional	ZeroOrOne	node	Get, Replace

This interior node contains a geographical area described by an ellipsoid arc.

5.2.48B4A11 /<x>/<x>/OnNetwork/MCPTTGroupList/<x>/Entry/
RulesForAffiliation/<x>/ListOfLocationCriteria/<x>/Entry/
EnterSpecificArea/EllipsoidArcArea/Center

**Table 5.2.48B4A11.1: /<x>/<x>/OnNetwork/MCPTTGroupList/<x>/Entry/RulesForAffiliation/<x>/
ListOfLocationCriteria/<x>/Entry/EnterSpecificArea/EllipsoidArcArea/Center**

<x>/OnNetwork/MCPTTGroupList/<x>/Entry/RulesForAffiliation/<x>/ListOfLocationCriteria/<x>/Entry/EnterSpe
cificArea/EllipsoidArcArea/Center

Status	Occurrence	Format	Min. Access Types
Required	One	node	Get, Replace

This interior node contains the coordinates of the center point of the ellipsoid arc.

5.2.48B4A12 /<x>/<x>/OnNetwork/MCPTTGroupList/<x>/Entry/
RulesForAffiliation/<x>/ListOfLocationCriteria/<x>/Entry/
EnterSpecificArea/EllipsoidArcArea/Center/
PointCoordinateType

Table 5.2.48B4A12.1: /<x>/<x>/OnNetwork/MCPTTGroupList/<x>/Entry/RulesForAffiliation/<x>/ListOfLocationCriteria/<x>/Entry/EnterSpecificArea/EllipsoidArcArea/Center/PointCoordinateType

<x>/OnNetwork/MCPTTGroupList/<x>/Entry/RulesForAffiliation/<x>/ListOfLocationCriteria/<x>/Entry/EnterSpecificArea/EllipsoidArcArea/Center/PointCoordinateType

Status	Occurrence	Format	Min. Access Types
Required	One	node	Get, Replace

This interior node contains the coordinates of the center point of the ellipsoid arc.

5.2.48B4A13 /<x>/<x>/OnNetwork/MCPTTGroupList/<x>/Entry/
RulesForAffiliation/<x>/ListOfLocationCriteria/<x>/Entry/
EnterSpecificArea/EllipsoidArcArea/Center/
PointCoordinateType/Longitude

Table 5.2.48B4A13.1: /<x>/<x>/OnNetwork/MCPTTGroupList/<x>/Entry/RulesForAffiliation/<x>/ListOfLocationCriteria/<x>/Entry/EnterSpecificArea/EllipsoidArcArea/Center/PointCoordinateType/Longitude

<x>/OnNetwork/MCPTTGroupList/<x>/Entry/RulesForAffiliation/<x>/ListOfLocationCriteria/<x>/Entry/EnterSpecificArea/EllipsoidArcArea/Center/PointCoordinateType/Longitude

Status	Occurrence	Format	Min. Access Types
Required	One	int	Get, Replace

This leaf node contains the longitudinal coordinate of the center.

5.2.48B4A14 /<x>/<x>/OnNetwork/MCPTTGroupList/<x>/Entry/
RulesForAffiliation/<x>/ListOfLocationCriteria/<x>/Entry/
EnterSpecificArea/EllipsoidArcArea/Center/
PointCoordinateType/Latitude

Table 5.2.48B4A14.1: /<x>/<x>/OnNetwork/MCPTTGroupList/<x>/Entry/RulesForAffiliation/<x>/ListOfLocationCriteria/<x>/Entry/EnterSpecificArea/EllipsoidArcArea/Center/PointCoordinateType/Latitude

<x>/OnNetwork/MCPTTGroupList/<x>/Entry/RulesForAffiliation/<x>/ListOfLocationCriteria/<x>/Entry/EnterSpecificArea/EllipsoidArcArea/Center/PointCoordinateType/Latitude

Status	Occurrence	Format	Min. Access Types
Required	One	int	Get, Replace

This leaf node contains the latitudinal coordinate of a center.

5.2.48B4A15 /<x>/<x>/OnNetwork/MCPTTGroupList/<x>/Entry/ RulesForAffiliation/<x>/ListOfLocationCriteria/<x>/Entry/ EnterSpecificArea/EllipsoidArcArea/Radius

**Table 5.2.48B4A15.1: /<x>/<x>/OnNetwork/MCPTTGroupList/<x>/Entry/RulesForAffiliation/<x>/
ListOfLocationCriteria/<x>/Entry/EnterSpecificArea/EllipsoidArcArea/Radius**

<x>/OnNetwork/MCPTTGroupList/<x>/Entry/RulesForAffiliation/<x>/ListOfLocationCriteria/<x>/Entry/EnterSpe
cificArea/EllipsoidArcArea/Center/Radius

Status	Occurrence	Format	Min. Access Types
Required	One	int	Get, Replace

This leaf node contains the radius of the ellipsoid arc.

5.2.48B4A16 /<x>/<x>/OnNetwork/MCPTTGroupList/<x>/Entry/ RulesForAffiliation/<x>/ListOfLocationCriteria/<x>/Entry/ EnterSpecificArea/EllipsoidArcArea/OffsetAngle

**Table 5.2.48B4A16.1: /<x>/<x>/OnNetwork/MCPTTGroupList/<x>/Entry/RulesForAffiliation/<x>/
ListOfLocationCriteria/<x>/Entry/EnterSpecificArea/EllipsoidArcArea/OffsetAngle**

<x>/OnNetwork/MCPTTGroupList/<x>/Entry/RulesForAffiliation/<x>/ListOfLocationCriteria/<x>/Entry/EnterSpe
cificArea/EllipsoidArcArea/OffsetAngle

Status	Occurrence	Format	Min. Access Types
Required	One	int	Get, Replace

This leaf node contains the offset angle of the ellipsoid arc.

5.2.48B4A17 /<x>/<x>/OnNetwork/MCPTTGroupList/<x>/Entry/ RulesForAffiliation/<x>/ListOfLocationCriteria/<x>/Entry/ EnterSpecificArea/EllipsoidArcArea/IncludedAngle

**Table 5.2.48B4A17.1: /<x>/<x>/OnNetwork/MCPTTGroupList/<x>/Entry/RulesForAffiliation/<x>/
ListOfLocationCriteria/<x>/Entry/EnterSpecificArea/EllipsoidArcArea/IncludedAngle**

<x>/OnNetwork/MCPTTGroupList/<x>/Entry/RulesForAffiliation/<x>/ListOfLocationCriteria/<x>/Entry/EnterSpe
cificArea/EllipsoidArcArea/IncludedAngle

Status	Occurrence	Format	Min. Access Types
Required	One	int	Get, Replace

This leaf node contains the included angle of the ellipsoid arc.

5.2.48B4A18 /<x>/<x>/OnNetwork/MCPTTGroupList/<x>/Entry/ RulesForAffiliation/<x>/ListOfLocationCriteria/<x>/Entry/ EnterSpecificArea/Speed

**Table 5.2.48B4A18.1: /<x>/<x>/OnNetwork/MCPTTGroupList/<x>/Entry/RulesForAffiliation/<x>/<x>/
ListOfLocationCriteria/<x>/Entry/EnterSpecificArea/Speed**

<x>/OnNetwork/MCPTTGroupList/<x>/Entry/RulesForAffiliation/<x>/ListOfLocationCriteria/<x>/Entry/EnterSpe
cificArea/Speed

Status	Occurrence	Format	Min. Access Types

Optional	One	node	Get, Replace
----------	-----	------	--------------

This interior node contains the speed.

5.2.48B4A19 /<x>/<x>/OnNetwork/MCPTTGroupList/<x>/Entry/RulesForAffiliation/<x>/ListOfLocationCriteria/<x>/Entry/EnterSpecificArea/Speed/MinimumSpeed

Table 5.2.48B4A19.1: /<x>/<x>/OnNetwork/MCPTTGroupList/<x>/Entry/RulesForAffiliation/<x>/ListOfLocationCriteria/<x>/Entry/EnterSpecificArea/Speed/MinimumSpeed

<x>/OnNetwork/MCPTTGroupList/<x>/Entry/RulesForAffiliation/<x>/ListOfLocationCriteria/<x>/Entry/EnterSpecificArea/Speed/MinimumSpeed

Status	Occurrence	Format	Min. Access Types
Required	One	int	Get, Replace

This leaf node contains the minimum speed.

- Values: non-negative integer in units of kilometers/hour.

5.2.48B4A20 /<x>/<x>/OnNetwork/MCPTTGroupList/<x>/Entry/RulesForAffiliation/<x>/ListOfLocationCriteria/<x>/Entry/EnterSpecificArea/Speed/MaximumSpeed

Table 5.2.48B4A20.1: /<x>/<x>/OnNetwork/MCPTTGroupList/<x>/Entry/RulesForAffiliation/<x>/ListOfLocationCriteria/<x>/Entry/EnterSpecificArea/Speed/MaximumSpeed

<x>/OnNetwork/MCPTTGroupList/<x>/Entry/RulesForAffiliation/<x>/ListOfLocationCriteria/<x>/Entry/EnterSpecificArea/Speed/MaximumSpeed

Status	Occurrence	Format	Min. Access Types
Required	One	int	Get, Replace

This leaf node contains the maximum speed.

- Values: non-negative integer in units of kilometers/hour.

5.2.48B4A21 /<x>/<x>/OnNetwork/MCPTTGroupList/<x>/Entry/RulesForAffiliation/<x>/ListOfLocationCriteria/<x>/Entry/EnterSpecificArea/Heading

Table 5.2.48B4A21.1: /<x>/<x>/OnNetwork/MCPTTGroupList/<x>/Entry/RulesForAffiliation/<x>/ListOfLocationCriteria/<x>/Entry/EnterSpecificArea/Heading

<x>/OnNetwork/MCPTTGroupList/<x>/Entry/RulesForAffiliation/<x>/ListOfLocationCriteria/<x>/Entry/EnterSpecificArea/Heading

Status	Occurrence	Format	Min. Access Types
Optional	One	node	Get, Replace

This interior node contains the heading.

5.2.48B4A22 /<x>/<x>/OnNetwork/MCPTTGroupList/<x>/Entry/
RulesForAffiliation/<x>/ListOfLocationCriteria/<x>/Entry/
EnterSpecificArea/Heading/MinimumHeading

**Table 5.2.48B4A22.1: /<x>/<x>/OnNetwork/MCPTTGroupList/<x>/Entry/RulesForAffiliation/<x>/
ListOfLocationCriteria/<x>/Entry/EnterSpecificArea/Heading/MinimumHeading**

<x>/OnNetwork/MCPTTGroupList/<x>/Entry/RulesForAffiliation/<x>/ListOfLocationCriteria/<x>/Entry/EnterSpe
cificArea/Heading/MinimumHeading

Status	Occurrence	Format	Min. Access Types
Required	One	int	Get, Replace

This leaf node contains the minimum heading.

- Values: 0-359

5.2.48B4A23 /<x>/<x>/OnNetwork/MCPTTGroupList/<x>/Entry/
RulesForAffiliation/<x>/ListOfLocationCriteria/<x>/Entry/
EnterSpecificArea/Heading/MaximumHeading

**Table 5.2.48B4A23.1: /<x>/<x>/OnNetwork/MCPTTGroupList/<x>/Entry/RulesForAffiliation/<x>/
ListOfLocationCriteria/<x>/Entry/EnterSpecificArea/Heading/MaximumHeading**

<x>/OnNetwork/MCPTTGroupList/<x>/Entry/RulesForAffiliation/<x>/ListOfLocationCriteria/<x>/Entry/EnterSpe
cificArea/Heading/MaximumHeading

Status	Occurrence	Format	Min. Access Types
Required	One	int	Get, Replace

This leaf node contains the maximum heading.

- Values: 0-359

5.2.48B4A24 /<x>/<x>/OnNetwork/MCPTTGroupList/<x>/Entry/
RulesForAffiliation/<x>/ListOfLocationCriteria/<x>/Entry/
ExitSpecificArea

**Table 5.2.48B4A24.1: /<x>/<x>/OnNetwork/MCPTTGroupList/<x>/Entry/RulesForAffiliation/<x>/
ListOfLocationCriteria/<x>/Entry/ExitSpecificArea**

<x>/OnNetwork/MCPTTGroupList/<x>/Entry/RulesForAffiliation/<x>/ListOfLocationCriteria/<x>/Entry/ExitSpeci
ficArea

Status	Occurrence	Format	Min. Access Types
Optional	ZeroOrOne	node	Get, Replace

This interior node contains a geographical area which when entered by the MC service UE triggers evaluation of the rules.

5.2.48B4A25 /<x>/<x>/OnNetwork/MCPTTGroupList/<x>/Entry/ RulesForAffiliation/<x>/ListOfLocationCriteria/<x>/Entry/ ExitSpecificArea/PolygonArea

**Table 5.2.48B4A25.1: /<x>/<x>/OnNetwork/MCPTTGroupList/<x>/Entry/RulesForAffiliation/<x>/
ListOfLocationCriteria/<x>/Entry/ExitSpecificArea/PolygonArea**

<x>/OnNetwork/MCPTTGroupList/<x>/Entry/RulesForAffiliation/<x>/ListOfLocationCriteria/<x>/Entry/ExitSpecificArea/PolygonArea

Status	Occurrence	Format	Min. Access Types
Optional	ZeroOrOne	node	Get, Replace

This interior node contains a geographical area described by a polygon.

5.2.48B4A26 /<x>/<x>/OnNetwork/MCPTTGroupList/<x>/Entry/ RulesForAffiliation/<x>/ListOfLocationCriteria/<x>/Entry/ ExitSpecificArea/PolygonArea/<x>

**Table 5.2.48B4A26.1: /<x>/<x>/OnNetwork/MCPTTGroupList/<x>/Entry/RulesForAffiliation/<x>/
ListOfLocationCriteria/<x>/Entry/ExitSpecificArea/PolygonArea/<x>**

<x>/OnNetwork/MCPTTGroupList/<x>/Entry/RulesForAffiliation/<x>/ListOfLocationCriteria/<x>/Entry/ExitSpecificArea/PolygonArea/<x>

Status	Occurrence	Format	Min. Access Types
Required	OneOrN	node	Get, Replace

This interior node contains the coordinates of the corners which define a polygon. The occurrence of this leaf node is "3 to 15" as per 3GPP TS 23.032 [21].

5.2.48B4A27 /<x>/<x>/OnNetwork/MCPTTGroupList/<x>/Entry/ RulesForAffiliation/<x>/ListOfLocationCriteria/<x>/Entry/ ExitSpecificArea/PolygonArea/<x>/PointCoordinateType

**Table 5.2.48B4A27.1: /<x>/<x>/OnNetwork/MCPTTGroupList/<x>/Entry/RulesForAffiliation/<x>/
ListOfLocationCriteria/<x>/Entry/ExitSpecificArea/PolygonArea/<x>/PointCoordinateType**

<x>/OnNetwork/MCPTTGroupList/<x>/Entry/RulesForAffiliation/<x>/ListOfLocationCriteria/<x>/Entry/ExitSpecificArea/PolygonArea/<x>/PointCoordinateType

Status	Occurrence	Format	Min. Access Types
Required	One	node	Get, Replace

This interior node contains the type of the coordinates.

5.2.48B4A28 /<x>/<x>/OnNetwork/MCPTTGroupList/<x>/Entry/
RulesForAffiliation/<x>/ListOfLocationCriteria/<x>/Entry/
ExitSpecificArea/PolygonArea/<x>/PointCoordinateType/
Longitude

**Table 5.2.48B4A28.1: /<x>/<x>/OnNetwork/MCPTTGroupList/<x>/Entry/RulesForAffiliation/<x>/
ListOfLocationCriteria/<x>/Entry/ExitSpecificArea/PolygonArea/<x>/PointCoordinateType/
Longitude**

<x>/OnNetwork/MCPTTGroupList/<x>/Entry/RulesForAffiliation/<x>/ListOfLocationCriteria/<x>/Entry/ExitSpecificArea/PolygonArea/<x>/PointCoordinateType/Longitude

Status	Occurrence	Format	Min. Access Types
Required	One	int	Get, Replace

This leaf node contains the longitudinal coordinate of a corner.

5.2.48B4A29 /<x>/<x>/OnNetwork/MCPTTGroupList/<x>/Entry/
RulesForAffiliation/<x>/ListOfLocationCriteria/<x>/Entry/
ExitSpecificArea/PolygonArea/<x>/PointCoordinateType/
Latitude

**Table 5.2.48B4A29.1: /<x>/<x>/OnNetwork/MCPTTGroupList/<x>/Entry/RulesForAffiliation/<x>/
ListOfLocationCriteria/<x>/Entry/ExitSpecificArea/PolygonArea/<x>/PointCoordinateType/Latitude**

<x>/OnNetwork/MCPTTGroupList/<x>/Entry/RulesForAffiliation/<x>/ListOfLocationCriteria/<x>/Entry/ExitSpecificArea/PolygonArea/<x>/PointCoordinateType/Latitude

Status	Occurrence	Format	Min. Access
Required	One	int	Get, Replace

This leaf node contains the latitudinal coordinate of a corner.

5.2.48B4A30 /<x>/<x>/OnNetwork/MCPTTGroupList/<x>/Entry/
RulesForAffiliation/<x>/ListOfLocationCriteria/<x>/Entry/
ExitSpecificArea/EllipsoidArcArea

**Table 5.2.48B4A30.1: /<x>/<x>/OnNetwork/MCPTTGroupList/<x>/Entry/RulesForAffiliation/<x>/
ListOfLocationCriteria/<x>/Entry/ExitSpecificArea/EllipsoidArcArea**

<x>/OnNetwork/MCPTTGroupList/<x>/Entry/RulesForAffiliation/<x>/ListOfLocationCriteria/<x>/Entry/ExitSpecificArea/EllipsoidArcArea

Status	Occurrence	Format	Min. Access Types
Optional	ZeroOrOne	node	Get, Replace

This interior node contains a geographical area described by an ellipsoid arc.

5.2.48B4A31 /<x>/<x>/OnNetwork/MCPTTGroupList/<x>/Entry/ RulesForAffiliation/<x>/ListOfLocationCriteria/<x>/Entry/ ExitSpecificArea/EllipsoidArcArea/Center

**Table 5.2.48B4A31.1: /<x>/<x>/OnNetwork/MCPTTGroupList/<x>/Entry/RulesForAffiliation/<x>/
ListOfLocationCriteria/<x>/Entry/ExitSpecificArea/EllipsoidArcArea/Center**

<x>/OnNetwork/MCPTTGroupList/<x>/Entry/RulesForAffiliation/<x>/ListOfLocationCriteria/<x>/Entry/ExitSpecificArea/EllipsoidArcArea/Center

Status	Occurrence	Format	Min. Access Types
Required	One	node	Get, Replace

This interior node contains the coordinates of the center point of the ellipsoid arc.

5.2.48B4A32 /<x>/<x>/OnNetwork/MCPTTGroupList/<x>/Entry/ RulesForAffiliation/<x>/ListOfLocationCriteria/<x>/Entry/ ExitSpecificArea/EllipsoidArcArea/Center/PointCoordinateType

**Table 5.2.48B4A32.1: /<x>/<x>/OnNetwork/MCPTTGroupList/<x>/Entry/RulesForAffiliation/<x>/
ListOfLocationCriteria/<x>/Entry/ExitSpecificArea/EllipsoidArcArea/Center/PointCoordinateType**

<x>/OnNetwork/MCPTTGroupList/<x>/Entry/RulesForAffiliation/<x>/ListOfLocationCriteria/<x>/Entry/ExitSpecificArea/EllipsoidArcArea/Center/PointCoordinateType

Status	Occurrence	Format	Min. Access Types
Required	One	node	Get, Replace

This interior node contains the coordinates of the center point of the ellipsoid arc.

5.2.48B4A33 /<x>/<x>/OnNetwork/MCPTTGroupList/<x>/Entry/ RulesForAffiliation/<x>/ListOfLocationCriteria/<x>/Entry/ ExitSpecificArea/EllipsoidArcArea/Center/ PointCoordinateType/Longitude

**Table 5.2.48B4A33.1: /<x>/<x>/OnNetwork/MCPTTGroupList/<x>/Entry/RulesForAffiliation/<x>/
ListOfLocationCriteria/<x>/Entry/ExitSpecificArea/EllipsoidArcArea/Center/PointCoordinateType/
Longitude**

<x>/OnNetwork/MCPTTGroupList/<x>/Entry/RulesForAffiliation/<x>/ListOfLocationCriteria/<x>/Entry/ExitSpecificArea/EllipsoidArcArea/Center/PointCoordinateType/Longitude

Status	Occurrence	Format	Min. Access Types
Required	One	int	Get, Replace

This leaf node contains the longitudinal coordinate of the center.

5.2.48B4A34 /<x>/<x>/OnNetwork/MCPTTGroupList/<x>/Entry/
 RulesForAffiliation/<x>/ListOfLocationCriteria/<x>/Entry/
 ExitSpecificArea/EllipsoidArcArea/Center/
 PointCoordinateType/Latitude

**Table 5.2.48B4A34.1: /<x>/<x>/OnNetwork/MCPTTGroupList/<x>/Entry/RulesForAffiliation/<x>/
 ListOfLocationCriteria/<x>/Entry/ExitSpecificArea/EllipsoidArcArea/Center/PointCoordinateType/
 Latitude**

<x>/OnNetwork/MCPTTGroupList/<x>/Entry/RulesForAffiliation/<x>/ListOfLocationCriteria/<x>/Entry/ExitSpeci
 ficArea/EllipsoidArcArea/Center/PointCoordinateType/Latitude

Status	Occurrence	Format	Min. Access Types
Required	One	int	Get, Replace

This leaf node contains the latitudinal coordinate of a center.

5.2.48B4A35 /<x>/<x>/OnNetwork/MCPTTGroupList/<x>/Entry/
 RulesForAffiliation/<x>/ListOfLocationCriteria/<x>/Entry/
 ExitSpecificArea/EllipsoidArcArea/Radius

**Table 5.2.48B4A35.1: /<x>/<x>/OnNetwork/MCPTTGroupList/<x>/Entry/RulesForAffiliation/<x>/
 ListOfLocationCriteria/<x>/Entry/ExitSpecificArea/EllipsoidArcArea/Radius**

<x>/OnNetwork/MCPTTGroupList/<x>/Entry/RulesForAffiliation/<x>/ListOfLocationCriteria/<x>/Entry/ExitSpeci
 ficArea/EllipsoidArcArea/Center/Radius

Status	Occurrence	Format	Min. Access Types
Required	One	int	Get, Replace

This leaf node contains the radius of the ellipsoid arc.

5.2.48B4A36 /<x>/<x>/OnNetwork/MCPTTGroupList/<x>/Entry/
 RulesForAffiliation/<x>/ListOfLocationCriteria/<x>/Entry/
 ExitSpecificArea/EllipsoidArcArea/OffsetAngle

**Table 5.2.48B4A36.1: /<x>/<x>/OnNetwork/MCPTTGroupList/<x>/Entry/RulesForAffiliation/<x>/
 ListOfLocationCriteria/<x>/Entry/ExitSpecificArea/EllipsoidArcArea/OffsetAngle**

<x>/OnNetwork/MCPTTGroupList/<x>/Entry/RulesForAffiliation/<x>/ListOfLocationCriteria/<x>/Entry/ExitSpeci
 ficArea/EllipsoidArcArea/OffsetAngle

Status	Occurrence	Format	Min. Access Types
Required	One	int	Get, Replace

This leaf node contains the offset angle of the ellipsoid arc.

5.2.48B4A37 /<x>/<x>/OnNetwork/MCPTTGroupList/<x>/Entry/
RulesForAffiliation/<x>/ListOfLocationCriteria/<x>/Entry/
ExitSpecificArea/EllipsoidArcArea/IncludedAngle

**Table 5.2.48B4A37.1: /<x>/<x>/OnNetwork/MCPTTGroupList/<x>/Entry/RulesForAffiliation/<x>/
ListOfLocationCriteria/<x>/Entry/ExitSpecificArea/EllipsoidArcArea/IncludedAngle**

<x>/OnNetwork/MCPTTGroupList/<x>/Entry/RulesForAffiliation/<x>/ListOfLocationCriteria/<x>/Entry/ExitSpecificArea/EllipsoidArcArea/IncludedAngle

Status	Occurrence	Format	Min. Access Types
Required	One	int	Get, Replace

This leaf node contains the included angle of the ellipsoid arc.

5.2.48B4A38 /<x>/<x>/OnNetwork/MCPTTGroupList/<x>/Entry/
RulesForAffiliation/<x>/ListOfLocationCriteria/<x>/Entry/
ExitSpecificArea/Speed

**Table 5.2.48B4A38.1: /<x>/<x>/OnNetwork/MCPTTGroupList/<x>/Entry/RulesForAffiliation/<x>/
ListOfLocationCriteria/<x>/Entry/ExitSpecificArea/Speed**

<x>/OnNetwork/MCPTTGroupList/<x>/Entry/RulesForAffiliation/<x>/ListOfLocationCriteria/<x>/Entry/ExitSpecificArea/Speed

Status	Occurrence	Format	Min. Access Types
Optional	One	node	Get, Replace

This interior node contains the speed.

5.2.48B4A39 /<x>/<x>/OnNetwork/MCPTTGroupList/<x>/Entry/
RulesForAffiliation/<x>/ListOfLocationCriteria/<x>/Entry/
ExitSpecificArea/Speed/MinimumSpeed

**Table 5.2.48B4A39.1: /<x>/<x>/OnNetwork/MCPTTGroupList/<x>/Entry/RulesForAffiliation/<x>/
ListOfLocationCriteria/<x>/Entry/ExitSpecificArea/Speed/MinimumSpeed**

<x>/OnNetwork/MCPTTGroupList/<x>/Entry/RulesForAffiliation/<x>/ListOfLocationCriteria/<x>/Entry/ExitSpecificArea/Speed/MinimumSpeed

Status	Occurrence	Format	Min. Access Types
Required	One	int	Get, Replace

This leaf node contains the minimum speed.

- Values: non-negative integer in units of kilometers/hour.

5.2.48B4A40 /<x>/<x>/OnNetwork/MCPTTGroupList/<x>/Entry/
RulesForAffiliation/<x>/ListOfLocationCriteria/<x>/Entry/
ExitSpecificArea/Speed/MaximumSpeed

**Table 5.2.48B4A40.1: /<x>/<x>/OnNetwork/MCPTTGroupList/<x>/Entry/RulesForAffiliation/<x>/
ListOfLocationCriteria/<x>/Entry/ExitSpecificArea/Speed/MaximumSpeed**

<x>/OnNetwork/MCPTTGroupList/<x>/Entry/RulesForAffiliation/<x>/ListOfLocationCriteria/<x>/Entry/ExitSpecificArea/Speed/MaximumSpeed

Status	Occurrence	Format	Min. Access Types
Required	One	int	Get, Replace

This leaf node contains the maximum speed.

- Values: non-negative integer in units of kilometers/hour.

5.2.48B4A41 /<x>/<x>/OnNetwork/MCPTTGroupList/<x>/Entry/
RulesForAffiliation/<x>/ListOfLocationCriteria/<x>/Entry/
ExitSpecificArea/Heading

**Table 5.2.48B4A41.1: /<x>/<x>/OnNetwork/MCPTTGroupList/<x>/Entry/RulesForAffiliation/<x>/
ListOfLocationCriteria/<x>/Entry/ExitSpecificArea/Heading**

<x>/OnNetwork/MCPTTGroupList/<x>/Entry/RulesForAffiliation/<x>/ListOfLocationCriteria/<x>/Entry/ExitSpecificArea/Heading

Status	Occurrence	Format	Min. Access Types
Optional	One	node	Get, Replace

This interior node contains the heading.

5.2.48B4A42 /<x>/<x>/OnNetwork/MCPTTGroupList/<x>/Entry/
RulesForAffiliation/<x>/ListOfLocationCriteria/<x>/Entry/
ExitSpecificArea/Heading/MinimumHeading

**Table 5.2.48B4A42.1: /<x>/<x>/OnNetwork/MCPTTGroupList/<x>/Entry/RulesForAffiliation/<x>/
ListOfLocationCriteria/<x>/Entry/ExitSpecificArea/Heading/MinimumHeading**

<x>/OnNetwork/MCPTTGroupList/<x>/Entry/RulesForAffiliation/<x>/ListOfLocationCriteria/<x>/Entry/ExitSpecificArea/Heading/MinimumHeading

Status	Occurrence	Format	Min. Access Types
Required	One	int	Get, Replace

This leaf node contains the minimum heading.

- Values: 0-359

5.2.48B4A43 /<x>/<x>/OnNetwork/MCPTTGroupList/<x>/Entry/
RulesForAffiliation/<x>/ListOfLocationCriteria/<x>/Entry/
ExitSpecificArea/Heading/MaximumHeading

**Table 5.2.48B4A43.1: /<x>/<x>/OnNetwork/MCPTTGroupList/<x>/Entry/RulesForAffiliation/<x>/
ListOfLocationCriteria/<x>/Entry/ExitSpecificArea/Heading/MaximumHeading**

<x>/OnNetwork/MCPTTGroupList/<x>/Entry/RulesForAffiliation/<x>/ListOfLocationCriteria/<x>/Entry/ExitSpecificArea/Heading/MaximumHeading

Status	Occurrence	Format	Min. Access Types
Required	One	int	Get, Replace

This leaf node contains the maximum heading.

- Values: 0-359

5.2.48B4A44 /<x>/<x>/OnNetwork/MCPTTGroupList/<x>/Entry/
RulesForAffiliation/<x>/ListOfActiveFunctionalAliases

**Table 5.2.48B4A44.1: /<x>/<x>/OnNetwork/MCPTTGroupList/<x>/Entry/RulesForAffiliation/<x>/
ListOfActiveFunctionalAliases**

<x>/OnNetwork/MCPTTGroupList/<x>/Entry/RulesForAffiliation/<x>/ListOfActiveFunctionalAliases

Status	Occurrence	Format	Min. Access Types
Optional	One	node	Get, Replace

This interior node is a placeholder for the functional alias part of rules that control automatic affiliation.

5.2.48B4A45 /<x>/<x>/OnNetwork/MCPTTGroupList/<x>/Entry/
RulesForAffiliation/<x>/ListOfActiveFunctionalAliases/<x>

**Table 5.2.48B4A45.1: /<x>/<x>/OnNetwork/MCPTTGroupList/<x>/Entry/RulesForAffiliation/<x>/
ListOfActiveFunctionalAliases/<x>**

<x>/OnNetwork/MCPTTGroupList/<x>/Entry/RulesForAffiliation/<x>/ListOfActiveFunctionalAliases/<x>

Status	Occurrence	Format	Min. Access Types
Optional	OneOrMore	node	Get, Replace

This interior node is a placeholder for the functional alias part of rules that control automatic affiliation.

5.2.48B4A46 /<x>/<x>/OnNetwork/MCPTTGroupList/<x>/Entry/
RulesForAffiliation/<x>/ListOfActiveFunctionalAliases/<x>/Entry

**Table 5.2.48B4A46.1: /<x>/<x>/OnNetwork/MCPTTGroupList/<x>/Entry/RulesForAffiliation/<x>/
ListOfActiveFunctionalAliases/<x>/Entry**

<x>/OnNetwork/MCPTTGroupList/<x>/Entry/RulesForAffiliation/<x>/ListOfActiveFunctionalAliases/<x>/Entry

Status	Occurrence	Format	Min. Access Types
Optional	One	node	Get, Replace

This interior node is a placeholder for the functional alias part of rules that control automatic affiliation.

5.2.48B4A47 /<x>/<x>/OnNetwork/MCPTTGroupList/<x>/Entry/ RulesForAffiliation/<x>/ListOfActiveFunctionalAliases/<x>/ Entry/FunctionalAlias

**Table 5.2.48B4A47.1: /<x>/<x>/OnNetwork/MCPTTGroupList/<x>/Entry/RulesForAffiliation/<x>/
ListOfActiveFunctionalAliases/<x>/Entry/FunctionalAlias**

<x>/OnNetwork/MCPTTGroupList/<x>/Entry/RulesForAffiliation/<x>/ListOfActiveFunctionalAliases/<x>/Entry/
FunctionalAlias

Status	Occurrence	Format	Min. Access Types
Required	One	chr	Get, Replace

This leaf node contains a functional alias.

5.2.48B4B /<x>/<x>/OnNetwork/MCPTTGroupList/<x>/Entry/ RulesForDeaffiliation

Table 5.2.48B4B.1: /<x>/<x>/OnNetwork/MCPTTGroupList/<x>/Entry/RulesForDeaffiliation

<x>/OnNetwork/MCPTTGroupList/<x>/Entry/RulesForDeaffiliation

Status	Occurrence	Format	Min. Access Types
Optional	ZeroOrOne	node	Get, Replace

This interior node is a placeholder for the rules that control automatic deaffiliation.

5.2.48B4B0 /<x>/<x>/OnNetwork/MCPTTGroupList/<x>/Entry/ RulesForDeaffiliation/<x>

Table 5.2.48B4B0.1: /<x>/<x>/OnNetwork/MCPTTGroupList/<x>/Entry/RulesForDeaffiliation/<x>

<x>/OnNetwork/MCPTTGroupList/<x>/Entry/RulesForDeaffiliation/<x>

Status	Occurrence	Format	Min. Access Types
Optional	ZeroOrMore	node	Get, Replace

This interior node is a placeholder for the zero or more rules that control automatic deaffiliation.

5.2.48B4B1 /<x>/<x>/OnNetwork/MCPTTGroupList/<x>/Entry/ RulesForDeaffiliation/<x>/ListOfLocationCriteria

**Table 5.2.48B4B1.1: /<x>/<x>/OnNetwork/MCPTTGroupList/<x>/Entry/RulesForDeaffiliation/<x>/
ListOfLocationCriteria**

<x>/OnNetwork/MCPTTGroupList/<x>/Entry/RulesForDeaffiliation/<x>/ListOfLocationCriteria

Status	Occurrence	Format	Min. Access Types
Optional	One	node	Get, Replace

This interior node is a placeholder for the location portion of the rules that control automatic deaffiliation.

5.2.48B4B2 /<x>/<x>/OnNetwork/MCPTTGroupList/<x>/Entry/ RulesForDeaffiliation/<x>/ListOfLocationCriteria/<x>

**Table 5.2.48B4B2.1: /<x>/<x>/OnNetwork/MCPTTGroupList/<x>/Entry/RulesForDeaffiliation/<x>/
ListOfLocationCriteria/<x>**

<x>/OnNetwork/MCPTTGroupList/<x>/Entry/RulesForDeaffiliation/<x>/ListOfLocationCriteria/<x>

Status	Occurrence	Format	Min. Access Types
Optional	ZeroOrMore	node	Get, Replace

This interior node is a placeholder for the location portion of the rules that control automatic deaffiliation.

5.2.48B4B3 /<x>/<x>/OnNetwork/MCPTTGroupList/<x>/Entry/ RulesForDeaffiliation/<x>/ListOfLocationCriteria/<x>/Entry

**Table 5.2.48B4B3.1: /<x>/<x>/OnNetwork/MCPTTGroupList/<x>/Entry/RulesForDeaffiliation/<x>/
ListOfLocationCriteria/<x>/Entry**

<x>/OnNetwork/MCPTTGroupList/<x>/Entry/RulesForDeaffiliation/<x>/ListOfLocationCriteria/<x>/Entry

Status	Occurrence	Format	Min. Access Types
Optional	One	node	Get, Replace

This interior node is a placeholder for the location portion of the rules that control automatic deaffiliation.

5.2.48B4B4 /<x>/<x>/OnNetwork/MCPTTGroupList/<x>/Entry/ RulesForDeaffiliation/<x>/ListOfLocationCriteria/<x>/Entry/ EnterSpecificArea

**Table 5.2.48B4B4.1: /<x>/<x>/OnNetwork/MCPTTGroupList/<x>/Entry/RulesForDeaffiliation/<x>/
ListOfLocationCriteria/<x>/Entry/EnterSpecificArea**

<x>/OnNetwork/MCPTTGroupList/<x>/Entry/RulesForDeaffiliation/<x>/ListOfLocationCriteria/<x>/Entry/EnterS
pecificArea

Status	Occurrence	Format	Min. Access Types
Optional	ZeroOrOne	node	Get, Replace

This interior node contains a geographical area which, when entered by the MC service UE triggers evaluation of the rules.

5.2.48B4B5 /<x>/<x>/OnNetwork/MCPTTGroupList/<x>/Entry/ RulesForDeaffiliation/<x>/ListOfLocationCriteria/<x>/Entry/ EnterSpecificArea/PolygonArea

**Table 5.2.48B4B5.1: /<x>/<x>/OnNetwork/MCPTTGroupList/<x>/Entry/RulesForDeaffiliation/<x>/
ListOfLocationCriteria/<x>/Entry/EnterSpecificArea/PolygonArea**

<x>/OnNetwork/MCPTTGroupList/<x>/Entry/RulesForDeaffiliation/<x>/ListOfLocationCriteria/<x>/Entry/EnterS
pecificArea/PolygonArea

Status	Occurrence	Format	Min. Access Types
Optional	ZeroOrOne	node	Get, Replace

This interior node contains a geographical area described by a polygon.

5.2.48B4B6 /<x>/<x>/OnNetwork/MCPTTGroupList/<x>/Entry/ RulesForDeaffiliation/<x>/ListOfLocationCriteria/<x>/Entry/ EnterSpecificArea/PolygonArea/<x>

**Table 5.2.48B4B6.1: /<x>/<x>/OnNetwork/MCPTTGroupList/<x>/Entry/RulesForDeaffiliation/<x>/
ListOfLocationCriteria/<x>/Entry/EnterSpecificArea/PolygonArea/<x>**

<x>/OnNetwork/MCPTTGroupList/<x>/Entry/RulesForDeaffiliation/<x>/ListOfLocationCriteria/<x>/Entry/EnterS
pecificArea/PolygonArea/<x>

Status	Occurrence	Format	Min. Access Types
Required	OneOrN	node	Get, Replace

This interior node contains the coordinates of the corners which define a polygon. The occurrence of this leaf node is "3 to 15" as per 3GPP TS 23.032 [21].

5.2.48B4B7 /<x>/<x>/OnNetwork/MCPTTGroupList/<x>/Entry/ RulesForDeaffiliation/<x>/ListOfLocationCriteria/<x>/Entry/ EnterSpecificArea/PolygonArea/<x>/PointCoordinateType

**Table 5.2.48B4B7.1: /<x>/<x>/OnNetwork/MCPTTGroupList/<x>/Entry/RulesFordeaffiliation/<x>/
ListOfLocationCriteria/<x>/Entry/EnterSpecificArea/PolygonArea/<x>/PointCoordinateType**

<x>/OnNetwork/MCPTTGroupList/<x>/Entry/RulesForDeaffiliation/<x>/ListOfLocationCriteria/<x>/Entry/EnterS
pecificArea/PolygonArea/<x>/PointCoordinateType

Status	Occurrence	Format	Min. Access Types
Required	One	node	Get, Replace

This interior node contains the type of the coordinates.

5.2.48B4B8 /<x>/<x>/OnNetwork/MCPTTGroupList/<x>/Entry/ RulesForDeaffiliation/<x>/ListOfLocationCriteria/<x>/Entry/ EnterSpecificArea/PolygonArea/<x>/PointCoordinateType/ Longitude

**Table 5.2.48B4B8.1: /<x>/<x>/OnNetwork/MCPTTGroupList/<x>/Entry/RulesForDeaffiliation/<x>/
ListOfLocationCriteria/<x>/Entry/EnterSpecificArea/PolygonArea/<x>/PointCoordinateType/
Longitude**

<x>/OnNetwork/MCPTTGroupList/<x>/Entry/RulesForDeaffiliation/<x>/ListOfLocationCriteria/<x>/Entry/EnterS
pecificArea/PolygonArea/<x>/PointCoordinateType/Longitude

Status	Occurrence	Format	Min. Access Types
Required	One	int	Get, Replace

This leaf node contains the longitudinal coordinate of a corner.

5.2.48B4B9 /<x>/<x>/OnNetwork/MCPTTGroupList/<x>/Entry/
RulesForDeaffiliation/<x>/ListOfLocationCriteria/<x>/Entry/
EnterSpecificArea/PolygonArea/<x>/PointCoordinateType/
Latitude

**Table 5.2.48B4B9.1: /<x>/<x>/OnNetwork/MCPTTGroupList/<x>/Entry/RulesForDeaffiliation/<x>/
ListOfLocationCriteria/<x>/Entry/EnterSpecificArea/PolygonArea/<x>/PointCoordinateType/
Latitude**

<x>/OnNetwork/MCPTTGroupList/<x>/Entry/RulesForDeaffiliation/<x>/ListOfLocationCriteria/<x>/Entry/EnterS
pecificArea/PolygonArea/<x>/PointCoordinateType/Latitude

Status	Occurrence	Format	Min. Access
Required	One	int	Get, Replace

This leaf node contains the latitudinal coordinate of a corner.

5.2.48B4B10 /<x>/<x>/OnNetwork/MCPTTGroupList/<x>/Entry/
RulesForDeaffiliation/<x>/ListOfLocationCriteria/<x>/Entry/
EnterSpecificArea/EllipsoidArcArea

**Table 5.2.48B4B10.1: /<x>/<x>/OnNetwork/MCPTTGroupList/<x>/Entry/RulesForDeaffiliation/<x>/
ListOfLocationCriteria/<x>/Entry/EnterSpecificArea/EllipsoidArcArea**

<x>/OnNetwork/MCPTTGroupList/<x>/Entry/RulesForDeaffiliation/<x>/ListOfLocationCriteria/<x>/Entry/EnterS
pecificArea/EllipsoidArcArea

Status	Occurrence	Format	Min. Access Types
Optional	ZeroOrOne	node	Get, Replace

This interior node contains a geographical area described by an ellipsoid arc.

5.2.48B4B11 /<x>/<x>/OnNetwork/MCPTTGroupList/<x>/Entry/
RulesForDeaffiliation/<x>/ListOfLocationCriteria/<x>/Entry/
EnterSpecificArea/EllipsoidArcArea/Center

**Table 5.2.48B4B11.1: /<x>/<x>/OnNetwork/MCPTTGroupList/<x>/Entry/RulesForDeaffiliation/<x>/
ListOfLocationCriteria/<x>/Entry/EnterSpecificArea/EllipsoidArcArea/Center**

<x>/OnNetwork/MCPTTGroupList/<x>/Entry/RulesForDeaffiliation/<x>/ListOfLocationCriteria/<x>/Entry/EnterS
pecificArea/EllipsoidArcArea/Center

Status	Occurrence	Format	Min. Access Types
Required	One	node	Get, Replace

This interior node contains the coordinates of the center point of the ellipsoid arc.

5.2.48B4B12 /<x>/<x>/OnNetwork/MCPTTGroupList/<x>/Entry/ RulesForDeaffiliation/<x>/ListOfLocationCriteria/<x>/Entry/ EnterSpecificArea/EllipsoidArcArea/Center/PointCoordinateType

Table 5.2.48B4B12.1: /<x>/<x>/OnNetwork/MCPTTGroupList/<x>/Entry/RulesForDeaffiliation/<x>/ListOfLocationCriteria/<x>/Entry/EnterSpecificArea/EllipsoidArcArea/Center/PointCoordinateType

<x>/OnNetwork/MCPTTGroupList/<x>/Entry/RulesForDeaffiliation/<x>/ListOfLocationCriteria/<x>/Entry/EnterSpecificArea/EllipsoidArcArea/Center/PointCoordinateType

Status	Occurrence	Format	Min. Access Types
Required	One	node	Get, Replace

This interior node contains the coordinates of the center point of the ellipsoid arc.

5.2.48B4B13 /<x>/<x>/OnNetwork/MCPTTGroupList/<x>/Entry/ RulesForDeaffiliation/<x>/ListOfLocationCriteria/<x>/Entry/ EnterSpecificArea/EllipsoidArcArea/Center/ PointCoordinateType/Longitude

Table 5.2.48B4B13.1: /<x>/<x>/OnNetwork/MCPTTGroupList/<x>/Entry/RulesForDeaffiliation/<x>/ListOfLocationCriteria/<x>/Entry/EnterSpecificArea/EllipsoidArcArea/Center/PointCoordinateType/Longitude

<x>/OnNetwork/MCPTTGroupList/<x>/Entry/RulesForDeaffiliation/<x>/ListOfLocationCriteria/<x>/Entry/EnterSpecificArea/EllipsoidArcArea/Center/PointCoordinateType/Longitude

Status	Occurrence	Format	Min. Access Types
Required	One	int	Get, Replace

This leaf node contains the longitudinal coordinate of the center.

5.2.48B4B14 /<x>/<x>/OnNetwork/MCPTTGroupList/<x>/Entry/ RulesForDeaffiliation/<x>/ListOfLocationCriteria/<x>/Entry/ EnterSpecificArea/EllipsoidArcArea/Center/ PointCoordinateType/Latitude

Table 5.2.48B4B14.1: /<x>/<x>/OnNetwork/MCPTTGroupList/<x>/Entry/RulesForDeaffiliation/<x>/ListOfLocationCriteria/<x>/Entry/EnterSpecificArea/EllipsoidArcArea/Center/PointCoordinateType/Latitude

<x>/OnNetwork/MCPTTGroupList/<x>/Entry/RulesForDeaffiliation/<x>/ListOfLocationCriteria/<x>/Entry/EnterSpecificArea/EllipsoidArcArea/Center/PointCoordinateType/Latitude

Status	Occurrence	Format	Min. Access Types
Required	One	int	Get, Replace

This leaf node contains the latitudinal coordinate of a center.

5.2.48B4B15 /<x>/<x>/OnNetwork/MCPTTGroupList/<x>/Entry/ RulesForDeaffiliation/<x>/ListOfLocationCriteria/<x>/Entry/ EnterSpecificArea/EllipsoidArcArea/Radius

**Table 5.2.48B4B15.1: /<x>/<x>/OnNetwork/MCPTTGroupList/<x>/Entry/RulesForDeaffiliation/<x>/
ListOfLocationCriteria/<x>/Entry/EnterSpecificArea/EllipsoidArcArea/Radius**

<x>/OnNetwork/MCPTTGroupList/<x>/Entry/RulesForDeaffiliation/<x>/ListOfLocationCriteria/<x>/Entry/EnterS
pecificArea/EllipsoidArcArea/Center/Radius

Status	Occurrence	Format	Min. Access Types
Required	One	int	Get, Replace

This leaf node contains the radius of the ellipsoid arc.

5.2.48B4B16 /<x>/<x>/OnNetwork/MCPTTGroupList/<x>/Entry/ RulesForDeaffiliation/<x>/ListOfLocationCriteria/<x>/Entry/ EnterSpecificArea/EllipsoidArcArea/OffsetAngle

**Table 5.2.48B4B16.1: /<x>/<x>/OnNetwork/MCPTTGroupList/<x>/Entry/RulesForDeaffiliation/<x>/
ListOfLocationCriteria/<x>/Entry/EnterSpecificArea/EllipsoidArcArea/OffsetAngle**

<x>/OnNetwork/MCPTTGroupList/<x>/Entry/RulesForDeaffiliation/<x>/ListOfLocationCriteria/<x>/Entry/EnterS
pecificArea/EllipsoidArcArea/OffsetAngle

Status	Occurrence	Format	Min. Access Types
Required	One	int	Get, Replace

This leaf node contains the offset angle of the ellipsoid arc.

5.2.48B4B17 /<x>/<x>/OnNetwork/MCPTTGroupList/<x>/Entry/ RulesForDeaffiliation/<x>/ListOfLocationCriteria/<x>/Entry/ EnterSpecificArea/EllipsoidArcArea/IncludedAngle

**Table 5.2.48B4B17.1: /<x>/<x>/OnNetwork/MCPTTGroupList/<x>/Entry/RulesForDeaffiliation/<x>/
ListOfLocationCriteria/<x>/Entry/EnterSpecificArea/EllipsoidArcArea/IncludedAngle**

<x>/OnNetwork/MCPTTGroupList/<x>/Entry/RulesForDeaffiliation/<x>/ListOfLocationCriteria/<x>/Entry/EnterS
pecificArea/EllipsoidArcArea/IncludedAngle

Status	Occurrence	Format	Min. Access Types
Required	One	int	Get, Replace

This leaf node contains the included angle of the ellipsoid arc.

5.2.48B4B18 /<x>/<x>/OnNetwork/MCPTTGroupList/<x>/Entry/ RulesForDeaffiliation/<x>/ListOfLocationCriteria/<x>/Entry/ EnterSpecificArea/Speed

**Table 5.2.48B4B18.1: /<x>/<x>/OnNetwork/MCPTTGroupList/<x>/Entry/RulesForDeaffiliation/<x>/
ListOfLocationCriteria/<x>/Entry/EnterSpecificArea/Speed**

<x>/OnNetwork/MCPTTGroupList/<x>/Entry/RulesForDeaffiliation/<x>/ListOfLocationCriteria/<x>/Entry/EnterS
pecificArea/Speed

Status	Occurrence	Format	Min. Access Types

Optional	One	node	Get, Replace
----------	-----	------	--------------

This interior node contains the speed.

5.2.48B4B19 /<x>/<x>/OnNetwork/MCPTTGroupList/<x>/Entry/ RulesForDeaffiliation/<x>/ListOfLocationCriteria/<x>/Entry/ EnterSpecificArea/Speed/MinimumSpeed

**Table 5.2.48B4B19.1: /<x>/<x>/OnNetwork/MCPTTGroupList/<x>/Entry/RulesForDeaffiliation/<x>/
ListOfLocationCriteria/<x>/Entry/EnterSpecificArea/Speed/MinimumSpeed**

<x>/OnNetwork/MCPTTGroupList/<x>/Entry/RulesForDeaffiliation/<x>/ListOfLocationCriteria/<x>/Entry/EnterS
pecificArea/Speed/MinimumSpeed

Status	Occurrence	Format	Min. Access Types
Required	One	int	Get, Replace

This leaf node contains the minimum speed.

- Values: non-negative integer in units of kilometers/hour.

5.2.48B4B20 /<x>/<x>/OnNetwork/MCPTTGroupList/<x>/Entry/ RulesForDeaffiliation/<x>/ListOfLocationCriteria/<x>/Entry/ EnterSpecificArea/Speed/MaximumSpeed

**Table 5.2.48B4B20.1: /<x>/<x>/OnNetwork/MCPTTGroupList/<x>/Entry/RulesForDeaffiliation/<x>/
ListOfLocationCriteria/<x>/Entry/EnterSpecificArea/Speed/MaximumSpeed**

<x>/OnNetwork/MCPTTGroupList/<x>/Entry/RulesForDeaffiliation/<x>/ListOfLocationCriteria/<x>/Entry/EnterS
pecificArea/Speed/MaximumSpeed

Status	Occurrence	Format	Min. Access Types
Required	One	int	Get, Replace

This leaf node contains the maximum speed.

- Values: non-negative integer in units of kilometers/hour.

5.2.48B4B21 /<x>/<x>/OnNetwork/MCPTTGroupList/<x>/Entry/ RulesForDeaffiliation/<x>/ListOfLocationCriteria/<x>/Entry/ EnterSpecificArea/Heading

**Table 5.2.48B4B21.1: /<x>/<x>/OnNetwork/MCPTTGroupList/<x>/Entry/RulesForDeaffiliation/<x>/
ListOfLocationCriteria/<x>/Entry/EnterSpecificArea/Heading**

<x>/OnNetwork/MCPTTGroupList/<x>/Entry/RulesForDeaffiliation/<x>/ListOfLocationCriteria/<x>/Entry/EnterS
pecificArea/Heading

Status	Occurrence	Format	Min. Access Types
Optional	One	node	Get, Replace

This interior node contains the heading.

5.2.48B4B22 /<x>/<x>/OnNetwork/MCPTTGroupList/<x>/Entry/ RulesForDeaffiliation/<x>/ListOfLocationCriteria/<x>/Entry/ EnterSpecificArea/Heading/MinimumHeading

**Table 5.2.48B4B22.1: /<x>/<x>/OnNetwork/MCPTTGroupList/<x>/Entry/RulesForDeaffiliation/<x>/
ListOfLocationCriteria/<x>/Entry/EnterSpecificArea/Heading/MinimumHeading**

<x>/OnNetwork/MCPTTGroupList/<x>/Entry/RulesForDeaffiliation/<x>/ListOfLocationCriteria/<x>/Entry/EnterS
pecificArea/Heading/MinimumHeading

Status	Occurrence	Format	Min. Access Types
Required	One	int	Get, Replace

This leaf node contains the minimum heading.

- Values: 0-359

5.2.48B4B23 /<x>/<x>/OnNetwork/MCPTTGroupList/<x>/Entry/ RulesForDeaffiliation/<x>/ListOfLocationCriteria/<x>/Entry/ EnterSpecificArea/Heading/MaximumHeading

**Table 5.2.48B4B23.1: /<x>/<x>/OnNetwork/MCPTTGroupList/<x>/Entry/RulesForDeaffiliation/<x>/
ListOfLocationCriteria/<x>/Entry/EnterSpecificArea/Heading/MaximumHeading**

<x>/OnNetwork/MCPTTGroupList/<x>/Entry/RulesForDeaffiliation/<x>/ListOfLocationCriteria/<x>/Entry/EnterS
pecificArea/Heading/MaximumHeading

Status	Occurrence	Format	Min. Access Types
Required	One	int	Get, Replace

This leaf node contains the maximum heading.

- Values: 0-359

5.2.48B4B24 /<x>/<x>/OnNetwork/MCPTTGroupList/<x>/Entry/ RulesForDeaffiliation/<x>/ListOfLocationCriteria/<x>/Entry/ ExitSpecificArea

**Table 5.2.48B4B24.1: /<x>/<x>/OnNetwork/MCPTTGroupList/<x>/Entry/RulesForDeaffiliation/<x>/
ListOfLocationCriteria/<x>/Entry/ExitSpecificArea**

<x>/OnNetwork/MCPTTGroupList/<x>/Entry/RulesForDeaffiliation/<x>/ListOfLocationCriteria/<x>/Entry/ExitSpe
cificArea

Status	Occurrence	Format	Min. Access Types
Optional	ZeroOrOne	node	Get, Replace

This interior node contains a geographical area which when entered by the MC service UE triggers evaluation of the rules.

5.2.48B4B25 /<x>/<x>/OnNetwork/MCPTTGroupList/<x>/Entry/ RulesForDeaffiliation/<x>/ListOfLocationCriteria/<x>/Entry/ ExitSpecificArea/PolygonArea

**Table 5.2.48B4B25.1: /<x>/<x>/OnNetwork/MCPTTGroupList/<x>/Entry/RulesForDeaffiliation/<x>/
ListOfLocationCriteria/<x>/Entry/ExitSpecificArea/PolygonArea**

<x>/OnNetwork/MCPTTGroupList/<x>/Entry/RulesForDeaffiliation/<x>/ListOfLocationCriteria/<x>/Entry/ExitSpe
cificArea/PolygonArea

Status	Occurrence	Format	Min. Access Types
Optional	ZeroOrOne	node	Get, Replace

This interior node contains a geographical area described by a polygon.

5.2.48B4B26 /<x>/<x>/OnNetwork/MCPTTGroupList/<x>/Entry/ RulesForDeaffiliation/<x>/ListOfLocationCriteria/<x>/Entry/ ExitSpecificArea/PolygonArea/<x>

**Table 5.2.48B4B26.1: /<x>/<x>/OnNetwork/MCPTTGroupList/<x>/Entry/RulesForDeaffiliation/<x>/
ListOfLocationCriteria/<x>/Entry/ExitSpecificArea/PolygonArea/<x>**

<x>/OnNetwork/MCPTTGroupList/<x>/Entry/RulesForDeaffiliation/<x>/ListOfLocationCriteria/<x>/Entry/ExitSpe
cificArea/PolygonArea/<x>

Status	Occurrence	Format	Min. Access Types
Required	OneOrN	node	Get, Replace

This interior node contains the coordinates of the corners which define a polygon. The occurrence of this
leaf node is "3 to 15" as per 3GPP TS 23.032 [21].

5.2.48B4B27 /<x>/<x>/OnNetwork/MCPTTGroupList/<x>/Entry/ RulesForDeaffiliation/<x>/ListOfLocationCriteria/<x>/Entry/ ExitSpecificArea/PolygonArea/<x>/PointCoordinateType

**Table 5.2.48B4B27.1: /<x>/<x>/OnNetwork/MCPTTGroupList/<x>/Entry/RulesForDeaffiliation/<x>/
ListOfLocationCriteria/<x>/Entry/ExitSpecificArea/PolygonArea/<x>/PointCoordinateType**

<x>/OnNetwork/MCPTTGroupList/<x>/Entry/RulesForDeaffiliation/<x>/ListOfLocationCriteria/<x>/Entry/ExitSpe
cificArea/PolygonArea/<x>/PointCoordinateType

Status	Occurrence	Format	Min. Access Types
Required	One	node	Get, Replace

This interior node contains the type of the coordinates.

5.2.48B4B28 /<x>/<x>/OnNetwork/MCPTTGroupList/<x>/Entry/
RulesForDeaffiliation/<x>/ListOfLocationCriteria/<x>/Entry/
ExitSpecificArea/PolygonArea/<x>/PointCoordinateType/
Longitude

**Table 5.2.48B4B28.1: /<x>/<x>/OnNetwork/MCPTTGroupList/<x>/Entry/RulesForDeaffiliation/<x>/
ListOfLocationCriteria/<x>/Entry/ExitSpecificArea/PolygonArea/<x>/PointCoordinateType/
Longitude**

<x>/OnNetwork/MCPTTGroupList/<x>/Entry/RulesForDeaffiliation/<x>/ListOfLocationCriteria/<x>/Entry/ExitSpe
cificArea/PolygonArea/<x>/PointCoordinateType/Longitude

Status	Occurrence	Format	Min. Access Types
Required	One	int	Get, Replace

This leaf node contains the longitudinal coordinate of a corner.

5.2.48B4B29 /<x>/<x>/OnNetwork/MCPTTGroupList/<x>/Entry/
RulesForDeaffiliation/<x>/ListOfLocationCriteria/<x>/Entry/
ExitSpecificArea/PolygonArea/<x>/PointCoordinateType/
Latitude

**Table 5.2.48B4B29.1: /<x>/<x>/OnNetwork/MCPTTGroupList/<x>/Entry/RulesForDeaffiliation/<x>/
ListOfLocationCriteria/<x>/Entry/ExitSpecificArea/PolygonArea/<x>/PointCoordinateType/Latitude**

<x>/OnNetwork/MCPTTGroupList/<x>/Entry/RulesForDeaffiliation/<x>/ListOfLocationCriteria/<x>/Entry/ExitSpe
cificArea/PolygonArea/<x>/PointCoordinateType/Latitude

Status	Occurrence	Format	Min. Access
Required	One	int	Get, Replace

This leaf node contains the latitudinal coordinate of a corner.

5.2.48B4B30 /<x>/<x>/OnNetwork/MCPTTGroupList/<x>/Entry/
RulesForDeaffiliation/<x>/ListOfLocationCriteria/<x>/Entry/
ExitSpecificArea/EllipsoidArcArea

**Table 5.2.48B4B30.1: /<x>/<x>/OnNetwork/MCPTTGroupList/<x>/Entry/RulesForDeaffiliation/<x>/
ListOfLocationCriteria/<x>/Entry/ExitSpecificArea/EllipsoidArcArea**

<x>/OnNetwork/MCPTTGroupList/<x>/Entry/RulesForDeaffiliation/<x>/ListOfLocationCriteria/<x>/Entry/ExitSpe
cificArea/EllipsoidArcArea

Status	Occurrence	Format	Min. Access Types
Optional	ZeroOrOne	node	Get, Replace

This interior node contains a geographical area described by an ellipsoid arc.

5.2.48B4B31 /<x>/<x>/OnNetwork/MCPTTGroupList/<x>/Entry/
RulesForDeaffiliation/<x>/ListOfLocationCriteria/<x>/Entry/
ExitSpecificArea/EllipsoidArcArea/Center

Table 5.2.48B431.1: /<x>/<x>/OnNetwork/MCPTTGroupList/<x>/Entry/RulesForDeaffiliation/<x>/ListOfLocationCriteria/<x>/Entry/ExitSpecificArea/EllipsoidArcArea/Center

<x>/OnNetwork/MCPTTGroupList/<x>/Entry/RulesForDeaffiliation/<x>/ListOfLocationCriteria/<x>/Entry/ExitSpecificArea/EllipsoidArcArea/Center

Status	Occurrence	Format	Min. Access Types
Required	One	node	Get, Replace

This interior node contains the coordinates of the center point of the ellipsoid arc.

5.2.48B4B32 /<x>/<x>/OnNetwork/MCPTTGroupList/<x>/Entry/
RulesForDeaffiliation/<x>/ListOfLocationCriteria/<x>/Entry/
ExitSpecificArea/EllipsoidArcArea/Center/PointCoordinateType

Table 5.2.48B432.1: /<x>/<x>/OnNetwork/MCPTTGroupList/<x>/Entry/RulesForDeaffiliation/<x>/ListOfLocationCriteria/<x>/Entry/ExitSpecificArea/EllipsoidArcArea/Center/PointCoordinateType

<x>/OnNetwork/MCPTTGroupList/<x>/Entry/RulesForDeaffiliation/<x>/ListOfLocationCriteria/<x>/Entry/ExitSpecificArea/EllipsoidArcArea/Center/PointCoordinateType

Status	Occurrence	Format	Min. Access Types
Required	One	node	Get, Replace

This interior node contains the coordinates of the center point of the ellipsoid arc.

5.2.48B4B33 /<x>/<x>/OnNetwork/MCPTTGroupList/<x>/Entry/
RulesForDeaffiliation/<x>/ListOfLocationCriteria/<x>/Entry/
ExitSpecificArea/EllipsoidArcArea/Center/PointCoordinateType/
Longitude

Table 5.2.48B433.1: /<x>/<x>/OnNetwork/MCPTTGroupList/<x>/Entry/RulesForDeaffiliation/<x>/ListOfLocationCriteria/<x>/Entry/ExitSpecificArea/EllipsoidArcArea/Center/PointCoordinateType/Longitude

<x>/OnNetwork/MCPTTGroupList/<x>/Entry/RulesForDeaffiliation/<x>/ListOfLocationCriteria/<x>/Entry/ExitSpecificArea/EllipsoidArcArea/Center/PointCoordinateType/Longitude

Status	Occurrence	Format	Min. Access Types
Required	One	int	Get, Replace

This leaf node contains the longitudinal coordinate of the center.

5.2.48B4B34 /<x>/<x>/OnNetwork/MCPTTGroupList/<x>/Entry/ RulesForDeaffiliation/<x>/ListOfLocationCriteria/<x>/Entry/ ExitSpecificArea/EllipsoidArcArea/Center/PointCoordinateType/ Latitude

**Table 5.2.48B4B34.1: /<x>/<x>/OnNetwork/MCPTTGroupList/<x>/Entry/RulesForDeaffiliation/<x>/
ListOfLocationCriteria/<x>/Entry/ExitSpecificArea/EllipsoidArcArea/Center/PointCoordinateType/
Latitude**

<x>/OnNetwork/MCPTTGroupList/<x>/Entry/RulesForDeaffiliation/<x>/ListOfLocationCriteria/<x>/Entry/ExitSpe
cificArea/EllipsoidArcArea/Center/PointCoordinateType/Latitude

Status	Occurrence	Format	Min. Access Types
Required	One	int	Get, Replace

This leaf node contains the latitudinal coordinate of a center.

5.2.48B4B35 /<x>/<x>/OnNetwork/MCPTTGroupList/<x>/Entry/ RulesForDeaffiliation/<x>/ListOfLocationCriteria/<x>/Entry/ ExitSpecificArea/EllipsoidArcArea/Radius

**Table 5.2.48B4B35.1: /<x>/<x>/OnNetwork/MCPTTGroupList/<x>/Entry/RulesForDeaffiliation/<x>/
ListOfLocationCriteria/<x>/Entry/ExitSpecificArea/EllipsoidArcArea/Radius**

<x>/OnNetwork/MCPTTGroupList/<x>/Entry/RulesForDeaffiliation/<x>/ListOfLocationCriteria/<x>/Entry/ExitSpe
cificArea/EllipsoidArcArea/Center/Radius

Status	Occurrence	Format	Min. Access Types
Required	One	int	Get, Replace

This leaf node contains the radius of the ellipsoid arc.

5.2.48B4B36 /<x>/<x>/OnNetwork/MCPTTGroupList/<x>/Entry/ RulesForDeaffiliation/<x>/ListOfLocationCriteria/<x>/Entry/ ExitSpecificArea/EllipsoidArcArea/OffsetAngle

**Table 5.2.48B4B36.1: /<x>/<x>/OnNetwork/MCPTTGroupList/<x>/Entry/RulesForDeaffiliation/<x>/
ListOfLocationCriteria/<x>/Entry/ExitSpecificArea/EllipsoidArcArea/OffsetAngle**

<x>/OnNetwork/MCPTTGroupList/<x>/Entry/RulesForDeaffiliation/<x>/ListOfLocationCriteria/<x>/Entry/ExitSpe
cificArea/EllipsoidArcArea/OffsetAngle

Status	Occurrence	Format	Min. Access Types
Required	One	int	Get, Replace

This leaf node contains the offset angle of the ellipsoid arc.

5.2.48B4B37 /<x>/<x>/OnNetwork/MCPTTGroupList/<x>/Entry/ RulesForDeaffiliation/<x>/ListOfLocationCriteria/<x>/Entry/ ExitSpecificArea/EllipsoidArcArea/IncludedAngle

**Table 5.2.48B4B37.1: /<x>/<x>/OnNetwork/MCPTTGroupList/<x>/Entry/RulesForDeaffiliation/<x>/
ListOfLocationCriteria/<x>/Entry/ExitSpecificArea/EllipsoidArcArea/IncludedAngle**

<x>/OnNetwork/MCPTTGroupList/<x>/Entry/RulesForDeaffiliation/<x>/ListOfLocationCriteria/<x>/Entry/ExitSpe
cificArea/EllipsoidArcArea/IncludedAngle

Status	Occurrence	Format	Min. Access Types
Required	One	int	Get, Replace

This leaf node contains the included angle of the ellipsoid arc.

5.2.48B4B38 /<x>/<x>/OnNetwork/MCPTTGroupList/<x>/Entry/ RulesForDeaffiliation/<x>/ListOfLocationCriteria/<x>/Entry/ ExitSpecificArea/Speed

**Table 5.2.48B4B38.1: /<x>/<x>/OnNetwork/MCPTTGroupList/<x>/Entry/RulesForDeaffiliation/<x>/
ListOfLocationCriteria/<x>/Entry/ExitSpecificArea/Speed**

<x>/OnNetwork/MCPTTGroupList/<x>/Entry/RulesForDeaffiliation/<x>/ListOfLocationCriteria/<x>/Entry/ExitSpe
cificArea/Speed

Status	Occurrence	Format	Min. Access Types
Optional	One	node	Get, Replace

This interior node contains the speed.

5.2.48B4B39 /<x>/<x>/OnNetwork/MCPTTGroupList/<x>/Entry/ RulesForDeaffiliation/<x>/ListOfLocationCriteria/<x>/Entry/ ExitSpecificArea/Speed/MinimumSpeed

**Table 5.2.48B4B39.1: /<x>/<x>/OnNetwork/MCPTTGroupList/<x>/Entry/RulesForDeaffiliation/<x>/
ListOfLocationCriteria/<x>/Entry/ExitSpecificArea/Speed/MinimumSpeed**

<x>/OnNetwork/MCPTTGroupList/<x>/Entry/RulesForDeaffiliation/<x>/ListOfLocationCriteria/<x>/Entry/ExitSpe
cificArea/Speed/MinimumSpeed

Status	Occurrence	Format	Min. Access Types
Required	One	int	Get, Replace

This leaf node contains the minimum speed.

- Values: non-negative integer in units of kilometers/hour.

5.2.48B4B40 /<x>/<x>/OnNetwork/MCPTTGroupList/<x>/Entry/
RulesForDeaffiliation/<x>/ListOfLocationCriteria/<x>/Entry/
ExitSpecificArea/Speed/MaximumSpeed

**Table 5.2.48B4B40.1: /<x>/<x>/OnNetwork/MCPTTGroupList/<x>/Entry/RulesForDeaffiliation/<x>/
ListOfLocationCriteria/<x>/Entry/ExitSpecificArea/Speed/MaximumSpeed**

<x>/OnNetwork/MCPTTGroupList/<x>/Entry/RulesForDeaffiliation/<x>/ListOfLocationCriteria/<x>/Entry/ExitSpe
cificArea/Speed/MaximumSpeed

Status	Occurrence	Format	Min. Access Types
Required	One	int	Get, Replace

This leaf node contains the maximum speed.

- Values: non-negative integer in units of kilometers/hour.

5.2.48B4B41 /<x>/<x>/OnNetwork/MCPTTGroupList/<x>/Entry/
RulesForDeaffiliation/<x>/ListOfLocationCriteria/<x>/Entry/
ExitSpecificArea/Heading

**Table 5.2.48B4B41.1: /<x>/<x>/OnNetwork/MCPTTGroupList/<x>/Entry/RulesForDeaffiliation/<x>/
ListOfLocationCriteria/<x>/Entry/ExitSpecificArea/Heading**

<x>/OnNetwork/MCPTTGroupList/<x>/Entry/RulesForDeaffiliation/<x>/ListOfLocationCriteria/<x>/Entry/ExitSpe
cificArea/Heading

Status	Occurrence	Format	Min. Access Types
Optional	One	node	Get, Replace

This interior node contains the heading.

5.2.48B4B42 /<x>/<x>/OnNetwork/MCPTTGroupList/<x>/Entry/
RulesForDeaffiliation/<x>/ListOfLocationCriteria/<x>/Entry/
ExitSpecificArea/Heading/MinimumHeading

**Table 5.2.48B4B42.1: /<x>/<x>/OnNetwork/MCPTTGroupList/<x>/Entry/RulesForDeaffiliation/<x>/
ListOfLocationCriteria/<x>/Entry/ExitSpecificArea/Heading/MinimumHeading**

<x>/OnNetwork/MCPTTGroupList/<x>/Entry/RulesForDeaffiliation/<x>/ListOfLocationCriteria/<x>/Entry/ExitSpe
cificArea/Heading/MinimumHeading

Status	Occurrence	Format	Min. Access Types
Required	One	int	Get, Replace

This leaf node contains the minimum heading.

- Values: 0-359

5.2.48B4B43 /<x>/<x>/OnNetwork/MCPTTGroupList/<x>/Entry/
RulesForDeaffiliation/<x>/ListOfLocationCriteria/<x>/Entry/
ExitSpecificArea/Heading/MaximumHeading

**Table 5.2.48B4B43.1: /<x>/<x>/OnNetwork/MCPTTGroupList/<x>/Entry/RulesForDeaffiliation/<x>/
ListOfLocationCriteria/<x>/Entry/ExitSpecificArea/Heading/MaximumHeading**

<x>/OnNetwork/MCPTTGroupList/<x>/Entry/RulesForDeaffiliation/<x>/ListOfLocationCriteria/<x>/Entry/ExitSpe
cificArea/Heading/MaximumHeading

Status	Occurrence	Format	Min. Access Types
Required	One	int	Get, Replace

This leaf node contains the maximum heading.

- Values: 0-359

5.2.48B4B44 /<x>/<x>/OnNetwork/MCPTTGroupList/<x>/Entry/
RulesForDeaffiliation/<x>/ListOfActiveFunctionalAliases

**Table 5.2.48B4B44.1: /<x>/<x>/OnNetwork/MCPTTGroupList/<x>/Entry/RulesForDeaffiliation/<x>/
ListOfActiveFunctionalAliases**

<x>/OnNetwork/MCPTTGroupList/<x>/Entry/RulesForDeaffiliation/<x>/ListOfActiveFunctionalAliases

Status	Occurrence	Format	Min. Access Types
Optional	One	node	Get, Replace

This interior node is a placeholder for the functional alias part of rules that control automatic deaffiliation.

5.2.48B4B45 /<x>/<x>/OnNetwork/MCPTTGroupList/<x>/Entry/
RulesForDeaffiliation/<x>/ListOfActiveFunctionalAliases/<x>

**Table 5.2.48B4B45.1: /<x>/<x>/OnNetwork/MCPTTGroupList/<x>/Entry/RulesForDeaffiliation/<x>/
ListOfActiveFunctionalAliases/<x>**

<x>/OnNetwork/MCPTTGroupList/<x>/Entry/RulesForDeaffiliation/<x>/ListOfActiveFunctionalAliases/<x>

Status	Occurrence	Format	Min. Access Types
Optional	OneOrMore	node	Get, Replace

This interior node is a placeholder for the functional alias part of rules that control automatic deaffiliation.

5.2.48B4B46 /<x>/<x>/OnNetwork/MCPTTGroupList/<x>/Entry/
RulesForDeaffiliation/<x>/ListOfActiveFunctionalAliases/<x>/Entry

**Table 5.2.48B4B46.1: /<x>/<x>/OnNetwork/MCPTTGroupList/<x>/Entry/RulesForDeaffiliation/<x>/
ListOfActiveFunctionalAliases/<x>/Entry**

<x>/OnNetwork/MCPTTGroupList/<x>/Entry/RulesForDeaffiliation/<x>/ListOfActiveFunctionalAliases/<x>/Entry

Status	Occurrence	Format	Min. Access Types
Optional	One	node	Get, Replace

This interior node is a placeholder for the functional alias part of rules that control automatic deaffiliation.

5.2.48B4B47 /<x>/<x>/OnNetwork/MCPTTGroupList/<x>/Entry/ RulesForDeaffiliation/<x>/ListOfActiveFunctionalAliases/<x>/ Entry/FunctionalAlias

**Table 5.2.48B4B47.1: /<x>/<x>/OnNetwork/MCPTTGroupList/<x>/Entry/RulesForDeaffiliation/<x>/
ListOfActiveFunctionalAliases/<x>/Entry/FunctionalAlias**

<x>/OnNetwork/MCPTTGroupList/<x>/Entry/RulesForDeaffiliation/<x>/ListOfActiveFunctionalAliases/<x>/Entry/
FunctionalAlias

Status	Occurrence	Format	Min. Access Types
Required	One	chr	Get, Replace

This leaf node contains a functional alias.

5.2.48B5/<x>/<x>/OnNetwork/MCPTTGroupList/<x>/Entry/DisplayName

Table 5.2.48B5.1: /<x>/<x>/OnNetwork/MCPTTGroupList/<x>/Entry/DisplayName

<x>/OnNetwork/MCPTTGroupList/<x>/Entry/DisplayName

Status	Occurrence	Format	Min. Access Types
Optional	One	chr	Get, Replace

This leaf node contains a human readable name that corresponds to the MCPTT Group ID.

5.2.48B6/<x>/<x>/OnNetwork/MCPTTGroupList/<x>/Entry/ ManualDeaffiliationNotAllowedIfAffiliationRulesAreMet

**Table 5.2.48B6.1: /<x>/<x>/OnNetwork/MCPTTGroupList/<x>/Entry/
ManualDeaffiliationNotAllowedIfAffiliationRulesAreMet**

<x>/OnNetwork/MCPTTGroupList/<x>/Entry/ManualDeaffiliationNotAllowedIfAffiliationRulesAreMet

Status	Occurrence	Format	Min. Access Types
Optional	ZeroOrOne	bool	Get, Replace

This leaf node indicates whether the MCPTT user is authorised to deaffiliate if the affiliation criteria are met.

5.2.48B7/<x>/<x>/OnNetwork/MCPTTGroupList/<x>/Entry/ RelativePresentationPriority

**Table 5.2.48B7.1: /<x>/<x>/OnNetwork/MCPTTGroupList/<x>/Entry/
RelativePresentationPriority**

<x>/OnNetwork/MCPTTGroupList/<x>/Entry/RelativePresentationPriority

Status	Occurrence	Format	Min. Access Types
Optional	One	int	Get, Replace

This leaf node indicates the presentation priority of the on-network group, identified by the MCPTTGroupID, relative to other on-network groups and on-network users.

- Values: 0-255

The lowest RelativePresentationPriority value shall be considered as the MCPTT group transaction having the lowest priority for presentation among other group MCPTT and one-to-one user transactions.

5.2.48B8/ <x>/ <x>/OnNetwork/MCPTTGroupList/ <x>/Entry/GMSServID

Table 5.2.48B8.1: / <x>/ <x>/OnNetwork/MCPTTGroupList/ <x>/Entry/GMSServID

<x>/OnNetwork/MCPTTGroupList/ <x>/Entry/GMSServID

Status	Occurrence	Format	Min. Access Types
Required	One	chr	Get, Replace

This leaf node indicates the identity (URI) of the GMS owning the group identified by the MCPTTGroupID.

5.2.48B9/ <x>/ <x>/OnNetwork/MCPTTGroupList/ <x>/Entry/IDMSTokenEndPoint

Table 5.2.48B9.1: / <x>/ <x>/OnNetwork/MCPTTGroupList/ <x>/Entry/IDMSTokenEndPoint

<x>/OnNetwork/MCPTTGroupList/ <x>/Entry/IDMSTokenEndPoint

Status	Occurrence	Format	Min. Access Types
Required	One	chr	Get, Replace

This leaf node indicates the identity (URI) of the IDMS token endpoint for the group identified by the MCPTTGroupID. If the value is empty, the IDMS identities (IDMSAuthEndPoint and IDMSTokenEndPoint) present in the MCS UE initial configuration MO are used.

5.2.48B10 / <x>/ <x>/OnNetwork/MCPTTGroupList/ <x>/Entry/GroupKMSURI

Table 5.2.48B10.1: / <x>/ <x>/OnNetwork/MCPTTGroupList/ <x>/Entry/GroupKMSURI

<x>/OnNetwork/MCPTTGroupList/ <x>/Entry/GroupKMSURI

Status	Occurrence	Format	Min. Access Types
Required	One	chr	Get, Replace

This leaf node indicates the identity (URI) of the KMS identity (URI) for the group identified by the MCPTTGroupID. If the value is empty, the KMS identity (URI) (kms) present in the MCS UE initial configuration MO is used.

5.2.48C1 / <x>/ <x>/OnNetwork/ImplicitAffiliations

Table 5.2.48C1.1: / <x>/ <x>/OnNetwork/ImplicitAffiliations

<x>/OnNetwork/ImplicitAffiliations

Status	Occurrence	Format	Min. Access Types
Required	One	node	Get, Replace

This interior node is a placeholder for the implicit affiliation configuration.

5.2.48C2 / <x>/ <x>/OnNetwork/ImplicitAffiliations/ <x>

Table 5.2.48C2.1: / <x>/ <x>/OnNetwork/ImplicitAffiliations/ <x>

<x>/OnNetwork/ImplicitAffiliations/ <x>

Status	Occurrence	Format	Min. Access Types

Required	OneOrMore	node	Get, Replace
----------	-----------	------	--------------

This interior node is a placeholder for one or more implicit affiliation configuration.

5.2.48C3 /<x>/<x>/OnNetwork/ImplicitAffiliations/<x>/Entry

Table 5.2.48C3.1: /<x>/<x>/OnNetwork/ImplicitAffiliations/<x>/Entry

<x>/OnNetwork/ImplicitAffiliations/<x>/Entry

Status	Occurrence	Format	Min. Access Types
Optional	One	node	Get, Replace

This interior node is a placeholder for the details of the on-network MCPTT groups that the MCPTT user is implicitly affiliated to.

5.2.48C4 /<x>/<x>/OnNetwork/ImplicitAffiliations/<x>/Entry/MCPTTGroupID

Table 5.2.48C4.1: /<x>/<x>/OnNetwork/ImplicitAffiliations/<x>/Entry/MCPTTGroupID

<x>/OnNetwork/ImplicitAffiliations/<x>/Entry/MCPTTGroupID

Status	Occurrence	Format	Min. Access Types
Required	One	chr	Get, Replace

This leaf node indicates a MCPTT group ID to which the MCPTT user is implicitly affiliated to.

The value is a "uri" attribute specified in OMA OMA-TS-XDM_Group-V1_1 [4].

5.2.48C5 /<x>/<x>/OnNetwork/ImplicitAffiliations/<x>/Entry/DisplayName

Table 5.2.48C5.1: /<x>/<x>/OnNetwork/ImplicitAffiliations/<x>/Entry/DisplayName

<x>/OnNetwork/ImplicitAffiliations/<x>/Entry/DisplayName

Status	Occurrence	Format	Min. Access Types
Optional	One	chr	Get, Replace

This leaf node contains a human readable name that corresponds to the MCPTT Group ID.

5.2.48D /<x>/<x>/OnNetwork/AllowedRegroup

Table 5.2.48D.1: /<x>/<x>/OnNetwork/AllowedRegroup

<x>/OnNetwork/AllowedRegroup

Status	Occurrence	Format	Min. Access Types
Required	One	bool	Get, Replace

This leaf node indicates whether the MCPTT user is authorised to perform dynamic regrouping operations.

When set to "true" the MCPTT user is authorised to perform dynamic regrouping operations.

When set to "false" the MCPTT user is not authorised to perform dynamic regrouping operations.

5.2.48E /<x>/<x>/OnNetwork/AllowedPresenceStatus

Table 5.2.48E.1: /<x>/<x>/OnNetwork/AllowedPresenceStatus

<x>/OnNetwork/AllowedPresenceStatus

Status	Occurrence	Format	Min. Access Types
Optional	One	bool	Get, Replace

This leaf node indicates the presence status on the network of this MCPTT user is available.

When set to "true" the presence status on the network of this MCPTT user is available.

When set to "false" the presence status on the network of this MCPTT user is not available. This is the default if this leaf node is not present.

5.2.48F /<x>/<x>/OnNetwork/AllowedPresence

Table 5.2.48F.1: /<x>/<x>/OnNetwork/AllowedPresence

<x>/OnNetwork/AllowedPresence

Status	Occurrence	Format	Min. Access Types
Optional	One	bool	Get, Replace

This leaf node indicates whether the MCPTT user is authorised to obtain whether a particular MCPTT User is present on the network.

When set to "true" the MCPTT user is authorised to obtain whether a particular MCPTT User is present on the network.

When set to "false" the MCPTT user is not authorised to obtain whether a particular MCPTT User is present on the network.

5.2.48G /<x>/<x>/OnNetwork/EnabledParticipation

Table 5.2.48G.1: /<x>/<x>/OnNetwork/EnabledParticipation

<x>/OnNetwork/EnabledParticipation

Status	Occurrence	Format	Min. Access Types
Required	One	bool	Get, Replace

This leaf node indicates whether the MCPTT user is allowed to participate in MCPTT private calls that they are invited to.

When set to "true" the MCPTT user is allowed to participate in MCPTT private calls that they are invited to.

When set to "false" the MCPTT user is not allowed to participate in MCPTT private calls that they are invited to.

5.2.48H /<x>/<x>/OnNetwork/AllowedTransmission

Table 5.2.48H.1: /<x>/<x>/OnNetwork/AllowedTransmission

<x>/OnNetwork/AllowedTransmission

Status	Occurrence	Format	Min. Access Types
Required	One	bool	Get, Replace

This leaf node indicates whether the MCPTT user is authorised to override transmission in a MCPTT private call.

When set to "true" the MCPTT user is authorised to override transmission in a MCPTT private call.

When set to "false" the MCPTT user is not authorised to override transmission in a MCPTT private call.

5.2.48I /<x>/<x>/OnNetwork/AllowedManualSwitch

Table 5.2.48I.1: /<x>/<x>/OnNetwork/AllowedManualSwitch

<x>/OnNetwork/AllowedManualSwitch

Status	Occurrence	Format	Min. Access Types
Required	One	bool	Get, Replace

This leaf node indicates whether the MCPTT user is authorised to manually switch to off-network operation while in on-network operation.

When set to "true" the MCPTT user is authorised to manually switch to off-network operation while in on-network operation.

When set to "false" the MCPTT user is not authorised to manually switch to off-network operation while in on-network operation.

5.2.48J /<x>/<x>/OnNetwork/PrivateCall

Table 5.2.48J.1: /<x>/<x>/OnNetwork/PrivateCall

<x>/OnNetwork/PrivateCall

Status	Occurrence	Format	Min. Access Types
Required	One	node	Get, Replace

This interior node is a placeholder for the MCPTT private call configuration.

5.2.48K /<x>/<x>/OnNetwork/PrivateCall/EmergencyAlert

Table 5.2.48K.1: /<x>/<x>/OnNetwork/PrivateCall/EmergencyAlert

<x>/OnNetwork/PrivateCall/EmergencyAlert

Status	Occurrence	Format	Min. Access Types
Required	One	node	Get, Replace

This interior node is a placeholder for the MCPTT private emergency alert policy.

5.2.48L /<x>/<x>/OnNetwork/PrivateCall/EmergencyAlert/Entry

Table 5.2.48L.1: /<x>/<x>/OnNetwork/PrivateCall/EmergencyAlert/Entry

<x>/OnNetwork/PrivateCall/EmergencyAlert/Entry

Status	Occurrence	Format	Min. Access Types
Required	One	node	Get, Replace

This interior node is a placeholder for the details of an MCPTT private emergency alert for on-network.

5.2.48M /<x>/<x>/OnNetwork/PrivateCall/EmergencyAlert/Entry/ID

Table 5.2.48M.1: /<x>/<x>/OnNetwork/PrivateCall/EmergencyAlert/Entry/ID

<x>/OnNetwork/PrivateCall/EmergencyAlert/Entry/ID

Status	Occurrence	Format	Min. Access Types
Required	One	chr	Get, Replace

This leaf node indicates the MCPTT user ID used upon certain criteria on initiation of an MCPTT private emergency alert for on-network.

5.2.48N /<x>/<x>/OnNetwork/PrivateCall/EmergencyAlert/Entry/DisplayName

Table 5.2.48N.1: /<x>/<x>/OnNetwork/PrivateCall/EmergencyAlert/Entry/DisplayName

<x>/OnNetwork/PrivateCall/EmergencyAlert/Entry/DisplayName

Status	Occurrence	Format	Min. Access Types
Optional	One	chr	Get, Replace

This leaf node contains a human readable name that corresponds to the ID.

5.2.48O /<x>/<x>/OnNetwork/PrivateCall/EmergencyAlert/Entry/Usage

Table 5.2.48O.1: /<x>/<x>/OnNetwork/PrivateCall/EmergencyAlert/Entry/Usage

<x>/OnNetwork/PrivateCall/EmergencyAlert/Entry/Usage

Status	Occurrence	Format	Min. Access Types
Required	One	chr	Get, Replace

This leaf node indicates the criteria to determine when initiation of an MCPTT private emergency alert uses the ID.

The valid values are 'LocallyDetermined' and 'UsePreConfigured'.

When set to 'LocallyDetermined' then if the MCPTT user selects an MCPTT ID then use that MCPTT ID for an on-network MCPTT private emergency alert, if the MCPTT user does not select a MCPTT ID then use the MCPTT ID identified by the ID in clause 5.2.48M for an on-network MCPTT private emergency alert.

When set to 'UsePreConfigured' then use the ID identified by the ID in clause 5.2.48M for an on-network MCPTT private emergency alert.

5.2.48P /<x>/<x>/OnNetwork/PrivateCall/AllowedCallBackRequest

Table 5.2.48P.1: /<x>/<x>/OnNetwork/PrivateCall/AllowedCallBackRequest

<x>/OnNetwork/PrivateCall/AllowedCallBackRequest

Status	Occurrence	Format	Min. Access Types
Optional	One	bool	Get, Replace

This leaf node indicates whether the MCPTT user is allowed to request a private call call-back.

When set to "true" the MCPTT user is allowed to request a private call call-back.

When set to "false" the MCPTT user is not allowed to request a private call call-back.

5.2.48Q /<x>/<x>/OnNetwork/PrivateCall/AllowedCallBackCancelRequest

Table 5.2.48Q.1: /<x>/<x>/OnNetwork/PrivateCall/AllowedCallBackCancelRequest

<x>/OnNetwork/PrivateCall/AllowedCallBackCancelRequest

Status	Occurrence	Format	Min. Access Types
Optional	One	bool	Get, Replace

This leaf node indicates whether the MCPTT user is allowed to cancel an outstanding private call call-back request.

When set to "true" the MCPTT user is allowed to cancel an outstanding private call call-back request.

When set to "false" the MCPTT user is not allowed to cancel an outstanding private call call-back request.

5.2.48R /<x>/<x>/OnNetwork/PrivateCall/AllowedRemoteInitiatedAmbientListening

Table 5.2.48R.1: /<x>/<x>/OnNetwork/PrivateCall/AllowedRemoteInitiatedAmbientListening

<x>/OnNetwork/PrivateCall/AllowedRemoteInitiatedAmbientListening

Status	Occurrence	Format	Min. Access Types
Optional	One	bool	Get, Replace

This leaf node indicates whether the MCPTT user is allowed to request a remote initiated ambient listening call.

When set to "true" the MCPTT user is allowed to request a remote initiated ambient listening call.

When set to "false" the MCPTT user is not allowed to request a remote initiated ambient listening call.

5.2.48S /<x>/<x>/OnNetwork/PrivateCall/AllowedLocallyInitiatedAmbientListening

Table 5.2.48S.1: /<x>/<x>/OnNetwork/PrivateCall/AllowedLocallyInitiatedAmbientListening

<x>/OnNetwork/PrivateCall/AllowedLocallyInitiatedAmbientListening

Status	Occurrence	Format	Min. Access Types
Optional	One	bool	Get, Replace

This leaf node indicates whether the MCPTT user is allowed to request a locally initiated ambient listening call.

When set to "true" the MCPTT user is allowed to request a locally initiated ambient listening call.

When set to "false" the MCPTT user is not allowed to request a locally initiated ambient listening call.

5.2.48T /<x>/<x>/OnNetwork/PrivateCall/AllowedRequestFirstToAnswerCall

Table 5.2.48T.1: /<x>/<x>/OnNetwork/PrivateCall/AllowedRequestFirstToAnswerCall

<x>/OnNetwork/PrivateCall/AllowedRequestFirstToAnswerCall

Status	Occurrence	Format	Min. Access Types

Optional	One	bool	Get, Replace
----------	-----	------	--------------

This leaf node indicates whether the MCPTT user is allowed to request a first to answer call.

When set to "true" the MCPTT user is allowed to request a first to answer call.

When set to "false" the MCPTT user is not allowed to request a first to answer call.

5.2.48T1 /<x>/<x>/OnNetwork/PrivateCall/AllowedCallTransfer

Table 5.2.48T1.1: /<x>/<x>/OnNetwork/PrivateCall/AllowedCallTransfer

<x>/OnNetwork/PrivateCall/AllowedCallTransfer

Status	Occurrence	Format	Min. Access Types
Optional	One	bool	Get, Replace

This leaf node indicates whether the MCPTT user is allowed to request a call transfer.

When set to "true" the MCPTT user is allowed to request a call transfer.

When set to "false" the MCPTT user is not allowed to request a call transfer.

5.2.48T2 /<x>/<x>/OnNetwork/PrivateCall/AllowedCallTransferAny

Table 5.2.48T2.1: /<x>/<x>/OnNetwork/PrivateCall/AllowedCallTransferAny

<x>/OnNetwork/PrivateCall/AllowedCallTransferAny

Status	Occurrence	Format	Min. Access Types
Optional	One	bool	Get, Replace

This leaf node indicates whether the MCPTT user is allowed to request a call transfer to any target user.

When set to "true" the MCPTT user is allowed to request a call transfer to any target user.

When set to "false" the MCPTT user is not allowed to request a call transfer to any user, permission of call transfer is checked based on on entries in the <AllowedTargetMCPTTIDList>/<AllowedTargetFunctionalAliasIDList> as defined in 3GPP TS 24.484 [12] using the procedures defined in 3GPP TS 24.379 [7].

5.2.48T3 /<x>/<x>/OnNetwork/PrivateCall/AllowedCallForwardManualInput

Table 5.2.48T3.1: /<x>/<x>/OnNetwork/PrivateCall/AllowedCallForwardManualInput

<x>/OnNetwork/PrivateCall/AllowedCallForwardManualInput

Status	Occurrence	Format	Min. Access Types
Optional	One	bool	Get, Replace

This leaf node indicates whether the MCPTT user is allowed to request a call forwarding based on manual user input.

When set to "true" the MCPTT user is allowed to request a call forwarding based on manual user input. The target of the forwarding is not restricted (e.g. can be any MCPTT user).

When set to "false" the MCPTT user is not allowed to request a call forwarding based on manual user input.

5.2.48U1 /<x>/<x>/OnNetwork/RemoteGroupSelection

Table 5.2.48U1.1: /<x>/<x>/OnNetwork/RemoteGroupSelection

<x>/OnNetwork/RemoteGroupSelection

Status	Occurrence	Format	Min. Access Types
Required	One	node	Get, Replace

This interior node is a placeholder for the remote group selection configuration.

5.2.48U2 /<x>/<x>/OnNetwork/RemoteGroupSelection/<x>

Table 5.2.48U2.1: /<x>/<x>/OnNetwork/RemoteGroupSelection/<x>

<x>/OnNetwork/RemoteGroupSelection/<x>

Status	Occurrence	Format	Min. Access Types
Required	OneOrMore	node	Get, Replace

This interior node is a placeholder for one or more remote group selection configuration elements.

5.2.48U3 /<x>/<x>/OnNetwork/RemoteGroupSelection/<x>/Entry

Table 5.2.48U3.1: /<x>/<x>/OnNetwork/RemoteGroupSelection/<x>/Entry

<x>/OnNetwork/RemoteGroupSelection/<x>/Entry

Status	Occurrence	Format	Min. Access Types
Optional	One	node	Get, Replace

This interior node is a placeholder for the details of the on-network MCPTT users whose selected MCPTT group is allowed to be remotely changed by the MCPTT user.

5.2.48U4 /<x>/<x>/OnNetwork/RemoteGroupSelection/<x>/Entry/MCPTTID

Table 5.2.48U4.1: /<x>/<x>/OnNetwork/RemoteGroupSelection/<x>/Entry/MCPTTID

<x>/OnNetwork/RemoteGroupSelection/<x>/Entry/MCPTTID

Status	Occurrence	Format	Min. Access Types
Required	One	chr	Get, Replace

This leaf node indicates a MCPTT ID of an MCPTT user whose selected MCPTT group is allowed to be remotely changed by the MCPTT user.

The value is a "uri" attribute specified in OMA OMA-TS-XDM_Group-V1_1 [4].

5.2.48U5 /<x>/<x>/OnNetwork/RemoteGroupSelection/<x>/Entry/DisplayName

Table 5.2.48U5.1: /<x>/<x>/OnNetwork/RemoteGroupSelection/<x>/Entry/DisplayName

<x>/OnNetwork/RemoteGroupSelection/<x>/Entry/DisplayName

Status	Occurrence	Format	Min. Access Types
Optional	One	chr	Get, Replace

This leaf node contains a human readable name that corresponds to the MCPTT ID of the MCPTT user.

5.2.48V1Void

5.2.48V2Void

5.2.48V3Void

5.2.48V4Void

5.2.48V5Void

5.2.48V6Void

5.2.48V7Void

5.2.48V8Void

5.2.48V9Void

5.2.48V10 Void

5.2.48V11 Void

5.2.48V12 Void

5.2.48V13 Void

5.2.48V14 Void

5.2.48V15 Void

5.2.48V16 Void

5.2.48V17 Void

5.2.48W1 /<x>/<x>/OnNetwork/AllowedRequestRemoteInitPrivateCall

Table 5.2.48W1.1: /<x>/<x>/OnNetwork/AllowedRequestRemoteInitPrivateCall

<x>/OnNetwork/AllowedRequestRemoteInitPrivateCall

Status	Occurrence	Format	Min. Access Types
Required	One	bool	Get, Replace

This leaf node indicates whether the MCPTT user is authorised to request a remotely initiated private call.

When set to "true" the MCPTT user is authorised to request remotely initiated private calls.

When set to "false" the MCPTT user is not authorised to request remotely initiated private calls.

5.2.48W2 `<x>/<x>/OnNetwork/AllowedRequestRemoteInitGroupCall`

Table 5.2.48W2.1: `<x>/<x>/OnNetwork/AllowedRequestRemoteInitGroupCall`

`<x>/OnNetwork/AllowedRequestRemoteInitGroupCall`

Status	Occurrence	Format	Min. Access Types
Required	One	bool	Get, Replace

This leaf node indicates whether the MCPTT user is authorised to request a remotely initiated group call.

When set to "true" the MCPTT user is authorised to request remotely initiated group calls.

When set to "false" the MCPTT user is not authorised to request remotely initiated group calls.

5.2.48W3 `<x>/<x>/OnNetwork/FunctionalAliasList`

Table 5.2.48W3.1: `<x>/<x>/OnNetwork/FunctionalAliasList`

`<x>/OnNetwork/FunctionalAliasList`

Status	Occurrence	Format	Min. Access Types
Required	One	node	Get, Replace

This interior node is a placeholder for the functional alias configuration.

5.2.48W4 `<x>/<x>/OnNetwork/FunctionalAliasList/<x>`

Table 5.2.48W4.1: `<x>/<x>/OnNetwork/FunctionalAliasList/<x>`

`<x>/OnNetwork/FunctionalAliasList/<x>`

Status	Occurrence	Format	Min. Access Types
Required	OneOrMore	node	Get, Replace

This interior node is a placeholder for one or more functional alias configuration elements.

5.2.48W5 `<x>/<x>/OnNetwork/FunctionalAliasList/<x>/Entry`

Table 5.2.48W5.1: `<x>/<x>/OnNetwork/FunctionalAliasList/<x>/Entry`

`<x>/OnNetwork/FunctionalAliasList/<x>/Entry`

Status	Occurrence	Format	Min. Access Types
Optional	One	node	Get, Replace

This interior node is a placeholder for the details of the functional alias.

5.2.48W6 /<x>/<x>/OnNetwork/FunctionalAliasList/<x>/Entry/ FunctionalAlias

Table 5.2.48W6.1: /<x>/<x>/OnNetwork/FunctionalAliasList/<x>/Entry/FunctionalAlias

<x>/OnNetwork/FunctionalAliasList/<x>/Entry/FunctionalAlias

Status	Occurrence	Format	Min. Access Types
Required	One	chr	Get, Replace

This leaf node indicates a functional alias that can be activated by the MCPTT user.

The value is a "uri" attribute specified in OMA OMA-TS-XDM_Group-V1_1 [4].

5.2.48W6A/<x>/<x>/OnNetwork/FunctionalAliasList/<x>/Entry/ LocationCriteriaForActivation

Table 5.2.48W6A.1: /<x>/<x>/OnNetwork/FunctionalAliasList/<x>/Entry/LocationCriteriaForActivation

<x>/OnNetwork/FunctionalAliasList/<x>/Entry/LocationCriteriaForActivation

Status	Occurrence	Format	Min. Access Types
Optional	ZeroOrOne	node	Get, Replace

This interior node contains the location criteria for activation of a functional alias.

5.2.48W6A0 /<x>/<x>/OnNetwork/FunctionalAliasList/<x>/Entry/ LocationCriteriaForActivation/<x>

Table 5.2.48W6A0.1:

/<x>/<x>/OnNetwork/FunctionalAliasList/<x>/Entry/LocationCriteriaForActivation/<x>

<x>/OnNetwork/FunctionalAliasList/<x>/Entry/LocationCriteriaForActivation/<x>

Status	Occurrence	Format	Min. Access Types
Optional	ZeroOrMore	node	Get, Replace

This interior node contains the zero or more location criteria for activation of a functional alias.

5.2.48W6A1 /<x>/<x>/OnNetwork/FunctionalAliasList/<x>/Entry/ LocationCriteriaForActivation/<x>/EnterSpecificArea

Table 5.2.48W6A1.1:

**/<x>/<x>/OnNetwork/FunctionalAliasList/<x>/Entry/LocationCriteriaForActivation/<x>/
EnterSpecificArea**

<x>/OnNetwork/FunctionalAliasList/<x>/Entry/LocationCriteriaForActivation/<x>/EnterSpecificArea

Status	Occurrence	Format	Min. Access Types
Optional	ZeroOrOne	node	Get, Replace

This interior node contains a geographical area which when entered by the MC service UE triggers the functional alias activation.

5.2.48W6A2 /<x>/<x>/OnNetwork/FunctionalAliasList/<x>/Entry/ LocationCriteriaForActivation/<x>/EnterSpecificArea/ PolygonArea

Table 5.2.48W6A2.1:

**/<x>/<x>/OnNetwork/FunctionalAliasList/<x>/Entry/LocationCriteriaForActivation/<x>/
EnterSpecificArea/PolygonArea**

<x>/OnNetwork/FunctionalAliasList/<x>/Entry/LocationCriteriaForActivation/<x>/EnterSpecificArea/PolygonArea

Status	Occurrence	Format	Min. Access Types
Optional	ZeroOrOne	node	Get, Replace

This interior node contains a geographical area described by a polygon.

5.2.48W6A3 /<x>/<x>/OnNetwork/FunctionalAliasList/<x>/Entry/ LocationCriteriaForActivation/<x>/EnterSpecificArea/ PolygonArea/<x>

Table 5.2.48W6A3.1:

**/<x>/<x>/OnNetwork/FunctionalAliasList/<x>/Entry/LocationCriteriaForActivation/<x>/
EnterSpecificArea/PolygonArea/<x>**

<x>/OnNetwork/FunctionalAliasList/<x>/Entry/LocationCriteriaForActivation/<x>/EnterSpecificArea/PolygonArea
<x>

Status	Occurrence	Format	Min. Access Types
Required	OneOrN	node	Get, Replace

This interior node contains the coordinates of the corners which define a polygon. The occurrence of this leaf node is "3 to 15" as per 3GPP TS 23.032 [21].

5.2.48W6A3A /<x>/<x>/OnNetwork/FunctionalAliasList/<x>/Entry/ LocationCriteriaForActivation/<x>/EnterSpecificArea/ PolygonArea/<x>/PointCoordinateType

**Table 5.2.48W6A3A.1: /<x>/<x>/OnNetwork/FunctionalAliasList/<x>/Entry/
LocationCriteriaForActivation/<x>/EnterSpecificArea/PolygonArea/<x>/PointCoordinateType**

<x>/OnNetwork/FunctionalAliasList/<x>/Entry/LocationCriteriaForActivation/<x>/EnterSpecificArea/PolygonArea
<x>/PointCoordinateType

Status	Occurrence	Format	Min. Access Types
Required	One	node	Get, Replace

This interior node contains the coordinates of the center point of the ellipsoid arc.

5.2.48W6A4 /<x>/<x>/OnNetwork/FunctionalAliasList/<x>/Entry/
LocationCriteriaForActivation/<x>/EnterSpecificArea/
PolygonArea/<x>/PointCoordinateType/Longitude

Table 5.2.48W6A4.1:
**/<x>/<x>/OnNetwork/FunctionalAliasList/<x>/Entry/LocationCriteriaForActivation/<x>/
EnterSpecificArea/PolygonArea/<x>/PointCoordinateType/Longitude**

<x>/OnNetwork/FunctionalAliasList/<x>/Entry/LocationCriteriaForActivation/<x>/EnterSpecificArea/PolygonArea
/<x>/PointCoordinateType/Longitude

Status	Occurrence	Format	Min. Access Types
Required	One	int	Get, Replace

This leaf node contains the longitudinal coordinate of a corner.

- Values: 0-16777215

5.2.48W6A5 /<x>/<x>/OnNetwork/FunctionalAliasList/<x>/Entry/
LocationCriteriaForActivation/<x>/EnterSpecificArea/
PolygonArea/<x>/PointCoordinateType/Latitude

Table 5.2.48W6A5.1:
**/<x>/<x>/OnNetwork/FunctionalAliasList/<x>/Entry/LocationCriteriaForActivation/<x>/
EnterSpecificArea/PolygonArea/<x>/PointCoordinateType/Latitude**

<x>/OnNetwork/FunctionalAliasList/<x>/Entry/LocationCriteriaForActivation/<x>/EnterSpecificArea/PolygonArea
/<x>/PointCoordinateType/Latitude

Status	Occurrence	Format	Min. Access Types
Required	One	int	Get, Replace

This leaf node contains the latitudinal coordinate of a corner.

- Values: 0-16777215

5.2.48W6A6 /<x>/<x>/OnNetwork/FunctionalAliasList/<x>/Entry/
LocationCriteriaForActivation/<x>/EnterSpecificArea/
EllipsoidArcArea

Table 5.2.48W6A6.1:
**/<x>/<x>/OnNetwork/FunctionalAliasList/<x>/Entry/LocationCriteriaForActivation/<x>/
EnterSpecificArea/EllipsoidArcArea**

<x>/OnNetwork/FunctionalAliasList/<x>/Entry/LocationCriteriaForActivation/<x>/EnterSpecificArea/EllipsoidArc

Status	Occurrence	Format	Min. Access Types
Optional	ZeroOrOne	node	Get, Replace

This interior node contains a geographical area described by an ellipsoid arc.

5.2.48W6A7 /<x>/<x>/OnNetwork/FunctionalAliasList/<x>/Entry/
LocationCriteriaForActivation/<x>/EnterSpecificArea/
EllipsoidArcArea/Center

Table 5.2.48W6A7.1:
/<x>/<x>/OnNetwork/FunctionalAliasList/<x>/Entry/LocationCriteriaForActivation/<x>/
EnterSpecificArea/EllipsoidArcArea/Center

<x>/OnNetwork/FunctionalAliasList/<x>/Entry/LocationCriteriaForActivation/<x>/EnterSpecificArea/EllipsoidArc
Area/Center

Status	Occurrence	Format	Min. Access Types
Required	One	node	Get, Replace

This interior node contains the coordinates of the center point of the ellipsoid arc.

5.2.48W6A7A /<x>/<x>/OnNetwork/FunctionalAliasList/<x>/Entry/
LocationCriteriaForActivation/<x>/EnterSpecificArea/
EllipsoidArcArea/Center/PointCoordinateType

**Table 5.2.48W6A7A.1: /<x>/<x>/OnNetwork/FunctionalAliasList/<x>/Entry/
LocationCriteriaForActivation/<x>/EnterSpecificArea/EllipsoidArcArea/Center/PointCoordinateType**

<x>/OnNetwork/FunctionalAliasList/<x>/Entry/LocationCriteriaForActivation/<x>/EnterSpecificArea/EllipsoidArc
Area/Center/PointCoordinateType

Status	Occurrence	Format	Min. Access Types
Required	One	node	Get, Replace

This interior node contains the coordinates of the center point of the ellipsoid arc.

5.2.48W6A8 /<x>/<x>/OnNetwork/FunctionalAliasList/<x>/Entry/
LocationCriteriaForActivation/<x>/EnterSpecificArea/
EllipsoidArcArea/Center/PointCoordinateType/Longitude

**Table 5.2.48W6A8.1: /<x>/<x>/OnNetwork/FunctionalAliasList/<x>/Entry/
LocationCriteriaForActivation/<x>/EnterSpecificArea/EllipsoidArcArea/Center/PointCoordinateType/
Longitude**

<x>/OnNetwork/FunctionalAliasList/<x>/Entry/LocationCriteriaForActivation/<x>/EnterSpecificArea/EllipsoidArc
Area/Center/PointCoordinateType/Longitude

Status	Occurrence	Format	Min. Access Types
Required	One	int	Get, Replace

This leaf node contains the longitudinal coordinate of the center.

- Values: 0-16777215

5.2.48W6A9 /<x>/<x>/OnNetwork/FunctionalAliasList/<x>/Entry/ LocationCriteriaForActivation/<x>/EnterSpecificArea/ EllipsoidArcArea/Center/PointCoordinateType/Latitude

**Table 5.2.48W6A9.1: /<x>/<x>/OnNetwork/FunctionalAliasList/<x>/Entry/
LocationCriteriaForActivation/<x>/EnterSpecificArea/EllipsoidArcArea/Center/PointCoordinateType/
Latitude**

<x>/OnNetwork/FunctionalAliasList/<x>/Entry/LocationCriteriaForActivation/<x>/EnterSpecificArea/EllipsoidArc
Area/Center/PointCoordinateType/Latitude

Status	Occurrence	Format	Min. Access Types
Required	One	int	Get, Replace

This leaf node contains the latitudinal coordinate of the center.

- Values: 0-16777215

5.2.48W6A10/<x>/<x>/OnNetwork/FunctionalAliasList/<x>/Entry/ LocationCriteriaForActivation/<x>/ EnterSpecificArea/EllipsoidArcArea/Radius

**Table 5.2.48W6A10.1: /<x>/<x>/OnNetwork/FunctionalAliasList/<x>/Entry/
LocationCriteriaForActivation/<x>/EnterSpecificArea/EllipsoidArcArea/Radius**

<x>/OnNetwork/FunctionalAliasList/<x>/Entry/LocationCriteriaForActivation/<x>/EnterSpecificArea/EllipsoidArc
Area/Radius

Status	Occurrence	Format	Min. Access Types
Required	One	int	Get, Replace

This leaf node contains the radius of the ellipsoid arc.

- Values: non-negative integer

5.2.48W6A11/<x>/<x>/OnNetwork/FunctionalAliasList/<x>/Entry/ LocationCriteriaForActivation/<x>/ EnterSpecificArea/EllipsoidArcArea/OffsetAngle

**Table 5.2.48W6A11.1: /<x>/<x>/OnNetwork/FunctionalAliasList/<x>/Entry/
LocationCriteriaForActivation/<x>/EnterSpecificArea/EllipsoidArcArea/OffsetAngle**

<x>/OnNetwork/FunctionalAliasList/<x>/Entry/LocationCriteriaForActivation/<x>/EnterSpecificArea/EllipsoidArc
Area/OffsetAngle

Status	Occurrence	Format	Min. Access Types
Required	One	int	Get, Replace

This leaf node contains the offset angle of the ellipsoid arc.

- Values: 0-255

5.2.48W6A12/<x>/<x>/OnNetwork/FunctionalAliasList/<x>/Entry/LocationCriteriaForActivation/<x>/EnterSpecificArea/EllipsoidArcArea/IncludedAngle

Table 5.2.48W6A12.1: /<x>/<x>/OnNetwork/FunctionalAliasList/<x>/Entry/LocationCriteriaForActivation/<x>/EnterSpecificArea/EllipsoidArcArea/IncludedAngle

<x>/OnNetwork/FunctionalAliasList/<x>/Entry/LocationCriteriaForActivation/<x>/EnterSpecificArea/EllipsoidArcArea/IncludedAngle

Status	Occurrence	Format	Min. Access Types
Required	One	int	Get, Replace

This leaf node contains the included angle of the ellipsoid arc.

- Values: 0-255

5.2.48W6A12A /<x>/<x>/OnNetwork/FunctionalAliasList/<x>/Entry/LocationCriteriaForActivation/<x>/EnterSpecificArea/Speed

Table 5.2.48W6A12A.1: /<x>/<x>/OnNetwork/FunctionalAliasList/<x>/Entry/LocationCriteriaForActivation/<x>/EnterSpecificArea/Speed

<x>/OnNetwork/FunctionalAliasList/<x>/Entry/LocationCriteriaForActivation/<x>/EnterSpecificArea/Speed

Status	Occurrence	Format	Min. Access Types
Optional	One	node	Get, Replace

This interior node contains the speed.

5.2.48W6A12B /<x>/<x>/OnNetwork/FunctionalAliasList/<x>/Entry/LocationCriteriaForActivation/<x>/EnterSpecificArea/Speed/MinimumSpeed

Table 5.2.48W6A12B.1: /<x>/<x>/OnNetwork/FunctionalAliasList/<x>/Entry/LocationCriteriaForActivation/<x>/EnterSpecificArea/Speed/MinimumSpeed

<x>/OnNetwork/FunctionalAliasList/<x>/Entry/LocationCriteriaForActivation/<x>/EnterSpecificArea/Speed/MinimumSpeed

Status	Occurrence	Format	Min. Access Types
Required	One	int	Get, Replace

This leaf node contains the minimum speed.

- Values: non-negative integer in units of kilometers/hour.

5.2.48W6A12C /<x>/<x>/OnNetwork/FunctionalAliasList/<x>/Entry/ LocationCriteriaForActivation/<x>/EnterSpecificArea/Speed/ MaximumSpeed

**Table 5.2.48W6A12C.1: /<x>/<x>/OnNetwork/FunctionalAliasList/<x>/Entry/
LocationCriteriaForActivation/<x>/EnterSpecificArea/Speed/MaximumSpeed**

<x>/OnNetwork/FunctionalAliasList/<x>/Entry/LocationCriteriaForActivation/<x>/EnterSpecificArea/Speed/MaximumSpeed

Status	Occurrence	Format	Min. Access Types
Required	One	int	Get, Replace

This leaf node contains the maximum speed.

- Values: non-negative integer in units of kilometers/hour.

5.2.48W6A12D /<x>/<x>/OnNetwork/FunctionalAliasList/<x>/Entry/ LocationCriteriaForActivation/<x>/EnterSpecificArea/Heading

**Table 5.2.48W6A12D.1: /<x>/<x>/OnNetwork/FunctionalAliasList/<x>/Entry/
LocationCriteriaForActivation/<x>/EnterSpecificArea/Heading**

<x>/OnNetwork/FunctionalAliasList/<x>/Entry/LocationCriteriaForActivation/<x>/EnterSpecificArea/Heading

Status	Occurrence	Format	Min. Access Types
Optional	One	node	Get, Replace

This interior node contains the heading.

5.2.48W6A12E /<x>/<x>/OnNetwork/FunctionalAliasList/<x>/Entry/ LocationCriteriaForActivation/<x>/EnterSpecificArea/Heading/ MinimumHeading

**Table 5.2.48W6A12E.1: /<x>/<x>/OnNetwork/FunctionalAliasList/<x>/Entry/
LocationCriteriaForActivation/<x>/EnterSpecificArea/Heading/MinimumHeading**

<x>/OnNetwork/FunctionalAliasList/<x>/Entry/LocationCriteriaForActivation/<x>/EnterSpecificArea/Heading/MinimumHeading

Status	Occurrence	Format	Min. Access Types
Required	One	int	Get, Replace

This leaf node contains the minimum heading.

- Values: 0-359

5.2.48W6A12F /<x>/<x>/OnNetwork/FunctionalAliasList/<x>/Entry/
LocationCriteriaForActivation/<x>/EnterSpecificArea/Heading/
MaximumHeading

**Table 5.2.48W6A12F.1: /<x>/<x>/OnNetwork/FunctionalAliasList/<x>/Entry/
LocationCriteriaForActivation/<x>/EnterSpecificArea/Heading/MaximumHeading**

<x>/OnNetwork/FunctionalAliasList/<x>/Entry/LocationCriteriaForActivation/<x>/EnterSpecificArea/Heading/MaximumHeading

Status	Occurrence	Format	Min. Access Types
Required	One	int	Get, Replace

This leaf node contains the maximum heading.

- Values: 0-359

5.2.48W6A13/<x>/<x>/OnNetwork/FunctionalAliasList/<x>/Entry/
LocationCriteriaForActivation/<x>/
ExitSpecificArea

**Table 5.2.48W6A13.1: /<x>/<x>/OnNetwork/FunctionalAliasList/<x>/Entry/
LocationCriteriaForActivation/<x>/ExitSpecificArea**

<x>/OnNetwork/FunctionalAliasList/<x>/Entry/LocationCriteriaForActivation/<x>/ExitSpecificArea

Status	Occurrence	Format	Min. Access Types
Optional	ZeroOrOne	node	Get, Replace

This interior node contains a geographical area which when exited by the MC service UE triggers the functional alias activation.

5.2.48W6A14/<x>/<x>/OnNetwork/FunctionalAliasList/<x>/Entry/
LocationCriteriaForActivation/<x>/
ExitSpecificArea/PolygonArea

**Table 5.2.48W6A14.1: /<x>/<x>/OnNetwork/FunctionalAliasList/<x>/Entry/
LocationCriteriaForActivation/<x>/ExitSpecificArea/PolygonArea**

<x>/OnNetwork/FunctionalAliasList/<x>/Entry/LocationCriteriaForActivation/<x>/ExitSpecificArea/PolygonArea

Status	Occurrence	Format	Min. Access Types
Optional	ZeroOrOne	node	Get, Replace

This interior node contains a geographical area described by a polygon.

5.2.48W6A15/<x>/<x>/OnNetwork/FunctionalAliasList/<x>/Entry/
LocationCriteriaForActivation/<x>/
ExitSpecificArea/PolygonArea/<x>

**Table 5.2.48W6A15.1: /<x>/<x>/OnNetwork/FunctionalAliasList/<x>/Entry/
LocationCriteriaForActivation/<x>/ExitSpecificArea/PolygonArea/<x>**

<x>/OnNetwork/FunctionalAliasList/<x>/Entry/LocationCriteriaForActivation/<x>/ExitSpecificArea/PolygonArea/
<x>

Status	Occurrence	Format	Min. Access Types
Required	OneOrN	node	Get, Replace

This interior node contains the coordinates of the corners which define a polygon. The occurrence of this leaf node is "3 to 15" as per 3GPP TS 23.032 [21].

5.2.48W6A15A /<x>/<x>/OnNetwork/FunctionalAliasList/<x>/Entry/
LocationCriteriaForActivation/<x>/ExitSpecificArea/
PolygonArea/<x>/PointCoordinateType

**Table 5.2.48W6A15A.1: /<x>/<x>/OnNetwork/FunctionalAliasList/<x>/Entry/
LocationCriteriaForActivation/<x>/ExitSpecificArea/PolygonArea/<x>/PointCoordinateType**

<x>/OnNetwork/FunctionalAliasList/<x>/Entry/LocationCriteriaForActivation/<x>/ExitSpecificArea/PolygonArea/
<x>/PointCoordinateType

Status	Occurrence	Format	Min. Access Types
Required	One	node	Get, Replace

This interior node contains the type of the coordinates.

5.2.48W6A16/<x>/<x>/OnNetwork/FunctionalAliasList/<x>/Entry/
LocationCriteriaForActivation/<x>/
ExitSpecificArea/PolygonArea/<x>/PointCoordinateType/Longitude

**Table 5.2.48W6A16.1: /<x>/<x>/OnNetwork/FunctionalAliasList/<x>/Entry/
LocationCriteriaForActivation/<x>/ExitSpecificArea/PolygonArea/<x>/
PointCoordinateType/Longitude**

<x>/OnNetwork/FunctionalAliasList/<x>/Entry/LocationCriteriaForActivation/<x>/ExitSpecificArea/PolygonArea/
<x>/PointCoordinateType/Longitude

Status	Occurrence	Format	Min. Access Types
Required	One	int	Get, Replace

This leaf node contains the longitudinal coordinate of a corner.

- Values: 0-16777215

5.2.48W6A17/<x>/<x>/OnNetwork/FunctionalAliasList/<x>/Entry/
LocationCriteriaForActivation/<x>/
ExitSpecificArea/PolygonArea/<x>/PointCoordinateType/Latitude

**Table 5.2.48W6A17.1: /<x>/<x>/OnNetwork/FunctionalAliasList/<x>/Entry/
LocationCriteriaForActivation/<x>/ExitSpecificArea/PolygonArea/<x>/PointCoordinateType/Latitude**

<x>/OnNetwork/FunctionalAliasList/<x>/Entry/LocationCriteriaForActivation/<x>/ExitSpecificArea/PolygonArea/
<x>/PointCoordinateType/Latitude

Status	Occurrence	Format	Min. Access Types
Required	One	int	Get, Replace

This leaf node contains the latitudinal coordinate of a corner.

- Values: 0-16777215

5.2.48W6A18/<x>/<x>/OnNetwork/FunctionalAliasList/<x>/Entry/
LocationCriteriaForActivation/<x>/
ExitSpecificArea/EllipsoidArcArea

**Table 5.2.48W6A18.1: /<x>/<x>/OnNetwork/FunctionalAliasList/<x>/Entry/
LocationCriteriaForActivation/<x>/ExitSpecificArea/EllipsoidArcArea**

<x>/OnNetwork/FunctionalAliasList/<x>/Entry/LocationCriteriaForActivation/<x>/ExitSpecificArea/EllipsoidArcA

Status	Occurrence	Format	Min. Access Types
Optional	ZeroOrOne	node	Get, Replace

This interior node contains a geographical area described by an ellipsoid arc.

5.2.48W6A19/<x>/<x>/OnNetwork/FunctionalAliasList/<x>/Entry/
LocationCriteriaForActivation/<x>/
ExitSpecificArea/EllipsoidArcArea/Center

**Table 5.2.48W6A19.1: /<x>/<x>/OnNetwork/FunctionalAliasList/<x>/Entry/
LocationCriteriaForActivation/<x>/ExitSpecificArea/EllipsoidArcArea/Center**

<x>/OnNetwork/FunctionalAliasList/<x>/Entry/LocationCriteriaForActivation/<x>/ExitSpecificArea/EllipsoidArcA
rea/Center

Status	Occurrence	Format	Min. Access Types
Required	One	node	Get, Replace

This interior node contains the coordinates of the center point of the ellipsoid arc.

5.2.48W6A19A /<x>/<x>/OnNetwork/FunctionalAliasList/<x>/Entry/
LocationCriteriaForActivation/<x>/ExitSpecificArea/
EllipsoidArcArea/Center/PointCoordinateType

**Table 5.2.48W6A19A.1: /<x>/<x>/OnNetwork/FunctionalAliasList/<x>/Entry/
LocationCriteriaForActivation/<x>/ExitSpecificArea/EllipsoidArcArea/Center/PointCoordinateType**

<x>/OnNetwork/FunctionalAliasList/<x>/Entry/LocationCriteriaForActivation/<x>/ExitSpecificArea/EllipsoidArcA
rea/Center/PointCoordinateType

Status	Occurrence	Format	Min. Access Types
Required	One	node	Get, Replace

This interior node contains the coordinates of the center point of the ellipsoid arc.

5.2.48W6A20/<x>/<x>/OnNetwork/FunctionalAliasList/<x>/Entry/ LocationCriteriaForActivation/<x>/ ExitSpecificArea/EllipsoidArcArea/Center/PointCoordinateType/ Longitude

**Table 5.2.48W6A20.1: /<x>/<x>/OnNetwork/FunctionalAliasList/<x>/Entry/
LocationCriteriaForActivation/<x>/ExitSpecificArea/EllipsoidArcArea/Center/PointCoordinateType/
Longitude**

<x>/OnNetwork/FunctionalAliasList/<x>/Entry/LocationCriteriaForActivation/<x>/ExitSpecificArea/EllipsoidArcArea/Center/PointCoordinateType/Longitude

Status	Occurrence	Format	Min. Access Types
Required	One	int	Get, Replace

This leaf node contains the longitudinal coordinate of the center.

- Values: 0-16777215

5.2.48W6A21/<x>/<x>/OnNetwork/FunctionalAliasList/<x>/Entry/ LocationCriteriaForActivation/<x>/ ExitSpecificArea/EllipsoidArcArea/Center/PointCoordinateType/ Latitude

**Table 5.2.48W6A21.1: /<x>/<x>/OnNetwork/FunctionalAliasList/<x>/Entry/
LocationCriteriaForActivation/<x>/ExitSpecificArea/EllipsoidArcArea/Center/PointCoordinateType/
Latitude**

<x>/OnNetwork/FunctionalAliasList/<x>/Entry/LocationCriteriaForActivation/<x>/ExitSpecificArea/EllipsoidArcArea/Center/PointCoordinateType/Latitude

Status	Occurrence	Format	Min. Access Types
Required	One	int	Get, Replace

This leaf node contains the latitudinal coordinate of the center.

- Values: 0-16777215

5.2.48W6A22/<x>/<x>/OnNetwork/FunctionalAliasList/<x>/Entry/ LocationCriteriaForActivation/<x>/ ExitSpecificArea/EllipsoidArcArea/Radius

**Table 5.2.48W6A22.1: /<x>/<x>/OnNetwork/FunctionalAliasList/<x>/Entry/
LocationCriteriaForActivation/<x>/ExitSpecificArea/EllipsoidArcArea/Radius**

<x>/OnNetwork/FunctionalAliasList/<x>/Entry/LocationCriteriaForActivation/<x>/ExitSpecificArea/EllipsoidArcArea/Radius

Status	Occurrence	Format	Min. Access Types
Required	One	int	Get, Replace

This leaf node contains the radius of the ellipsoid arc.

- Values: non-negative integer

**5.2.48W6A23/<x>/<x>/OnNetwork/FunctionalAliasList/<x>/Entry/
LocationCriteriaForActivation/<x>/
ExitSpecificArea/EllipsoidArcArea/OffsetAngle**

**Table 5.2.48W6A23.1: /<x>/<x>/OnNetwork/FunctionalAliasList/<x>/Entry/
LocationCriteriaForActivation/<x>/ExitSpecificArea/EllipsoidArcArea/OffsetAngle**

<x>/OnNetwork/FunctionalAliasList/<x>/Entry/LocationCriteriaForActivation/<x>/ExitSpecificArea/EllipsoidArcArea/OffsetAngle

Status	Occurrence	Format	Min. Access Types
Required	One	int	Get, Replace

This leaf node contains the offset angle of the ellipsoid arc.

- Values: 0-255

**5.2.48W6A24/<x>/<x>/OnNetwork/FunctionalAliasList/<x>/Entry/
LocationCriteriaForActivation/<x>/
ExitSpecificArea/EllipsoidArcArea/IncludedAngle**

**Table 5.2.48W6A24.1: /<x>/<x>/OnNetwork/FunctionalAliasList/<x>/Entry/
LocationCriteriaForActivation/<x>/ExitSpecificArea/EllipsoidArcArea/IncludedAngle**

<x>/OnNetwork/FunctionalAliasList/<x>/Entry/LocationCriteriaForActivation/<x>/ExitSpecificArea/EllipsoidArcArea/IncludedAngle

Status	Occurrence	Format	Min. Access Types
Required	One	int	Get, Replace

This leaf node contains the included angle of the ellipsoid arc.

- Values: 0-255

**5.2.48W6A24A /<x>/<x>/OnNetwork/FunctionalAliasList/<x>/Entry/
LocationCriteriaForActivation/<x>/ExitSpecificArea/Speed**

**Table 5.2.48W6A24A.1: /<x>/<x>/OnNetwork/FunctionalAliasList/<x>/Entry/
LocationCriteriaForActivation/<x>/ExitSpecificArea/Speed**

<x>/OnNetwork/FunctionalAliasList/<x>/Entry/LocationCriteriaForActivation/<x>/ExitSpecificArea/Speed

Status	Occurrence	Format	Min. Access Types
Optional	One	node	Get, Replace

This interior node contains the speed.

5.2.48W6A24B /<x>/<x>/OnNetwork/FunctionalAliasList/<x>/Entry/ LocationCriteriaForActivation/<x>/ExitSpecificArea/Speed/ MinimumSpeed

**Table 5.2.48W6A24B.1: /<x>/<x>/OnNetwork/FunctionalAliasList/<x>/Entry/
LocationCriteriaForActivation/<x>/ExitSpecificArea/Speed/MinimumSpeed**

<x>/OnNetwork/FunctionalAliasList/<x>/Entry/LocationCriteriaForActivation/<x>/ExitSpecificArea/Speed/MinimumSpeed

Status	Occurrence	Format	Min. Access Types
Required	One	int	Get, Replace

This leaf node contains the minimum speed.

- Values: non-negative integer in units of kilometers/hour.

5.2.48W6A24C /<x>/<x>/OnNetwork/FunctionalAliasList/<x>/Entry/ LocationCriteriaForActivation/<x>/ExitSpecificArea/Speed/ MaximumSpeed

**Table 5.2.48W6A24C.1: /<x>/<x>/OnNetwork/FunctionalAliasList/<x>/Entry/
LocationCriteriaForActivation/<x>/ExitSpecificArea/Speed/MaximumSpeed**

<x>/OnNetwork/FunctionalAliasList/<x>/Entry/LocationCriteriaForActivation/<x>/ExitSpecificArea/Speed/MaximumSpeed

Status	Occurrence	Format	Min. Access Types
Required	One	int	Get, Replace

This leaf node contains the maximum speed.

- Values: non-negative integer in units of kilometers/hour.

5.2.48W6A24D /<x>/<x>/OnNetwork/FunctionalAliasList/<x>/Entry/ LocationCriteriaForActivation/<x>/ExitSpecificArea/Heading

**Table 5.2.48W6A24D.1: /<x>/<x>/OnNetwork/FunctionalAliasList/<x>/Entry/
LocationCriteriaForActivation/<x>/ExitSpecificArea/Heading**

<x>/OnNetwork/FunctionalAliasList/<x>/Entry/LocationCriteriaForActivation/<x>/ExitSpecificArea/Heading

Status	Occurrence	Format	Min. Access Types
Optional	One	node	Get, Replace

This interior node contains the heading.

5.2.48W6A24E /<x>/<x>/OnNetwork/FunctionalAliasList/<x>/Entry/
LocationCriteriaForActivation/<x>/ExitSpecificArea/Heading/
MinimumHeading

**Table 5.2.48W6A24E.1: /<x>/<x>/OnNetwork/FunctionalAliasList/<x>/Entry/
LocationCriteriaForActivation/<x>/ExitSpecificArea/Heading/MinimumHeading**

<x>/OnNetwork/FunctionalAliasList/<x>/Entry/LocationCriteriaForActivation/<x>/ExitSpecificArea/Heading/MinimumHeading

Status	Occurrence	Format	Min. Access Types
Required	One	int	Get, Replace

This leaf node contains the minimum heading.

- Values: 0-359

5.2.48W6A24F /<x>/<x>/OnNetwork/FunctionalAliasList/<x>/Entry/
LocationCriteriaForActivation/<x>/ExitSpecificArea/Heading/
MaximumHeading

**Table 5.2.48W6A24F.1: /<x>/<x>/OnNetwork/FunctionalAliasList/<x>/Entry/
LocationCriteriaForActivation/<x>/ExitSpecificArea/Heading/MaximumHeading**

<x>/OnNetwork/FunctionalAliasList/<x>/Entry/LocationCriteriaForActivation/<x>/ExitSpecificArea/Heading/MaximumHeading

Status	Occurrence	Format	Min. Access Types
Required	One	int	Get, Replace

This leaf node contains the maximum heading.

- Values: 0-359

5.2.48W6B/<x>/<x>/OnNetwork/FunctionalAliasList/<x>/Entry/
LocationCriteriaForDeactivation

**Table 5.2.48W6B.1: /<x>/<x>/OnNetwork/FunctionalAliasList/<x>/Entry/
LocationCriteriaForDeactivation**

<x>/OnNetwork/FunctionalAliasList/<x>/Entry/LocationCriteriaForDeactivation

Status	Occurrence	Format	Min. Access Types
Optional	ZeroOrOne	node	Get, Replace

This interior node contains the location criteria for de-activation of a functional alias.

5.2.48W6B0 /<x>/<x>/OnNetwork/FunctionalAliasList/<x>/Entry/
LocationCriteriaForDeactivation/<x>

**Table 5.2.48W6B0.1: /<x>/<x>/OnNetwork/FunctionalAliasList/<x>/Entry/
LocationCriteriaForDeactivation/<x>**

<x>/OnNetwork/FunctionalAliasList/<x>/Entry/LocationCriteriaForDeactivation/<x>

Status	Occurrence	Format	Min. Access Types
Optional	ZeroOrMore	node	Get, Replace

This interior node contains the zero or more location criteria for de-activation of a functional alias.

5.2.48W6B1 /<x>/<x>/OnNetwork/FunctionalAliasList/<x>/Entry/LocationCriteriaForDeactivation/<x>/EnterSpecificArea

Table 5.2.48W6B1.1: /<x>/<x>/OnNetwork/FunctionalAliasList/<x>/Entry/LocationCriteriaForDeactivation/<x>/EnterSpecificArea

<x>/OnNetwork/FunctionalAliasList/<x>/Entry/LocationCriteriaForDeactivation/<x>/EnterSpecificArea

Status	Occurrence	Format	Min. Access Types
Optional	ZeroOrOne	node	Get, Replace

This interior node contains a geographical area which when entered by the MC service UE triggers the functional alias de-activation.

5.2.48W6B2 /<x>/<x>/OnNetwork/FunctionalAliasList/<x>/Entry/LocationCriteriaForDeactivation/<x>/EnterSpecificArea/PolygonArea

Table 5.2.48W6B2.1: /<x>/<x>/OnNetwork/FunctionalAliasList/<x>/Entry/LocationCriteriaForDeactivation/<x>/EnterSpecificArea/PolygonArea

<x>/OnNetwork/FunctionalAliasList/<x>/Entry/LocationCriteriaForDeactivation/<x>/EnterSpecificArea/PolygonArea

Status	Occurrence	Format	Min. Access Types
Optional	ZeroOrOne	node	Get, Replace

This interior node contains a geographical area described by a polygon.

5.2.48W6B3 /<x>/<x>/OnNetwork/FunctionalAliasList/<x>/Entry/LocationCriteriaForDeactivation/<x>/EnterSpecificArea/PolygonArea/<x>

Table 5.2.48W6B3.1: /<x>/<x>/OnNetwork/FunctionalAliasList/<x>/Entry/LocationCriteriaForDeactivation/<x>/EnterSpecificArea/PolygonArea/<x>

<x>/OnNetwork/FunctionalAliasList/<x>/Entry/LocationCriteriaForDeactivation/<x>/EnterSpecificArea/PolygonArea/<x>

Status	Occurrence	Format	Min. Access Types
Required	OneOrN	node	Get, Replace

This interior node contains the coordinates of the corners which define a polygon. The occurrence of this leaf node is "3 to 15" as per 3GPP TS 23.032 [21].

5.2.48W6B3A /<x>/<x>/OnNetwork/FunctionalAliasList/<x>/Entry/
LocationCriteriaForDeactivation/<x>/EnterSpecificArea/
PolygonArea/<x>/PointCoordinateType

**Table 5.2.48W6B3A.1: /<x>/<x>/OnNetwork/FunctionalAliasList/<x>/Entry/
LocationCriteriaForDeactivation/<x>/EnterSpecificArea/PolygonArea/<x>/PointCoordinateType**

<x>/OnNetwork/FunctionalAliasList/<x>/Entry/LocationCriteriaForDeactivation/<x>/EnterSpecificArea/PolygonArea/<x>/PointCoordinateType

Status	Occurrence	Format	Min. Access Types
Required	One	node	Get, Replace

This interior node contains the coordinates of the center point of the ellipsoid arc.

5.2.48W6B4 /<x>/<x>/OnNetwork/FunctionalAliasList/<x>/Entry/
LocationCriteriaForDeactivation/<x>/EnterSpecificArea/
PolygonArea/<x>/PointCoordinateType/Longitude

**Table 5.2.48W6B4.1: /<x>/<x>/OnNetwork/FunctionalAliasList/<x>/Entry/
LocationCriteriaForDeactivation/<x>/EnterSpecificArea/PolygonArea/<x>/PointCoordinateType/
Longitude**

<x>/OnNetwork/FunctionalAliasList/<x>/Entry/LocationCriteriaForDeactivation/<x>/EnterSpecificArea/PolygonArea/<x>/PointCoordinateType/Longitude

Status	Occurrence	Format	Min. Access Types
Required	One	int	Get, Replace

This leaf node contains the longitudinal coordinate of a corner.

- Values: 0-16777215

5.2.48W6B5 /<x>/<x>/OnNetwork/FunctionalAliasList/<x>/Entry/
LocationCriteriaForDeactivation/<x>/EnterSpecificArea/
PolygonArea/<x>/PointCoordinateType/Latitude

**Table 5.2.48W6B5.1: /<x>/<x>/OnNetwork/FunctionalAliasList/<x>/Entry/
LocationCriteriaForDeactivation/<x>/EnterSpecificArea/PolygonArea/<x>/PointCoordinateType/
Latitude**

<x>/OnNetwork/FunctionalAliasList/<x>/Entry/LocationCriteriaForDeactivation/<x>/EnterSpecificArea/PolygonArea/<x>/PointCoordinateType/Latitude

Status	Occurrence	Format	Min. Access Types
Required	One	int	Get, Replace

This leaf node contains the latitudinal coordinate of a corner.

- Values: 0-16777215

5.2.48W6B6 /<x>/<x>/OnNetwork/FunctionalAliasList/<x>/Entry/LocationCriteriaForDeactivation/<x>/EnterSpecificArea/EllipsoidArcArea

Table 5.2.48W6B6.1: /<x>/<x>/OnNetwork/FunctionalAliasList/<x>/Entry/LocationCriteriaForDeactivation/<x>/EnterSpecificArea/EllipsoidArcArea

<x>/OnNetwork/FunctionalAliasList/<x>/Entry/LocationCriteriaForDeactivation/<x>/EnterSpecificArea/EllipsoidArcArea

Status	Occurrence	Format	Min. Access Types
Optional	ZeroOrOne	node	Get, Replace

This interior node contains a geographical area described by an ellipsoid arc.

5.2.48W6B7 /<x>/<x>/OnNetwork/FunctionalAliasList/<x>/Entry/LocationCriteriaForDeactivation/<x>/EnterSpecificArea/EllipsoidArcArea/Center

Table 5.2.48W6B7.1: /<x>/<x>/OnNetwork/FunctionalAliasList/<x>/Entry/LocationCriteriaForDeactivation/<x>/EnterSpecificArea/EllipsoidArcArea/Center

<x>/OnNetwork/FunctionalAliasList/<x>/Entry/LocationCriteriaForDeactivation/<x>/EnterSpecificArea/EllipsoidArcArea/Center

Status	Occurrence	Format	Min. Access Types
Required	One	node	Get, Replace

This interior node contains the coordinates of the center point of the ellipsoid arc.

5.2.48W6B7A /<x>/<x>/OnNetwork/FunctionalAliasList/<x>/Entry/LocationCriteriaForDeactivation/<x>/EnterSpecificArea/EllipsoidArcArea/Center/PointCoordinateType

Table 5.2.48W6B7A.1: /<x>/<x>/OnNetwork/FunctionalAliasList/<x>/Entry/LocationCriteriaForDeactivation/<x>/EnterSpecificArea/EllipsoidArcArea/Center/PointCoordinateType

<x>/OnNetwork/FunctionalAliasList/<x>/Entry/LocationCriteriaForDeactivation/<x>/EnterSpecificArea/EllipsoidArcArea/Center/PointCoordinateType

Status	Occurrence	Format	Min. Access Types
Required	One	node	Get, Replace

This interior node contains the coordinates of the center point of the ellipsoid arc.

5.2.48W6B8 /<x>/<x>/OnNetwork/FunctionalAliasList/<x>/Entry/ LocationCriteriaForDeactivation/<x>/EnterSpecificArea/ EllipsoidArcArea/Center/PointCoordinateType/Longitude

**Table 5.2.48W6B8.1: /<x>/<x>/OnNetwork/FunctionalAliasList/<x>/Entry/
LocationCriteriaForDeactivation/<x>/EnterSpecificArea/EllipsoidArcArea/Center/PointCoordinateType/
Longitude**

<x>/OnNetwork/FunctionalAliasList/<x>/Entry/LocationCriteriaForDeactivation/<x>/EnterSpecificArea/EllipsoidArcArea/Center/PointCoordinateType/Longitude

Status	Occurrence	Format	Min. Access Types
Required	One	int	Get, Replace

This leaf node contains the longitudinal coordinate of the center.

- Values: 0-16777215

5.2.48W6B9 /<x>/<x>/OnNetwork/FunctionalAliasList/<x>/Entry/ LocationCriteriaForDeactivation/<x>/EnterSpecificArea/ EllipsoidArcArea/Center/PointCoordinateType/Latitude

**Table 5.2.48W6B9.1: /<x>/<x>/OnNetwork/FunctionalAliasList/<x>/Entry/
LocationCriteriaForDeactivation/<x>/EnterSpecificArea/EllipsoidArcArea/Center/PointCoordinateType/
Latitude**

<x>/OnNetwork/FunctionalAliasList/<x>/Entry/LocationCriteriaForDeactivation/<x>/EnterSpecificArea/EllipsoidArcArea/Center/PointCoordinateType/Latitude

Status	Occurrence	Format	Min. Access Types
Required	One	int	Get, Replace

This leaf node contains the latitudinal coordinate of the center.

- Values: 0-16777215

5.2.48W6B10/<x>/<x>/OnNetwork/FunctionalAliasList/<x>/Entry/ LocationCriteriaForDeactivation/<x>/EnterSpecificArea/ EllipsoidArcArea/Radius

**Table 5.2.48W6B10.1: /<x>/<x>/OnNetwork/FunctionalAliasList/<x>/Entry/
LocationCriteriaForDeactivation/<x>/EnterSpecificArea/EllipsoidArcArea/Radius**

<x>/OnNetwork/FunctionalAliasList/<x>/Entry/LocationCriteriaForDeactivation/<x>/EnterSpecificArea/EllipsoidArcArea/Radius

Status	Occurrence	Format	Min. Access Types
Required	One	int	Get, Replace

This leaf node contains the radius of the ellipsoid arc.

- Values: non-negative integer

5.2.48W6B11/<x>/<x>/OnNetwork/FunctionalAliasList/<x>/Entry/ LocationCriteriaForDeactivation/<x>/EnterSpecificArea/ EllipsoidArcArea/OffsetAngle

**Table 5.2.48W6B11.1: /<x>/<x>/OnNetwork/FunctionalAliasList/<x>/Entry/
LocationCriteriaForDeactivation/<x>/EnterSpecificArea/EllipsoidArcArea/OffsetAngle**

<x>/OnNetwork/FunctionalAliasList/<x>/Entry/LocationCriteriaForDeactivation/<x>/EnterSpecificArea/EllipsoidArcArea/OffsetAngle

Status	Occurrence	Format	Min. Access Types
Required	One	int	Get, Replace

This leaf node contains the offset angle of the ellipsoid arc.

- Values: 0-255

5.2.48W6B12/<x>/<x>/OnNetwork/FunctionalAliasList/<x>/Entry/ LocationCriteriaForDeactivation/<x>/EnterSpecificArea/ EllipsoidArcArea/IncludedAngle

**Table 5.2.48W6B12.1: /<x>/<x>/OnNetwork/FunctionalAliasList/<x>/Entry/
LocationCriteriaForDeactivation/<x>/EnterSpecificArea/EllipsoidArcArea/IncludedAngle**

<x>/OnNetwork/FunctionalAliasList/<x>/Entry/LocationCriteriaForDeactivation/<x>/EnterSpecificArea/EllipsoidArcArea/IncludedAngle

Status	Occurrence	Format	Min. Access Types
Required	One	int	Get, Replace

This leaf node contains the included angle of the ellipsoid arc.

- Values: 0-255

5.2.48W6B12A /<x>/<x>/OnNetwork/FunctionalAliasList/<x>/Entry/ LocationCriteriaForDeactivation/<x>/EnterSpecificArea/Speed

**Table 5.2.48W6B12A.1: /<x>/<x>/OnNetwork/FunctionalAliasList/<x>/Entry/
LocationCriteriaForDeactivation/<x>/EnterSpecificArea/Speed**

<x>/OnNetwork/FunctionalAliasList/<x>/Entry/LocationCriteriaForDeactivation/<x>/EnterSpecificArea/Speed

Status	Occurrence	Format	Min. Access Types
Optional	One	node	Get, Replace

This interior node contains the speed.

5.2.48W6B12B /<x>/<x>/OnNetwork/FunctionalAliasList/<x>/Entry/
LocationCriteriaForDeactivation/<x>/EnterSpecificArea/Speed/
MinimumSpeed

**Table 5.2.48W6B12B.1: /<x>/<x>/OnNetwork/FunctionalAliasList/<x>/Entry/
LocationCriteriaForDeactivation/<x>/EnterSpecificArea/Speed/MinimumSpeed**

<x>/OnNetwork/FunctionalAliasList/<x>/Entry/LocationCriteriaForDeactivation/<x>/EnterSpecificArea/Speed/MinimumSpeed

Status	Occurrence	Format	Min. Access Types
Required	One	int	Get, Replace

This leaf node contains the minimum speed.

- Values: non-negative integer in units of kilometers/hour.

5.2.48W6B12C /<x>/<x>/OnNetwork/FunctionalAliasList/<x>/Entry/
LocationCriteriaForDeactivation/<x>/EnterSpecificArea/Speed/
MaximumSpeed

**Table 5.2.48W6B12C.1: /<x>/<x>/OnNetwork/FunctionalAliasList/<x>/Entry/
LocationCriteriaForDeactivation/<x>/EnterSpecificArea/Speed/MaximumSpeed**

<x>/OnNetwork/FunctionalAliasList/<x>/Entry/LocationCriteriaForDeactivation/<x>/EnterSpecificArea/Speed/MaximumSpeed

Status	Occurrence	Format	Min. Access Types
Required	One	int	Get, Replace

This leaf node contains the maximum speed.

- Values: non-negative integer in units of kilometers/hour.

5.2.48W6B12D /<x>/<x>/OnNetwork/FunctionalAliasList/<x>/Entry/
LocationCriteriaForDeactivation/<x>/EnterSpecificArea/Heading

**Table 5.2.48W6B12D.1: /<x>/<x>/OnNetwork/FunctionalAliasList/<x>/Entry/
LocationCriteriaForDeactivation/<x>/EnterSpecificArea/Heading**

<x>/OnNetwork/FunctionalAliasList/<x>/Entry/LocationCriteriaForDeactivation/<x>/EnterSpecificArea/Heading

Status	Occurrence	Format	Min. Access Types
Optional	One	node	Get, Replace

This interior node contains the heading.

5.2.48W6B12E /<x>/<x>/OnNetwork/FunctionalAliasList/<x>/Entry/ LocationCriteriaForDeactivation/<x>/EnterSpecificArea/Heading/ MinimumHeading

**Table 5.2.48W6B12E.1: /<x>/<x>/OnNetwork/FunctionalAliasList/<x>/Entry/
LocationCriteriaForDeactivation/<x>/EnterSpecificArea/Heading/MinimumHeading**

<x>/OnNetwork/FunctionalAliasList/<x>/Entry/LocationCriteriaForDeactivation/<x>/EnterSpecificArea/Heading/MinimumHeading

Status	Occurrence	Format	Min. Access Types
Required	One	int	Get, Replace

This leaf node contains the minimum heading.

- Values: 0-359

5.2.48W6B12F /<x>/<x>/OnNetwork/FunctionalAliasList/<x>/Entry/ LocationCriteriaForDeactivation/<x>/EnterSpecificArea/Heading/ MaximumHeading

**Table 5.2.48W6B12F.1: /<x>/<x>/OnNetwork/FunctionalAliasList/<x>/Entry/
LocationCriteriaForDeactivation/<x>/EnterSpecificArea/Heading/MaximumHeading**

<x>/OnNetwork/FunctionalAliasList/<x>/Entry/LocationCriteriaForDeactivation/<x>/EnterSpecificArea/Heading/MaximumHeading

Status	Occurrence	Format	Min. Access Types
Required	One	int	Get, Replace

This leaf node contains the maximum heading.

- Values: 0-359

5.2.48W6B13/<x>/<x>/OnNetwork/FunctionalAliasList/<x>/Entry/ LocationCriteriaForDeactivation/<x>/ExitSpecificArea

**Table 5.2.48W6B13.1: /<x>/<x>/OnNetwork/FunctionalAliasList/<x>/Entry/
LocationCriteriaForDeactivation/<x>/ExitSpecificArea**

<x>/OnNetwork/FunctionalAliasList/<x>/Entry/LocationCriteriaForDeactivation/<x>/ExitSpecificArea

Status	Occurrence	Format	Min. Access Types
Optional	ZeroOrOne	node	Get, Replace

This interior node contains a geographical area which when exited by the MC service UE triggers the functional alias de-activation.

5.2.48W6B14/<x>/<x>/OnNetwork/FunctionalAliasList/<x>/Entry/ LocationCriteriaForDeactivation/<x>/ExitSpecificArea/ PolygonArea

**Table 5.2.48W6B14.1: /<x>/<x>/OnNetwork/FunctionalAliasList/<x>/Entry/
LocationCriteriaForDeactivation/<x>/ExitSpecificArea/PolygonArea**

<x>/OnNetwork/FunctionalAliasList/<x>/Entry/LocationCriteriaForDeactivation/<x>/ExitSpecificArea/PolygonArea
a

Status	Occurrence	Format	Min. Access Types
Optional	ZeroOrOne	node	Get, Replace

This interior node contains a geographical area described by a polygon.

5.2.48W6B15/<x>/<x>/OnNetwork/FunctionalAliasList/<x>/Entry/ LocationCriteriaForDeactivation/<x>/ExitSpecificArea/ PolygonArea/<x>

**Table 5.2.48W6B15.1: /<x>/<x>/OnNetwork/FunctionalAliasList/<x>/Entry/
LocationCriteriaForDeactivation/<x>/ExitSpecificArea/PolygonArea/<x>**

<x>/OnNetwork/FunctionalAliasList/<x>/Entry/LocationCriteriaForDeactivation/<x>/ExitSpecificArea/PolygonArea
a/<x>

Status	Occurrence	Format	Min. Access Types
Required	OneOrN	node	Get, Replace

This interior node contains the coordinates of the corners which define a polygon. The occurrence of this leaf node is "3 to 15" as per 3GPP TS 23.032 [21].

5.2.48W6B15A /<x>/<x>/OnNetwork/FunctionalAliasList/<x>/Entry/ LocationCriteriaForDeactivation/<x>/ExitSpecificArea/ PolygonArea/<x>/PointCoordinateType

**Table 5.2.48W6B15A.1: /<x>/<x>/OnNetwork/FunctionalAliasList/<x>/Entry/
LocationCriteriaForDeactivation/<x>/ExitSpecificArea/PolygonArea/<x>/PointCoordinateType**

<x>/OnNetwork/FunctionalAliasList/<x>/Entry/LocationCriteriaForDeactivation/<x>/ExitSpecificArea/PolygonArea
a/<x>/PointCoordinateType

Status	Occurrence	Format	Min. Access Types
Required	One	node	Get, Replace

This interior node contains the coordinates of the center point of the ellipsoid arc.

5.2.48W6B16/<x>/<x>/OnNetwork/FunctionalAliasList/<x>/Entry/ LocationCriteriaForDeactivation/<x>/ExitSpecificArea/ PolygonArea/<x>/PointCoordinateType/Longitude

**Table 5.2.48W6B16.1: /<x>/<x>/OnNetwork/FunctionalAliasList/<x>/Entry/
LocationCriteriaForDeactivation/<x>/ExitSpecificArea/PolygonArea/<x>/PointCoordinateType/
Longitude**

<x>/OnNetwork/FunctionalAliasList/<x>/Entry/LocationCriteriaForDeactivation/<x>/ExitSpecificArea/PolygonArea/<x>/PointCoordinateType/Longitude

Status	Occurrence	Format	Min. Access Types
Required	One	int	Get, Replace

This leaf node contains the longitudinal coordinate of a corner.

- Values: 0-16777215

5.2.48W6B17/<x>/<x>/OnNetwork/FunctionalAliasList/<x>/Entry/ LocationCriteriaForDeactivation/<x>/ExitSpecificArea/ PolygonArea/<x>/PointCoordinateType/Latitude

**Table 5.2.48W6B17.1: /<x>/<x>/OnNetwork/FunctionalAliasList/<x>/Entry/
LocationCriteriaForDeactivation/<x>/ExitSpecificArea/PolygonArea/<x>/PointCoordinateType/Latitud
e**

<x>/OnNetwork/FunctionalAliasList/<x>/Entry/LocationCriteriaForDeactivation/<x>/ExitSpecificArea/PolygonArea/<x>/PointCoordinateType/Latitude

Status	Occurrence	Format	Min. Access Types
Required	One	int	Get, Replace

This leaf node contains the latitudinal coordinate of a corner.

- Values: 0-16777215

5.2.48W6B18/<x>/<x>/OnNetwork/FunctionalAliasList/<x>/Entry/ LocationCriteriaForDeactivation/<x>/ExitSpecificArea/ EllipsoidArcArea

**Table 5.2.48W6B18.1: /<x>/<x>/OnNetwork/FunctionalAliasList/<x>/Entry/
LocationCriteriaForDeactivation/<x>/ExitSpecificArea/EllipsoidArcArea**

<x>/OnNetwork/FunctionalAliasList/<x>/Entry/LocationCriteriaForDeactivation/<x>/ExitSpecificArea/EllipsoidArc

Status	Occurrence	Format	Min. Access Types
Optional	ZeroOrOne	node	Get, Replace

This interior node contains a geographical area described by an ellipsoid arc.

5.2.48W6B19/<x>/<x>/OnNetwork/FunctionalAliasList/<x>/Entry/
LocationCriteriaForDeactivation/<x>/ExitSpecificArea/
EllipsoidArcArea/Center

**Table 5.2.48W6B19.1: /<x>/<x>/OnNetwork/FunctionalAliasList/<x>/Entry/
LocationCriteriaForDeactivation/<x>/ExitSpecificArea/EllipsoidArcArea/Center**

<x>/OnNetwork/FunctionalAliasList/<x>/Entry/LocationCriteriaForDeactivation/<x>/ExitSpecificArea/EllipsoidArc
Area/Center

Status	Occurrence	Format	Min. Access Types
Required	One	node	Get, Replace

This interior node contains the coordinates of the center point of the ellipsoid arc.

5.2.48W6B19A /<x>/<x>/OnNetwork/FunctionalAliasList/<x>/Entry/
LocationCriteriaForDeactivation/<x>/ExitSpecificArea/
EllipsoidArcArea/Center/PointCoordinateType

**Table 5.2.48W6B19A.1: /<x>/<x>/OnNetwork/FunctionalAliasList/<x>/Entry/
LocationCriteriaForDeactivation/<x>/ExitSpecificArea/EllipsoidArcArea/Center/PointCoordinateType**

<x>/OnNetwork/FunctionalAliasList/<x>/Entry/LocationCriteriaForDeactivation/<x>/ExitSpecificArea/EllipsoidArc
Area/Center/PointCoordinateType

Status	Occurrence	Format	Min. Access Types
Required	One	node	Get, Replace

This interior node contains the coordinates of the center point of the ellipsoid arc.

5.2.48W6B20/<x>/<x>/OnNetwork/FunctionalAliasList/<x>/Entry/
LocationCriteriaForDeactivation/<x>/ExitSpecificArea/
EllipsoidArcArea/Center/PointCoordinateType/Longitude

**Table 5.2.48W6B20.1: /<x>/<x>/OnNetwork/FunctionalAliasList/<x>/Entry/
LocationCriteriaForDeactivation/<x>/ExitSpecificArea/EllipsoidArcArea/Center/PointCoordinateType/
Longitude**

<x>/OnNetwork/FunctionalAliasList/<x>/Entry/LocationCriteriaForDeactivation/<x>/ExitSpecificArea/EllipsoidArc
Area/Center/PointCoordinateType/Longitude

Status	Occurrence	Format	Min. Access Types
Required	One	int	Get, Replace

This leaf node contains the longitudinal coordinate of the center.

- Values: 0-16777215

5.2.48W6B21/<x>/<x>/OnNetwork/FunctionalAliasList/<x>/Entry/ LocationCriteriaForDeactivation/<x>/ExitSpecificArea/ EllipsoidArcArea/Center/PointCoordinateType/Latitude

**Table 5.2.48W6B21.1: /<x>/<x>/OnNetwork/FunctionalAliasList/<x>/Entry/
LocationCriteriaForDeactivation/<x>/ExitSpecificArea/EllipsoidArcArea/Center/PointCoordinateType/
Latitude**

<x>/OnNetwork/FunctionalAliasList/<x>/Entry/LocationCriteriaForDeactivation/<x>/ExitSpecificArea/EllipsoidArc
Area/Center/PointCoordinateType/Latitude

Status	Occurrence	Format	Min. Access Types
Required	One	int	Get, Replace

This leaf node contains the latitudinal coordinate of the center.

- Values: 0-16777215

5.2.48W6B22/<x>/<x>/OnNetwork/FunctionalAliasList/<x>/Entry/ LocationCriteriaForDeactivation/<x>/ExitSpecificArea/ EllipsoidArcArea/Radius

**Table 5.2.48W6B22.1: /<x>/<x>/OnNetwork/FunctionalAliasList/<x>/Entry/
LocationCriteriaForDeactivation/<x>/ExitSpecificArea/EllipsoidArcArea/Radius**

<x>/OnNetwork/FunctionalAliasList/<x>/Entry/LocationCriteriaForDeactivation/<x>/ExitSpecificArea/EllipsoidArc
Area/Radius

Status	Occurrence	Format	Min. Access Types
Required	One	int	Get, Replace

This leaf node contains the radius of the ellipsoid arc.

- Values: non-negative integer

5.2.48W6B23/<x>/<x>/OnNetwork/FunctionalAliasList/<x>/Entry/ LocationCriteriaForDeactivation/<x>/ExitSpecificArea/ EllipsoidArcArea/OffsetAngle

**Table 5.2.48W6B23.1: /<x>/<x>/OnNetwork/FunctionalAliasList/<x>/Entry/
LocationCriteriaForDeactivation/<x>/ExitSpecificArea/EllipsoidArcArea/OffsetAngle**

<x>/OnNetwork/FunctionalAliasList/<x>/Entry/LocationCriteriaForDeactivation/<x>/ExitSpecificArea/EllipsoidArc
Area/OffsetAngle

Status	Occurrence	Format	Min. Access Types
Required	One	int	Get, Replace

This leaf node contains the offset angle of the ellipsoid arc.

- Values: 0-255

5.2.48W6B24/<x>/<x>/OnNetwork/FunctionalAliasList/<x>/Entry/ LocationCriteriaForDeactivation/<x>/ExitSpecificArea/ EllipsoidArcArea/IncludedAngle

**Table 5.2.48W6B24.1: /<x>/<x>/OnNetwork/FunctionalAliasList/<x>/Entry/
LocationCriteriaForDeactivation/<x>/ExitSpecificArea/EllipsoidArcArea/IncludedAngle**

<x>/OnNetwork/FunctionalAliasList/<x>/Entry/LocationCriteriaForDeactivation/<x>/ExitSpecificArea/EllipsoidArc
Area/IncludedAngle

Status	Occurrence	Format	Min. Access Types
Required	One	int	Get, Replace

This leaf node contains the included angle of the ellipsoid arc.

- Values: 0-255

5.2.48W6B24A /<x>/<x>/OnNetwork/FunctionalAliasList/<x>/Entry/ LocationCriteriaForDeactivation/<x>/ExitSpecificArea/Speed

**Table 5.2.48W6B24A.1: /<x>/<x>/OnNetwork/FunctionalAliasList/<x>/Entry/
LocationCriteriaForDeactivation/<x>/ExitSpecificArea/Speed**

<x>/OnNetwork/FunctionalAliasList/<x>/Entry/LocationCriteriaForDeactivation/<x>/ExitSpecificArea/Speed

Status	Occurrence	Format	Min. Access Types
Optional	One	node	Get, Replace

This interior node contains the speed.

5.2.48W6B24B /<x>/<x>/OnNetwork/FunctionalAliasList/<x>/Entry/ LocationCriteriaForDeactivation/<x>/ExitSpecificArea/Speed/ MinimumSpeed

**Table 5.2.48W6B24B.1: /<x>/<x>/OnNetwork/FunctionalAliasList/<x>/Entry/
LocationCriteriaForDeactivation/<x>/ExitSpecificArea/Speed/MinimumSpeed**

<x>/OnNetwork/FunctionalAliasList/<x>/Entry/LocationCriteriaForDeactivation/<x>/ExitSpecificArea/Speed/Mini
mumSpeed

Status	Occurrence	Format	Min. Access Types
Required	One	int	Get, Replace

This leaf node contains the minimum speed.

- Values: non-negative integer in units of kilometers/hour.

5.2.48W6B24C /<x>/<x>/OnNetwork/FunctionalAliasList/<x>/Entry/
LocationCriteriaForDeactivation/<x>/ExitSpecificArea/Speed/
MaximumSpeed

**Table 5.2.48W6B24C.1: /<x>/<x>/OnNetwork/FunctionalAliasList/<x>/Entry/
LocationCriteriaForDeactivation/<x>/ExitSpecificArea/Speed/MaximumSpeed**

<x>/OnNetwork/FunctionalAliasList/<x>/Entry/LocationCriteriaForDeactivation/<x>/ExitSpecificArea/Speed/MaximumSpeed

Status	Occurrence	Format	Min. Access Types
Required	One	int	Get, Replace

This leaf node contains the maximum speed.

- Values: non-negative integer in units of kilometers/hour.

5.2.48W6B24D /<x>/<x>/OnNetwork/FunctionalAliasList/<x>/Entry/
LocationCriteriaForDeactivation/<x>/ExitSpecificArea/Heading

**Table 5.2.48W6B24D.1: /<x>/<x>/OnNetwork/FunctionalAliasList/<x>/Entry/
LocationCriteriaForDeactivation/<x>/ExitSpecificArea/Heading**

<x>/OnNetwork/FunctionalAliasList/<x>/Entry/LocationCriteriaForDeactivation/<x>/ExitSpecificArea/Heading

Status	Occurrence	Format	Min. Access Types
Optional	One	node	Get, Replace

This interior node contains the heading.

5.2.48W6B24E /<x>/<x>/OnNetwork/FunctionalAliasList/<x>/Entry/
LocationCriteriaForDeactivation/<x>/ExitSpecificArea/Heading/
MinimumHeading

**Table 5.2.48W6B24E.1: /<x>/<x>/OnNetwork/FunctionalAliasList/<x>/Entry/
LocationCriteriaForDeactivation/<x>/ExitSpecificArea/Heading/MinimumHeading**

<x>/OnNetwork/FunctionalAliasList/<x>/Entry/LocationCriteriaForDeactivation/<x>/ExitSpecificArea/Heading/MinimumHeading

Status	Occurrence	Format	Min. Access Types
Required	One	int	Get, Replace

This leaf node contains the minimum heading.

- Values: 0-359

5.2.48W6B24F /<x>/<x>/OnNetwork/FunctionalAliasList/<x>/Entry/ LocationCriteriaForDeactivation/<x>/ExitSpecificArea/Heading/ MaximumHeading

**Table 5.2.48W6B24F.1: /<x>/<x>/OnNetwork/FunctionalAliasList/<x>/Entry/
LocationCriteriaForDeactivation/<x>/ExitSpecificArea/Heading/MaximumHeading**

<x>/OnNetwork/FunctionalAliasList/<x>/Entry/LocationCriteriaForDeactivation/<x>/ExitSpecificArea/Heading/MaximumHeading

Status	Occurrence	Format	Min. Access Types
Required	One	int	Get, Replace

This leaf node contains the maximum heading.

- Values: 0-359

5.2.48W6C/<x>/<x>/OnNetwork/FunctionalAliasList/<x>/Entry/ ManualDeactivationNotAllowedIfLocationCriteriaMet

**Table 5.2.48W6C.1: /<x>/<x>/OnNetwork/FunctionalAliasList/<x>/Entry/
ManualDeactivationNotAllowedIfLocationCriteriaMet**

<x>/OnNetwork/FunctionalAliasList/<x>/Entry/ManualDeactivationNotAllowedIfLocationCriteriaMet

Status	Occurrence	Format	Min. Access Types
Optional	ZeroOrOne	bool	Get, Replace

This leaf node indicates whether the MCPTT user is authorised to de-activate a functional alias if the location criteria is met.

5.2.48W7 /<x>/<x>/OnNetwork/FunctionalAliasList/<x>/Entry/ DisplayName

Table 5.2.48W7.1: /<x>/<x>/OnNetwork/FunctionalAliasList/<x>/Entry/DisplayName

<x>/OnNetwork/FunctionalAliasList/<x>/Entry/DisplayName

Status	Occurrence	Format	Min. Access Types
Optional	One	chr	Get, Replace

This leaf node contains a human readable name that corresponds to a functional alias that can be activated by the MCPTT user.

5.2.48W7A/<x>/<x>/OnNetwork/FunctionalAliasList/<x>/Entry/ MaxSimultaneousEmergencyGroupCalls

**Table 5.2.48W7A.1: /<x>/<x>/OnNetwork/FunctionalAliasList/<x>/Entry/
MaxSimultaneousEmergencyGroupCalls**

<x>/OnNetwork/FunctionalAliasList/<x>/Entry/MaxSimultaneousEmergencyGroupCalls

Status	Occurrence	Format	Min. Access Types
Optional	One	int	Get, Replace

This leaf node indicates the maximum number of simultaneous emergency group calls for a functional alias.

5.2.48W7B/<x>/<x>/OnNetwork/FunctionalAliasList/<x>/Entry/ FAsAllowedToCall

**Table 5.2.48W7B.1: /<x>/<x>/OnNetwork/FunctionalAliasList/<x>/Entry/
FAsAllowedToCall**

<x>/OnNetwork/FunctionalAliasList/<x>/Entry/FAsAllowedToCall

Status	Occurrence	Format	Min. Access Types
Required	One	node	Get, Replace

This interior node is a placeholder for the functional alias configuration regarding the authorized functional aliases to be called in a private call by the functional alias indicated in the parent Entry node.

5.2.48W7C/<x>/<x>/OnNetwork/FunctionalAliasList/<x>/Entry/ FAsAllowedToCall/<x>

Table 5.2.48W7C.1: /<x>/<x>/OnNetwork/FunctionalAliasList/<x>/Entry/FAsAllowedToCall/<x>

<x>/OnNetwork/FunctionalAliasList/<x>/Entry/FAsAllowedToCall/<x>

Status	Occurrence	Format	Min. Access Types
Required	OneOrMore	node	Get, Replace

This interior node is a placeholder for one or more functional alias configuration elements indicating the functional aliases that can be called in a private call by the functional alias indicated in the parent Entry node.

5.2.48W7D/<x>/<x>/OnNetwork/FunctionalAliasList/<x>/Entry/ FAsAllowedToCall/<x>/Entry

Table 5.2.48W7D.1: /<x>/<x>/OnNetwork/FunctionalAliasList/<x>/Entry/FAsAllowedToCall/<x>/Entry

<x>/OnNetwork/FunctionalAliasList/<x>/Entry/FAsAllowedToCall/<x>/Entry

Status	Occurrence	Format	Min. Access Types
Optional	One	node	Get, Replace

This interior node is a placeholder for the details of the functional alias that can be called in a private call by the functional alias indicated in the parent Entry node.

5.2.48W7E /<x>/<x>/OnNetwork/FunctionalAliasList/<x>/Entry/ FAsAllowedToCall/<x>/Entry/FunctionalAlias

**Table 5.2.48W7E.1: /<x>/<x>/OnNetwork/FunctionalAliasList/<x>/Entry/FAsAllowedToCall/
<x>/Entry/FunctionalAlias**

<x>/OnNetwork/FunctionalAliasList/<x>/Entry/FAsAllowedToCall/<x>/Entry/FunctionalAlias

Status	Occurrence	Format	Min. Access Types
Required	One	chr	Get, Replace

This leaf node indicates a functional alias that can be called in a private call by the functional alias indicated in the parent Entry node.

5.2.48W8 /<x>/<x>/OnNetwork/AllowedQueryFunctionalAliasOtherUser

Table 5.2.48W8.1: /<x>/<x>/OnNetwork/AllowedQueryFunctionalAliasOtherUser

<x>/OnNetwork/AllowedQueryFunctionalAliasOtherUser

Status	Occurrence	Format	Min. Access Types
Required	One	bool	Get, Replace

This leaf node indicates whether the MCPTT user is authorised query the functional alias(es) activated by another MCPTT user.

When set to "true" the MCPTT user is authorised to query the functional alias(es) activated by another MCPTT user.

When set to "false" the MCPTT user is not authorised to query the functional alias(es) activated by another MCPTT user.

5.2.48W9 /<x>/<x>/OnNetwork/AllowedTakeoverFunctionalAliasOtherUser

Table 5.2.48W9.1: /<x>/<x>/OnNetwork/AllowedTakeoverFunctionalAliasOtherUser

<x>/OnNetwork/AllowedTakeoverFunctionalAliasOtherUser

Status	Occurrence	Format	Min. Access Types
Required	One	bool	Get, Replace

This leaf node indicates whether the MCPTT user is authorised to take over the functional alias(es) previously activated by another MCPTT user.

When set to "true" the MCPTT user is authorised to take over the functional alias(es) previously activated by another MCPTT user.

When set to "false" the MCPTT user is not authorised to take over the functional alias(es) previously activated by another MCPTT user.

5.2.48W10 /<x>/<x>/OnNetwork/AllowedLocationInfoWhenTalking

Table 5.2.48W10.1: /<x>/<x>/OnNetwork/AllowedLocationInfoWhenTalking

<x>/OnNetwork/AllowedLocationInfoWhenTalking

Status	Occurrence	Format	Min. Access Types
Required	One	bool	Get, Replace

This leaf node indicates whether the MCPTT user is authorised to send its location information when it is requesting the floor.

When set to "true" the MCPTT user is authorised to send its location information when it is requesting the floor.

When set to "false" the MCPTT user is not authorised to send its location information when it is requesting the floor.

5.2.48W11 /<x>/<x>/OnNetwork/AllowedFunctionalAliasGroupBinding

Table 5.2.48W11.1: /<x>/<x>/OnNetwork/AllowedFunctionalAliasGroupBinding

<x>/OnNetwork/AllowedFunctionalAliasGroupBinding

Status	Occurrence	Format	Min. Access Types
Optional	One	bool	Get, Replace

This leaf node indicates whether the MCPTT user is authorised to request the binding of a particular functional alias with a group or list of groups.

When set to "true" the MCPTT user is authorised to request the binding of a particular functional alias with a group or list of groups.

When set to "false" the MCPTT user is not authorised to request the binding of a particular functional alias with a group or list of groups.

5.2.48W12 /<x>/<x>/OnNetwork/MCPTTAdhocGroup

Table 5.2.48W12.1: /<x>/<x>/OnNetwork/MCPTTAdhocGroup

<x>/OnNetwork/MCPTTAdhocGroup

Status	Occurrence	Format	Min. Access Types
Required	One	node	Get, Replace

This interior node is a placeholder for the MCPTT adhoc group call and alert related configurations.

5.2.48W12A /<x>/<x>/OnNetwork/MCPTTAdhocGroup/EmergencyAlert

Table 5.2.48W12A.1: /<x>/<x>/OnNetwork/MCPTTAdhocGroup/EmergencyAlert

<x>/OnNetwork/MCPTTAdhocGroup/EmergencyAlert

Status	Occurrence	Format	Min. Access Types
Required	One	node	Get, Replace

This interior node is a placeholder for the MCPTT adhoc group emergency alert policy.

5.2.48W12A1/<x>/<x>/OnNetwork/MCPTTAdhocGroup/EmergencyAlert/Authorised

Table 5.2.48W12A1.1: /<x>/<x>/OnNetwork/MCPTTAdhocGroup/EmergencyAlert/Authorised

<x>/OnNetwork/MCPTTAdhocGroup/EmergencyAlert/Authorised

Status	Occurrence	Format	Min. Access Types
Required	One	bool	Get, Replace

This leaf node indicates the authorisation to activate an MCPTT adhoc group emergency alert.

When set to "true" the MCPTT user is authorised to make an MCPTT adhoc group emergency alert.

When set to "false" the MCPTT user is not authorised to make an MCPTT adhoc group emergency alert.

5.2.48W12A2/<x>/<x>/OnNetwork/MCPTTAdhocGroup/EmergencyAlert/Cancel

Table 5.2.48W12A2.1: /<x>/<x>/OnNetwork/MCPTTAdhocGroup/EmergencyAlert/Cancel

<x>/OnNetwork/MCPTTAdhocGroup/EmergencyAlert/Cancel

Status	Occurrence	Format	Min. Access Types
Required	One	bool	Get, Replace

This leaf node indicates the authorisation to cancel an MCPTT adhoc group emergency alert.

When set to "true" the MCPTT user is authorised to cancel an MCPTT adhoc group emergency alert.

When set to "false" the MCPTT user is not authorised to cancel an MCPTT adhoc group emergency alert.

5.2.48W12A3/<x>/<x>/OnNetwork/MCPTTAdhocGroup/EmergencyAlert/AuthRecvParticipantInfo

Table 5.2.48W12A3.1:

/<x>/<x>/OnNetwork/MCPTTAdhocGroup/EmergencyAlert/AuthRecvParticipantInfo

<x>/OnNetwork/MCPTTAdhocGroup/EmergencyAlert/AuthRecvParticipantInfo

Status	Occurrence	Format	Min. Access Types
Required	One	bool	Get, Replace

This leaf node indicates the authorisation to receive adhoc group emergency alert participants information.

When set to "true" the MCPTT user is authorised to receive adhoc group emergency alert participants information.

When set to "false" the MCPTT user is not authorised to receive adhoc group emergency alert participants information.

5.2.48W12A4/<x>/<x>/OnNetwork/MCPTTAdhocGroup/EmergencyAlert/AuthSetupAdhocGroupCall

Table 5.2.48W12A4.1:

/<x>/<x>/OnNetwork/MCPTTAdhocGroup/EmergencyAlert/AuthSetupAdhocGroupCall

<x>/OnNetwork/MCPTTAdhocGroup/EmergencyAlert/AuthSetupAdhocGroupCall

Status	Occurrence	Format	Min. Access Types
Required	One	bool	Get, Replace

This leaf node indicates the authorisation to set up an adhoc group call using the adhoc group used for the adhoc group emergency alert.

When set to "true" the MCPTT user is authorised to set up an adhoc group call using the adhoc group used for the adhoc group emergency alert.

When set to "false" the MCPTT user is not authorised to set up an adhoc group call using the adhoc group used for the adhoc group emergency alert.

5.2.48W12B /<x>/<x>/OnNetwork/MCPTTAdhocGroup/AdhocGroupCall

Table 5.2.48W12B.1: /<x>/<x>/OnNetwork/MCPTTAdhocGroup/AdhocGroupCall

<x>/OnNetwork/MCPTTAdhocGroup/AdhocGroupCall

Status	Occurrence	Format	Min. Access Types
Required	One	node	Get, Replace

This interior node is a placeholder for the MCPTT adhoc group call related policy.

5.2.48W12B1/<x>/<x>/OnNetwork/MCPTTAdhocGroup/AdhocGroupCall/Authorised

Table 5.2.48W12B1.1: /<x>/<x>/OnNetwork/MCPTTAdhocGroup/AdhocGroupCall/Authorised

<x>/OnNetwork/MCPTTAdhocGroup/AdhocGroupCall/Authorised

Status	Occurrence	Format	Min. Access Types
Required	One	bool	Get, Replace

This leaf node indicates the authorisation to make an MCPTT adhoc group call.

When set to "true" the MCPTT user is authorised to make an MCPTT adhoc group call.

When set to "false" the MCPTT user is not authorised to make an MCPTT adhoc group call.

5.2.48W12B2/<x>/<x>/OnNetwork/MCPTTAdhocGroup/AdhocGroupCall/AuthorisedParticipation

Table 5.2.48W12B2.1:

/<x>/<x>/OnNetwork/MCPTTAdhocGroup/AdhocGroupCall/AuthorisedParticipation

<x>/OnNetwork/MCPTTAdhocGroup/AdhocGroupCall/AuthorisedParticipation

Status	Occurrence	Format	Min. Access Types
Required	One	bool	Get, Replace

This leaf node indicates the authorisation to participate in MCPTT adhoc group call.

When set to "true" the MCPTT user is authorised to participate in MCPTT adhoc group calls that they are invited.

When set to "false" the MCPTT user is not authorised to participate in MCPTT adhoc group calls that they are invited.

5.2.48W12B3/<x>/<x>/OnNetwork/MCPTTAdhocGroup/AdhocGroupCall/AuthInitEmergencyCall

Table 5.2.48W12B3.1:

/<x>/<x>/OnNetwork/MCPTTAdhocGroup/AdhocGroupCall/AuthInitEmergencyCall

<x>/OnNetwork/MCPTTAdhocGroup/AdhocGroupCall/AuthInitEmergencyCall

Status	Occurrence	Format	Min. Access Types
Required	One	bool	Get, Replace

This leaf node indicates the authorisation to make an MCPTT adhoc group emergency call.

When set to "true" the MCPTT user is authorised to make an MCPTT adhoc group emergency call.

When set to "false" the MCPTT user is not authorised to make an MCPTT adhoc group emergency call.

5.2.48W12B4/<x>/<x>/OnNetwork/MCPTTAdhocGroup/AdhocGroupCall/AuthInitImminentPerilCall

Table 5.2.48W12B4.1:

/<x>/<x>/OnNetwork/MCPTTAdhocGroup/AdhocGroupCall/AuthInitImminentPerilCall

<x>/OnNetwork/MCPTTAdhocGroup/AdhocGroupCall/AuthInitImminentPerilCall

Status	Occurrence	Format	Min. Access Types
Required	One	bool	Get, Replace

This leaf node indicates the authorisation to make an MCPTT adhoc group imminent-peril call.

When set to "true" the MCPTT user is authorised to make an MCPTT adhoc group imminent-peril call.

When set to "false" the MCPTT user is not authorised to make an MCPTT adhoc group imminent-peril call.

5.2.48W12B5/<x>/<x>/OnNetwork/MCPTTAdhocGroup/AdhocGroupCall/AuthRecvCallParticipantInfo

Table 5.2.48W12B5.1:

/<x>/<x>/OnNetwork/MCPTTAdhocGroup/AdhocGroupCall/AuthRecvCallParticipantInfo

<x>/OnNetwork/MCPTTAdhocGroup/AdhocGroupCall/AuthRecvCallParticipantInfo

Status	Occurrence	Format	Min. Access Types
Required	One	bool	Get, Replace

This leaf node indicates the authorisation to receive adhoc group call participants information.

When set to "true" the MCPTT user is authorised to receive adhoc group call participants information.

When set to "false" the MCPTT user is not authorised to receive adhoc group call participants information.

5.2.48W12B6/<x>/<x>/OnNetwork/MCPTTAdhocGroup/AdhocGroupCall/AuthModifyCallParticipantInfo

Table 5.2.48W12B6.1:

/<x>/<x>/OnNetwork/MCPTTAdhocGroup/AdhocGroupCall/AuthModifyCallParticipantInfo

<x>/OnNetwork/MCPTTAdhocGroup/AdhocGroupCall/AuthModifyCallParticipantInfo

Status	Occurrence	Format	Min. Access Types
Required	One	bool	Get, Replace

This leaf node indicates the authorisation to modify adhoc group call participants information.

When set to "true" the MCPTT user is authorised to modify adhoc group call participants information.

When set to "false" the MCPTT user is not authorised to modify adhoc group call participants information.

5.2.48X /<x>/<x>/OnNetwork/AuthorisedIncomingAny

Table 5.2.48X.1: /<x>/<x>/OnNetwork/AuthorisedIncomingAny

<x>/OnNetwork/AuthorisedIncomingAny

Status	Occurrence	Format	Min. Access Types
Required	One	bool	Get, Replace

This leaf node indicates the authorisation to receive a MCPTT private call by any MCPTT user.

When set to "true" the MCPTT user is authorised to receive an MCPTT private call by any MCPTT user.

When set to "false" the MCPTT user is not authorised to receive an MCPTT private call by any MCPTT user.

5.2.48Y1/<x>/<x>/OnNetwork/UserList

Table 5.2.48Y1.1: /<x>/<x>/OnNetwork/UserList

<x>/OnNetwork/UserList

Status	Occurrence	Format	Min. Access Types
Required	One	node	Get, Replace

This interior node is a placeholder for a list of MCPTT user(s) who can call this particular user in a MCPTT private call.

5.2.48Y2/<x>/<x>/OnNetwork/UserList/<x>

Table 5.2.48Y2.1: /<x>/<x>/OnNetwork/UserList/<x>

<x>/OnNetwork/UserList/<x>

Status	Occurrence	Format	Min. Access Types
Optional	OneOrMore	node	Get, Replace

This interior node is a placeholder for one or more list of MCPTT users who can call this particular user in a MCPTT private call.

5.2.48Y3/<x>/<x>/OnNetwork/UserList/<x>/Entry

Table 5.2.48Y3.1: /<x>/<x>/OnNetwork/UserList/<x>/Entry

<x>/OnNetwork/UserList/<x>/Entry

Status	Occurrence	Format	Min. Access Types
Required	One	node	Get, Replace

This interior node is a placeholder for one or more MCPTT users who can call the particular user in a private call.

5.2.48Y4/<x>/<x>/OnNetwork/UserList/<x>/Entry/MCPTTID

Table 5.2.48Y4.1: /<x>/<x>/OnNetwork/UserList/<x>/Entry/MCPTTID

<x>/OnNetwork/UserList/<x>/Entry/MCPTTID

Status	Occurrence	Format	Min. Access Types
Optional	One	chr	Get, Replace

This leaf node indicates an MCPTT user identity (MCPTT ID) which is a globally unique identifier within the MCPTT service that represents the MCPTT user.

The value is a "uri" attribute specified in OMA OMA-TS-XDM_Group-V1_1 [4].

5.2.48Y5/<x>/<x>/OnNetwork/UserList/<x>/Entry/PrivateCallKMSURI

Table 5.2.48Y5.1: /<x>/<x>/OnNetwork/UserList/<x>/Entry/PrivateCallKMSURI

<x>/OnNetwork/UserList/<x>/Entry/PrivateCallKMSURI

Status	Occurrence	Format	Min. Access Types
Optional	One	chr	Get, Replace

This leaf node indicates the identity (URI) of the KMS associated with the MCPTTID. If the value is empty, the KMS leaf node present in the MCS UE initial configuration MO is used.

5.2.48Z /<x>/<x>/OnNetwork/AuthorisedReceiveNonAcknowledged

Table 5.2.48Z.1: /<x>/<x>/OnNetwork/AuthorisedReceiveNonAcknowledged

<x>/OnNetwork/AuthorisedReceiveNonAcknowledged

Status	Occurrence	Format	Min. Access Types
Required	One	bool	Get, Replace

This leaf node indicates the authorisation to receive the list of non-acknowledged MCPTT users to a group session invitation.

When set to "true" the MCPTT user is authorised to receive information about the MCPTT Users that did not acknowledge a group session invitation.

When set to "false" the MCPTT user is not authorised to receive information about MCPTT Users that did not acknowledge a group session invitation.

5.2.49 /<x>/<x>/OffNetwork

Table 5.2.49.1: /<x>/<x>/OffNetwork

<x>/OffNetwork

Status	Occurrence	Format	Min. Access Types
Required	ZeroOrOne	node	Get, Replace

This interior node represents a container for off-network operation.

5.2.50 /<x>/<x>/OffNetwork/Authorised

Table 5.2.50.1: /<x>/<x>/OffNetwork/Authorised

<x>/OffNetwork/Authorised

Status	Occurrence	Format	Min. Access Types
Required	One	bool	Get, Replace

This leaf node indicates the authorisation for off-network services.

When set to "true" the MCPTT user is authorised for off-network.

When set to "false" the MCPTT user is not authorised for off-network operation.

5.2.51 /<x>/<x>/OffNetwork/MCPTTGroupInfo

Table 5.2.51.1: /<x>/<x>/OffNetwork/MCPTTGroupInfo

<x>/OffNetwork/MCPTTGroupInfo

Status	Occurrence	Format	Min. Access Types
Required	One	node	Get, Replace

This interior node is a placeholder for group information.

5.2.52 /<x>/<x>/OffNetwork/MCPTTGroupInfo/<x>

Table 5.2.52.1: /<x>/<x>/OffNetwork/MCPTTGroupInfo/<x>

<x>/OffNetwork/MCPTTGroupInfo/<x>

Status	Occurrence	Format	Min. Access Types
Required	OneOrMore	node	Get, Replace

This interior node is a placeholder for one or more group information.

5.2.52A /<x>/<x>/OffNetwork/MCPTTGroupInfo/<x>/Entry

Table 5.2.52A.1: /<x>/<x>/OffNetwork/MCPTTGroupInfo/<x>/Entry

<x>/OffNetwork/MCPTTGroupInfo/<x>/Entry

Status	Occurrence	Format	Min. Access Types
Required	One	node	Get, Replace

This interior node is a placeholder for one off-network MCPTT group for use by an MCPTT user.

5.2.53 /<x>/<x>/OffNetwork/MCPTTGroupInfo/<x>/Entry/MCPTTGroupID

Table 5.2.53.1: /<x>/<x>/OffNetwork/MCPTTGroupInfo/<x>/Entry/MCPTTGroupID

<x>/OffNetwork/MCPTTGroupInfo/<x>/Entry/MCPTTGroupID

Status	Occurrence	Format	Min. Access Types
Required	One	int	Get, Replace

This leaf node indicates an off-network MCPTT group for use by an MCPTT user.

5.2.53A /<x>/<x>/OffNetwork/MCPTTGroupInfo/<x>/Entry/DisplayName

Table 5.2.53A.1: /<x>/<x>/OffNetwork/MCPTTGroupInfo/<x>/Entry/DisplayName

<x>/OffNetwork/MCPTTGroupInfo/<x>/Entry/DisplayName

Status	Occurrence	Format	Min. Access Types
Optional	One	chr	Get, Replace

This leaf node contains a human readable name that corresponds to the MCPTT group represented by the MCPTT group ID.

5.2.53B /<x>/<x>/OffNetwork/MCPTTGroupInfo/<x>/Entry/RelativePresentationPriority

Table 5.2.53B.1: /<x>/<x>/OffNetwork/MCPTTGroupInfo/<x>/Entry/RelativePresentationPriority

<x>/OffNetwork/MCPTTGroupInfo/<x>/Entry/RelativePresentationPriority

Status	Occurrence	Format	Min. Access Types
Optional	One	int	Get, Replace

This leaf node indicates indicating the presentation priority of the off-network group for the MCPTT user relative to other off-network groups and off-network users.

- Values: 0-255

The lowest RelativePresentationPriority value shall be considered as the MCPTT group transaction having the lowest priority for presentation among other group MCPTT and one-to-one user transactions.

5.2.53C /<x>/<x>/OffNetwork/MCPTTGroupInfo/<x>/Entry/GMSServID

Table 5.2.53C.1: /<x>/<x>/OffNetwork/MCPTTGroupInfo/<x>/Entry/GMSServID

<x>/OffNetwork/MCPTTGroupInfo/<x>/Entry/GMSServID

Status	Occurrence	Format	Min. Access Types
Required	One	chr	Get, Replace

This leaf node indicates the identity (URI) of the GMS owning a specific group contained in the off-network MCPTTGroupList.

5.2.53D /<x>/<x>/OffNetwork/MCPTTGroupInfo/<x>/Entry/IDMSTokenEndPoint

Table 5.2.53D.1: /<x>/<x>/OffNetwork/MCPTTGroupInfo/<x>/Entry/IDMSTokenEndPoint

<x>/OffNetwork/MCPTTGroupInfo/<x>/Entry/IDMSTokenEndPoint

Status	Occurrence	Format	Min. Access Types
Required	One	chr	Get, Replace

This leaf node indicates the identity (URI) of the IDMS token endpoint for a specific group contained in the off-network MCPTTGroupList. If the value is empty, the IDMS identities (IDMSAuthEndpoint and IDMSTokenEndPoint) present in the MCS UE initial configuration MO are used.

5.2.53E /<x>/<x>/OffNetwork/MCPTTGroupInfo/<x>/Entry/GroupKMSURI

Table 5.2.53E.1: /<x>/<x>/OffNetwork/MCPTTGroupInfo/<x>/Entry/GroupKMSURI

<x>/OffNetwork/MCPTTGroupInfo/<x>/Entry/GroupKMSURI

Status	Occurrence	Format	Min. Access Types
Required	One	chr	Get, Replace

This leaf node indicates the identity (URI) of the KMS identity (URI) for a specific group contained in the off-network MCPTTGroupList. If the value is empty, the KMS identity (URI) (kms) present in the MCS UE initial configuration MO is used.

5.2.54 /<x>/<x>/OffNetwork/AllowedListen

Table 5.2.54.1: /<x>/<x>/OffNetwork/AllowedListen

<x>/OffNetwork/AllowedListen

Status	Occurrence	Format	Min. Access Types
Required	One	bool	Get, Replace

This leaf node indicates whether the MCPTT user is allowed to listen both overriding and overridden.

When set to "true" the MCPTT user is allowed to listen both overriding and overridden.

When set to "false" the MCPTT user is not allowed to listen both overriding and overridden.

5.2.55 /<x>/<x>/OffNetwork/AllowedTransmission

Table 5.2.55.1: /<x>/<x>/OffNetwork/AllowedTransmission

<x>/OffNetwork/AllowedTransmission

Status	Occurrence	Format	Min. Access Types
Required	One	bool	Get, Replace

This leaf node indicates whether the MCPTT user is allowed to transmit in case of override (overriding and/or overridden).

When set to "true" the MCPTT user is allowed to transmit in case of override (overriding and/or overridden).

When set to "false" the MCPTT user is not allowed to transmit in case of override (overriding and/or overridden).

5.2.56 /<x>/<x>/OffNetwork/EmergencyCallChange

Table 5.2.56.1: /<x>/<x>/OffNetwork/EmergencyCallChange

<x>/OffNetwork/EmergencyCallChange

Status	Occurrence	Format	Min. Access Types
Required	One	bool	Get, Replace

This leaf node indicates the authorization for a participant to change an off-network group call in-progress to an off-network MCPTT emergency group call.

When set to "true" the MCPTT user is authorised to change an MCPTT emergency group call.

When set to "false" the MCPTT user is not authorised to change an MCPTT emergency group call.

5.2.57 /<x>/<x>/OffNetwork/ImminentPerilCallChange

Table 5.2.57.1: /<x>/<x>/OffNetwork/ImminentPerilCallChange

<x>/OffNetwork/ImminentPerilCallChange

Status	Occurrence	Format	Min. Access Types
Required	One	bool	Get, Replace

This leaf node indicates the authorization for a participant to change an off-network group call in-progress to an off-network MCPTT imminent peril group call.

When set to "true" the MCPTT user is authorised to change an MCPTT imminent peril group call.

When set to "false" the MCPTT user is not authorised to change an MCPTT imminent peril group call.

5.2.58 /<x>/<x>/OffNetwork/UserInfoID

Table 5.2.58.1: /<x>/<x>/OffNetwork/UserInfoID

<x>/OffNetwork/UserInfoID

Status	Occurrence	Format	Min. Access Types
Required	One	chr	Get, Replace

This leaf node indicates the ProSe user info ID as specified in 3GPP TS 23.303 [6].

5.2.58A1Void

5.2.58A2Void

5.2.58A3Void

5.2.58A4Void

5.2.58A5Void

5.2.58A6Void

5.2.58A7Void

5.2.58A8Void

5.2.58A9Void

5.2.58A10 Void

5.2.58A11 Void

5.2.58A12 Void

5.2.58A13 Void

5.2.58A14 Void

5.2.58A15 Void

5.2.58A16 Void

5.2.58A17 Void

5.2.59 /<x>/Status

Table 5.2.59.1: /<x>/Status

Status

Status	Occurrence	Format	Min. Access Types
Optional	One	bool	Get, Replace

This leaf node indicates whether this MCPTT user profile is enabled or disabled.

When set to "true" this MCPTT user profile is enabled.

When set to "false" this MCPTT user profile is disabled.

6 MCS group configuration MO

6.1 General

The MCS group configuration Management Object (MO) is used to configure the MCS Client behaviour for the on-network or off-network MC services. The MCS group configuration parameters may be stored in the ME, or in the USIM as specified in 3GPP TS 31.102 [10], or in both the ME and the USIM. If both the ME and the USIM contain the same parameters, the values stored in the USIM shall take precedence.

NOTE: For historical reasons some of the elements in the MCS group configuration Management Object (MO) use the terminology "MCPTT", however this MO is common to all MCS with some MCPTT specific elements, some MCDATA specific elements and some MCVideo specific elements. Not all elements that contain the terminology "MCPTT" are just MCPTT specific. In the clauses that follow, it is made clear what aspects are specific to MCPTT and what aspects are specific to all MC services. MCDATA specific elements are contained under "MCDATA" nodes. MCVideo specific elements are contained under "MCVideo" nodes.

The Management Object Identifier is: urn:oma:mo:ext-3gpp-MCPTT-group-configuration:1.0.

Protocol compatibility: This MO is compatible with OMA OMA DM 1.2 [3].

The OMA DM ACL property mechanism (see OMA OMA-ERELD-DM-V1_2 [2]) may be used to grant or deny access rights to OMA DM servers in order to modify nodes and leaf objects of the MCS group configuration MO.

The following nodes and leaf objects are possible under the MCS group configuration node as described in figure 6.1.1.

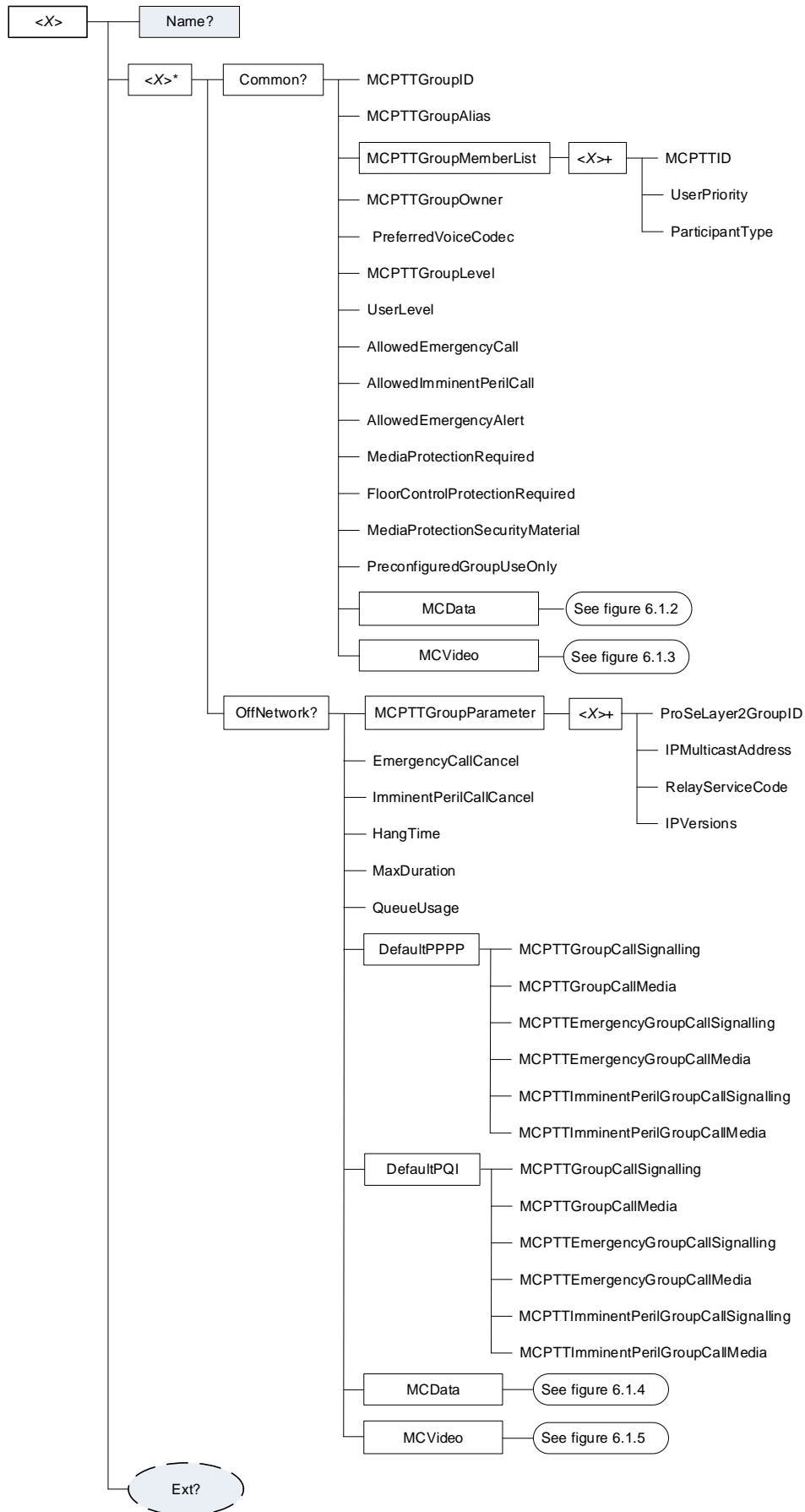

Figure 6.1.1: The MCS group configuration MO (1 of 5)

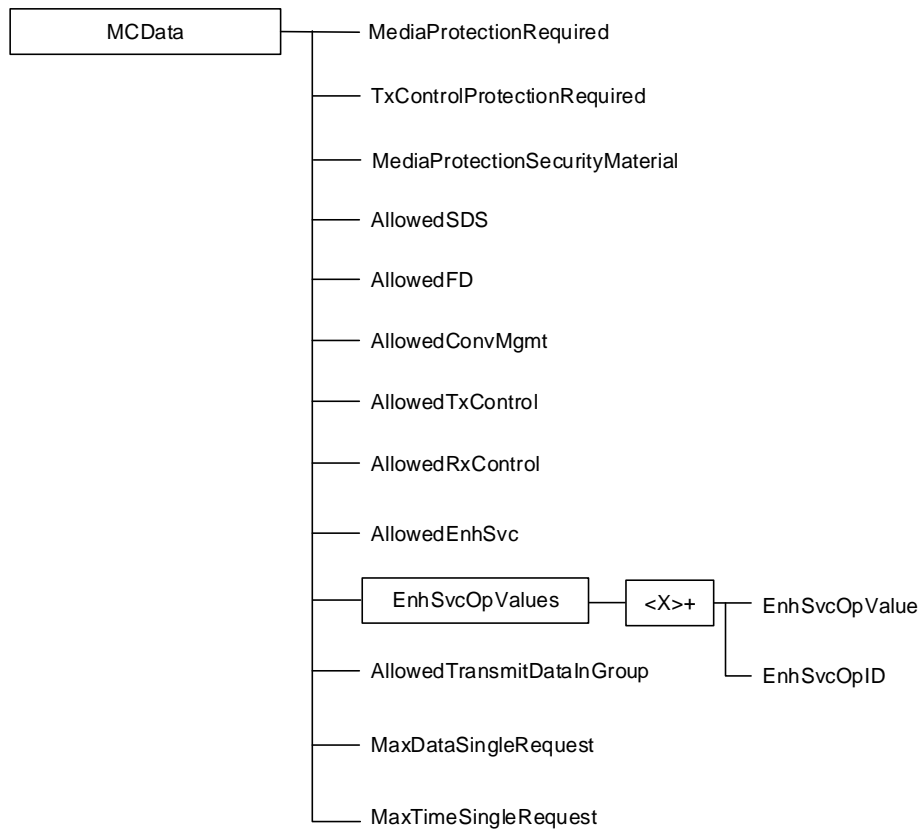

Figure 6.1.2: The MCS group configuration MO (2 of 5)

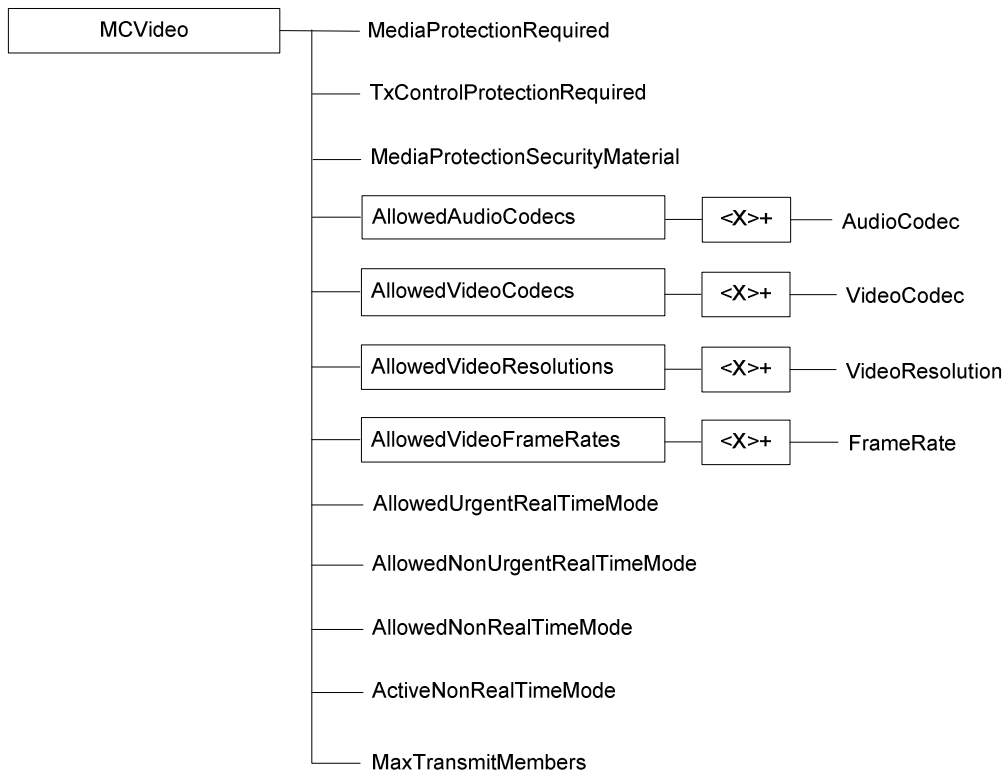

Figure 6.1.3: The MCS group configuration MO (3 of 5)

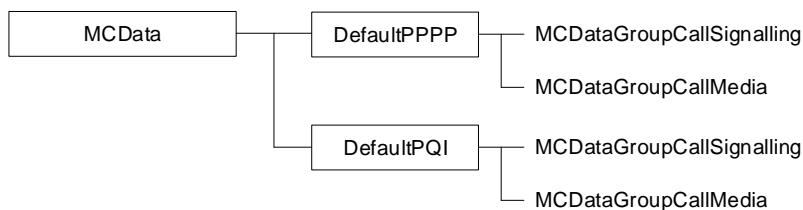

Figure 6.1.4: The MCS group configuration MO (4 of 5)

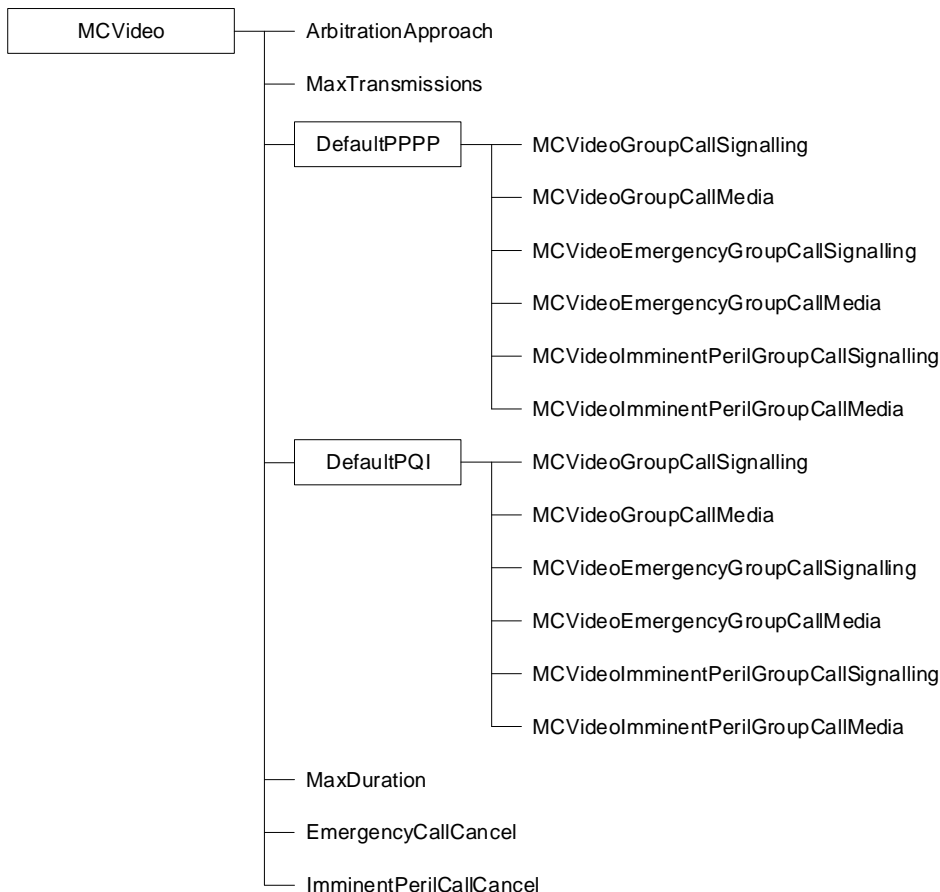

Figure 6.1.5: The MCS group configuration MO (5 of 5)

6.2 MCS group configuration MO parameters

6.2.1 General

This clause describes the parameters for the MCS group configuration Management Object (MO).

6.2.2 Node: <x>

Table 6.2.2.1: Node: <x>

<x>

Status	Occurrence	Format	Min. Access Types
Required	OneOrMore	node	Get

This interior node acts as a placeholder for the MCS group configuration Management Object (MO).

For the MCS group configuration MO, the namespace specific string is: "urn:oma:mo:oma-dm-mcptt-group configuration:1.0"

- Values: N/A

6.2.3 /<x>/Name

Table 6.2.3.1: /<x>/Name

Name

Status	Occurrence	Format	Min. Access Types
Required	ZeroOrOne	chr	Get

The Name leaf is a name for the MCS group configuration settings.

- Values: <User displayable name>

6.2.4 /<x>/Ext

Table 6.2.4.1: /<x>/Ext

Ext

Status	Occurrence	Format	Min. Access Types
Optional	ZeroOrOne	node	Get, Replace

The Ext is an interior node for where the vendor specific information about the MCSgroup configuration MO is being placed.

Usually the vendor extension is identified by vendor specific name under the ext node and contains the vendor meaning application vendor, device vendor etc. The tree structure under the vendor identified is not defined and can therefore include one or more un-standardized sub-trees.

- Values: N/A

6.2.5 /<x>/<x>

Table 6.2.5.1: /<x>/<x>

<x>

Status	Occurrence	Format	Min. Access Types
Required	ZeroOrMore	node	Get, Replace

This interior node represents a container for on-network operation and off-network operation.

6.2.6 /<x>/<x>/Common

Table 6.2.6.1: /<x>/<x>/Common

<x>/Common

Status	Occurrence	Format	Min. Access Types
Required	ZeroOrOne	node	Get, Replace

This interior node represents a container for the common network operation which means both on-network operation and off-network operation.

6.2.7 `<x>/<x>/Common/MCPTTGroupID`

Table 6.2.7.1: `<x>/<x>/Common/MCPTTGroupID`

`<x>/Common/MCPTTGroupID`

Status	Occurrence	Format	Min. Access Types
Required	One	chr	Get, Replace

This leaf node indicates the MCS group ID.

The value is a "uri" attribute specified in OMA OMA-TS-XDM_Group-V1_1 [4].

NOTE: This element is common for all MC services.

6.2.8 `<x>/<x>/Common/MCPTTGroupAlias`

Table 6.2.8.1: `<x>/<x>/Common/MCPTTGroupAlias`

`<x>/Common/MCPTTGroupAlias`

Status	Occurrence	Format	Min. Access Types
Required	One	chr	Get, Replace

This leaf node indicates the MCS group alias.

The value is a `<display-name>` element specified in OMA OMA-TS-XDM_Group-V1_1 [4].

NOTE: This element is common for all MC services.

6.2.9 `<x>/<x>/Common/MCPTTGroupMemberList`

Table 6.2.9.1: `<x>/<x>/Common/MCPTTGroupMemberList`

`<x>/Common/MCPTTGroupMemberList`

Status	Occurrence	Format	Min. Access Types
Required	One	node	Get, Replace

This interior node is a placeholder for a list of MCS group members (group membership information).

NOTE: This element is common for all MC services.

6.2.10 `<x>/<x>/Common/MCPTTGroupMemberList/<x>`

Table 6.2.10.1: `<x>/<x>/Common/MCPTTGroupMemberList/<x>`

`<x>/Common/MCPTTGroupMemberList/<x>`

Status	Occurrence	Format	Min. Access Types
Required	OneOrMore	node	Get, Replace

This interior node is a placeholder for one or more list(s) of MCS group members.

NOTE: This element is common for all MC services.

6.2.11 /<x>/<x>/Common/MCPTTGroupMemberList/<x>/MCPTTID

Table 6.2.11.1: /<x>/<x>/Common/MCPTTGroupMemberList/<x>/MCPTTID

<x>/Common/MCPTTGroupMemberList/<x>/MCPTTID

Status	Occurrence	Format	Min. Access Types
Required	One	chr	Get, Replace

This leaf node indicates an MCS user identity (MC Service ID) which is a globally unique identifier within the MC service that represents the MCS user.

The value is a "uri" attribute specified in OMA OMA-TS-XDM_Group-V1_1 [4].

NOTE: This element is common for all MC services.

6.2.12 /<x>/<x>/Common/MCPTTGroupMemberList/<x>/UserPriority

Table 6.2.12.1: /<x>/<x>/Common/MCPTTGroupMemberList/<x>/UserPriority

<x>/Common/MCPTTGroupMemberList/<x>/UserPriority

Status	Occurrence	Format	Min. Access Types
Required	One	int	Get, Replace

This leaf node indicates the user priority for the group.

The value is a <user-priority> element specified in 3GPP TS 24.481 [9] clause 7.2.4.2.

NOTE: This element is common for all MC services.

6.2.13 /<x>/<x>/Common/MCPTTGroupMemberList/<x>/ParticipantType

Table 6.2.13.1: /<x>/<x>/Common/MCPTTGroupMemberList/<x>/ParticipantType

<x>/Common/MCPTTGroupMemberList/<x>/ParticipantType

Status	Occurrence	Format	Min. Access Types
Required	One	chr	Get, Replace

This leaf node indicates the participant type for the group.

The ParticipantType values are defined and configured by the Mission Critical Organisation (e.g., first responder, second responder, dispatcher, dispatch supervisor, MCS administrator).

NOTE: This element is common for all MC services.

6.2.14 Void

6.2.15 /<x>/<x>/Common/MCPTTGroupOwner

Table 6.2.15.1: /<x>/<x>/Common/MCPTTGroupOwner

<x>/Common/MCPTTGroupOwner

Status	Occurrence	Format	Min. Access Types
Required	One	chr	Get, Replace

This leaf node indicates the group's owner (Mission Critical Organisation).

NOTE: This element is common for all MC services.

6.2.16 `<x>/<x>/Common/PreferredVoiceCodec`

Table 6.2.16.1: `<x>/<x>/Common/PreferredVoiceCodec`

`<x>/Common/PreferredVoiceCodec`

Status	Occurrence	Format	Min. Access Types
Required	One	chr	Get, Replace

This leaf node indicates the MCPTT preferred voice codec for an MCS group.

The value of the preferred voice codec is a RTP payload format name specified in IETF RFC 4566 [13].

NOTE: This element is specific for MCPTT.

6.2.17 `<x>/<x>/Common/MCPTTGroupLevel`

Table 6.2.17.1: `<x>/<x>/Common/MCPTTGroupLevel`

`<x>/Common/MCPTTGroupLevel`

Status	Occurrence	Format	Min. Access Types
Required	One	int	Get, Replace

This leaf node indicates the level within a group hierarchy (only applicable for group-broadcast group).

- Values: 0-255

The group-broadcast group with the lowest MCPTTGroupLevel value shall be considered as the group-broadcast group having the lowest level among the groups.

NOTE: This element is common for all MC services.

6.2.18 `<x>/<x>/Common/UserLevel`

Table 6.2.18.1: `<x>/<x>/Common/UserLevel`

`<x>/Common/UserLevel`

Status	Occurrence	Format	Min. Access Types
Required	One	int	Get, Replace

This leaf node indicates the level within user hierarchy (only applicable for user-broadcast group).

The user-broadcast group with the lowest UserLevel value shall be considered as the user-broadcast group having the lowest level among the groups.

NOTE: This element is common for all MC services.

6.2.19 `<x>/Common/AllowedEmergencyCall`

Table 6.2.19.1: `<x>/Common/AllowedEmergencyCall`

`<x>/Common/AllowedEmergencyCall`

Status	Occurrence	Format	Min. Access Types
Required	One	bool	Get, Replace

This leaf node indicates whether an MCPTT emergency group call is permitted on the MCS group.

When set to "true" the MCPTT emergency group call is allowed on the group.

When set to "false" the MCPTT emergency group call is not allowed on the group.

NOTE: This element is specific for MCPTT.

6.2.20 `<x>/Common/AllowedImminentPerilCall`

Table 6.2.20.1: `<x>/Common/AllowedImminentPerilCall`

`<x>/Common/AllowedImminentPerilCall`

Status	Occurrence	Format	Min. Access Types
Required	One	bool	Get, Replace

This leaf node indicates whether an MCPTT imminent peril group call is permitted on the MCS group.

When set to "true" the MCPTT imminent peril group call is allowed on the group.

When set to "false" the MCPTT imminent peril group call is not allowed on the group.

NOTE: This element is specific for MCPTT.

6.2.21 `<x>/Common/AllowedEmergencyAlert`

Table 6.2.21.1: `<x>/Common/AllowedEmergencyAlert`

`<x>/Common/AllowedEmergencyAlert`

Status	Occurrence	Format	Min. Access Types
Required	One	bool	Get, Replace

This leaf node indicates whether an MCPTT emergency alert is possible on the MCS group.

When set to "true" the MCPTT emergency alert is allowed on the group.

When set to "false" the MCPTT emergency alert is not allowed on the group.

NOTE: This element is for specific for MCPTT.

6.2.22 `<x>/Common/MediaProtectionRequired`

Table 6.2.22.1: `<x>/Common/MediaProtectionRequired`

`<x>/Common/MediaProtectionRequired`

Status	Occurrence	Format	Min. Access Types
Required	One	bool	Get, Replace

This leaf node indicates whether confidentiality and integrity of MCPTT media is required on the MCS group.

When set to "true" confidentiality and integrity of media is required on the group.

When set to "false" confidentiality and integrity of media is not required on the group.

The default value is set to "true".

NOTE: This element is specific for MCPTT.

6.2.22A /<x>/<x>/Common/PreconfiguredGroupUseOnly

Table 6.2.22A.1: /<x>/<x>/Common/PreconfiguredGroupUseOnly

<x>/Common/PreconfiguredGroupUseOnly

Status	Occurrence	Format	Min. Access Types
Required	One	bool	Get, Replace

This leaf node indicates whether the MCS group is to be used only to provide configuration information for a preconfigured regroup.

When set to "true" the group may only be used to provide configuration information for a preconfigured regroup.

When set to "false" the group may be used for group calls as well as to provide configuration information for a preconfigured regroup.

The default value is set to "false".

NOTE: This element is common for all MC services.

6.2.23 /<x>/<x>/Common/FloorControlProtectionRequired

Table 6.2.23.1: /<x>/<x>/Common/FloorControlProtectionRequired

<x>/Common/FloorControlProtectionRequired

Status	Occurrence	Format	Min. Access Types
Required	One	bool	Get, Replace

This leaf node indicates whether confidentiality and integrity of MCPTT floor control signalling is required on the MCS group.

When set to "true" confidentiality and integrity of floor control signalling is required on the group.

When set to "false" confidentiality and integrity of floor control signalling is not required on the group.

The default value is set to "true".

NOTE: This element is specific for MCPTT.

6.2.23A /<x>/<x>/Common/MediaProtectionSecurityMaterial

Table 6.2.23A.1: /<x>/<x>/Common/MediaProtectionSecurityMaterial

<x>/Common/MediaProtectionSecurityMaterial

Status	Occurrence	Format	Min. Access Types
Required	One	chr	Get, Replace

This leaf node indicates security material (as specified in 3GPP TS 33.180 [20]) for MCPTT media protection in the MCS group.

NOTE: This element is specific for MCPTT.

6.2.23B `<x>/<x>/Common/MCData`

Table 6.2.23B.1: `<x>/<x>/Common/MCData`

`<x>/Common/MCData`

Status	Occurrence	Format	Min. Access Types
Required	One	node	Get, Replace

This interior node is a placeholder for a Common MCData group information

6.2.23C `<x>/<x>/Common/MCData/MediaProtectionRequired`

Table 6.2.23C.1: `<x>/<x>/Common/MCData/MediaProtectionRequired`

`<x>/Common/MCData/MediaProtectionRequired`

Status	Occurrence	Format	Min. Access Types
Required	One	bool	Get, Replace

This leaf node indicates whether confidentiality and integrity of media is required for MCData transactions on the MCS group.

When set to "true" confidentiality and integrity of MCData media is required on the group.

When set to "false" confidentiality and integrity of MCData media is not required on the group.

The default value is set to "true".

6.2.23D `<x>/<x>/Common/MCData/TxControlProtectionRequired`

Table 6.2.23D.1: `<x>/<x>/Common/MCData/TxControlProtectionRequired`

`<x>/Common/MCData/TxControlProtectionRequired`

Status	Occurrence	Format	Min. Access Types
Required	One	bool	Get, Replace

This leaf node indicates whether confidentiality and integrity protection is required for on-network and off-network MCData transmission control signalling on the MCS group

When set to "true" confidentiality and integrity of MCData transmission control signalling is required on the group.

When set to "false" confidentiality and integrity of MCData transmission control signalling is not required on the group.

The default value is set to "true".

6.2.23E `<x>/<x>/Common/MCData/MediaProtectionSecurityMaterial`

Table 6.2.23E.1: `<x>/<x>/Common/MCData/MediaProtectionSecurityMaterial`

`<x>/Common/MCData/MediaProtectionSecurityMaterial`

Status	Occurrence	Format	Min. Access Types
Required	One	chr	Get, Replace

This leaf node indicates security material (as specified in 3GPP TS 33.180 [20]) for MCDData media protection in the MCS group.

6.2.23F /<x>/<x>/Common/MCDData/AllowedSDS

Table 6.2.23F.1: /<x>/<x>/Common/MCDData/AllowedSDS

<x>/Common/MCDData/AllowedSDS

Status	Occurrence	Format	Min. Access Types
Required	One	bool	Get, Replace

This leaf node indicates whether Short Data Service (SDS) is enabled for the group.

When set to "true" the Short Data Service (SDS) is allowed on the group.

When set to "false" the Short Data Service (SDS) is not allowed on the group.

6.2.23G /<x>/<x>/Common/MCDData/AllowedFD

Table 6.2.23G.1: /<x>/<x>/Common/MCDData/AllowedFD

<x>/Common/MCDData/AllowedFD

Status	Occurrence	Format	Min. Access Types
Required	One	bool	Get, Replace

This leaf node indicates whether File Distribution (FD) is enabled for the group.

When set to "true" File Distribution (FD) is allowed on the group.

When set to "false" File Distribution (FD) is not allowed on the group.

6.2.23H /<x>/<x>/Common/MCDData/AllowedConvMgmt

Table 6.2.23H.1: /<x>/<x>/Common/MCDData/AllowedConvMgmt

<x>/Common/MCDData/AllowedConvMgmt

Status	Occurrence	Format	Min. Access Types
Required	One	bool	Get, Replace

This leaf node indicates whether conversation management is enabled for the group.

When set to "true" conversation management is allowed on the group.

When set to "false" conversation management is not allowed on the group.

6.2.23I /<x>/<x>/Common/MCDData/AllowedTxControl

Table 6.2.23I.1: /<x>/<x>/Common/MCDData/AllowedTxControl

<x>/Common/MCDData/AllowedTxControl

Status	Occurrence	Format	Min. Access Types
--------	------------	--------	-------------------

Required	One	bool	Get, Replace
----------	-----	------	--------------

This leaf node indicates whether transmission control is enabled for the group.

When set to "true" transmission control is allowed on the group.

When set to "false" transmission control is not allowed on the group.

6.2.23J /<x>/<x>/Common/MCData/AllowedRxControl

Table 6.2.23J.1: /<x>/<x>/Common/MCData/AllowedRxControl

<x>/Common/MCData/AllowedRxControl

Status	Occurrence	Format	Min. Access Types
Required	One	bool	Get, Replace

This leaf node indicates whether reception control is enabled for the group.

When set to "true" reception control is allowed on the group.

When set to "false" reception control not allowed on the group.

6.2.23K /<x>/<x>/Common/MCData/AllowedEnhSvc

Table 6.2.23K.1: /<x>/<x>/Common/MCData/AllowedEnhSvc

<x>/Common/MCData/AllowedEnhSvc

Status	Occurrence	Format	Min. Access Types
Required	One	bool	Get, Replace

This leaf node indicates whether Enhanced Service is enabled for the group.

When set to "true" Enhanced Service is allowed on the group.

When set to "false" Enhanced Service is not allowed on the group.

6.2.23L /<x>/<x>/Common/MCData/EnhSvcOpValues

Table 6.2.23L.1: /<x>/<x>/Common/MCData/EnhSvcOpValues

<x>/Common/MCData/EnhSvcOpValues

Status	Occurrence	Format	Min. Access Types
Required	One	node	Get, Replace

This interior node is a placeholder for a list of operational values for Enhanced Service.

6.2.23M /<x>/<x>/Common/MCData/EnhSvcOpValues/<x>

Table 6.2.23M.1: /<x>/<x>/Common/MCData/EnhSvcOpValues/<x>

<x>/Common/MCData/EnhSvcOpValues/<x>

Status	Occurrence	Format	Min. Access Types
Optional	OneOrMore	node	Get, Replace

This interior node is a placeholder for one or more list of operational values for Enhanced Service.

6.2.23N /<x>/<x>/Common/MCData/EnhSvcOpValues/<x>/EnhSvcOpValue

Table 6.2.23N.1: /<x>/<x>/Common/MCData/EnhSvcOpValues/<x>/EnhSvcOpValue

<x>/Common/MCData/EnhSvcOpValues/<x>/EnhSvcOpValue

Status	Occurrence	Format	Min. Access Types
Optional	One	chr	Get, Replace

This leaf node indicates an enhanced service operational value.

6.2.23NA /<x>/<x>/Common/MCData/EnhSvcOpValues/<x>/EnhSvcOpID

Table 6.2.23NA.1: /<x>/<x>/Common/MCData/EnhSvcOpValues/<x>/EnhSvcOpID

<x>/Common/MCData/EnhSvcOpValues/<x>/EnhSvcOpID

Status	Occurrence	Format	Min. Access Types
Optional	One	int	Get, Replace

This leaf node indicates a unique id associated with enhanced service operational value.

6.2.23O /<x>/<x>/Common/MCData/AllowedTransmitDataInGroup

Table 6.2.23O.1: /<x>/<x>/Common/MCData/AllowedTransmitDataInGroup

<x>/Common/MCData/AllowedTransmitDataInGroup

Status	Occurrence	Format	Min. Access Types
Required	One	bool	Get, Replace

This leaf node indicates whether an MC data user is permitted to transmit data in the group.

When set to "true" an MC data user is allowed to transmit data in the group.

When set to "false" an MC data user is not allowed to transmit data in the group.

6.2.23P /<x>/<x>/Common/MCData/MaxDataSingleRequest

Table 6.2.23P.1: /<x>/<x>/Common/MCData/MaxDataSingleRequest

<x>/Common/MCData/MaxDataSingleRequest

Status	Occurrence	Format	Min. Access Types
Required	One	int	Get, Replace

This leaf node indicates the maximum amount of data (in megabytes) that an MCData user can transmit in a single request during group communication.

- Values: 0-65535

The MaxDataSingleRequest size is in megabytes.

6.2.23Q /<x>/<x>/Common/MCData/MaxTimeSingleRequest

Table 6.2.23Q.1: /<x>/<x>/Common/MCData/MaxTimeSingleRequest

<x>/Common/MCData/MaxTimeSingleRequest

Status	Occurrence	Format	Min. Access Types
Required	One	int	Get, Replace

This leaf node indicates the maximum amount of time that an MCData user can transmit for in a single request during group communication.

- Values: 0-65535

The MaxTimeSingleRequest time is in seconds.

6.2.23R /<x>/<x>/Common/MCVideo

Table 6.2.23R.1: /<x>/<x>/Common/MCVideo

<x>/Common/MCVideo

Status	Occurrence	Format	Min. Access Types
Required	One	node	Get, Replace

This interior node is a placeholder for a Common MCVideo group information

6.2.23S /<x>/<x>/Common/MCVideo/MediaProtectionRequired

Table 6.2.23S.1: /<x>/<x>/Common/MCVideo/MediaProtectionRequired

<x>/Common/MCVideo/MediaProtectionRequired

Status	Occurrence	Format	Min. Access Types
Required	One	bool	Get, Replace

This leaf node indicates whether confidentiality and integrity of media is required for MCVideo calls on the MCS group.

When set to "true" confidentiality and integrity of MCvideo media is required on the group.

When set to "false" confidentiality and integrity of MCvideo media is not required on the group.

The default value is set to "true".

6.2.23T /<x>/<x>/Common/MCVideo/TxControlProtectionRequired

Table 6.2.23T.1: /<x>/<x>/Common/MCVideo/TxControlProtectionRequired

<x>/Common/MCVideo/TxControlProtectionRequired

Status	Occurrence	Format	Min. Access Types
Required	One	bool	Get, Replace

This leaf node indicates whether confidentiality and integrity protection is required for on-network and off-network MCVideo transmission control signalling on the MCS group

When set to "true" confidentiality and integrity of MCVideo transmission control signalling is required on the group.

When set to "false" confidentiality and integrity of MCVideo transmission control signalling is not required on the group.

The default value is set to "true".

6.2.23U /<x>/<x>/Common/MCVideo/MediaProtectionSecurityMaterial

Table 6.2.23U.1: /<x>/<x>/Common/MCVideo/MediaProtectionSecurityMaterial

<x>/Common/MCVideo/MediaProtectionSecurityMaterial

Status	Occurrence	Format	Min. Access Types
Required	One	chr	Get, Replace

This leaf node indicates security material (as specified in 3GPP TS 33.180 [20]) for MCVideo media protection in the MCS group.

6.2.23V /<x>/<x>/Common/MCVideo/AllowedAudioCodecs

Table 6.2.23V.1: /<x>/<x>/Common/MCVideo/AllowedAudioCodecs

<x>/Common/MCVideo/AllowedAudioCodecs

Status	Occurrence	Format	Min. Access Types
Required	One	node	Get, Replace

This interior node is a placeholder for a list of allowed audio codecs for MCVideo sessions on the group

6.2.23W /<x>/<x>/Common/MCVideo/AllowedAudioCodecs/<x>

Table 6.2.23W.1: /<x>/<x>/Common/MCVideo/AllowedAudioCodecs/<x>

<x>/Common/MCVideo/AllowedAudioCodecs/<x>

Status	Occurrence	Format	Min. Access Types
Optional	OneOrMore	node	Get, Replace

This interior node is a placeholder for one or more list of allowed audio codecs for MCVideo sessions on the group

6.2.23X /<x>/<x>/Common/MCVideo/AllowedAudioCodecs/<x>/AudioCodec

Table 6.2.23X.1: /<x>/<x>/Common/MCVideo/AllowedAudioCodecs/<x>/AudioCodec

<x>/Common/MCVideo/AllowedAudioCodecs/<x>/AudioCodec

Status	Occurrence	Format	Min. Access Types
Optional	One	chr	Get, Replace

This leaf node indicates the preferred RTP payload format to be used for audio encoding in MCVideo group sessions for the group.

6.2.23Y /<x>/<x>/Common/MCVideo/AllowedVideoCodecs

Table 6.2.23Y.1: /<x>/<x>/Common/MCVideo/AllowedVideoCodecs

<x>/Common/MCVideo/AllowedVideoCodecs

Status	Occurrence	Format	Min. Access Types
Required	One	node	Get, Replace

This interior node is a placeholder for a list of allowed video codecs for MCVideo sessions on the group

6.2.23Z /<x>/<x>/Common/MCVideo/AllowedVideoCodecs/<x>

Table 6.2.23Z.1: /<x>/<x>/Common/MCVideo/AllowedVideoCodecs/<x>

<x>/Common/MCVideo/AllowedVideoCodecs/<x>

Status	Occurrence	Format	Min. Access Types
Optional	OneOrMore	node	Get, Replace

This interior node is a placeholder for one or more list of allowed video codecs for MCVideo sessions on the group

6.2.23AA /<x>/<x>/Common/MCVideo/AllowedVideoCodecs/<x>/VideoCodec

Table 6.2.23AA.1: /<x>/<x>/Common/MCVideo/AllowedVideoCodecs/<x>/VideoCodec

<x>/Common/MCVideo/AllowedVideoCodecs/<x>/VideoCodec

Status	Occurrence	Format	Min. Access Types
Optional	One	chr	Get, Replace

This leaf node indicates the preferred RTP payload format to be used for video encoding in MCVideo group sessions for the group.

6.2.23AB /<x>/<x>/Common/MCVideo/AllowedVideoResolutions

Table 6.2.23AB.1: /<x>/<x>/Common/MCVideo/AllowedVideoResolutions

<x>/Common/MCVideo/AllowedVideoResolutions

Status	Occurrence	Format	Min. Access Types
Required	One	node	Get, Replace

This interior node is a placeholder for a list of allowed video resolutions used in MCVideo group sessions for the group.

6.2.23AC /<x>/<x>/Common/MCVideo/AllowedVideoResolutions/<x>

Table 6.2.23AC.1: /<x>/<x>/Common/MCVideo/AllowedVideoResolutions/<x>

<x>/Common/MCVideo/AllowedVideoResolutions/<x>

Status	Occurrence	Format	Min. Access Types
Optional	OneOrMore	node	Get, Replace

This interior node is a placeholder for one or more list of allowed video resolutions used in MCVideo group sessions for the group.

6.2.23AD /<x>/<x>/Common/MCVideo/AllowedVideoResolutions/<x>/VideoResolution

Table 6.2.23AD.1: /<x>/<x>/Common/MCVideo/AllowedVideoResolutions/<x>/VideoResolution

<x>/Common/MCVideo/AllowedVideoResolutions/<x>/VideoResolution

Status	Occurrence	Format	Min. Access Types
Optional	One	chr	Get, Replace

This leaf node indicates a video resolution (number of horizontal pixels x number of vertical pixels) to be used in MCVideo group sessions for the group.

6.2.23AE /<x>/<x>/Common/MCVideo/AllowedVideoFrameRates

Table 6.2.23AE.1: /<x>/<x>/Common/MCVideo/AllowedVideoFrameRates

<x>/Common/MCVideo/AllowedVideoFrameRates

Status	Occurrence	Format	Min. Access Types
Required	One	node	Get, Replace

This interior node is a placeholder for a list of allowed video frame rates to be used in MCVideo group sessions for the group.

6.2.23AF /<x>/<x>/Common/MCVideo/AllowedVideoFrameRates/<x>

Table 6.2.23AF.1: /<x>/<x>/Common/MCVideo/AllowedVideoFrameRates/<x>

<x>/Common/MCVideo/AllowedVideoFrameRates/<x>

Status	Occurrence	Format	Min. Access Types
Optional	OneOrMore	node	Get, Replace

This interior node is a placeholder for one or more list of allowed video frame rates to be used in MCVideo group sessions for the group.

6.2.23AG /<x>/<x>/Common/MCVideo/AllowedVideoFrameRates/<x>/FrameRate

Table 6.2.23AG.1: /<x>/<x>/Common/MCVideo/AllowedVideoFrameRates/<x>/FrameRate

<x>/Common/MCVideo/AllowedVideoFrameRates/<x>/FrameRate

Status	Occurrence	Format	Min. Access Types
Optional	One	int	Get, Replace

This leaf node indicates a video frame rate (in frames per second) to be used in MCVideo group sessions for the group.

6.2.23AH /<x>/<x>/Common/MCVideo/AllowedUrgentRealTimeMode

Table 6.2.23AH.1: /<x>/<x>/Common/MCVideo/AllowedUrgentRealTimeMode

<x>/Common/MCVideo/AllowedUrgentRealTimeMode

Status	Occurrence	Format	Min. Access Types
Required	One	bool	Get, Replace

This leaf node indicates whether urgent real time mode is allowed for MCVideo sessions on the group.

When set to "true" urgent real-time video mode is allowed for MCVideo sessions on the group.

When set to "false" urgent real-time video mode is not allowed for MCVideo sessions on the group.

6.2.23AI /<x>/<x>/Common/MCVideo/AllowedNonUrgentRealTimeMode

Table 6.2.23AI.1: /<x>/<x>/Common/MCVideo/AllowedNonUrgentRealTimeMode

<x>/Common/MCVideo/AllowedNonUrgentRealTimeMode

Status	Occurrence	Format	Min. Access Types
Required	One	bool	Get, Replace

This leaf node indicates whether non-urgent real time mode is allowed for MCVideo sessions on the group.

When set to "true" non-urgent real-time video mode is allowed for MCVideo sessions on the group.

When set to "false" non-urgent real-time video mode is not allowed for MCVideo sessions on the group.

6.2.23AJ /<x>/<x>/Common/MCVideo/AllowedNonRealTimeMode

Table 6.2.23AJ.1: /<x>/<x>/Common/MCVideo/AllowedNonRealTimeMode

<x>/Common/MCVideo/AllowedNonRealTimeMode

Status	Occurrence	Format	Min. Access Types
Required	One	bool	Get, Replace

This leaf node indicates whether non-real time mode is allowed for MCVideo sessions on the group.

When set to "true" non-real-time video mode is allowed for MCVideo sessions on the group.

When set to "false" non-real-time video mode is not allowed for MCVideo sessions on the group.

6.2.23AK /<x>/<x>/Common/MCVideo/ActiveNonRealTimeMode

Table 6.2.23AK.1: /<x>/<x>/Common/MCVideo/ActiveNonRealTimeMode

<x>/Common/MCVideo/ActiveNonRealTimeMode

Status	Occurrence	Format	Min. Access Types
Required	One	chr	Get, Replace

This leaf node indicates the active non-real-time mode used for MCVideo sessions on the group.

The valid values are:

- a) "urgent-real-time";

- b) "non-urgent-real-time"; and
- c) "non-real-time".

6.2.23AL /<x>/<x>/Common/MCVideo/MaxTransmitMembers

Table 6.2.23AL.1: /<x>/<x>/Common/MCVideo/MaxTransmitMembers

<x>/Common/MCVideo/MaxTransmitMembers

Status	Occurrence	Format	Min. Access Types
Required	One	int	Get, Replace

This leaf node indicates the maximum number of simultaneous transmitting group members for MCVideo sessions on the group.

- Values: 0-65535

6.2.24 /<x>/<x>/OffNetwork

Table 6.2.24.1: /<x>/<x>/OffNetwork

<x>/OffNetwork

Status	Occurrence	Format	Min. Access Types
Required	ZeroOrOne	node	Get, Replace

This interior node represents a container for off-network operation.

6.2.25 /<x>/<x>/OffNetwork/MCPTTGroupParameter

Table 6.2.25.1: /<x>/<x>/OffNetwork/MCPTTGroupParameter

<x>/OffNetwork/MCPTTGroupParameter

Status	Occurrence	Format	Min. Access Types
Required	One	node	Get, Replace

This interior node is a placeholder for the group parameters.

6.2.26 /<x>/<x>/OffNetwork/MCPTTGroupParameter/<x>

Table 6.2.26.1: /<x>/<x>/OffNetwork/MCPTTGroupParameter/<x>

<x>/OffNetwork/MCPTTGroupParameter/<x>

Status	Occurrence	Format	Min. Access Types
Required	OneOrMore	node	Get, Replace

This interior node is a placeholder for one or more group parameters.

6.2.27 /<x>/<x>/OffNetwork/MCPTTGroupParameter/<x>/ProSeLayer2GroupID

Table 6.2.27.1: /<x>/<x>/OffNetwork/MCPTTGroupParameter/<x>/ProSeLayer2GroupID

<x>/OffNetwork/MCPTTGroupParameter/<x>/ProSeLayer2GroupID

Status	Occurrence	Format	Min. Access Types
Required	One	chr	Get, Replace

This leaf node indicates the Prose layer-2 group ID as specified in 3GPP TS 23.303 [6].

NOTE: This element is common for all MC services.

6.2.28 /<x>/<x>/OffNetwork/MCPTTGroupParameter/<x>/IPMulticastAddress

Table 6.2.28.1: /<x>/<x>/OffNetwork/MCPTTGroupParameter/<x>/IPMulticastAddress

<x>/OffNetwork/MCPTTGroupParameter/<x>/IPMulticastAddress

Status	Occurrence	Format	Min. Access Types
Required	One	chr	Get, Replace

This leaf node indicates the ProSe group IP multicast address as specified in 3GPP TS 23.303 [6].

The value is an IPv4 address or an IPv6 address.

NOTE: This element is common for all MC services.

6.2.29 /<x>/<x>/OffNetwork/MCPTTGroupParameter/<x>/RelayServiceCode

Table 6.2.29.1: /<x>/<x>/OffNetwork/MCPTTGroupParameter/<x>/RelayServiceCode

<x>/OffNetwork/MCPTTGroupParameter/<x>/RelayServiceCode

Status	Occurrence	Format	Min. Access Types
Required	One	chr	Get, Replace

This leaf node indicates the connectivity service that the ProSe UE-to-network relay provides to public safety applications as specified in 3GPP TS 23.303 [6].

NOTE: This element is common for all MC services.

6.2.30 /<x>/<x>/OffNetwork/MCPTTGroupParameter/<x>/IPVersions

Table 6.2.30.1: /<x>/<x>/OffNetwork/MCPTTGroupParameter/<x>/IPVersions

<x>/OffNetwork/MCPTTGroupParameter/<x>/IPVersions

Status	Occurrence	Format	Min. Access Types
Required	One	chr	Get, Replace

This leaf node indicates whether IPv4 or IPv6 is used for the MCS group as specified in 3GPP TS 23.303 [6].

The value is "IPv4" or "IPv6".

NOTE: This element is common for all MC services.

6.2.31 /<x>/<x>/OffNetwork/EmergencyCallCancel

Table 6.2.31.1: /<x>/<x>/OffNetwork/EmergencyCallCancel

<x>/OffNetwork/EmergencyCallCancel

Status	Occurrence	Format	Min. Access Types
Required	One	int	Get, Replace

This leaf node indicates the timeout value for the cancellation of an in progress emergency group call for MCPTT.

- Values: 0-65535

The EmergencyCallCancel time is in seconds.

NOTE: This element is specific for MCPTT.

6.2.32 /<x>/<x>/OffNetwork/ImminentPerilCallCancel

Table 6.2.32.1: /<x>/<x>/OffNetwork/ImminentPerilCallCancel

<x>/OffNetwork/ImminentPerilCallCancel

Status	Occurrence	Format	Min. Access Types
Required	One	int	Get, Replace

This leaf node indicates the timeout value for the cancellation of an in progress MCPTT imminent peril group call.

- Values: 0-65535

The ImminentPerilCallCancel time is in seconds.

NOTE: This element is specific for MCPTT.

6.2.33 /<x>/<x>/OffNetwork/HangTime

Table 6.2.33.1: /<x>/<x>/OffNetwork/HangTime

<x>/OffNetwork/HangTime

Status	Occurrence	Format	Min. Access Types
Required	One	int	Get, Replace

This leaf node indicates the group call hang timer.

- Values: 0-65535

The HangTime is in seconds.

NOTE: This element is specific for MCPTT.

6.2.34 /<x>/<x>/OffNetwork/MaxDuration

Table 6.2.34.1: /<x>/<x>/OffNetwork/MaxDuration

<x>/OffNetwork/MaxDuration

Status	Occurrence	Format	Min. Access Types
Required	One	int	Get, Replace

This leaf node indicates the max duration of group calls.

- Values: 0-65535

The MaxDuration time is in seconds.

NOTE: This element is specific for MCPTT.

6.2.34A /<x>/<x>/OffNetwork/QueueUsage

Table 6.2.34A.1: /<x>/<x>/OffNetwork/QueueUsage

<x>/OffNetwork/QueueUsage

Status	Occurrence	Format	Min. Access Types
Required	One	bool	Get, Replace

This leaf node indicates if queuing is enabled or not.

When set to "true" queuing floor requests is enabled on the group.

When set to "false" queuing floor requests is not enabled on the group.

The default value is set to "true".

NOTE: This element is specific for MCPTT.

6.2.35 /<x>/<x>/OffNetwork/DefaultPPPP

Table 6.2.35.1: /<x>/<x>/OffNetwork/DefaultPPPP

<x>/OffNetwork/DefaultPPPP

Status	Occurrence	Format	Min. Access Types
Required	One	node	Get, Replace

This interior node is a placeholder for the default ProSe Per-Packet Priority (PPPP) configuration.

6.2.36 /<x>/<x>/OffNetwork/DefaultPPPP/MCPTTGroupCallSignalling

Table 6.2.36.1: /<x>/<x>/OffNetwork/DefaultPPPP/MCPTTGroupCallSignalling

<x>/OffNetwork/DefaultPPPP/MCPTTGroupCallSignalling

Status	Occurrence	Format	Min. Access Types
Required	One	int	Get, Replace

This leaf node indicates the default ProSe Per-Packet Priority (PPPP) value (as specified in 3GPP TS 23.303 [6]) for the group call signalling for MCPTT.

- Values: 1-8

The MCPTT user data with the lowest ProSe Per-Packet Priority value shall be considered as the MCPTT user data having the highest priority among the MCPTT user data.

NOTE: This element is specific for MCPTT.

6.2.37 /<x>/<x>/OffNetwork/DefaultPPPP/MCPTTGroupCallMedia

Table 6.2.37.1: /<x>/<x>/OffNetwork/DefaultPPPP/MCPTTGroupCallMedia

<x>/OffNetwork/DefaultPPPP/MCPTTGroupCallMedia

Status	Occurrence	Format	Min. Access Types
Required	One	int	Get, Replace

This leaf node indicates the default ProSe Per-Packet Priority (PPPP) value (as specified in 3GPP TS 23.303 [6]) for the group call media for MCPTT.

- Values: 1-8

The MCPTT user data with the lowest ProSe Per-Packet Priority value shall be considered as the MCPTT user data having the highest priority among the MCPTT user data.

NOTE: This element is specific for MCPTT.

6.2.38 /<x>/<x>/OffNetwork/DefaultPPPP/MCPTTEmergencyGroupCallSignalling

Table 6.2.38.1: /<x>/<x>/OffNetwork/DefaultPPPP/MCPTTEmergencyGroupCallSignalling

<x>/OffNetwork/DefaultPPPP/MCPTTEmergencyGroupCallSignalling

Status	Occurrence	Format	Min. Access Types
Required	One	int	Get, Replace

This leaf node indicates the default ProSe Per-Packet Priority (PPPP) value (as specified in 3GPP TS 23.303 [6]) for the MCPTT emergency group call signalling.

- Values: 1-8

The MCPTT user data with the lowest ProSe Per-Packet Priority value shall be considered as the MCPTT user data having the highest priority among the MCPTT user data.

NOTE: This element is specific for MCPTT.

6.2.39 /<x>/<x>/OffNetwork/DefaultPPPP/MCPTTEmergencyGroupCallMedia

Table 6.2.39.1: /<x>/<x>/OffNetwork/DefaultPPPP/MCPTTEmergencyGroupCallMedia

<x>/OffNetwork/DefaultPPPP/MCPTTEmergencyGroupCallMedia

Status	Occurrence	Format	Min. Access Types
Required	One	int	Get, Replace

This leaf node indicates the default ProSe Per-Packet Priority (PPPP) value (as specified in 3GPP TS 23.303 [6]) for the MCPTT emergency group call media.

- Values: 1-8

The MCPTT user data with the lowest ProSe Per-Packet Priority value shall be considered as the MCPTT user data having the highest priority among the MCPTT user data.

NOTE: This element is specific for MCPTT.

6.2.40 /<x>/<x>/OffNetwork/DefaultPPPP/MCPTTImminentPerilGroupCallSignalling

Table 6.2.40.1: /<x>/<x>/OffNetwork/DefaultPPPP/MCPTTImminentPerilGroupCallSignalling

<x>/OffNetwork/DefaultPPPP/MCPTTImminentPerilGroupCallSignalling

Status	Occurrence	Format	Min. Access Types
Required	One	int	Get, Replace

This leaf node indicates the default ProSe Per-Packet Priority (PPPP) value (as specified in 3GPP TS 23.303 [6]) for the MCPTT imminent peril group call signalling.

- Values: 1-8

The MCPTT user data with the lowest ProSe Per-Packet Priority value shall be considered as the MCPTT user data having the highest priority among the MCPTT user data.

NOTE: This element is specific for MCPTT.

6.2.41 /<x>/<x>/OffNetwork/DefaultPPPP/MCPTTImminentPerilGroupCallMedia

Table 6.2.41.1: /<x>/<x>/OffNetwork/DefaultPPPP/MCPTTImminentPerilGroupCallMedia

<x>/OffNetwork/DefaultPPPP/MCPTTImminentPerilGroupCallMedia

Status	Occurrence	Format	Min. Access Types
Required	One	int	Get, Replace

This leaf node indicates the default ProSe Per-Packet Priority (PPPP) value (as specified in 3GPP TS 23.303 [6]) for the MCPTT imminent peril group call media.

- Values: 1-8

The MCPTT user data with the lowest ProSe Per-Packet Priority value shall be considered as the MCPTT user data having the highest priority among the MCPTT user data.

NOTE: This element is specific for MCPTT.

6.2.41A /<x>/<x>/OffNetwork/DefaultPQI

Table 6.2.41A.1: /<x>/<x>/OffNetwork/DefaultPQI

<x>/OffNetwork/DefaultPQI

Status	Occurrence	Format	Min. Access Types
Required	One	node	Get, Replace

This interior node is a placeholder for the default PQI configuration.

6.2.41B /<x>/<x>/OffNetwork/DefaultPQI/MCPTTGroupCallSignalling

Table 6.2.41B.1: /<x>/<x>/OffNetwork/DefaultPQI/MCPTTGroupCallSignalling

<x>/OffNetwork/DefaultPQI/MCPTTGroupCallSignalling

Status	Occurrence	Format	Min. Access Types
Required	One	int	Get, Replace

This leaf node indicates the default PQI value (as specified in 3GPP TS 23.304 [25]) for the group call signalling for MCPTT.

- Values: 21-26, 55-61, 90-93

The MCPTT user data with the lowest PQI value shall be considered as the MCPTT user data having the highest priority among the MCPTT user data.

NOTE: This element is specific for MCPTT.

6.2.41C /<x>/<x>/OffNetwork/DefaultPQI/MCPTTGroupCallMedia

Table 6.2.41C.1: /<x>/<x>/OffNetwork/DefaultPQI/MCPTTGroupCallMedia

<x>/OffNetwork/DefaultPQI/MCPTTGroupCallMedia

Status	Occurrence	Format	Min. Access Types
Required	One	int	Get, Replace

This leaf node indicates the default PQI value (as specified in 3GPP TS 23.304 [25]) for the group call media for MCPTT.

- Values: 21-26, 55-61, 90-93

The MCPTT user data with the lowest PQI value shall be considered as the MCPTT user data having the highest priority among the MCPTT user data.

NOTE: This element is specific for MCPTT.

6.2.41D /<x>/<x>/OffNetwork/DefaultPQI/MCPTTEmergencyGroupCallSignalling

Table 6.2.41D.1: /<x>/<x>/OffNetwork/DefaultPQI/MCPTTEmergencyGroupCallSignalling

<x>/OffNetwork/DefaultPQI/MCPTTEmergencyGroupCallSignalling

Status	Occurrence	Format	Min. Access Types
Required	One	int	Get, Replace

This leaf node indicates the default PQI value (as specified in 3GPP TS 23.304 [25]) for the MCPTT emergency group call signalling.

- Values: 21-26, 55-61, 90-93

The MCPTT user data with the lowest PQI value shall be considered as the MCPTT user data having the highest priority among the MCPTT user data.

NOTE: This element is specific for MCPTT.

6.2.41E /<x>/<x>/OffNetwork/DefaultPQI/MCPTTEmergencyGroupCallMedia

Table 6.2.41E.1: /<x>/<x>/OffNetwork/DefaultPQI/MCPTTEmergencyGroupCallMedia

<x>/OffNetwork/DefaultPQI/MCPTTEmergencyGroupCallMedia

Status	Occurrence	Format	Min. Access Types
Required	One	int	Get, Replace

This leaf node indicates the default PQI value (as specified in 3GPP TS 23.304 [25]) for the MCPTT emergency group call media.

- Values: 21-26, 55-61, 90-93

The MCPTT user data with the lowest PQI value shall be considered as the MCPTT user data having the highest priority among the MCPTT user data.

NOTE: This element is specific for MCPTT.

6.2.41F /<x>/<x>/OffNetwork/DefaultPQI/MCPTTImminentPerilGroupCallSignalling

Table 6.2.41F.1: /<x>/<x>/OffNetwork/DefaultPQI/MCPTTImminentPerilGroupCallSignalling

<x>/OffNetwork/DefaultPQI/MCPTTImminentPerilGroupCallSignalling

Status	Occurrence	Format	Min. Access Types
Required	One	int	Get, Replace

This leaf node indicates the default PQI value (as specified in 3GPP TS 23.304 [25]) for the MCPTT imminent peril group call signalling.

- Values: 21-26, 55-61, 90-93

The MCPTT user data with the lowest PQI value shall be considered as the MCPTT user data having the highest priority among the MCPTT user data.

NOTE: This element is specific for MCPTT.

6.2.41G /<x>/<x>/OffNetwork/DefaultPQI/MCPTTImminentPerilGroupCallMedia

Table 6.2.41G.1: /<x>/<x>/OffNetwork/DefaultPQI/MCPTTImminentPerilGroupCallMedia

<x>/OffNetwork/DefaultPQI/MCPTTImminentPerilGroupCallMedia

Status	Occurrence	Format	Min. Access Types
Required	One	int	Get, Replace

This leaf node indicates the default PQI value (as specified in 3GPP TS 23.304 [25]) for the MCPTT imminent peril group call media.

- Values: 21-26, 55-61, 90-93

The MCPTT user data with the lowest PQI value shall be considered as the MCPTT user data having the highest priority among the MCPTT user data.

NOTE: This element is specific for MCPTT.

6.2.42 /<x>/<x>/OffNetwork/MCData

Table 6.2.42.1: /<x>/<x>/OffNetwork/MCData

<x>/OffNetwork/MCData

Status	Occurrence	Format	Min. Access Types
Required	One	node	Get, Replace

This interior node is a placeholder for off-network MCDData configuration.

6.2.43 /<x>/<x>/OffNetwork/MCDData/DefaultPPPP

Table 6.2.43.1: /<x>/<x>/OffNetwork/MCDData/DefaultPPPP

<x>/OffNetwork/MCDData/DefaultPPPP

Status	Occurrence	Format	Min. Access Types
Required	One	node	Get, Replace

This interior node is a placeholder for the default ProSe Per-Packet Priority (PPPP) configuration.

6.2.44 /<x>/<x>/OffNetwork/MCDData/DefaultPPPP/ MCDDataGroupCallSignalling

Table 6.2.44.1: /<x>/<x>/OffNetwork/MCDData/DefaultPPPP/MCDDataGroupCallSignalling

<x>/OffNetwork/MCDData/DefaultPPPP/MCDDataGroupCallSignalling

Status	Occurrence	Format	Min. Access Types
Required	One	int	Get, Replace

This leaf node indicates the default ProSe Per-Packet Priority (PPPP) value (as specified in 3GPP TS 23.303 [6]) for the group call signalling for MCDData.

- Values: 1-8

The MCDData user data with the lowest ProSe Per-Packet Priority value shall be considered as the MCDData user data having the highest priority among the MCDData user data.

6.2.45 /<x>/<x>/OffNetwork/MCDData/DefaultPPPP/ MCDDataGroupCallMedia

Table 6.2.45.1: /<x>/<x>/OffNetwork/MCDData/DefaultPPPP/MCDDataGroupCallMedia

<x>/OffNetwork/MCDData/DefaultPPPP/MCDDataGroupCallMedia

Status	Occurrence	Format	Min. Access Types
Required	One	int	Get, Replace

This leaf node indicates the default ProSe Per-Packet Priority (PPPP) value (as specified in 3GPP TS 23.303 [6]) for the group call media for MCDData.

- Values: 1-8

The MCDData user data with the lowest ProSe Per-Packet Priority value shall be considered as the MCDData user data having the highest priority among the MCDData user data.

6.2.45A /<x>/<x>/OffNetwork/MCDData/DefaultPQI

Table 6.2.45A.1: /<x>/<x>/OffNetwork/MCDData/DefaultPQI

<x>/OffNetwork/MCDData/DefaultPQI

Status	Occurrence	Format	Min. Access Types

Required	One	node	Get, Replace
----------	-----	------	--------------

This interior node is a placeholder for the default PQI configuration.

6.2.45B /<x>/<x>/OffNetwork/MCData/DefaultPQI/MCDataGroupCallSignalling

Table 6.2.45B.1: /<x>/<x>/OffNetwork/MCData/DefaultPQI/MCDataGroupCallSignalling

<x>/OffNetwork/MCData/DefaultPQI/MCDataGroupCallSignalling

Status	Occurrence	Format	Min. Access Types
Required	One	int	Get, Replace

This leaf node indicates the default PQI value (as specified in 3GPP TS 23.304 [25]) for the group call signalling for MCData.

- Values: 21-26, 55-61, 90-93

The MCData user data with the lowest PQI value shall be considered as the MCData user data having the highest priority among the MCData user data.

6.2.45C /<x>/<x>/OffNetwork/MCData/DefaultPQI/MCDataGroupCallMedia

Table 6.2.45C.1: /<x>/<x>/OffNetwork/MCData/DefaultPQI/MCDataGroupCallMedia

<x>/OffNetwork/MCData/DefaultPQI/MCDataGroupCallMedia

Status	Occurrence	Format	Min. Access Types
Required	One	int	Get, Replace

This leaf node indicates the default PQI value (as specified in 3GPP TS 23.304 [25]) for the group call media for MCData.

- Values: 21-26, 55-61, 90-93

The MCData user data with the lowest PQI value shall be considered as the MCData user data having the highest priority among the MCData user data.

6.2.46 /<x>/<x>/OffNetwork/MCVideo

Table 6.2.46.1: /<x>/<x>/OffNetwork/MCVideo

<x>/OffNetwork/MCVideo

Status	Occurrence	Format	Min. Access Types
Required	One	node	Get, Replace

This interior node is a placeholder for off-network MCVideo group configuration.

6.2.47 /<x>/<x>/OffNetwork/MCVideo/ArbitrationApproach

Table 6.2.47.1: /<x>/<x>/OffNetwork/MCVideo/ArbitrationApproach

<x>/OffNetwork/MCVideo/ArbitrationApproach

Status	Occurrence	Format	Min. Access Types
Required	One	chr	Get, Replace

This leaf node indicates the arbitration approach used for off-network video transmissions on the group

The valid values are:

- a) "single" which indicates transmission participants rely on a single participant designated as transmission arbitrator for the arbitration of transmission requests; and
- b) "self" which indicates each transmission participant arbitrates its own transmission based on its view of the topology.

6.2.48 /<x>/<x>/OffNetwork/MCVideo/MaxTransmissions

Table 6.2.48.1: /<x>/<x>/OffNetwork/MCVideo/MaxTransmissions

<x>/OffNetwork/MCVideo/MaxTransmissions

Status	Occurrence	Format	Min. Access Types
Required	One	int	Get, Replace

This leaf node indicates maximum number of simultaneous transmissions for off-network MCVideo procedures.

- Values: 0-65535

6.2.49 /<x>/<x>/OffNetwork/MCVideo/DefaultPPPP

Table 6.2.49.1: /<x>/<x>/OffNetwork/MCVideo/DefaultPPPP

<x>/OffNetwork/MCVideo/DefaultPPPP

Status	Occurrence	Format	Min. Access Types
Required	One	node	Get, Replace

This interior node is a placeholder for the default ProSe Per-Packet Priority (PPPP) configuration.

6.2.50 /<x>/<x>/OffNetwork/MCVideo/DefaultPPPP/MCVideoGroupCallSignalling

Table 6.2.50.1: /<x>/<x>/OffNetwork/MCVideo/DefaultPPPP/MCVideoGroupCallSignalling

<x>/OffNetwork/MCVideo/DefaultPPPP/MCVideoGroupCallSignalling

Status	Occurrence	Format	Min. Access Types
Required	One	int	Get, Replace

This leaf node indicates the default ProSe Per-Packet Priority (PPPP) value (as specified in 3GPP TS 23.303 [6]) for the group call signalling for MCVideo.

- Values: 1-8

The MCVideo user data with the lowest ProSe Per-Packet Priority value shall be considered as the MCVideo user data having the highest priority among the MCVideo user data.

6.2.51 /<x>/<x>/OffNetwork/MCVideo/DefaultPPPP/ MCVideoGroupCallMedia

Table 6.2.51.1: /<x>/<x>/OffNetwork/MCVideo/DefaultPPPP/MCVideoGroupCallMedia

<x>/OffNetwork/MCVideo/DefaultPPPP/MCVideoGroupCallMedia

Status	Occurrence	Format	Min. Access Types
Required	One	int	Get, Replace

This leaf node indicates the default ProSe Per-Packet Priority (PPPP) value (as specified in 3GPP TS 23.303 [6]) for the group call media for MCVideo.

- Values: 1-8

The MCVideo user data with the lowest ProSe Per-Packet Priority value shall be considered as the MCVideo user data having the highest priority among the MCVideo user data.

6.2.52 /<x>/<x>/OffNetwork/MCVideo/DefaultPPPP/ MCVideoEmergencyGroupCallSignalling

Table 6.2.52.1: /<x>/<x>/OffNetwork/MCVideo/DefaultPPPP/MCVideoEmergencyGroupCallSignalling

<x>/OffNetwork/MCVideo/DefaultPPPP/MCVideoEmergencyGroupCallSignalling

Status	Occurrence	Format	Min. Access Types
Required	One	int	Get, Replace

This leaf node indicates the default ProSe Per-Packet Priority (PPPP) value (as specified in 3GPP TS 23.303 [6]) for the MCVideo emergency group call signalling.

- Values: 1-8

The MCVideo user data with the lowest ProSe Per-Packet Priority value shall be considered as the MCVideo user data having the highest priority among the MCVideo user data.

6.2.53 /<x>/<x>/OffNetwork/MCVideo/DefaultPPPP/ MCVideoEmergencyGroupCallMedia

Table 6.2.53.1: /<x>/<x>/OffNetwork/MCVideo/DefaultPPPP/MCVideoEmergencyGroupCallMedia

<x>/OffNetwork/MCVideo/DefaultPPPP/MCVideoEmergencyGroupCallMedia

Status	Occurrence	Format	Min. Access Types
Required	One	int	Get, Replace

This leaf node indicates the default ProSe Per-Packet Priority (PPPP) value (as specified in 3GPP TS 23.303 [6]) for the MCVideo emergency group call media.

- Values: 1-8

The MCVideo user data with the lowest ProSe Per-Packet Priority value shall be considered as the MCVideo user data having the highest priority among the MCVideo user data.

6.2.54 /<x>/<x>/OffNetwork/MCVideo/DefaultPPPP/ MCVideoImminentPerilGroupCallSignalling

Table 6.2.54.1:

/<x>/<x>/OffNetwork/MCVideo/DefaultPPPP/MCVideoImminentPerilGroupCallSignalling

<x>/OffNetwork/MCVideo/DefaultPPPP/MCVideoImminentPerilGroupCallSignalling

Status	Occurrence	Format	Min. Access Types
Required	One	int	Get, Replace

This leaf node indicates the default ProSe Per-Packet Priority (PPPP) value (as specified in 3GPP TS 23.303 [6]) for the MCVideo imminent peril group call signalling.

- Values: 1-8

The MCVideo user data with the lowest ProSe Per-Packet Priority value shall be considered as the MCVideo user data having the highest priority among the MCVideo user data.

6.2.55 /<x>/<x>/OffNetwork/MCVideo/DefaultPPPP/ MCVideoImminentPerilGroupCallMedia

Table 6.2.55.1: /<x>/<x>/OffNetwork/MCVideo/DefaultPPPP/MCVideoImminentPerilGroupCallMedia

<x>/OffNetwork/MCVideo/DefaultPPPP/MCVideoImminentPerilGroupCallMedia

Status	Occurrence	Format	Min. Access Types
Required	One	int	Get, Replace

This leaf node indicates the default ProSe Per-Packet Priority (PPPP) value (as specified in 3GPP TS 23.303 [6]) for the MCVideo imminent peril group call media.

- Values: 1-8

The MCVideo user data with the lowest ProSe Per-Packet Priority value shall be considered as the MCVideo user data having the highest priority among the MCVideo user data.

6.2.55A /<x>/<x>/OffNetwork/MCVideo/DefaultPQI

Table 6.2.55A.1: /<x>/<x>/OffNetwork/MCVideo/DefaultPQI

<x>/OffNetwork/MCVideo/DefaultPQI

Status	Occurrence	Format	Min. Access Types
Required	One	node	Get, Replace

This interior node is a placeholder for the default PQI configuration.

6.2.55B /<x>/<x>/OffNetwork/MCVideo/DefaultPQI/ MCVideoGroupCallSignalling

Table 6.2.55B.1: /<x>/<x>/OffNetwork/MCVideo/DefaultPQI/MCVideoGroupCallSignalling

<x>/OffNetwork/MCVideo/DefaultPQI/MCVideoGroupCallSignalling

Status	Occurrence	Format	Min. Access Types
Required	One	int	Get, Replace

This leaf node indicates the default PQI value (as specified in 3GPP TS 23.304 [25]) for the group call signalling for MCVideo.

- Values: 21-26, 55-61, 90-93

The MCVideo user data with the lowest ProSe Per-Packet Priority value shall be considered as the MCVideo user data having the highest priority among the MCVideo user data.

6.2.55C /<x>/<x>/OffNetwork/MCVideo/DefaultPQI/MCVideoGroupCallMedia

Table 6.2.55C.1: /<x>/<x>/OffNetwork/MCVideo/DefaultPQI/MCVideoGroupCallMedia

<x>/OffNetwork/MCVideo/DefaultPQI/MCVideoGroupCallMedia

Status	Occurrence	Format	Min. Access Types
Required	One	int	Get, Replace

This leaf node indicates the default PQI value (as specified in 3GPP TS 23.304 [25]) for the group call media for MCVideo.

- Values: 21-26, 55-61, 90-93

The MCVideo user data with the lowest PQI value shall be considered as the MCVideo user data having the highest priority among the MCVideo user data.

6.2.55D /<x>/<x>/OffNetwork/MCVideo/DefaultPQI/MCVideoEmergencyGroupCallSignalling

Table 6.2.55D.1: /<x>/<x>/OffNetwork/MCVideo/DefaultPQI/MCVideoEmergencyGroupCallSignalling

<x>/OffNetwork/MCVideo/DefaultPQI/MCVideoEmergencyGroupCallSignalling

Status	Occurrence	Format	Min. Access Types
Required	One	int	Get, Replace

This leaf node indicates the default PQI value (as specified in 3GPP TS 23.304 [25]) for the MCVideo emergency group call signalling.

- Values: 21-26, 55-61, 90-93

The MCVideo user data with the lowest PQI value shall be considered as the MCVideo user data having the highest priority among the MCVideo user data.

6.2.55E /<x>/<x>/OffNetwork/MCVideo/DefaultPQI/MCVideoEmergencyGroupCallMedia

Table 6.2.55E.1: /<x>/<x>/OffNetwork/MCVideo/DefaultPQI/MCVideoEmergencyGroupCallMedia

<x>/OffNetwork/MCVideo/DefaultPQI/MCVideoEmergencyGroupCallMedia

Status	Occurrence	Format	Min. Access Types
Required	One	int	Get, Replace

This leaf node indicates the default PQI value (as specified in 3GPP TS 23.304 [25]) for the MCVideo emergency group call media.

- Values: 21-26, 55-61, 90-93

The MCVideo user data with the lowest PQI value shall be considered as the MCVideo user data having the highest priority among the MCVideo user data.

6.2.55F /<x>/<x>/OffNetwork/MCVideo/DefaultPQI/MCVideoImminentPerilGroupCallSignalling

Table 6.2.55F.1: /<x>/<x>/OffNetwork/MCVideo/DefaultPQI/MCVideoImminentPerilGroupCallSignalling

<x>/OffNetwork/MCVideo/DefaultPQI/MCVideoImminentPerilGroupCallSignalling

Status	Occurrence	Format	Min. Access Types
Required	One	int	Get, Replace

This leaf node indicates the default PQI value (as specified in 3GPP TS 23.304 [25]) for the MCVideo imminent peril group call signalling.

- Values: 21-26, 55-61, 90-93

The MCVideo user data with the lowest PQI value shall be considered as the MCVideo user data having the highest priority among the MCVideo user data.

6.2.55G /<x>/<x>/OffNetwork/MCVideo/DefaultPQI/MCVideoImminentPerilGroupCallMedia

Table 6.2.55G.1: /<x>/<x>/OffNetwork/MCVideo/DefaultPQI/MCVideoImminentPerilGroupCallMedia

<x>/OffNetwork/MCVideo/DefaultPQI/MCVideoImminentPerilGroupCallMedia

Status	Occurrence	Format	Min. Access Types
Required	One	int	Get, Replace

This leaf node indicates the default PQI value (as specified in 3GPP TS 23.304 [25]) for the MCVideo imminent peril group call media.

- Values: 21-26, 55-61, 90-93

The MCVideo user data with the lowest PQI value shall be considered as the MCVideo user data having the highest priority among the MCVideo user data.

6.2.56 /<x>/<x>/OffNetwork/MCVideo/MaxDuration

Table 6.2.56.1: /<x>/<x>/OffNetwork/MCVideo/MaxDuration

<x>/OffNetwork/MCVideo/MaxDuration

Status	Occurrence	Format	Min. Access Types
Required	One	int	Get, Replace

This leaf node indicates the max duration of MCVideo group calls.

- Values: 0-65535

The MaxDuration time is in seconds.

6.2.57 /<x>/<x>/OffNetwork/MCVideo/EmergencyCallCancel

Table 6.2.57.1: /<x>/<x>/OffNetwork/MCVideo/EmergencyCallCancel

<x>/OffNetwork/MCVideo/EmergencyCallCancel

Status	Occurrence	Format	Min. Access Types
Required	One	int	Get, Replace

This leaf node indicates the timeout value for the cancellation of an in progress MCVideo emergency group call for MCVideo.

- Values: 0-65535

The EmergencyCallCancel time is in seconds.

6.2.58 /<x>/<x>/OffNetwork/MCVideo/ImminentPerilCallCancel

Table 6.2.58.1: /<x>/<x>/OffNetwork/MCVideo/ImminentPerilCallCancel

<x>/OffNetwork/MCVideo/ImminentPerilCallCancel

Status	Occurrence	Format	Min. Access Types
Required	One	int	Get, Replace

This leaf node indicates the timeout value for the cancellation of an in progress MCVideo imminent peril group call.

- Values: 0-65535

The ImminentPerilCallCancel time is in seconds.

7 MCPTT service configuration MO

7.1 General

The MCPTT service configuration Management Object (MO) is used to configure MCPTT Client behaviour for the on-network or off-network MCPTT Service. The MCPTT service configuration parameters may be stored in the ME, or in the USIM as specified in 3GPP TS 31.102 [10], or in both the ME and the USIM. If both the ME and the USIM contain the same parameters, the values stored in the USIM shall take precedence.

The Management Object Identifier is: urn:oma:mo:ext-3gpp-MCPTT-service-configuration:1.0.

Protocol compatibility: This MO is compatible with OMA OMA DM 1.2 [3].

The OMA DM ACL property mechanism (see OMA OMA-ERELED-DM-V1_2 [2]) may be used to grant or deny access rights to OMA DM servers in order to modify nodes and leaf objects of the MCPTT service configuration MO.

The following nodes and leaf objects are possible under the MCPTT service configuration node as described in figure 7.1.1.

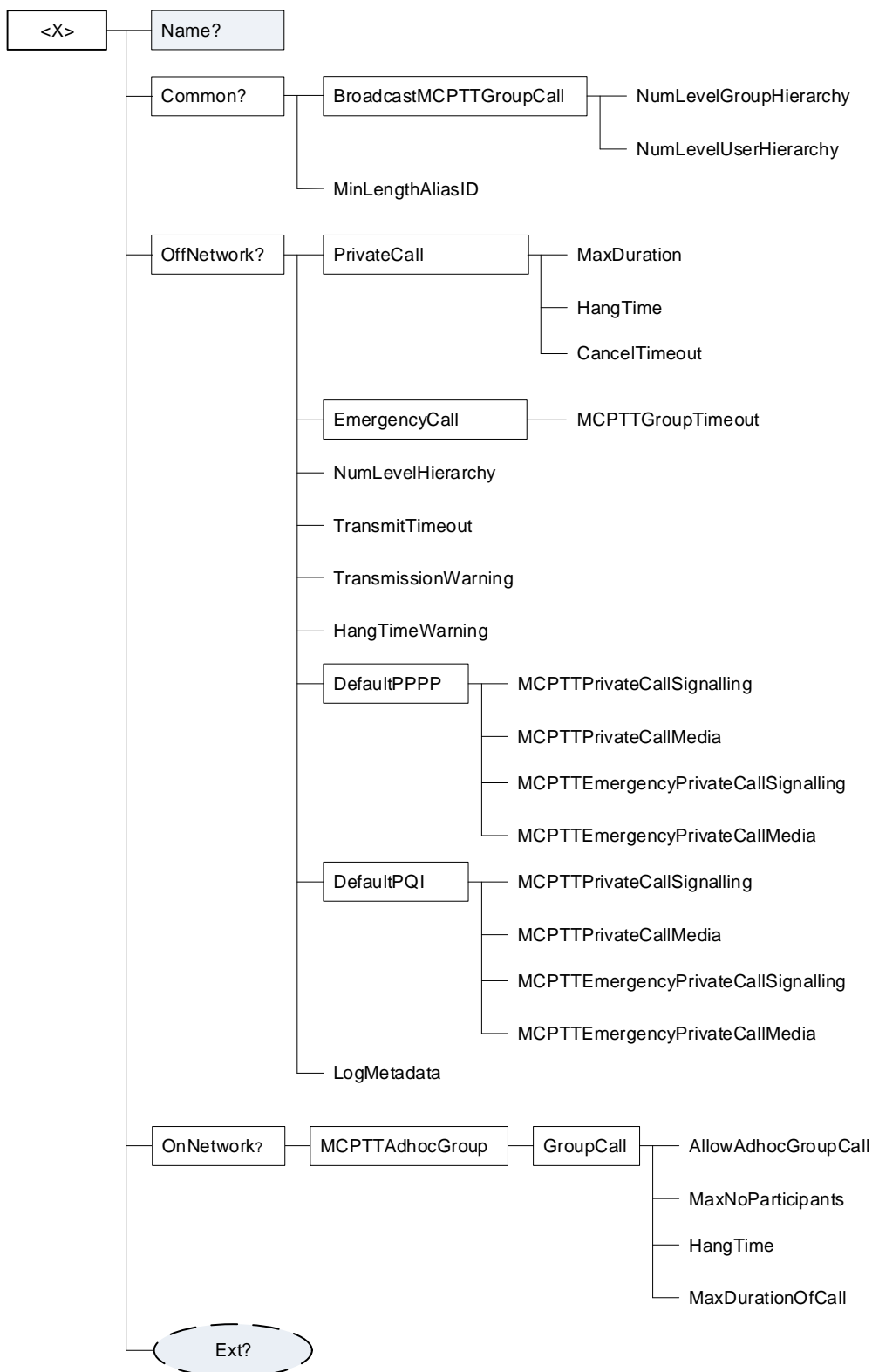

Figure 7.1.1: The MCPTT service configuration MO

7.2 MCPTT service configuration MO parameters

7.2.1 General

This clause describes the parameters for the MCPTT service configuration Management Object (MO).

7.2.2 Node: <x>

Table 7.2.2.1: Node: <x>

<x>

Status	Occurrence	Format	Min. Access Types
Required	OneOrMore	node	Get

This interior node acts as a placeholder for the MCPTT service configuration Management Object (MO).

For the MCPTT service configuration MO, the namespace specific string is: "urn:oma:mo:oma-dm-mcptt-service configuration:1.0"

- Values: N/A

7.2.3 /<x>/Name

Table 7.2.3.1: /<x>/Name

Name

Status	Occurrence	Format	Min. Access Types
Required	ZeroOrOne	chr	Get

The Name leaf is a name for the MCPTT service configuration settings.

- Values: <User displayable name>

7.2.4 /<x>/Ext/

Table 7.2.4.1: /<x>/Ext/

Ext

Status	Occurrence	Format	Min. Access Types
Optional	ZeroOrOne	node	Get, Replace

The Ext is an interior node for where the vendor specific information about the MCPTT service configuration MO is being placed.

Usually the vendor extension is identified by vendor specific name under the ext node and contains the vendor meaning application vendor, device vendor etc. The tree structure under the vendor identified is not defined and can therefore include one or more un-standardized sub-trees.

- Values: N/A

7.2.5 /<x>/Common

Table 7.2.5.1: /<x>/Common

Common

Status	Occurrence	Format	Min. Access Types
Required	ZeroOrOne	node	Get, Replace

This interior node represents a container for the common network operation which means both on-network operation and off-network operation.

7.2.6 /<x>/Common/BroadcastMCPTTGroupCall

Table 7.2.6.1: /<x>/Common/BroadcastMCPTTGroupCall

Common/BroadcastMCPTTGroupCall

Status	Occurrence	Format	Min. Access Types
Required	One	node	Get, Replace

This interior node is a placeholder for Broadcast MCPTT Group Call configuration.

7.2.7 /<x>/Common/BroadcastMCPTTGroupCall/ NumLevelGroupHierarchy

Table 7.2.7.1: /<x>/Common/BroadcastMCPTTGroupCall/NumLevelGroupHierarchy

Common/BroadcastMCPTTGroupCall/NumLevelGroupHierarchy

Status	Occurrence	Format	Min. Access Types
Required	One	int	Get, Replace

This leaf node indicates the number of levels of group hierarchy for group-broadcast groups.

- Values: 0-255

The group-broadcast group with the lowest NumLevelGroupHierarchy value shall be considered as the group-broadcast group having the lowest level among the groups.

7.2.8 /<x>/Common/BroadcastMCPTTGroupCall/ NumLevelUserHierarchy

Table 7.2.8.1: /<x>/Common/BroadcastMCPTTGroupCall/NumLevelUserHierarchy

Common/BroadcastMCPTTGroupCall/NumLevelUserHierarchy

Status	Occurrence	Format	Min. Access Types
Required	One	int	Get, Replace

This leaf node indicates the number of levels of user hierarchy for user-broadcast groups.

- Values: 0-255

The user-broadcast group with the lowest NumLevelUserHierarchy value shall be considered as the user-broadcast group the lowest level among the groups.

7.2.9 /<x>/Common/MinLengthAliasID

Table 7.2.9.1: /<x>/Common/MinLengthAliasID

Common/MinLengthAliasID

Status	Occurrence	Format	Min. Access Types
Required	One	int	Get, Replace

This leaf node indicates minimum length of an alphanumeric identifier (i.e., alias) assigned by an MCPTT administrator.

- Values: 0-255

7.2.10 /<x>/OffNetwork

Table 7.2.10.1: /<x>/OffNetwork

OffNetwork

Status	Occurrence	Format	Min. Access Types
Required	ZeroOrOne	node	Get, Replace

This interior node represents a container for off-network operation.

7.2.11 /<x>/OffNetwork/PrivateCall

Table 7.2.11.1: /<x>/OffNetwork/PrivateCall

OffNetwork/PrivateCall

Status	Occurrence	Format	Min. Access Types
Required	One	node	Get, Replace

This interior node is a placeholder for private call configuration.

7.2.12 /<x>/OffNetwork/PrivateCall/MaxDuration

Table 7.2.12.1: /<x>/OffNetwork/PrivateCall/MaxDuration

OffNetwork/PrivateCall/MaxDuration

Status	Occurrence	Format	Min. Access Types
Required	One	int	Get, Replace

This leaf node indicates max private call (with floor control) duration.

- Values: 0-65535

The MaxDuration time is in seconds.

7.2.13 /<x>/OffNetwork/PrivateCall/HangTime

Table 7.2.13.1: /<x>/OffNetwork/PrivateCall/HangTime

OffNetwork/PrivateCall/HangTime

Status	Occurrence	Format	Min. Access Types
Required	One	int	Get, Replace

This leaf node indicates hang timer for private calls (with floor control).

- Values: 0-65535

The HangTime is in seconds.

7.2.14 /<x>/OffNetwork/PrivateCall/CancelTimeout

Table 7.2.14.1: /<x>/OffNetwork/PrivateCall/CancelTimeout

OffNetwork/PrivateCall/CancelTimeout

Status	Occurrence	Format	Min. Access Types

Required	One	int	Get, Replace
----------	-----	-----	--------------

This leaf node indicates timeout value for the cancellation of an in progress emergency for an MCPTT private call.

- Values: 0-65535

The CancelTimeout is in seconds.

7.2.15 /<x>/OffNetwork/EmergencyCall

Table 7.2.15.1: /<x>/OffNetwork/EmergencyCall

OffNetwork/EmergencyCall

Status	Occurrence	Format	Min. Access Types
Required	One	node	Get, Replace

This interior node indicates a placeholder for the MCPTT emergency call policy.

7.2.16 /<x>/OffNetwork/EmergencyCall/MCPTTGroupTimeout

Table 7.2.16.1: /<x>/OffNetwork/EmergencyCall/MCPTTGroupTimeout

OffNetwork/EmergencyCall/MCPTTGroupTimeout

Status	Occurrence	Format	Min. Access Types
Required	One	int	Get, Replace

This leaf node indicates time limit for an in progress MCPTT emergency call related to an MCPTT group.

- Values: 0-65535

The GroupTimeout is in seconds.

7.2.17 /<x>/OffNetwork/NumLevelHierarchy

Table 7.2.17.1: /<x>/OffNetwork/NumLevelHierarchy

OffNetwork/NumLevelHierarchy

Status	Occurrence	Format	Min. Access Types
Required	One	int	Get, Replace

This leaf node indicates the number of levels of hierarchy for floor control override in off-network.

- Values: 4-256

The request with the lowest NumLevelHierarchy value shall be considered as the request having the lowest priority level given to override an active transmission among the requests.

7.2.18 /<x>/OffNetwork/TransmitTimeout

Table 7.2.18.1: /<x>/OffNetwork/TransmitTimeout

OffNetwork/TransmitTimeout

Status	Occurrence	Format	Min. Access Types

Required	One	int	Get, Replace
----------	-----	-----	--------------

This leaf node indicates transmit time limit from a single request to transmit in a group or private call.

- Values: 0-65535

The TransmitTimeout is in seconds.

7.2.19 /<x>/OffNetwork/TransmissionWarning

Table 7.2.19.1: /<x>/OffNetwork/TransmissionWarning

OffNetwork/TransmissionWarning

Status	Occurrence	Format	Min. Access Types
Required	One	int	Get, Replace

This leaf node indicates configuration of warning time before time limit of transmission is reached (off-network).

- Values: 0-255

The TransmissionWarning time is in seconds.

7.2.20 /<x>/OffNetwork/HangTimeWarning

Table 7.2.20.1: /<x>/OffNetwork/HangTimeWarning

OffNetwork/HangTimeWarning

Status	Occurrence	Format	Min. Access Types
Required	One	int	Get, Replace

This leaf node indicates configuration of warning time before hang time is reached (off-network).

- Values: 0-255

The HangTimeWarning time is in seconds.

7.2.21 /<x>/OffNetwork/DefaultPPPP

Table 7.2.21.1: /<x>/OffNetwork/DefaultPPPP

OffNetwork/DefaultPPPP

Status	Occurrence	Format	Min. Access Types
Required	One	node	Get, Replace

This interior node is a placeholder for the default ProSe Per-Packet Priority (PPPP) configuration.

7.2.22 /<x>/OffNetwork/DefaultPPPP/MCPTTPrivateCallSignalling

Table 7.2.22.1: /<x>/OffNetwork/DefaultPPPP/MCPTTPrivateCallSignalling

OffNetwork/DefaultPPPP/MCPTTPrivateCallSignalling

Status	Occurrence	Format	Min. Access Types
Required	One	int	Get, Replace

This leaf node indicates the default ProSe Per-Packet Priority (PPPP) value (as specified in 3GPP TS 23.303 [6]) for the MCPTT private call signalling.

- Values: 1-8

The MCPTT user data with the lowest ProSe Per-Packet Priority value shall be considered as the MCPTT user data having the highest priority among the MCPTT user data.

7.2.23 /<x>/OffNetwork/DefaultPPPP/MCPTTPrivateCallMedia

Table 7.2.23.1: /<x>/OffNetwork/DefaultPPPP/MCPTTPrivateCallMedia

OffNetwork/DefaultPPPP/MCPTTPrivateCallMedia

Status	Occurrence	Format	Min. Access Types
Required	One	int	Get, Replace

This leaf node indicates the default ProSe Per-Packet Priority (PPPP) value (as specified in 3GPP TS 23.303 [6]) for the MCPTT private call media.

- Values: 1-8

The MCPTT user data with the lowest ProSe Per-Packet Priority value shall be considered as the MCPTT user data having the highest priority among the MCPTT user data.

7.2.24 /<x>/OffNetwork/DefaultPPPP/MCPTTEmergencyPrivateCallSignalling

Table 7.2.24.1: /<x>/OffNetwork/DefaultPPPP/MCPTTEmergencyPrivateCallSignalling

OffNetwork/DefaultPPPP/MCPTTEmergencyPrivateCallSignalling

Status	Occurrence	Format	Min. Access Types
Required	One	int	Get, Replace

This leaf node indicates the default ProSe Per-Packet Priority (PPPP) value (as specified in 3GPP TS 23.303 [6]) for the MCPTT emergency private call signalling.

- Values: 1-8

The MCPTT user data with the lowest ProSe Per-Packet Priority value shall be considered as the MCPTT user data having the highest priority among the MCPTT user data.

7.2.25 /<x>/OffNetwork/DefaultPPPP/MCPTTEmergencyPrivateCallMedia

Table 7.2.25.1: /<x>/OffNetwork/DefaultPPPP/MCPTTEmergencyPrivateCallMedia

OffNetwork/DefaultPPPP/MCPTTEmergencyPrivateCallMedia

Status	Occurrence	Format	Min. Access Types
Required	One	int	Get, Replace

This leaf node indicates the default ProSe Per-Packet Priority (PPPP) value (as specified in 3GPP TS 23.303 [6]) for the MCPTT emergency private call media.

- Values: 1-8

The MCPTT user data with the lowest ProSe Per-Packet Priority value shall be considered as the MCPTT user data having the highest priority among the MCPTT user data.

7.2.25A /<x>/OffNetwork/DefaultPQI

Table 7.2.25A.1: /<x>/OffNetwork/DefaultPQI

OffNetwork/DefaultPQI

Status	Occurrence	Format	Min. Access Types
Required	One	node	Get, Replace

This interior node is a placeholder for the default PQI configuration.

7.2.25B /<x>/OffNetwork/DefaultPQI/MCPTTPrivateCallSignalling

Table 7.2.25B.1: /<x>/OffNetwork/DefaultPQI/MCPTTPrivateCallSignalling

OffNetwork/DefaultPQI/MCPTTPrivateCallSignalling

Status	Occurrence	Format	Min. Access Types
Required	One	int	Get, Replace

This leaf node indicates the default PQI value (as specified in 3GPP TS 23.304 [25]) for the MCPTT private call signalling.

- Values: 21-26, 55-61, 90-93

The MCPTT user data with the lowest PQI value shall be considered as the MCPTT user data having the highest priority among the MCPTT user data.

7.2.25C /<x>/OffNetwork/DefaultPQI/MCPTTPrivateCallMedia

Table 7.2.25C.1: /<x>/OffNetwork/DefaultPQI/MCPTTPrivateCallMedia

OffNetwork/DefaultPQI/MCPTTPrivateCallMedia

Status	Occurrence	Format	Min. Access Types
Required	One	int	Get, Replace

This leaf node indicates the default PQI value (as specified in 3GPP TS 23.304 [25]) for the MCPTT private call media.

- Values: 21-26, 55-61, 90-93

The MCPTT user data with the lowest PQI value shall be considered as the MCPTT user data having the highest priority among the MCPTT user data.

7.2.25D /<x>/OffNetwork/DefaultPQI/MCPTTEmergencyPrivateCallSignalling

Table 7.2.25D.1: /<x>/OffNetwork/DefaultPQI/MCPTTEmergencyPrivateCallSignalling

OffNetwork/DefaultPQI/MCPTTEmergencyPrivateCallSignalling

Status	Occurrence	Format	Min. Access Types
Required	One	int	Get, Replace

This leaf node indicates the default PQI value (as specified in 3GPP TS 23.304 [25]) for the MCPTT emergency private call signalling.

- Values: 21-26, 55-61, 90-93

The MCPTT user data with the lowest PQI value shall be considered as the MCPTT user data having the highest priority among the MCPTT user data.

7.2.25E /<x>/OffNetwork/DefaultPQI/MCPTTEmergencyPrivateCallMedia

Table 7.2.25E.1: /<x>/OffNetwork/DefaultPQI/MCPTTEmergencyPrivateCallMedia

OffNetwork/DefaultPQI/MCPTTEmergencyPrivateCallMedia

Status	Occurrence	Format	Min. Access Types
Required	One	int	Get, Replace

This leaf node indicates the default PQI value (as specified in 3GPP TS 23.304 [25]) for the MCPTT emergency private call media.

- Values: 21-26, 55-61, 90-93

The MCPTT user data with the lowest PQI value shall be considered as the MCPTT user data having the highest priority among the MCPTT user data.

7.2.26 /<x>/OffNetwork/LogMetadata

Table 7.2.26.1: /<x>/OffNetwork/LogMetadata

OffNetwork/LogMetadata

Status	Occurrence	Format	Min. Access Types
Required	One	bool	Get, Replace

This leaf node indicates whether logging of metadata for MCPTT group calls, MCPTT private calls and non-call activities is permitted.

When set to "true" logging of metadata for MCPTT group calls, MCPTT private calls and non-call activities, is enabled.

When set to "false" logging of metadata for MCPTT group calls, MCPTT private calls and non-call activities, is not enabled.

7.2.27 /<x>/OnNetwork

Table 7.2.27.1: /<x>/OnNetwork

OnNetwork

Status	Occurrence	Format	Min. Access Types
Required	ZeroOrOne	node	Get, Replace

This interior node represents a container for on-network operation.

7.2.28 /<x>/OnNetwork/MCPTTAdhocGroup

Table 7.2.28.1: /<x>/OnNetwork/MCPTTAdhocGroup

OnNetwork/MCPTTAdhocGroup

Status	Occurrence	Format	Min. Access Types
Required	One	node	Get, Replace

This interior node is a placeholder for the MCPTT adhoc group call related configurations.

7.2.29 /<x>/OnNetwork/MCPTTAdhocGroup/GroupCall

Table 7.2.29.1: /<x>/OnNetwork/MCPTTAdhocGroup/GroupCall

OnNetwork/MCPTTAdhocGroup/GroupCall

Status	Occurrence	Format	Min. Access Types
Required	One	node	Get, Replace

This interior node is a placeholder for the MCPTT adhoc group call policy and configurations.

7.2.30 /<x>/OnNetwork/MCPTTAdhocGroup/GroupCall/ AllowAdhocGroupCall

Table 7.2.30.1: /<x>/OnNetwork/MCPTTAdhocGroup/GroupCall/AllowAdhocGroupCall

OnNetwork/MCPTTAdhocGroup/GroupCall/AllowAdhocGroupCall

Status	Occurrence	Format	Min. Access Types
Required	One	bool	Get, Replace

This leaf node indicates whether on-network adhoc group calls support enabled or disabled.

When set to "true" the MCPTT system supports the adhoc group call and is enabled to allow the MCPTT users to make an MCPTT adhoc group call.

When set to "false" the MCPTT system supports the adhoc group call and is disabled to not allow the MCPTT users to make an MCPTT adhoc group call.

7.2.31 /<x>/OnNetwork/MCPTTAdhocGroup/GroupCall/MaxNoParticipants

Table 7.2.31.1: /<x>/OnNetwork/MCPTTAdhocGroup/GroupCall/MaxNoParticipants

OnNetwork/MCPTTAdhocGroup/GroupCall/MaxNoParticipants

Status	Occurrence	Format	Min. Access Types
Required	One	int	Get, Replace

This leaf node indicates maximum number of participants allowed in an adhoc group call and the value is left to deployment requirement.

7.2.32 /<x>/OnNetwork/MCPTTAdhocGroup/GroupCall/HangTime

Table 7.2.32.1: /<x>/OnNetwork/MCPTTAdhocGroup/GroupCall/HangTime

OnNetwork/MCPTTAdhocGroup/GroupCall/HangTime

Status	Occurrence	Format	Min. Access Types
Required	One	int	Get, Replace

This leaf node indicates hang timer for adhoc group calls.

- Values: 0-65535

The HangTime is in seconds.

7.2.33 /<x>/OnNetwork/MCPTTAdhocGroup/GroupCall/MaxDurationOfCall

Table 7.2.33.1: /<x>/OnNetwork/MCPTTAdhocGroup/GroupCall/MaxDurationOfCall

OnNetwork/MCPTTAdhocGroup/GroupCall/MaxDurationOfCall

Status	Occurrence	Format	Min. Access Types
Required	One	int	Get, Replace

This leaf node indicates max adhoc group call duration.

- Values: 0-65535

The MaxDurationOfCall time is in seconds.

8 MCS UE initial configuration MO

8.1 General

The MCS UE initial configuration Management Object (MO) is used to configure the MCS Client behaviour for the on-network or off-network MCS Service. The MCS UE initial configuration parameters may be stored in the ME, or in the USIM as specified in 3GPP TS 31.102 [10], or in both the ME and the USIM. If both the ME and the USIM contain the same parameters, the values stored in the USIM shall take precedence.

NOTE: For historical reasons some of the elements in the MCS UE initial MO uses the terminology "MCPTT", however this MO is common to all MCS with some MCPTT specific elements, some MCDATA specific elements and some MCVideo specific elements. Not all elements that contain the terminology "MCPTT" are just MCPTT specific.

The Management Object Identifier is: urn:oma:mo:ext-3gpp-MCPTT-UE-initial-configuration:1.0.

Protocol compatibility: This MO is compatible with OMA OMA DM 1.2 [3].

The OMA DM ACL property mechanism (see OMA OMA-ERELD-DM-V1_2 [2]) may be used to grant or deny access rights to OMA DM servers in order to modify nodes and leaf objects of the MCPTT user profile MO.

The following nodes and leaf objects are possible under the MCPTT node as described in figure 8.1.1, figure 8.1.2, figure 8.1.3 and figure 8.1.4.

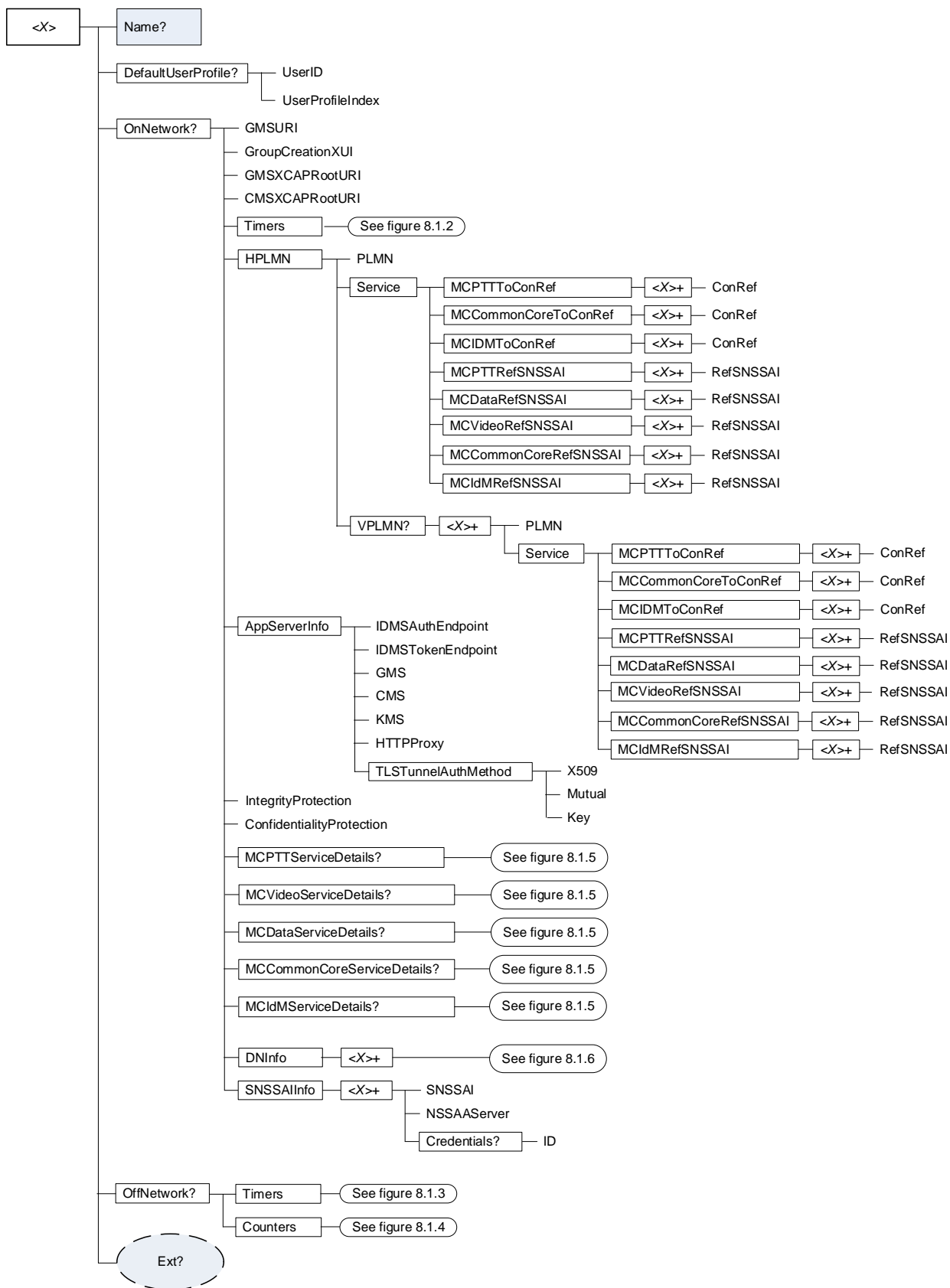

Figure 8.1.1: The MCS UE initial configuration MO (1 of 6)

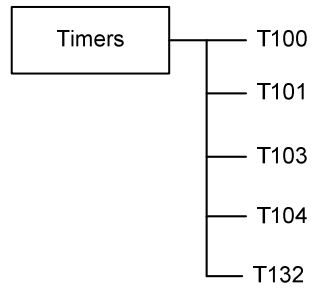

Figure 8.1.2: The MCS UE initial configuration MO (2 of 6)

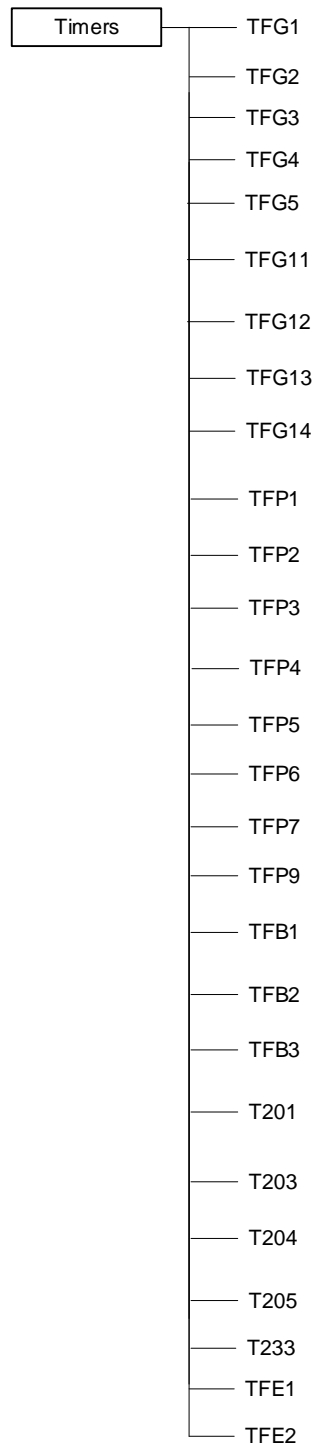

Figure 8.1.3: The MCS UE initial configuration MO (3 of 6)

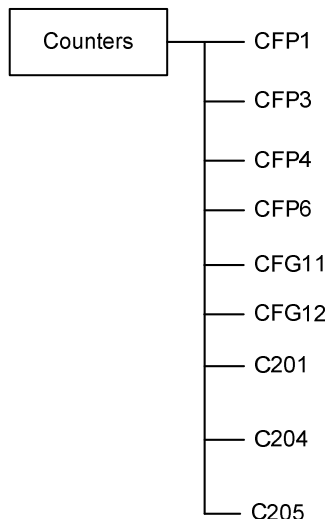

Figure 8.1.4: The MCS UE initial configuration MO (4 of 6)

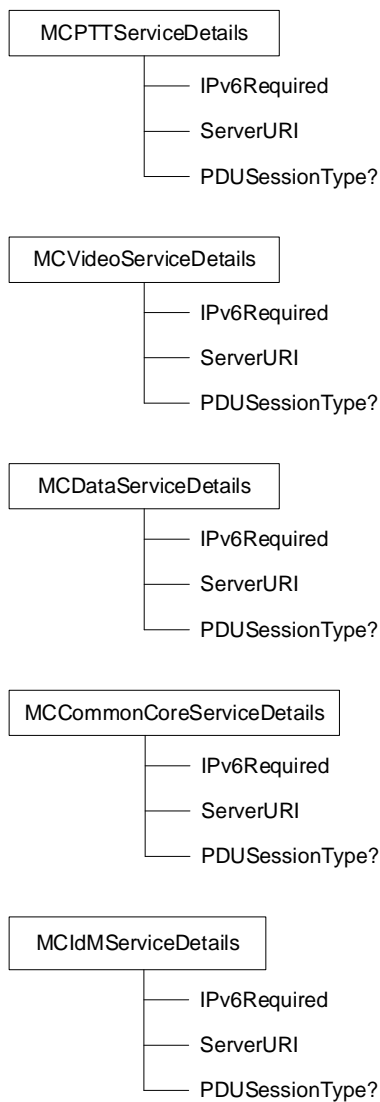

Figure 8.1.5: The MCS UE initial configuration MO (5 of 6)

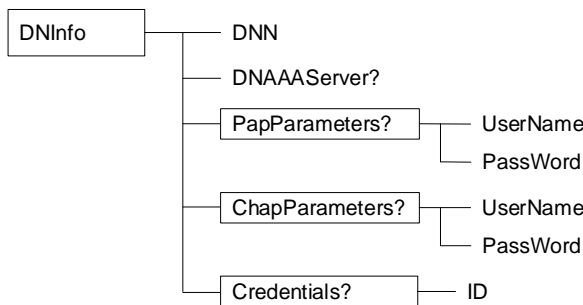

Figure 8.1.6: The MCS UE initial configuration MO (6 of 6)

8.2 MCS UE initial configuration MO parameters

8.2.1 General

This clause describes the parameters for the MCS UE initial configuration Management Object (MO).

8.2.2 Node: <x>

Table 8.2.2.1: Node: <x>

<x>

Status	Occurrence	Format	Min. Access Types
Required	OneOrMore	node	Get

This interior node acts as a placeholder for the MCS UE initial configuration Management Object (MO).

For the MCS UE initial configuration MO, the namespace specific string is: "urn:oma:mo:oma-dm-mcptt-ue-initial-configuration:1.0"

- Values: N/A

8.2.3 /<x>/Name

Table 8.2.3.1: /<x>/Name

Name

Status	Occurrence	Format	Min. Access Types
Required	ZeroOrOne	chr	Get

The Name leaf is a name for the MCPTT UE initial configuration settings.

- Values: <User displayable name>

8.2.4 /<x>/Ext/

Table 8.2.4.1: /<x>/Ext/

Ext

Status	Occurrence	Format	Min. Access Types
Optional	ZeroOrOne	node	Get, Replace

The Ext is an interior node for where the vendor specific information about the MCPTT UE initial configuration MO is being placed.

Usually the vendor extension is identified by vendor specific name under the ext node and contains the vendor meaning application vendor, device vendor etc. The tree structure under the vendor identified is not defined and can therefore include one or more un-standardized sub-trees.

- Values: N/A

8.2.5 /<x>/DefaultUserProfile

Table 8.2.5.1: /<x>/DefaultUserProfile

DefaultUserProfile

Status	Occurrence	Format	Min. Access Types
Required	ZeroOrOne	node	Get, Replace

This interior node represents a container for the default user profile.

The DefaultUserProfile nodes are:

- the same MCPTT user profile nodes defined in MCPTT user profile MO with a default MCPTT user ID;
- the same MCDData user profile nodes defined in MCDData user profile MO with a default MCDData user ID; or
- the same MCVideo user profile nodes defined in MCVideo user profile MO with a default MCVideo user ID.

8.2.6 /<x>/DefaultUserProfile/UserID

Table 8.2.6.1: /<x>/DefaultUserProfile/UserID

DefaultUserProfile/UserID

Status	Occurrence	Format	Min. Access Types
Required	One	chr	Get, Replace

This leaf node indicates a default MCS user identity.

8.2.7 /<x>/DefaultUserProfile/UserProfileIndex

Table 8.2.7.1: /<x>/DefaultUserProfile/UserProfileIndex

DefaultUserProfile/UserProfileIndex

Status	Occurrence	Format	Min. Access Types
Required	One	int	Get, Replace

This leaf node represents an indicator for the particular user profile.

- Values: 0-255

8.2.8 /<x>/OnNetwork

Table 8.2.8.1: /<x>/OnNetwork

OnNetwork

Status	Occurrence	Format	Min. Access Types
Required	ZeroOrOne	node	Get, Replace

This interior node represents a container for on-network operation.

8.2.9 /<x>/OnNetwork/GMSURI

Table 8.2.9.1: /<x>/OnNetwork/GMSURI

OnNetwork/GMSURI

Status	Occurrence	Format	Min. Access Types
Required	One	chr	Get, Replace

This leaf node indicates the group management service URI information which contains the public service identity for performing subscription proxy function of the GMS.

The value is a URI as specified in 3GPP TS 23.003 [5].

8.2.9A /<x>/OnNetwork/GroupCreationXUI

Table 8.2.9A.1: /<x>/OnNetwork/GroupCreationXUI

OnNetwork/GroupCreationXUI

Status	Occurrence	Format	Min. Access Types
Required	One	chr	Get, Replace

This leaf node indicates the group creation XUI information for creation of groups.

The value is a URI as specified in 3GPP TS 23.003 [5].

8.2.9B /<x>/OnNetwork/GMSXCAPRootURI

Table 8.2.9B.1: /<x>/OnNetwork/GMSXCAPRootURI

OnNetwork/GMSXCAPRootURI

Status	Occurrence	Format	Min. Access Types
Required	One	chr	Get, Replace

This leaf node indicates the group management server XCAP Root URI information.

The value is a URI as specified in 3GPP TS 23.003 [5].

8.2.9C /<x>/OnNetwork/CMSXCAPRootURI

Table 8.2.9C.1: /<x>/OnNetwork/CMSXCAPRootURI

OnNetwork/CMSXCAPRootURI

Status	Occurrence	Format	Min. Access Types
Required	One	chr	Get, Replace

This leaf node indicates the configuration management server XCAP Root URI information.

The value is a URI as specified in 3GPP TS 23.003 [5].

8.2.10 /<x>/OnNetwork/Timers

Table 8.2.10.1: /<x>/OnNetwork/Timers

OnNetwork/Timers

Status	Occurrence	Format	Min. Access Types
Required	One	node	Get, Replace

This interior node is a placeholder for timer configuration.

8.2.11 /<x>/OnNetwork/Timers/T100

Table 8.2.11.1: /<x>/OnNetwork/Timers/T100

OnNetwork/Timers/T100

Status	Occurrence	Format	Min. Access Types
Required	One	int	Get, Replace

This leaf node indicates the MCPTT timer for floor release as specified in 3GPP TS 24.380 [8].

- Values: 0-255

The T100 is in seconds.

8.2.12 /<x>/OnNetwork/Timers/T101

Table 8.2.12.1: /<x>/OnNetwork/Timers/T101

OnNetwork/Timers/T101

Status	Occurrence	Format	Min. Access Types
Required	One	int	Get, Replace

This leaf node indicates the MCPTT timer for floor request as specified in 3GPP TS 24.380 [8].

- Values: 0-255

The timer T101 is in seconds.

8.2.13 /<x>/OnNetwork/Timers/T103

Table 8.2.13.1: /<x>/OnNetwork/Timers/T103

OnNetwork/Timers/T103

Status	Occurrence	Format	Min. Access Types
Required	One	int	Get, Replace

This leaf node indicates the MCPTT timer for end of RTP media as specified in 3GPP TS 24.380 [8].

- Values: 0-255

The timer T103 is in seconds.

8.2.14 /<x>/OnNetwork/Timers/T104

Table 8.2.14.1: /<x>/OnNetwork/Timers/T104

OnNetwork/Timers/T104

Status	Occurrence	Format	Min. Access Types
Required	One	int	Get, Replace

This leaf node indicates the MCPTT timer for floor queue position request as specified in 3GPP TS 24.380 [8].

- Values: 0-255

The timer T104 is in seconds.

8.2.15 /<x>/OnNetwork/Timers/T132

Table 8.2.15.1: /<x>/OnNetwork/Timers/T132

OnNetwork/Timers/T132

Status	Occurrence	Format	Min. Access Types
Required	One	int	Get, Replace

This leaf node indicates the MCPTT timer for queued request granted MCPTT user action as specified in 3GPP TS 24.380 [8].

- Values: 0-255

The timer T132 is in seconds.

8.2.16 /<x>/OnNetwork/HPLMN

Table 8.2.16.1: /<x>/OnNetwork/HPLMN

OnNetwork/HPLMN

Status	Occurrence	Format	Min. Access Types
Required	One	node	Get, Replace

This interior node is a placeholder for the HPLMN configuration.

8.2.17 /<x>/OnNetwork/HPLMN/PLMN

Table 8.2.17.1: /<x>/OnNetwork/HPLMN/PLMN

OnNetwork/HPLMN/PLMN

Status	Occurrence	Format	Min. Access Types
Required	One	chr	Get, Replace

This leaf node indicates the HPLMN code.

- Values: <PLMN>

The format of the PLMN is defined by 3GPP TS 23.003 [5].

8.2.18 /<x>/OnNetwork/HPLMN/Service

Table 8.2.18.1: /<x>/OnNetwork/HPLMN/Service

OnNetwork/HPLMN/Service

Status	Occurrence	Format	Min. Access Types
Required	One	node	Get, Replace

This interior node indicates the MCS related services on a per HPLMN basis.

8.2.19 /<x>/OnNetwork/HPLMN/Service/MCPTTTtoConRef

Table 8.2.19.1: /<x>/OnNetwork/HPLMN/Service/MCPTTTtoConRef

OnNetwork/HPLMN/Service/MCPTTTtoConRef

Status	Occurrence	Format	Min. Access Types
Required	One	node	Get, Replace

This interior node contains the configuration parameters for establishment of the PDN connection for the MCS service on a per HPLMN basis.

8.2.20 /<x>/OnNetwork/HPLMN/Service/MCPTTTtoConRef/<x>

Table 8.2.20.1: /<x>/OnNetwork/HPLMN/Service/MCPTTTtoConRef/<x>

OnNetwork/HPLMN/Service/MCPTTTtoConRef/<x>

Status	Occurrence	Format	Min. Access Types
Required	OneOrMore	node	Get, Replace

This run-time node acts as a placeholder for each reference to the connectivity parameters on a per HPLMN basis.

8.2.21 /<x>/OnNetwork/HPLMN/Service/MCPTTTtoConRef/<x>/ConRef

Table 8.2.21.1: /<x>/OnNetwork/HPLMN/Service/MCPTTTtoConRef/<x>/ConRef

OnNetwork/HPLMN/Service/MCPTTTtoConRef/<x>/ConRef

Status	Occurrence	Format	Min. Access Types
Required	One	chr	Get, Replace

The ConRef specifies a specific linkage to the connectivity parameters on a per HPLMN basis.

- Values: <A network access point object>

8.2.22 /<x>/OnNetwork/HPLMN/Service/MCCommonCoreToConRef

Table 8.2.22.1: /<x>/OnNetwork/HPLMN/Service/MCCommonCoreToConRef

OnNetwork/HPLMN/Service/MCCommonCoreToConRef

Status	Occurrence	Format	Min. Access Types
Required	One	node	Get, Replace

This interior node contains the configuration parameters for establishment of the PDN connection for the MC common core service on a per HPLMN basis.

8.2.23 /<x>/OnNetwork/HPLMN/Service/MCCommonCoreToConRef/<x>

Table 8.2.23.1: /<x>/OnNetwork/HPLMN/Service/MCCommonCoreToConRef/<x>

OnNetwork/HPLMN/Service/MCCommonCoreToConRef/<x>

Status	Occurrence	Format	Min. Access Types
Required	OneOrMore	node	Get, Replace

This run-time node acts as a placeholder for each reference to the connectivity parameters on a per HPLMN basis.

8.2.24 /<x>/OnNetwork/HPLMN/Service/MCCommonCoreToConRef/<x>/ConRef

Table 8.2.24.1: /<x>/OnNetwork/HPLMN/Service/MCCommonCoreToConRef/<x>/ConRef

OnNetwork/HPLMN/Service/MCCommonCoreToConRef/<x>/ConRef

Status	Occurrence	Format	Min. Access Types
Required	One	chr	Get, Replace

The ConRef specifies a specific linkage to the connectivity parameters on a per HPLMN basis.

- Values: <A network access point object>

8.2.25 /<x>/OnNetwork/HPLMN/Service/MCIDMTToConRef

Table 8.2.25.1: /<x>/OnNetwork/HPLMN/Service/MCIDMTToConRef

OnNetwork/HPLMN/Service/MCIDMTToConRef

Status	Occurrence	Format	Min. Access Types
Required	One	node	Get, Replace

This interior node contains the configuration parameters for establishment of the PDN connection for the MC identity management service on a per HPLMN basis.

8.2.26 /<x>/OnNetwork/HPLMN/Service/MCIDMTToConRef/<x>

Table 8.2.26.1: /<x>/OnNetwork/HPLMN/Service/MCIDMTToConRef/<x>

OnNetwork/HPLMN/Service/MCIDMTToConRef/<x>

Status	Occurrence	Format	Min. Access Types
Required	OneOrMore	node	Get, Replace

This run-time node acts as a placeholder for each reference to the connectivity parameters on a per HPLMN basis.

8.2.27 /<x>/OnNetwork/HPLMN/Service/MCIDMTtoConRef/<x>/ConRef

Table 8.2.27.1: /<x>/OnNetwork/HPLMN/Service/MCIDMTtoConRef/<x>/ConRef

OnNetwork/HPLMN/Service/MCIDMTtoConRef/<x>/ConRef

Status	Occurrence	Format	Min. Access Types
Required	One	chr	Get, Replace

The ConRef specifies a specific linkage to the connectivity parameters on a per HPLMN basis.

- Values: <A network access point object>

8.2.27A1/<x>/OnNetwork/HPLMN/Service/MCPTTRefSNSSAI

Table 8.2.27A1.1: /<x>/OnNetwork/HPLMN/Service/MCPTTRefSNSSAI

OnNetwork/HPLMN/Service/MCPTTRefSNSSAI

Status	Occurrence	Format	Min. Access Types
Optional	One	node	Get, Replace

This interior node contains the list of S-NSSAIs to be used for MCPTT service in the HPLMN.

8.2.27A2/<x>/OnNetwork/HPLMN/Service/MCPTTRefSNSSAI/<x>

Table 8.2.27A2.1: /<x>/OnNetwork/HPLMN/Service/MCPTTRefSNSSAI/<x>

OnNetwork/HPLMN/Service/MCPTTRefSNSSAI/<x>

Status	Occurrence	Format	Min. Access Types
Required	OneOrMore	node	Get, Replace

This run-time node acts as a placeholder for each reference to parameters for a slice (S-NSSAI) used for MCPTT service in the HPLMN.

8.2.27A3/<x>/OnNetwork/HPLMN/Service/MCPTTRefSNSSAI/<x>/RefSNSSAI

Table 8.2.27A3.1: /<x>/OnNetwork/HPLMN/Service/MCPTTRefSNSSAI/<x>/RefSNSSAI

OnNetwork/HPLMN/Service/MCPTTRefSNSSAI/<x>/RefSNSSAI

Status	Occurrence	Format	Min. Access Types
Required	One	chr	Get, Replace

This leaf node specifies a specific linkage to the slice (S-NSSAI) parameters used for MCPTT service in the HPLMN.

- Values: A string that identifies an S-NSSAI.

8.2.27A4/<x>/OnNetwork/HPLMN/Service/MCCommonCoreRefSNSSAI

Table 8.2.27A4.1: /<x>/OnNetwork/HPLMN/Service/MCCommonCoreRefSNSSAI

OnNetwork/HPLMN/Service/MCCommonCoreRefSNSSAI

Status	Occurrence	Format	Min. Access Types

Optional	One	node	Get, Replace
----------	-----	------	--------------

This interior node contains a list of S-NSSAIs to be used for MC Common Core services in the HPLMN.

8.2.27A5/<x>/OnNetwork/HPLMN/Service/MCCommonCoreRefSNSSAI/<x>

Table 8.2.27A5.1: /<x>/OnNetwork/HPLMN/Service/MCCommonCoreRefSNSSAI/<x>

OnNetwork/HPLMN/Service/MCCommonCoreRefSNSSAI/<x>

Status	Occurrence	Format	Min. Access Types
Optional	OneOrMore	node	Get, Replace

This run-time node acts as a placeholder for each reference to parameters for a slice (S-NSSAI) used for MC Common Core services in the HPLMN.

8.2.27A6/<x>/OnNetwork/HPLMN/Service/MCCommonCoreRefSNSSAI/<x>/RefSNSSAI

Table 8.2.27A6.1: /<x>/OnNetwork/HPLMN/Service/MCCommonCoreRefSNSSAI/<x>/RefSNSSAI

OnNetwork/HPLMN/Service/MCCommonCoreRefSNSSAI/<x>/RefSNSSAI

Status	Occurrence	Format	Min. Access Types
Optional	One	chr	Get, Replace

This leaf node specifies a specific linkage to the slice (S-NSSAI) parameters used for MC Common Core services in the HPLMN.

- Values: A string that identifies an S-NSSAI.

8.2.27A7/<x>/OnNetwork/HPLMN/Service/MCIdMRefSNSSAI

Table 8.2.27A7.1: /<x>/OnNetwork/HPLMN/Service/MCIdMRefSNSSAI

OnNetwork/HPLMN/Service/MCIdMRefSNSSAI

Status	Occurrence	Format	Min. Access Types
Optional	One	node	Get, Replace

This interior node contains a list of S-NSSAIs to be used for MC Identity Management services in the HPLMN.

8.2.27A8/<x>/OnNetwork/HPLMN/Service/MCIdMRefSNSSAI/<x>

Table 8.2.27A8.1: /<x>/OnNetwork/HPLMN/Service/MCIdMRefSNSSAI/<x>

OnNetwork/HPLMN/Service/MCIdMRefSNSSAI/<x>

Status	Occurrence	Format	Min. Access Types
Optional	OneOrMore	node	Get, Replace

This run-time node acts as a placeholder for each reference to parameters for a slice (S-NSSAI) used for MC Identity Management services in the HPLMN.

8.2.27A9 /<x>/OnNetwork/HPLMN/Service/MCIdMRefSNSSAI/<x>/RefSNSSAI

Table 8.2.27A9.1: /<x>/OnNetwork/HPLMN/Service/MCIdMRefSNSSAI/<x>/RefSNSSAI

OnNetwork/HPLMN/Service/MCIdMRefSNSSAI/<x>/RefSNSSAI

Status	Occurrence	Format	Min. Access Types
Optional	One	chr	Get, Replace

This leaf node specifies a specific linkage to the slice (S-NSSAI) parameters used for MC Identity Management services in the HPLMN.

- Values: A string that identifies an S-NSSAI.

8.2.27A10 /<x>/OnNetwork/HPLMN/Service/MCDataRefSNSSAI

Table 8.2.27A10.1: /<x>/OnNetwork/HPLMN/Service/MCDataRefSNSSAI

OnNetwork/HPLMN/Service/MCDataRefSNSSAI

Status	Occurrence	Format	Min. Access Types
Optional	One	node	Get, Replace

This interior node contains a list of S-NSSAIs to be used for MCData service in the HPLMN.

8.2.27A11 /<x>/OnNetwork/HPLMN/Service/MCDataRefSNSSAI/<x>

Table 8.2.27A11.1: /<x>/OnNetwork/HPLMN/Service/MCDataRefSNSSAI/<x>

OnNetwork/HPLMN/Service/MCDataRefSNSSAI/<x>

Status	Occurrence	Format	Min. Access Types
Required	OneOrMore	node	Get, Replace

This run-time node acts as a placeholder for each reference to parameters for a slice (S-NSSAI) used for MCData services in the HPLMN.

8.2.27A12 /<x>/OnNetwork/HPLMN/Service/MCDataRefSNSSAI/<x>/RefSNSSAI

Table 8.2.27A12.1: /<x>/OnNetwork/HPLMN/Service/MCDataRefSNSSAI/<x>/RefSNSSAI

OnNetwork/HPLMN/Service/MCDataRefSNSSAI/<x>/RefSNSSAI

Status	Occurrence	Format	Min. Access Types
Required	One	chr	Get, Replace

The RefSNSSAI specifies a specific linkage to the slice (S-NSSAI) parameters used for MCData service in the HPLMN.

- Values: A string that identifies an S-NSSAI.

8.2.27A13 /<x>/OnNetwork/HPLMN/Service/MCVideoRefSNSSAI

Table 8.2.27A13.1: /<x>/OnNetwork/HPLMN/Service/MCVideoRefSNSSAI

OnNetwork/HPLMN/Service/MCVideoRefSNSSAI

Status	Occurrence	Format	Min. Access Types
Optional	One	node	Get, Replace

This interior node contains a list of S-NSSAIs to be used for MCVideo service in the HPLMN.

8.2.27A14 /<x>/OnNetwork/HPLMN/Service/MCVideoRefSNSSAI/<x>

Table 8.2.27A14.1: /<x>/OnNetwork/HPLMN/Service/MCVideoRefSNSSAI/<x>

OnNetwork/HPLMN/Service/MCVideoRefSNSSAI/<x>

Status	Occurrence	Format	Min. Access Types
Optional	OneOrMore	node	Get, Replace

This run-time node acts as a placeholder for each reference to parameters for a slice (S-NSSAI) used for MCVideo service in the HPLMN.

8.2.27A15 /<x>/OnNetwork/HPLMN/Service/MCVideoRefSNSSAI/<x>/RefSNSSAI

Table 8.2.27A15.1: /<x>/OnNetwork/HPLMN/Service/MCVideoRefSNSSAI/<x>/RefSNSSAI

OnNetwork/HPLMN/Service/MCVideoRefSNSSAI/<x>/RefSNSSAI

Status	Occurrence	Format	Min. Access Types
Required	One	chr	Get, Replace

The RefSNSSAI specifies a specific linkage to the slice (S-NSSAI) parameters used for MCVideo service in the HPLMN.

- Values: A string that identifies an S-NSSAI.

8.2.28 /<x>/OnNetwork/HPLMN/VPLMN

Table 8.2.28.1: /<x>/OnNetwork/HPLMN/VPLMN

OnNetwork/HPLMN/VPLMN

Status	Occurrence	Format	Min. Access Types
Optional	ZeroOrOne	node	Get, Replace

This interior node is a placeholder for a list of VPLMN configurations.

8.2.28A /<x>/OnNetwork/HPLMN/VPLMN/<x>

Table 8.2.28A.1: /<x>/OnNetwork/HPLMN/VPLMN/<x>

OnNetwork/HPLMN/VPLMN/<x>

Status	Occurrence	Format	Min. Access Types
Optional	OneOrMore	node	Get, Replace

This run-time node is a placeholder for the list of VPLMN configurations.

8.2.29 /<x>/OnNetwork/HPLMN/VPLMN/<x>/PLMN

Table 8.2.29.1: /<x>/OnNetwork/HPLMN/VPLMN/<x>/PLMN

OnNetwork/HPLMN/VPLMN/<x>/PLMN

Status	Occurrence	Format	Min. Access Types
Required	One	chr	Get, Replace

This leaf node indicates the VPLMN code.

- Values: <PLMN>

The format of the PLMN is defined by 3GPP TS 23.003 [5].

8.2.30 /<x>/OnNetwork/HPLMN/VPLMN/<x>/Service

Table 8.2.30.1: /<x>/OnNetwork/HPLMN/VPLMN/<x>/Service

OnNetwork/HPLMN/VPLMN/<x>/Service

Status	Occurrence	Format	Min. Access Types
Required	One	node	Get, Replace

This interior node indicates the MCS related services on a per VPLMN and HPLMN basis.

8.2.31 /<x>/OnNetwork/HPLMN/VPLMN/<x>/Service/MCPTTTtoConRef

Table 8.2.31.1: /<x>/OnNetwork/HPLMN/VPLMN/<x>/Service/MCPTTTtoConRef

OnNetwork/HPLMN/VPLMN/<x>/Service/MCPTTTtoConRef

Status	Occurrence	Format	Min. Access Types
Required	One	node	Get, Replace

This interior node contains the configuration parameters for establishment of the PDN connection for the MCS service on a per VPLMN and HPLMN basis.

8.2.32

/<x>/OnNetwork/HPLMN/VPLMN/<x>/Service/MCPTTTtoConRef/<x>
>

Table 8.2.32.1: /<x>/OnNetwork/HPLMN/VPLMN/<x>/Service/MCPTTTtoConRef/<x>

OnNetwork/HPLMN/VPLMN/<x>/Service/MCPTTTtoConRef/<x>

Status	Occurrence	Format	Min. Access Types
Required	OneOrMore	node	Get, Replace

This run-time node acts as a placeholder for each reference to the connectivity parameters on a per VPLMN and HPLMN basis.

8.2.33 /<x>/OnNetwork/HPLMN/VPLMN/<x>/Service/MCPTTToConRef/<x>/ConRef

Table 8.2.33.1: /<x>/OnNetwork/HPLMN/VPLMN/<x>/Service/MCPTTToConRef/<x>/ConRef

OnNetwork/HPLMN/VPLMN/<x>/Service/MCPTTToConRef/<x>/ConRef

Status	Occurrence	Format	Min. Access Types
Required	One	chr	Get, Replace

The ConRef specifies a specific linkage to the connectivity parameters on a per VPLMN and HPLMN basis.

- Values: <A network access point object>

8.2.34 /<x>/OnNetwork/HPLMN/VPLMN/<x>/Service/MCCommonCoreToConRef

Table 8.2.34.1: /<x>/OnNetwork/HPLMN/VPLMN/<x>/Service/MCCommonCoreToConRef

OnNetwork/HPLMN/VPLMN/<x>/Service/MCCommonCoreToConRef

Status	Occurrence	Format	Min. Access Types
Required	One	node	Get, Replace

This interior node contains the configuration parameters for establishment of the PDN connection for the MC common core service on a per VPLMN and HPLMN basis.

8.2.35 /<x>/OnNetwork/HPLMN/VPLMN/<x>/Service/MCCommonCoreToConRef/<x>

Table 8.2.35.1: /<x>/OnNetwork/HPLMN/VPLMN/<x>/Service/MCCommonCoreToConRef/<x>

OnNetwork/HPLMN/VPLMN/<x>/Service/MCCommonCoreToConRef/<x>

Status	Occurrence	Format	Min. Access Types
Required	OneOrMore	node	Get, Replace

This run-time node acts as a placeholder for each reference to the connectivity parameters on a per VPLMN and HPLMN basis.

8.2.36 /<x>/OnNetwork/HPLMN/VPLMN/<x>/Service/MCCommonCoreToConRef/<x>/ConRef

Table 8.2.36.1: /<x>/OnNetwork/HPLMN/VPLMN/<x>/Service/MCCommonCoreToConRef/<x>/ConRef

OnNetwork/HPLMN/VPLMN/<x>/Service/MCCommonCoreToConRef/<x>/ConRef

Status	Occurrence	Format	Min. Access Types
Required	One	chr	Get, Replace

The ConRef specifies a specific linkage to the connectivity parameters on a per VPLMN and HPLMN basis.

- Values: <A network access point object>

8.2.37 /<x>/OnNetwork/HPLMN/VPLMN/<x>/Service/MCIDMTtoConRef

Table 8.2.37.1: /<x>/OnNetwork/HPLMN/VPLMN/<x>/Service/MCIDMTtoConRef

OnNetwork/HPLMN/VPLMN/<x>/Service/MCIDMTtoConRef

Status	Occurrence	Format	Min. Access Types
Required	One	node	Get, Replace

This interior node contains the configuration parameters for establishment of the PDN connection for the MC identity management service on a per VPLMN and HPLMN basis.

8.2.38

/<x>/OnNetwork/HPLMN/VPLMN/<x>/Service/MCIDMTtoConRef/<x>

Table 8.2.38.1: /<x>/OnNetwork/HPLMN/VPLMN/<x>/Service/MCIDMTtoConRef/<x>

OnNetwork/HPLMN/VPLMN/<x>/Service/MCIDMTtoConRef/<x>

Status	Occurrence	Format	Min. Access Types
Required	OneOrMore	node	Get, Replace

This run-time node acts as a placeholder for each reference to the connectivity parameters on a per VPLMN and HPLMN basis.

8.2.39 /<x>/OnNetwork/HPLMN/VPLMN/<x>/Service/MCIDMTtoConRef/<x>/ConRef

Table 8.2.39.1: /<x>/OnNetwork/HPLMN/VPLMN/<x>/Service/MCIDMTtoConRef/<x>/ConRef

OnNetwork/HPLMN/VPLMN/<x>/Service/MCIDMTtoConRef/<x>/ConRef

Status	Occurrence	Format	Min. Access Types
Required	One	chr	Get, Replace

The ConRef specifies a specific linkage to the connectivity parameters on a per VPLMN and HPLMN basis.

- Values: <A network access point object>

8.2.39A1/<x>/OnNetwork/HPLMN/VPLMN/<x>/Service/MCPTTRefSNSSAI

Table 8.2.39A1.1: /<x>/OnNetwork/HPLMN/VPLMN/<x>/Service/MCPTTRefSNSSAI

OnNetwork/HPLMN/VPLMN/<x>/Service/MCPTTRefSNSSAI

Status	Occurrence	Format	Min. Access Types
Optional	One	node	Get, Replace

This interior node contains the list of S-NSSAIs to be used for MCPTT service in the VPLMN.

8.2.39A2/<x>/OnNetwork/HPLMN/VPLMN/<x>/Service/MCPTTRefSNSSAI/<x>

Table 8.2.39A2.1: /<x>/OnNetwork/HPLMN/VPLMN/<x>/Service/MCPTTRefSNSSAI/<x>

OnNetwork/HPLMN/VPLMN/<x>/Service/MCPTTRefSNSSAI/<x>

Status	Occurrence	Format	Min. Access Types
Required	OneOrMore	node	Get, Replace

This run-time node acts as a placeholder for each reference to parameters for a slice (S-NSSAI) used for MCPTT service in the VPLMN.

8.2.39A3/<x>/OnNetwork/HPLMN/VPLMN/<x>/Service/MCPTTRefSNSSAI/<x>/RefSNSSAI

Table 8.2.39A3.1: /<x>/OnNetwork/HPLMN/VPLMN/<x>/Service/MCPTTRefSNSSAI/<x>/RefSNSSAI

OnNetwork/HPLMN/VPLMN/<x>/Service/MCPTTRefSNSSAI/<x>/RefSNSSAI

Status	Occurrence	Format	Min. Access Types
Required	One	chr	Get, Replace

This leaf node specifies a specific linkage to the slice (S-NSSAI) parameters used for MCPTT service in the VPLMN.

- Values: A string that identifies an S-NSSAI.

8.2.39A4/<x>/OnNetwork/HPLMN/VPLMN/<x>/Service/MCCommonCoreRefSNSSAI

Table 8.2.39A4.1: /<x>/OnNetwork/HPLMN/VPLMN/<x>/Service/MCCommonCoreRefSNSSAI

OnNetwork/HPLMN/VPLMN/<x>/Service/MCCommonCoreRefSNSSAI

Status	Occurrence	Format	Min. Access Types
Optional	One	node	Get, Replace

This interior node contains a list of S-NSSAIs to be used for MC Common Core services in the VPLMN.

8.2.39A5/<x>/OnNetwork/HPLMN/VPLMN/<x>/Service/MCCommonCoreRefSNSSAI/<x>

Table 8.2.39A5.1: /<x>/OnNetwork/HPLMN/VPLMN/<x>/Service/MCCommonCoreRefSNSSAI/<x>

OnNetwork/HPLMN/VPLMN/<x>/Service/MCCommonCoreRefSNSSAI/<x>

Status	Occurrence	Format	Min. Access Types
Optional	OneOrMore	chr	Get, Replace

This run-time node acts as a placeholder for each reference to parameters for a slice (S-NSSAI) used for MC Common Core services in the VPLMN.

8.2.39A6/<x>/OnNetwork/HPLMN/VPLMN/<x>/Service/MCCommonCoreRefSNSSAI/<x>/RefSNSSAI

Table 8.2.39A6.1:

/<x>/OnNetwork/HPLMN/VPLMN/<x>/Service/MCCommonCoreRefSNSSAI/<x>/RefSNSSAI

OnNetwork/HPLMN/VPLMN/<x>/Service/MCCommonCoreRefSNSSAI/<x>/RefSNSSAI

Status	Occurrence	Format	Min. Access Types
Optional	One	chr	Get, Replace

This leaf node specifies a specific linkage to the slice (S-NSSAI) parameters used for MC Common Core services in the VPLMN.

- Values: A string that identifies an S-NSSAI.

8.2.39A7/<x>/OnNetwork/HPLMN/VPLMN/<x>/Service/MCIdMRefSNSSAI

Table 8.2.39A7.1: /<x>/OnNetwork/HPLMN/VPLMN/<x>/Service/MCIdMRefSNSSAI

OnNetwork/HPLMN/VPLMN/<x>/Service/MCIdMRefSNSSAI

Status	Occurrence	Format	Min. Access Types
Optional	One	node	Get, Replace

This interior node contains a list of S-NSSAIs to be used for MC Identity Management services in the VPLMN.

8.2.39A8/<x>/OnNetwork/HPLMN/VPLMN/<x>/Service/MCIdMRefSNSSAI/<x>

Table 8.2.39A8.1: /<x>/OnNetwork/HPLMN/VPLMN/<x>/Service/MCIdMRefSNSSAI/<x>

OnNetwork/HPLMN/VPLMN/<x>/Service/MCIdMRefSNSSAI/<x>

Status	Occurrence	Format	Min. Access Types
Optional	OneOrMore	node	Get, Replace

This run-time node acts as a placeholder for each reference to parameters for a slice (S-NSSAI) used for MC Identity Management services in the VPLMN.

8.2.39A9/<x>/OnNetwork/HPLMN/VPLMN/<x>/Service/MCIdMRefSNSSAI/<x>/RefSNSSAI

Table 8.2.39A9.1: /<x>/OnNetwork/HPLMN/VPLMN/<x>/Service/MCIdMRefSNSSAI/<x>/RefSNSSAI

OnNetwork/HPLMN/VPLMN/<x>/Service/MCIdMRefSNSSAI/<x>/RefSNSSAI

Status	Occurrence	Format	Min. Access Types
Optional	One	chr	Get, Replace

This leaf node specifies a specific linkage to the slice (S-NSSAI) parameters used for MC Identity Management services in the HPLMN.

- Values: A string that identifies an S-NSSAI.

8.2.39A10 /<x>/OnNetwork/HPLMN/VPLMN/<x>/Service/ MCDataRefSNSSAI

Table 8.2.39A10.1: /<x>/OnNetwork/HPLMN/VPLMN/<x>/Service/MCDataRefSNSSAI

OnNetwork/HPLMN/VPLMN/<x>/Service/MCDataRefSNSSAI

Status	Occurrence	Format	Min. Access Types
Optional	One	node	Get, Replace

This interior node contains a list of S-NSSAIs to be used for MCData service in the VPLMN.

8.2.39A11 /<x>/OnNetwork/HPLMN/VPLMN/<x>/Service/ MCDataRefSNSSAI/<x>

Table 8.2.39A11.1: /<x>/OnNetwork/HPLMN/VPLMN/<x>/Service/MCDataRefSNSSAI/<x>

OnNetwork/HPLMN/VPLMN/<x>/Service/MCDataRefSNSSAI/<x>

Status	Occurrence	Format	Min. Access Types
Required	OneOrMore	node	Get, Replace

This run-time node acts as a placeholder for each reference to parameters for a slice (S-NSSAI) used for MCData services in the VPLMN.

8.2.39A12 /<x>/OnNetwork/HPLMN/VPLMN/<x>/Service/ MCDataRefSNSSAI/<x>/RefSNSSAI

Table 8.2.39A12.1: /<x>/OnNetwork/HPLMN/VPLMN/<x>/Service/MCDataRefSNSSAI/<x>/RefSNSSAI

OnNetwork/HPLMN/VPLMN/<x>/Service/MCDataRefSNSSAI/<x>/RefSNSSAI

Status	Occurrence	Format	Min. Access Types
Required	One	chr	Get, Replace

The RefSNSSAI specifies a specific linkage to the slice (S-NSSAI) parameters used for MCData service in the VPLMN.

- Values: A string that identifies an S-NSSAI.

8.2.39A13 /<x>/OnNetwork/HPLMN/VPLMN/<x>/Service/ MCVideoRefSNSSAI

Table 8.2.39A13.1: /<x>/OnNetwork/HPLMN/VPLMN/<x>/Service/MCVideoRefSNSSAI

OnNetwork/HPLMN/VPLMN/<x>/Service/MCVideoRefSNSSAI

Status	Occurrence	Format	Min. Access Types
Optional	One	node	Get, Replace

This interior node contains a list of S-NSSAIs to be used for MCVideo service in the VPLMN.

8.2.39A14 /<x>/OnNetwork/HPLMN/VPLMN/<x>/Service/MCVideoRefSNSSAI/<x>

Table 8.2.39A14.1: /<x>/OnNetwork/HPLMN/VPLMN/<x>/Service/MCVideoRefSNSSAI/<x>

OnNetwork/HPLMN/VPLMN/<x>/Service/MCVideoRefSNSSAI/<x>

Status	Occurrence	Format	Min. Access Types
Optional	OneOrMore	node	Get, Replace

This run-time node acts as a placeholder for each reference to parameters for a slice (S-NSSAI) used for MCVideo service in the VPLMN.

8.2.39A15 /<x>/OnNetwork/HPLMN/VPLMN/<x>/Service/MCVideoRefSNSSAI/<x>/RefSNSSAI

Table 8.2.39A15.1: /<x>/OnNetwork/HPLMN/VPLMN/<x>/Service/MCVideoRefSNSSAI/<x>/RefSNSSAI

OnNetwork/HPLMN/VPLMN/<x>/Service/MCVideoRefSNSSAI/<x>/RefSNSSAI

Status	Occurrence	Format	Min. Access Types
Required	One	chr	Get, Replace

The RefSNSSAI specifies a specific linkage to the slice (S-NSSAI) parameters used for MCVideo service in the VPLMN.

- Values: A string that identifies an S-NSSAI.

8.2.40 /<x>/OnNetwork/AppServerInfo

Table 8.2.40.1: /<x>/OnNetwork/AppServerInfo

OnNetwork/AppServerInfo

Status	Occurrence	Format	Min. Access Types
Required	One	node	Get, Replace

This interior node is a placeholder for the application plane server identity information configuration.

8.2.41 /<x>/OnNetwork/AppServerInfo/IDMSAuthEndpoint

Table 8.2.41.1: /<x>/OnNetwork/AppServerInfo/IDMSAuthEndpoint

OnNetwork/AppServerInfo/IDMSAuthEndpoint

Status	Occurrence	Format	Min. Access Types
Required	One	chr	Get, Replace

This leaf node indicates the identity management server authorisation endpoint identity information.

The value is a URI as specified in 3GPP TS 23.003 [5].

8.2.41A /<x>/OnNetwork/AppServerInfo/IDMSTokenEndpoint

Table 8.2.41A.1: /<x>/OnNetwork/AppServerInfo/IDMSTokenEndpoint

OnNetwork/AppServerInfo/IDMSTokenEndpoint

Status	Occurrence	Format	Min. Access Types
Required	One	chr	Get, Replace

This leaf node indicates the identity management server token endpoint identity information.

The value is a URI as specified in 3GPP TS 23.003 [5].

8.2.41B /<x>/OnNetwork/AppServerInfo/HTTPProxy

Table 8.2.41B.1: /<x>/OnNetwork/AppServerInfo/HTTPProxy

OnNetwork/AppServerInfo/HTTPProxy

Status	Occurrence	Format	Min. Access Types
Required	One	chr	Get, Replace

This leaf node indicates the HTTP Proxy identity information.

The value is a URI as specified in 3GPP TS 23.003 [5].

8.2.42 /<x>/OnNetwork/AppServerInfo/GMS

Table 8.2.42.1: /<x>/OnNetwork/AppServerInfo/GMS

OnNetwork/AppServerInfo/GMS

Status	Occurrence	Format	Min. Access Types
Required	One	chr	Get, Replace

This leaf node indicates the group management server identity information.

The value is a URI as specified in 3GPP TS 23.003 [5].

8.2.43 /<x>/OnNetwork/AppServerInfo/CMS

Table 8.2.43.1: /<x>/OnNetwork/AppServerInfo/CMS

OnNetwork/AppServerInfo/CMS

Status	Occurrence	Format	Min. Access Types
Required	One	chr	Get, Replace

This leaf node indicates the configuration management server identity information.

The value is a URI as specified in 3GPP TS 23.003 [5].

8.2.44 /<x>/OnNetwork/AppServerInfo/KMS

Table 8.2.44.1: /<x>/OnNetwork/AppServerInfo/KMS

OnNetwork/AppServerInfo/KMS

Status	Occurrence	Format	Min. Access Types

Required	One	chr	Get, Replace
----------	-----	-----	--------------

This leaf node indicates key management server identity information.

The value is a URI as specified in 3GPP TS 23.003 [5].

8.2.44A /<x>/OnNetwork/AppServerInfo/TLSTunnelAuthMethod

Table 8.2.44A.1: /<x>/OnNetwork/AppServerInfo/TLSTunnelAuthMethod

OnNetwork/AppServerInfo/TLSTunnelAuthMethod

Status	Occurrence	Format	Min. Access Types
Required	One	node	Get, Replace

This interior node is a placeholder for the TLS tunnel authentication method configuration.

8.2.44B /<x>/OnNetwork/AppServerInfo/TLSTunnelAuthMethod/Mutual

Table 8.2.44B.1: /<x>/OnNetwork/AppServerInfo/TLSTunnelAuthMethod/Mutual

OnNetwork/AppServerInfo/TLSTunnelAuthMethod/Mutual

Status	Occurrence	Format	Min. Access Types
Required	One	bool	Get, Replace

This leaf node indicates whether mutual authentication is used for the TLS tunnel authentication.

When set to "true" mutual authentication is used.

When set to "false" one-way authentication based on the server certificate is used.

The default value is "false".

8.2.44C /<x>/OnNetwork/AppServerInfo/TLSTunnelAuthMethod/X509

Table 8.2.44C.1: /<x>/OnNetwork/AppServerInfo/TLSTunnelAuthMethod/X509

OnNetwork/AppServerInfo/TLSTunnelAuthMethod/X509

Status	Occurrence	Format	Min. Access Types
Optional	One	chr	Get, Replace

This leaf node contains the X.509 certificate for mutual authentication for the TLS tunnel authentication.

8.2.44D /<x>/OnNetwork/AppServerInfo/TLSTunnelAuthMethod/Key

Table 8.2.44D.1: /<x>/OnNetwork/AppServerInfo/TLSTunnelAuthMethod/Key

OnNetwork/AppServerInfo/TLSTunnelAuthMethod/Key

Status	Occurrence	Format	Min. Access Types
Optional	One	chr	Get, Replace

This leaf node contains the pre-shared key for mutual authentication for the TLS tunnel authentication.

8.2.44E /<x>/OnNetwork/IntegrityProtection

Table 8.2.44E.1: /<x>/OnNetwork/IntegrityProtection

OnNetwork/IntegrityProtection

Status	Occurrence	Format	Min. Access Types
Required	One	bool	Get, Replace

This leaf node indicates whether integrity protection is enabled.

When set to "true" integrity protection is enabled.

When set to "false" integrity protection is disabled.

The default value is "true".

8.2.44F /<x>/OnNetwork/ConfidentialityProtection

Table 8.2.44F.1: /<x>/OnNetwork/ConfidentialityProtection

OnNetwork/ConfidentialityProtection

Status	Occurrence	Format	Min. Access Types
Required	One	bool	Get, Replace

This leaf node indicates whether integrity protection is enabled.

When set to "true" confidentiality protection is enabled.

When set to "false" confidentiality protection is disabled.

The default value is "true".

8.2.44G1 /<x>/OnNetwork/MCPTTServiceDetails

Table 8.2.44G1.1: /<x>/OnNetwork/MCPTTServiceDetails

OnNetwork/MCPTTServiceDetails

Status	Occurrence	Format	Min. Access Types
Required	One	node	Get, Replace

This interior node is a placeholder for the details of the MCPTT service.

8.2.44G2 /<x>/OnNetwork/MCPTTServiceDetails/IPv6Required

Table 8.2.44G2.1: /<x>/OnNetwork/MCPTTServiceDetails/IPv6Required

OnNetwork/MCPTTServiceDetails/IPv6Required

Status	Occurrence	Format	Min. Access Types
Required	One	bool	Get, Replace

This leaf node indicates whether IP version 6 is required to use to access the MCPTT service.

When set to "true", IPv6 shall be used to access the service.

When set to "false", IPv4 shall be used to access the service.

8.2.44G3 /<x>/OnNetwork/MCPTTServiceDetails/ServerURI

Table 8.2.44G3.1: /<x>/OnNetwork/MCPTTServiceDetails/ServerURI

OnNetwork/MCPTTServiceDetails/ServerURI

Status	Occurrence	Format	Min. Access Types
Required	One	chr	Get, Replace

This leaf node indicates the URI to use to access the MCPTT service.

The value is a URI as specified in 3GPP TS 23.003 [5].

8.2.44G3A /<x>/OnNetwork/MCPTTServiceDetails/PDUSessionType

Table 8.2.44G3A.1: /<x>/OnNetwork/MCPTTServiceDetails/PDUSessionType

OnNetwork/MCPTTServiceDetails/PDUSessionType

Status	Occurrence	Format	Min. Access Types
Optional	One	chr	Get, Replace

This leaf node indicates the type of PDU session to be established and used for the MCPTT service.

- Values: one of {"IPv4", "IPv6", "IPv4v6", "Ethernet", or "Unstructured"}.

8.2.44G3A1 Void

8.2.44G3A2 Void

8.2.44G3A3 Void

8.2.44G3A4 Void

8.2.44G3A5 Void

8.2.44G3A6 Void

8.2.44G3A7 Void

8.2.44G3A8 Void

8.2.44G4 /<x>/OnNetwork/MCVideoServiceDetails

Table 8.2.44G4.1: /<x>/OnNetwork/MCVideoServiceDetails

OnNetwork/MCVideoServiceDetails

Status	Occurrence	Format	Min. Access Types
Required	One	node	Get, Replace

This interior node is a placeholder for the details of the MCVideo service.

8.2.44G5 /<x>/OnNetwork/MCVideoServiceDetails/IPv6Required

Table 8.2.44G5.1: /<x>/OnNetwork/MCVideoServiceDetails/IPv6Required

OnNetwork/MCVideoServiceDetails/IPv6Required

Status	Occurrence	Format	Min. Access Types
Required	One	bool	Get, Replace

This leaf node indicates the IP version to use to access the MCVideo service.

When set to "true", IPv6 shall be used to access the service.

When set to "false", IPv4 shall be used to access the service.

8.2.44G6 /<x>/OnNetwork/MCVideoServiceDetails/ServerURI

Table 8.2.44G6.1: /<x>/OnNetwork/MCVideoServiceDetails/ServerURI

OnNetwork/MCVideoServiceDetails/ServerURI

Status	Occurrence	Format	Min. Access Types
Required	One	chr	Get, Replace

This leaf node indicates the URI to use to access the MCVideo service.

The value is a URI as specified in 3GPP TS 23.003 [5].

8.2.44G6A /<x>/OnNetwork/MCVideoServiceDetails/PDUSessionType

Table 8.2.44G6A.1: /<x>/OnNetwork/MCVideoServiceDetails/PDUSessionType

OnNetwork/MCVideoServiceDetails/PDUSessionType

Status	Occurrence	Format	Min. Access Types
Optional	One	chr	Get, Replace

This leaf node indicates the type of PDU session to be established and used for the MCVideo service.

- Values: one of {"IPv4", "IPv6", "IPv4v6", "Ethernet", or "Unstructured"}.

8.2.44G6A1 Void

8.2.44G6A2 Void

8.2.44G6A3 Void

8.2.44G6A4 Void

8.2.44G6A5 Void

8.2.44G6A6 Void

8.2.44G6A7 Void

8.2.44G6A8 Void

8.2.44G7 /<x>/OnNetwork/MCDataServiceDetails

Table 8.2.44G7.1: /<x>/OnNetwork/MCDataServiceDetails

OnNetwork/MCDataServiceDetails

Status	Occurrence	Format	Min. Access Types
Required	One	node	Get, Replace

This interior node is a placeholder for the details of the MCData service.

8.2.44G8 /<x>/OnNetwork/MCDataServiceDetails/IPv6Required

Table 8.2.44G8.1: /<x>/OnNetwork/MCDataServiceDetails/IPv6Required

OnNetwork/MCDataServiceDetails/IPv6Required

Status	Occurrence	Format	Min. Access Types
Required	One	bool	Get, Replace

This leaf node indicates the IP version to use to access the MCData service.

When set to "true", IPv6 shall be used to access the service.

When set to "false", IPv4 shall be used to access the service.

8.2.44G9 /<x>/OnNetwork/MCDataServiceDetails/ServerURI

Table 8.2.44G9.1: /<x>/OnNetwork/MCDataServiceDetails/ServerURI

OnNetwork/MCDataServiceDetails/ServerURI

Status	Occurrence	Format	Min. Access Types
Required	One	chr	Get, Replace

This leaf node indicates the URI to use to access the MCData service.

The value is a URI as specified in 3GPP TS 23.003 [5].

8.2.44G9A /<x>/OnNetwork/MCDataServiceDetails/PDUSessionType

Table 8.2.44G9A.1: /<x>/OnNetwork/MCDataServiceDetails/PDUSessionType

OnNetwork/MCDataServiceDetails/PDUSessionType

Status	Occurrence	Format	Min. Access Types
Optional	One	chr	Get, Replace

This leaf node indicates the type of PDU session to be established and used for the MCData service.

- Values: one of {"IPv4", "IPv6", "IPv4v6", "Ethernet", or "Unstructured"}.

8.2.44G9A1 Void

8.2.44G9A2 Void

8.2.44G9A3 Void

8.2.44G9A4 Void

8.2.44G9A5 Void

8.2.44G9A6 Void

8.2.44G9A7 Void

8.2.44G9A8 Void

8.2.44G10 Void

8.2.44G11 Void

8.2.44G12 Void

8.2.44G13 Void

8.2.44G14 Void

8.2.44G15 Void

8.2.44G16 Void

8.2.44G17 Void

8.2.44G18 Void

8.2.44G19 Void

8.2.44G20 Void

8.2.44G21 Void

8.2.44G22 Void

8.2.44G23 Void

8.2.44G24 Void

8.2.44G25 Void

8.2.44G26 /<x>/OnNetwork/MCCommonCoreServiceDetails

Table 8.2.44G26.1: /<x>/OnNetwork/MCCommonCoreServiceDetails

OnNetwork/MCCommonCoreServiceDetails

Status	Occurrence	Format	Min. Access Types
Required	One	node	Get, Replace

This interior node is a placeholder for the details of the MC Common Core service.

8.2.44G27 /<x>/OnNetwork/MCCommonCoreServiceDetails/IPv6Required

Table 8.2.44G27.1: /<x>/OnNetwork/MCCommonCoreServiceDetails/IPv6Required

OnNetwork/MCCommonCoreServiceDetails/IPv6Required

Status	Occurrence	Format	Min. Access Types
Required	One	bool	Get, Replace

This leaf node indicates the IP version to use to access the MC Common Core services.

When set to "true", IPv6 shall be used to access the service.

When set to "false", IPv4 shall be used to access the service.

8.2.44G28 /<x>/OnNetwork/MCCommonCoreServiceDetails/ServerURI

Table 8.2.44G28.1: /<x>/OnNetwork/MCCommonCoreServiceDetails/ServerURI

OnNetwork/MCCommonCoreServiceDetails/ServerURI

Status	Occurrence	Format	Min. Access Types
Required	One	chr	Get, Replace

This leaf node indicates the URI to use to access the MC Common Core services.

The value is a URI as specified in 3GPP TS 23.003 [5].

8.2.44G29 /<x>/OnNetwork/MCCommonCoreServiceDetails/
PDUSessionType**Table 8.2.44G29.1: /<x>/OnNetwork/MCCommonCoreServiceDetails/PDUSessionType**

OnNetwork/MCCommonCoreServiceDetails/PDUSessionType

Status	Occurrence	Format	Min. Access Types
Optional	One	chr	Get, Replace

This leaf node indicates the type of PDU session to be established and used for the MC Common Core services.

- Values: one of {"IPv4", "IPv6", "IPv4v6", "Ethernet", or "Unstructured"}.

8.2.44G30 /<x>/OnNetwork/MCIdMServiceDetails

Table 8.2.44G30.1: /<x>/OnNetwork/MCIdMServiceDetails

OnNetwork/MCIdMServiceDetails

Status	Occurrence	Format	Min. Access Types
Required	One	node	Get, Replace

This interior node is a placeholder for the details of the MC Identity Management service.

8.2.44G31 /<x>/OnNetwork/MCIdMServiceDetails/IPv6Required

Table 8.2.44G31.1: /<x>/OnNetwork/MCIdMServiceDetails/IPv6Required

OnNetwork/MCIdMServiceDetails/IPv6Required

Status	Occurrence	Format	Min. Access Types
Required	One	bool	Get, Replace

This leaf node indicates the IP version to use to access the MC Identity Management services.

When set to "true", IPv6 shall be used to access the service.

When set to "false", IPv4 shall be used to access the service.

8.2.44G32 /<x>/OnNetwork/MCIdMServiceDetails/ServerURI

Table 8.2.44G32.1: /<x>/OnNetwork/MCIdMServiceDetails/ServerURI

OnNetwork/MCIdMServiceDetails/ServerURI

Status	Occurrence	Format	Min. Access Types
Required	One	chr	Get, Replace

This leaf node indicates the URI to use to access the MC Identity Management services.

The value is a URI as specified in 3GPP TS 23.003 [5].

8.2.44G33 /<x>/OnNetwork/MCIdMServiceDetails/PDUSessionType

Table 8.2.44G33.1: /<x>/OnNetwork/MCIdMServiceDetails/PDUSessionType

OnNetwork/MCIdMServiceDetails/PDUSessionType

Status	Occurrence	Format	Min. Access Types
Optional	One	chr	Get, Replace

This leaf node indicates the type of PDU session to be established and used for the MC Identity Management services.

- Values: one of {"IPv4", "IPv6", "IPv4v6", "Ethernet", or "Unstructured"}.

8.2.44H /<x>/OnNetwork/DNInfo

Table 8.2.44H.1: /<x>/OnNetwork/DNInfo

OnNetwork/DNInfo

Status	Occurrence	Format	Min. Access Types
Required	One	node	Get, Replace

This interior node is a placeholder for a list of Data Networks.

8.2.44H1 /<x>/OnNetwork/DNInfo/<x>

Table 8.2.44H1.1: /<x>/OnNetwork/DNInfo/<x>

OnNetwork/DNInfo/<x>

Status	Occurrence	Format	Min. Access Types
Required	OneOrMore	node	Get, Replace

This run-time node is a placeholder for parameters for a Data Network.

8.2.44H2 /<x>/OnNetwork/DNInfo/<x>/DNN

Table 8.2.44H2.1: /<x>/OnNetwork/DNInfo/<x>/DNN

OnNetwork/DNInfo/<x>/DNN

Status	Occurrence	Format	Min. Access Types
Required	One	chr	Get, Replace

This leaf node contains the DNN of a Data Network.

- Value: The DNN is a string that identifies a Data Network or an APN. The ConRef leaf node value provides mapping into the DNN/APN that is to be used.

8.2.44H3 /<x>/OnNetwork/DNInfo/<x>/DNAAAServer

Table 8.2.44H3.1: /<x>/OnNetwork/DNInfo/<x>/DNAAAServer

OnNetwork/DNInfo/<x>/DNAAAServer

Status	Occurrence	Format	Min. Access Types
Optional	One	chr	Get, Replace

This leaf node contains the DNN of a Data Network.

Value: a valid URI pointing to the DN AAA server.

8.2.44H4 /<x>/OnNetwork/DNInfo/<x>/PapParameters

Table 8.2.44H4.1: /<x>/OnNetwork/DNInfo/<x>/PapParameters

OnNetwork/DNInfo/<x>/PapParameters

Status	Occurrence	Format	Min. Access Types
Optional	ZeroOrOne	node	Get, Replace

This interior node is a placeholder for PAP access credentials to access the Data Network.

8.2.44H5 /<x>/OnNetwork/DNInfo/<x>/PapParameters/UserName

Table 8.2.44H5.1: /<x>/OnNetwork/DNInfo/<x>/PapParameters/UserName

OnNetwork/DNInfo/<x>/PapParameters/UserName

Status	Occurrence	Format	Min. Access Types
Required	One	chr	Get, Replace

This leaf node indicates the PAP user name if needed to access the Data Network.

8.2.44H6 /<x>/OnNetwork/DNInfo/<x>/PapParameters/PassWord

Table 8.2.44H6.1: /<x>/OnNetwork/DNInfo/<x>/PapParameters/PassWord

OnNetwork/DNInfo/<x>/PapParameters/PassWord

Status	Occurrence	Format	Min. Access Types
Required	One	chr	Get, Replace

This leaf node indicates the PAP password if needed to access the Data Network.

8.2.44H7 /<x>/OnNetwork/DNInfo/<x>/ChapParameters

Table 8.2.44H7.1: /<x>/OnNetwork/DNInfo/<x>/ChapParameters

OnNetwork/DNInfo/<x>/ChapParameters

Status	Occurrence	Format	Min. Access Types
Optional	ZeroOrOne	node	Get, Replace

This interior node is a placeholder for CHAP access credentials to access the Data Network.

8.2.44H8 /<x>/OnNetwork/DNInfo/<x>/ChapParameters/UserName

Table 8.2.44H8.1: /<x>/OnNetwork/DNInfo/<x>/ChapParameters/UserName

OnNetwork/DNInfo/<x>/ChapParameters/UserName

Status	Occurrence	Format	Min. Access Types
Required	One	chr	Get, Replace

This leaf node indicates the CHAP user name if needed to access the Data Network.

8.2.44H9 /<x>/OnNetwork/DNInfo/<x>/ChapParameters/PassWord

Table 8.2.44H9.1: /<x>/OnNetwork/DNInfo/<x>/ChapParameters/PassWord

OnNetwork/DNInfo/<x>/ChapParameters/PassWord

Status	Occurrence	Format	Min. Access Types
Required	One	chr	Get, Replace

This leaf node indicates the CHAP password if needed to access the Data Network.

8.2.44H10 /<x>/OnNetwork/DNInfo/<x>/Credentials

Table 8.2.44H10.1: /<x>/OnNetwork/DNInfo/<x>/Credentials

OnNetwork/DNInfo/<x>/Credentials

Status	Occurrence	Format	Min. Access Types
Optional	ZeroOrOne	node	Get, Replace

This internal node is a placeholder for the credentials needed for authentication of the UE during authentication by the Data Network.

8.2.44H11 /<x>/OnNetwork/DNInfo/<x>/Credentials/ID

Table 8.2.44H11.1: /<x>/OnNetwork/DNInfo/<x>/Credentials/ID

OnNetwork/DNInfo/<x>/Credentials/ID

Status	Occurrence	Format	Min. Access Types
Required	One	chr	Get, Replace

This leaf node indicates the EAP Identity as specified in IETF RFC 3748 [24] to be used for authentication of the UE during authentication by the Data Network.

8.2.44H12 /<x>/OnNetwork/SNSSAInfo

Table 8.2.44H12.1: /<x>/OnNetwork/SNSSAInfo

OnNetwork/SNSSAInfo

Status	Occurrence	Format	Min. Access Types
Optional	One	node	Get, Replace

This interior node is a placeholder for the NSSAI containing the S-NSSAIs for mission critical services.

8.2.44H13 /<x>/OnNetwork/SNSSAInfo/<x>

Table 8.2.44H13.1: /<x>/OnNetwork/SNSSAInfo/<x>

OnNetwork/SNSSAInfo/<x>

Status	Occurrence	Format	Min. Access Types
Optional	One	node	Get, Replace

This run-time node is a placeholder for the list of S-NSSAIs.

8.2.44H14 /<x>/OnNetwork/SNSSAInfo/<x>/NSSAAServer

Table 8.2.44H14.1: /<x>/OnNetwork/SNSSAInfo/<x>/NSSAAServer

OnNetwork/SNSSAInfo/<x>/NSSAAServer

Status	Occurrence	Format	Min. Access Types
Optional	One	chr	Get, Replace

This leaf node contains the URI of a NSSAA server.

- Value: a valid URI as specified in 3GPP TS 23.003 [5] pointing to the NSSAA server.

8.2.44H15 /<x>/OnNetwork/SNSSAInfo/<x>/SNSSAI

Table 8.2.44H15.1: /<x>/OnNetwork/SNSSAInfo/<x>/SNSSAI

OnNetwork/SNSSAInfo/<x>/SNSSAI

Status	Occurrence	Format	Min. Access Types
Required	One	chr	Get, Replace

This leaf node indicates an S-NSSAI used to access mission critical services.

- Value: a string consisting of the SST and SD of the S-NSSAI in the format: characters to represent the SST value, followed by the colon character ":", followed by characters to represent the SD value, if an SD value exists for the S-NSSAI.

8.2.44H16 /<x>/OnNetwork/SNSSAInfo/<x>/SNSSAI/Credentials

Table 8.2.44H16.1: /<x>/OnNetwork/SNSSAInfo/<x>/SNSSAI/Credentials

OnNetwork/SNSSAInfo/<x>/SNSSAI/Credentials

Status	Occurrence	Format	Min. Access Types
Optional	ZeroOrOne	node	Get, Replace

This internal node is a placeholder for the credentials needed for authentication of the UE at NSSAA during registration of this S-NSSAI by the UE.

8.2.44H17 /<x>/OnNetwork/SNSSAInfo/<x>/SNSSAI/Credentials/ID

Table 8.2.44H17.1: /<x>/OnNetwork/SNSSAInfo/<x>/SNSSAI/Credentials/ID

OnNetwork/SNSSAInfo/<x>/SNSSAI/Credentials/ID

Status	Occurrence	Format	Min. Access Types
Required	One	chr	Get, Replace

This leaf node indicates the EAP Identity as specified in IETF RFC 3748 [24] to be used for NSSAA for this S-NSSAI at network registration.

8.2.45 /<x>/OffNetwork

Table 8.2.45.1: /<x>/OffNetwork

OffNetwork

Status	Occurrence	Format	Min. Access Types
Required	ZeroOrOne	node	Get, Replace

This interior node represents a container for the off-network operation.

8.2.46 /<x>/OffNetwork/Timers

Table 8.2.46.1: /<x>/OffNetwork/Timers

OffNetwork/Timers

Status	Occurrence	Format	Min. Access Types
Required	One	node	Get, Replace

This interior node is a placeholder for the timer configuration.

8.2.47 /<x>/OffNetwork/Timers/TFG1

Table 8.2.47.1: /<x>/OffNetwork/Timers/TFG1

OffNetwork/Timers/TFG1

Status	Occurrence	Format	Min. Access Types
Required	One	int	Get, Replace

This leaf node indicates the MCPTT timer for wait for call announcement as specified in 3GPP TS 24.379 [7].

- Values: 0-65535

The timer TFG1 is in milliseconds.

8.2.48 /<x>/OffNetwork/Timers/TFG2

Table 8.2.48.1: /<x>/OffNetwork/Timers/TFG2

OffNetwork/Timers/TFG2

Status	Occurrence	Format	Min. Access Types
Required	One	int	Get, Replace

This leaf node indicates the MCPTT timer for call announcement as specified in 3GPP TS 24.379 [7].

- Values: 0-65535

The timer TFG2 is in milliseconds.

8.2.49 /<x>/OffNetwork/Timers/TFG3

Table 8.2.49.1: /<x>/OffNetwork/Timers/TFG3

OffNetwork/Timers/TFG3

Status	Occurrence	Format	Min. Access Types
Required	One	int	Get, Replace

This leaf node indicates the MCPTT timer for call probe retransmission as specified in 3GPP TS 24.379 [7].

- Values: 0-65535

The timer TFG3 is in milliseconds.

8.2.50 /<x>/OffNetwork/Timers/TFG4

Table 8.2.50.1: /<x>/OffNetwork/Timers/TFG4

OffNetwork/Timers/TFG4

Status	Occurrence	Format	Min. Access Types

Required	One	int	Get, Replace
----------	-----	-----	--------------

This leaf node indicates the MCPTT timer for waiting for the MCPTT user as specified in 3GPP TS 24.379 [7].

- Values: 0-60

The timer TFG4 is in seconds.

8.2.51 /<x>/OffNetwork/Timers/TFG5

Table 8.2.51.1: /<x>/OffNetwork/Timers/TFG5

OffNetwork/Timers/TFG5

Status	Occurrence	Format	Min. Access Types
Required	One	int	Get, Replace

This leaf node indicates the MCPTT timer for not present incoming call announcements as specified in 3GPP TS 24.379 [7].

- Values: 0-255

The timer TFG5 is in seconds.

8.2.52 /<x>/OffNetwork/Timers/TFG11

Table 8.2.52.1: /<x>/OffNetwork/Timers/TFG11

OffNetwork/Timers/TFG11

Status	Occurrence	Format	Min. Access Types
Required	One	int	Get, Replace

This leaf node indicates the timer for MCPTT emergency end retransmission as specified in 3GPP TS 24.379 [7].

- Values: 0-65535

The timer TFG11 is in milliseconds.

8.2.53 /<x>/OffNetwork/Timers/TFG12

Table 8.2.53.1: /<x>/OffNetwork/Timers/TFG12

OffNetwork/Timers/TFG12

Status	Occurrence	Format	Min. Access Types
Required	One	int	Get, Replace

This leaf node indicates the timer for MCPTT imminent peril end retransmission as specified in 3GPP TS 24.379 [7].

- Values: 0-65535

The timer TFG12 is in milliseconds.

8.2.54 /<x>/OffNetwork/Timers/TFG13

Table 8.2.54.1: /<x>/OffNetwork/Timers/TFG13

OffNetwork/Timers/TFG13

Status	Occurrence	Format	Min. Access Types
Required	One	int	Get, Replace

This leaf node indicates the MCPTT timer for implicit priority downgrade as specified in 3GPP TS 24.379 [7].

- Values: 0-255

The timer TFG13 is in seconds.

8.2.54A /<x>/OffNetwork/Timers/TFG14

Table 8.2.54A.1: /<x>/OffNetwork/Timers/TFG14

OffNetwork/Timers/TFG14

Status	Occurrence	Format	Min. Access Types
Required	One	int	Get, Replace

This leaf node indicates the MCPTT timer for implicit priority downgrade (imminent peril) as specified in 3GPP TS 24.379 [7].

- Values: 0-255

The timer TFG14 is in seconds.

8.2.55 /<x>/OffNetwork/Timers/TFP1

Table 8.2.55.1: /<x>/OffNetwork/Timers/TFP1

OffNetwork/Timers/TFP1

Status	Occurrence	Format	Min. Access Types
Required	One	int	Get, Replace

This leaf node indicates the MCPTT timer for private call request retransmission as specified in 3GPP TS 24.379 [7].

- Values: 0-65535

The timer TFP1 is in milliseconds.

8.2.56 /<x>/OffNetwork/Timers/TFP2

Table 8.2.56.1: /<x>/OffNetwork/Timers/TFP2

OffNetwork/Timers/TFP2

Status	Occurrence	Format	Min. Access Types
Required	One	int	Get, Replace

This leaf node indicates the MCPTT timer for waiting for the MCPTT user to respond to the setup request message when manual commencement mode is used as specified in 3GPP TS 24.379 [7].

- Values: 0-60

The timer TFP2 is in seconds.

8.2.57 /<x>/OffNetwork/Timers/TFP3

Table 8.2.57.1: /<x>/OffNetwork/Timers/TFP3

OffNetwork/Timers/TFP3

Status	Occurrence	Format	Min. Access Types
Required	One	int	Get, Replace

This leaf node indicates the MCPTT timer for private call release retransmission as specified in 3GPP TS 24.379 [7].

- Values: 0-65535

The timer TFP3 is in milliseconds.

8.2.58 /<x>/OffNetwork/Timers/TFP4

Table 8.2.58.1: /<x>/OffNetwork/Timers/TFP4

OffNetwork/Timers/TFP4

Status	Occurrence	Format	Min. Access Types
Required	One	int	Get, Replace

This leaf node indicates the MCPTT timer for private call accept retransmission as specified in 3GPP TS 24.379 [7].

- Values: 0-65535

The timer TFP4 is in milliseconds.

8.2.59 /<x>/OffNetwork/Timers/TFP5

Table 8.2.59.1: /<x>/OffNetwork/Timers/TFP5

OffNetwork/Timers/TFP5

Status	Occurrence	Format	Min. Access Types
Required	One	int	Get, Replace

This leaf node indicates the MCPTT timer for call release as specified in 3GPP TS 24.379 [7].

- Values: 0-600

The timer TFP5 is in seconds.

8.2.60 /<x>/OffNetwork/Timers/TFP6

Table 8.2.60.1: /<x>/OffNetwork/Timers/TFP6

OffNetwork/Timers/TFP6

Status	Occurrence	Format	Min. Access Types
Required	One	int	Get, Replace

This leaf node indicates the MCPTT timer for MCPTT emergency private call cancel retransmission as specified in 3GPP TS 24.379 [7].

- Values: 0-65535

The timer TFP6 is in milliseconds.

8.2.61 /<x>/OffNetwork/Timers/TFP7

Table 8.2.61.1: /<x>/OffNetwork/Timers/TFP7

OffNetwork/Timers/TFP7

Status	Occurrence	Format	Min. Access Types
Required	One	int	Get, Replace

This leaf node indicates the MCPTT timer for waiting for any message with same call identifier as specified in 3GPP TS 24.379 [7].

- Values: 0-255

The timer TFP7 is in seconds.

8.2.61A /<x>/OffNetwork/Timers/TFP9

Table 8.2.61A: /<x>/OffNetwork/Timers/TFP9

OffNetwork/Timers/TFP9

Status	Occurrence	Format	Min. Access Types
Required	One	int	Get, Replace

This leaf node indicates the MCPTT timer for waiting for call response message as specified in 3GPP TS 24.379 [7].

- Values: 0-60

The timer TFP9 is in seconds.

8.2.62 /<x>/OffNetwork/Timers/TFB1

Table 8.2.62.1: /<x>/OffNetwork/Timers/TFB1

OffNetwork/Timers/TFB1

Status	Occurrence	Format	Min. Access Types
Required	One	int	Get, Replace

This leaf node indicates the MCPTT timer for max duration as specified in 3GPP TS 24.379 [7].

- Values: 0-600

The timer TFB1 is in seconds.

8.2.63 /<x>/OffNetwork/Timers/TFB2

Table 8.2.63.1: /<x>/OffNetwork/Timers/TFB2

OffNetwork/Timers/TFB2

Status	Occurrence	Format	Min. Access Types
Required	One	int	Get, Replace

This leaf node indicates the MCPTT timer for broadcast retransmission as specified in 3GPP TS 24.379 [7].

- Values: 0-10

The timer TFB2 is in seconds.

8.2.64 /<x>/OffNetwork/Timers/TFB3

Table 8.2.64.1: /<x>/OffNetwork/Timers/TFB3

OffNetwork/Timers/TFB3

Status	Occurrence	Format	Min. Access Types
Required	One	int	Get, Replace

This leaf node indicates the MCPTT timer for waiting for the MCPTT user as specified in 3GPP TS 24.379 [7].

- Values: 0-60

The timer TFB3 is in seconds.

8.2.65 /<x>/OffNetwork/Timers/T201

Table 8.2.65.1: /<x>/OffNetwork/Timers/T201

OffNetwork/Timers/T201

Status	Occurrence	Format	Min. Access Types
Required	One	int	Get, Replace

This leaf node indicates the MCPTT timer for floor request as specified in 3GPP TS 24.380 [8].

- Values: 0-65535

The timer T201 is in milliseconds.

8.2.66 /<x>/OffNetwork/Timers/T203

Table 8.2.66.1: /<x>/OffNetwork/Timers/T203

OffNetwork/Timers/T203

Status	Occurrence	Format	Min. Access Types
Required	One	int	Get, Replace

This leaf node indicates the MCPTT timer for end of RTP media as specified in 3GPP TS 24.380 [8].

- Values: 0-255

The timer T203 is in seconds.

8.2.67 /<x>/OffNetwork/Timers/T204

Table 8.2.67.1: /<x>/OffNetwork/Timers/T204

OffNetwork/Timers/T204

Status	Occurrence	Format	Min. Access Types
Required	One	int	Get, Replace

This leaf node indicates the MCPTT timer for floor queue position request as specified in 3GPP TS 24.380 [8].

- Values: 0-65535

The timer T204 is in milliseconds.

8.2.68 /<x>/OffNetwork/Timers/T205

Table 8.2.68.1: /<x>/OffNetwork/Timers/T205

OffNetwork/Timers/T205

Status	Occurrence	Format	Min. Access Types
Required	One	int	Get, Replace

This leaf node indicates the MCPTT timer for floor granted request as specified in 3GPP TS 24.380 [8].

- Values: 0-65535

The timer T205 is in milliseconds.

8.2.69 Void

8.2.70 /<x>/OffNetwork/Timers/T233

Table 8.2.70.1: /<x>/OffNetwork/Timers/T233

OffNetwork/Timers/T233

Status	Occurrence	Format	Min. Access Types
Required	One	int	Get, Replace

This leaf node indicates the MCPTT timer for pending user action as specified in 3GPP TS 24.380 [8].

- Values: 0-255

The timer T233 is in seconds.

8.2.71 /<x>/OffNetwork/Timers/TFE1

Table 8.2.71.1: /<x>/OffNetwork/Timers/TFE1

OffNetwork/Timers/TFE1

Status	Occurrence	Format	Min. Access Types
Required	One	int	Get, Replace

This leaf node indicates the timer for MCPTT emergency alert as specified in 3GPP TS 24.379 [7].

- Values: 0-65535

The timer TFE1 is in seconds.

8.2.72 /<x>/OffNetwork/Timers/TFE2

Table 8.2.72.1: /<x>/OffNetwork/Timers/TFE2

OffNetwork/Timers/TFE2

Status	Occurrence	Format	Min. Access Types
Required	One	int	Get, Replace

This leaf node indicates the timer for MCPTT emergency alert retransmission as specified in 3GPP TS 24.379 [7].

- Values: 0-10

The timer TFE2 is in seconds.

8.2.73 /<x>/OffNetwork/Counters

Table 8.2.73.1: /<x>/OffNetwork/Counters

OffNetwork/Counters

Status	Occurrence	Format	Min. Access Types
Required	One	node	Get, Replace

This interior node is a placeholder for the counter configuration.

8.2.74 /<x>/OffNetwork/Counters/CFP1

Table 8.2.74.1: /<x>/OffNetwork/Counters/CFP1

OffNetwork/Counters/CFP1

Status	Occurrence	Format	Min. Access Types
Required	One	int	Get, Replace

This leaf node indicates the MCPTT counter for private call request retransmission as specified in 3GPP TS 24.379 [7].

- Values: 0-255

8.2.75 /<x>/OffNetwork/Counters/CFP3

Table 8.2.75.1: /<x>/OffNetwork/Counters/CFP3

OffNetwork/Counters/CFP3

Status	Occurrence	Format	Min. Access Types
Required	One	int	Get, Replace

This leaf node indicates the MCPTT counter for private call release retransmission as specified in 3GPP TS 24.379 [7].

- Values: 0-255

8.2.76 /<x>/OffNetwork/Counters/CFP4

Table 8.2.76.1: /<x>/OffNetwork/Counters/CFP4

OffNetwork/Counters/CFP4

Status	Occurrence	Format	Min. Access Types
Required	One	int	Get, Replace

This leaf node indicates the MCPTT counter for private call accept retransmission as specified in 3GPP TS 24.379 [7].

- Values: 0-255

8.2.77 /<x>/OffNetwork/Counters/CFP6

Table 8.2.77.1: /<x>/OffNetwork/Counters/CFP6

OffNetwork/Counters/CFP6

Status	Occurrence	Format	Min. Access Types
Required	One	int	Get, Replace

This leaf node indicates the MCPTT counter for emergency private call cancel retransmission as specified in 3GPP TS 24.379 [7].

- Values: 0-255

8.2.78 /<x>/OffNetwork/Counters/CFG11

Table 8.2.78.1: /<x>/OffNetwork/Counters/CFG11

OffNetwork/Counters/CFG11

Status	Occurrence	Format	Min. Access Types
Required	One	int	Get, Replace

This leaf node indicates the counter for MCPTT group call emergency end retransmission as specified in 3GPP TS 24.379 [7].

- Values: 0-255

8.2.79 /<x>/OffNetwork/Counters/CFG12

Table 8.2.79.1: /<x>/OffNetwork/Counters/CFG12

OffNetwork/Counters/CFG12

Status	Occurrence	Format	Min. Access Types
Required	One	int	Get, Replace

This leaf node indicates the counter for MCPTT imminent peril call emergency end retransmission as specified in 3GPP TS 24.379 [7].

- Values: 0-255

8.2.80 /<x>/OffNetwork/Counters/C201

Table 8.2.80.1: /<x>/OffNetwork/Counters/C201

OffNetwork/Counters/C201

Status	Occurrence	Format	Min. Access Types
Required	One	int	Get, Replace

This leaf node indicates the MCPTT counter for floor request as specified in 3GPP TS 24.380 [8].

- Values: 0-255

8.2.81 /<x>/OffNetwork/Counters/C204

Table 8.2.81.1: /<x>/OffNetwork/Counters/C204

OffNetwork/Counters/C204

Status	Occurrence	Format	Min. Access Types
Required	One	int	Get, Replace

This leaf node indicates the MCPTT counter for floor queue position request as specified in 3GPP TS 24.380 [8].

- Values: 0-255

8.2.82 /<x>/OffNetwork/Counters/C205

Table 8.2.82.1: /<x>/OffNetwork/Counters/C205

OffNetwork/Counters/C205

Status	Occurrence	Format	Min. Access Types
Required	One	int	Get, Replace

This leaf node indicates the MCPTT counter for floor granted request as specified in 3GPP TS 24.380 [8].

- Values: 0-255

9 MCDData UE configuration MO

9.1 General

The MCDData UE configuration Management Object (MO) is used to configure MCDData Client behaviour for the on-network or off-network MCDData Service. The MCDData UE configuration parameters may be stored in the ME, or in the USIM as specified in 3GPP TS 31.102 [10], or in both the ME and the USIM. If both the ME and the USIM contain the same parameters, the values stored in the USIM shall take precedence.

The Management Object Identifier is: urn:oma:mo:ext-3gpp-MCDData-UE-configuration:1.0.

Protocol compatibility: This MO is compatible with OMA OMA DM 1.2 [3].

The OMA DM ACL property mechanism (see OMA OMA-ERELED-DM-V1_2 [2]) may be used to grant or deny access rights to OMA DM servers in order to modify nodes and leaf objects of the MCDData UE configuration MO.

The following nodes and leaf objects are possible under the MCDData UE configuration node as described in figure 9.1.1 and figure 9.1.2.

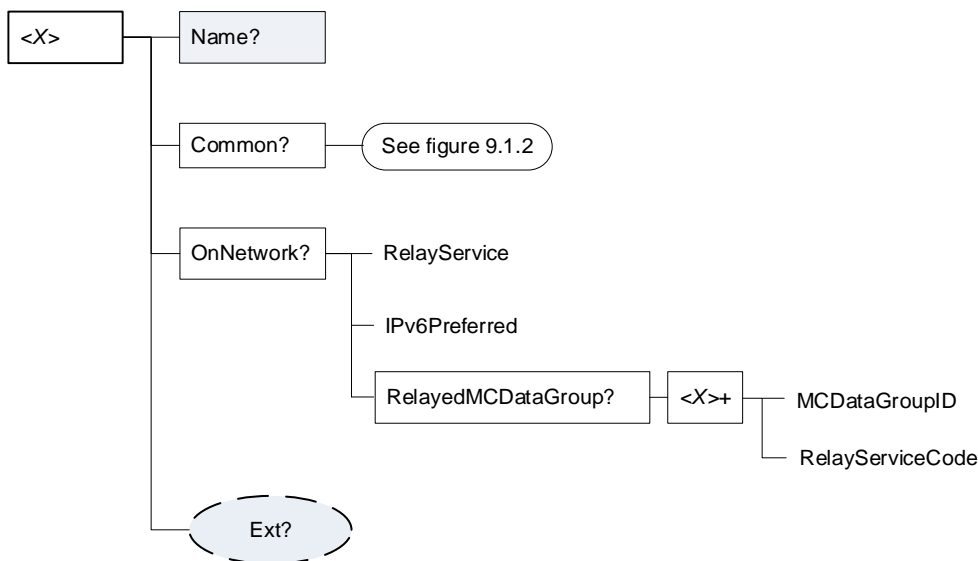

Figure 9.1.1: The MCDData UE configuration MO (1 of 2)

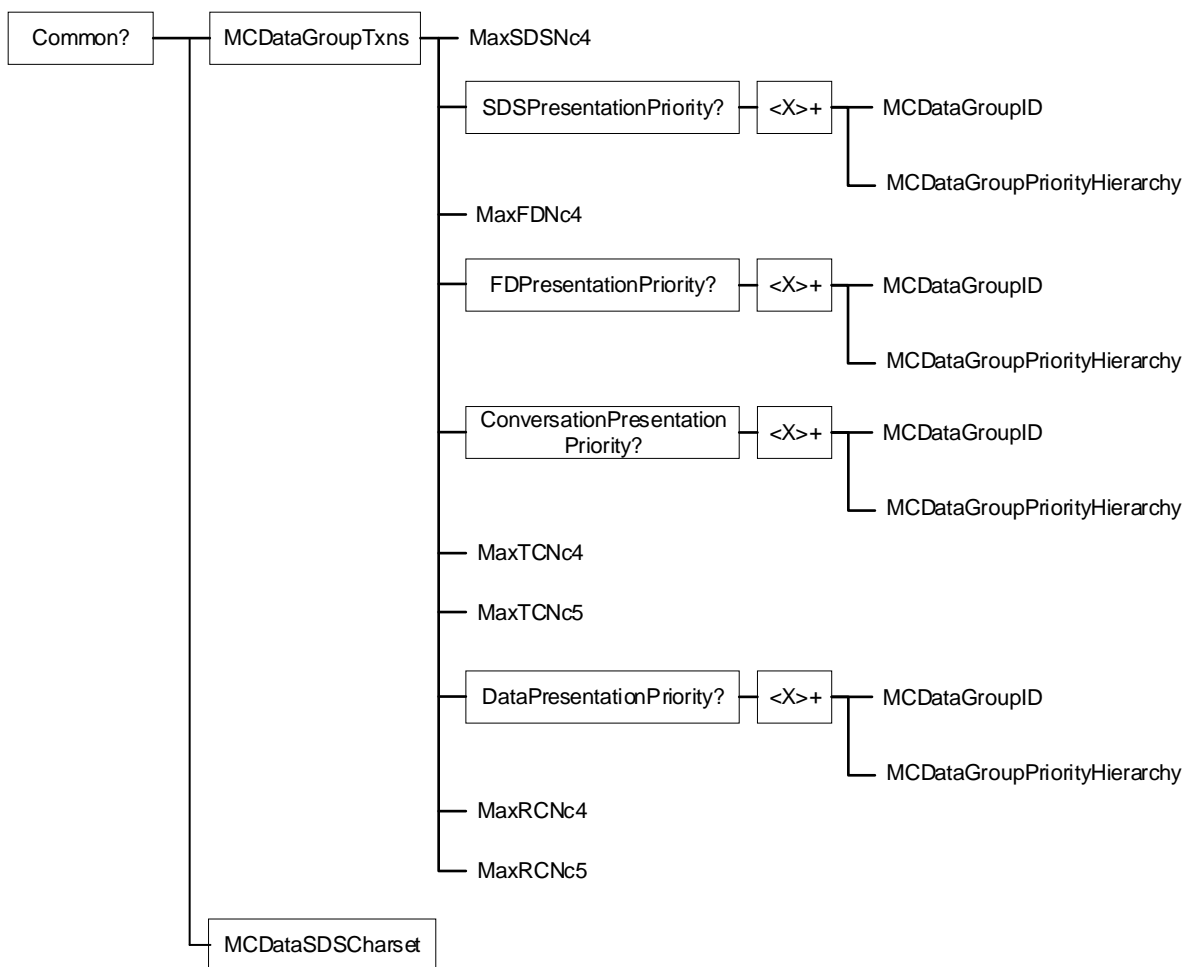

Figure 9.1.2: The MCDData UE configuration MO (2 of 2)

9.2 MCDData UE configuration MO parameters

9.2.1 General

This clause describes the parameters for the MCDData UE configuration Management Object (MO).

9.2.2 Node: <x>

Table 9.2.2.1: Node: <x>

<x>

Status	Occurrence	Format	Min. Access Types
Required	OneOrMore	node	Get

This interior node acts as a placeholder for the MCDData UE configuration Management Object (MO).

For the MCDData UE configuration MO, the namespace specific string is: "urn:oma:mo:oma-dm-mcddata-ue-configuration:1.0"

- Values: N/A

9.2.3 /<x>/Name

Table 9.2.3.1: /<x>/Name

Name

Status	Occurrence	Format	Min. Access Types
Required	ZeroOrOne	chr	Get

The Name leaf is a name for the MCDData UE configuration settings.

- Values: <User displayable name>

9.2.4 /<x>/Ext/

Table 9.2.4.1: /<x>/Ext/

Ext

Status	Occurrence	Format	Min. Access Types
Optional	ZeroOrOne	node	Get, Replace

The Ext is an interior node for where the vendor specific information about the MCDData UE configuration MO is being placed.

Usually the vendor extension is identified by vendor specific name under the ext node and contains the vendor meaning application vendor, device vendor etc. The tree structure under the vendor identified is not defined and can therefore include one or more un-standardized sub-trees.

- Values: N/A

9.2.5 /<x>/Common

Table 9.2.5.1: /<x>/Common

Common

Status	Occurrence	Format	Min. Access Types
Required	ZeroOrOne	node	Get, Replace

This interior node represents a container for the common network operation which means both on-network operation and off-network operation.

9.2.6 /<x>/Common/MCDataGroupTxns

Table 9.2.6.1: /<x>/Common/MCDataGroupTxns

Common/MCDataGroupTxns

Status	Occurrence	Format	Min. Access Types
Required	One	node	Get, Replace

This interior node is a placeholder for the MCData group transactions configuration.

9.2.7 /<x>/Common/MCDataGroupTxns/MaxSDSNc4

Table 9.2.7.1: /<x>/Common/MCDataGroupTxns/MaxSDSNc4

Common/MCDataGroupTxns/MaxSDSNc4

Status	Occurrence	Format	Min. Access Types
Required	One	int	Get, Replace

This leaf node indicates the maximum number of simultaneous SDS transactions.

- Values: 0-255

9.2.8 /<x>/Common/MCDataGroupTxns/SDSPresentationPriority

Table 9.2.8.1: /<x>/Common/MCDataGroupTxns/SDSPresentationPriority

Common/MCDataGroupTxns/SDSPresentationPriority

Status	Occurrence	Format	Min. Access Types
Required	ZeroOrOne	node	Get, Replace

This interior node is a placeholder for the prioritized MCData SDS configuration.

9.2.9 /<x>/Common/MCDataGroupTxns/SDSPresentationPriority/<x>

Table 9.2.9.1: /<x>/Common/MCDataGroupTxns/SDSPresentationPriority/<x>

Common/MCDataGroupTxns/SDSPresentationPriority/<x>

Status	Occurrence	Format	Min. Access Types
Required	OneOrMore	node	Get, Replace

This interior node is a placeholder for one or more prioritized MCData SDS configuration.

9.2.10 /<x>/Common/MCDataGroupTxns/SDSPresentationPriority/<x>/MCDataGroupID

Table 9.2.10.1: /<x>/Common/MCDataGroupTxns/SDSPresentationPriority/<x>/MCDataGroupID

Common/MCDataGroupTxns/SDSPresentationPriority/<x>/MCDataGroupID

Status	Occurrence	Format	Min. Access Types
Required	One	chr	Get, Replace

This leaf node indicates the associated MCData group ID.

The value is a "uri" attribute specified in OMA OMA-TS-XDM_Group-V1_1 [4].

9.2.11 /<x>/Common/MCDataGroupTxns/SDSPresentationPriority/<x>/MCDataGroupPriorityHierarchy

Table 9.2.11.1: /<x>/Common/MCDataGroupTxns/SDSPresentationPriority/<x>/MCDataGroupPriorityHierarchy

Common/MCDataGroupTxns/SDSPresentationPriority/<x>/MCDataGroupPriorityHierarchy

Status	Occurrence	Format	Min. Access Types
Required	One	int	Get, Replace

This leaf node indicates the requested presentation priority of SDS transactions.

- Values: 0-255

The group with the lowest MCDataGroupPriorityHierarchy value shall be considered as the group having the lowest priority among the groups.

9.2.12 /<x>/Common/MCDataGroupTxns/MaxFDNc4

Table 9.2.12.1: /<x>/Common/MCDataGroupTxns/MaxFDNc4

Common/MCDataGroupTxns/MaxFDNc4

Status	Occurrence	Format	Min. Access Types
Required	One	int	Get, Replace

This leaf node indicates the maximum number of simultaneous FD transactions.

- Values: 0-255

9.2.13 /<x>/Common/MCDataGroupTxns/FDPresentationPriority

Table 9.2.13.1: /<x>/Common/MCDataGroupTxns/FDPresentationPriority

Common/MCDataGroupTxns/FDPresentationPriority

Status	Occurrence	Format	Min. Access Types
Required	ZeroOrOne	node	Get, Replace

This interior node is a placeholder for the prioritized MCData FD configuration.

9.2.14 /<x>/Common/MCDataGroupTxns/FDPresentationPriority/<x>

Table 9.2.14.1: /<x>/Common/MCDataGroupTxns/FDPresentationPriority/<x>

Common/MCDataGroupTxns/FDPresentationPriority /<x>

Status	Occurrence	Format	Min. Access Types
Required	OneOrMore	node	Get, Replace

This interior node is a placeholder for one or more prioritized MCData FD configuration.

9.2.15 /<x>/Common/MCDataGroupTxns/FDPresentationPriority/<x>/MCDataGroupID

Table 9.2.15.1: /<x>/Common/MCDataGroupTxns/FDPresentationPriority/<x>/MCDataGroupID

Common/MCDataGroupTxns/FDPresentationPriority/<x>/MCDataGroupID

Status	Occurrence	Format	Min. Access Types
Required	One	chr	Get, Replace

This leaf node indicates the associated MCData group ID.

The value is a "uri" attribute specified in OMA OMA-TS-XDM_Group-V1_1 [4].

9.2.16 /<x>/Common/MCDataGroupTxns/FDPresentationPriority/<x>/MCDataGroupPriorityHierarchy

Table 9.2.16.1: /<x>/Common/MCDataGroupTxns/FDPresentationPriority/<x>/MCDataGroupPriorityHierarchy

Common/MCDataGroupTxns/FDPresentationPriority/<x>/MCDataGroupPriorityHierarchy

Status	Occurrence	Format	Min. Access Types
Required	One	int	Get, Replace

This leaf node indicates the requested presentation priority of FD transactions.

- Values: 0-255

The group with the lowest MCDataGroupPriorityHierarchy value shall be considered as the group having the lowest priority among the groups.

9.2.17 /<x>/Common/MCDataGroupTxns/ConversationPresentationPriority

Table 9.2.17.1: /<x>/Common/MCDataGroupTxns/ConversationPresentationPriority

Common/MCDataGroupTxns/ConversationPresentationPriority

Status	Occurrence	Format	Min. Access Types
Required	ZeroOrOne	node	Get, Replace

This interior node is a placeholder for the prioritized MCData conversation management configuration.

9.2.18 /<x>/Common/MCDataGroupTxns/ ConversationPresentationPriority/<x>

Table 9.2.18.1: /<x>/Common/MCDataGroupTxns/ConversationPresentationPriority/<x>

Common/MCDataGroupTxns/ConversationPresentationPriority /<x>

Status	Occurrence	Format	Min. Access Types
Required	OneOrMore	node	Get, Replace

This interior node is a placeholder for one or more prioritized MCData conversation management configuration.

9.2.19 /<x>/Common/MCDataGroupTxns/ ConversationPresentationPriority/<x>/MCDataGroupID

**Table 9.2.19.1: /<x>/Common/MCDataGroupTxns/ConversationPresentationPriority/<x>/
MCDataGroupID**

Common/MCDataGroupTxns/ConversationPresentationPriority/<x>/MCDataGroupID

Status	Occurrence	Format	Min. Access Types
Required	One	chr	Get, Replace

This leaf node indicates the associated MCData group ID.

The value is a "uri" attribute specified in OMA OMA-TS-XDM_Group-V1_1 [4].

9.2.20 /<x>/Common/MCDataGroupTxns/ ConversationPresentationPriority/<x>/ MCDataGroupPriorityHierarchy

**Table 9.2.20.1: /<x>/Common/MCDataGroupTxns/ConversationPresentationPriority/<x>/
MCDataGroupPriorityHierarchy**

Common/MCDataGroupTxns/ConversationPresentationPriority/<x>/MCDataGroupPriorityHierarchy

Status	Occurrence	Format	Min. Access Types
Required	One	int	Get, Replace

This leaf node indicates the requested presentation priority of conversation management transactions.

- Values: 0-255

The group with the lowest MCDataGroupPriorityHierarchy value shall be considered as the group having the lowest priority among the groups.

9.2.21 /<x>/Common/MCDataGroupTxns/MaxTCNc4

Table 9.2.21.1: /<x>/Common/MCDataGroupTxns/MaxTCNc4

Common/MCDataGroupTxns/MaxTCNc4

Status	Occurrence	Format	Min. Access Types
Required	One	int	Get, Replace

This leaf node indicates the maximum number of simultaneous data transmissions.

- Values: 0-255

9.2.22 /<x>/Common/MCDataGroupTxns/MaxTCNc5

Table 9.2.22.1: /<x>/Common/MCDataGroupTxns/MaxTCNc5

Common/MCDataGroupTxns/MaxTCN5

Status	Occurrence	Format	Min. Access Types
Required	One	int	Get, Replace

This leaf node indicates the maximum number of data transmissions in a group.

- Values: 0-255

9.2.23 /<x>/Common/MCDataGroupTxns/DataPresentationPriority

Table 9.2.23.1: /<x>/Common/MCDataGroupTxns/DataPresentationPriority

Common/MCDataGroupTxns/DataPresentationPriority

Status	Occurrence	Format	Min. Access Types
Required	ZeroOrOne	node	Get, Replace

This interior node is a placeholder for the prioritized MCData Transmission Control configuration.

9.2.24 /<x>/Common/MCDataGroupTxns/DataPresentationPriority/<x>

Table 9.2.24.1: /<x>/Common/MCDataGroupTxns/DataPresentationPriority/<x>

Common/MCDataGroupTxns/DataPresentationPriority/<x>

Status	Occurrence	Format	Min. Access Types
Required	OneOrMore	node	Get, Replace

This interior node is a placeholder for one or more prioritized MCData Transmission Control configuration.

9.2.25 /<x>/Common/MCDataGroupTxns/DataPresentationPriority/<x>/MCDataGroupID

Table 9.2.25.1: /<x>/Common/MCDataGroupTxns/DataPresentationPriority/<x>/MCDataGroupID

Common/MCDataGroupTxns/DataPresentationPriority/<x>/MCDataGroupID

Status	Occurrence	Format	Min. Access Types
Required	One	chr	Get, Replace

This leaf node indicates the associated MCData group ID.

The value is a "uri" attribute specified in OMA OMA-TS-XDM_Group-V1_1 [4].

9.2.26 /<x>/Common/MCDataGroupTxns/DataPresentationPriority/<x>/MCDataGroupPriorityHierarchy

Table 9.2.26.1: /<x>/Common/MCDataGroupTxns/DataPresentationPriority/<x>/MCDataGroupPriorityHierarchy

Common/MCDataGroupTxns/DataPresentationPriority/<x>/MCDataGroupPriorityHierarchy

Status	Occurrence	Format	Min. Access Types
Required	One	int	Get, Replace

This leaf node indicates the requested presentation priority of data received.

- Values: 0-255

The group with the lowest MCDataGroupPriorityHierarchy value shall be considered as the group having the lowest priority among the groups.

9.2.27 /<x>/Common/MCDataGroupTxns/MaxRCNc4

Table 9.2.27.1: /<x>/Common/MCDataGroupTxns/MaxRCNc4

Common/MCDataGroupTxns/MaxRCNc4

Status	Occurrence	Format	Min. Access Types
Required	One	int	Get, Replace

This leaf node indicates the maximum number of simultaneous data receptions.

- Values: 0-255

9.2.28 /<x>/Common/MCDataGroupTxns/MaxRCNc5

Table 9.2.28.1: /<x>/Common/MCDataGroupTxns/MaxRCNc5

Common/MCDataGroupTxns/MaxRCN5

Status	Occurrence	Format	Min. Access Types
Required	One	int	Get, Replace

This leaf node indicates the maximum number of data receptions in a group.

- Values: 0-255

9.2.28A /<x>/Common/MCDataSDSCharset

Table 9.2.28A.1: /<x>/Common/MCDataSDSCharset

Common/MCDataSDSCharset

Status	Occurrence	Format	Min. Access Types
Optional	ZeroOrMore	int	Get, Replace

This leaf node indicates an available charset for text use in SDS messages.

- Values: 0-2999 as indexed in the MIBenum values for IANA Character Sets [27]

9.2.29 /<x>/OnNetwork

Table 9.2.29.1: /<x>/OnNetwork

OnNetwork

Status	Occurrence	Format	Min. Access Types
Required	ZeroOrOne	node	Get, Replace

This interior node represents a container for on-network operation.

9.2.30 /<x>/OnNetwork/RelayService

Table 9.2.30.1: /<x>/OnNetwork/RelayService

OnNetwork/RelayService

Status	Occurrence	Format	Min. Access Types
Required	One	bool	Get, Replace

This leaf node indicates the authorisation to use a relay service.

When set to "true" the MCDData group is allowed to use a relay service.

When set to "false" the MCDData group is not allowed to use a relay service.

9.2.31 /<x>/OnNetwork/IPv6Preferred

Table 9.2.31.1: /<x>/OnNetwork/IPv6Preferred

OnNetwork/IPv6Preferred

Status	Occurrence	Format	Min. Access Types
Required	One	bool	Get, Replace

This leaf node indicates whether IPv6 is preferred over IPv4 for on-network operation when the MCDData UE has both IPv4 and IPv6 host configuration.

If the MCDData UE has both IPv4 and IPv6 host configuration and:

- if IPv6Preferred is set to "true" then the UE uses IPv6 for all on-network signalling and media; otherwise
- if IPv6Preferred is set to "false" then the UE uses IPv4 for all on-network signalling and media.

9.2.32 /<x>/OnNetwork/RelayedMCDDataGroup

Table 9.2.32.1: /<x>/OnNetwork/RelayedMCDDataGroup

OnNetwork/RelayedMCDDataGroup

Status	Occurrence	Format	Min. Access Types
Optional	ZeroOrOne	node	Get, Replace

This interior node is a placeholder for the allowed relayed MCDData groups.

9.2.33 /<x>/OnNetwork/RelayedMCDataGroup/<x>

Table 9.2.33.1: /<x>/OnNetwork/RelayedMCDataGroup/<x>

OnNetwork/RelayedMCDataGroup/<x>

Status	Occurrence	Format	Min. Access Types
Required	OneOrMore	node	Get, Replace

This interior node is a placeholder for one or more allowed relayed MCData groups.

9.2.34 /<x>/OnNetwork/RelayedMCDataGroup/<x>/MCDataGroupID

Table 9.2.34.1: /<x>/OnNetwork/RelayedMCDataGroup/<x>/MCDataGroupID

OnNetwork/RelayedMCDataGroup/<x>/MCDataGroupID

Status	Occurrence	Format	Min. Access Types
Required	One	chr	Get, Replace

This leaf node indicates the associated MCData group ID.

The value is a "uri" attribute specified in OMA OMA-TS-XDM_Group-V1_1 [4].

9.2.35 /<x>/OnNetwork/RelayedMCDataGroup/<x>/RelayServiceCode

Table 9.2.35.1: /<x>/OnNetwork/RelayedMCDataGroup/<x>/RelayServiceCode

OnNetwork/RelayedMCDataGroup/<x>/RelayServiceCode

Status	Occurrence	Format	Min. Access Types
Required	One	chr	Get, Replace

This leaf node indicates the connectivity service that the ProSe UE-to-network relay provides to public safety applications as specified in 3GPP TS 23.303 [6].

10 MCData user profile MO

10.1 General

The MCData user profile configuration Management Object (MO) is used to configure the MCData Client behaviour for the on-network or off-network MCData Service. The MCData user profile configuration parameters may be stored in the ME, or in the USIM as specified in 3GPP TS 31.102 [10], or in both the ME and the USIM. If both the ME and the USIM contain the same parameters, the values stored in the USIM shall take precedence.

The Management Object Identifier is: urn:oma:mo:ext-3gpp-MCData-user-profile:1.0.

Protocol compatibility: This MO is compatible with OMA OMA DM 1.2 [3].

The OMA DM ACL property mechanism (see OMA OMA-ERELD-DM-V1_2 [2]) may be used to grant or deny access rights to OMA DM servers in order to modify nodes and leaf objects of the MCData user profile MO.

The following nodes and leaf objects are possible under the MCData user profile node as described in figures 10.1.1 through 10.1.5.

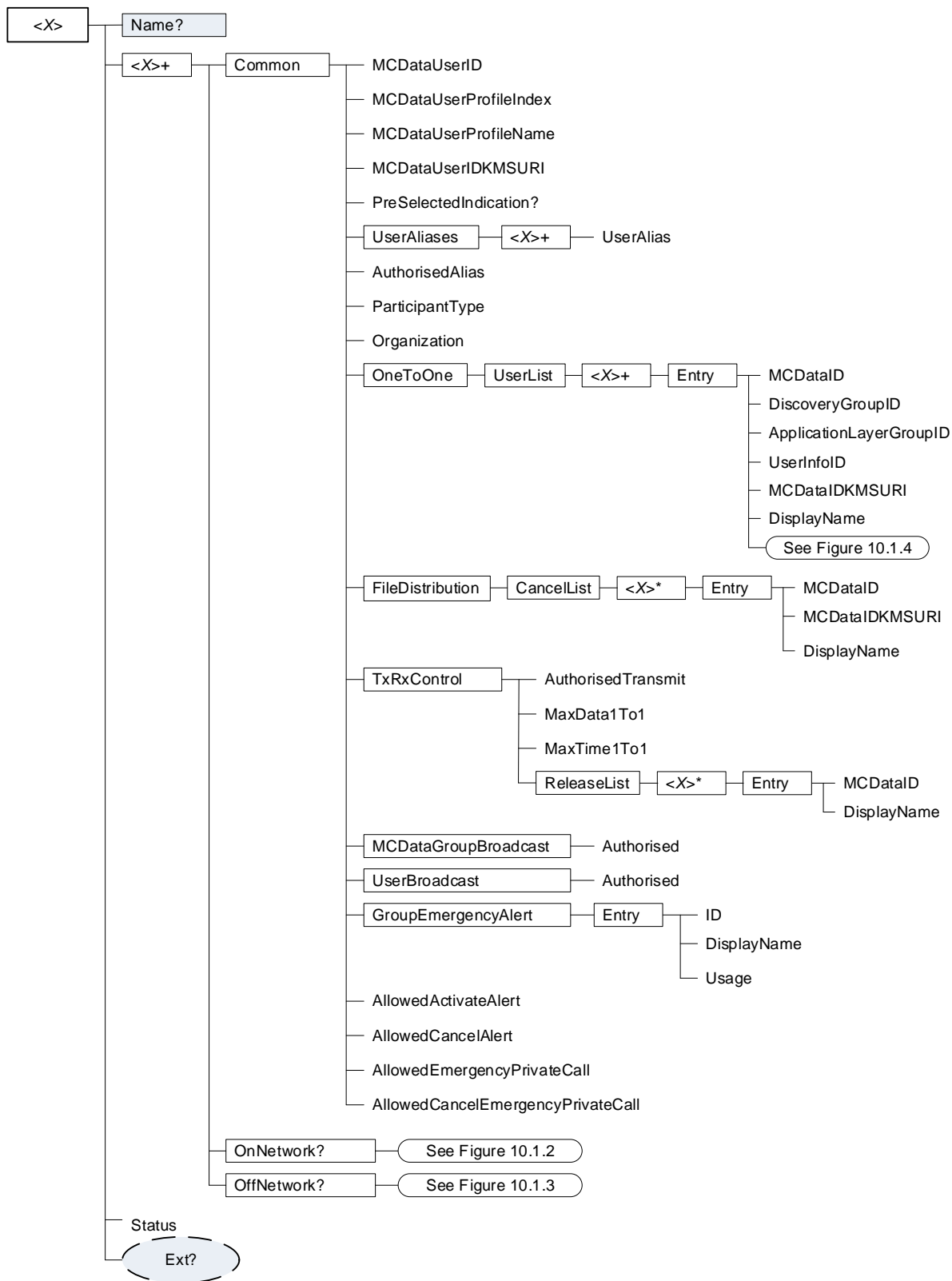

Figure 10.1.1: The MCDATA user profile MO (1 of 5)

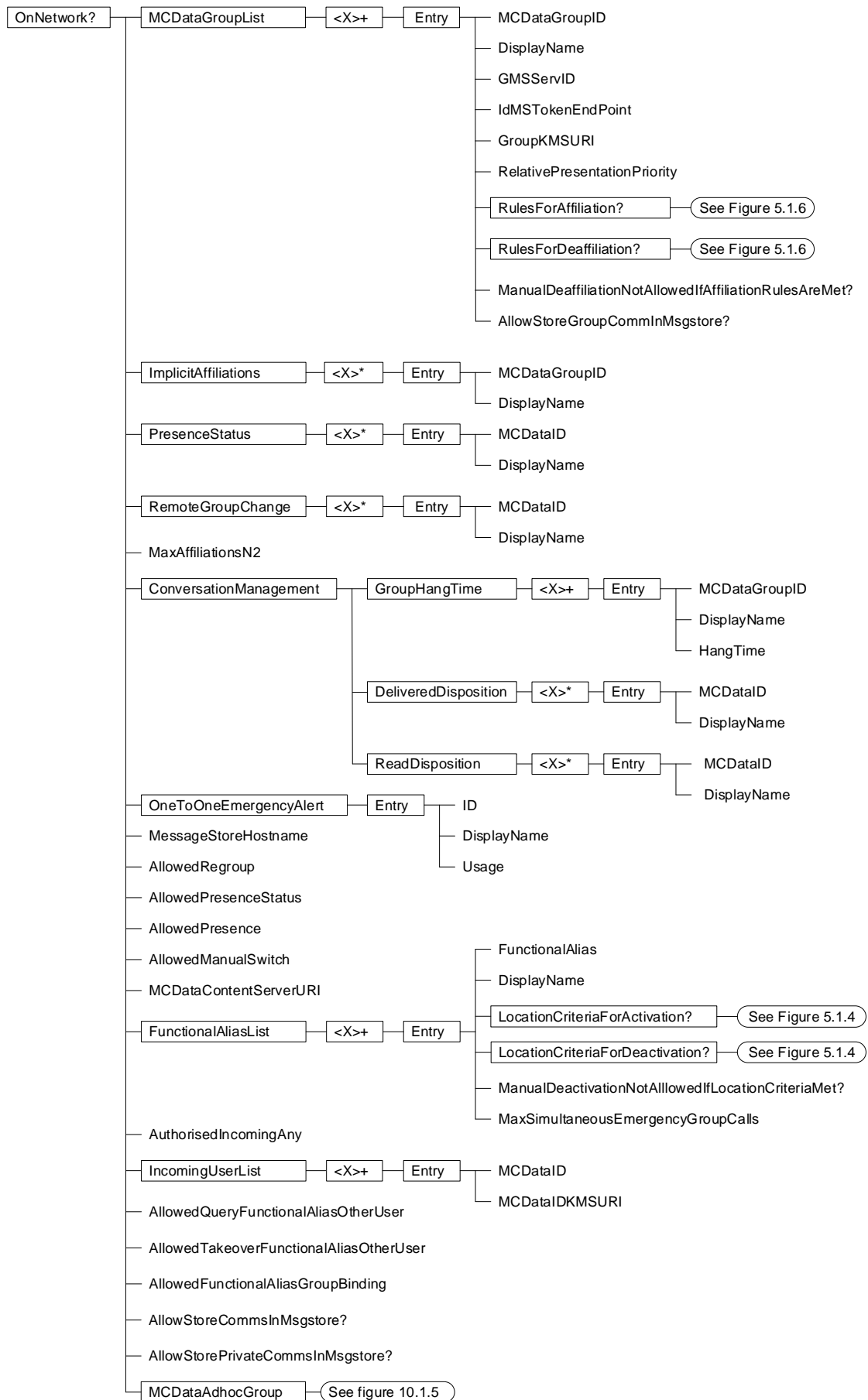

Figure 10.1.2: The MCDATA user profile MO (2 of 5)

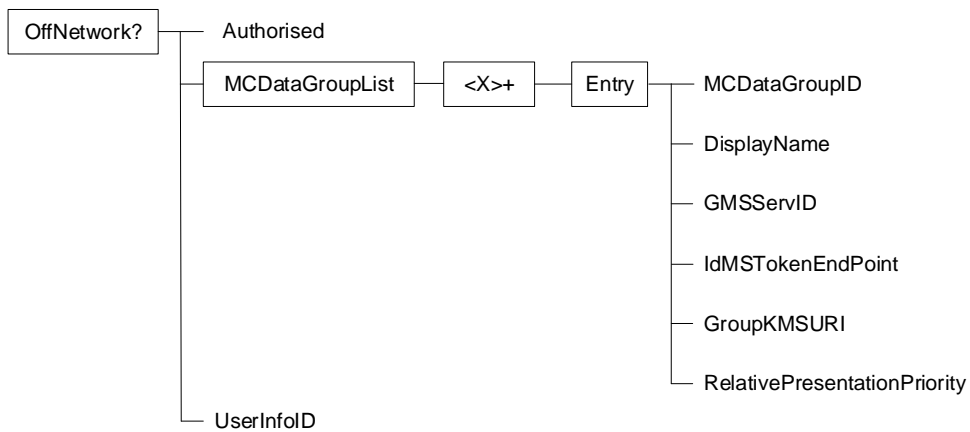

Figure 10.1.3: The MCData user profile MO (3 of 5)

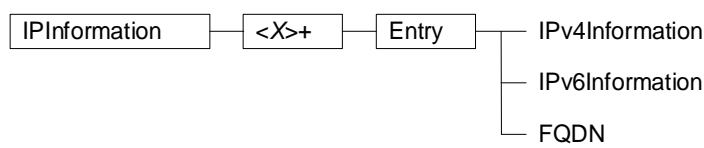

Figure 10.1.4: The MCData user profile MO (4 of 5)

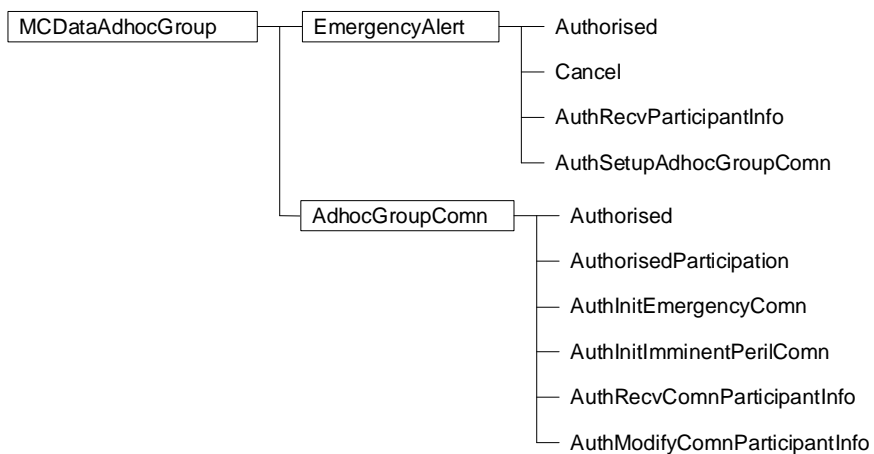

Figure 10.1.5: MCDataAdhocGroup MO contents (5 of 5)

10.2 MCData user profile MO parameters

10.2.1 General

This clause describes the parameters for the MCData user profile Management Object (MO).

10.2.2 Node: <x>

Table 10.2.2.1: Node: <x>

<x>

Status	Occurrence	Format	Min. Access Types
Required	OneOrMore	node	Get

This interior node acts as a placeholder for the MCDData user profile Management Object (MO).

For the MCDData user profile MO, the namespace specific string is: "urn:oma:mo:oma-dm-mcdata-user-profile:1.0"

- Values: N/A

10.2.3 /<x>/Name

Table 10.2.3.1: /<x>/Name

Name

Status	Occurrence	Format	Min. Access Types
Required	ZeroOrOne	chr	Get

The Name leaf is a name for the MCDData user profile settings.

- Values: <User displayable name>

10.2.4 /<x>/Ext/

Table 10.2.4.1: /<x>/Ext/

Ext

Status	Occurrence	Format	Min. Access Types
Optional	ZeroOrOne	node	Get, Replace

The Ext is an interior node for where the vendor specific information about the MCDData user profile MO is being placed.

Usually the vendor extension is identified by vendor specific name under the ext node and contains the vendor meaning application vendor, device vendor etc. The tree structure under the vendor identified is not defined and can therefore include one or more un-standardized sub-trees.

- Values: N/A

10.2.5 /<x>/<x>

Table 10.2.5.1: /<x>/<x>

<x>

Status	Occurrence	Format	Min. Access Types
Required	OneOrMore	node	Get, Replace

This interior node represents a container for on-network operation and off-network operation.

10.2.6 /<x>/<x>/Common

Table 10.2.6.1: /<x>/<x>/Common

<x>/Common

Status	Occurrence	Format	Min. Access Types
Required	One	node	Get, Replace

This interior node represents a container for the common network operation which means both on-network operation and off-network operation.

10.2.7 /<x>/<x>/Common/MCDataUserID

Table 10.2.7.1: /<x>/<x>/Common/MCDataUserID

<x>/Common/MCDataUserID

Status	Occurrence	Format	Min. Access Types
Required	One	chr	Get, Replace

This leaf node indicates an MCData user identity (MCData ID) which is a globally unique identifier within the MCData service that represents the MCData user.

10.2.8 /<x>/<x>/Common/MCDataUserProfileIndex

Table 10.2.8.1: /<x>/<x>/Common/MCDataUserProfileIndex

<x>/Common/MCDataUserProfileIndex

Status	Occurrence	Format	Min. Access Types
Required	One	int	Get, Replace

This leaf node indicates an index for the particular MCData user profile.

- Values: 0-255

10.2.9 /<x>/<x>/Common/MCDataUserProfileName

Table 10.2.9.1: /<x>/<x>/Common/MCDataUserProfileName

<x>/Common/MCDataUserProfileName

Status	Occurrence	Format	Min. Access Types
Optional	One	chr	Get, Replace

This leaf node indicates a profile name for the particular MCData user profile.

10.2.9A /<x>/<x>/Common/MCDataUserIDKMSURI

Table 10.2.9A.1: /<x>/<x>/Common/MCDataUserIDKMSURI

<x>/Common/MCDataUserIDKMSURI

Status	Occurrence	Format	Min. Access Types
Optional	One	chr	Get, Replace

This leaf node indicates key management server URI for the security domain of the MCData user.

The value is a URI as specified in 3GPP TS 23.003 [5].

10.2.10 /<x>/<x>/Common/PreSelectedIndication

Table 10.2.10.1: /<x>/<x>/Common/PreSelectedIndication

<x>/Common/PreSelectedIndication

Status	Occurrence	Format	Min. Access Types
Optional	ZeroOrOne	null	Get, Replace

This leaf node indicates that this MCDData user profile MO is designated to be the pre-selected MCDData user profile as defined by 3GPP TS 23.179 [15]

- Values: null

When this leaf node is present, this MCDData user profile MO is designated as the pre-selected MCDData user profile.

When this leaf node is absent, this MCDData user profile MO is not designated as the pre-selected MCDData user profile.

If more than one MCDData user profile MO is specified for the MCDData user, then only one MCDData user profile MO for the MCDData user shall contain the <x>/Common/PreSelectedIndication leaf node.

If there is only one MCDData user profile MO specified for the MCDData user, then it is optional to include the <x>/Common/PreSelectedIndication leaf node.

10.2.11 /<x>/<x>/Common/UserAliases

Table 10.2.11.1: /<x>/<x>/Common/UserAliases

<x>/Common/UserAliases

Status	Occurrence	Format	Min. Access Types
Required	One	node	Get, Replace

This interior node is a placeholder for a list of aliases of an MCDData user.

10.2.12 /<x>/<x>/Common/UserAliases/<x>

Table 10.2.12.1: /<x>/<x>/Common/UserAliases/<x>

<x>/Common/UserAliases/<x>

Status	Occurrence	Format	Min. Access Types
Required	OneOrMore	node	Get, Replace

This interior node is a placeholder for one or more aliases of an MCDData user.

10.2.13 /<x>/<x>/Common/UserAliases/<x>UserAlias

Table 10.2.13.1: /<x>/<x>/Common/UserAliases/<x>/UserAlias

<x>/Common/UserAliases/<x>/UserAlias

Status	Occurrence	Format	Min. Access Types
Required	One	chr	Get, Replace

This leaf node indicates an alphanumeric alias of the MCDData user.

10.2.14 /<x>/<x>/Common/AuthorisedAlias

Table 10.2.14.1: /<x>/<x>/Common/AuthorisedAlias

<x>/Common/AuthorisedAlias

Status	Occurrence	Format	Min. Access Types
Optional	One	bool	Get, Replace

This leaf node indicates authorisation to create and delete aliases of other MCDData users and their associated MCDData user profiles.

When set to "true" the MCDData user is authorised to create and delete aliases of other MCDData users and their associated MCDData user profiles.

When set to "false" the MCDData user is not authorised to create and delete aliases of other MCDData user and their associated MCDData user profiles. This is the default if this leaf node is not present.

10.2.15 /<x>/<x>/Common/ParticipantType

Table 10.2.15.1: /<x>/<x>/Common/ParticipantType

<x>/Common/ParticipantType

Status	Occurrence	Format	Min. Access Types
Required	One	chr	Get, Replace

This leaf node indicates the participant type of the MCDData user.

The ParticipantType means the functional category of the participant (e.g., first responder, second responder, dispatch, dispatch supervisor), typically defined by the MCDData administrators.

10.2.16 /<x>/<x>/Common/Organization

Table 10.2.16.1: /<x>/<x>/Common/Organization

<x>/Common/Organization

Status	Occurrence	Format	Min. Access Types
Required	One	chr	Get, Replace

This leaf node indicates the organization an MCDData user belongs to.

10.2.16A/<x>/<x>/Common/OnetoOne

Table 10.2.16A.1: /<x>/<x>/Common/OnetoOne

<x>/Common/OnetoOne

Status	Occurrence	Format	Min. Access Types
Required	One	node	Get, Replace

This interior node is a placeholder for the MCDData on-network or off-network one-to-one communication configuration.

10.2.16B/ <x>/<x>/Common/OnetoOne/UserList

Table 10.2.16B.1: /<x>/<x>/Common/OnetoOne/UserList

<x>/Common/OnetoOne/UserList

Status	Occurrence	Format	Min. Access Types
Required	One	node	Get, Replace

This interior node is a placeholder for a list of MCDData users who can be involved in an on-network or off-network MCDData one-to-one transaction.

10.2.16C /<x>/<x>/Common/OnetoOne/UserList/<x>

Table 10.2.16C.1: /<x>/<x>/Common/OnetoOne/UserList/<x>

<x>/Common/OnetoOne/UserList/<x>

Status	Occurrence	Format	Min. Access Types
Optional	OneOrMore	node	Get, Replace

This interior node is a placeholder for one or more list of MCDData users who can be involved in an on-network or off-network MCDData one-to-one transaction.

10.2.16D /<x>/<x>/Common/OnetoOne/UserList/<x>/Entry

Table 10.2.16D.1: /<x>/<x>/Common/OnetoOne/UserList/<x>/Entry

<x>/Common/OnetoOne/UserList/<x>/Entry

Status	Occurrence	Format	Min. Access Types
Required	One	node	Get, Replace

This interior node is a placeholder for one or more MCDData users who can be involved in an on-network or off-network MCDData one-to-one transaction.

10.2.16E/ <x>/<x>/Common/OnetoOne/UserList/<x>/Entry/MCDDataID

Table 10.2.16E.1: /<x>/<x>/Common/OnetoOne/UserList/<x>/Entry/MCDDataID

<x>/Common/OnetoOne/UserList/<x>/Entry/MCDDataID

Status	Occurrence	Format	Min. Access Types
Optional	One	chr	Get, Replace

This leaf node indicates an MCDData user identity (MCDData ID) which is a globally unique identifier within the MCDData service that represents the MCDData user.

The value is a "uri" attribute specified in OMA OMA-TS-XDM_Group-V1_1 [4].

10.2.16F/ <x>/<x>/Common/OnetoOne/UserList/<x>/Entry/DiscoveryGroupID

Table 10.2.16F.1: /<x>/<x>/Common/OnetoOne/UserList/<x>/Entry/DiscoveryGroupID

<x>/Common/OnetoOne/UserList/<x>/Entry/DiscoveryGroupID

Status	Occurrence	Format	Min. Access Types

Optional	One	int	Get, Replace
----------	-----	-----	--------------

This leaf node indicates a discovery group ID as specified in 3GPP TS 23.303 [6].

The value is used as the discovery group ID in the ProSe discovery procedures as specified in 3GPP TS 23.303 [6].

10.2.16F1 /<x>/<x>/Common/OnetoOne/UserList/<x>/Entry/ ApplicationLayerGroupID

Table 10.2.16F1.1: /<x>/<x>/Common/OnetoOne/UserList/<x>/Entry/ApplicationLayerGroupID

<x>/Common/OnetoOne/UserList/<x>/Entry/ApplicationLayerGroupID

Status	Occurrence	Format	Min. Access Types
Optional	One	int	Get, Replace

This leaf node indicates an application layer group ID as specified in 3GPP TS 23.304 [25].

The value is used as the application layer group ID in the ProSe discovery procedures as specified in 3GPP TS 23.304 [25].

10.2.16G /<x>/<x>/Common/OnetoOne/UserList/<x>/Entry/UserInfoID

Table 10.2.16G.1: /<x>/<x>/Common/OnetoOne/UserList/<x>/Entry/UserInfoID

<x>/Common/OnetoOne/UserList/<x>/Entry/UserInfoID

Status	Occurrence	Format	Min. Access Types
Optional	One	int	Get, Replace

This leaf node indicates a ProSe user info ID as specified in 3GPP TS 23.303 [6].

10.2.16H /<x>/<x>/Common/OnetoOne/UserList/<x>/Entry/ MCDataIDKMSURI

Table 10.2.16H.1: /<x>/<x>/Common/OnetoOne/UserList/<x>/Entry/MCDataUserIDKMSURI

<x>/Common/OnetoOne/UserList/<x>/Entry/MCDataUserIDKMSURI

Status	Occurrence	Format	Min. Access Types
Optional	One	chr	Get, Replace

This leaf node indicates key management server URI for the security domain of the MCData user of an MCData user that the configured MCData user is authorised to initiate a one-to-one communication with.

The value is a URI as specified in 3GPP TS 23.003 [5].

10.2.16I /<x>/<x>/Common/OnetoOne/UserList/<x>/Entry/DisplayName

Table 10.2.16I.1: /<x>/<x>/Common/OnetoOne/UserList/<x>/Entry/DisplayName

<x>/Common/OnetoOne/UserList/<x>/Entry/DisplayName

Status	Occurrence	Format	Min. Access Types
Optional	One	chr	Get, Replace

This leaf node contains a human readable name.

10.2.16J /<x>/<x>/Common/OnetoOne/UserList/<x>/Entry/IPInformation

Table 10.2.16J.1: /<x>/<x>/Common/OnetoOne/UserList/<x>/Entry/IPInformation

<x>/Common/OnetoOne/UserList/<x>/Entry/IPInformation

Status	Occurrence	Format	Min. Access Types
Optional	One	node	Get, Replace

This interior node is a placeholder for one or more list of IPInformation data that can be used in the setup of an IP Connectivity session for a specific MCDATA user in a one-to-one communication.

10.2.16K /<x>/<x>/Common/OnetoOne/UserList/<x>/Entry/IPInformation/<x>

Table 10.2.16K.1: /<x>/<x>/Common/OnetoOne/UserList/<x>/Entry/IPInformation/<x>

<x>/Common/OnetoOne/UserList/<x>/Entry/IPInformation/<x>

Status	Occurrence	Format	Min. Access Types
Optional	OneOrMore	node	Get, Replace

This interior node is a placeholder for one or more list of IPInformation data that can be used in the setup of an IP Connectivity session for a specific MCDATA user in a one-to-one communication.

10.2.16L /<x>/<x>/Common/OnetoOne/UserList/<x>/Entry/IPInformation/<x>/Entry

Table 10.2.16L.1: /<x>/<x>/Common/OnetoOne/UserList/<x>/Entry/IPInformation/<x>/Entry

<x>/Common/OnetoOne/UserList/<x>/Entry/IPInformation/<x>/Entry

Status	Occurrence	Format	Min. Access Types
Required	One	node	Get, Replace

This interior node is a placeholder for one or more list of IPInformation data that can be used in the setup of an IP Connectivity session for a specific MCDATA user in a one-to-one communication.

10.2.16M /<x>/<x>/Common/OnetoOne/UserList/<x>/Entry/IPInformation/<x>/Entry/IPv4Information

Table 10.2.16M.1: /<x>/<x>/Common/OnetoOne/UserList/<x>/Entry/IPInformation/<x>/Entry/IPv4Information

<x>/Common/OnetoOne/UserList/<x>/Entry/IPInformation/<x>/Entry/IPv4Information

Status	Occurrence	Format	Min. Access Types
Optional	One	chr	Get, Replace

This leaf node indicates an IPv4 host address or an IPv4 network that can be addressed on an IP Connectivity session in a one-to-one communication for a specific MCDATA ID.

10.2.16N /<x>/<x>/Common/OnetoOne/UserList/<x>/Entry/ IPInformation/<x>/Entry/IPv6Information

Table 10.2.16N.1: /<x>/<x>/Common/OnetoOne/UserList/<x>/Entry/IPInformation/<x>/Entry/ IPv6Information

<x>/Common/OnetoOne/UserList/<x>/Entry/IPInformation/<x>/Entry/IPv6Information

Status	Occurrence	Format	Min. Access Types
Optional	One	chr	Get, Replace

This leaf node indicates an IPv6 host address or an IPv6 network that can be addressed on an IP Connectivity session in a one-to-one communication for a specific MCDData ID.

10.2.16O /<x>/<x>/Common/OnetoOne/UserList/<x>/Entry/ IPInformation/<x>/Entry/FQDN

Table 10.2.16O.1: /<x>/<x>/Common/OnetoOne/UserList/<x>/Entry/IPInformation/<x>/Entry/FQDN

<x>/Common/OnetoOne/UserList/<x>/Entry/IPInformation/<x>/Entry/FQDN

Status	Occurrence	Format	Min. Access Types
Optional	One	chr	Get, Replace

This leaf node indicates a fully qualified domain name for a specific host or domain that can be addressed on an IP Connectivity session in a one-to-one communication for a specific MCDData ID.

10.2.17 /<x>/<x>/Common/FileDistribution

Table 10.2.17.1: /<x>/<x>/Common/FileDistribution

<x>/Common/FileDistribution

Status	Occurrence	Format	Min. Access Types
Required	One	node	Get, Replace

This interior node is a placeholder for the MCDData file distribution configuration.

10.2.18 /<x>/<x>/Common/FileDistribution/CancelList

Table 10.2.18.1: /<x>/<x>/Common/FileDistribution/CancelList

<x>/Common/FileDistribution/CancelList

Status	Occurrence	Format	Min. Access Types
Required	One	node	Get, Replace

This interior node is a placeholder for a list of MCDData user(s) this MCDData user is allowed to cancel distribution of files beings sent or waiting to be sent.

10.2.19 /<x>/<x>/Common/FileDistribution/CancelList/<x>

Table 10.2.19.1: /<x>/<x>/Common/FileDistribution/CancelList/<x>

<x>/Common/FileDistribution/CancelList/<x>

Status	Occurrence	Format	Min. Access Types
Optional	ZeroOrMore	node	Get, Replace

This interior node is a placeholder for zero or more list of MCDData users this MCDData user is allowed to cancel distribution of files beings sent or waiting to be sent.

10.2.20 /<x>/<x>/Common/FileDistribution/CancelList/<x>/Entry

Table 10.2.20.1: /<x>/<x>/Common/FileDistribution/CancelList/<x>/Entry

<x>/Common/FileDistribution/CancelList/<x>/Entry

Status	Occurrence	Format	Min. Access Types
Required	One	node	Get, Replace

This interior node is a placeholder for one or more MCDData users this MCDData user is allowed to cancel distribution of files beings sent or waiting to be sent.

10.2.21 /<x>/<x>/Common/FileDistribution/CancelList/<x>/Entry/MCDDataID

Table 10.2.21.1: /<x>/<x>/Common/FileDistribution/CancelList/<x>/Entry/MCDDataID

<x>/Common/FileDistribution/CancelList/<x>/Entry/MCDDataID

Status	Occurrence	Format	Min. Access Types
Optional	One	chr	Get, Replace

This leaf node indicates an MCDData user identity (MCDData ID) which is a globally unique identifier within the MCDData service that represents the MCDData user.

The value is a "uri" attribute specified in OMA OMA-TS-XDM_Group-V1_1 [4].

10.2.21A/<x>/<x>/Common/FileDistribution/CancelList/<x>/Entry/MCDDataDKMSURI

Table 10.2.21A.1: /<x>/<x>/Common/FileDistribution/CancelList/<x>/Entry/MCDDataDKMSURI

<x>/Common/FileDistribution/CancelList/<x>/Entry/MCDDataDKMSURI

Status	Occurrence	Format	Min. Access Types
Optional	One	chr	Get, Replace

This leaf node indicates key management server URI for the security domain of the MCDData user of an MCDData user that the configured MCDData user is authorised to cancel distribution of files being sent or waiting to be sent.

The value is a URI as specified in 3GPP TS 23.003 [5].

10.2.22 /<x>/<x>/Common/FileDistribution/CancelList/<x>/Entry/DisplayName

Table 10.2.22.1: /<x>/<x>/Common/FileDistribution/CancelList/<x>/Entry/DisplayName

<x>/Common/FileDistribution/CancelList/<x>/Entry/DisplayName

Status	Occurrence	Format	Min. Access Types
Optional	One	chr	Get, Replace

This leaf node contains a human readable name.

10.2.23 `<x>/<x>/Common/TxRxControl`

Table 10.2.23.1: `<x>/<x>/Common/TxRxControl`

`<x>/Common/TxRxControl`

Status	Occurrence	Format	Min. Access Types
Required	One	node	Get, Replace

This interior node is a placeholder for the MCDData transmission and reception control configuration.

10.2.24 `<x>/<x>/Common/TxRxControl/AuthorisedTransmit`

Table 10.2.24.1: `<x>/<x>/Common/TxRxControl/AuthorisedTransmit`

`<x>/Common/TxRxControl/AuthorisedTransmit`

Status	Occurrence	Format	Min. Access Types
Required	One	bool	Get, Replace

This leaf node indicates the authorisation to transmit data.

When set to "true" the MCDData user is authorised to transmit data.

When set to "false" the MCDData user is not authorised to transmit data.

10.2.25 `<x>/<x>/Common/TxRxControl/MaxData1To1`

Table 10.2.25.1: `<x>/<x>/Common/TxRxControl/MaxData1To1`

`<x>/Common/TxRxControl/MaxData1To1`

Status	Occurrence	Format	Min. Access Types
Required	One	int	Get, Replace

This leaf node indicates the maximum amount of data (in megabytes) that an MCDData user can transmit in a single request during one-to-one communication.

- Values: 0-65535

The MaxData1to1 size is in megabytes.

10.2.26 `<x>/<x>/Common/TxRxControl/MaxTime1To1`

Table 10.2.26.1: `<x>/<x>/Common/TxRxControl/MaxTime1To1`

`<x>/Common/TxRxControl/MaxTime1To1`

Status	Occurrence	Format	Min. Access Types
Required	One	int	Get, Replace

This leaf node indicates the maximum amount of time that an MCDData user can transmit for in a single request during one-to-one communication.

- Values: 0-65535

The MaxTime1To1 time is in seconds.

10.2.27 `<x>/Common/TxRxControl/ReleaseList`

Table 10.2.27.1: `<x>/Common/TxRxControl/ReleaseList`

`<x>/Common/TxRxControl/ReleaseList`

Status	Occurrence	Format	Min. Access Types
Required	One	node	Get, Replace

This interior node is a placeholder for a list of MCDData users that this MCDData user is allowed to request release of an ongoing transmission.

10.2.28 `<x>/Common/TxRxControl/ReleaseList/<x>`

Table 10.2.28.1: `<x>/Common/TxRxControl/ReleaseList/<x>`

`<x>/Common/TxRxControl/ReleaseList/<x>`

Status	Occurrence	Format	Min. Access Types
Optional	ZeroOrMore	node	Get, Replace

This interior node is a placeholder for zero or more list of MCDData users this MCDData user is allowed to request release of an ongoing transmission.

10.2.29 `<x>/Common/TxRxControl/ReleaseList/<x>/Entry`

Table 10.2.29.1: `<x>/Common/TxRxControl/ReleaseList/<x>/Entry`

`<x>/Common/TxRxControl/ReleaseList/<x>/Entry`

Status	Occurrence	Format	Min. Access Types
Required	One	node	Get, Replace

This interior node is a placeholder for one or more MCDData users this MCDData user is allowed to request release of an ongoing transmission.

10.2.30 `<x>/Common/TxRxControl/ReleaseList/<x>/Entry/MCDDataID`

Table 10.2.30.1: `<x>/Common/TxRxControl/ReleaseList/<x>/Entry/MCDDataID`

`<x>/Common/TxRxControl/ReleaseList/<x>/Entry/MCDDataID`

Status	Occurrence	Format	Min. Access Types
Optional	One	chr	Get, Replace

This leaf node indicates an MCDData user identity (MCDData ID) which is a globally unique identifier within the MCDData service that represents the MCDData user.

The value is a "uri" attribute specified in OMA OMA-TS-XDM_Group-V1_1 [4].

10.2.31 /<x>/<x>/Common/TxRxControl/ReleaseList/<x>/Entry/DisplayName

Table 10.2.31.1: /<x>/<x>/Common/TxRxControl/ReleaseList/<x>/Entry/DisplayName

<x>/Common/TxRxControl/ReleaseList/<x>/Entry/DisplayName

Status	Occurrence	Format	Min. Access Types
Optional	One	chr	Get, Replace

This leaf node contains a human readable name.

10.2.32 /<x>/<x>/Common/MCDataGroupBroadcast

Table 10.2.32.1: /<x>/<x>/Common/MCDataGroupBroadcast

<x>/Common/MCDataGroupBroadcast

Status	Occurrence	Format	Min. Access Types
Required	One	node	Get, Replace

This interior node is a placeholder for the group-broadcast group policy.

10.2.33 /<x>/<x>/Common/MCDataGroupBroadcast/Authorised

Table 10.2.33.1: /<x>/<x>/Common/MCDataGroupBroadcast/Authorised

<x>/Common/MCDataGroupBroadcast/Authorised

Status	Occurrence	Format	Min. Access Types
Required	One	bool	Get, Replace

This leaf node indicates the authorisation to create a group-broadcast group.

When set to "true" the MCData user is authorised to create a group-broadcast group.

When set to "false" the MCData user is not authorised to create a group-broadcast group.

10.2.34 /<x>/<x>/Common/UserBroadcast

Table 10.2.34.1: /<x>/<x>/Common/UserBroadcast

<x>/Common/UserBroadcast

Status	Occurrence	Format	Min. Access Types
Required	One	node	Get, Replace

This interior node is a placeholder for the user-broadcast group policy.

10.2.35 /<x>/<x>/Common/UserBroadcast/Authorised

Table 10.2.35.1: /<x>/<x>/Common/UserBroadcast/Authorised

<x>/Common/UserBroadcast/Authorised

Status	Occurrence	Format	Min. Access Types
Required	One	bool	Get, Replace

This leaf node indicates the authorisation to create a user-broadcast group.

When set to "true" the MCDData user is authorised to create a user-broadcast group.

When set to "false" the MCDData user is not authorised to create a user-broadcast group.

10.2.36 /<x>/<x>/Common/GroupEmergencyAlert

Table 10.2.36.1: /<x>/<x>/Common/GroupEmergencyAlert

<x>/Common/GroupEmergencyAlert

Status	Occurrence	Format	Min. Access Types
Required	One	node	Get, Replace

This interior node is a placeholder for Group Emergency Alert configuration.

10.2.37 /<x>/<x>/Common/GroupEmergencyAlert/Entry

Table 10.2.37.1: /<x>/<x>/Common/GroupEmergencyAlert/Entry

<x>/Common/GroupEmergencyAlert/Entry

Status	Occurrence	Format	Min. Access Types
Required	One	node	Get, Replace

This interior node is a placeholder for the details of the MCDData group of an MCDData emergency alert.

10.2.38 /<x>/<x>/Common/GroupEmergencyAlert/Entry/ID

Table 10.2.38.1: /<x>/<x>/Common/GroupEmergencyAlert/Entry/ID

<x>/Common/GroupEmergencyAlert/Entry/ID

Status	Occurrence	Format	Min. Access Types
Required	One	chr	Get, Replace

This leaf node indicates the MCDData group used upon certain criteria on initiation of an MCDData emergency alert.

10.2.39 /<x>/<x>/Common/GroupEmergencyAlert/Entry/DisplayName

Table 10.2.39.1: /<x>/<x>/Common/GroupEmergencyAlert/Entry/DisplayName

<x>/Common/GroupEmergencyAlert/Entry/DisplayName

Status	Occurrence	Format	Min. Access Types
Optional	One	chr	Get, Replace

This leaf node contains a human readable name that corresponds to the ID.

10.2.40 /<x>/<x>/Common/GroupEmergencyAlert/Entry/Usage

Table 10.2.40.1: /<x>/<x>/Common/GroupEmergencyAlert/Entry/Usage

<x>/Common/GroupEmergencyAlert/Entry/Usage

Status	Occurrence	Format	Min. Access Types
Required	One	chr	Get, Replace

This leaf node indicates the criteria to determine when initiation of an MCDData emergency alert uses the ID.

The valid values are 'UseCurrentlySelectedGroup' and 'DedicatedGroup'.

When set to 'UseCurrentlySelectedGroup' then if the MCDData user has currently selected an MCDData group then use that MCDData group for an on-network MCDData emergency alert, if the MCDData user does not have a currently selected MCDData group then use the MCDData group identified by the ID in clause 10.2.38 for an MCDData emergency alert.

When set to 'DedicatedGroup' then use the MCDData group identified by the ID in clause 10.2.38 for an MCDData emergency alert.

10.2.41 /<x>/<x>/Common/AllowedActivateAlert

Table 10.2.41.1: /<x>/<x>/Common/AllowedActivateAlert

<x>/Common/AllowedActivateAlert

Status	Occurrence	Format	Min. Access Types
Optional	One	bool	Get, Replace

This leaf node indicates whether the MCDData user is authorised to activate an emergency alert

When set to "true" the MCDData user is authorised to activate an emergency alert.

When set to "false" the MCDData user is not authorised to activate an emergency alert.

10.2.42 /<x>/<x>/Common/AllowedCancelAlert

Table 10.2.42.1: /<x>/<x>/Common/AllowedCancelAlert

<x>/Common/AllowedCancelAlert

Status	Occurrence	Format	Min. Access Types
Required	One	bool	Get, Replace

This leaf node indicates whether the MCDData user is allowed to cancel an emergency alert.

When set to "true" the MCDData user is authorised to cancel an emergency alert.

When set to "false" the MCDData user is not authorised to cancel an emergency alert.

10.2.42A/<x>/<x>/Common/AllowedEmergencyPrivateCall

Table 10.2.42A.1: /<x>/<x>/Common/AllowedEmergencyPrivateCall

<x>/Common/AllowedEmergencyPrivateCall

Status	Occurrence	Format	Min. Access Types
Required	One	bool	Get, Replace

This leaf node indicates the authorisation to initiate an MCDData emergency one-to-one communication or to upgrade an MCDData normal priority one-to-one communication to an MCDData emergency one-to-one communication.

When set to "true" the MCDData user is authorised to initiate an MCDData emergency one-to-one communication or to upgrade an MCDData normal priority one-to-one communication to an MCDData emergency one-to-one communication.

When set to "false" the MCDData user is not authorised to initiate an MCDData emergency one-to-one communication or to upgrade an MCDData normal priority one-to-one communication to an MCDData emergency one-to-one communication.

10.2.42B /<x>/<x>/Common/AllowedCancelEmergencyPrivateCall

Table 10.2.42B.1: /<x>/<x>/Common/AllowedCancelEmergencyPrivateCall

<x>/Common/AllowedCancelEmergencyPrivateCall

Status	Occurrence	Format	Min. Access Types
Required	One	bool	Get, Replace

This leaf node indicates the authorisation to downgrade an MCDData emergency one-to-one communication to a normal priority one-to-one communication (e.g. reduce the priority of the communication).

When set to "true" the MCDData user is authorised to downgrade an MCDData emergency one-to-one communication to a normal priority one-to-one communication.

When set to "false" the MCDData user is not authorised to downgrade an MCDData emergency one-to-one communication to a normal priority one-to-one communication.

10.2.43 /<x>/<x>/OnNetwork

Table 10.2.43.1: /<x>/<x>/OnNetwork

<x>/OnNetwork

Status	Occurrence	Format	Min. Access Types
Required	ZeroOrOne	node	Get, Replace

This interior node represents a container for on-network operation.

10.2.44 /<x>/<x>/OnNetwork/MCDDataGroupList

Table 10.2.44.1: /<x>/<x>/OnNetwork/MCDDataGroupList

<x>/OnNetwork/MCDDataGroupList

Status	Occurrence	Format	Min. Access Types
Required	One	node	Get, Replace

This interior node is a placeholder for the list of on-network MCDData groups that the MCDData user is allowed to use.

10.2.45 /<x>/<x>/OnNetwork/MCDDataGroupList/<x>

Table 10.2.45.1: /<x>/<x>/OnNetwork/MCDDataGroupList/<x>

<x>/OnNetwork/MCDDataGroupList/<x>

Status	Occurrence	Format	Min. Access Types
Required	OneOrMore	node	Get, Replace

This interior node is a placeholder for one or more list of on-network MCDData groups that the MCDData user is allowed to use.

10.2.46 /<x>/<x>/OnNetwork/MCDDataGroupList/<x>/Entry

Table 10.2.46.1: /<x>/<x>/OnNetwork/MCDDataGroupList/<x>/Entry

<x>/OnNetwork/MCDDataGroupList/<x>/Entry

Status	Occurrence	Format	Min. Access Types
Optional	One	node	Get, Replace

This interior node is a placeholder for the details of the on-network MCDData groups that the MCDData user is allowed to use.

10.2.47 /<x>/<x>/OnNetwork/MCDDataGroupList/<x>/Entry/MCDDataGroupID

Table 10.2.47.1: /<x>/<x>/OnNetwork/MCDDataGroupList/<x>/Entry/MCDDataGroupID

<x>/OnNetwork/MCDDataGroupList/<x>/Entry/MCDDataGroupID

Status	Occurrence	Format	Min. Access Types
Required	One	chr	Get, Replace

This leaf node indicates the MCDData group ID for the on-network MCDData group that the MCDData user is allowed to use.

The value is a "uri" attribute specified in OMA OMA-TS-XDM_Group-V1_1 [4].

10.2.48 /<x>/<x>/OnNetwork/MCDDataGroupList/<x>/Entry/DisplayName

Table 10.2.48.1: /<x>/<x>/OnNetwork/MCDDataGroupList/<x>/Entry/DisplayName

<x>/OnNetwork/MCDDataGroupList/<x>/Entry/DisplayName

Status	Occurrence	Format	Min. Access Types
Optional	One	chr	Get, Replace

This leaf node contains a human readable name that corresponds to the MCDData Group ID.

10.2.49 Void

10.2.50 Void

10.2.51 /<x>/<x>/OnNetwork/MCDDataGroupList/<x>/Entry/GMSServID

Table 10.2.51.1: /<x>/<x>/OnNetwork/MCDDataGroupList/<x>/Entry/GMSServID

<x>/OnNetwork/MCDDataGroupList/<x>/Entry/GMSServID

Status	Occurrence	Format	Min. Access Types
Optional	One	chr	Get, Replace

This leaf node indicates the identity (URI) of the group management server hosting the MCDData Group ID.

10.2.52 Void

10.2.53 Void

10.2.54 /<x>/<x>/OnNetwork/MCDDataGroupList/<x>/Entry/IdMSTokenEndPoint

Table 10.2.54.1: /<x>/<x>/OnNetwork/MCDDataGroupList/<x>/Entry/IdMSTokenEndPoint

<x>/OnNetwork/MCDDataGroupList/<x>/Entry/IdMSTokenEndPoint

Status	Occurrence	Format	Min. Access Types
Optional	One	chr	Get, Replace

This leaf node indicates the identity (URI) of the IDMS token endpoint for the MCDData Group ID in the MCDDataGroupList. If the value is empty, the IDMS identities (IDMSAuthEndpoint and IDMSTokenEndPoint) present in the MCS UE initial configuration MO are used.

10.2.54A/<x>/<x>/OnNetwork/MCDDataGroupList/<x>/Entry/GroupKMSURI

Table 10.2.54A.1: /<x>/<x>/OnNetwork/MCDDataGroupList/<x>/Entry/GroupKMSURI

<x>/OnNetwork/MCDDataGroupList/<x>/Entry/GroupKMSURI

Status	Occurrence	Format	Min. Access Types
Required	One	chr	Get, Replace

This leaf node indicates key management server URI for the security domain of the MCDData group identity (MCDData Group ID) of the on-network MCDData group

The value is a URI as specified in 3GPP TS 23.003 [5].

10.2.55 /<x>/<x>/OnNetwork/MCDDataGroupList/<x>/Entry/RelativePresentationPriority

Table 10.2.55.1: /<x>/<x>/OnNetwork/MCDDataGroupList/<x>/Entry/RelativePresentationPriority

<x>/OnNetwork/MCDDataGroupList/<x>/Entry/RelativePresentationPriority

Status	Occurrence	Format	Min. Access Types
Optional	One	int	Get, Replace

This leaf node indicates indicating the presentation priority of the on-network group for the MCDData user relative to other on-network groups and on-network users.

- Values: 0-255

The lowest RelativePresentationPriority value shall be considered as the MCDData group transaction having the lowest priority for presentation among other group MCDData and one-to-one user transactions.

10.2.55A/<x>/<x>/OnNetwork/MCDataGroupList/<x>/Entry/ RulesForAffiliation

Table 10.2.55A.1: /<x>/<x>/OnNetwork/MCDataGroupList/<x>/Entry/RulesForAffiliation

<x>/OnNetwork/MCDataGroupList/<x>/Entry/RulesForAffiliation

Status	Occurrence	Format	Min. Access Types
Optional	ZeroOrOne	node	Get, Replace

This interior node is a placeholder for the rules that control automatic affiliation.

10.2.55A0 /<x>/<x>/OnNetwork/MCDataGroupList/<x>/Entry/ RulesForAffiliation/<x>

Table 10.2.55A0.1: /<x>/<x>/OnNetwork/MCDataGroupList/<x>/Entry/RulesForAffiliation/<x>

<x>/OnNetwork/MCDataGroupList/<x>/Entry/RulesForAffiliation/<x>

Status	Occurrence	Format	Min. Access Types
Optional	ZeroOrMore	node	Get, Replace

This interior node is a placeholder for the rules that control automatic affiliation.

10.2.55A1 /<x>/<x>/OnNetwork/MCDataGroupList/<x>/Entry/ RulesForAffiliation/<x>/ListOfLocationCriteria/

Table 10.2.55A1.1: /<x>/<x>/OnNetwork/MCDataGroupList/<x>/Entry/RulesForAffiliation/<x>/ListOfLocationCriteria

<x>/OnNetwork/MCDataGroupList/<x>/Entry/RulesForAffiliation/<x>/ListOfLocationCriteria

Status	Occurrence	Format	Min. Access Types
Optional	One	node	Get, Replace

This interior node is a placeholder for the location portion of the rules that control automatic affiliation.

10.2.55A2 /<x>/<x>/OnNetwork/MCDataGroupList/<x>/Entry/ RulesForAffiliation/<x>/ListOfLocationCriteria/<x>

Table 10.2.55A2.1: /<x>/<x>/OnNetwork/MCDataGroupList/<x>/Entry/RulesForAffiliation/<x>/ListOfLocationCriteria/<x>

<x>/OnNetwork/MCDataGroupList/<x>/Entry/RulesForAffiliation/<x>/ListOfLocationCriteria/<x>

Status	Occurrence	Format	Min. Access Types
Optional	ZeroOrMore	node	Get, Replace

This interior node is a placeholder for the location portion of the rules that control automatic affiliation.

10.2.55A3 /<x>/<x>/OnNetwork/MCDataGroupList/<x>/Entry/ RulesForAffiliation/<x>/ListOfLocationCriteria/<x>/Entry

**Table 10.2.55A3.1: /<x>/<x>/OnNetwork/MCDataGroupList/<x>/Entry/RulesForAffiliation/<x>/
ListOfLocationCriteria/<x>/Entry**

<x>/OnNetwork/MCDataGroupList/<x>/Entry/RulesForAffiliation/<x>/ListOfLocationCriteria/<x>/Entry

Status	Occurrence	Format	Min. Access Types
Optional	One	node	Get, Replace

This interior node is a placeholder for the location portion of the rules that control automatic affiliation.

10.2.55A4 /<x>/<x>/OnNetwork/MCDataGroupList/<x>/Entry/ RulesForAffiliation/<x>/ListOfLocationCriteria/<x>/Entry/ EnterSpecificArea

**Table 10.2.55A4.1: /<x>/<x>/OnNetwork/MCDataGroupList/<x>/Entry/RulesForAffiliation/<x>/
ListOfLocationCriteria/<x>/Entry/EnterSpecificArea**

<x>/OnNetwork/MCDataGroupList/<x>/Entry/RulesForAffiliation/<x>/ListOfLocationCriteria/<x>/Entry/EnterSpe
cificArea

Status	Occurrence	Format	Min. Access Types
Optional	ZeroOrOne	node	Get, Replace

This interior node contains a geographical area which when entered by the MC service UE triggers evaluation of the rules.

10.2.55A5 /<x>/<x>/OnNetwork/MCDataGroupList/<x>/Entry/ RulesForAffiliation/<x>/ListOfLocationCriteria/<x>/Entry/ EnterSpecificArea/PolygonArea

**Table 10.2.55A5.1: /<x>/<x>/OnNetwork/MCDataGroupList/<x>/Entry/RulesForAffiliation/<x>/
ListOfLocationCriteria/<x>/Entry/EnterSpecificArea/PolygonArea**

<x>/OnNetwork/MCDataGroupList/<x>/Entry/RulesForAffiliation/<x>/ListOfLocationCriteria/<x>/Entry/EnterSpe
cificArea/PolygonArea

Status	Occurrence	Format	Min. Access Types
Optional	ZeroOrOne	node	Get, Replace

This interior node contains a geographical area described by a polygon.

10.2.55A6 /<x>/<x>/OnNetwork/MCDataGroupList/<x>/Entry/ RulesForAffiliation/<x>/ListOfLocationCriteria/<x>/Entry/ EnterSpecificArea/PolygonArea/<x>

**Table 10.2.55A6.1: /<x>/<x>/OnNetwork/MCDataGroupList/<x>/Entry/RulesForAffiliation/<x>/
ListOfLocationCriteria/<x>/Entry/EnterSpecificArea/PolygonArea/<x>**

<x>/OnNetwork/MCDataGroupList/<x>/Entry/RulesForAffiliation/<x>/ListOfLocationCriteria/<x>/Entry/EnterSpe
cificArea/PolygonArea/<x>

Status	Occurrence	Format	Min. Access Types
Required	OneOrN	node	Get, Replace

This interior node contains the coordinates of the corners which define a polygon. The occurrence of this leaf node is "3 to 15" as per 3GPP TS 23.032 [21].

10.2.55A7 /<x>/<x>/OnNetwork/MCDataGroupList/<x>/Entry/ RulesForAffiliation/<x>/ListOfLocationCriteria/<x>/Entry/ EnterSpecificArea/PolygonArea/<x>/PointCoordinateType

**Table 10.2.55A7.1: /<x>/<x>/OnNetwork/MCDataGroupList/<x>/Entry/RulesForAffiliation/<x>/
ListOfLocationCriteria/<x>/Entry/EnterSpecificArea/PolygonArea/<x>/PointCoordinateType**

<x>/OnNetwork/MCDataGroupList/<x>/Entry/RulesForAffiliation/<x>/ListOfLocationCriteria/<x>/Entry/EnterSpe
cificArea/PolygonArea/<x>/PointCoordinateType

Status	Occurrence	Format	Min. Access Types
Required	One	node	Get, Replace

This interior node contains the type of the coordinates.

10.2.55A8 /<x>/<x>/OnNetwork/MCDataGroupList/<x>/Entry/ RulesForAffiliation/<x>/ListOfLocationCriteria/<x>/Entry/ EnterSpecificArea/PolygonArea/<x>/PointCoordinateType/ Longitude

**Table 10.2.55A8.1: /<x>/<x>/OnNetwork/MCDataGroupList/<x>/Entry/RulesForAffiliation/<x>/
ListOfLocationCriteria/<x>/Entry/EnterSpecificArea/PolygonArea/<x>/PointCoordinateType/
Longitude**

<x>/OnNetwork/MCDataGroupList/<x>/Entry/RulesForAffiliation/<x>/ListOfLocationCriteria/<x>/Entry/EnterSpe
cificArea/PolygonArea/<x>/PointCoordinateType/Longitude

Status	Occurrence	Format	Min. Access Types
Required	One	int	Get, Replace

This leaf node contains the longitudinal coordinate of a corner.

10.2.55A9 /<x>/<x>/OnNetwork/MCDataGroupList/<x>/Entry/ RulesForAffiliation/<x>/ListOfLocationCriteria/<x>/Entry/ EnterSpecificArea/PolygonArea/<x>/PointCoordinateType/ Latitude

**Table 10.2.55A9.1: /<x>/<x>/OnNetwork/MCDataGroupList/<x>/Entry/RulesForAffiliation/<x>/
ListOfLocationCriteria/<x>/Entry/EnterSpecificArea/PolygonArea/<x>/PointCoordinateType/
Latitude**

<x>/OnNetwork/MCDataGroupList/<x>/Entry/RulesForAffiliation/<x>/ListOfLocationCriteria/<x>/Entry/EnterSpe
cificArea/PolygonArea/<x>/PointCoordinateType/Latitude

Status	Occurrence	Format	Min. Access Types
Required	One	int	Get, Replace

This leaf node contains the latitudinal coordinate of a corner.

10.2.55A10 /<x>/<x>/OnNetwork/MCDataGroupList/<x>/Entry/
RulesForAffiliation/<x>/ListOfLocationCriteria/<x>/Entry/
EnterSpecificArea/EllipsoidArcArea

Table 10.2.55A10.1: /<x>/<x>/OnNetwork/MCDataGroupList/<x>/Entry/RulesForAffiliation/<x>/ListOfLocationCriteria/<x>/Entry/EnterSpecificArea/EllipsoidArcArea

<x>/OnNetwork/MCDataGroupList/<x>/Entry/RulesForAffiliation/<x>/ListOfLocationCriteria/<x>/Entry/EnterSpecificArea/EllipsoidArcArea

Status	Occurrence	Format	Min. Access Types
Optional	ZeroOrOne	node	Get, Replace

This interior node contains a geographical area described by an ellipsoid arc.

10.2.55A11 /<x>/<x>/OnNetwork/MCDataGroupList/<x>/Entry/
RulesForAffiliation/<x>/ListOfLocationCriteria/<x>/Entry/
EnterSpecificArea/EllipsoidArcArea/Center

Table 10.2.55A11.1: /<x>/<x>/OnNetwork/MCDataGroupList/<x>/Entry/RulesForAffiliation/<x>/ListOfLocationCriteria/<x>/Entry/EnterSpecificArea/EllipsoidArcArea/Center

<x>/OnNetwork/MCDataGroupList/<x>/Entry/RulesForAffiliation/<x>/ListOfLocationCriteria/<x>/Entry/EnterSpecificArea/EllipsoidArcArea/Center

Status	Occurrence	Format	Min. Access Types
Required	One	node	Get, Replace

This interior node contains the coordinates of the center point of the ellipsoid arc.

10.2.55A12 /<x>/<x>/OnNetwork/MCDataGroupList/<x>/Entry/
RulesForAffiliation/<x>/ListOfLocationCriteria/<x>/Entry/
EnterSpecificArea/EllipsoidArcArea/Center/PointCoordinateType

Table 10.2.55A12.1: /<x>/<x>/OnNetwork/MCDataGroupList/<x>/Entry/RulesForAffiliation/<x>/ListOfLocationCriteria/<x>/Entry/EnterSpecificArea/EllipsoidArcArea/Center/PointCoordinateType

<x>/OnNetwork/MCDataGroupList/<x>/Entry/RulesForAffiliation/<x>/ListOfLocationCriteria/<x>/Entry/EnterSpecificArea/EllipsoidArcArea/Center/PointCoordinateType

Status	Occurrence	Format	Min. Access Types
Required	One	node	Get, Replace

This interior node contains the coordinates of the center point of the ellipsoid arc.

10.2.55A13 /<x>/<x>/OnNetwork/MCDataGroupList/<x>/Entry/
RulesForAffiliation/<x>/ListOfLocationCriteria/<x>/Entry/
EnterSpecificArea/EllipsoidArcArea/Center/PointCoordinateType/
Longitude

**Table 10.2.55A13.1: /<x>/<x>/OnNetwork/MCDataGroupList/<x>/Entry/RulesForAffiliation/<x>/
ListOfLocationCriteria/<x>/Entry/EnterSpecificArea/EllipsoidArcArea/Center/PointCoordinateType/
Longitude**

<x>/OnNetwork/MCDataGroupList/<x>/Entry/RulesForAffiliation/<x>/ListOfLocationCriteria/<x>/Entry/EnterSpe
cificArea/EllipsoidArcArea/Center/PointCoordinateType/Longitude

Status	Occurrence	Format	Min. Access Types
Required	One	int	Get, Replace

This leaf node contains the longitudinal coordinate of the center.

10.2.55A14 /<x>/<x>/OnNetwork/MCDataGroupList/<x>/Entry/
RulesForAffiliation/<x>/ListOfLocationCriteria/<x>/Entry/
EnterSpecificArea/EllipsoidArcArea/Center/PointCoordinateType/
Latitude

**Table 10.2.55A14.1: /<x>/<x>/OnNetwork/MCDataGroupList/<x>/Entry/RulesForAffiliation/<x>/
ListOfLocationCriteria/<x>/Entry/EnterSpecificArea/EllipsoidArcArea/Center/PointCoordinateType/
Latitude**

<x>/OnNetwork/MCDataGroupList/<x>/Entry/RulesForAffiliation/<x>/ListOfLocationCriteria/<x>/Entry/EnterSpe
cificArea/EllipsoidArcArea/Center/PointCoordinateType/Latitude

Status	Occurrence	Format	Min. Access Types
Required	One	int	Get, Replace

This leaf node contains the latitudinal coordinate of a center.

10.2.55A15 /<x>/<x>/OnNetwork/MCDataGroupList/<x>/Entry/
RulesForAffiliation/<x>/ListOfLocationCriteria/<x>/Entry/
EnterSpecificArea/EllipsoidArcArea/Radius

**Table 10.2.55A15.1: /<x>/<x>/OnNetwork/MCDataGroupList/<x>/Entry/RulesForAffiliation/<x>/
ListOfLocationCriteria/<x>/Entry/EnterSpecificArea/EllipsoidArcArea/Radius**

<x>/OnNetwork/MCDataGroupList/<x>/Entry/RulesForAffiliation/<x>/ListOfLocationCriteria/<x>/Entry/EnterSpe
cificArea/EllipsoidArcArea/Center/Radius

Status	Occurrence	Format	Min. Access Types
Required	One	int	Get, Replace

This leaf node contains the radius of the ellipsoid arc.

10.2.55A16 /<x>/<x>/OnNetwork/MCDataGroupList/<x>/Entry/ RulesForAffiliation/<x>/ListOfLocationCriteria/<x>/Entry/ EnterSpecificArea/EllipsoidArcArea/OffsetAngle

**Table 10.2.55A16.1: /<x>/<x>/OnNetwork/MCDataGroupList/<x>/Entry/RulesForAffiliation/<x>/
ListOfLocationCriteria/<x>/Entry/EnterSpecificArea/EllipsoidArcArea/OffsetAngle**

<x>/OnNetwork/MCDataGroupList/<x>/Entry/RulesForAffiliation/<x>/ListOfLocationCriteria/<x>/Entry/EnterSpe
cificArea/EllipsoidArcArea/OffsetAngle

Status	Occurrence	Format	Min. Access Types
Required	One	int	Get, Replace

This leaf node contains the offset angle of the ellipsoid arc.

10.2.55A17 /<x>/<x>/OnNetwork/MCDataGroupList/<x>/Entry/ RulesForAffiliation/<x>/ListOfLocationCriteria/<x>/Entry/ EnterSpecificArea/EllipsoidArcArea/IncludedAngle

**Table 10.2.55A17.1: /<x>/<x>/OnNetwork/MCDataGroupList/<x>/Entry/RulesForAffiliation/<x>/
ListOfLocationCriteria/<x>/Entry/EnterSpecificArea/EllipsoidArcArea/IncludedAngle**

<x>/OnNetwork/MCDataGroupList/<x>/Entry/RulesForAffiliation/<x>/ListOfLocationCriteria/<x>/Entry/EnterSpe
cificArea/EllipsoidArcArea/IncludedAngle

Status	Occurrence	Format	Min. Access Types
Required	One	int	Get, Replace

This leaf node contains the included angle of the ellipsoid arc.

10.2.55A18 /<x>/<x>/OnNetwork/MCDataGroupList/<x>/Entry/ RulesForAffiliation/<x>/ListOfLocationCriteria/<x>/Entry/ EnterSpecificArea/Speed

**Table 10.2.55A18.1: /<x>/<x>/OnNetwork/MCDataGroupList/<x>/Entry/RulesForAffiliation/<x>/
ListOfLocationCriteria/<x>/Entry/EnterSpecificArea/Speed**

<x>/OnNetwork/MCDataGroupList/<x>/Entry/RulesForAffiliation/<x>/ListOfLocationCriteria/<x>/Entry/EnterSpe
cificArea/Speed

Status	Occurrence	Format	Min. Access Types
Optional	One	node	Get, Replace

This interior node contains the speed.

10.2.55A19 /<x>/<x>/OnNetwork/MCDataGroupList/<x>/Entry/ RulesForAffiliation/<x>/ListOfLocationCriteria/<x>/Entry/ EnterSpecificArea/Speed/MinimumSpeed

**Table 10.2.55A19.1: /<x>/<x>/OnNetwork/MCDataGroupList/<x>/Entry/RulesForAffiliation/<x>/
ListOfLocationCriteria/<x>/Entry/EnterSpecificArea/Speed/MinimumSpeed**

<x>/OnNetwork/MCDataGroupList/<x>/Entry/RulesForAffiliation/<x>/ListOfLocationCriteria/<x>/Entry/EnterSpe
cificArea/Speed/MinimumSpeed

Status	Occurrence	Format	Min. Access Types

Required	One	int	Get, Replace
----------	-----	-----	--------------

This leaf node contains the minimum speed.

- Values: non-negative integer in units of kilometers/hour.

10.2.55A20 /<x>/<x>/OnNetwork/MCDataGroupList/<x>/Entry/RulesForAffiliation/<x>/ListOfLocationCriteria/<x>/Entry/EnterSpecificArea/Speed/MaximumSpeed

Table 10.2.55A20.1: /<x>/<x>/OnNetwork/MCDataGroupList/<x>/Entry/RulesForAffiliation/<x>/ListOfLocationCriteria/<x>/Entry/EnterSpecificArea/Speed/MaximumSpeed

<x>/OnNetwork/MCDataGroupList/<x>/Entry/RulesForAffiliation/<x>/ListOfLocationCriteria/<x>/Entry/EnterSpecificArea/Speed/MaximumSpeed

Status	Occurrence	Format	Min. Access Types
Required	One	int	Get, Replace

This leaf node contains the maximum speed.

- Values: non-negative integer in units of kilometers/hour.

10.2.55A21 /<x>/<x>/OnNetwork/MCDataGroupList/<x>/Entry/RulesForAffiliation/<x>/ListOfLocationCriteria/<x>/Entry/EnterSpecificArea/Heading

Table 10.2.55A21.1: /<x>/<x>/OnNetwork/MCDataGroupList/<x>/Entry/RulesForAffiliation/<x>/ListOfLocationCriteria/<x>/Entry/EnterSpecificArea/Heading

<x>/OnNetwork/MCDataGroupList/<x>/Entry/RulesForAffiliation/<x>/ListOfLocationCriteria/<x>/Entry/EnterSpecificArea/Heading

Status	Occurrence	Format	Min. Access Types
Optional	One	node	Get, Replace

This interior node contains the heading.

10.2.55A22 /<x>/<x>/OnNetwork/MCDataGroupList/<x>/Entry/RulesForAffiliation/<x>/ListOfLocationCriteria/<x>/Entry/EnterSpecificArea/Heading/MinimumHeading

Table 10.2.55A22.1: /<x>/<x>/OnNetwork/MCDataGroupList/<x>/Entry/RulesForAffiliation/<x>/ListOfLocationCriteria/<x>/Entry/EnterSpecificArea/Heading/MinimumHeading

<x>/OnNetwork/MCDataGroupList/<x>/Entry/RulesForAffiliation/<x>/ListOfLocationCriteria/<x>/Entry/EnterSpecificArea/Heading/MinimumHeading

Status	Occurrence	Format	Min. Access Types
Required	One	int	Get, Replace

This leaf node contains the minimum heading.

- Values: 0-359

10.2.55A23 /<x>/<x>/OnNetwork/MCDataGroupList/<x>/Entry/
RulesForAffiliation/<x>/ListOfLocationCriteria/<x>/Entry/
EnterSpecificArea/Heading/MaximumHeading

Table 10.2.55A23.1: /<x>/<x>/OnNetwork/MCDataGroupList/<x>/Entry/RulesForAffiliation/<x>/ListOfLocationCriteria/<x>/Entry/EnterSpecificArea/Heading/MaximumHeading

<x>/OnNetwork/MCDataGroupList/<x>/Entry/RulesForAffiliation/<x>/ListOfLocationCriteria/<x>/Entry/EnterSpecificArea/Heading/MaximumHeading

Status	Occurrence	Format	Min. Access Types
Required	One	int	Get, Replace

This leaf node contains the maximum heading.

- Values: 0-359

10.2.55A24 /<x>/<x>/OnNetwork/MCDataGroupList/<x>/Entry/
RulesForAffiliation/<x>/ListOfLocationCriteria/<x>/Entry/
ExitSpecificArea

Table 10.2.55A24.1: /<x>/<x>/OnNetwork/MCDataGroupList/<x>/Entry/RulesForAffiliation/<x>/ListOfLocationCriteria/<x>/Entry/ExitSpecificArea

<x>/OnNetwork/MCDataGroupList/<x>/Entry/RulesForAffiliation/<x>/ListOfLocationCriteria/<x>/Entry/ExitSpecificArea

Status	Occurrence	Format	Min. Access Types
Optional	ZeroOrOne	node	Get, Replace

This interior node contains a geographical area which when entered by the MC service UE triggers evaluation of the rules.

10.2.55A25 /<x>/<x>/OnNetwork/MCDataGroupList/<x>/Entry/
RulesForAffiliation/<x>/ListOfLocationCriteria/<x>/Entry/
ExitSpecificArea/PolygonArea

Table 10.2.55A25.1: /<x>/<x>/OnNetwork/MCDataGroupList/<x>/Entry/RulesForAffiliation/<x>/ListOfLocationCriteria/<x>/Entry/ExitSpecificArea/PolygonArea

<x>/OnNetwork/MCDataGroupList/<x>/Entry/RulesForAffiliation/<x>/ListOfLocationCriteria/<x>/Entry/ExitSpecificArea/PolygonArea

Status	Occurrence	Format	Min. Access Types
Optional	ZeroOrOne	node	Get, Replace

This interior node contains a geographical area described by a polygon.

10.2.55A26 /<x>/<x>/OnNetwork/MCDataGroupList/<x>/Entry/ RulesForAffiliation/<x>/ListOfLocationCriteria/<x>/Entry/ ExitSpecificArea/PolygonArea/<x>

**Table 10.2.55A26.1: /<x>/<x>/OnNetwork/MCDataGroupList/<x>/Entry/RulesForAffiliation/<x>/
ListOfLocationCriteria/<x>/Entry/ExitSpecificArea/PolygonArea/<x>**

<x>/OnNetwork/MCDataGroupList/<x>/Entry/RulesForAffiliation/<x>/ListOfLocationCriteria/<x>/Entry/ExitSpecificArea/PolygonArea/<x>

Status	Occurrence	Format	Min. Access Types
Required	OneOrN	node	Get, Replace

This interior node contains the coordinates of the corners which define a polygon. The occurrence of this leaf node is "3 to 15" as per 3GPP TS 23.032 [21].

10.2.55A27 /<x>/<x>/OnNetwork/MCDataGroupList/<x>/Entry/ RulesForAffiliation/<x>/ListOfLocationCriteria/<x>/Entry/ ExitSpecificArea/PolygonArea/<x>/PointCoordinateType

**Table 10.2.55A27.1: /<x>/<x>/OnNetwork/MCDataGroupList/<x>/Entry/RulesForAffiliation/<x>/
ListOfLocationCriteria/<x>/Entry/ExitSpecificArea/PolygonArea/<x>/PointCoordinateType**

<x>/OnNetwork/MCDataGroupList/<x>/Entry/RulesForAffiliation/<x>/ListOfLocationCriteria/<x>/Entry/ExitSpecificArea/PolygonArea/<x>/PointCoordinateType

Status	Occurrence	Format	Min. Access Types
Required	One	node	Get, Replace

This interior node contains the type of the coordinates.

10.2.55A28 /<x>/<x>/OnNetwork/MCDataGroupList/<x>/Entry/ RulesForAffiliation/<x>/ListOfLocationCriteria/<x>/Entry/ ExitSpecificArea/PolygonArea/<x>/PointCoordinateType/ Longitude

**Table 10.2.55A28.1: /<x>/<x>/OnNetwork/MCDataGroupList/<x>/Entry/RulesForAffiliation/<x>/
ListOfLocationCriteria/<x>/Entry/ExitSpecificArea/PolygonArea/<x>/PointCoordinateType/
Longitude**

<x>/OnNetwork/MCDataGroupList/<x>/Entry/RulesForAffiliation/<x>/ListOfLocationCriteria/<x>/Entry/ExitSpecificArea/PolygonArea/<x>/PointCoordinateType/Longitude

Status	Occurrence	Format	Min. Access Types
Required	One	int	Get, Replace

This leaf node contains the longitudinal coordinate of a corner.

10.2.55A29 /<x>/<x>/OnNetwork/MCDataGroupList/<x>/Entry/
RulesForAffiliation/<x>/ListOfLocationCriteria/<x>/Entry/
ExitSpecificArea/PolygonArea/<x>/PointCoordinateType/
Latitude

Table 10.2.55A29.1: /<x>/<x>/OnNetwork/MCDataGroupList/<x>/Entry/RulesForAffiliation/<x>/ListOfLocationCriteria/<x>/Entry/ExitSpecificArea/PolygonArea/<x>/PointCoordinateType/Latitude

<x>/OnNetwork/MCDataGroupList/<x>/Entry/RulesForAffiliation/<x>/ListOfLocationCriteria/<x>/Entry/ExitSpecificArea/PolygonArea/<x>/PointCoordinateType/Latitude

Status	Occurrence	Format	Min. Access Types
Required	One	int	Get, Replace

This leaf node contains the latitudinal coordinate of a corner.

10.2.55A30 /<x>/<x>/OnNetwork/MCDataGroupList/<x>/Entry/
RulesForAffiliation/<x>/ListOfLocationCriteria/<x>/Entry/
ExitSpecificArea/EllipsoidArcArea

Table 10.2.55A30.1: /<x>/<x>/OnNetwork/MCDataGroupList/<x>/Entry/RulesForAffiliation/<x>/ListOfLocationCriteria/<x>/Entry/ExitSpecificArea/EllipsoidArcArea

<x>/OnNetwork/MCDataGroupList/<x>/Entry/RulesForAffiliation/<x>/ListOfLocationCriteria/<x>/Entry/ExitSpecificArea/EllipsoidArcArea

Status	Occurrence	Format	Min. Access Types
Optional	ZeroOrOne	node	Get, Replace

This interior node contains a geographical area described by an ellipsoid arc.

10.2.55A31 /<x>/<x>/OnNetwork/MCDataGroupList/<x>/Entry/
RulesForAffiliation/<x>/ListOfLocationCriteria/<x>/Entry/
ExitSpecificArea/EllipsoidArcArea/Center

Table 10.2.55A31.1: /<x>/<x>/OnNetwork/MCDataGroupList/<x>/Entry/RulesForAffiliation/<x>/ListOfLocationCriteria/<x>/Entry/ExitSpecificArea/EllipsoidArcArea/Center

<x>/OnNetwork/MCDataGroupList/<x>/Entry/RulesForAffiliation/<x>/ListOfLocationCriteria/<x>/Entry/ExitSpecificArea/EllipsoidArcArea/Center

Status	Occurrence	Format	Min. Access Types
Required	One	node	Get, Replace

This interior node contains the coordinates of the center point of the ellipsoid arc.

10.2.55A32 /<x>/<x>/OnNetwork/MCDataGroupList/<x>/Entry/
RulesForAffiliation/<x>/ListOfLocationCriteria/<x>/Entry/
ExitSpecificArea/EllipsoidArcArea/Center/PointCoordinateType

Table 10.2.55A32.1: /<x>/<x>/OnNetwork/MCDataGroupList/<x>/Entry/RulesForAffiliation/<x>/ListOfLocationCriteria/<x>/Entry/ExitSpecificArea/EllipsoidArcArea/Center/PointCoordinateType

<x>/OnNetwork/MCDataGroupList/<x>/Entry/RulesForAffiliation/<x>/ListOfLocationCriteria/<x>/Entry/ExitSpecificArea/EllipsoidArcArea/Center/PointCoordinateType

Status	Occurrence	Format	Min. Access Types
Required	One	node	Get, Replace

This interior node contains the coordinates of the center point of the ellipsoid arc.

10.2.55A33 /<x>/<x>/OnNetwork/MCDataGroupList/<x>/Entry/ RulesForAffiliation/<x>/ListOfLocationCriteria/<x>/Entry/ ExitSpecificArea/EllipsoidArcArea/Center/PointCoordinateType/ Longitude

**Table 10.2.55A33.1: /<x>/<x>/OnNetwork/MCDataGroupList/<x>/Entry/RulesForAffiliation/<x>/
ListOfLocationCriteria/<x>/Entry/ExitSpecificArea/EllipsoidArcArea/Center/PointCoordinateType/
Longitude**

<x>/OnNetwork/MCDataGroupList/<x>/Entry/RulesForAffiliation/<x>/ListOfLocationCriteria/<x>/Entry/ExitSpecificArea/EllipsoidArcArea/Center/PointCoordinateType/Longitude

Status	Occurrence	Format	Min. Access Types
Required	One	int	Get, Replace

This leaf node contains the longitudinal coordinate of the center.

10.2.55A34 /<x>/<x>/OnNetwork/MCDataGroupList/<x>/Entry/ RulesForAffiliation/<x>/ListOfLocationCriteria/<x>/Entry/ ExitSpecificArea/EllipsoidArcArea/Center/PointCoordinateType/ Latitude

**Table 10.2.55A34.1: /<x>/<x>/OnNetwork/MCDataGroupList/<x>/Entry/RulesForAffiliation/<x>/
ListOfLocationCriteria/<x>/Entry/ExitSpecificArea/EllipsoidArcArea/Center/PointCoordinateType/
Latitude**

<x>/OnNetwork/MCDataGroupList/<x>/Entry/RulesForAffiliation/<x>/ListOfLocationCriteria/<x>/Entry/ExitSpecificArea/EllipsoidArcArea/Center/PointCoordinateType/Latitude

Status	Occurrence	Format	Min. Access Types
Required	One	int	Get, Replace

This leaf node contains the latitudinal coordinate of a center.

10.2.55A35 /<x>/<x>/OnNetwork/MCDataGroupList/<x>/Entry/ RulesForAffiliation/<x>/ListOfLocationCriteria/<x>/Entry/ ExitSpecificArea/EllipsoidArcArea/Radius

**Table 10.2.55A35.1: /<x>/<x>/OnNetwork/MCDataGroupList/<x>/Entry/RulesForAffiliation/<x>/
ListOfLocationCriteria/<x>/Entry/ExitSpecificArea/EllipsoidArcArea/Radius**

<x>/OnNetwork/MCDataGroupList/<x>/Entry/RulesForAffiliation/<x>/ListOfLocationCriteria/<x>/Entry/ExitSpecificArea/EllipsoidArcArea/Center/Radius

Status	Occurrence	Format	Min. Access Types
Required	One	int	Get, Replace

This leaf node contains the radius of the ellipsoid arc.

10.2.55A36 /<x>/<x>/OnNetwork/MCDataGroupList/<x>/Entry/ RulesForAffiliation/<x>/ListOfLocationCriteria/<x>/Entry/ ExitSpecificArea/EllipsoidArcArea/OffsetAngle

**Table 10.2.55A36.1: /<x>/<x>/OnNetwork/MCDataGroupList/<x>/Entry/RulesForAffiliation/<x>/
ListOfLocationCriteria/<x>/Entry/ExitSpecificArea/EllipsoidArcArea/OffsetAngle**

<x>/OnNetwork/MCDataGroupList/<x>/Entry/RulesForAffiliation/<x>/ListOfLocationCriteria/<x>/Entry/ExitSpecificArea/EllipsoidArcArea/OffsetAngle

Status	Occurrence	Format	Min. Access Types
Required	One	int	Get, Replace

This leaf node contains the offset angle of the ellipsoid arc.

10.2.55A37 /<x>/<x>/OnNetwork/MCDataGroupList/<x>/Entry/ RulesForAffiliation/<x>/ListOfLocationCriteria/<x>/Entry/ ExitSpecificArea/EllipsoidArcArea/IncludedAngle

**Table 10.2.55A37.1: /<x>/<x>/OnNetwork/MCDataGroupList/<x>/Entry/RulesForAffiliation/<x>/
ListOfLocationCriteria/<x>/Entry/ExitSpecificArea/EllipsoidArcArea/IncludedAngle**

<x>/OnNetwork/MCDataGroupList/<x>/Entry/RulesForAffiliation/<x>/ListOfLocationCriteria/<x>/Entry/ExitSpecificArea/EllipsoidArcArea/IncludedAngle

Status	Occurrence	Format	Min. Access Types
Required	One	int	Get, Replace

This leaf node contains the included angle of the ellipsoid arc.

10.2.55A38 /<x>/<x>/OnNetwork/MCDataGroupList/<x>/Entry/ RulesForAffiliation/<x>/ListOfLocationCriteria/<x>/Entry/ ExitSpecificArea/Speed

**Table 10.2.55A38.1: /<x>/<x>/OnNetwork/MCDataGroupList/<x>/Entry/RulesForAffiliation/<x>/
ListOfLocationCriteria/<x>/Entry/ExitSpecificArea/Speed**

<x>/OnNetwork/MCDataGroupList/<x>/Entry/RulesForAffiliation/<x>/ListOfLocationCriteria/<x>/Entry/ExitSpecificArea/Speed

Status	Occurrence	Format	Min. Access Types
Optional	One	node	Get, Replace

This interior node contains the speed.

10.2.55A39 /<x>/<x>/OnNetwork/MCDataGroupList/<x>/Entry/ RulesForAffiliation/<x>/ListOfLocationCriteria/<x>/Entry/ ExitSpecificArea/Speed/MinimumSpeed

**Table 10.2.55A39.1: /<x>/<x>/OnNetwork/MCDataGroupList/<x>/Entry/RulesForAffiliation/<x>/
ListOfLocationCriteria/<x>/Entry/ExitSpecificArea/Speed/MinimumSpeed**

<x>/OnNetwork/MCDataGroupList/<x>/Entry/RulesForAffiliation/<x>/ListOfLocationCriteria/<x>/Entry/ExitSpecificArea/Speed/MinimumSpeed

Status	Occurrence	Format	Min. Access Types

Required	One	int	Get, Replace
----------	-----	-----	--------------

This leaf node contains the minimum speed.

- Values: non-negative integer in units of kilometers/hour.

10.2.55A40 /<x>/<x>/OnNetwork/MCDataGroupList/<x>/Entry/RulesForAffiliation/<x>/ListOfLocationCriteria/<x>/Entry/ExitSpecificArea/Speed/MaximumSpeed

Table 10.2.55A40.1: /<x>/<x>/OnNetwork/MCDataGroupList/<x>/Entry/RulesForAffiliation/<x>/ListOfLocationCriteria/<x>/Entry/ExitSpecificArea/Speed/MaximumSpeed

<x>/OnNetwork/MCDataGroupList/<x>/Entry/RulesForAffiliation/<x>/ListOfLocationCriteria/<x>/Entry/ExitSpecificArea/Speed/MaximumSpeed

Status	Occurrence	Format	Min. Access Types
Required	One	int	Get, Replace

This leaf node contains the maximum speed.

- Values: non-negative integer in units of kilometers/hour.

10.2.55A41 /<x>/<x>/OnNetwork/MCDataGroupList/<x>/Entry/RulesForAffiliation/<x>/ListOfLocationCriteria/<x>/Entry/ExitSpecificArea/Heading

Table 5. 10.2.55A41.1: /<x>/<x>/OnNetwork/MCDataGroupList/<x>/Entry/RulesForAffiliation/<x>/ListOfLocationCriteria/<x>/Entry/ExitSpecificArea/Heading

<x>/OnNetwork/MCDataGroupList/<x>/Entry/RulesForAffiliation/<x>/ListOfLocationCriteria/<x>/Entry/ExitSpecificArea/Heading

Status	Occurrence	Format	Min. Access Types
Optional	One	node	Get, Replace

This interior node contains the heading.

10.2.55A42 /<x>/<x>/OnNetwork/MCDataGroupList/<x>/Entry/RulesForAffiliation/<x>/ListOfLocationCriteria/<x>/Entry/ExitSpecificArea/Heading/MinimumHeading

Table 10.2.55A42.1: /<x>/<x>/OnNetwork/MCDataGroupList/<x>/Entry/RulesForAffiliation/<x>/ListOfLocationCriteria/<x>/Entry/ExitSpecificArea/Heading/MinimumHeading

<x>/OnNetwork/MCDataGroupList/<x>/Entry/RulesForAffiliation/<x>/ListOfLocationCriteria/<x>/Entry/ExitSpecificArea/Heading/MinimumHeading

Status	Occurrence	Format	Min. Access Types
Required	One	int	Get, Replace

This leaf node contains the minimum heading.

- Values: 0-359

10.2.55A43 /<x>/<x>/OnNetwork/MCDataGroupList/<x>/Entry/
RulesForAffiliation/<x>/ListOfLocationCriteria/<x>/Entry/
ExitSpecificArea/Heading/MaximumHeading

**Table 10.2.55A43.1: /<x>/<x>/OnNetwork/MCDataGroupList/<x>/Entry/RulesForAffiliation/<x>/
ListOfLocationCriteria/<x>/Entry/ExitSpecificArea/Heading/MaximumHeading**

<x>/OnNetwork/MCDataGroupList/<x>/Entry/RulesForAffiliation/<x>/ListOfLocationCriteria/<x>/Entry/ExitSpecificArea/Heading/MaximumHeading

Status	Occurrence	Format	Min. Access Types
Required	One	int	Get, Replace

This leaf node contains the maximum heading.

- Values: 0-359

10.2.55A44 /<x>/<x>/OnNetwork/MCDataGroupList/<x>/Entry/
RulesForAffiliation/<x>/ListOfActiveFunctionalAliases

**Table 10.2.55A44.1: /<x>/<x>/OnNetwork/MCDataGroupList/<x>/Entry/RulesForAffiliation/<x>/
ListOfActiveFunctionalAliases**

<x>/OnNetwork/MCDataGroupList/<x>/Entry/RulesForAffiliation/<x>/ListOfActiveFunctionalAliases

Status	Occurrence	Format	Min. Access Types
Optional	One	node	Get, Replace

This interior node is a placeholder for the functional alias part of rules that control automatic affiliation.

10.2.55A45 /<x>/<x>/OnNetwork/MCDataGroupList/<x>/Entry/
RulesForAffiliation/<x>/ListOfActiveFunctionalAliases/<x>

**Table 10.2.55A45.1: /<x>/<x>/OnNetwork/MCDataGroupList/<x>/Entry/RulesForAffiliation/<x>/
ListOfActiveFunctionalAliases/<x>**

<x>/OnNetwork/MCDataGroupList/<x>/Entry/RulesForAffiliation/<x>/ListOfActiveFunctionalAliases/<x>

Status	Occurrence	Format	Min. Access Types
Optional	OneOrMore	node	Get, Replace

This interior node is a placeholder for the functional alias part of rules that control automatic affiliation.

10.2.55A46 /<x>/<x>/OnNetwork/MCDataGroupList/<x>/Entry/
RulesForAffiliation/<x>/ListOfActiveFunctionalAliases/<x>/Entry

**Table 10.2.55A46.1: /<x>/<x>/OnNetwork/MCDataGroupList/<x>/Entry/RulesForAffiliation/<x>/
ListOfActiveFunctionalAliases/<x>/Entry**

<x>/OnNetwork/MCDataGroupList/<x>/Entry/RulesForAffiliation/<x>/ListOfActiveFunctionalAliases/<x>/Entry

Status	Occurrence	Format	Min. Access Types
Optional	One	node	Get, Replace

This interior node is a placeholder for the functional alias part of rules that control automatic affiliation.

10.2.55A47 /<x>/<x>/OnNetwork/MCDataGroupList/<x>/Entry/ RulesForAffiliation/<x>/ListOfActiveFunctionalAliases/<x>/ Entry/FunctionalAlias

**Table 10.2.55A47.1: /<x>/<x>/OnNetwork/MCDataGroupList/<x>/Entry/RulesForAffiliation/<x>/
ListOfActiveFunctionalAliases/<x>/Entry/FunctionalAlias**

<x>/OnNetwork/MCDataGroupList/<x>/Entry/RulesForAffiliation/<x>/ListOfActiveFunctionalAliases/<x>/Entry/F
unctionalAlias

Status	Occurrence	Format	Min. Access Types
Required	One	chr	Get, Replace

This leaf node contains a functional alias.

10.2.55B/<x>/<x>/OnNetwork/MCDataGroupList/<x>/Entry/ RulesForDeaffiliation

Table 10.2.55B.1: /<x>/<x>/OnNetwork/MCDataGroupList/<x>/Entry/RulesForDeaffiliation

<x>/OnNetwork/MCDataGroupList/<x>/Entry/RulesForDeaffiliation

Status	Occurrence	Format	Min. Access Types
Optional	ZeroOrOne	node	Get, Replace

This interior node is a placeholder for the rules that control automatic deaffiliation.

10.2.55B0 /<x>/<x>/OnNetwork/MCDataGroupList/<x>/Entry/ RulesForDeaffiliation/<x>

Table 10.2.55B0.1: /<x>/<x>/OnNetwork/MCDataGroupList/<x>/Entry/RulesForDeaffiliation/<x>

<x>/OnNetwork/MCDataGroupList/<x>/Entry/RulesForDeaffiliation/<x>

Status	Occurrence	Format	Min. Access Types
Optional	ZeroOrMore	node	Get, Replace

This interior node is a placeholder for the zero or more rules that control automatic deaffiliation.

10.2.55B1 /<x>/<x>/OnNetwork/MCDataGroupList/<x>/Entry/ RulesForDeaffiliation/<x>/ListOfLocationCriteria/

**Table 10.2.55B1.1: /<x>/<x>/OnNetwork/MCDataGroupList/<x>/Entry/RulesForDeaffiliation/<x>/
ListOfLocationCriteria**

<x>/OnNetwork/MCDataGroupList/<x>/Entry/RulesForDeaffiliation/<x>/ListOfLocationCriteria

Status	Occurrence	Format	Min. Access Types
Optional	One	node	Get, Replace

This interior node is a placeholder for the location portion of the rules that control automatic deaffiliation.

10.2.55B2 /<x>/<x>/OnNetwork/MCDataGroupList/<x>/Entry/ RulesForDeaffiliation/<x>/ListOfLocationCriteria/<x>

**Table 10.2.55B2.1: /<x>/<x>/OnNetwork/MCDataGroupList/<x>/Entry/RulesForDeaffiliation/<x>/
ListOfLocationCriteria/<x>**

<x>/OnNetwork/MCDataGroupList/<x>/Entry/RulesForDeaffiliation/<x>/ListOfLocationCriteria/<x>

Status	Occurrence	Format	Min. Access Types
Optional	ZeroOrMore	node	Get, Replace

This interior node is a placeholder for the location portion of the rules that control automatic deaffiliation.

10.2.55B3 /<x>/<x>/OnNetwork/MCDataGroupList/<x>/Entry/ RulesForDeaffiliation/<x>/ListOfLocationCriteria/<x>/Entry

**Table 10.2.55B3.1: /<x>/<x>/OnNetwork/MCDataGroupList/<x>/Entry/RulesForDeaffiliation/<x>/
ListOfLocationCriteria/<x>/Entry**

<x>/OnNetwork/MCDataGroupList/<x>/Entry/RulesForDeaffiliation/<x>/ListOfLocationCriteria/<x>/Entry

Status	Occurrence	Format	Min. Access Types
Optional	One	node	Get, Replace

This interior node is a placeholder for the location portion of the rules that control automatic deaffiliation.

10.2.55B4 /<x>/<x>/OnNetwork/MCDataGroupList/<x>/Entry/ RulesForDeaffiliation/<x>/ListOfLocationCriteria/<x>/Entry/ EnterSpecificArea

**Table 10.2.55B4.1: /<x>/<x>/OnNetwork/MCDataGroupList/<x>/Entry/RulesForDeaffiliation/<x>/
ListOfLocationCriteria/<x>/Entry/EnterSpecificArea**

<x>/OnNetwork/MCDataGroupList/<x>/Entry/RulesForDeaffiliation/<x>/ListOfLocationCriteria/<x>/Entry/EnterS
pecificArea

Status	Occurrence	Format	Min. Access Types
Optional	ZeroOrOne	node	Get, Replace

This interior node contains a geographical area which, when entered by the MC service UE triggers evaluation of the rules.

10.2.55B5 /<x>/<x>/OnNetwork/MCDataGroupList/<x>/Entry/ RulesForDeaffiliation/<x>/ListOfLocationCriteria/<x>/Entry/ EnterSpecificArea/PolygonArea

**Table 10.2.55B5.1: /<x>/<x>/OnNetwork/MCDataGroupList/<x>/Entry/RulesForDeaffiliation/<x>/
ListOfLocationCriteria/<x>/Entry/EnterSpecificArea/PolygonArea**

<x>/OnNetwork/MCDataGroupList/<x>/Entry/RulesForDeaffiliation/<x>/ListOfLocationCriteria/<x>/Entry/EnterS
pecificArea/PolygonArea

Status	Occurrence	Format	Min. Access Types
Optional	ZeroOrOne	node	Get, Replace

This interior node contains a geographical area described by a polygon.

10.2.55B6 /<x>/<x>/OnNetwork/MCDataGroupList/<x>/Entry/
RulesForDeaffiliation/<x>/ListOfLocationCriteria/<x>/Entry/
EnterSpecificArea/PolygonArea/<x>

**Table 10.2.55B6.1: /<x>/<x>/OnNetwork/MCDataGroupList/<x>/Entry/RulesForDeaffiliation/<x>/
ListOfLocationCriteria/<x>/Entry/EnterSpecificArea/PolygonArea/<x>**

<x>/OnNetwork/MCDataGroupList/<x>/Entry/RulesForDeaffiliation/<x>/ListOfLocationCriteria/<x>/Entry/EnterS
pecificArea/PolygonArea/<x>

Status	Occurrence	Format	Min. Access Types
Required	OneOrN	node	Get, Replace

This interior node contains the coordinates of the corners which define a polygon. The occurrence of this leaf node is "3 to 15" as per 3GPP TS 23.032 [21].

10.2.55B7 /<x>/<x>/OnNetwork/MCDataGroupList/<x>/Entry/
RulesForDeaffiliation/<x>/ListOfLocationCriteria/<x>/Entry/
EnterSpecificArea/PolygonArea/<x>/PointCoordinateType

**Table 10.2.55B7.1: /<x>/<x>/OnNetwork/MCDataGroupList/<x>/Entry/RulesFordeaffiliation/<x>/
ListOfLocationCriteria/<x>/Entry/EnterSpecificArea/PolygonArea/<x>/PointCoordinateType**

<x>/OnNetwork/MCDataGroupList/<x>/Entry/RulesForDeaffiliation/<x>/ListOfLocationCriteria/<x>/Entry/EnterS
pecificArea/PolygonArea/<x>/PointCoordinateType

Status	Occurrence	Format	Min. Access Types
Required	One	node	Get, Replace

This interior node contains the type of the coordinates.

10.2.55B8 /<x>/<x>/OnNetwork/MCDataGroupList/<x>/Entry/
RulesForDeaffiliation/<x>/ListOfLocationCriteria/<x>/Entry/
EnterSpecificArea/PolygonArea/<x>/PointCoordinateType/
Longitude

**Table 10.2.55B8.1: /<x>/<x>/OnNetwork/MCDataGroupList/<x>/Entry/RulesForDeaffiliation/<x>/
ListOfLocationCriteria/<x>/Entry/EnterSpecificArea/PolygonArea/<x>/PointCoordinateType/
Longitude**

<x>/OnNetwork/MCDataGroupList/<x>/Entry/RulesForDeaffiliation/<x>/ListOfLocationCriteria/<x>/Entry/EnterS
pecificArea/PolygonArea/<x>/PointCoordinateType/Longitude

Status	Occurrence	Format	Min. Access Types
Required	One	int	Get, Replace

This leaf node contains the longitudinal coordinate of a corner.

10.2.55B9 /<x>/<x>/OnNetwork/MCDataGroupList/<x>/Entry/
 RulesForDeaffiliation/<x>/ListOfLocationCriteria/<x>/Entry/
 EnterSpecificArea/PolygonArea/<x>/PointCoordinateType/
 Latitude

**Table 10.2.55B9.1: /<x>/<x>/OnNetwork/MCDataGroupList/<x>/Entry/RulesForDeaffiliation/<x>/
 ListOfLocationCriteria/<x>/Entry/EnterSpecificArea/PolygonArea/<x>/PointCoordinateType/
 Latitude**

<x>/OnNetwork/MCDataGroupList/<x>/Entry/RulesForDeaffiliation/<x>/ListOfLocationCriteria/<x>/Entry/EnterS
 pecificArea/PolygonArea/<x>/PointCoordinateType/Latitude

Status	Occurrence	Format	Min. Access Types
Required	One	int	Get, Replace

This leaf node contains the latitudinal coordinate of a corner.

10.2.55B10 /<x>/<x>/OnNetwork/MCDataGroupList/<x>/Entry/
 RulesForDeaffiliation/<x>/ListOfLocationCriteria/<x>/Entry/
 EnterSpecificArea/EllipsoidArcArea

**Table 10.2.55B10.1: /<x>/<x>/OnNetwork/MCDataGroupList/<x>/Entry/RulesForDeaffiliation/<x>/
 ListOfLocationCriteria/<x>/Entry/EnterSpecificArea/EllipsoidArcArea**

<x>/OnNetwork/MCDataGroupList/<x>/Entry/RulesForDeaffiliation/<x>/ListOfLocationCriteria/<x>/Entry/EnterS
 pecificArea/EllipsoidArcArea

Status	Occurrence	Format	Min. Access Types
Optional	ZeroOrOne	node	Get, Replace

This interior node contains a geographical area described by an ellipsoid arc.

10.2.55B11 /<x>/<x>/OnNetwork/MCDataGroupList/<x>/Entry/
 RulesForDeaffiliation/<x>/ListOfLocationCriteria/<x>/Entry/
 EnterSpecificArea/EllipsoidArcArea/Center

**Table 10.2.55B11.1: /<x>/<x>/OnNetwork/MCDataGroupList/<x>/Entry/RulesForDeaffiliation/<x>/
 ListOfLocationCriteria/<x>/Entry/EnterSpecificArea/EllipsoidArcArea/Center**

<x>/OnNetwork/MCDataGroupList/<x>/Entry/RulesForDeaffiliation/<x>/ListOfLocationCriteria/<x>/Entry/EnterS
 pecificArea/EllipsoidArcArea/Center

Status	Occurrence	Format	Min. Access Types
Required	One	node	Get, Replace

This interior node contains the coordinates of the center point of the ellipsoid arc.

10.2.55B12 /<x>/<x>/OnNetwork/MCDataGroupList/<x>/Entry/ RulesForDeaffiliation/<x>/ListOfLocationCriteria/<x>/Entry/ EnterSpecificArea/EllipsoidArcArea/Center/PointCoordinateType

Table 10.2.55B12.1: /<x>/<x>/OnNetwork/MCDataGroupList/<x>/Entry/RulesForDeaffiliation/<x>/ListOfLocationCriteria/<x>/Entry/EnterSpecificArea/EllipsoidArcArea/Center/PointCoordinateType

<x>/OnNetwork/MCDataGroupList/<x>/Entry/RulesForDeaffiliation/<x>/ListOfLocationCriteria/<x>/Entry/EnterSpecificArea/EllipsoidArcArea/Center/PointCoordinateType

Status	Occurrence	Format	Min. Access Types
Required	One	node	Get, Replace

This interior node contains the coordinates of the center point of the ellipsoid arc.

10.2.55B13 /<x>/<x>/OnNetwork/MCDataGroupList/<x>/Entry/ RulesForDeaffiliation/<x>/ListOfLocationCriteria/<x>/Entry/ EnterSpecificArea/EllipsoidArcArea/Center/PointCoordinateType/ Longitude

Table 10.2.55B13.1: /<x>/<x>/OnNetwork/MCDataGroupList/<x>/Entry/RulesForDeaffiliation/<x>/ListOfLocationCriteria/<x>/Entry/EnterSpecificArea/EllipsoidArcArea/Center/PointCoordinateType/Longitude

<x>/OnNetwork/MCDataGroupList/<x>/Entry/RulesForDeaffiliation/<x>/ListOfLocationCriteria/<x>/Entry/EnterSpecificArea/EllipsoidArcArea/Center/PointCoordinateType/Longitude

Status	Occurrence	Format	Min. Access Types
Required	One	int	Get, Replace

This leaf node contains the longitudinal coordinate of the center.

10.2.55B14 /<x>/<x>/OnNetwork/MCDataGroupList/<x>/Entry/ RulesForDeaffiliation/<x>/ListOfLocationCriteria/<x>/Entry/ EnterSpecificArea/EllipsoidArcArea/Center/PointCoordinateType/ Latitude

Table 10.2.55B14.1: /<x>/<x>/OnNetwork/MCDataGroupList/<x>/Entry/RulesForDeaffiliation/<x>/ListOfLocationCriteria/<x>/Entry/EnterSpecificArea/EllipsoidArcArea/Center/PointCoordinateType/Latitude

<x>/OnNetwork/MCDataGroupList/<x>/Entry/RulesForDeaffiliation/<x>/ListOfLocationCriteria/<x>/Entry/EnterSpecificArea/EllipsoidArcArea/Center/PointCoordinateType/Latitude

Status	Occurrence	Format	Min. Access Types
Required	One	int	Get, Replace

This leaf node contains the latitudinal coordinate of a center.

10.2.55B15 /<x>/<x>/OnNetwork/MCDataGroupList/<x>/Entry/ RulesForDeaffiliation/<x>/ListOfLocationCriteria/<x>/Entry/ EnterSpecificArea/EllipsoidArcArea/Radius

**Table 10.2.55B15.1: /<x>/<x>/OnNetwork/MCDataGroupList/<x>/Entry/RulesForDeaffiliation/<x>/
ListOfLocationCriteria/<x>/Entry/EnterSpecificArea/EllipsoidArcArea/Radius**

<x>/OnNetwork/MCDataGroupList/<x>/Entry/RulesForDeaffiliation/<x>/ListOfLocationCriteria/<x>/Entry/EnterS
pecificArea/EllipsoidArcArea/Center/Radius

Status	Occurrence	Format	Min. Access Types
Required	One	int	Get, Replace

This leaf node contains the radius of the ellipsoid arc.

10.2.55B16 /<x>/<x>/OnNetwork/MCDataGroupList/<x>/Entry/ RulesForDeaffiliation/<x>/ListOfLocationCriteria/<x>/Entry/ EnterSpecificArea/EllipsoidArcArea/OffsetAngle

**Table 10.2.55B16.1: /<x>/<x>/OnNetwork/MCDataGroupList/<x>/Entry/RulesForDeaffiliation/<x>/
ListOfLocationCriteria/<x>/Entry/EnterSpecificArea/EllipsoidArcArea/OffsetAngle**

<x>/OnNetwork/MCDataGroupList/<x>/Entry/RulesForDeaffiliation/<x>/ListOfLocationCriteria/<x>/Entry/EnterS
pecificArea/EllipsoidArcArea/OffsetAngle

Status	Occurrence	Format	Min. Access Types
Required	One	int	Get, Replace

This leaf node contains the offset angle of the ellipsoid arc.

10.2.55B17 /<x>/<x>/OnNetwork/MCDataGroupList/<x>/Entry/ RulesForDeaffiliation/<x>/ListOfLocationCriteria/<x>/Entry/ EnterSpecificArea/EllipsoidArcArea/IncludedAngle

**Table 10.2.55B17.1: /<x>/<x>/OnNetwork/MCDataGroupList/<x>/Entry/RulesForDeaffiliation/<x>/
ListOfLocationCriteria/<x>/Entry/EnterSpecificArea/EllipsoidArcArea/IncludedAngle**

<x>/OnNetwork/MCDataGroupList/<x>/Entry/RulesForDeaffiliation/<x>/ListOfLocationCriteria/<x>/Entry/EnterS
pecificArea/EllipsoidArcArea/IncludedAngle

Status	Occurrence	Format	Min. Access Types
Required	One	int	Get, Replace

This leaf node contains the included angle of the ellipsoid arc.

10.2.55B18 /<x>/<x>/OnNetwork/MCDataGroupList/<x>/Entry/ RulesForDeaffiliation/<x>/ListOfLocationCriteria/<x>/Entry/ EnterSpecificArea/Speed

**Table 10.2.55B18.1: /<x>/<x>/OnNetwork/MCDataGroupList/<x>/Entry/RulesForDeaffiliation/<x>/
ListOfLocationCriteria/<x>/Entry/EnterSpecificArea/Speed**

<x>/OnNetwork/MCDataGroupList/<x>/Entry/RulesForDeaffiliation/<x>/ListOfLocationCriteria/<x>/Entry/EnterS
pecificArea/Speed

Status	Occurrence	Format	Min. Access Types

Optional	One	node	Get, Replace
----------	-----	------	--------------

This interior node contains the speed.

10.2.55B19 /<x>/<x>/OnNetwork/MCDataGroupList/<x>/Entry/
RulesForDeaffiliation/<x>/ListOfLocationCriteria/<x>/Entry/
EnterSpecificArea/Speed/MinimumSpeed

Table 10.2.55B19.1: /<x>/<x>/OnNetwork/MCDataGroupList/<x>/Entry/RulesForDeaffiliation/<x>/ListOfLocationCriteria/<x>/Entry/EnterSpecificArea/Speed/MinimumSpeed

<x>/OnNetwork/MCDataGroupList/<x>/Entry/RulesForDeaffiliation/<x>/ListOfLocationCriteria/<x>/Entry/EnterSpecificArea/Speed/MinimumSpeed

Status	Occurrence	Format	Min. Access Types
Required	One	int	Get, Replace

This leaf node contains the minimum speed.

- Values: non-negative integer in units of kilometers/hour.

10.2.55B20 /<x>/<x>/OnNetwork/MCDataGroupList/<x>/Entry/
RulesForDeaffiliation/<x>/ListOfLocationCriteria/<x>/Entry/
EnterSpecificArea/Speed/MaximumSpeed

Table 10.2.55B20.1: /<x>/<x>/OnNetwork/MCDataGroupList/<x>/Entry/RulesForDeaffiliation/<x>/ListOfLocationCriteria/<x>/Entry/EnterSpecificArea/Speed/MaximumSpeed

<x>/OnNetwork/MCDataGroupList/<x>/Entry/RulesForDeaffiliation/<x>/ListOfLocationCriteria/<x>/Entry/EnterSpecificArea/Speed/MaximumSpeed

Status	Occurrence	Format	Min. Access Types
Required	One	int	Get, Replace

This leaf node contains the maximum speed.

- Values: non-negative integer in units of kilometers/hour.

10.2.55B21 /<x>/<x>/OnNetwork/MCDataGroupList/<x>/Entry/
RulesForDeaffiliation/<x>/ListOfLocationCriteria/<x>/Entry/
EnterSpecificArea/Heading

Table 10.2.55B21.1: /<x>/<x>/OnNetwork/MCDataGroupList/<x>/Entry/RulesForDeaffiliation/<x>/ListOfLocationCriteria/<x>/Entry/EnterSpecificArea/Heading

<x>/OnNetwork/MCDataGroupList/<x>/Entry/RulesForDeaffiliation/<x>/ListOfLocationCriteria/<x>/Entry/EnterSpecificArea/Heading

Status	Occurrence	Format	Min. Access Types
Optional	One	node	Get, Replace

This interior node contains the heading.

10.2.55B22 /<x>/<x>/OnNetwork/MCDataGroupList/<x>/Entry/
RulesForDeaffiliation/<x>/ListOfLocationCriteria/<x>/Entry/
EnterSpecificArea/Heading/MinimumHeading

**Table 10.2.55B22.1: /<x>/<x>/OnNetwork/MCDataGroupList/<x>/Entry/RulesForDeaffiliation/<x>/
ListOfLocationCriteria/<x>/Entry/EnterSpecificArea/Heading/MinimumHeading**

<x>/OnNetwork/MCDataGroupList/<x>/Entry/RulesForDeaffiliation/<x>/ListOfLocationCriteria/<x>/Entry/EnterS
pecificArea/Heading/MinimumHeading

Status	Occurrence	Format	Min. Access Types
Required	One	int	Get, Replace

This leaf node contains the minimum heading.

- Values: 0-359

10.2.55B23 /<x>/<x>/OnNetwork/MCDataGroupList/<x>/Entry/
RulesForDeaffiliation/<x>/ListOfLocationCriteria/<x>/Entry/
EnterSpecificArea/Heading/MaximumHeading

**Table 10.2.55B23.1: /<x>/<x>/OnNetwork/MCDataGroupList/<x>/Entry/RulesForDeaffiliation/<x>/
ListOfLocationCriteria/<x>/Entry/EnterSpecificArea/Heading/MaximumHeading**

<x>/OnNetwork/MCDataGroupList/<x>/Entry/RulesForDeaffiliation/<x>/ListOfLocationCriteria/<x>/Entry/EnterS
pecificArea/Heading/Maximum

Status	Occurrence	Format	Min. Access Types
Required	One	int	Get, Replace

This leaf node contains the maximum heading.

- Values: 0-359

10.2.55B24 /<x>/<x>/OnNetwork/MCDataGroupList/<x>/Entry/
RulesForDeaffiliation/<x>/ListOfLocationCriteria/<x>/Entry/
ExitSpecificArea

**Table 10.2.55B24.1: /<x>/<x>/OnNetwork/MCDataGroupList/<x>/Entry/RulesForDeaffiliation/<x>/
ListOfLocationCriteria/<x>/Entry/ExitSpecificArea**

<x>/OnNetwork/MCDataGroupList/<x>/Entry/RulesForDeaffiliation/<x>/ListOfLocationCriteria/<x>/Entry/ExitSp
ecificArea

Status	Occurrence	Format	Min. Access Types
Optional	ZeroOrOne	node	Get, Replace

This interior node contains a geographical area which when entered by the MC service UE triggers
evaluation of the rules.

10.2.55B25 /<x>/<x>/OnNetwork/MCDataGroupList/<x>/Entry/
RulesForDeaffiliation/<x>/ListOfLocationCriteria/<x>/Entry/
ExitSpecificArea/PolygonArea

**Table 10.2.55B25.1: /<x>/<x>/OnNetwork/MCDataGroupList/<x>/Entry/RulesForDeaffiliation/<x>/
ListOfLocationCriteria/<x>/Entry/ExitSpecificArea/PolygonArea**

<x>/OnNetwork/MCDataGroupList/<x>/Entry/RulesForDeaffiliation/<x>/ListOfLocationCriteria/<x>/Entry/ExitSp
ecificArea/PolygonArea

Status	Occurrence	Format	Min. Access Types
Optional	ZeroOrOne	node	Get, Replace

This interior node contains a geographical area described by a polygon.

10.2.55B26 /<x>/<x>/OnNetwork/MCDataGroupList/<x>/Entry/
RulesForDeaffiliation/<x>/ListOfLocationCriteria/<x>/Entry/
ExitSpecificArea/PolygonArea/<x>

**Table 10.2.55B26.1: /<x>/<x>/OnNetwork/MCDataGroupList/<x>/Entry/RulesForDeaffiliation/<x>/
ListOfLocationCriteria/<x>/Entry/ExitSpecificArea/PolygonArea/<x>**

<x>/OnNetwork/MCDataGroupList/<x>/Entry/RulesForDeaffiliation/<x>/ListOfLocationCriteria/<x>/Entry/ExitSp
ecificArea/PolygonArea/<x>

Status	Occurrence	Format	Min. Access Types
Required	OneOrN	node	Get, Replace

This interior node contains the coordinates of the corners which define a polygon. The occurrence of this
leaf node is "3 to 15" as per 3GPP TS 23.032 [21].

10.2.55B27 /<x>/<x>/OnNetwork/MCDataGroupList/<x>/Entry/
RulesForDeaffiliation/<x>/ListOfLocationCriteria/<x>/Entry/
ExitSpecificArea/PolygonArea/<x>/PointCoordinateType

**Table 10.2.55B27.1: /<x>/<x>/OnNetwork/MCDataGroupList/<x>/Entry/RulesForDeaffiliation/<x>/
ListOfLocationCriteria/<x>/Entry/ExitSpecificArea/PolygonArea/<x>/PointCoordinateType**

<x>/OnNetwork/MCDataGroupList/<x>/Entry/RulesForDeaffiliation/<x>/ListOfLocationCriteria/<x>/Entry/ExitSp
ecificArea/PolygonArea/<x>/PointCoordinateType

Status	Occurrence	Format	Min. Access Types
Required	One	node	Get, Replace

This interior node contains the type of the coordinates.

10.2.55B28 /<x>/<x>/OnNetwork/MCDataGroupList/<x>/Entry/
RulesForDeaffiliation/<x>/ListOfLocationCriteria/<x>/Entry/
ExitSpecificArea/PolygonArea/<x>/PointCoordinateType/
Longitude

Table 10.2.55B28.1: /<x>/<x>/OnNetwork/MCDataGroupList/<x>/Entry/RulesForDeaffiliation/<x>/ListOfLocationCriteria/<x>/Entry/ExitSpecificArea/PolygonArea/<x>/PointCoordinateType/Longitude

<x>/OnNetwork/MCDataGroupList/<x>/Entry/RulesForDeaffiliation/<x>/ListOfLocationCriteria/<x>/Entry/ExitSpecificArea/PolygonArea/<x>/PointCoordinateType/Longitude

Status	Occurrence	Format	Min. Access Types
Required	One	int	Get, Replace

This leaf node contains the longitudinal coordinate of a corner.

10.2.55B29 /<x>/<x>/OnNetwork/MCDataGroupList/<x>/Entry/
RulesForDeaffiliation/<x>/ListOfLocationCriteria/<x>/Entry/
ExitSpecificArea/PolygonArea/<x>/PointCoordinateType/
Latitude

Table 10.2.55B29.1: /<x>/<x>/OnNetwork/MCDataGroupList/<x>/Entry/RulesForDeaffiliation/<x>/ListOfLocationCriteria/<x>/Entry/ExitSpecificArea/PolygonArea/<x>/PointCoordinateType/Latitude

<x>/OnNetwork/MCDataGroupList/<x>/Entry/RulesForDeaffiliation/<x>/ListOfLocationCriteria/<x>/Entry/ExitSpecificArea/PolygonArea/<x>/PointCoordinateType/Latitude

Status	Occurrence	Format	Min. Access Types
Required	One	int	Get, Replace

This leaf node contains the latitudinal coordinate of a corner.

10.2.55B30 /<x>/<x>/OnNetwork/MCDataGroupList/<x>/Entry/
RulesForDeaffiliation/<x>/ListOfLocationCriteria/<x>/Entry/
ExitSpecificArea/EllipsoidArcArea

Table 10.2.55B30.1: /<x>/<x>/OnNetwork/MCDataGroupList/<x>/Entry/RulesForDeaffiliation/<x>/ListOfLocationCriteria/<x>/Entry/ExitSpecificArea/EllipsoidArcArea

<x>/OnNetwork/MCDataGroupList/<x>/Entry/RulesForDeaffiliation/<x>/ListOfLocationCriteria/<x>/Entry/ExitSpecificArea/EllipsoidArcArea

Status	Occurrence	Format	Min. Access Types
Optional	ZeroOrOne	node	Get, Replace

This interior node contains a geographical area described by an ellipsoid arc.

10.2.55B31 /<x>/<x>/OnNetwork/MCDataGroupList/<x>/Entry/
RulesForDeaffiliation/<x>/ListOfLocationCriteria/<x>/Entry/
ExitSpecificArea/EllipsoidArcArea/Center

Table 10.2.55B31.1: /<x>/<x>/OnNetwork/MCDataGroupList/<x>/Entry/RulesForDeaffiliation/<x>/ListOfLocationCriteria/<x>/Entry/ExitSpecificArea/EllipsoidArcArea/Center

<x>/OnNetwork/MCDataGroupList/<x>/Entry/RulesForDeaffiliation/<x>/ListOfLocationCriteria/<x>/Entry/ExitSpecificArea/EllipsoidArcArea/Center

Status	Occurrence	Format	Min. Access Types
Required	One	node	Get, Replace

This interior node contains the coordinates of the center point of the ellipsoid arc.

10.2.55B32 /<x>/<x>/OnNetwork/MCDataGroupList/<x>/Entry/
RulesForDeaffiliation/<x>/ListOfLocationCriteria/<x>/Entry/
ExitSpecificArea/EllipsoidArcArea/Center/PointCoordinateType

Table 10.2.55B32.1: /<x>/<x>/OnNetwork/MCDataGroupList/<x>/Entry/RulesForDeaffiliation/<x>/ListOfLocationCriteria/<x>/Entry/ExitSpecificArea/EllipsoidArcArea/Center/PointCoordinateType

<x>/OnNetwork/MCDataGroupList/<x>/Entry/RulesForDeaffiliation/<x>/ListOfLocationCriteria/<x>/Entry/ExitSpecificArea/EllipsoidArcArea/Center/PointCoordinateType

Status	Occurrence	Format	Min. Access Types
Required	One	node	Get, Replace

This interior node contains the coordinates of the center point of the ellipsoid arc.

10.2.55B33 /<x>/<x>/OnNetwork/MCDataGroupList/<x>/Entry/
RulesForDeaffiliation/<x>/ListOfLocationCriteria/<x>/Entry/
ExitSpecificArea/EllipsoidArcArea/Center/PointCoordinateType/
Longitude

Table 10.2.55B33.1: /<x>/<x>/OnNetwork/MCDataGroupList/<x>/Entry/RulesForDeaffiliation/<x>/ListOfLocationCriteria/<x>/Entry/ExitSpecificArea/EllipsoidArcArea/Center/PointCoordinateType/Longitude

<x>/OnNetwork/MCDataGroupList/<x>/Entry/RulesForDeaffiliation/<x>/ListOfLocationCriteria/<x>/Entry/ExitSpecificArea/EllipsoidArcArea/Center/PointCoordinateType/Longitude

Status	Occurrence	Format	Min. Access Types
Required	One	int	Get, Replace

This leaf node contains the longitudinal coordinate of the center.

10.2.55B34 /<x>/<x>/OnNetwork/MCDataGroupList/<x>/Entry/ RulesForDeaffiliation/<x>/ListOfLocationCriteria/<x>/Entry/ /ExitSpecificArea/EllipsoidArcArea/Center/PointCoordinateType/ Latitude

**Table 10.2.55B34.1: /<x>/<x>/OnNetwork/MCDataGroupList/<x>/Entry/RulesForDeaffiliation/<x>/
ListOfLocationCriteria/<x>/Entry/ExitSpecificArea/EllipsoidArcArea/Center/PointCoordinateType/
Latitude**

<x>/OnNetwork/MCDataGroupList/<x>/Entry/RulesForDeaffiliation/<x>/ListOfLocationCriteria/<x>/Entry/ExitSp
ecificArea/EllipsoidArcArea/Center/PointCoordinateType/Latitude

Status	Occurrence	Format	Min. Access Types
Required	One	int	Get, Replace

This leaf node contains the latitudinal coordinate of a center.

10.2.55B35 /<x>/<x>/OnNetwork/MCDataGroupList/<x>/Entry/ RulesForDeaffiliation/<x>/ListOfLocationCriteria/<x>/Entry/ ExitSpecificArea/EllipsoidArcArea/Radius

**Table 10.2.55B35.1: /<x>/<x>/OnNetwork/MCDataGroupList/<x>/Entry/RulesForDeaffiliation/<x>/
ListOfLocationCriteria/<x>/Entry/ExitSpecificArea/EllipsoidArcArea/Radius**

<x>/OnNetwork/MCDataGroupList/<x>/Entry/RulesForDeaffiliation/<x>/ListOfLocationCriteria/<x>/Entry/ExitSp
ecificArea/EllipsoidArcArea/Center/Radius

Status	Occurrence	Format	Min. Access Types
Required	One	int	Get, Replace

This leaf node contains the radius of the ellipsoid arc.

10.2.55B36 /<x>/<x>/OnNetwork/MCDataGroupList/<x>/Entry/ RulesForDeaffiliation/<x>/ListOfLocationCriteria/<x>/Entry/ ExitSpecificArea/EllipsoidArcArea/OffsetAngle

**Table 10.2.55B36.1: /<x>/<x>/OnNetwork/MCDataGroupList/<x>/Entry/RulesForDeaffiliation/<x>/
ListOfLocationCriteria/<x>/Entry/ExitSpecificArea/EllipsoidArcArea/OffsetAngle**

<x>/OnNetwork/MCDataGroupList/<x>/Entry/RulesForDeaffiliation/<x>/ListOfLocationCriteria/<x>/Entry/ExitSp
ecificArea/EllipsoidArcArea/OffsetAngle

Status	Occurrence	Format	Min. Access Types
Required	One	int	Get, Replace

This leaf node contains the offset angle of the ellipsoid arc.

10.2.55B37 /<x>/<x>/OnNetwork/MCDataGroupList/<x>/Entry/ RulesForDeaffiliation/<x>/ListOfLocationCriteria/<x>/Entry/ ExitSpecificArea/EllipsoidArcArea/IncludedAngle

**Table 10.2.55B37.1: /<x>/<x>/OnNetwork/MCDataGroupList/<x>/Entry/RulesForDeaffiliation/<x>/
ListOfLocationCriteria/<x>/Entry/ExitSpecificArea/EllipsoidArcArea/IncludedAngle**

<x>/OnNetwork/MCDataGroupList/<x>/Entry/RulesForDeaffiliation/<x>/ListOfLocationCriteria/<x>/Entry/ExitSp
ecificArea/EllipsoidArcArea/IncludedAngle

Status	Occurrence	Format	Min. Access Types
Required	One	int	Get, Replace

This leaf node contains the included angle of the ellipsoid arc.

10.2.55B38 /<x>/<x>/OnNetwork/MCDataGroupList/<x>/Entry/ RulesForDeaffiliation/<x>/ListOfLocationCriteria/<x>/Entry/ ExitSpecificArea/Speed

**Table 10.2.55B38.1: /<x>/<x>/OnNetwork/MCDataGroupList/<x>/Entry/RulesForDeaffiliation/<x>/
ListOfLocationCriteria/<x>/Entry/ExitSpecificArea/Speed**

<x>/OnNetwork/MCDataGroupList/<x>/Entry/RulesForDeaffiliation/<x>/ListOfLocationCriteria/<x>/Entry/ExitSp
ecificArea/Speed

Status	Occurrence	Format	Min. Access Types
Optional	One	node	Get, Replace

This interior node contains the speed.

10.2.55B39 /<x>/<x>/OnNetwork/MCDataGroupList/<x>/Entry/ RulesForDeaffiliation/<x>/ListOfLocationCriteria/<x>/Entry/ ExitSpecificArea/Speed/MinimumSpeed

**Table 10.2.55B39.1: /<x>/<x>/OnNetwork/MCDataGroupList/<x>/Entry/RulesForDeaffiliation/<x>/
ListOfLocationCriteria/<x>/Entry/ExitSpecificArea/Speed/MinimumSpeed**

<x>/OnNetwork/MCDataGroupList/<x>/Entry/RulesForDeaffiliation/<x>/ListOfLocationCriteria/<x>/Entry/ExitSp
ecificArea/Speed/MinimumSpeed

Status	Occurrence	Format	Min. Access Types
Required	One	int	Get, Replace

This leaf node contains the minimum speed.

- Values: non-negative integer in units of kilometers/hour.

10.2.55B40 /<x>/<x>/OnNetwork/MCDataGroupList/<x>/Entry/
RulesForDeaffiliation/<x>/ListOfLocationCriteria/<x>/Entry/
ExitSpecificArea/Speed/MaximumSpeed

**Table 10.2.55B40.1: /<x>/<x>/OnNetwork/MCDataGroupList/<x>/Entry/RulesForDeaffiliation/<x>/
ListOfLocationCriteria/<x>/Entry/ExitSpecificArea/Speed/MaximumSpeed**

<x>/OnNetwork/MCDataGroupList/<x>/Entry/RulesForDeaffiliation/<x>/ListOfLocationCriteria/<x>/Entry/ExitSp
ecificArea/Speed/MaximumSpeed

Status	Occurrence	Format	Min. Access Types
Required	One	int	Get, Replace

This leaf node contains the maximum speed.

- Values: non-negative integer in units of kilometers/hour.

10.2.55B41 /<x>/<x>/OnNetwork/MCDataGroupList/<x>/Entry/
RulesForDeaffiliation/<x>/ListOfLocationCriteria/<x>/Entry/
ExitSpecificArea/Heading

**Table 10.2.55B41.1: /<x>/<x>/OnNetwork/MCDataGroupList/<x>/Entry/RulesForDeaffiliation/<x>/
ListOfLocationCriteria/<x>/Entry/ExitSpecificArea/Heading**

<x>/OnNetwork/MCDataGroupList/<x>/Entry/RulesForDeaffiliation/<x>/ListOfLocationCriteria/<x>/Entry/ExitSp
ecificArea/Heading

Status	Occurrence	Format	Min. Access Types
Optional	One	node	Get, Replace

This interior node contains the heading.

10.2.55B42 /<x>/<x>/OnNetwork/MCDataGroupList/<x>/Entry/
RulesForDeaffiliation/<x>/ListOfLocationCriteria/<x>/Entry/
ExitSpecificArea/Heading/MinimumHeading

**Table 10.2.55B42.1: /<x>/<x>/OnNetwork/MCDataGroupList/<x>/Entry/RulesForDeaffiliation/<x>/
ListOfLocationCriteria/<x>/Entry/ExitSpecificArea/Heading/MinimumHeading**

<x>/OnNetwork/MCDataGroupList/<x>/Entry/RulesForDeaffiliation/<x>/ListOfLocationCriteria/<x>/Entry/ExitSp
ecificArea/Heading/MinimumHeading

Status	Occurrence	Format	Min. Access Types
Required	One	int	Get, Replace

This leaf node contains the minimum heading.

- Values: in the range 0-359.

10.2.55B43 /<x>/<x>/OnNetwork/MCDataGroupList/<x>/Entry/
RulesForDeaffiliation/<x>/ListOfLocationCriteria/<x>/Entry/
ExitSpecificArea/Heading/MaximumHeading

**Table 10.2.55B43.1: /<x>/<x>/OnNetwork/MCDataGroupList/<x>/Entry/RulesForDeaffiliation/<x>/
ListOfLocationCriteria/<x>/Entry/ExitSpecificArea/Heading/MaximumHeading**

<x>/OnNetwork/MCDataGroupList/<x>/Entry/RulesForDeaffiliation/<x>/ListOfLocationCriteria/<x>/Entry/ExitSp
ecificArea/Heading/MaximumHeading

Status	Occurrence	Format	Min. Access Types
Required	One	int	Get, Replace

This leaf node contains the maximum heading.

- Values: 0-359

10.2.55B44 /<x>/<x>/OnNetwork/MCDataGroupList/<x>/Entry/
RulesForDeaffiliation/<x>/ListOfActiveFunctionalAliases

**Table 10.2.55B44.1: /<x>/<x>/OnNetwork/MCDataGroupList/<x>/Entry/RulesForDeaffiliation/<x>/
ListOfActiveFunctionalAliases**

<x>/OnNetwork/MCDataGroupList/<x>/Entry/RulesForDeaffiliation/<x>/ListOfActiveFunctionalAliases

Status	Occurrence	Format	Min. Access Types
Optional	One	node	Get, Replace

This interior node is a placeholder for the functional alias part of rules that control automatic deaffiliation.

10.2.55B45 /<x>/<x>/OnNetwork/MCDataGroupList/<x>/Entry/
RulesForDeaffiliation/<x>/ListOfActiveFunctionalAliases/<x>

**Table 10.2.55B45.1: /<x>/<x>/OnNetwork/MCDataGroupList/<x>/Entry/RulesForDeaffiliation/<x>/
ListOfActiveFunctionalAliases/<x>**

<x>/OnNetwork/MCDataGroupList/<x>/Entry/RulesForDeaffiliation/<x>/ListOfActiveFunctionalAliases/<x>

Status	Occurrence	Format	Min. Access Types
Optional	OneOrMore	node	Get, Replace

This interior node is a placeholder for the functional alias part of rules that control automatic deaffiliation.

10.2.55B46 /<x>/<x>/OnNetwork/MCDataGroupList/<x>/Entry/
RulesForDeaffiliation/<x>/ListOfActiveFunctionalAliases/<x>/Entry

**Table 10.2.55B46.1: /<x>/<x>/OnNetwork/MCDataGroupList/<x>/Entry/RulesForDeaffiliation/<x>/
ListOfActiveFunctionalAliases/<x>/Entry**

<x>/OnNetwork/MCDataGroupList/<x>/Entry/RulesForDeaffiliation/<x>/ListOfActiveFunctionalAliases/<x>/Entry

Status	Occurrence	Format	Min. Access Types
Optional	One	node	Get, Replace

This interior node is a placeholder for the functional alias part of rules that control automatic deaffiliation.

10.2.55B47 /<x>/<x>/OnNetwork/MCDataGroupList/<x>/Entry/ RulesForDeaffiliation/<x>/ListOfActiveFunctionalAliases/<x>/Entry/ FunctionalAlias

**Table 10.2.55B47.1: /<x>/<x>/OnNetwork/MCDataGroupList/<x>/Entry/RulesForDeaffiliation/<x>/
ListOfActiveFunctionalAliases/<x>/Entry/FunctionalAlias**

<x>/OnNetwork/MCDataGroupList/<x>/Entry/RulesForDeaffiliation/<x>/ListOfActiveFunctionalAliases/<x>/Entry/
FunctionalAlias

Status	Occurrence	Format	Min. Access Types
Required	One	chr	Get, Replace

This leaf node contains a functional alias.

10.2.55B48 /<x>/<x>/OnNetwork/MCDataGroupList/<x>/Entry/ ManualDeaffiliationNotAllowedIfAffiliationRulesAreMet

**Table 10.2.55B48.1: /<x>/<x>/OnNetwork/MCDataGroupList/<x>/Entry/
ManualDeaffiliationNotAllowedIfAffiliationRulesAreMet**

<x>/OnNetwork/MCDataGroupList/<x>/Entry/ManualDeAffiliationNotAllowedIfAffiliationRulesAreMet

Status	Occurrence	Format	Min. Access Types
Optional	ZeroOrOne	bool	Get, Replace

This leaf node indicates whether the MCData user is authorised to deaffiliate if the affiliation criteria are met.

10.2.55C /<x>/<x>/OnNetwork/MCDataGroupList/<x>/Entry/ AllowStoreGroupCommInMsgstore

**Table 10.2.55C.1:
/<x>/<x>/OnNetwork/MCDataGroupList/<x>/Entry/AllowStoreGroupCommInMsgstore**

<x>/OnNetwork/MCDataGroupList/<x>/Entry/AllowStoreGroupCommInMsgstore

Status	Occurrence	Format	Min. Access Types
Optional	ZeroOrOne	bool	Get, Replace

This leaf node indicates whether the MCData user is authorised to request an MCData server to store his/her group communication into message store or not.

When set to "true", the MCData user is authorised to request an MCData server to store this group communication into message store. The group is identified by the MCData Group ID in the same structure of the group entry.

When set to "false", the MCData user is not authorised to request an MCData server to store this group communication into message store. The group is identified by the MCData Group ID in the same structure of the group entry.

10.2.56 /<x>/<x>/OnNetwork/ImplicitAffiliations

Table 10.2.56.1: /<x>/<x>/OnNetwork/ImplicitAffiliations

<x>/OnNetwork/ImplicitAffiliations

Status	Occurrence	Format	Min. Access Types
Required	One	node	Get, Replace

This interior node is a placeholder for the implicit affiliation configuration.

10.2.57 /<x>/<x>/OnNetwork/ImplicitAffiliations/<x>

Table 10.2.57.1: /<x>/<x>/OnNetwork/ImplicitAffiliations/<x>

<x>/OnNetwork/ImplicitAffiliations/<x>

Status	Occurrence	Format	Min. Access Types
Required	ZeroOrMore	node	Get, Replace

This interior node is a placeholder for zero or more implicit affiliation configuration.

10.2.58 /<x>/<x>/OnNetwork/ImplicitAffiliations/<x>/Entry

Table 10.2.58.1: /<x>/<x>/OnNetwork/ImplicitAffiliations/<x>/Entry

<x>/OnNetwork/ImplicitAffiliations/<x>/Entry

Status	Occurrence	Format	Min. Access Types
Optional	One	node	Get, Replace

This interior node is a placeholder for the details of the on-network MCDATA groups that the MCDATA user is implicitly affiliated to.

10.2.59 /<x>/<x>/OnNetwork/ImplicitAffiliations/<x>/Entry/MCDATAGroupID

Table 10.2.59.1: /<x>/<x>/OnNetwork/ImplicitAffiliations/<x>/Entry/MCDATAGroupID

<x>/OnNetwork/ImplicitAffiliations/<x>/Entry/MCDATAGroupID

Status	Occurrence	Format	Min. Access Types
Required	One	chr	Get, Replace

This leaf node indicates a MCDATA group ID to which the MCDATA user is implicitly affiliated to.

The value is a "uri" attribute specified in OMA OMA-TS-XDM_Group-V1_1 [4].

10.2.60 /<x>/<x>/OnNetwork/ImplicitAffiliations/<x>/Entry/DisplayName

Table 10.2.60.1: /<x>/<x>/OnNetwork/ImplicitAffiliations/<x>/Entry/DisplayName

<x>/OnNetwork/ImplicitAffiliations/<x>/Entry/DisplayName

Status	Occurrence	Format	Min. Access Types
Optional	One	chr	Get, Replace

This leaf node contains a human readable name that corresponds to the MCDATA Group ID.

10.2.61 /<x>/<x>/OnNetwork/PresenceStatus

Table 10.2.61.1: /<x>/<x>/OnNetwork/PresenceStatus

<x>/OnNetwork/PresenceStatus

Status	Occurrence	Format	Min. Access Types

Required	One	node	Get, Replace
----------	-----	------	--------------

This interior node is a placeholder for the presence status configuration.

10.2.62 /<x>/<x>/OnNetwork/PresenceStatus/<x>

Table 10.2.62.1: /<x>/<x>/OnNetwork/PresenceStatus/<x>

<x>/OnNetwork/PresenceStatus/<x>

Status	Occurrence	Format	Min. Access Types
Required	ZeroOrMore	node	Get, Replace

This interior node is a placeholder for zero or more presence status configuration.

10.2.63 /<x>/<x>/OnNetwork/PresenceStatus/<x>/Entry

Table 10.2.63.1: /<x>/<x>/OnNetwork/PresenceStatus/<x>/Entry

<x>/OnNetwork/PresenceStatus/<x>/Entry

Status	Occurrence	Format	Min. Access Types
Optional	One	node	Get, Replace

This interior node is a placeholder for the details of the MCDData IDs of MCDData users that the configured MCDData user is authorised to obtain presence status.

10.2.64 /<x>/<x>/OnNetwork/PresenceStatus/<x>/Entry/MCDDataID

Table 10.2.64.1: /<x>/<x>/OnNetwork/PresenceStatus/<x>/Entry/MCDDataID

<x>/OnNetwork/PresenceStatus/<x>/Entry/MCDDataID

Status	Occurrence	Format	Min. Access Types
Required	One	chr	Get, Replace

This leaf node indicates an MCDData ID of an MCDData user that the configured MCDData user is authorised to obtain presence status.

The value is a "uri" attribute specified in OMA OMA-TS-XDM_Group-V1_1 [4].

10.2.65 /<x>/<x>/OnNetwork/PresenceStatus/<x>/Entry/DisplayName

Table 10.2.65.1: /<x>/<x>/OnNetwork/PresenceStatus/<x>/Entry/DisplayName

<x>/OnNetwork/PresenceStatus/<x>/Entry/DisplayName

Status	Occurrence	Format	Min. Access Types
Optional	One	chr	Get, Replace

This leaf node contains a human readable name that corresponds to the MCDData ID.

10.2.66 /<x>/<x>/OnNetwork/RemoteGroupChange

Table 10.2.66.1: /<x>/<x>/OnNetwork/RemoteGroupChange

<x>/OnNetwork/RemoteGroupChange

Status	Occurrence	Format	Min. Access Types
Required	One	node	Get, Replace

This interior node is a placeholder for the remote group change configuration.

10.2.67 /<x>/<x>/>/OnNetwork/RemoteGroupChange/<x>

Table 10.2.67.1: /<x>/<x>/>/OnNetwork/RemoteGroupChange/<x>

<x>/OnNetwork/RemoteGroupChange/<x>

Status	Occurrence	Format	Min. Access Types
Required	ZeroOrMore	node	Get, Replace

This interior node is a placeholder for zero or more remote group change configuration.

10.2.68 /<x>/<x>/OnNetwork/RemoteGroupChange/<x>/Entry

Table 10.2.68.1: /<x>/<x>/OnNetwork/RemoteGroupChange/<x>/Entry

<x>/OnNetwork/RemoteGroupChange/<x>/Entry

Status	Occurrence	Format	Min. Access Types
Optional	One	node	Get, Replace

This interior node is a placeholder for the details of the MCDData IDs of MCDData users whose selected groups are authorised to be remotely changed by the configured MCDData user.

10.2.69 /<x>/<x>/OnNetwork/RemoteGroupChange/<x>/Entry/MCDDataID

Table 10.2.69.1: /<x>/<x>/OnNetwork/RemoteGroupChange/<x>/Entry/MCDDataID

<x>/OnNetwork/RemoteGroupChange/<x>/Entry/MCDDataID

Status	Occurrence	Format	Min. Access Types
Required	One	chr	Get, Replace

This leaf node indicates an MCDData ID of an MCDData user whose selected groups are authorised to be remotely changed by the configured MCDData user.

The value is a "uri" attribute specified in OMA OMA-TS-XDM_Group-V1_1 [4].

10.2.70 /<x>/<x>/OnNetwork/RemoteGroupChange/<x>/Entry/DisplayName

Table 10.2.70.1: /<x>/<x>/OnNetwork/RemoteGroupChange/<x>/Entry/DisplayName

<x>/OnNetwork/RemoteGroupChange/<x>/Entry/DisplayName

Status	Occurrence	Format	Min. Access Types
Optional	One	chr	Get, Replace

This leaf node contains a human readable name that corresponds to the MCDData ID.

10.2.71 /<x>/<x>/OnNetwork/MaxAffiliationsN2

Table 10.2.71.1: /<x>/<x>/OnNetwork/MaxAffiliationsN2

<x>/OnNetwork/MaxAffiliationsN2

Status	Occurrence	Format	Min. Access Types
Optional	One	int	Get, Replace

This leaf node indicates the maximum number of MCDATA groups that the MCDATA user is authorised to affiliate with.

- Values: 0-65535

10.2.72 /<x>/<x>/OnNetwork/ConversationManagement

Table 10.2.72.1: /<x>/<x>/OnNetwork/ConversationManagement

<x>/OnNetwork/ConversationManagement

Status	Occurrence	Format	Min. Access Types
Required	One	node	Get, Replace

This interior node is a placeholder for conversation management configuration

10.2.73 /<x>/<x>/OnNetwork/ConversationManagement/GroupHangTime

Table 10.2.73.1: /<x>/<x>/OnNetwork/ConversationManagement/GroupHangTime

<x>/OnNetwork/ConversationManagement/GroupHangTime

Status	Occurrence	Format	Min. Access Types
Required	One	node	Get, Replace

This interior node is a placeholder for group hang time configuration

10.2.74 /<x>/<x>/OnNetwork/ConversationManagement/GroupHangTime/<x>

Table 10.2.74.1: /<x>/<x>/OnNetwork/ConversationManagement/GroupHangTime/<x>

<x>/OnNetwork/ConversationManagement/GroupHangTime/<x>

Status	Occurrence	Format	Min. Access Types
Required	OneOrMore	node	Get, Replace

This interior node is a placeholder for one or more hang time configurations.

10.2.75 /<x>/<x>/OnNetwork/ConversationManagement/GroupHangTime/<x>/Entry

Table 10.2.75.1: /<x>/<x>/OnNetwork/ConversationManagement/GroupHangTime/<x>/Entry

<x>/OnNetwork/ConversationManagement/GroupHangTime/<x>/Entry

Status	Occurrence	Format	Min. Access Types
Optional	One	node	Get, Replace

This interior node is a placeholder for the conversation hang time configuration associated with the configured MCDData group, for the MCDData user.

10.2.76 /<x>/<x>/OnNetwork/ConversationManagement/GroupHangTime/<x>/Entry/MCDDataGroupID

Table 10.2.76.1: /<x>/<x>/OnNetwork/ConversationManagement/GroupHangTime/<x>/Entry/MCDDataGroupID

<x>/OnNetwork/ConversationManagement/GroupHangTime/<x>/Entry/MCDDataGroupID

Status	Occurrence	Format	Min. Access Types
Required	One	chr	Get, Replace

This leaf node indicates the MCDData group ID for the on-network MCDData group.

The value is a "uri" attribute specified in OMA OMA-TS-XDM_Group-V1_1 [4].

10.2.77 /<x>/<x>/OnNetwork/ConversationManagement/GroupHangTime/<x>/Entry/DisplayName

Table 10.2.77.1: /<x>/<x>/OnNetwork/ConversationManagement/GroupHangTime/<x>/Entry/DisplayName

<x>/OnNetwork/ConversationManagement/GroupHangTime/<x>/Entry/DisplayName

Status	Occurrence	Format	Min. Access Types
Optional	One	chr	Get, Replace

This leaf node contains a human readable name that corresponds to the MCDData Group ID.

10.2.78 /<x>/<x>/OnNetwork/ConversationManagement/GroupHangTime/<x>/Entry/HangTime

Table 10.2.78.1: /<x>/<x>/OnNetwork/ConversationManagement/GroupHangTime/<x>/Entry/HangTime

<x>/OnNetwork/ConversationManagement/GroupHangTime/<x>/Entry/HangTime

Status	Occurrence	Format	Min. Access Types
Required	One	int	Get, Replace

This leaf node indicates the group call hang timer of the MCDData group for conversation management, for the MCDData user.

- Values: 0-65535

The HangTime is in seconds.

10.2.79 /<x>/<x>/OnNetwork/ConversationManagement/DeliveredDisposition

Table 10.2.79.1: /<x>/<x>/OnNetwork/ConversationManagement/DeliveredDisposition

<x>/OnNetwork/ConversationManagement/DeliveredDisposition

Status	Occurrence	Format	Min. Access Types
Required	One	node	Get, Replace

This interior node is a placeholder for delivered disposition configuration

10.2.80 /<x>/<x>/OnNetwork/ConversationManagement/DeliveredDisposition/<x>

Table 10.2.80.1: /<x>/<x>/OnNetwork/ConversationManagement/DeliveredDisposition/<x>

<x>/OnNetwork/ConversationManagement/DeliveredDisposition/<x>

Status	Occurrence	Format	Min. Access Types
Required	ZeroOrMore	node	Get, Replace

This interior node is a placeholder for zero or more delivered disposition configurations.

10.2.81 /<x>/<x>/OnNetwork/ConversationManagement/DeliveredDisposition/<x>/Entry

Table 10.2.81.1: /<x>/<x>/OnNetwork/ConversationManagement/DeliveredDisposition/<x>/Entry

<x>/OnNetwork/ConversationManagement/DeliveredDisposition/<x>/Entry

Status	Occurrence	Format	Min. Access Types
Optional	One	node	Get, Replace

This interior node is a placeholder for the delivered disposition configuration associated with the MCDData user, indicating an MCDData ID of an MCDData user who is to be sent a message delivered disposition notification in addition to the message sender.

10.2.82 /<x>/<x>/OnNetwork/ConversationManagement/DeliveredDisposition/<x>/Entry/MCDDataID

Table 10.2.82.1: /<x>/<x>/OnNetwork/ConversationManagement/DeliveredDisposition/<x>/Entry/MCDDataID

<x>/OnNetwork/ConversationManagement/DeliveredDisposition/<x>/Entry/MCDDataID

Status	Occurrence	Format	Min. Access Types
Required	One	chr	Get, Replace

This leaf node indicates the MCDData ID for the on-network MCDData user.

The value is a "uri" attribute specified in OMA OMA-TS-XDM_Group-V1_1 [4].

10.2.83 /<x>/<x>/OnNetwork/ConversationManagement/DeliveredDisposition/<x>/Entry/DisplayName

Table 10.2.83.1: /<x>/<x>/OnNetwork/ConversationManagement/DeliveredDisposition/<x>/Entry/DisplayName

<x>/OnNetwork/ConversationManagement/DeliveredDisposition/<x>/Entry/DisplayName

Status	Occurrence	Format	Min. Access Types
Optional	One	chr	Get, Replace

This leaf node contains a human readable name that corresponds to the MCDData ID.

10.2.84 /<x>/<x>/OnNetwork/ConversationManagement/ReadDisposition

Table 10.2.84.1: /<x>/<x>/OnNetwork/ConversationManagement/ReadDisposition

<x>/OnNetwork/ConversationManagement/ReadDisposition

Status	Occurrence	Format	Min. Access Types
Required	One	node	Get, Replace

This interior node is a placeholder for read disposition configuration

10.2.85 /<x>/<x>/OnNetwork/ConversationManagement/ReadDisposition/<x>

Table 10.2.85.1: /<x>/<x>/OnNetwork/ConversationManagement/ReadDisposition/<x>

<x>/OnNetwork/ConversationManagement/ReadDisposition/<x>

Status	Occurrence	Format	Min. Access Types
Required	ZeroOrMore	node	Get, Replace

This interior node is a placeholder for zero or more read disposition configurations.

10.2.86 /<x>/<x>/OnNetwork/ConversationManagement/ReadDisposition/<x>/Entry

Table 10.2.86.1: /<x>/<x>/OnNetwork/ConversationManagement/ReadDisposition/<x>/Entry

<x>/OnNetwork/ConversationManagement/ReadDisposition/<x>/Entry

Status	Occurrence	Format	Min. Access Types
Optional	One	node	Get, Replace

This interior node is a placeholder for the read disposition configuration associated with the MCDData user, indicating an MCDData ID of an MCDData user who is to be sent a message read disposition notification in addition to the message sender.

10.2.87 /<x>/<x>/OnNetwork/ConversationManagement/ReadDisposition/<x>/Entry/MCDataID

Table 10.2.87.1: /<x>/<x>/OnNetwork/ConversationManagement/ReadDisposition/<x>/Entry/MCDataID

<x>/OnNetwork/ConversationManagement/ReadDisposition/<x>/Entry/MCDataID

Status	Occurrence	Format	Min. Access Types
Required	One	chr	Get, Replace

This leaf node indicates the MCData ID for the on-network MCData user.

The value is a "uri" attribute specified in OMA OMA-TS-XDM_Group-V1_1 [4].

10.2.88 /<x>/<x>/OnNetwork/ConversationManagement/ReadDisposition/<x>/Entry/DisplayName

Table 10.2.88.1:

/<x>/<x>/OnNetwork/ConversationManagement/ReadDisposition/<x>/Entry/DisplayName

<x>/OnNetwork/ConversationManagement/ReadDisposition/<x>/Entry/DisplayName

Status	Occurrence	Format	Min. Access Types
Optional	One	chr	Get, Replace

This leaf node contains a human readable name that corresponds to the MCData ID.

10.2.89 /<x>/<x>/OnNetwork/OneToOneEmergencyAlert

Table 10.2.89.1: /<x>/<x>/OnNetwork/OneToOneEmergencyAlert

<x>/OnNetwork/OneToOneEmergencyAlert

Status	Occurrence	Format	Min. Access Types
Required	One	node	Get, Replace

This interior node is a placeholder for on-network one-to-one emergency alert configuration.

10.2.90 /<x>/<x>/OnNetwork/OneToOneEmergencyAlert/Entry

Table 10.2.90.1: /<x>/<x>/OnNetwork/OneToOneEmergencyAlert/Entry

<x>/OnNetwork/OneToOneEmergencyAlert/Entry

Status	Occurrence	Format	Min. Access Types
Required	One	node	Get, Replace

This interior node is a placeholder for the details of the MCData ID of an MCData emergency alert.

10.2.91 /<x>/<x>/OnNetwork/OneToOneEmergencyAlert/Entry/ID

Table 10.2.91.1: /<x>/<x>/OnNetwork/OneToOneEmergencyAlert/Entry/ID

<x>/OnNetwork/OneToOneEmergencyAlert/Entry/ID

Status	Occurrence	Format	Min. Access Types
Required	One	chr	Get, Replace

This leaf node indicates the MCDData user ID used upon certain criteria on initiation of a one-to-one MCDData emergency alert.

10.2.92 /<x>/<x>/OnNetwork/OneToOneEmergencyAlert/Entry/DisplayName

Table 10.2.92.1: /<x>/<x>/OnNetwork/OneToOneEmergencyAlert/Entry/DisplayName

<x>/OnNetwork/OneToOneEmergencyAlert/Entry/DisplayName

Status	Occurrence	Format	Min. Access Types
Optional	One	chr	Get, Replace

This leaf node contains a human readable name that corresponds to the ID.

10.2.93 /<x>/<x>/OnNetwork/OneToOneEmergencyAlert/Entry/Usage

Table 10.2.93.1: /<x>/<x>/OnNetwork/OneToOneEmergencyAlert/Entry/Usage

<x>/OnNetwork/OneToOneEmergencyAlert/Entry/Usage

Status	Occurrence	Format	Min. Access Types
Required	One	chr	Get, Replace

This leaf node indicates the criteria to determine when initiation of an MCDData emergency alert uses the ID.

The valid values are 'LocallyDetermined' and 'UsePreConfigured'.

When set to 'LocallyDetermined' then if the MCDData user selects an MCDData ID then use that MCDData ID for an on-network MCDData emergency alert, if the MCDData user does not select a MCDData ID then use the MCDData ID identified by the ID in clause 10.2.91 for an on-network MCDData emergency alert.

When set to 'UsePreConfigured' then use the ID identified by the ID in clause 10.2.91 for an on-network MCDData emergency alert.

10.2.94 /<x>/<x>/OnNetwork/AllowedRegroup

Table 10.2.94.1: /<x>/<x>/OnNetwork/AllowedRegroup

<x>/OnNetwork/AllowedRegroup

Status	Occurrence	Format	Min. Access Types
Required	One	bool	Get, Replace

This leaf node indicates whether the MCDData user is authorised to perform dynamic regrouping operations.

When set to "true" the MCDData user is authorised to perform dynamic regrouping operations.

When set to "false" the MCDData user is not authorised to perform dynamic regrouping operations.

10.2.95 /<x>/<x>/OnNetwork/AllowedPresenceStatus

Table 10.2.95.1: /<x>/<x>/OnNetwork/AllowedPresenceStatus

<x>/OnNetwork/AllowedPresenceStatus

Status	Occurrence	Format	Min. Access Types

Optional	One	bool	Get, Replace
----------	-----	------	--------------

This leaf node indicates the presence status on the network of this MCDData user is available.

When set to "true" the presence status on the network of this MCDData user is available.

When set to "false" the presence status on the network of this MCDData user is not available. This is the default if this leaf node is not present.

10.2.96 /<x>/<x>/OnNetwork/AllowedPresence

Table 10.2.96.1: /<x>/<x>/OnNetwork/AllowedPresence

<x>/OnNetwork/AllowedPresence

Status	Occurrence	Format	Min. Access Types
Optional	One	bool	Get, Replace

This leaf node indicates whether the MCDData user is authorised to obtain whether a particular MCDData User is present on the network.

When set to "true" the MCDData user is authorised to obtain whether a particular MCDData User is present on the network.

When set to "false" the MCDData user is not authorised to obtain whether a particular MCDData User is present on the network.

10.2.97 /<x>/<x>/OnNetwork/AllowedManualSwitch

Table 10.2.97.1: /<x>/<x>/OnNetwork/AllowedManualSwitch

<x>/OnNetwork/AllowedManualSwitch

Status	Occurrence	Format	Min. Access Types
Required	One	bool	Get, Replace

This leaf node indicates whether the MCDData user is authorised to manually switch to off-network operation while in on-network operation.

When set to "true" the MCDData user is authorised to manually switch to off-network operation while in on-network operation.

When set to "false" the MCDData user is not authorised to manually switch to off-network operation while in on-network operation.

10.2.97A/<x>/<x>/OnNetwork/MCDDataContentServerURI

Table 10.2.97A.1: /<x>/<x>/OnNetwork/MCDDataContentServerURI

<x>/OnNetwork/MCDDataContentServerURI

Status	Occurrence	Format	Min. Access Types
Required	One	chr	Get, Replace

This leaf node indicates the absolute URI associated with the media storage function of the MCDData content server.

The value is a URI as specified in 3GPP TS 23.003 [5].

10.2.97B /<x>/<x>/OnNetwork/FunctionalAliasList

Table 10.2.97B.1: /<x>/<x>/OnNetwork/FunctionalAliasList

<x>/OnNetwork/FunctionalAliasList

Status	Occurrence	Format	Min. Access Types
Required	One	node	Get, Replace

This interior node is a placeholder for the functional alias configuration.

10.2.97B1 /<x>/<x>/OnNetwork/FunctionalAliasList/<x>

Table 10.2.97B1.1: /<x>/<x>/OnNetwork/FunctionalAliasList/<x>

<x>/OnNetwork/FunctionalAliasList/<x>

Status	Occurrence	Format	Min. Access Types
Required	OneOrMore	node	Get, Replace

This interior node is a placeholder for one or more functional alias configuration elements.

10.2.97B2 /<x>/<x>/OnNetwork/FunctionalAliasList/<x>/Entry

Table 10.2.97B2.1: /<x>/<x>/OnNetwork/FunctionalAliasList/<x>/Entry

<x>/OnNetwork/FunctionalAliasList/<x>/Entry

Status	Occurrence	Format	Min. Access Types
Optional	One	node	Get, Replace

This interior node is a placeholder for the details of the functional alias.

10.2.97B3 /<x>/<x>/OnNetwork/FunctionalAliasList/<x>/Entry/ FunctionalAlias

Table 10.2.97B3.1: /<x>/<x>/OnNetwork/FunctionalAliasList/<x>/Entry/FunctionalAlias

<x>/OnNetwork/FunctionalAliasList/<x>/Entry/FunctionalAlias

Status	Occurrence	Format	Min. Access Types
Required	One	chr	Get, Replace

This leaf node indicates a functional alias that can be activated by the MCDData user.

The value is a "uri" attribute specified in OMA OMA-TS-XDM_Group-V1_1 [4].

10.2.97B3A /<x>/<x>/OnNetwork/FunctionalAliasList/<x>/ Entry/DisplayName

Table 10.2.97B3A.1: /<x>/<x>/OnNetwork/FunctionalAliasList/<x>/Entry/DisplayName

<x>/OnNetwork/FunctionalAliasList/<x>/Entry/DisplayName

Status	Occurrence	Format	Min. Access Types
Optional	One	chr	Get, Replace

This leaf node contains a human readable name that corresponds to a functional alias that can be activated by the MCDData user.

10.2.97B3B /<x>/<x>/OnNetwork/FunctionalAliasList/<x>/Entry/ LocationCriteriaForActivation

Table 10.2.97B3B.1: /<x>/<x>/OnNetwork/FunctionalAliasList/<x>/Entry/LocationCriteriaForActivation

<x>/OnNetwork/FunctionalAliasList/<x>/Entry/LocationCriteriaForActivation

Status	Occurrence	Format	Min. Access Types
Optional	ZeroOrOne	node	Get, Replace

This interior node contains the location criteria for activation of a functional alias.

10.2.97B3B0 /<x>/<x>/OnNetwork/FunctionalAliasList/<x>/Entry/ LocationCriteriaForActivation/<x>

Table 10.2.97B3B0.1:

/<x>/<x>/OnNetwork/FunctionalAliasList/<x>/Entry/LocationCriteriaForActivation/<x>

<x>/OnNetwork/FunctionalAliasList/<x>/Entry/LocationCriteriaForActivation/<x>

Status	Occurrence	Format	Min. Access Types
Optional	ZeroOrMore	node	Get, Replace

This interior node contains the zero or more location criteria for activation of a functional alias.

10.2.97B3B1 /<x>/<x>/OnNetwork/FunctionalAliasList/<x>/Entry/ LocationCriteriaForActivation/<x>/EnterSpecificArea

**Table 10.2.97B3B1.1: /<x>/<x>/OnNetwork/FunctionalAliasList/<x>/Entry/
LocationCriteriaForActivation/<x>/EnterSpecificArea**

<x>/OnNetwork/FunctionalAliasList/<x>/Entry/LocationCriteriaForActivation/<x>/EnterSpecificArea

Status	Occurrence	Format	Min. Access Types
Optional	ZeroOrOne	node	Get, Replace

This interior node contains a geographical area which when entered by the MC service UE triggers the functional alias activation.

10.2.97B3B2 /<x>/<x>/OnNetwork/FunctionalAliasList/<x>/Entry/ LocationCriteriaForActivation/<x>/EnterSpecificArea/ PolygonArea

**Table 10.2.97B3B2.1: /<x>/<x>/OnNetwork/FunctionalAliasList/<x>/Entry/
LocationCriteriaForActivation/<x>/EnterSpecificArea/PolygonArea**

<x>/OnNetwork/FunctionalAliasList/<x>/Entry/LocationCriteriaForActivation/<x>/EnterSpecificArea/PolygonArea

Status	Occurrence	Format	Min. Access Types
Optional	ZeroOrOne	node	Get, Replace

This interior node contains a geographical area described by a polygon.

10.2.97B3B3 /<x>/<x>/OnNetwork/FunctionalAliasList/<x>/Entry/LocationCriteriaForActivation/<x>/EnterSpecificArea/PolygonArea/<x>

Table 10.2.97B3B3.1: /<x>/<x>/OnNetwork/FunctionalAliasList/<x>/Entry/LocationCriteriaForActivation/<x>/EnterSpecificArea/PolygonArea/<x>

<x>/OnNetwork/FunctionalAliasList/<x>/Entry/LocationCriteriaForActivation/<x>/EnterSpecificArea/PolygonArea/<x>

Status	Occurrence	Format	Min. Access Types
Required	OneOrN	node	Get, Replace

This interior node contains the coordinates of the corners which define a polygon. The occurrence of this leaf node is "3 to 15" as per 3GPP TS 23.032 [21].

10.2.97B3B4 /<x>/<x>/OnNetwork/FunctionalAliasList/<x>/Entry/LocationCriteriaForActivation/<x>/EnterSpecificArea/PolygonArea/<x>/PointCoordinateType

Table 10.2.97B3B4.1: /<x>/<x>/OnNetwork/FunctionalAliasList/<x>/Entry/LocationCriteriaForActivation/<x>/EnterSpecificArea/PolygonArea/<x>/PointCoordinateType

<x>/OnNetwork/FunctionalAliasList/<x>/Entry/LocationCriteriaForActivation/<x>/EnterSpecificArea/PolygonArea/<x>/PointCoordinateType

Status	Occurrence	Format	Min. Access Types
Required	One	node	Get, Replace

This interior node contains the coordinates of the center point of the ellipsoid arc.

10.2.97B3B5 /<x>/<x>/OnNetwork/FunctionalAliasList/<x>/Entry/LocationCriteriaForActivation/<x>/EnterSpecificArea/PolygonArea/<x>/PointCoordinateType/Longitude

Table 10.2.97B3B5.1: /<x>/<x>/OnNetwork/FunctionalAliasList/<x>/Entry/LocationCriteriaForActivation/<x>/EnterSpecificArea/PolygonArea/<x>/PointCoordinateType/Longitude

<x>/OnNetwork/FunctionalAliasList/<x>/Entry/LocationCriteriaForActivation/<x>/EnterSpecificArea/PolygonArea/<x>/PointCoordinateType/Longitude

Status	Occurrence	Format	Min. Access Types
Required	One	int	Get, Replace

This leaf node contains the longitudinal coordinate of a corner.

- Values: 0-16777215

10.2.97B3B6 /<x>/<x>/OnNetwork/FunctionalAliasList/<x>/Entry/ LocationCriteriaForActivation/<x>/EnterSpecificArea/ PolygonArea/<x>/PointCoordinateType/Latitude

**Table 10.2.97B3B6.1: /<x>/<x>/OnNetwork/FunctionalAliasList/<x>/Entry/
LocationCriteriaForActivation/<x>/EnterSpecificArea/PolygonArea/<x>/PointCoordinateType/Latitude**

<x>/OnNetwork/FunctionalAliasList/<x>/Entry/LocationCriteriaForActivation/<x>/EnterSpecificArea/PolygonArea
/<x>/PointCoordinateType/Latitude

Status	Occurrence	Format	Min. Access Types
Required	One	int	Get, Replace

This leaf node contains the latitudinal coordinate of a corner.

- Values: 0-16777215

10.2.97B3B7 /<x>/<x>/OnNetwork/FunctionalAliasList/<x>/Entry/ LocationCriteriaForActivation/<x>/EnterSpecificArea/ EllipsoidArcArea

**Table 10.2.97B3B7.1: /<x>/<x>/OnNetwork/FunctionalAliasList/<x>/Entry/
LocationCriteriaForActivation/<x>/EnterSpecificArea/EllipsoidArcArea**

<x>/OnNetwork/FunctionalAliasList/<x>/Entry/LocationCriteriaForActivation/<x>/EnterSpecificArea/EllipsoidArc

Status	Occurrence	Format	Min. Access Types
Optional	ZeroOrOne	node	Get, Replace

This interior node contains a geographical area described by an ellipsoid arc.

10.2.97B3B8 /<x>/<x>/OnNetwork/FunctionalAliasList/<x>/Entry/ LocationCriteriaForActivation/<x>/EnterSpecificArea/ EllipsoidArcArea/Center

**Table 10.2.97B3B8.1: /<x>/<x>/OnNetwork/FunctionalAliasList/<x>/Entry/
LocationCriteriaForActivation/<x>/EnterSpecificArea/EllipsoidArcArea/Center**

<x>/OnNetwork/FunctionalAliasList/<x>/Entry/LocationCriteriaForActivation/<x>/EnterSpecificArea/EllipsoidArc
Area/Center

Status	Occurrence	Format	Min. Access Types
Required	One	node	Get, Replace

This interior node contains the coordinates of the center point of the ellipsoid arc.

10.2.97B3B9 /<x>/<x>/OnNetwork/FunctionalAliasList/<x>/Entry/ LocationCriteriaForActivation/<x>/EnterSpecificArea/ EllipsoidArcArea/Center/PointCoordinateType

**Table 10.2.97B3B9.1: /<x>/<x>/OnNetwork/FunctionalAliasList/<x>/Entry/
LocationCriteriaForActivation/<x>/EnterSpecificArea/EllipsoidArcArea/Center/PointCoordinateType**

<x>/OnNetwork/FunctionalAliasList/<x>/Entry/LocationCriteriaForActivation/<x>/EnterSpecificArea/EllipsoidArc
Area/Center/PointCoordinateType

Status	Occurrence	Format	Min. Access Types
Required	One	node	Get, Replace

This interior node contains the coordinates of the center point of the ellipsoid arc.

10.2.97B3B10 /<x>/<x>/OnNetwork/FunctionalAliasList/<x>/Entry/ LocationCriteriaForActivation/<x>/EnterSpecificArea/ EllipsoidArcArea/Center/PointCoordinateType/Longitude

**Table 10.2.97B3B8.1: /<x>/<x>/OnNetwork/FunctionalAliasList/<x>/Entry/
LocationCriteriaForActivation/<x>/EnterSpecificArea/EllipsoidArcArea/Center/PointCoordinateType/
Longitude**

<x>/OnNetwork/FunctionalAliasList/<x>/Entry/LocationCriteriaForActivation/<x>/EnterSpecificArea/EllipsoidArc
Area/Center/PointCoordinateType/Longitude

Status	Occurrence	Format	Min. Access Types
Required	One	int	Get, Replace

This leaf node contains the longitudinal coordinate of the center.

- Values: 0-16777215

10.2.97B3B11 /<x>/<x>/OnNetwork/FunctionalAliasList/<x>/Entry/ LocationCriteriaForActivation/<x>/EnterSpecificArea/ EllipsoidArcArea/Center/PointCoordinateType/Latitude

**Table 10.2.97B3B11.1: /<x>/<x>/OnNetwork/FunctionalAliasList/<x>/Entry/
LocationCriteriaForActivation/<x>/EnterSpecificArea/EllipsoidArcArea/Center/PointCoordinateType/
Latitude**

<x>/OnNetwork/FunctionalAliasList/<x>/Entry/LocationCriteriaForActivation/<x>/EnterSpecificArea/EllipsoidArc
Area/Center/PointCoordinateType/Latitude

Status	Occurrence	Format	Min. Access Types
Required	One	int	Get, Replace

This leaf node contains the latitudinal coordinate of the center.

- Values: 0-16777215

10.2.97B3B12 /<x>/<x>/OnNetwork/FunctionalAliasList/<x>/Entry/ LocationCriteriaForActivation/<x>/EnterSpecificArea/ EllipsoidArcArea/Radius

**Table 10.2.97B3B12.1: /<x>/<x>/OnNetwork/FunctionalAliasList/<x>/Entry/
LocationCriteriaForActivation/<x>/EnterSpecificArea/EllipsoidArcArea/Radius**

<x>/OnNetwork/FunctionalAliasList/<x>/Entry/LocationCriteriaForActivation/<x>/EnterSpecificArea/EllipsoidArc
Area/Radius

Status	Occurrence	Format	Min. Access Types
Required	One	int	Get, Replace

This leaf node contains the radius of the ellipsoid arc.

- Values: non-negative integer

10.2.97B3B13 /<x>/<x>/OnNetwork/FunctionalAliasList/<x>/Entry/LocationCriteriaForActivation/<x>/EnterSpecificArea/EllipsoidArcArea/OffsetAngle

Table 10.2.97B3B13.1: /<x>/<x>/OnNetwork/FunctionalAliasList/<x>/Entry/LocationCriteriaForActivation/<x>/EnterSpecificArea/EllipsoidArcArea/OffsetAngle

<x>/OnNetwork/FunctionalAliasList/<x>/Entry/LocationCriteriaForActivation/<x>/EnterSpecificArea/EllipsoidArcArea/OffsetAngle

Status	Occurrence	Format	Min. Access Types
Required	One	int	Get, Replace

This leaf node contains the offset angle of the ellipsoid arc.

- Values: 0-255

10.2.97B3B14 /<x>/<x>/OnNetwork/FunctionalAliasList/<x>/Entry/LocationCriteriaForActivation/<x>/EnterSpecificArea/EllipsoidArcArea/IncludedAngle

Table 10.2.97B3B14.1: /<x>/<x>/OnNetwork/FunctionalAliasList/<x>/Entry/LocationCriteriaForActivation/<x>/EnterSpecificArea/EllipsoidArcArea/IncludedAngle

<x>/OnNetwork/FunctionalAliasList/<x>/Entry/LocationCriteriaForActivation/<x>/EnterSpecificArea/EllipsoidArcArea/IncludedAngle

Status	Occurrence	Format	Min. Access Types
Required	One	int	Get, Replace

This leaf node contains the included angle of the ellipsoid arc.

- Values: 0-255

10.2.97B3B15 /<x>/<x>/OnNetwork/FunctionalAliasList/<x>/Entry/LocationCriteriaForActivation/<x>/EnterSpecificArea/Speed

Table 10.2.97B3B15.1: /<x>/<x>/OnNetwork/FunctionalAliasList/<x>/Entry/LocationCriteriaForActivation/<x>/EnterSpecificArea/Speed

<x>/OnNetwork/FunctionalAliasList/<x>/Entry/LocationCriteriaForActivation/<x>/EnterSpecificArea/Speed

Status	Occurrence	Format	Min. Access Types
Optional	One	node	Get, Replace

This interior node contains the speed.

10.2.97B3B16 /<x>/<x>/OnNetwork/FunctionalAliasList/<x>/Entry/ LocationCriteriaForActivation/<x>/EnterSpecificArea/Speed/ MinimumSpeed

**Table 10.2.97B3B16.1: /<x>/<x>/OnNetwork/FunctionalAliasList/<x>/Entry/
LocationCriteriaForActivation/<x>/EnterSpecificArea/Speed/MinimumSpeed**

<x>/OnNetwork/FunctionalAliasList/<x>/Entry/LocationCriteriaForActivation/<x>/EnterSpecificArea/Speed/MinimumSpeed

Status	Occurrence	Format	Min. Access Types
Required	One	int	Get, Replace

This leaf node contains the minimum speed.

- Values: non-negative integer in units of kilometers/hour.

10.2.97B3B17 /<x>/<x>/OnNetwork/FunctionalAliasList/<x>/Entry/ LocationCriteriaForActivation/<x>/EnterSpecificArea/Speed/ MaximumSpeed

**Table 10.2.97B3B17.1: /<x>/<x>/OnNetwork/FunctionalAliasList/<x>/Entry/
LocationCriteriaForActivation/<x>/EnterSpecificArea/Speed/MaximumSpeed**

<x>/OnNetwork/FunctionalAliasList/<x>/Entry/LocationCriteriaForActivation/<x>/EnterSpecificArea/Speed/MaximumSpeed

Status	Occurrence	Format	Min. Access Types
Required	One	int	Get, Replace

This leaf node contains the maximum speed.

- Values: non-negative integer in units of kilometers/hour.

10.2.97B3B18 /<x>/<x>/OnNetwork/FunctionalAliasList/<x>/Entry/ LocationCriteriaForActivation/<x>/EnterSpecificArea/Heading

**Table 10.2.97B3B18.1: /<x>/<x>/OnNetwork/FunctionalAliasList/<x>/Entry/
LocationCriteriaForActivation/<x>/EnterSpecificArea/Heading**

<x>/OnNetwork/FunctionalAliasList/<x>/Entry/LocationCriteriaForActivation/<x>/EnterSpecificArea/Heading

Status	Occurrence	Format	Min. Access Types
Optional	One	node	Get, Replace

This interior node contains the heading.

10.2.97B3B19 /<x>/<x>/OnNetwork/FunctionalAliasList/<x>/Entry/LocationCriteriaForActivation/<x>/EnterSpecificArea/Heading/MinimumHeading

Table 10.2.97B3B19.1: /<x>/<x>/OnNetwork/FunctionalAliasList/<x>/Entry/LocationCriteriaForActivation/<x>/EnterSpecificArea/Heading/MinimumHeading

<x>/OnNetwork/FunctionalAliasList/<x>/Entry/LocationCriteriaForActivation/<x>/EnterSpecificArea/Heading/MinimumHeading

Status	Occurrence	Format	Min. Access Types
Required	One	int	Get, Replace

This leaf node contains the minimum heading.

- Values: 0-359

10.2.97B3B20 /<x>/<x>/OnNetwork/FunctionalAliasList/<x>/Entry/LocationCriteriaForActivation/<x>/EnterSpecificArea/Heading/MaximumHeading

Table 10.2.97B3B20.1: /<x>/<x>/OnNetwork/FunctionalAliasList/<x>/Entry/LocationCriteriaForActivation/<x>/EnterSpecificArea/Heading/MaximumHeading

<x>/OnNetwork/FunctionalAliasList/<x>/Entry/LocationCriteriaForActivation/<x>/EnterSpecificArea/Heading/MaximumHeading

Status	Occurrence	Format	Min. Access Types
Required	One	int	Get, Replace

This leaf node contains the maximum heading.

- Values: 0-359

10.2.97B3B21 /<x>/<x>/OnNetwork/FunctionalAliasList/<x>/Entry/LocationCriteriaForActivation/<x>/ExitSpecificArea

Table 10.2.97B3B21.1: /<x>/<x>/OnNetwork/FunctionalAliasList/<x>/Entry/LocationCriteriaForActivation/<x>/ExitSpecificArea

<x>/OnNetwork/FunctionalAliasList/<x>/Entry/LocationCriteriaForActivation/<x>/ExitSpecificArea

Status	Occurrence	Format	Min. Access Types
Optional	ZeroOrOne	node	Get, Replace

This interior node contains a geographical area which when exited by the MC service UE triggers the functional alias activation.

10.2.97B3B22 /<x>/<x>/OnNetwork/FunctionalAliasList/<x>/Entry/LocationCriteriaForActivation/<x>/ExitSpecificArea/PolygonArea

Table 10.2.97B3B22.1: /<x>/<x>/OnNetwork/FunctionalAliasList/<x>/Entry/LocationCriteriaForActivation/<x>/ExitSpecificArea/PolygonArea

<x>/OnNetwork/FunctionalAliasList/<x>/Entry/LocationCriteriaForActivation/<x>/ExitSpecificArea/PolygonArea

Status	Occurrence	Format	Min. Access Types
Optional	ZeroOrOne	node	Get, Replace

This interior node contains a geographical area described by a polygon.

10.2.97B3B23 /<x>/<x>/OnNetwork/FunctionalAliasList/<x>/Entry/LocationCriteriaForActivation/<x>/ExitSpecificArea/PolygonArea/<x>

Table 10.2.97B3B23.1: /<x>/<x>/OnNetwork/FunctionalAliasList/<x>/Entry/LocationCriteriaForActivation/<x>/ExitSpecificArea/PolygonArea/<x>

<x>/OnNetwork/FunctionalAliasList/<x>/Entry/LocationCriteriaForActivation/<x>/ExitSpecificArea/PolygonArea/<x>

Status	Occurrence	Format	Min. Access Types
Required	OneOrN	node	Get, Replace

This interior node contains the coordinates of the corners which define a polygon. The occurrence of this leaf node is "3 to 15" as per 3GPP TS 23.032 [21].

10.2.97B3B24 /<x>/<x>/OnNetwork/FunctionalAliasList/<x>/Entry/LocationCriteriaForActivation/<x>/ExitSpecificArea/PolygonArea/<x>/PointCoordinateType

Table 10.2.97B3B24.1: /<x>/<x>/OnNetwork/FunctionalAliasList/<x>/Entry/LocationCriteriaForActivation/<x>/ExitSpecificArea/PolygonArea/<x>/PointCoordinateType

<x>/OnNetwork/FunctionalAliasList/<x>/Entry/LocationCriteriaForActivation/<x>/ExitSpecificArea/PolygonArea/<x>/PointCoordinateType

Status	Occurrence	Format	Min. Access Types
Required	One	node	Get, Replace

This interior node contains the type of the coordinates.

10.2.97B3B25 /<x>/<x>/OnNetwork/FunctionalAliasList/<x>/Entry/LocationCriteriaForActivation/<x>/ExitSpecificArea/PolygonArea/<x>/PointCoordinateType/Longitude

Table 10.2.97B3B25.1: /<x>/<x>/OnNetwork/FunctionalAliasList/<x>/Entry/LocationCriteriaForActivation/<x>/ExitSpecificArea/PolygonArea/<x>/PointCoordinateType/Longitude

<x>/OnNetwork/FunctionalAliasList/<x>/Entry/LocationCriteriaForActivation/<x>/ExitSpecificArea/PolygonArea/<x>/PointCoordinateType/Longitude

Status	Occurrence	Format	Min. Access Types
Required	One	int	Get, Replace

This leaf node contains the longitudinal coordinate of a corner.

- Values: 0-16777215

10.2.97B3B26 /<x>/<x>/OnNetwork/FunctionalAliasList/<x>/Entry/ LocationCriteriaForActivation/<x>/ExitSpecificArea/ PolygonArea/<x>/PointCoordinateType/Latitude

**Table 10.2.97B3B26.1: /<x>/<x>/OnNetwork/FunctionalAliasList/<x>/Entry/
LocationCriteriaForActivation/<x>/ExitSpecificArea/PolygonArea/<x>/PointCoordinateType/Latitude**

<x>/OnNetwork/FunctionalAliasList/<x>/Entry/LocationCriteriaForActivation/<x>/ExitSpecificArea/PolygonArea/
<x>/PointCoordinateType/Latitude

Status	Occurrence	Format	Min. Access Types
Required	One	int	Get, Replace

This leaf node contains the latitudinal coordinate of a corner.

- Values: 0-16777215

10.2.97B3B27 /<x>/<x>/OnNetwork/FunctionalAliasList/<x>/Entry/ LocationCriteriaForActivation/<x>/ExitSpecificArea/ EllipsoidArcArea

**Table 10.2.97B3B27.1: /<x>/<x>/OnNetwork/FunctionalAliasList/<x>/Entry/
LocationCriteriaForActivation/<x>/ExitSpecificArea/EllipsoidArcArea**

<x>/OnNetwork/FunctionalAliasList/<x>/Entry/LocationCriteriaForActivation/<x>/ExitSpecificArea/EllipsoidArcA

Status	Occurrence	Format	Min. Access Types
Optional	ZeroOrOne	node	Get, Replace

This interior node contains a geographical area described by an ellipsoid arc.

10.2.97B3B28 /<x>/<x>/OnNetwork/FunctionalAliasList/<x>/Entry/ LocationCriteriaForActivation/<x>/ExitSpecificArea/ EllipsoidArcArea/Center

**Table 10.2.97B3B28.1: /<x>/<x>/OnNetwork/FunctionalAliasList/<x>/Entry/
LocationCriteriaForActivation/<x>/ExitSpecificArea/EllipsoidArcArea/Center**

<x>/OnNetwork/FunctionalAliasList/<x>/Entry/LocationCriteriaForActivation/<x>/ExitSpecificArea/EllipsoidArcA
rea/Center

Status	Occurrence	Format	Min. Access Types
Required	One	node	Get, Replace

This interior node contains the coordinates of the center point of the ellipsoid arc.

10.2.97B3B29 /<x>/<x>/OnNetwork/FunctionalAliasList/<x>/Entry/LocationCriteriaForActivation/<x>/ExitSpecificArea/EllipsoidArcArea/Center/PointCoordinateType

Table 10.2.97B3B29.1: /<x>/<x>/OnNetwork/FunctionalAliasList/<x>/Entry/LocationCriteriaForActivation/<x>/ExitSpecificArea/EllipsoidArcArea/Center/PointCoordinateType

<x>/OnNetwork/FunctionalAliasList/<x>/Entry/LocationCriteriaForActivation/<x>/ExitSpecificArea/EllipsoidArcArea/Center/PointCoordinateType

Status	Occurrence	Format	Min. Access Types
Required	One	node	Get, Replace

This interior node contains the coordinates of the center point of the ellipsoid arc.

10.2.97B3B30 /<x>/<x>/OnNetwork/FunctionalAliasList/<x>/Entry/LocationCriteriaForActivation/<x>/ExitSpecificArea/EllipsoidArcArea/Center/PointCoordinateType/Longitude

Table 10.2.97B3B30.1: /<x>/<x>/OnNetwork/FunctionalAliasList/<x>/Entry/LocationCriteriaForActivation/<x>/ExitSpecificArea/EllipsoidArcArea/Center/PointCoordinateType/Longitude

<x>/OnNetwork/FunctionalAliasList/<x>/Entry/LocationCriteriaForActivation/<x>/ExitSpecificArea/EllipsoidArcArea/Center/PointCoordinateType/Longitude

Status	Occurrence	Format	Min. Access Types
Required	One	int	Get, Replace

This leaf node contains the longitudinal coordinate of the center.

- Values: 0-16777215

10.2.97B3B31 /<x>/<x>/OnNetwork/FunctionalAliasList/<x>/Entry/LocationCriteriaForActivation/<x>/ExitSpecificArea/EllipsoidArcArea/Center/PointCoordinateType/Latitude

Table 10.2.97B3B31.1: /<x>/<x>/OnNetwork/FunctionalAliasList/<x>/Entry/LocationCriteriaForActivation/<x>/ExitSpecificArea/EllipsoidArcArea/Center/PointCoordinateType/Latitude

<x>/OnNetwork/FunctionalAliasList/<x>/Entry/LocationCriteriaForActivation/<x>/ExitSpecificArea/EllipsoidArcArea/Center/PointCoordinateType/Latitude

Status	Occurrence	Format	Min. Access Types
Required	One	int	Get, Replace

This leaf node contains the latitudinal coordinate of the center.

- Values: 0-16777215

10.2.97B3B32 /<x>/<x>/OnNetwork/FunctionalAliasList/<x>/Entry/ LocationCriteriaForActivation/<x>/ExitSpecificArea/ EllipsoidArcArea/Radius

**Table 10.2.97B3B32.1: /<x>/<x>/OnNetwork/FunctionalAliasList/<x>/Entry/
LocationCriteriaForActivation/<x>/ExitSpecificArea/EllipsoidArcArea/Radius**

<x>/OnNetwork/FunctionalAliasList/<x>/Entry/LocationCriteriaForActivation/<x>/ExitSpecificArea/EllipsoidArcArea/Radius

Status	Occurrence	Format	Min. Access Types
Required	One	int	Get, Replace

This leaf node contains the radius of the ellipsoid arc.

- Values: non-negative integer

10.2.97B3B33 /<x>/<x>/OnNetwork/FunctionalAliasList/<x>/Entry/ LocationCriteriaForActivation/<x>/ExitSpecificArea/ EllipsoidArcArea/OffsetAngle

**Table 10.2.97B3B33.1: /<x>/<x>/OnNetwork/FunctionalAliasList/<x>/Entry/
LocationCriteriaForActivation/<x>/ExitSpecificArea/EllipsoidArcArea/OffsetAngle**

<x>/OnNetwork/FunctionalAliasList/<x>/Entry/LocationCriteriaForActivation/<x>/ExitSpecificArea/EllipsoidArcArea/OffsetAngle

Status	Occurrence	Format	Min. Access Types
Required	One	int	Get, Replace

This leaf node contains the offset angle of the ellipsoid arc.

- Values: 0-255

10.2.97B3B34 /<x>/<x>/OnNetwork/FunctionalAliasList/<x>/Entry/ LocationCriteriaForActivation/<x>/ExitSpecificArea/ EllipsoidArcArea/IncludedAngle

**Table 10.2.97B3B34.1: /<x>/<x>/OnNetwork/FunctionalAliasList/<x>/Entry/
LocationCriteriaForActivation/<x>/ExitSpecificArea/EllipsoidArcArea/IncludedAngle**

<x>/OnNetwork/FunctionalAliasList/<x>/Entry/LocationCriteriaForActivation/<x>/ExitSpecificArea/EllipsoidArcArea/IncludedAngle

Status	Occurrence	Format	Min. Access Types
Required	One	int	Get, Replace

This leaf node contains the included angle of the ellipsoid arc.

- Values: 0-255

10.2.97B3B35 /<x>/<x>/OnNetwork/FunctionalAliasList/<x>/Entry/LocationCriteriaForActivation/<x>/ExitSpecificArea/Speed

Table 10.2.97B3B35.1: /<x>/<x>/OnNetwork/FunctionalAliasList/<x>/Entry/LocationCriteriaForActivation/<x>/ExitSpecificArea/Speed

<x>/OnNetwork/FunctionalAliasList/<x>/Entry/LocationCriteriaForActivation/<x>/ExitSpecificArea/Speed

Status	Occurrence	Format	Min. Access Types
Optional	One	node	Get, Replace

This interior node contains the speed.

10.2.97B3B36 /<x>/<x>/OnNetwork/FunctionalAliasList/<x>/Entry/LocationCriteriaForActivation/<x>/ExitSpecificArea/Speed/MinimumSpeed

Table 10.2.97B3B36.1: /<x>/<x>/OnNetwork/FunctionalAliasList/<x>/Entry/LocationCriteriaForActivation/<x>/ExitSpecificArea/Speed/MinimumSpeed

<x>/OnNetwork/FunctionalAliasList/<x>/Entry/LocationCriteriaForActivation/<x>/ExitSpecificArea/Speed/MinimumSpeed

Status	Occurrence	Format	Min. Access Types
Required	One	int	Get, Replace

This leaf node contains the minimum speed.

- Values: non-negative integer in units of kilometers/hour.

10.2.97B3B37 /<x>/<x>/OnNetwork/FunctionalAliasList/<x>/Entry/LocationCriteriaForActivation/<x>/ExitSpecificArea/Speed/MaximumSpeed

Table 10.2.97B3B37.1: /<x>/<x>/OnNetwork/FunctionalAliasList/<x>/Entry/LocationCriteriaForActivation/<x>/ExitSpecificArea/Speed/MaximumSpeed

<x>/OnNetwork/FunctionalAliasList/<x>/Entry/LocationCriteriaForActivation/<x>/ExitSpecificArea/Speed/MaximumSpeed

Status	Occurrence	Format	Min. Access Types
Required	One	int	Get, Replace

This leaf node contains the maximum speed.

- Values: non-negative integer in units of kilometers/hour.

10.2.97B3B38 /<x>/<x>/OnNetwork/FunctionalAliasList/<x>/Entry/LocationCriteriaForActivation/<x>/ExitSpecificArea/Heading

Table 10.2.97B3B38.1: /<x>/<x>/OnNetwork/FunctionalAliasList/<x>/Entry/LocationCriteriaForActivation/<x>/ExitSpecificArea/Heading

<x>/OnNetwork/FunctionalAliasList/<x>/Entry/LocationCriteriaForActivation/<x>/ExitSpecificArea/Heading

Status	Occurrence	Format	Min. Access Types
Optional	One	node	Get, Replace

This interior node contains the heading.

10.2.97B3B39 /<x>/<x>/OnNetwork/FunctionalAliasList/<x>/Entry/ LocationCriteriaForActivation/<x>/ExitSpecificArea/Heading/ MinimumHeading

**Table 10.2.97B3B39.1: /<x>/<x>/OnNetwork/FunctionalAliasList/<x>/Entry/
LocationCriteriaForActivation/<x>/ExitSpecificArea/Heading/MinimumHeading**

<x>/OnNetwork/FunctionalAliasList/<x>/Entry/LocationCriteriaForActivation/<x>/ExitSpecificArea/Heading/MinimumHeading

Status	Occurrence	Format	Min. Access Types
Required	One	int	Get, Replace

This leaf node contains the minimum heading.

- Values: 0-359

10.2.97B3B40 /<x>/<x>/OnNetwork/FunctionalAliasList/<x>/Entry/ LocationCriteriaForActivation/<x>/ExitSpecificArea/Heading/ MaximumHeading

**Table 10.2.97B3B40.1: /<x>/<x>/OnNetwork/FunctionalAliasList/<x>/Entry/
LocationCriteriaForActivation/<x>/ExitSpecificArea/Heading/MaximumHeading**

<x>/OnNetwork/FunctionalAliasList/<x>/Entry/LocationCriteriaForActivation/<x>/ExitSpecificArea/Heading/MaximumHeading

Status	Occurrence	Format	Min. Access Types
Required	One	int	Get, Replace

This leaf node contains the maximum heading.

- Values: 0-359

10.2.97B3C /<x>/<x>/OnNetwork/FunctionalAliasList/<x>/Entry/ LocationCriteriaForDeactivation

**Table 10.2.97B3C.1: /<x>/<x>/OnNetwork/FunctionalAliasList/<x>/Entry/
LocationCriteriaForDeactivation**

<x>/OnNetwork/FunctionalAliasList/<x>/Entry/LocationCriteriaForDeactivation

Status	Occurrence	Format	Min. Access Types
Optional	ZeroOrOne	node	Get, Replace

This interior node contains the location criteria for de-activation of a functional alias.

10.2.97B3C0 /<x>/<x>/OnNetwork/FunctionalAliasList/<x>/Entry/ LocationCriteriaForDeactivation/<x>

**Table 10.2.97B3C0.1: /<x>/<x>/OnNetwork/FunctionalAliasList/<x>/Entry/
LocationCriteriaForDeactivation/<x>**

<x>/OnNetwork/FunctionalAliasList/<x>/Entry/LocationCriteriaForDeactivation/<x>

Status	Occurrence	Format	Min. Access Types
Optional	ZeroOrMore	node	Get, Replace

This interior node contains the zero or more location criteria for de-activation of a functional alias.

10.2.97B3C1 /<x>/<x>/OnNetwork/FunctionalAliasList/<x>/Entry/ LocationCriteriaForDeactivation/<x>/EnterSpecificArea

**Table 10.2.97B3C1.1: /<x>/<x>/OnNetwork/FunctionalAliasList/<x>/Entry/
LocationCriteriaForDeactivation/<x>/EnterSpecificArea**

<x>/OnNetwork/FunctionalAliasList/<x>/Entry/LocationCriteriaForDeactivation/<x>/EnterSpecificArea

Status	Occurrence	Format	Min. Access Types
Optional	ZeroOrOne	node	Get, Replace

This interior node contains a geographical area which when entered by the MC service UE triggers the functional alias de-activation.

10.2.97B3C2 /<x>/<x>/OnNetwork/FunctionalAliasList/<x>/Entry/ LocationCriteriaForDeactivation/<x>/EnterSpecificArea/ PolygonArea

**Table 10.2.97B3C2.1: /<x>/<x>/OnNetwork/FunctionalAliasList/<x>/Entry/
LocationCriteriaForDeactivation/<x>/EnterSpecificArea/PolygonArea**

<x>/OnNetwork/FunctionalAliasList/<x>/Entry/LocationCriteriaForDeactivation/<x>/EnterSpecificArea/PolygonArea

Status	Occurrence	Format	Min. Access Types
Optional	ZeroOrOne	node	Get, Replace

This interior node contains a geographical area described by a polygon.

10.2.97B3C3 /<x>/<x>/OnNetwork/FunctionalAliasList/<x>/Entry/ LocationCriteriaForDeactivation/<x>/EnterSpecificArea/ PolygonArea/<x>

**Table 10.2.97B3C3.1: /<x>/<x>/OnNetwork/FunctionalAliasList/<x>/Entry/
LocationCriteriaForDeactivation/<x>/EnterSpecificArea/PolygonArea/<x>**

<x>/OnNetwork/FunctionalAliasList/<x>/Entry/LocationCriteriaForDeactivation/<x>/EnterSpecificArea/PolygonArea/<x>

Status	Occurrence	Format	Min. Access Types
Required	OneOrN	node	Get, Replace

This interior node contains the coordinates of the corners which define a polygon. The occurrence of this leaf node is "3 to 15" as per 3GPP TS 23.032 [21].

10.2.97B3C4 /<x>/<x>/OnNetwork/FunctionalAliasList/<x>/Entry/LocationCriteriaForDeactivation/<x>/EnterSpecificArea/PolygonArea/<x>/PointCoordinateType

Table 10.2.97B3C4.1: /<x>/<x>/OnNetwork/FunctionalAliasList/<x>/Entry/LocationCriteriaForDeactivation/<x>/EnterSpecificArea/PolygonArea/<x>/PointCoordinateType

<x>/OnNetwork/FunctionalAliasList/<x>/Entry/LocationCriteriaForDeactivation/<x>/EnterSpecificArea/PolygonArea/<x>/PointCoordinateType

Status	Occurrence	Format	Min. Access Types
Required	One	node	Get, Replace

This interior node contains the coordinates of the center point of the ellipsoid arc.

10.2.97B3C5 /<x>/<x>/OnNetwork/FunctionalAliasList/<x>/Entry/LocationCriteriaForDeactivation/<x>/EnterSpecificArea/PolygonArea/<x>/PointCoordinateType/Longitude

Table 10.2.97B3C5.1: /<x>/<x>/OnNetwork/FunctionalAliasList/<x>/Entry/LocationCriteriaForDeactivation/<x>/EnterSpecificArea/PolygonArea/<x>/PointCoordinateType/Longitude

<x>/OnNetwork/FunctionalAliasList/<x>/Entry/LocationCriteriaForDeactivation/<x>/EnterSpecificArea/PolygonArea/<x>/PointCoordinateType/Longitude

Status	Occurrence	Format	Min. Access Types
Required	One	int	Get, Replace

This leaf node contains the longitudinal coordinate of a corner.

- Values: 0-16777215

10.2.97B3C6 /<x>/<x>/OnNetwork/FunctionalAliasList/<x>/Entry/LocationCriteriaForDeactivation/<x>/EnterSpecificArea/PolygonArea/<x>/PointCoordinateType/Latitude

Table 10.2.97B3C6.1: /<x>/<x>/OnNetwork/FunctionalAliasList/<x>/Entry/LocationCriteriaForDeactivation/<x>/EnterSpecificArea/PolygonArea/<x>/PointCoordinateType/Latitude

<x>/OnNetwork/FunctionalAliasList/<x>/Entry/LocationCriteriaForDeactivation/<x>/EnterSpecificArea/PolygonArea/<x>/PointCoordinateType/Latitude

Status	Occurrence	Format	Min. Access Types
Required	One	int	Get, Replace

This leaf node contains the latitudinal coordinate of a corner.

- Values: 0-16777215

10.2.97B3C7 /<x>/<x>/OnNetwork/FunctionalAliasList/<x>/Entry/
LocationCriteriaForDeactivation/<x>/EnterSpecificArea/
EllipsoidArcArea

**Table 10.2.97B3C7.1: /<x>/<x>/OnNetwork/FunctionalAliasList/<x>/Entry/
LocationCriteriaForDeactivation/<x>/EnterSpecificArea/EllipsoidArcArea**

<x>/OnNetwork/FunctionalAliasList/<x>/Entry/LocationCriteriaForDeactivation/<x>/EnterSpecificArea/EllipsoidArcArea

Status	Occurrence	Format	Min. Access Types
Optional	ZeroOrOne	node	Get, Replace

This interior node contains a geographical area described by an ellipsoid arc.

10.2.97B3C8 /<x>/<x>/OnNetwork/FunctionalAliasList/<x>/Entry/
LocationCriteriaForDeactivation/<x>/EnterSpecificArea/
EllipsoidArcArea/Center

**Table 10.2.97B3C8.1: /<x>/<x>/OnNetwork/FunctionalAliasList/<x>/Entry/
LocationCriteriaForDeactivation/<x>/EnterSpecificArea/EllipsoidArcArea/Center**

<x>/OnNetwork/FunctionalAliasList/<x>/Entry/LocationCriteriaForDeactivation/<x>/EnterSpecificArea/EllipsoidArcArea/Center

Status	Occurrence	Format	Min. Access Types
Required	One	node	Get, Replace

This interior node contains the coordinates of the center point of the ellipsoid arc.

10.2.97B3C9 /<x>/<x>/OnNetwork/FunctionalAliasList/<x>/Entry/
LocationCriteriaForDeactivation/<x>/EnterSpecificArea/
EllipsoidArcArea/Center/PointCoordinateType

**Table 10.2.97B3C9.1: /<x>/<x>/OnNetwork/FunctionalAliasList/<x>/Entry/
LocationCriteriaForDeactivation/<x>/EnterSpecificArea/EllipsoidArcArea/Center/PointCoordinateType**

<x>/OnNetwork/FunctionalAliasList/<x>/Entry/LocationCriteriaForDeactivation/<x>/EnterSpecificArea/EllipsoidArcArea/Center/PointCoordinateType

Status	Occurrence	Format	Min. Access Types
Required	One	node	Get, Replace

This interior node contains the coordinates of the center point of the ellipsoid arc.

10.2.97B3C10 /<x>/<x>/OnNetwork/FunctionalAliasList/<x>/Entry/
LocationCriteriaForDeactivation/<x>/EnterSpecificArea/
EllipsoidArcArea/Center/PointCoordinateType/Longitude

**Table 10.2.97B3C10.1: /<x>/<x>/OnNetwork/FunctionalAliasList/<x>/Entry/
LocationCriteriaForDeactivation/<x>/EnterSpecificArea/EllipsoidArcArea/Center/PointCoordinateType/
Longitude**

<x>/OnNetwork/FunctionalAliasList/<x>/Entry/LocationCriteriaForDeactivation/<x>/EnterSpecificArea/EllipsoidArcArea/Center/PointCoordinateType/Longitude

Status	Occurrence	Format	Min. Access Types
Required	One	int	Get, Replace

This leaf node contains the longitudinal coordinate of the center.

- Values: 0-16777215

10.2.97B3C11 /<x>/<x>/OnNetwork/FunctionalAliasList/<x>/Entry/
LocationCriteriaForDeactivation/<x>/EnterSpecificArea/
EllipsoidArcArea/Center/PointCoordinateType/Latitude

**Table 10.2.97B3C11.1: /<x>/<x>/OnNetwork/FunctionalAliasList/<x>/Entry/
LocationCriteriaForDeactivation/<x>/EnterSpecificArea/EllipsoidArcArea/Center/PointCoordinateType/
Latitude**

<x>/OnNetwork/FunctionalAliasList/<x>/Entry/LocationCriteriaForDeactivation/<x>/EnterSpecificArea/EllipsoidArcArea/Center/PointCoordinateType/Latitude

Status	Occurrence	Format	Min. Access Types
Required	One	int	Get, Replace

This leaf node contains the latitudinal coordinate of the center.

- Values: 0-16777215

10.2.97B3C12 /<x>/<x>/OnNetwork/FunctionalAliasList/<x>/Entry/
LocationCriteriaForDeactivation/<x>/EnterSpecificArea/
EllipsoidArcArea/Radius

**Table 10.2.97B3C12.1: /<x>/<x>/OnNetwork/FunctionalAliasList/<x>/Entry/
LocationCriteriaForDeactivation/<x>/EnterSpecificArea/EllipsoidArcArea/Radius**

<x>/OnNetwork/FunctionalAliasList/<x>/Entry/LocationCriteriaForDeactivation/<x>/EnterSpecificArea/EllipsoidArcArea/Radius

Status	Occurrence	Format	Min. Access Types
Required	One	int	Get, Replace

This leaf node contains the radius of the ellipsoid arc.

- Values: non-negative integer

10.2.97B3C13 /<x>/<x>/OnNetwork/FunctionalAliasList/<x>/Entry/ LocationCriteriaForDeactivation/<x>/EnterSpecificArea/ EllipsoidArcArea/OffsetAngle

**Table 10.2.97B3C13.1: /<x>/<x>/OnNetwork/FunctionalAliasList/<x>/Entry/
LocationCriteriaForDeactivation/<x>/EnterSpecificArea/EllipsoidArcArea/OffsetAngle**

<x>/OnNetwork/FunctionalAliasList/<x>/Entry/LocationCriteriaForDeactivation/<x>/EnterSpecificArea/EllipsoidArcArea/OffsetAngle

Status	Occurrence	Format	Min. Access Types
Required	One	int	Get, Replace

This leaf node contains the offset angle of the ellipsoid arc.

- Values: 0-255

10.2.97B3C14 /<x>/<x>/OnNetwork/FunctionalAliasList/<x>/Entry/ LocationCriteriaForDeactivation/<x>/EnterSpecificArea/ EllipsoidArcArea/IncludedAngle

**Table 10.2.97B3C14.1: /<x>/<x>/OnNetwork/FunctionalAliasList/<x>/Entry/
LocationCriteriaForDeactivation/<x>/EnterSpecificArea/EllipsoidArcArea/IncludedAngle**

<x>/OnNetwork/FunctionalAliasList/<x>/Entry/LocationCriteriaForDeactivation/<x>/EnterSpecificArea/EllipsoidArcArea/IncludedAngle

Status	Occurrence	Format	Min. Access Types
Required	One	int	Get, Replace

This leaf node contains the included angle of the ellipsoid arc.

- Values: 0-255

10.2.97B3C15 /<x>/<x>/OnNetwork/FunctionalAliasList/<x>/Entry/ LocationCriteriaForDeactivation/<x>/EnterSpecificArea/Speed

**Table 10.2.97B3C15.1: /<x>/<x>/OnNetwork/FunctionalAliasList/<x>/Entry/
LocationCriteriaForDeactivation/<x>/EnterSpecificArea/Speed**

<x>/OnNetwork/FunctionalAliasList/<x>/Entry/LocationCriteriaForDeactivation/<x>/EnterSpecificArea/Speed

Status	Occurrence	Format	Min. Access Types
Optional	One	node	Get, Replace

This interior node contains the speed.

10.2.97B3C16 /<x>/<x>/OnNetwork/FunctionalAliasList/<x>/Entry/
LocationCriteriaForDeactivation/<x>/EnterSpecificArea/Speed/
MinimumSpeed

**Table 10.2.97B3C16.1: /<x>/<x>/OnNetwork/FunctionalAliasList/<x>/Entry/
LocationCriteriaForDeactivation/<x>/EnterSpecificArea/Speed/MinimumSpeed**

<x>/OnNetwork/FunctionalAliasList/<x>/Entry/LocationCriteriaForDeactivation/<x>/EnterSpecificArea/Speed/MinimumSpeed

Status	Occurrence	Format	Min. Access Types
Required	One	int	Get, Replace

This leaf node contains the minimum speed.

- Values: non-negative integer in units of kilometers/hour.

10.2.97B3C17 /<x>/<x>/OnNetwork/FunctionalAliasList/<x>/Entry/
LocationCriteriaForDeactivation/<x>/EnterSpecificArea/Speed/
MaximumSpeed

**Table 10.2.97B3C17.1: /<x>/<x>/OnNetwork/FunctionalAliasList/<x>/Entry/
LocationCriteriaForDeactivation/<x>/EnterSpecificArea/Speed/MaximumSpeed**

<x>/OnNetwork/FunctionalAliasList/<x>/Entry/LocationCriteriaForDeactivation/<x>/EnterSpecificArea/Speed/MaximumSpeed

Status	Occurrence	Format	Min. Access Types
Required	One	int	Get, Replace

This leaf node contains the maximum speed.

- Values: non-negative integer in units of kilometers/hour.

10.2.97B3C18 /<x>/<x>/OnNetwork/FunctionalAliasList/<x>/Entry/
LocationCriteriaForDeactivation/<x>/EnterSpecificArea/Heading

**Table 10.2.97B3C18.1: /<x>/<x>/OnNetwork/FunctionalAliasList/<x>/Entry/
LocationCriteriaForDeactivation/<x>/EnterSpecificArea/Heading**

<x>/OnNetwork/FunctionalAliasList/<x>/Entry/LocationCriteriaForDeactivation/<x>/EnterSpecificArea/Heading

Status	Occurrence	Format	Min. Access Types
Optional	One	node	Get, Replace

This interior node contains the heading.

10.2.97B3C19 /<x>/<x>/OnNetwork/FunctionalAliasList/<x>/Entry/
LocationCriteriaForDeactivation/<x>/EnterSpecificArea/Heading/
MinimumHeading

**Table 10.2.97B3C19.1: /<x>/<x>/OnNetwork/FunctionalAliasList/<x>/Entry/
LocationCriteriaForDeactivation/<x>/EnterSpecificArea/Heading/MinimumHeading**

<x>/OnNetwork/FunctionalAliasList/<x>/Entry/LocationCriteriaForDeactivation/<x>/EnterSpecificArea/Heading/M
inimumHeading

Status	Occurrence	Format	Min. Access Types
Required	One	int	Get, Replace

This leaf node contains the minimum heading.

- Values: 0-359

10.2.97B3C20 /<x>/<x>/OnNetwork/FunctionalAliasList/<x>/Entry/
LocationCriteriaForDeactivation/<x>/EnterSpecificArea/Heading/
MaximumHeading

**Table 10.2.97B3C20.1: /<x>/<x>/OnNetwork/FunctionalAliasList/<x>/Entry/
LocationCriteriaForDeactivation/<x>/EnterSpecificArea/Heading/MaximumHeading**

<x>/OnNetwork/FunctionalAliasList/<x>/Entry/LocationCriteriaForDeactivation/<x>/EnterSpecificArea/Heading/M
aximumHeading

Status	Occurrence	Format	Min. Access Types
Required	One	int	Get, Replace

This leaf node contains the maximum heading.

- Values: 0-359

10.2.97B3C21 /<x>/<x>/OnNetwork/FunctionalAliasList/<x>/Entry/
LocationCriteriaForDeactivation/<x>/ExitSpecificArea

**Table 10.2.97B3C21.1: /<x>/<x>/OnNetwork/FunctionalAliasList/<x>/Entry/
LocationCriteriaForDeactivation/<x>/ExitSpecificArea**

<x>/OnNetwork/FunctionalAliasList/<x>/Entry/LocationCriteriaForDeactivation/<x>/ExitSpecificArea

Status	Occurrence	Format	Min. Access Types
Optional	ZeroOrOne	node	Get, Replace

This interior node contains a geographical area which when exited by the MC service UE triggers the functional alias de-activation.

10.2.97B3C22 /<x>/<x>/OnNetwork/FunctionalAliasList/<x>/Entry/ LocationCriteriaForDeactivation/<x>/ExitSpecificArea/ PolygonArea

**Table 10.2.97B3C22.1: /<x>/<x>/OnNetwork/FunctionalAliasList/<x>/Entry/
LocationCriteriaForDeactivation/<x>/ExitSpecificArea/PolygonArea**

<x>/OnNetwork/FunctionalAliasList/<x>/Entry/LocationCriteriaForDeactivation/<x>/ExitSpecificArea/PolygonArea
a

Status	Occurrence	Format	Min. Access Types
Optional	ZeroOrOne	node	Get, Replace

This interior node contains a geographical area described by a polygon.

10.2.97B3C23 /<x>/<x>/OnNetwork/FunctionalAliasList/<x>/Entry/ LocationCriteriaForDeactivation/<x>/ExitSpecificArea/ PolygonArea/<x>

**Table 10.2.97B3C23.1: /<x>/<x>/OnNetwork/FunctionalAliasList/<x>/Entry/
LocationCriteriaForDeactivation/<x>/ExitSpecificArea/PolygonArea/<x>**

<x>/OnNetwork/FunctionalAliasList/<x>/Entry/LocationCriteriaForDeactivation/<x>/ExitSpecificArea/PolygonArea
a/<x>

Status	Occurrence	Format	Min. Access Types
Required	OneOrN	node	Get, Replace

This interior node contains the coordinates of the corners which define a polygon. The occurrence of this leaf node is "3 to 15" as per 3GPP TS 23.032 [21].

10.2.97B3C24 /<x>/<x>/OnNetwork/FunctionalAliasList/<x>/Entry/ LocationCriteriaForDeactivation/<x>/ExitSpecificArea/ PolygonArea/<x>/PointCoordinateType

**Table 10.2.97B3C24.1: /<x>/<x>/OnNetwork/FunctionalAliasList/<x>/Entry/
LocationCriteriaForDeactivation/<x>/ExitSpecificArea/PolygonArea/<x>/PointCoordinateType**

<x>/OnNetwork/FunctionalAliasList/<x>/Entry/LocationCriteriaForDeactivation/<x>/ExitSpecificArea/PolygonArea
a/<x>/PointCoordinateType

Status	Occurrence	Format	Min. Access Types
Required	One	node	Get, Replace

This interior node contains the coordinates of the center point of the ellipsoid arc.

10.2.97B3C25 /<x>/<x>/OnNetwork/FunctionalAliasList/<x>/Entry/
LocationCriteriaForDeactivation/<x>/ExitSpecificArea/
PolygonArea/<x>/PointCoordinateType/Longitude

**Table 10.2.97B3C25.1: /<x>/<x>/OnNetwork/FunctionalAliasList/<x>/Entry/
LocationCriteriaForDeactivation/<x>/ExitSpecificArea/PolygonArea/<x>/PointCoordinateType/
Longitude**

<x>/OnNetwork/FunctionalAliasList/<x>/Entry/LocationCriteriaForDeactivation/<x>/ExitSpecificArea/PolygonArea/<x>/PointCoordinateType/Longitude

Status	Occurrence	Format	Min. Access Types
Required	One	int	Get, Replace

This leaf node contains the longitudinal coordinate of a corner.

- Values: 0-16777215

10.2.97B3C26 /<x>/<x>/OnNetwork/FunctionalAliasList/<x>/Entry/
LocationCriteriaForDeactivation/<x>/ExitSpecificArea/
PolygonArea/<x>/PointCoordinateType/Latitude

**Table 10.2.97B3C26.1: /<x>/<x>/OnNetwork/FunctionalAliasList/<x>/Entry/
LocationCriteriaForDeactivation/<x>/ExitSpecificArea/PolygonArea/<x>/PointCoordinateType/Latitud
e**

<x>/OnNetwork/FunctionalAliasList/<x>/Entry/LocationCriteriaForDeactivation/<x>/ExitSpecificArea/PolygonArea/<x>/PointCoordinateType/Latitude

Status	Occurrence	Format	Min. Access Types
Required	One	int	Get, Replace

This leaf node contains the latitudinal coordinate of a corner.

- Values: 0-16777215

10.2.97B3C27 /<x>/<x>/OnNetwork/FunctionalAliasList/<x>/Entry/
LocationCriteriaForDeactivation/<x>/ExitSpecificArea/
EllipsoidArcArea

**Table 10.2.97B3C27.1: /<x>/<x>/OnNetwork/FunctionalAliasList/<x>/Entry/
LocationCriteriaForDeactivation/<x>/ExitSpecificArea/EllipsoidArcArea**

<x>/OnNetwork/FunctionalAliasList/<x>/Entry/LocationCriteriaForDeactivation/<x>/ExitSpecificArea/EllipsoidArc

Status	Occurrence	Format	Min. Access Types
Optional	ZeroOrOne	node	Get, Replace

This interior node contains a geographical area described by an ellipsoid arc.

10.2.97B3C28 /<x>/<x>/OnNetwork/FunctionalAliasList/<x>/Entry/
LocationCriteriaForDeactivation/<x>/ExitSpecificArea/
EllipsoidArcArea/Center

**Table 10.2.97B3C28.1: /<x>/<x>/OnNetwork/FunctionalAliasList/<x>/Entry/
LocationCriteriaForDeactivation/<x>/ExitSpecificArea/EllipsoidArcArea/Center**

<x>/OnNetwork/FunctionalAliasList/<x>/Entry/LocationCriteriaForDeactivation/<x>/ExitSpecificArea/EllipsoidArc
Area/Center

Status	Occurrence	Format	Min. Access Types
Required	One	node	Get, Replace

This interior node contains the coordinates of the center point of the ellipsoid arc.

10.2.97B3C29 /<x>/<x>/OnNetwork/FunctionalAliasList/<x>/Entry/
LocationCriteriaForDeactivation/<x>/ExitSpecificArea/
EllipsoidArcArea/Center/PointCoordinateType

**Table 10.2.97B3C29.1: /<x>/<x>/OnNetwork/FunctionalAliasList/<x>/Entry/
LocationCriteriaForDeactivation/<x>/ExitSpecificArea/EllipsoidArcArea/Center/PointCoordinateType**

<x>/OnNetwork/FunctionalAliasList/<x>/Entry/LocationCriteriaForDeactivation/<x>/ExitSpecificArea/EllipsoidArc
Area/Center/PointCoordinateType

Status	Occurrence	Format	Min. Access Types
Required	One	node	Get, Replace

This interior node contains the coordinates of the center point of the ellipsoid arc.

10.2.97B3C30 /<x>/<x>/OnNetwork/FunctionalAliasList/<x>/Entry/
LocationCriteriaForDeactivation/<x>/ExitSpecificArea/
EllipsoidArcArea/Center/PointCoordinateType/Longitude

**Table 10.2.97B3C30.1: /<x>/<x>/OnNetwork/FunctionalAliasList/<x>/Entry/
LocationCriteriaForDeactivation/<x>/ExitSpecificArea/EllipsoidArcArea/Center/PointCoordinateType/
Longitude**

<x>/OnNetwork/FunctionalAliasList/<x>/Entry/LocationCriteriaForDeactivation/<x>/ExitSpecificArea/EllipsoidArc
Area/Center/PointCoordinateType/Longitude

Status	Occurrence	Format	Min. Access Types
Required	One	int	Get, Replace

This leaf node contains the longitudinal coordinate of the center.

- Values: 0-16777215

10.2.97B3C31 /<x>/<x>/OnNetwork/FunctionalAliasList/<x>/Entry/ LocationCriteriaForDeactivation/<x>/ExitSpecificArea/ EllipsoidArcArea/Center/PointCoordinateType/Latitude

**Table 10.2.97B3C31.1: /<x>/<x>/OnNetwork/FunctionalAliasList/<x>/Entry/
LocationCriteriaForDeactivation/<x>/ExitSpecificArea/EllipsoidArcArea/Center/PointCoordinateType/
Latitude**

<x>/OnNetwork/FunctionalAliasList/<x>/Entry/LocationCriteriaForDeactivation/<x>/ExitSpecificArea/EllipsoidArc
Area/Center/PointCoordinateType/Latitude

Status	Occurrence	Format	Min. Access Types
Required	One	int	Get, Replace

This leaf node contains the latitudinal coordinate of the center.

- Values: 0-16777215

10.2.97B3C32 /<x>/<x>/OnNetwork/FunctionalAliasList/<x>/Entry/ LocationCriteriaForDeactivation/<x>/ExitSpecificArea/ EllipsoidArcArea/Radius

**Table 10.2.97B3C32.1: /<x>/<x>/OnNetwork/FunctionalAliasList/<x>/Entry/
LocationCriteriaForDeactivation/<x>/ExitSpecificArea/EllipsoidArcArea/Radius**

<x>/OnNetwork/FunctionalAliasList/<x>/Entry/LocationCriteriaForDeactivation/<x>/ExitSpecificArea/EllipsoidArc
Area/Radius

Status	Occurrence	Format	Min. Access Types
Required	One	int	Get, Replace

This leaf node contains the radius of the ellipsoid arc.

- Values: non-negative integer

10.2.97B3C33 /<x>/<x>/OnNetwork/FunctionalAliasList/<x>/Entry/ LocationCriteriaForDeactivation/<x>/ExitSpecificArea/ EllipsoidArcArea/OffsetAngle

**Table 10.2.97B3C33.1: /<x>/<x>/OnNetwork/FunctionalAliasList/<x>/Entry/
LocationCriteriaForDeactivation/<x>/ExitSpecificArea/EllipsoidArcArea/OffsetAngle**

<x>/OnNetwork/FunctionalAliasList/<x>/Entry/LocationCriteriaForDeactivation/<x>/ExitSpecificArea/EllipsoidArc
Area/OffsetAngle

Status	Occurrence	Format	Min. Access Types
Required	One	int	Get, Replace

This leaf node contains the offset angle of the ellipsoid arc.

- Values: 0-255

10.2.97B3C34 /<x>/<x>/OnNetwork/FunctionalAliasList/<x>/Entry/ LocationCriteriaForDeactivation/<x>/ExitSpecificArea/ EllipsoidArcArea/IncludedAngle

**Table 10.2.97B3C34.1: /<x>/<x>/OnNetwork/FunctionalAliasList/<x>/Entry/
LocationCriteriaForDeactivation/<x>/ExitSpecificArea/EllipsoidArcArea/IncludedAngle**

<x>/OnNetwork/FunctionalAliasList/<x>/Entry/LocationCriteriaForDeactivation/<x>/ExitSpecificArea/EllipsoidArc
Area/IncludedAngle

Status	Occurrence	Format	Min. Access Types
Required	One	int	Get, Replace

This leaf node contains the included angle of the ellipsoid arc.

- Values: 0-255

10.2.97B3C35 /<x>/<x>/OnNetwork/FunctionalAliasList/<x>/Entry/ LocationCriteriaForDeactivation/<x>/ExitSpecificArea/Speed

**Table 10.2.97B3C35.1: /<x>/<x>/OnNetwork/FunctionalAliasList/<x>/Entry/
LocationCriteriaForDeactivation/<x>/ExitSpecificArea/Speed**

<x>/OnNetwork/FunctionalAliasList/<x>/Entry/LocationCriteriaForDeactivation/<x>/ExitSpecificArea/Speed

Status	Occurrence	Format	Min. Access Types
Optional	One	node	Get, Replace

This interior node contains the speed.

10.2.97B3C36 /<x>/<x>/OnNetwork/FunctionalAliasList/<x>/Entry/ LocationCriteriaForDeactivation/<x>/ExitSpecificArea/Speed/ MinimumSpeed

**Table 10.2.97B3C36.1: /<x>/<x>/OnNetwork/FunctionalAliasList/<x>/Entry/
LocationCriteriaForDeactivation/<x>/ExitSpecificArea/Speed/MinimumSpeed**

<x>/OnNetwork/FunctionalAliasList/<x>/Entry/LocationCriteriaForDeactivation/<x>/ExitSpecificArea/Speed/Mini
mumSpeed

Status	Occurrence	Format	Min. Access Types
Required	One	int	Get, Replace

This leaf node contains the minimum speed.

- Values: non-negative integer in units of kilometers/hour.

10.2.97B3C37 /<x>/<x>/OnNetwork/FunctionalAliasList/<x>/Entry/
LocationCriteriaForDeactivation/<x>/ExitSpecificArea/Speed/
MaximumSpeed

**Table 10.2.97B3C37.1: /<x>/<x>/OnNetwork/FunctionalAliasList/<x>/Entry/
LocationCriteriaForDeactivation/<x>/ExitSpecificArea/Speed/MaximumSpeed**

<x>/OnNetwork/FunctionalAliasList/<x>/Entry/LocationCriteriaForDeactivation/<x>/ExitSpecificArea/Speed/MaximumSpeed

Status	Occurrence	Format	Min. Access Types
Required	One	int	Get, Replace

This leaf node contains the maximum speed.

- Values: non-negative integer in units of kilometers/hour.

10.2.97B3C38 /<x>/<x>/OnNetwork/FunctionalAliasList/<x>/Entry/
LocationCriteriaForDeactivation/<x>/ExitSpecificArea/Heading

**Table 10.2.97B3C38.1: /<x>/<x>/OnNetwork/FunctionalAliasList/<x>/Entry/
LocationCriteriaForDeactivation/<x>/ExitSpecificArea/Heading**

<x>/OnNetwork/FunctionalAliasList/<x>/Entry/LocationCriteriaForDeactivation/<x>/ExitSpecificArea/Heading

Status	Occurrence	Format	Min. Access Types
Optional	One	node	Get, Replace

This interior node contains the heading.

10.2.97B3C39 /<x>/<x>/OnNetwork/FunctionalAliasList/<x>/Entry/
LocationCriteriaForDeactivation/<x>/ExitSpecificArea/Heading/
MinimumHeading

**Table 10.2.97B3C39.1: /<x>/<x>/OnNetwork/FunctionalAliasList/<x>/Entry/
LocationCriteriaForDeactivation/<x>/ExitSpecificArea/Heading/MinimumHeading**

<x>/OnNetwork/FunctionalAliasList/<x>/Entry/LocationCriteriaForDeactivation/<x>/ExitSpecificArea/Heading/MinimumHeading

Status	Occurrence	Format	Min. Access Types
Required	One	int	Get, Replace

This leaf node contains the minimum heading.

- Values: 0-359

10.2.97B3C40 /<x>/<x>/OnNetwork/FunctionalAliasList/<x>/Entry/LocationCriteriaForDeactivation/<x>/ExitSpecificArea/Heading/MaximumHeading

Table 10.2.97B3C40.1: /<x>/<x>/OnNetwork/FunctionalAliasList/<x>/Entry/LocationCriteriaForDeactivation/<x>/ExitSpecificArea/Heading/MaximumHeading

<x>/OnNetwork/FunctionalAliasList/<x>/Entry/LocationCriteriaForDeactivation/<x>/ExitSpecificArea/Heading/MaximumHeading

Status	Occurrence	Format	Min. Access Types
Required	One	int	Get, Replace

This leaf node contains the maximum heading.

- Values: 0-359

10.2.97B3D /<x>/<x>/OnNetwork/FunctionalAliasList/<x>/Entry/ManualDeactivationNotAllowedIfLocationCriteriaMet

Table 10.2.97B3D.1: /<x>/<x>/OnNetwork/FunctionalAliasList/<x>/Entry/ManualDeactivationNotAllowedIfLocationCriteriaMet

<x>/OnNetwork/FunctionalAliasList/<x>/Entry/ManualDeactivationNotAllowedIfLocationCriteriaMet

Status	Occurrence	Format	Min. Access Types
Optional	ZeroOrOne	bool	Get, Replace

This leaf node indicates whether the MCDData user is authorised to de-activate a functional alias if the location criteria are met.

10.2.97B4 /<x>/<x>/OnNetwork/FunctionalAliasList/<x>/Entry/MaxSimultaneousEmergencyGroupCalls

Table 10.2.97B4.1: /<x>/<x>/OnNetwork/FunctionalAliasList/<x>/Entry/MaxSimultaneousEmergencyGroupCalls

<x>/OnNetwork/FunctionalAliasList/<x>/Entry/MaxSimultaneousEmergencyGroupCalls

Status	Occurrence	Format	Min. Access Types
Optional	One	int	Get, Replace

This leaf node indicates the maximum number of simultaneous emergency group calls for a functional alias.

10.2.97C /<x>/<x>/OnNetwork/AllowedQueryFunctionalAliasOtherUser

Table 10.2.97C.1: /<x>/<x>/OnNetwork/AllowedQueryFunctionalAliasOtherUser

<x>/OnNetwork/AllowedQueryFunctionalAliasOtherUser

Status	Occurrence	Format	Min. Access Types
Required	One	bool	Get, Replace

This leaf node indicates whether the MCDData user is authorised query the functional alias(es) activated by another MCDData user.

When set to "true" the MCDData user is authorised to query the functional alias(es) activated by another MCDData user.

When set to "false" the MCDData user is not authorised to query the functional alias(es) activated by another MCDData user.

10.2.97D /<x>/<x>/OnNetwork/AllowedTakeoverFunctionalAliasOtherUser

Table 10.2.97D.1: /<x>/<x>/OnNetwork/AllowedTakeoverFunctionalAliasOtherUser

<x>/OnNetwork/AllowedTakeoverFunctionalAliasOtherUser

Status	Occurrence	Format	Min. Access Types
Required	One	bool	Get, Replace

This leaf node indicates whether the MCDData user is authorised to take over the functional alias(es) previously activated by another MCDData user.

When set to "true" the MCDData user is authorised to take over the functional alias(es) previously activated by another MCDData user.

When set to "false" the MCDData user is not authorised to take over the functional alias(es) previously activated by another MCDData user.

10.2.97E/<x>/<x>/OnNetwork/MessageStoreHostname

Table 10.2.97E.1: /<x>/<x>/OnNetwork/MessageStoreHostname

<x>/OnNetwork/MessageStoreHostname

Status	Occurrence	Format	Min. Access Types
Required	One	chr	Get, Replace

This leaf node indicates value of the hostname identifying the message store function.

The value is a string.

10.2.97F/<x>/<x>/OnNetwork/AuthorisedIncomingAny

Table 10.2.97F.1: /<x>/<x>/OnNetwork/AuthorisedIncomingAny

<x>/OnNetwork/AuthorisedIncomingAny

Status	Occurrence	Format	Min. Access Types
Required	One	bool	Get, Replace

This leaf node indicates the authorisation to receive MCDData communication from any MCDData user.

When set to "true" the MCDData user is authorised to receive MCDData communication from any MCDData user.

When set to "false" the MCDData user is not authorised to receive an MCDData communication from any MCDData user, but only from the MCDData users contained in the IncomingUserList.

10.2.97G /<x>/<x>/OnNetwork/IncomingUserList

Table 10.2.97G.1: /<x>/<x>/OnNetwork/IncomingUserList

<x>/OnNetwork/IncomingUserList

Status	Occurrence	Format	Min. Access Types

Required	One	node	Get, Replace
----------	-----	------	--------------

This interior node is a placeholder for a list of MCDData user(s) who are authorised to initiate one-to-one MCDData communication to the configured MCDData user.

10.2.97G1 /<x>/<x>/OnNetwork/IncomingUserList/<x>

Table 10.2.97G1.1: /<x>/<x>/OnNetwork/IncomingUserList/<x>

<x>/OnNetwork/IncomingUserList/<x>

Status	Occurrence	Format	Min. Access Types
Optional	OneOrMore	node	Get, Replace

This interior node is a placeholder for one or more list of MCDData users who are authorised to initiate one-to-one MCDData communication to the configured MCDData user.

10.2.97G2 /<x>/<x>/OnNetwork/IncomingUserList/<x>/Entry

Table 10.2.97G2.1: /<x>/<x>/OnNetwork/IncomingUserList/<x>/Entry

<x>/OnNetwork/IncomingUserList/<x>/Entry

Status	Occurrence	Format	Min. Access Types
Required	One	node	Get, Replace

This interior node is a placeholder for one or more MCDData users who are authorised to initiate one-to-one MCDData communication to the configured MCDData user.

10.2.97G3 /<x>/<x>/OnNetwork/IncomingUserList/<x>/Entry/MCDDataID

Table 10.2.97G3.1: /<x>/<x>/OnNetwork/IncomingUserList/<x>/Entry/MCDDataID

<x>/OnNetwork/IncomingUserList/<x>/Entry/MCDDataID

Status	Occurrence	Format	Min. Access Types
Optional	One	chr	Get, Replace

This leaf node indicates an MCDData user identity (MCDData ID) which is a globally unique identifier within the MCDData service that represents the MCDData user.

The value is a "uri" attribute specified in OMA OMA-TS-XDM_Group-V1_1 [4].

10.2.97G4 /<x>/<x>/OnNetwork/IncomingUserList/<x>/Entry/MCDDataDKMSURI

Table 10.2.97G4.1: /<x>/<x>/OnNetwork/IncomingUserList/<x>/Entry/MCDDataDKMSURI

<x>/OnNetwork/IncomingUserList/<x>/Entry/MCDDataDKMSURI

Status	Occurrence	Format	Min. Access Types
Optional	One	chr	Get, Replace

This leaf node indicates the identity (URI) of the KMS associated with the MCDDataID of an MCDData user who is authorised to initiate a one-to-one communication to the configured MCDData user.

The value is a URI as specified in 3GPP TS 23.003 [5].

10.2.97H /<x>/<x>/OnNetwork/AllowedFunctionalAliasGroupBinding

Table 10.2.97H.1: /<x>/<x>/OnNetwork/AllowedFunctionalAliasGroupBinding

<x>/OnNetwork/AllowedFunctionalAliasGroupBinding

Status	Occurrence	Format	Min. Access Types
Optional	One	bool	Get, Replace

This leaf node indicates whether the MCDData user is authorised to request the binding of a particular functional alias with a group or list of groups.

When set to "true" the MCDData user is authorised to request the binding of a particular functional alias with a group or list of groups.

When set to "false" the MCDData user is not authorised to request the binding of a particular functional alias with a group or list of groups.

10.2.97I /<x>/<x>/OnNetwork/AllowStoreCommsInMsgstore

Table 10.2.97I.1: /<x>/<x>/OnNetwork/AllowStoreCommsInMsgstore

<x>/OnNetwork/AllowStoreCommsInMsgstore

Status	Occurrence	Format	Min. Access Types
Optional	ZeroOrOne	bool	Get, Replace

This leaf node indicates whether the MCDData communications of an MCDData user are authorised to be stored in the message store or not.

When set to "true", the MCDData communications of a MCDData user are authorised to be stored in the message store.

When set to "false", the MCDData communications of a MCDData user are not authorised to be stored in the message store.

10.2.97J /<x>/<x>/OnNetwork/AllowStorePrivateCommsInMsgstore

Table 10.2.97J.1: /<x>/<x>/OnNetwork/AllowStorePrivateCommsInMsgstore

<x>/OnNetwork/AllowStorePrivateCommsInMsgstore

Status	Occurrence	Format	Min. Access Types
Optional	ZeroOrOne	bool	Get, Replace

This leaf node indicates whether the MCDData user is authorised to request an MCDData server to store his/her private communications into message store or not.

When set to "true", the MCDData user is authorised to request an MCDData server to store his/her private communications into message store.

When set to "false", the MCDData user is not authorised to request an MCDData server to store his/her private communications into message store.

10.2.97K /<x>/<x>/OnNetwork/MCDataAdhocGroup

Table 10.2.97K.1: /<x>/<x>/OnNetwork/MCDataAdhocGroup

<x>/OnNetwork/MCDataAdhocGroup

Status	Occurrence	Format	Min. Access Types
Required	One	node	Get, Replace

This interior node is a placeholder for the MCData adhoc group data communication and alert related configurations.

10.2.97K1 /<x>/<x>/OnNetwork/MCDataAdhocGroup/EmergencyAlert

Table 10.2.97K1.1: /<x>/<x>/OnNetwork/MCDataAdhocGroup/EmergencyAlert

<x>/OnNetwork/MCDataAdhocGroup/EmergencyAlert

Status	Occurrence	Format	Min. Access Types
Required	One	node	Get, Replace

This interior node is a placeholder for the MCData adhoc group emergency alert policy.

10.2.97K2 /<x>/<x>/OnNetwork/MCDataAdhocGroup/EmergencyAlert/Authorised

Table 10.2.97K2.1: /<x>/<x>/OnNetwork/MCDataAdhocGroup/EmergencyAlert/Authorised

<x>/OnNetwork/MCDataAdhocGroup/EmergencyAlert/Authorised

Status	Occurrence	Format	Min. Access Types
Required	One	bool	Get, Replace

This leaf node indicates the authorisation to activate an MCData adhoc group emergency alert.

When set to "true" the MCData user is authorised to make an MCData adhoc group emergency alert.

When set to "false" the MCData user is not authorised to make an MCData adhoc group emergency alert.

10.2.97K3 /<x>/<x>/OnNetwork/MCDataAdhocGroup/EmergencyAlert/Cancel

Table 10.2.97K3.1: /<x>/<x>/OnNetwork/MCDataAdhocGroup/EmergencyAlert/Cancel

<x>/OnNetwork/MCDataAdhocGroup/EmergencyAlert/Cancel

Status	Occurrence	Format	Min. Access Types
Required	One	bool	Get, Replace

This leaf node indicates the authorisation to cancel an MCData adhoc group emergency alert.

When set to "true" the MCData user is authorised to cancel an MCData adhoc group emergency alert.

When set to "false" the MCData user is not authorised to cancel an MCData adhoc group emergency alert.

10.2.97K4 /<x>/<x>/OnNetwork/MCDataAdhocGroup/EmergencyAlert/AuthRecvParticipantInfo

Table 10.2.97K4.1:
/<x>/<x>/OnNetwork/MCDataAdhocGroup/EmergencyAlert/AuthRecvParticipantInfo

<x>/OnNetwork/MCDataAdhocGroup/EmergencyAlert/AuthRecvParticipantInfo

Status	Occurrence	Format	Min. Access Types
Required	One	bool	Get, Replace

This leaf node indicates the authorisation to receive MCData adhoc group emergency alert participants information.

When set to "true" the MCData user is authorised to receive adhoc group emergency alert participants information.

When set to "false" the MCData user is not authorised to receive adhoc group emergency alert participants information.

10.2.97K5 /<x>/<x>/OnNetwork/MCDataAdhocGroup/EmergencyAlert/AuthSetupAdhocGroupComn

Table 10.2.97K5.1:
/<x>/<x>/OnNetwork/MCDataAdhocGroup/EmergencyAlert/AuthSetupAdhocGroupComn

<x>/OnNetwork/MCDataAdhocGroup/EmergencyAlert/AuthSetupAdhocGroupComn

Status	Occurrence	Format	Min. Access Types
Required	One	bool	Get, Replace

This leaf node indicates the authorisation to set up an adhoc group communication using the adhoc group used for the adhoc group emergency alert.

When set to "true" the MCData user is authorised to set up an adhoc group communication using the adhoc group used for the adhoc group emergency alert.

When set to "false" the MCData user is not authorised to set up an adhoc group communication using the adhoc group used for the adhoc group emergency alert.

10.2.97K6 /<x>/<x>/OnNetwork/MCDataAdhocGroup/AdhocGroupComn

Table 10.2.97K6.1: /<x>/<x>/OnNetwork/MCDataAdhocGroup/AdhocGroupComn

<x>/OnNetwork/MCDataAdhocGroup/AdhocGroupComn

Status	Occurrence	Format	Min. Access Types
Required	One	node	Get, Replace

This interior node is a placeholder for the MCData adhoc group communication related policy.

10.2.97K7 /<x>/<x>/OnNetwork/MCDataAdhocGroup/AdhocGroupComn/Authorised

Table 10.2.97K7.1: /<x>/<x>/OnNetwork/MCDataAdhocGroup/AdhocGroupComn/Authorised

<x>/OnNetwork/MCDataAdhocGroup/AdhocGroupComn/Authorised

Status	Occurrence	Format	Min. Access Types
Required	One	bool	Get, Replace

This leaf node indicates the authorisation to make an MCDData adhoc group communication.

When set to "true" the MCDData user is authorised to make an MCDData adhoc group communication.

When set to "false" the MCDData user is not authorised to make an MCDData adhoc group communication.

10.2.97K8 `<x>/<x>/OnNetwork/MCDDataAdhocGroup/AdhocGroupComn/AuthorisedParticipation`

Table 10.2.97K8.1:

`<x>/<x>/OnNetwork/MCDDataAdhocGroup/AdhocGroupComn/AuthorisedParticipation`

`<x>/OnNetwork/MCDDataAdhocGroup/AdhocGroupComn/AuthorisedParticipation`

Status	Occurrence	Format	Min. Access Types
Required	One	bool	Get, Replace

This leaf node indicates the authorisation to participate in MCDData adhoc group communication.

When set to "true" the MCDData user is authorised to participate in MCDData adhoc group communications that they are invited.

When set to "false" the MCDData user is not authorised to participate in MCDData adhoc group communications that they are invited.

10.2.97K9 `<x>/<x>/OnNetwork/MCDDataAdhocGroup/AdhocGroupComn/AuthInitEmergencyComn`

Table 10.2.97K9.1:

`<x>/<x>/OnNetwork/MCDDataAdhocGroup/AdhocGroupComn/AuthInitEmergencyComn`

`<x>/OnNetwork/MCDDataAdhocGroup/AdhocGroupComn/AuthInitEmergencyComn`

Status	Occurrence	Format	Min. Access Types
Required	One	bool	Get, Replace

This leaf node indicates the authorisation to make an MCDData adhoc group emergency communication.

When set to "true" the MCDData user is authorised to make an MCDData adhoc group emergency communication.

When set to "false" the MCDData user is not authorised to make an MCDData adhoc group emergency communication.

10.2.97K10 `<x>/<x>/OnNetwork/MCDDataAdhocGroup/AdhocGroupComn/AuthInitImminentPerilComn`

Table 10.2.97K10.1:

`<x>/<x>/OnNetwork/MCDDataAdhocGroup/AdhocGroupComn/AuthInitImminentPerilComn`

`<x>/OnNetwork/MCDDataAdhocGroup/AdhocGroupComn/AuthInitImminentPerilComn`

Status	Occurrence	Format	Min. Access Types
Required	One	bool	Get, Replace

This leaf node indicates the authorisation to make an MCDData adhoc group imminent-peril communication.

When set to "true" the MCDData user is authorised to make an MCDData adhoc group imminent-peril communication.

When set to "false" the MCDData user is not authorised to make an MCDData adhoc group imminent-peril communication.

10.2.97K11 /<x>/<x>/OnNetwork/MCDDataAdhocGroup/AdhocGroupComn/AuthRecvComnParticipantInfo

Table 10.2.97K11.1:

/<x>/<x>/OnNetwork/MCDDataAdhocGroup/AdhocGroupComn/AuthRecvComnParticipantInfo

<x>/OnNetwork/MCDDataAdhocGroup/AdhocGroupComn/AuthRecvComnParticipantInfo

Status	Occurrence	Format	Min. Access Types
Required	One	bool	Get, Replace

This leaf node indicates the authorisation to receive adhoc group communication participants information.

When set to "true" the MCDData user is authorised to receive adhoc group communication participants information.

When set to "false" the MCDData user is not authorised to receive adhoc group communication participants information.

10.2.97K12 /<x>/<x>/OnNetwork/MCDDataAdhocGroup/AdhocGroupComn/AuthModifyComnParticipantInfo

Table 10.2.97K12.1:

/<x>/<x>/OnNetwork/MCDDataAdhocGroup/AdhocGroupComn/AuthModifyComnParticipantInfo

<x>/OnNetwork/MCDDataAdhocGroup/AdhocGroupComn/AuthModifyComnParticipantInfo

Status	Occurrence	Format	Min. Access Types
Required	One	bool	Get, Replace

This leaf node indicates the authorisation to modify adhoc group communication participants information.

When set to "true" the MCDData user is authorised to modify adhoc group communication participants information.

When set to "false" the MCDData user is not authorised to modify adhoc group communication participants information.

10.2.98 /<x>/<x>/OffNetwork

Table 10.2.98.1: /<x>/<x>/OffNetwork

<x>/OffNetwork

Status	Occurrence	Format	Min. Access Types
Required	ZeroOrOne	node	Get, Replace

This interior node represents a container for off-network operation.

10.2.99 /<x>/<x>/OffNetwork/Authorised

Table 10.2.99.1: /<x>/<x>/OffNetwork/Authorised

<x>/OffNetwork/Authorised

Status	Occurrence	Format	Min. Access Types
Required	One	bool	Get, Replace

This leaf node indicates the authorisation for off-network services.

When set to "true" the MCDData user is authorised for off-network.

When set to "false" the MCDData user is not authorised for off-network operation.

10.2.100 /<x>/<x>/OffNetwork/MCDDataGroupList

Table 10.2.100.1: /<x>/<x>/OffNetwork/MCDDataGroupList

<x>/OffNetwork/MCDDataGroupList

Status	Occurrence	Format	Min. Access Types
Required	One	node	Get, Replace

This interior node is a placeholder for the list of off-network MCDData groups that the MCDData user is allowed to use.

10.2.101 /<x>/<x>/OffNetwork/MCDDataGroupList/<x>

Table 10.2.101.1: /<x>/<x>/OffNetwork/MCDDataGroupList/<x>

<x>/OffNetwork/MCDDataGroupList/<x>

Status	Occurrence	Format	Min. Access Types
Required	OneOrMore	node	Get, Replace

This interior node is a placeholder for one or more list of off-network MCDData groups that the MCDData user is allowed to use.

10.2.102 /<x>/<x>/OffNetwork/MCDDataGroupList/<x>/Entry

Table 10.2.102.1: /<x>/<x>/OffNetwork/MCDDataGroupList/<x>/Entry

<x>/OffNetwork/MCDDataGroupList/<x>/Entry

Status	Occurrence	Format	Min. Access Types
Optional	One	node	Get, Replace

This interior node is a placeholder for the details of the off-network MCDData groups that the MCDData user is allowed to use.

10.2.103 /<x>/<x>/OffNetwork/MCDDataGroupList/<x>/Entry/MCDDataGroupID

Table 10.2.103.1: /<x>/<x>/OffNetwork/MCDDataGroupList/<x>/Entry/MCDDataGroupID

<x>/OffNetwork/MCDDataGroupList/<x>/Entry/MCDDataGroupID

Status	Occurrence	Format	Min. Access Types
Required	One	chr	Get, Replace

This leaf node indicates the MCDData group ID for the off-network MCDData group that the MCDData user is allowed to use.

The value is a "uri" attribute specified in OMA OMA-TS-XDM_Group-V1_1 [4].

10.2.104 /<x>/<x>/OffNetwork/MCDataGroupList/<x>/Entry/DisplayName

Table 10.2.104.1: /<x>/<x>/OffNetwork/MCDataGroupList/<x>/Entry/DisplayName

<x>/OffNetwork/MCDataGroupList/<x>/Entry/DisplayName

Status	Occurrence	Format	Min. Access Types
Optional	One	chr	Get, Replace

This leaf node contains a human readable name that corresponds to the MCData Group ID.

10.2.105 Void

10.2.106 Void

10.2.107 /<x>/<x>/OffNetwork/MCDataGroupList/<x>/Entry/GMSServID

Table 10.2.107.1: /<x>/<x>/OffNetwork/MCDataGroupList/<x>/Entry/GMSServID

<x>/OffNetwork/MCDataGroupList/<x>/Entry/GMSServID

Status	Occurrence	Format	Min. Access Types
Optional	One	chr	Get, Replace

This leaf node indicates the identity (URI) of the group management server hosting the MCData Group ID.

10.2.108 Void

10.2.109 Void

10.2.110 /<x>/<x>/OffNetwork/MCDataGroupList/<x>/Entry/
IdMSTokenEndPoint**Table 10.2.110.1: /<x>/<x>/OffNetwork/MCDataGroupList/<x>/Entry/IdMSTokenEndPoint**

<x>/OffNetwork/MCDataGroupList/<x>/Entry/IdMSTokenEndPoint

Status	Occurrence	Format	Min. Access Types
Optional	One	chr	Get, Replace

This leaf node indicates the identity (URI) of the IDMS token endpoint for the MCData Group ID in the MCDataGroupList. If the value is empty, the IDMS identities (IDMSAuthEndpoint and IDMSTokenEndpoint) present in the MCS UE initial configuration MO are used.

10.2.110A /<x>/<x>/OffNetwork/MCDataGroupList/<x>/Entry/
GroupKMSURI**Table 10.2.110A.1: /<x>/<x>/OffNetwork/MCDataGroupList/<x>/Entry/GroupKMSURI**

<x>/OffNetwork/MCDataGroupList/<x>/Entry/GroupKMSURI

Status	Occurrence	Format	Min. Access Types
Required	One	chr	Get, Replace

This leaf node indicates key management server URI for the security domain of the MCDData group identity (MCDData Group ID) of the off-network MCDData group

The value is a URI as specified in 3GPP TS 23.003 [5].

10.2.111 /<x>/<x>/OffNetwork/MCDDataGroupList/<x>/Entry/ RelativePresentationPriority

Table 10.2.111.1: /<x>/<x>/OffNetwork/MCDDataGroupList/<x>/Entry/RelativePresentationPriority

<x>/OffNetwork/MCDDataGroupList/<x>/Entry/RelativePresentationPriority

Status	Occurrence	Format	Min. Access Types
Optional	One	int	Get, Replace

This leaf node indicates indicating the presentation priority of the off-network group for the MCDData user relative to other off-network groups and off-network users.

- Values: 0-255

The lowest RelativePresentationPriority value shall be considered as the MCDData group transaction having the lowest priority for presentation among other group MCDData and one-to-one user transactions.

10.2.112 /<x>/<x>/OffNetwork/UserInfoID

Table 10.2.112.1: /<x>/<x>/OffNetwork/UserInfoID

<x>/OffNetwork/UserInfoID

Status	Occurrence	Format	Min. Access Types
Required	One	chr	Get, Replace

This leaf node indicates the ProSe user info ID as specified in 3GPP TS 23.303 [6].

10.2.113 Void

10.2.114 Void

10.2.115 Void

10.2.116 Void

10.2.117 Void

10.2.118 Void

10.2.119 Void

10.2.120 Void

10.2.121 /<x>/Status

Table 10.2.121.1: /<x>/Status

Status

Status	Occurrence	Format	Min. Access Types
Optional	One	bool	Get, Replace

This leaf node indicates whether this MCDData user profile is enabled or disabled.

When set to "true" this MCDData user profile is enabled.

When set to "false" this MCDData user profile is disabled.

11 MCDData service configuration MO

11.1 General

The MCDData service configuration Management Object (MO) is used to configure MCDData Client behaviour for the on-network or off-network MCDData Service. The MCDData service configuration parameters may be stored in the ME, or in the USIM as specified in 3GPP TS 31.102 [10], or in both the ME and the USIM. If both the ME and the USIM contain the same parameters, the values stored in the USIM shall take precedence.

The Management Object Identifier is: urn:oma:mo:ext-3gpp-MCDData-service-configuration:1.0.

Protocol compatibility: This MO is compatible with OMA OMA DM 1.2 [3].

The OMA DM ACL property mechanism (see OMA OMA-ERELD-DM-V1_2 [2]) may be used to grant or deny access rights to OMA DM servers in order to modify nodes and leaf objects of the MCDData service configuration MO.

The following nodes and leaf objects are possible under the MCDData service configuration node as described in figure 11.1.1.

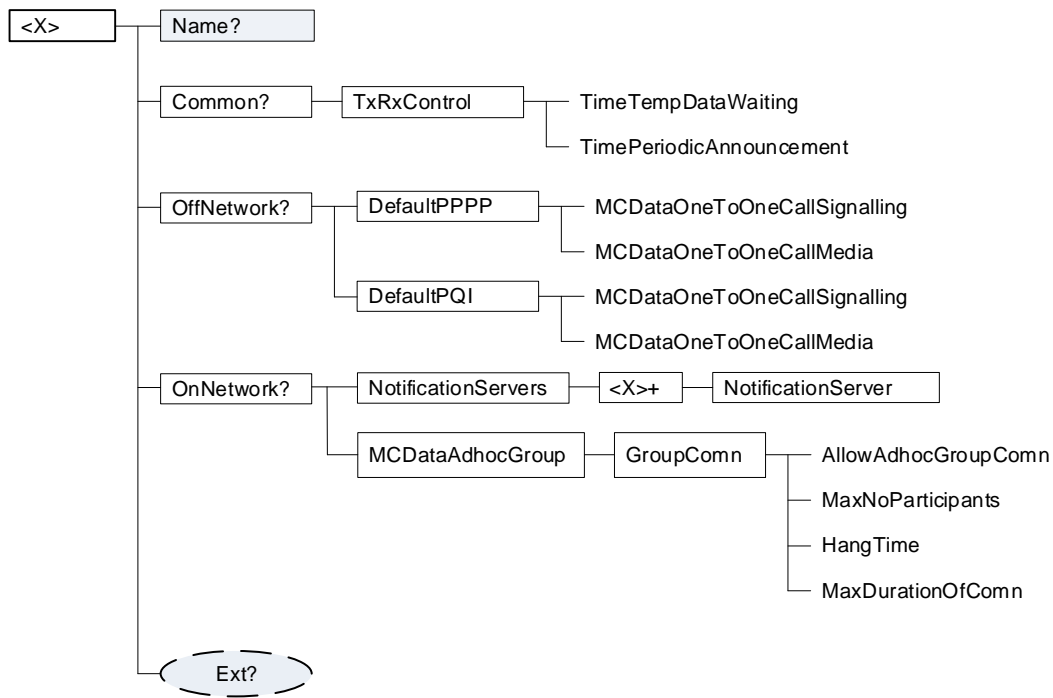

Figure 11.1.1: The MCDATA service configuration MO

11.2 MCDATA service configuration MO parameters

11.2.1 General

This clause describes the parameters for the MCDATA service configuration Management Object (MO).

11.2.2 Node: <x>

Table 11.2.2.1: Node: <x>

<x>

Status	Occurrence	Format	Min. Access Types
Required	OneOrMore	node	Get

This interior node acts as a placeholder for the MCDATA service configuration Management Object (MO).

For the MCDATA service configuration MO, the namespace specific string is: "urn:oma:mo:oma-dm-mcdata-service configuration:1.0"

- Values: N/A

11.2.3 /<x>/Name

Table 11.2.3.1: /<x>/Name

Name

Status	Occurrence	Format	Min. Access Types
Required	ZeroOrOne	chr	Get

The Name leaf is a name for the MCDATA service configuration settings.

- Values: <User displayable name>

11.2.4 /<x>/Ext/

Table 11.2.4.1: /<x>/Ext/

Ext

Status	Occurrence	Format	Min. Access Types
Optional	ZeroOrOne	node	Get, Replace

The Ext is an interior node for where the vendor specific information about the MCDData service configuration MO is being placed.

Usually the vendor extension is identified by vendor specific name under the ext node and contains the vendor meaning application vendor, device vendor etc. The tree structure under the vendor identified is not defined and can therefore include one or more un-standardized sub-trees.

- Values: N/A

11.2.5 /<x>/Common

Table 11.2.5.1: /<x>/Common

Common

Status	Occurrence	Format	Min. Access Types
Required	ZeroOrOne	node	Get, Replace

This interior node represents a container for the common network operation which means both on-network operation and off-network operation.

11.2.6 /<x>/Common/TxRxControl

Table 11.2.6.1: /<x>/Common/TxRxControl

Common/TxRxControl

Status	Occurrence	Format	Min. Access Types
Required	One	node	Get, Replace

This interior node is a placeholder for transmission and reception control configuration.

11.2.7 /<x>/Common/TxRxControl/TimeTempDataWaiting

Table 11.2.7.1: /<x>/Common/TxRxControl/TimeTempDataWaiting

Common/TxRxControl/TimeTempDataWaiting

Status	Occurrence	Format	Min. Access Types
Required	One	int	Get, Replace

This leaf node indicates the time limit for the temporarily stored data that is waiting to be delivered to a receiving user.

- Values: 0-65535

The TimeTempDataWaiting is in minutes.

11.2.8 /<x>/Common/TxRxControl/TimePeriodicAnnouncement

Table 11.2.8.1: /<x>/Common/TxRxControl/TimePeriodicAnnouncement

Common/TxRxControl/TimePeriodicAnnouncement

Status	Occurrence	Format	Min. Access Types
Required	One	int	Get, Replace

This leaf node indicates the timer for the periodic announcement which contains a list of available recently invited data group communications.

- Values: 0-65535

The TimePeriodicAnnouncement is in minutes.

11.2.9 /<x>/OffNetwork

Table 11.2.9.1: /<x>/OffNetwork

OffNetwork

Status	Occurrence	Format	Min. Access Types
Required	ZeroOrOne	node	Get, Replace

This interior node represents a container for off-network operation.

11.2.10 /<x>/OffNetwork/DefaultPPPP

Table 11.2.10.1: /<x>/OffNetwork/DefaultPPPP

OffNetwork/DefaultPPPP

Status	Occurrence	Format	Min. Access Types
Required	One	node	Get, Replace

This interior node is a placeholder for the default ProSe Per-Packet Priority (PPPP) configuration.

11.2.11 /<x>/OffNetwork/DefaultPPPP/MCDataOneToOneCallSignalling

Table 11.2.11.1: /<x>/OffNetwork/DefaultPPPP/MCDataOneToOneCallSignalling

OffNetwork/DefaultPPPP/MCDataOneToOneCallSignalling

Status	Occurrence	Format	Min. Access Types
Required	One	int	Get, Replace

This leaf node indicates the default ProSe Per-Packet Priority (PPPP) value (as specified in 3GPP TS 23.303 [6]) for the MCData one-to-one call signalling.

- Values: 1-8

The MCData user data with the lowest ProSe Per-Packet Priority value shall be considered as the MCData user data having the highest priority among the MCData user data.

11.2.12 /<x>/OffNetwork/DefaultPPPP/MCDataOneToOneCallMedia

Table 11.2.12.1: /<x>/OffNetwork/DefaultPPPP/MCDataOneToOneCallMedia

OffNetwork/DefaultPPPP/MCDataOneToOneCallMedia

Status	Occurrence	Format	Min. Access Types
Required	One	int	Get, Replace

This leaf node indicates the default ProSe Per-Packet Priority (PPPP) value (as specified in 3GPP TS 23.303 [6]) for the MCData private call media.

- Values: 1-8

The MCData user data with the lowest ProSe Per-Packet Priority value shall be considered as the MCData user data having the highest priority among the MCData user data.

11.2.12A/<x>/OffNetwork/DefaultPQI

Table 11.2.12A.1: /<x>/OffNetwork/DefaultPQI

OffNetwork/DefaultPQI

Status	Occurrence	Format	Min. Access Types
Required	One	node	Get, Replace

This interior node is a placeholder for the default PQI configuration.

11.2.12B/<x>/OffNetwork/DefaultPQI/MCDataOneToOneCallSignalling

Table 11.2.12B.1: /<x>/OffNetwork/DefaultPQI/MCDataOneToOneCallSignalling

OffNetwork/DefaultPQI/MCDataOneToOneCallSignalling

Status	Occurrence	Format	Min. Access Types
Required	One	int	Get, Replace

This leaf node indicates the default PQI value (as specified in 3GPP TS 23.304 [25]) for the MCData one-to-one call signalling.

- Values: 21-26, 55-61, 90-93

The MCData user data with the lowest PQI value shall be considered as the MCData user data having the highest priority among the MCData user data.

11.2.12C /<x>/OffNetwork/DefaultPQI/MCDataOneToOneCallMedia

Table 11.2.12C.1: /<x>/OffNetwork/DefaultPQI/MCDataOneToOneCallMedia

OffNetwork/DefaultPQI/MCDataOneToOneCallMedia

Status	Occurrence	Format	Min. Access Types
Required	One	int	Get, Replace

This leaf node indicates the default PQI value (as specified in 3GPP TS 23.304 [25]) for the MCData private call media.

- Values: 21-26, 55-61, 90-93

The MCDData user data with the lowest PQI value shall be considered as the MCDData user data having the highest priority among the MCDData user data.

11.2.13 /<x>/OnNetwork

Table 11.2.13.1: /<x>/OnNetwork

OnNetwork

Status	Occurrence	Format	Min. Access Types
Required	ZeroOrOne	node	Get, Replace

This interior node represents a container for on-network operation.

11.2.14 /<x>/OnNetwork/NotificationServers

Table 11.2.14.1: /<x>/OnNetwork/NotificationServers

<x>/OnNetwork/NotificationServers

Status	Occurrence	Format	Min. Access Types
Optional	One	node	Get, Replace

This interior node is a placeholder for a list of hostnames of the Notification servers.

11.2.15 /<x>/OnNetwork/NotificationServers/<x>

Table 11.2.15.1: /<x>/OnNetwork/NotificationServers/<x>

<x>/OnNetwork/NotificationServers/<x>

Status	Occurrence	Format	Min. Access Types
Optional	OneOrMore	node	Get, Replace

This interior node is a placeholder for one or more hostnames of the Notification servers.

11.2.16 /<x>/OnNetwork/NotificationServers/<x>/NotificationServer

Table 11.2.16.1: /<x>/OnNetwork/NotificationServers/<x>/NotificationServer

<x>/OnNetwork/NotificationServers/<x>/NotificationServer

Status	Occurrence	Format	Min. Access Types
Required	One	chr	Get, Replace

This leaf node indicates a hostname of the Notification server.

11.2.17 /<x>/OnNetwork/MCDDataAdhocGroup

Table 11.2.17.1: /<x>/OnNetwork/MCDDataAdhocGroup

OnNetwork/MCDDataAdhocGroup

Status	Occurrence	Format	Min. Access Types
Required	One	node	Get, Replace

This interior node is a placeholder for the MCDData adhoc group communication related configurations.

11.2.18 /<x>/OnNetwork/MCDataAdhocGroup/GroupComn

Table 11.2.18.1: /<x>/OnNetwork/MCDataAdhocGroup/GroupComn

OnNetwork/MCDataAdhocGroup/GroupComn

Status	Occurrence	Format	Min. Access Types
Required	One	node	Get, Replace

This interior node is a placeholder for the MCData adhoc group communication policy and configurations.

11.2.19 /<x>/OnNetwork/MCDataAdhocGroup/GroupComn/AllowAdhocGroupComn

Table 11.2.19.1: /<x>/OnNetwork/MCDataAdhocGroup/GroupComn/AllowAdhocGroupComn

OnNetwork/MCDataAdhocGroup/GroupComn/AllowAdhocGroupComn

Status	Occurrence	Format	Min. Access Types
Required	One	bool	Get, Replace

This leaf node indicates whether on-network adhoc group communications support enabled or disabled.

When set to "true" the MCData system supports the adhoc group communication and is enabled to allow the MCData users to make an MCData adhoc group communication.

When set to "false" the MCData system supports the adhoc group communication and is disabled to not allow the MCData users to make an MCData adhoc group communication.

11.2.20 /<x>/OnNetwork/MCDataAdhocGroup/GroupComn/MaxNoParticipants

Table 11.2.20.1: /<x>/OnNetwork/MCDataAdhocGroup/GroupComn/MaxNoParticipants

OnNetwork/MCDataAdhocGroup/GroupComn/MaxNoParticipants

Status	Occurrence	Format	Min. Access Types
Required	One	int	Get, Replace

This leaf node indicates maximum number of participants allowed in an adhoc group communication and the value is left to deployment requirement.

11.2.21 /<x>/OnNetwork/MCDataAdhocGroup/GroupComn/HangTime

Table 11.2.21.1: /<x>/OnNetwork/MCDataAdhocGroup/GroupComn/HangTime

OnNetwork/MCDataAdhocGroup/GroupComn/HangTime

Status	Occurrence	Format	Min. Access Types
Required	One	int	Get, Replace

This leaf node indicates hang timer for adhoc group communications.

- Values: 0-65535

The HangTime is in seconds.

11.2.22 /<x>/OnNetwork/MCDataAdhocGroup/GroupComn/MaxDurationOfComn

Table 11.2.22.1: /<x>/OnNetwork/MCDataAdhocGroup/GroupComn/MaxDurationOfComn

OnNetwork/MCDataAdhocGroup/GroupComn/MaxDurationOfComn

Status	Occurrence	Format	Min. Access Types
Required	One	int	Get, Replace

This leaf node indicates max adhoc group communication duration.

- Values: 0-65535

The MaxDurationOfComn time is in seconds.

12 MCVideo UE configuration MO

12.1 General

The MCVideo UE configuration Management Object (MO) is used to configure MCVideo Client behaviour for the on-network or off-network MCVideo Service. The MCVideo UE configuration parameters may be stored in the ME, or in the USIM as specified in 3GPP TS 31.102 [10], or in both the ME and the USIM. If both the ME and the USIM contain the same parameters, the values stored in the USIM shall take precedence.

The Management Object Identifier is: urn:oma:mo:ext-3gpp-MCVideo-UE-configuration:1.0.

Protocol compatibility: This MO is compatible with OMA OMA DM 1.2 [3].

The OMA DM ACL property mechanism (see OMA OMA-ERELD-DM-V1_2 [2]) may be used to grant or deny access rights to OMA DM servers in order to modify nodes and leaf objects of the MCVideo UE configuration MO.

The following nodes and leaf objects are possible under the MCVideo UE configuration node as described in figure 12.1.1.

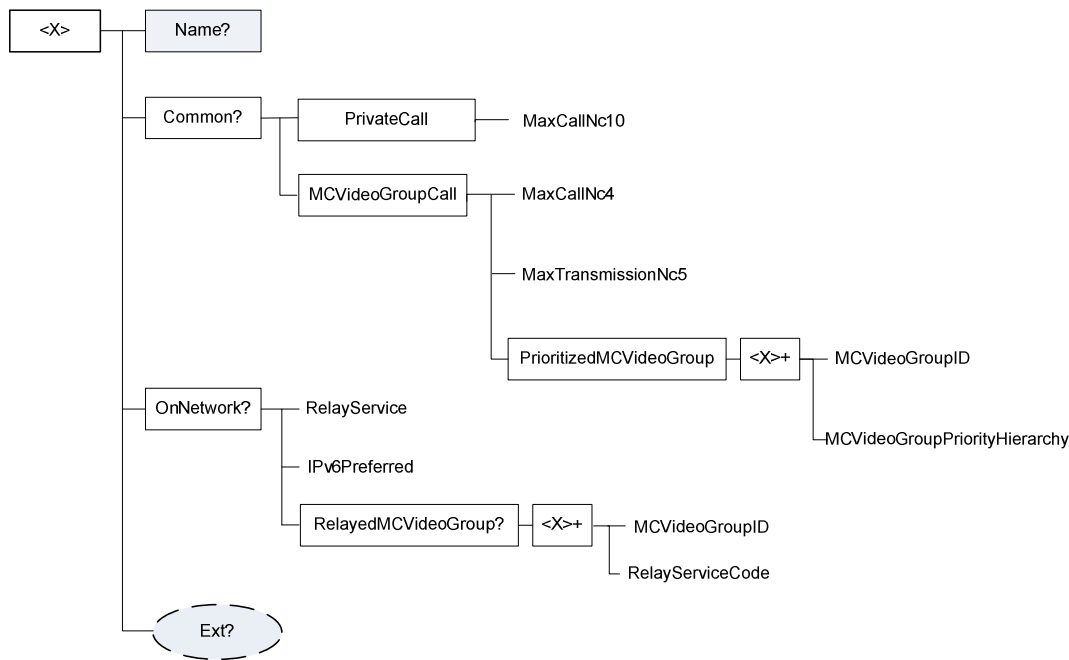

Figure 12.1.1: The MCVideo UE configuration MO

12.2 MCVideo UE configuration MO parameters

12.2.1 General

This clause describes the parameters for the MCVideo UE configuration Management Object (MO).

12.2.2 Node: <x>

Table 12.2.2.1: Node: <x>

<x>

Status	Occurrence	Format	Min. Access Types
Required	OneOrMore	node	Get

This interior node acts as a placeholder for the MCVideo UE configuration Management Object (MO).

For the MCVideo UE configuration MO, the namespace specific string is: "urn:oma:mo:oma-dm-mcvideo-ue-configuration:1.0"

- Values: N/A

12.2.3 /<x>/Name

Table 12.2.3.1: /<x>/Name

Name

Status	Occurrence	Format	Min. Access Types
Required	ZeroOrOne	chr	Get

The Name leaf is a name for the MCVideo UE configuration settings.

- Values: <User displayable name>

12.2.4 /<x>/Ext/

Table 12.2.4.1: /<x>/Ext/

Ext

Status	Occurrence	Format	Min. Access Types
Optional	ZeroOrOne	node	Get, Replace

The Ext is an interior node for where the vendor specific information about the MCVideo UE configuration MO is being placed.

Usually the vendor extension is identified by vendor specific name under the ext node and contains the vendor meaning application vendor, device vendor etc. The tree structure under the vendor identified is not defined and can therefore include one or more un-standardized sub-trees.

- Values: N/A

12.2.5 /<x>/Common

Table 12.2.5.1: /<x>/Common

Common

Status	Occurrence	Format	Min. Access Types
Required	ZeroOrOne	node	Get, Replace

This interior node represents a container for the common network operation which means both on-network operation and off-network operation.

12.2.5A /<x>/Common/PrivateCall

Table 12.2.5A.1: /<x>/Common/PrivateCall

Common/PrivateCall

Status	Occurrence	Format	Min. Access Types
Required	One	node	Get, Replace

This interior node is a placeholder for the private call configuration.

12.2.5B /<x>/Common/PrivateCall/MaxCallNc10

Table 12.2.5B.1: /<x>/Common/PrivateCall/MaxCallNc10

Common/PrivateCall/MaxCallNc10

Status	Occurrence	Format	Min. Access Types
Required	One	int	Get, Replace

This leaf node indicates the maximum number of private calls.

- Values: 0-255

12.2.6 /<x>/Common/MCVideoGroupCall

Table 12.2.6.1: /<x>/Common/MCVideoGroupCall

Common/MCVideoGroupCall

Status	Occurrence	Format	Min. Access Types
Required	One	node	Get, Replace

This interior node is a placeholder for the MCVideo group call configuration.

12.2.7 /<x>/Common/MCVideoGroupCall/MaxCallNc4

Table 12.2.7.1: /<x>/Common/MCVideoGroupCall/MaxCallNc4

Common/MCVideoGroupCall/MaxCallNc4

Status	Occurrence	Format	Min. Access Types
Required	One	int	Get, Replace

This leaf node indicates the maximum number of simultaneous MCVideo group calls.

- Values: 0-255

12.2.8 /<x>/Common/MCVideoGroupCall/MaxTransmissionNc5

Table 12.2.8.1: /<x>/Common/MCVideoGroupCall/MaxTransmissionNc5

Common/MCVideoGroupCall/MaxTransmissionNc5

Status	Occurrence	Format	Min. Access Types
Required	One	int	Get, Replace

This leaf node indicates the maximum number of video transmissions in a group.

- Values: 0-255

12.2.9 /<x>/Common/MCVideoGroupCall/PrioritizedMCVideoGroup

Table 12.2.9.1: /<x>/Common/MCVideoGroupCall/PrioritizedMCVideoGroup

Common/MCVideoGroupCall/PrioritizedMCVideoGroup

Status	Occurrence	Format	Min. Access Types
Required	One	node	Get, Replace

This interior node is a placeholder for the prioritized MCVideo group call configuration.

12.2.10 /<x>/Common/MCVideoGroupCall/PrioritizedMCVideoGroup/<x>

Table 12.2.10.1: /<x>/Common/MCVideoGroupCall/PrioritizedMCVideoGroup/<x>

Common/MCVideoGroupCall/PrioritizedMCVideoGroup/<x>

Status	Occurrence	Format	Min. Access Types
Required	OneOrMore	node	Get, Replace

This interior node is a placeholder for one or more prioritized MCVideo group call configuration.

12.2.11 /<x>/Common/MCVideoGroupCall/PrioritizedMCVideoGroup/<x>/MCVideoGroupID

Table 12.2.11.1: /<x>/Common/MCVideoGroupCall/PrioritizedMCVideoGroup/<x>/MCVideoGroupID

Common/MCVideoGroupCall/PrioritizedMCVideoGroup/<x>/MCVideoGroupID

Status	Occurrence	Format	Min. Access Types
Required	One	chr	Get, Replace

This leaf node indicates the associated MCVideo group ID.

The value is a "uri" attribute specified in OMA OMA-TS-XDM_Group-V1_1 [4].

12.2.12 /<x>/Common/MCVideoGroupCall/PrioritizedMCVideoGroup/<x>/MCVideoGroupPriorityHierarchy

Table 12.2.12.1: /<x>/Common/MCVideoGroupCall/PrioritizedMCVideoGroup/<x>/MCVideoGroupPriorityHierarchy

Common/MCVideoGroupCall/PrioritizedMCVideoGroup/<x>/MCVideoGroupPriorityHierarchy

Status	Occurrence	Format	Min. Access Types
Required	One	int	Get, Replace

This leaf node indicates the requested presentation priority of MCVideo group call.

- Values: 0-255

The group with the lowest MCVideoGroupPriorityHierarchy value shall be considered as the group having the lowest priority among the groups.

12.2.13 /<x>/OnNetwork

Table 12.2.13.1: /<x>/OnNetwork

OnNetwork

Status	Occurrence	Format	Min. Access Types
Required	ZeroOrOne	node	Get, Replace

This interior node represents a container for on-network operation.

12.2.14 /<x>/OnNetwork/RelayService

Table 12.2.14.1: /<x>/OnNetwork/RelayService

OnNetwork/RelayService

Status	Occurrence	Format	Min. Access Types
Required	One	bool	Get, Replace

This leaf node indicates the authorisation to use a relay service.

When set to "true" the MCVideo group is allowed to use a relay service.

When set to "false" the MCVideo group is not allowed to use a relay service.

12.2.15 /<x>/OnNetwork/IPv6Preferred

Table 12.2.15.1: /<x>/OnNetwork/IPv6Preferred

OnNetwork/IPv6Preferred

Status	Occurrence	Format	Min. Access Types
Required	One	bool	Get, Replace

This leaf node indicates whether IPv6 is preferred over IPv4 for on-network operation when the MCVideo UE has both IPv4 and IPv6 host configuration.

If the MCVideo UE has both IPv4 and IPv6 host configuration and:

- if IPv6Preferred is set to "true" then the UE uses IPv6 for all on-network signalling and media; otherwise
- if IPv6Preferred is set to "false" then the UE uses IPv4 for all on-network signalling and media.

12.2.16 /<x>/OnNetwork/RelayedMCVideoGroup

Table 12.2.16.1: /<x>/OnNetwork/RelayedMCVideoGroup

OnNetwork/RelayedMCVideoGroup

Status	Occurrence	Format	Min. Access Types
Optional	ZeroOrOne	node	Get, Replace

This interior node is a placeholder for the allowed relayed MCVideo groups.

12.2.17 /<x>/OnNetwork/RelayedMCVideoGroup/<x>

Table 12.2.17.1: /<x>/OnNetwork/RelayedMCVideoGroup/<x>

OnNetwork/RelayedMCVideoGroup/<x>

Status	Occurrence	Format	Min. Access Types
Required	OneOrMore	node	Get, Replace

This interior node is a placeholder for one or more allowed relayed MCVideo groups.

12.2.18 /<x>/OnNetwork/RelayedMCVideoGroup/<x>/MCVideoGroupID

Table 12.2.18.1: /<x>/OnNetwork/RelayedMCVideoGroup/<x>/MCVideoGroupID

OnNetwork/RelayedMCVideoGroup/<x>/MCVideoGroupID

Status	Occurrence	Format	Min. Access Types
Required	One	chr	Get, Replace

This leaf node indicates the associated MCVideo group ID.

The value is a "uri" attribute specified in OMA OMA-TS-XDM_Group-V1_1 [4].

12.2.19 /<x>/OnNetwork/RelayedMCVideoGroup/<x>/RelayServiceCode

Table 12.2.19.1: /<x>/OnNetwork/RelayedMCVideoGroup/<x>/RelayServiceCode

OnNetwork/RelayedMCVideoGroup/<x>/RelayServiceCode

Status	Occurrence	Format	Min. Access Types
Required	One	chr	Get, Replace

This leaf node indicates the connectivity service that the ProSe UE-to-network relay provides to public safety applications as specified in 3GPP TS 23.303 [6].

13 MCVideo user profile MO

13.1 General

The MCVideo user profile configuration Management Object (MO) is used to configure the MCVideo Client behaviour for the on-network or off-network MCVideo Service. The MCVideo user profile configuration parameters may be stored in the ME, or in the USIM as specified in 3GPP TS 31.102 [10], or in both the ME and the USIM. If both the ME and the USIM contain the same parameters, the values stored in the USIM shall take precedence.

The Management Object Identifier is: urn:oma:mo:ext-3gpp-MCVideo-user-profile:1.0.

Protocol compatibility: This MO is compatible with OMA OMA DM 1.2 [3].

The OMA DM ACL property mechanism (see OMA OMA-ERELD-DM-V1_2 [2]) may be used to grant or deny access rights to OMA DM servers in order to modify nodes and leaf objects of the MCVideo user profile MO.

The following nodes and leaf objects are possible under the MCVideo user profile node as described in figure 13.1.1, figure 13.1.2 and figure 13.1.3.

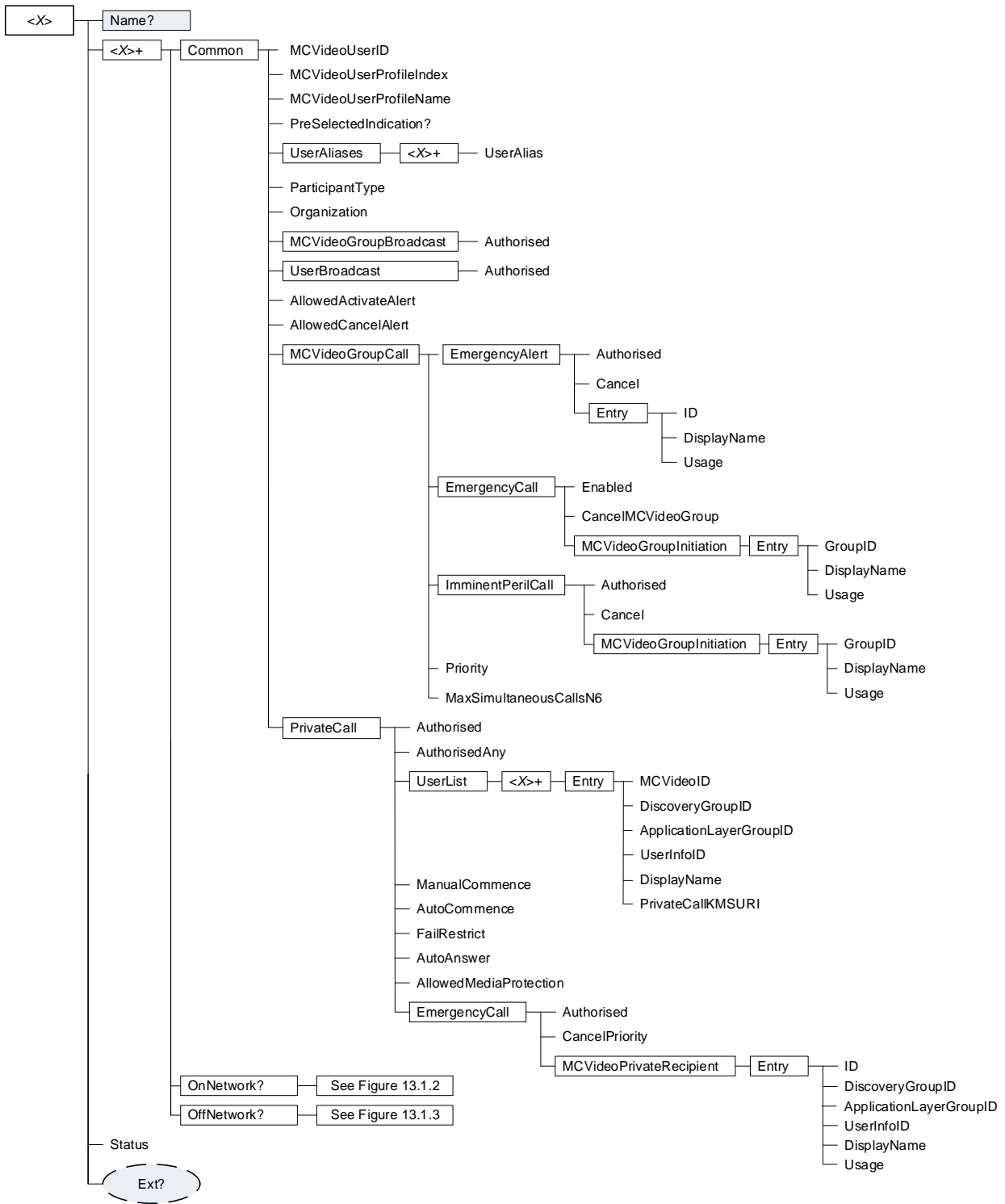

Figure 13.1.1: The MCVideo user profile MO (1 of 3)

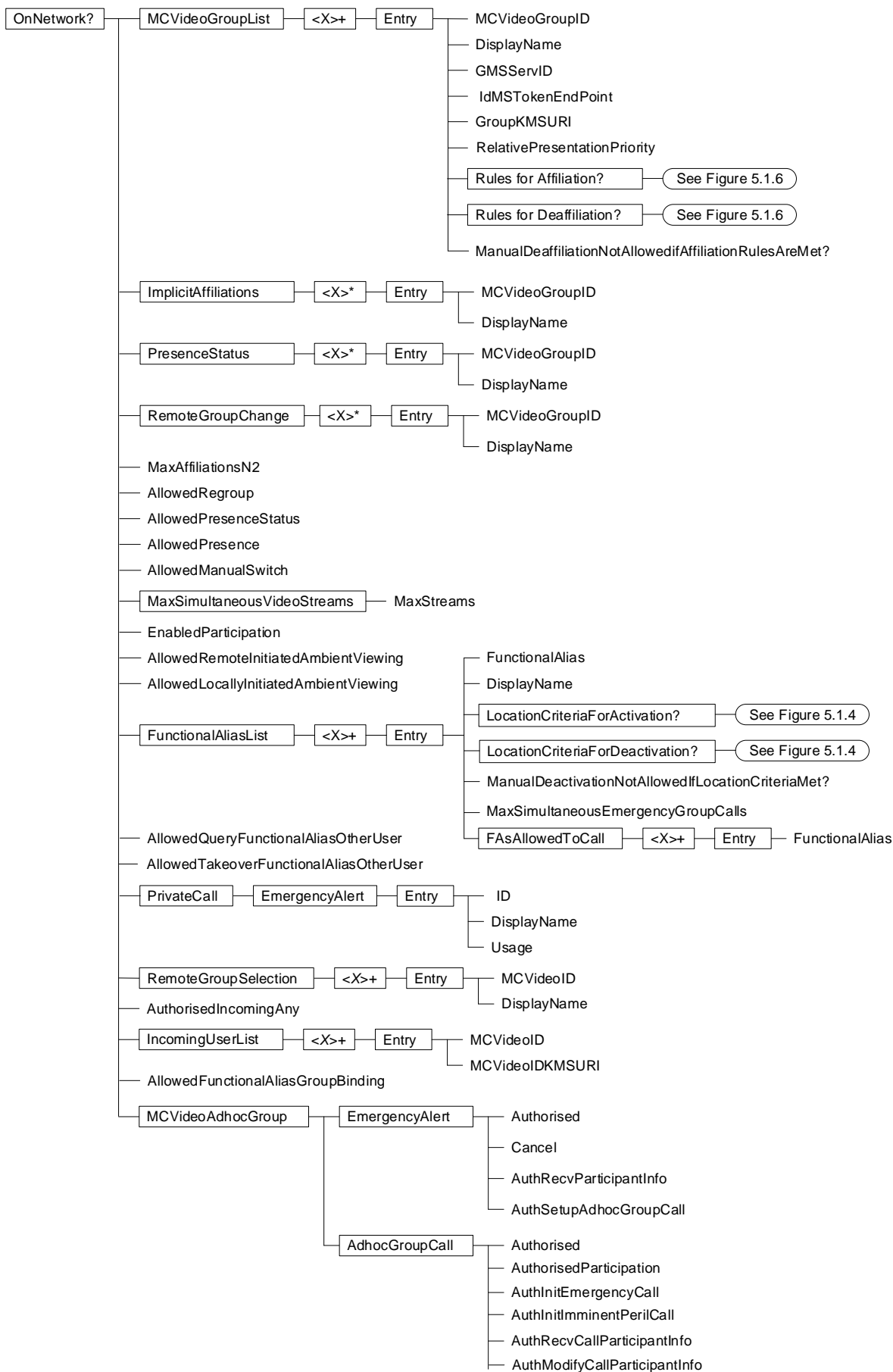

Figure 13.1.2: The MCVideo user profile MO (2 of 3)

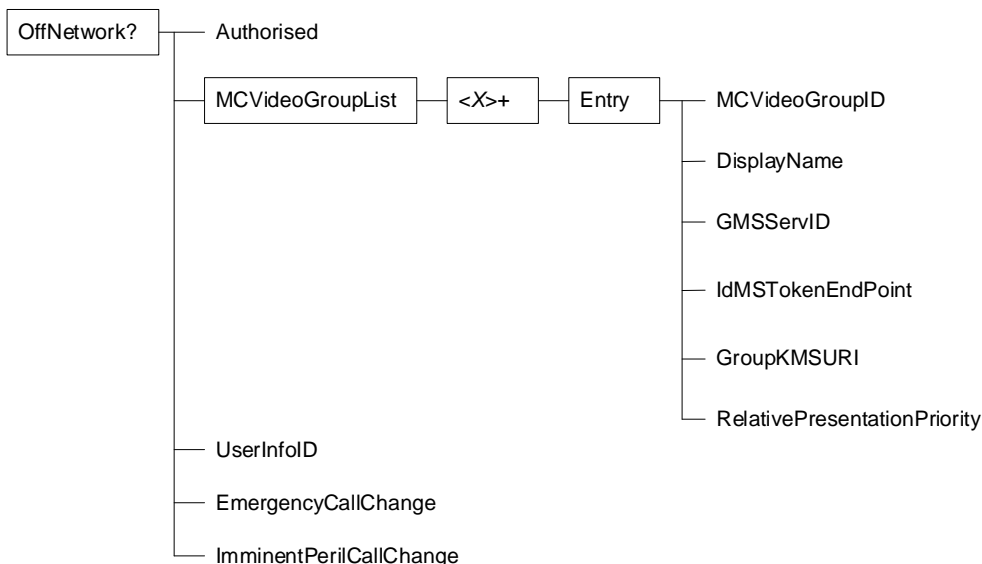

Figure 13.1.3: The MCVideo user profile MO (3 of 3)

13.2 MCVideo user profile MO parameters

13.2.1 General

This clause describes the parameters for the MCVideo user profile Management Object (MO).

13.2.2 Node: <x>

Table 13.2.2.1: Node: <x>

<x>

Status	Occurrence	Format	Min. Access Types
Required	OneOrMore	node	Get

This interior node acts as a placeholder for the MCVideo user profile Management Object (MO).

For the MCVideo user profile MO, the namespace specific string is: "urn:oma:mo:oma-dm-mcvideo-user-profile:1.0"

- Values: N/A

13.2.3 /<x>/Name

Table 13.2.3.1: /<x>/Name

Name

Status	Occurrence	Format	Min. Access Types
Required	ZeroOrOne	chr	Get

The Name leaf is a name for the MCVideo user profile settings.

- Values: <User displayable name>

13.2.4 /<x>/Ext/

Table 13.2.4.1: /<x>/Ext/

Ext

Status	Occurrence	Format	Min. Access Types
Optional	ZeroOrOne	node	Get, Replace

The Ext is an interior node for where the vendor specific information about the MCVideo user profile MO is being placed.

Usually the vendor extension is identified by vendor specific name under the ext node and contains the vendor meaning application vendor, device vendor etc. The tree structure under the vendor identified is not defined and can therefore include one or more un-standardized sub-trees.

- Values: N/A

13.2.5 /<x>/<x>

Table 13.2.5.1: /<x>/<x>

<x>

Status	Occurrence	Format	Min. Access Types
Required	OneOrMore	node	Get, Replace

This interior node represents a container for on-network operation and off-network operation.

13.2.6 /<x>/<x>/Common

Table 13.2.6.1: /<x>/<x>/Common

<x>/Common

Status	Occurrence	Format	Min. Access Types
Required	One	node	Get, Replace

This interior node represents a container for the common network operation which means both on-network operation and off-network operation.

13.2.7 /<x>/<x>/Common/MCVideoUserID

Table 13.2.7.1: /<x>/<x>/Common/MCVideoUserID

<x>/Common/MCVideoUserID

Status	Occurrence	Format	Min. Access Types
Required	One	chr	Get, Replace

This leaf node indicates an MCVideo user identity (MCVideo ID) which is a globally unique identifier within the MCVideo service that represents the MCVideo user.

13.2.8 /<x>/<x>/Common/MCVideoUserProfileIndex

Table 13.2.8.1: /<x>/<x>/Common/MCVideoUserProfileIndex

<x>/Common/MCVideoUserProfileIndex

Status	Occurrence	Format	Min. Access Types
Required	One	int	Get, Replace

This leaf node indicates an index for the particular MCVideo user profile.

- Values: 0-255

13.2.9 /<x>/<x>/Common/MCVideoUserProfileName

Table 13.2.9.1: /<x>/<x>/Common/MCVideoUserProfileName

<x>/Common/MCVideoUserProfileName

Status	Occurrence	Format	Min. Access Types
Optional	One	chr	Get, Replace

This leaf node indicates a profile name for the particular MCVideo user profile.

13.2.10 /<x>/<x>/Common/PreSelectedIndication

Table 13.2.10.1: /<x>/<x>/Common/PreSelectedIndication

<x>/Common/PreSelectedIndication

Status	Occurrence	Format	Min. Access Types
Optional	ZeroOrOne	null	Get, Replace

This leaf node indicates that this MCVideo user profile MO is designated to be the pre-selected MCVideo user profile as defined by 3GPP TS 23.179 [15]

- Values: null

When this leaf node is present, this MCVideo user profile MO is designated as the pre-selected MCVideo user profile.

When this leaf node is absent, this MCVideo user profile MO is not designated as the pre-selected MCVideo user profile.

If more than one MCVideo user profile MO is specified for the MCVideo user, then only one MCVideo user profile MO for the MCVideo user shall contain the <x>/Common/PreSelectedIndication leaf node.

If there is only one MCVideo user profile MO specified for the MCVideo user, then it is optional to include the <x>/Common/PreSelectedIndication leaf node.

13.2.11 /<x>/<x>/Common/UserAliases

Table 13.2.11.1: /<x>/<x>/Common/UserAliases

<x>/Common/UserAliases

Status	Occurrence	Format	Min. Access Types
Required	One	node	Get, Replace

This interior node is a placeholder for a list of aliases of an MCVideo user.

13.2.12 /<x>/<x>/Common/UserAliases/<x>

Table 13.2.12.1: /<x>/<x>/Common/UserAliases/<x>

<x>/Common/UserAliases/<x>

Status	Occurrence	Format	Min. Access Types
Required	OneOrMore	node	Get, Replace

This interior node is a placeholder for one or more aliases of an MCVideo user.

13.2.13 /<x>/<x>/Common/UserAliases/<x>/UserAlias

Table 13.2.13.1: /<x>/<x>/Common/UserAliases/<x>/UserAlias

<x>/Common/UserAliases/<x>/UserAlias

Status	Occurrence	Format	Min. Access Types
Required	One	chr	Get, Replace

This leaf node indicates an alphanumeric alias of the MCVideo user.

13.2.14 Void

13.2.15 /<x>/<x>/Common/ParticipantType

Table 13.2.15.1: /<x>/<x>/Common/ParticipantType

<x>/Common/ParticipantType

Status	Occurrence	Format	Min. Access Types
Required	One	chr	Get, Replace

This leaf node indicates the participant type of the MCVideo user.

The ParticipantType means the functional category of the participant (e.g., first responder, second responder, dispatch, dispatch supervisor), typically defined by the MCVideo administrators.

13.2.16 /<x>/<x>/Common/Organization

Table 13.2.16.1: /<x>/<x>/Common/Organization

<x>/Common/Organization

Status	Occurrence	Format	Min. Access Types
Required	One	chr	Get, Replace

This leaf node indicates the organization an MCVideo user belongs to.

13.2.17 /<x>/<x>/Common/MCVideoGroupBroadcast

Table 13.2.17.1: /<x>/<x>/Common/MCVideoGroupBroadcast

<x>/Common/MCVideoGroupBroadcast

Status	Occurrence	Format	Min. Access Types
Required	One	node	Get, Replace

This interior node is a placeholder for the group-broadcast group policy.

13.2.18 /<x>/<x>/Common/MCVideoGroupBroadcast/Authorised

Table 13.2.18.1: /<x>/<x>/Common/MCVideoGroupBroadcast/Authorised

<x>/Common/MCVideoGroupBroadcast/Authorised

Status	Occurrence	Format	Min. Access Types
Required	One	bool	Get, Replace

This leaf node indicates the authorisation to create a group-broadcast group.

When set to "true" the MCVideo user is authorised to create a group-broadcast group.

When set to "false" the MCVideo user is not authorised to create a group-broadcast group.

13.2.19 /<x>/<x>/Common/UserBroadcast

Table 13.2.19.1: /<x>/<x>/Common/UserBroadcast

<x>/Common/UserBroadcast

Status	Occurrence	Format	Min. Access Types
Required	One	node	Get, Replace

This interior node is a placeholder for the user-broadcast group policy.

13.2.20 /<x>/<x>/Common/UserBroadcast/Authorised

Table 13.2.20.1: /<x>/<x>/Common/UserBroadcast/Authorised

<x>/Common/UserBroadcast/Authorised

Status	Occurrence	Format	Min. Access Types
Required	One	bool	Get, Replace

This leaf node indicates the authorisation to create a user-broadcast group.

When set to "true" the MCVideo user is authorised to create a user-broadcast group.

When set to "false" the MCVideo user is not authorised to create a user-broadcast group.

13.2.21 Void

13.2.22 Void

13.2.23 Void

13.2.24 Void

13.2.25 Void

13.2.26 Void

13.2.27 Void

13.2.28 Void

13.2.29 `<x>/<x>/Common/AllowedActivateAlert`

Table 13.2.29.1: `<x>/<x>/Common/AllowedActivateAlert`

`<x>/Common/AllowedActivateAlert`

Status	Occurrence	Format	Min. Access Types
Required	One	bool	Get, Replace

This leaf node indicates whether the MCVideo user is authorised to activate an emergency alert.

When set to "true" the MCVideo user is authorised to activate an emergency alert.

When set to "false" the MCVideo user is not authorised to activate an emergency alert.

13.2.30 `<x>/<x>/Common/AllowedCancelAlert`

Table 13.2.30.1: `<x>/<x>/Common/AllowedCancelAlert`

`<x>/Common/AllowedCancelAlert`

Status	Occurrence	Format	Min. Access Types
Required	One	bool	Get, Replace

This leaf node indicates whether the MCVideo user is allowed to cancel an emergency alert.

When set to "true" the MCVideo user is authorised to cancel an emergency alert.

When set to "false" the MCVideo user is not authorised to cancel an emergency alert.

13.2.31 Void

13.2.32 Void

13.2.33 Void

13.2.34 Void

13.2.35 Void

13.2.36 Void

13.2.37 Void

13.2.38 Void

13.2.38A/<x>/<x>/Common/MCVideoGroupCall

Table 13.2.38A.1: /<x>/<x>/Common/MCVideoGroupCall

<x>/Common/MCVideoGroupCall

Status	Occurrence	Format	Min. Access Types
Required	One	node	Get, Replace

This interior node is a placeholder for the MCVideo group call configuration.

13.2.38A1 /<x>/<x>/Common/MCVideoGroupCall/EmergencyAlert

Table 13.2.38A1.1: /<x>/<x>/Common/MCVideoGroupCall/EmergencyAlert

<x>/Common/MCVideoGroupCall/EmergencyAlert

Status	Occurrence	Format	Min. Access Types
Required	One	node	Get, Replace

This interior node is a placeholder for the MCVideo emergency alert policy.

13.2.38A2 /<x>/<x>/Common/MCVideoGroupCall/EmergencyAlert/
Authorised**Table 13.2.38A2.1: /<x>/<x>/Common/MCVideoGroupCall/EmergencyAlert/Authorised**

<x>/Common/MCVideoGroupCall/EmergencyAlert/Authorised

Status	Occurrence	Format	Min. Access Types
Required	One	bool	Get, Replace

This leaf node indicates the authorisation to activate an MCVideo emergency alert.

When set to "true" the MCVideo user is authorised to make an MCVideo emergency alert.

When set to "false" the MCVideo user is not authorised to make an MCVideo emergency alert.

13.2.38A3 /<x>/<x>/Common/MCVideoGroupCall/EmergencyAlert/Cancel

Table 13.2.38A3.1: /<x>/<x>/Common/MCVideoGroupCall/EmergencyAlert/Cancel

<x>/Common/MCVideoGroupCall/EmergencyAlert/Cancel

Status	Occurrence	Format	Min. Access Types
Required	One	bool	Get, Replace

This leaf node indicates the authorisation to cancel an MCVideo emergency alert.

When set to "true" the MCVideo user is authorised to cancel an MCVideo emergency alert.

When set to "false" the MCVideo user is not authorised to cancel an MCVideo emergency alert.

13.2.38A4 /<x>/<x>/Common/MCVideoGroupCall/EmergencyAlert/Entry

Table 13.2.38A4.1: /<x>/<x>/Common/MCVideoGroupCall/EmergencyAlert/Entry

<x>/Common/MCVideoGroupCall/EmergencyAlert/Entry

Status	Occurrence	Format	Min. Access Types
Required	One	node	Get, Replace

This interior node is a placeholder for the details of the MCVideo group of an MCVideo emergency alert.

13.2.38A5 /<x>/<x>/Common/MCVideoGroupCall/EmergencyAlert/Entry/ID

Table 13.2.38A5.1: /<x>/<x>/Common/MCVideoGroupCall/EmergencyAlert/Entry/ID

<x>/Common/MCVideoGroupCall/EmergencyAlert/Entry/ID

Status	Occurrence	Format	Min. Access Types
Required	One	chr	Get, Replace

This leaf node indicates the MCVideo group used upon certain criteria on initiation of an MCVideo emergency alert.

13.2.38A6 /<x>/<x>/Common/MCVideoGroupCall/EmergencyAlert/Entry/DisplayName

Table 13.2.38A6.1: /<x>/<x>/Common/MCVideoGroupCall/EmergencyAlert/Entry/DisplayName

<x>/Common/MCVideoGroupCall/EmergencyAlert/Entry/DisplayName

Status	Occurrence	Format	Min. Access Types
Optional	One	chr	Get, Replace

This leaf node contains a human readable name that corresponds to the ID.

13.2.38A7 /<x>/<x>/Common/MCVideoGroupCall/EmergencyAlert/Entry/Usage

Table 13.2.38A7.1: /<x>/<x>/Common/MCVideoGroupCall/EmergencyAlert/Entry/Usage

<x>/Common/MCVideoGroupCall/EmergencyAlert/Entry/Usage

Status	Occurrence	Format	Min. Access Types
Required	One	chr	Get, Replace

This leaf node indicates the criteria to determine when initiation of an MCVideo emergency alert uses the ID.

The valid values are 'LocallyDetermined', 'UseCurrentlySelectedGroup', 'UsePreConfigured' and 'DedicatedGroup'.

When set to 'LocallyDetermined' then if the MCVideo user selects an MCVideo ID then use that MCVideo ID for an on-network MCVideo emergency alert, if the MCVideo user does not select a MCVideo ID then use the MCVideo ID identified by the ID in clause 13.2.38A5 for an on-network MCVideo emergency alert.

When set to 'UseCurrentlySelectedGroup' then if the MCVideo user has currently selected an MCVideo group then use that MCVideo group for an on-network MCVideo emergency alert, if the MCVideo user does not have a currently selected MCVideo group then use the MCVideo group identified by the ID in clause 13.2.38A5 for an MCVideo emergency alert.

When set to 'UsePreConfigured' then use the ID identified by the ID in clause 13.2.38A5 for an on-network MCVideo emergency alert.

When set to 'DedicatedGroup' then use the MCVideo group identified by the ID in clause 13.2.38A5 for an MCVideo emergency alert.

13.2.38B /<x>/<x>/Common/MCVideoGroupCall/EmergencyCall

Table 13.2. 38B.1: /<x>/<x>/Common/MCVideoGroupCall/EmergencyCall

<x>/Common/MCVideoGroupCall/EmergencyCall

Status	Occurrence	Format	Min. Access Types
Required	One	node	Get, Replace

This interior node is a placeholder for the MCVideo emergency call policy.

13.2.38C /<x>/<x>/Common/MCVideoGroupCall/EmergencyCall/Enabled

Table 13.2.38C.1: /<x>/<x>/Common/MCVideoGroupCall/EmergencyCall/Enabled

<x>/Common/MCVideoGroupCall/EmergencyCall/Enabled

Status	Occurrence	Format	Min. Access Types
Optional	One	bool	Get, Replace

This leaf node indicates the authorisation to make an MCVideo emergency group call functionality enabled for MCVideo user.

When set to "true" the MCVideo user is authorised to make an MCVideo emergency group call functionality enabled.

When set to "false" the MCVideo user is not authorised to make an MCVideo emergency group call functionality enabled.

13.2.38D /<x>/<x>/Common/MCVideoGroupCall/EmergencyCall/CancelMCVideoGroup

Table 13.2.38D.1: /<x>/<x>/Common/MCVideoGroupCall/EmergencyCall/CancelMCVideoGroup

<x>/Common/MCVideoGroupCall/EmergencyCall/CancelMCVideoGroup

Status	Occurrence	Format	Min. Access Types
Required	One	bool	Get, Replace

This leaf node indicates the authorisation to cancel an in progress MCVideo emergency group call associated with a group.

When set to "true" the MCVideo user is authorised to cancel a MCVideo emergency group call.

When set to "false" the MCVideo user is not authorised to cancel a MCTT emergency group call.

13.2.38D1 `<x>/<x>/Common/MCVideoGroupCall/EmergencyCall/MCVideoGroupInitiation`

Table 13.2.38D1.1: `<x>/<x>/Common/MCVideoGroupCall/EmergencyCall/MCVideoGroupInitiation`

`<x>/Common/MCVideoGroupCall/EmergencyCall/MCVideoGroupInitiation`

Status	Occurrence	Format	Min. Access Types
Required	One	node	Get, Replace

This interior node is a placeholder for the group used on initiation of an MCVideo emergency group call.

13.2.38D2 `<x>/<x>/Common/MCVideoGroupCall/EmergencyCall/MCVideoGroupInitiation/Entry`

Table 13.2.38D2.1:

`<x>/<x>/Common/MCVideoGroupCall/EmergencyCall/MCVideoGroupInitiation/Entry`

`<x>/Common/MCVideoGroupCall/EmergencyCall/MCVideoGroupInitiation/Entry`

Status	Occurrence	Format	Min. Access Types
Required	One	node	Get, Replace

This interior node is a placeholder for the details of the group used on initiation of an MCVideo emergency group call.

13.2.38D3 `<x>/<x>/Common/MCVideoGroupCall/EmergencyCall/MCVideoGroupInitiation/Entry/GroupID`

Table 13.2.38D3.1:

`<x>/<x>/Common/MCVideoGroupCall/EmergencyCall/MCVideoGroupInitiation/Entry/GroupID`

`<x>/Common/MCVideoGroupCall/EmergencyCall/MCVideoGroupInitiation/Entry/GroupID`

Status	Occurrence	Format	Min. Access Types
Optional	One	chr	Get, Replace

This leaf node indicates the group used upon certain criteria on initiation of an MCVideo emergency group call.

13.2.38D4 `<x>/<x>/Common/MCVideoGroupCall/EmergencyCall/MCVideoGroupInitiation/Entry/DisplayName`

Table 13.2.38D4.1:

`<x>/<x>/Common/MCVideoGroupCall/EmergencyCall/MCVideoGroupInitiation/Entry/DisplayName`

`<x>/Common/MCVideoGroupCall/EmergencyCall/MCVideoGroupInitiation/Entry/DisplayName`

Status	Occurrence	Format	Min. Access Types
Optional	One	chr	Get, Replace

This leaf node contains a human readable name that corresponds to the Group ID.

13.2.38D5 /<x>/<x>/Common/MCVideoGroupCall/EmergencyCall/MCVideoGroupInitiation/Entry/Usage

Table 13.2.38D5.1:

/<x>/<x>/Common/MCVideoGroupCall/EmergencyCall/MCVideoGroupInitiation/Entry/Usage

<x>/Common/MCVideoGroupCall/EmergencyCall/MCVideoGroupInitiation/Entry/Usage

Status	Occurrence	Format	Min. Access Types
Required	One	chr	Get, Replace

This leaf node indicates the criteria to determine when initiation of an MCVideo emergency group call uses the GroupID.

The valid values are 'UseCurrentlySelectedGroup' and 'DedicatedGroup'.

When set to 'UseCurrentlySelectedGroup' then if the MCVideo user has currently selected an MCVideo group then use that MCVideo group for an on-network MCVideo emergency group call, if the MCVideo user does not have a currently selected MCVideo group then use the MCVideo group identified by the GroupID in clause 13.2.38D3 for an MCVideo emergency group call.

When set to 'DedicatedGroup' then use the MCVideo group identified by the GroupID in clause 13.2.38D3 for an MCVideo emergency group call.

13.2.38E/<x>/<x>/Common/MCVideoGroupCall/ImminentPerilCall

Table 13.2.38E.1: /<x>/<x>/Common/MCVideoGroupCall/ImminentPerilCall

<x>/Common/MCVideoGroupCall/ImminentPerilCall

Status	Occurrence	Format	Min. Access Types
Required	One	node	Get, Replace

This interior node is a placeholder for the MCVideo imminent peril call policy.

13.2.38F/<x>/<x>/Common/MCVideoGroupCall/ImminentPerilCall/Authorised

Table 13.2.38F.1: /<x>/<x>/Common/MCVideoGroupCall/ImminentPerilCall/Authorised

<x>/Common/MCVideoGroupCall/ImminentPerilCall/Authorised

Status	Occurrence	Format	Min. Access Types
Required	One	bool	Get, Replace

This leaf node indicates the authorisation to make an Imminent Peril group call.

When set to "true" the MCVideo user is authorised to create an MCVideo imminent peril group call.

When set to "false" the MCVideo user is not authorised to create an MCVideo imminent peril group call.

13.2.38G /<x>/<x>/Common/MCVideoGroupCall/ImminentPerilCall/Cancel

Table 13.2.38G.1: /<x>/<x>/Common/MCVideoGroupCall/ImminentPerilCall/Cancel

<x>/Common/MCVideoGroupCall/ImminentPerilCall/Cancel

Status	Occurrence	Format	Min. Access Types
Required	One	bool	Get, Replace

This leaf node indicates the authorisation for in-progress MCVideo imminent peril cancelation.

When set to "true" the MCVideo user is authorised to cancel an MCVideo imminent peril call.

When set to "false" the MCVideo user is not authorised to cancel an MCVideo imminent peril call.

13.2.38G1 /<x>/<x>/Common/MCVideoGroupCall/ImminentPerilCall/MCVideoGroupInitiation

Table 13.2.38G1.1: /<x>/<x>/Common/MCVideoGroupCall/ImminentPerilCall/MCVideoGroupInitiation

<x>/Common/MCVideoGroupCall/ImminentPerilCall/MCVideoGroupInitiation

Status	Occurrence	Format	Min. Access Types
Optional	One	node	Get, Replace

This interior node is a placeholder for the group used on initiation of an MCVideo imminent peril group call.

13.2.38G2 /<x>/<x>/Common/MCVideoGroupCall/ImminentPerilCall/MCVideoGroupInitiation/Entry

Table 13.2.38G2.1:

/<x>/<x>/Common/MCVideoGroupCall/ImminentPerilCall/MCVideoGroupInitiation/Entry

<x>/Common/MCVideoGroupCall/ImminentPerilCall/MCVideoGroupInitiation/Entry

Status	Occurrence	Format	Min. Access Types
Required	One	node	Get, Replace

This interior node is a placeholder for the details of the group used on initiation of an imminent peril call.

13.2.38G3 /<x>/<x>/Common/MCVideoGroupCall/ImminentPerilCall/MCVideoGroupInitiation/Entry/GroupID

Table 13.2.38G3.1:

/<x>/<x>/Common/MCVideoGroupCall/ImminentPerilCall/MCVideoGroupInitiation/Entry/GroupID

<x>/Common/MCVideoGroupCall/ImminentPerilCall/MCVideoGroupInitiation/Entry/GroupID

Status	Occurrence	Format	Min. Access Types
Required	One	chr	Get, Replace

This leaf node indicates the group used upon certain criteria on initiation of an MCVideo imminent peril group call.

13.2.38G4 /<x>/<x>/Common/MCVideoGroupCall/ImminentPerilCall/ MCVideoGroupInitiation/DisplayName

Table 13.2.38G4.1:

/<x>/<x>/Common/MCVideoGroupCall/ImminentPerilCall/MCVideoGroupInitiation/Entry/DisplayName

<x>/Common/MCVideoGroupCall/ImminentPerilCall/MCVideoGroupInitiation/Entry/DisplayName

Status	Occurrence	Format	Min. Access Types
Optional	One	chr	Get, Replace

This leaf node contains a human readable name that corresponds to the Group ID.

13.2.38G5 /<x>/<x>/Common/MCVideoGroupCall/ImminentPerilCall/ MCVideoGroupInitiation/Entry/Usage

Table 13.2.38G5.1:

/<x>/<x>/Common/MCVideoGroupCall/ImminentPerilCall/MCVideoGroupInitiation/Entry/Usage

<x>/Common/MCVideoGroupCall/ImminentPerilCall/MCVideoGroupInitiation/Entry/Usage

Status	Occurrence	Format	Min. Access Types
Required	One	chr	Get, Replace

This leaf node indicates the criteria to determine when initiation of an MCVideo imminent peril group call uses the GroupID.

The valid values are 'UseCurrentlySelectedGroup' and 'DedicatedGroup'.

When set to 'UseCurrentlySelectedGroup' then if the MCVideo user has currently selected an MCVideo group then use that MCVideo group for an on-network MCVideo imminent peril group call, if the MCVideo user does not have a currently selected MCVideo group then use the MCVideo group identified by the GroupID in clause 13.2.38G3 for an MCVideo imminent peril group call.

When set to 'DedicatedGroup' then use the MCVideo group identified by the GroupID in clause 13.2.38G3 for an MCVideo imminent peril group call.

13.2.38G6 /<x>/<x>/Common/MCVideoGroupCall/Priority

Table 13.2.38G6.1: /<x>/<x>/Common/MCVideoGroupCall/Priority

<x>/Common/MCVideoGroupCall/Priority

Status	Occurrence	Format	Min. Access Types
Required	One	int	Get, Replace

This leaf node indicates the priority of the MCVideo group calls.

- Values: 0-255

The MCVideo group call with the lowest Priority value shall be considered as the MCVideo group call having the lowest level among the MCVideo group calls.

13.2.38G7 /<x>/<x>/Common/MCVideoGroupCall/MaxSimultaneousCallsN6

Table 13.2.38G7.1: /<x>/<x>/Common/MCVideoGroupCall/MaxSimultaneousCallsN6

<x>/Common/MCVideoGroupCall/MaxSimultaneousCallsN6

Status	Occurrence	Format	Min. Access Types
Required	One	int	Get, Replace

This leaf node indicates the maximum number of simultaneously received MCVideo group calls (N6).

13.2.38H /<x>/<x>/Common/PrivateCall

Table 13.2.38H.1: /<x>/<x>/Common/PrivateCall

<x>/Common/PrivateCall

Status	Occurrence	Format	Min. Access Types
Required	One	node	Get, Replace

This interior node is a placeholder for the MCVideo private call configuration.

13.2.38H1 Void

13.2.38H2 Void

13.2.38H3 Void

13.2.38H4 Void

13.2.38H5 Void

13.2.38H6 Void

13.2.38I /<x>/<x>/Common/PrivateCall/Authorised

Table 13.2.38I.1: /<x>/<x>/Common/PrivateCall/Authorised

<x>/Common/PrivateCall/Authorised

Status	Occurrence	Format	Min. Access Types
Required	One	bool	Get, Replace

This leaf node indicates the authorisation to make a MCVideo private call.

13.2.38I1 /<x>/<x>/Common/PrivateCall/AuthorisedAny

Table 13.2.38I1.1: /<x>/<x>/Common/PrivateCall/AuthorisedAny

<x>/Common/PrivateCall/AuthorisedAny

Status	Occurrence	Format	Min. Access Types
Required	One	bool	Get, Replace

This leaf node indicates the authorisation to make a MCVideo private call to any MCVideo user.

When set to "true" the MCVideo user is authorised to make an MCVideo private call to any MCVideo user.

When set to "false" the MCVideo user is not authorised to make an MCVideo private call to any MCVideo user.

13.2.38I2 /<x>/<x>/Common/PrivateCall/UserList

Table 13.2.38I2.1: /<x>/<x>/Common/PrivateCall/UserList

<x>/Common/PrivateCall/UserList

Status	Occurrence	Format	Min. Access Types
Required	One	node	Get, Replace

This interior node is a placeholder for a list of MCVideo user(s) who can be called in a MCVideo private call.

13.2.38I3 /<x>/<x>/Common/PrivateCall/UserList/<x>

Table 13.2.38I3.1: /<x>/<x>/Common/PrivateCall/UserList/<x>

<x>/Common/PrivateCall/UserList/<x>

Status	Occurrence	Format	Min. Access Types
Optional	OneOrMore	node	Get, Replace

This interior node is a placeholder for one or more list of MCVideo users who can be called in a MCVideo private call.

13.2.38I4 /<x>/<x>/Common/PrivateCall/UserList/<x>/Entry

Table 13.2.38I4.1: /<x>/<x>/Common/PrivateCall/UserList/<x>/Entry

<x>/Common/PrivateCall/UserList/<x>/Entry

Status	Occurrence	Format	Min. Access Types
Required	One	node	Get, Replace

This interior node is a placeholder for one or more MCVideo users who can be called in a private call.

13.2.38I5 /<x>/<x>/Common/PrivateCall/UserList/<x>/Entry/MCVideoID

Table 13.2.38I5.1: /<x>/<x>/Common/PrivateCall/UserList/<x>/Entry/MCVideoID

<x>/Common/PrivateCall/UserList/<x>/Entry/MCVideoID

Status	Occurrence	Format	Min. Access Types
Optional	One	chr	Get, Replace

This leaf node indicates an MCVideo user identity (MCVideo ID) which is a globally unique identifier within the MCVideo service that represents the MCVideo user.

The value is a "uri" attribute specified in OMA OMA-TS-XDM_Group-V1_1 [4].

13.2.3816 /<x>/<x>/Common/PrivateCall/UserList/<x>/Entry/DiscoveryGroupID

Table 13.2.3816.1: /<x>/<x>/Common/PrivateCall/UserList/<x>/Entry/DiscoveryGroupID

<x>/Common/PrivateCall/UserList/<x>/Entry/DiscoveryGroupID

Status	Occurrence	Format	Min. Access Types
Optional	One	int	Get, Replace

This leaf node indicates a discovery group ID as specified in 3GPP TS 23.303 [6].

The value is used as the discovery group ID in the ProSe discovery procedures as specified in 3GPP TS 23.303 [6].

13.2.3816A /<x>/<x>/Common/PrivateCall/UserList/<x>/Entry/ApplicationLayerGroupID

Table 13.2.3816A.1: /<x>/<x>/Common/PrivateCall/UserList/<x>/Entry/ApplicationLayerGroupID

<x>/Common/PrivateCall/UserList/<x>/Entry/ApplicationLayerGroupID

Status	Occurrence	Format	Min. Access Types
Optional	One	Int	Get, Replace

This leaf node indicates an application layer group ID as specified in 3GPP TS 23.304 [25].

The value is used as the application layer group ID in the ProSe discovery procedures as specified in 3GPP TS 23.304 [25].

13.2.3817 /<x>/<x>/Common/PrivateCall/UserList/<x>/Entry/UserInfoID

Table 13.2.3817.1: /<x>/<x>/Common/PrivateCall/UserList/<x>/Entry/UserInfoID

<x>/Common/PrivateCall/UserList/<x>/Entry/UserInfoID

Status	Occurrence	Format	Min. Access Types
Optional	One	int	Get, Replace

This leaf node indicates a ProSe user info ID as specified in 3GPP TS 23.303 [6].

13.2.3818 /<x>/<x>/Common/PrivateCall/UserList/<x>/Entry/DisplayName

Table 13.2.3818.1: /<x>/<x>/Common/PrivateCall/UserList/<x>/Entry/DisplayName

<x>/Common/PrivateCall/UserList/<x>/Entry/DisplayName

Status	Occurrence	Format	Min. Access Types
Optional	One	chr	Get, Replace

This leaf node contains a human readable name.

13.2.38I9 /<x>/<x>/Common/PrivateCall/UserList/<x>/Entry/PrivateCallKMSURI

Table 13.2.38I9.1: /<x>/<x>/Common/PrivateCall/UserList/<x>/Entry/PrivateCallKMSURI

<x>/Common/PrivateCall/UserList/<x>/Entry/PrivateCallKMSURI

Status	Occurrence	Format	Min. Access Types
Optional	One	chr	Get, Replace

This leaf node indicates the identity (URI) of the KMS associated with the MCVidoeID. If the value is empty, the KMS leaf node present in the MCS UE initial configuration MO is used.

13.2.38J /<x>/<x>/Common/PrivateCall/ManualCommence

Table 13.2.38J.1: /<x>/<x>/Common/PrivateCall/ManualCommence

<x>/Common/PrivateCall/ManualCommence

Status	Occurrence	Format	Min. Access Types
Required	One	bool	Get, Replace

This leaf node indicates the authorisation to make a MCVidoe private call with manual commencement.

When set to "true" the MCVidoe user is authorised to make a MCVidoe private call in manual commencement mode.

When set to "false" the MCVidoe user is not authorised to make a MCVidoe private call in manual commencement mode.

13.2.38K/<x>/<x>/Common/PrivateCall/AutoCommence

Table 13.2.38K.1: /<x>/<x>/Common/PrivateCall/AutoCommence

<x>/Call/Common/PrivateCall/AutoCommence

Status	Occurrence	Format	Min. Access Types
Required	One	bool	Get, Replace

This leaf node indicates the authorisation to make a MCVidoe private call with automatic commencement.

When set to "true" the MCVidoe user is authorised to make a MCVidoe private call in automatic commencement mode.

When set to "false" the MCVidoe user is not authorised to make a MCVidoe private call in automatic commencement mode.

13.2.38L/<x>/<x>/Common/PrivateCall/FailRestrict

Table 13.2.38L.1: /<x>/<x>/Common/PrivateCall/FailRestrict

<x>/Call/Common/PrivateCall/FailRestrict

Status	Occurrence	Format	Min. Access Types
Required	One	bool	Get, Replace

This leaf node indicates the authorisation to restrict the provision of a notification of call failure reason for a MCVidoe private call.

When set to "true" the MCVideo user is authorised to restrict notification of call failure reason for MCVideo private call.

When set to "false" the MCVideo user is not authorised to restrict notification of call failure reason for MCVideo private call.

13.2.38M Void

13.2.38N /<x>/<x>/Common/PrivateCall/AllowedMediaProtection

Table 13.2.38N.1: /<x>/<x>/Common/PrivateCall/AllowedMediaProtection

<x>/Common/PrivateCall/AllowedMediaProtection

Status	Occurrence	Format	Min. Access Types
Required	One	bool	Get, Replace

This leaf node indicates authorisation to protect confidentiality and integrity of media for MCVideo private calls.

When set to "true" the MCVideo user is authorised to protect confidentiality and integrity of media for MCVideo private calls.

When set to "false" the MCVideo user is not authorised to protect confidentiality and integrity of media for MCVideo private calls.

The default value is set to "true".

13.2.38O /<x>/<x>/Common/PrivateCall/EmergencyCall

Table 13.2.38O.1: /<x>/<x>/Common/PrivateCall/EmergencyCall

<x>/Common/PrivateCall/EmergencyCall

Status	Occurrence	Format	Min. Access Types
Required	One	node	Get, Replace

This interior node is a placeholder for the MCVideo emergency call policy.

13.2.38P/<x>/<x>/Common/PrivateCall/EmergencyCall/Authorised

Table 13.2.38P.1: /<x>/<x>/Common/PrivateCall/EmergencyCall/Authorised

<x>/Common/PrivateCall/EmergencyCall/Authorised

Status	Occurrence	Format	Min. Access Types
Required	One	bool	Get, Replace

This leaf node indicates the authorisation to make an MCVideo emergency private call.

When set to "true" the MCVideo user is authorised to make an MCVideo emergency private call.

When set to "false" the MCVideo user is not authorised to make an MCVideo emergency private call.

13.2.38Q /<x>/<x>/Common/PrivateCall/EmergencyCall/CancelPriority

Table 13.2.38Q.1: /<x>/<x>/Common/PrivateCall/EmergencyCall/CancelPriority

<x>/Common/PrivateCall/EmergencyCall/CancelPriority

Status	Occurrence	Format	Min. Access Types
Required	One	bool	Get, Replace

This leaf node indicates the authorisation to cancel emergency priority in an MCVideo emergency private call by an authorised MCVideo user.

When set to "true" the MCVideo user is authorised to cancel an emergency priority in an MCVideo private call.

When set to "false" the MCVideo user is not authorised to cancel an emergency priority in an MPCTT private call.

13.2.38R /<x>/<x>/Common/PrivateCall/EmergencyCall/MCVideoPrivateRecipient

Table 13.2.38R.1: /<x>/<x>/Common/PrivateCall/EmergencyCall/MCVideoPrivateRecipient

<x>/Common/PrivateCall/EmergencyCall/MCVideoPrivateRecipient

Status	Occurrence	Format	Min. Access Types
Optional	One	node	Get, Replace

This interior node is a placeholder for the MCVideo private recipient for an MCVideo emergency private call.

13.2.38S /<x>/<x>/Common/PrivateCall/EmergencyCall/MCVideoPrivateRecipient/Entry

Table 13.2.38S.1: /<x>/<x>/Common/PrivateCall/EmergencyCall/MCVideoPrivateRecipient/Entry

<x>/Common/PrivateCall/EmergencyCall/MCVideoPrivateRecipient/Entry

Status	Occurrence	Format	Min. Access Types
Required	One	node	Get, Replace

This interior node is a placeholder for the details of the MCVideo private recipient for an MCVideo emergency private call.

13.2.38T /<x>/<x>/Common/PrivateCall/EmergencyCall/MCVideoPrivateRecipient/Entry/ID

Table 13.2.38T.1: /<x>/<x>/Common/PrivateCall/EmergencyCall/MCVideoPrivateRecipient/Entry/ID

<x>/Common/PrivateCall/EmergencyCall/MCVideoPrivateRecipient/Entry/ID

Status	Occurrence	Format	Min. Access Types
Optional	One	chr	Get, Replace

This leaf node indicates the MCVideo private recipient used upon certain criteria on initiation of an MCVideo emergency private call.

13.2.38U /<x>/<x>/Common/PrivateCall/EmergencyCall/ MCVideoPrivateRecipient/Entry/DiscoveryGroupID

Table 13.2.38U.1:

/<x>/<x>/Common/PrivateCall/EmergencyCall/MCVideoPrivateRecipient/Entry/DiscoveryGroupID

<x>/Common/PrivateCall/EmergencyCall/MCVideoPrivateRecipient/Entry/DiscoveryGroupID

Status	Occurrence	Format	Min. Access Types
Optional	One	int	Get, Replace

This leaf node indicates the discovery group ID as specified in 3GPP TS 23.303 [6].

13.2.38U1 /<x>/<x>/Common/PrivateCall/EmergencyCall/ MCVideoPrivateRecipient/Entry/ApplicationLayerGroupID

Table 13.2.38U1.1:

/<x>/<x>/Common/PrivateCall/EmergencyCall/MCVideoPrivateRecipient/Entry/ApplicationLayerGroupID

<x>/Common/PrivateCall/EmergencyCall/MCVideoPrivateRecipient/Entry/ApplicationLayerGroupID

Status	Occurrence	Format	Min. Access Types
Optional	One	int	Get, Replace

This leaf node indicates the discovery group ID as specified in 3GPP TS 23.304 [25].

13.2.38V /<x>/<x>/Common/PrivateCall/EmergencyCall/ MCVideoPrivateRecipient/Entry/UserInfoID

Table 13.2.38V.1:

/<x>/<x>/Common/PrivateCall/EmergencyCall/MCVideoPrivateRecipient/Entry/UserInfoID

<x>/Common/PrivateCall/EmergencyCall/MCVideoPrivateRecipient/Entry/UserInfoID

Status	Occurrence	Format	Min. Access Types
Optional	One	int	Get, Replace

This leaf node indicates a ProSe user info ID as specified in 3GPP TS 23.303 [6].

The "UserInfoID" element identifies the MCVideo private recipient when making an off-network private call.

13.2.38W /<x>/<x>/Common/PrivateCall/EmergencyCall/ MCVideoPrivateRecipient/Entry/DisplayName

Table 13.2.38W.1:

/<x>/<x>/Common/PrivateCall/EmergencyCall/MCVideoPrivateRecipient/Entry/DisplayName

<x>/Common/PrivateCall/EmergencyCall/MCVideoPrivateRecipient/Entry/DisplayName

Status	Occurrence	Format	Min. Access Types
Optional	One	chr	Get, Replace

This leaf node contains a human readable name that corresponds to the MCVideo private recipient ID.

13.2.38X/<x>/<x>/Common/PrivateCall/EmergencyCall/ MCVideoPrivateRecipient/Entry/Usage

Table 13.2.38X.1:
/<x>/<x>/Common/PrivateCall/EmergencyCall/MCVideoPrivateRecipient/Entry/Usage

<x>/Common/PrivateCall/EmergencyCall/MCVideoPrivateRecipient/Entry/Usage

Status	Occurrence	Format	Min. Access Types
Required	One	chr	Get, Replace

This leaf node indicates the criteria to determine when initiation of an MCVideo emergency private call uses the MCVideo private recipient ID.

The valid values are 'LocallyDetermined' and 'UsePreConfigured'.

When set to 'LocallyDetermined' then if the MCVideo user selects an MCVideo ID then use that MCVideo ID for the MCVideo emergency private call, if the MCVideo user does not select a MCVideo ID then use the MCVideo ID identified by the MCVideo private recipient ID in clause 13.2.38T for an on-network MCVideo emergency private call.

When set to 'UsePreConfigured' then use the MCVideo ID identified by the MCVideo private recipient ID in clause 13.2.38T for an on-network MCVideo emergency private call.

When set to 'LocallyDetermined' then if the MCVideo user selects an MCVideo user then use the UserInfoID that corresponds to that MCVideo user for the MCVideo emergency private call, if the MCVideo user does not select a MCVideo user then use the User Info ID identified by the UserInfoID in clause 13.2.38T for an off-network MCVideo emergency private call.

When set to 'UsePreConfigured' then use the User Info ID identified by the UserInfoID in clause 13.2.38T for an off-network MCVideo emergency private call.

13.2.38Y/<x>/<x>/Common/PrivateCall/AutoAnswer

Table 13.2.38Y.1: /<x>/<x>/Common/PrivateCall/AutoAnswer

<x>/Common/PrivateCall/AutoAnswer

Status	Occurrence	Format	Min. Access Types
Required	One	bool	Get, Replace

This leaf node indicates the authorisation of MCVideo user to force automatic answer for a MCVideo private call.

When set to "true" the MCVideo user is authorised to force automatic answer for a MCVideo private call.

When set to "false" the MCVideo user is not authorised to force automatic answer for a MCVideo private call.

13.2.39 /<x>/<x>/OnNetwork

Table 13.2.39.1: /<x>/<x>/OnNetwork

<x>/OnNetwork

Status	Occurrence	Format	Min. Access Types
Required	ZeroOrOne	node	Get, Replace

This interior node represents a container for on-network operation.

13.2.40 /<x>/<x>/OnNetwork/MCVideoGroupList

Table 13.2.40.1: /<x>/<x>/OnNetwork/MCVideoGroupList

<x>/OnNetwork/MCVideoGroupList

Status	Occurrence	Format	Min. Access Types
Required	One	node	Get, Replace

This interior node is a placeholder for the list of on-network MCVideo groups that the MCVideo user is allowed to use.

13.2.41 /<x>/<x>/OnNetwork/MCVideoGroupList/<x>

Table 13.2.41.1: /<x>/<x>/OnNetwork/MCVideoGroupList/<x>

<x>/OnNetwork/MCVideoGroupList/<x>

Status	Occurrence	Format	Min. Access Types
Required	OneOrMore	node	Get, Replace

This interior node is a placeholder for one or more list of on-network MCVideo groups that the MCVideo user is allowed to use.

13.2.42 /<x>/<x>/OnNetwork/MCVideoGroupList/<x>/Entry

Table 13.2.42.1: /<x>/<x>/OnNetwork/MCVideoGroupList/<x>/Entry

<x>/OnNetwork/MCVideoGroupList/<x>/Entry

Status	Occurrence	Format	Min. Access Types
Optional	One	node	Get, Replace

This interior node is a placeholder for the details of the on-network MCVideo groups that the MCVideo user is allowed to use.

13.2.43 /<x>/<x>/OnNetwork/MCVideoGroupList/<x>/Entry/ MCVideoGroupID

Table 13.2.43.1: /<x>/<x>/OnNetwork/MCVideoGroupList/<x>/Entry/MCVideoGroupID

<x>/OnNetwork/MCVideoGroupList/<x>/Entry/MCVideoGroupID

Status	Occurrence	Format	Min. Access Types
Required	One	chr	Get, Replace

This leaf node indicates the MCVideo group ID for the on-network MCVideo group that the MCVideo user is allowed to use.

The value is a "uri" attribute specified in OMA OMA-TS-XDM_Group-V1_1 [4].

13.2.43A/OnNetwork/MCVideoGroupList/Entry/ RulesForAffiliation

Table 13.2.43A.1: /OnNetwork/MCVideoGroupList/Entry/ RulesForAffiliation

/OnNetwork/MCVideoGroupList/Entry/ RulesForAffiliation

Status	Occurrence	Format	Min. Access Types
Optional	ZeroOrOne	node	Get, Replace

This interior node is a placeholder for the rules that control automatic affiliation.

13.2.43A0 /OnNetwork/MCVideoGroupList/Entry/ RulesForAffiliation/

Table 13.2.43A0.1: /OnNetwork/MCVideoGroupList/Entry/ RulesForAffiliation/

/OnNetwork/MCVideoGroupList/Entry/ RulesForAffiliation/

Status	Occurrence	Format	Min. Access Types
Optional	ZeroOrMore	node	Get, Replace

This interior node is a placeholder for zero or more rules that control automatic affiliation.

13.2.43A1 /OnNetwork/MCVideoGroupList/Entry/ RulesForAffiliation/ListOfLocationCriteria

Table 13.2.43A1.1: /OnNetwork/MCVideoGroupList/Entry/ RulesForAffiliation/ListOfLocationCriteria

/OnNetwork/MCVideoGroupList/Entry/ RulesForAffiliation/ListOfLocationCriteria

Status	Occurrence	Format	Min. Access Types
Optional	One	node	Get, Replace

This interior node is a placeholder for the location portion of the rules that control automatic affiliation.

13.2.43A2 /OnNetwork/MCVideoGroupList/Entry/ RulesForAffiliation/ListOfLocationCriteria/

Table 5.2.48B84A2.1: /OnNetwork/MCVideoGroupList/Entry/ RulesForAffiliation/ListOfLocationCriteria/

/OnNetwork/MCVideoGroupList/Entry/ RulesForAffiliation/ListOfLocationCriteria/

Status	Occurrence	Format	Min. Access Types
Optional	ZeroOrMore	node	Get, Replace

This interior node is a placeholder for the location portion of the rules that control automatic affiliation.

13.2.43A3 /<x>/<x>/OnNetwork/MCVideoGroupList/<x>/Entry/ RulesForAffiliation/<x>/ListOfLocationCriteria/<x>/Entry

Table 13.2.43A3.1: /<x>/<x>/OnNetwork/MCVideoGroupList/<x>/Entry/RulesForAffiliation/<x>/ListOfLocationCriteria/<x>/Entry

<x>/OnNetwork/MCVideoGroupList/<x>/Entry/RulesForAffiliation/<x>/ListOfLocationCriteria/<x>/Entry

Status	Occurrence	Format	Min. Access Types
Optional	One	node	Get, Replace

This interior node is a placeholder for the location portion of the rules that control automatic affiliation.

13.2.43A4 /<x>/<x>/OnNetwork/MCVideoGroupList/<x>/Entry/ RulesForAffiliation/<x>/ListOfLocationCriteria/<x>/Entry/ EnterSpecificArea

Table 13.2.43A4.1: /<x>/<x>/OnNetwork/MCVideoGroupList/<x>/Entry/RulesForAffiliation/<x>/ListOfLocationCriteria/<x>/Entry/EnterSpecificArea

<x>/OnNetwork/MCVideoGroupList/<x>/Entry/RulesForAffiliation/<x>/ListOfLocationCriteria/<x>/Entry/EnterSpecificArea

Status	Occurrence	Format	Min. Access Types
Optional	ZeroOrOne	node	Get, Replace

This interior node contains a geographical area which when entered by the MC service UE triggers evaluation of the rules.

13.2.43A5 /<x>/<x>/OnNetwork/MCVideoGroupList/<x>/Entry/ RulesForAffiliation/<x>/ListOfLocationCriteria/<x>/Entry/ EnterSpecificArea/PolygonArea

Table 13.2.43A5.1: /<x>/<x>/OnNetwork/MCVideoGroupList/<x>/Entry/RulesForAffiliation/<x>/ListOfLocationCriteria/<x>/Entry/EnterSpecificArea/PolygonArea

<x>/OnNetwork/MCVideoGroupList/<x>/Entry/RulesForAffiliation/<x>/ListOfLocationCriteria/<x>/Entry/EnterSpecificArea/PolygonArea

Status	Occurrence	Format	Min. Access Types
Optional	ZeroOrOne	node	Get, Replace

This interior node contains a geographical area described by a polygon.

13.2.43A6 /<x>/<x>/OnNetwork/MCVideoGroupList/<x>/Entry/ RulesForAffiliation/<x>/ListOfLocationCriteria/<x>/Entry/ EnterSpecificArea/PolygonArea/<x>

Table 13.2.43A6.1: /<x>/<x>/OnNetwork/MCVideoGroupList/<x>/Entry/RulesForAffiliation/<x>/ListOfLocationCriteria/<x>/Entry/EnterSpecificArea/PolygonArea/<x>

<x>/OnNetwork/MCVideoGroupList/<x>/Entry/RulesForAffiliation/<x>/ListOfLocationCriteria/<x>/Entry/EnterSpecificArea/PolygonArea/<x>

Status	Occurrence	Format	Min. Access Types
Required	OneOrN	node	Get, Replace

This interior node contains the coordinates of the corners which define a polygon. The occurrence of this leaf node is "3 to 15" as per 3GPP TS 23.032 [21].

13.2.43A7 /<x>/<x>/OnNetwork/MCVideoGroupList/<x>/Entry/ RulesForAffiliation/<x>/ListOfLocationCriteria/<x>/Entry/ EnterSpecificArea/PolygonArea/<x>/PointCoordinateType

**Table 13.2.43A7.1: /<x>/<x>/OnNetwork/MCVideoGroupList/<x>/Entry/RulesForAffiliation/<x>/
ListOfLocationCriteria/<x>/Entry/EnterSpecificArea/PolygonArea/<x>/PointCoordinateType**

<x>/OnNetwork/MCVideoGroupList/<x>/Entry/RulesForAffiliation/<x>/ListOfLocationCriteria/<x>/Entry/EnterSp
ecificArea/PolygonArea/<x>/PointCoordinateType

Status	Occurrence	Format	Min. Access Types
Required	One	node	Get, Replace

This interior node contains the type of the coordinates.

13.2.43A8 /<x>/<x>/OnNetwork/MCVideoGroupList/<x>/Entry/ RulesForAffiliation/<x>/ListOfLocationCriteria/<x>/Entry/ EnterSpecificArea/PolygonArea/<x>/PointCoordinateType/ Longitude

**Table 13.2.43A8.1: /<x>/<x>/OnNetwork/MCVideoGroupList/<x>/Entry/RulesForAffiliation/<x>/
ListOfLocationCriteria/<x>/Entry/EnterSpecificArea/PolygonArea/<x>/PointCoordinateType/
Longitude**

<x>/OnNetwork/MCVideoGroupList/<x>/Entry/RulesForAffiliation/<x>/ListOfLocationCriteria/<x>/Entry/EnterSp
ecificArea/PolygonArea/<x>/PointCoordinateType/Longitude

Status	Occurrence	Format	Min. Access Types
Required	One	int	Get, Replace

This leaf node contains the longitudinal coordinate of a corner.

13.2.43A9 /<x>/<x>/OnNetwork/MCVideoGroupList/<x>/Entry/ RulesForAffiliation/<x>/ListOfLocationCriteria/<x>/Entry/ EnterSpecificArea/PolygonArea/<x>/PointCoordinateType/ Latitude

**Table 13.2.43A9.1: /<x>/<x>/OnNetwork/MCVideoGroupList/<x>/Entry/RulesForAffiliation/<x>/
ListOfLocationCriteria/<x>/Entry/EnterSpecificArea/PolygonArea/<x>/PointCoordinateType/
Latitude**

<x>/OnNetwork/MCVideoGroupList/<x>/Entry/RulesForAffiliation/<x>/ListOfLocationCriteria/<x>/Entry/EnterSp
ecificArea/PolygonArea/<x>/PointCoordinateType/Latitude

Status	Occurrence	Format	Min. Access Types
Required	One	int	Get, Replace

This leaf node contains the latitudinal coordinate of a corner.

13.2.43A10 /<x>/<x>/OnNetwork/MCVideoGroupList/<x>/Entry/
RulesForAffiliation/<x>/ListOfLocationCriteria/<x>/Entry/
EnterSpecificArea/EllipsoidArcArea

**Table 13.2.43A10.1: /<x>/<x>/OnNetwork/MCVideoGroupList/<x>/Entry/RulesForAffiliation/<x>/
ListOfLocationCriteria/<x>/Entry/EnterSpecificArea/EllipsoidArcArea**

<x>/OnNetwork/MCVideoGroupList/<x>/Entry/RulesForAffiliation/<x>/ListOfLocationCriteria/<x>/Entry/EnterSp
ecificArea/EllipsoidArcArea

Status	Occurrence	Format	Min. Access Types
Optional	ZeroOrOne	node	Get, Replace

This interior node contains a geographical area described by an ellipsoid arc.

13.2.43A11 /<x>/<x>/OnNetwork/MCVideoGroupList/<x>/Entry/
RulesForAffiliation/<x>/ListOfLocationCriteria/<x>/Entry/
EnterSpecificArea/EllipsoidArcArea/Center

**Table 13.2.43A11.1: /<x>/<x>/OnNetwork/MCVideoGroupList/<x>/Entry/RulesForAffiliation/<x>/
ListOfLocationCriteria/<x>/Entry/EnterSpecificArea/EllipsoidArcArea/Center**

<x>/OnNetwork/MCVideoGroupList/<x>/Entry/RulesForAffiliation/<x>/ListOfLocationCriteria/<x>/Entry/EnterSp
ecificArea/EllipsoidArcArea/Center

Status	Occurrence	Format	Min. Access Types
Required	One	node	Get, Replace

This interior node contains the coordinates of the center point of the ellipsoid arc.

13.2.43A12 /<x>/<x>/OnNetwork/MCVideoGroupList/<x>/Entry/
RulesForAffiliation/<x>/ListOfLocationCriteria/<x>/Entry/
EnterSpecificArea/EllipsoidArcArea/Center/PointCoordinateType

**Table 13.2.43A12.1: /<x>/<x>/OnNetwork/MCVideoGroupList/<x>/Entry/RulesForAffiliation/<x>/
ListOfLocationCriteria/<x>/Entry/EnterSpecificArea/EllipsoidArcArea/Center/PointCoordinateType**

<x>/OnNetwork/MCVideoGroupList/<x>/Entry/RulesForAffiliation/<x>/ListOfLocationCriteria/<x>/Entry/EnterSp
ecificArea/EllipsoidArcArea/Center/PointCoordinateType

Status	Occurrence	Format	Min. Access Types
Required	One	node	Get, Replace

This interior node contains the coordinates of the center point of the ellipsoid arc.

13.2.43A13 /<x>/<x>/OnNetwork/MCVideoGroupList/<x>/Entry/
RulesForAffiliation/<x>/ListOfLocationCriteria/<x>/Entry/
EnterSpecificArea/EllipsoidArcArea/Center/PointCoordinateType/
Longitude

**Table 13.2.43A13.1: /<x>/<x>/OnNetwork/MCVideoGroupList/<x>/Entry/RulesForAffiliation/<x>/
ListOfLocationCriteria/<x>/Entry/EnterSpecificArea/EllipsoidArcArea/Center/PointCoordinateType/
Longitude**

<x>/OnNetwork/MCVideoGroupList/<x>/Entry/RulesForAffiliation/<x>/ListOfLocationCriteria/<x>/Entry/EnterSp
ecificArea/EllipsoidArcArea/Center/PointCoordinateType/Longitude

Status	Occurrence	Format	Min. Access Types
Required	One	int	Get, Replace

This leaf node contains the longitudinal coordinate of the center.

13.2.43A14 /<x>/<x>/OnNetwork/MCVideoGroupList/<x>/Entry/
RulesForAffiliation/<x>/ListOfLocationCriteria/<x>/Entry/
EnterSpecificArea/EllipsoidArcArea/Center/PointCoordinateType/
Latitude

**Table 13.2.43A14.1: /<x>/<x>/OnNetwork/MCVideoGroupList/<x>/Entry/RulesForAffiliation/<x>/
ListOfLocationCriteria/<x>/Entry/EnterSpecificArea/EllipsoidArcArea/Center/PointCoordinateType/
Latitude**

<x>/OnNetwork/MCVideoGroupList/<x>/Entry/RulesForAffiliation/<x>/ListOfLocationCriteria/<x>/Entry/EnterSp
ecificArea/EllipsoidArcArea/Center/PointCoordinateType/Latitude

Status	Occurrence	Format	Min. Access Types
Required	One	int	Get, Replace

This leaf node contains the latitudinal coordinate of a center.

13.2.43A15 /<x>/<x>/OnNetwork/MCVideoGroupList/<x>/Entry/
RulesForAffiliation/<x>/ListOfLocationCriteria/<x>/Entry/
EnterSpecificArea/EllipsoidArcArea/Radius

**Table 13.2.43A15.1: /<x>/<x>/OnNetwork/MCVideoGroupList/<x>/Entry/RulesForAffiliation/<x>/
ListOfLocationCriteria/<x>/Entry/EnterSpecificArea/EllipsoidArcArea/Radius**

<x>/OnNetwork/MCVideoGroupList/<x>/Entry/RulesForAffiliation/<x>/ListOfLocationCriteria/<x>/Entry/EnterSp
ecificArea/EllipsoidArcArea/Radius

Status	Occurrence	Format	Min. Access Types
Required	One	int	Get, Replace

This leaf node contains the radius of the ellipsoid arc.

13.2.43A16 /<x>/<x>/OnNetwork/MCVideoGroupList/<x>/Entry/
RulesForAffiliation/<x>/ListOfLocationCriteria/<x>/Entry/
EnterSpecificArea/EllipsoidArcArea/OffsetAngle

**Table 13.2.43A16.1: /<x>/<x>/OnNetwork/MCVideoGroupList/<x>/Entry/RulesForAffiliation/<x>/
ListOfLocationCriteria/<x>/Entry/EnterSpecificArea/EllipsoidArcArea/OffsetAngle**

<x>/OnNetwork/MCVideoGroupList/<x>/Entry/RulesForAffiliation/<x>/ListOfLocationCriteria/<x>/Entry/EnterSp
ecificArea/EllipsoidArcArea/OffsetAngle

Status	Occurrence	Format	Min. Access Types
Required	One	int	Get, Replace

This leaf node contains the offset angle of the ellipsoid arc.

13.2.43A17 /<x>/<x>/OnNetwork/MCVideoGroupList/<x>/Entry/
RulesForAffiliation/<x>/ListOfLocationCriteria/<x>/Entry/
EnterSpecificArea/EllipsoidArcArea/IncludedAngle

**Table 13.2.43A17.1: /<x>/<x>/OnNetwork/MCVideoGroupList/<x>/Entry/RulesForAffiliation/<x>/
ListOfLocationCriteria/<x>/Entry/EnterSpecificArea/EllipsoidArcArea/IncludedAngle**

<x>/OnNetwork/MCVideoGroupList/<x>/Entry/RulesForAffiliation/<x>/ListOfLocationCriteria/<x>/Entry/EnterSp
ecificArea/EllipsoidArcArea/IncludedAngle

Status	Occurrence	Format	Min. Access Types
Required	One	int	Get, Replace

This leaf node contains the included angle of the ellipsoid arc.

13.2.43A18 /<x>/<x>/OnNetwork/MCVideoGroupList/<x>/Entry/
RulesForAffiliation/<x>/ListOfLocationCriteria/<x>/Entry/
EnterSpecificArea/Speed

**Table 13.2.43A18.1: /<x>/<x>/OnNetwork/MCVideoGroupList/<x>/Entry/RulesForAffiliation/<x>/
ListOfLocationCriteria/<x>/Entry/EnterSpecificArea/Speed**

<x>/OnNetwork/MCVideoGroupList/<x>/Entry/RulesForAffiliation/<x>/ListOfLocationCriteria/<x>/Entry/EnterSp
ecificArea/Speed

Status	Occurrence	Format	Min. Access Types
Optional	One	node	Get, Replace

This interior node contains the speed.

13.2.43A19 /<x>/<x>/OnNetwork/MCVideoGroupList/<x>/Entry/
RulesForAffiliation/<x>/ListOfLocationCriteria/<x>/Entry/
EnterSpecificArea/Speed/MinimumSpeed

**Table 13.2.43A19.1: /<x>/<x>/OnNetwork/MCVideoGroupList/<x>/Entry/RulesForAffiliation/<x>/
ListOfLocationCriteria/<x>/Entry/EnterSpecificArea/Speed/MinimumSpeed**

<x>/OnNetwork/MCVideoGroupList/<x>/Entry/RulesForAffiliation/<x>/ListOfLocationCriteria/<x>/Entry/EnterSp
ecificArea/Speed/MinimumSpeed

Status	Occurrence	Format	Min. Access Types

Required	One	int	Get, Replace
----------	-----	-----	--------------

This leaf node contains the minimum speed.

- Values: non-negative integer in units of kilometers/hour.

13.2.43A20 /<x>/<x>/OnNetwork/MCVideoGroupList/<x>/Entry/RulesForAffiliation/<x>/ListOfLocationCriteria/<x>/Entry/EnterSpecificArea/Speed/MaximumSpeed

Table 13.2.43A20.1: /<x>/<x>/OnNetwork/MCVideoGroupList/<x>/Entry/RulesForAffiliation/<x>/ListOfLocationCriteria/<x>/Entry/EnterSpecificArea/Speed/MaximumSpeed

<x>/OnNetwork/MCVideoGroupList/<x>/Entry/RulesForAffiliation/<x>/ListOfLocationCriteria/<x>/Entry/EnterSpecificArea/Speed/MaximumSpeed

Status	Occurrence	Format	Min. Access Types
Required	One	int	Get, Replace

This leaf node contains the maximum speed.

- Values: non-negative integer in units of kilometers/hour.

13.2.43A21 /<x>/<x>/OnNetwork/MCVideoGroupList/<x>/Entry/RulesForAffiliation/<x>/ListOfLocationCriteria/<x>/Entry/EnterSpecificArea/Heading

Table 13.2.43A21.1: /<x>/<x>/OnNetwork/MCVideoGroupList/<x>/Entry/RulesForAffiliation/<x>/ListOfLocationCriteria/<x>/Entry/EnterSpecificArea/Heading

<x>/OnNetwork/MCVideoGroupList/<x>/Entry/RulesForAffiliation/<x>/ListOfLocationCriteria/<x>/Entry/EnterSpecificArea/Heading

Status	Occurrence	Format	Min. Access Types
Optional	One	node	Get, Replace

This interior node contains the heading.

13.2.43A22 /<x>/<x>/OnNetwork/MCVideoGroupList/<x>/Entry/RulesForAffiliation/<x>/ListOfLocationCriteria/<x>/Entry/EnterSpecificArea/Heading/MinimumHeading

Table 13.2.43A22.1: /<x>/<x>/OnNetwork/MCVideoGroupList/<x>/Entry/RulesForAffiliation/<x>/ListOfLocationCriteria/<x>/Entry/EnterSpecificArea/Heading/MinimumHeading

<x>/OnNetwork/MCVideoGroupList/<x>/Entry/RulesForAffiliation/<x>/ListOfLocationCriteria/<x>/Entry/EnterSpecificArea/Heading/MinimumHeading

Status	Occurrence	Format	Min. Access Types
Required	One	int	Get, Replace

This leaf node contains the minimum heading.

- Values: 0-359

13.2.43A23 /<x>/<x>/OnNetwork/MCVideoGroupList/<x>/Entry/
RulesForAffiliation/<x>/ListOfLocationCriteria/<x>/Entry/
EnterSpecificArea/Heading/MaximumHeading

Table 13.2.43A23.1: /<x>/<x>/OnNetwork/MCVideoGroupList/<x>/Entry/RulesForAffiliation/<x>/ListOfLocationCriteria/<x>/Entry/EnterSpecificArea/Heading/MaximumHeading

<x>/OnNetwork/MCVideoGroupList/<x>/Entry/RulesForAffiliation/<x>/ListOfLocationCriteria/<x>/Entry/EnterSpecificArea/Heading/MaximumHeading

Status	Occurrence	Format	Min. Access Types
Required	One	int	Get, Replace

This leaf node contains the maximum heading.

- Values: 0-359

13.2.43A24 /<x>/<x>/OnNetwork/MCVideoGroupList/<x>/Entry/
RulesForAffiliation/<x>/ListOfLocationCriteria/<x>/Entry/
ExitSpecificArea

Table 13.2.43A24.1: /<x>/<x>/OnNetwork/MCVideoGroupList/<x>/Entry/RulesForAffiliation/<x>/ListOfLocationCriteria/<x>/Entry/ExitSpecificArea

<x>/OnNetwork/MCVideoGroupList/<x>/Entry/RulesForAffiliation/<x>/ListOfLocationCriteria/<x>/Entry/ExitSpecificArea

Status	Occurrence	Format	Min. Access Types
Optional	ZeroOrOne	node	Get, Replace

This interior node contains a geographical area which when entered by the MC service UE triggers evaluation of the rules.

13.2.43A25 /<x>/<x>/OnNetwork/MCVideoGroupList/<x>/Entry/
RulesForAffiliation/<x>/ListOfLocationCriteria/<x>/Entry/
ExitSpecificArea/PolygonArea

Table 13.2.43A25.1: /<x>/<x>/OnNetwork/MCVideoGroupList/<x>/Entry/RulesForAffiliation/<x>/ListOfLocationCriteria/<x>/Entry/ExitSpecificArea/PolygonArea

<x>/OnNetwork/MCVideoGroupList/<x>/Entry/RulesForAffiliation/<x>/ListOfLocationCriteria/<x>/Entry/ExitSpecificArea/PolygonArea

Status	Occurrence	Format	Min. Access Types
Optional	ZeroOrOne	node	Get, Replace

This interior node contains a geographical area described by a polygon.

13.2.43A26 /<x>/<x>/OnNetwork/MCVideoGroupList/<x>/Entry/RulesForAffiliation/<x>/ListOfLocationCriteria/<x>/Entry/ExitSpecificArea/PolygonArea/<x>

Table 13.2.43A26.1: /<x>/<x>/OnNetwork/MCVideoGroupList/<x>/Entry/RulesForAffiliation/<x>/ListOfLocationCriteria/<x>/Entry/ExitSpecificArea/PolygonArea/<x>

<x>/OnNetwork/MCVideoGroupList/<x>/Entry/RulesForAffiliation/<x>/ListOfLocationCriteria/<x>/Entry/ExitSpecificArea/PolygonArea/<x>

Status	Occurrence	Format	Min. Access Types
Required	OneOrN	node	Get, Replace

This interior node contains the coordinates of the corners which define a polygon. The occurrence of this leaf node is "3 to 15" as per 3GPP TS 23.032 [21].

13.2.43A27 /<x>/<x>/OnNetwork/MCVideoGroupList/<x>/Entry/RulesForAffiliation/<x>/ListOfLocationCriteria/<x>/Entry/ExitSpecificArea/PolygonArea/<x>/PointCoordinateType

Table 13.2.43A27.1: /<x>/<x>/OnNetwork/MCVideoGroupList/<x>/Entry/RulesForAffiliation/<x>/ListOfLocationCriteria/<x>/Entry/ExitSpecificArea/PolygonArea/<x>/PointCoordinateType

<x>/OnNetwork/MCVideoGroupList/<x>/Entry/RulesForAffiliation/<x>/ListOfLocationCriteria/<x>/Entry/ExitSpecificArea/PolygonArea/<x>/PointCoordinateType

Status	Occurrence	Format	Min. Access Types
Required	One	node	Get, Replace

This interior node contains the type of the coordinates.

13.2.43A28 /<x>/<x>/OnNetwork/MCVideoGroupList/<x>/Entry/RulesForAffiliation/<x>/ListOfLocationCriteria/<x>/Entry/ExitSpecificArea/PolygonArea/<x>/PointCoordinateType/Longitude

Table 13.2.43A28.1: /<x>/<x>/OnNetwork/MCVideoGroupList/<x>/Entry/RulesForAffiliation/<x>/ListOfLocationCriteria/<x>/Entry/ExitSpecificArea/PolygonArea/<x>/PointCoordinateType/Longitude

<x>/OnNetwork/MCVideoGroupList/<x>/Entry/RulesForAffiliation/<x>/ListOfLocationCriteria/<x>/Entry/ExitSpecificArea/PolygonArea/<x>/PointCoordinateType/Longitude

Status	Occurrence	Format	Min. Access Types
Required	One	int	Get, Replace

This leaf node contains the longitudinal coordinate of a corner.

13.2.43A29 /<x>/<x>/OnNetwork/MCVideoGroupList/<x>/Entry/ RulesForAffiliation/<x>/ListOfLocationCriteria/<x>/Entry/ ExitSpecificArea/PolygonArea/<x>/PointCoordinateType/ Latitude

**Table 13.2.43A29.1: /<x>/<x>/OnNetwork/MCVideoGroupList/<x>/Entry/RulesForAffiliation/<x>/
ListOfLocationCriteria/<x>/Entry/ExitSpecificArea/PolygonArea/<x>/PointCoordinateType/Latitude**

<x>/OnNetwork/MCVideoGroupList/<x>/Entry/RulesForAffiliation/<x>/ListOfLocationCriteria/<x>/Entry/ExitSpe
cificArea/PolygonArea/<x>/PointCoordinateType/Latitude

Status	Occurrence	Format	Min. Access Types
Required	One	int	Get, Replace

This leaf node contains the latitudinal coordinate of a corner.

13.2.43A30 /<x>/<x>/OnNetwork/MCVideoGroupList/<x>/Entry/ RulesForAffiliation/<x>/ListOfLocationCriteria/<x>/Entry/ ExitSpecificArea/EllipsoidArcArea

**Table 13.2.43A30.1: /<x>/<x>/OnNetwork/MCVideoGroupList/<x>/Entry/RulesForAffiliation/<x>/
ListOfLocationCriteria/<x>/Entry/ExitSpecificArea/EllipsoidArcArea**

<x>/OnNetwork/MCVideoGroupList/<x>/Entry/RulesForAffiliation/<x>/ListOfLocationCriteria/<x>/Entry/ExitSpe
cificArea/EllipsoidArcArea

Status	Occurrence	Format	Min. Access Types
Optional	ZeroOrOne	node	Get, Replace

This interior node contains a geographical area described by an ellipsoid arc.

13.2.43A31 /<x>/<x>/OnNetwork/MCVideoGroupList/<x>/Entry/ RulesForAffiliation/<x>/ListOfLocationCriteria/<x>/Entry/ ExitSpecificArea/EllipsoidArcArea/Center

**Table 13.2.43A31.1: /<x>/<x>/OnNetwork/MCVideoGroupList/<x>/Entry/RulesForAffiliation/<x>/
ListOfLocationCriteria/<x>/Entry/ExitSpecificArea/EllipsoidArcArea/Center**

<x>/OnNetwork/MCVideoGroupList/<x>/Entry/RulesForAffiliation/<x>/ListOfLocationCriteria/<x>/Entry/ExitSpe
cificArea/EllipsoidArcArea/Center

Status	Occurrence	Format	Min. Access Types
Required	One	node	Get, Replace

This interior node contains the coordinates of the center point of the ellipsoid arc.

13.2.43A32 /<x>/<x>/OnNetwork/MCVideoGroupList/<x>/Entry/ RulesForAffiliation/<x>/ListOfLocationCriteria/<x>/Entry/ ExitSpecificArea/EllipsoidArcArea/Center/PointCoordinateType

**Table 13.2.43A32.1: /<x>/<x>/OnNetwork/MCVideoGroupList/<x>/Entry/RulesForAffiliation/<x>/
ListOfLocationCriteria/<x>/Entry/ExitSpecificArea/EllipsoidArcArea/Center/PointCoordinateType**

<x>/OnNetwork/MCVideoGroupList/<x>/Entry/RulesForAffiliation/<x>/ListOfLocationCriteria/<x>/Entry/ExitSpe
cificArea/EllipsoidArcArea/Center/PointCoordinateType

Status	Occurrence	Format	Min. Access Types
Required	One	node	Get, Replace

This interior node contains the coordinates of the center point of the ellipsoid arc.

13.2.43A33 /<x>/<x>/OnNetwork/MCVideoGroupList/<x>/Entry/RulesForAffiliation/<x>/ListOfLocationCriteria/<x>/Entry/ExitSpecificArea/EllipsoidArcArea/Center/PointCoordinateType/Longitude

Table 13.2.43A33.1: /<x>/<x>/OnNetwork/MCVideoGroupList/<x>/Entry/RulesForAffiliation/<x>/ListOfLocationCriteria/<x>/Entry/ExitSpecificArea/EllipsoidArcArea/Center/PointCoordinateType/Longitude

<x>/OnNetwork/MCVideoGroupList/<x>/Entry/RulesForAffiliation/<x>/ListOfLocationCriteria/<x>/Entry/ExitSpecificArea/EllipsoidArcArea/Center/PointCoordinateType/Longitude

Status	Occurrence	Format	Min. Access Types
Required	One	int	Get, Replace

This leaf node contains the longitudinal coordinate of the center.

13.2.43A34 /<x>/<x>/OnNetwork/MCVideoGroupList/<x>/Entry/RulesForAffiliation/<x>/ListOfLocationCriteria/<x>/Entry/ExitSpecificArea/EllipsoidArcArea/Center/PointCoordinateType/Latitude

Table 13.2.43A34.1: /<x>/<x>/OnNetwork/MCVideoGroupList/<x>/Entry/RulesForAffiliation/<x>/ListOfLocationCriteria/<x>/Entry/ExitSpecificArea/EllipsoidArcArea/Center/PointCoordinateType/Latitude

<x>/OnNetwork/MCVideoGroupList/<x>/Entry/RulesForAffiliation/<x>/ListOfLocationCriteria/<x>/Entry/ExitSpecificArea/EllipsoidArcArea/Center/PointCoordinateType/Latitude

Status	Occurrence	Format	Min. Access Types
Required	One	int	Get, Replace

This leaf node contains the latitudinal coordinate of a center.

13.2.43A35 /<x>/<x>/OnNetwork/MCVideoGroupList/<x>/Entry/RulesForAffiliation/<x>/ListOfLocationCriteria/<x>/Entry/ExitSpecificArea/EllipsoidArcArea/Radius

Table 13.2.43A35.1: /<x>/<x>/OnNetwork/MCVideoGroupList/<x>/Entry/RulesForAffiliation/<x>/ListOfLocationCriteria/<x>/Entry/ExitSpecificArea/EllipsoidArcArea/Radius

<x>/OnNetwork/MCVideoGroupList/<x>/Entry/RulesForAffiliation/<x>/ListOfLocationCriteria/<x>/Entry/ExitSpecificArea/EllipsoidArcArea/Radius

Status	Occurrence	Format	Min. Access Types
Required	One	int	Get, Replace

This leaf node contains the radius of the ellipsoid arc.

13.2.43A36 /<x>/<x>/OnNetwork/MCVideoGroupList/<x>/Entry/RulesForAffiliation/<x>/ListOfLocationCriteria/<x>/Entry/ExitSpecificArea/EllipsoidArcArea/OffsetAngle

Table 13.2.43A36.1: /<x>/<x>/OnNetwork/MCVideoGroupList/<x>/Entry/RulesForAffiliation/<x>/ListOfLocationCriteria/<x>/Entry/ExitSpecificArea/EllipsoidArcArea/OffsetAngle

<x>/OnNetwork/MCVideoGroupList/<x>/Entry/RulesForAffiliation/<x>/ListOfLocationCriteria/<x>/Entry/ExitSpecificArea/EllipsoidArcArea/OffsetAngle

Status	Occurrence	Format	Min. Access Types
Required	One	int	Get, Replace

This leaf node contains the offset angle of the ellipsoid arc.

13.2.43A37 /<x>/<x>/OnNetwork/MCVideoGroupList/<x>/Entry/RulesForAffiliation/<x>/ListOfLocationCriteria/<x>/Entry/ExitSpecificArea/EllipsoidArcArea/IncludedAngle

Table 13.2.43A37.1: /<x>/<x>/OnNetwork/MCVideoGroupList/<x>/Entry/RulesForAffiliation/<x>/ListOfLocationCriteria/<x>/Entry/ExitSpecificArea/EllipsoidArcArea/IncludedAngle

<x>/OnNetwork/MCVideoGroupList/<x>/Entry/RulesForAffiliation/<x>/ListOfLocationCriteria/<x>/Entry/ExitSpecificArea/EllipsoidArcArea/IncludedAngle

Status	Occurrence	Format	Min. Access Types
Required	One	int	Get, Replace

This leaf node contains the included angle of the ellipsoid arc.

13.2.43A38 /<x>/<x>/OnNetwork/MCVideoGroupList/<x>/Entry/RulesForAffiliation/<x>/ListOfLocationCriteria/<x>/Entry/ExitSpecificArea/Speed

Table 13.2.43A38.1: /<x>/<x>/OnNetwork/MCVideoGroupList/<x>/Entry/RulesForAffiliation/<x>/ListOfLocationCriteria/<x>/Entry/ExitSpecificArea/Speed

<x>/OnNetwork/MCVideoGroupList/<x>/Entry/RulesForAffiliation/<x>/ListOfLocationCriteria/<x>/Entry/ExitSpecificArea/Speed

Status	Occurrence	Format	Min. Access Types
Optional	One	node	Get, Replace

This interior node contains the speed.

13.2.43A39 /<x>/<x>/OnNetwork/MCVideoGroupList/<x>/Entry/RulesForAffiliation/<x>/ListOfLocationCriteria/<x>/Entry/ExitSpecificArea/Speed/MinimumSpeed

Table 13.2.43A39.1: /<x>/<x>/OnNetwork/MCVideoGroupList/<x>/Entry/RulesForAffiliation/<x>/ListOfLocationCriteria/<x>/Entry/ExitSpecificArea/Speed/MinimumSpeed

<x>/OnNetwork/MCVideoGroupList/<x>/Entry/RulesForAffiliation/<x>/ListOfLocationCriteria/<x>/Entry/ExitSpecificArea/Speed/MinimumSpeed

Status	Occurrence	Format	Min. Access Types

Required	One	int	Get, Replace
----------	-----	-----	--------------

This leaf node contains the minimum speed.

- Values: non-negative integer in units of kilometers/hour.

13.2.43A40 /<x>/<x>/OnNetwork/MCVideoGroupList/<x>/Entry/RulesForAffiliation/<x>/ListOfLocationCriteria/<x>/Entry/ExitSpecificArea/Speed/MaximumSpeed

Table 13.2.43A40.1: /<x>/<x>/OnNetwork/MCVideoGroupList/<x>/Entry/RulesForAffiliation/<x>/ListOfLocationCriteria/<x>/Entry/ExitSpecificArea/Speed/MaximumSpeed

<x>/OnNetwork/MCVideoGroupList/<x>/Entry/RulesForAffiliation/<x>/ListOfLocationCriteria/<x>/Entry/ExitSpecificArea/Speed/MaximumSpeed

Status	Occurrence	Format	Min. Access Types
Required	One	int	Get, Replace

This leaf node contains the maximum speed.

- Values: non-negative integer in units of kilometers/hour.

13.2.43A41 /<x>/<x>/OnNetwork/MCVideoGroupList/<x>/Entry/RulesForAffiliation/<x>/ListOfLocationCriteria/<x>/Entry/ExitSpecificArea/Heading

Table 13.2.43A41.1: /<x>/<x>/OnNetwork/MCVideoGroupList/<x>/Entry/RulesForAffiliation/<x>/ListOfLocationCriteria/<x>/Entry/ExitSpecificArea/Heading

<x>/OnNetwork/MCVideoGroupList/<x>/Entry/RulesForAffiliation/<x>/ListOfLocationCriteria/<x>/Entry/ExitSpecificArea/Heading

Status	Occurrence	Format	Min. Access Types
Optional	One	node	Get, Replace

This interior node contains the heading.

13.2.43A42 /<x>/<x>/OnNetwork/MCVideoGroupList/<x>/Entry/RulesForAffiliation/<x>/ListOfLocationCriteria/<x>/Entry/ExitSpecificArea/Heading/MinimumHeading

Table 13.2.43A42.1: /<x>/<x>/OnNetwork/MCVideoGroupList/<x>/Entry/RulesForAffiliation/<x>/ListOfLocationCriteria/<x>/Entry/ExitSpecificArea/Heading/MinimumHeading

<x>/OnNetwork/MCVideoGroupList/<x>/Entry/RulesForAffiliation/<x>/ListOfLocationCriteria/<x>/Entry/ExitSpecificArea/Heading/MinimumHeading

Status	Occurrence	Format	Min. Access Types
Required	One	int	Get, Replace

This leaf node contains the minimum heading.

- Values: 0-359

13.2.43A43 /<x>/<x>/OnNetwork/MCVideoGroupList/<x>/Entry/
RulesForAffiliation/<x>/ListOfLocationCriteria/<x>/Entry/
ExitSpecificArea/Heading/MaximumHeading

**Table 13.2.43A43.1: /<x>/<x>/OnNetwork/MCVideoGroupList/<x>/Entry/RulesForAffiliation/<x>/
ListOfLocationCriteria/<x>/Entry/ExitSpecificArea/Heading/MaximumHeading**

<x>/OnNetwork/MCVideoGroupList/<x>/Entry/RulesForAffiliation/<x>/ListOfLocationCriteria/<x>/Entry/ExitSpe
cificArea/Heading/MaximumHeading

Status	Occurrence	Format	Min. Access Types
Required	One	int	Get, Replace

This leaf node contains the maximum heading.

- Values: 0-359

13.2.43A44 /<x>/<x>/OnNetwork/MCVideoGroupList/<x>/Entry/
RulesForAffiliation/<x>/ListOfActiveFunctionalAliases

**Table 13.2.43A44.1: /<x>/<x>/OnNetwork/MCVideoGroupList/<x>/Entry/RulesForAffiliation/<x>/
ListOfActiveFunctionalAliases**

<x>/OnNetwork/MCVideoGroupList/<x>/Entry/RulesForAffiliation/<x>/ListOfActiveFunctionalAliases

Status	Occurrence	Format	Min. Access Types
Optional	One	node	Get, Replace

This interior node is a placeholder for the functional alias part of rules that control automatic affiliation.

13.2.43A45 /<x>/<x>/OnNetwork/MCVideoGroupList/<x>/Entry/
RulesForAffiliation/<x>/ListOfActiveFunctionalAliases/<x>

**Table 13.2.43A45.1: /<x>/<x>/OnNetwork/MCVideoGroupList/<x>/Entry/RulesForAffiliation/<x>/
ListOfActiveFunctionalAliases/<x>**

<x>/OnNetwork/MCVideoGroupList/<x>/Entry/RulesForAffiliation/<x>/ListOfActiveFunctionalAliases/<x>

Status	Occurrence	Format	Min. Access Types
Optional	OneOrMore	node	Get, Replace

This interior node is a placeholder for the functional alias part of rules that control automatic affiliation.

13.2.43A46 /<x>/<x>/OnNetwork/MCVideoGroupList/<x>/Entry/
RulesForAffiliation/<x>/ListOfActiveFunctionalAliases/<x>/Entry

**Table 13.2.43A46.1: /<x>/<x>/OnNetwork/MCVideoGroupList/<x>/Entry/RulesForAffiliation/<x>/
ListOfActiveFunctionalAliases/<x>/Entry**

<x>/OnNetwork/MCVideoGroupList/<x>/Entry/RulesForAffiliation/<x>/ListOfActiveFunctionalAliases/<x>/Entry

Status	Occurrence	Format	Min. Access Types
Optional	One	node	Get, Replace

This interior node is a placeholder for the functional alias part of rules that control automatic affiliation.

13.2.43A47 /<x>/<x>/OnNetwork/MCVideoGroupList/<x>/Entry/
RulesForAffiliation/<x>/ListOfActiveFunctionalAliases/<x>/Entry/
FunctionalAlias

**Table 13.2.43A47.1: /<x>/<x>/OnNetwork/MCVideoGroupList/<x>/Entry/RulesForAffiliation/<x>/
ListOfActiveFunctionalAliases/<x>/Entry/FunctionalAlias**

<x>/OnNetwork/MCVideoGroupList/<x>/Entry/RulesForAffiliation/<x>/ListOfActiveFunctionalAliases/<x>/Entry/
FunctionalAlias

Status	Occurrence	Format	Min. Access Types
Required	One	chr	Get, Replace

This leaf node contains a functional alias.

13.2.43B/<x>/<x>/OnNetwork/MCVideoGroupList/<x>/Entry/
RulesForDeaffiliation

Table 13.2.43B.1: /<x>/<x>/OnNetwork/MCVideoGroupList/<x>/Entry/RulesForDeaffiliation

<x>/OnNetwork/MCVideoGroupList/<x>/Entry/RulesForDeaffiliation

Status	Occurrence	Format	Min. Access Types
Optional	ZeroOrOne	node	Get, Replace

This interior node is a placeholder for the rules that control automatic deaffiliation.

13.2.43B0 /<x>/<x>/OnNetwork/MCVideoGroupList/<x>/Entry/
RulesForDeaffiliation/<x>

Table 13.2.43B0.1: /<x>/<x>/OnNetwork/MCVideoGroupList/<x>/Entry/RulesForDeaffiliation/<x>

<x>/OnNetwork/MCVideoGroupList/<x>/Entry/RulesForDeaffiliation/<x>

Status	Occurrence	Format	Min. Access Types
Optional	ZeroOrMore	node	Get, Replace

This interior node is a placeholder for the rules that control automatic deaffiliation.

13.2.43B1 /<x>/<x>/OnNetwork/MCVideoGroupList/<x>/Entry/
RulesForDeaffiliation/<x>/ListOfLocationCriteria

**Table 13.2.43B1.1: /<x>/<x>/OnNetwork/MCVideoGroupList/<x>/Entry/RulesForDeaffiliation/<x>/
ListOfLocationCriteria**

<x>/OnNetwork/MCVideoGroupList/<x>/Entry/RulesForDeaffiliation/<x>/ListOfLocationCriteria

Status	Occurrence	Format	Min. Access Types
Optional	One	node	Get, Replace

This interior node is a placeholder for the location portion of the rules that control automatic deaffiliation.

13.2.43B2 /<x>/<x>/OnNetwork/MCVideoGroupList/<x>/Entry/ RulesForDeaffiliation/<x>/ListOfLocationCriteria/<x>

**Table 13.2.43B2.1: /<x>/<x>/OnNetwork/MCVideoGroupList/<x>/Entry/RulesForDeaffiliation/<x>/
ListOfLocationCriteria/<x>**

<x>/OnNetwork/MCVideoGroupList/<x>/Entry/RulesForDeaffiliation/<x>/ListOfLocationCriteria/<x>

Status	Occurrence	Format	Min. Access Types
Optional	ZeroOrMore	node	Get, Replace

This interior node is a placeholder for the location portion of the rules that control automatic deaffiliation.

13.2.43B3 /<x>/<x>/OnNetwork/MCVideoGroupList/<x>/Entry/ RulesForDeaffiliation/<x>/ListOfLocationCriteria/<x>/Entry

**Table 13.2.43B3.1: /<x>/<x>/OnNetwork/MCVideoGroupList/<x>/Entry/RulesForDeaffiliation/<x>/
ListOfLocationCriteria/<x>/Entry**

<x>/OnNetwork/MCVideoGroupList/<x>/Entry/RulesForDeaffiliation/<x>/ListOfLocationCriteria/<x>/Entry

Status	Occurrence	Format	Min. Access Types
Optional	One	node	Get, Replace

This interior node is a placeholder for the location portion of the rules that control automatic deaffiliation.

13.2.43B4 /<x>/<x>/OnNetwork/MCVideoGroupList/<x>/Entry/ RulesForDeaffiliation/<x>/ListOfLocationCriteria/<x>/Entry/ EnterSpecificArea

**Table 13.2.43B4.1: /<x>/<x>/OnNetwork/MCVideoGroupList/<x>/Entry/RulesForDeaffiliation/<x>/
ListOfLocationCriteria/<x>/Entry/EnterSpecificArea**

<x>/OnNetwork/MCVideoGroupList/<x>/Entry/RulesForDeaffiliation/<x>/ListOfLocationCriteria/<x>/Entry/Enter
SpecificArea

Status	Occurrence	Format	Min. Access Types
Optional	ZeroOrOne	node	Get, Replace

This interior node contains a geographical area which, when entered by the MC service UE triggers evaluation of the rules.

13.2.43B5 /<x>/<x>/OnNetwork/MCVideoGroupList/<x>/Entry/ RulesForDeaffiliation/<x>/ListOfLocationCriteria/<x>/Entry/ EnterSpecificArea/PolygonArea

**Table 13.2.43B5.1: /<x>/<x>/OnNetwork/MCVideoGroupList/<x>/Entry/RulesForDeaffiliation/<x>/
ListOfLocationCriteria/<x>/Entry/EnterSpecificArea/PolygonArea**

<x>/OnNetwork/MCVideoGroupList/<x>/Entry/RulesForDeaffiliation/<x>/ListOfLocationCriteria/<x>/Entry/Enter
SpecificArea/PolygonArea

Status	Occurrence	Format	Min. Access Types
Optional	ZeroOrOne	node	Get, Replace

This interior node contains a geographical area described by a polygon.

13.2.43B6 /<x>/<x>/OnNetwork/MCVideoGroupList/<x>/Entry/
RulesForDeaffiliation/<x>/ListOfLocationCriteria/<x>/Entry/
EnterSpecificArea/PolygonArea/<x>

Table 13.2.43B6.1: /<x>/<x>/OnNetwork/MCVideoGroupList/<x>/Entry/RulesForDeaffiliation/<x>/ListOfLocationCriteria/<x>/Entry/EnterSpecificArea/PolygonArea/<x>

<x>/OnNetwork/MCVideoGroupList/<x>/Entry/RulesForDeaffiliation/<x>/ListOfLocationCriteria/<x>/Entry/EnterSpecificArea/PolygonArea/<x>

Status	Occurrence	Format	Min. Access Types
Required	OneOrN	node	Get, Replace

This interior node contains the coordinates of the corners which define a polygon. The occurrence of this leaf node is "3 to 15" as per 3GPP TS 23.032 [21].

13.2.43B7 /<x>/<x>/OnNetwork/MCVideoGroupList/<x>/Entry/
RulesForDeaffiliation/<x>/ListOfLocationCriteria/<x>/Entry/
EnterSpecificArea/PolygonArea/<x>/PointCoordinateType

Table 13.2.43B7.1: /<x>/<x>/OnNetwork/MCVideoGroupList/<x>/Entry/RulesFordeaffiliation/<x>/ListOfLocationCriteria/<x>/Entry/EnterSpecificArea/PolygonArea/<x>/PointCoordinateType

<x>/OnNetwork/MCVideoGroupList/<x>/Entry/RulesForDeaffiliation/<x>/ListOfLocationCriteria/<x>/Entry/EnterSpecificArea/PolygonArea/<x>/PointCoordinateType

Status	Occurrence	Format	Min. Access Types
Required	One	node	Get, Replace

This interior node contains the type of the coordinates.

13.2.43B8 /<x>/<x>/OnNetwork/MCVideoGroupList/<x>/Entry/
RulesForDeaffiliation/<x>/ListOfLocationCriteria/<x>/Entry/
EnterSpecificArea/PolygonArea/<x>/PointCoordinateType/
Longitude

Table 13.2.43B8.1: /<x>/<x>/OnNetwork/MCVideoGroupList/<x>/Entry/RulesForDeaffiliation/<x>/ListOfLocationCriteria/<x>/Entry/EnterSpecificArea/PolygonArea/<x>/PointCoordinateType/Longitude

<x>/OnNetwork/MCVideoGroupList/<x>/Entry/RulesForDeaffiliation/<x>/ListOfLocationCriteria/<x>/Entry/EnterSpecificArea/PolygonArea/<x>/PointCoordinateType/Longitude

Status	Occurrence	Format	Min. Access Types
Required	One	int	Get, Replace

This leaf node contains the longitudinal coordinate of a corner.

13.2.43B9 /<x>/<x>/OnNetwork/MCVideoGroupList/<x>/Entry/ RulesForDeaffiliation/<x>/ListOfLocationCriteria/<x>/Entry/ EnterSpecificArea/PolygonArea/<x>/PointCoordinateType/ Latitude

**Table 13.2.43B9.1: /<x>/<x>/OnNetwork/MCVideoGroupList/<x>/Entry/RulesForDeaffiliation/<x>/
ListOfLocationCriteria/<x>/Entry/EnterSpecificArea/PolygonArea/<x>/PointCoordinateType/
Latitude**

<x>/OnNetwork/MCVideoGroupList/<x>/Entry/RulesForDeaffiliation/<x>/ListOfLocationCriteria/<x>/Entry/Enter
SpecificArea/PolygonArea/<x>/PointCoordinateType/Latitude

Status	Occurrence	Format	Min. Access Types
Required	One	int	Get, Replace

This leaf node contains the latitudinal coordinate of a corner.

13.2.43B10 /<x>/<x>/OnNetwork/MCVideoGroupList/<x>/Entry/ RulesForDeaffiliation/<x>/ListOfLocationCriteria/<x>/Entry/ EnterSpecificArea/EllipsoidArcArea

**Table 13.2.43B10.1: /<x>/<x>/OnNetwork/MCVideoGroupList/<x>/Entry/RulesForDeaffiliation/<x>/
ListOfLocationCriteria/<x>/Entry/EnterSpecificArea/EllipsoidArcArea**

<x>/OnNetwork/MCVideoGroupList/<x>/Entry/RulesForDeaffiliation/<x>/ListOfLocationCriteria/<x>/Entry/Enter
SpecificArea/EllipsoidArcArea

Status	Occurrence	Format	Min. Access Types
Optional	ZeroOrOne	node	Get, Replace

This interior node contains a geographical area described by an ellipsoid arc.

13.2.43B11 /<x>/<x>/OnNetwork/MCVideoGroupList/<x>/Entry/ RulesForDeaffiliation/<x>/ListOfLocationCriteria/<x>/Entry/ EnterSpecificArea/EllipsoidArcArea/Center

**Table 13.2.43B11.1: /<x>/<x>/OnNetwork/MCVideoGroupList/<x>/Entry/RulesForDeaffiliation/<x>/
ListOfLocationCriteria/<x>/Entry/EnterSpecificArea/EllipsoidArcArea/Center**

<x>/OnNetwork/MCVideoGroupList/<x>/Entry/RulesForDeaffiliation/<x>/ListOfLocationCriteria/<x>/Entry/Enter
SpecificArea/EllipsoidArcArea/Center

Status	Occurrence	Format	Min. Access Types
Required	One	node	Get, Replace

This interior node contains the coordinates of the center point of the ellipsoid arc.

13.2.43B12 /<x>/<x>/OnNetwork/MCVideoGroupList/<x>/Entry/
RulesForDeaffiliation/<x>/ListOfLocationCriteria/<x>/Entry/
EnterSpecificArea/EllipsoidArcArea/Center/PointCoordinateType

Table 13.2.43B12.1: /<x>/<x>/OnNetwork/MCVideoGroupList/<x>/Entry/RulesForDeaffiliation/<x>/ListOfLocationCriteria/<x>/Entry/EnterSpecificArea/EllipsoidArcArea/Center/PointCoordinateType

<x>/OnNetwork/MCVideoGroupList/<x>/Entry/RulesForDeaffiliation/<x>/ListOfLocationCriteria/<x>/Entry/EnterSpecificArea/EllipsoidArcArea/Center/PointCoordinateType

Status	Occurrence	Format	Min. Access Types
Required	One	node	Get, Replace

This interior node contains the coordinates of the center point of the ellipsoid arc.

13.2.43B13 /<x>/<x>/OnNetwork/MCVideoGroupList/<x>/Entry/
RulesForDeaffiliation/<x>/ListOfLocationCriteria/<x>/Entry/
EnterSpecificArea/EllipsoidArcArea/Center/PointCoordinateType/
Longitude

Table 13.2.43B13.1: /<x>/<x>/OnNetwork/MCVideoGroupList/<x>/Entry/RulesForDeaffiliation/<x>/ListOfLocationCriteria/<x>/Entry/EnterSpecificArea/EllipsoidArcArea/Center/PointCoordinateType/Longitude

<x>/OnNetwork/MCVideoGroupList/<x>/Entry/RulesForDeaffiliation/<x>/ListOfLocationCriteria/<x>/Entry/EnterSpecificArea/EllipsoidArcArea/Center/PointCoordinateType/Longitude

Status	Occurrence	Format	Min. Access Types
Required	One	int	Get, Replace

This leaf node contains the longitudinal coordinate of the center.

13.2.43B14 /<x>/<x>/OnNetwork/MCVideoGroupList/<x>/Entry/
RulesForDeaffiliation/<x>/ListOfLocationCriteria/<x>/Entry/
EnterSpecificArea/EllipsoidArcArea/Center/PointCoordinateType/
Latitude

Table 13.2.43B14.1: /<x>/<x>/OnNetwork/MCVideoGroupList/<x>/Entry/RulesForDeaffiliation/<x>/ListOfLocationCriteria/<x>/Entry/EnterSpecificArea/EllipsoidArcArea/Center/PointCoordinateType/Latitude

<x>/OnNetwork/MCVideoGroupList/<x>/Entry/RulesForDeaffiliation/<x>/ListOfLocationCriteria/<x>/Entry/EnterSpecificArea/EllipsoidArcArea/Center/PointCoordinateType/Latitude

Status	Occurrence	Format	Min. Access Types
Required	One	int	Get, Replace

This leaf node contains the latitudinal coordinate of a center.

13.2.43B15 /<x>/<x>/OnNetwork/MCVideoGroupList/<x>/Entry/
RulesForDeaffiliation/<x>/ListOfLocationCriteria/<x>/Entry/
EnterSpecificArea/EllipsoidArcArea/Radius

**Table 13.2.43B15.1: /<x>/<x>/OnNetwork/MCVideoGroupList/<x>/Entry/RulesForDeaffiliation/<x>/
ListOfLocationCriteria/<x>/Entry/EnterSpecificArea/EllipsoidArcArea/Radius**

<x>/OnNetwork/MCVideoGroupList/<x>/Entry/RulesForDeaffiliation/<x>/ListOfLocationCriteria/<x>/Entry/Enter
SpecificArea/EllipsoidArcArea/Radius

Status	Occurrence	Format	Min. Access Types
Required	One	int	Get, Replace

This leaf node contains the radius of the ellipsoid arc.

13.2.43B16 /<x>/<x>/OnNetwork/MCVideoGroupList/<x>/Entry/
RulesForDeaffiliation/<x>/ListOfLocationCriteria/<x>/Entry/
EnterSpecificArea/EllipsoidArcArea/OffsetAngle

**Table 13.2.43B16.1: /<x>/<x>/OnNetwork/MCVideoGroupList/<x>/Entry/RulesForDeaffiliation/<x>/
ListOfLocationCriteria/<x>/Entry/EnterSpecificArea/EllipsoidArcArea/OffsetAngle**

<x>/OnNetwork/MCVideoGroupList/<x>/Entry/RulesForDeaffiliation/<x>/ListOfLocationCriteria/<x>/Entry/Enter
SpecificArea/EllipsoidArcArea/OffsetAngle

Status	Occurrence	Format	Min. Access Types
Required	One	int	Get, Replace

This leaf node contains the offset angle of the ellipsoid arc.

13.2.43B17 /<x>/<x>/OnNetwork/MCVideoGroupList/<x>/Entry/
RulesForDeaffiliation/<x>/ListOfLocationCriteria/<x>/Entry/
EnterSpecificArea/EllipsoidArcArea/IncludedAngle

**Table 13.2.43B17.1: /<x>/<x>/OnNetwork/MCVideoGroupList/<x>/Entry/RulesForDeaffiliation/<x>/
ListOfLocationCriteria/<x>/Entry/EnterSpecificArea/EllipsoidArcArea/IncludedAngle**

<x>/OnNetwork/MCVideoGroupList/<x>/Entry/RulesForDeaffiliation/<x>/ListOfLocationCriteria/<x>/Entry/Enter
SpecificArea/EllipsoidArcArea/IncludedAngle

Status	Occurrence	Format	Min. Access Types
Required	One	int	Get, Replace

This leaf node contains the included angle of the ellipsoid arc.

13.2.43B18 /<x>/<x>/OnNetwork/MCVideoGroupList/<x>/Entry/
RulesForDeaffiliation/<x>/ListOfLocationCriteria/<x>/Entry/
EnterSpecificArea/Speed

**Table 13.2.43B18.1: /<x>/<x>/OnNetwork/MCVideoGroupList/<x>/Entry/RulesForDeaffiliation/<x>/
ListOfLocationCriteria/<x>/Entry/EnterSpecificArea/Speed**

<x>/OnNetwork/MCVideoGroupList/<x>/Entry/RulesForDeaffiliation/<x>/ListOfLocationCriteria/<x>/Entry/Enter
SpecificArea/Speed

Status	Occurrence	Format	Min. Access Types

Optional	One	node	Get, Replace
----------	-----	------	--------------

This interior node contains the speed.

13.2.43B19 /<x>/<x>/OnNetwork/MCVideoGroupList/<x>/Entry/RulesForDeaffiliation/<x>/ListOfLocationCriteria/<x>/Entry/EnterSpecificArea/Speed/MinimumSpeed

Table 13.2.43B19.1: /<x>/<x>/OnNetwork/MCVideoGroupList/<x>/Entry/RulesForDeaffiliation/<x>/ListOfLocationCriteria/<x>/Entry/EnterSpecificArea/Speed/MinimumSpeed

<x>/OnNetwork/MCVideoGroupList/<x>/Entry/RulesForDeaffiliation/<x>/ListOfLocationCriteria/<x>/Entry/EnterSpecificArea/Speed/MinimumSpeed

Status	Occurrence	Format	Min. Access Types
Required	One	int	Get, Replace

This leaf node contains the minimum speed.

- Values: non-negative integer in units of kilometers/hour.

13.2.43B20 /<x>/<x>/OnNetwork/MCVideoGroupList/<x>/Entry/RulesForDeaffiliation/<x>/ListOfLocationCriteria/<x>/Entry/EnterSpecificArea/Speed/MaximumSpeed

Table 13.2.43B20.1: /<x>/<x>/OnNetwork/MCVideoGroupList/<x>/Entry/RulesForDeaffiliation/<x>/ListOfLocationCriteria/<x>/Entry/EnterSpecificArea/Speed/MaximumSpeed

<x>/OnNetwork/MCVideoGroupList/<x>/Entry/RulesForDeaffiliation/<x>/ListOfLocationCriteria/<x>/Entry/EnterSpecificArea/Speed/MaximumSpeed

Status	Occurrence	Format	Min. Access Types
Required	One	int	Get, Replace

This leaf node contains the maximum speed.

- Values: non-negative integer in units of kilometers/hour.

13.2.43B21 /<x>/<x>/OnNetwork/MCVideoGroupList/<x>/Entry/RulesForDeaffiliation/<x>/ListOfLocationCriteria/<x>/Entry/EnterSpecificArea/Heading

Table 13.2.43B21.1: /<x>/<x>/OnNetwork/MCVideoGroupList/<x>/Entry/RulesForDeaffiliation/<x>/ListOfLocationCriteria/<x>/Entry/EnterSpecificArea/Heading

<x>/OnNetwork/MCVideoGroupList/<x>/Entry/RulesForDeaffiliation/<x>/ListOfLocationCriteria/<x>/Entry/EnterSpecificArea/Heading

Status	Occurrence	Format	Min. Access Types
Optional	One	node	Get, Replace

This interior node contains the heading.

13.2.43B22 /<x>/<x>/OnNetwork/MCVideoGroupList/<x>/Entry/ RulesForDeaffiliation/<x>/ListOfLocationCriteria/<x>/Entry/ EnterSpecificArea/Heading/MinimumHeading

**Table 13.2.43B22.1: /<x>/<x>/OnNetwork/MCVideoGroupList/<x>/Entry/RulesForDeaffiliation/<x>/
ListOfLocationCriteria/<x>/Entry/EnterSpecificArea/Heading/MinimumHeading**

<x>/OnNetwork/MCVideoGroupList/<x>/Entry/RulesForDeaffiliation/<x>/ListOfLocationCriteria/<x>/Entry/Enter
SpecificArea/Heading/MinimumHeading

Status	Occurrence	Format	Min. Access Types
Required	One	int	Get, Replace

This leaf node contains the minimum heading.

- Values: 0-359

13.2.43B23 /<x>/<x>/OnNetwork/MCVideoGroupList/<x>/Entry/ RulesForDeaffiliation/<x>/ListOfLocationCriteria/<x>/Entry/ EnterSpecificArea/Heading/MaximumHeading

**Table 13.2.43B23.1: /<x>/<x>/OnNetwork/MCVideoGroupList/<x>/Entry/RulesForDeaffiliation/<x>/
ListOfLocationCriteria/<x>/Entry/EnterSpecificArea/Heading/MaximumHeading**

<x>/OnNetwork/MCVideoGroupList/<x>/Entry/RulesForDeaffiliation/<x>/ListOfLocationCriteria/<x>/Entry/Enter
SpecificArea/Heading/MaximumHeading

Status	Occurrence	Format	Min. Access Types
Required	One	int	Get, Replace

This leaf node contains the maximum heading.

- Values: 0-359

13.2.43B24 /<x>/<x>/OnNetwork/MCVideoGroupList/<x>/Entry/ RulesForDeaffiliation/<x>/ListOfLocationCriteria/<x>/Entry/ ExitSpecificArea

**Table 13.2.43B24.1: /<x>/<x>/OnNetwork/MCVideoGroupList/<x>/Entry/RulesForDeaffiliation/<x>/
ListOfLocationCriteria/<x>/Entry/ExitSpecificArea**

<x>/OnNetwork/MCVideoGroupList/<x>/Entry/RulesForDeaffiliation/<x>/ListOfLocationCriteria/<x>/Entry/ExitS
pecificArea

Status	Occurrence	Format	Min. Access Types
Optional	ZeroOrOne	node	Get, Replace

This interior node contains a geographical area which when entered by the MC service UE triggers
evaluation of the rules.

13.2.43B25 /<x>/<x>/OnNetwork/MCVideoGroupList/<x>/Entry/
RulesForDeaffiliation/<x>/ListOfLocationCriteria/<x>/Entry/
ExitSpecificArea/PolygonArea

**Table 13.2.43B25.1: /<x>/<x>/OnNetwork/MCVideoGroupList/<x>/Entry/RulesForDeaffiliation/<x>/
ListOfLocationCriteria/<x>/Entry/ExitSpecificArea/PolygonArea**

<x>/OnNetwork/MCVideoGroupList/<x>/Entry/RulesForDeaffiliation/<x>/ListOfLocationCriteria/<x>/Entry/ExitS
pecificArea/PolygonArea

Status	Occurrence	Format	Min. Access Types
Optional	ZeroOrOne	node	Get, Replace

This interior node contains a geographical area described by a polygon.

13.2.43B26 /<x>/<x>/OnNetwork/MCVideoGroupList/<x>/Entry/
RulesForDeaffiliation/<x>/ListOfLocationCriteria/<x>/Entry/
ExitSpecificArea/PolygonArea/<x>

**Table 13.2.43B26.1: /<x>/<x>/OnNetwork/MCVideoGroupList/<x>/Entry/RulesForDeaffiliation/<x>/
ListOfLocationCriteria/<x>/Entry/ExitSpecificArea/PolygonArea/<x>**

<x>/OnNetwork/MCVideoGroupList/<x>/Entry/RulesForDeaffiliation/<x>/ListOfLocationCriteria/<x>/Entry/ExitS
pecificArea/PolygonArea/<x>

Status	Occurrence	Format	Min. Access Types
Required	OneOrN	node	Get, Replace

This interior node contains the coordinates of the corners which define a polygon. The occurrence of this leaf node is "3 to 15" as per 3GPP TS 23.032 [21].

13.2.43B27 /<x>/<x>/OnNetwork/MCVideoGroupList/<x>/Entry/
RulesForDeaffiliation/<x>/ListOfLocationCriteria/<x>/Entry/
ExitSpecificArea/PolygonArea/<x>/PointCoordinateType

**Table 13.2.43B27.1: /<x>/<x>/OnNetwork/MCVideoGroupList/<x>/Entry/RulesForDeaffiliation/<x>/
ListOfLocationCriteria/<x>/Entry/ExitSpecificArea/PolygonArea/<x>/PointCoordinateType**

<x>/OnNetwork/MCVideoGroupList/<x>/Entry/RulesForDeaffiliation/<x>/ListOfLocationCriteria/<x>/Entry/ExitS
pecificArea/PolygonArea/<x>/PointCoordinateType

Status	Occurrence	Format	Min. Access Types
Required	One	node	Get, Replace

This interior node contains the type of the coordinates.

13.2.43B28 /<x>/<x>/OnNetwork/MCVideoGroupList/<x>/Entry/
RulesForDeaffiliation/<x>/ListOfLocationCriteria/<x>/Entry/
ExitSpecificArea/PolygonArea/<x>/PointCoordinateType/
Longitude

**Table 13.2.43B28.1: /<x>/<x>/OnNetwork/MCVideoGroupList/<x>/Entry/RulesForDeaffiliation/<x>/
ListOfLocationCriteria/<x>/Entry/ExitSpecificArea/PolygonArea/<x>/PointCoordinateType/
Longitude**

<x>/OnNetwork/MCVideoGroupList/<x>/Entry/RulesForDeaffiliation/<x>/ListOfLocationCriteria/<x>/Entry/ExitS
pecificArea/PolygonArea/<x>/PointCoordinateType/Longitude

Status	Occurrence	Format	Min. Access Types
Required	One	int	Get, Replace

This leaf node contains the longitudinal coordinate of a corner.

13.2.43B29 /<x>/<x>/OnNetwork/MCVideoGroupList/<x>/Entry/
RulesForDeaffiliation/<x>/ListOfLocationCriteria/<x>/Entry/
ExitSpecificArea/PolygonArea/<x>/PointCoordinateType/
Latitude

**Table 13.2.43B29.1: /<x>/<x>/OnNetwork/MCVideoGroupList/<x>/Entry/RulesForDeaffiliation/<x>/
ListOfLocationCriteria/<x>/Entry/ExitSpecificArea/PolygonArea/<x>/PointCoordinateType/Latitude**

<x>/OnNetwork/MCVideoGroupList/<x>/Entry/RulesForDeaffiliation/<x>/ListOfLocationCriteria/<x>/Entry/ExitS
pecificArea/PolygonArea/<x>/PointCoordinateType/Latitude

Status	Occurrence	Format	Min. Access Types
Required	One	int	Get, Replace

This leaf node contains the latitudinal coordinate of a corner.

13.2.43B30 /<x>/<x>/OnNetwork/MCVideoGroupList/<x>/Entry/
RulesForDeaffiliation/<x>/ListOfLocationCriteria/<x>/Entry/
ExitSpecificArea/EllipsoidArcArea

**Table 13.2.43B30.1: /<x>/<x>/OnNetwork/MCVideoGroupList/<x>/Entry/RulesForDeaffiliation/<x>/
ListOfLocationCriteria/<x>/Entry/ExitSpecificArea/EllipsoidArcArea**

<x>/OnNetwork/MCVideoGroupList/<x>/Entry/RulesForDeaffiliation/<x>/ListOfLocationCriteria/<x>/Entry/ExitS
pecificArea/EllipsoidArcArea

Status	Occurrence	Format	Min. Access Types
Optional	ZeroOrOne	node	Get, Replace

This interior node contains a geographical area described by an ellipsoid arc.

13.2.43B31 /<x>/<x>/OnNetwork/MCVideoGroupList/<x>/Entry/
RulesForDeaffiliation/<x>/ListOfLocationCriteria/<x>/Entry/
ExitSpecificArea/EllipsoidArcArea/Center

Table 13.2.43B31.1: /<x>/<x>/OnNetwork/MCVideoGroupList/<x>/Entry/RulesForDeaffiliation/<x>/ListOfLocationCriteria/<x>/Entry/ExitSpecificArea/EllipsoidArcArea/Center

<x>/OnNetwork/MCVideoGroupList/<x>/Entry/RulesForDeaffiliation/<x>/ListOfLocationCriteria/<x>/Entry/ExitSpecificArea/EllipsoidArcArea/Center

Status	Occurrence	Format	Min. Access Types
Required	One	node	Get, Replace

This interior node contains the coordinates of the center point of the ellipsoid arc.

13.2.43B32 /<x>/<x>/OnNetwork/MCVideoGroupList/<x>/Entry/
RulesForDeaffiliation/<x>/ListOfLocationCriteria/<x>/Entry/
ExitSpecificArea/EllipsoidArcArea/Center/PointCoordinateType

Table 13.2.43B32.1: /<x>/<x>/OnNetwork/MCVideoGroupList/<x>/Entry/RulesForDeaffiliation/<x>/ListOfLocationCriteria/<x>/Entry/ExitSpecificArea/EllipsoidArcArea/Center/PointCoordinateType

<x>/OnNetwork/MCVideoGroupList/<x>/Entry/RulesForDeaffiliation/<x>/ListOfLocationCriteria/<x>/Entry/ExitSpecificArea/EllipsoidArcArea/Center/PointCoordinateType

Status	Occurrence	Format	Min. Access Types
Required	One	node	Get, Replace

This interior node contains the coordinates of the center point of the ellipsoid arc.

13.2.43B33 /<x>/<x>/OnNetwork/MCVideoGroupList/<x>/Entry/
RulesForDeaffiliation/<x>/ListOfLocationCriteria/<x>/Entry/
ExitSpecificArea/EllipsoidArcArea/Center/PointCoordinateType/
Longitude

Table 13.2.43B33.1: /<x>/<x>/OnNetwork/MCVideoGroupList/<x>/Entry/RulesForDeaffiliation/<x>/ListOfLocationCriteria/<x>/Entry/ExitSpecificArea/EllipsoidArcArea/Center/PointCoordinateType/Longitude

<x>/OnNetwork/MCVideoGroupList/<x>/Entry/RulesForDeaffiliation/<x>/ListOfLocationCriteria/<x>/Entry/ExitSpecificArea/EllipsoidArcArea/Center/PointCoordinateType/Longitude

Status	Occurrence	Format	Min. Access Types
Required	One	int	Get, Replace

This leaf node contains the longitudinal coordinate of the center.

13.2.43B34 /<x>/<x>/OnNetwork/MCVideoGroupList/<x>/Entry/ RulesForDeaffiliation/<x>/ListOfLocationCriteria/<x>/Entry/ ExitSpecificArea/EllipsoidArcArea/Center/PointCoordinateType/ Latitude

**Table 13.2.43B34.1: /<x>/<x>/OnNetwork/MCVideoGroupList/<x>/Entry/RulesForDeaffiliation/<x>/
ListOfLocationCriteria/<x>/Entry/ExitSpecificArea/EllipsoidArcArea/Center/PointCoordinateType/
Latitude**

<x>/OnNetwork/MCVideoGroupList/<x>/Entry/RulesForDeaffiliation/<x>/ListOfLocationCriteria/<x>/Entry/ExitS
pecificArea/EllipsoidArcArea/Center/PointCoordinateType/Latitude

Status	Occurrence	Format	Min. Access Types
Required	One	int	Get, Replace

This leaf node contains the latitudinal coordinate of a center.

13.2.43B35 /<x>/<x>/OnNetwork/MCVideoGroupList/<x>/Entry/ RulesForDeaffiliation/<x>/ListOfLocationCriteria/<x>/Entry/ ExitSpecificArea/EllipsoidArcArea/Radius

**Table 13.2.43B35.1: /<x>/<x>/OnNetwork/MCVideoGroupList/<x>/Entry/RulesForDeaffiliation/<x>/
ListOfLocationCriteria/<x>/Entry/ExitSpecificArea/EllipsoidArcArea/Radius**

<x>/OnNetwork/MCVideoGroupList/<x>/Entry/RulesForDeaffiliation/<x>/ListOfLocationCriteria/<x>/Entry/ExitS
pecificArea/EllipsoidArcArea/Radius

Status	Occurrence	Format	Min. Access Types
Required	One	int	Get, Replace

This leaf node contains the radius of the ellipsoid arc.

13.2.43B36 /<x>/<x>/OnNetwork/MCVideoGroupList/<x>/Entry/ RulesForDeaffiliation/<x>/ListOfLocationCriteria/<x>/Entry/ ExitSpecificArea/EllipsoidArcArea/OffsetAngle

**Table 13.2.43B36.1: /<x>/<x>/OnNetwork/MCVideoGroupList/<x>/Entry/RulesForDeaffiliation/<x>/
ListOfLocationCriteria/<x>/Entry/ExitSpecificArea/EllipsoidArcArea/OffsetAngle**

<x>/OnNetwork/MCVideoGroupList/<x>/Entry/RulesForDeaffiliation/<x>/ListOfLocationCriteria/<x>/Entry/ExitS
pecificArea/EllipsoidArcArea/OffsetAngle

Status	Occurrence	Format	Min. Access Types
Required	One	int	Get, Replace

This leaf node contains the offset angle of the ellipsoid arc.

13.2.43B37 /<x>/<x>/OnNetwork/MCVideoGroupList/<x>/Entry/ RulesForDeaffiliation/<x>/ListOfLocationCriteria/<x>/Entry/ ExitSpecificArea/EllipsoidArcArea/IncludedAngle

**Table 13.2.43B37.1: /<x>/<x>/OnNetwork/MCVideoGroupList/<x>/Entry/RulesForDeaffiliation/<x>/
ListOfLocationCriteria/<x>/Entry/ExitSpecificArea/EllipsoidArcArea/IncludedAngle**

<x>/OnNetwork/MCVideoGroupList/<x>/Entry/RulesForDeaffiliation/<x>/ListOfLocationCriteria/<x>/Entry/ExitS
pecificArea/EllipsoidArcArea/IncludedAngle

Status	Occurrence	Format	Min. Access Types
Required	One	int	Get, Replace

This leaf node contains the included angle of the ellipsoid arc.

13.2.43B38 /<x>/<x>/OnNetwork/MCVideoGroupList/<x>/Entry/ RulesForDeaffiliation/<x>/ListOfLocationCriteria/<x>/Entry/ ExitSpecificArea/Speed

**Table 13.2.43B38.1: /<x>/<x>/OnNetwork/MCVideoGroupList/<x>/Entry/RulesForDeaffiliation/<x>/
ListOfLocationCriteria/<x>/Entry/ExitSpecificArea/Speed**

<x>/OnNetwork/MCVideoGroupList/<x>/Entry/RulesForDeaffiliation/<x>/ListOfLocationCriteria/<x>/Entry/ExitS
pecificArea/Speed

Status	Occurrence	Format	Min. Access Types
Optional	One	node	Get, Replace

This interior node contains the speed.

13.2.43B39 /<x>/<x>/OnNetwork/MCVideoGroupList/<x>/Entry/ RulesForDeaffiliation/<x>/ListOfLocationCriteria/<x>/Entry/ ExitSpecificArea/Speed/MinimumSpeed

**Table 13.2.43B39.1: /<x>/<x>/OnNetwork/MCVideoGroupList/<x>/Entry/RulesForDeaffiliation/<x>/
ListOfLocationCriteria/<x>/Entry/ExitSpecificArea/Speed/MinimumSpeed**

<x>/OnNetwork/MCVideoGroupList/<x>/Entry/RulesForDeaffiliation/<x>/ListOfLocationCriteria/<x>/Entry/ExitS
pecificArea/Speed/MinimumSpeed

Status	Occurrence	Format	Min. Access Types
Required	One	int	Get, Replace

This leaf node contains the minimum speed.

- Values: non-negative integer in units of kilometers/hour.

13.2.43B40 /<x>/<x>/OnNetwork/MCVideoGroupList/<x>/Entry/
RulesForDeaffiliation/<x>/ListOfLocationCriteria/<x>/Entry/
ExitSpecificArea/Speed/MaximumSpeed

**Table 13.2.43B40.1: /<x>/<x>/OnNetwork/MCVideoGroupList/<x>/Entry/RulesForDeaffiliation/<x>/
ListOfLocationCriteria/<x>/Entry/ExitSpecificArea/Speed/MaximumSpeed**

<x>/OnNetwork/MCVideoGroupList/<x>/Entry/RulesForDeaffiliation/<x>/ListOfLocationCriteria/<x>/Entry/ExitS
pecificArea/Speed/MaximumSpeed

Status	Occurrence	Format	Min. Access Types
Required	One	int	Get, Replace

This leaf node contains the maximum speed.

- Values: non-negative integer in units of kilometers/hour.

13.2.43B41 /<x>/<x>/OnNetwork/MCVideoGroupList/<x>/Entry/
RulesForDeaffiliation/<x>/ListOfLocationCriteria/<x>/Entry/
ExitSpecificArea/Heading

**Table 13.2.43B41.1: /<x>/<x>/OnNetwork/MCVideoGroupList/<x>/Entry/RulesForDeaffiliation/<x>/
ListOfLocationCriteria/<x>/Entry/ExitSpecificArea/Heading**

<x>/OnNetwork/MCVideoGroupList/<x>/Entry/RulesForDeaffiliation/<x>/ListOfLocationCriteria/<x>/Entry/ExitS
pecificArea/Heading

Status	Occurrence	Format	Min. Access Types
Optional	One	node	Get, Replace

This interior node contains the heading.

13.2.43B42 /<x>/<x>/OnNetwork/MCVideoGroupList/<x>/Entry/
RulesForDeaffiliation/<x>/ListOfLocationCriteria/<x>/Entry/
ExitSpecificArea/Heading/MinimumHeading

**Table 13.2.43B42.1: /<x>/<x>/OnNetwork/MCVideoGroupList/<x>/Entry/RulesForDeaffiliation/<x>/
ListOfLocationCriteria/<x>/Entry/ExitSpecificArea/Heading/MinimumHeading**

<x>/OnNetwork/MCVideoGroupList/<x>/Entry/RulesForDeaffiliation/<x>/ListOfLocationCriteria/<x>/Entry/ExitS
pecificArea/Heading/MinimumHeading

Status	Occurrence	Format	Min. Access Types
Required	One	int	Get, Replace

This leaf node contains the minimum heading.

- Values: 0-359

13.2.43B43 /<x>/<x>/OnNetwork/MCVideoGroupList/<x>/Entry/
RulesForDeaffiliation/<x>/ListOfLocationCriteria/<x>/Entry/
ExitSpecificArea/Heading/MaximumHeading

**Table 13.2.43B43.1: /<x>/<x>/OnNetwork/MCVideoGroupList/<x>/Entry/RulesForDeaffiliation/<x>/
ListOfLocationCriteria/<x>/Entry/ExitSpecificArea/Heading/MaximumHeading**

<x>/OnNetwork/MCVideoGroupList/<x>/Entry/RulesForDeaffiliation/<x>/ListOfLocationCriteria/<x>/Entry/ExitS
pecificArea/Heading/MaximumHeading

Status	Occurrence	Format	Min. Access Types
Required	One	int	Get, Replace

This leaf node contains the maximum heading.

- Values: 0-359

13.2.43B44 /<x>/<x>/OnNetwork/MCVideoGroupList/<x>/Entry/
RulesForDeaffiliation/<x>/ListOfActiveFunctionalAliases

**Table 13.2.43B44.1: /<x>/<x>/OnNetwork/MCVideoGroupList/<x>/Entry/RulesForDeaffiliation/<x>/
ListOfActiveFunctionalAliases**

<x>/OnNetwork/MCVideoGroupList/<x>/Entry/RulesForDeaffiliation/<x>/ListOfActiveFunctionalAliases

Status	Occurrence	Format	Min. Access Types
Optional	One	node	Get, Replace

This interior node is a placeholder for the functional alias part of rules that control automatic deaffiliation.

13.2.43B45 /<x>/<x>/OnNetwork/MCVideoGroupList/<x>/Entry/
RulesForDeaffiliation/<x>/ListOfActiveFunctionalAliases/<x>

**Table 13.2.43B45.1: /<x>/<x>/OnNetwork/MCVideoGroupList/<x>/Entry/RulesForDeaffiliation/<x>/
ListOfActiveFunctionalAliases/<x>**

<x>/OnNetwork/MCVideoGroupList/<x>/Entry/RulesForDeaffiliation/<x>/ListOfActiveFunctionalAliases/<x>

Status	Occurrence	Format	Min. Access Types
Optional	OneOrMore	node	Get, Replace

This interior node is a placeholder for the functional alias part of rules that control automatic deaffiliation.

13.2.43B46 /<x>/<x>/OnNetwork/MCVideoGroupList/<x>/Entry/
RulesForDeaffiliation/<x>/ListOfActiveFunctionalAliases/<x>/Entry

**Table 13.2.43B46.1: /<x>/<x>/OnNetwork/MCVideoGroupList/<x>/Entry/RulesForDeaffiliation/<x>/
ListOfActiveFunctionalAliases/<x>/Entry**

<x>/OnNetwork/MCVideoGroupList/<x>/Entry/RulesForDeaffiliation/<x>/ListOfActiveFunctionalAliases/<x>/Entr

Status	Occurrence	Format	Min. Access Types
Optional	One	node	Get, Replace

This interior node is a placeholder for the functional alias part of rules that control automatic deaffiliation.

13.2.43B47 /<x>/<x>/OnNetwork/MCVideoGroupList/<x>/Entry/ RulesForDeaffiliation/<x>/ListOfActiveFunctionalAliases/<x>/Entry/ FunctionalAlias

**Table 13.2.43B47.1: /<x>/<x>/OnNetwork/MCVideoGroupList/<x>/Entry/RulesForDeaffiliation/<x>/
ListOfActiveFunctionalAliases/<x>/Entry/FunctionalAlias**

<x>/OnNetwork/MCVideoGroupList/<x>/Entry/RulesForDeaffiliation/<x>/ListOfActiveFunctionalAliases/<x>/Entry/FunctionalAlias

Status	Occurrence	Format	Min. Access Types
Required	One	chr	Get, Replace

This leaf node contains a functional alias.

13.2.43C /<x>/<x>/OnNetwork/MCVideoGroupList/<x>/Entry/ ManualDeaffiliationNotAllowedIfAffiliationRulesAreMet

**Table 13.2.43C.1: /<x>/<x>/OnNetwork/MCVideoGroupList/<x>/Entry/
ManualDeaffiliationNotAllowedIfAffiliationRulesAreMet**

<x>/OnNetwork/MCVideoGroupList/<x>/Entry/ManualDeaffiliationNotAllowedIfAffiliationRulesAreMet

Status	Occurrence	Format	Min. Access Types
Optional	ZeroOrOne	bool	Get, Replace

This leaf node indicates whether the MCVideo user is authorised to deaffiliate if the affiliation criteria are met.

13.2.44 /<x>/<x>/OnNetwork/MCVideoGroupList/<x>/Entry/DisplayName

Table 13.2.44.1: /<x>/<x>/OnNetwork/MCVideoGroupList/<x>/Entry/DisplayName

<x>/OnNetwork/MCVideoGroupList/<x>/Entry/DisplayName

Status	Occurrence	Format	Min. Access Types
Optional	One	chr	Get, Replace

This leaf node contains a human readable name that corresponds to the MCVideo Group ID.

13.2.45 Void

13.2.46 Void

13.2.47 /<x>/<x>/OnNetwork/MCVideoGroupList/<x>/Entry/GMSServID

Table 13.2.47.1: /<x>/<x>/OnNetwork/MCVideoGroupList/<x>/Entry/GMSServID

<x>/OnNetwork/MCVideoGroupList/<x>/Entry/GMSServID

Status	Occurrence	Format	Min. Access Types
Optional	One	chr	Get, Replace

This leaf node indicates the identity (URI) of the group management server hosting the MCVideo Group ID.

13.2.48 Void

13.2.49 Void

13.2.50 /<x>/<x>/OnNetwork/MCVideoGroupList/<x>/Entry/
IdMSTokenEndPoint**Table 13.2.50.1: /<x>/<x>/OnNetwork/MCVideoGroupList/<x>/Entry/IdMSTokenEndPoint**

<x>/OnNetwork/MCVideoGroupList/<x>/Entry/IdMSTokenEndPoint

Status	Occurrence	Format	Min. Access Types
Optional	One	chr	Get, Replace

This leaf node indicates the identity (URI) of the identity management server hosting the MCVideo Group ID.

13.2.50A Void

13.2.50B Void

13.2.50C Void

13.2.50D /<x>/<x>/OnNetwork/MCVideoGroupList/<x>/Entry/
GroupKMSURI**Table 13.2.50D.1: /<x>/<x>/OnNetwork/MCVideoGroupList/<x>/Entry/GroupKMSURI**

<x>/OnNetwork/MCVideoGroupList/<x>/Entry/GroupKMSURI

Status	Occurrence	Format	Min. Access Types
Required	One	chr	Get, Replace

This leaf node indicates the identity (URI) of the KMS identity (URI) for a specific group contained in the MCVideoGroupList. If the value is empty, the KMS identity (URI) (kms) present in the MCS UE initial configuration MO is used.

13.2.51 /<x>/<x>/OnNetwork/MCVideoGroupList/<x>/Entry/
RelativePresentationPriority**Table 13.2.51.1: /<x>/<x>/OnNetwork/MCVideoGroupList/<x>/Entry/RelativePresentationPriority**

<x>/OnNetwork/MCVideoGroupList/<x>/Entry/RelativePresentationPriority

Status	Occurrence	Format	Min. Access Types
Optional	One	int	Get, Replace

This leaf node indicates indicating the presentation priority of the on-network group for the MCVideo user relative to other on-network groups and on-network users.

- Values: 0-255

The lowest RelativePresentationPriority value shall be considered as the MCVideo group transaction having the lowest priority for presentation among other group MCVideo and one-to-one user transactions.

13.2.52 /<x>/<x>/OnNetwork/ImplicitAffiliations

Table 13.2.52.1: /<x>/<x>/OnNetwork/ImplicitAffiliations

<x>/OnNetwork/ImplicitAffiliations

Status	Occurrence	Format	Min. Access Types
Required	One	node	Get, Replace

This interior node is a placeholder for the implicit affiliation configuration.

13.2.53 /<x>/<x>/OnNetwork/ImplicitAffiliations/<x>

Table 13.2.53.1: /<x>/<x>/OnNetwork/ImplicitAffiliations/<x>

<x>/OnNetwork/ImplicitAffiliations/<x>

Status	Occurrence	Format	Min. Access Types
Required	ZeroOrMore	node	Get, Replace

This interior node is a placeholder for zero or more implicit affiliation configuration.

13.2.54 /<x>/<x>/OnNetwork/ImplicitAffiliations/<x>/Entry

Table 13.2.54.1: /<x>/<x>/OnNetwork/ImplicitAffiliations/<x>/Entry

<x>/OnNetwork/ImplicitAffiliations/<x>/Entry

Status	Occurrence	Format	Min. Access Types
Optional	One	node	Get, Replace

This interior node is a placeholder for the details of the on-network MCVideo groups that the MCVideo user is implicitly affiliated to.

13.2.55 /<x>/<x>/OnNetwork/ImplicitAffiliations/<x>/Entry/MCVideoGroupID

Table 13.2.55.1: /<x>/<x>/OnNetwork/ImplicitAffiliations/<x>/Entry/MCVideoGroupID

<x>/OnNetwork/ImplicitAffiliations/<x>/Entry/MCVideoGroupID

Status	Occurrence	Format	Min. Access Types
Required	One	chr	Get, Replace

This leaf node indicates a MCVideo group ID to which the MCVideo user is implicitly affiliated to.

The value is a "uri" attribute specified in OMA OMA-TS-XDM_Group-V1_1 [4].

13.2.56 /<x>/<x>/OnNetwork/ImplicitAffiliations/<x>/Entry/DisplayName

Table 13.2.56.1: /<x>/<x>/OnNetwork/ImplicitAffiliations/<x>/Entry/DisplayName

<x>/OnNetwork/ImplicitAffiliations/<x>/Entry/DisplayName

Status	Occurrence	Format	Min. Access Types
Optional	One	chr	Get, Replace

This leaf node contains a human readable name that corresponds to the MCVideo Group ID.

13.2.57 /<x>/<x>/OnNetwork/PresenceStatus

Table 13.2.57.1: /<x>/<x>/OnNetwork/PresenceStatus

<x>/OnNetwork/PresenceStatus

Status	Occurrence	Format	Min. Access Types
Required	One	node	Get, Replace

This interior node is a placeholder for the presence status configuration.

13.2.58 /<x>/<x>/OnNetwork/PresenceStatus/<x>

Table 13.2.58.1: /<x>/<x>/OnNetwork/PresenceStatus/<x>

<x>/OnNetwork/PresenceStatus/<x>

Status	Occurrence	Format	Min. Access Types
Required	ZeroOrMore	node	Get, Replace

This interior node is a placeholder for zero or more presence status configuration.

13.2.59 /<x>/<x>/OnNetwork/PresenceStatus/<x>/Entry

Table 13.2.59.1: /<x>/<x>/OnNetwork/PresenceStatus/<x>/Entry

<x>/OnNetwork/PresenceStatus/<x>/Entry

Status	Occurrence	Format	Min. Access Types
Optional	One	node	Get, Replace

This interior node is a placeholder for the details of the MCVidéo IDs of MCVidéo users that the configured MCVidéo user is authorised to obtain presence status.

13.2.60 /<x>/<x>/OnNetwork/PresenceStatus/<x>/Entry/MCVidéoGroupID

Table 13.2.60.1: /<x>/<x>/OnNetwork/PresenceStatus/<x>/Entry/MCVidéoGroupID

<x>/OnNetwork/PresenceStatus/<x>/Entry/MCVidéoGroupID

Status	Occurrence	Format	Min. Access Types
Required	One	chr	Get, Replace

This leaf node indicates an MCVidéo ID of an MCVidéo user that the configured MCVidéo user is authorised to obtain presence status.

The value is a "uri" attribute specified in OMA OMA-TS-XDM_Group-V1_1 [4].

13.2.61 /<x>/<x>/OnNetwork/PresenceStatus/<x>/Entry/DisplayName

Table 13.2.61.1: /<x>/<x>/OnNetwork/PresenceStatus/<x>/Entry/DisplayName

<x>/OnNetwork/PresenceStatus/<x>/Entry/DisplayName

Status	Occurrence	Format	Min. Access Types
Optional	One	chr	Get, Replace

This leaf node contains a human readable name that corresponds to the MCVidéo ID.

13.2.62 Void

13.2.63 Void

13.2.64 Void

13.2.65 Void

13.2.66 Void

13.2.67 `/<x>/<x>/OnNetwork/MaxAffiliationsN2`

Table 13.2.67.1: `/<x>/<x>/OnNetwork/MaxAffiliationsN2`

`<x>/OnNetwork/MaxAffiliationsN2`

Status	Occurrence	Format	Min. Access Types
Optional	One	int	Get, Replace

This leaf node indicates the maximum number of MCVideo groups that the MCVideo user is authorised to affiliate with.

- Values: 0-65535

13.2.68 `/<x>/<x>/OnNetwork/AllowedRegroup`

Table 13.2.68.1: `/<x>/<x>/OnNetwork/AllowedRegroup`

`<x>/OnNetwork/AllowedRegroup`

Status	Occurrence	Format	Min. Access Types
Required	One	bool	Get, Replace

This leaf node indicates whether the MCVideo user is authorised to perform dynamic regrouping operations.

When set to "true" the MCVideo user is authorised to perform dynamic regrouping operations.

When set to "false" the MCVideo user is not authorised to perform dynamic regrouping operations.

13.2.69 `/<x>/<x>/OnNetwork/AllowedPresenceStatus`

Table 13.2.69.1: `/<x>/<x>/OnNetwork/AllowedPresenceStatus`

`<x>/OnNetwork/AllowedPresenceStatus`

Status	Occurrence	Format	Min. Access Types
Optional	One	bool	Get, Replace

This leaf node indicates the presence status on the network of this MCVideo user is available.

When set to "true" the presence status on the network of this MCVideo user is available.

When set to "false" the presence status on the network of this MCVideo user is not available. This is the default if this leaf node is not present.

13.2.70 /<x>/<x>/OnNetwork/AllowedPresence

Table 13.2.70.1: /<x>/<x>/OnNetwork/AllowedPresence

<x>/OnNetwork/AllowedPresence

Status	Occurrence	Format	Min. Access Types
Optional	One	bool	Get, Replace

This leaf node indicates whether the MCVideo user is authorised to obtain whether a particular MCVideo User is present on the network.

When set to "true" the MCVideo user is authorised to obtain whether a particular MCVideo User is present on the network.

When set to "false" the MCVideo user is not authorised to obtain whether a particular MCVideo User is present on the network. This is the default if this leaf node is not present.

13.2.71 /<x>/<x>/OnNetwork/AllowedManualSwitch

Table 13.2.71.1: /<x>/<x>/OnNetwork/AllowedManualSwitch

<x>/OnNetwork/AllowedManualSwitch

Status	Occurrence	Format	Min. Access Types
Required	One	bool	Get, Replace

This leaf node indicates whether the MCVideo user is authorised to manually switch to off-network operation while in on-network operation.

When set to "true" the MCVideo user is authorised to manually switch to off-network operation while in on-network operation.

When set to "false" the MCVideo user is not authorised to manually switch to off-network operation while in on-network operation.

13.2.72 Void

13.2.73 /<x>/<x>/OnNetwork/MaxSimultaneousVideoStreams

Table 13.2.73.1: /<x>/<x>/OnNetwork/MaxSimultaneousVideoStreams

<x>/OnNetwork/MaxSimultaneousVideoStreams

Status	Occurrence	Format	Min. Access Types
Required	One	node	Get, Replace

This interior node is a placeholder for maximum number of simultaneous video streams that can be received.

13.2.74 /<x>/<x>/OnNetwork/MaxSimultaneousVideoStreams/MaxStreams

Table 13.2.74.1: /<x>/<x>/OnNetwork/MaxSimultaneousVideoStreams/MaxStreams

<x>/OnNetwork/MaxSimultaneousVideoStreams/MaxStreams

Status	Occurrence	Format	Min. Access Types
Optional	One	int	Get, Replace

This leaf node indicates the maximum number of simultaneous video streams that can be received.

- Values: 1-65535

13.2.75 Void

13.2.76 Void

13.2.77 Void

13.2.78 Void

13.2.79 Void

13.2.80 Void

13.2.81 Void

13.2.82 Void

13.2.83 Void

13.2.84 Void

13.2.85 Void

13.2.86 Void

13.2.87 Void

13.2.87A/<x>/<x>/OnNetwork/EnabledParticipation

Table 13.2.87A.1: /<x>/<x>/OnNetwork/EnabledParticipation

<x>/OnNetwork/EnabledParticipation

Status	Occurrence	Format	Min. Access Types
Required	One	bool	Get, Replace

This leaf node indicates whether the MCVideo user is allowed to participate in MCVideo private calls that they are invited to.

When set to "true" the MCVideo user is allowed to participate in MCVideo private calls that they are invited to.

When set to "false" the MCVideo user is not allowed to participate in MCVideo private calls that they are invited to.

13.2.87A1 /<x>/<x>/OnNetwork/AllowedRemoteInitiatedAmbientViewing

Table 13.2.87A1.1: /<x>/<x>/AllowedRemoteInitiatedAmbientViewing

<x>/OnNetwork/AllowedRemoteInitiatedAmbientViewing

Status	Occurrence	Format	Min. Access Types
Optional	One	bool	Get, Replace

This leaf node indicates the presence status on the network of this MCVideo user is available.

When set to "true" the MCVideo user is authorised to remotely initiate ambient viewing at another MCVideo user's device.

When set to "false" the MCVideo user is not authorised to remotely initiate ambient viewing at another MCVideo user's device.

13.2.87A2 /<x>/<x>/OnNetwork/AllowedLocallyInitiatedAmbientViewing

Table 13.2.87A2.1: /<x>/<x>/OnNetwork/AllowedLocallyInitiatedAmbientViewing

<x>/OnNetwork/AllowedLocallyInitiatedAmbientViewing

Status	Occurrence	Format	Min. Access Types
Optional	One	bool	Get, Replace

This leaf node indicates the presence status on the network of this MCVideo user is available.

When set to "true" the MCVideo user is authorised to locally initiate ambient viewing.

When set to "false" the MCVideo user is not authorised to locally initiate ambient viewing.

13.2.87A3 /<x>/<x>/OnNetwork/FunctionalAliasList

Table 13.2.87A3.1: /<x>/<x>/OnNetwork/FunctionalAliasList

<x>/OnNetwork/FunctionalAliasList

Status	Occurrence	Format	Min. Access Types
Required	One	node	Get, Replace

This interior node is a placeholder for the functional alias configuration.

13.2.87A4 /<x>/<x>/OnNetwork/FunctionalAliasList/<x>

Table 13.2.87A4.1: /<x>/<x>/OnNetwork/FunctionalAliasList/<x>

<x>/OnNetwork/FunctionalAliasList/<x>

Status	Occurrence	Format	Min. Access Types
Required	OneOrMore	node	Get, Replace

This interior node is a placeholder for one or more functional alias configuration elements.

13.2.87A5 /<x>/<x>/OnNetwork/FunctionalAliasList/<x>/Entry

Table 13.2.87A5.1: /<x>/<x>/OnNetwork/FunctionalAliasList/<x>/Entry

<x>/OnNetwork/FunctionalAliasList/<x>/Entry

Status	Occurrence	Format	Min. Access Types
Optional	One	node	Get, Replace

This interior node is a placeholder for the details of the functional alias.

13.2.87A6 /<x>/<x>/OnNetwork/FunctionalAliasList/<x>/Entry/ FunctionalAlias

Table 13.2.87A6.1: /<x>/<x>/OnNetwork/FunctionalAliasList/<x>/Entry/MCVIDEOID

<x>/OnNetwork/FunctionalAliasList/<x>/Entry/FunctionalAlias

Status	Occurrence	Format	Min. Access Types
Required	One	chr	Get, Replace

This leaf node indicates a functional alias that can be activated by the MCVideo user.

The value is a "uri" attribute specified in OMA OMA-TS-XDM_Group-V1_1 [4].

13.2.87A6A /<x>/<x>/OnNetwork/FunctionalAliasList/<x>/Entry/ LocationCriteriaForActivation

Table 13.2.87A6A.1: /<x>/<x>/OnNetwork/FunctionalAliasList/<x>/Entry/LocationCriteriaForActivation

<x>/OnNetwork/FunctionalAliasList/<x>/Entry/LocationCriteriaForActivation

Status	Occurrence	Format	Min. Access Types
Optional	ZeroOrOne	node	Get, Replace

This interior node contains the location criteria for activation of a functional alias.

13.2.87A6A0 /<x>/<x>/OnNetwork/FunctionalAliasList/<x>/Entry/ LocationCriteriaForActivation/<x>

Table 13.2.87A6A0.1:

/<x>/<x>/OnNetwork/FunctionalAliasList/<x>/Entry/LocationCriteriaForActivation/<x>

<x>/OnNetwork/FunctionalAliasList/<x>/Entry/LocationCriteriaForActivation/<x>

Status	Occurrence	Format	Min. Access Types
Optional	ZeroOrMore	node	Get, Replace

This interior node contains the zero or more location criteria for activation of a functional alias.

13.2.87A6A1 /<x>/<x>/OnNetwork/FunctionalAliasList/<x>/Entry/ LocationCriteriaForActivation/<x>/EnterSpecificArea

**Table 13.2.87A6A1.1: /<x>/<x>/OnNetwork/FunctionalAliasList/<x>/Entry/
LocationCriteriaForActivation/<x>/EnterSpecificArea**

<x>/OnNetwork/FunctionalAliasList/<x>/Entry/LocationCriteriaForActivation/<x>/EnterSpecificArea

Status	Occurrence	Format	Min. Access Types
Optional	ZeroOrOne	node	Get, Replace

This interior node contains a geographical area which when entered by the MC service UE triggers the functional alias activation.

13.2.87A6A2 /<x>/<x>/OnNetwork/FunctionalAliasList/<x>/Entry/ LocationCriteriaForActivation/<x>/EnterSpecificArea/PolygonArea

**Table 13.2.87A6A2.1: /<x>/<x>/OnNetwork/FunctionalAliasList/<x>/Entry/
LocationCriteriaForActivation/<x>/EnterSpecificArea/PolygonArea**

<x>/OnNetwork/FunctionalAliasList/<x>/Entry/LocationCriteriaForActivation/<x>/EnterSpecificArea/PolygonArea

Status	Occurrence	Format	Min. Access Types
Optional	ZeroOrOne	node	Get, Replace

This interior node contains a geographical area described by a polygon.

13.2.87A6A3 /<x>/<x>/OnNetwork/FunctionalAliasList/<x>/Entry/ LocationCriteriaForActivation/<x>/EnterSpecificArea/ PolygonArea/<x>

**Table 13.2.87A6A3.1: /<x>/<x>/OnNetwork/FunctionalAliasList/<x>/Entry/
LocationCriteriaForActivation/<x>/EnterSpecificArea/PolygonArea/<x>**

<x>/OnNetwork/FunctionalAliasList/<x>/Entry/LocationCriteriaForActivation/<x>/EnterSpecificArea/PolygonArea
/<x>

Status	Occurrence	Format	Min. Access Types
Required	OneOrN	node	Get, Replace

This interior node contains the coordinates of the corners which define a polygon. The occurrence of this leaf node is "3 to 15" as per 3GPP TS 23.032 [21].

13.2.87A6A3A /<x>/<x>/OnNetwork/FunctionalAliasList/<x>/Entry/ LocationCriteriaForActivation/<x>/EnterSpecificArea/ PolygonArea/<x>/PointCoordinateType

**Table 13.2.87A6A3A.1: /<x>/<x>/OnNetwork/FunctionalAliasList/<x>/Entry/
LocationCriteriaForActivation/<x>/EnterSpecificArea/PolygonArea/<x>/PointCoordinateType**

<x>/OnNetwork/FunctionalAliasList/<x>/Entry/LocationCriteriaForActivation/<x>/EnterSpecificArea/PolygonArea
/<x>/PointCoordinateType

Status	Occurrence	Format	Min. Access Types
Required	One	node	Get, Replace

This interior node contains the coordinates of the center point of the ellipsoid arc.

13.2.87A6A4 /<x>/<x>/OnNetwork/FunctionalAliasList/<x>/Entry/ LocationCriteriaForActivation/<x>/EnterSpecificArea/ PolygonArea/<x>/PointCoordinateType/Longitude

**Table 13.2.87A6A4.1: /<x>/<x>/OnNetwork/FunctionalAliasList/<x>/Entry/
LocationCriteriaForActivation/<x>/EnterSpecificArea/PolygonArea/<x>/PointCoordinateType/
Longitude**

<x>/OnNetwork/FunctionalAliasList/<x>/Entry/LocationCriteriaForActivation/<x>/EnterSpecificArea/PolygonArea
/<x>/PointCoordinateType/Longitude

Status	Occurrence	Format	Min. Access Types

Required	One	int	Get, Replace
----------	-----	-----	--------------

This leaf node contains the longitudinal coordinate of a corner.

- Values: 0-16777215

13.2.87A6A5 /<x>/<x>/OnNetwork/FunctionalAliasList/<x>/Entry/
LocationCriteriaForActivation/<x>/EnterSpecificArea/
PolygonArea/<x>/PointCoordinateType/Latitude

**Table 13.2.87A6A5.1: /<x>/<x>/OnNetwork/FunctionalAliasList/<x>/Entry/
LocationCriteriaForActivation/<x>/EnterSpecificArea/PolygonArea/<x>/PointCoordinateType/Latitude**

<x>/OnNetwork/FunctionalAliasList/<x>/Entry/LocationCriteriaForActivation/<x>/EnterSpecificArea/PolygonArea
/<x>/PointCoordinateType/Latitude

Status	Occurrence	Format	Min. Access Types
Required	One	int	Get, Replace

This leaf node contains the latitudinal coordinate of a corner.

- Values: 0-16777215

13.2.87A6A6 /<x>/<x>/OnNetwork/FunctionalAliasList/<x>/Entry/
LocationCriteriaForActivation/<x>/EnterSpecificArea/
EllipsoidArcArea

**Table 13.2.87A6A6.1: /<x>/<x>/OnNetwork/FunctionalAliasList/<x>/Entry/
LocationCriteriaForActivation/<x>/EnterSpecificArea/EllipsoidArcArea**

<x>/OnNetwork/FunctionalAliasList/<x>/Entry/LocationCriteriaForActivation/<x>/EnterSpecificArea/EllipsoidArc

Status	Occurrence	Format	Min. Access Types
Optional	ZeroOrOne	node	Get, Replace

This interior node contains a geographical area described by an ellipsoid arc.

13.2.87A6A7 /<x>/<x>/OnNetwork/FunctionalAliasList/<x>/Entry/
LocationCriteriaForActivation/<x>/EnterSpecificArea/
EllipsoidArcArea/Center

**Table 13.2.87A6A7.1: /<x>/<x>/OnNetwork/FunctionalAliasList/<x>/Entry/
LocationCriteriaForActivation/<x>/EnterSpecificArea/EllipsoidArcArea/Center**

<x>/OnNetwork/FunctionalAliasList/<x>/Entry/LocationCriteriaForActivation/<x>/EnterSpecificArea/EllipsoidArc
Area/Center

Status	Occurrence	Format	Min. Access Types
Required	One	node	Get, Replace

This interior node contains the coordinates of the center point of the ellipsoid arc.

13.2.87A6A7A /<x>/<x>/OnNetwork/FunctionalAliasList/<x>/Entry/
LocationCriteriaForActivation/<x>/EnterSpecificArea/
EllipsoidArcArea/Center/PointCoordinateType

**Table 13.2.87A6A7A.1: /<x>/<x>/OnNetwork/FunctionalAliasList/<x>/Entry/
LocationCriteriaForActivation/<x>/EnterSpecificArea/EllipsoidArcArea/Center/PointCoordinateType**

<x>/OnNetwork/FunctionalAliasList/<x>/Entry/LocationCriteriaForActivation/<x>/EnterSpecificArea/EllipsoidArc
Area/Center/PointCoordinateType

Status	Occurrence	Format	Min. Access Types
Required	One	node	Get, Replace

This interior node contains the coordinates of the center point of the ellipsoid arc.

13.2.87A6A8 /<x>/<x>/OnNetwork/FunctionalAliasList/<x>/Entry/
LocationCriteriaForActivation/<x>/EnterSpecificArea/
EllipsoidArcArea/Center/PointCoordinateType/Longitude

**Table 13.2.87A6A8.1: /<x>/<x>/OnNetwork/FunctionalAliasList/<x>/Entry/
LocationCriteriaForActivation/<x>/EnterSpecificArea/EllipsoidArcArea/Center/PointCoordinateType/
Longitude**

<x>/OnNetwork/FunctionalAliasList/<x>/Entry/LocationCriteriaForActivation/<x>/EnterSpecificArea/EllipsoidArc
Area/Center/PointCoordinateType/Longitude

Status	Occurrence	Format	Min. Access Types
Required	One	int	Get, Replace

This leaf node contains the longitudinal coordinate of the center.

- Values: 0-16777215

13.2.87A6A9 /<x>/<x>/OnNetwork/FunctionalAliasList/<x>/Entry/
LocationCriteriaForActivation/<x>/EnterSpecificArea/
EllipsoidArcArea/Center/PointCoordinateType/Latitude

**Table 13.2.87A6A9.1: /<x>/<x>/OnNetwork/FunctionalAliasList/<x>/Entry/
LocationCriteriaForActivation/<x>/EnterSpecificArea/EllipsoidArcArea/Center/PointCoordinateType/
Latitude**

<x>/OnNetwork/FunctionalAliasList/<x>/Entry/LocationCriteriaForActivation/<x>/EnterSpecificArea/EllipsoidArc
Area/Center/PointCoordinateType/Latitude

Status	Occurrence	Format	Min. Access Types
Required	One	int	Get, Replace

This leaf node contains the latitudinal coordinate of the center.

- Values: 0-16777215

13.2.87A6A10 /<x>/<x>/OnNetwork/FunctionalAliasList/<x>/Entry/ LocationCriteriaForActivation/<x>/EnterSpecificArea/ EllipsoidArcArea/Radius

**Table 13.2.87A6A10.1: /<x>/<x>/OnNetwork/FunctionalAliasList/<x>/Entry/
LocationCriteriaForActivation/<x>/EnterSpecificArea/EllipsoidArcArea/Radius**

<x>/OnNetwork/FunctionalAliasList/<x>/Entry/LocationCriteriaForActivation/<x>/EnterSpecificArea/EllipsoidArc
Area/Radius

Status	Occurrence	Format	Min. Access Types
Required	One	int	Get, Replace

This leaf node contains the radius of the ellipsoid arc.

- Values: non-negative integer

13.2.87A6A11 /<x>/<x>/OnNetwork/FunctionalAliasList/<x>/Entry/ LocationCriteriaForActivation/<x>/EnterSpecificArea/ EllipsoidArcArea/OffsetAngle

**Table 13.2.87A6A11.1: /<x>/<x>/OnNetwork/FunctionalAliasList/<x>/Entry/
LocationCriteriaForActivation/<x>/EnterSpecificArea/EllipsoidArcArea/OffsetAngle**

<x>/OnNetwork/FunctionalAliasList/<x>/Entry/LocationCriteriaForActivation/<x>/EnterSpecificArea/EllipsoidArc
Area/OffsetAngle

Status	Occurrence	Format	Min. Access Types
Required	One	int	Get, Replace

This leaf node contains the offset angle of the ellipsoid arc.

- Values: 0-255

13.2.87A6A12 /<x>/<x>/OnNetwork/FunctionalAliasList/<x>/Entry/ LocationCriteriaForActivation/<x>/EnterSpecificArea/ EllipsoidArcArea/IncludedAngle

**Table 13.2.87A6A12.1: /<x>/<x>/OnNetwork/FunctionalAliasList/<x>/Entry/
LocationCriteriaForActivation/<x>/EnterSpecificArea/EllipsoidArcArea/IncludedAngle**

<x>/OnNetwork/FunctionalAliasList/<x>/Entry/LocationCriteriaForActivation/<x>/EnterSpecificArea/EllipsoidArc
Area/IncludedAngle

Status	Occurrence	Format	Min. Access Types
Required	One	int	Get, Replace

This leaf node contains the included angle of the ellipsoid arc.

- Values: 0-255

13.2.87A6A12A/<x>/<x>/OnNetwork/FunctionalAliasList/<x>/Entry/ LocationCriteriaForActivation/<x>/EnterSpecificArea/Speed

**Table 13.2.87A6A12A.1: /<x>/<x>/OnNetwork/FunctionalAliasList/<x>/Entry/
LocationCriteriaForActivation/<x>/EnterSpecificArea/Speed**

<x>/OnNetwork/FunctionalAliasList/<x>/Entry/LocationCriteriaForActivation/<x>/EnterSpecificArea/Speed

Status	Occurrence	Format	Min. Access Types
Optional	One	node	Get, Replace

This interior node contains the speed.

13.2.87A6A12B/<x>/<x>/OnNetwork/FunctionalAliasList/<x>/Entry/ LocationCriteriaForActivation/<x>/EnterSpecificArea/Speed/ MinimumSpeed

**Table 13.2.87A6A12B.1: /<x>/<x>/OnNetwork/FunctionalAliasList/<x>/Entry/
LocationCriteriaForActivation/<x>/EnterSpecificArea/Speed/MinimumSpeed**

<x>/OnNetwork/FunctionalAliasList/<x>/Entry/LocationCriteriaForActivation/<x>/EnterSpecificArea/Speed/MinimumSpeed

Status	Occurrence	Format	Min. Access Types
Required	One	int	Get, Replace

This leaf node contains the minimum speed.

- Values: non-negative integer in units of kilometers/hour.

13.2.87A6A12C/<x>/<x>/OnNetwork/FunctionalAliasList/<x>/Entry/ LocationCriteriaForActivation/<x>/EnterSpecificArea/Speed/ MaximumSpeed

**Table 13.2.87A6A12C.1: /<x>/<x>/OnNetwork/FunctionalAliasList/<x>/Entry/
LocationCriteriaForActivation/<x>/EnterSpecificArea/Speed/MaximumSpeed**

<x>/OnNetwork/FunctionalAliasList/<x>/Entry/LocationCriteriaForActivation/<x>/EnterSpecificArea/Speed/MaximumSpeed

Status	Occurrence	Format	Min. Access Types
Required	One	int	Get, Replace

This leaf node contains the maximum speed.

- Values: non-negative integer in units of kilometers/hour.

13.2.87A6A12D/<x>/<x>/OnNetwork/FunctionalAliasList/<x>/Entry/ LocationCriteriaForActivation/<x>/EnterSpecificArea/Heading

**Table 13.2.87A6A12D.1: /<x>/<x>/OnNetwork/FunctionalAliasList/<x>/Entry/
LocationCriteriaForActivation/<x>/EnterSpecificArea/Heading**

<x>/OnNetwork/FunctionalAliasList/<x>/Entry/LocationCriteriaForActivation/<x>/EnterSpecificArea/Heading

Status	Occurrence	Format	Min. Access Types
Optional	One	node	Get, Replace

This interior node contains the heading.

13.2.87A6A12E /<x>/<x>/OnNetwork/FunctionalAliasList/<x>/Entry/LocationCriteriaForActivation/<x>/EnterSpecificArea/Heading/MinimumHeading

Table 13.2.87A6A12E.1: /<x>/<x>/OnNetwork/FunctionalAliasList/<x>/Entry/LocationCriteriaForActivation/<x>/EnterSpecificArea/Heading/MinimumHeading

<x>/OnNetwork/FunctionalAliasList/<x>/Entry/LocationCriteriaForActivation/<x>/EnterSpecificArea/Heading/MinimumHeading

Status	Occurrence	Format	Min. Access Types
Required	One	int	Get, Replace

This leaf node contains the minimum heading.

- Values: 0-359

13.2.87A6A12F /<x>/<x>/OnNetwork/FunctionalAliasList/<x>/Entry/LocationCriteriaForActivation/<x>/EnterSpecificArea/Heading/MaximumHeading

Table 13.2.87A6A12F.1: /<x>/<x>/OnNetwork/FunctionalAliasList/<x>/Entry/LocationCriteriaForActivation/<x>/EnterSpecificArea/Heading/MaximumHeading

<x>/OnNetwork/FunctionalAliasList/<x>/Entry/LocationCriteriaForActivation/<x>/EnterSpecificArea/Heading/MaximumHeading

Status	Occurrence	Format	Min. Access Types
Required	One	int	Get, Replace

This leaf node contains the maximum heading.

- Values: 0-359

13.2.87A6A13 /<x>/<x>/OnNetwork/FunctionalAliasList/<x>/Entry/LocationCriteriaForActivation/<x>/ExitSpecificArea

Table 13.2.87A6A13.1: /<x>/<x>/OnNetwork/FunctionalAliasList/<x>/Entry/LocationCriteriaForActivation/<x>/ExitSpecificArea

<x>/OnNetwork/FunctionalAliasList/<x>/Entry/LocationCriteriaForActivation/<x>/ExitSpecificArea

Status	Occurrence	Format	Min. Access Types
Optional	ZeroOrOne	node	Get, Replace

This interior node contains a geographical area which when exited by the MC service UE triggers the functional alias activation.

13.2.87A6A14 /<x>/<x>/OnNetwork/FunctionalAliasList/<x>/Entry/LocationCriteriaForActivation/<x>/ExitSpecificArea/PolygonArea

Table 13.2.87A6A14.1: /<x>/<x>/OnNetwork/FunctionalAliasList/<x>/Entry/LocationCriteriaForActivation/<x>/ExitSpecificArea/PolygonArea

<x>/OnNetwork/FunctionalAliasList/<x>/Entry/LocationCriteriaForActivation/<x>/ExitSpecificArea/PolygonArea

Status	Occurrence	Format	Min. Access Types
Optional	ZeroOrOne	node	Get, Replace

This interior node contains a geographical area described by a polygon.

13.2.87A6A15 /<x>/<x>/OnNetwork/FunctionalAliasList/<x>/Entry/LocationCriteriaForActivation/<x>/ExitSpecificArea/PolygonArea/<x>

Table 13.2.87A6A15.1: /<x>/<x>/OnNetwork/FunctionalAliasList/<x>/Entry/LocationCriteriaForActivation/<x>/ExitSpecificArea/PolygonArea/<x>

<x>/OnNetwork/FunctionalAliasList/<x>/Entry/LocationCriteriaForActivation/<x>/ExitSpecificArea/PolygonArea/<x>

Status	Occurrence	Format	Min. Access Types
Required	OneOrN	node	Get, Replace

This interior node contains the coordinates of the corners which define a polygon. The occurrence of this leaf node is "3 to 15" as per 3GPP TS 23.032 [21].

13.2.87A6A15A/<x>/<x>/OnNetwork/FunctionalAliasList/<x>/Entry/LocationCriteriaForActivation/<x>/ExitSpecificArea/PolygonArea/<x>/PointCoordinateType

Table 13.2.87A6A15A.1: /<x>/<x>/OnNetwork/FunctionalAliasList/<x>/Entry/LocationCriteriaForActivation/<x>/ExitSpecificArea/PolygonArea/<x>/PointCoordinateType

<x>/OnNetwork/FunctionalAliasList/<x>/Entry/LocationCriteriaForActivation/<x>/ExitSpecificArea/PolygonArea/<x>/PointCoordinateType

Status	Occurrence	Format	Min. Access Types
Required	One	node	Get, Replace

This interior node contains the type of the coordinates.

13.2.87A6A16 /<x>/<x>/OnNetwork/FunctionalAliasList/<x>/Entry/LocationCriteriaForActivation/<x>/ExitSpecificArea/PolygonArea/<x>/PointCoordinateType/Longitude

Table 13.2.87A6A16.1: /<x>/<x>/OnNetwork/FunctionalAliasList/<x>/Entry/LocationCriteriaForActivation/<x>/ExitSpecificArea/PolygonArea/<x>/PointCoordinateType/Longitude

<x>/OnNetwork/FunctionalAliasList/<x>/Entry/LocationCriteriaForActivation/<x>/ExitSpecificArea/PolygonArea/<x>/PointCoordinateType/Longitude

Status	Occurrence	Format	Min. Access Types

Required	One	int	Get, Replace
----------	-----	-----	--------------

This leaf node contains the longitudinal coordinate of a corner.

- Values: 0-16777215

13.2.87A6A17 /<x>/<x>/OnNetwork/FunctionalAliasList/<x>/Entry/LocationCriteriaForActivation/<x>/ExitSpecificArea/PolygonArea/<x>/PointCoordinateType/Latitude

Table 13.2.87A6A17.1: /<x>/<x>/OnNetwork/FunctionalAliasList/<x>/Entry/LocationCriteriaForActivation/<x>/ExitSpecificArea/PolygonArea/<x>/PointCoordinateType/Latitude

<x>/OnNetwork/FunctionalAliasList/<x>/Entry/LocationCriteriaForActivation/<x>/ExitSpecificArea/PolygonArea/<x>/PointCoordinateType/Latitude

Status	Occurrence	Format	Min. Access Types
Required	One	int	Get, Replace

This leaf node contains the latitudinal coordinate of a corner.

- Values: 0-16777215

13.2.87A6A18 /<x>/<x>/OnNetwork/FunctionalAliasList/<x>/Entry/LocationCriteriaForActivation/<x>/ExitSpecificArea/EllipsoidArcArea

Table 13.2.87A6A18.1: /<x>/<x>/OnNetwork/FunctionalAliasList/<x>/Entry/LocationCriteriaForActivation/<x>/ExitSpecificArea/EllipsoidArcArea

<x>/OnNetwork/FunctionalAliasList/<x>/Entry/LocationCriteriaForActivation/<x>/ExitSpecificArea/EllipsoidArcA

Status	Occurrence	Format	Min. Access Types
Optional	ZeroOrOne	node	Get, Replace

This interior node contains a geographical area described by an ellipsoid arc.

13.2.87A6A19 /<x>/<x>/OnNetwork/FunctionalAliasList/<x>/Entry/LocationCriteriaForActivation/<x>/ExitSpecificArea/EllipsoidArcArea/Center

Table 13.2.87A6A19.1: /<x>/<x>/OnNetwork/FunctionalAliasList/<x>/Entry/LocationCriteriaForActivation/<x>/ExitSpecificArea/EllipsoidArcArea/Center

<x>/OnNetwork/FunctionalAliasList/<x>/Entry/LocationCriteriaForActivation/<x>/ExitSpecificArea/EllipsoidArcArea/Center

Status	Occurrence	Format	Min. Access Types
Required	One	node	Get, Replace

This interior node contains the coordinates of the center point of the ellipsoid arc.

13.2.87A6A19A/<x>/<x>/OnNetwork/FunctionalAliasList/<x>/Entry/
LocationCriteriaForActivation/<x>/ExitSpecificArea/
EllipsoidArcArea/Center/PointCoordinateType

**Table 13.2.87A6A19A.1: /<x>/<x>/OnNetwork/FunctionalAliasList/<x>/Entry/
LocationCriteriaForActivation/<x>/ExitSpecificArea/EllipsoidArcArea/Center/PointCoordinateType**

<x>/OnNetwork/FunctionalAliasList/<x>/Entry/LocationCriteriaForActivation/<x>/ExitSpecificArea/EllipsoidArcArea/Center/PointCoordinateType

Status	Occurrence	Format	Min. Access Types
Required	One	node	Get, Replace

This interior node contains the coordinates of the center point of the ellipsoid arc.

13.2.87A6A20 /<x>/<x>/OnNetwork/FunctionalAliasList/<x>/Entry/
LocationCriteriaForActivation/<x>/ExitSpecificArea/
EllipsoidArcArea/Center/PointCoordinateType/Longitude

**Table 13.2.87A6A20.1: /<x>/<x>/OnNetwork/FunctionalAliasList/<x>/Entry/
LocationCriteriaForActivation/<x>/ExitSpecificArea/EllipsoidArcArea/Center/PointCoordinateType/
Longitude**

<x>/OnNetwork/FunctionalAliasList/<x>/Entry/LocationCriteriaForActivation/<x>/ExitSpecificArea/EllipsoidArcArea/Center/PointCoordinateType/Longitude

Status	Occurrence	Format	Min. Access Types
Required	One	int	Get, Replace

This leaf node contains the longitudinal coordinate of the center.

- Values: 0-16777215

13.2.87A6A21 /<x>/<x>/OnNetwork/FunctionalAliasList/<x>/Entry/
LocationCriteriaForActivation/<x>/ExitSpecificArea/
EllipsoidArcArea/Center/PointCoordinateType/Latitude

**Table 13.2.87A6A21.1: /<x>/<x>/OnNetwork/FunctionalAliasList/<x>/Entry/
LocationCriteriaForActivation/<x>/ExitSpecificArea/EllipsoidArcArea/Center/PointCoordinateType/
Latitude**

<x>/OnNetwork/FunctionalAliasList/<x>/Entry/LocationCriteriaForActivation/<x>/ExitSpecificArea/EllipsoidArcArea/Center/PointCoordinateType/Latitude

Status	Occurrence	Format	Min. Access Types
Required	One	int	Get, Replace

This leaf node contains the latitudinal coordinate of the center.

- Values: 0-16777215

13.2.87A6A22 /<x>/<x>/OnNetwork/FunctionalAliasList/<x>/Entry/ LocationCriteriaForActivation/<x>/ExitSpecificArea/ EllipsoidArcArea/Radius

**Table 13.2.87A6A22.1: /<x>/<x>/OnNetwork/FunctionalAliasList/<x>/Entry/
LocationCriteriaForActivation/<x>/ExitSpecificArea/EllipsoidArcArea/Radius**

<x>/OnNetwork/FunctionalAliasList/<x>/Entry/LocationCriteriaForActivation/<x>/ExitSpecificArea/EllipsoidArcArea/Radius

Status	Occurrence	Format	Min. Access Types
Required	One	int	Get, Replace

This leaf node contains the radius of the ellipsoid arc.

- Values: non-negative integer

13.2.87A6A23 /<x>/<x>/OnNetwork/FunctionalAliasList/<x>/Entry/ LocationCriteriaForActivation/<x>/ExitSpecificArea/ EllipsoidArcArea/OffsetAngle

**Table 13.2.87A6A23.1: /<x>/<x>/OnNetwork/FunctionalAliasList/<x>/Entry/
LocationCriteriaForActivation/<x>/ExitSpecificArea/EllipsoidArcArea/OffsetAngle**

<x>/OnNetwork/FunctionalAliasList/<x>/Entry/LocationCriteriaForActivation/<x>/ExitSpecificArea/EllipsoidArcArea/OffsetAngle

Status	Occurrence	Format	Min. Access Types
Required	One	int	Get, Replace

This leaf node contains the offset angle of the ellipsoid arc.

- Values: 0-255

13.2.87A6A24 /<x>/<x>/OnNetwork/FunctionalAliasList/<x>/Entry/ LocationCriteriaForActivation/<x>/ExitSpecificArea/ EllipsoidArcArea/IncludedAngle

**Table 13.2.87A6A24.1: /<x>/<x>/OnNetwork/FunctionalAliasList/<x>/Entry/
LocationCriteriaForActivation/<x>/ExitSpecificArea/EllipsoidArcArea/IncludedAngle**

<x>/OnNetwork/FunctionalAliasList/<x>/Entry/LocationCriteriaForActivation/<x>/ExitSpecificArea/EllipsoidArcArea/IncludedAngle

Status	Occurrence	Format	Min. Access Types
Required	One	int	Get, Replace

This leaf node contains the included angle of the ellipsoid arc.

- Values: 0-255

13.2.87A6A24A/<x>/<x>/OnNetwork/FunctionalAliasList/<x>/Entry/ LocationCriteriaForActivation/<x>/ExitSpecificArea/Speed

**Table 13.2.87A6A24A.1: /<x>/<x>/OnNetwork/FunctionalAliasList/<x>/Entry/
LocationCriteriaForActivation/<x>/ExitSpecificArea/Speed**

<x>/OnNetwork/FunctionalAliasList/<x>/Entry/LocationCriteriaForActivation/<x>/ExitSpecificArea/Speed

Status	Occurrence	Format	Min. Access Types
Optional	One	node	Get, Replace

This interior node contains the speed.

13.2.87A6A24B/<x>/<x>/OnNetwork/FunctionalAliasList/<x>/Entry/ LocationCriteriaForActivation/<x>/ExitSpecificArea/Speed/ MinimumSpeed

**Table 13.2.87A6A24B.1: /<x>/<x>/OnNetwork/FunctionalAliasList/<x>/Entry/
LocationCriteriaForActivation/<x>/ExitSpecificArea/Speed/MinimumSpeed**

<x>/OnNetwork/FunctionalAliasList/<x>/Entry/LocationCriteriaForActivation/<x>/ExitSpecificArea/Speed/MinimumSpeed

Status	Occurrence	Format	Min. Access Types
Required	One	int	Get, Replace

This leaf node contains the minimum speed.

- Values: non-negative integer in units of kilometers/hour.

13.2.87A6A24C/<x>/<x>/OnNetwork/FunctionalAliasList/<x>/Entry/ LocationCriteriaForActivation/<x>/ExitSpecificArea/Speed/ MaximumSpeed

**Table 13.2.87A6A24C.1: /<x>/<x>/OnNetwork/FunctionalAliasList/<x>/Entry/
LocationCriteriaForActivation/<x>/ExitSpecificArea/Speed/MaximumSpeed**

<x>/OnNetwork/FunctionalAliasList/<x>/Entry/LocationCriteriaForActivation/<x>/ExitSpecificArea/Speed/MaximumSpeed

Status	Occurrence	Format	Min. Access Types
Required	One	int	Get, Replace

This leaf node contains the maximum speed.

- Values: non-negative integer in units of kilometers/hour.

13.2.87A6A24D/<x>/<x>/OnNetwork/FunctionalAliasList/<x>/Entry/ LocationCriteriaForActivation/<x>/ExitSpecificArea/Heading

**Table 13.2.87A6A24D.1: /<x>/<x>/OnNetwork/FunctionalAliasList/<x>/Entry/
LocationCriteriaForActivation/<x>/ExitSpecificArea/Heading**

<x>/OnNetwork/FunctionalAliasList/<x>/Entry/LocationCriteriaForActivation/<x>/ExitSpecificArea/Heading

Status	Occurrence	Format	Min. Access Types
Optional	One	node	Get, Replace

This interior node contains the heading.

13.2.87A6A24E /<x>/<x>/OnNetwork/FunctionalAliasList/<x>/Entry/LocationCriteriaForActivation/<x>/ExitSpecificArea/Heading/MinimumHeading

Table 13.2.87A6A24E.1: /<x>/<x>/OnNetwork/FunctionalAliasList/<x>/Entry/LocationCriteriaForActivation/<x>/ExitSpecificArea/Heading/MinimumHeading

<x>/OnNetwork/FunctionalAliasList/<x>/Entry/LocationCriteriaForActivation/<x>/ExitSpecificArea/Heading/MinimumHeading

Status	Occurrence	Format	Min. Access Types
Required	One	int	Get, Replace

This leaf node contains the minimum heading.

- Values: 0-359

13.2.87A6A24F /<x>/<x>/OnNetwork/FunctionalAliasList/<x>/Entry/LocationCriteriaForActivation/<x>/ExitSpecificArea/Heading/MaximumHeading

Table 13.2.87A6A24F.1: /<x>/<x>/OnNetwork/FunctionalAliasList/<x>/Entry/LocationCriteriaForActivation/<x>/ExitSpecificArea/Heading/MaximumHeading

<x>/OnNetwork/FunctionalAliasList/<x>/Entry/LocationCriteriaForActivation/<x>/ExitSpecificArea/Heading/MaximumHeading

Status	Occurrence	Format	Min. Access Types
Required	One	int	Get, Replace

This leaf node contains the maximum heading.

- Values: 0-359

13.2.87A6B /<x>/<x>/OnNetwork/FunctionalAliasList/<x>/Entry/LocationCriteriaForDeactivation

Table 13.2.87A6B.1: /<x>/<x>/OnNetwork/FunctionalAliasList/<x>/Entry/LocationCriteriaForDeactivation

<x>/OnNetwork/FunctionalAliasList/<x>/Entry/LocationCriteriaForDeactivation

Status	Occurrence	Format	Min. Access Types
Optional	ZeroOrOne	node	Get, Replace

This interior node contains the location criteria for de-activation of a functional alias.

13.2.87A6B0 /<x>/<x>/OnNetwork/FunctionalAliasList/<x>/Entry/ LocationCriteriaForDeactivation/<x>

**Table 13.2.87A6B0.1: /<x>/<x>/OnNetwork/FunctionalAliasList/<x>/Entry/
LocationCriteriaForDeactivation/<x>**

<x>/OnNetwork/FunctionalAliasList/<x>/Entry/LocationCriteriaForDeactivation/<x>

Status	Occurrence	Format	Min. Access Types
Optional	ZeroOrMore	node	Get, Replace

This interior node contains the zero or more location criteria for de-activation of a functional alias.

13.2.87A6B1 /<x>/<x>/OnNetwork/FunctionalAliasList/<x>/Entry/ LocationCriteriaForDeactivation/<x>/EnterSpecificArea

**Table 13.2.87A6B1.1: /<x>/<x>/OnNetwork/FunctionalAliasList/<x>/Entry/
LocationCriteriaForDeactivation/<x>/EnterSpecificArea**

<x>/OnNetwork/FunctionalAliasList/<x>/Entry/LocationCriteriaForDeactivation/<x>/EnterSpecificArea

Status	Occurrence	Format	Min. Access Types
Optional	ZeroOrOne	node	Get, Replace

This interior node contains a geographical area which when entered by the MC service UE triggers the functional alias de-activation.

13.2.87A6B2 /<x>/<x>/OnNetwork/FunctionalAliasList/<x>/Entry/ LocationCriteriaForDeactivation/<x>/EnterSpecificArea/ PolygonArea

**Table 13.2.87A6B2.1: /<x>/<x>/OnNetwork/FunctionalAliasList/<x>/Entry/
LocationCriteriaForDeactivation/<x>/EnterSpecificArea/PolygonArea**

<x>/OnNetwork/FunctionalAliasList/<x>/Entry/LocationCriteriaForDeactivation/<x>/EnterSpecificArea/PolygonAr

Status	Occurrence	Format	Min. Access Types
Optional	ZeroOrOne	node	Get, Replace

This interior node contains a geographical area described by a polygon.

13.2.87A6B3 /<x>/<x>/OnNetwork/FunctionalAliasList/<x>/Entry/ LocationCriteriaForDeactivation/<x>/EnterSpecificArea/ PolygonArea/<x>

**Table 13.2.87A6B3.1: /<x>/<x>/OnNetwork/FunctionalAliasList/<x>/Entry/
LocationCriteriaForDeactivation/<x>/EnterSpecificArea/PolygonArea/<x>**

<x>/OnNetwork/FunctionalAliasList/<x>/Entry/LocationCriteriaForDeactivation/<x>/EnterSpecificArea/PolygonAr
ea/<x>

Status	Occurrence	Format	Min. Access Types
Required	OneOrN	node	Get, Replace

This interior node contains the coordinates of the corners which define a polygon. The occurrence of this leaf node is "3 to 15" as per 3GPP TS 23.032 [21].

13.2.87A6B3A /<x>/<x>/OnNetwork/FunctionalAliasList/<x>/Entry/
LocationCriteriaForDeactivation/<x>/EnterSpecificArea/
PolygonArea/<x>/PointCoordinateType

**Table 13.2.87A6B3A.1: /<x>/<x>/OnNetwork/FunctionalAliasList/<x>/Entry/
LocationCriteriaForDeactivation/<x>/EnterSpecificArea/PolygonArea/<x>/PointCoordinateType**

<x>/OnNetwork/FunctionalAliasList/<x>/Entry/LocationCriteriaForDeactivation/<x>/EnterSpecificArea/PolygonAr
ea/<x>/PointCoordinateType

Status	Occurrence	Format	Min. Access Types
Required	One	node	Get, Replace

This interior node contains the coordinates of the center point of the ellipsoid arc.

13.2.87A6B4 /<x>/<x>/OnNetwork/FunctionalAliasList/<x>/Entry/
LocationCriteriaForDeactivation/<x>/EnterSpecificArea/
PolygonArea/<x>/PointCoordinateType/Longitude

**Table 13.2.87A6B4.1: /<x>/<x>/OnNetwork/FunctionalAliasList/<x>/Entry/
LocationCriteriaForDeactivation/<x>/EnterSpecificArea/PolygonArea/<x>/PointCoordinateType/
Longitude**

<x>/OnNetwork/FunctionalAliasList/<x>/Entry/LocationCriteriaForDeactivation/<x>/EnterSpecificArea/PolygonAr
ea/<x>/PointCoordinateType/Longitude

Status	Occurrence	Format	Min. Access Types
Required	One	int	Get, Replace

This leaf node contains the longitudinal coordinate of a corner.

- Values: 0-16777215

13.2.87A6B5 /<x>/<x>/OnNetwork/FunctionalAliasList/<x>/Entry/
LocationCriteriaForDeactivation/<x>/EnterSpecificArea/
PolygonArea/<x>/PointCoordinateType/Latitude

**Table 13.2.87A6B5.1: /<x>/<x>/OnNetwork/FunctionalAliasList/<x>/Entry/
LocationCriteriaForDeactivation/<x>/EnterSpecificArea/PolygonArea/<x>/PointCoordinateType/
Latitude**

<x>/OnNetwork/FunctionalAliasList/<x>/Entry/LocationCriteriaForDeactivation/<x>/EnterSpecificArea/PolygonAr
ea/<x>/PointCoordinateType/Latitude

Status	Occurrence	Format	Min. Access Types
Required	One	int	Get, Replace

This leaf node contains the latitudinal coordinate of a corner.

- Values: 0-16777215

13.2.87A6B6 /<x>/<x>/OnNetwork/FunctionalAliasList/<x>/Entry/ LocationCriteriaForDeactivation/<x>/EnterSpecificArea/ EllipsoidArcArea

**Table 13.2.87A6B6.1: /<x>/<x>/OnNetwork/FunctionalAliasList/<x>/Entry/
LocationCriteriaForDeactivation/<x>/EnterSpecificArea/EllipsoidArcArea**

<x>/OnNetwork/FunctionalAliasList/<x>/Entry/LocationCriteriaForDeactivation/<x>/EnterSpecificArea/EllipsoidA

Status	Occurrence	Format	Min. Access Types
Optional	ZeroOrOne	node	Get, Replace

This interior node contains a geographical area described by an ellipsoid arc.

13.2.87A6B7 /<x>/<x>/OnNetwork/FunctionalAliasList/<x>/Entry/ LocationCriteriaForDeactivation/<x>/EnterSpecificArea/ EllipsoidArcArea/Center

**Table 13.2.87A6B7.1: /<x>/<x>/OnNetwork/FunctionalAliasList/<x>/Entry/
LocationCriteriaForDeactivation/<x>/EnterSpecificArea/EllipsoidArcArea/Center**

<x>/OnNetwork/FunctionalAliasList/<x>/Entry/LocationCriteriaForDeactivation/<x>/EnterSpecificArea/EllipsoidA
rcArea/Center

Status	Occurrence	Format	Min. Access Types
Required	One	node	Get, Replace

This interior node contains the coordinates of the center point of the ellipsoid arc.

13.2.87A6B7A /<x>/<x>/OnNetwork/FunctionalAliasList/<x>/Entry/ LocationCriteriaForDeactivation/<x>/EnterSpecificArea/ EllipsoidArcArea/Center/PointCoordinateType

**Table 13.2.87A6B7A.1: /<x>/<x>/OnNetwork/FunctionalAliasList/<x>/Entry/
LocationCriteriaForDeactivation/<x>/EnterSpecificArea/EllipsoidArcArea/Center/PointCoordinateTyp
e**

<x>/OnNetwork/FunctionalAliasList/<x>/Entry/LocationCriteriaForDeactivation/<x>/EnterSpecificArea/EllipsoidA
rcArea/Center/PointCoordinateType

Status	Occurrence	Format	Min. Access Types
Required	One	node	Get, Replace

This interior node contains the coordinates of the center point of the ellipsoid arc.

13.2.87A6B8 /<x>/<x>/OnNetwork/FunctionalAliasList/<x>/Entry/LocationCriteriaForDeactivation/<x>/EnterSpecificArea/EllipsoidArcArea/Center/PointCoordinateType/Longitude

Table 13.2.87A6B8.1: /<x>/<x>/OnNetwork/FunctionalAliasList/<x>/Entry/LocationCriteriaForDeactivation/<x>/EnterSpecificArea/EllipsoidArcArea/Center/PointCoordinateType/Longitude

<x>/OnNetwork/FunctionalAliasList/<x>/Entry/LocationCriteriaForDeactivation/<x>/EnterSpecificArea/EllipsoidArcArea/Center/PointCoordinateType/Longitude

Status	Occurrence	Format	Min. Access Types
Required	One	int	Get, Replace

This leaf node contains the longitudinal coordinate of the center.

- Values: 0-16777215

13.2.87A6B9 /<x>/<x>/OnNetwork/FunctionalAliasList/<x>/Entry/LocationCriteriaForDeactivation/<x>/EnterSpecificArea/EllipsoidArcArea/Center/PointCoordinateType/Latitude

Table 13.2.87A6B9.1: /<x>/<x>/OnNetwork/FunctionalAliasList/<x>/Entry/LocationCriteriaForDeactivation/<x>/EnterSpecificArea/EllipsoidArcArea/Center/PointCoordinateType/Latitude

<x>/OnNetwork/FunctionalAliasList/<x>/Entry/LocationCriteriaForDeactivation/<x>/EnterSpecificArea/EllipsoidArcArea/Center/PointCoordinateType/Latitude

Status	Occurrence	Format	Min. Access Types
Required	One	int	Get, Replace

This leaf node contains the latitudinal coordinate of the center.

- Values: 0-16777215

13.2.87A6B10 /<x>/<x>/OnNetwork/FunctionalAliasList/<x>/Entry/LocationCriteriaForDeactivation/<x>/EnterSpecificArea/EllipsoidArcArea/Radius

Table 13.2.87A6B10.1: /<x>/<x>/OnNetwork/FunctionalAliasList/<x>/Entry/LocationCriteriaForDeactivation/<x>/EnterSpecificArea/EllipsoidArcArea/Radius

<x>/OnNetwork/FunctionalAliasList/<x>/Entry/LocationCriteriaForDeactivation/<x>/EnterSpecificArea/EllipsoidArcArea/Radius

Status	Occurrence	Format	Min. Access Types
Required	One	int	Get, Replace

This leaf node contains the radius of the ellipsoid arc.

- Values: non-negative integer

13.2.87A6B11 /<x>/<x>/OnNetwork/FunctionalAliasList/<x>/Entry/
LocationCriteriaForDeactivation/<x>/EnterSpecificArea/
EllipsoidArcArea/OffsetAngle

**Table 13.2.87A6B11.1: /<x>/<x>/OnNetwork/FunctionalAliasList/<x>/Entry/
LocationCriteriaForDeactivation/<x>/EnterSpecificArea/EllipsoidArcArea/OffsetAngle**

<x>/OnNetwork/FunctionalAliasList/<x>/Entry/LocationCriteriaForDeactivation/<x>/EnterSpecificArea/EllipsoidArcArea/OffsetAngle

Status	Occurrence	Format	Min. Access Types
Required	One	int	Get, Replace

This leaf node contains the offset angle of the ellipsoid arc.

- Values: 0-255

13.2.87A6B12 /<x>/<x>/OnNetwork/FunctionalAliasList/<x>/Entry/
LocationCriteriaForDeactivation/<x>/EnterSpecificArea/
EllipsoidArcArea/IncludedAngle

**Table 13.2.87A6B12.1: /<x>/<x>/OnNetwork/FunctionalAliasList/<x>/Entry/
LocationCriteriaForDeactivation/<x>/EnterSpecificArea/EllipsoidArcArea/IncludedAngle**

<x>/OnNetwork/FunctionalAliasList/<x>/Entry/LocationCriteriaForDeactivation/<x>/EnterSpecificArea/EllipsoidArcArea/IncludedAngle

Status	Occurrence	Format	Min. Access Types
Required	One	int	Get, Replace

This leaf node contains the included angle of the ellipsoid arc.

- Values: 0-255

13.2.87A6B12A/<x>/<x>/OnNetwork/FunctionalAliasList/<x>/Entry/
LocationCriteriaForDeactivation/<x>/EnterSpecificArea/Speed

**Table 13.2.87A6B12A.1: /<x>/<x>/OnNetwork/FunctionalAliasList/<x>/Entry/
LocationCriteriaForDeactivation/<x>/EnterSpecificArea/Speed**

<x>/OnNetwork/FunctionalAliasList/<x>/Entry/LocationCriteriaForDeactivation/<x>/EnterSpecificArea/Speed

Status	Occurrence	Format	Min. Access Types
Optional	One	node	Get, Replace

This interior node contains the speed.

13.2.87A6B12B/<x>/<x>/OnNetwork/FunctionalAliasList/<x>/Entry/ LocationCriteriaForDeactivation/<x>/EnterSpecificArea/Speed/ MinimumSpeed

**Table 13.2.87A6B12B.1: /<x>/<x>/OnNetwork/FunctionalAliasList/<x>/Entry/
LocationCriteriaForDeactivation/<x>/EnterSpecificArea/Speed/MinimumSpeed**

<x>/OnNetwork/FunctionalAliasList/<x>/Entry/LocationCriteriaForDeactivation/<x>/EnterSpecificArea/Speed/MinimumSpeed

Status	Occurrence	Format	Min. Access Types
Required	One	int	Get, Replace

This leaf node contains the minimum speed.

- Values: non-negative integer in units of kilometers/hour.

13.2.87A6B12C/<x>/<x>/OnNetwork/FunctionalAliasList/<x>/Entry/ LocationCriteriaForDeactivation/<x>/EnterSpecificArea/Speed/ MaximumSpeed

**Table 13.2.87A6B12C.1: /<x>/<x>/OnNetwork/FunctionalAliasList/<x>/Entry/
LocationCriteriaForDeactivation/<x>/EnterSpecificArea/Speed/MaximumSpeed**

<x>/OnNetwork/FunctionalAliasList/<x>/Entry/LocationCriteriaForDeactivation/<x>/EnterSpecificArea/Speed/MaximumSpeed

Status	Occurrence	Format	Min. Access Types
Required	One	int	Get, Replace

This leaf node contains the maximum speed.

- Values: non-negative integer in units of kilometers/hour.

13.2.87A6B12D/<x>/<x>/OnNetwork/FunctionalAliasList/<x>/Entry/ LocationCriteriaForDeactivation/<x>/EnterSpecificArea/Heading

**Table 13.2.87A6B12D.1: /<x>/<x>/OnNetwork/FunctionalAliasList/<x>/Entry/
LocationCriteriaForDeactivation/<x>/EnterSpecificArea/Heading**

<x>/OnNetwork/FunctionalAliasList/<x>/Entry/LocationCriteriaForDeactivation/<x>/EnterSpecificArea/Heading

Status	Occurrence	Format	Min. Access Types
Optional	One	node	Get, Replace

This interior node contains the heading.

13.2.87A6B12E /<x>/<x>/OnNetwork/FunctionalAliasList/<x>/Entry/
LocationCriteriaForDeactivation/<x>/EnterSpecificArea/Heading/
MinimumHeading

**Table 13.2.87A6B12E.1: /<x>/<x>/OnNetwork/FunctionalAliasList/<x>/Entry/
LocationCriteriaForDeactivation/<x>/EnterSpecificArea/Heading/MinimumHeading**

<x>/OnNetwork/FunctionalAliasList/<x>/Entry/LocationCriteriaForDeactivation/<x>/EnterSpecificArea/Heading/M
inimumHeading

Status	Occurrence	Format	Min. Access Types
Required	One	int	Get, Replace

This leaf node contains the minimum heading.

- Values: 0-359

13.2.87A6B12F /<x>/<x>/OnNetwork/FunctionalAliasList/<x>/Entry/
LocationCriteriaForDeactivation/<x>/EnterSpecificArea/Heading/
MaximumHeading

**Table 13.2.87A6B12F.1: /<x>/<x>/OnNetwork/FunctionalAliasList/<x>/Entry/
LocationCriteriaForDeactivation/<x>/EnterSpecificArea/Heading/MaximumHeading**

<x>/OnNetwork/FunctionalAliasList/<x>/Entry/LocationCriteriaForDeactivation/<x>/EnterSpecificArea/Heading/M
aximumHeading

Status	Occurrence	Format	Min. Access Types
Required	One	int	Get, Replace

This leaf node contains the maximum heading.

- Values: 0-359

13.2.87A6B13 /<x>/<x>/OnNetwork/FunctionalAliasList/<x>/Entry/
LocationCriteriaForDeactivation/<x>/ExitSpecificArea

**Table 13.2.87A6B13.1: /<x>/<x>/OnNetwork/FunctionalAliasList/<x>/Entry/
LocationCriteriaForDeactivation/<x>/ExitSpecificArea**

<x>/OnNetwork/FunctionalAliasList/<x>/Entry/LocationCriteriaForDeactivation/<x>/ExitSpecificArea

Status	Occurrence	Format	Min. Access Types
Optional	ZeroOrOne	node	Get, Replace

This interior node contains a geographical area which when exited by the MC service UE triggers the functional alias de-activation.

13.2.87A6B14 /<x>/<x>/OnNetwork/FunctionalAliasList/<x>/Entry/
LocationCriteriaForDeactivation/<x>/ExitSpecificArea/
PolygonArea

**Table 13.2.87A6B14.1: /<x>/<x>/OnNetwork/FunctionalAliasList/<x>/Entry/
LocationCriteriaForDeactivation/<x>/ExitSpecificArea/PolygonArea**

<x>/OnNetwork/FunctionalAliasList/<x>/Entry/LocationCriteriaForDeactivation/<x>/ExitSpecificArea/PolygonAre

Status	Occurrence	Format	Min. Access Types
Optional	ZeroOrOne	node	Get, Replace

This interior node contains a geographical area described by a polygon.

13.2.87A6B15 /<x>/<x>/OnNetwork/FunctionalAliasList/<x>/Entry/LocationCriteriaForDeactivation/<x>/ExitSpecificArea/PolygonArea/<x>

Table 13.2.87A6B15.1: /<x>/<x>/OnNetwork/FunctionalAliasList/<x>/Entry/LocationCriteriaForDeactivation/<x>/ExitSpecificArea/PolygonArea/<x>

<x>/OnNetwork/FunctionalAliasList/<x>/Entry/LocationCriteriaForDeactivation/<x>/ExitSpecificArea/PolygonArea/<x>

Status	Occurrence	Format	Min. Access Types
Required	OneOrN	node	Get, Replace

This interior node contains the coordinates of the corners which define a polygon. The occurrence of this leaf node is "3 to 15" as per 3GPP TS 23.032 [21].

13.2.87A6B15A/<x>/<x>/OnNetwork/FunctionalAliasList/<x>/Entry/LocationCriteriaForDeactivation/<x>/ExitSpecificArea/PolygonArea/<x>/PointCoordinateType

Table 13.2.87A6B15A.1: /<x>/<x>/OnNetwork/FunctionalAliasList/<x>/Entry/LocationCriteriaForDeactivation/<x>/ExitSpecificArea/PolygonArea/<x>/PointCoordinateType

<x>/OnNetwork/FunctionalAliasList/<x>/Entry/LocationCriteriaForDeactivation/<x>/ExitSpecificArea/PolygonArea/<x>/PointCoordinateType

Status	Occurrence	Format	Min. Access Types
Required	One	node	Get, Replace

This interior node contains the coordinates of the center point of the ellipsoid arc.

13.2.87A6B16 /<x>/<x>/OnNetwork/FunctionalAliasList/<x>/Entry/LocationCriteriaForDeactivation/<x>/ExitSpecificArea/PolygonArea/<x>/PointCoordinateType/Longitude

Table 13.2.87A6B16.1: /<x>/<x>/OnNetwork/FunctionalAliasList/<x>/Entry/LocationCriteriaForDeactivation/<x>/ExitSpecificArea/PolygonArea/<x>/PointCoordinateType/Longitude

<x>/OnNetwork/FunctionalAliasList/<x>/Entry/LocationCriteriaForDeactivation/<x>/ExitSpecificArea/PolygonArea/<x>/PointCoordinateType/Longitude

Status	Occurrence	Format	Min. Access Types
Required	One	int	Get, Replace

This leaf node contains the longitudinal coordinate of a corner.

- Values: 0-16777215

13.2.87A6B17 /<x>/<x>/OnNetwork/FunctionalAliasList/<x>/Entry/
LocationCriteriaForDeactivation/<x>/ExitSpecificArea/
PolygonArea/<x>/PointCoordinateType/Latitude

**Table 13.2.87A6B17.1: /<x>/<x>/OnNetwork/FunctionalAliasList/<x>/Entry/
LocationCriteriaForDeactivation/<x>/ExitSpecificArea/PolygonArea/<x>/PointCoordinateType/Latitud
e**

<x>/OnNetwork/FunctionalAliasList/<x>/Entry/LocationCriteriaForDeactivation/<x>/ExitSpecificArea/PolygonArea/<x>/PointCoordinateType/Latitude

Status	Occurrence	Format	Min. Access Types
Required	One	int	Get, Replace

This leaf node contains the latitudinal coordinate of a corner.

- Values: 0-16777215

13.2.87A6B18 /<x>/<x>/OnNetwork/FunctionalAliasList/<x>/Entry/
LocationCriteriaForDeactivation/<x>/ExitSpecificArea/
EllipsoidArcArea

**Table 13.2.87A6B18.1: /<x>/<x>/OnNetwork/FunctionalAliasList/<x>/Entry/
LocationCriteriaForDeactivation/<x>/ExitSpecificArea/EllipsoidArcArea**

<x>/OnNetwork/FunctionalAliasList/<x>/Entry/LocationCriteriaForDeactivation/<x>/ExitSpecificArea/EllipsoidArc

Status	Occurrence	Format	Min. Access Types
Optional	ZeroOrOne	node	Get, Replace

This interior node contains a geographical area described by an ellipsoid arc.

13.2.87A6B19 /<x>/<x>/OnNetwork/FunctionalAliasList/<x>/Entry/
LocationCriteriaForDeactivation/<x>/ExitSpecificArea/
EllipsoidArcArea/Center

**Table 13.2.87A6B19.1: /<x>/<x>/OnNetwork/FunctionalAliasList/<x>/Entry/
LocationCriteriaForDeactivation/<x>/ExitSpecificArea/EllipsoidArcArea/Center**

<x>/OnNetwork/FunctionalAliasList/<x>/Entry/LocationCriteriaForDeactivation/<x>/ExitSpecificArea/EllipsoidArcArea/Center

Status	Occurrence	Format	Min. Access Types
Required	One	node	Get, Replace

This interior node contains the coordinates of the center point of the ellipsoid arc.

13.2.87A6B19A/<x>/<x>/OnNetwork/FunctionalAliasList/<x>/Entry/
LocationCriteriaForDeactivation/<x>/ExitSpecificArea/
EllipsoidArcArea/Center/PointCoordinateType

**Table 13.2.87A6B19A.1: /<x>/<x>/OnNetwork/FunctionalAliasList/<x>/Entry/
LocationCriteriaForDeactivation/<x>/ExitSpecificArea/EllipsoidArcArea/Center/PointCoordinateType**

<x>/OnNetwork/FunctionalAliasList/<x>/Entry/LocationCriteriaForDeactivation/<x>/ExitSpecificArea/EllipsoidArc
Area/Center/PointCoordinateType

Status	Occurrence	Format	Min. Access Types
Required	One	node	Get, Replace

This interior node contains the coordinates of the center point of the ellipsoid arc.

13.2.87A6B20 /<x>/<x>/OnNetwork/FunctionalAliasList/<x>/Entry/
LocationCriteriaForDeactivation/<x>/ExitSpecificArea/
EllipsoidArcArea/Center/PointCoordinateType/Longitude

**Table 13.2.87A6B20.1: /<x>/<x>/OnNetwork/FunctionalAliasList/<x>/Entry/
LocationCriteriaForDeactivation/<x>/ExitSpecificArea/EllipsoidArcArea/Center/PointCoordinateType/
Longitude**

<x>/OnNetwork/FunctionalAliasList/<x>/Entry/LocationCriteriaForDeactivation/<x>/ExitSpecificArea/EllipsoidArc
Area/Center/PointCoordinateType/Longitude

Status	Occurrence	Format	Min. Access Types
Required	One	int	Get, Replace

This leaf node contains the longitudinal coordinate of the center.

- Values: 0-16777215

13.2.87A6B21 /<x>/<x>/OnNetwork/FunctionalAliasList/<x>/Entry/
LocationCriteriaForDeactivation/<x>/ExitSpecificArea/
EllipsoidArcArea/Center/PointCoordinateType/Latitude

**Table 13.2.87A6B21.1: /<x>/<x>/OnNetwork/FunctionalAliasList/<x>/Entry/
LocationCriteriaForDeactivation/<x>/ExitSpecificArea/EllipsoidArcArea/Center/PointCoordinateType/
Latitude**

<x>/OnNetwork/FunctionalAliasList/<x>/Entry/LocationCriteriaForDeactivation/<x>/ExitSpecificArea/EllipsoidArc
Area/Center/PointCoordinateType/Latitude

Status	Occurrence	Format	Min. Access Types
Required	One	int	Get, Replace

This leaf node contains the latitudinal coordinate of the center.

- Values: 0-16777215

13.2.87A6B22 /<x>/<x>/OnNetwork/FunctionalAliasList/<x>/Entry/ LocationCriteriaForDeactivation/<x>/ExitSpecificArea/ EllipsoidArcArea/Radius

**Table 13.2.87A6B22.1: /<x>/<x>/OnNetwork/FunctionalAliasList/<x>/Entry/
LocationCriteriaForDeactivation/<x>/ExitSpecificArea/EllipsoidArcArea/Radius**

<x>/OnNetwork/FunctionalAliasList/<x>/Entry/LocationCriteriaForDeactivation/<x>/ExitSpecificArea/EllipsoidArc
Area/Radius

Status	Occurrence	Format	Min. Access Types
Required	One	int	Get, Replace

This leaf node contains the radius of the ellipsoid arc.

- Values: non-negative integer

13.2.87A6B23 /<x>/<x>/OnNetwork/FunctionalAliasList/<x>/Entry/ LocationCriteriaForDeactivation/<x>/ExitSpecificArea/ EllipsoidArcArea/OffsetAngle

**Table 13.2.87A6B23.1: /<x>/<x>/OnNetwork/FunctionalAliasList/<x>/Entry/
LocationCriteriaForDeactivation/<x>/ExitSpecificArea/EllipsoidArcArea/OffsetAngle**

<x>/OnNetwork/FunctionalAliasList/<x>/Entry/LocationCriteriaForDeactivation/<x>/ExitSpecificArea/EllipsoidArc
Area/OffsetAngle

Status	Occurrence	Format	Min. Access Types
Required	One	int	Get, Replace

This leaf node contains the offset angle of the ellipsoid arc.

- Values: 0-255

13.2.87A6B24 /<x>/<x>/OnNetwork/FunctionalAliasList/<x>/Entry/ LocationCriteriaForDeactivation/<x>/ExitSpecificArea/ EllipsoidArcArea/IncludedAngle

**Table 13.2.87A6B24.1: /<x>/<x>/OnNetwork/FunctionalAliasList/<x>/Entry/
LocationCriteriaForDeactivation/<x>/ExitSpecificArea/EllipsoidArcArea/IncludedAngle**

<x>/OnNetwork/FunctionalAliasList/<x>/Entry/LocationCriteriaForDeactivation/<x>/ExitSpecificArea/EllipsoidArc
Area/IncludedAngle

Status	Occurrence	Format	Min. Access Types
Required	One	int	Get, Replace

This leaf node contains the included angle of the ellipsoid arc.

- Values: 0-255

13.2.87A6B24A/<x>/<x>/OnNetwork/FunctionalAliasList/<x>/Entry/
LocationCriteriaForDeactivation/<x>/ExitSpecificArea/Speed

**Table 13.2.87A6B24A.1: /<x>/<x>/OnNetwork/FunctionalAliasList/<x>/Entry/
LocationCriteriaForDeactivation/<x>/ExitSpecificArea/Speed**

<x>/OnNetwork/FunctionalAliasList/<x>/Entry/LocationCriteriaForDeactivation/<x>/ExitSpecificArea/Speed

Status	Occurrence	Format	Min. Access Types
Optional	One	node	Get, Replace

This interior node contains the speed.

13.2.87A6B24B/<x>/<x>/OnNetwork/FunctionalAliasList/<x>/Entry/
LocationCriteriaForDeactivation/<x>/ExitSpecificArea/Speed/
MinimumSpeed

**Table 13.2.87A6B24B.1: /<x>/<x>/OnNetwork/FunctionalAliasList/<x>/Entry/
LocationCriteriaForDeactivation/<x>/ExitSpecificArea/Speed/MinimumSpeed**

<x>/OnNetwork/FunctionalAliasList/<x>/Entry/LocationCriteriaForDeactivation/<x>/ExitSpecificArea/Speed/MinimumSpeed

Status	Occurrence	Format	Min. Access Types
Required	One	int	Get, Replace

This leaf node contains the minimum speed.

- Values: non-negative integer in units of kilometers/hour.

13.2.87A6B24C/<x>/<x>/OnNetwork/FunctionalAliasList/<x>/Entry/
LocationCriteriaForDeactivation/<x>/ExitSpecificArea/Speed/
MaximumSpeed

**Table 13.2.87A6B24C.1: /<x>/<x>/OnNetwork/FunctionalAliasList/<x>/Entry/
LocationCriteriaForDeactivation/<x>/ExitSpecificArea/Speed/MaximumSpeed**

<x>/OnNetwork/FunctionalAliasList/<x>/Entry/LocationCriteriaForDeactivation/<x>/ExitSpecificArea/Speed/MaximumSpeed

Status	Occurrence	Format	Min. Access Types
Required	One	int	Get, Replace

This leaf node contains the maximum speed.

- Values: non-negative integer in units of kilometers/hour.

13.2.87A6B24D/<x>/<x>/OnNetwork/FunctionalAliasList/<x>/Entry/
LocationCriteriaForDeactivation/<x>/ExitSpecificArea/Heading

**Table 13.2.87A6B24D.1: /<x>/<x>/OnNetwork/FunctionalAliasList/<x>/Entry/
LocationCriteriaForDeactivation/<x>/ExitSpecificArea/Heading**

<x>/OnNetwork/FunctionalAliasList/<x>/Entry/LocationCriteriaForDeactivation/<x>/ExitSpecificArea/Heading

Status	Occurrence	Format	Min. Access Types
Optional	One	node	Get, Replace

This interior node contains the heading.

13.2.87A6B24E /<x>/<x>/OnNetwork/FunctionalAliasList/<x>/Entry/ LocationCriteriaForDeactivation/<x>/ExitSpecificArea/Heading/ MinimumHeading

**Table 13.2.87A6B24E.1: /<x>/<x>/OnNetwork/FunctionalAliasList/<x>/Entry/
LocationCriteriaForDeactivation/<x>/ExitSpecificArea/Heading/MinimumHeading**

<x>/OnNetwork/FunctionalAliasList/<x>/Entry/LocationCriteriaForDeactivation/<x>/ExitSpecificArea/Heading/MinimumHeading

Status	Occurrence	Format	Min. Access Types
Required	One	int	Get, Replace

This leaf node contains the minimum heading.

- Values: 0-359

13.2.87A6B24F /<x>/<x>/OnNetwork/FunctionalAliasList/<x>/Entry/ LocationCriteriaForDeactivation/<x>/ExitSpecificArea/Heading/ MaximumHeading

**Table 13.2.87A6B24F.1: /<x>/<x>/OnNetwork/FunctionalAliasList/<x>/Entry/
LocationCriteriaForDeactivation/<x>/ExitSpecificArea/Heading/MaximumHeading**

<x>/OnNetwork/FunctionalAliasList/<x>/Entry/LocationCriteriaForDeactivation/<x>/ExitSpecificArea/Heading/MaximumHeading

Status	Occurrence	Format	Min. Access Types
Required	One	int	Get, Replace

This leaf node contains the maximum heading.

- Values: 0-359

13.2.87A6C /<x>/<x>/OnNetwork/FunctionalAliasList/<x>/Entry/ ManualDeactivationNotAllowedIfLocationCriteriaMet

**Table 13.2.87A6C.1: /<x>/<x>/OnNetwork/FunctionalAliasList/<x>/Entry/
ManualDeactivationNotAllowedIfLocationCriteriaMet**

<x>/OnNetwork/FunctionalAliasList/<x>/Entry/ManualDeactivationNotAllowedIfLocationCriteriaMet

Status	Occurrence	Format	Min. Access Types
Optional	ZeroOrOne	bool	Get, Replace

This leaf node indicates whether the MCVideo user is authorised to de-activate a functional alias if the location criteria is met.

13.2.87A7 /<x>/<x>/OnNetwork/FunctionalAliasList/<x>/Entry/DisplayName

Table 13.2.87A7.1: /<x>/<x>/OnNetwork/FunctionalAliasList/<x>/Entry/DisplayName

<x>/OnNetwork/FunctionalAliasList/<x>/Entry/DisplayName

Status	Occurrence	Format	Min. Access Types
Optional	One	chr	Get, Replace

This leaf node contains a human readable name that corresponds to a functional alias that can be activated by the MCVideo user.

13.2.87A7A /<x>/<x>/OnNetwork/FunctionalAliasList/<x>/Entry/MaxSimultaneousEmergencyGroupCalls

Table 13.2.87A7A.1:**/<x>/<x>/OnNetwork/FunctionalAliasList/<x>/Entry/MaxSimultaneousEmergencyGroupCalls**

<x>/OnNetwork/FunctionalAliasList/<x>/Entry/MaxSimultaneousEmergencyGroupCalls

Status	Occurrence	Format	Min. Access Types
Optional	One	int	Get, Replace

This leaf node indicates the maximum number of simultaneous emergency group calls for a functional alias.

13.2.87A7B /<x>/<x>/OnNetwork/FunctionalAliasList/<x>/Entry/FAsAllowedToCall

Table 13.2.87A7B.1: /<x>/<x>/OnNetwork/FunctionalAliasList/<x>/Entry/FAsAllowedToCall

<x>/OnNetwork/FunctionalAliasList/<x>/Entry/FAsAllowedToCall

Status	Occurrence	Format	Min. Access Types
Required	One	node	Get, Replace

This interior node is a placeholder for the functional alias configuration regarding the allowed functional aliases to be called in a private call.

13.2.87A7C /<x>/<x>/OnNetwork/FunctionalAliasList/<x>/Entry/FAsAllowedToCall/<x>

Table 13.2.87A7C.1: /<x>/<x>/OnNetwork/FunctionalAliasList/<x>/Entry/FAsAllowedToCall/<x>

<x>/OnNetwork/FunctionalAliasList/<x>/Entry/FAsAllowedToCall/<x>

Status	Occurrence	Format	Min. Access Types
Required	OneOrMore	node	Get, Replace

This interior node is a placeholder for one or more functional alias configuration elements indicating the functional aliases that can be called.

13.2.87A7D /<x>/<x>/OnNetwork/FunctionalAliasList/<x>/Entry/ FAsAllowedToCall/<x>/Entry

Table 13.2.87A7D.1: /<x>/<x>/OnNetwork/FunctionalAliasList/<x>/Entry/FAsAllowedToCall/<x>/Entry

<x>/OnNetwork/FunctionalAliasList/<x>/Entry/FAsAllowedToCall/<x>/Entry

Status	Occurrence	Format	Min. Access Types
Optional	One	node	Get, Replace

This interior node is a placeholder for the details of the functional alias that can be called.

13.2.87A7E /<x>/<x>/OnNetwork/FunctionalAliasList/<x>/Entry/ FAsAllowedToCall/<x>/Entry/FunctionalAlias

Table 13.2.87A7E.1:

/<x>/<x>/OnNetwork/FunctionalAliasList/<x>/Entry/FAsAllowedToCall/<x>/Entry/FunctionalAlias

<x>/OnNetwork/FunctionalAliasList/<x>/Entry/FAsAllowedToCall/<x>/Entry/FunctionalAlias

Status	Occurrence	Format	Min. Access Types
Required	One	chr	Get, Replace

This leaf node indicates a functional alias that can be called by the MCVideo user.

The value is a "uri" attribute specified in OMA OMA-TS-XDM_Group-V1_1 [4].

13.2.87A8 /<x>/<x>/OnNetwork/AllowedQueryFunctionalAliasOtherUser

Table 13.2.87A8.1: /<x>/<x>/OnNetwork/AllowedQueryFunctionalAliasOtherUser

<x>/OnNetwork/AllowedQueryFunctionalAliasOtherUser

Status	Occurrence	Format	Min. Access Types
Required	One	bool	Get, Replace

This leaf node indicates whether the MCVideo user is authorised query the functional alias(es) activated by another MCVideo user.

When set to "true" the MCVideo user is authorised to query the functional alias(es) activated by another MCVideo user.

When set to "false" the MCVideo user is not authorised to query the functional alias(es) activated by another MCVideo user.

13.2.87A9 /<x>/<x>/OnNetwork/AllowedTakeoverFunctionalAliasOtherUser

Table 13.2.87A9.1: /<x>/<x>/OnNetwork/AllowedTakeoverFunctionalAliasOtherUser

<x>/OnNetwork/AllowedTakeoverFunctionalAliasOtherUser

Status	Occurrence	Format	Min. Access Types
Required	One	bool	Get, Replace

This leaf node indicates whether the MCVideo user is authorised to take over the functional alias(es) previously activated by another MCVideo user.

When set to "true" the MCVideo user is authorised to take over the functional alias(es) previously activated by another MCVideo user.

When set to "false" the MCVideo user is not authorised to take over the functional alias(es) previously activated by another MCVideo user.

13.2.87A10 /<x>/<x>/OnNetwork/AllowedFunctionalAliasGroupBinding

Table 13.2.87A10.1: /<x>/<x>/OnNetwork/AllowedFunctionalAliasGroupBinding

<x>/OnNetwork/AllowedFunctionalAliasGroupBinding

Status	Occurrence	Format	Min. Access Types
Optional	One	bool	Get, Replace

This leaf node indicates whether the MCVideo user is authorised to request the binding of a particular functional alias with a group or list of groups.

When set to "true" the MCVideo user is authorised to request the binding of a particular functional alias with a group or list of groups.

When set to "false" the MCVideo user is not authorised to request the binding of a particular functional alias with a group or list of groups.

13.2.87B/<x>/<x>/OnNetwork/AuthorisedIncomingAny

Table 13.2.87B.1: /<x>/<x>/OnNetwork/AuthorisedIncomingAny

<x>/OnNetwork/AuthorisedIncomingAny

Status	Occurrence	Format	Min. Access Types
Required	One	bool	Get, Replace

This leaf node indicates the authorisation to receive a MCVideo private call from any MCVideo user.

When set to "true" the MCVideo user is authorised to receive an MCVideo private call by any MCVideo user.

When set to "false" the MCVideo user is not authorised to receive an MCVideo private call by any MCVideo user, but only from the MCVideo users contained in the IncomingUserList.

13.2.87C /<x>/<x>/OnNetwork/IncomingUserList

Table 13.2.87C.1: /<x>/<x>/OnNetwork/IncomingUserList

<x>/OnNetwork/IncomingUserList

Status	Occurrence	Format	Min. Access Types
Required	One	node	Get, Replace

This interior node is a placeholder for a list of MCVideo user(s) who are authorised to initiate an MCVideo private call to the configured MCVideo user.

13.2.87C1 /<x>/<x>/OnNetwork/IncomingUserList/<x>

Table 13.2.87C1.1: /<x>/<x>/OnNetwork/IncomingUserList/<x>

<x>/OnNetwork/IncomingUserList/<x>

Status	Occurrence	Format	Min. Access Types
Optional	OneOrMore	node	Get, Replace

This interior node is a placeholder for one or more list of MCVideo users who are authorised to initiate an MCVideo private call to the configured MCVideo user.

13.2.87C2 /<x>/<x>/OnNetwork/IncomingUserList/<x>/Entry

Table 13.2.87C2.1: /<x>/<x>/OnNetwork/IncomingUserList/<x>/Entry

<x>/OnNetwork/IncomingUserList/<x>/Entry

Status	Occurrence	Format	Min. Access Types
Required	One	node	Get, Replace

This interior node is a placeholder for one or more MCVideo users who are authorised to initiate an MCVideo private call to the configured MCVideo user.

13.2.87C3 /<x>/<x>/OnNetwork/IncomingUserList/<x>/Entry/MCVideoID

Table 13.2.87C3.1: /<x>/<x>/OnNetwork/IncomingUserList/<x>/Entry/MCVideoID

<x>/OnNetwork/IncomingUserList/<x>/Entry/MCVideoID

Status	Occurrence	Format	Min. Access Types
Optional	One	chr	Get, Replace

This leaf node indicates an MCVideo user identity (MCVideo ID) which is a globally unique identifier within the MCVideo service that represents the MCVideo user.

The value is a "uri" attribute specified in OMA OMA-TS-XDM_Group-V1_1 [4].

13.2.87C4 /<x>/<x>/OnNetwork/IncomingUserList/<x>/Entry/MCVideoIDKMSURI

Table 13.2.87C4.1: /<x>/<x>/OnNetwork/IncomingUserList/<x>/Entry/MCVideoIDKMSURI

<x>/OnNetwork/IncomingUserList/<x>/Entry/MCVideoIDKMSURI

Status	Occurrence	Format	Min. Access Types
Optional	One	chr	Get, Replace

This leaf node indicates the identity (URI) of the KMS associated with the MCVideoID.

The value is a URI as specified in 3GPP TS 23.003 [5].

13.2.87D /<x>/<x>/OnNetwork/PrivateCall

Table 13.2.87D.1: /<x>/<x>/OnNetwork/PrivateCall

<x>/OnNetwork/PrivateCall

Status	Occurrence	Format	Min. Access Types
Required	One	node	Get, Replace

This interior node is a placeholder for the MCVideo private call configuration.

13.2.87E /<x>/<x>/OnNetwork/PrivateCall/EmergencyAlert

Table 13.2.87E.1: /<x>/<x>/OnNetwork/PrivateCall/EmergencyAlert

<x>/OnNetwork/PrivateCall/EmergencyAlert

Status	Occurrence	Format	Min. Access Types
Required	One	node	Get, Replace

This interior node is a placeholder for the MCVideo private emergency alert policy.

13.2.87F /<x>/<x>/OnNetwork/PrivateCall/EmergencyAlert/Entry

Table 13.2.87F.1: /<x>/<x>/OnNetwork/PrivateCall/EmergencyAlert/Entry

<x>/OnNetwork/PrivateCall/EmergencyAlert/Entry

Status	Occurrence	Format	Min. Access Types
Required	One	node	Get, Replace

This interior node is a placeholder for the details of an MCVideo private emergency alert for on-network.

13.2.87G /<x>/<x>/OnNetwork/PrivateCall/EmergencyAlert/Entry/ID

Table 13.2.87G.1: /<x>/<x>/OnNetwork/PrivateCall/EmergencyAlert/Entry/ID

<x>/OnNetwork/PrivateCall/EmergencyAlert/Entry/ID

Status	Occurrence	Format	Min. Access Types
Required	One	chr	Get, Replace

This leaf node indicates the MCVideo user ID used upon certain criteria on initiation of an MCVideo private emergency alert for on-network.

13.2.87H /<x>/<x>/OnNetwork/PrivateCall/EmergencyAlert/Entry/DisplayName

Table 13.2.87H.1: /<x>/<x>/OnNetwork/PrivateCall/EmergencyAlert/Entry/DisplayName

<x>/OnNetwork/PrivateCall/EmergencyAlert/Entry/DisplayName

Status	Occurrence	Format	Min. Access Types
Optional	One	chr	Get, Replace

This leaf node contains a human readable name that corresponds to the ID.

13.2.87I /<x>/<x>/OnNetwork/PrivateCall/EmergencyAlert/Entry/Usage

Table 13.2.87I.1: /<x>/<x>/OnNetwork/PrivateCall/EmergencyAlert/Entry/Usage

<x>/OnNetwork/PrivateCall/EmergencyAlert/Entry/Usage

Status	Occurrence	Format	Min. Access Types
Required	One	chr	Get, Replace

This leaf node indicates the criteria to determine when initiation of an MCVideo private emergency alert uses the ID.

The valid values are 'LocallyDetermined' and 'UsePreConfigured'.

When set to 'LocallyDetermined' then if the MCVideo user selects an MCVideo ID then use that MCVideo ID for an on-network MCVideo private emergency alert, if the MCVideo user does not select a MCVideo ID then use the MCVideo ID identified by the ID in clause 13.2.38I12 for an on-network MCVideo private emergency alert.

When set to 'UsePreConfigured' then use the ID identified by the ID in clause 13.2.38I12 for an on-network MCVideo private emergency alert.

13.2.87J /<x>/<x>/OnNetwork/RemoteGroupSelection

Table 13.2.87J.1: /<x>/<x>/OnNetwork/RemoteGroupSelection

<x>/OnNetwork/RemoteGroupSelection

Status	Occurrence	Format	Min. Access Types
Required	One	node	Get, Replace

This interior node is a placeholder for the remote group selection configuration.

13.2.87K /<x>/<x>/OnNetwork/RemoteGroupSelection/<x>

Table 13.2.87K.1: /<x>/<x>/OnNetwork/RemoteGroupSelection/<x>

<x>/OnNetwork/RemoteGroupSelection/<x>

Status	Occurrence	Format	Min. Access Types
Required	OneOrMore	node	Get, Replace

This interior node is a placeholder for one or more remote group selection configuration elements.

13.2.87L /<x>/<x>/OnNetwork/RemoteGroupSelection/<x>/Entry

Table 13.2.87L.1: /<x>/<x>/OnNetwork/RemoteGroupSelection/<x>/Entry

<x>/OnNetwork/RemoteGroupSelection/<x>/Entry

Status	Occurrence	Format	Min. Access Types
Optional	One	node	Get, Replace

This interior node is a placeholder for the details of the on-network MCVideo users whose selected MCVideo group is allowed to be remotely changed by the MCVideo user.

13.2.87M /<x>/<x>/OnNetwork/RemoteGroupSelection/<x>/Entry/MCVideoID

Table 13.2.87M.1: /<x>/<x>/OnNetwork/RemoteGroupSelection/<x>/Entry/MCVideoID

<x>/OnNetwork/RemoteGroupSelection/<x>/Entry/MCVideoID

Status	Occurrence	Format	Min. Access Types
Required	One	chr	Get, Replace

This leaf node indicates a MCVideo ID of an MCVideo user whose selected MCVideo group is allowed to be remotely changed by the MCVideo user.

The value is a "uri" attribute specified in OMA OMA-TS-XDM_Group-V1_1 [4].

13.2.87N /<x>/<x>/OnNetwork/RemoteGroupSelection/<x>/Entry/DisplayName

Table 13.2.87N.1: /<x>/<x>/OnNetwork/RemoteGroupSelection/<x>/Entry/DisplayName

<x>/OnNetwork/RemoteGroupSelection/<x>/Entry/DisplayName

Status	Occurrence	Format	Min. Access Types
Optional	One	chr	Get, Replace

This leaf node contains a human readable name that corresponds to the MCVideo ID of the MCVideo user.

13.2.87O1 /<x>/<x>/OnNetwork/MCVideoAdhocGroup

Table 13.2.87O1.1: /<x>/<x>/OnNetwork/MCVideoAdhocGroup

<x>/OnNetwork/MCVideoAdhocGroup

Status	Occurrence	Format	Min. Access Types
Required	One	node	Get, Replace

This interior node is a placeholder for the MCVideo adhoc group call and alert related configurations.

13.2.87O1A /<x>/<x>/OnNetwork/MCVideoAdhocGroup/EmergencyAlert

Table 13.2.87O1A.1: /<x>/<x>/OnNetwork/MCVideoAdhocGroup/EmergencyAlert

<x>/OnNetwork/MCVideoAdhocGroup/EmergencyAlert

Status	Occurrence	Format	Min. Access Types
Required	One	node	Get, Replace

This interior node is a placeholder for the MCVideo adhoc group emergency alert policy.

13.2.87O1A1 /<x>/<x>/OnNetwork/MCVideoAdhocGroup/EmergencyAlert/Authorised

Table 13.2.87O1A1.1: /<x>/<x>/OnNetwork/MCVideoAdhocGroup/EmergencyAlert/Authorised

<x>/OnNetwork/MCVideoAdhocGroup/EmergencyAlert/Authorised

Status	Occurrence	Format	Min. Access Types
Required	One	bool	Get, Replace

This leaf node indicates the authorisation to activate an MCVideo adhoc group emergency alert.

When set to "true" the MCVideo user is authorised to make an MCVideo adhoc group emergency alert.

When set to "false" the MCVideo user is not authorised to make an MCVideo adhoc group emergency alert.

13.2.8701A2 /<x>/<x>/OnNetwork/MCVideoAdhocGroup/EmergencyAlert/Cancel

Table 13.2.8701A2.1: /<x>/<x>/OnNetwork/MCVideoAdhocGroup/EmergencyAlert/Cancel

<x>/OnNetwork/MCVideoAdhocGroup/EmergencyAlert/Cancel

Status	Occurrence	Format	Min. Access Types
Required	One	bool	Get, Replace

This leaf node indicates the authorisation to cancel an MCVideo adhoc group emergency alert.

When set to "true" the MCVideo user is authorised to cancel an MCVideo adhoc group emergency alert.

When set to "false" the MCVideo user is not authorised to cancel an MCVideo adhoc group emergency alert.

13.2.8701A3 /<x>/<x>/OnNetwork/MCVideoAdhocGroup/EmergencyAlert/AuthRecvParticipantInfo

Table 13.2.8701A3.1:

/<x>/<x>/OnNetwork/MCVideoAdhocGroup/EmergencyAlert/AuthRecvParticipantInfo

<x>/OnNetwork/MCVideoAdhocGroup/EmergencyAlert/AuthRecvParticipantInfo

Status	Occurrence	Format	Min. Access Types
Required	One	bool	Get, Replace

This leaf node indicates the authorisation to receive MCVideo adhoc group emergency alert participants information.

When set to "true" the MCVideo user is authorised to receive adhoc group emergency alert participants information.

When set to "false" the MCVideo user is not authorised to receive adhoc group emergency alert participants information.

13.2.8701A4 /<x>/<x>/OnNetwork/MCVideoAdhocGroup/EmergencyAlert/AuthSetupAdhocGroupCall

Table 13.2.8701A4.1:

/<x>/<x>/OnNetwork/MCVideoAdhocGroup/EmergencyAlert/AuthSetupAdhocGroupCall

<x>/OnNetwork/MCVideoAdhocGroup/EmergencyAlert/AuthSetupAdhocGroupCall

Status	Occurrence	Format	Min. Access Types
Required	One	bool	Get, Replace

This leaf node indicates the authorisation to set up an adhoc group call using the adhoc group used for the adhoc group emergency alert.

When set to "true" the MCVideo user is authorised to set up an adhoc group call using the adhoc group used for the adhoc group emergency alert.

When set to "false" the MCVideo user is not authorised to set up an adhoc group call using the adhoc group used for the adhoc group emergency alert.

13.2.8701B /<x>/<x>/OnNetwork/MCVideoAdhocGroup/AdhocGroupCall

Table 13.2.8701B.1: /<x>/<x>/OnNetwork/MCVideoAdhocGroup/AdhocGroupCall

<x>/OnNetwork/MCVideoAdhocGroup/AdhocGroupCall

Status	Occurrence	Format	Min. Access Types
Required	One	node	Get, Replace

This interior node is a placeholder for the MCVideo adhoc group call related policy.

13.2.8701B1 /<x>/<x>/OnNetwork/MCVideoAdhocGroup/AdhocGroupCall/Authorised

Table 13.2.8701B1.1: /<x>/<x>/OnNetwork/MCVideoAdhocGroup/AdhocGroupCall/Authorised

<x>/OnNetwork/MCVideoAdhocGroup/AdhocGroupCall/Authorised

Status	Occurrence	Format	Min. Access Types
Required	One	bool	Get, Replace

This leaf node indicates the authorisation to make an MCVideo adhoc group call.

When set to "true" the MCVideo user is authorised to make an MCVideo adhoc group call.

When set to "false" the MCVideo user is not authorised to make an MCVideo adhoc group call.

13.2.8701B2 /<x>/<x>/OnNetwork/MCVideoAdhocGroup/AdhocGroupCall/AuthorisedParticipation

Table 13.2.8701B2.1: /<x>/<x>/OnNetwork/MCVideoAdhocGroup/AdhocGroupCall/AuthorisedParticipation

<x>/OnNetwork/MCVideoAdhocGroup/AdhocGroupCall/AuthorisedParticipation

Status	Occurrence	Format	Min. Access Types
Required	One	bool	Get, Replace

This leaf node indicates the authorisation to participate in MCVideo adhoc group call.

When set to "true" the MCVideo user is authorised to participate in MCVideo adhoc group calls that they are invited.

When set to "false" the MCVideo user is not authorised to participate in MCVideo adhoc group calls that they are invited.

13.2.8701B3 /<x>/<x>/OnNetwork/MCVideoAdhocGroup/AdhocGroupCall/AuthInitEmergencyCall

Table 13.2.8701B3.1: /<x>/<x>/OnNetwork/MCVideoAdhocGroup/AdhocGroupCall/AuthInitEmergencyCall

<x>/OnNetwork/MCVideoAdhocGroup/AdhocGroupCall/AuthInitEmergencyCall

Status	Occurrence	Format	Min. Access Types
Required	One	bool	Get, Replace

This leaf node indicates the authorisation to make an MCVideo adhoc group emergency call.

When set to "true" the MCVideo user is authorised to make an MCVideo adhoc group emergency call.

When set to "false" the MCVideo user is not authorised to make an MCVideo adhoc group emergency call.

13.2.8701B4 /<x>/<x>/OnNetwork/MCVideoAdhocGroup/AdhocGroupCall/AuthInitImminentPerilCall

Table 13.2.8701B4.1:

/<x>/<x>/OnNetwork/MCVideoAdhocGroup/AdhocGroupCall/AuthInitImminentPerilCall

<x>/OnNetwork/MCVideoAdhocGroup/AdhocGroupCall/AuthInitImminentPerilCall

Status	Occurrence	Format	Min. Access Types
Required	One	bool	Get, Replace

This leaf node indicates the authorisation to make an MCVideo adhoc group imminent-peril call.

When set to "true" the MCVideo user is authorised to make an MCVideo adhoc group imminent-peril call.

When set to "false" the MCVideo user is not authorised to make an MCVideo adhoc group imminent-peril call.

13.2.8701B5 /<x>/<x>/OnNetwork/MCVideoAdhocGroup/AdhocGroupCall/AuthRecvCallParticipantInfo

Table 13.2.8701B5.1:

/<x>/<x>/OnNetwork/MCVideoAdhocGroup/AdhocGroupCall/AuthRecvCallParticipantInfo

<x>/OnNetwork/MCVideoAdhocGroup/AdhocGroupCall/AuthRecvCallParticipantInfo

Status	Occurrence	Format	Min. Access Types
Required	One	bool	Get, Replace

This leaf node indicates the authorisation to receive adhoc group call participants information.

When set to "true" the MCVideo user is authorised to receive adhoc group call participants information.

When set to "false" the MCVideo user is not authorised to receive adhoc group call participants information.

13.2.8701B6 /<x>/<x>/OnNetwork/MCVideoAdhocGroup/AdhocGroupCall/AuthModifyCallParticipantInfo

Table 13.2.8701B6.1:

/<x>/<x>/OnNetwork/MCVideoAdhocGroup/AdhocGroupCall/AuthModifyCallParticipantInfo

<x>/OnNetwork/MCVideoAdhocGroup/AdhocGroupCall/AuthModifyCallParticipantInfo

Status	Occurrence	Format	Min. Access Types
Required	One	bool	Get, Replace

This leaf node indicates the authorisation to modify adhoc group call participants information.

When set to "true" the MCVideo user is authorised to modify adhoc group call participants information.

When set to "false" the MCVideo user is not authorised to modify adhoc group call participants information.

13.2.88 /<x>/<x>/OffNetwork

Table 13.2.88.1: /<x>/<x>/OffNetwork

<x>/OffNetwork

Status	Occurrence	Format	Min. Access Types
Required	ZeroOrOne	node	Get, Replace

This interior node represents a container for off-network operation.

13.2.89 /<x>/<x>/OffNetwork/Authorised

Table 13.2.89.1: /<x>/<x>/OffNetwork/Authorised

<x>/OffNetwork/Authorised

Status	Occurrence	Format	Min. Access Types
Required	One	bool	Get, Replace

This leaf node indicates the authorisation for off-network services.

When set to "true" the MCVideo user is authorised for off-network operation.

When set to "false" the MCVideo user is not authorised for off-network operation.

13.2.90 /<x>/<x>/OffNetwork/MCVideoGroupList

Table 13.2.90.1: /<x>/<x>/OffNetwork/MCVideoGroupList

<x>/OffNetwork/MCVideoGroupList

Status	Occurrence	Format	Min. Access Types
Required	One	node	Get, Replace

This interior node is a placeholder for the list of off-network MCVideo groups that the MCVideo user is allowed to use.

13.2.91 /<x>/<x>/OffNetwork/MCVideoGroupList/<x>

Table 13.2.91.1: /<x>/<x>/OffNetwork/MCVideoGroupList/<x>

<x>/OffNetwork/MCVideoGroupList/<x>

Status	Occurrence	Format	Min. Access Types
Required	OneOrMore	node	Get, Replace

This interior node is a placeholder for one or more list of off-network MCVideo groups that the MCVideo user is allowed to use.

13.2.92 /<x>/<x>/OffNetwork/MCVideoGroupList/<x>/Entry

Table 13.2.92.1: /<x>/<x>/OffNetwork/MCVideoGroupList/<x>/Entry

<x>/OffNetwork/MCVideoGroupList/<x>/Entry

Status	Occurrence	Format	Min. Access Types
Optional	One	node	Get, Replace

This interior node is a placeholder for the details of the off-network MCVideo groups that the MCVideo user is allowed to use.

13.2.93 /<x>/<x>/OffNetwork/MCVideoGroupList/<x>/Entry/MCVideoGroupID

Table 13.2.93.1: /<x>/<x>/OffNetwork/MCVideoGroupList/<x>/Entry/MCVideoGroupID

<x>/OffNetwork/MCVideoGroupList/<x>/Entry/MCVideoGroupID

Status	Occurrence	Format	Min. Access Types
Required	One	chr	Get, Replace

This leaf node indicates the MCVideo group ID for the off-network MCVideo group that the MCVideo user is allowed to use.

The value is a "uri" attribute specified in OMA OMA-TS-XDM_Group-V1_1 [4].

13.2.94 /<x>/<x>/OffNetwork/MCVideoGroupList/<x>/Entry/DisplayName

Table 13.2.94.1: /<x>/<x>/OffNetwork/MCVideoGroupList/<x>/Entry/DisplayName

<x>/OffNetwork/MCVideoGroupList/<x>/Entry/DisplayName

Status	Occurrence	Format	Min. Access Types
Optional	One	chr	Get, Replace

This leaf node contains a human readable name that corresponds to the MCVideo Group ID.

13.2.95 Void

13.2.96 Void

13.2.97 /<x>/<x>/OffNetwork/MCVideoGroupList/<x>/Entry/GMSServID

Table 13.2.97.1: /<x>/<x>/OffNetwork/MCVideoGroupList/<x>/Entry/GMSServID

<x>/OffNetwork/MCVideoGroupList/<x>/Entry/GMSServID

Status	Occurrence	Format	Min. Access Types
Optional	One	chr	Get, Replace

This leaf node indicates the identity (URI) of the group management server hosting the MCVideo Group ID.

13.2.98 Void

13.2.99 Void

13.2.100 /<x>/<x>/OffNetwork/MCVideoGroupList/<x>/Entry/
IdMSTokenEndPoint**Table 13.2.100.1: /<x>/<x>/OffNetwork/MCVideoGroupList/<x>/Entry/IdMSTokenEndPoint**

<x>/OffNetwork/MCVideoGroupList/<x>/Entry/IdMSTokenEndPoint

Status	Occurrence	Format	Min. Access Types
Optional	One	chr	Get, Replace

This leaf node indicates the identity (URI) of the identity management server hosting the MCVideo Group ID.

13.2.100A Void

13.2.100B Void

13.2.100C /<x>/<x>/OffNetwork/MCVideoGroupList/<x>/Entry/
GroupKMSURI**Table 13.2.100C.1: /<x>/<x>/OffNetwork/MCVideoGroupList/<x>/Entry/GroupKMSURI**

<x>/OffNetwork/MCVideoGroupList/<x>/Entry/GroupKMSURI

Status	Occurrence	Format	Min. Access Types
Required	One	chr	Get, Replace

This leaf node indicates the identity (URI) of the KMS identity (URI) for a specific group contained in the off-network MCVideoGroupList. If the value is empty, the KMS identity (URI) (kms) present in the MCS UE initial configuration MO is used.

13.2.101 /<x>/<x>/OffNetwork/MCVideoGroupList/<x>/Entry/
RelativePresentationPriority**Table 13.2.101.1: /<x>/<x>/OffNetwork/MCVideoGroupList/<x>/Entry/RelativePresentationPriority**

<x>/OffNetwork/MCVideoGroupList/<x>/Entry/RelativePresentationPriority

Status	Occurrence	Format	Min. Access Types
Optional	One	int	Get, Replace

This leaf node indicates indicating the presentation priority of the off-network group for the MCVideo user relative to other off-network groups and off-network users.

- Values: 0-255

The lowest RelativePresentationPriority value shall be considered as the MCVideo group transaction having the lowest priority for presentation among other group MCVideo and one-to-one user transactions.

13.2.102 /<x>/<x>/OffNetwork/UserInfoID

Table 13.2.102.1: /<x>/<x>/OffNetwork/UserInfoID

<x>/OffNetwork/UserInfoID

Status	Occurrence	Format	Min. Access Types
Required	One	chr	Get, Replace

This leaf node indicates the ProSe user info ID as specified in 3GPP TS 23.303 [6].

13.2.102A /<x>/<x>/OffNetwork/EmergencyCallChange

Table 13.2.102A.1: /<x>/<x>/OffNetwork/EmergencyCallChange

<x>/OffNetwork/EmergencyCallChange

Status	Occurrence	Format	Min. Access Types
Required	One	bool	Get, Replace

This leaf node indicates the authorization for a participant to change an off-network group call in-progress to an off-network MCVideo emergency group call.

When set to "true" the MCVideo user is authorised to change an MCVideo emergency group call.

When set to "false" the MCVideo user is not authorised to change an MCVideo emergency group call.

13.2.102B /<x>/<x>/OffNetwork/ImminentPerilCallChange

Table 13.2.102B.1: /<x>/<x>/OffNetwork/ImminentPerilCallChange

<x>/OffNetwork/ImminentPerilCallChange

Status	Occurrence	Format	Min. Access Types
Required	One	bool	Get, Replace

This leaf node indicates the authorization for a participant to change an off-network group call in-progress to an off-network MCVideo imminent peril group call.

When set to "true" the MCVideo user is authorised to change an MCVideo imminent peril group call.

When set to "false" the MCVideo user is not authorised to change an MCVideo imminent peril group call.

13.2.103 /<x>/Status

Table 13.2.103.1: /<x>/Status

Status

Status	Occurrence	Format	Min. Access Types
Optional	One	bool	Get, Replace

This leaf node indicates whether this MCVideo user profile is enabled or disabled.

When set to "true" this MCVideo user profile is enabled.

When set to "false" this MCVideo user profile is disabled.

14 MCVideo service configuration MO

14.1 General

The MCVideo service configuration Management Object (MO) is used to configure MCVideo Client behaviour for the on-network or off-network MCVideo Service. The MCVideo service configuration parameters may be stored in the ME, or in the USIM as specified in 3GPP TS 31.102 [10], or in both the ME and the USIM. If both the ME and the USIM contain the same parameters, the values stored in the USIM shall take precedence.

The Management Object Identifier is: urn:oma:mo:ext-3gpp-MCVideo-service-configuration:1.0.

Protocol compatibility: This MO is compatible with OMA OMA DM 1.2 [3].

The OMA DM ACL property mechanism (see OMA OMA-ERELED-DM-V1_2 [2]) may be used to grant or deny access rights to OMA DM servers in order to modify nodes and leaf objects of the MCVideo service configuration MO.

The following nodes and leaf objects are possible under the MCVideo service configuration node as described in figure 14.1.1.

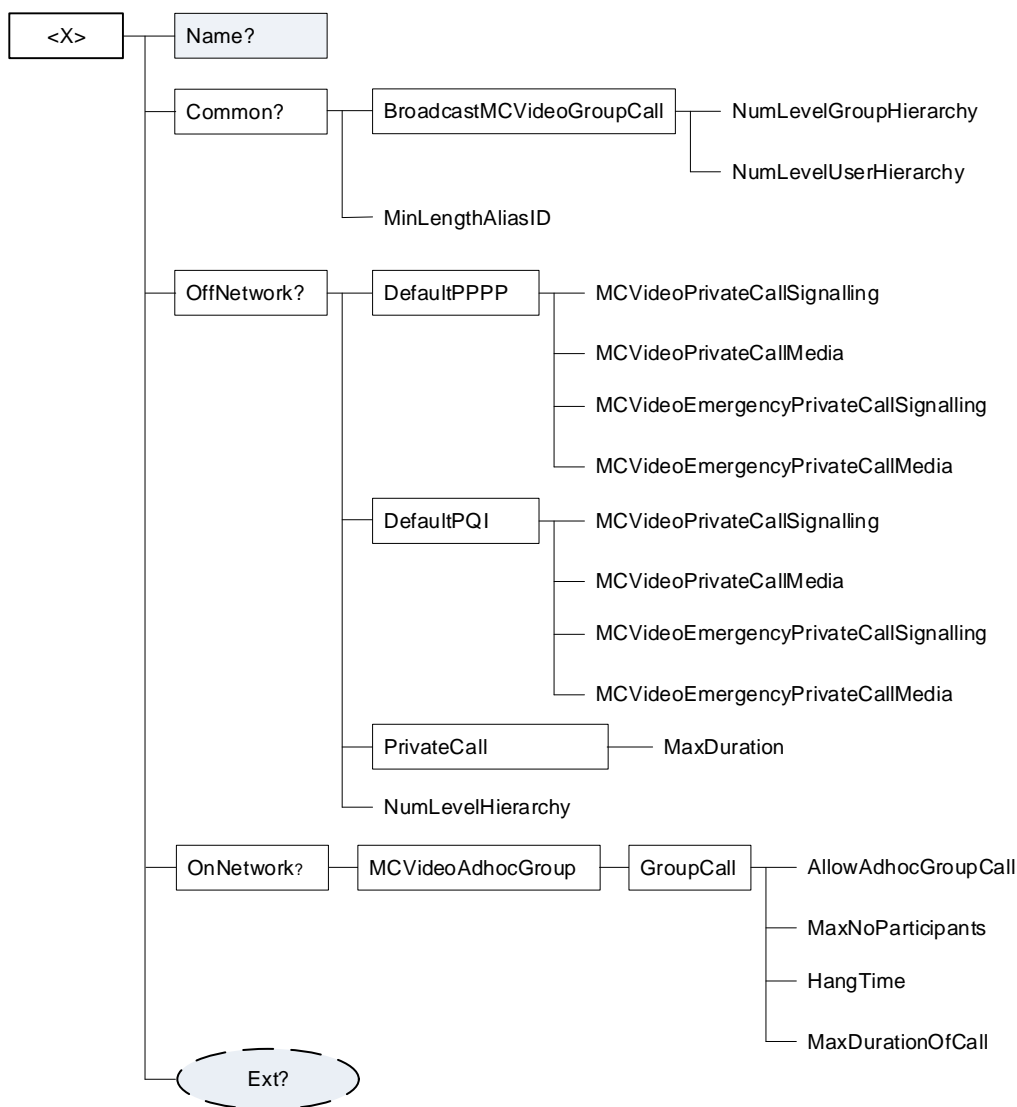

Figure 14.1.1: The MCVideo service configuration MO

14.2 MCVideo service configuration MO parameters

14.2.1 General

This clause describes the parameters for the MCVideo service configuration Management Object (MO).

14.2.2 Node: <x>

Table 14.2.2.1: Node: <x>

<x>

Status	Occurrence	Format	Min. Access Types
Required	OneOrMore	node	Get

This interior node acts as a placeholder for the MCVideo service configuration Management Object (MO).

For the MCVideo service configuration MO, the namespace specific string is: "urn:oma:mo:oma-dm-mcvideo-service configuration:1.0"

- Values: N/A

14.2.3 /<x>/Name

Table 14.2.3.1: /<x>/Name

Name

Status	Occurrence	Format	Min. Access Types
Required	ZeroOrOne	chr	Get

The Name leaf is a name for the MCVideo service configuration settings.

- Values: <User displayable name>

14.2.4 /<x>/Ext/

Table 14.2.4.1: /<x>/Ext/

Ext

Status	Occurrence	Format	Min. Access Types
Optional	ZeroOrOne	node	Get, Replace

The Ext is an interior node for where the vendor specific information about the MCVideo service configuration MO is being placed.

Usually the vendor extension is identified by vendor specific name under the ext node and contains the vendor meaning application vendor, device vendor etc. The tree structure under the vendor identified is not defined and can therefore include one or more un-standardized sub-trees.

- Values: N/A

14.2.5 /<x>/Common

Table 14.2.5.1: /<x>/Common

Common

Status	Occurrence	Format	Min. Access Types
Required	ZeroOrOne	node	Get, Replace

This interior node represents a container for the common network operation which means both on-network operation and off-network operation.

14.2.6 `<x>/Common/BroadcastMCVideoGroupCall`

Table 14.2.6.1: `<x>/Common/BroadcastMCVideoGroupCall`

Common/BroadcastMCVideoGroupCall

Status	Occurrence	Format	Min. Access Types
Required	One	node	Get, Replace

This interior node is a placeholder for Broadcast MCVideo Group Call configuration.

14.2.7 `<x>/Common/BroadcastMCVideoGroupCall/NumLevelGroupHierarchy`

Table 14.2.7.1: `<x>/Common/BroadcastMCVideoGroupCall/NumLevelGroupHierarchy`

Common/BroadcastMCVideoGroupCall/NumLevelGroupHierarchy

Status	Occurrence	Format	Min. Access Types
Required	One	int	Get, Replace

This leaf node indicates the number of levels of group hierarchy for group-broadcast groups.

- Values: 0-255

The group-broadcast group with the lowest NumLevelGroupHierarchy value shall be considered as the group-broadcast group having the lowest level among the groups.

14.2.8 `<x>/Common/BroadcastMCVideoGroupCall/NumLevelUserHierarchy`

Table 14.2.8.1: `<x>/Common/BroadcastMCVideoGroupCall/NumLevelUserHierarchy`

Common/BroadcastMCVideoGroupCall/NumLevelUserHierarchy

Status	Occurrence	Format	Min. Access Types
Required	One	int	Get, Replace

This leaf node indicates the number of levels of user hierarchy for user-broadcast groups.

- Values: 0-255

The user-broadcast group with the lowest NumLevelUserHierarchy value shall be considered as the user-broadcast group the lowest level among the groups.

14.2.9 `<x>/Common/MinLengthAliasID`

Table 14.2.9.1: `<x>/Common/MinLengthAliasID`

Common/MinLengthAliasID

Status	Occurrence	Format	Min. Access Types
Required	One	int	Get, Replace

This leaf node indicates minimum length of an alphanumeric identifier (i.e., alias) assigned by an MCVideo administrator.

- Values: 0-255

14.2.10 /<x>/OffNetwork

Table 14.2.10.1: /<x>/OffNetwork

OffNetwork

Status	Occurrence	Format	Min. Access Types
Required	ZeroOrOne	node	Get, Replace

This interior node represents a container for off-network operation.

14.2.11 /<x>/OffNetwork/DefaultPPPP

Table 14.2.11.1: /<x>/OffNetwork/DefaultPPPP

OffNetwork/DefaultPPPP

Status	Occurrence	Format	Min. Access Types
Required	One	node	Get, Replace

This interior node is a placeholder for the default ProSe Per-Packet Priority (PPPP) configuration.

14.2.12 /<x>/OffNetwork/DefaultPPPP/MCVideoPrivateCallSignalling

Table 14.2.12.1: /<x>/OffNetwork/DefaultPPPP/MCVideoPrivateCallSignalling

OffNetwork/DefaultPPPP/MCVideoPrivateCallSignalling

Status	Occurrence	Format	Min. Access Types
Required	One	int	Get, Replace

This leaf node indicates the default ProSe Per-Packet Priority (PPPP) value (as specified in 3GPP TS 23.303 [6]) for the MCVideo private call signalling.

- Values: 1-8

The MCVideo user data with the lowest ProSe Per-Packet Priority value shall be considered as the MCVideo user data having the highest priority among the MCVideo user data.

14.2.13 /<x>/OffNetwork/DefaultPPPP/MCVideoPrivateCallMedia

Table 14.2.13.1: /<x>/OffNetwork/DefaultPPPP/MCVideoPrivateCallMedia

OffNetwork/DefaultPPPP/MCVideoPrivateCallMedia

Status	Occurrence	Format	Min. Access Types
Required	One	int	Get, Replace

This leaf node indicates the default ProSe Per-Packet Priority (PPPP) value (as specified in 3GPP TS 23.303 [6]) for the MCVideo private call media.

- Values: 1-8

The MCVideo user data with the lowest ProSe Per-Packet Priority value shall be considered as the MCVideo user data having the highest priority among the MCVideo user data.

14.2.14 /<x>/OffNetwork/DefaultPPPP/ MCVideoEmergencyPrivateCallSignalling

Table 14.2.14.1: /<x>/OffNetwork/DefaultPPPP/MCVideoEmergencyPrivateCallSignalling

OffNetwork/DefaultPPPP/MCVideoEmergencyPrivateCallSignalling

Status	Occurrence	Format	Min. Access Types
Required	One	int	Get, Replace

This leaf node indicates the default ProSe Per-Packet Priority (PPPP) value (as specified in 3GPP TS 23.303 [6]) for the MCVideo emergency private call signalling.

- Values: 1-8

The MCVideo user data with the lowest ProSe Per-Packet Priority value shall be considered as the MCVideo user data having the highest priority among the MCVideo user data.

14.2.15 /<x>/OffNetwork/DefaultPPPP/ MCVideoEmergencyPrivateCallMedia

Table 14.2.15.1: /<x>/OffNetwork/DefaultPPPP/MCVideoEmergencyPrivateCallMedia

OffNetwork/DefaultPPPP/MCVideoEmergencyPrivateCallMedia

Status	Occurrence	Format	Min. Access Types
Required	One	int	Get, Replace

This leaf node indicates the default ProSe Per-Packet Priority (PPPP) value (as specified in 3GPP TS 23.303 [6]) for the MCVideo emergency private call media.

- Values: 1-8

The MCVideo user data with the lowest ProSe Per-Packet Priority value shall be considered as the MCVideo user data having the highest priority among the MCVideo user data.

14.2.15A/<x>/OffNetwork/DefaultPQI

Table 14.2.15A.1: /<x>/OffNetwork/DefaultPQI

OffNetwork/DefaultPQI

Status	Occurrence	Format	Min. Access Types
Required	One	node	Get, Replace

This interior node is a placeholder for the default PQI configuration.

14.2.15B /<x>/OffNetwork/DefaultPQI/MCVideoPrivateCallSignalling

Table 14.2.15B.1: /<x>/OffNetwork/DefaultPQI/MCVideoPrivateCallSignalling

OffNetwork/DefaultPQI/MCVideoPrivateCallSignalling

Status	Occurrence	Format	Min. Access Types
Required	One	int	Get, Replace

This leaf node indicates the default PQI value (as specified in 3GPP TS 23.304 [25]) for the MCVideo private call signalling.

- Values: 21-26, 55-61, 90-93

The MCVideo user data with the lowest PQI value shall be considered as the MCVideo user data having the highest priority among the MCVideo user data.

14.2.15C /<x>/OffNetwork/DefaultPQI/MCVideoPrivateCallMedia

Table 14.2.15C.1: /<x>/OffNetwork/DefaultPQI/MCVideoPrivateCallMedia

OffNetwork/DefaultPQI/MCVideoPrivateCallMedia

Status	Occurrence	Format	Min. Access Types
Required	One	int	Get, Replace

This leaf node indicates the default PQI value (as specified in 3GPP TS 23.304 [25]) for the MCVideo private call media.

- Values: 21-26, 55-61, 90-93

The MCVideo user data with the lowest PQI value shall be considered as the MCVideo user data having the highest priority among the MCVideo user data.

14.2.15D /<x>/OffNetwork/DefaultPQI/MCVideoEmergencyPrivateCallSignalling

Table 14.2.15D.1: /<x>/OffNetwork/DefaultPQI/MCVideoEmergencyPrivateCallSignalling

OffNetwork/DefaultPQI/MCVideoEmergencyPrivateCallSignalling

Status	Occurrence	Format	Min. Access Types
Required	One	int	Get, Replace

This leaf node indicates the default PQI value (as specified in 3GPP TS 23.304 [25]) for the MCVideo emergency private call signalling.

- Values: 21-26, 55-61, 90-93

The MCVideo user data with the lowest PQI value shall be considered as the MCVideo user data having the highest priority among the MCVideo user data.

14.2.15E /<x>/OffNetwork/DefaultPQI/MCVideoEmergencyPrivateCallMedia

Table 14.2.15E.1: /<x>/OffNetwork/DefaultPQI/MCVideoEmergencyPrivateCallMedia

OffNetwork/DefaultPQI/MCVideoEmergencyPrivateCallMedia

Status	Occurrence	Format	Min. Access Types
Required	One	int	Get, Replace

This leaf node indicates the default PQI value (as specified in 3GPP TS 23.304 [25]) for the MCVideo emergency private call media.

- Values: 21-26, 55-61, 90-93

The MCVideo user data with the lowest PQI value shall be considered as the MCVideo user data having the highest priority among the MCVideo user data.

14.2.16 /<x>/OffNetwork/PrivateCall

Table 14.2.16.1: /<x>/OffNetwork/PrivateCall

OffNetwork/PrivateCall

Status	Occurrence	Format	Min. Access Types
Required	One	node	Get, Replace

This interior node is a placeholder for private call configuration.

14.2.17 /<x>/OffNetwork/PrivateCall/MaxDuration

Table 14.2.17.1: /<x>/OffNetwork/PrivateCall/MaxDuration

OffNetwork/PrivateCall/MaxDuration

Status	Occurrence	Format	Min. Access Types
Required	One	int	Get, Replace

This leaf node indicates max private call duration.

- Values: 0-65535

The MaxDuration time is in seconds.

14.2.18 /<x>/OffNetwork/NumLevelHierarchy

Table 14.2.18.1: /<x>/OffNetwork/NumLevelHierarchy

OffNetwork/NumLevelHierarchy

Status	Occurrence	Format	Min. Access Types
Required	One	int	Get, Replace

This leaf node indicates the number of levels of hierarchy for transmission control override in off-network.

- Values: 4-256

The request with the lowest NumLevelHierarchy value shall be considered as the request having the lowest priority level given to override an active transmission among the requests.

14.2.19 /<x>/OnNetwork

Table 14.2.19.1: /<x>/OnNetwork

OnNetwork

Status	Occurrence	Format	Min. Access Types
Required	ZeroOrOne	node	Get, Replace

This interior node represents a container for on-network operation.

14.2.20 /<x>/OnNetwork/MCVideoAdhocGroup

Table 14.2.20.1: /<x>/OnNetwork/MCVideoAdhocGroup

OnNetwork/MCVideoAdhocGroup

Status	Occurrence	Format	Min. Access Types
Required	One	node	Get, Replace

This interior node is a placeholder for the MCVideo adhoc group call related configurations.

14.2.21 /<x>/OnNetwork/MCVideoAdhocGroup/GroupCall

Table 14.2.21.1: /<x>/OnNetwork/MCVideoAdhocGroup/GroupCall

OnNetwork/MCVideoAdhocGroup/GroupCall

Status	Occurrence	Format	Min. Access Types
Required	One	node	Get, Replace

This interior node is a placeholder for the MCVideo adhoc group call policy and configurations.

14.2.22 /<x>/OnNetwork/MCVideoAdhocGroup/GroupCall/ AllowAdhocGroupCall

Table 14.2.22.1: /<x>/OnNetwork/MCVideoAdhocGroup/GroupCall/AllowAdhocGroupCall

OnNetwork/MCVideoAdhocGroup/GroupCall/AllowAdhocGroupCall

Status	Occurrence	Format	Min. Access Types
Required	One	bool	Get, Replace

This leaf node indicates whether on-network adhoc group calls support enabled or disabled.

When set to "true" the MCVideo system supports the adhoc group call and is enabled to allow the MCVideo users to make an MCVideo adhoc group call.

When set to "false" the MCVideo system supports the adhoc group call and is disabled to not allow the MCVideo users to make an MCVideo adhoc group call.

14.2.23 /<x>/OnNetwork/MCVideoAdhocGroup/GroupCall/ MaxNoParticipants

Table 14.2.23.1: /<x>/OnNetwork/MCVideoAdhocGroup/GroupCall/MaxNoParticipants

OnNetwork/MCVideoAdhocGroup/GroupCall/MaxNoParticipants

Status	Occurrence	Format	Min. Access Types
Required	One	int	Get, Replace

This leaf node indicates maximum number of participants allowed in an adhoc group call and the value is left to deployment requirement.

14.2.24 /<x>/OnNetwork/MCVideoAdhocGroup/GroupCall/HangTime

Table 14.2.24.1: /<x>/OnNetwork/MCVideoAdhocGroup/GroupCall/HangTime

OnNetwork/MCVideoAdhocGroup/GroupCall/HangTime

Status	Occurrence	Format	Min. Access Types
Required	One	int	Get, Replace

This leaf node indicates hang timer for adhoc group calls.

- Values: 0-65535

The HangTime is in seconds.

14.2.25 /<x>/OnNetwork/MCVideoAdhocGroup/GroupCall/MaxDurationOfCall

Table 14.2.25.1: /<x>/OnNetwork/MCVideoAdhocGroup/GroupCall/MaxDurationOfCall

OnNetwork/MCVideoAdhocGroup/GroupCall/MaxDurationOfCall

Status	Occurrence	Format	Min. Access Types
Required	One	int	Get, Replace

This leaf node indicates max adhoc group call duration.

- Values: 0-65535

The MaxDurationOfCall time is in seconds.

Annex A (informative): MCPTT UE configuration MO DDF

This DDF is the standardized minimal set. A vendor can define its own DDF for the complete device. This DDF can include more features than this minimal standardized version. The DDF is included as an XML file.

Annex B (informative): MCPTT user profile MO DDF

This DDF is the standardized minimal set. A vendor can define its own DDF for the complete device. This DDF can include more features than this minimal standardized version. The DDF is included as an XML file.

Annex C (informative): MCS group configuration MO DDF

This DDF is the standardized minimal set. A vendor can define its own DDF for the complete device. This DDF can include more features than this minimal standardized version. The DDF is included as an XML file.

Annex D (informative): MCPTT service configuration MO DDF

This DDF is the standardized minimal set. A vendor can define its own DDF for the complete device. This DDF can include more features than this minimal standardized version. The DDF is included as an XML file.

Annex E (informative): MCS UE initial configuration MO DDF

This DDF is the standardized minimal set. A vendor can define its own DDF for the complete device. This DDF can include more features than this minimal standardized version. The DDF is included as an XML file.

Annex F (informative): MCVideo UE configuration MO DDF

This DDF is the standardized minimal set. A vendor can define its own DDF for the complete device. This DDF can include more features than this minimal standardized version. The DDF is included as an XML file.

Annex G (informative): MCVideo user profile configuration MO DDF

This DDF is the standardized minimal set. A vendor can define its own DDF for the complete device. This DDF can include more features than this minimal standardized version. The DDF is included as an XML file.

Annex H (informative): MCVideo service configuration MO DDF

This DDF is the standardized minimal set. A vendor can define its own DDF for the complete device. This DDF can include more features than this minimal standardized version. The DDF is included as an XML file.

Annex I (informative): MCData UE configuration MO DDF

This DDF is the standardized minimal set. A vendor can define its own DDF for the complete device. This DDF can include more features than this minimal standardized version. The DDF is included as an XML file.

Annex J (informative): MCData user profile configuration MO DDF

This DDF is the standardized minimal set. A vendor can define its own DDF for the complete device. This DDF can include more features than this minimal standardized version. The DDF is included as an XML file.

Annex K (informative): MCData service configuration MO DDF

This DDF is the standardized minimal set. A vendor can define its own DDF for the complete device. This DDF can include more features than this minimal standardized version. The DDF is included as an XML file.

Annex L (normative): MO specific concepts for the support of mission critical services over 5GS

L.1 General

The present document applies to both EPS and 5GS. This annex lists the aspects of Mission Critical Services (MCSs) Management Objects (MO) which are different in 5GS from EPS. Certain aspects that are only applicable to EPS are described in clause L.2. 5GS-specific concepts are captured in clause L.3. A mapping of EPS-specific terms to their 5GS equivalents is provided in clause L.4.

L.2 Aspects not applicable to 5GS

The following aspects of EPS mentioned in the present document are not applicable to 5GS:

- Multimedia Broadcast and Multicast Service (MBMS) and the corresponding MOs.

L.3 5GS specific aspects not applicable to EPS

In order to identify a Network Slice end to end, the 5GS uses information called S-NSSAI (Single Network Slice Selection Assistance Information) as specified in 3GPP TS 23.501 [23]. Network slicing and the S-NSSAI related configuration are not applicable to EPS.

L.4 Mapping of EPS-specific terms to 5GS

In 5GS, the PDU session is the equivalent of a PDN connection in EPS. The requirements and configurations for a PDN connection throughout this document shall also apply to PDU sessions. For example, in 5GS, the Data Network Name (DNN) is the equivalent of an APN in EPS as specified in 3GPP TS 23.003 [5]. The requirements and configurations for an APN throughout this document shall apply to 5GS as well.

When using the 5GS, a bearer is provided by a 5GS QoS flow. The requirements, procedures, and configurations for a bearer throughout this document, including those stating EPS explicitly (e.g., EPS bearer priority), shall also apply to QoS flows.

The MOs defined in this specification are reused for off-network communication and on-network communication (i.e. UE-to-network relay) for MC service over 5G ProSe with following differences:

- ProSe direct discovery for public safety shall be replaced with 5G ProSe direct discovery, as specified in 3GPP TS 24.554 [26];
- ProSe direct communication shall be replaced with 5G ProSe direct communication, as specified in 3GPP TS 24.554 [26];
- ProSe UE-to-network relay shall be replaced with 5G ProSe UE-to-network relay, as specified in 3GPP TS 24.554 [26];
- default ProSe Per-Packet Priority (PPPP) is replaced by default 5G ProSe PC5 5QI (PQI) as specified in the present specification; and
- the discovery group ID is replaced by application layer group ID as specified in the present specification.

Annex M (informative): Change history

Change history							
Date	TSG #	TSG Doc.	CR	Rev	Subject/Comment	Old	New
2015-07					Initial proposal to CT1	-	0.0.0
2015-08					Included skeleton from C1ah-150016 and scope from C1ah-150038 agreed at CT1#92bis	0.0.0	0.10
2015-08					Included CRs C1-152964 and C1-152965 agreed at CT1#93	0.1.0	0.2.0
2015-08					Revision number changed due to cover sheet modifications	0.2.0	0.2.1
2015-09					Modifying the cover sheet to add the TS number. Changes by the rapporteur.	0.2.1	0.2.2
2015-10					Included CRs C1-153754, and C1-153755 agreed at CT1#94	0.2.2	0.3.0
2016-01					Included CRs C1-160352, C1-160474, C1-160475, C1-160476, C1-160477 and C1-160478 agreed at CT1#95bis	0.3.0	0.4.0
2016-01					Editorial and formatting fixes	0.4.0	0.4.1
2016-02					Included CRs C1-161077, C1-161078, C1-161231, C1-161324, C1-161326, C1-161327, C1-161509 and C1-161510 agreed at CT1#96 Editorial and formatting fixes by the rapporteur.	0.4.1	0.5.0
2016-03	CT-71	CP-160056			Version 1.0.0 created for presentation for information and approval	0.5.0	1.0.0
2016-03	CT-71				Version 13.0.0 created after approval	1.0.0	13.0.0
2016-03					An editorial change from TS rapporteur	13.0.0	13.0.10
2016-06	CT-72	CP-160322	0002	1	Corrections to the scope of MCPTT Management Object (MO)	13.0.1	13.1.0
2016-06	CT-72	CP-160322	0003	3	Correction for MCPTT UE configuration management object (MO)	13.0.1	13.1.0
2016-06	CT-72	CP-160322	0004	3	Correction for MCPTT user profile management object (MO)	13.0.1	13.1.0
2016-06	CT-72	CP-160322	0005	2	Correction for MCPTT group configuration management object (MO)	13.0.1	13.1.0
2016-06	CT-72	CP-160322	0006	1	Correction for MCPTT service configuration management object (MO)	13.0.1	13.1.0
2016-06	CT-72	CP-160322	0007	3	Correction for MCPTT UE initial configuration management object (MO)	13.0.1	13.1.0
2016-06	CT-72	CP-160322	0011		Correction for security configuration parameters in MCPTT management object (MO)	13.0.1	13.1.0

Change history							
Date	Meeting	TDoc	CR	Rev	Cat	Subject/Comment	New version
2016-09	CT#73	CP-160565	0013	3	F	Correction for configuration parameters in MCPTT user profile management object (MO)	13.2.0
2016-09	CT#73	CP-160503	0014	1	F	Correction for group related parameters in MCPTT UE initial configuration management object (MO)	13.2.0
2016-09	CT#73	CP-160503	0015	1	F	Correction for security material parameter in MCPTT group configuration management object (MO)	13.2.0
2016-09	CT#73	CP-160503	0016		F	Correction for "MCPTTGroupPriorityHierarchy" value in MCPTT UE configuration management object (MO)	24.383 13.2.0
2016-12	CT#74					Change of spec number from 24.383 to 24.483 with wider scope and changed title	24.483 13.2.1
2016-12	CT#74	CP-160733	0018	1	F	Identity management endpoint UE initial configuration MO correction (24.383 CR)	13.3.0
2016-12	CT#74	CP-160733	0019	1	F	Correction for ProSe related configuration parameters (24.383 CR)	13.3.0
2016-12	CT#74	CP-160733	0020	3	F	Correction for MCPTT Private Call and Group Call in MCPTT user profile management (MO) (24.383 CR)	13.3.0
2016-12	CT#74	CP-160733	0021		F	Modify number of levels for priority hierarchy (24.383 CR)	13.3.0
2016-12	CT#74	CP-160733	0022	1	F	Identification of pre-selected MCPTT user profile in MCPTT user profile managed object. (24.383 CR)	13.3.0
2016-12	CT#74	CP-160734	0023	2	F	Off-network configuration parameter for queue (24.383 CR)	13.3.0
2017-03	CT#75	CP-170117	0001	2	F	Scope alignment with TS 24.483 title	13.4.0
2017-03	CT#75	CP-170117	0004		F	Corrections to upper limits	13.4.0
2017-03	CT#75	CP-170127	0002	1	F	Modifying references in TS 24.483 to cater for rel-14 Stage 2 and Stage 3 mission critical restructure	14.0.0
2017-03	CT#75	CP-170127	0003	1	F	Corrections and clean-up for 24.483	14.0.0
2017-03	CT#75	CP-170125	0005	1	B	MCPTT user profile MO modifications in support of private call call-back	14.0.0
2017-06	CT#76	CP-171080	0006		B	Updating general parts of TS 24.483 for MCDData, MCVideo and the initial configuration MO	14.1.0
2017-06	CT#76	CP-171080	0007	2	B	Modifications to the Group Configuration MO for MCDData and MCVideo	14.1.0
2017-06	CT#76	CP-171081	0008	1	B	MCVideo UE configuration MO	14.1.0
2017-06	CT#76	CP-171081	0009	2	B	MCVideo user profile configuration MO	14.1.0
2017-06	CT#76	CP-171081	0010		B	MCVideo service configuration MO	14.1.0
2017-06	CT#76	CP-171080	0011	2	B	MCDData UE configuration MO	14.1.0
2017-06	CT#76	CP-171080	0012	2	B	MCDData user profile configuration MO	14.1.0
2017-06	CT#76	CP-171080	0013	1	B	MCDData service configuration MO	14.1.0
2017-06	CT#76	CP-171114	0014	1	B	eMCPTT user profile MO updates	14.1.0
2017-06	CT#76	CP-171113	0016	1	A	AllowedFloorControlProtection configuration parameter	14.1.0
2017-06	CT#76	CP-171113	0018		A	QueueUsage configuration parameter	14.1.0
2017-06	CT#76	CP-171082	0019	1	F	Correction of User Aliases configuration parameter in the MCPTT user profile MO	14.1.0
2017-09	CT#77	CP-172101	0020	1	B	User profile MO additions for eMCPTT	14.2.0
2017-09	CT#77	CP-172096	0022	1	A	Clause 4 - Correction of occurrences of parameters	14.2.0
2017-09	CT#77	CP-172104	0025		F	Clause 6 - Correction of occurrences of parameters	14.2.0
2017-09	CT#77	CP-172102	0026	1	F	Clause 9 - Correction of occurrences of parameters	14.2.0
2017-09	CT#77	CP-172143	0028	2	F	Specify KMS-URI configuration for MCDATA in the MCDData User Profile Management Object.	14.2.0
2017-09	CT#77	CP-172144	0029	2	F	Clause 10 - Correction of names and formats of some parameters	14.2.0
2017-09	CT#77	CP-172104	0030		F	Clause 12 - Correction of occurrences of parameters	14.2.0
2017-09	CT#77	CP-172104	0031		F	Clause 13 - Correction of occurrences of parameters and their graphical representation	14.2.0
2017-09	CT#77	CP-172096	0032	2	A	Clause 8 – Inclusion of missing timer TFG14	14.2.0
2017-09	CT#77	CP-172096	0034	1	A	Include missing elements in MCPTT UE initial configuration MO	14.2.0
2017-09	CT#77	CP-172134	0037		F	DDF files for TS 24.483	14.2.0
2017-12	CT#78	CP-173066	0039	1	F	Off-network MCVideo configurations	14.3.0
2017-12	CT#78	CP-173073	0038	1	B	Authorisation parameters for remotely initiated calls - user profile MO	15.0.0
2018-03	CT#79	CP-180087	0040	1	B	User profile MO updates for functional alias	15.1.0
2018-03	CT#79	CP-180072	0042	1	A	User profile presentation priority	15.1.0
2018-06	CT#80	CP-181064	0043		F	Unique ID leaf node for enhanced status operational value	15.2.0
2018-09	CT#81	CP-182149	0045	2	B	Location of Talker	15.3.0
2018-09	CT#81	CP-182148	0046		B	Reception Priority	15.3.0
2019-03	CT#83	CP-190078	0051	1	A	Correction of MO counter names CFx11 and CFx12	15.4.0
2019-03	CT#83	CP-190078	0055	1	A	Remove T230 from TS 24.483	15.4.0
2019-03	CT#83	CP-190103	0048	2	F	24.483 Server URI and IP version additions	16.0.0
2019-03	CT#83	CP-190103	0052	1	F	Correction of Annex C and Annex E	16.0.0
2019-09	CT#85	CP-192066	0057	1	B	Restricting incoming private communications MO	16.1.0
2019-12	CT#86	CP-193110	0058	1	B	MO for limiting the number of emergency group calls for a specific functional alias	16.2.0

2019-12	CT#86	CP-193110	0059	1	B	Automatic activation and deactivation of functional aliases based on location	16.2.0
2019-12	CT#86	CP-193082	0063		A	Correction of single timer TFP2 mistakenly use for two different purposes	16.2.0
2019-12	CT#86	CP-193110	0065		B	List of MCPTT group members who did not acknowledge the group call request	16.2.0
2020-03	CT#87e	CP-200122	0064	3	B	Automatic group affiliation and deaffiliation based on location or functional alias	16.3.0
2020-03	CT#87e	CP-200115	0066	1	C	Included absolute URI associated with the media storage function of MCDData content server	16.3.0
2020-06	CT#88e	CP-201124	0067	1	B	Error! Unknown document property name.	16.4.0
2020-06	CT#88e	CP-201086	0071	1	A	Error! Unknown document property name.	16.4.0
2020-06	CT#88e	CP-201124	0072	1	B	Add PointCoordinate, Speed, Heading nodes in 5.2.48W	16.4.0
2020-06	CT#88e	CP-201124	0073	1	D	Correct capitalisation in ListOfFunctionalaliases	16.4.0
2020-06	CT#88e	CP-201124	0074	1	B	MCDData FA (de)affiliation by location criteria MOs	16.4.0
2020-06	CT#88e	CP-201124	0075	1	B	MCDData Functional Alias by location criteria	16.4.0
2020-06	CT#88e	CP-201121	0076		F	Correction of node formats	16.4.0
2020-06	CT#88e	CP-201112	0077	1	B	Included the MessageStoreHostname element	16.4.0
2020-06	CT#88e	CP-201124	0078	1	F	Restricting incoming MCDData communications MO	16.4.0
2020-09	CT#89e	CP-202165	0081		F	MOs Corrections related to MONASTERY2 CRs implementation	16.5.0
2020-09	CT#89e	CP-202178	0080	1	B	Add PreconfiguredGroupUseOnly MO	17.0.0
2020-12	CT#90e	CP-203184	0086	2	F	Inclusion of Functional Alias related configurations for MCVideo service	17.1.0
2021-03	CT#91e	CP-210125	0088	1	B	MOs to restrict MCVideo private communications	17.2.0
2021-03	CT#91e	CP-210128	0089	2	F	Corrections to figures and text in clause 5 MCPTT user profile MO	17.2.0
2021-03	CT#91e	CP-210128	0090	1	F	Corrections, addition of missing reference, and editorials to clause 6 MCS group configuration MO	17.2.0
2021-03	CT#91e	CP-210128	0092	1	F	Corrections to clause 10 MCDData user profile MO	17.2.0
2021-03	CT#91e	CP-210128	0093	1	F	Corrections to clause 13 MCVideo user profile MO	17.2.0
2021-03	CT#91e	CP-210128	0094		D	Editorials to multiple Annexes A, B, and D	17.2.0
2021-03	CT#91e	CP-210125	0095	1	B	Call transfer for MCPTT private call, Management Object part	17.2.0
2021-03	CT#91e	CP-210126	0096	1	B	Management object for APN configuration	17.2.0
2021-03	CT#91e	CP-210128	0097		D	Errors in clause 8	17.2.0
2021-03	CT#91e	CP-210125	0098	1	B	MO update to support allowed FAs	17.2.0
2021-06	CT#92e	CP-211154	0099	1	B	MO for limiting the number of MCDData emergency groups per FA	17.3.0
2021-06	CT#92e	CP-211125	0103	2	A	Correct MCVideo MOs R17	17.3.0
2021-06	CT#92e	CP-211154	0104	1	B	Call forwarding for MCPTT private call, Management Object part	17.3.0
2021-06	CT#92e	CP-211125	0108		A	Clause 12: name of node indicating the maximum number of private calls	17.3.0
2021-06	CT#92e	CP-211126	0111		A	Invalid MCPTT user profile MO DDF	17.3.0
2021-06	CT#92e	CP-211132	0113	1	A	Occurrence "ThreeToFifteen" in MCPTT user profile MO	17.3.0
2021-06	CT#92e	CP-211132	0115	1	A	Occurrence "ThreeToFifteen" in MCDData user profile MO	17.3.0
2021-06	CT#92e	CP-211154	0116	1	F	Occurrence "ThreeToFifteen" in MCVideo user profile MO	17.3.0
2021-06	CT#92e	CP-211157	0117	1	F	MO representation rules and MOs alignment	17.3.0
2021-09	CT#93e	CP-212113	0123		A	MCPTT user profile MO: occurrence of the node "Common"	17.4.0
2021-09	CT#93e	CP-212115	0127		A	MCDData user profile MO: occurrence of the node "Common"	17.4.0
2021-09	CT#93e	CP-212115	0131		A	MCVideo user profile MO: occurrence of the node "Common"	17.4.0
2021-09	CT#93e	CP-212123	0133		A	Occurrence of the ManualDeactivationNotAllowedIfLocationCriteriaMet	17.4.0
2021-12	CT#94e	CP-213029	0136	1	B	Functional alias association with group – MO configurations	17.5.0
2021-12	CT#94e	CP-213061	0139	1	B	User control of communications storage into message store – MO configurations	17.5.0
2021-12	CT#94e	CP-213059	0142	1	B	MO Annex with 5GS/EPS terminology alignment	17.5.0
2022-03	CT#95e	CP-220279	0143	1	B	Add support for authorization to initiate/upgrd and cancel emgcy one-to-one comms.	17.6.0
2022-03	CT#95e	CP-220279	0145	1	B	The hostname of the MCDData notification server(s) configured in the MCDData service configuration – MO	17.6.0
2022-06	CT#96	CP-221227	0149	2	B	5G DN and S-NSSAI Config	17.7.0
2022-06	CT#96	CP-221193	0153	1	A	Group info and presentation priorities, MO	17.7.0
2022-06	CT#96	CP-221225	0154	1	B	Update MCVideo user profile MO to indicate allowed FAs	17.7.0
2022-06	CT#96	CP-221227	0155		B	5GS QoS aspects in MO configuration	17.7.0
2022-09	CT#97	CP-222173	0158		D	Correcting MCDData user profile MO below IPIInformation	18.0.0
2022-09						Editorial correction	18.0.1
2023-09	CT#101	CP-232206	0160	2	B	Adhoc group communication related user profile and service configuration for MCPTT	18.1.0
2023-09	CT#101	CP-232206	0161	1	B	Adhoc group communication related user profile and service configuration for MCVideo	18.1.0
2023-12	CT#102	CP-233173	0159	4	B	PQI for MC over 5GProSe in 24.483	18.2.0
2023-12	CT#102	CP-233173	0163	3	B	MO for MCS over 5G ProSe	18.2.0
2023-12	CT#102	CP-233169	0164		B	Adhoc group call participants modify related user profile configuration – mgmt object MCPTT	18.2.0

2023-12	CT#102	CP-233169	0165		B	Adhoc group call participants modify related user profile configuration configuration – mgmt object MCVideo	18.2.0
2023-12	CT#102	CP-233169	0166	1	B	Adhoc group data comn participants modify related user profile configuration – mgmt object MCDData	18.2.0
2023-12	CT#102	CP-233169	0167		B	Adhoc group communication related user profile and service configuration – mgmt object MCDData	18.2.0
2023-12	CT#102	CP-233173	0168	1	B	Application Layer Group ID for MCS over 5G ProSe	18.2.0
2024-03	CT#103	CP-240113	0169		F	Adding default PQI configuration MO in figures	18.3.0
2024-09	CT#105	CP-242208	0185	1	A	Correction of SDS to allow indication of text charset	18.4.0

History

Document history		
V18.3.0	May 2024	Publication
V18.4.0	September 2024	Publication