

ETSI TS 124 501 V18.13.0 (2026-02)



TECHNICAL SPECIFICATION

**5G;
Non-Access-Stratum (NAS) protocol for 5G System (5GS);
Stage 3
(3GPP TS 24.501 version 18.13.0 Release 18)**



Reference

RTS/TSGC-0124501 vid0

Keywords

5G

ETSI

650 Route des Lucioles
F-06921 Sophia Antipolis Cedex - FRANCE

Tel.: +33 4 92 94 42 00 Fax: +33 4 93 65 47 16

Siret N° 348 623 562 00017 - APE 7112B
Association à but non lucratif enregistrée à la
Sous-Préfecture de Grasse (06) N° w061004871

Important notice

The present document can be downloaded from the
[ETSI Search & Browse Standards](#) application.

The present document may be made available in electronic versions and/or in print. The content of any electronic and/or print versions of the present document shall not be modified without the prior written authorization of ETSI. In case of any existing or perceived difference in contents between such versions and/or in print, the prevailing version of an ETSI deliverable is the one made publicly available in PDF format on [ETSI deliver](#) repository.

Users should be aware that the present document may be revised or have its status changed, this information is available in the [Milestones listing](#).

If you find errors in the present document, please send your comments to the relevant service listed under [Committee Support Staff](#).

If you find a security vulnerability in the present document, please report it through our [Coordinated Vulnerability Disclosure \(CVD\)](#) program.

Notice of disclaimer & limitation of liability

The information provided in the present deliverable is directed solely to professionals who have the appropriate degree of experience to understand and interpret its content in accordance with generally accepted engineering or other professional standard and applicable regulations.

No recommendation as to products and services or vendors is made or should be implied.

No representation or warranty is made that this deliverable is technically accurate or sufficient or conforms to any law and/or governmental rule and/or regulation and further, no representation or warranty is made of merchantability or fitness for any particular purpose or against infringement of intellectual property rights.

In no event shall ETSI be held liable for loss of profits or any other incidental or consequential damages.

Any software contained in this deliverable is provided "AS IS" with no warranties, express or implied, including but not limited to, the warranties of merchantability, fitness for a particular purpose and non-infringement of intellectual property rights and ETSI shall not be held liable in any event for any damages whatsoever (including, without limitation, damages for loss of profits, business interruption, loss of information, or any other pecuniary loss) arising out of or related to the use of or inability to use the software.

Copyright Notification

No part may be reproduced or utilized in any form or by any means, electronic or mechanical, including photocopying and microfilm except as authorized by written permission of ETSI.

The content of the PDF version shall not be modified without the written authorization of ETSI.

The copyright and the foregoing restriction extend to reproduction in all media.

© ETSI 2026.
All rights reserved.

Intellectual Property Rights

Essential patents

IPRs essential or potentially essential to normative deliverables may have been declared to ETSI. The declarations pertaining to these essential IPRs, if any, are publicly available for **ETSI members and non-members**, and can be found in ETSI SR 000 314: "*Intellectual Property Rights (IPRs); Essential, or potentially Essential, IPRs notified to ETSI in respect of ETSI standards*", which is available from the ETSI Secretariat. Latest updates are available on the [ETSI IPR online database](#).

Pursuant to the ETSI Directives including the ETSI IPR Policy, no investigation regarding the essentiality of IPRs, including IPR searches, has been carried out by ETSI. No guarantee can be given as to the existence of other IPRs not referenced in ETSI SR 000 314 (or the updates on the ETSI Web server) which are, or may be, or may become, essential to the present document.

Trademarks

The present document may include trademarks and/or tradenames which are asserted and/or registered by their owners. ETSI claims no ownership of these except for any which are indicated as being the property of ETSI, and conveys no right to use or reproduce any trademark and/or tradename. Mention of those trademarks in the present document does not constitute an endorsement by ETSI of products, services or organizations associated with those trademarks.

DECT™, **PLUGTESTS™**, **UMTS™** and the ETSI logo are trademarks of ETSI registered for the benefit of its Members. **3GPP™**, **LTE™** and **5G™** logo are trademarks of ETSI registered for the benefit of its Members and of the 3GPP Organizational Partners. **oneM2M™** logo is a trademark of ETSI registered for the benefit of its Members and of the oneM2M Partners. **GSM®** and the GSM logo are trademarks registered and owned by the GSM Association.

Legal Notice

This Technical Specification (TS) has been produced by ETSI 3rd Generation Partnership Project (3GPP).

The present document may refer to technical specifications or reports using their 3GPP identities. These shall be interpreted as being references to the corresponding ETSI deliverables.

The cross reference between 3GPP and ETSI identities can be found at [3GPP to ETSI numbering cross-referencing](#).

Modal verbs terminology

In the present document "**shall**", "**shall not**", "**should**", "**should not**", "**may**", "**need not**", "**will**", "**will not**", "**can**" and "**cannot**" are to be interpreted as described in clause 3.2 of the [ETSI Drafting Rules](#) (Verbal forms for the expression of provisions).

"**must**" and "**must not**" are **NOT** allowed in ETSI deliverables except when used in direct citation.

Contents

Intellectual Property Rights	2
Legal Notice	2
Modal verbs terminology.....	2
Foreword.....	26
1 Scope	27
2 References	27
3 Definitions and abbreviations.....	32
3.1 Definitions	32
3.2 Abbreviations	44
4 General	47
4.1 Overview	47
4.2 Coordination between the protocols for 5GS mobility management and 5GS session management	48
4.3 UE domain selection	49
4.3.1 UE's usage setting	49
4.3.2 Domain selection for UE originating sessions / calls.....	49
4.3.3 Change of UE's usage setting.....	50
4.3.4 Change or determination of IMS voice availability	51
4.4 NAS security	52
4.4.1 General.....	52
4.4.2 Handling of 5G NAS security contexts.....	52
4.4.2.1 General	52
4.4.2.1.1 Establishment of 5G NAS security context	52
4.4.2.1.2 UE leaving state 5GMM-DEREGISTERED	55
4.4.2.1.3 UE entering state 5GMM-DEREGISTERED.....	55
4.4.2.2 Establishment of a mapped 5G NAS security context during inter-system change from S1 mode to N1 mode in 5GMM-CONNECTED mode.....	55
4.4.2.3 Establishment of a 5G NAS security context during N1 mode to N1 mode handover	56
4.4.2.4 Establishment of an EPS security context during inter-system change from N1 mode to S1 mode in 5GMM-CONNECTED mode	57
4.4.2.5 Establishment of secure exchange of NAS messages	58
4.4.2.6 Change of security keys	60
4.4.3 Handling of NAS COUNT and NAS sequence number	60
4.4.3.1 General	60
4.4.3.2 Replay protection	61
4.4.3.3 Integrity protection and verification.....	61
4.4.3.4 Cipherring and deciphering	62
4.4.3.5 NAS COUNT wrap around	62
4.4.4 Integrity protection of NAS signalling messages.....	63
4.4.4.1 General	63
4.4.4.2 Integrity checking of NAS signalling messages in the UE	63
4.4.4.3 Integrity checking of NAS signalling messages in the AMF	64
4.4.5 Cipherring of NAS signalling messages	65
4.4.6 Protection of initial NAS signalling messages.....	66
4.4.7 Protection of NAS IEs	68
4.5 Unified access control	69
4.5.1 General.....	69
4.5.2 Determination of the access identities and access category associated with a request for access for UEs not operating in SNPN access operation mode over 3GPP access.....	70
4.5.2A Determination of the access identities and access category associated with a request for access for UEs operating in SNPN access operation mode over 3GPP access.....	76
4.5.3 Operator-defined access categories.....	81
4.5.4 Access control and checking.....	83
4.5.4.1 Access control and checking in 5GMM-IDLE mode and in 5GMM-IDLE mode with suspend indication.....	83

4.5.4.2	Access control and checking in 5GMM-CONNECTED mode and in 5GMM-CONNECTED mode with RRC inactive indication	85
4.5.5	Exception handling and avoiding double barring	87
4.5.6	Mapping between access categories/access identities and RRC establishment cause	91
4.6	Network slicing	93
4.6.1	General.....	93
4.6.2	Mobility management aspects.....	96
4.6.2.1	General	96
4.6.2.2	NSSAI storage.....	97
4.6.2.3	Provision of NSSAI to lower layers in 5GMM-IDLE mode.....	104
4.6.2.4	Network slice-specific authentication and authorization.....	106
4.6.2.5	Mobility management based network slice admission control.....	108
4.6.2.6	Provision of NSAG information to lower layers.....	109
4.6.2.7	Mobility management based network slice replacement.....	110
4.6.2.8	Mobility management for optimised handling of temporarily available network slices	111
4.6.2.9	Mobility management based network slice usage control.....	112
4.6.2.10	Mobility management aspects of handling network slices with NS-AoS not matching deployed tracking areas	114
4.6.2.11	Mobility management for partial network slice	114
4.6.3	Session management aspects	116
4.6.3.0	General	116
4.6.3.1	Session management based network slice admission control	116
4.6.3.2	Support of network slice admission control and interworking with EPC	116
4.6.3.3	Session management based network slice data rate limitation control.....	117
4.6.3.4	Session management based network slice replacement	117
4.6.3.5	Session management for optimized handling of temporarily available network slices.....	118
4.6.3.6	Session management for partial network slice	118
4.6.3.7	Session management aspect of handling network slices with NS-AoS not matching deployed tracking areas	120
4.7	NAS over non-3GPP access	120
4.7.1	General.....	120
4.7.2	5GS mobility management aspects.....	120
4.7.2.1	General	120
4.7.2.2	Establishment cause for non-3GPP access.....	121
4.7.3	5GS session management aspects.....	123
4.7.4	Limited service state over non-3GPP access	123
4.7.5	NAS signalling using trusted WLAN access network	123
4.8	Interworking with E-UTRAN connected to EPC	124
4.8.1	General.....	124
4.8.2	Single-registration mode.....	124
4.8.2.1	General	124
4.8.2.2	Single-registration mode with N26 interface	124
4.8.2.3	Single-registration mode without N26 interface	125
4.8.2.3.1	Interworking between NG-RAN and E-UTRAN	125
4.8.2.3.2	Interworking between TNGF or N3IWF connected to 5GCN and E-UTRAN.....	126
4.8.3	Dual-registration mode	127
4.8.4	Core Network selection for UEs not using CIoT 5GS optimizations	128
4.8.4A	Core Network selection and redirection for UEs using CIoT optimizations.....	129
4.8.4A.1	Core network selection.....	129
4.8.4A.2	Redirection of the UE by the core network.....	129
4.9	Disabling and re-enabling of UE's N1 mode capability	130
4.9.1	General.....	130
4.9.2	Disabling and re-enabling of UE's N1 mode capability for 3GPP access.....	130
4.9.3	Disabling and re-enabling of UE's N1 mode capability for non-3GPP access.....	133
4.9.4	Disabling and re-enabling of UE's satellite NG-RAN capability.....	134
4.10	Interworking with ePDG connected to EPC.....	134
4.11	UE configuration parameter updates	134
4.12	Access traffic steering, switching and splitting (ATSSS).....	135
4.13	Support of NAS signalling using wireline access network.....	135
4.14	Non-public network (NPN)	137
4.14.1	General.....	137
4.14.2	Stand-alone non-public network (SNPN)	137

4.14.3	Public network integrated non-public network (PNI-NPN).....	139
4.15	Time synchronization and time sensitive communication.....	140
4.15.1	General.....	140
4.15.2	Void.....	141
4.15.2.1	Void.....	141
4.15.2.2	Void.....	141
4.15.2.3	Void.....	141
4.15.3	Time synchronization.....	141
4.15.4	User plane node management.....	141
4.16	UE radio capability signalling optimisation.....	141
4.17	5GS mobility management in NB-N1 mode.....	143
4.18	5GS session management in NB-N1 mode.....	143
4.19	5GS mobility management in WB-N1 mode for IoT.....	143
4.20	5GS session management in WB-N1 mode for IoT.....	144
4.21	Authentication and Key Management for Applications (AKMA).....	144
4.22	Uncrewed aerial vehicle identification, authentication, and authorization.....	145
4.22.1	General.....	145
4.22.2	Authentication and authorization of UAV.....	145
4.22.3	Authorization of C2 communication.....	146
4.22.4	Void.....	147
4.23	NAS over Non-Terrestrial Network.....	147
4.23.1	General.....	147
4.23.2	List of "PLMNs not allowed to operate at the present UE location".....	147
4.23.3	5GS mobility management via a satellite NG-RAN cell.....	148
4.23.4	5GS session management via a satellite NG-RAN cell.....	148
4.23.5	Handling multiple tracking area codes from the lower layers.....	148
4.24	Minimization of service interruption.....	149
4.25	Support of MUSIM features.....	151
4.26	Support for Personal IoT Network service.....	151
4.27	Mobile base station relay support.....	152
5	Elementary procedures for 5GS mobility management.....	152
5.1	Overview.....	152
5.1.1	General.....	152
5.1.2	Types of 5GMM procedures.....	153
5.1.3	5GMM sublayer states.....	154
5.1.3.1	General.....	154
5.1.3.2	5GMM sublayer states.....	154
5.1.3.2.1	5GMM sublayer states in the UE.....	154
5.1.3.2.1.1	General.....	154
5.1.3.2.1.2	Main states.....	155
5.1.3.2.1.2.1	5GMM-NUL.....	155
5.1.3.2.1.2.2	5GMM-DEREGISTERED.....	155
5.1.3.2.1.2.3	5GMM-REGISTERED-INITIATED.....	155
5.1.3.2.1.2.4	5GMM-REGISTERED.....	155
5.1.3.2.1.2.5	5GMM-DEREGISTERED-INITIATED.....	155
5.1.3.2.1.2.6	5GMM-SERVICE-REQUEST-INITIATED.....	155
5.1.3.2.1.3	Substates of state 5GMM-DEREGISTERED.....	156
5.1.3.2.1.3.1	General.....	156
5.1.3.2.1.3.2	5GMM-DEREGISTERED.NORMAL-SERVICE.....	156
5.1.3.2.1.3.3	5GMM-DEREGISTERED.LIMITED-SERVICE.....	156
5.1.3.2.1.3.4	5GMM-DEREGISTERED.ATTEMPTING-REGISTRATION.....	156
5.1.3.2.1.3.5	5GMM-DEREGISTERED.PLMN-SEARCH.....	156
5.1.3.2.1.3.6	5GMM-DEREGISTERED.NO-SUPI.....	156
5.1.3.2.1.3.7	5GMM-DEREGISTERED.NO-CELL-AVAILABLE.....	156
5.1.3.2.1.3.8	5GMM-DEREGISTERED.eCALL-INACTIVE.....	157
5.1.3.2.1.3.9	5GMM-DEREGISTERED.INITIAL-REGISTRATION-NEEDED.....	157
5.1.3.2.1.4	Substates of state 5GMM-REGISTERED.....	157
5.1.3.2.1.4.1	General.....	157
5.1.3.2.1.4.2	5GMM-REGISTERED.NORMAL-SERVICE.....	157
5.1.3.2.1.4.3	5GMM-REGISTERED.NON-ALLOWED-SERVICE.....	157
5.1.3.2.1.4.4	5GMM-REGISTERED.ATTEMPTING-REGISTRATION-UPDATE.....	157

5.1.3.2.1.4.5	5GMM-REGISTERED.LIMITED-SERVICE	158
5.1.3.2.1.4.6	5GMM-REGISTERED.PLMN-SEARCH	158
5.1.3.2.1.4.7	5GMM-REGISTERED.NO-CELL-AVAILABLE	158
5.1.3.2.1.4.8	5GMM-REGISTERED.UPDATE-NEEDED	158
5.1.3.2.2	5GS update status in the UE	159
5.1.3.2.3	5GMM sublayer states in the network side	159
5.1.3.2.3.1	General	159
5.1.3.2.3.2	5GMM-DEREGISTERED	160
5.1.3.2.3.3	5GMM-COMMON-PROCEDURE-INITIATED	160
5.1.3.2.3.4	5GMM-REGISTERED	160
5.1.3.2.3.5	5GMM-DEREGISTERED-INITIATED	160
5.1.4	Coordination between 5GMM and EMM	160
5.1.4.1	General	160
5.1.4.2	Coordination between 5GMM for 3GPP access and EMM with N26 interface	161
5.1.4.3	Coordination between 5GMM for 3GPP access and EMM without N26 interface	161
5.1.5	Coordination between 5GMM and GMM	162
5.2	Behaviour of the UE in state 5GMM-DEREGISTERED and state 5GMM-REGISTERED	162
5.2.1	General	162
5.2.2	UE behaviour in state 5GMM-DEREGISTERED	162
5.2.2.1	General	162
5.2.2.2	Primary substate selection	162
5.2.2.2.1	Selection of the substate after power on	162
5.2.2.3	Detailed description of UE behaviour in state 5GMM-DEREGISTERED	163
5.2.2.3.1	NORMAL-SERVICE	163
5.2.2.3.2	LIMITED-SERVICE	163
5.2.2.3.3	ATTEMPTING-REGISTRATION	163
5.2.2.3.4	PLMN-SEARCH	165
5.2.2.3.5	NO-SUPI	165
5.2.2.3.6	NO-CELL-AVAILABLE	165
5.2.2.3.7	eCALL-INACTIVE	165
5.2.2.3.8	INITIAL-REGISTRATION-NEEDED	165
5.2.2.4	Substate when back to state 5GMM-DEREGISTERED from another 5GMM state	166
5.2.3	UE behaviour in state 5GMM-REGISTERED	166
5.2.3.1	General	166
5.2.3.2	Detailed description of UE behaviour in state 5GMM-REGISTERED	166
5.2.3.2.1	NORMAL-SERVICE	166
5.2.3.2.2	NON-ALLOWED-SERVICE	167
5.2.3.2.3	ATTEMPTING-REGISTRATION-UPDATE	167
5.2.3.2.4	LIMITED-SERVICE	168
5.2.3.2.5	PLMN-SEARCH	169
5.2.3.2.6	NO-CELL-AVAILABLE	169
5.2.3.2.7	UPDATE-NEEDED	169
5.3	General on elementary 5GMM procedures	169
5.3.1	5GMM modes and N1 NAS signalling connection	169
5.3.1.1	Establishment of the N1 NAS signalling connection	169
5.3.1.2	Re-establishment of the N1 NAS signalling connection	171
5.3.1.3	Release of the N1 NAS signalling connection	172
5.3.1.4	5GMM-CONNECTED mode with RRC inactive indication	177
5.3.1.5	Suspend and resume of the N1 NAS signalling connection	181
5.3.2	Permanent identifiers	182
5.3.3	Temporary identities	185
5.3.4	Registration areas	186
5.3.5	Service area restrictions	186
5.3.5.1	General	186
5.3.5.2	3GPP access service area restrictions	187
5.3.5.3	Wireline access service area restrictions	191
5.3.6	Mobile initiated connection only mode	192
5.3.7	Handling of the periodic registration update timer and mobile reachable timer	194
5.3.8	Handling of timer T3502	196
5.3.9	Handling of NAS level mobility management congestion control	197
5.3.10	Handling of DNN based congestion control	198
5.3.11	Handling of S-NSSAI based congestion control	198

5.3.12	Handling of local emergency numbers	198
5.3.12A	Handling of local emergency numbers received via 3GPP access and non-3GPP access	199
5.3.12A.1	General	199
5.3.12A.2	Receiving a REGISTRATION ACCEPT message via non-3GPP access.....	200
5.3.13	Lists of 5GS forbidden tracking areas.....	200
5.3.13A	Forbidden PLMN lists	202
5.3.14	List of equivalent PLMNs.....	202
5.3.14A	List of equivalent SNPNs	202
5.3.15	Transmission failure abnormal case in the UE	203
5.3.16	Extended DRX cycle for UEs in 5GMM-IDLE and 5GMM-CONNECTED mode with RRC inactive indication	203
5.3.17	Service Gap Control.....	204
5.3.18	Restriction on use of enhanced coverage.....	206
5.3.19	Handling of congestion control for transport of user data via the control plane	206
5.3.19A	Specific requirements for UE configured to use timer T3245	207
5.3.19A.1	UE not operating in SNPN access operation mode	207
5.3.19A.2	UE operating in SNPN access operation mode	207
5.3.20	Specific requirements for UE when receiving non-integrity protected reject messages	208
5.3.20.1	General	208
5.3.20.2	Requirements for UE in a PLMN.....	208
5.3.20.3	Requirements for UE in an SNPN.....	213
5.3.21	CIoT 5GS optimizations	217
5.3.22	Interaction between MICO mode with active time and extended idle mode DRX cycle	220
5.3.23	Forbidden wireline access area	220
5.3.24	WUS assistance	220
5.3.25	Paging Early Indication with Paging Subgrouping Assistance	221
5.3.26	Support for unavailability period	222
5.4	5GMM common procedures.....	223
5.4.1	Primary authentication and key agreement procedure	223
5.4.1.1	General	223
5.4.1.2	EAP based primary authentication and key agreement procedure	224
5.4.1.2.1	General	224
5.4.1.2.2	EAP-AKA' related procedures.....	226
5.4.1.2.3	EAP-TLS related procedures.....	232
5.4.1.2.3A	Procedures related to EAP methods other than EAP-AKA' and EAP-TLS.....	237
5.4.1.2.3B	Procedures related to EAP methods used for primary authentication of an N5GC device.....	241
5.4.1.2.3C	Procedures related to EAP methods used for primary authentication of an AUN3 device.....	243
5.4.1.2.4	EAP message reliable transport procedure	244
5.4.1.2.5	EAP result message transport procedure	247
5.4.1.3	5G AKA based primary authentication and key agreement procedure	249
5.4.1.3.1	General	249
5.4.1.3.2	Authentication initiation by the network	249
5.4.1.3.3	Authentication response by the UE	250
5.4.1.3.4	Authentication completion by the network.....	251
5.4.1.3.5	Authentication not accepted by the network.....	251
5.4.1.3.6	Authentication not accepted by the UE	254
5.4.1.3.7	Abnormal cases	254
5.4.2	Security mode control procedure	258
5.4.2.1	General	258
5.4.2.2	NAS security mode control initiation by the network.....	259
5.4.2.3	NAS security mode command accepted by the UE.....	262
5.4.2.4	NAS security mode control completion by the network	265
5.4.2.5	NAS security mode command not accepted by the UE.....	266
5.4.2.6	Abnormal cases in the UE.....	266
5.4.2.7	Abnormal cases on the network side.....	266
5.4.3	Identification procedure	267
5.4.3.1	General	267
5.4.3.2	Identification initiation by the network	267
5.4.3.3	Identification response by the UE	267
5.4.3.4	Identification completion by the network	267
5.4.3.5	Abnormal cases in the UE.....	268
5.4.3.6	Abnormal cases on the network side.....	268

5.4.4	Generic UE configuration update procedure.....	269
5.4.4.1	General	269
5.4.4.2	Generic UE configuration update procedure initiated by the network	272
5.4.4.3	Generic UE configuration update accepted by the UE.....	279
5.4.4.4	Generic UE configuration update completion by the network	287
5.4.4.5	Abnormal cases in the UE.....	288
5.4.4.6	Abnormal cases on the network side.....	289
5.4.5	NAS transport procedure(s).....	290
5.4.5.1	General	290
5.4.5.2	UE-initiated NAS transport procedure	291
5.4.5.2.1	General	291
5.4.5.2.2	UE-initiated NAS transport procedure initiation	291
5.4.5.2.3	UE-initiated NAS transport of messages accepted by the network	294
5.4.5.2.4	UE-initiated NAS transport of messages not accepted by the network	299
5.4.5.2.5	Abnormal cases on the network side	302
5.4.5.2.6	Abnormal cases in the UE	307
5.4.5.3	Network-initiated NAS transport procedure	309
5.4.5.3.1	General	309
5.4.5.3.2	Network-initiated NAS transport procedure initiation	310
5.4.5.3.3	Network-initiated NAS transport of messages accepted by the UE	315
5.4.6	5GMM status procedure	321
5.4.6.1	General	321
5.4.6.2	5GMM status received in the UE.....	321
5.4.6.3	5GMM status received in the network	321
5.4.7	Network slice-specific authentication and authorization procedure	321
5.4.7.1	General	321
5.4.7.2	Network slice-specific EAP message reliable transport procedure	323
5.4.7.2.1	Network slice-specific EAP message reliable transport procedure initiation	323
5.4.7.2.2	Network slice-specific EAP message reliable transport procedure accepted by the UE	323
5.4.7.2.3	Abnormal cases on the network side	323
5.4.7.2.4	Abnormal cases in the UE	324
5.4.7.3	Network slice-specific EAP result message transport procedure	325
5.4.7.3.1	Network slice-specific EAP result message transport procedure initiation	325
5.5	5GMM specific procedures	326
5.5.1	Registration procedure.....	326
5.5.1.1	General	326
5.5.1.2	Registration procedure for initial registration	327
5.5.1.2.1	General	327
5.5.1.2.2	Initial registration initiation	327
5.5.1.2.3	5GMM common procedure initiation	337
5.5.1.2.4	Initial registration accepted by the network.....	337
5.5.1.2.5	Initial registration not accepted by the network.....	365
5.5.1.2.6	Initial registration for emergency services not accepted by the network.....	380
5.5.1.2.6A	Initial registration for initiating an emergency PDU session not accepted by the network	381
5.5.1.2.7	Abnormal cases in the UE	382
5.5.1.2.8	Abnormal cases on the network side	385
5.5.1.3	Registration procedure for mobility and periodic registration update.....	387
5.5.1.3.1	General	387
5.5.1.3.2	Mobility and periodic registration update initiation	387
5.5.1.3.3	5GMM common procedure initiation	404
5.5.1.3.4	Mobility and periodic registration update accepted by the network	405
5.5.1.3.5	Mobility and periodic registration update not accepted by the network.....	440
5.5.1.3.6	Mobility and periodic registration update for initiating an emergency PDU session not accepted by the network	457
5.5.1.3.6A	Mobility and periodic registration update for an emergency services fallback not accepted by the network	458
5.5.1.3.7	Abnormal cases in the UE	458
5.5.1.3.8	Abnormal cases on the network side	462
5.5.2	De-registration procedure	466
5.5.2.1	General	466
5.5.2.2	UE-initiated de-registration procedure.....	468
5.5.2.2.1	UE-initiated de-registration procedure initiation.....	468

5.5.2.2.2	UE-initiated de-registration procedure completion	469
5.5.2.2.3	UE-initiated de-registration procedure completion for 5GS services over 3GPP access.....	469
5.5.2.2.4	UE-initiated de-registration procedure completion for 5GS services over non-3GPP access	470
5.5.2.2.5	UE-initiated de-registration procedure completion for 5GS services over both 3GPP access and non-3GPP access	470
5.5.2.2.6	Abnormal cases in the UE	470
5.5.2.2.7	Abnormal cases in the network side	472
5.5.2.3	Network-initiated de-registration procedure	473
5.5.2.3.1	Network-initiated de-registration procedure initiation	473
5.5.2.3.2	Network-initiated de-registration procedure completion by the UE.....	475
5.5.2.3.3	Network-initiated de-registration procedure completion by the network	487
5.5.2.3.4	Abnormal cases in the UE	487
5.5.2.3.5	Abnormal cases in the network side	488
5.5.3	eCall inactivity procedure.....	489
5.5.4	Authentication and key agreement procedure for 5G ProSe UE-to-network relay and 5G ProSe UE- to-UE relay.....	490
5.5.4.1	General	490
5.5.4.2	ProSe relay transaction identity (PRTI)	491
5.5.4.3	UE-initiated authentication and key agreement procedure initiation	491
5.5.4.4	UE-initiated authentication and key agreement procedure accepted by the network.....	492
5.5.4.5	UE-initiated authentication and key agreement procedure not accepted by the network.....	493
5.5.4.6	Abnormal cases in the UE.....	493
5.5.4.7	Abnormal cases on the network side.....	493
5.6	5GMM connection management procedures.....	494
5.6.1	Service request procedure	494
5.6.1.1	General	494
5.6.1.2	Service request procedure initiation.....	499
5.6.1.2.1	UE is not using 5GS services with control plane CIoT 5GS optimization	499
5.6.1.2.2	UE is using 5GS services with control plane CIoT 5GS optimization	502
5.6.1.3	Common procedure initiation.....	505
5.6.1.4	Service request procedure accepted by the network.....	505
5.6.1.4.1	UE is not using 5GS services with control plane CIoT 5GS optimization	505
5.6.1.4.2	UE is using 5GS services with control plane CIoT 5GS optimization	509
5.6.1.5	Service request procedure not accepted by the network.....	514
5.6.1.6	Service request procedure for initiating an emergency PDU session not accepted by the network	527
5.6.1.6A	Service request procedure for an emergency services fallback not accepted by the network	527
5.6.1.7	Abnormal cases in the UE.....	528
5.6.1.8	Abnormal cases on the network side.....	532
5.6.2	Paging procedure	533
5.6.2.1	General	533
5.6.2.2	Paging for 5GS services	534
5.6.2.2.1	General	534
5.6.2.2.2	Abnormal cases on the network side	536
5.6.2.2.3	Abnormal cases in the UE	536
5.6.3	Notification procedure	537
5.6.3.1	General	537
5.6.3.2	Notification procedure initiation	537
5.6.3.3	Notification procedure completion.....	540
5.6.3.4	Abnormal cases on the network side.....	541
5.6.3.5	Abnormal cases on the UE side.....	541
6	Elementary procedures for 5GS session management	541
6.1	Overview	541
6.1.1	General.....	541
6.1.2	Types of 5GSM procedures	542
6.1.3	5GSM sublayer states	543
6.1.3.1	General	543
6.1.3.2	5GSM sublayer states in the UE	543
6.1.3.2.1	Overview	543
6.1.3.2.2	PDU SESSION INACTIVE	543
6.1.3.2.3	PDU SESSION ACTIVE PENDING.....	543
6.1.3.2.4	PDU SESSION ACTIVE	543

6.1.3.2.5	PDU SESSION INACTIVE PENDING.....	544
6.1.3.2.6	PDU SESSION MODIFICATION PENDING	544
6.1.3.2.7	PROCEDURE TRANSACTION INACTIVE.....	544
6.1.3.2.8	PROCEDURE TRANSACTION PENDING.....	544
6.1.3.3	5GSM sublayer states in the network side	544
6.1.3.3.1	Overview	544
6.1.3.3.2	PDU SESSION INACTIVE.....	545
6.1.3.3.3	PDU SESSION ACTIVE	545
6.1.3.3.4	PDU SESSION INACTIVE PENDING.....	545
6.1.3.3.5	PDU SESSION MODIFICATION PENDING	545
6.1.3.3.6	PROCEDURE TRANSACTION INACTIVE.....	545
6.1.3.3.7	PROCEDURE TRANSACTION PENDING.....	545
6.1.4	Coordination between 5GSM and ESM.....	546
6.1.4.1	Coordination between 5GSM and ESM with N26 interface	546
6.1.4.2	Coordination between 5GSM and ESM without N26 interface	559
6.1.4a	Coordination between 5GSM and SM.....	562
6.1.5	Coordination for interworking with ePDG connected to EPC.....	562
6.2	General on elementary 5GSM procedures.....	563
6.2.1	Principles of PTI handling for 5GSM procedures.....	563
6.2.2	PDU session types	565
6.2.3	PDU session management	565
6.2.4	IP address allocation	566
6.2.4.1	General	566
6.2.4.2	IP address allocation via NAS signalling.....	566
6.2.4.2a	IPv6 prefix delegation via DHCPv6.....	567
6.2.4.3	Additional RG related requirements for IP address allocation.....	567
6.2.4.4	Additional requirements of the UE acting as 5G ProSe layer-3 UE-to-network relay UE for IP address allocation.....	568
6.2.5	Quality of service.....	568
6.2.5.1	General	568
6.2.5.1.1	QoS rules	568
6.2.5.1.1.1	General.....	568
6.2.5.1.1.2	Signalled QoS rules	568
6.2.5.1.1.3	Derived QoS rules.....	570
6.2.5.1.1.4	QoS flow descriptions.....	570
6.2.5.1.2	Session-AMBR.....	571
6.2.5.1.2A	Void.....	571
6.2.5.1.3	UL user data packet matching	571
6.2.5.1.4	Reflective QoS.....	571
6.2.5.1.4.1	General.....	571
6.2.5.1.4.2	Derivation of packet filter for UL direction from DL user data packet	572
6.2.5.1.4.3	Creating a derived QoS rule by reflective QoS in the UE.....	574
6.2.5.1.4.4	Updating a derived QoS rule by reflective QoS in the UE	574
6.2.5.1.4.5	Deleting a derived QoS rule in the UE	574
6.2.5.1.4.6	Ignoring RQI in the UE.....	575
6.2.5.2	QoS in MA PDU session.....	575
6.2.6	Local area data network (LADN)	575
6.2.7	Handling of DNN based congestion control	577
6.2.8	Handling of S-NSSAI based congestion control.....	578
6.2.9	Interaction with upper layers	582
6.2.9.1	General	582
6.2.9.2	URSP.....	582
6.2.9.3	ProSeP.....	582
6.2.10	Handling of 3GPP PS data off	583
6.2.11	Multi-homed IPv6 PDU session	584
6.2.12	Handling of network rejection not due to congestion control	584
6.2.13	Handling of Small data rate control	586
6.2.14	Handling of Serving PLMN rate control.....	587
6.2.15	Handling of Reliable Data Service	588
6.2.16	Handling of header compression for control plane CIoT optimizations	588
6.2.17	Handling of edge computing enhancements	588
6.2.18	Support of redundant PDU sessions	589

6.2.19	Handling of maximum group data rate limitation.....	589
6.2.20	Support of UL PDU set handling.....	590
6.3	Network-requested 5GSM procedures	590
6.3.1	PDU session authentication and authorization procedure.....	590
6.3.1.1	General	590
6.3.1.2	PDU EAP message reliable transport procedure.....	592
6.3.1.2.1	PDU EAP message reliable transport procedure initiation.....	592
6.3.1.2.2	PDU EAP message reliable transport procedure accepted by the UE.....	594
6.3.1.2.3	Abnormal cases on the network side	594
6.3.1.2.4	Abnormal cases in the UE	595
6.3.1.3	PDU EAP result message transport procedure.....	595
6.3.1.3.1	PDU EAP result message transport procedure initiation.....	595
6.3.1.3.2	Abnormal cases in the UE	595
6.3.1A	Service-level authentication and authorization procedure	596
6.3.1A.1	General	596
6.3.1A.2	Service-level authentication and authorization procedure initiation	597
6.3.1A.3	Service-level authentication and authorization procedure accepted by the UE.....	599
6.3.1A.4	Abnormal cases on the network side.....	599
6.3.1A.5	Abnormal cases in the UE.....	599
6.3.2	Network-requested PDU session modification procedure	600
6.3.2.1	General	600
6.3.2.2	Network-requested PDU session modification procedure initiation	600
6.3.2.3	Network-requested PDU session modification procedure accepted by the UE.....	606
6.3.2.4	Network-requested PDU session modification procedure not accepted by the UE.....	615
6.3.2.5	Abnormal cases on the network side.....	620
6.3.2.6	Abnormal cases in the UE.....	622
6.3.3	Network-requested PDU session release procedure	622
6.3.3.1	General	622
6.3.3.2	Network-requested PDU session release procedure initiation	622
6.3.3.3	Network-requested PDU session release procedure accepted by the UE.....	625
6.3.3.4	N1 SM delivery skipped.....	641
6.3.3.5	Abnormal cases on the network side.....	641
6.3.3.6	Abnormal cases in the UE.....	642
6.4	UE-requested 5GSM procedures.....	642
6.4.1	UE-requested PDU session establishment procedure	642
6.4.1.1	General	642
6.4.1.2	UE-requested PDU session establishment procedure initiation	643
6.4.1.3	UE-requested PDU session establishment procedure accepted by the network.....	655
6.4.1.4	UE-requested PDU session establishment procedure not accepted by the network.....	670
6.4.1.4.1	General	670
6.4.1.4.2	Handling of network rejection due to congestion control.....	674
6.4.1.4.3	Handling of network rejection not due to congestion control.....	686
6.4.1.5	Handling the maximum number of established PDU sessions.....	696
6.4.1.5A	Handling the maximum number of allowed active user-plane resources for PDU sessions of UEs in NB-N1 mode	697
6.4.1.6	Abnormal cases in the UE.....	697
6.4.1.7	Abnormal cases on the network side.....	700
6.4.2	UE-requested PDU session modification procedure.....	701
6.4.2.1	General	701
6.4.2.2	UE-requested PDU session modification procedure initiation.....	702
6.4.2.3	UE-requested PDU session modification procedure accepted by the network	708
6.4.2.4	UE-requested PDU session modification procedure not accepted by the network	708
6.4.2.4.1	General	708
6.4.2.4.2	Handling of network rejection due to congestion control.....	709
6.4.2.4.3	Handling of network rejection not due to congestion control.....	721
6.4.2.5	Abnormal cases in the UE.....	726
6.4.2.6	Abnormal cases on the network side.....	727
6.4.3	UE-requested PDU session release procedure	728
6.4.3.1	General	728
6.4.3.2	UE-requested PDU session release procedure initiation	728
6.4.3.3	UE-requested PDU session release procedure accepted by the network.....	729
6.4.3.4	UE-requested PDU session release procedure not accepted by the network.....	730

6.4.3.5	Abnormal cases in the UE.....	730
6.4.3.6	Abnormal cases on the network side.....	731
6.5	5GSM status procedure	732
6.5.1	General.....	732
6.5.2	5GSM status received in the UE.....	732
6.5.3	5GSM status received in the SMF.....	732
6.6	Miscellaneous procedures	733
6.6.1	Exchange of extended protocol configuration options.....	733
6.6.2	Remote UE report procedure	733
6.6.2.1	General	733
6.6.2.2	Remote UE report procedure initiation	733
6.6.2.3	Remote UE report procedure accepted by the network.....	734
6.6.2.4	Abnormal cases in the UE.....	734
6.6.2.5	Abnormal cases on the network side.....	735
7	Handling of unknown, unforeseen, and erroneous protocol data	735
7.1	General	735
7.2	Message too short or too long	735
7.2.1	Message too short	735
7.2.2	Message too long	735
7.3	Unknown or unforeseen procedure transaction identity or PDU Session identity.....	736
7.3.1	Procedure transaction identity.....	736
7.3.2	PDU Session identity.....	737
7.4	Unknown or unforeseen message type	737
7.5	Non-semantic mandatory information element errors	738
7.5.1	Common procedures	738
7.5.2	5GS mobility management	738
7.5.3	5GS session management	738
7.6	Unknown and unforeseen IEs in the non-imperative message part.....	739
7.6.1	IEs unknown in the message	739
7.6.2	Out of sequence IEs	739
7.6.3	Repeated IEs	739
7.6.4	Unknown and unforeseen IEs in a Type 6 IE container information element	739
7.6.4.1	IEs unknown in the Type 6 IE container information element	739
7.6.4.2	Out of sequence IEs	740
7.6.4.3	Repeated IEs	740
7.7	Non-imperative message part errors.....	740
7.7.1	Syntactically incorrect optional IEs	740
7.7.2	Conditional IE errors	740
7.7.3	Errors in a Type 6 IE container information element	740
7.7.3.1	Syntactically incorrect optional IEs	740
7.7.3.2	Conditional IE errors.....	741
7.8	Messages with semantically incorrect contents.....	741
8	Message functional definitions and contents.....	741
8.1	Overview	741
8.2	5GS mobility management messages.....	742
8.2.1	Authentication request	742
8.2.1.1	Message definition	742
8.2.1.2	Authentication parameter RAND.....	743
8.2.1.3	Authentication parameter AUTN	743
8.2.1.4	Void.....	743
8.2.1.5	EAP message.....	743
8.2.2	Authentication response.....	743
8.2.2.1	Message definition	743
8.2.2.2	Authentication response parameter	744
8.2.2.3	EAP message.....	744
8.2.3	Authentication result.....	744
8.2.3.1	Message definition	744
8.2.3.2	ABBA	745
8.2.3.3	AUN3 device security key	745
8.2.4	Authentication failure	745

8.2.4.1	Message definition	745
8.2.4.2	Authentication failure parameter.....	745
8.2.5	Authentication reject.....	745
8.2.5.1	Message definition	745
8.2.5.2	EAP message.....	746
8.2.6	Registration request	746
8.2.6.1	Message definition	746
8.2.6.2	Non-current native NAS key set identifier.....	749
8.2.6.3	5GMM capability	749
8.2.6.4	UE security capability	749
8.2.6.5	Requested NSSAI	749
8.2.6.6	Last visited registered TAI.....	749
8.2.6.7	S1 UE network capability	750
8.2.6.8	Uplink data status.....	750
8.2.6.9	PDU session status	750
8.2.6.10	MICO indication	750
8.2.6.11	UE status	750
8.2.6.12	Additional GUTI.....	750
8.2.6.13	Allowed PDU session status	750
8.2.6.14	UE's usage setting	750
8.2.6.15	Requested DRX parameters	750
8.2.6.16	EPS NAS message container.....	750
8.2.6.17	LADN indication.....	751
8.2.6.17A	Payload container type	751
8.2.6.18	Payload container	751
8.2.6.19	Network slicing indication	751
8.2.6.20	5GS update type	751
8.2.6.21	NAS message container	751
8.2.6.22	Requested extended DRX parameters.....	752
8.2.6.23	EPS bearer context status	752
8.2.6.24	T3324 value.....	752
8.2.6.25	Mobile station classmark 2.....	752
8.2.6.26	Supported codecs	752
8.2.6.27	UE radio capability ID	752
8.2.6.28	Requested mapped NSSAI.....	752
8.2.6.29	Additional information requested.....	752
8.2.6.30	Requested WUS assistance information.....	752
8.2.6.31	Void.....	752
8.2.6.32	N5GC indication	752
8.2.6.33	Requested NB-N1 mode DRX parameters.....	752
8.2.6.34	UE request type	753
8.2.6.35	Paging restriction	753
8.2.6.35	Service-level-AA container.....	753
8.2.6.36	NID	753
8.2.6.37	UE determined PLMN with disaster condition	753
8.2.6.38	Requested PEIPS assistance information	753
8.2.6.39	Requested T3512 value	753
8.2.6.40	Unavailability information	753
8.2.6.41	Non-3GPP path switching information	753
8.2.6.42	AUN3 indication	753
8.2.7	Registration accept.....	753
8.2.7.1	Message definition	753
8.2.7.2	5G-GUTI.....	757
8.2.7.3	Equivalent PLMNs.....	757
8.2.7.4	TAI list	757
8.2.7.5	Allowed NSSAI	757
8.2.7.6	Rejected NSSAI	757
8.2.7.7	Configured NSSAI	757
8.2.7.8	5GS network feature support.....	757
8.2.7.9	PDU session status	758
8.2.7.10	PDU session reactivation result.....	758
8.2.7.11	PDU session reactivation result error cause	758

8.2.7.12	LADN information.....	758
8.2.7.13	MICO indication	758
8.2.7.14	Network slicing indication	758
8.2.7.15	Service area list	758
8.2.7.16	T3512 value.....	758
8.2.7.17	Non-3GPP de-registration timer value	758
8.2.7.18	T3502 value.....	758
8.2.7.19	Emergency number list	759
8.2.7.20	Extended emergency number list	759
8.2.7.21	SOR transparent container	759
8.2.7.22	EAP message.....	759
8.2.7.23	NSSAI inclusion mode.....	759
8.2.7.24	Operator-defined access category definitions	759
8.2.7.25	Negotiated DRX parameters	759
8.2.7.26	Non-3GPP NW policies	759
8.2.7.27	Negotiated extended DRX parameters	759
8.2.7.28	T3447 value.....	759
8.2.7.29	T3448 value.....	760
8.2.7.30	T3324 value.....	760
8.2.7.31	EPS bearer context status	760
8.2.7.32	UE radio capability ID	760
8.2.7.33	UE radio capability ID deletion indication.....	760
8.2.7.34	Pending NSSAI	760
8.2.7.35	Ciphering key data	760
8.2.7.36	CAG information list.....	760
8.2.7.37	Truncated 5G-S-TMSI configuration	760
8.2.7.38	Negotiated NB-N1 mode DRX parameters.....	760
8.2.7.39	Negotiated WUS assistance information.....	761
8.2.7.40	Extended rejected NSSAI	761
8.2.7.41	Service-level-AA container.....	761
8.2.7.42	Negotiated PEIPS assistance information	761
8.2.7.43	5GS additional request result	761
8.2.7.44	NSSRG information	761
8.2.7.45	Disaster roaming wait range.....	761
8.2.7.46	Disaster return wait range	761
8.2.7.47	List of PLMNs to be used in disaster condition	761
8.2.7.48	Forbidden TAI(s) for the list of "5GS forbidden tracking areas for roaming"	761
8.2.7.49	Forbidden TAI(s) for the list of "5GS forbidden tracking areas for regional provision of service"	762
8.2.7.50	Extended CAG information list.....	762
8.2.7.51	NSAG information	762
8.2.7.52	Equivalent SNPNs.....	762
8.2.7.53	NID	762
8.2.7.54	Registration accept type 6 IE container.....	762
8.2.7.54.1	General	762
8.2.7.54.2	Extended LADN information	762
8.2.7.54.3	S-NSSAI location validity information	762
8.2.7.54.4	Void.....	763
8.2.7.54.5	Partially allowed NSSAI	763
8.2.7.54.6	Partially rejected NSSAI	763
8.2.7.55	RAN timing synchronization	763
8.2.7.56	Alternative NSSAI	763
8.2.7.57	Maximum time offset.....	763
8.2.7.58	S-NSSAI time validity information.....	763
8.2.7.59	Unavailability configuration	763
8.2.7.60	Feature authorization indication	763
8.2.7.61	On-demand NSSAI	763
8.2.8	Registration complete	763
8.2.8.1	Message definition	763
8.2.8.2	SOR transparent container	764
8.2.9	Registration reject.....	764
8.2.9.1	Message definition	764
8.2.9.2	T3346 value.....	765

8.2.9.3	T3502 value.....	765
8.2.9.4	EAP message.....	765
8.2.9.5	Rejected NSSAI	766
8.2.9.6	CAG information list.....	766
8.2.9.7	Extended rejected NSSAI	766
8.2.9.8	Disaster return wait range	766
8.2.9.9	Extended CAG information list.....	766
8.2.9.10	Lower bound timer value	766
8.2.9.11	Forbidden TAI(s) for the list of "5GS forbidden tracking areas for roaming"	766
8.2.9.12	Forbidden TAI(s) for the list of "5GS forbidden tracking areas for regional provision of service"	766
8.2.9.13	N3IWF identifier.....	766
8.2.9.14	TNAN information.....	766
8.2.9.15	Extended 5GMM cause.....	766
8.2.10	UL NAS transport.....	767
8.2.10.1	Message definition	767
8.2.10.2	PDU session ID.....	767
8.2.10.3	Old PDU session ID.....	767
8.2.10.4	Request type.....	768
8.2.10.5	S-NSSAI	768
8.2.10.6	DNN.....	768
8.2.10.7	Additional information.....	768
8.2.10.8	MA PDU session information.....	768
8.2.10.9	Release assistance indication	768
8.2.10.10	Non-3GPP access path switching indication.....	768
8.2.10.11	Alternative S-NSSAI.....	768
8.2.10.12	Payload container information	768
8.2.11	DL NAS transport.....	768
8.2.11.1	Message definition	768
8.2.11.2	PDU session ID.....	769
8.2.11.3	Additional information.....	769
8.2.11.4	5GMM cause.....	769
8.2.11.5	Back-off timer value	769
8.2.11.6	Lower bound timer value	769
8.2.12	De-registration request (UE originating de-registration)	770
8.2.12.1	Message definition	770
8.2.12.2	Unavailability information.....	770
8.2.12.3	NAS message container	770
8.2.13	De-registration accept (UE originating de-registration).....	770
8.2.13.1	Message definition	770
8.2.14	De-registration request (UE terminated de-registration).....	771
8.2.14.1	Message definition	771
8.2.14.2	5GMM cause.....	772
8.2.14.3	T3346 value.....	772
8.2.14.4	Rejected NSSAI	772
8.2.14.5	CAG information list.....	772
8.2.14.6	Extended rejected NSSAI	772
8.2.14.7	Disaster return wait range	772
8.2.14.7A	Extended CAG information list.....	772
8.2.14.8	Lower bound timer value	772
8.2.14.9	Forbidden TAI(s) for the list of "5GS forbidden tracking areas for roaming"	772
8.2.14.10	Forbidden TAI(s) for the list of "5GS forbidden tracking areas for regional provision of service"	772
8.2.15	De-registration accept (UE terminated de-registration).....	772
8.2.15.1	Message definition	772
8.2.16	Service request.....	773
8.2.16.1	Message definition	773
8.2.16.2	Uplink data status.....	774
8.2.16.3	PDU session status	774
8.2.16.4	Allowed PDU session status	774
8.2.16.5	NAS message container	774
8.2.16.6	UE request type.....	774
8.2.16.7	Paging restriction	774
8.2.17	Service accept.....	774

8.2.17.1	Message definition	774
8.2.17.2	PDU session status	775
8.2.17.3	PDU session reactivation result.....	775
8.2.17.4	PDU session reactivation result error cause	775
8.2.17.5	EAP message.....	775
8.2.17.6	T3448 value.....	775
8.2.17.7	5GS additional request result	776
8.2.17.8	Forbidden TAI(s) for the list of "5GS forbidden tracking areas for roaming"	776
8.2.17.9	Forbidden TAI(s) for the list of "5GS forbidden tracking areas for regional provision of service"	776
8.2.18	Service reject	776
8.2.18.1	Message definition	776
8.2.18.2	PDU session status	777
8.2.18.3	T3346 value.....	777
8.2.18.4	EAP message.....	777
8.2.18.5	T3448 value.....	777
8.2.18.6	CAG information list.....	778
8.2.18.7	Disaster return wait range	778
8.2.18.8	Extended CAG information list.....	778
8.2.18.9	Lower bound timer value	778
8.2.18.10	Forbidden TAI(s) for the list of "5GS forbidden tracking areas for roaming"	778
8.2.18.11	Forbidden TAI(s) for the list of "5GS forbidden tracking areas for regional provision of service"	778
8.2.19	Configuration update command.....	778
8.2.19.1	Message definition	778
8.2.19.2	Configuration update indication.....	781
8.2.19.3	5G-GUTI.....	781
8.2.19.4	TAI list	781
8.2.19.5	Allowed NSSAI	781
8.2.19.6	Service area list	781
8.2.19.7	Full name for network.....	781
8.2.19.8	Short name for network.....	782
8.2.19.9	Local time zone	782
8.2.19.10	Universal time and local time zone	782
8.2.19.11	Network daylight saving time	782
8.2.19.12	LADN information.....	782
8.2.19.13	MICO indication	782
8.2.19.14	Network slicing indication	782
8.2.19.15	Configured NSSAI.....	782
8.2.19.16	Rejected NSSAI	782
8.2.19.17	Operator-defined access category definitions	782
8.2.19.18	SMS indication.....	782
8.2.19.19	T3447 value.....	782
8.2.19.20	CAG information list.....	782
8.2.19.21	UE radio capability ID	783
8.2.19.22	UE radio capability ID deletion indication.....	783
8.2.19.23	5GS registration result.....	783
8.2.19.24	Truncated 5G-S-TMSI configuration	783
8.2.19.25	Additional configuration indication	783
8.2.19.26	Extended rejected NSSAI	783
8.2.19.27	Service-level-AA container.....	783
8.2.19.28	NSSRG information	783
8.2.19.29	Disaster roaming wait range.....	783
8.2.19.30	Disaster return wait range	783
8.2.19.31	List of PLMNs to be used in disaster condition	783
8.2.19.32	Extended CAG information list.....	783
8.2.19.33	Updated PEIPS assistance information	784
8.2.19.34	NSAG information	784
8.2.19.35	Priority indicator	784
8.2.19.36	RAN timing synchronization	784
8.2.19.37	Extended LADN information.....	784
8.2.19.38	Alternative NSSAI	784
8.2.19.39	S-NSSAI location validity information.....	784
8.2.19.40	S-NSSAI time validity information.....	784

8.2.19.41	Maximum time offset	784
8.2.19.42	Partially allowed NSSAI	784
8.2.19.43	Partially rejected NSSAI	784
8.2.19.44	Feature authorization indication	784
8.2.19.45	On-demand NSSAI	785
8.2.20	Configuration update complete	785
8.2.20.1	Message definition	785
8.2.20.2	Void	785
8.2.21	Identity request	785
8.2.21.1	Message definition	785
8.2.22	Identity response	786
8.2.22.1	Message definition	786
8.2.23	Notification	786
8.2.23.1	Message definition	786
8.2.24	Notification response	787
8.2.24.1	Message definition	787
8.2.24.2	PDU session status	787
8.2.25	Security mode command	787
8.2.25.1	Message definition	787
8.2.25.2	IMEISV request	788
8.2.25.3	Void	788
8.2.25.4	Selected EPS NAS security algorithms	788
8.2.25.5	Additional 5G security information	788
8.2.25.6	EAP message	789
8.2.25.7	ABBA	789
8.2.25.8	Replayed S1 UE security capabilities	789
8.2.25.9	AUN3 device security key	789
8.2.26	Security mode complete	789
8.2.26.1	Message definition	789
8.2.26.2	IMEISV	789
8.2.26.3	NAS message container	789
8.2.26.4	non-IMEISV PEI	790
8.2.27	Security mode reject	790
8.6.27.1	Message definition	790
8.2.28	Security protected 5GS NAS message	790
8.2.28.1	Message definition	790
8.2.29	5GMM status	791
8.2.29.1	Message definition	791
8.2.30	Control Plane Service request	791
8.2.30.1	Message definition	791
8.2.30.2	CIoT small data container	792
8.2.30.3	Payload container type	792
8.2.30.4	Payload container	792
8.2.30.5	PDU session ID	792
8.2.30.6	PDU session status	793
8.2.30.7	Release assistance indication	793
8.2.30.8	Uplink data status	793
8.2.30.9	NAS message container	793
8.2.30.10	Additional information	793
8.2.30.11	Allowed PDU session status	793
8.2.30.12	UE request type	793
8.2.30.13	Paging restriction	793
8.2.31	Network slice-specific authentication command	793
8.2.31.1	Message definition	793
8.2.32	Network slice-specific authentication complete	794
8.2.32.1	Message definition	794
8.2.33	Network slice-specific authentication result	794
8.2.33.1	Message definition	794
8.2.34	Relay key request	795
8.2.34.1	Message definition	795
8.2.35	Relay key accept	795
8.2.35.1	Message definition	795

8.2.35.2	EAP message.....	796
8.2.36	Relay key reject	796
8.2.36.1	Message definition	796
8.2.36.2	EAP message.....	796
8.2.37	Relay authentication request	797
8.2.37.1	Message definition	797
8.2.38	Relay authentication response.....	797
8.2.38.1	Message definition	797
8.3	5GS session management messages	798
8.3.1	PDU session establishment request	798
8.3.1.1	Message definition	798
8.3.1.2	PDU session type	799
8.3.1.3	SSC mode.....	799
8.3.1.4	Maximum number of supported packet filters	800
8.3.1.5	5GSM capability	800
8.3.1.6	Void.....	800
8.3.1.7	Always-on PDU session requested	800
8.3.1.8	SM PDU DN request container.....	800
8.3.1.9	Extended protocol configuration options	800
8.3.1.10	IP header compression configuration	800
8.3.1.11	DS-TT Ethernet port MAC address	800
8.3.1.12	UE-DS-TT residence time.....	800
8.3.1.13	Port management information container	800
8.3.1.14	Ethernet header compression configuration	800
8.3.1.15	Suggested interface identifier.....	801
8.3.1.16	Service-level-AA container.....	801
8.3.1.17	Requested MBS container.....	801
8.3.1.18	PDU session pair ID.....	801
8.3.1.19	RSN.....	801
8.3.1.20	URSP rule enforcement reports.....	801
8.3.2	PDU session establishment accept.....	801
8.3.2.1	Message definition	801
8.3.2.2	5GSM cause	803
8.3.2.3	PDU address.....	803
8.3.2.4	RQ timer value	803
8.3.2.5	S-NSSAI	803
8.3.2.6	Always-on PDU session indication.....	803
8.3.2.7	Mapped EPS bearer contexts.....	803
8.3.2.8	EAP message.....	803
8.3.2.9	Authorized QoS flow descriptions	803
8.3.2.10	Extended protocol configuration options	803
8.3.2.11	DNN.....	803
8.3.2.12	5GSM network feature support.....	803
8.3.2.13	Void.....	803
8.3.2.14	Serving PLMN rate control	803
8.3.2.15	ATSSS container	804
8.3.2.16	Control plane only indication.....	804
8.3.2.17	IP header compression configuration	804
8.3.2.18	Ethernet header compression configuration	804
8.3.2.19	Service-level-AA container.....	804
8.3.2.20	Received MBS container.....	804
8.3.2.21	N3QAI.....	804
8.3.2.22	Protocol description	804
8.3.3	PDU session establishment reject	804
8.3.3.1	Message definition	804
8.3.3.2	Back-off timer value	805
8.3.3.3	Allowed SSC mode	805
8.3.3.4	EAP message.....	805
8.3.3.4A	5GSM congestion re-attempt indicator	805
8.3.3.5	Extended protocol configuration options	805
8.3.3.6	Re-attempt indicator.....	806
8.3.3.7	Service-level-AA container.....	806

8.3.4	PDU session authentication command.....	806
8.3.4.1	Message definition	806
8.3.4.2	Extended protocol configuration options	806
8.3.4.3	Void.....	807
8.3.5	PDU session authentication complete.....	807
8.3.5.1	Message definition	807
8.3.5.2	Extended protocol configuration options	807
8.3.5.3	Void.....	807
8.3.6	PDU session authentication result	807
8.3.6.1	Message definition	807
8.3.6.2	EAP message.....	808
8.3.6.3	Extended protocol configuration options	808
8.3.7	PDU session modification request	808
8.3.7.1	Message definition	808
8.3.7.2	5GSM capability	809
8.3.7.3	5GSM cause	810
8.3.7.4	Maximum number of supported packet filters	810
8.3.7.5	Always-on PDU session requested	810
8.3.7.6	Integrity protection maximum data rate	810
8.3.7.7	Requested QoS rules	810
8.3.7.8	Requested QoS flow descriptions	810
8.3.7.9	Extended protocol configuration options	810
8.3.7.10	Mapped EPS bearer contexts.....	810
8.3.7.11	Port management information container	810
8.3.7.12	IP header compression configuration	810
8.3.7.13	Ethernet header compression configuration	811
8.3.7.14	Requested MBS container.....	811
8.3.7.15	Service-level-AA container.....	811
8.3.7.16	Non-3GPP delay budget.....	811
8.3.7.17	URSP rule enforcement reports.....	811
8.3.8	PDU session modification reject.....	811
8.3.8.1	Message definition	811
8.3.8.2	Back-off timer value	812
8.3.8.2A	5GSM congestion re-attempt indicator	812
8.3.8.3	Extended protocol configuration options	812
8.3.8.4	Re-attempt indicator.....	812
8.3.9	PDU session modification command.....	812
8.3.9.1	Message definition	812
8.3.9.2	5GSM cause	813
8.3.9.3	Session-AMBR	813
8.3.9.4	RQ timer value	814
8.3.9.5	Always-on PDU session indication.....	814
8.3.9.6	Authorized QoS rules	814
8.3.9.7	Mapped EPS bearer contexts.....	814
8.3.9.8	Authorized QoS flow descriptions	814
8.3.9.9	Extended protocol configuration options	814
8.3.9.10	Void.....	814
8.3.9.11	ATSSS container	814
8.3.9.12	IP header compression configuration	814
8.3.9.13	Port management information container	814
8.3.9.14	Serving PLMN rate control	814
8.3.9.15	Ethernet header compression configuration	814
8.3.9.16	Received MBS container.....	814
8.3.9.17	Service-level-AA container.....	815
8.3.9.18	Alternative S-NSSAI.....	815
8.3.9.19	N3QAI.....	815
8.3.9.20	Protocol description	815
8.3.10	PDU session modification complete.....	815
8.3.10.1	Message definition	815
8.3.10.2	Extended protocol configuration options	816
8.3.10.3	Port management information container	816
8.3.11	PDU session modification command reject.....	816

8.3.11.1	Message definition	816
8.3.11.2	Extended protocol configuration options	816
8.3.12	PDU session release request	816
8.3.12.1	Message definition	816
8.3.12.2	5GSM cause	817
8.3.12.3	Extended protocol configuration options	817
8.3.13	PDU session release reject	817
8.3.13.1	Message definition	817
8.3.13.2	Extended protocol configuration options	818
8.3.14	PDU session release command	818
8.3.14.1	Message definition	818
8.3.14.2	Back-off timer value	818
8.3.14.3	EAP message.....	818
8.3.14.4	Extended protocol configuration options	818
8.3.14.5	5GSM congestion re-attempt indicator	819
8.3.14.6	Access type	819
8.3.14.7	Service-level-AA container.....	819
8.3.14.8	Alternative S-NSSAI.....	819
8.3.15	PDU session release complete	819
8.3.15.1	Message definition	819
8.3.15.2	5GSM cause	819
8.3.15.3	Extended protocol configuration options	819
8.3.16	5GSM status.....	820
8.3.16.1	Message definition	820
8.3.17	Service-level authentication command	820
8.3.17.1	Message definition	820
8.3.18	Service-level authentication complete	821
8.3.18.1	Message definition	821
8.3.19	Remote UE report	821
8.3.19.1	Message definition	821
8.3.19.2	Remote UE context connected	822
8.3.19.3	Remote UE context disconnected	822
8.3.20	Remote UE report response	822
8.3.20.1	Message definition	822
8.3.20.2	Void.....	822
8.3.20.3	Void.....	822
8.3.20.4	Void.....	822
9	General message format and information elements coding.....	822
9.1	Overview	822
9.1.1	NAS message format	822
9.1.2	Field format and mapping.....	823
9.2	Extended protocol discriminator	824
9.3	Security header type	824
9.4	PDU session identity	824
9.5	Spare half octet.....	825
9.6	Procedure transaction identity	825
9.7	Message type	825
9.8	Message authentication code.....	827
9.9	Plain 5GS NAS message	827
9.10	Sequence number	827
9.11	Other information elements.....	828
9.11.1	General.....	828
9.11.2	Common information elements.....	828
9.11.2.1	Additional information.....	828
9.11.2.1A	Access type	829
9.11.2.1B	DNN	829
9.11.2.2	EAP message.....	829
9.11.2.3	GPRS timer	830
9.11.2.4	GPRS timer 2	830
9.11.2.5	GPRS timer 3	830
9.11.2.6	Intra N1 mode NAS transparent container	830

9.11.2.7	N1 mode to S1 mode NAS transparent container	831
9.11.2.8	S-NSSAI	831
9.11.2.9	S1 mode to N1 mode NAS transparent container	833
9.11.2.10	Service-level-AA container.....	834
9.11.2.11	Service-level device ID.....	837
9.11.2.12	Service-level-AA server address.....	837
9.11.2.13	Service-level-AA payload.....	838
9.11.2.14	Service-level-AA response.....	838
9.11.2.15	Service-level-AA payload type.....	839
9.11.2.16	Void.....	839
9.11.2.17	Service-level-AA pending indication.....	839
9.11.2.18	Service-level-AA service status indication.....	840
9.11.2.19	Time duration.....	840
9.11.2.20	Unavailability information.....	840
9.11.2.21	Unavailability configuration.....	840
9.11.3	5GS mobility management (5GMM) information elements.....	840
9.11.3.1	5GMM capability.....	840
9.11.3.2	5GMM cause.....	850
9.11.3.2A	5GS DRX parameters.....	853
9.11.3.3	5GS identity type.....	853
9.11.3.4	5GS mobile identity.....	854
9.11.3.5	5GS network feature support.....	860
9.11.3.6	5GS registration result.....	866
9.11.3.7	5GS registration type.....	867
9.11.3.8	5GS tracking area identity.....	868
9.11.3.9	5GS tracking area identity list.....	869
9.11.3.9A	5GS update type.....	874
9.11.3.10	ABBA.....	875
9.11.3.11	Void.....	875
9.11.3.12	Additional 5G security information.....	875
9.11.3.12A	Additional information requested.....	876
9.11.3.13	Allowed PDU session status.....	876
9.11.3.14	Authentication failure parameter.....	877
9.11.3.15	Authentication parameter AUTN.....	877
9.11.3.16	Authentication parameter RAND.....	877
9.11.3.17	Authentication response parameter.....	877
9.11.3.18	Configuration update indication.....	877
9.11.3.18A	CAG information list.....	878
9.11.3.18B	CIoT small data container.....	879
9.11.3.18C	Ciphering key data.....	883
9.11.3.18D	Control plane service type.....	893
9.11.3.19	Daylight saving time.....	893
9.11.3.20	De-registration type.....	893
9.11.3.21	Void.....	894
9.11.3.22	Void.....	894
9.11.3.23	Emergency number list.....	894
9.11.3.23A	EPS bearer context status.....	894
9.11.3.24	EPS NAS message container.....	894
9.11.3.25	EPS NAS security algorithms.....	895
9.11.3.26	Extended emergency number list.....	895
9.11.3.26A	Extended DRX parameters.....	895
9.11.3.27	Void.....	895
9.11.3.28	IMEISV request.....	895
9.11.3.29	LADN indication.....	895
9.11.3.30	LADN information.....	896
9.11.3.31	MICO indication.....	897
9.11.3.31A	MA PDU session information.....	898
9.11.3.31B	Mapped NSSAI.....	898
9.11.3.31C	Mobile station classmark 2.....	899
9.11.3.32	NAS key set identifier.....	899
9.11.3.33	NAS message container.....	900
9.11.3.34	NAS security algorithms.....	900

9.11.3.35	Network name	901
9.11.3.36	Network slicing indication	901
9.11.3.36A	Non-3GPP NW provided policies	902
9.11.3.37	NSSAI	902
9.11.3.37A	NSSAI inclusion mode	903
9.11.3.38	Operator-defined access category definitions	903
9.11.3.39	Payload container	907
9.11.3.40	Payload container type	913
9.11.3.41	PDU session identity 2	913
9.11.3.42	PDU session reactivation result	914
9.11.3.43	PDU session reactivation result error cause	914
9.11.3.44	PDU session status	915
9.11.3.45	PLMN list	915
9.11.3.46	Rejected NSSAI	915
9.11.3.46A	Release assistance indication	917
9.11.3.47	Request type	917
9.11.3.48	S1 UE network capability	917
9.11.3.48A	S1 UE security capability	917
9.11.3.49	Service area list	917
9.11.3.50	Service type	922
9.11.3.50A	SMS indication	922
9.11.3.51	SOR transparent container	923
9.11.3.51A	Supported codec list	941
9.11.3.52	Time zone	941
9.11.3.53	Time zone and time	941
9.11.3.53A	UE parameters update transparent container	942
9.11.3.54	UE security capability	944
9.11.3.55	UE's usage setting	949
9.11.3.56	UE status	949
9.11.3.57	Uplink data status	950
9.11.3.58	Void	951
9.11.3.59	Void	951
9.11.3.60	Void	951
9.11.3.61	Void	951
9.11.3.62	Void	951
9.11.3.63	Void	951
9.11.3.64	Void	951
9.11.3.65	Void	951
9.11.3.66	Void	951
9.11.3.67	Void	951
9.11.3.68	UE radio capability ID	951
9.11.3.69	UE radio capability ID deletion indication	951
9.11.3.70	Truncated 5G-S-TMSI configuration	952
9.11.3.71	WUS assistance information	953
9.11.3.72	N5GC indication	953
9.11.3.73	NB-N1 mode DRX parameters	954
9.11.3.74	Additional configuration indication	954
9.11.3.75	Extended rejected NSSAI	955
9.11.3.76	UE request type	959
9.11.3.77	Paging restriction	959
9.11.3.78	Void	960
9.11.3.79	NID	960
9.11.3.80	PEIPS assistance information	960
9.11.3.81	5GS additional request result	962
9.11.3.82	NSSRG information	963
9.11.3.83	List of PLMNs to be used in disaster condition	964
9.11.3.84	Registration wait range	965
9.11.3.85	PLMN identity	965
9.11.3.86	Extended CAG information list	966
9.11.3.87	NSAG information	971
9.11.3.88	ProSe relay transaction identity	972
9.11.3.89	Relay key request parameters	973

9.11.3.90	Relay key response parameters	974
9.11.3.91	Priority indicator	975
9.11.3.92	SNPN list	975
9.11.3.93	N3IWF identifier	976
9.11.3.94	TNAN information	977
9.11.3.95	RAN timing synchronization	978
9.11.3.96	Extended LADN information	979
9.11.3.97	Alternative NSSAI	980
9.11.3.98	Type 6 IE container	981
9.11.3.99	Non-3GPP access path switching indication	982
9.11.3.100	S-NSSAI location validity information	982
9.11.3.101	S-NSSAI time validity information	984
9.11.3.102	Non-3GPP path switching information	986
9.11.3.103	Partial NSSAI	987
9.11.3.104	AUN3 indication	988
9.11.3.105	Feature authorization indication	988
9.11.3.106	Payload container information	989
9.11.3.107	AUN3 device security key	989
9.11.3.108	On-demand NSSAI	990
9.11.3.109	Extended 5GMM cause	991
9.11.4	5GS session management (5GSM) information elements	991
9.11.4.1	5GSM capability	991
9.11.4.2	5GSM cause	995
9.11.4.3	Always-on PDU session indication	996
9.11.4.4	Always-on PDU session requested	997
9.11.4.5	Allowed SSC mode	997
9.11.4.6	Extended protocol configuration options	998
9.11.4.7	Integrity protection maximum data rate	998
9.11.4.8	Mapped EPS bearer contexts	999
9.11.4.9	Maximum number of supported packet filters	1003
9.11.4.10	PDU address	1003
9.11.4.11	PDU session type	1004
9.11.4.12	QoS flow descriptions	1005
9.11.4.13	QoS rules	1012
9.11.4.14	Session-AMBR	1020
9.11.4.15	SM PDU DN request container	1021
9.11.4.16	SSC mode	1022
9.11.4.17	Re-attempt indicator	1022
9.11.4.18	5GSM network feature support	1023
9.11.4.19	Void	1024
9.11.4.20	Serving PLMN rate control	1024
9.11.4.21	5GSM congestion re-attempt indicator	1024
9.11.4.22	ATSSS container	1024
9.11.4.23	Control plane only indication	1025
9.11.4.24	IP header compression configuration	1025
9.11.4.25	DS-TT Ethernet port MAC address	1028
9.11.4.26	UE-DS-TT residence time	1028
9.11.4.27	Port management information container	1029
9.11.4.28	Ethernet header compression configuration	1029
9.11.4.29	Remote UE context list	1030
9.11.4.30	Requested MBS container	1034
9.11.4.31	Received MBS container	1036
9.11.4.32	PDU session pair ID	1043
9.11.4.33	RSN	1044
9.11.4.34	ECS address	1044
9.11.4.35	Void	1049
9.11.4.36	N3QAI	1049
9.11.4.37	Non-3GPP delay budget	1053
9.11.4.38	URSP rule enforcement reports	1056
9.11.4.39	Protocol description	1056
9.12	3GPP specific coding information defined within present document	1060
9.12.1	Serving network name (SNN)	1060

10	List of system parameters.....	1061
10.1	General.....	1061
10.2	Timers of 5GS mobility management.....	1061
10.3	Timers of 5GS session management.....	1073
10.4	Void.....	1079
Annex A (informative): Cause values for 5GS mobility management.....		1080
A.1	Causes related to UE identification.....	1080
A.2	Cause related to subscription options.....	1080
A.3	Causes related to PLMN or SNPN specific network failures and congestion/authentication failures.....	1082
A.4	Causes related to invalid messages.....	1083
Annex B (informative): Cause values for 5GS session management.....		1085
B.1	Causes related to nature of request.....	1085
B.2	Protocol errors (e.g., unknown message).....	1087
Annex C (normative): Storage of 5GMM information.....		1089
C.1	Storage of 5GMM information for UEs not operating in SNPN access operation mode.....	1089
C.2	Storage of 5GMM information for UEs operating in SNPN access operation mode.....	1091
Annex D (normative): UE policy delivery service.....		1095
D.1	General.....	1095
D.1.1	Overview.....	1095
D.1.2	Principles of PTI handling for UE policy delivery service procedures.....	1095
D.2	Procedures.....	1097
D.2.1	Network-requested UE policy management procedure.....	1097
D.2.1.1	General.....	1097
D.2.1.2	Network-requested UE policy management procedure initiation.....	1097
D.2.1.3	Network-requested UE policy management procedure accepted by the UE.....	1099
D.2.1.4	Network-requested UE policy management procedure not accepted by the UE.....	1099
D.2.1.5	Abnormal cases on the network side.....	1100
D.2.1.6	Abnormal cases in the UE.....	1100
D.2.2	UE-initiated UE state indication procedure.....	1101
D.2.2.1	General.....	1101
D.2.2.2	UE-initiated UE state indication procedure initiation.....	1102
D.2.2.3	UE-initiated UE state indication procedure accepted by the network.....	1102
D.2.2.4	Abnormal cases on the network side.....	1102
D.3	UE policy re-assembly at the UE.....	1103
D.4	Void.....	1104
D.5	Message functional definition and contents.....	1104
D.5.1	Manage UE policy command.....	1104
D.5.1.1	Message definition.....	1104
D.5.1.2	UE policy network classmark.....	1104
D.5.1.3	VPS URSP configuration.....	1104
D.5.2	Manage UE policy complete.....	1105
D.5.2.1	Message definition.....	1105
D.5.3	Manage UE policy command reject.....	1105
D.5.3.1	Message definition.....	1105
D.5.4	UE state indication.....	1105
D.5.4.1	Message definition.....	1105
D.6	Information elements coding.....	1107
D.6.1	UE policy delivery service message type.....	1107

D.6.2	UE policy section management list	1107
D.6.3	UE policy section management result	1112
D.6.4	UPSI list	1114
D.6.5	UE policy classmark.....	1116
D.6.6	UE OS Id.....	1117
D.6.7	UE policy network classmark.....	1117
D.6.8	VPS URSP configuration	1118
D.7	Timers of UE policy delivery service.....	1122
D.8	Handling of unknown, unforeseen, and erroneous UPDS data	1122
D.8.1	General	1122
D.8.2	Message too short or too long	1122
D.8.2.1	Message too short	1122
D.8.2.2	Message too long	1122
D.8.3	Unknown or unforeseen procedure transaction identity	1123
D.8.3.1	Procedure transaction identity.....	1123
D.8.4	Unknown or unforeseen message type	1123
D.8.5	Non-semantic mandatory information element errors	1123
D.8.5.1	Common procedures	1123
D.8.6	Unknown and unforeseen IEs in the non-imperative message part.....	1124
D.8.6.1	IEs unknown in the message	1124
D.8.6.2	Out of sequence IEs	1124
D.8.6.3	Repeated IEs	1124
D.8.7	Non-imperative message part errors.....	1124
D.8.7.1	Syntactically incorrect optional IEs.....	1124
D.8.7.2	Conditional IE errors	1124
D.8.8	Messages with semantically incorrect contents.....	1125
Annex E (informative):	Void	1126
Annex F (informative):	Change history	1127
History		1204

Foreword

This Technical Specification has been produced by the 3rd Generation Partnership Project (3GPP).

The contents of the present document are subject to continuing work within the TSG and may change following formal TSG approval. Should the TSG modify the contents of the present document, it will be re-released by the TSG with an identifying change of release date and an increase in version number as follows:

Version x.y.z

where:

- x the first digit:
 - 1 presented to TSG for information;
 - 2 presented to TSG for approval;
 - 3 or greater indicates TSG approved document under change control.
- y the second digit is incremented for all changes of substance, i.e. technical enhancements, corrections, updates, etc.
- z the third digit is incremented when editorial only changes have been incorporated in the document.

1 Scope

The present document specifies the non-access stratum (NAS) procedures in the 5G system (5GS) used by the protocols for:

- mobility management between the user equipment (UE) and the access and mobility management function (AMF) for both 3GPP access and non-3GPP access; and
- session management between the user equipment (UE) and the session management function (SMF) for both 3GPP access and non-3GPP access.

The 5GS mobility management (5GMM) protocol defined in the present document provides procedures for the control of mobility when the user equipment (UE) is using the NG radio access network (NG-RAN), non-3GPP access network, or both. The 5GMM protocol also provides control of security for the NAS protocols.

The 5GS session management (5GSM) protocol defined in the present document provides procedures for the handling of 5GS PDU sessions. Together with the bearer control provided by the access stratum, this protocol is used for the control of user-plane resources.

For both NAS protocols the present document specifies procedures for the support of inter-system mobility between the NG-RAN and the evolved universal terrestrial radio access (E-UTRAN), between the NG-RAN and the non-3GPP access network connected to the EPC, and between the non-3GPP access network connected to the 5G core network (5GCN) and the E-UTRAN.

For both NAS protocols the present document specifies procedures for the support of mobility between the NG-RAN and the non-3GPP access network connected to the 5GCN.

In addition, the present document specifies the procedures in the 5GS for UE policy delivery service between the UE and the policy control function (PCF) for both 3GPP access and non-3GPP access.

The present document is applicable to the UE, the access and mobility management function (AMF), the session management function (SMF), and the PCF in the 5GS.

The clauses and subclauses in the present document are common for both 3GPP access and non-3GPP access unless it is explicitly stated that they apply to 3GPP access only or non-3GPP access only.

2 References

The following documents contain provisions which, through reference in this text, constitute provisions of the present document.

- References are either specific (identified by date of publication, edition number, version number, etc.) or non-specific.
- For a specific reference, subsequent revisions do not apply.
- For a non-specific reference, the latest version applies. In the case of a reference to a 3GPP document (including a GSM document), a non-specific reference implicitly refers to the latest version of that document in the same Release as the present document.

- [1] 3GPP TR 21.905: "Vocabulary for 3GPP Specifications".
- [1A] 3GPP TS 22.011: "Service accessibility".
- [2] 3GPP TS 22.101: "Service aspects; Service principles".
- [3] 3GPP TS 22.261: "Service requirements for the 5G system; Stage 1".
- [4] 3GPP TS 23.003: "Numbering, addressing and identification".
- [4A] 3GPP TS 23.040: "Technical realization of Short Message Service (SMS)".
- [4B] 3GPP TS 23.032: "Universal Geographical Area Description (GAD)".

- [5] 3GPP TS 23.122: "Non-Access-Stratum functions related to Mobile Station (MS) in idle mode".
- [6] 3GPP TS 23.167: "IP Multimedia Subsystem (IMS) emergency sessions".
- [6A] 3GPP TS 23.216: "Single Radio Voice Call Continuity (SRVCC); Stage 2".
- [6AB] 3GPP TS 23.256: "Support of Uncrewed Aerial Systems (UAS) connectivity, identification and tracking; Stage 2".
- [6B] 3GPP TS 23.273: "5G System (5GS) Location Services (LCS); Stage 2".
- [6C] 3GPP TS 23.287: "Architecture enhancements for 5G System (5GS) to support Vehicle-to-Everything (V2X) services".
- [6D] 3GPP TS 23.316: "Wireless and wireline convergence access support for the 5G System (5GS)".
- [6E] 3GPP TS 23.304: "Proximity based Services (ProSe) in the 5G System (5GS)".
- [7] 3GPP TS 23.401: "GPRS enhancements for E-UTRAN access".
- [8] 3GPP TS 23.501: "System Architecture for the 5G System; Stage 2".
- [9] 3GPP TS 23.502: "Procedures for the 5G System; Stage 2".
- [10] 3GPP TS 23.503: "Policy and Charging Control Framework for the 5G System; Stage 2".
- [10A] 3GPP TS 23.548: "5G System Enhancements for Edge Computing; Stage 2".
- [11] 3GPP TS 24.007: "Mobile radio interface signalling layer 3; General aspects".
- [12] 3GPP TS 24.008: "Mobile Radio Interface Layer 3 specification; Core Network Protocols; Stage 3".
- [13] 3GPP TS 24.011: "Point-to-Point Short Message Service (SMS) support on mobile radio interface".
- [13A] 3GPP TS 24.080: "Mobile radio interface layer 3 Supplementary services specification; Formats and coding".
- [13B] 3GPP TS 24.193: "Access Traffic Steering, Switching and Splitting; Stage 3".
- [13C] 3GPP TS 24.173: "IMS Multimedia telephony communication service and supplementary services; Stage 3".
- [13D] 3GPP TS 24.174: "Support of multi-device and multi-identity in the IP Multimedia Subsystem (IMS); Stage 3".
- [14] 3GPP TS 24.229: "IP multimedia call control protocol based on Session Initiation Protocol (SIP) and Session Description Protocol (SDP); Stage 3".
- [14AA] 3GPP TS 24.237: "IP Multimedia (IM) Core Network (CN) subsystem IP Multimedia Subsystem (IMS) service continuity; Stage 3".
- [14A] 3GPP TS 24.250: "Protocol for Reliable Data Service; Stage 3".
- [15] 3GPP TS 24.301: "Non-Access-Stratum (NAS) protocol for Evolved Packet System (EPS); Stage 3".
- [16] 3GPP TS 24.302: "Access to the 3GPP Evolved Packet Core (EPC) via non-3GPP access networks; Stage 3".
- [17] 3GPP TS 24.368: "Non-Access Stratum (NAS) configuration Management Object (MO)".
- [18] 3GPP TS 24.502: "Access to the 3GPP 5G System (5GS) via non-3GPP access networks; Stage 3".
- [19] 3GPP TS 24.526: "UE policies for 5G System (5GS); Stage 3".

- [19BA] 3GPP TS 24.539: "5G System (5GS); Network to TSN translator (TT) protocol aspects; Stage 3".
- [19A] 3GPP TS 24.535: "Device-Side Time-Sensitive Networking (TSN) Translator (DS-TT) to Network-Side TSN Translator (NW-TT) protocol aspects; Stage 3".
- [19B] 3GPP TS 24.587: "Vehicle-to-Everything (V2X) services in 5G System (5GS); Protocol aspects; Stage 3"
- [19C] 3GPP TS 24.588: "Vehicle-to-Everything (V2X) services in 5G System (5GS); User Equipment (UE) policies; Stage 3"
- [19D] Void.
- [19E] 3GPP TS 24.554: "Proximity-service (ProSe) in 5G System (5GS) protocol aspects; Stage 3".
- [19F] 3GPP TS 24.555: "Proximity-services (ProSe) in 5G System (5GS); User Equipment (UE) policies; Stage 3".
- [20] 3GPP TS 24.623: "Extensive Markup Language (XML) Configuration Access Protocol (XCAP) over the Ut interface for Manipulating Supplementary Services".
- [20AA] 3GPP TS 29.500: "5G System; Technical Realization of Service Based Architecture; Stage 3".
- [20A] 3GPP TS 29.502: "5G System; Session Management Services; Stage 3".
- [20AB] 3GPP TS 29.503: "5G System; Unified Data Management Services; Stage 3".
- [20B] 3GPP TS 29.518: "5G System; Access and Mobility Management Services; Stage 3".
- [21] 3GPP TS 29.525: "5G System; UE Policy Control Service; Stage 3".
- [21A] 3GPP TS 29.526: "5G System; Network Slice-Specific Authentication and Authorization (NSSAA) services; Stage 3".
- [21B] 3GPP TS 29.256: "5G System; Uncrewed Aerial Systems Network Function (UAS-NF); Aerial Management Services; Stage 3.
- [22] 3GPP TS 31.102: "Characteristics of the Universal Subscriber Identity Module (USIM) application".
- [22A] 3GPP TS 31.111: "USIM Application Toolkit (USAT)".
- [22B] 3GPP TS 31.115: "Secured packet structure for (Universal) Subscriber Identity Module (U)SIM Toolkit applications".
- [23] 3GPP TS 33.102: "3G security; Security architecture".
- [23A] 3GPP TS 33.401: "3GPP System Architecture Evolution; Security architecture".
- [24] 3GPP TS 33.501: "Security architecture and procedures for 5G System".
- [24A] 3GPP TS 33.535: "Authentication and Key Management for Applications (AKMA) based on 3GPP credentials in the 5G System (5GS)".
- [24B] 3GPP TS 33.256: "Security aspects of Uncrewed Aerial Systems (UAS)".
- [25] 3GPP TS 36.323: "NR; Packet Data Convergence Protocol (PDCP) specification".
- [25A] 3GPP TS 36.331: "Evolved Universal Terrestrial Radio Access (E-UTRA); Radio Resource Control (RRC) protocol specification".
- [25B] 3GPP TS 36.300: "Evolved Universal Terrestrial Radio Access (E-UTRA) and Evolved Universal Terrestrial Radio Access Network (E-UTRAN); Overall description".
- [25C] 3GPP TS 36.304: "Evolved Universal Terrestrial Radio Access (E-UTRA); User Equipment (UE) procedures in idle mode".

- [25D] 3GPP TS 36.306: "Evolved Universal Terrestrial Radio Access (E-UTRA); User Equipment (UE) radio access capabilities".
- [25E] 3GPP TS 36.321: "Evolved Universal Terrestrial Radio Access (E-UTRA); Medium Access Control (MAC) protocol specification".
- [26] 3GPP TS 37.355: "LTE Positioning Protocol (LPP)".
- [26A] 3GPP TS 38.355: "Sidelink Positioning Protocol (SLPP); Protocol specification".
- [27] 3GPP TS 38.300: "NR; NR and NG-RAN Overall Description; Stage 2".
- [28] 3GPP TS 38.304: "New Generation Radio Access Network; User Equipment (UE) procedures in Idle mode".
- [28A] 3GPP TS 38.306: "New Generation Radio Access Network; User Equipment (UE) radio access capabilities".
- [29] 3GPP TS 38.323: "Evolved Universal Terrestrial Radio Access (E-UTRA); Packet Data Convergence Protocol (PDCP) specification".
- [30] 3GPP TS 38.331: "NR; Radio Resource Control (RRC); Protocol Specification".
- [31] 3GPP TS 38.413: "NG Radio Access Network (NG-RAN); NG Application Protocol (NGAP)".
- [31A] IEEE Std 802.3™-2022: "Ethernet".
- [31AA] 3GPP TS 38.509: "Special conformance testing functions for User Equipment (UE)".
- [32] IETF RFC 768: "User Datagram Protocol".
- [33] IETF RFC 793: "Transmission Control Protocol."
- [33A] IETF RFC 3095: "RObust Header Compression (ROHC): Framework and four profiles: RTP, UDP, ESP and uncompressed".
- [33B] Void.
- [33C] Void.
- [33D] IETF RFC 8415: "Dynamic Host Configuration Protocol for IPv6 (DHCPv6)".
- [33E] IETF RFC 2131: "Dynamic Host Configuration Protocol".
- [33F] IETF RFC 2132: "DHCP Options and BOOTP Vendor Extensions".
- [34] IETF RFC 3748: "Extensible Authentication Protocol (EAP)".
- [34A] IETF RFC 3843: "RObust Header Compression (ROHC): A Compression Profile for IP".
- [35] Void.
- [35A] IETF RFC 4122: "A Universally Unique Identifier (UUID) URN Namespace".
- [36] IETF RFC 4191: "Default Router Preferences and More-Specific Routes".
- [36A] IETF RFC 5905: "Network Time Protocol Version 4: Protocol and Algorithms Specification".
- [37] IETF RFC 7542: "The Network Access Identifier".
- [38] IETF RFC 4303: "IP Encapsulating Security Payload (ESP)".
- [38A] IETF RFC 4815: "RObust Header Compression (ROHC): Corrections and Clarifications to RFC 3095".
- [38B] IETF RFC 4861: "Neighbor Discovery for IP version 6 (IPv6)".
- [39] IETF RFC 4862: "IPv6 Stateless Address Autoconfiguration".

- [39A] IETF RFC 5225: "RObust Header Compression (ROHC) Version 2: Profiles for RTP, UDP, IP, ESP and UDP Lite".
- [39B] IETF RFC 5795: "The RObust Header Compression (ROHC) Framework".
- [40] IETF RFC 5448: "Improved Extensible Authentication Protocol Method for 3rd Generation Authentication and Key Agreement (EAP-AKA)".
- [40A] IETF RFC 6603: "Prefix Exclude Option for DHCPv6-based Prefix Delegation".
- [40B] IETF RFC 6846: "RObust Header Compression (ROHC): A Profile for TCP/IP (ROHC-TCP)".
- [41] IETF RFC 7296: "Internet Key Exchange Protocol Version 2 (IKEv2)".
- [42] ITU-T Recommendation E.212: "The international identification plan for public networks and subscriptions", 2016-09-23.
- [43] IEEE Std 802-2014: "IEEE Standard for Local and Metropolitan Area Networks: Overview and Architecture" (30 June 2014).
- [43A] Void
- [43B] IEEE Std 1588™-2019: "IEEE Standard for a Precision Clock Synchronization Protocol for Networked Measurement and Control Systems".
- [43C] Void.
- [43D] Void.
- [43E] Void.
- [44] Void.
- [45] Void.
- [46] Void.
- [47] Void.
- [48] IEEE: "Guidelines for Use of Extended Unique Identifier (EUI), Organizationally Unique Identifier (OUI), and Company ID (CID)".
- [49] BBF TR-069: "CPE WAN Management Protocol".
- [50] BBF TR-369: "User Services Platform (USP)".
- [51] 3GPP TS 37.340: "Evolved Universal Terrestrial Radio Access (E-UTRA) and NR; Multi-connectivity; Stage 2".
- [52] IETF RFC 8106: "IPv6 Router Advertisement Options for DNS Configuration".
- [53] 3GPP TS 23.247: "Architectural enhancements for 5G multicast-broadcast services; Stage 2".
- [54] 3GPP TS 23.380: "IMS Restoration Procedures".
- [55] IETF RFC 3948: "UDP Encapsulation of IPsec ESP Packets".
- [56] 3GPP TS 33.503: "Security Aspects of Proximity based Services (ProSe) in the 5G System (5GS)".
- [57] 3GPP TS 33.246: "Security of Multimedia Broadcast/Multicast Service (MBMS)".
- [58] 3GPP TS 38.321: "NR; Medium Access Control (MAC); Protocol specification".
- [59] IEEE Std 802.11™-2020: "Information Technology- Telecommunications and information exchange between systems-Local and metropolitan area networks-Specific requirements-Part 11: Wireless LAN Medium Access Control (MAC) and Physical Layer (PHY) Specifications".

- [60] 3GPP TS 24.577: "Aircraft-to-Everything (A2X) services in 5G System (5GS) protocol aspects; Stage 3".
- [61] 3GPP TS 24.578: "Aircraft-to-Everything (A2X) services in 5G System (5GS); UE policies".
- [62] 3GPP TS 24.514: "Ranging based services and sidelink positioning in 5G system (5GS); Stage 3".
- [63] 3GPP TS 23.586: "Architectural Enhancements to support Ranging based services and Sidelink Positioning".
- [64] 3GPP TS 24.572: "User Plane Location Services (LCS) Protocols And Procedures; Stage 3".
- [65] 3GPP TS 24.575: "5G System; Multicast/Broadcast UE pre-configuration Management Object (MO)".
- [66] IETF RFC 4291: "IP Version 6 Addressing Architecture".
- [67] 3GPP TS 38.305: "Stage 2 functional specification of User Equipment (UE) positioning in NG-RAN".
- [68] 3GPP TS 23.271: "Functional stage 2 description of Location Services (LCS)".
- [69] 3GPP TS 26.522: "5G Real-time Media Transport Protocol Configurations".
- [70] IETF RFC 8285: "A General Mechanism for RTP Header Extensions".

3 Definitions and abbreviations

3.1 Definitions

For the purposes of the present document, the terms and definitions given in 3GPP TR 21.905 [1] and the following apply. A term defined in the present document takes precedence over the definition of the same term, if any, in 3GPP TR 21.905 [1].

5GMM-IDLE mode: In this specification, if the term is used standalone, a UE in 5GMM-IDLE mode means the UE can be either in 5GMM-IDLE mode over 3GPP access or in 5GMM-IDLE mode over non-3GPP access.

5GMM-CONNECTED mode: In this specification, if the term is used standalone, a UE in 5GMM-CONNECTED mode means the UE can be either in 5GMM-CONNECTED mode over 3GPP access or in 5GMM-CONNECTED mode over non-3GPP access.

5GMM-IDLE mode over 3GPP access: A UE is in 5GMM-IDLE mode over 3GPP access when no N1 NAS signalling connection between the UE and network over 3GPP access exists. The term 5GMM-IDLE mode over 3GPP access used in the present document corresponds to the term CM-IDLE state for 3GPP access used in 3GPP TS 23.501 [8].

5GMM-CONNECTED mode over 3GPP access: A UE is in 5GMM-CONNECTED mode over 3GPP access when an N1 NAS signalling connection between the UE and network over 3GPP access exists. The term 5GMM-CONNECTED mode over 3GPP access used in the present document corresponds to the term CM-CONNECTED state for 3GPP access used in 3GPP TS 23.501 [8].

5GMM-IDLE mode over non-3GPP access: A UE is in 5GMM-IDLE mode over non-3GPP access when no N1 NAS signalling connection between the UE and network over non-3GPP access exists. The term 5GMM-IDLE mode over non-3GPP access used in the present document corresponds to the term CM-IDLE state for non-3GPP access used in 3GPP TS 23.501 [8].

5GMM-CONNECTED mode over non-3GPP access: A UE is in 5GMM-CONNECTED mode over non-3GPP access when an N1 NAS signalling connection between the UE and network over non-3GPP access exists. The term 5GMM-CONNECTED mode over non-3GPP access used in the present document corresponds to the term CM-CONNECTED state for non-3GPP access used in 3GPP TS 23.501 [8].

5GS services: Services provided by PS domain. Within the context of this specification, 5GS services is used as a synonym for EPS services.

5G-EA: 5GS encryption algorithms. The term 5G-EA, 5G-EA0, 128-5G-EA1, 128-5G-EA2, 128-5G-EA3, 5G-EA4, 5G-EA5, 5G-EA6 and 5G-EA7 used in the present document corresponds to the term NEA, NEA0, 128-NEA1, 128-NEA2, 128-NEA3, NEA4, NEA5, NEA6 and NEA7 defined in 3GPP TS 33.501 [24].

5G-IA: 5GS integrity algorithms. The term 5G-IA, 5G-IA0, 128-5G-IA1, 128-5G-IA2, 128-5G-IA3, 5G-IA4, 5G-IA5, 5G-IA6 and 5G-IA7 used in the present document corresponds to the term NIA, NIA0, 128-NIA1, 128-NIA2, 128-NIA3, NIA4, NIA5, NIA6 and NIA7 defined in 3GPP TS 33.501 [24].

Access stratum connection: A peer to peer access stratum connection:

- between the UE and the NG-RAN for 3GPP access;
- between the UE and the N3IWF for untrusted non-3GPP access;
- between the UE and the TNGF for trusted non-3GPP access used by the UE;
- within the TWIF acting on behalf of the N5CW device for trusted non-3GPP access used by the N5CW device;
- between the 5G-RG and the W-AGF for wireline access used by the 5G-RG;
- within the W-AGF acting on behalf of the FN-RG for wireline access used by the FN-RG; or
- within the W-AGF acting on behalf of the N5GC device for wireline access used by the N5GC device.

The access stratum connection for 3GPP access corresponds to an RRC connection via the Uu reference point. The creation of the access stratum connection for untrusted non-3GPP access corresponds to the completion of the IKE_SA_INIT exchange (see IETF RFC 7296 [41]) via the NWu reference point. The creation of the access stratum connection for trusted non-3GPP access used by the UE corresponds to the UE reception of an EAP-request/5G-start via NWt reference point (see 3GPP TS 23.502 [9]). The creation of the access stratum connection for trusted non-3GPP access used by the N5CW device corresponds to the TWIF's start of acting on behalf of the N5CW device. The creation of the access stratum connection for wireline access used by the 5G-RG corresponds to establishment of signalling connection using W-CP protocol stack via the Y4 reference point (see 3GPP TS 23.316 [6D]). The creation of the access stratum connection for wireline access used by the FN-RG corresponds to the W-AGF's start of acting on behalf of the FN-RG. The creation of the access stratum connection for wireline access used by the N5GC device corresponds to the W-AGF's start of acting on behalf of the N5GC device.

Access to SNPN services via a PLMN/To access SNPN services via a PLMN: A UE is accessing SNPN services via a PLMN when the UE is connecting to the 5GCN of the SNPN using the 3GPP access of the PLMN.

Aggregate maximum bit rate: The maximum bit rate that limits the aggregate bit rate of a set of non-GBR bearers of a UE. Definition derived from 3GPP TS 23.501 [8].

Alternative NSSAI: A list of mapping information between the S-NSSAI to be replaced and the alternative S-NSSAI.

Always-on PDU session: A PDU session for which user-plane resources have to be established during every transition from 5GMM-IDLE mode to 5GMM-CONNECTED mode. A UE requests a PDU session to be established as an always-on PDU session based on indication from upper layers and the network decides whether a PDU session is established as an always-on PDU session.

NOTE 1: How the upper layers in the UE are configured to provide an indication is outside the scope of the present document.

Applicable UE radio capability ID for the current UE radio configuration in the selected network: The UE has an applicable UE radio capability ID for the current UE radio configuration in the selected network if:

- a) the UE supports RACS; and
- b) the UE has:
 - 1) a stored network-assigned UE radio capability ID which is associated with the PLMN ID or SNPN identity of the serving network and which maps to the set of radio capabilities currently enabled at the UE; or

- 2) a manufacturer-assigned UE radio capability ID which maps to the set of radio capabilities currently enabled at the UE.

CAG cell: A cell in which only members of the CAG can get normal service. Depending on local regulation, the CAG cell can provide emergency services and emergency services fallback also to subscribers who are not members of the CAG.

CAG-ID: A CAG-ID is a unique identifier within the scope of one PLMN defined in 3GPP TS 23.003 [4] which identifies a Closed Access Group (CAG) in the PLMN associated with a cell or group of cells to which access is restricted to members of the CAG.

CAG restrictions: Restrictions applied to a UE in accessing a PLMN's 5GCN via:

- a) a non-CAG cell if the entry for the PLMN in the UE's "CAG information list" includes an "indication that the UE is only allowed to access 5GS via CAG cells"; or
- b) a CAG cell if none of the CAG-ID(s) supported by the CAG cell is authorized based on the "allowed CAG list" for the PLMN in the UE's "CAG information list".

The CAG restrictions are not applied in a PLMN when a UE accesses the PLMN due to emergency services or emergency services fallback.

Cleartext IEs: Information elements that can be sent without confidentiality protection in initial NAS messages as specified in subclause 4.4.6.

Configuration of SNPN subscription parameters in PLMN via the user plane: Configuration of a UE in a PLMN with one or more entries of the "list of subscriber data" via the user plane.

Control plane CIoT 5GS optimization: Signalling optimizations to enable efficient transport of user data (IP, Ethernet, Unstructured or SMS) over control plane via the AMF including optional header compression of IP data and Ethernet data.

Current TAI: A TAI of a selected PLMN broadcast in the cell on which the UE is camping. If the cell is a satellite NG-RAN cell broadcasting multiple TACs of the selected PLMN, the UE NAS layer selects the current TAI from these multiple TACs of the selected PLMN as specified in subclause 4.23.5.

NOTE 2: For the purpose of this definition, the selected PLMN can either be the registered PLMN or a PLMN selected according to PLMN selection rules as specified in 3GPP TS 23.122 [5].

DNN determined by the AMF: If no DNN requested by the UE is provided, a DNN determined by the AMF based subscription information or local policy. Otherwise DNN determined by the AMF is the DNN requested by the UE.

DNN requested by the UE: A DNN explicitly requested by the UE and included in a NAS request message.

DNN selected by the network: If DNN replacement applies, a DNN selected and indicated to the AMF by PCF. Otherwise DNN selected by the network is the DNN determined by the AMF.

Default S-NSSAI: An S-NSSAI in the subscribed S-NSSAIs marked as default.

Globally-unique SNPN identity: An SNPN identity with an NID whose assignment mode is not set to 1 (see 3GPP TS 23.003 [4]).

HPLMN S-NSSAI: An S-NSSAI applicable in the HPLMN without any further mapping by the network. If the UE has an EHPLMN list which is not empty, then the HPLMN S-NSSAIs are applicable without any further mapping in the PLMN whose PLMN code is derived from the IMSI, regardless of whether or not this PLMN is included in the EHPLMN list.

The UE considers as HPLMN S-NSSAIs at least the following S-NSSAIs:

- a) any S-NSSAI included in the configured NSSAI or allowed NSSAI for a PLMN or SNPN if it is provided by
 - 1) the HPLMN, if the EHPLMN list is not present or is empty;
 - 2) the PLMN whose PLMN code is derived from the IMSI, if the EHPLMN list is available and not empty, regardless of whether or not the PLMN code derived from the IMSI is included in the EHPLMN list; or

- 3) the subscribed SNPN;
- b) any S-NSSAI provided as mapped S-NSSAI for the configured NSSAI or allowed NSSAI or partially allowed NSSAI for a PLMN or SNPN;
- c) any S-NSSAI associated with a PDU session if there is no mapped S-NSSAI associated with the PDU session and the UE is
 - 1) in the HPLMN, if the EHPLMN list is not present or is empty;
 - 2) the PLMN whose PLMN code is derived from the IMSI, if the EHPLMN list is available and not empty, regardless of whether or not the PLMN code derived from the IMSI is included in the EHPLMN list; or
 - 3) in the subscribed SNPN; and
- d) any mapped S-NSSAI associated with a PDU session.

NOTE 3: The above list is not intended to be complete. E.g., also in case of PLMN the S-NSSAIs included in URSP rules or in the signalling messages for network slice-specific authentication and authorization are HPLMN S-NSSAIs.

User plane CIoT 5GS optimization: Signalling optimizations to enable efficient transport of user data (IP, Ethernet or Unstructured) over the user plane.

UE supporting CIoT 5GS optimizations: A UE that supports control plane CIoT 5GS optimization or user plane CIoT 5GS optimization and one or more other CIoT 5GS optimizations when the UE is in N1 mode.

Registered for 5GS services with control plane CIoT 5GS optimization: A UE supporting CIoT 5GS optimizations is registered for 5GS services, and control plane CIoT 5GS optimization along with one or more other CIoT 5GS optimizations have been accepted by the network.

Registered for 5GS services with user plane CIoT 5GS optimization: A UE supporting CIoT 5GS optimizations is registered for 5GS services, and user plane CIoT 5GS optimization along with one or more other CIoT 5GS optimizations have been accepted by the network.

Registered for 5GS services with CIoT 5GS optimization: A UE is registered for 5GS services with control plane CIoT 5GS optimization or registered for 5GS services with user plane CIoT 5GS optimization.

DNN based congestion control: Type of congestion control at session management level that is applied to reject session management requests from UEs or release PDU sessions when the associated DNN is congested. DNN based congestion control can be activated at the SMF over session management level and also activated at the AMF over mobility management level.

Emergency PDU session: A PDU session established with the request type "initial emergency request" or "existing emergency PDU session".

General NAS level congestion control: Type of congestion control at mobility management level that is applied at a general overload or congestion situation in the network, e.g. lack of processing resources.

Home country: The country of the HPLMN (see 3GPP TS 23.122 [5] for the definition of country).

Initial NAS message: A NAS message is considered as an initial NAS message, if this NAS message can trigger the establishment of an N1 NAS signalling connection. For instance, the REGISTRATION REQUEST message is an initial NAS message.

Initial registration for emergency services: A registration performed with 5GS registration type "emergency registration" in the REGISTRATION REQUEST message.

Initial registration for onboarding services in SNPN: A registration performed with 5GS registration type "SNPN onboarding registration" in the REGISTRATION REQUEST message.

Initial registration for disaster roaming services: A registration performed with 5GS registration type "disaster roaming initial registration" in the REGISTRATION REQUEST message.

Last visited registered TAI: A TAI which is contained in the registration area that the UE registered to the network and which identifies the tracking area last visited by the UE. If the cell is a satellite NG-RAN cell broadcasting multiple

TAIs, a TAI which is contained in the registration area that the UE registered to the network and last selected by the UE as the current TAI.

Mapped 5G-GUTI: A 5G-GUTI which is mapped from a 4G-GUTI previously allocated by an MME. Mapping rules are defined in 3GPP TS 23.003 [4].

Mapped S-NSSAI: An S-NSSAI in the subscribed S-NSSAIs for the HPLMN or the subscribed SNPN, to which an S-NSSAI of the registered PLMN (in case of a roaming scenario) or the registered non-subscribed SNPN is mapped.

MBSR-UE: a UE that is operating as a MBSR and supporting UE NAS functionalities specified in this specification.

Mobility registration for disaster roaming services: A registration performed with 5GS registration type "disaster roaming mobility registration updating" in the REGISTRATION REQUEST message.

MUSIM UE: A UE with multiple valid USIMs, capable of initiating and maintaining simultaneous separate registration states over 3GPP access with PLMN(s) using identities and credentials associated with those USIMs and supporting one or more of the N1 NAS signalling connection release, the paging indication for voice services, the reject paging request, the paging restriction and the paging timing collision control (see 3GPP TS 23.501 [8]).

N1 mode: A mode of a UE allowing access to the 5G core network via the 5G access network.

Native 5G-GUTI: A 5G-GUTI previously allocated by an AMF.

Non 5G capable over WLAN (N5CW) device: A device that is not capable to operate as a UE supporting NAS signalling with the 5GCN over a WLAN access network. However, this device may be capable to operate as a UE supporting NAS signalling with 5GCN using the N1 reference point as specified in this specification over 3GPP access. An N5CW device may be allowed to access the 5GCN via trusted WLAN access network (TWAN) that supports a trusted WLAN interworking function (TWIF) as specified in 3GPP TS 24.502 [18].

Non-CAG Cell: An NR cell which does not broadcast any Closed Access Group identity or an E-UTRA cell connected to 5GCN.

Non-equivalent PLMN: A PLMN which is not an equivalent PLMN.

Non-equivalent SNPN: An SNPN which is not an equivalent SNPN.

Non-globally-unique SNPN identity: An SNPN identity with an NID whose assignment mode is set to 1 (see 3GPP TS 23.003 [4]).

In NB-N1 mode: Indicates this paragraph applies only to a system which operates in NB-N1 mode. For a multi-access system this case applies if the current serving radio access network provides access to network services via E-UTRA connected to 5GCN by NB-IoT (see 3GPP TS 36.300 [25B], 3GPP TS 36.331 [25A], 3GPP TS 36.306 [25D]).

In WB-N1 mode: Indicates this paragraph applies only to a system which operates in WB-N1 mode. For a multi-access system this case applies if the system operates in N1 mode with E-UTRA connected to 5GCN, but not in NB-N1 mode.

In WB-N1/CE mode: Indicates this paragraph applies only when a UE, which is a CE mode B capable UE (see 3GPP TS 36.306 [25D]), is operating in CE mode A or B in WB-N1 mode.

Initial small data rate control parameters: Parameters that, if received by the UE during the establishment of a PDU session, are used as initial parameters to limit the allowed data for the PDU session according to small data rate control after establishment of a PDU session as described in subclause 6.2.13. At expiry of the associated validity period, the initial small data rate control parameters are no longer valid and the small data rate control parameters apply.

Initial small data rate control parameters for exception data: Parameters corresponding to initial small data rate control parameters for small data rate control of exception data.

N1 NAS signalling connection: A peer to peer N1 mode connection between UE and AMF. An N1 NAS signalling connection is either the concatenation of an RRC connection via the Uu reference point and an NG connection via the N2 reference point for 3GPP access, or the concatenation of an IPsec tunnel via the NWu reference point and an NG connection via the N2 reference point for non-3GPP access.

N5CW device supporting 3GPP access: An N5CW device which supports acting as a UE in 3GPP access (i.e. which supports NAS over 3GPP access).

N6 PDU session: A PDU session established between the UE and the User Plane Function (UPF) for transmitting the UE's IP data, Ethernet data or Unstructured data related to a specific application.

NEF PDU session: A PDU session established between the UE and the Network Exposure Function (NEF) for transmitting the UE's Unstructured data related to a specific application.

Network slicing information: information stored at the UE consisting of one or more of the following:

- a) default configured NSSAI for PLMN or SNPN;
- b) configured NSSAI for a PLMN or an SNPN;
- b1) NSSRG information for the configured NSSAI for a PLMN or an SNPN;
- b2) S-NSSAI location validity information for the configured NSSAI for a PLMN or an SNPN;
- b3) S-NSSAI time validity information for the configured NSSAI for a PLMN or an SNPN;
- c) mapped S-NSSAI(s) for the configured NSSAI for a PLMN or an SNPN;
- d) pending NSSAI for a PLMN or an SNPN;
- e) mapped S-NSSAI(s) for the pending NSSAI for a PLMN or an SNPN;
- f) rejected NSSAI for the current PLMN or SNPN;
- g) mapped S-NSSAI(s) for the rejected NSSAI for the current PLMN or an SNPN;
- h) rejected NSSAI for the failed or revoked NSSAI;
- i) for each access type:
 - 1) allowed NSSAI for a PLMN or an SNPN;
 - 2) mapped S-NSSAI(s) for the allowed NSSAI for a PLMN;
 - 3) rejected NSSAI for the current registration area;
 - 4) mapped S-NSSAI(s) for the rejected NSSAI for the current registration area;
 - 5) rejected NSSAI for the maximum number of UEs reached;
 - 6) mapped S-NSSAI(s) for the rejected NSSAI for the maximum number of UEs reached;
 - 7) alternative NSSAI for a PLMN or an SNPN; and
 - 8) on-demand NSSAI for a PLMN or an SNPN; and
- j) for 3GPP access type:
 - 1) NSAG information for the configured NSSAI for a PLMN or an SNPN;
 - 2) partially allowed NSSAI for a PLMN or an SNPN;
 - 3) mapped S-NSSAI(s) for the partially allowed NSSAI for a PLMN or an SNPN;
 - 4) partially rejected NSSAI for a PLMN or an SNPN; and
 - 5) mapped S-NSSAI(s) for the partially rejected NSSAI for a PLMN or an SNPN;

NG-RAN cell: A cell with NG-RAN access technology or satellite NG-RAN access technology.

NITZ information: Network Identity and Time Zone (NITZ) information includes full name for network, short name for network, local time zone, universal time and local time zone, network daylight saving time.

Non-cleartext IEs: Information elements that are not cleartext IEs.

Non-emergency PDU session: Any PDU session which is not an emergency PDU session.

Non-satellite NG-RAN cell: A cell with NG-RAN access technology.

Onboarding SUCI: SUCI derived from onboarding SUPI.

Onboarding SUPI: SUPI with the SUPI format "network specific identifier" containing a network specific identifier or with the SUPI format "IMSI" containing an IMSI, derived by a UE in SNPN access operation mode, from default UE credentials for primary authentication and used to identify the UE during initial registration for onboarding services in SNPN and while registered for onboarding services in SNPN.

On-demand NSSAI: A list of on-demand S-NSSAI(s) and optionally slice deregistration inactivity timer per on-demand S-NSSAI.

On-demand S-NSSAI: An S-NSSAI included in the configured NSSAI that the UE supporting network slice usage control is allowed to request only when this S-NSSAI is used by the UE to establish a PDU session for user data transmission.

Partially rejected NSSAI: Indicating the S-NSSAI(s) is rejected by the network in some TA(s) but not all TAs of the registration area. Each S-NSSAI in the partially rejected NSSAI is associated with a list of TAs where the S-NSSAI is rejected.

PDU address: An IP address assigned to the UE by the packet data network.

PDU session for LADN: A PDU session with a DNN associated with an LADN or a PDU session with a DNN and an S-NSSAI associated with an LADN.

PDU session with suspended user-plane resources: A PDU session for which user-plane resources were established or re-established, and for which data radio bearers were suspended when transition to 5GMM-CONNECTED mode with RRC inactive indication.

Persistent PDU session: Either a non-emergency PDU session contains a GBR QoS flow with QoS equivalent to QoS of teleservice 11 and where there is a radio bearer associated with that PDU session over 3GPP access, or an emergency PDU session where there is a radio bearer associated with that PDU session over 3GPP access.

NOTE 4: An example of a persistent PDU session is a non-emergency PDU session with 5QI = 1 where there is a radio bearer associated with that context.

Procedure transaction identity: An identity which is dynamically allocated by the UE for the UE-requested 5GSM procedures or allocated by the UE or the PCF for the UE policy delivery procedures. The procedure transaction identity is released when the procedure is completed but it should not be released immediately.

RAT frequency selection priority index: A parameter provided by the AMF to the NG-RAN via the N2 reference point. The AMF selects an RFSP index for a particular UE based on the subscribed RFSP index, the locally configured operator's policies, the allowed NSSAI, the partially allowed NSSAI, the partially rejected NSSAI, the rejected NSSAI for the current registration area, the pending NSSAI and the UE context information, including the UE's usage setting, if received during the registration procedure. Definition derived from 3GPP TS 23.501 [8].

Registered for disaster roaming services: A UE is considered as "registered for disaster roaming services" when it has successfully completed initial registration or mobility registration for disaster roaming services.

Registered for emergency services: A UE is considered as "registered for emergency services" when it has successfully completed initial registration for emergency services.

Registered for onboarding services in SNPN: A UE is considered as "registered for onboarding services in SNPN" when it has successfully completed initial registration for onboarding services in SNPN. While registered for onboarding services in SNPN, services other than the onboarding services are not available.

Registered PLMN: The PLMN on which the UE performed the last successful registration. The identity of the registered PLMN (MCC and MNC) is provided to the UE within the GUAMI field of the 5G-GUTI.

Rejected NSSAI: Rejected NSSAI for the current PLMN or SNPN, rejected NSSAI for the current registration area, rejected NSSAI for the failed or revoked NSSAI or rejected NSSAI for the maximum number of UEs reached.

NOTE 5: Rejected NSSAI for the current PLMN or SNPN, rejected NSSAI for the current registration area or rejected NSSAI for the maximum number of UEs reached contains a set of S-NSSAI(s) associated with a PLMN identity or SNPN identity for the current PLMN or SNPN and in roaming scenarios also contains a set of mapped S-NSSAI(s) if available. Rejected NSSAI for the failed or revoked NSSAA only contains a set of S-NSSAI(s) associated with a PLMN identity or SNPN identity for the HPLMN or RSNPN.

Rejected NSSAI for the current PLMN or SNPN: A set of S-NSSAI(s) which was included in the requested NSSAI by the UE and is sent by the AMF with the rejection cause "S-NSSAI not available in the current PLMN or SNPN".

Rejected NSSAI for the current registration area: A set of S-NSSAI(s) which was included in the requested NSSAI by the UE and is sent by the AMF with the rejection cause "S-NSSAI not available in the current registration area".

Rejected NSSAI for the failed or revoked NSSAA: A set of S-NSSAI(s) which is sent by the AMF with the rejection cause "S-NSSAI not available due to the failed or revoked network slice-specific authentication and authorization".

Rejected NSSAI for the maximum number of UEs reached: A set of S-NSSAI(s) which was included in the requested NSSAI by the UE and is sent by the AMF with the rejection cause "S-NSSAI not available due to maximum number of UEs reached".

Local release: Release of a PDU session without peer-to-peer signalling between the network and the UE.

NOTE 6: Local release can include communication among network entities.

Removal of eCall only mode restriction: All the limitations as described in 3GPP TS 22.101 [2] for the eCall only mode do not apply any more.

Satellite NG-RAN cell: A cell with satellite NG-RAN access technology.

SNPN access operation mode: A UE operating in SNPN access operation mode only selects SNPNs. This includes the case when the UE is accessing an SNPN over 3GPP access, the case when the UE is accessing an SNPN over non-3GPP access and the case where the UE is accessing SNPN services via a PLMN

NOTE 7: In this release of specification, the term "SNPN access operation mode" is the same as the term "SNPN access mode" used in 3GPP TS 23.501 [8].

S-NSSAI based congestion control: Type of congestion control at session management level that is applied to reject session management requests from UEs or release PDU sessions when the associated S-NSSAI and optionally the associated DNN are congested. S-NSSAI based congestion control can be activated at the SMF over session management level and also activated at the AMF over mobility management level.

Satellite NG-RAN RAT type: In case of satellite NG-RAN access, RAT types are used to distinguish different types of satellite NG-RAN access, as defined in 3GPP TS 38.413 [31]. In this version of the specification, the defined satellite NG-RAN RAT types are "NR(LEO)", "NR(MEO)" and "NR(GEO)".

Selected core network type information: A type of core network (EPC or 5GCN) selected by the UE NAS layer in case of an E-UTRA cell connected to both EPC and 5GCN.

UE supporting UAS services: A UE which supports an aerial vehicle, such as a drone, with an onboard or built-in USIM and is able to perform UE NAS functionalities specified in this specification. Upper layers of the UE supporting UAS services are responsible for UAS related procedures, such as UUAA and C2 authorization, for which the NAS layer of the UE supporting UAS services performs the necessary NAS procedures.

UE configured for high priority access in selected PLMN: A UE configured with one or more access identities equal to 1, 2, or 11-15 applicable in the selected PLMN as specified in subclause 4.5.2. Definition derived from 3GPP TS 22.261 [3].

UE operating in single-registration mode in a network supporting N26 interface: A UE, supporting both N1 mode and S1 mode. During the last attach, tracking area update (see 3GPP TS 24.301 [15]) or registration procedures, the UE has received either a 5GS network feature support IE with IWK N26 bit set to "interworking without N26 interface not supported" or an EPS network feature support IE with IWK N26 bit set to "interworking without N26 interface not supported".

UE using 5GS services with control plane CIoT 5GS optimization: A UE that is registered for 5GS services with the control plane CIoT 5GS optimization accepted by the network.

User Plane Positioning Connection Management Information (UPP-CMI): The messages defined in clause 6 of 3GPP TS 24.572 [64] that is utilized to manage the user plane connection between the UE and the LMF for LCS-UPP.

User-plane resources: Resources established between the UE and the UPF. The user-plane resources consist of one of the following:

- user plane radio bearers via the Uu reference point, a tunnel via the N3 reference point and a tunnel via the N9 reference point (if any) for 3GPP access;
- IPsec tunnels via the NWu reference point, a tunnel via the N3 reference point and a tunnel via the N9 reference point (if any) for untrusted non-3GPP access;
- IPsec tunnels via the NWt reference point, a tunnel via the N3 reference point and a tunnel via the N9 reference point (if any) for trusted non-3GPP access used by the UE;
- a layer-2 connection via the Yt reference point, a layer-2 or layer-3 connection via the Yw reference point, a tunnel via the N3 reference point and a tunnel via the N9 reference point (if any) for trusted non-3GPP access used by the N5CW device;
- W-UP resources via Y4 reference point, a tunnel via the N3 reference point and a tunnel via the N9 reference point (if any) for wireline access used by the 5G-RG; and
- L-W-UP resources via Y5 reference point, a tunnel via the N3 reference point and a tunnel via the N9 reference point (if any) for wireline access used by the FN-RG.

W-AGF acting on behalf of the N5GC device: A W-AGF that enables an N5GC device behind a 5G-CRG or an FN-CRG to connect to the 5G Core.

UE configured for high priority access in selected SNPN: A UE configured with one or more access identities equal to 1, 2, or 11-15 applicable in the selected SNPN as specified in subclause 4.5.2A.

UE policy section identifier: A UE policy section identifier (UPSI) is an identifier of a UE policy section, which is composed of the MCC and MNC of:

- the PLMN ID of a PLMN of the PCF which provides the UE policy section, and a UE policy section code (UPSC), assigned by the PCF in that PLMN; or
- the PLMN ID part of an SNPN of the PCF which provides the UE policy section, and a UPSC, assigned by the PCF in that SNPN.

For the purposes of the present document, the following terms and definitions given in 3GPP TS 22.261 [3] apply:

**Non-public network
Disaster Roaming
satellite NG-RAN**

For the purposes of the present document, the following terms and definitions given in 3GPP TS 23.003 [4] apply:

**5G-GUTI
5G-S-TMSI
5G-TMSI
Global Line Identifier (GLI)
Global Cable Identifier (GCI)
GUAMI
IMEI
IMEISV
IMSI
PEI
SUPI
SUCI**

For the purposes of the present document, the following terms and definitions given in 3GPP TS 23.122 [5] apply:

**Access Technology
CAG selection
CAG-ID authorized based on "Allowed CAG list"**

Country
EHPLMN
HPLMN
Onboarding services in SNPN
UE determined PLMN with disaster condition
Registered SNPN
Selected PLMN
Selected SNPN
Shared network
SNPN identity
Steering of roaming SNPN selection information (SOR-SNPN-SI)
Steering of roaming SNPN selection information for localized services in SNPN (SOR-SNPN-SI-LS)
Steering of Roaming (SOR)
Steering of roaming connected mode control information (SOR-CMCI)
Steering of Roaming information
Subscribed SNPN
Suitable cell
VPLMN

For the purposes of the present document, the following terms and definitions given in 3GPP TS 23.167 [6] apply:

eCall over IMS

For the purposes of the present document, the following terms and definitions given in 3GPP TS 23.216 [6A] apply:

SRVCC

For the purposes of the present document, the following terms and definitions given in 3GPP TS 23.401 [7] apply:

eCall only mode

For the purposes of the present document, the following terms and definitions given in 3GPP TS 23.501 [8] apply:

5G access network
5G core network
5G QoS flow
5G QoS identifier
5G-RG
5G-BRG
5G-CRG
5G System
5G VN Group
Allowed area
Allowed NSSAI
Alternative S-NSSAI
AMF region
AMF set
Closed access group
Configured NSSAI
Credentials Holder (CH)
Default Credentials Server (DCS)
Group ID for Network Selection (GIN)
IAB-node
Local area data network
Mobile Base Station Relay
N3QAI
Network identifier (NID)
Network slice
Network slice area of service
NG-RAN
Non-allowed area
Onboarding Standalone Non-Public Network
Partially allowed NSSAI

PDU connectivity service
PDU session
PDU session type
PDU set
PEGC
PEMC
Pending NSSAI
PIN
PIN direct communication
PIN indirect communication
PIN-DN communication
PINE
Requested NSSAI
Routing Indicator
Service data flow
Service Gap Control
Serving PLMN rate control
Small data rate control status
SNPN-enabled UE
Stand-alone Non-Public Network
Time Sensitive Communication
Time Sensitive Communication and Time Synchronization Function
UE-DS-TT residence time
UE-Slice-MBR
UE presence in LADN service area

For the purposes of the present document, the following terms and definitions given in 3GPP TS 23.503 [10] apply:

UE local configuration
VPLMN specific (VPS) URSP

For the purposes of the present document, the following terms and definitions given in 3GPP TS 24.008 [12] apply:

GMM
MM
A/Gb mode
Iu mode
GPRS
Non-GPRS

For the purposes of the present document, the following terms and definitions given in 3GPP TS 24.301 [15] apply:

CIoT EPS optimization
Control plane CIoT EPS optimization
EENLV
EMM
EMM-DEREGISTERED
EMM-DEREGISTERED-INITIATED
EMM-IDLE mode
EMM-NULL
EMM-REGISTERED
EMM-REGISTERED-INITIATED
EMM-SERVICE-REQUEST-INITIATED
EMM-TRACKING-AREA-UPDATING-INITIATED
EPS
EPS security context
EPS services
Lower layer failure
Megabit
Message header
NAS signalling connection recovery
Native GUTI
NB-S1 mode

Non-EPS services
S1 mode
User plane CIoT EPS optimization
WB-S1 mode

For the purposes of the present document, the following terms and definitions given in 3GPP TS 33.501 [24] apply:

5G security context
5G NAS security context
ABBA
Current 5G NAS security context
Default UE credentials for primary authentication
Default UE credentials for secondary authentication
Full native 5G NAS security context
 K'_{AME}
 K_{AMF}
 K_{ASME}
Mapped 5G NAS security context
Mapped security context
Native 5G NAS security context
NCC
Non-current 5G NAS security context
Partial native 5G NAS security context
RES*

For the purposes of the present document, the following terms and definitions given in 3GPP TS 38.413 [31] apply:

NG connection
User Location Information

For the purposes of the present document, the following terms and definitions given in 3GPP TS 24.587 [19B] apply:

E-UTRA-PC5
NR-PC5
V2X

For the purposes of the present document, the following terms and its definitions given in 3GPP TS 23.256 [6AB] apply:

3GPP UAV ID
CAA (Civil Aviation Administration)-Level UAV Identity
Command and Control (C2) Communication
UAV controller (UAV-C)
UAS Services
UAS Service Supplier (USS)
Uncrewed Aerial System (UAS)
USS communication
UUAA
UUAA-MM
UUAA-SM
Direct C2 communication

For the purposes of the present document, the following terms and definitions given in 3GPP TS 24.554 [19E] apply:

5G ProSe

For the purposes of the present document, the following terms and definitions given in 3GPP TS 23.548 [10A] apply:

Edge Application Server
Edge DNS Client

For the purposes of the present document, the following terms and definitions given in 3GPP TS 24.526 [19] apply:

PLMN generic (PG) URSP
Non-subscribed SNPN signalled URSP

VPLMN specific (VPS) URSP of the RPLMN
VPLMN specific (VPS) URSP of the equivalent PLMN of the RPLMN

For the purposes of the present document, the following terms and definitions given in 3GPP TS 24.577 [60] apply:

A2X

For the purposes of the present document, the following terms and definitions given in 3GPP TS 24.514 [62] apply:

RSLPP
A2XP

For the purposes of the present document, the following terms and definitions given in 3GPP TS 23.316 [6D] apply:

Authenticable Non-3GPP (AUN3) device
Non-Authenticable Non-3GPP (NAUN3) device

For the purposes of the present document, the following terms and definitions given in 3GPP TS 23.586 [63] apply:

SL Positioning Server UE

For the purposes of the present document, the following terms and definitions given in 3GPP TS 38.300 [27] apply:

NCR-MT

For the purposes of the present document, the following terms and definitions given in 3GPP TS 24.572 [64] apply:

LCS-UPP

3.2 Abbreviations

For the purposes of the present document, the abbreviations given in 3GPP TR 21.905 [1] and the following apply. An abbreviation defined in the present document takes precedence over the definition of the same abbreviation, if any, in 3GPP TR 21.905 [1].

4G-GUTI	4G-Globally Unique Temporary Identifier
5GCN	5G Core Network
5G-GUTI	5G-Globally Unique Temporary Identifier
5GMM	5GS Mobility Management
5G-RG	5G Residential Gateway
5G-BRG	5G Broadband Residential Gateway
5G-CRG	5G Cable Residential Gateway
5GS	5G System
5GSM	5GS Session Management
5G-S-TMSI	5G S-Temporary Mobile Subscription Identifier
5G-TMSI	5G Temporary Mobile Subscription Identifier
5QI	5G QoS Identifier
ABBA	Anti-Bidding down Between Architectures
ACS	Auto-Configuration Server
AKA	Authentication and Key Agreement
AKMA	Authentication and Key Management for Applications
A-KID	AKMA Key Identifier
A-TID	AKMA Temporary Identifier
AMBR	Aggregate Maximum Bit Rate
AMF	Access and Mobility Management Function
ANDSP	Access Network Discovery and Selection Policy
APN	Access Point Name
AS	Access stratum
ATSSS	Access Traffic Steering, Switching and Splitting
AUN3	Authenticable Non-3GPP
AUSF	Authentication Server Function
AVC	Advanced Video Coding
CAG	Closed access group
CGI	Cell Global Identity

CHAP	Challenge Handshake Authentication Protocol
DDX	Downlink Data Expected
DEI	Drop Eligible Indicator
DL	Downlink
DN	Data Network
DNN	Data Network Name
DNS	Domain Name System
DS-TT	Device-Side TSN Translator
eDRX	Extended DRX cycle
ePDG	Evolved Packet Data Gateway
EUI	Extended Unique Identifier
E-UTRAN	Evolved Universal Terrestrial Radio Access Network
EAC	Early Admission Control
EAP-AKA'	Improved Extensible Authentication Protocol method for 3rd generation Authentication and Key Agreement
EAS	Edge Application Server
EASDF	Edge Application Server Discovery Function
ECIES	Elliptic Curve Integrated Encryption Scheme
ECS	Edge Configuration Server
ECSP	Edge Computing Service Provider
EDC	Edge DNS Client
EEC	Edge Enabler Client
EPD	Extended Protocol Discriminator
EMM	EPS Mobility Management
EPC	Evolved Packet Core Network
EPS	Evolved Packet System
EPS-UIPI	User-plane integrity protection in EPS
ESM	EPS Session Management
FN-RG	Fixed Network RG
FN-BRG	Fixed Network Broadband RG
FN-CRG	Fixed Network Cable RG
FQDN	Fully Qualified Domain Name
Gbps	Gigabits per second
GEO	Geostationary Orbit
GFBR	Guaranteed Flow Bit Rate
GUAMI	Globally Unique AMF Identifier
HEVC	High Efficiency Video Coding
IAB	Integrated access and backhaul
IMEI	International Mobile station Equipment Identity
IMEISV	International Mobile station Equipment Identity and Software Version number
IMSI	International Mobile Subscriber Identity
IP-CAN	IP-Connectivity Access Network
KSI	Key Set Identifier
LADN	Local Area Data Network
LCS	LoCation Services
LCS-UPP	Location Services User Plane Protocol
LEO	Low Earth Orbit
LMF	Location Management Function
LPP	LTE Positioning Protocol
MAC	Message Authentication Code
MA PDU	Multi-Access PDU
MBS	Multicast/Broadcast Services
MBSR	Mobile Base Station Relay
Mbps	Megabits per second
MCS	Mission Critical Service
MEO	Medium Earth Orbit
MFBR	Maximum Flow Bit Rate
MICO	Mobile Initiated Connection Only
MINT	Minimization of Service Interruption
MPS	Multimedia Priority Service
MSK	MBS Service Key
MTK	MBS Traffic Key

MUSIM	Multi-USIM
N3IWF	Non-3GPP Inter-Working Function
N3QAI	Non-3GPP QoS Assistance Information
N5CW	Non-5G-Capable over WLAN
N5GC	Non-5G Capable
NAI	Network Access Identifier
NAUN3	Non-Authenticable Non-3GPP
NITZ	Network Identity and Time Zone
ngKSI	Key Set Identifier for Next Generation Radio Access Network
NPN	Non-public network
NR	New Radio
NSAC	Network Slice Admission Control
NSACF	Network Slice Admission Control Function
NSAG	Network slice AS group
NS-AoS	Network slice area of service
NSSAA	Network slice-specific authentication and authorization
NSSAAF	Network Slice-Specific and SNPN authentication and authorization Function
NSSAI	Network Slice Selection Assistance Information
NSSRG	Network Slice Simultaneous Registration Group
ON-SNPN	Onboarding Standalone Non-Public Network
OS	Operating System
OS Id	OS Identity
PAP	Password Authentication Protocol
PCO	Protocol Configuration Option
PCP	Priority Code Point
PEI	Permanent Equipment Identifier
PEIPS	Paging Early Indication with Paging Subgrouping
PEGC	PIN Element with Gateway Capability
PEMC	PIN Element with Management Capability
PIN	Personal IoT Network
PINE	PIN Element
PMF	Performance Measurement Function
PNI-NPN	Public Network Integrated Non-Public Network
ProSe	Proximity based Services
ProSeP	5G ProSe policy
PG	PLMN Generic
PTI	Procedure Transaction Identity
PTP	Precision Time Protocol
PVS	Provisioning Server
QFI	QoS Flow Identifier
QoS	Quality of Service
QRI	QoS Rule Identifier
RACS	Radio Capability Signalling Optimisation
(R)AN	(Radio) Access Network
RFSP	RAT Frequency Selection Priority
RG	Residential Gateway
RPLMN	Registered PLMN
RQA	Reflective QoS Attribute
RQI	Reflective QoS Indication
RSC	Relay Service Code
RSN	Redundancy Sequence Number
RSNPN	Registered SNPN
RTT	Round Trip Time
S-NSSAI	Single NSSAI
SA	Security Association
SDF	Service Data Flow
SDNAEPC	Secondary DN authentication and authorization over EPC
SDT	Small Data Transmission
SMF	Session Management Function
SGC	Service Gap Control
SLPP	SideLink Positioning Protocol
SNN	Serving Network Name

SNPN	Stand-alone Non-Public Network
SOR	Steering of Roaming
SOR-CMCI	Steering of Roaming Connected Mode Control Information
SRTSP	Secure Real-time Transport Protocol
SUCI	Subscription Concealed Identifier
SUPI	Subscription Permanent Identifier
TA	Tracking Area
TAC	Tracking Area Code
TAI	Tracking Area Identity
Tbps	Terabits per second
TMGI	Temporary Mobile Group Identity
TNAN	Trusted Non-3GPP Access Network
TNGF	Trusted Non-3GPP Gateway Function
TSC	Time Sensitive Communication
TSCTSF	Time Sensitive Communication and Time Synchronization Function
TWIF	Trusted WLAN Interworking Function
TSN	Time-Sensitive Networking
UAS	Uncrewed Aerial System
UAV	Uncrewed Aerial Vehicle
UAV-C	Uncrewed Aerial Vehicle-Controller
UDM	Unified Data Management
UL	Uplink
UPDS	UE policy delivery service
UPF	User Plane Function
UP-PRUK	User Plane ProSe Remote User Key
UPP-CMI	User Plane Positioning Connection Management Information
UPSC	UE Policy Section Code
UPSI	UE Policy Section Identifier
URN	Uniform Resource Name
URSP	UE Route Selection Policy
USS	UAS Service Supplier
UUAA	USS UAV Authorization/Authentication
V2X	Vehicle-to-Everything
V2XP	V2X policy
VID	VLAN Identifier
VPS	VPLMN Specific
W-AGF	Wireline Access Gateway Function
WLAN	Wireless Local Area Network
WUS	Wake-up signal

4 General

4.1 Overview

The non-access stratum (NAS) described in the present document forms the highest stratum of the control plane between the UE and the AMF (reference point "N1" see 3GPP TS 23.501 [8]) for both 3GPP and non-3GPP access.

Main functions of the protocols that are part of the NAS are:

- a) support of mobility of the user equipment (UE) including also common procedures such as authentication, identification, generic UE configuration update and security mode control procedures;
- b) support of session management procedures to establish and maintain data connectivity between the UE and the data network; and
- c) NAS transport procedure to provide a transport of SMS, LPP, SLPP, LCS, UPP-CMI container, UE policy container, SOR transparent container and UE parameters update information payload.

Principles for the handling of 5GS security contexts and for the activation of ciphering and integrity protection, when a NAS signalling connection is established, are provided in subclause 4.4.

For the support of the above functions, the following procedures are supplied within this specification:

- a) elementary procedures for 5GS mobility management in clause 5; and
- b) elementary procedures for 5GS session management in clause 6.

Signalling procedures for the control of NAS security are described as part of the 5GMM common procedures in subclause 5.4.

Complete NAS transactions consist of specific sequences of elementary procedures. Examples of such specific sequences can be found in 3GPP TS 23.502 [9].

The NAS for 5GS follows the protocol architecture model for layer 3 as described in 3GPP TS 24.007 [11].

4.2 Coordination between the protocols for 5GS mobility management and 5GS session management

A 5GS session management (5GSM) message is piggybacked in specific 5GS mobility management (5GMM) transport messages. To this purpose, the 5GSM messages can be transmitted in an information element in the 5GMM transport messages. In this case, the UE, the AMF and the SMF execute the 5GMM procedure and the 5GSM procedure in parallel. The success of the 5GMM procedure is not dependent on the success of the piggybacked 5GSM procedure.

The UE can only initiate the 5GSM procedure when there is a 5GMM context established at the UE.

During 5GMM procedures, the UE and the AMF shall suspend the transmission of 5GSM messages, except when:

- a) the 5GMM procedure is piggybacking 5GSM messages; or
- b) the UE is in 5GMM-CONNECTED mode and a service request procedure for re-establishing user-plane resources of PDU session(s) is initiated without including PDU session status IE or Allowed PDU session status IE. In this case, the UE and the AMF need not suspend the transmission of 5GSM messages related to other PDU session(s) than the one(s) for which the user- plane resources re-establishment is requested.

If the UE determines to locally release the N1 NAS signalling connection upon receiving an SOR transparent container during a registration procedure as specified in 3GPP TS 23.122 [5] Annex C.2, the UE shall suspend the transmission of 5GSM messages after sending the REGISTRATION COMPLETE message and until the N1 NAS signalling connection is released to obtain service on a higher priority PLMN, with the exception of the case when the UE has an emergency PDU session.

A 5GMM message piggybacking a 5GSM message for a PDU session shall be delivered via the access associated with the PDU session, if any, with the following exceptions:

- a) the AMF shall send, via 3GPP access, a DL NAS TRANSPORT message piggybacking a downlink 5GSM message of a network-requested 5GSM procedure for a PDU session associated with non-3GPP access if the conditions specified in subclause 5.5.1.3.4 or subclause 5.6.1.4 are met;
- b) the UE shall send an UL NAS TRANSPORT message piggybacking a response message to the 5GSM message described in a) via either:
 - 1) 3GPP access; or
 - 2) non-3GPP access if the UE is in 5GMM-CONNECTED mode over non-3GPP access; and

NOTE: The interaction between the 5GMM sublayer and the 5GSM sublayer to enable the UE to send the UL NAS TRANSPORT message containing the response message via 3GPP access is required. This is achieved via UE implementation.

- c) the UE shall send, via the target access, an UL NAS TRANSPORT message piggybacking a 5GSM message associated with a request type set to "existing PDU session" or "existing emergency PDU session" for handover of an existing PDU session between 3GPP access and non-3GPP access.

A 5GMM message piggybacking a 5GSM message as a response message to a request message associated with an MA PDU session, shall be delivered via the same access that the initial message was received.

4.3 UE domain selection

4.3.1 UE's usage setting

The UE's usage setting defined in 3GPP TS 24.301 [15] applies to voice capable UEs in 5GS and indicates whether the UE has preference for voice services over data services or vice-versa, where:

- a) voice services include IMS voice; and
- b) data services include any kind of user data transfer without a voice media component.

The UE's usage setting can be set to:

- a) "voice centric"; or
- b) "data centric".

If the UE is capable of S1 mode, there is a single UE's usage setting at the UE which applies to both 5GS and EPS.

4.3.2 Domain selection for UE originating sessions / calls

The behaviour of the UE for domain selection is determined by:

- a) the UE usage setting;
- b) the availability of IMS voice; and
- c) whether the UE operates in single-registration mode or dual-registration mode (see 3GPP TS 23.501 [8]).

In the present document the condition "the UE supports IMS voice over 3GPP access" evaluates to "true" if at least one of the following is fulfilled:

- 1) the UE supports IMS voice over NR connected to 5GCN;
- 2) the UE supports IMS voice over E-UTRA connected to 5GCN; or
- 3) the UE supports IMS voice in EPS.

In the present document the condition "the UE does not support IMS voice over 3GPP access" evaluates to "true" if the condition "the UE supports IMS voice over 3GPP access" evaluates to "false".

In the present document the condition "the UE supports IMS voice over non-3GPP access" evaluates to "true" if the UE supports IMS voice over non-3GPP access connected to 5GCN.

In the present document the condition "the UE does not support IMS voice over non-3GPP access" evaluates to "true" if the condition "the UE supports IMS voice over non-3GPP access" evaluates to "false".

In the present document, "IMS voice not available" is determined per access type independently, i.e. 3GPP access or non-3GPP access.

In the present document, "IMS voice not available" refers to one of the following conditions:

- a) the UE does not support IMS voice;
- b) the UE supports IMS voice, but the network indicates in the REGISTRATION ACCEPT message that IMS voice over PS sessions are not supported; or
- c) the UE supports IMS voice, the network indicates in the REGISTRATION ACCEPT message that IMS voice over PS sessions are supported, but the upper layers:
 - 1) provide no indication that the UE is available for voice call in the IMS within a manufacturer determined period of time; or
 - 2) indicate that the UE is not available for voice calls in the IMS.

NOTE 1: If conditions a and b evaluate to false, the upper layers need time to attempt IMS registration. In the event an indication from the upper layers that the UE is available for voice calls in the IMS takes longer than the manufacturer determined period of time (e.g. due to delay when attempting IMS registration or due to delay in obtaining a QoS flow for SIP signalling), the NAS layer assumes the UE is not available for voice calls in the IMS.

Other conditions may exist but these are implementation specific.

In the present document, "IMS voice available" applies when "IMS voice not available" does not apply.

When IMS voice is not available over 3GPP access, if the UE's usage setting is "voice centric", the UE operates in single-registration mode, and the UE:

- a) does not have a persistent PDU session, and:
 - 1) if the UE is only registered over 3GPP access, or if the UE is registered over both 3GPP access and non-3GPP access and IMS voice is not available over non-3GPP access, the UE shall disable the N1 mode capability for 3GPP access and proceed as specified in subclause 4.9.2 with modifications described below; or
 - 2) if the UE is registered over both 3GPP access and non-3GPP access and IMS voice is available over non-3GPP access, the UE may disable the N1 mode capability for 3GPP access and proceed as specified in subclause 4.9.2 with modifications described below; or
- b) has a persistent PDU session, then the UE waits until the radio bearer associated with the persistent PDU session has been released. When the radio bearer associated with the persistent PDU session has been released, then:
 - 1) if the UE is only registered over 3GPP access, or if the UE is registered over both 3GPP access and non-3GPP access and IMS voice is not available over non-3GPP access, the UE shall disable the N1 mode capability for 3GPP access and proceed as specified in subclause 4.9.2 with modifications described below; or
 - 2) If the UE is registered over both 3GPP access and non-3GPP access and IMS voice is available over non-3GPP access, the UE may disable the N1 mode capability for 3GPP access and proceed as specified in subclause 4.9.2 with modifications described below.

The following modifications are applied to the procedure in subclause 4.9.2 for disabling the N1 mode capability for 3GPP access, if the UE's usage setting is "voice centric" and the UE operates in single-registration mode:

- a) in item a) of subclause 4.9.2, the UE shall attempt to select an E-UTRA cell connected to EPC. If such a cell is found, the UE shall then perform voice domain selection procedures as defined in 3GPP TS 24.301 [15]; and
- b) in item b) of subclause 4.9.2, if an E-UTRA cell connected to EPC cannot be found, the UE shall attempt to select another supported radio access technology which supports voice services.

When IMS voice is not available over non-3GPP access, if the UE's usage setting is "voice centric" and the UE operates in single-registration mode, then:

- a) if the UE is only registered over non-3GPP access, the UE shall disable the N1 mode capability for non-3GPP access (see subclause 4.9.3); or
- b) if the UE is registered over both 3GPP access and non-3GPP access and IMS voice is not available also over 3GPP access, the UE may disable the N1 mode capability for non-3GPP access (see subclause 4.9.3).

NOTE 2: The UE can register over 3GPP access in another mode, e.g., S1 mode, for voice service, and in this case the UE can keep the N1 mode capability for non-3GPP access enabled.

4.3.3 Change of UE's usage setting

If the UE operates in single-registration mode, whenever the UE's usage setting changes, the UE shall execute procedures according to table 4.3.3.1:

Table 4.3.3.1: Change of UE's usage setting for a UE in single-registration mode

UE's usage setting change	Procedure to execute
From "data centric" to "voice centric" and "IMS voice not available" over 3GPP access only	Disable the N1 mode capability for 3GPP access (see subclause 4.9.2), if the UE is only registered over 3GPP access (NOTE)
From "data centric" to "voice centric", and "IMS voice not available" over both 3GPP access and non-3GPP access	Disable the N1 mode capability for 3GPP access (see subclause 4.9.2) and non-3GPP access (see subclause 4.9.3), if the UE is registered over both 3GPP access and non-3GPP access Disable the N1 mode capability for 3GPP access (see subclause 4.9.2), if the UE is only registered over 3GPP access. Disable the N1 mode capability for non-3GPP access (see subclause 4.9.3), if the UE is only registered over non-3GPP access. (NOTE)
From "voice centric" to "data centric" and the N1 mode capability for 3GPP access is disabled at the UE due to "IMS voice not available"	Re-enable the N1 mode capability for 3GPP access (see subclause 4.9.2)
From "data centric" to "voice centric" and "IMS voice not available" over non-3GPP access only	Disable the N1 mode capability for non-3GPP access (see subclause 4.9.3), if the UE is only registered over non-3GPP access
From "voice centric" to "data centric", and the N1 mode capability for non-3GPP access is disabled at the UE due to "IMS voice not available"	Re-enable the N1 mode capability for non-3GPP access (see subclause 4.9.3)
NOTE: If the UE is registered over 3GPP access and has a persistent PDU session, then the UE waits until the radio bearer associated with the persistent PDU session has been released.	

4.3.4 Change or determination of IMS voice availability

If the UE operates in single-registration mode, whenever the IMS voice availability is determined or changes, the UE shall execute procedures according to table 4.3.4.1:

Table 4.3.4.1: Change of IMS voice availability for a UE in single-registration mode

Change of IMS voice available condition	Procedure to execute
"IMS voice not available" over 3GPP access only and the UE's usage setting is "voice centric"	Disable the N1 mode capability for 3GPP access, if the UE is only registered over 3GPP access (see subclause 4.9.2). (NOTE 2)
"IMS voice not available" over non-3GPP access only and the UE's usage setting is "voice centric"	Disable the N1 mode capability for non-3GPP access (see subclause 4.9.3), if the UE is only registered over non-3GPP access. (NOTE 2)
"IMS voice not available" over both 3GPP access and non-3GPP access, and the UE's usage setting is "voice centric"	Disable the N1 mode capability for 3GPP access (see subclause 4.9.2) and non-3GPP access (see subclause 4.9.3), if the UE is registered over both 3GPP access and non-3GPP access. Disable the N1 mode capability for 3GPP access (see subclause 4.9.2), if the UE is only registered over 3GPP access Disable the N1 mode capability for non-3GPP access (see subclause 4.9.3), if the UE is only registered over non-3GPP access. (NOTE 1, NOTE 2)
NOTE 1: If the UE is registered over 3GPP access and has a persistent PDU session, then the UE waits until the radio bearer associated with the persistent PDU session has been released. NOTE 2: If the UE determines "IMS voice not available" upon receipt of a 5GS session management reject message including a back-off timer value, and the re-attempt indicator indicates that the UE is not allowed to re-attempt the procedure in S1 mode then, upon inter-system change from N1 mode to S1 mode, the UE proceeds as specified in 3GPP TS 24.301 [15], subclause 4.3.2.4, Change or determination of IMS registration status.	

4.4 NAS security

4.4.1 General

This clause describes the principles for the handling of 5G NAS security contexts in the UE and in the AMF, the procedures used for the security protection of NAS messages between the UE and the AMF, and the procedures used for the protection of NAS IEs between the UE and the UDM. Security protection involves integrity protection and ciphering of the 5GMM messages. 5GSM messages are security protected indirectly by being piggybacked by the security protected 5GMM messages (i.e. UL NAS TRANSPORT message and the DL NAS TRANSPORT message).

The signalling procedures for the control of NAS security are part of the 5GMM protocol and are described in detail in clause 5.

NOTE: The use of ciphering in a network is an operator option. In this subclause, for the ease of description, it is assumed that ciphering is used, unless explicitly indicated otherwise. Operation of a network without ciphering is achieved by configuring the AMF so that it always selects the "null ciphering algorithm", 5G-EA0.

4.4.2 Handling of 5G NAS security contexts

4.4.2.1 General

4.4.2.1.1 Establishment of 5G NAS security context

The security parameters for authentication, integrity protection and ciphering are tied together in a 5G NAS security context and identified by a key set identifier (ngKSI). The relationship between the security parameters is defined in 3GPP TS 33.501 [24].

Before security can be activated, the AMF and the UE need to establish a 5G NAS security context. Usually, the 5G NAS security context is created as the result of a primary authentication and key agreement procedure between the AMF and the UE. A new 5G NAS security context may also be created during an N1 mode to N1 mode handover. Alternatively, during inter-system change from S1 mode to N1 mode, the AMF not supporting interworking without

N26 and the UE operating in single-registration mode may derive a mapped 5G NAS security context from an EPS security context that has been established while the UE was in S1 mode.

The 5G NAS security context is taken into use by the UE and the AMF, when the AMF initiates a security mode control procedure, during an N1 mode to N1 mode handover, or during the inter-system change procedure from S1 mode to N1 mode. The 5G NAS security context which has been taken into use by the network most recently is called current 5G NAS security context. This current 5G NAS security context can be of type native or mapped, i.e. originating from a native 5G NAS security context or mapped 5G NAS security context.

The key set identifier ngKSI is assigned by the AMF either during the primary authentication and key agreement procedure or, for the mapped 5G NAS security context, during the inter-system change. The ngKSI consists of a value and a type of security context parameter indicating whether a 5G NAS security context is a native 5G NAS security context or a mapped 5G NAS security context. When the 5G NAS security context is a native 5G NAS security context, the ngKSI has the value of KSI_{AMF} , and when the current 5G NAS security context is of type mapped, the ngKSI has the value of KSI_{ASME} .

The 5G NAS security context which is indicated by an ngKSI can be taken into use to establish the secure exchange of NAS messages when a new N1 NAS signalling connection is established without executing a new primary authentication and key agreement procedure (see subclause 5.4.1) or when the AMF initiates a security mode control procedure. For this purpose, the initial NAS messages (i.e. REGISTRATION REQUEST, DEREGISTRATION REQUEST, SERVICE REQUEST and CONTROL PLANE SERVICE REQUEST) and the SECURITY MODE COMMAND message contain an ngKSI in the ngKSI IE indicating the current 5G NAS security context used to integrity protect the NAS message.

In the present document, when the UE is required to delete an ngKSI, the UE shall set the ngKSI to the value "no key is available" and consider also the associated keys K_{AMF} or K'_{AMF} , 5G NAS ciphering key and 5G NAS integrity key invalid (i.e. the 5G NAS security context associated with the ngKSI as no longer valid). In the initial registration procedure, when the key K_{AUSF} is invalid, the UE shall delete the ngKSI.

NOTE: In some specifications the term ciphering key sequence number might be used instead of the term key set identifier (KSI).

As described in subclause 4.8 in order to interwork with E-UTRAN connected to EPC, the UE supporting both S1 mode and N1 mode can operate in either single-registration mode or dual-registration mode. A UE operating in dual-registration mode shall independently maintain and use both EPS security context (see 3GPP TS 24.301 [15]) and 5G NAS security context. When the UE operating in dual-registration mode performs an EPS attach procedure, it shall take into use an EPS security context and follow the handling of this security context as specified in 3GPP TS 24.301 [15]. However, when the UE operating in dual-registration mode performs an initial registration procedure, it shall take into use a 5G NAS security context and follow the handling of this security context as described in the present specification.

The UE and the AMF need to be able to maintain two 5G NAS security contexts simultaneously, i.e. a current 5G NAS security context and a non-current 5G NAS security context, since:

- a) after a 5G re-authentication, the UE and the AMF can have both a current 5G NAS security context and a non-current 5G NAS security context which has not yet been taken into use (i.e. a partial native 5G NAS security context); and
- b) after an inter-system change from S1 mode to N1 mode, the UE and the AMF can have both a mapped 5G NAS security context, which is the current 5G NAS security context, and a non-current native 5G NAS security context that was created during a previous access in N1 mode.

The number of 5G NAS security contexts that need to be maintained simultaneously by the UE and the AMF is limited by the following requirements:

- a) after a successful 5G (re-)authentication, which creates a new partial native 5G NAS security context, the AMF and the UE shall delete the non-current 5G NAS security context, if any;
- b) when a partial native 5G NAS security context is taken into use through a security mode control procedure, the AMF shall delete the previously current 5G NAS security context. If the UE does not support multiple records of NAS security context storage for multiple registration (see 3GPP TS 31.102 [22]), the UE shall delete the previously current 5G NAS security context. If the UE supports multiple records of NAS security context storage for multiple registration, the UE shall:

- 1) replace the previously current 5G NAS security context stored in the first 5G security context of that access (see 3GPP TS 31.102 [22]) with the new 5G security context (taken into use through a security mode control procedure), when the UE activates the new 5G security context for the same PLMN and access;
 - 1a) replace the previously current 5G NAS security context stored in the first 5G security context of that access (see 3GPP TS 31.102 [22]) with the new 5G security context (taken into use through a security mode control procedure), when the UE activates the new 5G security context for a different PLMN over that access but the previously current 5G NAS security context is not associated with the 5G-GUTI of the other access; or
 - 2) store the previously current 5G NAS security context in the second 5G security context of that access (see 3GPP TS 31.102 [22]) and store the new 5G security context (taken into use through a security mode control procedure) in the first 5G security context, when the UE activates the new 5G security context for a different PLMN over that access but the previously current 5G NAS security context is associated with the 5G-GUTI of the other access;
- c) when the AMF and the UE create a 5G NAS security context using "null integrity protection algorithm" and "null ciphering algorithm" during an initial registration procedure for emergency services, or a registration procedure for mobility and periodic registration update for a UE that has an emergency PDU session (see subclause 5.4.2.2), the AMF and the UE shall delete the previous current 5G NAS security context. The UE shall not update the USIM and non-volatile ME memory with the current 5G NAS security context and shall delete the current 5G NAS security context when the UE is deregistered from emergency services (e.g. before registering for normal service);
- d) when a new mapped 5G NAS security context or 5G NAS security context created using "null integrity protection algorithm" and "null ciphering algorithm" is taken into use during the inter-system change from S1 mode to N1 mode, the AMF and the UE shall not delete the previously current native 5G NAS security context, if any. Instead, the previously current native 5G NAS security context shall become a non-current native 5G NAS security context, and the AMF and the UE shall delete any partial native 5G NAS security context;
- If no previously current native 5G NAS security context exists, the AMF and the UE shall not delete the partial native 5G NAS security context, if any;
- e) when the AMF and the UE derive a new mapped 5G NAS security context during inter-system change from S1 mode to N1 mode, the AMF and the UE shall delete any existing current mapped 5G NAS security context;
- f) when a non-current full native 5G NAS security context is taken into use by a security mode control procedure, then the AMF and the UE shall delete the previously current mapped 5G NAS security context;
- g) when the UE or the AMF moves from 5GMM-REGISTERED to 5GMM-DEREGISTERED state, if the current 5G NAS security context is a mapped 5G NAS security context and a non-current full native 5G NAS security context exists, then the non-current 5G NAS security context shall become the current 5G NAS security context. Furthermore, the UE and the AMF shall delete any mapped 5G NAS security context or partial native 5G NAS security context.
- h) when the UE operating in single-registration mode in a network supporting N26 interface performs an inter-system change from N1 mode to S1 mode:
- 1) if the UE has a mapped 5G NAS security context and the inter-system change is performed in:
 - i) 5GMM-IDLE mode, the UE shall delete the mapped 5G NAS security context after the successful completion of the tracking area update procedure or attach procedure (see 3GPP TS 24.301 [15]); or
 - ii) 5GMM-CONNECTED mode, the UE shall delete the mapped 5G NAS security context after the completion of the inter-system change.

After deletion of the mapped 5G NAS security context, if the UE has a non-current full native 5G NAS security context, then the non-current full native 5G NAS security context shall become the current full native 5G NAS security context; and
 - i) when the UE operating in single-registration mode in a network supporting N26 interface performs an inter-system change from S1 mode to N1 mode in 5GMM-IDLE mode, if the UE has a non-current full native 5G NAS security context, then the UE shall make the non-current full native 5G NAS security context as the current native 5G NAS security context. The UE shall delete the mapped 5G NAS security context, if any.

4.4.2.1.2 UE leaving state 5GMM-DEREGISTERED

If the UE is capable of registration over a single access only, the UE shall mark the 5G NAS security context on the USIM or in the non-volatile memory as invalid when the UE initiates an initial registration procedure as described in subclause 5.5.1.2 or when the UE leaves state 5GMM-DEREGISTERED for any other state except 5GMM-NULL.

If the UE is capable of registration over both 3GPP access and non-3GPP access and was last registered on the same PLMN over both 3GPP access and the non-3GPP access, the UE in the state 5GMM-DEREGISTERED over both 3GPP access and non-3GPP access shall mark the 5G NAS security contexts in record 1 of the 3GPP access and the non-3GPP access on the USIM or in the non-volatile memory as invalid when the UE initiates an initial registration procedure over either 3GPP access or non-3GPP access as described in subclause 5.5.1.2 or when the UE leaves state 5GMM-DEREGISTERED for any other state except 5GMM-NULL over either 3GPP access or non-3GPP access.

4.4.2.1.3 UE entering state 5GMM-DEREGISTERED

If the UE is capable of registration over a single access only, the UE shall store the current native 5G NAS security context on the USIM or in the non-volatile memory and mark it as valid only when the UE enters state 5GMM-DEREGISTERED from any other state except 5GMM-NULL or when the UE aborts the initial registration procedure without having left 5GMM-DEREGISTERED.

If the UE is capable of registration over both 3GPP access and non-3GPP access and is registered on the same PLMN over both 3GPP access and the non-3GPP access, the UE shall store the current native 5G NAS security contexts of the 3GPP access and the non-3GPP access as specified in annex C and mark them as valid only when the UE enters state 5GMM-DEREGISTERED from any other state except 5GMM-NULL over both the 3GPP access and non-3GPP access or only when the UE aborts the initial registration procedure without having left 5GMM-DEREGISTERED over both the 3GPP access and non-3GPP access.

4.4.2.2 Establishment of a mapped 5G NAS security context during inter-system change from S1 mode to N1 mode in 5GMM-CONNECTED mode

In order for the UE operating in single-registration mode in a network supporting N26 interface to derive a mapped 5G NAS security context for an inter-system change from S1 mode to N1 mode in 5GMM-CONNECTED mode, the AMF shall construct a mapped 5G NAS security context from the EPS security context received from the source MME as indicated in 3GPP TS 33.501 [24]. The AMF shall select the 5G NAS security algorithms and derive the 5G NAS keys (i.e. K_{NASenc} and K_{NASint}). The AMF shall define an ngKSI for the newly derived K'_{AMF} key such that the value field is taken from the eKSI of the K_{ASME} key and the type field is set to indicate a mapped security context and associate this ngKSI with the newly created mapped 5G NAS security context. The AMF shall then include the message authentication code, selected NAS algorithms, NCC and generated ngKSI in the S1 mode to N1 mode NAS transparent container IE (see subclause 9.11.2.9).

When the UE operating in single-registration mode in a network supporting N26 interface receives the command to perform inter-system change to N1 mode in 5GMM-CONNECTED mode, the UE shall derive a mapped K'_{AMF} , as indicated in 3GPP TS 33.501 [24], using the K_{ASME} from the EPS security context. Furthermore, the UE shall also derive the 5G NAS keys from the mapped K'_{AMF} using the selected NAS algorithm identifiers included in the S1 mode to N1 mode NAS transparent container IE and associate this mapped 5G NAS security context with the ngKSI value received. The UE shall then verify the received NAS MAC. In case the received NAS MAC is not verified successfully (see subclause 4.4.3.3) the UE shall discard the content of the received S1 mode to N1 mode NAS transparent container IE and inform the lower layers that the received S1 mode to N1 mode NAS transparent container is invalid.

When the UE operating in single-registration mode in a network supporting N26 interface has a PDN connection for emergency bearer services and has no current EPS security context, the AMF shall set 5G-IA0 and 5G-EA0 as the selected 5G NAS security algorithms in the S1 mode to N1 mode NAS transparent container IE. The AMF shall create a locally generated K'_{AMF} . The AMF shall set the ngKSI value of the associated security context to "000" and the type of security context flag to "mapped security context" in the S1 mode to N1 mode NAS transparent container IE.

When the UE operating in single-registration mode in a network supporting N26 interface receives the command to perform inter-system change to N1 mode in 5GMM-CONNECTED mode (see 3GPP TS 38.331 [30]) and has a PDN connection for emergency bearer services, if 5G-IA0 and 5G-EA0 as the selected 5G NAS security algorithms are included in the S1 mode to N1 mode NAS transparent container IE, the UE shall create a locally generated K'_{AMF} . Furthermore, the UE shall set the ngKSI value of the associated security context to the KSI value received.

After the new mapped 5G NAS security context is taken into use for the 3GPP access following a successful inter system change from S1 mode to N1 mode in 5GMM-CONNECTED mode and the UE is registered with the same PLMN over the 3GPP access and non-3GPP access:

- a) if a native 5G NAS security context is used on the non-3GPP access and:
 - 1) the UE is in 5GMM-IDLE mode over non-3GPP access, then the AMF and the UE shall activate and take into use the new mapped 5G NAS security context on the 3GPP access for the non-3GPP access as described in 3GPP TS 33.501 [24] after the AMF sends or the UE receives the REGISTRATION ACCEPT message respectively. The UE and AMF shall keep the native 5G NAS security context which was used on the non-3GPP access and make it a non-current native 5G NAS security context. The non-current native 5G NAS security context may be re-activated later using the security mode control procedure; or
 - 2) the UE is in 5GMM-CONNECTED mode over non-3GPP access, in order to activate the native 5G NAS security context over the 3GPP access that is active on the non-3GPP access the AMF shall send the SECURITY MODE COMMAND message over the 3GPP access as described in 3GPP TS 33.501 [24]. The SECURITY MODE COMMAND message shall include the same ngKSI to identify the native 5G NAS security context that is used on the non-3GPP access; or
- b) if a mapped 5G NAS security context is used on the non-3GPP access and:
 - 1) the UE is in 5GMM-IDLE mode over non-3GPP access, the AMF and the UE shall activate and take into use the new mapped 5G NAS security context active on the 3GPP access for the non-3GPP access as described in 3GPP TS 33.501 [24] after the AMF sends or the UE receives the REGISTRATION ACCEPT message respectively; or
 - 2) the UE is in 5GMM-CONNECTED mode over non-3GPP access, in order to activate the same mapped 5G NAS security context over one access that is used on the other access the AMF shall send the SECURITY MODE COMMAND message over one-access as described in 3GPP TS 33.501 [24]. The SECURITY MODE COMMAND message shall include the same ngKSI to identify the mapped 5G NAS security context that is used over the other access.

If the inter-system change from S1 mode to N1 mode in 5GMM-CONNECTED mode is not completed successfully, the AMF and the UE operating in single-registration mode in a network supporting N26 interface shall delete the new mapped 5G NAS security context.

4.4.2.3 Establishment of a 5G NAS security context during N1 mode to N1 mode handover

During an N1 mode to N1 mode handover, the target AMF may derive a new 5G NAS security context for which the target AMF creates a new 5G NAS security context as indicated in 3GPP TS 33.501 [24].

When a new 5G NAS security context is derived using the same K_{AMF} , the target AMF includes the 8 least significant bits of the downlink NAS COUNT in the Intra N1 mode NAS transparent container IE, and indicates that a new K_{AMF} shall not be derived (see subclause 9.11.2.6). The AMF shall increment the downlink NAS COUNT by one after creating the Intra N1 mode NAS transparent container IE.

When a new 5G NAS security context is created from a new K_{AMF} , the target AMF includes the 8 least significant bits of the downlink NAS COUNT in the Intra N1 mode NAS transparent container IE and indicates that a new K_{AMF} shall be derived (see subclause 9.11.2.6). The AMF shall then set both the uplink and downlink NAS COUNT counters of this 5G NAS security context to zero. The AMF shall increment the downlink NAS COUNT by one after creating the Intra N1 mode NAS transparent container IE.

The target AMF also includes the ngKSI with the same value as the ngKSI currently being used with the UE, the message authentication code, and the selected NAS algorithms in the Intra N1 mode NAS transparent container IE.

When the UE receives a command to perform handover to NG-RAN including an Intra N1 mode NAS transparent container IE (see subclause 9.11.2.6), the UE derives a new 5G NAS security context as described in 3GPP TS 33.501 [24]. When the Intra N1 mode NAS transparent container IE indicates that a new K_{AMF} needs to be derived, the UE shall set both the downlink NAS COUNT and uplink NAS COUNT to zero after creating the new 5G NAS security context.

If the received Intra N1 mode NAS transparent container IE does not have a valid NAS COUNT (see subclause 4.4.3.2) or the received NAS MAC is not verified successfully (see subclause 4.4.3.3) the UE shall discard the content of the

received Intra N1 mode NAS transparent container IE, continue to use the current 5G NAS security context, and inform the lower layers that the received Intra N1 mode NAS transparent container is invalid.

NOTE 1: During N1 mode to N1 mode handover, the Intra N1 mode NAS transparent container IE (see subclause 9.11.2.6) is equivalent to sending a SECURITY MODE COMMAND message to the UE in order to derive and use a new 5G NAS security context, optionally created with a new K_{AMF} . The UE maintains the Selected EPS NAS security algorithms until the UE receives a new Selected EPS NAS security algorithms.

After the new 5G NAS security context is taken into use for 3GPP access following a successful N1 mode to N1 mode handover and the UE is registered with the same PLMN over the 3GPP access and non-3GPP access:

- a) the UE is in 5GMM-IDLE mode over non-3GPP access, the AMF and the UE shall activate and take into use the new 5G NAS security context over the non-3GPP access as described in 3GPP TS 33.501 [24] after the AMF sends or the UE receives the REGISTRATION ACCEPT message respectively. If the new 5G NAS security context is created from a new K_{AMF} , the AMF and the UE shall set the downlink NAS COUNT and uplink NAS COUNT to zero also for the non-3GPP access, otherwise the downlink NAS COUNT and uplink NAS COUNT for the non-3GPP access are not changed; or
- b) the UE is in 5GMM-CONNECTED mode over non-3GPP access, in order to activate the new 5G NAS security context over the non-3GPP access that has been activated for the 3GPP access the AMF shall send the SECURITY MODE COMMAND message over the non-3GPP access as described in 3GPP TS 33.501 [24]. The SECURITY MODE COMMAND message shall include the same ngKSI to identify the new 5G NAS security context that was activated over the 3GPP access and shall include the horizontal derivation parameter indicating " K_{AMF} derivation is not required". Otherwise, if the new 5G NAS security context is created from a new K_{AMF} , the AMF and the UE shall set the downlink NAS COUNT and uplink NAS COUNT to zero for the non-3GPP access.

NOTE 2: Explicit indication " K_{AMF} derivation is not required" for the non-3GPP access is to align security contexts within the UE without a subsequent derivation of a new K_{AMF} in the non-3GPP access.

4.4.2.4 Establishment of an EPS security context during inter-system change from N1 mode to S1 mode in 5GMM-CONNECTED mode

In order for the UE operating in single-registration mode in a network supporting N26 interface to derive a mapped EPS security context for an inter-system change from N1 mode to S1 mode in 5GMM-CONNECTED mode, the AMF shall prepare a mapped EPS security context for the target MME as indicated in 3GPP TS 33.501 [24].

The AMF shall derive a K'_{ASME} using the K_{AMF} key and the downlink NAS COUNT of the current 5G NAS security context, include the corresponding NAS sequence number in the N1 mode to S1 mode NAS transparent container IE (see subclause 9.11.2.7) and then increments its stored downlink NAS COUNT value by one.

NOTE: The creation of the N1 mode to S1 mode NAS transparent container and the increment of the stored downlink NAS COUNT value by one are performed in prior to transferring the mapped EPS security context to the MME.

The AMF shall select the NAS algorithms identifiers to be used in the target MME after the inter-system change from N1 mode to S1 mode in 5GMM-CONNECTED mode, for encryption and integrity protection. The uplink and downlink NAS COUNT associated with the newly derived K'_{ASME} key are set to the uplink and downlink NAS COUNT value of the current 5G NAS security context, respectively. The eKSI for the newly derived K'_{ASME} key shall be defined such as the value field is taken from the ngKSI and the type field is set to indicate a mapped security context.

When the UE operating in single-registration mode in a network supporting N26 interface receives a command to perform inter-system change from N1 mode to S1 mode in 5GMM-CONNECTED mode, the UE shall derive the mapped EPS security context, i.e. derive K'_{ASME} from K_{AMF} using a downlink NAS COUNT based on the NAS sequence number received in the N1 mode to S1 mode NAS transparent container IE (see subclause 9.11.2.7) as described in 3GPP TS 33.501 [24]. The UE shall set the uplink and downlink NAS COUNT values associated with the newly derived K'_{ASME} key to the uplink and downlink NAS COUNT values of the current 5G NAS security context respectively. The eKSI for the newly derived K'_{ASME} key is defined such that the value field is taken from the ngKSI and the type field is set to indicate a mapped security context. The UE shall also derive the NAS keys as specified in 3GPP TS 33.401 [23A] using the EPS NAS security algorithms identifiers that are stored in the UE's 5G NAS security context.

If the received N1 mode to S1 mode NAS transparent container IE does not have a valid NAS COUNT (see subclause 4.4.3.2) the UE shall discard the content of the received N1 mode to S1 mode NAS transparent container IE and inform the lower layers that the received N1 mode to S1 mode NAS transparent container is invalid.

If the inter-system change from N1 mode to S1 mode in 5GMM-CONNECTED mode is not completed successfully, the AMF and the UE shall delete the new mapped EPS security context.

4.4.2.5 Establishment of secure exchange of NAS messages

Secure exchange of NAS messages via a NAS signalling connection is usually established by the AMF during the registration procedure by initiating a security mode control procedure. After successful completion of the security mode control procedure, all NAS messages exchanged between the UE and the AMF are sent integrity protected using the current 5G security algorithms, and except for the messages specified in subclause 4.4.5, all NAS messages exchanged between the UE and the AMF are sent ciphered using the current 5G security algorithms.

During inter-system change from S1 mode to N1 mode in 5GMM-CONNECTED mode, secure exchange of NAS messages is established between the AMF and the UE by:

- a) the transmission of NAS security related parameters encapsulated in the AS signalling from the AMF to the UE triggering the inter-system change in 5GMM-CONNECTED mode (see 3GPP TS 33.501 [24]). The UE uses these parameters to generate the mapped 5G NAS security context (see subclause 8.6.2 of 3GPP TS 33.501 [24]); and
- b) after the inter-system change in 5GMM-CONNECTED mode, the transmission of a REGISTRATION REQUEST message from the UE to the AMF. The UE shall send this message integrity protected using the mapped 5G NAS security context and further protect this message as specified in subclause 4.4.6 and subclause 5.5.1.3.2. After the AMF receives the REGISTRATION REQUEST message:
 - 1) if the AMF decides to take the native 5G NAS security context into use, the security mode control procedure is performed. From this time onward, all NAS messages exchanged between the UE and the AMF are sent integrity protected using the native 5G NAS security context, and except for the messages specified in subclause 4.4.5, all NAS messages exchanged between the UE and the AMF are sent ciphered using the native 5G NAS security context; or
 - 2) if the AMF decides to take the mapped 5G NAS security context into use, from this time onward, all NAS messages exchanged between the UE and the AMF are sent integrity protected using the mapped 5G NAS security context, and except for the messages specified in subclause 4.4.5, all NAS messages exchanged between the UE and the AMF are sent ciphered using the mapped 5G NAS security context.

During inter-system change from S1 mode to N1 mode in 5GMM-IDLE mode, if the UE is operating in single-registration mode and:

- a) if the UE has a valid native 5G NAS security context, the UE shall transmit a REGISTRATION REQUEST message integrity protected with the native 5G NAS security context. The UE shall include the ngKSI indicating the native 5G NAS security context value in the REGISTRATION REQUEST message.

After receiving the REGISTRATION REQUEST message including the ngKSI indicating a native 5G NAS security context value, the AMF shall check whether the ngKSI included in the REGISTRATION REQUEST message belongs to a 5G NAS security context available in the AMF, and shall verify the MAC of the REGISTRATION REQUEST message. If the verification is successful, the AMF deletes the EPS security context received from the source MME if any, and the AMF re-establishes the secure exchange of NAS messages by either:

- 1) replying with a REGISTRATION ACCEPT message that is integrity protected and ciphered using the native 5G NAS security context. From this time onward, all NAS messages exchanged between the UE and the AMF are sent integrity protected and except for the messages specified in subclause 4.4.5, all NAS messages exchanged between the UE and the AMF are sent ciphered; or
 - 2) initiating a security mode control procedure. This can be used by the AMF to take a non-current 5G NAS security context into use or to modify the current 5G NAS security context by selecting new NAS security algorithms.
- b) if the UE has no valid native 5G NAS security context, the UE shall send the REGISTRATION REQUEST message without integrity protection and encryption.

After receiving the REGISTRATION REQUEST message without integrity protection and encryption:

- 1) if N26 interface is supported:
 - i) if an EPS security context received from the source MME does not include the NAS security algorithms set to EIA0 and EEA0, the AMF shall either create a fresh mapped 5G NAS security context (see subclause 8.6.2 of 3GPP TS 33.501 [24]) or trigger a primary authentication and key agreement procedure to create a fresh native 5G NAS security context; or
 - ii) if an EPS security context received from the source MME includes the NAS security algorithms set to EIA0 and EEA0, the AMF shall trigger a primary authentication and key agreement procedure to create a fresh native 5G NAS security context; or
- 2) if N26 interface is not supported, the AMF shall trigger a primary authentication and key agreement procedure.

The newly created 5G NAS security context is taken into use by initiating a security mode control procedure and this context becomes the current 5G NAS security context in both the UE and the AMF. This re-establishes the secure exchange of NAS messages.

During an N1 mode to N1 mode handover, secure exchange of NAS messages is established between the AMF and the UE by:

- the transmission of NAS security related parameters encapsulated in the AS signalling from the target AMF to the UE triggering the N1 mode to N1 mode handover (see 3GPP TS 33.501 [24]). The UE uses these parameters to create a new 5G NAS security context.

The secure exchange of NAS messages shall be continued after N1 mode to N1 mode handover. It is terminated after inter-system change from N1 mode to S1 mode in 5GMM-CONNECTED mode or when the NAS signalling connection is released.

When a UE in 5GMM-IDLE mode establishes a new NAS signalling connection and has a valid current 5G NAS security context, the UE shall transmit the initial NAS message integrity protected with the current 5G NAS security context and further protect this message as specified in subclause 4.4.6. The UE shall include the ngKSI indicating the current 5G NAS security context value in the initial NAS message. The AMF shall check whether the ngKSI included in the initial NAS message belongs to a 5G NAS security context available in the AMF, and shall verify the MAC of the NAS message. If the verification is successful, the AMF may re-establish the secure exchange of NAS messages:

- a) by replying with a NAS message that is integrity protected and ciphered using the current 5G NAS security context. From this time onward, all NAS messages exchanged between the UE and the AMF are sent integrity protected and except for the messages specified in subclause 4.4.5, all NAS messages exchanged between the UE and the AMF are sent ciphered; or
- b) by initiating a security mode control procedure. This can be used by the AMF to take a non-current 5G NAS security context into use or to modify the current 5G NAS security context by selecting new NAS security algorithms.

When a UE attempts multiple registrations in the same or different serving network, both the AMF and the UE shall follow the behavior specified in subclause 6.3.2 of 3GPP TS 33.501 [24]. The UE may support multiple records of NAS security context storage for multiple registration (see 3GPP TS 31.102 [22]). If the UE supports multiple records of NAS security context storage for multiple registration, the UE can select the appropriate one among the stored 5G security contexts to protect the initial NAS message (see 3GPP TS 33.501 [24]).

NOTE: For the case when the UE has two records of NAS security context stored and is attempting registration to the PLMN associated with the 5G-GUTI (or an equivalent PLMN) for that access, the UE uses the first NAS security context of that access to protect the initial NAS message. For the case when the UE has two records of NAS security context stored and is attempting registration to the PLMN associated with the second record (or an equivalent PLMN) of that access, the UE uses the second NAS security context of that access to protect the initial NAS message. For other cases when the UE has two records of NAS security context stored and is attempting registration to a PLMN which is not associated with any NAS security context record, the UE uses either record of the NAS security context of that access to protect the initial NAS message.

4.4.2.6 Change of security keys

When the AMF initiates a re-authentication to create a new 5G NAS security context, the messages exchanged during the authentication procedure are integrity protected and ciphered using the current 5G NAS security context, if any.

Both UE and AMF shall continue to use the current 5G NAS security context, until the AMF initiates a security mode control procedure. The SECURITY MODE COMMAND message sent by the AMF includes the ngKSI of the new 5G NAS security context to be used. The AMF shall send the SECURITY MODE COMMAND message integrity protected with the new 5G NAS security context, but unciphered. When the UE responds with a SECURITY MODE COMPLETE message, it shall send the message integrity protected and ciphered with the new 5G NAS security context.

The AMF can also modify the current 5G NAS security context or take the non-current native 5G NAS security context, if any, into use, by sending a SECURITY MODE COMMAND message including the ngKSI of the 5G NAS security context to be modified and including a new set of selected NAS security algorithms. In this case the AMF shall send the SECURITY MODE COMMAND message integrity protected with the modified 5G NAS security context, but unciphered. When the UE replies with a SECURITY MODE COMPLETE message, it shall send the message integrity protected and ciphered with the modified 5G NAS security context.

4.4.3 Handling of NAS COUNT and NAS sequence number

4.4.3.1 General

Each 5G NAS security context shall be associated with two separate counters NAS COUNT per access type in the same PLMN: one related to uplink NAS messages and one related to downlink NAS messages. If the 5G NAS security context is used for access via both 3GPP and non-3GPP access in the same PLMN, there are two NAS COUNT counter pairs associated with the 5G NAS security context. The NAS COUNT counters use 24-bit internal representation and are independently maintained by UE and AMF. The NAS COUNT shall be constructed as a NAS sequence number (8 least significant bits) concatenated with a NAS overflow counter (16 most significant bits).

When NAS COUNT is input to NAS ciphering or NAS integrity algorithms it shall be considered to be a 32-bit entity which shall be constructed by padding the 24-bit internal representation with 8 zeros in the most significant bits.

The value of the uplink NAS COUNT that is stored or read out of the USIM or non-volatile memory as described in annex C, is the value that shall be used in the next NAS message.

The value of the downlink NAS COUNT that is stored or read out of the USIM or non-volatile memory as described in annex C, is the largest downlink NAS COUNT used in a successfully integrity checked NAS message.

The value of the uplink NAS COUNT stored in the AMF is the largest uplink NAS COUNT used in a successfully integrity checked NAS message.

The value of the downlink NAS COUNT stored in the AMF is the value that shall be used in the next NAS message.

The NAS sequence number part of the NAS COUNT shall be exchanged between the UE and the AMF as part of the NAS signalling. After each new or retransmitted outbound SECURITY PROTECTED 5GS NAS MESSAGE message, the sender shall increase the NAS COUNT number by one, except for the initial NAS messages if the lower layers indicated the failure to establish the RRC connection (see 3GPP TS 38.331 [30]). Specifically, on the sender side, the NAS sequence number shall be increased by one, and if the result is zero (due to wrap around), the stored NAS overflow counter shall also be incremented by one (see subclause 4.4.3.5). If, through implementation-dependent means, the receiver determines that the NAS message is a replay of an earlier NAS message, then the receiver handles the received NAS message as described in subclause 4.4.3.2. Otherwise, in order to determine the estimated NAS COUNT value to be used for integrity verification of a received NAS message:

- The sequence number part of the estimated NAS COUNT value shall be equal to the sequence number in the received NAS message; and
- If the receiver can guarantee that this NAS message was not previously accepted, then the receiver may select the estimated NAS overflow counter so that the estimated NAS COUNT value is lower than the stored NAS COUNT value; otherwise, the receiver selects the estimated NAS overflow counter so that the estimated NAS COUNT value is higher than the stored NAS COUNT value.

During the inter-system change from S1 mode to N1 mode in 5GMM-CONNECTED mode, when a mapped 5G NAS security context is derived and taken into use, the AMF shall set both the uplink and downlink NAS COUNT counters of this 5G NAS security context to zero. The UE shall set both the uplink and downlink NAS COUNT counters of this 5G NAS security context to zero.

During the inter-system change from S1 mode to N1 mode in 5GMM-CONNECTED mode, the AMF shall increment the downlink NAS COUNT by one after it has created an S1 mode to N1 mode NAS transparent container (see subclause 9.11.2.9).

During the inter-system change from N1 mode to S1 mode in 5GMM-CONNECTED mode, the AMF shall increment the downlink NAS COUNT by one after it has created an N1 mode to S1 mode NAS transparent container (see subclause 9.11.2.7).

During N1 mode to N1 mode handover:

- a) if the new 5G NAS security context is created with the same K_{AMF} , the AMF shall signal the 8 least significant bits of the current downlink NAS COUNT value in an Intra N1 mode NAS transparent container (see subclause 9.11.2.6). The AMF shall then increment the downlink NAS COUNT by one; or
- b) if the new 5G NAS security context is created with a new K_{AMF} , the AMF shall signal the 8 least significant bits of the current downlink NAS COUNT value in an Intra N1 mode NAS transparent container (see subclause 9.11.2.6) and shall then set both the uplink and downlink NAS COUNT counters of this 5G NAS security context to zero. The AMF shall then increment the downlink NAS COUNT by one. The UE shall also set both the uplink and downlink NAS COUNT counters to zero.

NOTE: During the inter-system change from S1 mode to N1 mode in 5GMM-CONNECTED mode, the S1 mode to N1 mode NAS transparent container (see subclause 9.11.2.9) is treated as an implicit SECURITY MODE COMMAND message for the UE and the AMF, and therefore the AMF regards the sending of the S1 mode to N1 mode NAS transparent container as the sending of an initial SECURITY MODE COMMAND message in order to derive and take into use a mapped 5G NAS security context for the purpose of the NAS COUNT handling.

4.4.3.2 Replay protection

Replay protection shall be supported for received NAS messages both in the AMF and the UE. However, since the realization of replay protection does not affect the interoperability between nodes, no specific mechanism is required for implementation.

Replay protection assures that one and the same NAS message is not accepted twice by the receiver. Specifically, for a given 5G NAS security context, a given NAS COUNT value shall be accepted at most one time and only if message integrity verifies correctly.

Replay protection is not applicable when 5G-IA0 is used.

4.4.3.3 Integrity protection and verification

The sender shall use its locally stored NAS COUNT as input to the integrity protection algorithm.

The receiver shall use the NAS sequence number included in the received message and an estimate for the NAS overflow counter as defined in subclause 4.4.3.1 to form the NAS COUNT input to the integrity verification algorithm.

The algorithm to calculate the integrity protection information is specified in 3GPP TS 33.501 [24], and in case of the:

- a) SECURITY PROTECTED 5GS NAS MESSAGE message, the integrity protection shall include octet 7 to n, i.e. the Sequence number IE and the NAS message IE.
- b) Intra N1 mode NAS transparent container IE and S1 mode to N1 mode NAS transparent container IE, the integrity protection shall include all octets of the value part of the IE starting from octet 7.

NOTE: To ensure backward compatibility, the UE uses all octets starting from octet 7 in the received NAS transparent container for the purpose of integrity check of the NAS transparent container irrespective of the release/version it supports. After a successful integrity check, the UE can ignore the octets which are not specified in the release/version which the UE supports.

In addition to the data that is to be integrity protected, the BEARER ID, DIRECTION bit, NAS COUNT and 5G NAS integrity key are input to the integrity protection algorithm. These parameters are described in 3GPP TS 33.501 [24].

After successful integrity protection validation, the receiver shall update its corresponding locally stored NAS COUNT with the value of the estimated NAS COUNT for this NAS message.

Integrity verification is not applicable when 5G-IA0 is used.

4.4.3.4 Cipherng and deciphering

The sender shall use its locally stored NAS COUNT as input to the cipherng algorithm.

The receiver shall use the NAS sequence number included in the received message and an estimate for the NAS overflow counter as defined in subclause 4.4.3.1 to form the NAS COUNT input to the deciphering algorithm.

The input parameters to the NAS cipherng algorithm are the BEARER ID, DIRECTION bit, NAS COUNT, NAS encryption key and the length of the key stream to be generated by the encryption algorithm.

When applying initial NAS message protection to the REGISTRATION REQUEST, DEREGISTRATION REQUEST or SERVICE REQUEST message as described in subclause 4.4.6, the length of the key stream is set to the length of the entire plain NAS message that is included in the NAS message container IE, i.e. the value part of the NAS message container IE, that is to be cipherng.

When applying initial NAS message protection to the CONTROL PLANE SERVICE REQUEST message as described in subclause 4.4.6, the length of the key stream is set to the length of:

- a) the value part of the CIoT small data container IE that is to be cipherng; or
- b) the value part of the NAS message container IE that is to be cipherng.

4.4.3.5 NAS COUNT wrap around

If, when increasing the NAS COUNT as specified above, the AMF detects that either its downlink NAS COUNT or the UE's uplink NAS COUNT is "close" to wrap around, (close to 2^{24}), the AMF shall take the following actions:

- If there is no non-current native 5G NAS security context with sufficiently low NAS COUNT values, the AMF shall initiate a new primary authentication and key agreement procedure with the UE, leading to a new established 5G NAS security context and the NAS COUNT being reset to 0 in both the UE and the AMF when the new 5G NAS security context is activated;
- Otherwise, the AMF can activate a non-current native 5G NAS security context with sufficiently low NAS COUNT values or initiate a new primary authentication and key agreement procedure as specified above.

If for some reason a new K_{AMF} has not been established using primary authentication and key agreement procedure before the NAS COUNT wraps around, the node (AMF or UE) in need of sending a NAS message shall instead release the NAS signalling connection. Prior to sending the next uplink NAS message, the UE shall delete the ngKSI indicating the current 5G NAS security context.

When the 5G-IA0 is used as the NAS integrity algorithm, the UE and the AMF shall allow NAS COUNT wrap around. If NAS COUNT wrap around occurs, the following requirements apply:

- a) the UE and the AMF shall continue to use the current 5G NAS security context;
- b) the AMF shall not initiate the primary authentication and key agreement procedure;
- c) the AMF shall not release the NAS signalling connection; and
- d) the UE shall not perform a local release of the NAS signalling connection.

4.4.4 Integrity protection of NAS signalling messages

4.4.4.1 General

For the UE, integrity protected signalling is mandatory for the 5GMM NAS messages once a valid 5G NAS security context exists and has been taken into use. For the network, integrity protected signalling is mandatory for the 5GMM NAS messages once a secure exchange of 5GS NAS messages has been established for the NAS signalling connection. Integrity protection of all NAS signalling messages is the responsibility of the NAS. It is the network which activates integrity protection.

The use of "null integrity protection algorithm" 5G-IA0 (see subclause 9.11.3.34) in the current 5G NAS security context is only allowed:

- a) for an unauthenticated UE for which establishment of emergency services is allowed;
- b) for a W-AGF acting on behalf of an FN-RG;
- c) for a W-AGF acting on behalf of an N5GC device; and
- d) for a 5G-RG acting on behalf of an AUN3 device.

For setting the security header type in outbound NAS messages, the UE and the AMF shall apply the same rules irrespective of whether the "null integrity protection algorithm" or any other integrity protection algorithm is indicated in the 5G NAS security context.

If the "null integrity protection algorithm" 5G-IA0 has been selected as an integrity protection algorithm, the receiver shall regard the NAS messages with the security header indicating integrity protection as integrity protected.

Details of the integrity protection and verification of NAS signalling messages are specified in 3GPP TS 33.501 [24].

When a NAS message needs to be sent both ciphered and integrity protected, the NAS message is first ciphered and then the ciphered NAS message and the NAS sequence number are integrity protected by calculating the MAC.

NOTE: NAS messages that are ciphered with the "null ciphering algorithm" 5G-EA0 are regarded as ciphered (see subclause 4.4.5).

When a NAS message needs to be sent only integrity protected and unciphered, the unciphered NAS message and the NAS sequence number are integrity protected by calculating the MAC.

When a 5GSM message is piggybacked in a 5GMM message, there is only one Sequence number IE and one Message authentication code IE for the 5GMM message piggybacking the 5GSM message.

4.4.4.2 Integrity checking of NAS signalling messages in the UE

Except the messages listed below, no NAS signalling messages shall be processed by the receiving 5GMM entity in the UE or forwarded to the 5GSM entity, unless the network has established secure exchange of 5GS NAS messages for the NAS signalling connection:

- a) IDENTITY REQUEST (if requested identification parameter is SUCI);
- b) AUTHENTICATION REQUEST;
- c) AUTHENTICATION RESULT;
- d) AUTHENTICATION REJECT;
- e) REGISTRATION REJECT (if the 5GMM cause is not #76, #78, #81 or #82);
- f) DEREGISTRATION ACCEPT (for non switch off); and
- g) SERVICE REJECT (if the 5GMM cause is not #76 or #78).

NOTE: These messages are accepted by the UE without integrity protection, as in certain situations they are sent by the network before security can be activated.

Integrity protection is never applied directly to 5GSM messages, but to the 5GMM message in which the 5GSM message is included.

Once the secure exchange of NAS messages has been established, the receiving 5GMM entity in the UE shall not process any NAS signalling messages unless they have been successfully integrity checked by the NAS. If NAS signalling messages, having not successfully passed the integrity check, are received, then the NAS in the UE shall discard that message. The processing of the SECURITY MODE COMMAND message that has not successfully passed the integrity check is specified in subclause 5.4.2.5. If any NAS signalling message is received as not integrity protected even though the secure exchange of NAS messages has been established by the network, then the NAS shall discard this message.

4.4.4.3 Integrity checking of NAS signalling messages in the AMF

Except the messages listed below, no NAS signalling messages shall be processed by the receiving 5GMM entity in the AMF or forwarded to the 5GSM entity, unless the secure exchange of NAS messages has been established for the NAS signalling connection:

- a) REGISTRATION REQUEST;
- b) IDENTITY RESPONSE (if requested identification parameter is SUCI);
- c) AUTHENTICATION RESPONSE;
- d) AUTHENTICATION FAILURE;
- e) SECURITY MODE REJECT;
- f) DEREGISTRATION REQUEST; and
- g) DEREGISTRATION ACCEPT;

NOTE 1: The REGISTRATION REQUEST message is sent by the UE without integrity protection, if the registration procedure is initiated due to an inter-system change in 5GMM-IDLE mode and no current 5G NAS security context is available in the UE. The other messages are accepted by the AMF without integrity protection, as in certain situations they are sent by the UE before security can be activated.

NOTE 2: The DEREGISTRATION REQUEST message can be sent by the UE without integrity protection, e.g. if the UE is registered for emergency services and there is no valid 5G NAS security context available, or if due to user interaction a registration procedure is cancelled before the secure exchange of NAS messages has been established. For these cases the network can attempt to use additional criteria (e.g. whether the UE is subsequently still performing periodic registration update or still responding to paging) before marking the UE as 5GMM-DEREGISTERED.

Integrity protection is never applied directly to 5GSM messages, but to the 5GMM message in which the 5GSM message is included.

Once a current 5G NAS security context exists, until the secure exchange of NAS messages has been established for the NAS signalling connection, the receiving 5GMM entity in the AMF shall process the following NAS signalling messages, even if the MAC included in the message fails the integrity check or cannot be verified, as the 5G NAS security context is not available in the network:

- a) REGISTRATION REQUEST;
- b) IDENTITY RESPONSE (if requested identification parameter is SUCI);
- c) AUTHENTICATION RESPONSE;
- d) AUTHENTICATION FAILURE;
- e) SECURITY MODE REJECT;
- f) DEREGISTRATION REQUEST;
- g) DEREGISTRATION ACCEPT;
- h) SERVICE REQUEST; and

i) CONTROL PLANE SERVICE REQUEST;

NOTE 3: These messages are processed by the AMF even when the MAC that fails the integrity check or cannot be verified, as in certain situations they can be sent by the UE protected with a 5G NAS security context that is no longer available in the network.

If a REGISTRATION REQUEST message for initial registration fails the integrity check and it is not a registration request for emergency services, the AMF shall authenticate the subscriber before processing the registration request any further. Additionally, the AMF shall initiate a security mode control procedure, and include the Additional 5G security information IE with the RINMR bit set to "Retransmission of the initial NAS message requested" in the SECURITY MODE COMMAND message as specified in subclause 5.4.2.2. If authentication procedure is not successful the AMF shall maintain, if any, the 5GMM-context and 5G NAS security context unchanged. For the case when the registration procedure is for emergency services see subclause 5.5.1.2.3 and subclause 5.4.1.3.5.

If a REGISTRATION REQUEST message for mobility and periodic registration update fails the integrity check and the UE provided EPS NAS message container IE which was successfully verified by the source MME, the AMF may create a mapped 5G NAS security context and initiate a security mode control procedure to take the new mapped 5G NAS security context into use; otherwise if the UE has only a non-emergency PDU session established, the AMF shall initiate a primary authentication and key agreement procedure to create a new native 5G NAS security context. Additionally, the AMF shall initiate a security mode control procedure, and include the Additional 5G security information IE with the RINMR bit set to "Retransmission of the initial NAS message requested" in the SECURITY MODE COMMAND message as specified in subclause 5.4.2.2. If authentication procedure is not successful the AMF shall maintain, if any, the 5GMM-context and 5G NAS security context unchanged. For the case when the UE has an emergency PDU session see subclause 5.5.1.3.3 and subclause 5.4.1.3.5.

If a DEREGISTRATION REQUEST message fails the integrity check, the AMF shall proceed as follows:

- If it is not a deregistration request due to switch off, and the AMF can initiate an authentication procedure, the AMF should authenticate the subscriber before processing the deregistration request any further.
- If it is a deregistration request due to switch off, or the AMF does not initiate an authentication procedure for any other reason, the AMF may ignore the deregistration request and remain in state 5GMM-REGISTERED.

NOTE 4: The network can attempt to use additional criteria (e.g. whether the UE is subsequently still performing periodic registration update or still responding to paging) before marking the UE as 5GMM-DEREGISTERED.

If a SERVICE REQUEST or CONTROL PLANE SERVICE REQUEST message fails the integrity check and the UE has only non-emergency PDU sessions established, the AMF shall send the SERVICE REJECT message with 5GMM cause #9 "UE identity cannot be derived by the network" and keep the 5GMM-context and 5G NAS security context unchanged. For the case when the UE has an emergency PDU session and integrity check fails, the AMF may skip the authentication procedure even if no 5G NAS security context is available and proceed directly to the execution of the security mode control procedure as specified in subclause 5.4.2. Additionally, the AMF shall include the Additional 5G security information IE with the RINMR bit set to "Retransmission of the initial NAS message requested" in the SECURITY MODE COMMAND message as specified in subclause 5.4.2.2. After successful completion of the service request procedure, the network shall perform a local release of all non-emergency PDU sessions. The emergency PDU session shall not be released.

Once the secure exchange of NAS messages has been established for the NAS signalling connection, the receiving 5GMM entity in the AMF shall not process any NAS signalling messages unless they have been successfully integrity checked by the NAS. If any NAS signalling message, having not successfully passed the integrity check, is received, then the NAS in the AMF shall discard that message. If any NAS signalling message is received, as not integrity protected even though the secure exchange of NAS messages has been established, then the NAS shall discard this message.

4.4.5 Cipherring of NAS signalling messages

The use of cipherring in a network is an operator option subject to AMF configuration. When operation of the network without cipherring is configured, the AMF shall indicate the use of "null cipherring algorithm" 5G-EA0 (see subclause 9.11.3.34) in the current 5G NAS security context for all UEs. For setting the security header type in outbound NAS messages, the UE and the AMF shall apply the same rules irrespective of whether the "null cipherring algorithm" or any other cipherring algorithm is indicated in the 5G NAS security context.

When the UE establishes a new N1 NAS signalling connection, it shall apply security protection to the initial NAS message as described in subclause 4.4.6.

The UE shall start the ciphering and deciphering of NAS messages when the secure exchange of NAS messages has been established for an N1 NAS signalling connection. From this time onward, unless explicitly defined, the UE shall send all NAS messages ciphered until the N1 NAS signalling connection is released, or the UE performs inter-system change to S1 mode.

The AMF shall start ciphering and deciphering of NAS messages as described in subclause 4.4.2.5. From this time onward, except for the SECURITY MODE COMMAND message, the AMF shall send all NAS messages ciphered until the N1 NAS signalling connection is released, or the UE performs inter-system change to S1 mode.

Ciphering is never applied directly to 5GSM messages, but to the 5GMM message in which the 5GSM message is included.

Once the encryption of NAS messages has been started between the AMF and the UE, the receiver shall discard the unciphered NAS messages which shall have been ciphered according to the rules described in this specification.

If the "null ciphering algorithm" 5G-EA0 has been selected as a ciphering algorithm, the NAS messages with the security header indicating ciphering are regarded as ciphered.

Details of ciphering and deciphering of NAS signalling messages are specified in 3GPP TS 33.501 [24].

4.4.6 Protection of initial NAS signalling messages

The 5GS supports protection of initial NAS messages as specified in 3GPP TS 33.501 [24]. The protection of initial NAS messages applies to the REGISTRATION REQUEST, DEREGISTRATION REQUEST, SERVICE REQUEST and CONTROL PLANE SERVICE REQUEST message, and is achieved as follows:

- a) If the UE does not have a valid 5G NAS security context, the UE sends a REGISTRATION REQUEST message including cleartext IEs only. After activating a 5G NAS security context resulting from a security mode control procedure:
 - 1) if the UE needs to send non-cleartext IEs, the UE shall include the entire REGISTRATION REQUEST message (i.e. containing both cleartext IEs and non-cleartext IEs) in the NAS message container IE and shall include the NAS message container IE in the SECURITY MODE COMPLETE message; or
 - 2) if the UE does not need to send non-cleartext IEs, the UE shall include the entire REGISTRATION REQUEST message (i.e. containing cleartext IEs only) in the NAS message container IE and shall include the NAS message container IE in the SECURITY MODE COMPLETE message.
- b) If the UE has a valid 5G NAS security context and:
 - 1) the UE needs to send non-cleartext IEs in a REGISTRATION REQUEST, DEREGISTRATION REQUEST, or SERVICE REQUEST message, the UE includes the entire REGISTRATION REQUEST, DEREGISTRATION REQUEST or SERVICE REQUEST message (i.e. containing both cleartext IEs and non-cleartext IEs) in the NAS message container IE and shall cipher the value part of the NAS message container IE. The UE shall then send a REGISTRATION REQUEST, DEREGISTRATION REQUEST, or SERVICE REQUEST message containing the cleartext IEs and the NAS message container IE;
 - 2) the UE needs to send non-cleartext IEs in a CONTROL PLANE SERVICE REQUEST message:
 - i) if CIoT small data container IE is the only non-cleartext IE to be sent, the UE shall cipher the value part of the CIoT small data container IE. The UE shall then send a CONTROL PLANE SERVICE REQUEST message containing the cleartext IEs and the CIoT small data container IE;
 - ii) otherwise, the UE includes non-cleartext IEs in the NAS message container IE and shall cipher the value part of the NAS message container IE. The UE shall then send a CONTROL PLANE SERVICE REQUEST message containing the cleartext IEs and the NAS message container IE;
 - 3) the UE does not need to send non-cleartext IEs in a REGISTRATION REQUEST, DEREGISTRATION REQUEST, or SERVICE REQUEST message, the UE sends the REGISTRATION REQUEST, DEREGISTRATION REQUEST, or SERVICE REQUEST message without including the NAS message container IE; or

- 4) the UE does not need to send non-plaintext IEs in a CONTROL PLANE SERVICE REQUEST message, the UE sends the CONTROL PLANE SERVICE REQUEST message without including the NAS message container IE and the CIoT small data container IE.

When the initial NAS message is a REGISTRATION REQUEST message, the plaintext IEs are:

- Extended protocol discriminator;
- Security header type;
- Spare half octet;
- Registration request message identity;
- 5GS registration type;
- ngKSI;
- 5GS mobile identity;
- UE security capability;
- Additional GUTI;
- UE status;
- EPS NAS message container;
- NID; and
- UE determined PLMN with disaster condition.

When the initial NAS message is a DEREGISTRATION REQUEST message, the plaintext IEs are:

- Extended protocol discriminator;
- Security header type;
- Spare half octet;
- De-registration request message identity;
- De-registration type;
- ngKSI; and
- 5GS mobile identity.

When the initial NAS message is a SERVICE REQUEST message, the plaintext IEs are:

- Extended protocol discriminator;
- Security header type;
- Spare half octet;
- ngKSI;
- Service request message identity;
- Service type; and
- 5G-S-TMSI.

When the initial NAS message is a CONTROL PLANE SERVICE REQUEST message, the plaintext IEs are:

- Extended protocol discriminator;
- Security header type;

- Spare half octet;
- ngKSI;
- Control plane service request message identity; and
- Control plane service type.

When the UE sends a REGISTRATION REQUEST, DEREGISTRATION REQUEST, SERVICE REQUEST or CONTROL PLANE SERVICE REQUEST message that includes a NAS message container IE, the UE shall set the security header type of the initial NAS message to "integrity protected".

When the AMF receives an integrity protected initial NAS message which includes a NAS message container IE, the AMF shall decipher the value part of the NAS message container IE. If the received initial NAS message is a REGISTRATION REQUEST, DEREGISTRATION REQUEST, or a SERVICE REQUEST message, the AMF shall consider the NAS message that is obtained from the NAS message container IE as the initial NAS message that triggered the procedure.

When the AMF receives a CONTROL PLANE SERVICE REQUEST message which includes a CIoT small data container IE, the AMF shall decipher the value part of the CIoT small data container IE and handle the message as specified in subclause 5.6.1.4.2.

If the UE:

- a) has 5G-EA0 as a selected 5G NAS security algorithm; and
- b) selects a PLMN other than Registered PLMN and EPLMN over one access;

the UE shall send an initial NAS message including cleartext IEs only via the access type associated with the newly selected PLMN as described in this subclause for the case when the UE does not have a valid 5G NAS security context.

If the UE:

- a) has 5G-EA0 as a selected 5G NAS security algorithm; and
- b) selects a PLMN other than Registered PLMN and EPLMN over one access, and the Registered PLMN or EPLMN is not registering or registered over other access;

the UE shall delete the 5G NAS security context.

NOTE: UE deletes the 5G NAS security context only if the UE is not in the connected mode.

4.4.7 Protection of NAS IEs

The network can provide the SOR transparent container IE during the registration procedure to the UE in the REGISTRATION ACCEPT message. The SOR transparent container IE is integrity protected by the HPLMN or subscribed SNPN as specified in 3GPP TS 33.501 [24].

The UE can provide the SOR transparent container IE during the registration procedure to the network in the REGISTRATION COMPLETE message. The SoR-MAC-I_{UE} in the SOR transparent container IE is generated by the UE as specified in 3GPP TS 33.501 [24].

The network can provide the Payload container IE during the Network-initiated NAS transport procedure to the UE in DL NAS TRANSPORT message. If the Payload container type IE is set to "SOR transparent container" or "UE parameters update transparent container", the Payload container IE is integrity protected by the HPLMN or subscribed SNPN as specified in 3GPP TS 33.501 [24]. If the Payload container type IE is set to "Multiple payloads" and the payload container type field of the payload container entry is set to "SOR transparent container" or "UE parameters update transparent container", the payload container entry contents field of the payload container entry is integrity protected correspondingly.

The UE can provide the Payload container IE during the UE-initiated NAS transport procedure to the network in UL NAS TRANSPORT message. If the Payload container type IE is set to "SOR transparent container" or "UE parameters update transparent container", the SoR-MAC-I_{UE} or UPU-MAC-I_{UE} in the Payload container IE is generated by the UE as specified in 3GPP TS 33.501 [24]. If the Payload container type IE is set to "Multiple payloads" and the payload container type field of the payload container entry is set to "SOR transparent container" or "UE parameters update

transparent container", the SoR-MAC-I_{UE} or UPU-MAC-I_{UE} in the payload container entry contents field of the payload container entry is generated by the UE correspondingly.

4.5 Unified access control

4.5.1 General

When the UE needs to access the 5GS, the UE not operating as an IAB-node (see 3GPP TS 23.501 [8]), not acting as a 5G ProSe layer-2 UE-to-network relay UE (see 3GPP TS 23.304 [6E]) whose access attempt is triggered by a 5G ProSe layer-2 remote UE, and not acting as an NCR-MT node (see 3GPP TS 38.300 [27]), first performs access control checks to determine if the access is allowed. Access control checks shall be performed for the access attempts defined by the following list of events:

NOTE 1: Although the UE operating as an IAB-node or as an NCR-MT node skips the access control checks, the UE operating as an IAB-node or as an NCR-MT node determines an access category and one or more access identities for each access attempt in order to derive an RRC establishment cause. In this case the NAS provides the RRC establishment cause but does not provide the access category and the one or more access identities to the lower layers.

NOTE 1A: Although the UE acting as a 5G ProSe layer-2 UE-to-network relay UE skips the access control checks, the UE determines an access category and one or more access identities for each access attempt in order to derive an RRC establishment cause.

- a) the UE is in 5GMM-IDLE mode or 5GMM-IDLE mode with suspend indication over 3GPP access and an event that requires a transition to 5GMM-CONNECTED mode occurs; and
- b) the UE is in 5GMM-CONNECTED mode over 3GPP access or 5GMM-CONNECTED mode with RRC inactive indication and one of the following events occurs:
 - 1) 5GMM receives an MO-IMS-registration-related-signalling-started indication, an MO-MMTEL-voice-call-started indication, an MO-MMTEL-video-call-started indication or an MO-SMSoIP-attempt-started indication from upper layers;
 - 2) 5GMM receives a request from upper layers to send a mobile originated SMS over NAS unless the request triggered a service request procedure to transition the UE from 5GMM-IDLE mode or 5GMM-IDLE mode with suspend indication to 5GMM-CONNECTED mode;
 - 3) 5GMM receives a request from upper layers to send an UL NAS TRANSPORT message for the purpose of PDU session establishment unless the request triggered a service request procedure to transition the UE from 5GMM-IDLE mode or 5GMM-IDLE mode with suspend indication to 5GMM-CONNECTED mode;
 - 4) 5GMM receives a request from upper layers to send an UL NAS TRANSPORT message for the purpose of UE-requested PDU session modification procedure unless the request triggered a service request procedure to transition the UE from 5GMM-IDLE mode or 5GMM-IDLE mode with suspend indication to 5GMM-CONNECTED mode;
 - 5) 5GMM receives a request to re-establish the user-plane resources for an existing PDU session;
 - 6) 5GMM is notified that an uplink user data packet is to be sent for a PDU session with suspended user-plane resources;
 - 7) 5GMM receives a request from upper layers to send a mobile originated location request unless the request triggered a service request procedure to transition the UE from 5GMM-IDLE mode or 5GMM-IDLE mode with suspend indication to 5GMM-CONNECTED mode;
 - 8) 5GMM receives a request from upper layers to send a mobile originated signalling transaction towards the PCF by sending an UL NAS TRANSPORT message including a UE policy container (see 3GPP TS 24.587 [19B] and 3GPP TS 24.554 [19E]) unless the request triggered a service request procedure to transition the UE from 5GMM-IDLE mode to 5GMM-CONNECTED mode; and
 - 9) 5GMM receives an indication from lower layers of the RAN timing synchronization status change, and decides to transition the UE from 5GMM-CONNECTED mode with RRC inactive indication to 5GMM-CONNECTED mode as specified in subclause 5.3.1.4.

NOTE 2: 5GMM specific procedures initiated by NAS in 5GMM-CONNECTED mode or 5GMM-CONNECTED mode with RRC inactive indication are not subject to access control, e.g. a registration procedure after PS handover will not be prevented by access control (see subclause 5.5).

NOTE 3: LPP messages, SLPP messages, or location event report messages transported in the UL NAS TRANSPORT message sent in response to a mobile terminating or network induced location request, and the corresponding access attempts are handled as MT access.

NOTE 4: Initiating a mobile originated signalling transaction towards the UDM by sending an UL NAS TRANSPORT message including an SOR transparent container is not supported. Therefore, access control for these cases has not been specified.

When the NAS detects one of the above events, the NAS needs to perform the mapping of the kind of request to one or more access identities and one access category and lower layers will perform access barring checks for that request based on the determined access identities and access category.

NOTE 5: The NAS is aware of the above events through indications provided by upper layers or through determining the need to start 5GMM procedures through normal NAS behaviour, or both.

To determine the access identities and the access category for a request, the NAS checks the reason for access, types of service requested and profile of the UE including UE configurations, against a set of access identities and access categories defined in 3GPP TS 22.261 [3], namely:

- a) a set of standardized access identities;
- b) a set of standardized access categories; and
- c) a set of operator-defined access categories, if available.

For the purpose of determining the applicable access identities from the set of standardized access identities defined in 3GPP TS 22.261 [3], the NAS shall follow the requirements set out in:

- a) subclause 4.5.2 and the rules and actions defined in table 4.5.2.1, if the UE is not operating in SNPN access operation mode over 3GPP access; or
- b) subclause 4.5.2A and the rules and actions defined in table 4.5.2A.1, if the UE is operating in SNPN access operation mode over 3GPP access.

In order to enable access barring checks for access attempts identified by lower layers in 5GMM-CONNECTED mode with RRC inactive indication, the UE provides the applicable access identities to lower layers.

NOTE 6: When and how the NAS provides the applicable access identities to lower layers is UE implementation specific.

NOTE 7: Although the UE operating as an IAB-node or as an NCR-MT node skips the access control checks, the UE provides the applicable access identities to lower layers for access attempts identified by lower layers in 5GMM-CONNECTED mode with RRC inactive indication.

For the purpose of determining the applicable access category from the set of standardized access categories and operator-defined access categories defined in 3GPP TS 22.261 [3], the NAS shall follow the requirements set out in:

- a) subclause 4.5.2 and the rules and actions defined in table 4.5.2.2, if the UE is not operating in SNPN access operation mode over 3GPP access; or
- b) subclause 4.5.2A and the rules and actions defined in table 4.5.2A.2, if the UE is operating in SNPN access operation mode over 3GPP access.

4.5.2 Determination of the access identities and access category associated with a request for access for UEs not operating in SNPN access operation mode over 3GPP access

When the UE needs to initiate an access attempt in one of the events listed in subclause 4.5.1, the UE shall determine one or more access identities from the set of standardized access identities, and one access category from the set of standardized access categories and operator-defined access categories, to be associated with that access attempt.

The set of the access identities applicable for the request is determined by the UE in the following way:

- a) for each of the access identities 1, 2, 3, 11, 12, 13, 14 and 15 in table 4.5.2.1, the UE shall check whether the access identity is applicable in the selected PLMN, if a new PLMN is selected, or otherwise if it is applicable in the RPLMN or equivalent PLMN; and
- b) if none of the above access identities is applicable, then access identity 0 is applicable.

Table 4.5.2.1: Access identities

Access Identity number	UE configuration
0	UE is not configured with any parameters from this table
1 (NOTE 1)	UE is configured for multimedia priority service (MPS).
2 (NOTE 2)	UE is configured for mission critical service (MCS).
3 (NOTE 4)	UE for which a disaster condition applies
4-10	Reserved for future use
11 (NOTE 3)	Access Class 11 is configured in the UE.
12 (NOTE 3)	Access Class 12 is configured in the UE.
13 (NOTE 3)	Access Class 13 is configured in the UE.
14 (NOTE 3)	Access Class 14 is configured in the UE.
15 (NOTE 3)	Access Class 15 is configured in the UE.
<p>NOTE 1: Access identity 1 is valid when:</p> <ul style="list-style-type: none"> - the USIM file EF_{UAC_AIC} indicates the UE is configured for access identity 1 and the selected PLMN, if a new PLMN is selected, or RPLMN is the HPLMN (if the EHPLMN list is not present or is empty) or EHPLMN (if the EHPLMN list is present), or a visited PLMN of the home country; - the UE receives the 5GS network feature support IE with the MPS indicator bit set to "Access identity 1 valid" from the RPLMN as described in subclause 5.5.1.2.4 and subclause 5.5.1.3.4; or - the UE receives the Priority indicator IE with the MPS indicator bit set to "Access identity 1 valid" from the RPLMN as described in subclause 5.4.4.3. <p>NOTE 2: Access identity 2 is used by UEs configured for MCS and is valid when:</p> <ul style="list-style-type: none"> - the USIM file EF_{UAC_AIC} indicates the UE is configured for access identity 2 and the selected PLMN, if a new PLMN is selected, or RPLMN is the HPLMN (if the EHPLMN list is not present or is empty) or EHPLMN (if the EHPLMN list is present), or a visited PLMN of the home country; - the UE receives the 5GS network feature support IE with the MCS indicator bit set to "Access identity 2 valid" from the RPLMN as described in subclause 5.5.1.2.4 and subclause 5.5.1.3.4; or - the UE receives the Priority indicator IE with the MCS indicator bit set to "Access identity 2 valid" from the RPLMN as described in subclause 5.4.4.3. <p>NOTE 3: Access identities 11 and 15 are valid in HPLMN (if the EHPLMN list is not present or is empty) or EHPLMN (if the EHPLMN list is present). Access Identities 12, 13 and 14 are only valid in HPLMN and visited PLMNs of home country only.</p> <p>NOTE 4: Access Identity 3 is valid when the UE is registering or registered for disaster roaming services (see 3GPP TS 23.122 [5]).</p>	

The UE uses the MPS indicator bit of the 5GS network feature support IE or the Priority indicator IE to determine if access identity 1 is valid. Processing of the MPS indicator bit of the 5GS network feature support IE in the REGISTRATION ACCEPT message is described in subclause 5.5.1.2.4 and subclause 5.5.1.3.4. Processing of the MPS indicator bit of the Priority indicator IE in the CONFIGURATION UPDATE COMMAND message is described in subclause 5.4.4.3.

When the UE is neither in the HPLMN (if the EHPLMN list is not present or is empty) nor in an EHPLMN (if the EHPLMN list is present) nor in a visited PLMN of the home country, and the USIM file EF_{UAC_AIC} indicates the UE is configured for access identity 1, then the UE shall not consider access identity 1 to be valid, until the UE receives the MPS indicator bit of the 5GS network feature support IE in the REGISTRATION ACCEPT message or of the Priority indicator IE in the CONFIGURATION UPDATE COMMAND message being set to "Access identity 1 valid" from the RPLMN or from an equivalent PLMN.

When the UE is in the HPLMN (if the EHPLMN list is not present or is empty) or in an EHPLMN (if the EHPLMN list is present) or in a visited PLMN of the home country, the contents of the USIM file EF_{UAC_AIC} as specified in 3GPP TS 31.102 [22] and the rules specified in table 4.5.2.1 are used to determine the applicability of access identity 1. When the UE is in the HPLMN (if the EHPLMN list is not present or is empty) or in an EHPLMN (if the EHPLMN list is present) or in a visited PLMN of the home country, and the USIM file EF_{UAC_AIC} does not indicate the UE is configured for access identity 1, the UE uses the MPS indicator bit of the 5GS network feature support IE in the REGISTRATION ACCEPT message or of the Priority indicator IE in the CONFIGURATION UPDATE COMMAND message to determine if access identity 1 is valid. When the UE is in the HPLMN (if the EHPLMN list is not present or

is empty) or in an EHPLMN (if the EHPLMN list is present) or in a visited PLMN of the home country, and the USIM file EF_{UAC_AIC} indicates the UE is configured for access identity 1, the MPS indicator bit of the 5GS network feature support IE and the Priority indicator IE are not applicable. When the UE is not in the HPLMN (if the EHPLMN list is not present or is empty) or in an EHPLMN (if the EHPLMN list is present) or in a visited PLMN of the home country, the contents of the USIM file EF_{UAC_AIC} are not applicable.

The UE uses the MCS indicator bit of the 5GS network feature support IE or of the Priority indicator IE to determine if access identity 2 is valid. Processing of the MCS indicator bit of the 5GS network feature support IE in the REGISTRATION ACCEPT message is described in subclause 5.5.1.2.4 and subclause 5.5.1.3.4. Processing of the MCS indicator bit of the Priority indicator IE in the CONFIGURATION UPDATE COMMAND message is described in subclause 5.4.4.3. When the UE is neither in the HPLMN (if the EHPLMN list is not present or is empty) nor in an EHPLMN (if the EHPLMN list is present) nor in a visited PLMN of the home country, and the USIM file EF_{UAC_AIC} indicates the UE is configured for access identity 2, the UE shall not consider access identity 2 to be valid, until the UE receives the MCS indicator bit of the 5GS network feature support IE in the REGISTRATION ACCEPT message or of the Priority indicator IE in the CONFIGURATION UPDATE COMMAND message being set to "Access identity 2 valid" from the RPLMN or from an equivalent PLMN.

When the UE is in the HPLMN (if the EHPLMN list is not present or is empty) or in an EHPLMN (if the EHPLMN list is present) or in a visited PLMN of the home country, the contents of the USIM file EF_{UAC_AIC} as specified in 3GPP TS 31.102 [22] and the rules specified in table 4.5.2.1 are used to determine the applicability of access identity 2. When the UE is in the HPLMN (if the EHPLMN list is not present or is empty) or in an EHPLMN (if the EHPLMN list is present) or in a visited PLMN of the home country, and the USIM file EF_{UAC_AIC} does not indicate the UE is configured for access identity 2, the UE uses the MCS indicator bit of the 5GS network feature support IE in the REGISTRATION ACCEPT message or of the Priority indicator IE in the CONFIGURATION UPDATE COMMAND message to determine if access identity 2 is valid. When the UE is in the HPLMN (if the EHPLMN list is not present or is empty) or in an EHPLMN (if the EHPLMN list is present) or in a visited PLMN of the home country, and the USIM file EF_{UAC_AIC} indicates the UE is configured for access identity 2, the MCS indicator bit of the 5GS network feature support IE and the Priority indicator IE is not applicable. When the UE is not in the HPLMN (if the EHPLMN list is not present or is empty) or in an EHPLMN (if the EHPLMN list is present) or in a visited PLMN of the home country, the contents of the USIM file EF_{UAC_AIC} are not applicable.

The UE checks the conditions specified in subclause 4.4.3.1.1 of 3GPP TS 23.122 [5] to determine if access identity 3 is valid, and the applicability of access identity 3.

When the UE is in its HPLMN (if the EHPLMN list is not present or is empty) or in an EHPLMN (if the EHPLMN list is present), the contents of the USIM file EF_{ACC} as specified in 3GPP TS 31.102 [22] and the rules specified in table 4.5.2.1 are used to determine the applicability of access classes 11 and 15. When the UE is not in its HPLMN (if the EHPLMN list is not present or is empty) or in an EHPLMN (if the EHPLMN list is present), access classes 11 and 15 are not applicable.

When the UE is in the HPLMN or in a visited PLMN of the home country, the contents of the USIM file EF_{ACC} as specified in 3GPP TS 31.102 [22] and the rules specified in table 4.5.2.1 are used to determine the applicability of access classes 12 - 14. When the UE is neither in the HPLMN nor in a visited PLMN of the home country, access classes 12-14 are not applicable.

In order to determine the access category applicable for the access attempt, the NAS shall check the rules in table 4.5.2.2, and use the access category for which there is a match for barring check. If the access attempt matches more than one rule, the access category of the lowest rule number shall be selected. If the access attempt matches more than one operator-defined access category definition, the UE shall select the access category from the operator-defined access category definition with the lowest precedence value (see subclause 4.5.3).

NOTE: The case when an access attempt matches more than one rule includes the case when multiple events trigger an access attempt at the same time. When multiple events trigger an access attempt at the same time, how the access attempt is checked for multiple events is up to UE implementation.

Table 4.5.2.2: Mapping table for access categories

Rule #	Type of access attempt	Requirements to be met	Access Category
1	Response to paging or NOTIFICATION over non-3GPP access; 5GMM connection management procedure initiated for the purpose of transporting an LPP or SLPP message without an ongoing 5GC-MO-LR or SL-MO-LR procedure; Access attempt to handover of ongoing MMTel voice call, MMTel video call or SMSoIP from non-3GPP access; or Access attempt upon receipt of "call-pull-initiated" indication from the upper layers (see 3GPP TS 24.174 [13D])	Access attempt is for MT access, or handover of ongoing MMTel voice call, MMTel video call or SMSoIP from non-3GPP access; or Access attempt is made upon receipt of "call-pull-initiated" (3GPP TS 24.174 [13D])	0 (= MT_acc)
2	Emergency	UE is attempting access for an emergency session (NOTE 1, NOTE 2)	2 (= emergency)
3	Access attempt for operator-defined access category	UE stores operator-defined access category definitions valid in the current PLMN as specified in subclause 4.5.3, and access attempt is matching criteria of an operator-defined access category definition	32-63 (= based on operator classification)
3.1	Access attempt for MO exception data	UE is in NB-N1 mode and allowed to use exception data reporting (see the ExceptionDataReportingAllowed leaf of the NAS configuration MO in 3GPP TS 24.368 [17] or the USIM file EF _{NASCONFIG} in 3GPP TS 31.102 [22]), and access attempt is for MO data or for MO signalling initiated upon receiving a request from upper layers to transmit user data related to an exceptional event.	10 (= MO exception data)
4	Access attempt for delay tolerant service	(a) UE is configured for NAS signalling low priority or UE supporting S1 mode is configured for EAB (see the "ExtendedAccessBarring" leaf of NAS configuration MO in 3GPP TS 24.368 [17] or 3GPP TS 31.102 [22]) where "EAB override" does not apply, and (b):the UE received one of the categories a, b or c as part of the parameters for unified access control in the broadcast system information, and the UE is a member of the broadcasted category in the selected PLMN or RPLMN/equivalent PLMN (NOTE 3, NOTE 5, NOTE 6, NOTE 7, NOTE 8)	1 (= delay tolerant)
5	MO MMTel voice call; or MT MMTel voice call	Access attempt is for MO MMTel voice call or MT MMTel voice call or for NAS signalling connection recovery during ongoing MO MMTel voice call or ongoing MT MMTel voice call (NOTE 2)	4 (= MO MMTel voice)
6	MO MMTel video call; or MT MMTel video call	Access attempt is for MO MMTel video call or MT MMTel video call or for NAS signalling connection recovery during ongoing MO MMTel video call or ongoing MT MMTel video call (NOTE 2)	5 (= MO MMTel video)

7	MO SMS over NAS or MO SMS over SMIoIP; or MT SMS over SMIoIP	Access attempt is for MO SMS over NAS (NOTE 4) or MO SMS over SMIoIP transfer or MT SMS over SMIoIP or for NAS signalling connection recovery during ongoing MO SMS or SMIoIP transfer or ongoing MT SMS over SMIoIP (NOTE 2)	6 (= MO SMS and SMIoIP)
7.1	MO IMS registration related signalling	Access attempt is for MO IMS registration related signalling (e.g. IMS initial registration, re-registration, subscription refresh) or for NAS signalling connection recovery during ongoing procedure for MO IMS registration related signalling (NOTE 2a)	9 (= MO IMS registration related signalling)
8	UE NAS initiated 5GMM specific procedures	Access attempt is for MO signalling	3 (= MO_sig)
8.1	Mobile originated location request	Access attempt is for mobile originated location request (NOTE 9)	3 (= MO_sig)
8.2	Mobile originated signalling transaction towards the PCF	Access attempt is for mobile originated signalling transaction towards the PCF (NOTE 10)	3 (= MO_sig)
8.3	Access attempt for RAN timing synchronization	Access attempt is for mobile originated signalling for the reconnection to the network due to RAN timing synchronization status change	3 (= MO_sig)
9	UE NAS initiated 5GMM connection management procedure or 5GMM NAS transport procedure	Access attempt is for MO data	7 (= MO_data)
10	An uplink user data packet is to be sent for a PDU session with suspended user-plane resources	No further requirement is to be met	7 (= MO_data)

NOTE 1:	This includes 5GMM specific procedures while the service is ongoing and 5GMM connection management procedures required to establish a PDU session with request type = "initial emergency request" or "existing emergency PDU session", or to re-establish user-plane resources for such a PDU session. This further includes the service request procedure initiated with a SERVICE REQUEST message with the Service type IE set to "emergency services fallback".
NOTE 2:	Access for the purpose of NAS signalling connection recovery during an ongoing service as defined in subclause 4.5.5, or for the purpose of NAS signalling connection establishment following fallback indication from lower layers during an ongoing service as defined in subclause 4.5.5, is mapped to the access category of the ongoing service in order to derive an RRC establishment cause, but barring checks will be skipped for this access attempt.
NOTE 2a:	Access for the purpose of NAS signalling connection recovery during an ongoing procedure for MO IMS registration related signalling as defined in subclause 4.5.5, or for the purpose of NAS signalling connection establishment following fallback indication from lower layers during an ongoing procedure for MO IMS registration related signalling as defined in subclause 4.5.5, is mapped to the access category of the MO IMS registration related signalling in order to derive an RRC establishment cause, but barring checks will be skipped for this access attempt.
NOTE 3:	If the UE selects a new PLMN, then the selected PLMN is used to check the membership; otherwise the UE uses the RPLMN or a PLMN equivalent to the RPLMN.
NOTE 4:	This includes the 5GMM connection management procedures triggered by the UE-initiated NAS transport procedure for transporting the MO SMS.
NOTE 5:	The UE configured for NAS signalling low priority is not supported in this release of specification. If a UE supporting both S1 mode and N1 mode is configured for NAS signalling low priority in S1 mode as specified in 3GPP TS 24.368 [17] or 3GPP TS 31.102 [22], the UE shall ignore the configuration for NAS signalling low priority when in N1 mode.
NOTE 6:	If the access category applicable for the access attempt is 1, then the UE shall additionally determine a second access category from the range 3 to 7. If more than one access category matches, the access category of the lowest rule number shall be chosen. The UE shall use the second access category only to derive an RRC establishment cause for the access attempt.
NOTE 7:	"EAB override" does not apply, if the UE is not configured to allow overriding EAB (see the "Override_ExtendedAccessBarring" leaf of NAS configuration MO in 3GPP TS 24.368 [17] or 3GPP TS 31.102 [22]), or if NAS has not received an indication from the upper layers to override EAB and the UE does not have a PDU session that was established with EAB override.
NOTE 8:	For the definition of categories a, b and c associated with access category 1, see 3GPP TS 22.261 [3]. The categories associated with access category 1 are distinct from the categories a, b and c associated with EAB (see 3GPP TS 22.011 [1A]).
NOTE 9:	This includes: <ul style="list-style-type: none"> a) the UE-initiated NAS transport procedure for transporting a mobile originated location request; b) the 5GMM connection management procedure triggered by a) above; and c) NAS signalling connection recovery during an ongoing 5GC-MO-LR procedure.
NOTE 10:	This includes: <ul style="list-style-type: none"> a) the UE-initiated NAS transport procedure for transporting a mobile originated signalling transaction towards the PCF; b) the 5GMM connection management procedure triggered by a) above; and c) NAS signalling connection recovery during an ongoing UE-requested policy provisioning procedure for V2XP, ProSeP or both (see 3GPP TS 24.587 [19B] and see 3GPP TS 24.554 [19E]).

4.5.2A Determination of the access identities and access category associated with a request for access for UEs operating in SNPN access operation mode over 3GPP access

When the UE needs to initiate an access attempt in one of the events listed in subclause 4.5.1, the UE shall determine one or more access identities from the set of standardized access identities, and one access category from the set of standardized access categories and operator-defined access categories, to be associated with that access attempt.

The set of the access identities applicable for the request is determined by the UE in the following way:

- a) for each of the access identities 1, 2, 11, 12, 13, 14 and 15 in table 4.5.2A.1, the UE shall check whether the access identity is applicable in the selected SNPN, if a new SNPN is selected, or otherwise if it is applicable in the RSNPN or equivalent SNPN; and
- b) if none of the above access identities is applicable, then access identity 0 is applicable.

Table 4.5.2A.1: Access identities

Access Identity number	UE configuration
0	UE is not configured with any parameters from this table
1 (NOTE 1)	UE is configured for multimedia priority service (MPS).
2 (NOTE 2)	UE is configured for mission critical service (MCS).
3-10	Reserved for future use
11 (NOTE 3)	Access Class 11 is configured in the UE.
12 (NOTE 3)	Access Class 12 is configured in the UE.
13 (NOTE 3)	Access Class 13 is configured in the UE.
14 (NOTE 3)	Access Class 14 is configured in the UE.
15 (NOTE 3)	Access Class 15 is configured in the UE.
<p>NOTE 1: Access identity 1 is valid when:</p> <ul style="list-style-type: none"> - the unified access control configuration in the "list of subscriber data" stored in the ME (see 3GPP TS 23.122 [5]), if an entry of "list of subscriber data" is selected, or in the USIM (see 3GPP TS 31.102 [22]), if the PLMN subscription is selected, indicates the UE is configured for access identity 1 in the selected SNPN, if a new SNPN is selected, or RSNPN, and the selected SNPN or the RSNPN is the subscribed SNPN, an SNPN equivalent to the subscribed SNPN, or a non-subscribed SNPN of the same country as the subscribed SNPN if the MCC of the SNPN identity of the subscribed SNPN is not the MCC of value 999; - the UE receives the 5GS network feature support IE with the MPS indicator bit set to "Access identity 1 valid" from the RSNPN as described in subclause 5.5.1.2.4 and subclause 5.5.1.3.4; or - the UE receives the Priority indicator IE with the MPS indicator bit set to "Access identity 1 valid" from the RPLMN as described in subclause 5.4.4.3. <p>NOTE 2: Access identity 2 is used by UEs configured for MCS and is valid when:</p> <ul style="list-style-type: none"> - the unified access control configuration in the "list of subscriber data" stored in the ME (see 3GPP TS 23.122 [5]), if an entry of "list of subscriber data" is selected, or in the USIM (see 3GPP TS 31.102 [22]), if the PLMN subscription is selected, indicates the UE is configured for access identity 2 in the selected SNPN, if a new SNPN is selected, or RSNPN, and the selected SNPN or the RSNPN is the subscribed SNPN, or an SNPN equivalent to the subscribed SNPN, or a non-subscribed SNPN of the same country as the subscribed SNPN if the MCC of the SNPN identity of the subscribed SNPN is not the MCC of value 999; or - the UE receives the 5GS network feature support IE with the MCS indicator bit set to "Access identity 2 valid" from the RSNPN as described in subclause 5.5.1.2.4 and subclause 5.5.1.3.4. <p>NOTE 3: Access identities 11 and 15 are valid if indicated as configured for the UE in the unified access control configuration in the "list of subscriber data" stored in the ME (see 3GPP TS 23.122 [5]), if an entry of "list of subscriber data" is selected, or in the USIM (see 3GPP TS 31.102 [22]), if the PLMN subscription is selected, in the selected SNPN, if a new SNPN is selected, or RSNPN, and the selected SNPN or the RSNPN is the subscribed SNPN. Access identities 12, 13 and 14 are valid if indicated as configured for the UE in the unified access control configuration in the "list of subscriber data" stored in the ME (see 3GPP TS 23.122 [5]), if an entry of "list of subscriber data" is selected, or in the USIM (see 3GPP TS 31.102 [22]), if the PLMN subscription is selected, in the selected SNPN, if a new SNPN is selected, or RSNPN, and the selected SNPN or the RSNPN in the subscribed SNPN or a non-subscribed SNPN of the same country as the subscribed SNPN if the MCC of the SNPN identity of the subscribed SNPN is not the MCC of value 999.</p>	

The contents of the unified access control configuration in the "list of subscriber data" stored in the ME (see 3GPP TS 23.122 [5]), if an entry of "list of subscriber data" is selected, or in the USIM (see 3GPP TS 31.102 [22]), if the PLMN subscription is selected, and the rules specified in table 4.5.2A.1 are used to determine the applicability of access identity 1 in the SNPN. When the contents of the unified access control configuration in the "list of subscriber data" stored in the ME (see 3GPP TS 23.122 [5]), if an entry of "list of subscriber data" is selected, or in the USIM (see 3GPP TS 31.102 [22]), if the PLMN subscription is selected, do not indicate the UE is configured for access identity 1 for the SNPN, the UE uses the MPS indicator bit of the 5GS network feature support IE in the REGISTRATION ACCEPT message and the MPS indicator bit of the Priority indicator IE in the CONFIGURATION UPDATE COMMAND message to determine if access identity 1 is valid.

The contents of the unified access control configuration in the "list of subscriber data" stored in the ME (see 3GPP TS 23.122 [5]), if an entry of "list of subscriber data" is selected, or in the USIM (see 3GPP TS 31.102 [22]), if the PLMN subscription is selected, and the rules specified in table 4.5.2A.1 are used to determine the applicability of access identity 2 in the SNPN. When the contents of the unified access control configuration in the "list of subscriber data" stored in the ME (see 3GPP TS 23.122 [5]), if an entry of "list of subscriber data" is selected, or in the USIM (see 3GPP TS 31.102 [22]), if the PLMN subscription is selected, do not indicate the UE is configured for access identity 2 for the SNPN, the UE uses the MCS indicator bit of the 5GS network feature support IE in the REGISTRATION ACCEPT message to determine if access identity 2 is valid.

The contents of the unified access control configuration in the "list of subscriber data" stored in the ME (see 3GPP TS 23.122 [5]), if an entry of "list of subscriber data" is selected, or in the USIM (see 3GPP TS 31.102 [22]), if the PLMN subscription is selected, and the rules specified in table 4.5.2A.1 are used to determine the applicability of access classes 11 to 15 in the SNPN.

In order to determine the access category applicable for the access attempt, the NAS shall check the rules in table 4.5.2A.2, and use the access category for which there is a match for barring check. If the access attempt matches more than one rule, the access category of the lowest rule number shall be selected. If the access attempt matches more than one operator-defined access category definition, the UE shall select the access category from the operator-defined access category definition with the lowest precedence value (see subclause 4.5.3).

NOTE: The case when an access attempt matches more than one rule includes the case when multiple events trigger an access attempt at the same time. When multiple events trigger an access attempt at the same time, how the access attempt is checked for multiple events is up to UE implementation.

Table 4.5.2A.2: Mapping table for access categories

Rule #	Type of access attempt	Requirements to be met	Access Category
1	Response to paging or NOTIFICATION over non-3GPP access ; 5GMM connection management procedure initiated for the purpose of transporting an LPP or SLPP message without an ongoing 5GC-MO-LR or SL-MO-LR procedure; Access attempt to handover of MMTEL voice call, MMTEL video call or SMSoIP from non-3GPP access; Access attempt upon receipt of "call-pull-initiated" indication from the upper layers (see 3GPP TS 24.174 [13D])	Access attempt is for MT access, handover of ongoing MMTEL voice call, MMTEL video call or SMSoIP from non-3GPP access; or Access attempt is made upon receipt of "call-pull-initiated" indication (3GPP TS 24.174 [13D])	0 (= MT_acc)
2	Emergency	UE is attempting access for an emergency session (NOTE 1, NOTE 2)	2 (= emergency)
3	Access attempt for operator-defined access category	UE stores operator-defined access category definitions valid in the SNPN as specified in subclause 4.5.3, and access attempt is matching criteria of an operator-defined access category definition	32-63 (= based on operator classification)
4	Access attempt for delay tolerant service	(a) UE is configured for NAS signalling low priority, and (b) the UE received one of the categories a, b or c as part of the parameters for unified access control in the broadcast system information, and the UE is a member of the broadcasted category in the selected SNPN, RSNPN or equivalent SNPN (NOTE 3, NOTE 5, NOTE 6, NOTE 7, NOTE 8)	1 (= delay tolerant)
5	MO MMTel voice call; or MT MMTel voice call	Access attempt is for MO MMTel voice call or MT MMTel voice call or for NAS signalling connection recovery during ongoing MO MMTel voice call or ongoing MT MMTel voice call (NOTE 2)	4 (= MO MMTel voice)
6	MO MMTel video call; or MT MMTel video call	Access attempt is for MO MMTel video call or MT MMTel video call or for NAS signalling connection recovery during ongoing MO MMTel video call or ongoing MT MMTel video call (NOTE 2)	5 (= MO MMTel video)
7	MO SMS over NAS or MO SMSoIP; or MT SMSoIP	Access attempt is for MO SMS over NAS (NOTE 4) or MO SMS over SMSoIP transfer or MT SMS over SMSoIP or for NAS signalling connection recovery during ongoing MO SMS or SMSoIP transfer or MT SMS over SMSoIP (NOTE 2)	6 (= MO SMS and SMSoIP)
7.1	MO IMS registration related signalling	Access attempt is for MO IMS registration related signalling (e.g. IMS initial registration, re-registration, subscription refresh) or for NAS signalling connection recovery during ongoing procedure for MO IMS registration related signalling (NOTE 2a)	9 (= MO IMS registration related signalling)
8	UE NAS initiated 5GMM specific procedures	Access attempt is for MO signalling	3 (= MO_sig)
8.1	Mobile originated location request	Access attempt is for mobile originated location request (NOTE 9)	3 (= MO_sig)

8.2	Mobile originated signalling transaction towards the PCF	Access attempt is for mobile originated signalling transaction towards the PCF (NOTE 10)	3 (= MO_sig)
8.3	Access attempt for RAN timing synchronization	Access attempt is for mobile originated signalling for the reconnection to the network due to RAN timing synchronization status change	3 (= MO_sig)
9	UE NAS initiated 5GMM connection management procedure or 5GMM NAS transport procedure	Access attempt is for MO data	7 (= MO_data)
10	An uplink user data packet is to be sent for a PDU session with suspended user-plane resources	No further requirement is to be met	7 (= MO_data)

NOTE 1: Void

NOTE 2: Access for the purpose of NAS signalling connection recovery during an ongoing service as defined in subclause 4.5.5, or for the purpose of NAS signalling connection establishment following fallback indication from lower layers during an ongoing service as defined in subclause 4.5.5, is mapped to the access category of the ongoing service in order to derive an RRC establishment cause, but barring checks will be skipped for this access attempt.

NOTE 2a: Access for the purpose of NAS signalling connection recovery during an ongoing MO IMS registration related signalling as defined in subclause 4.5.5, or for the purpose of NAS signalling connection establishment following fallback indication from lower layers during an ongoing MO IMS registration related signalling as defined in subclause 4.5.5, is mapped to the access category of the MO IMS registration related signalling in order to derive an RRC establishment cause, but barring checks will be skipped for this access attempt.

NOTE 3: If the UE selects a new SNPN, then the selected SNPN is used to check the membership; otherwise the UE uses the RSNPN or an SNPN equivalent to the RSNPN.

NOTE 4: This includes the 5GMM connection management procedures triggered by the UE-initiated NAS transport procedure for transporting the MO SMS.

NOTE 5: The UE configured for NAS signalling low priority is not supported in this release of specification.

NOTE 6: If the access category applicable for the access attempt is 1, then the UE shall additionally determine a second access category from the range 3 to 7. If more than one access category matches, the access category of the lowest rule number shall be chosen. The UE shall use the second access category only to derive an RRC establishment cause for the access attempt.

NOTE 7: Void.

NOTE 8: For the definition of categories a, b and c associated with access category 1, see 3GPP TS 22.261 [3]. The categories associated with access category 1 are distinct from the categories a, b and c associated with EAB (see 3GPP TS 22.011 [1A]).

NOTE 9: This includes:

- a) the UE-initiated NAS transport procedure for transporting a mobile originated location request;
- b) the 5GMM connection management procedure triggered by a) above; and
- c) NAS signalling connection recovery during an ongoing 5GC-MO-LR procedure.

NOTE 10: This includes:

- a) the UE-initiated NAS transport procedure for transporting a mobile originated signalling transaction towards the PCF;
- b) the 5GMM connection management procedure triggered by a) above; and
- c) NAS signalling connection recovery during an ongoing UE-requested policy provisioning procedure for V2XP (see 3GPP TS 24.587 [19B]).

4.5.3 Operator-defined access categories

Operator-defined access category definitions can be signalled to the UE using NAS signalling. Each operator-defined access category definition consists of the following parameters:

- a) a precedence value which indicates in which order the UE shall evaluate the operator-defined category definition for a match;
- b) an operator-defined access category number, i.e. access category number in the 32-63 range that uniquely identifies the access category in the PLMN or SNPN in which the access categories are being sent to the UE;
- c) criteria consisting of one or more access category criteria type and associated access category criteria type values. The access category criteria type can be set to one of the following:

- 1) DNN;
- 2) Void;
- 3) OS Id + OS App Id of application triggering the access attempt; or
- 4) S-NSSAI; and

NOTE 1: An access category criteria type can be associated with more than one access category criteria values.

- d) optionally, a standardized access category. This standardized access category is used in combination with the access identities of the UE to determine the RRC establishment cause as specified in subclause 4.5.6.

If the access attempt is to establish a new PDU session i.e. it is triggered by:

- a request from upper layers to send an UL NAS TRANSPORT message for the purpose of PDU session establishment unless the request triggered a service request procedure (or a registration procedure if the UE is in state 5GMM-REGISTERED.ATTEMPTING-REGISTRATION-UPDATE) to transition the UE from 5GMM-IDLE mode or 5GMM-IDLE mode with suspend indication to 5GMM-CONNECTED mode; or
- a service request procedure (or a registration procedure if the UE is in state 5GMM-REGISTERED.ATTEMPTING-REGISTRATION-UPDATE) to transition the UE from 5GMM-IDLE mode or 5GMM-IDLE mode with suspend indication to 5GMM-CONNECTED mode triggered by a request from upper layers to send an UL NAS TRANSPORT message for the purpose of PDU session establishment,

then:

- the access attempt matches access category criteria type DNN if the DNN requested by the UE during the PDU session establishment procedure matches any of the access criteria type values associated with the access criteria type DNN; and
- the access attempt matches access category criteria type S-NSSAI if the S-NSSAI requested by the UE during the PDU session establishment procedure matches any of the access criteria type values associated with the access criteria type S-NSSAI.

If the access attempt is for an existing PDU session i.e. it is triggered by:

- a request from upper layers to send an UL NAS TRANSPORT message for the purpose of PDU session modification unless the request triggered a service request procedure (or a registration procedure if the UE is in state 5GMM-REGISTERED.ATTEMPTING-REGISTRATION-UPDATE) to transition the UE from 5GMM-IDLE mode or 5GMM-IDLE mode with suspend indication to 5GMM-CONNECTED mode;
- a service request procedure (or a registration procedure if the UE is in state 5GMM-REGISTERED.ATTEMPTING-REGISTRATION-UPDATE) to transition the UE from 5GMM-IDLE mode or 5GMM-IDLE mode with suspend indication to 5GMM-CONNECTED mode triggered by a request from upper layers to send an UL NAS TRANSPORT message for the purpose of PDU session modification;
- a service request procedure (or a registration procedure if the UE is in state 5GMM-REGISTERED.ATTEMPTING-REGISTRATION-UPDATE) to transition the UE from 5GMM-IDLE mode or 5GMM-IDLE mode with suspend indication to 5GMM-CONNECTED mode triggered by a request from upper layers to send an UL NAS TRANSPORT message for the purpose of PDU session release;
- a service request procedure (or a registration procedure if the UE is in state 5GMM-REGISTERED.ATTEMPTING-REGISTRATION-UPDATE) requesting user-plane resources for a PDU session; or
- an uplink user data packet is to be sent for a PDU session with suspended user-plane resources,

then:

- the access attempt matches access category criteria type DNN if the DNN provided by the network in the PDU SESSION ESTABLISHMENT ACCEPT message matches any of the access criteria type values associated with the access criteria type DNN; and
- the access attempt matches access category criteria type S-NSSAI if the S-NSSAI associated with the PDU session matches any of the access criteria type values associated with the access criteria type S-NSSAI.

NOTE 2: In order to avoid having access attempts for non-always-on PDU sessions blocked due to access barring of always-on PDU sessions, it is recommended that the network assigns the highest precedence values to operator-defined access category definition which can be matched by always-on PDU sessions.

An access attempt matches the criteria of an operator-defined access category definition, if the access attempt matches all access category criteria types included in the criteria with any of the associated access criteria type values.

Each operator-defined access category definition has a different precedence value.

Several operator-defined access category definitions can have the same operator-defined access category number.

If:

- an access category in bullet d) is not provided;
- an access category in bullet d) is provided and is not a standardized access category; or
- an access category in bullet d) is provided, is a standardized access category and is not recognized by the UE;

the UE shall use instead access category 7 (MO_data) in combination with the access identities of the UE to determine the RRC establishment cause as specified in subclause 4.5.6.

The operator-defined access category definitions are valid in the PLMN which provided them and in a PLMN equivalent to the PLMN which provided them, or in the SNPN which provided them and in an SNPN equivalent to the SNPN which provided them, as specified in annex C.

If the UE stores operator-defined access category definitions valid in the selected PLMN or the RPLMN, or valid in the selected SNPN or RSNPN, then access control in 5GMM-IDLE mode or 5GMM-IDLE mode with suspend indication will only be performed for the event a) defined in subclause 4.5.1. If the transition from 5GMM-IDLE mode or 5GMM-IDLE mode with suspend indication over 3GPP access to 5GMM-CONNECTED mode is due to a UE NAS initiated 5GMM specific procedure, then this access attempt shall be mapped to one of the standardized access categories in the range < 32, see subclause 4.5.2. I.e. for this case the UE shall skip the checking of operator-defined access category definitions.

If the UE stores operator-defined access category definitions valid in the selected PLMN or the RPLMN, or valid in the selected SNPN or RSNPN, then access control in 5GMM-CONNECTED mode and in 5GMM-CONNECTED mode with RRC inactive indication will only be performed for the events 1) to 8) defined in subclause 4.5.1.

The UE shall handle the operator-defined access category definitions stored for the RPLMN or RSNPN as specified in subclause 5.4.4.3, subclause 5.5.1.2.4, and subclause 5.5.1.3.4.

When the UE is switched off, the UE shall keep the operator-defined access category definitions so that the operator-defined access category definitions can be used after switch on.

When the UE selects a new PLMN which is not equivalent to the previously selected PLMN, or selects a new SNPN which is not equivalent to the previously selected SNPN, the UE shall stop using the operator-defined access category definitions stored for the previously selected PLMN or SNPN and should keep the operator-defined access category definitions stored for the previously selected PLMN or SNPN.

NOTE 3: When the UE selects a new PLMN which is not equivalent to the previously selected PLMN, or selects a new SNPN which is not equivalent to the previously selected SNPN, the UE can delete the operator-defined access category definitions stored for the previously selected PLMN or SNPN e.g. if there is no storage space in the UE.

4.5.4 Access control and checking

4.5.4.1 Access control and checking in 5GMM-IDLE mode and in 5GMM-IDLE mode with suspend indication

When the UE is in 5GMM-IDLE mode or 5GMM-IDLE mode with suspend indication, upon receiving a request from the upper layers for an access attempt, the NAS shall categorize the access attempt into access identities and an access category following:

- a) subclause 4.5.2, table 4.5.2.1 and table 4.5.2.2, and subclause 4.5.3, if the UE is not operating in SNPN access operation mode over 3GPP access ; or
- b) subclause 4.5.2A, table 4.5.2A.1 and table 4.5.2A.2, and subclause 4.5.3, if the UE is operating in SNPN access operation mode over 3GPP access ,

and provide the applicable access identities and the access category to the lower layers for the purpose of access control checking. In this request to the lower layer the NAS can also provide to the lower layer the RRC establishment cause determined as specified in subclause 4.5.6 of this specification.

NOTE 1: The access barring check is performed by the lower layers.

NOTE 2: As an implementation option, the NAS can provide the RRC establishment cause to the lower layers after being informed by the lower layers that the access attempt is allowed.

If the UE has uplink user data pending for one or more PDU sessions when it builds a REGISTRATION REQUEST or SERVICE REQUEST message as initial NAS message, the UE shall indicate the respective PDU sessions in the Uplink data status IE as specified in subclause 5.5.1.3.2 and 5.6.1.2.1, regardless of the access category for which the access barring check is performed.

If the UE is registered for 5GS services with control plane CIoT 5GS optimization has uplink user data pending for one or more PDU sessions when it builds a CONTROL PLANE SERVICE REQUEST message as initial NAS message, the UE shall indicate the respective PDU sessions as specified in subclause 5.6.1.2.2, regardless of the access category for which the access barring check is performed.

NOTE 3: The UE indicates pending user data for all the respective PDU sessions, even if barring timers are running for some of the corresponding access categories.

If the lower layers indicate that the access attempt is allowed, the NAS shall initiate the procedure to send the initial NAS message for the access attempt.

If the lower layers indicate that the access attempt is barred, the NAS shall not initiate the procedure to send the initial NAS message for the access attempt. Additionally:

- a) if the event which triggered the access attempt was an MO-MMTEL-voice-call-started indication or an MO-MMTEL-video-call-started indication:
 - 1) if the UE is operating in the single-registration mode, the UE's usage setting is "voice centric" and the UE has not disabled its E-UTRA capability as specified in 3GPP TS 24.301 [15], the UE may attempt to select an E-UTRA cell connected to EPC. If the UE finds a suitable E-UTRA cell connected to EPC, it then proceeds with the appropriate EMM specific procedures and, if necessary, ESM procedures to make a PDN connection providing access to IMS available; see subclause 4.8.2 and 3GPP TS 24.301 [15];
 - 2) if the UE is operating in the dual-registration mode, the UE may proceed in S1 mode with the appropriate EMM specific procedures and ESM procedures to make a PDN connection providing access to IMS available; see subclause 4.8.3 and 3GPP TS 24.301 [15]; or
 - 3) otherwise, the NAS shall notify the upper layers that the access attempt is barred. In this case, upon receiving an indication from the lower layers that the barring is alleviated for the access category with which the access attempt was associated, the NAS shall notify the upper layers that the barring is alleviated for the access category and may initiate the procedure to send the initial NAS message, if still needed;
- b) if the event which triggered the access attempt was an MO-SMSoIP-attempt-started indication or an MO-IMS-registration-related-signalling-started indication:
 - 1) if the UE is operating in the single-registration mode, the UE may attempt to select an E-UTRA cell connected to EPC. If the UE finds a suitable E-UTRA cell connected to EPC, it then proceeds with the appropriate EMM specific procedures and, if necessary, ESM procedures to make a PDN connection providing access to IMS available; see subclause 4.8.2 and 3GPP TS 24.301 [15];
 - 2) if the UE is operating in the dual-registration mode, the UE may proceed in S1 mode with the appropriate EMM specific procedures and ESM procedures to make a PDN connection providing access to IMS available; see subclause 4.8.3 and 3GPP TS 24.301 [15]; or

- 3) otherwise, the NAS shall notify the upper layers that the access attempt is barred. In this case, upon receiving an indication from the lower layers that the barring is alleviated for the access category with which the access attempt was associated, the NAS shall notify the upper layers that the barring is alleviated for the access category and may initiate the procedure to send the initial NAS message, if still needed; and

c) if the access attempt is for emergency:

- 1) the NAS shall notify the upper layers that the access attempt is barred. In this case, upon receiving an indication from the lower layers that the barring is alleviated for the access category with which the access attempt was associated, the NAS shall notify the upper layers of that the barring is alleviated for the access category and may initiate the procedure to send the initial NAS message, if still needed.

NOTE 4: This can result in the upper layers requesting another emergency call attempt using domain selection as specified in 3GPP TS 23.167 [6] and 3GPP TS 24.229 [14].

NOTE 5: Barring timers, on a per access category basis, are run by the lower layers. At expiry of barring timers, the indication of alleviation of access barring is indicated to the NAS on a per access category basis.

4.5.4.2 Access control and checking in 5GMM-CONNECTED mode and in 5GMM-CONNECTED mode with RRC inactive indication

When the UE is in 5GMM-CONNECTED mode or 5GMM-CONNECTED mode with RRC inactive indication, upon detecting one of events 1) through 8) listed in subclause 4.5.1, the NAS shall categorize the corresponding access attempt into access identities and an access category following:

- a) subclause 4.5.2, table 4.5.2.1 and table 4.5.2.2, and subclause 4.5.3, if the UE is not operating in SNPN access operation mode over 3GPP access ; or
- b) subclause 4.5.2A, table 4.5.2A.1 and table 4.5.2A.2, and subclause 4.5.3, if the UE is operating in SNPN access operation mode over 3GPP access ,

and provide the access identities and the access category to the lower layers for the purpose of access control checking. In this request to the lower layer the NAS can also provide to the lower layer the RRC establishment cause determined as specified in subclause 4.5.6 of this specification.

NOTE 1: As an implementation option, the NAS can provide the RRC establishment cause to the lower layers after being informed by the lower layers that the access attempt is allowed.

If the UE has uplink user data pending for one or more PDU sessions when it builds a REGISTRATION REQUEST or SERVICE REQUEST message for the access attempt, the UE shall indicate the respective PDU sessions in the Uplink data status IE as specified in subclause 5.5.1.3.2 and 5.6.1.2, regardless of the access category for which the access barring check is performed.

NOTE 2: The UE indicates pending user data for all the respective PDU sessions, even if barring timers are running for some of the corresponding access categories.

If the lower layers indicate that the access attempt is allowed, the NAS shall take the following action depending on the event which triggered the access attempt:

- a) if the event which triggered the access attempt was an MO-MMTTEL-voice-call-started indication, an MO-MMTTEL-video-call-started indication, an MO-SMSoIP-attempt-started indication, or an MO-IMS-registration-related-signalling-started indication, the NAS shall notify the upper layers that the access attempt is allowed;
- b) if the event which triggered the access attempt was a request from upper layers to send a mobile originated SMS over NAS, 5GMM shall initiate the NAS transport procedure as specified in subclause 5.4.5 to send the SMS in an UL NAS TRANSPORT message;
- c) if the event which triggered the access attempt was a request from upper layers to establish a new PDU session, 5GMM shall initiate the NAS transport procedure as specified in subclause 5.4.5 to send the PDU SESSION ESTABLISHMENT REQUEST message;
- d) if the event which triggered the access attempt was a request from upper layers to modify an existing PDU session, 5GMM shall initiate the NAS transport procedure as specified in subclause 5.4.5 to send the PDU SESSION MODIFICATION REQUEST message;

- e) if the event which triggered the access attempt was a request to re-establish the user-plane resources for an existing PDU session, 5GMM shall initiate the service request procedure as specified in subclause 5.6.1;
- f) if the event which triggered the access attempt was an uplink user data packet to be sent for a PDU session with suspended user-plane resources, 5GMM shall consider that the uplink user data packet is allowed to be sent;
- g) if the event which triggered the access attempt was a request from upper layers to send a mobile originated location request, 5GMM shall initiate the NAS transport procedure as specified in subclause 5.4.5 to send an LCS message in an UL NAS TRANSPORT message; and
- h) if the event which triggered the access attempt was a request from upper layers to send a mobile originated signalling transaction towards the PCF by sending an UL NAS TRANSPORT message including a UE policy container (see 3GPP TS 24.587 [19B] and 3GPP TS 24.554 [19E]), 5GMM shall initiate the NAS transport procedure as specified in subclause 5.4.5 to send the signalling transaction via an UL NAS TRANSPORT message.

If the lower layers indicate that the access attempt is barred, the NAS shall take the following action depending on the event which triggered the access attempt:

- a) if the event which triggered the access attempt was an MO-MMTEL-voice-call-started indication, an MO-MMTEL-video-call-started indication or an MO-SMSoIP-attempt-started indication, or an MO-IMS-registration-related-signalling-started indication:
 - 1) if the UE is operating in the dual-registration mode, the UE may proceed in S1 mode with the appropriate EMM specific procedures and ESM procedures to make a PDN connection providing access to IMS available; see subclause 4.8.3 and 3GPP TS 24.301 [15];
 - 2) otherwise, the NAS shall notify the upper layers that the access attempt is barred. In this case, upon receiving an indication from the lower layers that the barring is alleviated for the access category with which the access attempt was associated, the NAS shall notify the upper layers that the barring is alleviated for the access category;

NOTE 3: In this case prohibiting the initiation of the MMTEL voice session, MMTEL video session or prohibiting sending of the SMS over IP or the IMS registration related signalling is performed by the upper layers.

- b) if the event which triggered the access attempt was a request from upper layers to send a mobile originated SMS over NAS, 5GMM shall not initiate the NAS transport procedure as specified in subclause 5.4.5 to send the SMS in an UL NAS TRANSPORT message. Upon receiving an indication from the lower layers that the barring is alleviated for the access category with which the access attempt was associated, 5GMM may initiate the NAS transport procedure as specified in subclause 5.4.5 to send the SMS in an UL NAS TRANSPORT message, if still needed;
- c) if the event which triggered the access attempt was a request from upper layers to establish a new PDU session, 5GMM shall not initiate the NAS transport procedure to send the PDU SESSION ESTABLISHMENT REQUEST message. Upon receiving an indication from the lower layers that the barring is alleviated for the access category with which the access attempt was associated, the NAS may initiate the NAS transport procedure as specified in subclause 5.4.5, if still needed;
- d) if the event which triggered the access attempt was a request from upper layers to modify an existing PDU session modification, 5GMM shall not initiate the NAS transport procedure to send the PDU SESSION MODIFICATION REQUEST message. Upon receiving an indication from the lower layers that the barring is alleviated for the access category with which the access attempt was associated, the NAS may initiate the NAS transport procedure as specified in subclause 5.4.5, if still needed;
- e) if the event which triggered the access attempt was a request to re-establish the user-plane resources for an existing PDU session, the NAS shall not initiate the service request procedure as specified in subclause 5.6.1. Upon receiving an indication from the lower layers that the barring is alleviated for the access category with which the access attempt was associated, the NAS may initiate the service request procedure as specified in subclause 5.6.1, if still needed;
- f) if the event which triggered the access attempt was an uplink user data packet to be sent for a PDU session with suspended user-plane resources, 5GMM shall consider that the uplink user data packet is not allowed to be sent. Upon receiving an indication from the lower layers that the barring is alleviated for the access category with

which the access attempt was associated, the NAS shall consider that the barring is alleviated for the access category;

- g) if the event which triggered the access attempt was a request from upper layers to send a mobile originated location request, 5GMM shall not initiate the NAS transport procedure as specified in subclause 5.4.5 to send an LCS message in an UL NAS TRANSPORT message. Upon receiving an indication from the lower layers that the barring is alleviated for the access category with which the access attempt was associated, 5GMM may initiate the NAS transport procedure as specified in subclause 5.4.5 to send the LCS message in an UL NAS TRANSPORT message, if still needed; and
- h) if the event which triggered the access attempt was a request from upper layers to send a mobile originated signalling transaction towards the PCF by sending an UL NAS TRANSPORT message including a UE policy container (see 3GPP TS 24.587 [19B] and 3GPP TS 24.554 [19E]), 5GMM shall not initiate the NAS transport procedure as specified in subclause 5.4.5 to send the mobile originated signalling transaction via an UL NAS TRANSPORT message. Upon receiving an indication from the lower layers that the barring is alleviated for the access category with which the access attempt was associated, 5GMM may initiate the NAS transport procedure as specified in subclause 5.4.5 to send the mobile originated signalling transaction via an UL NAS TRANSPORT message, if still needed.

4.5.5 Exception handling and avoiding double barring

Access attempts are allowed to proceed without further access control checking in order to avoid double barring for any service request or registration procedure initiated for the purpose of NAS signalling connection recovery or following a fallback indication from the lower layers (see subclauses 5.3.1.2 and 5.3.1.4).

NOTE 1: The case of NAS signalling connection recovery also includes the cases where the UE was in S1 mode when the RRC connection failure occurred.

For any service request or registration procedure of this kind the UE determines an access category as specified in subclause 4.5.1 and 4.5.2 or 4.5.2A, unless a different access category is specified in the rest of the present subclause.

NOTE 2: Although the access control checking is skipped, the access category is determined for the specific access attempt in order to derive an RRC establishment cause.

There are several services or an MO IMS registration related signalling for which the NAS needs to be informed when the service starts and stops,

- because, while the service is ongoing or the MO IMS registration related signalling is ongoing, the mapping of other access attempts to a specific access category can be affected; and
- in order to avoid double barring at the start of these services or at the start of the MO IMS registration related signalling.

These services are:

- a) emergency service;
- b) MMTEL voice;
- c) MMTEL video;
- d) SMSoIP;
- e) SMS over NAS;
- f) 5GC-MO-LR procedure;
- g) UE-requested policy provisioning procedure for V2XP, ProSeP or both; and
- h) CIoT user data transfer over the control plane.

The UE considers an emergency service a) as started when 5GMM receives a request from upper layers to register for emergency services or to establish a PDU session with request type = "initial emergency request" or "existing emergency PDU session". It considers the emergency service as stopped when this PDU session is released.

In addition, the UE considers an emergency service a) as started when the 5GMM receives a request from the upper layers to perform emergency services fallback and performs emergency services fallback as specified in subclause 4.13.4.2 of 3GPP TS 23.502 [9]. In this case, the UE considers the emergency service as stopped when:

- the emergency PDU session established during the emergency services fallback is released if the UE has moved to an E-UTRA cell connected to 5GCN; or
- the service request procedure involved in the emergency services fallback is completed otherwise.

While an emergency service a) is ongoing, any access attempt triggered by the initiation of a registration, de-registration or service request procedure or by an uplink user data packet to be sent for an emergency PDU session with suspended user-plane resources is mapped to access category 2 = emergency.

Once the emergency service has successfully passed access control, then as long as the service is ongoing, the following access attempts are allowed to proceed without further access control checking in order to avoid double barring:

- any service request procedure related to the PDU session associated with request type = "initial emergency request" or "existing emergency PDU session"; and
- any uplink user data packet to be sent for a PDU session with suspended user-plane resources associated with request type = "initial emergency request" or "existing emergency PDU session".

NOTE 3: Although the access control checking is skipped, the mapping is performed in order to derive an RRC establishment cause.

For services b) to h) the 5GMM receives explicit start and stop indications from the upper layers.

For the case of handover of ongoing services b) to d) from non-3GPP access, the 5GMM receives an additional explicit handover of ongoing service from non-3GPP access indication from the upper layers.

The 5GMM may receive an additional explicit "call-pull-initiated" indication from the upper layers (see 3GPP TS 24.174 [13D]).

Once the service has successfully passed access control, then as long as the service is ongoing, the following access attempts are allowed to proceed without further access control checking in order to avoid double barring:

- for services b), c) and d):
 - 1) any service request procedure related to the PDU session established for DNN = "IMS" except between receiving from the lower layers an indication that access barring is applicable for all access categories except categories 0 and 2, or access barring is applicable for all access categories except category 0, and receiving from the lower layers an indication that the barring is alleviated for the access category determined for the access attempt;
 - 2) any uplink user data packet to be sent for a PDU session with suspended user-plane resources established for DNN = "IMS" except between receiving from the lower layers an indication that access barring is applicable for all access categories except categories 0 and 2, or access barring is applicable for all access categories except category 0, and receiving from the lower layers an indication that the barring is alleviated for the access category determined for the access attempt; and
 - 3) any start of the MO IMS registration related signalling;
- for service d), if the upper layers have indicated a DNN used for SMSoIP and the indicated DNN used for SMSoIP is different from "IMS":
 - 1) any service request procedure related to the PDU session established for the DNN used for SMSoIP except between receiving from the lower layers an indication that access barring is applicable for all access categories except categories 0 and 2, or access barring is applicable for all access categories except category 0, and receiving from the lower layers an indication that the barring is alleviated for access category 6; and
 - 2) any uplink user data packet to be sent for a PDU session with suspended user-plane resources established for the DNN used for SMSoIP except between receiving from the lower layers an indication that access barring is applicable for all access categories except categories 0 and 2, or access barring is applicable for all access categories except category 0, and receiving from the lower layers an indication that the barring is alleviated for access category 6.

For the MO IMS registration related signalling, the 5GMM receives explicit start and stop indications from the upper layers.

Once the MO IMS registration related signalling has successfully passed access control, then as long as the MO IMS registration related signalling is ongoing, the following access attempts are allowed to proceed without further access control checking in order to avoid double barring:

- 1) any service request procedure related to the PDU session established for DNN = "IMS" and for the DNN used for SMSoIP, if the upper layers have indicated a DNN used for SMSoIP and the indicated DNN used for SMSoIP is different from "IMS", except between receiving from the lower layers an indication that access barring is applicable for all access categories except categories 0 and 2, or access barring is applicable for all access categories except category 0 and receiving from the lower layers an indication that the barring is alleviated for the access category determined for the access attempt; and
- 2) any uplink user data packet to be sent for a PDU session with suspended user-plane resources established for DNN = "IMS" and for the DNN used for SMSoIP except between receiving from the lower layers an indication that access barring is applicable for all access categories except categories 0 and 2, or access barring is applicable for all access categories except category 0 and receiving from the lower layers an indication that the barring is alleviated for the access category determined for the access attempt;

While an MMTEL voice call is ongoing:

- any service request procedure related to the PDU session established for DNN = "IMS" is mapped to access category 4;
- any uplink user data packet to be sent for a PDU session with suspended user-plane resources established for DNN = "IMS" is mapped to access category 4; and
- any:
 - 1) service request procedure; or
 - 2) registration procedure;initiated in 5GMM-IDLE mode or 5GMM-IDLE mode with suspend indication for the purpose of NAS signalling connection recovery or following a fallback indication from the lower layers (see subclause 5.3.1.2 and 5.3.1.4) is mapped to access category 4.

While an MMTEL video call is ongoing and no MMTEL voice call is ongoing:

- any service request procedure related to the PDU session established for DNN = "IMS" is mapped to access category 5;
- any uplink user data packet to be sent for a PDU session with suspended user-plane resources established for DNN = "IMS" is mapped to access category 5; and
- any:
 - 1) service request procedure; or
 - 2) registration procedure;initiated in 5GMM-IDLE mode or 5GMM-IDLE mode with suspend indication for the purpose of NAS signalling connection recovery or following a fallback indication from the lower layers (see subclause 5.3.1.2 and 5.3.1.4) is mapped to access category 5.

While an SMSoIP is ongoing, no MMTEL video call is ongoing and no MMTEL voice call is ongoing:

- any service request procedure related to the PDU session established:
 - 1) for DNN = "IMS"; or
 - 2) for the DNN used for SMSoIP, if the upper layers have indicated a DNN used for SMSoIP and the indicated DNN used for SMSoIP is different from "IMS";is mapped to access category 6; and

- any uplink user data packet to be sent for a PDU session with suspended user-plane resources established:
 - 1) for DNN = "IMS"; or
 - 2) for the DNN used for SMSoIP, if the upper layers have indicated a DNN used for SMSoIP and the indicated DNN used for SMSoIP is different from "IMS";is mapped to access category 6; and

- any:

- 1) service request procedure; or
- 2) registration procedure;

initiated in 5GMM-IDLE mode or 5GMM-IDLE mode with suspend indication for the purpose of NAS signalling connection recovery or following a fallback indication from the lower layers (see subclause 5.3.1.2 and 5.3.1.4) is mapped to access category 6.

While an SMS over NAS is ongoing, no SMSoIP is ongoing, no MMTEL video call is ongoing and no MMTEL voice call is ongoing:

- any:

- 1) service request procedure; or
- 2) registration procedure;

initiated in 5GMM-IDLE mode or 5GMM-IDLE mode with suspend indication for the purpose of NAS signalling connection recovery or following a fallback indication from the lower layers (see subclause 5.3.1.2 and 5.3.1.4) is mapped to access category 6.

While an MO IMS registration related signalling is ongoing, no SMSoIP is ongoing, no MMTEL video call is ongoing and no MMTEL voice call is ongoing:

- any service request procedure related to the PDU session established:

- 1) for DNN = "IMS"; and
- 2) for the DNN used for SMSoIP, if the upper layers have indicated a DNN used for SMSoIP and the indicated DNN used for SMSoIP is different from "IMS";

is mapped to access category 9; and

- any uplink user data packet to be sent for a PDU session with suspended user-plane resources established:

- 1) for DNN = "IMS"; and
- 2) for the DNN used for SMSoIP, if the upper layers have indicated a DNN used for SMSoIP and the indicated DNN used for SMSoIP is different from "IMS";

is mapped to access category 9; and

- if no SMS over NAS is ongoing, any:

- 1) service request procedure; or
- 2) registration procedure;

initiated in 5GMM-IDLE mode for the purpose of NAS signalling connection recovery or following a fallback indication from the lower layers (see subclause 5.3.1.2 and 5.3.1.4) is mapped to access category 9.

While a 5GC-MO-LR procedure is ongoing, no SMS over NAS is ongoing, no SMSoIP is ongoing, no MO IMS registration related signalling is ongoing, no MMTEL video call is ongoing, and no MMTEL voice call is ongoing:

- any:

- 1) service request procedure; or

- 2) registration procedure;

initiated in 5GMM-IDLE mode or 5GMM-IDLE mode with suspend indication for the purpose of NAS signalling connection recovery or following a fallback indication from the lower layers (see subclauses 5.3.1.2 and 5.3.1.4) is mapped to access category 3.

While a UE-requested policy provisioning procedure for V2XP, ProSeP or both (see 3GPP TS 24.587 [19B] and 3GPP TS 24.554 [19E]), no 5GC-MO-LR procedure is ongoing, no SMS over NAS is ongoing, no SMSoIP is ongoing, no MMTEL video call is ongoing, and no MMTEL voice call is ongoing:

- any:

- 1) service request procedure; or
- 2) registration procedure;

initiated in 5GMM-IDLE mode for the purpose of NAS signalling connection recovery or following a fallback indication from the lower layers (see subclauses 5.3.1.2 and 5.3.1.4) is mapped to access category 3.

While CIoT user data transfer over the control plane is ongoing, no 5GC-MO-LR procedure is ongoing, no SMS over NAS is ongoing, no SMSoIP is ongoing, no MMTEL video call is ongoing, and no MMTEL voice call is ongoing, any service request procedure initiated in 5GMM-IDLE mode following a fallback indication from the lower layers (see subclause 5.3.1.4) is mapped to access category 7.

NOTE 3: Although the access control checking is skipped, the mapping is performed in order to derive an RRC establishment cause.

If an access category is determined and the access control checking is skipped, the NAS shall determine the RRC establishment cause from one or more determined access identities and the access category as specified in subclause 4.5.6, the NAS shall initiate the procedure to send the initial NAS message for the access attempt and shall provide the RRC establishment cause to lower layers.

If the UE receives from the lower layers an indication that access barring is applicable for all access categories except categories 0 and 2, or access barring is applicable for all access categories except category 0:

- a) if an MMTEL voice call or MMTEL video call is ongoing:
 - 1) if the UE is operating in the single-registration mode and the UE's usage setting is "voice centric", the UE may attempt to select an E-UTRA cell connected to EPC. If the UE finds a suitable E-UTRA cell connected to EPC, it then proceeds with the appropriate EMM specific procedures and, if necessary, ESM procedures to make a PDN connection providing access to IMS available; see subclause 4.8.2 and 3GPP TS 24.301 [15]; and
 - 2) if the UE is operating in the dual-registration mode, the UE may proceed in S1 mode with the appropriate EMM specific procedures and ESM procedures to make a PDN connection providing access to IMS available; see subclause 4.8.3 and 3GPP TS 24.301 [15]; and
- b) if SMSoIP is ongoing or an MO IMS registration related signalling is ongoing:
 - 1) if the UE is operating in the single-registration mode, the UE may attempt to select an E-UTRA cell connected to EPC. If the UE finds a suitable E-UTRA cell connected to EPC, it then proceeds with the appropriate EMM specific procedures and, if necessary, ESM procedures to make a PDN connection providing access to IMS available; see subclause 4.8.2 and 3GPP TS 24.301 [15]; and
 - 2) if the UE is operating in the dual-registration mode, the UE may proceed in S1 mode with the appropriate EMM specific procedures and ESM procedures to make a PDN connection providing access to IMS available; see subclause 4.8.3 and 3GPP TS 24.301 [15].

4.5.6 Mapping between access categories/access identities and RRC establishment cause

When 5GMM requests the establishment of a NAS-signalling connection, the RRC establishment cause used by the UE shall be selected according to one or more access identities (see subclauses 4.5.2 and 4.5.2A) and the determined access category by checking the rules specified in table 4.5.6.1 and table 4.5.6.2. If the access attempt matches more than one

rule, the RRC establishment cause of the lowest rule number shall be used. If the determined access category is an operator-defined access category, then the RRC establishment cause used by the UE shall be selected according to table 4.5.6.1 and table 4.5.6.2 based on one or more access identities (see subclauses 4.5.2 and 4.5.2A) and the standardized access category determined for the operator-defined access category as described in subclause 4.5.3.

NOTE 1: Following an RRC release with redirection, the lower layers can set the RRC establishment cause or the resume cause to "mps-PriorityAccess" in the case of redirection to an NR cell connected to 5GCN (see 3GPP TS 38.331 [30]) or to "highPriorityAccess" in the case of redirection to an E-UTRA cell connected to 5GCN (see 3GPP TS 36.331 [25A]), if the network indicates to the UE during RRC connection release with redirection that the UE has an active MPS session.

NOTE 2: When the UE is acting as a 5G ProSe layer-2 UE-to-network relay UE, it is possible for the lower layer to decide an applicable RRC establishment cause according to the request from the 5G ProSe layer-2 remote UE or according to the indication from upper layers, including the case when the request from the 5G ProSe layer-2 remote UE is for emergency services, as specified in 3GPP TS 38.331 [30].

Table 4.5.6.1: Mapping table for access identities/access categories and RRC establishment cause when establishing N1 NAS signalling connection via NR connected to 5GCN

Rule #	Access identities	Access categories	RRC establishment cause is set to
1	1	Any category	mps-PriorityAccess
2	2	Any category	mcs-PriorityAccess
3	11, 15	Any category	highPriorityAccess
4	12,13,14,	Any category	highPriorityAccess
5	0	0 (= MT_acc)	mt-Access
		1 (= delay tolerant)	Not applicable (NOTE 1)
		2 (= emergency)	emergency
		3 (= MO_sig)	mo-Signalling
		4 (= MO MMTel voice)	mo-VoiceCall
		5 (= MO MMTel video)	mo-VideoCall
		6 (= MO SMS and SMSoIP)	mo-SMS
		7 (= MO_data)	mo-Data
		9 (= MO IMS registration related signalling)	mo-Data
NOTE 1: A UE using access category 1 for the access barring check will determine a second access category in the range 3 to 7 that is to be used for determination of the RRC establishment cause. See subclause 4.5.2, table 4.5.2.2, NOTE 6.			
NOTE 2: See subclause 4.5.2, table 4.5.2.1 for use of the access identities of 0, 1, 2, and 11-15.			

Table 4.5.6.2: Mapping table for access identities/access categories and RRC establishment cause when establishing N1 NAS signalling connection via E-UTRA connected to 5GCN

Rule #	Access identities	Access categories	RRC establishment cause is set to
1	1	Any category	highPriorityAccess
2	2	Any category	highPriorityAccess
3	11, 15	Any category	highPriorityAccess
4	12,13,14,	Any category	highPriorityAccess
5	0	0 (= MT_acc)	mt-Access
		1 (= delay tolerant)	Not applicable (NOTE 1)
		2 (= emergency)	emergency
		3 (= MO_sig)	mo-Signalling
		4 (= MO MMTel voice)	mo-VoiceCall
		5 (= MO MMTel video)	mo-VoiceCall
		6 (= MO SMS and SMSoIP)	mo-Data
		7 (= MO_data)	mo-Data
		9 (= MO IMS registration related signalling)	mo-Data
		10 (= MO exception data)	mo-ExceptionData (NOTE 3)
NOTE 1: A UE using access category 1 for the access barring check will determine a second access category in the range 3 to 7 that is to be used for determination of the RRC establishment cause. See subclause 4.5.2, table 4.5.2.2, NOTE 6.			
NOTE 2: See subclause 4.5.2, table 4.5.2.1 for use of the access identities of 0, 1, 2, and 11-15.			
NOTE 3: This applies to the UE in NB-N1 mode.			

4.6 Network slicing

4.6.1 General

The 5GS supports network slicing as described in 3GPP TS 23.501 [8]. Within a PLMN or SNPN, a network slice is identified by an S-NSSAI, which is comprised of a slice/service type (SST) and a slice differentiator (SD). Inclusion of an SD in an S-NSSAI is optional. A set of one or more S-NSSAIs is called the NSSAI. The following S-NSSAIs and NSSAIs are defined in 3GPP TS 23.501 [8]:

- a) configured NSSAI;
- b) requested NSSAI;
- c) allowed NSSAI;
- d) subscribed S-NSSAIs;
- e) pending NSSAI;
- f) alternative S-NSSAIs; and
- g) partially allowed NSSAI.

The following S-NSSAIs and NSSAIs are defined in the present document:

- a) rejected NSSAI for the current PLMN or SNPN;
- b) rejected NSSAI for the current registration area;
- c) rejected NSSAI for the failed or revoked NSSAA;
- d) rejected NSSAI for the maximum number of UEs reached;
- e) alternative NSSAI;
- f) partially rejected NSSAI;

- g) on-demand S-NSSAIs; and
- h) on-demand NSSAI.

In roaming scenarios, rejected NSSAI for the current PLMN or SNPN, rejected NSSAI for the current registration area, rejected NSSAI for the maximum number of UEs reached, or partially rejected NSSAI includes one or more S-NSSAIs for the current PLMN and also contains a set of mapped S-NSSAI(s). An S-NSSAI included in the rejected NSSAI for the failed or revoked NSSAA is an HPLMN S-NSSAI.

In case of a PLMN, a serving PLMN may configure a UE with:

- a) the configured NSSAI per PLMN;
- b) NSSRG information if the UE has indicated that it supports the subscription-based restrictions to simultaneous registration of network slices feature;
- c) on-demand NSSAI if the UE has indicated it supports the network slice usage control feature;
- d) S-NSSAI time validity information if the UE has indicated that it supports S-NSSAI time validity information; and
- e) S-NSSAI location validity information if the UE has indicated that it supports S-NSSAI location validity information.

In addition, the HPLMN may configure a UE with a single default configured NSSAI and consider the default configured NSSAI as valid in a PLMN for which the UE has neither a configured NSSAI nor an allowed NSSAI. The support for NSSRG information by the UE and the network, respectively, is optional.

NOTE 0: In this version of the specification, the network slice usage control feature is not supported in roaming scenarios.

NOTE 1: The value(s) used in the default configured NSSAI are expected to be commonly decided by all roaming partners, e.g., values standardized by 3GPP or other bodies.

In case of an SNPN, the SNPN may configure a UE which is neither registering nor registered for onboarding services in SNPN with:

- a) a configured NSSAI applicable to the SNPN;
- b) NSSRG information if the UE has indicated that it supports the subscription-based restrictions to simultaneous registration of network slices feature;
- c) S-NSSAI time validity information if the UE has indicated that it supports S-NSSAI time validity information;
- d) on-demand NSSAI if the UE has indicated it supports the network slice usage control feature; and
- e) S-NSSAI location validity information if the UE has indicated that it supports S-NSSAI location validity information.

In addition, the credential holder may configure a single default configured NSSAI associated with the selected entry of the "list of subscriber data" or the PLMN subscription and consider the default configured NSSAI as valid in a SNPN for which the UE has neither a configured NSSAI nor an allowed NSSAI. If the UE is registering or registered for onboarding services in SNPN, the serving SNPN shall not provide a configured NSSAI to the UE. The support for NSSRG information by the UE and the network, respectively, is optional.

The allowed NSSAI and the rejected NSSAI for the current registration area are managed per access type independently, i.e. 3GPP access or non-3GPP access, and is applicable for the registration area. If the UE does not have a valid registration area, the rejected NSSAI for the current registration area is applicable to the tracking area on which it was received. If the registration area contains TAIs belonging to different PLMNs, which are equivalent PLMNs, the allowed NSSAI, the rejected NSSAI for the current registration area, rejected NSSAI for the failed or revoked NSSAA and rejected NSSAI for the maximum number of UEs reached are applicable to these PLMNs in this registration area.

The allowed NSSAI that is associated with a registration area containing TAIs belonging to different PLMNs, which are equivalent PLMNs, can be used to form the requested NSSAI for any of the equivalent PLMNs when the UE is outside of the registration area where the allowed NSSAI was received.

When the network slice-specific authentication and authorization procedure is to be initiated for one or more S-NSSAIs in the requested NSSAI or the network slice-specific authentication and authorization procedure is ongoing for one or more S-NSSAIs, these S-NSSAI(s) will be included in the pending NSSAI. When the network slice-specific authentication and authorization procedure is completed for an NSSAI that has been in the pending NSSAI, the S-NSSAI will be moved to the allowed NSSAI or rejected NSSAI depending on the outcome of the procedure. The AMF sends the updated allowed NSSAI to the UE over the same access of the requested S-NSSAI. The AMF sends the updated partially allowed NSSAI to the UE only over the 3GPP access. The AMF sends the updated rejected NSSAI over either 3GPP access or non-3GPP access. The pending NSSAI is managed regardless of access type i.e. the pending NSSAI is applicable to both 3GPP access and non-3GPP access for the current PLMN even if sent over only one of the accesses. If the registration area contains TAIs belonging to different PLMNs, which are equivalent PLMNs, the pending NSSAI is applicable to these PLMNs in this registration area.

The rejected NSSAI for the current PLMN or SNPN is applicable for the whole registered PLMN or SNPN regardless of the access type. The AMF shall only send a rejected NSSAI for the current PLMN when the registration area consists of TAIs that only belong to the registered PLMN. If the UE receives a rejected NSSAI for the current PLMN, and the registration area also contains TAIs belonging to different PLMNs, the UE shall treat the received rejected NSSAI for the current PLMN as applicable to the whole registered PLMN.

The rejected NSSAI for the failed or revoked NSSAA includes one or more S-NSSAIs that have failed the network slice-specific authentication and authorization or for which the authorization have been revoked, and are applicable for the whole registered PLMN or SNPN regardless of the access type.

The rejected NSSAI for the maximum number of UEs reached is applicable for the whole registered PLMN or SNPN, and the access type over which the rejected NSSAI was sent. The AMF shall send a rejected NSSAI including S-NSSAI(s) with the rejection cause "S-NSSAI not available due to maximum number of UEs reached", when one or more S-NSSAIs are indicated that the maximum number of UEs has been reached. If the timer T3526 associated with the S-NSSAI(s) was started upon reception of the rejected NSSAI for the maximum number of UEs reached, the UE may remove the S-NSSAI(s) from the rejected NSSAI including S-NSSAI(s) with the rejection cause "S-NSSAI not available due to maximum number of UEs reached", if the timer T3526 associated with the S-NSSAI(s) expires. If one or more S-NSSAIs are removed from the rejected NSSAI for the maximum number of UEs reached, the timer T3526 associated with the removed S-NSSAI(s) shall be stopped, if running. The UE shall not stop the timer T3526 if the UE selects an E-UTRA cell connected to EPC.

If the UE receives a rejected NSSAI for the maximum number of UEs reached, the registration area contains TAIs belonging to different PLMNs, which are equivalent PLMNs, the UE shall treat the received rejected NSSAI for the maximum number of UEs reached as applicable to these equivalent PLMNs when the UE is in this registration area.

If the UE has indicated that the UE supports network slice replacement feature and the AMF determines to provide the mapping information between the S-NSSAI to be replaced and the alternative S-NSSAI to the UE, the network shall provide the UE with the alternative NSSAI. The alternative NSSAI is managed per access type independently, i.e. 3GPP access or non-3GPP access, and is applicable for the registration area.

If the UE has indicated that the UE supports the partial network slice feature and includes the S-NSSAI(s) in the requested NSSAI, the AMF determines the S-NSSAI(s) to be included in the partially allowed NSSAI or the partially rejected NSSAI as specified in subclause 4.6.2.11. When the AMF provides both the partially allowed NSSAI and the partially rejected NSSAI to the UE, each S-NSSAI shall be either in the partially allowed NSSAI or in the partially rejected NSSAI but not both. The number of S-NSSAIs included in the partially allowed NSSAI or the partially rejected NSSAI shall not exceed 7. The sum of the number of S-NSSAI(s) stored in the partially allowed NSSAI and the allowed NSSAI shall not exceed 8. The partially allowed NSSAI is only applicable to 3GPP access and is applicable for the registration area. The partially rejected NSSAI is only applicable to 3GPP access and is applicable for the registration area.

NOTE 2: Based on local policies, the UE can remove an S-NSSAI from the rejected NSSAI for the failed or revoked NSSAA when the UE wants to register to the slice identified by this S-NSSAI.

NOTE 3: Based on network local policy, network slice-specific authentication and authorization procedure can be initiated by the AMF for an S-NSSAI in rejected NSSAI for the failed or revoked NSSAA when the S-NSSAI is requested by the UE based on its local policy.

NOTE 4: At least one S-NSSAI in the default configured NSSAI or at least one default S-NSSAI is recommended as not subject to network slice-specific authentication and authorization, in order to ensure that at least one PDU session can be established to access service, even when Network Slice-specific Authentication and Authorization fails.

NOTE 5: At least one S-NSSAI in the default configured NSSAI or at least one default S-NSSAI is recommended as not subject to network slice admission control, in order to ensure that at least one PDU session can be established to access service.

NOTE 6: The rejected NSSAI can be provided by the network via either Rejected NSSAI IE or the Extended rejected NSSAI IE.

4.6.2 Mobility management aspects

4.6.2.1 General

Upon registration to a PLMN or SNPN (except for the registration procedure for periodic registration update, the initial registration for onboarding services in SNPN, and the registration procedure for mobility registration update when registered for onboarding services in SNPN), the UE shall send to the AMF the requested NSSAI which includes one or more S-NSSAIs of the allowed NSSAI for the PLMN or SNPN or the configured NSSAI for the PLMN or SNPN and corresponds to the network slice(s) to which the UE intends to register with, if:

- a) the UE has a configured NSSAI for the current PLMN or SNPN;
- b) the UE has an allowed NSSAI for the current PLMN or SNPN; or
- c) the UE has neither allowed NSSAI for the current PLMN or SNPN nor configured NSSAI for the current PLMN or SNPN and has a default configured NSSAI. In this case the UE indicates to the AMF that the requested NSSAI is created from the default configured NSSAI.

In roaming scenarios, if the mapped S-NSSAI(s) associated to the allowed NSSAI or the configured NSSAI are missing, the UE shall locally set the mapped S-NSSAI to the same value as the received S-NSSAI. Additionally, if the UE receives a Rejected NSSAI IE or an Extended rejected NSSAI IE without associated mapped S-NSSAI(s), and the rejected NSSAI is different from the rejected NSSAI for the failed or revoked NSSAI, the UE shall locally set the mapped S-NSSAI(s) to the same value as the received S-NSSAI.

NOTE 1: The above occurs only when the UE is roaming and the AMF compliant with earlier versions of the specification omits providing to the UE a mapped S-NSSAI for one or more S-NSSAIs in, e.g., the allowed NSSAI or configured NSSAI.

Other than S-NSSAIs contained in the NSSAIs described above, the requested NSSAI can be formed based on the S-NSSAI(s) available in the UE (see subclause 5.5.1.3.2 for further details). In roaming scenarios, the UE shall also provide the mapped S-NSSAI(s) for the requested NSSAI.

NOTE 2: If the UE did not receive a mapped S-NSSAI for one or more S-NSSAIs in the allowed NSSAI or configured NSSAI, the UE still uses the S-NSSAI as received from the serving network (i.e., without the locally set mapped S-NSSAI) in any NAS message.

The AMF verifies if the requested NSSAI is permitted based on the subscribed S-NSSAIs in the UE subscription and, in roaming scenarios the mapped S-NSSAI(s) provided by the UE, and if so then the AMF shall provide the UE with the allowed NSSAI for the PLMN or SNPN, and shall also provide the UE with the mapped S-NSSAI(s) for the allowed NSSAI for the PLMN or SNPN. Additionally, if the AMF allows one or more subscribed S-NSSAIs for the UE, the AMF may include the allowed subscribed S-NSSAI(s) in the allowed NSSAI in the REGISTRATION ACCEPT message. The AMF shall ensure that there are not two or more S-NSSAIs of the allowed NSSAI which are mapped to the same S-NSSAI of the HPLMN or the subscribed SNPN. If

- a) all the S-NSSAIs included in the requested NSSAI are rejected, or the requested NSSAI was not included by the UE;
- b) all default S-NSSAIs are not allowed; and
- c) the UE is neither registering nor registered for onboarding services in SNPN and the UE is neither registering nor registered for emergency services;

then the AMF may reject the registration request (see subclauses 5.5.1.2.5 and 5.5.1.3.5 for further details).

In roaming scenarios, if the mapped S-NSSAI(s) associated to requested NSSAI are missing, the AMF shall locally set the mapped S-NSSAI to the same value as the received S-NSSAI.

NOTE 3: In roaming scenarios, when the UE is compliant with earlier versions of the specification or when the serving network does not provide a mapped S-NSSAI for one or more S-NSSAIs in the allowed NSSAI or configured NSSAI, the UE can omit a mapped S-NSSAI for one or more S-NSSAIs in requested NSSAI.

The set of network slice(s) for a UE can be changed at any time while the UE is registered to a PLMN or SNPN, and the change may be initiated by the network or the UE. In this case, the allowed NSSAI and associated registration area may be changed during the registration procedure or the generic UE configuration update procedure. The configured NSSAI and the rejected NSSAI may be changed during the registration procedure or the generic UE configuration update procedure. The default configured NSSAI may be changed by sending a UE parameters update transparent container to the UE during the NAS transport procedure. The pending NSSAI may be changed during the registration procedure. In addition, using the generic UE configuration update procedure, the network may trigger the registration procedure in order to update the allowed NSSAI.

The UE in NB-N1 mode does not include the requested NSSAI during the registration procedure if the 5GS registration type IE indicates "mobility registration updating", procedure is not initiated to change the slice(s) that the UE is currently registered to, and the UE is still in the current registration area.

The AMF does not include the allowed NSSAI during a registration procedure with the 5GS registration type IE indicating "mobility registration updating" for the UE in NB-N1 mode, except if the allowed NSSAI has changed for the UE.

The UE does not include the requested NSSAI during the registration procedure if the 5GS registration type IE indicates "SNPN onboarding registration" or the UE is registered for onboarding services in SNPN. The AMF does not include the allowed NSSAI during a registration procedure with the 5GS registration type IE indicating "SNPN onboarding registration" or during a registration procedure when the UE is registered for onboarding services in SNPN.

The UE considers the last received allowed NSSAI as valid until the UE receives a new allowed NSSAI.

4.6.2.2 NSSAI storage

If available, the configured NSSAI(s) shall be stored in a non-volatile memory in the ME as specified in annex C. For a configured NSSAI, if there is:

- a) associated NSSRG information, the NSSRG information shall also be stored in a non-volatile memory in the ME as specified in annex C;
- b) associated NSAG information, the NSAG information shall be stored in the ME;
- c) associated S-NSSAI time validity information, the S-NSSAI time validity information shall also be stored in a non-volatile memory in the ME as specified in annex C;
- d) associated S-NSSAI location validity information, the S-NSSAI location validity information shall also be stored in a non-volatile memory in the ME as specified in annex C; and
- e) associated on-demand NSSAI, the on-demand NSSAI shall also be stored in a non-volatile memory in the ME as specified in annex C.

Each of the configured NSSAI stored in the UE, including the default configured NSSAI, is a set composed of at most 16 S-NSSAIs. Each of the configured NSSAI, except the default configured NSSAI, is associated with a PLMN identity or SNPN identity and, if the UE supports access to an SNPN using credentials from a credentials holder, equivalent SNPNS or both, the selected entry of the "list of subscriber data" or the selected PLMN subscription.

The allowed NSSAI(s) should be stored in a non-volatile memory in the ME as specified in annex C. The partially allowed NSSAI(s) should be stored in a non-volatile memory in the ME as specified in annex C. For an allowed NSSAI, if there is associated alternative NSSAI, the alternative NSSAI should also be stored in a non-volatile memory in the ME as specified in annex C.

Each of the allowed NSSAI stored in the UE is a set composed of at most 8 S-NSSAIs and is associated with a PLMN identity or SNPN identity, an access type and, if the UE supports access to an SNPN using credentials from a credentials holder, equivalent SNPNS or both, the selected entry of the "list of subscriber data" or the selected PLMN subscription. Each of the alternative NSSAI stored in the UE is a set composed of at most 8 pairs of S-NSSAI to be replaced and alternative S-NSSAI, and is associated with a PLMN identity or SNPN identity, an access type and, if the UE supports access to an SNPN using credentials from a credentials holder, equivalent SNPNS or both, the selected

entry of the "list of subscriber data" or the selected PLMN subscription. Each of the partially allowed NSSAI stored in the UE is a set composed of at most 7 S-NSSAIs and a list of TAs for which S-NSSAI is supported, and is associated with a PLMN identity or SNPN identity, 3GPP access type and, if the UE supports access to an SNPN using credentials from a credentials holder, equivalent SNPNS or both, the selected entry of the "list of subscriber data" or the selected PLMN subscription. The sum of number of S-NSSAI(s) stored in the partially allowed NSSAI and the allowed NSSAI shall not exceed 8.

Each of the pending NSSAI stored in the UE is a set composed of at most 16 S-NSSAIs and is associated with a PLMN identity or SNPN identity and, if the UE supports access to an SNPN using credentials from a credentials holder, equivalent SNPNS or both, the selected entry of the "list of subscriber data" or the selected PLMN subscription.

Each of the rejected NSSAI is associated with a PLMN identity or SNPN identity and, if the UE supports access to an SNPN using credentials from a credentials holder, equivalent SNPNS or both, the selected entry of the "list of subscriber data" or the selected PLMN subscription. The S-NSSAI(s) in the rejected NSSAI for the current registration area are further associated with one or more tracking areas where the rejected S-NSSAI(s) is not available. The S-NSSAI(s) in the rejected NSSAI for the maximum number of UEs reached are further associated with the access type over which the rejected NSSAI was received. The S-NSSAI(s) in the partially rejected NSSAI are further associated with 3GPP access.

There shall be no duplicated PLMN identities or SNPN identities associated with each of the list of configured NSSAI(s), pending NSSAI(s), rejected NSSAI(s) for the current PLMN or SNPN, rejected NSSAI(s) for the current registration area, rejected NSSAI(s) for the failed or revoked NSSAI, and rejected NSSAI for the maximum number of UEs reached.

The UE stores NSSAIs as follows:

- a) The configured NSSAI shall be stored until a new configured NSSAI is received for a given PLMN or SNPN. The network may provide to the UE the mapped S-NSSAI(s) for the new configured NSSAI which shall also be stored in the UE. When the UE is provisioned with a new configured NSSAI for a PLMN or SNPN, the UE shall:
 - 1) replace any stored configured NSSAI for this PLMN or SNPN with the new configured NSSAI for this PLMN or SNPN;
 - 2) delete any stored mapped S-NSSAI(s) for the configured NSSAI and, if available, store the mapped S-NSSAI(s) for the new configured NSSAI;
 - 3) delete any stored allowed NSSAI and partially allowed NSSAI for this PLMN or SNPN and, if available, the stored mapped S-NSSAI(s) for the allowed NSSAI, if the UE received the new configured NSSAI for this PLMN or SNPN and the Configuration update indication IE with the Registration requested bit set to "registration requested", in the same CONFIGURATION UPDATE COMMAND message but without any new allowed NSSAI for this PLMN or SNPN included;
 - 4) delete any stored rejected NSSAI and partially rejected NSSAI, and stop any timer T3526 associated with a deleted S-NSSAI in the rejected NSSAI for the maximum number of UEs reached if running;
- 4A) delete any stored mapped S-NSSAI(s) for the rejected NSSAI; and
- 5) delete any S-NSSAI(s) stored in the pending NSSAI that are not included in the new configured NSSAI for the current PLMN or SNPN or any mapped S-NSSAI(s), if any, stored in the pending NSSAI that are not included in the mapped S-NSSAI(s) for the configured NSSAI (if the UE is roaming or is in a non-subscribed SNPN);

If the UE having a stored configured NSSAI for a PLMN ID, receives an S-NSSAI associated with a PLMN ID from the network during the PDN connection establishment procedure in EPS as specified in 3GPP TS 24.301 [15] or via ePDG as specified in 3GPP TS 24.302 [16], the UE may store the received S-NSSAI in the configured NSSAI for the PLMN identified by the PLMN ID associated with the S-NSSAI, if not already included in the configured NSSAI and if the number of S-NSSAIs in the configured NSSAI is less than 16;

The UE may continue storing a received configured NSSAI for a PLMN and associated mapped S-NSSAI(s), if available, when the UE registers in another PLMN.

NOTE 1: The maximum number of configured NSSAIs and associated mapped S-NSSAIs for PLMNs other than the HPLMN that need to be stored in the UE, and how to handle the stored entries, are up to UE implementation.

aa) The NSAG information shall be stored until:

- 1) a new NSAG information for the registered PLMN or the registered SNPN is received over 3GPP access; or
- 2) a new configured NSSAI without any associated NSAG information for the registered PLMN or the registered SNPN is received over 3GPP access.

The UE shall remove any S-NSSAI from the NSAG information which is not part of the configured NSSAI, if any.

NOTE 1A: If the UE is roaming or the current SNPN is a non-subscribed SNPN, the UE uses the S-NSSAI(s) in the configured NSSAI to compare against any S-NSSAI from the NSAG information.

When a new NSAG information for the registered PLMN or the registered SNPN is received over 3GPP access, the UE shall replace any stored NSAG information for the registered PLMN and its equivalent PLMN(s) or the registered SNPN and its equivalent SNPN(s) with the new NSAG information for the registered PLMN or the registered SNPN.

When a new configured NSSAI without any associated NSAG information for the registered PLMN or the registered SNPN is received over 3GPP access, the UE shall delete any stored NSAG information for the registered PLMN and its equivalent PLMN(s) or the registered SNPN and its equivalent SNPN(s).

The UE shall be able to store 32 NSAG entries in the NSAG information stored for the registered PLMN or the registered SNPN.

The UE shall be able to store TAI lists for up to 4 NSAG entries in the NSAG information stored for the registered PLMN or the registered SNPN.

The UE needs not to store the NSAG information when the UE is switched off or when the UE is deregistered from the registered PLMN or the registered SNPN.

NOTE 1B: The UE stores the NSAG information associated with the configured NSSAI for at least the registered PLMN and its equivalent PLMN(s) or the registered SNPN and its equivalent PLMN(s).

b) The allowed NSSAI shall be stored and the mapped S-NSSAI(s) for the allowed NSSAI (if available) shall be stored for a given PLMN and its equivalent PLMN(s) in the registration area or SNPN until:

- 1) a new allowed NSSAI for the same access type (i.e. 3GPP access or non-3GPP access) is received for a given PLMN or SNPN;
- 2) the CONFIGURATION UPDATE COMMAND message with the Registration requested bit of the Configuration update indication IE set to "registration requested" is received and contains no other parameters (see subclauses 5.4.4.2 and 5.4.4.3);
- 3) the REGISTRATION ACCEPT message is received with the "NSSAA to be performed" indicator of the 5GS registration result IE set to "Network slice-specific authentication and authorization is to be performed", and the REGISTRATION ACCEPT message contains a pending NSSAI and no new allowed NSSAI as described in subclause 5.5.1.2.4 and subclause 5.5.1.3.4; or
- 4) a new partially allowed NSSAI via 3GPP access is received for a given PLMN or SNPN.

b1) The UE shall delete the stored partially allowed NSSAI and stored mapped S-NSSAI(s) for partially allowed NSSAI over 3GPP access when:

- 1) new partially allowed NSSAI for a PLMN or SNPN is received and the new partially allowed NSSAI does not include any S-NSSAI(s);
- 2) the CONFIGURATION UPDATE COMMAND message with the Registration requested bit of the Configuration update indication IE set to "registration requested" is received and contains no other parameters (see subclauses 5.4.4.2 and 5.4.4.3); or
- 3) the REGISTRATION ACCEPT message is received with the "NSSAA to be performed" indicator of the 5GS registration result IE set to "Network slice-specific authentication and authorization is to be performed", and the REGISTRATION ACCEPT message contains a pending NSSAI and no new partially allowed NSSAI.

The network may provide to the UE the mapped S-NSSAI(s) for the new allowed NSSAI (see subclauses 5.5.1.2 and 5.5.1.3) which shall also be stored in the UE. When a new allowed NSSAI for a PLMN or SNPN is received, the UE shall:

- 1) replace any stored allowed NSSAI for this PLMN and its equivalent PLMN(s) in the registration area or this SNPN for the same access type with the new allowed NSSAI for this PLMN or SNPN;
- 2) delete any stored mapped S-NSSAI(s) for the allowed NSSAI for this PLMN and its equivalent PLMN(s) in the registration area or this SNPN for the same access type and, if available, store the mapped S-NSSAI(s) for the new allowed NSSAI;
- 3) remove from the stored rejected NSSAI for the current PLMN or SNPN, the rejected NSSAI for the current registration area, rejected NSSAI for the maximum number of UEs reached and the partially rejected NSSAI, the S-NSSAI(s), if any, included in the new allowed NSSAI for the current PLMN or SNPN, unless the S-NSSAI in the rejected NSSAI or the partially rejected NSSAI is associated with one or more S-NSSAI(s) in the stored mapped rejected NSSAI or the stored mapped partially rejected NSSAI, and at least one of these mapped S-NSSAI(s) is not included in the mapped S-NSSAI(s) for the new allowed NSSAI, and stop any timer T3526 associated with a deleted S-NSSAI in the rejected NSSAI for the maximum number of UEs reached if running;
- 4) remove from the stored rejected NSSAI for the failed or revoked NSSAA, the S-NSSAI(s), if any, included in the new allowed NSSAI for the current PLMN (if the UE is not roaming) or the current SNPN (if the SNPN is the subscribed SNPN) or the mapped S-NSSAI(s) for the new allowed NSSAI for the current PLMN (if the UE is roaming) or the current SNPN (if the SNPN is a non-subscribed SNPN);
- 5) remove from the stored mapped S-NSSAI(s) for the rejected NSSAI for the current PLMN or SNPN, the stored mapped S-NSSAI(s) for the rejected NSSAI for the current registration area, the stored mapped S-NSSAI(s) for the partially rejected NSSAI and the mapped S-NSSAI(s) for the rejected NSSAI for the maximum number of UEs reached, the S-NSSAI(s), if any, included in the mapped S-NSSAI(s) for the new allowed NSSAI for the current PLMN (if the UE is roaming) or the current SNPN (if the SNPN is a non-subscribed SNPN), and stop any timer T3526 associated with a deleted S-NSSAI in the rejected NSSAI for the maximum number of UEs reached if running; and
- 6) remove from the stored pending NSSAI for this PLMN and its equivalent PLMN(s) in the registration area or this SNPN, one or more S-NSSAI(s), if any, included in the new allowed NSSAI for the current PLMN and these equivalent PLMN(s) (if the UE is not roaming) or the current SNPN (if the SNPN is the subscribed SNPN) or the mapped S-NSSAI(s) for the new allowed NSSAI for the current PLMN and these equivalent PLMN(s) (if the UE is roaming) or the current SNPN (if the SNPN is a non-subscribed SNPN).

NOTE 2: Whether the UE stores the allowed NSSAI and the mapped S-NSSAI(s) for the allowed NSSAI also when the UE is switched off is implementation specific.

The network may provide to the UE the partially allowed NSSAI. When a new partially allowed NSSAI for a PLMN or SNPN is received and the new partially allowed NSSAI includes one or more S-NSSAI(s), the UE shall:

- 1) replace any stored partially allowed NSSAI for this PLMN and its equivalent PLMN(s) in the registration area or this SNPN via the 3GPP access with the new partially allowed NSSAI for this PLMN or SNPN;
- 2) delete any stored mapped S-NSSAI(s) for the partially allowed NSSAI for this PLMN and its equivalent PLMN(s) in the registration area or this SNPN for the 3GPP access type and, if available, store the mapped S-NSSAI(s) for the new partially allowed NSSAI;
- 3) remove from the stored rejected NSSAI for the current PLMN or SNPN, the rejected NSSAI for the current registration area, rejected NSSAI for the maximum number of UEs reached and the partially rejected NSSAI, the S-NSSAI(s), if any, included in the new partially allowed NSSAI for the current PLMN or SNPN, unless the S-NSSAI in the rejected NSSAI or the partially rejected NSSAI is associated with one or more S-NSSAI(s) in the stored mapped rejected NSSAI or the stored mapped partially rejected NSSAI, and at least one of these mapped S-NSSAI(s) is not included in the mapped S-NSSAI(s) for the new partially allowed NSSAI, and stop any timer T3526 associated with a deleted S-NSSAI in the rejected NSSAI for the maximum number of UEs reached if running;
- 4) remove from the stored rejected NSSAI for the failed or revoked NSSAA, the S-NSSAI(s), if any, included in the new partially allowed NSSAI for the current PLMN (if the UE is not roaming) or the current SNPN (if

the SNPN is the subscribed SNPN) or the mapped S-NSSAI(s) for the new partially allowed NSSAI for the current PLMN (if the UE is roaming) or the current SNPN (if the SNPN is a non-subscribed SNPN);

- 5) remove from the stored mapped S-NSSAI(s) for the rejected NSSAI for the current PLMN or SNPN, the stored mapped S-NSSAI(s) for the rejected NSSAI for the current registration area, the stored mapped S-NSSAI(s) for the partially rejected NSSAI and the mapped S-NSSAI(s) for the rejected NSSAI for the maximum number of UEs reached, the S-NSSAI(s), if any, included in the mapped S-NSSAI(s) for the new partially allowed NSSAI for the current PLMN (if the UE is roaming) or the current SNPN (if the SNPN is a non-subscribed SNPN), and stop any timer T3526 associated with a deleted S-NSSAI in the rejected NSSAI for the maximum number of UEs reached if running; and
 - 6) remove from the stored pending NSSAI for this PLMN and its equivalent PLMN(s) in the registration area or this SNPN, one or more S-NSSAIs, if any, included in the new partially allowed NSSAI for the current PLMN and these equivalent PLMN(s) (if the UE is not roaming) or the current SNPN (if the SNPN is the subscribed SNPN) or the mapped S-NSSAI(s) for the new partially allowed NSSAI for the current PLMN and these equivalent PLMN(s) (if the UE is roaming) or the current SNPN (if the SNPN is a non-subscribed SNPN).
- ba) The alternative NSSAI and the mapped S-NSSAI(s) for the alternative NSSAI (if the UE is roaming) shall be stored for a given PLMN and its equivalent PLMN(s) or SNPN until a new alternative NSSAI for the same access type (i.e. 3GPP access or non-3GPP access) is received for a given PLMN or SNPN.

When a new alternative NSSAI for a given PLMN or SNPN is received and the new alternative NSSAI includes a list of mapping information between the S-NSSAI to be replaced and the alternative S-NSSAI, the UE shall:

- 1) replace any stored alternative NSSAI for this PLMN and its equivalent PLMN(s) or this SNPN for the same access type with the new alternative NSSAI for this PLMN or SNPN; and
- 2) delete any stored mapped S-NSSAI(s) for the alternative NSSAI for this PLMN and its equivalent PLMN(s) or this SNPN for the same access type and, if available, store the mapped S-NSSAI(s) for the new alternative NSSAI.

When a new alternative NSSAI for a given PLMN or SNPN is received and the new alternative NSSAI does not include any mapping information between the S-NSSAI to be replaced and the alternative S-NSSAI, the UE shall delete any stored alternative NSSAI for this PLMN and its equivalent PLMN(s) or this SNPN for the same access type.

When the UE locally removes either the replaced S-NSSAI or the alternative S-NSSAI in the allowed NSSAI upon expiry of the associated slice deregistration inactivity timer, the UE shall delete the entry including the replaced S-NSSAI or the alternative S-NSSAI stored in the alternative NSSAI.

NOTE 3: Whether the UE stores the alternative NSSAI and the mapped S-NSSAI(s) for the alternative NSSAI also when the UE is switched off is implementation specific.

- c) When the UE receives the S-NSSAI(s) included in the rejected NSSAI in the REGISTRATION ACCEPT message, the REGISTRATION REJECT message, the DEREGISTRATION REQUEST message or in the CONFIGURATION UPDATE COMMAND message, or the partially rejected NSSAI in the REGISTRATION ACCEPT message or the CONFIGURATION UPDATE COMMAND message, the UE shall:
 - 1) store the S-NSSAI(s) into the rejected NSSAI and the mapped S-NSSAI(s) for the rejected NSSAI based on the associated rejection cause(s);
 - 2) if the UE receives the S-NSSAI(s) included in the Rejected NSSAI IE, or if the UE receives the S-NSSAI(s) included in the Extended rejected NSSAI IE, or if the UE receives the S-NSSAI(s) included in the Partially rejected NSSAI IE in non-roaming case when not in SNPN access operation mode or in the subscribed SNPN, remove from the stored allowed NSSAI or partially allowed NSSAI for the current PLMN and its equivalent PLMN(s) in the registration area or the current SNPN, the S-NSSAI(s), if any, included in the:
 - i) rejected NSSAI for the failed or revoked NSSAA, for each and every access type;
 - ii) rejected NSSAI for the current PLMN or SNPN, for each and every access type;
 - iii) rejected NSSAI for the current registration area, associated with the same access type;
 - iv) rejected NSSAI for the maximum number of UEs reached, associated with the same access type; or

- v) partially rejected NSSAI, associated with 3GPP access;
- 3) if the UE receives the S-NSSAI(s) included in the Extended rejected NSSAI IE or if the UE receives the S-NSSAI(s) included in the Partially rejected NSSAI IE in roaming case or in a non-subscribed SNPN, remove from the stored allowed NSSAI or partially allowed NSSAI for the current PLMN and its equivalent PLMN(s) in the registration area or the current SNPN, the S-NSSAI(s), if any, included in the:
- i) rejected NSSAI for the current PLMN or SNPN, for each and every access type;
 - ii) rejected NSSAI for the current registration area, associated with the same access type;
 - iii) rejected NSSAI for the maximum number of UEs reached, associated with the same access type; or
 - iv) partially rejected NSSAI, associated with 3GPP access;
- if the mapped S-NSSAI(s) for the S-NSSAI in the stored allowed NSSAI or partially allowed NSSAI for the current PLMN or SNPN are stored in the UE, and all of the mapped S-NSSAI(s) are included in the Extended rejected NSSAI IE or Partially rejected NSSAI IE;
- 4) remove from the stored mapped S-NSSAI(s) for the allowed NSSAI or partially allowed NSSAI (if available and if the UE is roaming or is a non-subscribed SNPN), the S-NSSAI(s), if any, included in the:
- i) rejected NSSAI for the failed or revoked NSSAA, for each and every access type;
 - ii) mapped S-NSSAI(s) for the rejected NSSAI for the current PLMN or SNPN, for each and every access type;
 - iii) mapped S-NSSAI(s) for the rejected NSSAI for the current registration area, associated with the same access type;
 - iv) mapped S-NSSAI(s) for the rejected NSSAI for the maximum number of UEs reached, associated with the same access type; or
 - v) partially rejected NSSAI, associated with 3GPP access;
- 5) if the UE receives the S-NSSAI(s) included in the Rejected NSSAI IE, or if the UE receives the S-NSSAI(s) included in the Extended rejected NSSAI IE in non-roaming case when not in SNPN access operation mode or in the subscribed SNPN, remove from the stored pending NSSAI for the current PLMN and its equivalent PLMN(s) in the registration area or the current SNPN, the S-NSSAI(s), if any, included in the:
- i) rejected NSSAI for the failed or revoked NSSAA, for each and every access type;
 - ii) rejected NSSAI for the current PLMN or SNPN, for each and every access type;
 - iii) rejected NSSAI for the current registration area, associated with the same access type; or
 - iv) rejected NSSAI for the maximum number of UEs reached, associated with the same access type;
- 6) if the UE receives the S-NSSAI(s) included in the Extended rejected NSSAI IE in roaming case or in a non-subscribed SNPN, remove from the stored pending NSSAI for the current PLMN and its equivalent PLMN(s) in the registration area or the current SNPN, the S-NSSAI(s), if any, included in the:
- i) rejected NSSAI for the current PLMN or SNPN, for each and every access type;
 - ii) rejected NSSAI for the current registration area, associated with the same access type; or
 - iii) rejected NSSAI for the maximum number of UEs reached, associated with the same access type,
- if the mapped S-NSSAI(s) for the S-NSSAI in the stored pending NSSAI are stored in the UE, and all of the mapped S-NSSAI(s) are included in the Extended rejected NSSAI IE; and
- 7) remove from the stored mapped S-NSSAI(s) for the pending NSSAI (if available and if the UE is roaming or is in a non-subscribed SNPN), the S-NSSAI(s), if any, included in the:
- i) rejected NSSAI for the failed or revoked NSSAA, for each and every access type;

- ii) mapped S-NSSAI(s) for the rejected NSSAI for the current PLMN or SNPN, for each and every access type;
- iii) mapped S-NSSAI(s) for the rejected NSSAI for the current registration area, associated with the same access type; or
- iv) mapped S-NSSAI(s) for the rejected NSSAI for the maximum number of UEs reached, associated with the same access type;

If the UE receives the CONFIGURATION UPDATE COMMAND message with the Registration requested bit of the Configuration update indication IE set to “registration requested” and contains no other parameters (see subclauses 5.4.4.2 and 5.4.4.3), the UE shall delete any stored rejected NSSAI and partially rejected NSSAI.

When the UE:

- 1) enters state 5GMM-DEREGISTERED following an unsuccessful registration for 5GMM causes other than #62 “No network slices available” for the current PLMN or SNPN;
- 2) successfully registers with a new PLMN or a new SNPN;
- 3) enters state 5GMM-DEREGISTERED following an unsuccessful registration with a new PLMN or a new SNPN; or
- 4) performs inter-system change from N1 mode to S1 mode and the UE successfully completes tracking area update procedure;

and the UE is not registered with the PLMN or SNPN, which provided the rejected NSSAI, over another access, the rejected NSSAI for the current PLMN or SNPN and the rejected NSSAI for the failed or revoked NSSAI shall be deleted.

When the UE receives ACTIVATE DEFAULT EPS BEARER CONTEXT REQUEST message provided with S-NSSAI and the PLMN ID in the Protocol configuration options IE or Extended protocol configuration options IE (see subclause 6.5.1.3 of 3GPP TS 24.301 [15]), the UE shall remove the S-NSSAI associated with the PLMN ID from the rejected NSSAI for the current PLMN. When the UE receives ACTIVATE DEFAULT EPS BEARER CONTEXT REQUEST message provided with S-NSSAI and the PLMN ID in the Protocol configuration options IE or Extended protocol configuration options IE (see subclause 6.5.1.3 of 3GPP TS 24.301 [15]), the UE may remove the S-NSSAI from the rejected NSSAI for the maximum number of UEs reached for each and every access type, if any, and stop the timer T3526 associated with the S-NSSAI if running.

When the UE:

- 1) deregisters over an access type;
- 2) successfully registers in a new registration area over an access type;
- 3) enters state 5GMM-DEREGISTERED or 5GMM-REGISTERED following an unsuccessful registration in a new registration area over an access type; or
- 4) performs inter-system change from N1 mode to S1 mode and the UE successfully completes tracking area update procedure;

the rejected NSSAI for the current registration area corresponding to the access type and the partially rejected NSSAI shall be deleted. When a new partially rejected NSSAI is received without any S-NSSAI(s), the UE shall delete any stored partially rejected NSSAI for the current registration area;

- d) When the UE receives the pending NSSAI in the REGISTRATION ACCEPT message, the UE shall replace any stored pending NSSAI for this PLMN or SNPN with the new pending NSSAI received in the REGISTRATION ACCEPT message for this PLMN or SNPN. If the UE does not receive the pending NSSAI in the REGISTRATION ACCEPT message and the “NSSAI to be performed” indicator is not set to “Network slice-specific authentication and authorization is to be performed” in the 5GS registration result IE of the REGISTRATION ACCEPT message, the UE shall delete the stored pending NSSAI, if any, for this PLMN and its equivalent PLMN(s) in the registration area or this SNPN.

If the registration area contains TAIs belonging to different PLMNs, which are equivalent PLMNs, then for each of the equivalent PLMNs, the UE shall replace any stored pending NSSAI with the pending NSSAI received in the registered PLMN.

When the UE:

- 1) deregisters with the current PLMN or SNPN using explicit signalling or enters state 5GMM-DEREGISTERED for the current PLMN or SNPN;
- 2) successfully registers with a new PLMN not in the list of equivalent PLMNs or a new SNPN;
- 3) enters state 5GMM-DEREGISTERED following an unsuccessful registration with a new PLMN or SNPN; or
- 4) successfully initiates an attach or tracking area update procedure in S1 mode and the UE is operating in single-registration mode;

and the UE is not registered with the PLMN or SNPN, which provided pending NSSAI, over another access, the pending NSSAI for the current PLMN and its equivalent PLMN(s) in the registration area or the current SNPN shall be deleted;

- e) When the UE receives the Network slicing indication IE with the Network slicing subscription change indication set to "Network slicing subscription changed" in the REGISTRATION ACCEPT message or in the CONFIGURATION UPDATE COMMAND message, the UE shall delete the network slicing information for each of the PLMNs or SNPNs that the UE has slicing information stored for (excluding the current PLMN or SNPN). The UE shall delete any stored rejected NSSAI and stop any timer T3526 associated with a deleted S-NSSAI in the rejected NSSAI for the maximum number of UEs reached if running. The UE shall not delete the default configured NSSAI. Additionally, the UE shall update the network slicing information for the current PLMN or SNPN (if received) as specified above in bullets a), b), c) and d);
- f) When the UE receives the new default configured NSSAI included in the default configured NSSAI update data in the Payload container IE of DL NAS TRANSPORT message, the UE shall replace any stored default configured NSSAI with the new default configured NSSAI. In case of SNPN, the UE shall replace the stored default configured NSSAI associated with the selected entry of the "list of subscriber data" or the PLMN subscription with the new default configured NSSAI; and
- g) When the UE receives the on-demand NSSAI in the REGISTRATION ACCEPT message or CONFIGURATION UPDATE COMMAND message, the UE shall replace any stored on-demand NSSAI for the serving PLMN with the new on-demand NSSAI.

4.6.2.3 Provision of NSSAI to lower layers in 5GMM-IDLE mode

The UE NAS layer may provide the lower layers with an NSSAI (either requested NSSAI or allowed NSSAI) when the UE in 5GMM-IDLE mode sends an initial NAS message.

The AMF may indicate, via the NSSAI inclusion mode IE of a REGISTRATION ACCEPT message, an NSSAI inclusion mode in which the UE shall operate over the current access within the current PLMN or SNPN, if any (see subclauses 5.5.1.2.4 and 5.5.1.3.4), where the NSSAI inclusion mode is chosen among the following NSSAI inclusion modes described in table 4.6.2.3.1.

Table 4.6.2.3.1: NSSAI inclusion modes and NSSAI which shall be provided to the lower layers

Initial NAS message	NSSAI inclusion mode A	NSSAI inclusion mode B	NSSAI inclusion mode C	NSSAI inclusion mode D
REGISTRATION REQUEST message: i) including the 5GS registration type IE set to "initial registration"	Requested NSSAI, if any	Requested NSSAI, if any	Requested NSSAI, if any	No NSSAI
REGISTRATION REQUEST message: i) including the 5GS registration type IE set to "mobility registration updating"; and ii) initiated by case other than case g) or n) in subclause 5.5.1.3.2	Requested NSSAI, if any	Requested NSSAI, if any	Requested NSSAI, if any	No NSSAI
REGISTRATION REQUEST message: i) including the 5GS registration type IE set to "mobility registration updating"; and ii) initiated by case g) or n) in subclause 5.5.1.3.2	Allowed NSSAI, and partially allowed NSSAI, if any	Allowed NSSAI, and partially allowed NSSAI, if any	No NSSAI	No NSSAI
REGISTRATION REQUEST message: i) including the 5GS registration type IE set to "periodic registration updating"	Allowed NSSAI, and partially allowed NSSAI, if any	Allowed NSSAI, and partially allowed NSSAI, if any	No NSSAI	No NSSAI
SERVICE REQUEST message	Allowed NSSAI, and partially allowed NSSAI, if any	See NOTE 1	No NSSAI	No NSSAI
<p>NOTE 1: All the S-NSSAIs of the PDU sessions that have the user-plane resources requested to be re-established by the service request procedure or the S-NSSAIs of a control plane interaction triggering the service request is related to (see 3GPP TS 23.501 [8])</p> <p>NOTE 2: For a REGISTRATION REQUEST message which is triggered by emergency services, a DEREGISTRATION REQUEST message, and a SERVICE REQUEST message which is triggered by emergency services (e.g. a SERVICE REQUEST message includes the service type IE set to "emergency services" or "emergency services fallback", a SERVICE REQUEST message triggered for emergency services includes the service type IE set to "high priority access" as specified in subclause 5.6.1.2.1), no NSSAI is provided to the lower layers. If the UE performs initial registration for onboarding services in SNPN or is registered for onboarding services in SNPN, the UE NAS layer shall not provide the lower layers with an NSSAI.</p> <p>NOTE 3: The mapped configured S-NSSAI(s) from the S-NSSAI(s) of the HPLMN are not included as part of the S-NSSAIs in the requested NSSAI or the allowed NSSAI when it is provided to the lower layers.</p>				

The UE shall store the NSSAI inclusion mode:

- a) indicated by the AMF, if the AMF included the NSSAI inclusion mode IE in the REGISTRATION ACCEPT message; or
- b) if the AMF did not include the NSSAI inclusion mode IE in the REGISTRATION ACCEPT message:
 - 1) if the UE is pre-configured by operator to operate by default to according to mode C in the HPLMN (if the EHPLMN list is not present or is empty) or EHPLMN (if the EHPLMN list is present), (see the DefaultNSSAIInclusionMode leaf of the NAS configuration MO in 3GPP TS 24.368 [17] or the USIM file EF_{NASCONFIG} in 3GPP TS 31.102 [22]), then mode C;
 - 2) otherwise:
 - i) mode D for 3GPP access and trusted non-3GPP access; or
 - ii) mode B for untrusted non-3GPP access and wireline access.

together with the identity of the current PLMN or SNPN and access type in a non-volatile memory in the ME as specified in annex C.

The UE shall apply the NSSAI inclusion mode received in the REGISTRATION ACCEPT message over the current access within the current PLMN and its equivalent PLMN(s), if any, or the current SNPN in the current registration area.

When a UE performs a registration procedure to a PLMN which is not a PLMN in the current registration area or an SNPN, if the UE has no NSSAI inclusion mode for the PLMN or the SNPN stored in a non-volatile memory in the ME, the UE shall provide the lower layers with:

- a) no NSSAI if the UE is performing the registration procedure over 3GPP access; or
- b) requested NSSAI if the UE is performing the registration procedure over non-3GPP access.

When a UE performs a registration procedure after an inter-system change from S1 mode to N1 mode, if the UE has no NSSAI inclusion mode for the PLMN stored in a non-volatile memory in the ME and the registration procedure is performed over 3GPP access, the UE shall not provide the lower layers with any NSSAI over the 3GPP access.

4.6.2.4 Network slice-specific authentication and authorization

The UE and network may support network slice-specific authentication and authorization.

A serving PLMN or SNPN shall perform network slice-specific authentication and authorization for the S-NSSAI(s) of the HPLMN or the subscribed SNPN which are subject to it based on subscription information. The UE shall indicate whether it supports network slice-specific authentication and authorization in the 5GMM Capability IE in the REGISTRATION REQUEST message as specified in subclauses 5.5.1.2.2 and 5.5.1.3.2.

The upper layer stores an association between each S-NSSAI and its corresponding credentials for the network slice-specific authentication and authorization.

NOTE 1: The credentials for network slice-specific authentication and authorization and how to provision them in the upper layer are out of the scope of 3GPP.

The network slice-specific authentication and authorization procedure shall not be performed unless the primary authentication and key agreement procedure as specified in the subclause 5.4.1 has successfully been completed.

The AMF informs the UE about S-NSSAI(s) for which network slice-specific authentication and authorization (except for re-NSSAA) will be performed or is ongoing in the pending NSSAI. The AMF informs the UE about S-NSSAI(s) for which NSSAA procedure is completed as success in the allowed NSSAI or in the partially allowed NSSAI. The AMF informs the UE about S-NSSAI(s) for which NSSAA procedure is completed as failure in the rejected NSSAI for the failed or revoked NSSAA. The AMF stores and handles allowed NSSAI, partially allowed NSSAI, pending NSSAI, rejected NSSAI, and 5GS registration result in the REGISTRATION ACCEPT message according to subclauses 5.5.1.2.4 and 5.5.1.3.4.

NOTE 2: The AMF maintains the NSSAA procedure status for each S-NSSAI, as specified in 3GPP TS 29.518 [20B] and the NSSAA procedure status for each S-NSSAI is not impacted by NSAC as specified in subclauses 4.6.2.5 and 4.6.3.1.

NOTE 3: Upon completion of NSSAA procedures, it can happen that the total number of S-NSSAIs which need to be included in the allowed NSSAI exceeds eight. In this case, it is up to the AMF implementation on how to pick up the S-NSSAIs included in the allowed NSSAI.

NOTE 4: It can happen that one or more S-NSSAIs included in the received allowed NSSAI, are not the S-NSSAIs that the UE intends to register to. In this case, it is up to the UE implementation on how to use these S-NSSAIs.

To perform network slice-specific authentication and authorization for an S-NSSAI, the AMF invokes an EAP-based network slice-specific authentication and authorization procedure for the S-NSSAI, see subclause 5.4.7 and 3GPP TS 23.502 [9] using the EAP framework as described in 3GPP TS 33.501 [24].

The AMF updates the allowed NSSAI, the partially allowed NSSAI and the rejected NSSAI using the generic UE configuration update procedure as specified in the subclause 5.4.4 after the network slice-specific authentication and authorization procedure is completed.

The AMF shall send the pending NSSAI containing all S-NSSAIs for which the network slice-specific authentication and authorization procedure (except for re-NSSAA) will be performed or is ongoing in the REGISTRATION ACCEPT message. The AMF shall also include in the REGISTRATION ACCEPT message the allowed NSSAI containing one or more S-NSSAIs from the requested NSSAI which are allowed by the AMF and for which network slice-specific authentication and authorization is not required, if any. The AMF shall also include in the REGISTRATION ACCEPT message the partially allowed NSSAI containing one or more S-NSSAIs from the requested NSSAI which are allowed by the AMF in a list of TAs within the current registration area and for which network slice-specific authentication and authorization is not required, if any.

The network slice-specific re-authentication and re-authorization procedure or the network slice-specific authorization revocation procedure can be invoked by the network for a UE supporting NSSAA at any time. After the network performs the network slice-specific re-authentication and re-authorization procedure or network slice-specific authorization revocation procedure:

- a) if network slice-specific re-authentication and re-authorization fails or network slice-specific authorization is revoked for some but not all S-NSSAIs in the allowed NSSAI or the partially allowed NSSAI, the AMF updates the allowed NSSAI or the partially allowed NSSAI and the rejected NSSAI accordingly using the generic UE configuration update procedure as specified in the subclause 5.4.4 and inform the SMF to release all PDU sessions associated with the S-NSSAI for which network slice-specific re-authentication and re-authorization fails or network slice-specific authorization is revoked;
- b) if network slice-specific re-authentication and re-authorization fails or network slice-specific authorization is revoked for all S-NSSAIs in the allowed NSSAI or the partially allowed NSSAI but there are one or more default S-NSSAIs which are not subject to network slice-specific authentication and authorization or for which the network slice-specific authentication and authorization has been successfully performed, the AMF updates the allowed NSSAI or the partially allowed NSSAI containing these default S-NSSAIs and the rejected NSSAI accordingly using the generic UE configuration update procedure as specified in the subclause 5.4.4. The AMF shall also inform the SMF to release all PDU sessions associated with the S-NSSAI for which network slice-specific re-authentication and re-authorization fails or network slice-specific authorization is revoked; or
- c) if network slice-specific re-authentication and re-authorization fails or network slice-specific authorization is revoked for all S-NSSAIs in the allowed NSSAI or the partially allowed NSSAI and all default S-NSSAIs are subject to network slice-specific authentication and authorization, and the network slice-specific authentication and authorization has not been successfully performed for any of these default S-NSSAIs, then AMF performs the network-initiated de-registration procedure and includes the rejected NSSAI in the DEREGISTRATION REQUEST message as specified in the subclause 5.5.2.3 except when the UE has an emergency PDU session established or the UE is establishing an emergency PDU session. In this case the AMF shall send the CONFIGURATION UPDATE COMMAND message containing rejected NSSAI and inform the SMF to release all PDU sessions associated with the S-NSSAI for which network slice-specific re-authentication and re-authorization fails or network slice-specific authorization is revoked. After the emergency PDU session is released, the AMF performs the network-initiated de-registration procedure as specified in the subclause 5.5.2.3.

The UE does not include in the requested NSSAI any of the S-NSSAIs from the pending NSSAI that the UE stores, regardless of the access type. When the UE storing a pending NSSAI intends to register to one or more additional S-NSSAIs not included in the pending NSSAI, the UE initiates the registration procedure with a requested NSSAI containing these S-NSSAIs as described in subclause 5.5.1.3.2. In this case, the requested NSSAI shall also include one or more S-NSSAIs from the allowed NSSAI or the partially allowed NSSAI, if the UE still wants to use the S-NSSAI(s) from the allowed NSSAI or the partially allowed NSSAI.

During the registration procedure, when the AMF receives a requested NSSAI from a UE over an access type, for which there is a pending NSSAI including one or more S-NSSAIs that were previously requested over the same access type, the AMF considers S-NSSAIs included in the requested NSSAI and S-NSSAIs in the pending NSSAI that were previously requested over the same access type as requested S-NSSAIs by the UE. The AMF handles the requested S-NSSAIs as described in subclause 5.5.1.3.4.

When performing the network slice-specific re-authentication and re-authorization procedure if the S-NSSAI is included in the allowed NSSAI for both 3GPP and non-3GPP accesses, and the UE is registered to both 3GPP and non-3GPP accesses in the same PLMN, then the AMF selects an access type to perform network slice-specific re-authentication and re-authorization based upon operator policy.

If network slice-specific authorization is revoked for an S-NSSAI that is in the current allowed NSSAI for an access type or for an S-NSSAI that is in the current partially allowed NSSAI for 3GPP access type, the AMF shall:

- a) provide a new allowed NSSAI or a new partially allowed NSSAI, excluding the S-NSSAI for which the network slice-specific authorization is revoked; and
- b) provide a new rejected NSSAI for the failed or revoked NSSAI, including the S-NSSAI for which the network slice-specific authorization is revoked, with the rejection cause "S-NSSAI not available due to the failed or revoked network slice-specific authentication and authorization",

to the UE using the generic UE configuration update procedure as specified in the subclause 5.4.4 and inform the SMF to release all PDU sessions associated with the S-NSSAI for which the network slice-specific authorization is revoked for this access type.

If the UE requests the establishment of a new PDU session or the modification of a PDU session for an S-NSSAI for which the AMF is performing network slice-specific re-authentication and re-authorization procedure, the AMF may determine to not forward the 5GSM message to the SMF as described in subclause 5.4.5.2.4.

NOTE 5: If the AMF receives the HTTP code set to "4xx" or "5xx" as specified in 3GPP TS 29.500 [20AA] or the AMF detects that the NSSAAF failure as specified in 3GPP TS 29.526 [21A] during the NSSAA procedure for an S-NSSAI, then the AMF considers the NSSAA procedure has failed for this S-NSSAI.

4.6.2.5 Mobility management based network slice admission control

A serving PLMN or SNPN can perform network slice admission control for the S-NSSAI(s) subject to NSAC to monitor and control the number of registered UEs per network slice. The timing of the network slice admission control is managed by the EAC mode per network slice, which can be either activated or deactivated for the network performing network slice admission control. The EAC mode is activated when the number of UEs associated with the S-NSSAI reaches a certain threshold (see 3GPP TS 23.502 [9])

If the EAC mode is activated for an S-NSSAI, the AMF performs network slice admission control before the S-NSSAI subject to NSAC is included in the allowed NSSAI or the partially allowed NSSAI sent to the UE. During a registration procedure (including initial registration or mobility registration updating from another AMF), if the AMF determines that the maximum number of UEs has been reached for:

- a) one or more S-NSSAIs but not all S-NSSAIs in the requested NSSAI, then the AMF includes the allowed NSSAI or the partially allowed NSSAI and the rejected NSSAI accordingly in the REGISTRATION ACCEPT message as specified in the subclauses 5.5.1.2.4 and 5.5.1.3.4;
- b) all S-NSSAIs in the requested NSSAI but there are one or more default S-NSSAIs which can be allowed to the UE, then the AMF includes the allowed NSSAI or the partially allowed NSSAI containing these default S-NSSAIs and the rejected NSSAI accordingly in the REGISTRATION ACCEPT message as specified in the subclauses 5.5.1.2.4 and 5.5.1.3.4; or
- c) all S-NSSAIs in the requested NSSAI and there are no default S-NSSAIs which can be allowed to the UE, then the AMF includes the rejected NSSAI accordingly in the REGISTRATION REJECT message as specified in the subclauses 5.5.1.2.5 and 5.5.1.3.5.

If the EAC mode is deactivated for an S-NSSAI, the AMF performs network slice admission control after the S-NSSAI subject to NSAC is included in the allowed NSSAI or the partially allowed NSSAI sent to the UE. While the AMF is waiting for response from the NSACF for the S-NSSAI, the AMF processes the NAS signalling message related to the S-NSSAI as usual i.e. like S-NSSAI in the allowed NSSAI or the partially allowed NSSAI. After the network performs the network slice admission control, if the AMF determines that the maximum number of UEs has been reached for:

- a) one or more S-NSSAIs but not all S-NSSAIs in the allowed NSSAI or the partially allowed NSSAI, then the AMF updates the allowed NSSAI or the partially allowed NSSAI and the rejected NSSAI accordingly using the generic UE configuration update procedure as specified in the subclause 5.4.4;
- b) for all S-NSSAIs in the allowed NSSAI or the partially allowed NSSAI but there are one or more default S-NSSAIs which can be allowed to the UE, then the AMF updates the allowed NSSAI or the partially allowed NSSAI containing these default S-NSSAIs and the rejected NSSAI accordingly using the generic UE configuration update procedure as specified in the subclause 5.4.4; or
- c) for all S-NSSAIs in the allowed NSSAI or the partially allowed NSSAI and there are no default S-NSSAIs which can be allowed to the UE, then the AMF performs the network-initiated de-registration procedure and includes the rejected NSSAI in the DEREGISTRATION REQUEST message as specified in the

subclause 5.5.2.3 except when the UE has an emergency PDU session established or the UE is establishing an emergency PDU session.

When the UE has an emergency PDU session established or the UE is establishing an emergency PDU session, the AMF updates the rejected NSSAI using the generic UE configuration update procedure as specified in the subclause 5.4.4 and informs the SMF to release all PDU sessions associated with the S-NSSAI. During the generic UE configuration update procedure, the AMF includes the 5GS registration result IE in the CONFIGURATION UPDATE COMMAND message and sets the Emergency registered bit of the 5GS registration result IE to "Registered for emergency services". After the emergency PDU session is released, the AMF performs the network-initiated de-registration procedure as specified in the subclause 5.5.2.3.

Based on operator policy, the mobility management based network slice admission control is not applicable for the S-NSSAI used for emergency services, or the mobility management based network slice admission control result is ignored for the S-NSSAI used for emergency services.

Based on operator policy, the mobility management based network slice admission control is not applicable for the UEs configured for priority services, or the mobility management based network slice admission control result is ignored for the UEs configured for priority services.

NOTE: A UE configured for priority services can be identified based on the RRC establishment cause received from the NG-RAN or based on the MPS priority information in the user's subscription context obtained from the UDM.

The mobility management based network slice admission control is not applicable to a UE that is registering or registered for onboarding services in SNPN.

4.6.2.6 Provision of NSAG information to lower layers

The support for NSAG information by the UE and the network, respectively, is optional. The NSAG information provided by the network and stored in the UE includes a list of NSAGs each of which contains:

- a) an NSAG ID;
- b) a list of S-NSSAI(s), which are associated with the NSAG and shall be part of the configured NSSAI;

NOTE 0: An alternative S-NSSAI is added to the configured NSSAI if not included yet.

- c) a priority value that is associated with the NSAG; and

NOTE 1: The AMF can take local configuration, UE 5GMM capabilities, subscribed S-NSSAIs, the mapping information between the S-NSSAI to be replaced and the alternative S-NSSAI, HPLMN, etc. to determine the NSAG priority information for the associated NSAG to a UE.

- d) optionally a list of TAIs in which the NSAG is valid. If it is not provided by the network, the NSAG is valid in the PLMN or SNPN which has sent the NSAG information and its equivalent PLMN(s).

NOTE 2: If the NSAG for the PLMN and its equivalent PLMN(s) have different associations with S-NSSAIs, then the AMF includes a list of TAIs in the NSAG information.

The UE NAS layer shall provide the lower layers with:

- a) the most recent NSAG information stored in the UE (see subclause 4.6.2.2);
- b) the allowed NSSAI and the partially allowed NSSAI (if any) or the requested NSSAI for the purpose of network slice-based cell reselection (see 3GPP TS 23.501 [8]); and
- c) zero or more S-NSSAIs related to an access attempt for the purpose of network slice-based random access, when the access attempt is made by the UE in 5GMM-IDLE mode or 5GMM-CONNECTED mode with RRC inactive indication, determined as follows:
 - i) requested NSSAI (if any), if an access attempt occurred due to the REGISTRATION REQUEST message;
 - ii) NSSAI(s) associated with all the PDU sessions included in the Uplink data status IE (if any), PDU session status IE (if any), or Allowed PDU session status IE (if any), if an access attempt occurred due to the SERVICE REQUEST message or CONTROL PLANE SERVICE REQUEST message;

iii) the S-NSSAI associated with the PDU session, if an access attempt occurred due to:

- an uplink user data packet to be sent for a PDU session with suspended user-plane resources;
- an UL NAS TRANSPORT which carries a 5GSM message for a PDU session associated with an S-NSSAI (if any); or
- CIoT user data to be sent in a CONTROL PLANE SERVICE REQUEST message or an UL NAS TRANSPORT message;

iv) no S-NSSAI, if an access attempt occurred due to:

- the deregistration procedure;
- a PDU session establishment request not associated with an S-NSSAI;
- the service request procedure for the UE-initiated NAS transport procedure for sending SMS, LPP message, UPP-CMI container, SLPP message, SOR transparent container, UE policy container, UE parameters update transparent container, or a location services message; or
- emergency services; or

v) the allowed NSSAI (if any) and the partially allowed NSSAI (if any), if an access attempt occurred for other reason than those specified in bullets i) - iv).

4.6.2.7 Mobility management based network slice replacement

The support for network slice replacement by a UE or network is optional. If the UE and network support network slice replacement, and the AMF determines that an S-NSSAI included in the allowed NSSAI or the partially allowed NSSAI needs to be replaced with an alternative S-NSSAI, the AMF provides:

- a) the alternative S-NSSAI in the allowed NSSAI or the partially allowed NSSAI, if not included yet;
- b) the alternative S-NSSAI in the configured NSSAI, if not included yet;
- c) the alternative S-NSSAI in the NSAG information, if not included yet and the UE supports NSAG; and
- d) the alternative NSSAI including the mapping information between the S-NSSAI to be replaced and the corresponding alternative S-NSSAI,

to the UE, during the generic UE configuration update procedure or during the registration procedure as follows:

- a) for non-roaming UE, the AMF provides the mapping information between the S-NSSAI included in the allowed NSSAI or the partially allowed NSSAI and the alternative S-NSSAI to the UE; or

NOTE 1: In non-roaming scenarios, the alternative S-NSSAI does not have to be part of the subscribed S-NSSAI(s) in the UE subscription.

b) for roaming UE:

- 1) if the S-NSSAI included in the allowed NSSAI or the partially allowed NSSAI needs to be replaced (i.e., the S-NSSAI to be replaced is part of the VPLMN S-NSSAIs), the AMF provides the mapping information between the S-NSSAI included in the allowed NSSAI or the partially allowed NSSAI and the alternative S-NSSAI to the UE; and
- 2) if the S-NSSAI included in the mapped S-NSSAI(s) for the allowed NSSAI needs to be replaced (i.e., the S-NSSAI to be replaced is part of the HPLMN S-NSSAIs), the AMF provides the mapping information between the S-NSSAI to be replaced and the alternative S-NSSAI to the UE.

NOTE 1A: In roaming scenarios, the alternative S-NSSAI, being part of the HPLMN S-NSSAIs does not have to be part of the subscribed S-NSSAI(s) in the UE subscription.

If the requested NSSAI contains alternative S-NSSAI(s) that are not subscribed S-NSSAI(s), the AMF shall verify the alternative S-NSSAI(s) based on the stored alternative NSSAI.

If the alternative S-NSSAI is subject to NSSAA, the alternative S-NSSAI provided by AMF shall be part of the subscribed S-NSSAI(s) in the UE subscription. The AMF shall perform NSSAA procedure for such alternative S-NSSAI and perform network slice replacement as specified above after the NSSAA procedure for the alternative S-NSSAI is completed as success.

If re-NSSAA procedure is ongoing for the S-NSSAI to be replaced, the AMF shall continue with the re-NSSAA procedure and perform network slice replacement as specified above after the re-NSSAA procedure for the S-NSSAI to be replaced is completed as success.

NOTE 2: When configuring the alternative S-NSSAI, the maximum number of S-NSSAIs defined for the allowed NSSAI, the partially allowed NSSAI and configured NSSAI in subclause 4.6.2.2 are applicable.

If the AMF determines that the replaced S-NSSAI is available again, the AMF provides the updated alternative NSSAI excluding the replaced S-NSSAI and the corresponding alternative S-NSSAI to the UE during the UE configuration update procedure or during the registration procedure.

If all the replaced S-NSSAI(s) in alternative NSSAI are available again, the AMF provides the alternative NSSAI with Length of Alternative NSSAI contents set to 0 in the UE configuration update procedure or registration procedure.

NOTE 3: If there is S-NSSAI location validity information for both the S-NSSAI to be replaced and the alternative S-NSSAI, the NS-AoS of the alternative S-NSSAI is the same as or larger than the NS-AoS of the S-NSSAI to be replaced.

If the UE is in a cell outside the NS-AoS of the replaced S-NSSAI but within the NS-AoS of the alternative S-NSSAI, the AMF provides the updated allowed NSSAI and partially allowed NSSAI excluding the replaced S-NSSAI, if included, in the allowed NSSAI or partially allowed NSSAI during the UE configuration update procedure or during the registration procedure.

If the alternative S-NSSAI is not part of the subscribed S-NSSAI(s), and:

- a) the replaced S-NSSAI is removed from the allowed NSSAI or the partially allowed NSSAI; or
- b) the replaced S-NSSAI is available again,

then the AMF shall provide updated allowed NSSAI or partially allowed NSSAI excluding the alternative S-NSSAI to the UE over the current access type during the UE configuration update procedure or during the registration procedure. Additionally, if the alternative S-NSSAI is not included in allowed NSSAI or partially allowed NSSAI over the other access type:

- a) for case a), the AMF may also provide updated configured NSSAI excluding the alternative S-NSSAI to the UE during the UE configuration update procedure or during the registration procedure; or
- b) for case b), the AMF shall also provide updated configured NSSAI excluding the alternative S-NSSAI to the UE during the UE configuration update procedure or during the registration procedure.

Based on SMF local configuration, if the replaced S-NSSAI is subject to NSAC or the alternative S-NSSAI is subject to NSAC or both, the SMF may perform NSAC for the replaced S-NSSAI or the alternative S-NSSAI or both.

4.6.2.8 Mobility management for optimised handling of temporarily available network slices

The UE and the network may support optimised handling of temporarily available network slices. The support for S-NSSAI time validity information by the UE and the network, respectively, is optional.

If the UE has indicated that it supports S-NSSAI time validity information, then the AMF may include the S-NSSAI time validity information for one or more S-NSSAIs included in the configured NSSAI in the REGISTRATION ACCEPT message or the CONFIGURATION UPDATE COMMAND message. If the AMF determines that the S-NSSAI time validity information for an S-NSSAI in the configured NSSAI is changed, the AMF may provide the UE with a new S-NSSAI time validity information for that S-NSSAI via the CONFIGURATION UPDATE COMMAND message.

If the UE supporting S-NSSAI time validity information, is configured with S-NSSAI time validity information for an S-NSSAI and:

- a) the S-NSSAI time validity information indicates that the S-NSSAI is available, then the UE may request the S-NSSAI in the requested NSSAI in the Registration Request message;
- b) the S-NSSAI time validity information indicates that the S-NSSAI is not available, then:
 - i) the UE shall not include the S-NSSAI in the requested NSSAI in the REGISTRATION REQUEST message;
 - ii) the UE shall remove the S-NSSAI from the stored allowed NSSAI (if any) and the stored partially allowed NSSAI (if any) in the non-volatile memory in the ME, as specified in annex C; and
 - iii) the S-NSSAI time validity information indicates that the S-NSSAI will not become available again, then the UE shall remove the S-NSSAI from the stored configured NSSAI in the non-volatile memory in the ME, as specified in annex C.

NOTE 1: If the S-NSSAI to be removed is the only S-NSSAI in the allowed NSSAI and partially allowed NSSAI, if applicable, the UE can before the time validity expiry initiate the registration procedure for mobility and periodic registration update and include a different S-NSSAI from the configured NSSAI in the Requested NSSAI IE of the REGISTRATION REQUEST message. If the UE does not initiate the registration procedure for mobility and periodic registration update and the time validity for the only S-NSSAI in the allowed NSSAI and partially allowed NSSAI expires, the UE locally enters the state 5GMM-DEREGISTERED.

When the S-NSSAI time validity information of an S-NSSAI indicates that the S-NSSAI is not available, then:

- a) if the AMF receives a requested NSSAI in the REGISTRATION REQUEST message with the S-NSSAI identifying the network slice, the AMF shall:
 - i) to a UE which has indicated that it supports S-NSSAI time validity information, provide:
 - 1) a configured NSSAI including the S-NSSAI together with the S-NSSAI time validity information in the REGISTRATION ACCEPT message if the S-NSSAI will become available again; or
 - 2) a configured NSSAI not including the S-NSSAI in the REGISTRATION ACCEPT message if the S-NSSAI will not become available again; or
 - ii) to a UE which has not indicated that it supports S-NSSAI time validity information, include the S-NSSAI in the rejected NSSAI for the current registration area;
- b) if the AMF detects that the S-NSSAI is included in the allowed NSSAI or the partially allowed NSSAI of a UE which has:
 - i) indicated that it supports S-NSSAI time validity information, the AMF shall locally remove the S-NSSAI from the allowed NSSAI (if any) and the partially allowed NSSAI (if any); or

NOTE 2: If there is no S-NSSAI included in the allowed NSSAI and partially allowed NSSAI after local removal of the S-NSSAI from the allowed NSSAI or the partially allowed NSSAI, the network locally enters the state 5GMM-DEREGISTERED for the UE.

- ii) not indicated that it supports S-NSSAI time validity information, the AMF shall remove the S-NSSAI from the stored allowed NSSAI (if any) and partially allowed NSSAI (if any) and include the S-NSSAI in the rejected NSSAI for the current registration area by sending the CONFIGURATION UPDATE COMMAND message.

When the S-NSSAI time validity information of an S-NSSAI indicates that the S-NSSAI becomes available again, the AMF shall update the allowed NSSAI or partially allowed NSSAI including the S-NSSAI to a UE which has not indicated that it supports S-NSSAI time validity information by sending CONFIGURATION UPDATE COMMAND message if the UE is subscribed to the S-NSSAI.

The S-NSSAI time validity information is applicable for the current PLMN or SNPN regardless of the access type.

4.6.2.9 Mobility management based network slice usage control

If the network supports network slice usage control, the AMF monitors network slice usage by running a slice deregistration inactivity timer per S-NSSAI and access type. If the UE supports network slice usage control, the AMF may also provide on-demand NSSAI to the UE in the REGISTRATION ACCEPT message or in the

CONFIGURATION UPDATE COMMAND message. The on-demand NSSAI consists of one or more on-demand S-NSSAIs and, optionally, the slice deregistration inactivity timer per on-demand S-NSSAI.

The slice deregistration inactivity timer is started using the stored slice deregistration inactivity timer value as follows:

- a) for a PDU session which is released using 5GSM signalling, after a PDU session is released and there is no established PDU session, including any MA PDU session, associated with the S-NSSAI over the corresponding access type;
- b) for a PDU session which is released locally:
 - 1) when the UE or AMF indicates via the PDU session status IE that a PDU session is now in 5GSM state PDU SESSION INACTIVE and there is no established PDU session, including any MA PDU session, associated with the S-NSSAI over the corresponding access type; or
 - 2) when the UE or AMF receives the the PDU session status IE for which a PDU session that was previously in 5GSM state PDU SESSION ACTIVE is now indicated as being in 5GSM state PDU SESSION INACTIVE and there is no established PDU session, including any MA PDU session, associated with the S-NSSAI over the corresponding access type; or
- c) when there is no established PDU session, including any MA PDU session, associated with the S-NSSAI included in the allowed NSSAI or in the partially allowed NSSAI over the corresponding access type.

The slice deregistration inactivity timer is stopped and reset:

- a) when at least a PDU session, including any MA PDU session, associated with the S-NSSAI is successfully established over the corresponding access type(s) or the S-NSSAI is removed from the allowed NSSAI or the partially allowed NSSAI; or
- b) when the UE enters the state 5GMM-DEREGISTERED.

If the slice deregistration inactivity timer value is updated, the AMF updates the stored timer value and may provide the updated timer value to the UE in the REGISTRATION ACCEPT message, in a current or the next registration procedure for mobility and periodic registration update, or the CONFIGURATION UPDATE COMMAND message.

When the UE receives an updated slice deregistration inactivity timer value in the REGISTRATION ACCEPT message or the CONFIGURATION UPDATE COMMAND message from the AMF, the UE shall update the stored timer value.

Upon expiry of the slice deregistration inactivity timer, the AMF:

- a) for UE supporting network slice usage control, shall locally remove the S-NSSAI from the allowed NSSAI over the corresponding access type. In addition, the AMF may send the CONFIGURATION UPDATE COMMAND message to the UE with the new allowed NSSAI; and
- b) for UE not supporting network slice usage control, shall provide the updated allowed NSSAI excluding the S-NSSAI in the CONFIGURATION UPDATE COMMAND message to the UE.

If the AMF locally removes either the replaced S-NSSAI or the alternative S-NSSAI in the allowed NSSAI upon expiry of the associated slice deregistration inactivity timer, the AMF shall delete the entry including the replaced S-NSSAI or the alternative S-NSSAI stored in the alternative NSSAI.

The UE includes the on-demand S-NSSAI which the UE requests in the requested NSSAI during the registration procedure. Upon expiry of the slice deregistration inactivity timer, the UE shall locally remove the S-NSSAI from the allowed NSSAI over the corresponding access type. If the locally removed on-demand S-NSSAI is included in the entry of the stored alternative NSSAI, the UE shall delete the entry as specified in subclause 4.6.2.2.

NOTE 0: If the UE determines the on-demand S-NSSAI for a PDU session establishment as specified in subclause 4.2.2 of 3GPP TS 24.526 [19], the UE includes the on-demand S-NSSAI in the requested NSSAI during the registration procedure.

On-demand NSSAI is associated with the configured NSSAI. The on-demand S-NSSAI(s) is deleted by the UE from the stored on-demand NSSAI, when the associated configured S-NSSAI(s) is deleted by the UE from the stored configured NSSAI.

NOTE 1: Based on regulatory requirements and operator policy, the AMF ensures that the network slice usage control does not apply for the S-NSSAI used for emergency services.

NOTE 2: In this version of the specification, the network slice usage control feature is not supported in roaming scenarios.

4.6.2.10 Mobility management aspects of handling network slices with NS-AoS not matching deployed tracking areas

An operator can choose to let the NS-AoS of an S-NSSAI not match the existing tracking area boundaries (see subclause 5.15.18 of 3GPP TS 23.501 [8]). In order to support this deployment option, the operator has to ensure that an AMF covering the NS-AoS operates as described below.

The support for S-NSSAI location validity information by the UE and the network, respectively, is optional. If a UE supports S-NSSAI location validity information, the UE indicates that it supports S-NSSAI location validity information during the registration procedure (see subclause 5.5.1). The AMF can provide a UE which has indicated that it supports S-NSSAI location validity information with S-NSSAI location validity information (see subclauses 5.4.4 and 5.5.1). The S-NSSAI location validity information consists of, for each of the applicable S-NSSAI(s) in the configured NSSAI:

- a) an S-NSSAI; and
- b) a list of cell identities of TA(s) belonging to the registration area where the related S-NSSAI(s) is available in some cells but not all cells of one or more TAs, which represents the NS-AoS of the S-NSSAI.

The UE shall consider itself to be inside the NS-AoS if the cell identity of the current serving cell matches any of the identities in the S-NSSAI location validity information. Otherwise, the UE shall consider itself to be outside the NS-AoS of an S-NSSAI.

NOTE 1: The cell identity of the current serving cell is received from the lower layers.

For an S-NSSAI in the S-NSSAI location validity information, even if the S-NSSAI is included in the rejected NSSAI with a rejection cause value set to "S-NSSAI not available in the current registration area" or is included in the partially rejected NSSAI, the UE is allowed to request the S-NSSAI if the UE determines that it is inside the NS-AoS of the S-NSSAI.

For an S-NSSAI limited by NS-AoS, if the UE in 5GMM-CONNECTED mode does not support S-NSSAI location validity information and the AMF determines that:

- a) the UE is outside the NS-AoS, then the AMF may:
 - 1) provide the UE with an allowed NSSAI or a partially allowed NSSAI excluding the S-NSSAI, and optionally a rejected NSSAI for the current registration area including the S-NSSAI; and

NOTE 2: If excluding the S-NSSAI limited by NS-AoS results in an empty allowed NSSAI or partially allowed NSSAI, the AMF includes one or more default S-NSSAIs in the provided allowed NSSAI or partially allowed NSSAI.

- 2) indicate to the SMF to release all PDU sessions associated with the S-NSSAI; or
- b) the UE is in the NS-AoS, then the AMF may update the allowed NSSAI or partially allowed NSSAI to include the S-NSSAI in the allowed NSSAI or partially allowed NSSAI.

If the UE that does not support S-NSSAI location validity information requests a PDU session establishment for an S-NSSAI limited by NS-AoS and the AMF determines that the UE is outside the NS-AoS of an S-NSSAI, the AMF may perform S-NSSAI based congestion control for the S-NSSAI as specified in subclauses 5.3.11 and 5.4.5.

The S-NSSAI location validity information is only applicable to 3GPP access.

4.6.2.11 Mobility management for partial network slice

A serving PLMN or SNPN can indicate the S-NSSAI(s) is allowed or rejected in some TA(s) but not all TAs of the registration area to the UE during the registration procedure as specified in subclause 5.5.1 and the generic UE configuration update procedure as specified in subclause 5.4.4. The support for the partial network slice by a UE or an AMF is optional.

If the UE supports the partial network slice and includes the S-NSSAI(s) in the requested NSSAI and:

- a) if the S-NSSAI(s) is allowed in the current TA but not all TAs of the registration area, and
 - 1) if the S-NSSAI(s) is subject to NSAC for the maximum number of UEs, the AMF should include the S-NSSAI(s) in the allowed NSSAI to the UE and limit the registration area so that the S-NSSAI(s) is allowed in all the TAs of the registration area;
 - 2) if the S-NSSAI(s) is subject to NSSAA, the AMF shall include the S-NSSAI(s) in:
 - i) the pending NSSAI to the UE when the AMF is going to perform the network slice-specific authentication and authorization for the S-NSSAI(s); or
 - ii) the partially allowed NSSAI to the UE after the network slice-specific authentication and authorization for the S-NSSAI(s) has been successfully performed; and
 - 3) otherwise, the AMF shall include the S-NSSAI(s) in the partially allowed NSSAI to the UE; or
- b) if the S-NSSAI(s) is rejected in the current TA but not all TAs of the registration area; and
 - 1) if the S-NSSAI is subject to NSAC for the maximum number of UEs, the AMF should include the S-NSSAI(s) in the partially rejected NSSAI to the UE;
 - 2) if the S-NSSAI(s) is subject to NSSAA, the AMF shall include the S-NSSAI(s) in:
 - i) the partially rejected NSSAI to the UE when the AMF determines not to perform the network slice-specific authentication and authorization for the S-NSSAI(s);
 - ii) the pending NSSAI to the UE when the AMF is going to perform the network slice-specific authentication and authorization for the S-NSSAI(s); or
 - iii) either the partially allowed NSSAI or the partially rejected NSSAI to the UE after the network slice-specific authentication and authorization for the S-NSSAI(s) has been successfully performed;

NOTE 1: The AMF determines whether to perform the network slice-specific authentication and authorization procedure for the partial network slice based on its own local policy.

- 3) if the S-NSSAI(s) is associated with a slice deregistration inactivity timer on the AMF side as specified in subclause 4.6.2.9, the AMF shall include the S-NSSAI(s) in the partially rejected NSSAI to the UE; and
 - 4) otherwise, the AMF shall include the S-NSSAI(s) in either the partially allowed NSSAI or the partially rejected NSSAI to the UE; or
- c) if the partially allowed NSSAI, the partially rejected NSSAI, or both are changed, the AMF shall provide the new partially allowed NSSAI, the new partially rejected NSSAI, or both to the UE.

Upon receiving the partially allowed NSSAI, the UE shall regard the S-NSSAI(s) included in partially allowed NSSAI, if any, as the allowed S-NSSAI(s) for the current registration area and store the received partially allowed NSSAI as specified in subclause 4.6.2.2.

Upon receiving the partially rejected NSSAI, the UE shall store the received partially rejected NSSAI as specified in subclause 4.6.2.2. The UE shall not attempt to include the S-NSSAI, if any, in the requested NSSAI if the current TAI is in the list of TAs for which S-NSSAI is rejected.

The AMF shall ensure that there is also at least one S-NSSAI in the allowed NSSAI allocated to the UE as specified in subclause 5.15.2.1 of 3GPP TS 23.501 [8].

The mobility management for partial network slice is only applicable to 3GPP access.

The mobility management for partial network slice is not applicable to a UE that is registering or registered for onboarding services in SNPN.

4.6.3 Session management aspects

4.6.3.0 General

In order to enable PDU transmission in a network slice, the UE may request establishment of a PDU session in a network slice towards a data network (DN) which is associated with an S-NSSAI and a data network name (DNN) if there is no established PDU session adequate for the PDU transmission. The S-NSSAI included is part of allowed NSSAI of the serving PLMN or SNPN, which is an S-NSSAI value valid in the serving PLMN or SNPN, and in roaming scenarios the mapped S-NSSAI is also included for the PDU session if available. See subclause 6.4.1 for further details. The UE determines whether to establish a new PDU session or use one of the established PDU session(s) based on the URSP rules which include S-NSSAIs, if any (see subclause 6.2.9), or based on UE local configuration, as described in subclause 4.2.2 of 3GPP TS 24.526 [19].

4.6.3.1 Session management based network slice admission control

A serving PLMN or the HPLMN, or SNPN can perform network slice admission control for the S-NSSAI(s) subject to NSAC to monitor and control the total number of established PDU sessions per network slice. The SMF performs network slice admission control on the S-NSSAI during the PDU session establishment procedure. If the maximum number of PDU sessions on a network slice associated with an S-NSSAI has been already reached, the SMF rejects the PDU session establishment request using S-NSSAI based congestion control as specified in subclause 6.2.8 and 6.4.1.4.2.

The SMF performs network slice admission control on the S-NSSAI for a PDU session that is associated with the non-3GPP access, when the UE requests to transfer a session from the non-3GPP access to the 3GPP access with the Allowed PDU session status IE as described in subclause 5.6.1.4. If the maximum number of PDU sessions on a network slice associated with an S-NSSAI has been already reached, the SMF rejects the request to establish the user-plane resources (see 3GPP TS 29.502 [20A]).

Based on operator policy, the session management based network slice admission control is not applicable for the PDU session for emergency services, or the session management based network slice admission control result is ignored for the PDU session for emergency services.

Based on operator policy, the session management based network slice admission control is not applicable for the PDU session for priority services, or the session management based network slice admission control result is ignored for the PDU session for priority services.

NOTE 1: The SMF can use the Sbi-Message-Priority field, as defined in TS 29.500 [20AA], to determine whether the PDU session is for priority services.

The session management based network slice admission control is not applicable to PDU session established for onboarding services in SNPN.

NOTE 2: For the MA PDU session during the PDU session establishment procedure, the SMF performs network slice admission control only when it is newly established over the associated access type.

NOTE 3: For a set of redundant PDU sessions, the SMF performs network slice admission control for each PDU session independently.

4.6.3.2 Support of network slice admission control and interworking with EPC

If EPS counting is required for a network slice, the network performs network slice admission control for the S-NSSAI(s) subject to NSAC to monitor and control the number of UEs per network slice and number of PDU sessions per network slice during the PDN connection establishment procedure. If the maximum number of UEs on a network slice associated with an S-NSSAI or the maximum number of PDU sessions on a network slice associated with an S-NSSAI have already been reached, the network rejects the PDN connectivity request using ESM cause #26 "insufficient resources" as specified in 3GPP TS 24.301 [15].

NOTE: If there are more than one S-NSSAI associated with the APN used in the PDN connectivity request and some of but not all associated S-NSSAIs are not available due to either maximum number of UEs reached or maximum number of PDU sessions reached, the network can use the associated S-NSSAI for which maximum number of UEs and maximum number of PDU sessions have not reached to avoid PDN connectivity request rejection.

4.6.3.3 Session management based network slice data rate limitation control

A serving PLMN or the HPLMN can perform network slice data rate limitation control for the S-NSSAI(s) subject to network slice data rate limitation control to monitor and control the total data rate of established PDU sessions per network slice as specified in 3GPP TS 23.503 [10]. If the maximum data rate of PDU sessions on a network slice associated with an S-NSSAI has been exceeded during the PDU session establishment procedure, the SMF may reject the PDU session establishment request using S-NSSAI based congestion control as specified in subclause 6.2.8 and 6.4.1.4.2.

A serving PLMN or the HPLMN can perform management of Slice-Maximum Bit Rate per UE (UE-Slice-MBR) as specified in 3GPP TS 23.503 [10]. When the UE-Slice-MBR for the UE and S-NSSAI to which the PDU session is allocated is exceeded during the PDU session establishment procedure, the SMF may reject the PDU session establishment request using S-NSSAI based congestion control as specified in subclause 6.2.8 and 6.4.1.4.2.

NOTE 1: Based on operator policy, the network slice data rate limitation control can be not applicable for the S-NSSAI(s) used for emergency services or priority services.

NOTE 2: The network slice data rate limitation control and UE-Slice-MBR management are performed by the PCF.

4.6.3.4 Session management based network slice replacement

If:

- a) the UE and network support network slice replacement;
- b) the UE is provided with the mapping information between the S-NSSAI to be replaced and the alternative S-NSSAI; and
- c) the UE decides to establish a new PDU session with the S-NSSAI to be replaced,

the UE provides both the S-NSSAI to be replaced and the alternative S-NSSAI during PDU session establishment procedure.

If:

- a) the UE and network support network slice replacement;
- b) the UE initiates UE-requested PDU session establishment procedure with an S-NSSAI; and
- c) the AMF determines that the S-NSSAI needs to be replaced with an alternative S-NSSAI;

the AMF shall initiate the generic UE configuration update procedure as part of the UE-requested PDU session establishment procedure to provide to the UE:

- a) the allowed NSSAI including the alternative S-NSSAI, if not included yet;
- b) the configured NSSAI including the alternative S-NSSAI, if not included yet; and
- c) the alternative NSSAI including the mapping information between the S-NSSAI to be replaced and the corresponding alternative S-NSSAI.

If the timer T3584 or timer T3585 is running for the S-NSSAI to be replaced, the UE should not stop the timer during PDU session establishment procedure. If the SMF receives both the S-NSSAI to be replaced and the alternative S-NSSAI during PDU session establishment procedure, the SMF proceeds with the PDU session establishment procedure with the alternative S-NSSAI. If the PDU session establishment request is accepted, the SMF includes the alternative S-NSSAI in the PDU session establishment accept message. The S-NSSAI for the established PDU session is the S-NSSAI to be replaced and the alternative S-NSSAI on the UE side.

If the UE is provided with the mapping of the VPLMN S-NSSAI to a VPLMN alternative S-NSSAI, the UE provides both the VPLMN alternative S-NSSAI and the VPLMN S-NSSAI during PDU session establishment procedure. The AMF sends both VPLMN alternative S-NSSAI and VPLMN S-NSSAI to the SMF. If the UE is provided with the mapping of the HPLMN S-NSSAI to a HPLMN Alternative S-NSSAI, the UE provides both the HPLMN alternative S-NSSAI and the HPLMN S-NSSAI during PDU session establishment procedure. The AMF sends both HPLMN alternative S-NSSAI and HPLMN S-NSSAI to the SMF.

If the SMF receives from the AMF an alternative S-NSSAI for existing PDU session and:

- a) if the SMF decides to retain the existing PDU session (i.e. the SMF can serve both the alternative S-NSSAI and the S-NSSAI to be replaced with), the SMF sends the alternative S-NSSAI to the UE during network-requested PDU session modification procedure; or
- b) if the SMF decides to re-activate the existing PDU session and:
 - 1) if the SSC mode of the PDU session is SSC mode 3, the SMF initiates PDU session modification procedure to trigger PDU session reactivation by the UE; or
 - 2) if the SSC mode of the PDU session is SSC mode 1 or SSC mode 2, the SMF initiates PDU session release procedure to trigger PDU session reactivation by the UE, and the UE provides both the S-NSSAI to be replaced and the alternative S-NSSAI during PDU session establishment procedure.

When the replaced S-NSSAI becomes available again, if the SMF receives from the AMF the replaced S-NSSAI for the existing PDU session and:

- a) if the SMF decides to retain the existing PDU session (i.e. the SMF can serve the replaced S-NSSAI), the SMF sends the replaced S-NSSAI to the UE during network-requested PDU session modification procedure; or
- b) if the SMF decides to re-activate the existing PDU session and:
 - 1) if the SSC mode of PDU session is SSC mode 3, the SMF sends the replaced S-NSSAI to the UE during PDU session modification procedure to trigger PDU session reactivation by the UE; or
 - 2) if the SSC mode of the PDU session is SSC mode 1 or SSC mode 2, the SMF sends the replaced S-NSSAI to the UE during PDU session release procedure to trigger PDU session reactivation by the UE; and the UE provides the replaced S-NSSAI during PDU establishment procedure.

If the timer T3584 or timer T3585 is running for the replaced S-NSSAI and the replaced S-NSSAI in alternative NSSAI is available and the AMF provides the updated allowed NSSAI, partially allowed NSSAI and configured NSSAI to the UE, the UE should stop the timer.

4.6.3.5 Session management for optimized handling of temporarily available network slices

A network slice can be available temporarily. Subclause 4.6.2.8 addresses how the allowed NSSAI and partially allowed NSSAI are managed based on the S-NSSAI time validity information.

If the S-NSSAI time validity information indicates that the S-NSSAI is available, the UE may initiate a UE-requested PDU session establishment procedure to establish a PDU session associated with the S-NSSAI.

If the S-NSSAI time validity information indicates that the S-NSSAI is not available, then the UE shall:

- a) initiate UE-requested PDU session release procedure to release any PDU session associated with the S-NSSAI, if the UE is in 5GMM-CONNECTED mode or in 5GMM-CONNECTED mode with RRC inactive indication; or
- b) locally release any PDU session associated with the S-NSSAI, if the UE is in 5GMM-IDLE mode.

When the S-NSSAI time validity information in the AMF indicates that the S-NSSAI is not available, independent of whether the UE is in 5GMM-CONNECTED mode, 5GMM-CONNECTED mode with RRC inactive indication or in 5GMM-IDLE mode, the AMF shall request the SMF to release any PDU session associated with the S-NSSAI.

4.6.3.6 Session management for partial network slice

If the S-NSSAI is included in the partially allowed NSSAI and:

- a) if the current TAI is in the list of TAs for which the S-NSSAI is allowed, the UE may initiate the UE-requested PDU session establishment procedure for the S-NSSAI; or
- b) if the current TAI is not in the list of TAs for which the S-NSSAI is allowed, the UE shall not initiate the UE-requested PDU session establishment procedure for the S-NSSAI.

If an existing PDU session is established for the S-NSSAI included in the partially allowed NSSAI and the current TAI is in the list of TAs for which the S-NSSAI is allowed:

- a) the UE:
 - 1) may initiate the service request procedure to re-establish the user plane resources for the established PDU session; or
 - 2) may initiate either the UE-initiated NAS transport procedure to send CIoT user data to the SMF (see subclause 5.4.5.2.1 case h) or the service request procedure to send CIoT user data to the SMF (see subclause 5.6.1.1 case d); and
- b) the SMF may initiate the network-initiated NAS transport procedure to send CIoT user data to the UE (see subclause 5.4.5.3.1 case l).

If an existing PDU session is established for the S-NSSAI included in the partially allowed NSSAI and the current TAI is not in the list of TAs for which the S-NSSAI is allowed:

- a) the UE:
 - 1) shall maintain the 5GSM contexts for the established PDU session;
 - 2) shall not initiate the UE-initiated NAS transport procedure to send CIoT user data to the SMF (see subclause 5.4.5.2.1 case h) nor the service request procedure to send CIoT user data to the SMF (see subclause 5.6.1.1 case d); and
 - 3) may initiate:
 - i) the UE-requested PDU session release procedure; or
 - ii) the UE-requested PDU session modification procedure to set the 3GPP PS data off status to "deactivated" as specified in 3GPP TS 24.008 [13]; and
- b) the SMF:
 - 1) shall maintain the 5GSM contexts for the established PDU session;
 - 2) shall not initiate the network-initiated NAS transport procedure to send CIoT user data to the UE (see subclause 5.4.5.3.1 case l); and
 - 3) may initiate the network-requested PDU session release procedure.

If the SMF cannot determine that the UE is located in a TA within the list of TAs associated with the S-NSSAI of an existing PDU session established for this S-NSSAI, the SMF may according to operator's policy:

- a) attempt to establish the user plane resources for the PDU session; or
- b) initiate the network-initiated NAS transport procedure to send CIoT user data to the UE (see subclause 5.4.5.3.1 case l).

If the SMF determines that:

- a) the UE is located in a TA within the list of TAs associated with the S-NSSAI of an existing always-on PDU session;
- b) the UE is in 5GMM-CONNECTED mode; and
- c) the user-plane resources for the always-on PDU session are not established,

the SMF shall attempt to establish the user plane resources for the always-on PDU session associated with the S-NSSAI included in the partially allowed NSSAI.

NOTE: The session management for partial network slice is not applicable to the PDU session established for onboarding services in SNPN.

4.6.3.7 Session management aspect of handling network slices with NS-AoS not matching deployed tracking areas

If a UE is outside the NS-AoS of an S-NSSAI (see subclause 4.6.2.10), the UE shall not:

- a) attempt to request the establishment of user plane resources of any PDU session associated with the S-NSSAI; and
- b) initiate the UE-initiated NAS transport procedure to send CIoT user data to the SMF (see subclause 5.4.5.2.1 case h) nor the service request procedure to send CIoT user data to the SMF (see subclause 5.6.1.1 case d).

If a UE is outside the NS-AoS of an S-NSSAI (see subclause 4.6.2.10), the SMF shall not:

- a) attempt to establish user plane resources of any PDU session associated with the S-NSSAI; and
- b) initiate the network-initiated NAS transport procedure to send CIoT user data to the UE (see subclause 5.4.5.3.1 case l).

If a UE is outside the NS-AoS of an S-NSSAI (see subclause 4.6.2.10), the UE may initiate the UE-initiated NAS transport procedure carrying the following 5GSM messages for the PDU session associated with the S-NSSAI:

- a) a PDU SESSION RELEASE REQUEST message; or
- b) a PDU SESSION MODIFICATION REQUEST message to set the 3GPP PS data off status to "deactivated" as specified in 3GPP TS 24.008 [13].

NOTE: A PDU session associated with an S-NSSAI is not released solely because a UE is outside the NS-AoS of the S-NSSAI.

If the SMF cannot determine that the UE is located inside the NS-AoS of the S-NSSAI of an existing PDU session established for this S-NSSAI, the SMF may according to operator's policy:

- a) attempt to establish the user plane resources for the PDU session; or
- b) initiate the network-initiated NAS transport procedure to send CIoT user data to the UE (see subclause 5.4.5.3.1 case l).

If the SMF determines that:

- a) the UE is located inside the NS-AoS of the S-NSSAI of an existing always-on PDU session;
- b) the UE is in 5GMM-CONNECTED mode; and
- c) the user plane resources for the always-on PDU session are not established,

the SMF shall attempt to establish the user-plane resources for the always-on PDU session associated with the S-NSSAI with S-NSSAI location validity information.

4.7 NAS over non-3GPP access

4.7.1 General

From the UE's NAS perspective, in general the procedures and messages defined for 5GMM and 5GSM are used over non-3GPP access as over 3GPP access. However, a number of aspects are different as described in the following subclauses.

4.7.2 5GS mobility management aspects

4.7.2.1 General

The mobility management procedures defined over 3GPP access are re-used over non-3GPP access with the following exceptions:

- a) the registration status, and the 5GMM parameters of the UE's 3GPP access and non-3GPP access 5GMM state machine instances are independent in each of these accesses and can be different;
- b) single-registration mode and dual-registration mode do not apply for 5GMM over non-3GPP access;
- c) the RPLMN over non-3GPP access can be different from the RPLMN over 3GPP access. The MCC of the RPLMN over 3GPP access and the MCC of the RPLMN over the non-3GPP access can also be different;
- d) the registration for 3GPP access and for non-3GPP access are performed separately. Like for 3GPP access, an access stratum connection exists before the UE can perform the registration procedure for non-3GPP access. As at registration over non-3GPP access the UE is allocated a registration area, which is associated with a single TAI, list management of registration areas is not required, and registration updating due to registration area change with the registered PLMN is not performed. Furthermore, the registration procedure for periodic registration update is also not performed. New registration at change of PLMN is required;
- e) the 5GMM over non-3GPP access in the UE considers that the N1 NAS signalling connection is established when the lower layers indicate that the access stratum connection is established successfully;
- f) the UE-initiated service request procedure via non-3GPP access is supported. Upon indication from the lower layers of non-3GPP access, that the access stratum connection is established between the UE and the network, the UE in 5GMM-REGISTERED state and in 5GMM-IDLE mode over non-3GPP access shall initiate the service request procedure via non-3GPP access. The UE may indicate with the service request message the PDU session(s) associated with non-3GPP access to re-establish user-plane resources for which the UE has pending user data to be sent;
- g) paging procedure is not performed via non-3GPP access;
- h) service area restrictions do not apply for non-3GPP access other than the wireline access;
- i) the establishment cause for non-3GPP access is determined according to subclause 4.7.2.2;
- j) eCall inactivity procedure is not performed via non-3GPP access;
- k) local area data network (LADN) does not apply for non-3GPP access;
- l) the Allowed PDU session IE shall not be included in the REGISTRATION REQUEST message or the SERVICE REQUEST message sent over non-3GPP access;
- m) DRX parameters do not apply for non-3GPP access;
- n) Mobile initiated connection only mode (MICO) does not apply for non-3GPP access;
- o) CIoT 5GS optimizations do not apply for non-3GPP access;
- p) unified access control does not apply for non-3GPP access;
- q) UE radio capability signalling optimisation (RACS) does not apply for non-3GPP access;
- r) Closed access group (CAG) does not apply for non-3GPP access;
- s) the N1 NAS signalling connection release, the paging indication for voice services and reject the paging request do not apply for non-3GPP access. The Paging restriction IE shall not be included in the REGISTRATION REQUEST message, the SERVICE REQUEST message or the CONTROL PLANE SERVICE REQUEST message sent over non-3GPP access. The AMF shall not delete any stored paging restriction preferences for the UE and shall not stop restricting paging when receiving REGISTRATION REQUEST message, SERVICE REQUEST message or CONTROL PLANE SERVICE REQUEST message over non-3GPP access;
- t) the partially allowed NSSAI and the partially rejected NSSAI do not apply for non-3GPP access; and
- u) support for unavailability period (see subclause 5.3.26) does not apply for non-3GPP access.

4.7.2.2 Establishment cause for non-3GPP access

When establishment of an N1 NAS signalling connection over non-3GPP access is initiated, the UE shall:

- a) determine one or more access identities to be associated with the establishment of the N1 NAS signalling connection as specified in subclause 4.5.2 and table 4.5.2.1;
- b) select the establishment cause for non-3GPP access from the determined one or more access identities and the event which triggered initiation of the N1 NAS signalling connection over non-3GPP access by checking the rules specified in table 4.7.2.2.1; and
- c) provide the selected establishment cause for non-3GPP access to the lower layers.

While an MMTEL voice call is ongoing:

- any:
 - 1) service request procedure; or
 - 2) registration procedure;
 initiated in 5GMM-IDLE mode is mapped to "MO MMTel voice call" type access attempt.

While an MMTEL video call is ongoing and no MMTEL voice call is ongoing:

- any:
 - 1) service request procedure; or
 - 2) registration procedure;
 initiated in 5GMM-IDLE mode is mapped to "MO MMTel video call" type access attempt.

While an SMS over IP is ongoing, no MMTEL video call is ongoing and no MMTEL voice call is ongoing:

- any:
 - 1) service request procedure; or
 - 2) registration procedure;
 initiated in 5GMM-IDLE mode is mapped to "MO SMS over IP" type access attempt.

If the access attempt matches more than one rule, the establishment cause for non-3GPP access of the lowest rule number shall be used.

Table 4.7.2.2.1: Mapping table for determination of establishment cause for non-3GPP access

Rule #	Access identities	Type of access attempt	Requirements to be met	Establishment cause for non-3GPP access
1	1	Any	Any	mps-PriorityAccess
2	2	Any	Any	mcs-PriorityAccess
3	11, 15	Any	Any	highPriorityAccess
4	12,13,14,	Any	Any	highPriorityAccess
5	0	Emergency	UE is attempting access for an emergency session (NOTE 1)	emergency
		UE NAS initiated 5GMM specific procedures	Access attempt is for MO signalling	mo-Signalling
		UE NAS initiated 5GMM connection management procedures or 5GMM NAS transport procedure	Access attempt is for MO data	mo-Data
		MO SMS over NAS or MO SMS over IP	Access attempt is for MO SMS over NAS or MO SMS over IP	mo-SMS
		MO MMTel voice call	Access attempt is for MO MMTel voice call	mo-VoiceCall

		MO MMTel video call	Access attempt is for MO MMTel video call	mo-Videocall
NOTE 1: This includes 5GMM specific procedures while the service is ongoing and 5GMM connection management procedures required to establish a PDU session with request type = "initial emergency request" or "existing emergency PDU session", or to re-establish user-plane resources for such a PDU session.				
NOTE 2: See subclause 4.5.2, table 4.5.2.1 for use of the access identities of 0, 1, 2, and 11-15.				

4.7.3 5GS session management aspects

The session management procedures defined over 3GPP access are re-used over non-3GPP access with the following exceptions:

- a) Serving PLMN rate control does not apply for non-3GPP access;
- b) Small data rate control does not apply for non-3GPP access;
- c) Handling of 5GSM cause value #82 "maximum data rate per UE for user-plane integrity protection is too low" does not apply for non-3GPP access;
- d) MBS does not apply for non-3GPP access;
- e) Support of redundant PDU sessions does not apply for non-3GPP access; and
- f) PDU set handling does not apply for non-3GPP access.

4.7.4 Limited service state over non-3GPP access

There are a number of situations in which the UE is unable to obtain normal service from a PLMN over non-3GPP access and the UE enters the limited service state over non-3GPP access. These include:

- a) no USIM in the ME;
- b) an "illegal UE" or "illegal ME" is received when registration, network-initiated de-registration or service request is performed (any USIM in the ME is then considered "invalid");
- c) a "5GS services not allowed" is received when a registration, network-initiated de-registration or service request is performed;
- d) a "PLMN not allowed" is received when registration, network-initiated de-registration or service request is performed;
- e) a "Tracking area not allowed" is received when a registration, network-initiated de-registration or service request is performed;
- f) a "Roaming not allowed in this tracking area" is received when a registration, network-initiated de-registration or service request is performed;
- g) void; or
- h) a "Serving network not authorized" is received when a registration or service request is performed.

In limited service state with a valid USIM in the UE, the network selection is performed as defined in 3GPP TS 24.502 [18].

With the exception of performing initial registration for emergency services, no registration requests are made until a valid USIM is present. For registration for emergency services, the PLMN of the current N3IWF or TNGF is considered as the selected PLMN for the duration the UE is registered for emergency services.

4.7.5 NAS signalling using trusted WLAN access network

A trusted WLAN interworking function (TWIF) provides functionalities for a non-5G capable over WLAN (N5CW) device to access 5GCN, including:

- a) NAS signalling over N1 NAS signalling connection with AMF; and
- b) PDU session establishment, modification and release on behalf of the N5CW device, over N2 connection with the AMF.

The TWIF registers on behalf of the N5CW device to an AMF according to subclause 5.5.1 by populating the parameters for the registration by using implementation specific default values which are the same for N5CW devices.

The TWIF may request to establish a PDU session as specified in subclause 6.4.1.2 on behalf of the N5CW device upon receipt of an IP configuration request from the N5CW device by populating either all the required parameters or part of the required parameters for the PDU session establishment by using implementation specific default values from the TWIF's configuration. Only one PDU session is supported when N5CW device accessing 5GCN via the TWIF.

NOTE 1: If part of the required parameters for the PDU session establishment is provided by the TWIF, the remaining of the required parameters are determined by the AMF or the SMF based on the N5CW device's subscription information.

Upon loss of the IP address of the N5CW device, the TWIF acting on behalf of the N5CW device shall initiate the UE-requested PDU session release procedure as defined in subclause 6.4.3.

NOTE 2: The established PDU session on behalf of the N5CW device can be modified by the TWIF or the network.

4.8 Interworking with E-UTRAN connected to EPC

4.8.1 General

In order to interwork with E-UTRAN connected to EPC, the UE supporting both S1 mode and N1 mode can operate in single-registration mode or dual-registration mode (see 3GPP TS 23.501 [8]). Support of single-registration mode is mandatory for UEs supporting both S1 mode and N1 mode.

During the EPS attach procedure (see 3GPP TS 24.301 [15]) or initial registration procedure (see subclause 5.5.1.2), the mode for interworking is selected if the UE supports both S1 mode and N1 mode, and the network supports interworking. The mode for interworking may also be selected during the EPS tracking area updating procedure (see 3GPP TS 24.301 [15]) or registration procedure for mobility and periodic registration update (see subclause 5.5.1.3).

For interworking between E-UTRAN connected to EPC and TNGF or N3IWF connected to 5GCN, the UE shall operate as specified in either subclause 4.8.2.3 or subclause 4.8.3. Which subclause the UE follows is chosen by the UE irrespective of the interworking without N26 interface indicator.

4.8.2 Single-registration mode

4.8.2.1 General

If the UE receives the indication that "interworking without N26 interface not supported" (see 3GPP TS 24.301 [15]), the UE operates as described in subclause 4.8.2.2.

If the UE receives the indication that "interworking without N26 interface supported" and

- a) the UE does not support dual-registration mode; or
- b) the UE supporting dual-registration mode determines to operate in single-registration mode,

the UE operates as described in subclause 4.8.2.3.

4.8.2.2 Single-registration mode with N26 interface

See subclause 5.1.4.2 for coordination between 5GMM and EMM and subclause 6.1.4.1 for coordination between 5GSM and ESM.

4.8.2.3 Single-registration mode without N26 interface

4.8.2.3.1 Interworking between NG-RAN and E-UTRAN

At inter-system change from N1 mode to S1 mode in EMM-IDLE mode when:

- a) the UE supports non-IP PDN type and at least one PDU session of Unstructured PDU session type is active;
- b) the UE supports IPv4 PDN type and at least one PDU session of IPv4 PDU session type is active;
- c) the UE supports IPv6 PDN type and at least one PDU session of IPv6 PDU session type is active;
- d) the UE supports IPv4v6 PDN type and at least one PDU session of IPv4v6 PDU session type is active; or
- e) at least one PDU session of Ethernet PDU session type is active and:
 - 1) the UE supports non-IP PDN type; or
 - 2) the UE and the network support Ethernet PDN type in S1 mode;

the UE shall proceed as follows:

- a) if the UE supports sending an ATTACH REQUEST message containing a PDN CONNECTIVITY REQUEST message with request type set to "handover" or "handover of emergency bearer services" to transfer a PDU session from N1 mode to S1 mode and the UE has received an "interworking without N26 interface supported" indication from the network, the UE shall:
 - 1) enter substates EMM-DEREGISTERED.NORMAL-SERVICE and 5GMM- DEREGISTERED.NO-CELL-AVAILABLE for 3GPP access;

NOTE: Since MM context transfer is not possible between MME and AMF in a network that indicates "Interworking without N26 supported", it is up to the UE implementation as to how to keep the 5GMM and EMM states in the UE in sync.

- 2) map the PDU session(s) which the UE intends to transfer to EPS to the default EPS bearer context of the corresponding PDN connection(s) as specified in subclause 6.1.4.2; and
- 3) initiate an EPS attach procedure and include in the ATTACH REQUEST message a PDN CONNECTIVITY REQUEST message with:
 - the request type set to "handover of emergency bearer services" to activate a default EPS bearer context for an active emergency PDU session, if the session to be transferred is an emergency PDU session; or
 - the request type set to "handover" message to activate a default EPS bearer context for an active non-emergency PDU session, if the session to be transferred is a non-emergency PDU session. If the selected PDU session is an MA PDU session established over 3GPP access, the UE shall include the ATSSS request parameter in the Protocol configuration options IE or the Extended protocol configuration options IE of the ESM INFORMATION RESPONSE message.

After successful completion of the EPS attach procedure, the UE shall reset the registration attempt counter for 3GPP access and the attach attempt counter (see 3GPP TS 24.301 [15]), enter substates EMM-REGISTERED.NORMAL-SERVICE and 5GMM-REGISTERED.NO-CELL-AVAILABLE for 3GPP access and attempt to activate each of the other default EPS bearer contexts, if any, by initiating a stand-alone PDN connectivity procedure with request type set to "handover" for non-emergency PDU session or "handover of emergency bearer services" for emergency PDU session in the PDN CONNECTIVITY REQUEST message. If the EPS attach procedure is unsuccessful the UE shall enter substates EMM-DEREGISTERED.NORMAL-SERVICE and 5GMM-DEREGISTERED.NO-CELL-AVAILABLE for 3GPP access; and

- b) otherwise, enter substates EMM-REGISTERED.NORMAL-SERVICE and 5GMM-REGISTERED.NO-CELL-AVAILABLE for 3GPP access and initiate a tracking area update procedure (see 3GPP TS 24.301 [15]).

At inter-system change from N1 mode to S1 mode in EMM-IDLE mode when:

- a) the UE does not support non-IP PDN type or no PDU session of Unstructured PDU session type is active;
- b) the UE does not support IPv4 PDN type or no PDU session of IPv4 PDU session type is active;

- c) the UE does not support IPv6 PDN type or no PDU session of IPv6 PDU session type is active;
- d) the UE does not support IPv4v6 PDN type or no PDU session of IPv4v6 PDU session type is active; and
- e) no PDU session of Ethernet PDU session type is active or:
 - 1) the UE does not support non-IP PDN type; and
 - 2) the UE, the network or both do not support Ethernet PDN type in S1 mode;

the UE shall enter substates EMM-DEREGISTERED.NORMAL-SERVICE and 5GMM-DEREGISTERED.NO-CELL-AVAILABLE for 3GPP access, and initiate an attach procedure.

At inter-system change from S1 mode to N1 mode in 5GMM-IDLE mode, the UE shall:

- a) enter substate 5GMM-REGISTERED.NORMAL-SERVICE for 3GPP access and substate EMM-REGISTERED.NO-CELL-AVAILABLE;
- b) map the default EPS bearer context(s) of the PDN connection(s) which the UE intends to transfer to 5GS, if any, to the corresponding PDU session(s) as specified in subclause 6.1.4.2; and
- c) initiate the registration procedure for mobility and periodic registration update over 3GPP access indicating "mobility registration updating" in the 5GS registration type IE of the REGISTRATION REQUEST message (see subclause 5.5.1.3).

After having successfully registered in N1 mode over 3GPP access, the UE shall reset the registration attempt counter for 3GPP access, and the attach attempt counter or tracking area updating attempt counter (see 3GPP TS 24.301 [15]) and:

- a) if the UE supports the PDU session establishment procedure with request type set to "existing PDU session" or "existing emergency PDU session" to transfer a PDN connection from S1 mode to N1 mode and the UE has received an "interworking without N26 interface supported" indication from the network, attempt to transfer the PDN connection(s) which the UE intends to transfer to 5GS, if any, from S1 mode to N1 mode by:
 - if the PDN connection which the UE intends to transfer is a PDN connection for emergency bearer services, initiating the PDU session establishment procedure with request type set to "existing emergency PDU session" to transfer the PDN connection for emergency bearer services; and
 - if the PDN connection which the UE intends to transfer is a non-emergency PDN connection, initiating the PDU session establishment procedure with request type set to:
 - 1) "MA PDU request", if the PDN connection to be transferred is a user-plane resource of an MA PDU session; or
 - 2) "existing PDU session" to transfer the non-emergency PDN connection; and
- b) otherwise, establish PDU session(s) corresponding to the PDN connection(s) which the UE intends to transfer to 5GS, if any, by initiating the PDU session establishment procedure with request type set to "initial request".

See subclause 5.1.4.3 for coordination between 5GMM and EMM and subclause 6.1.4.2 for coordination between 5GSM and ESM.

4.8.2.3.2 Interworking between TNGF or N3IWF connected to 5GCN and E-UTRAN

If:

- a) the UE has registered in neither N1 mode over 3GPP access nor S1 mode yet; and
- b) the UE has at least one active PDU session associated with non-3GPP access which the UE intends to transfer to EPS,

the UE shall initiate an EPS attach procedure and include a PDN CONNECTIVITY REQUEST message with a request type in the ATTACH REQUEST message to activate a default EPS bearer context for one of the active PDU sessions which the UE intends to transfer to EPS (see 3GPP TS 24.301 [15]). The request type is set as follows:

- if the PDU session which the UE intends to transfer is a non-emergency PDU session, the request type is set to "handover"; and
- if the PDU session which the UE intends to transfer is an emergency PDU session, the request type is set to "handover of emergency bearer services" and the default bearer to be activated is the default EPS bearer context for the emergency PDU session.

NOTE 1: It is necessary for the UE to support sending an ATTACH REQUEST message containing a PDN CONNECTIVITY REQUEST message with request type set to "handover" or "handover of emergency bearer services" to transfer a PDU session from N1 mode to S1 mode for interworking between TNGF or N3IWF connected to 5GCN and E-UTRAN.

NOTE 2: The order of PDU sessions to be transferred to EPS is up to UE implementation.

After successful completion of the EPS attach procedure where the activated default EPS bearer context is not for emergency service, the UE shall initiate a UE requested PDN connectivity procedure with request type set to "handover" for non-emergency PDU session or "handover of emergency bearer services" for emergency PDU session in the PDN CONNECTIVITY REQUEST message to transfer each of the other PDU sessions which the UE intends to transfer to EPS, if any.

If:

- a) the UE has not registered in N1 mode over non-3GPP access yet; and
- b) the UE has at least one active PDN connection which the UE intends to transfer to TNGF or N3IWF connected to 5GCN,

the UE shall initiate an initial registration procedure over non-3GPP access (see subclause 5.5.1.2).

After successful completion of the 5GS initial registration in N1 mode over non-3GPP access, the UE shall initiate a UE-requested PDU session establishment procedure with a request type to transfer each of the PDN connections which the UE intends to transfer to TNGF or N3IWF connected to 5GCN, if any. The request type is set as follows:

- if the PDN connection which the UE intends to transfer is a PDN connection for emergency bearer services, the request type is set to "existing emergency PDU session" to transfer the PDN connection for emergency bearer services; and
- if the PDN connection which the UE intends to transfer is a non-emergency PDN connection, the request type is set to "existing PDU session" to transfer the non-emergency PDN connection.

NOTE 3: If the UE has no active PDU session associated with non-3GPP access which the UE in N1 mode intends to transfer to EPS or no active PDN connection associated with 3GPP access which the UE in S1 mode intends to transfer to TNGF or N3IWF connected to 5GCN, the interworking between TNGF or N3IWF connected to 5GCN and E-UTRAN is not supported.

See subclause 6.1.4.2 for coordination between 5GSM and ESM.

4.8.3 Dual-registration mode

If both 5GMM and EMM are enabled, a UE, operating in the dual-registration mode shall maintain independent contexts for 5GMM and EMM and this includes independent lists of equivalent PLMNs. Coordination between 5GMM and EMM is not needed, except as specified in the present subclause, subclause 5.1.5 and 5.3.13A.

For dual-registration mode the following applies:

- a) a UE operating in the dual-registration mode may register to N1 mode only, S1 mode only, or to both N1 mode and S1 mode;
- b) when the UE decides to operate in dual-registration mode (see subclause 5.5.1.2.4), NAS informs the lower layers about this;
- c) if a UE is registered in N1 mode only, then for registration in S1 mode the UE shall use:
 - 1) the same PLMN to which it is registered in N1 mode; or

- 2) an equivalent PLMN; and
- d) if a UE is registered in S1 mode only, then for registration in N1 mode the UE shall use:
 - 1) the same PLMN to which it is registered in S1 mode; or
 - 2) an equivalent PLMN.

NOTE 1: It is up to UE implementation how to handle the case when the UE is registered in both N1 mode and S1 mode and the PLMNs to which the UE is registered, are not equivalent, e.g. search for a PLMN which is the same or equivalent to any of the registered ones.

When no PDU session is active and the UE has not registered to S1 mode yet, the UE may initiate the EPS attach procedure with PDN connection establishment if EMM-REGISTERED without PDN connection is not supported by the MME. If EMM-REGISTERED without PDN connection is supported by the MME, the UE may initiate either the EPS attach procedure without PDN connection establishment or the attach procedure with PDN connection establishment.

When at least one PDU session is active and the UE has not registered to S1 mode yet, the UE may initiate the EPS attach procedure. If necessary, the UE may transfer an active PDU session from N1 mode to S1 mode by initiating the EPS attach procedure with request type set to "handover" in the PDN CONNECTIVITY REQUEST message. After successfully attached in S1 mode, if necessary, the UE may transfer other active PDU sessions from N1 mode to S1 mode by initiating the PDN connectivity procedure with request type set to "handover" in the PDN CONNECTIVITY REQUEST message.

NOTE 2: It is up to UE implementation to determine which active PDU session is transferred from N1 mode to S1 mode.

When the UE has not registered to N1 mode, the UE may initiate the initial registration procedure. After successfully registered in N1 mode, if necessary, the UE may transfer one or more active PDN connections from S1 mode to N1 mode by initiating the PDU session establishment procedure with request type set to "existing PDU session".

NOTE 3: It is up to UE implementation to determine which active PDN connection is transferred from S1 mode to N1 mode.

If the MME supports EMM-REGISTERED without PDN connection, the UE that transferred all PDN connections to the 5GS, may stay in state EMM-REGISTERED. Otherwise, the UE shall enter state EMM-DEREGISTERED upon transferring all PDN connection to the 5GS.

NOTE 4: When the UE has registered in both N1 mode and S1 mode, it is up to UE implementation to maintain the registration update to date in both N1 mode and S1 mode.

See subclause 6.1.4 for coordination between 5GSM and ESM.

See subclause 4.8.2.3.2 for interworking between TNGF or N3IWF connected to 5GCN and E-UTRAN.

4.8.4 Core Network selection for UEs not using CloT 5GS optimizations

If the UE is capable of both N1 mode and S1 mode, when the UE needs to use one or more functionalities not supported in 5GS but supported in EPS and the UE is in 5GMM-IDLE mode, the UE may disable the N1 mode capability for 3GPP access (see subclause 4.9.2).

If the UE is capable of both N1 mode and S1 mode and lower layers provide an indication that the current E-UTRA cell is connected to both EPC and 5GCN without also providing an indication that a target core network type was received from the NG-RAN, the UE shall select a core network type (EPC or 5GCN) based on the PLMN selection procedures as specified in 3GPP TS 23.122 [5] and provide the selected core network type information to the lower layer during the initial registration procedure.

If the UE is capable of both N1 mode and S1 mode and the lower layers have provided an indication that the current E-UTRA cell is connected to both EPC and 5GCN and an indication of whether the network supports IMS emergency services via either EPC or 5GCN or both (see 3GPP TS 36.331 [25A]), the UE selects a core network type (EPC or 5GCN) as specified in 3GPP TS 23.167 [6] annex H.2 for initiating emergency calls when in the state 5GMM-DEREGISTERED.LIMITED-SERVICE or EMM-DEREGISTERED.LIMITED-SERVICE.

NOTE 1: If the PLMN selection information provisioned in the USIM does not contain any prioritization between E-UTRAN and NG-RAN for a PLMN, which core network type to select for that PLMN is up to UE implementation.

If the UE is capable of both N1 mode and S1 mode and lower layers provide an indication that the current E-UTRA cell is connected to both EPC and 5GCN with:

- 1) an indication that target core network type EPC was received from the NG-RAN, the UE shall select the EPC and proceed with the appropriate EMM procedure as specified in 3GPP TS 24.301 [15]; or
- 2) an indication that target core network type 5GCN was received from the NG-RAN, the UE shall select the 5GCN and proceed with the appropriate 5GMM procedure.

NOTE 2: The NG-RAN can provide a target core network type to the UE during RRC connection release with redirection (see 3GPP TS 36.331 [25A] and 3GPP TS 38.331 [30]).

4.8.4A Core Network selection and redirection for UEs using CIoT optimizations

4.8.4A.1 Core network selection

A UE that supports CIoT optimizations performs core network selection (i.e. it selects EPC or 5GCN) if the lower layers have provided an indication that the current E-UTRA cell is connected to both EPC and 5GCN as specified in 3GPP TS 23.501 [8].

When selecting a PLMN as described in 3GPP TS 23.122 [5], the UE shall select a core network type (EPC or 5GCN) based on:

- a) indication from the lower layers about the CIoT EPS optimizations supported in EPC;
- b) indication from the lower layers about the CIoT 5GS optimizations supported in 5GCN;
- c) the CIoT EPS optimizations supported by the UE;
- d) the CIoT 5GS optimizations supported by the UE;
- e) the UE's preferred CIoT network behaviour for EPC; and
- f) the UE's preferred CIoT network behaviour for 5GCN.

The UE shall provide the selected core network type information to the lower layer during the initial registration procedure.

4.8.4A.2 Redirection of the UE by the core network

The network that supports CIoT optimizations can redirect a UE between EPC and 5GCN as specified in subclause 5.31.3 of 3GPP TS 23.501 [8]. The network can take into account the UE's N1 mode capability or S1 mode capability, the CIoT network behaviour supported and preferred by the UE or the CIoT network behaviour supported by the network to determine the redirection.

NOTE: It is assumed that the network would avoid redirecting the UE back and forth between EPC and 5GCN.

The network redirects the UE to EPC by rejecting the registration request or service request with the 5GMM cause #31 "Redirection to EPC required" as specified in subclause 5.5.1.2.5, 5.5.1.3.5 and 5.6.1.5. Upon receipt of reject message, the UE disables the N1 mode capability for 3GPP access as specified in subclause 4.9.2 and enables the E-UTRA capability if it was disabled in order to move to EPC.

When there is no ongoing registration procedure or service request procedure for a UE in 5GMM-CONNECTED mode, if the AMF determines to redirect the UE to EPC, the AMF shall initiate the generic UE configuration update procedure to indicate registration requested and release of the N1 NAS signalling connection not requested as described in subclause 5.4.4. The network then redirects the UE to EPC by rejecting the registration request as specified in subclause 5.5.1.3.5.

The network that supports CIoT optimizations can also redirect a UE from EPC to 5GCN as specified in subclause 5.3.19.2 of 3GPP TS 24.301 [15].

4.9 Disabling and re-enabling of UE's N1 mode capability

4.9.1 General

The UE shall re-enable the N1 mode capability when the UE powers off and powers on again, the USIM is removed or an entry of the "list of subscriber data" with the SNPN identity of the SNPN is updated.

4.9.2 Disabling and re-enabling of UE's N1 mode capability for 3GPP access

The UE shall only disable the N1 mode capability for 3GPP access when in 5GMM-IDLE mode.

When the UE is disabling the N1 mode capability for 3GPP access for a PLMN not due to redirection to EPC, it should proceed as follows:

- a) select an E-UTRA cell connected to EPC, or for the UE which supports CIoT EPS optimization select a satellite E-UTRA cell connected to EPC via "WB-E-UTRAN(LEO)", "WB-E-UTRAN(MEO)", or "WB-E-UTRAN(GEO)", of the registered PLMN or a PLMN from the list of equivalent PLMNs, if the UE supports S1 mode and the UE has not disabled its E-UTRA capability as specified in 3GPP TS 24.301 [15];
- b) if an E-UTRA cell connected to EPC, or for the UE which supports CIoT EPS optimization if a satellite E-UTRA cell connected to EPC via "WB-E-UTRAN(LEO)", "WB-E-UTRAN(MEO)", or "WB-E-UTRAN(GEO)", of the registered PLMN or a PLMN from the list of equivalent PLMNs cannot be found, the UE does not support S1 mode or the UE has disabled its E-UTRA capability as specified in 3GPP TS 24.301 [15], the UE may select another RAT of the registered PLMN or a PLMN from the list of equivalent PLMNs that the UE supports;
- c) if another RAT of the registered PLMN or a PLMN from the list of equivalent PLMNs cannot be found, then enter the state 5GMM-REGISTERED.PLMN-SEARCH or 5GMM-DEREGISTERED.PLMN-SEARCH, or the UE does not have a registered PLMN, then enter the state 5GMM-DEREGISTERED.PLMN-SEARCH and perform PLMN selection as specified in 3GPP TS 23.122 [5]. If disabling of the N1 mode capability for 3GPP access was not due to a UE-initiated de-registration procedure for 5GS services over 3GPP access not due to switch-off, the UE may re-enable the N1 capability for this PLMN selection. As an implementation option, if the UE does not have a registered PLMN, instead of performing PLMN selection, the UE may select another RAT of the selected PLMN if the UE has chosen a PLMN and the RAT is supported by the UE; or
- d) if no other allowed PLMN and RAT combinations are available, then the UE may re-enable the N1 mode capability for 3GPP access and indicate to lower layers to remain camped in NG-RAN or satellite NG-RAN of the registered PLMN, and may periodically scan for another PLMN and RAT combination which can provide EPS services or non-EPS services (if the UE supports EPS services or non-EPS services). How this periodic scanning is done, is UE implementation dependent.

When the UE is disabling the N1 mode capability for 3GPP access for an SNPN, it should proceed as follows:

- a) enter the state 5GMM-REGISTERED.PLMN-SEARCH or 5GMM-DEREGISTERED.PLMN-SEARCH and perform SNPN selection as specified in 3GPP TS 23.122 [5]. If disabling of the N1 mode capability for 3GPP access was not due to a UE-initiated de-registration procedure for 5GS services over 3GPP access not due to switch-off, the UE may re-enable the N1 capability for this SNPN selection; or
- b) if no other SNPN is available, then the UE may re-enable the N1 mode capability for 3GPP access and indicate to lower layers to remain camped in NG-RAN of the registered SNPN.

When the UE is disabling the N1 mode capability upon receiving cause value #31 "Redirection to EPC required" as specified in subclauses 5.5.1.2.5, 5.5.1.3.5 and 5.6.1.5, it should proceed as follows:

- a) If the UE is in NB-N1 mode:

- 1) if lower layers do not provide an indication that the current E-UTRA cell is connected to EPC or lower layers do not provide an indication that the current E-UTRA cell supports CIoT EPS optimizations that are supported by the UE, search for a suitable NB-IoT cell connected to EPC according to 3GPP TS 36.304 [25C];
 - 2) if lower layers provide an indication that the current E-UTRA cell is connected to EPC and the current E-UTRA cell supports CIoT EPS optimizations that are supported by the UE, perform a core network selection to select EPC as specified in subclause 4.8.4A.1; or
 - 3) if lower layers cannot find a suitable NB-IoT cell connected to EPC or there is no suitable NB-IoT cell connected to EPC which supports CIoT EPS optimizations that are supported by the UE, the UE, as an implementation option, may indicate to lower layers to remain camped in E-UTRA cell connected to 5GCN, may then start an implementation-specific timer and enter the state 5GMM-REGISTERED.LIMITED-SERVICE. The UE may re-enable the N1 mode capability for 3GPP access at expiry of the implementation-specific timer, if the timer had been started, and may then proceed with the appropriate 5GMM procedure.
- b) If the UE is in WB-N1 mode:
- 1) if lower layers do not provide an indication that the current E-UTRA cell is connected to EPC or lower layers do not provide an indication that the current E-UTRA cell supports CIoT EPS optimizations that are supported by the UE, search for a suitable E-UTRA cell connected to EPC, or for the UE which supports CIoT EPS optimization select a satellite E-UTRA cell connected to EPC via "WB-E-UTRAN(LEO)", "WB-E-UTRAN(MEO)", or "WB-E-UTRAN(GEO)", according to 3GPP TS 36.304 [25C];
 - 2) if lower layers provide an indication that the current E-UTRA cell is connected to EPC and the current E-UTRA cell supports CIoT EPS optimizations that are supported by the UE, then perform a core network selection to select EPC as specified in subclause 4.8.4A.1; or
 - 3) if lower layers cannot find a suitable E-UTRA cell connected to EPC, or if the lower layers cannot find a suitable satellite E-UTRA cell via "WB-E-UTRAN(LEO)", "WB-E-UTRAN(MEO)", or "WB-E-UTRAN(GEO)", or there is no suitable E-UTRA cell connected to EPC, or there is no suitable satellite E-UTRA cell connected to EPC via "WB-E-UTRAN(LEO)", "WB-E-UTRAN(MEO)", or "WB-E-UTRAN(GEO)", which supports CIoT EPS optimizations that are supported by the UE, the UE, as an implementation option, may indicate to lower layers to remain camped in E-UTRA cell connected to 5GCN, may then start an implementation-specific timer and enter the state 5GMM-REGISTERED.LIMITED-SERVICE. The UE may re-enable the N1 mode capability for 3GPP access at expiry of the implementation-specific timer, if the timer had been started, and may then proceed with the appropriate 5GMM procedure.

When the UE supporting both N1 mode and S1 mode needs to stay in E-UTRA connected to EPC (e.g. due to the domain selection for UE originating sessions as specified in subclause 4.3.2), in order to prevent unintentional handover or cell reselection from E-UTRA connected to EPC to NG-RAN connected to 5GCN, the UE operating in single-registration mode shall disable the N1 mode capability for 3GPP access and:

- a) shall set the N1mode bit to "N1 mode for 3GPP access not supported" in the UE network capability IE (see 3GPP TS 24.301 [15]) of the ATTACH REQUEST message and the TRACKING AREA UPDATE REQUEST message in EPC; and
- b) the UE NAS layer shall indicate the access stratum layer(s) of disabling of the N1 mode capability for 3GPP access.

If the UE is required to disable the N1 mode capability for 3GPP access and select E-UTRA or another RAT, and the UE is in the 5GMM-CONNECTED mode,

- if the UE has a persistent PDU session, then the UE waits until the radio bearer associated with the persistent PDU session has been released;
- otherwise the UE shall locally release the established NAS signalling connection;

and enter the 5GMM-IDLE mode before selecting E-UTRA or another RAT.

If the UE is disabling its N1 mode capability for 3GPP access before selecting E-UTRA or another RAT, the UE shall not perform the UE-initiated de-registration procedure of subclause 5.5.2.2.

The UE shall re-enable the N1 mode capability for 3GPP access when the UE performs PLMN selection, SNPN selection or SNPN selection for onboarding services over 3GPP access, unless:

- a) disabling of the N1 mode capability for 3GPP access was due to a UE-initiated de-registration procedure for 5GS services over 3GPP access not due to switch-off;
- b) the UE has already re-enabled the N1 mode capability for 3GPP access when performing items c) or d) above; or
- c) the UE disables the N1 mode capability for 3GPP access for cases described in subclauses 5.5.1.2.7 and 5.5.1.3.7.

If the disabling of N1 mode capability for 3GPP access was due to IMS voice is not available over 3GPP access and the UE's usage setting is "voice centric", the UE shall re-enable the N1 mode capability for 3GPP access when the UE's usage setting is changed from "voice centric" to "data centric", as specified in subclauses 4.3.3.

The UE should memorize the identity of the PLMN or SNPN where N1 mode capability for 3GPP access was disabled and should use that stored information in subsequent PLMN or SNPN selections as specified in 3GPP TS 23.122 [5].

If the disabling of N1 mode capability for 3GPP access was due to successful completion of an emergency services fallback, the criteria to enable the N1 mode capability again are UE implementation specific.

The UE shall disable the N1 mode capability for 3GPP access if requested by the upper layers (e.g. see subclause U.2.2.6.4 in 3GPP TS 24.229 [14]). If the UE disabled the N1 mode capability for 3GPP access based on the request from the upper layers (e.g. see subclause U.2.2.6.4 in 3GPP TS 24.229 [14]), the criteria to re-enable the N1 mode capability for 3GPP access after the completion of an emergency service are UE implementation specific.

If the N1 mode capability for 3GPP access was disabled due to the UE initiated de-registration procedure for 3GPP access or for 3GPP access and non-3GPP access and the UE is operating in single-registration mode (see subclause 5.5.2.2.3), upon request of the upper layers to re-register for 5GS services over 3GPP access or the UE needs to come out of unavailability period and resume normal services, the UE shall enable the N1 mode capability for 3GPP access again.

As an implementation option, the UE may start a timer for enabling the N1 mode capability for 3GPP access when the UE disables the N1 mode capability for 3GPP access. The UE should memorize the identity of the PLMNs or SNPNS where N1 mode capability for 3GPP access was disabled. On expiry of this timer:

- a) if the UE is in Iu mode or A/Gb mode and is in idle mode as specified in 3GPP TS 24.008 [13], the UE should enable the N1 mode capability for 3GPP access;
- b) if the UE is in Iu mode and a PS signalling connection exists, but no RR connection exists, the UE may abort the PS signalling connection before enabling the N1 mode capability for 3GPP access;
- c) if the UE is in S1 mode and is in EMM-IDLE mode as specified in 3GPP TS 24.301 [15], the UE should enable the N1 mode capability for 3GPP access; and
- d) If the UE is in Iu mode or A/Gb mode and an RR connection exists, the UE should delay enabling the N1 mode capability for 3GPP access until the RR connection is released. If the UE is in S1 mode and is in EMM-CONNECTED mode as specified in 3GPP TS 24.301 [15], the UE should delay enabling the N1 mode capability for 3GPP access until the NAS signalling connection in S1 mode is released.

When the UE enables the N1 mode capability for 3GPP access, the UE shall remove the PLMN or SNPN from the memorized identity of the PLMNs or SNPNS where N1 mode capability for 3GPP access was disabled.

NOTE 1: As described in 3GPP TS 23.122 [5], if the UE is in automatic PLMN selection mode or automatic SNPN selection mode, the UE does not consider the memorized PLMNs as PLMN selection candidates for NG-RAN access technology or satellite NG-RAN access technology or the memorized SNPN as SNPN selection candidates till the timer expires.

The UE may disable the N1 mode capability for currently camped PLMN or SNPN over 3GPP access (see 3GPP TS 23.122 [5]) if no network slice is available for the camped PLMN or SNPN (see subclauses 5.5.1.2.5 and 5.5.1.3.5). If the disabling of N1 mode capability for 3GPP access was due to no network slices available, the UE should memorize the identity of the PLMN or SNPN where N1 mode is disabled due to no available network slices or the list of SNPNS where N1 mode is disabled due to no available network slices, respectively. As an implementation option, the UE may start a timer T_{NSU} for enabling the N1 mode capability that was disabled due to no available

network slices for the 3GPP access. The value of timer T_{NSU} is UE implementation specific. The UE should remove the memorized identity of the PLMNs or SNPNs where N1 mode is disabled due to no available network slice upon:

- a) the expiry of the timer T_{NSU} ; or
- b) receiving REGISTRATION ACCEPT message containing the Network slicing indication IE with the Network slicing subscription change indication set to "Network slicing subscription changed".

NOTE 1A: If a network slice is temporarily unavailable to the UE due to the S-NSSAI time validity information or the S-NSSAI location validity information as described in subclauses 4.6.2.8 and 4.6.2.10 respectively, and no other network slice is available to the UE for the camped PLMN or SNPN, as an implementation option the UE can keep the N1 mode capability enabled for currently camped PLMN or SNPN over 3GPP access.

If the UE receives ACTIVATE DEFAULT EPS BEARER CONTEXT REQUEST message provided with S-NSSAI and the PLMN ID in the Protocol configuration options IE or Extended protocol configuration options IE (see subclause 6.5.1.3 of 3GPP TS 24.301 [15]), the UE may remove the PLMN ID from the memorized identity of the PLMNs where N1 mode is disabled due to no available network slices.

If the UE attempts to establish an emergency PDU session in a PLMN or SNPN where N1 mode capability was disabled due to the UE's registration attempt counter have reached 5, the UE may enable N1 mode capability for that PLMN memorized by the UE.

NOTE 2: If N1 mode capability is disabled due to the UE's registration attempt counter reaches 5, the value of the timer for re-enabling N1 mode capability is recommended to be the same as the value of T_{3502} which follows the handling specified in subclause 5.3.8. If the value of T_{3502} is indicated as zero by the network, an implementation specific non-zero value can be used for the timer for re-enabling N1 mode capability.

If the UE supports access to an SNPN providing access for localized services in SNPN and access for localized services in SNPN is enabled, then:

- the UE may re-enable the N1 mode capability for 3GPP access if disabled for that SNPN when:
 - 1) the validity information of the SNPN contained in the "credentials holder controlled prioritized list of preferred SNPNs for access for localized services in SNPN" changes from not met to met; or
 - 2) the validity information of a GIN broadcasted by an SNPN contained in the "credentials holder controlled prioritized list of preferred GINs for access for localized services in SNPN" changes from not met to met; and
- the UE need not re-enable N1 mode capability for 3GPP access for that SNPN if the N1 mode capability for 3GPP access for that SNPN was disabled due to 5GMM cause value #27 (N1 mode not allowed).

NOTE 3: If the UE receives a reject message with a 5GMM cause value and the N1 mode capability is disabled again for the SNPN, it is up to UE implementation whether to re-enable N1 mode capability for the SNPN if the validity information of the SNPN is still met.

4.9.3 Disabling and re-enabling of UE's N1 mode capability for non-3GPP access

When the UE disables the N1 mode capability for non-3GPP access, the UE NAS layer shall not initiate any 5GS NAS procedures towards the network over non-3GPP access.

When the UE supporting both N1 mode and S1 mode needs to stay in non-3GPP access connected to EPC (e.g. due to the domain selection for UE originating sessions as specified in subclause 4.3.2), in order to prevent unintentional selection of a non-3GPP access network connected to 5GCN, the UE operating in single-registration mode shall not transfer any PDN connection to a non-3GPP access network connected to the 5GCN.

If the disabling of N1 mode capability for non-3GPP access was due to IMS voice is not available over non-3GPP access in 5GS and the UE's usage setting is "voice centric", the UE shall re-enable the N1 mode capability for non-3GPP access when the UE's usage setting is changed from "voice centric" to "data centric" as specified in subclauses 4.3.3.

The UE shall re-enable the N1 mode capability for non-3GPP access when a new PLMN or SNPN is selected over non-3GPP access.

The UE may disable the N1 mode capability for the currently camped PLMN or SNPN over non-3GPP access if no network slice is available for the camped PLMN or SNPN.

As an implementation option, the UE may start a timer for re-enabling the N1 mode capability for non-3GPP access, after the N1 mode capability for non-3GPP access was disabled. On the expiry of this timer, the UE should re-enable the N1 mode capability for non-3GPP access.

4.9.4 Disabling and re-enabling of UE's satellite NG-RAN capability

Disable of the satellite NG-RAN capability shall only be performed when the UE is in 5GMM-IDLE mode.

When disabling the satellite NG-RAN capability, the UE:

- a) may disable the NR NTN access capability (see 3GPP TS 38.304 [28] and 3GPP TS 38.306 [28A]);
- b) shall memorize the identity of the PLMN where the satellite NG-RAN capability was disabled; and
- c) shall use that stored information in subsequent PLMN selections as specified in 3GPP TS 23.122 [6].

NOTE: As an implementation option, the UE can disable satellite NG-RAN capability by disabling N1 mode capability for satellite NG-RAN access.

As an implementation option, the UE may start a timer for enabling satellite NG-RAN capability and on expiry of this timer UE shall remove the PLMN from the memorized identity of the PLMNs where the satellite NG-RAN capability was disabled.

4.10 Interworking with ePDG connected to EPC

In order to interwork with ePDG connected to EPC, the UE shall operate as specified in either subclause 4.8.2.3 or subclause 4.8.3. Which subclause the UE follows is chosen by the UE irrespective of the interworking without N26 interface indicator.

The UE shall not attempt to transfer PDU sessions with PDU session type "Ethernet" or "Unstructured" to an ePDG connected to EPC.

NOTE 1: PDU sessions with PDU session type "Ethernet" or "Unstructured" cannot be transferred to an ePDG connected to EPC because PDN connections with PDN type "non-IP" or PDN type "Ethernet" are not supported over ePDG connected to EPC.

The UE shall not attempt to transfer PDU sessions with the selected SSC mode set to "SSC mode 2" or "SSC mode 3" to an ePDG connected to EPC.

NOTE 2: Interworking between N1 mode over non-3GPP access and ePDG connected to EPC is not specified in this release of the specification.

4.11 UE configuration parameter updates

The 5GS in a PLMN supports updating UE parameters via NAS signalling. The feature enables the HPLMN to securely and dynamically re-configure the UE configuration parameters stored on the USIM and the ME.

- In this release of the specification, updates of the following USIM configuration parameters are supported:
 - routing indicator.
- In this release of specification, updates of the following ME configuration parameters are supported:
 - default configured NSSAI.
 - disaster roaming information.

The 5GS in an SNPN supports updating UE parameters via NAS signalling. The feature enables the SNPN to securely and dynamically re-configure the UE configuration parameter stored on the USIM if the UE used the USIM for registration to the SNPN.

- In this release of the specification, updates of the following USIM configuration parameters are supported:
 - routing indicator.
- In this release of specification, updates of the following ME configuration parameters are supported:
 - routing indicator.
 - default configured NSSAI.

The update of UE configuration parameters is initiated by the network using the network-initiated downlink NAS transport procedure as described in subclause 5.4.5.3. The ME acknowledgement of successful reception of the updated UE configuration parameter information is sent back to the network using the UE-initiated uplink NAS transport procedure as described in subclause 5.4.5.2.

4.12 Access traffic steering, switching and splitting (ATSSS)

The ATSSS feature is an optional feature that may be supported by the UE and the 5GCN.

The ATSSS feature enables a multi-access PDU connectivity service, which can exchange PDUs between the UE and a data network by simultaneously using one 3GPP access network and one non-3GPP access network. The multi-access PDU connectivity service is realized by establishing a multi-access PDU session, i.e. a PDU session that can have user-plane resources on two access networks.

NOTE 1: MA PDU session is not applicable for CIoT 5GS optimization in this release of specification.

The UE can request an MA PDU session when the UE is registered via both 3GPP and non-3GPP accesses, or when the UE is registered via one access only. The MA PDU session management is performed based on the PDU session management procedures.

The detailed description of the procedures for ATSSS between the UE and the network across one 3GPP access network and one non-3GPP access network are specified in 3GPP TS 24.193 [13B].

NOTE 2: In this version of the specification, PDU set handling is not supported in an MA PDU session.

4.13 Support of NAS signalling using wireline access network

A 5G-RG, a W-AGF acting on behalf of an FN-RG or a W-AGF acting on behalf of an N5GC device can use wireline access network to access the 5GCN by using NAS signalling procedures as described in 3GPP TS 23.501 [8], 3GPP TS 23.502 [9] and 3GPP TS 23.316 [6D].

Wireline access is a type of non-3GPP access.

A 5G-RG simultaneously connected to the same 5GCN of a PLMN over a 3GPP access and a wireline access is connected to a single AMF.

5G-RG maintains the N1 NAS signalling connection with the AMF over the wireline access network after all the PDU sessions for the 5G-RG over that access have been released or handed over to 3GPP access.

The 5G-RG connected to 5GCN via NG-RAN is specified in 3GPP TS 23.316 [6D].

When accessing the 5GCN over 3GPP access, in addition to requirements specified for the 5G-RG in the present document, the 5G-RG shall also perform requirements specified in the present document for a UE accessing 5GCN over 3GPP access. When accessing the 5GCN over wireline access, in addition to requirements specified for the 5G-RG in the present document, the 5G-RG shall also perform requirements specified in the present document for a UE accessing 5GCN over non-3GPP access. If a requirement specified for the 5G-RG in the present document contradicts a requirement specified for the UE in the present document, the 5G-RG shall perform the requirement specified in the present document for the 5G-RG.

For the scenario of FN-RG, which does not support N1 mode, the W-AGF acting on behalf of the FN-RG exchanges NAS signalling messages with an AMF.

For the scenario of N5GC device, which does not support N1 mode, the W-AGF acting on behalf of the N5GC device exchanges NAS signalling messages with an AMF.

For the scenario of AUN3 device, which does not support N1 mode, the 5G-RG acting on behalf of the AUN3 device exchanges NAS signalling messages with an AMF. If the 5G-RG is not registered and connected to the 5GCN over wireline access, the 5G-RG acting on behalf of an AUN3 device shall not initiate the initial registration procedure on behalf of the AUN3 device.

NOTE 1: The 5G-RG acting on behalf of an AUN3 device maintains a 5GMM context for each AUN3 device behind it. The AMF maintains a 5GMM context for each AUN3 device. The AMF is not aware of any association between the 5GMM context of the 5G-RG and the 5GMM context of the AUN3 device.

When the 5G-RG acting on behalf of an AUN3 device initiates the initial registration procedure on behalf of the AUN3 device, the 5G-RG shall not include the requested NSSAI in the REGISTRATION REQUEST message.

For the scenario of NAUN3 device, which does not support N1 mode, the 5G-RG acting on behalf of a connectivity group consisting of one or more NAUN3 devices exchanges NAS signalling messages with an AMF.

NOTE 2: It is also possible for 5G-RG that is connected to 5GCN via NG-RAN to act on behalf of a connectivity group consisting of one or more NAUN3 devices as specified in 3GPP TS 23.316 [6D].

In addition to requirements specified for the W-AGF acting on behalf of the FN-RG (or on behalf of the N5GC device) in the present document, the W-AGF acting on behalf of the FN-RG (or on behalf of the N5GC device) shall also perform requirements specified in the present document for a UE accessing 5GCN over non-3GPP access. If a requirement specified for the W-AGF acting on behalf of the FN-RG (or on behalf of the N5GC device) in the present document contradicts a requirement specified for the UE in the present document, the W-AGF acting on behalf of the FN-RG (or on behalf of the N5GC device) shall perform requirement specified in the present document for the W-AGF acting on behalf of the FN-RG (or on behalf of the N5GC device).

The PDU session authentication and authorization procedure is not supported in a PDU session established by the W-AGF acting on behalf of the FN-RG or on behalf of the N5GC device.

The W-AGF acting on behalf of the N5GC device requests the establishment of a PDU Session on behalf of the N5GC device upon registration. Only one PDU session per N5GC device is supported.

The 5G-RG acting on behalf of an AUN3 device requests the establishment of a PDU Session on behalf of the AUN3 device upon registration. Only one PDU session per AUN3 is supported.

The 5G-RG acting on behalf of a connectivity group consisting of one or more NAUN3 devices requests the establishment of a PDU Session on behalf of the connectivity group. Only one PDU session per the connectivity group is supported, where all the NAUN3 devices in the connectivity group share the same PDU session.

A 5G-RG or an FN-RG provide a non-3GPP access network to UEs. A UE connected to a non-3GPP access network provided by the 5G-RG or the FN-RG can access to the 5GCN via the N3IWF or via the TNGF as described in 3GPP TS 23.316 [6D].

The 5G-RG or the W-AGF acting on behalf of the FN-RG shall indicate "ANDSP not supported by the UE" in the UE policy classmark IE during the UE-initiated UE state indication procedure as specified in subclause D.2.2.

The 5G-RG or the W-AGF acting on behalf of the FN-RG shall indicate "Reporting URSP rule enforcement not supported by the UE" in the UE policy classmark IE during the UE-initiated UE state indication procedure as specified in subclause D.2.2.

The Non-3GPP QoS Assistance Information (N3QAI) is introduced to enable a 5G-RG to perform the QoS differentiation for the UE behind the 5G-RG, the AUN3 device behind the 5G-RG or the NAUN3 device behind the 5G-RG. The network may provide the N3QAI associated with the QoS flow during the PDU session establishment procedure as defined in subclause 6.4.1 or during the PDU session modification procedure as defined in subclause 6.4.2.

NOTE 3: How the 5G-RG applies N3QAI is outside the scope of the present document.

If the AMF receives an indication from the W-AGF that there is no 5G-RG connected to the same wireline for an AUN3 device as specified in 3GPP TS 23.316 [6D], the AMF shall locally de-register the AUN3 device.

4.14 Non-public network (NPN)

4.14.1 General

Two types of NPN can be deployed using 5GS: SNPN (see subclause 4.14.2) and PNI-NPN (see subclause 4.14.3).

4.14.2 Stand-alone non-public network (SNPN)

If the UE is not SNPN enabled, the UE is always considered to be not operating in SNPN access operation mode. If the UE is SNPN enabled, the UE can operate in SNPN access operation mode. Details of activation and deactivation of SNPN access operation mode at the SNPN-enabled UE are up to UE implementation.

The functions and procedures of NAS described in the present document are applicable to an SNPN and an SNPN-enabled UE unless indicated otherwise. The key differences brought by the SNPN to the NAS layer are as follows:

- a) instead of the PLMN selection process, the SNPN selection process is performed by a UE operating in SNPN access operation mode (see 3GPP TS 23.122 [5] and 3GPP TS 24.502 [18] for further details on the SNPN selection);
- b) a "permanently forbidden SNPNs" list and a "temporarily forbidden SNPNs" list are managed per access type independently (i.e. 3GPP access or non-3GPP access) and, if the UE supports access to an SNPN using credentials from a credentials holder, equivalent SNPNs or both, per entry of the "list of subscriber data" or, if the UE supports access to an SNPN using credentials from a credentials holder, per the PLMN subscription, by a UE operating in SNPN access operation mode instead of forbidden PLMN lists. If the UE supports onboarding services in SNPN, an additional "permanently forbidden SNPNs for onboarding services in SNPN" list and an additional "temporarily forbidden SNPNs for onboarding services in SNPN" list are managed. If the UE supports access to an SNPN providing access for localized services in SNPN, an additional "permanently forbidden SNPNs for access for localized services in SNPN" list and an additional "temporarily forbidden SNPNs for access for localized services in SNPN" list per entry of the "list of subscriber data" and per the PLMN subscription are managed for 3GPP access only. These lists shall be maintained across activation and deactivation of SNPN access operation mode;

NOTE 0: On timer T3245 expiry when the UE supports access to an SNPN using credentials from a credentials holder using PLMN subscription, and the UE is not operating in SNPN access operation mode, as an implementation option the UE can delete the list of "temporarily forbidden SNPNs" and "permanently forbidden SNPNs" and additionally the list of "permanently forbidden SNPNs for access for localized services in SNPN" and list of "temporarily forbidden SNPNs for access for localized services in SNPN" if the UE supports access to an SNPN providing access for localized services in SNPN.

- c) inter-system change to and from S1 mode is not supported;
- d) void;
- e) CAG is not supported in SNPN access operation mode;
- f) with respect to the 5GMM cause values:
 - 1) 5GMM cause values #74 "Temporarily not authorized for this SNPN" and #75 "Permanently not authorized for this SNPN" are supported whereas these 5GMM cause values cannot be used in a PLMN; and
 - 2) 5GMM cause values #11 "PLMN not allowed", #31 "Redirection to EPC required", #73 "Serving network not authorized", and #76 "Not authorized for this CAG or authorized for CAG cells only" are not supported whereas these 5GMM cause values can be used in a PLMN;
- g) a list of "5GS forbidden tracking areas for roaming" and a list of "5GS forbidden tracking areas for regional provision of service" are managed per SNPN and, if the UE supports access to an SNPN using credentials from a credentials holder, equivalent SNPNs or both, entry of the "list of subscriber data" or, if the UE supports access to an SNPN using credentials from a credentials holder, PLMN subscription (see 3GPP TS 23.122 [5]);
- h) when accessing SNPN services via a PLMN using 3GPP access, access to 5GCN of the SNPN is performed using 5GMM procedures for non-3GPP access, 5GMM parameters for non-3GPP access, the UE is performing access to SNPN over non-3GPP access and the UE is not operating in SNPN access operation mode over 3GPP access. When accessing PLMN services via a SNPN using 3GPP access, access to 5GCN of the PLMN is

performed using 5GMM procedures for non-3GPP access, 5GMM parameters for non-3GPP access, the UE is not performing access to SNPN over non-3GPP access, and the UE is operating in SNPN access operation mode over 3GPP access. From the UE's NAS perspective, accessing PLMN services via an SNPN and accessing SNPN services via a PLMN are treated as untrusted non-3GPP access. If the UE is accessing the PLMN using non-3GPP access, the access to 5GCN of the SNPN via PLMN is not specified in this release of the specification.

Emergency services are not supported in an SNPN when a UE accesses SNPN services via a PLMN;

- i) when registered to an SNPN, the UE shall use only the UE policies provided by the registered SNPN;
- j) inclusion of a TAI of an SNPN other than the registered SNPN, into the registration area is not supported. The AMF of an SNPN shall only include into the registration area one or more TAIs of the registered SNPN;
- j1) inclusion of a TAI of an SNPN other than the registered SNPN, into the LADN service area is not supported. The AMF of an SNPN shall only include one or more TAIs of the registered SNPN into the LADN service area;
- j2) inclusion of a TAI of an SNPN other than the registered SNPN, into the allowed area or the non-allowed area, of the 3GPP access service area restrictions is not supported. The AMF of an SNPN shall include only one or more TAIs of the registered SNPN into the allowed area or the non-allowed area, of the 3GPP access service area restrictions;
- k) void;
- l) void;
- m) UE mobility between SNPNs in 5GMM-CONNECTED mode is supported when the SNPNs are equivalent SNPNs for the selected entry of the "list of subscriber data" or the selected PLMN subscription. UE mobility between SNPNs in 5GMM-IDLE mode is supported when the UE supports access to an SNPN using credentials from a credentials holder or when the SNPNs are equivalent SNPNs or both for the selected entry of the "list of subscriber data" or the selected PLMN subscription. UE mobility between an SNPN and a PLMN is not supported;
- n) CIoT 5GS optimizations are not supported;
- o) void;
- p) when registering or registered to an SNPN, the UE shall handle the 5GS mobile identity as described in subclause 5.5.1.2.2;
- q) when registering or registered to an SNPN, the UE shall only consider:
 - 1) a last visited registered TAI visited in the same SNPN as an available last visited registered TAI; or
 - 2) a last visited registered TAI visited using the same entry of the "list of subscriber data" or the same PLMN subscription as an available last visited registered TAI, if the UE supports access to an SNPN using credentials from a credentials holder, equivalent SNPNs or both;

NOTE 1: If the last visited registered TAI is assigned by an SNPN other than the current SNPN, the serving AMF can determine the SNPN assigning the last visited registered TAI using the NID provided by the UE.

- r) emergency service fallback is not supported;
- s) when registering or registered for onboarding services in SNPN, the UE shall not provide the requested NSSAI to the network;
- s1) when performing initial registration for onboarding services in SNPN, the UE shall set the 5GS registration type value to "SNPN onboarding registration";
- t) when registering or registered for onboarding services in SNPN, the AMF shall not provide the configured NSSAI, the allowed NSSAI or the rejected NSSAI to the UE, shall use the S-NSSAI included in the AMF onboarding configuration data for onboarding services in SNPN and shall not perform NSSAA procedure for S-NSSAI used for onboarding services in SNPN;
- u) the UE can access an SNPN indicating that onboarding is allowed using default UE credentials for primary authentication in order for the UE to be configured with one or more entries of the "list of subscriber data";

- x) eCall over IMS is not supported in SNPN access operation mode and the UE ignores any USIM configuration for eCall only mode;
- y) when registering or registered for onboarding services in SNPN, the AMF shall store in the 5GMM context of the UE an indication that the UE is registered for onboarding services in SNPN;
- z) a UE with multiple valid entries of "list of subscriber data", or one or more valid USIMs and one or more valid entries of "list of subscriber data", capable of initiating and maintaining simultaneous separate registration states over 3GPP access with PLMN(s) or SNPN(s), using identities and credentials associated with those entries of "list of subscriber data", or USIMs and entries of "list of subscriber data", and supporting one or more of the N1 NAS signalling connection release, the paging indication for voice services, the reject paging request, the paging restriction and the paging timing collision control may use procedures defined for MUSIM UE, even if the UE does not include multiple valid USIMs;
- za) when the UE is registering or registered for onboarding services in SNPN, the network slice admission control is not performed;

NOTE 2: If the network determines that the UE cannot register to the onboarding SNPN due to lack of resources for the network slice used for onboarding, the AMF can reject the UE with 5GMM cause #22 "congestion".

- zb) when the UE is registered for onboarding services in SNPN (as specified in subclause 3.1), the UE determines that the number dialled is an emergency number, and emergency services are not supported in the SNPN, the UE shall perform a local de-registration and utilize the procedures specified in 3GPP TS 23.167 [6] and 3GPP TS 24.229 [14] to select a domain for the emergency session attempt; and

NOTE 3: The UE can select PS domain for emergency session attempt.

- v) proximity based services (5G ProSe as specified in 3GPP TS 24.554 [19E]) are not supported.

4.14.3 Public network integrated non-public network (PNI-NPN)

A PNI-NPN is made available by means of e.g. dedicated DNNs or by one or more S-NSSAIs allocated for it. A CAG can be optionally used in order to prevent UEs not allowed to access a PNI-NPN from accessing the PNI-NPN. The key enablers for the CAG in the NAS layer are as follows:

- a) CAG selection (see 3GPP TS 23.122 [5]); and
- b) provisioning of a "CAG information list" as specified in 3GPP TS 23.122 [5], from network to UE via the generic UE configuration update procedure, the registration procedure, the service request procedure, and the network-initiated de-registration procedure.

The "CAG information list" provisioned by the network, if available, is stored in the non-volatile memory in the ME as specified in annex C. The "CAG information list" stored in the ME is kept when the UE enters 5GMM-DEREGISTERED state. Annex C specifies condition under which the "CAG information list" stored in the ME is deleted. Additionally, when a USIM is inserted, if:

- no "CAG information list" is stored in the non-volatile memory of the ME; or
- the SUPI from the USIM does not match the SUPI stored together with the "CAG information list" in the non-volatile memory of the ME;

and the UE has a "CAG information list" stored in the USIM (see 3GPP TS 31.102 [22]), the UE shall store the "CAG information list" from the USIM into the ME, as specified in annex C. The "Allowed CAG list" included in the entry for the HPLMN or EHPLMN in "CAG information list" stored in the USIM can contain a range of CAG-IDs.

The UE supporting CAG may perform the initial registration for emergency services via a non-CAG cell in a PLMN for which the UE has an "indication that the UE is only allowed to access 5GS via CAG cells" or via a CAG cell for which none of CAG-ID(s) is authorized based on the "Allowed CAG list" (see 3GPP TS 23.122 [5]) for the selected PLMN. If a UE supporting CAG having an emergency PDU session is camping on:

- a) a CAG cell and none of the CAG-ID(s) of the CAG cell is authorized based on the "Allowed CAG list" for the current PLMN in the UE's subscription; or

- b) a non-CAG cell in a PLMN for which the UE's subscription contains an "indication that the UE is only allowed to access 5GS via CAG cells";

the AMF shall behave as specified in subclause 5.4.4.2, 5.5.1.3.4 or 5.6.1.4.1.

NOTE: The emergency services in a PLMN for which the UE's subscription contains an "indication that the UE is only allowed to access 5GS via CAG cells" can be subject to local regulation.

Proximity based services (5G ProSe as specified in 3GPP TS 24.554 [19E]) are not supported in this release of the specification when a UE is camping on a CAG cell.

If a UE supporting enhanced CAG information is in a CAG cell with a CAG-ID which:

- a) was authorized based on the "Allowed CAG list" associated with the current PLMN in the "CAG information list" stored in the ME; and
- b) becomes not authorized based on the "Allowed CAG list" (e.g., time validity information no longer matches UE's current time); and

none of the CAG-ID(s) supported by the current CAG cell is currently authorized based on the "Allowed CAG list" of the entry for the current PLMN in the stored "CAG information list", and:

- a) the entry for the current PLMN in the "CAG information list" does not include an "indication that the UE is only allowed to access 5GS via CAG cells", then the UE shall abort ongoing UE initiated 5GMM procedures, if any, locally release the NAS signalling connection, if any, enter the state 5GMM-REGISTERED.LIMITED-SERVICE and shall search for a suitable cell according to 3GPP TS 38.304 [28] or 3GPP TS 36.304 [25C] with the stored "CAG information list"; or
- b) the entry for the current PLMN in the stored "CAG information list" includes an "indication that the UE is only allowed to access 5GS via CAG cells" and:
 - 1) one or more CAG-ID(s) are authorized based on the "Allowed CAG list" of the entry for the current PLMN in the stored "CAG information list", the UE shall abort ongoing UE initiated 5GMM procedures, if any, locally release the NAS signalling connection, if any, enter the state 5GMM-REGISTERED.LIMITED-SERVICE and shall search for a suitable cell according to 3GPP TS 38.304 [28] or 3GPP TS 36.304 [25C] with the stored "CAG information list"; or
 - 2) no CAG-ID is authorized based on the "Allowed CAG list" of the entry for the current PLMN in the stored "CAG information list" and:
 - i) the UE does not have an emergency PDU session, then the UE shall abort ongoing UE initiated 5GMM procedures, if any, locally release the NAS signalling connection, if any, enter the state 5GMM-REGISTERED.PLMN-SEARCH and shall apply the PLMN selection process defined in 3GPP TS 23.122 [5] with the stored "CAG information list"; or
 - ii) the UE has an emergency PDU session, then the UE shall perform a local release of all PDU sessions associated with 3GPP access except for the emergency PDU session and enter the state 5GMM-REGISTERED.LIMITED-SERVICE;

4.15 Time synchronization and time sensitive communication

4.15.1 General

A 5GS can support time synchronization and TSC (see 3GPP TS 23.501 [8], 3GPP TS 23.502 [9], and 3GPP TS 23.503 [10]). This subclause describes NAS-specific aspects of the 5GS features to support time synchronization and TSC. Interworking with EPS is not supported for a PDU session for time synchronization or TSC.

4.15.2 Void

4.15.2.1 Void

4.15.2.2 Void

4.15.2.3 Void

4.15.3 Time synchronization

Two types of synchronization processes are supported by the 5GS: 5GS synchronization and (g)PTP domain synchronization (see 3GPP TS 23.501 [8]).

For 5GS synchronization, the lower layers provide the 5G internal system clock signalled via the NG-RAN (see 3GPP TS 38.331 [30]) and the UE forwards the 5G internal system clock to the DS-TT(s).

For (g)PTP domain synchronization, the UE supports forwarding (g)PTP messages (see 3GPP TS 23.501 [8], 3GPP TS 23.502 [9], and 3GPP TS 24.535 [19A]). For all (g)PTP domains associated with a PDU session:

- a) if the UE receives (g)PTP message via the PDU session, the UE forwards the (g)PTP messages to the DS-TT associated with the PDU session; or
- b) if the UE receives (g)PTP messages from the DS-TT associated with the PDU session, the UE forwards the (g)PTP messages via the PDU session.

Depending on the 5G access stratum-based time distribution or (g)PTP-based time distribution, the network timing synchronization status of the nodes involved in the operation (e.g., NG-RAN nodes, NW-TTs) may change. Using the 5GMM protocol, the network can request a supporting UE to reconnect to the network upon receiving an indication of a change in the RAN timing synchronization status.

4.15.4 User plane node management

A 5G system (5GS) can act as a user plane node of an external network (e.g. IEEE TSN bridge) or a 5GS can be independently used to enable TSC. For these purposes, information available at a UE is provided to the network and port management information containers are exchanged between a DS-TT and a TSN AF or a TSCTSF (see 3GPP TS 24.539 [19BA]).

During a UE-requested PDU session establishment procedure, if the UE supports transfer of port management information containers, then the UE indicates that transfer of port management information container is supported and the UE provides a DS-TT Ethernet port MAC address (if the PDU session type is Ethernet), port management information container, and a UE-DS-TT residence time (if available) to the network (see subclause 6.4.1.2).

Once the UE has successfully established a PDU session and the UE has indicated that transfer of port management information container is supported during the UE-requested PDU session establishment procedure (see subclause 6.4.1.2), then port management information containers are exchanged via a UE-requested PDU session modification procedure and a network-requested PDU session modification procedure (see subclauses 6.3.2 and 6.4.2). The UE receiving a port management information container from the network shall forward the port management information container to the DS-TT. The SMF receiving a port management information container from the UE shall operate as described in 3GPP TS 23.502 [9].

4.16 UE radio capability signalling optimisation

UE radio capability signalling optimisation (RACS) is a feature that is optional at both the UE and the network and which aims to optimise the transmission of UE radio capability over the radio interface (see 3GPP TS 23.501 [8]). RACS works by assigning an identifier to represent a set of UE radio capabilities. This identifier is called the UE radio capability ID. A UE radio capability ID can be either manufacturer-assigned or network-assigned. The UE radio capability ID is an alternative to the signalling of the radio capabilities container over the radio interface.

In this release of the specification, RACS is applicable to neither NB-N1 mode nor non-3GPP access.

If the UE supports RACS:

- a) the UE shall indicate support for RACS by setting the RACS bit to "RACS supported" in the 5GMM capability IE of the REGISTRATION REQUEST message;
- b) if the UE performs a registration procedure for initial registration and the UE has an applicable UE radio capability ID for the current UE radio configuration in the selected network, the UE shall include the UE radio capability ID in the UE radio capability ID IE as a non-clear-text IE in the REGISTRATION REQUEST message. If both a network-assigned UE radio capability ID and a manufacturer-assigned UE Radio Capability ID are applicable, the UE shall include the network-assigned UE radio capability ID in the REGISTRATION REQUEST message;
- c) if the radio configuration at the UE changes (for instance because the UE has disabled a specific radio capability) then:
 - 1) if the UE has an applicable UE radio capability ID for the new UE radio configuration, the UE shall initiate a registration procedure for mobility and periodic registration update. The UE shall include the applicable UE radio capability ID in the UE radio capability ID IE of the REGISTRATION REQUEST message and shall include the 5GS update type IE in the REGISTRATION REQUEST message with the NG-RAN-RCU bit set to "UE radio capability update needed". If both a network-assigned UE radio capability ID and a manufacturer-assigned UE Radio Capability ID are applicable, the UE shall include the network-assigned UE radio capability ID in the REGISTRATION REQUEST message; and
 - 2) if the UE does not have an applicable UE radio capability ID for the new UE radio configuration, the UE shall initiate a registration procedure for mobility and periodic registration update and include the 5GS update type IE in the REGISTRATION REQUEST message with the NG-RAN-RCU bit set to "UE radio capability update needed";

NOTE: Performing the registration procedure for mobility and periodic registration update and including the 5GS update type IE in the REGISTRATION REQUEST message with the NG-RAN-RCU bit set to "UE radio capability update needed" without a UE radio capability ID included in the REGISTRATION REQUEST message can trigger the network to assign a new UE radio capability ID to the UE.

- d) upon receiving a network-assigned UE radio capability ID in the REGISTRATION ACCEPT message or the CONFIGURATION UPDATE COMMAND message, the UE shall store the network-assigned UE radio capability ID and the PLMN ID or SNPN identity of the serving network and, if the UE supports access to an SNPN using credentials from a credentials holder, equivalent SNPNs or both, the selected entry of the "list of subscriber data" or the selected PLMN subscription along with a mapping to the current UE radio configuration in its non-volatile memory as specified in annex C. The UE shall be able to store at least the last 16 received network-assigned UE radio capability IDs with the associated PLMN ID or SNPN identity and, if the UE supports access to an SNPN using credentials from a credentials holder, equivalent SNPNs or both, the selected entry of the "list of subscriber data" or the selected PLMN subscription and the mapping to the corresponding UE radio configuration;
- e) the UE shall not use a network-assigned UE radio capability ID assigned by a PLMN in PLMNs equivalent to the PLMN which assigned it or by an SNPN in SNPNs equivalent to the SNPN which assigned it;
- f) upon receiving a UE radio capability ID deletion indication IE set to "Network-assigned UE radio capability IDs deletion requested" in the REGISTRATION ACCEPT message or the CONFIGURATION UPDATE COMMAND message, the UE shall delete all network-assigned UE radio capability IDs stored at the UE for the serving network, initiate a registration procedure for mobility and periodic registration update and include an applicable manufacturer-assigned UE radio capability ID for the current UE radio configuration, if available at the UE, in the UE radio capability ID IE of the REGISTRATION REQUEST message; and
- g) if the UE performs a registration procedure for mobility and periodic registration update due to entering a tracking area that is not in the list of tracking areas that the UE previously registered in the AMF and the UE has an applicable UE radio capability ID for the current UE radio configuration in the selected network, the UE shall include the UE radio capability ID in the UE radio capability ID IE as a non-clear-text IE in the REGISTRATION REQUEST message. If both a network-assigned UE radio capability ID and a manufacturer-assigned UE Radio Capability ID are applicable, the UE shall include the network-assigned UE radio capability ID in the REGISTRATION REQUEST message.

If the network supports RACS:

- a) the network may assign a network-assigned UE radio capability ID to a UE which supports RACS by including a UE radio capability ID IE in the REGISTRATION ACCEPT message or in the CONFIGURATION UPDATE COMMAND message;
- b) the network may trigger the UE to delete all network-assigned UE radio capability IDs stored at the UE for the serving network by including a UE radio capability ID deletion indication IE set to "Network-assigned UE radio capability IDs deletion requested" in the REGISTRATION ACCEPT message or in the CONFIGURATION UPDATE COMMAND message; and
- c) the network may send an IDENTITY REQUEST message to the UE that supports RACS to retrieve the PEI, if not available in the network.

4.17 5GS mobility management in NB-N1 mode

A UE in NB-N1 mode (see 3GPP TS 36.331 [25A]) shall calculate the value of the applicable NAS timer indicated in table 10.2.1 plus 240s.

The timer value obtained is used as described in the appropriate procedure subclause of this specification. The NAS timer value shall be calculated at start of a NAS procedure and shall not re-calculate the use of the NAS timer value until the NAS procedure is completed, restarted or aborted.

When an AMF that supports NB-N1 mode performs NAS signalling with a UE, which is using NB-N1 mode, the AMF shall calculate the value of the applicable NAS timer indicated in table 10.2.2 plus 240s.

The timer value obtained is used as described in the appropriate procedure subclause of this specification. The NAS timer value shall be calculated at start of a NAS procedure and shall not re-calculate the use of the NAS timer value until the NAS procedure is completed, restarted or aborted.

4.18 5GS session management in NB-N1 mode

A UE in NB-N1 mode (see 3GPP TS 36.331 [25A]) shall calculate the value of the applicable NAS timer indicated in table 10.3.1 plus 180s.

The timer value obtained is used as described in the appropriate procedure subclause of this specification. The NAS timer value shall be calculated at start of a NAS procedure and shall not re-calculate the use of the NAS timer value until the NAS procedure is completed, restarted or aborted.

When an SMF that supports NB-N1 mode performs NAS signalling with a UE, which is using NB-N1 mode, the SMF shall calculate the value of the applicable NAS timer indicated in table 10.3.2 plus 180s.

The timer value obtained is used as described in the appropriate procedure subclause of this specification. The NAS timer value shall be calculated at start of a NAS procedure and shall not re-calculate the use of the NAS timer value until the NAS procedure is completed, restarted or aborted.

4.19 5GS mobility management in WB-N1 mode for IoT

In WB-N1 mode, a UE operating in category CE can operate in either CE mode A or CE mode B (see 3GPP TS 36.306 [25D]). If a UE that supports CE mode B and operates in WB-N1 mode, the UE's usage setting is not set to "voice centric" (see 3GPP TS 23.501 [8]), and:

- a) the use of enhanced coverage is not restricted by the network; or
- b) CE mode B is not restricted by the network (see 3GPP TS 23.501 [8]);

the UE shall apply the value of the applicable NAS timer indicated in table 10.2.1 for WB-N1/CE mode.

A UE that supports CE mode B and operates in WB-N1 mode shall not apply the value of the applicable NAS timer indicated in table 10.2.1 for WB-N1/CE mode before receiving an indication from the network that the use of enhanced coverage is not restricted, or CE mode B is not restricted, as described in this subclause.

The NAS timer value obtained is used as described in the appropriate procedure subclause of this specification. The NAS timer value shall be calculated at start of a NAS procedure, and shall not be re-calculated until the NAS procedure is completed, restarted or aborted.

The support of CE mode B by a UE is indicated to the AMF by lower layers and shall be stored by the AMF. When an AMF that supports WB-N1 mode performs NAS signalling with a UE, which supports CE mode B and operates in WB-N1 mode, the UE's usage setting is not set to "voice centric" (see 3GPP TS 23.501 [8]) and the AMF determines that:

- a) the use of enhanced coverage is not restricted for the UE; or
- b) CE mode B is not restricted for the UE (see 3GPP TS 23.501 [8]);

the AMF shall calculate the value of the applicable NAS timer indicated in table 10.2.2 for WB-N1/CE mode.

The NAS timer value obtained is used as described in the appropriate procedure subclause of this specification. The NAS timer value shall be calculated at start of a NAS procedure and shall not be re-calculated until the NAS procedure is completed, restarted or aborted.

4.20 5GS session management in WB-N1 mode for IoT

In WB-N1 mode, a UE operating in category CE can operate in either CE mode A or CE mode B (see 3GPP TS 36.306 [25D]). If a UE that supports CE mode B and operates in WB-N1 mode and the UE's usage setting is not set to "voice centric" (see 3GPP TS 23.501 [8]), and:

- a) the use of enhanced coverage is not restricted by the network; or
- b) CE mode B is not restricted by the network (see 3GPP TS 23.501 [8]);

the UE shall apply the value of the applicable NAS timer indicated in table 10.3.1 for WB-N1/CE mode.

A UE that supports CE mode B and operates in WB-N1 mode shall not apply the value of the applicable NAS timer indicated in table 10.3.1 for WB-N1/CE mode before receiving an indication from the network that the use of enhanced coverage is not restricted, or CE mode B is not restricted, as described in this subclause.

The NAS timer value obtained is used as described in the appropriate procedure subclause of this specification. The NAS timer value shall be calculated at start of a NAS procedure, and shall not be re-calculated until the NAS procedure is completed, restarted or aborted.

If the use of extended NAS timer is indicated by the AMF (see 3GPP TS 23.501 [8] and 3GPP TS 23.502 [9]), the SMF shall calculate the value of the applicable NAS timer indicated in table 10.3.2 for WB-N1/CE mode.

The NAS timer value obtained is used as described in the appropriate procedure subclause of this specification. The NAS timer value shall be calculated at start of a NAS procedure and shall not be re-calculated until the NAS procedure is completed, restarted or aborted.

4.21 Authentication and Key Management for Applications (AKMA)

The UE may support AKMA.

The purpose of AKMA is to provide authentication and key management to applications based on 3GPP credentials used for 5GS access as specified in 3GPP TS 33.535 [24A], which allows the UE to securely exchange data with an AKMA application function.

Upon receiving a request from the upper layers to obtain AKMA Anchor Key (K_{AKMA}) and AKMA Key Identifier (A-KID), the UE supporting AKMA shall derive the K_{AKMA} and the AKMA Temporary Identifier (A-TID) from the valid K_{AUSF} if available as specified in 3GPP TS 33.535 [24A], shall further derive the A-KID from the A-TID as specified in 3GPP TS 33.535 [24A] and shall provide K_{AKMA} and A-KID to the upper layers.

The UE supporting AKMA shall notify the upper layers whenever there is a change of the K_{AUSF} upon reception of an EAP-success message in subclauses 5.4.1.2.2.8, 5.4.1.2.3.1 and 5.4.1.2.3A.1 or upon reception of SECURITY MODE COMMAND message in subclauses 5.4.2.3.

During an ongoing primary authentication and key agreement procedure (see subclause 5.4.1), if the UE receives a request from upper layers to obtain K_{AKMA} and A-KID, the UE shall derive the K_{AKMA} and A-TID after the completion of the ongoing primary authentication and key agreement procedure, shall further derive the A-KID from the A-TID as specified in 3GPP TS 33.535 [24A] and shall provide K_{AKMA} and A-KID to the upper layers.

NOTE 1: The upper layers derive the AKMA Application Key (K_{AF}) from K_{AKMA} as specified in 3GPP TS 33.535 [24A].

NOTE 2: The knowledge of whether a certain application needs to use AKMA or not is application specific and is out of the scope of 3GPP.

NOTE 3: The exact method of securing the data exchange at the upper layers using K_{AF} is application specific and is out of the scope of 3GPP.

NOTE 4: The upper layers request the UE NAS layer to provide K_{AKMA} and A-KID before the upper layers initiate communication with an AKMA application function.

NOTE 5: Upon receiving a request from the upper layers to obtain K_{AKMA} and A-KID, if there is no K_{AUSF} available, the UE NAS layer cannot derive the K_{AKMA} and A-KID and provides an indication to the upper layers that K_{AKMA} and A-KID cannot be generated.

4.22 Uncrewed aerial vehicle identification, authentication, and authorization

4.22.1 General

A 5GS can support UAV identification, authentication, and authorization (see 3GPP TS 23.256 [6AB]). This subclause describes NAS-specific aspects of the 5GS features to support UAV identification, authentication, authorization and C2 communication authorization.

Before accessing 5GS for UAS services, the UE supporting UAS services must have an assigned CAA-level UAV ID. The UE can be registered to 5GS for UAS services if there is a valid aerial subscription in the UE's subscription.

4.22.2 Authentication and authorization of UAV

The 5GS supports the USS UAV Authorization and Authentication (UUAA) procedure for a UE supporting UAS services. Depending on operator policy or regulatory requirements, the UUAA-MM procedure can be performed by the UE and the AMF at a registration procedure as specified in subclause 5.5.1.2, the UUAA-SM procedure can be performed by the UE and the SMF at a PDU session establishment procedure as specified in subclause 6.4.1.2, or both can be performed. The UE shall support UUAA-MM and UUAA-SM, and the network shall support UUAA-SM and may optionally support UUAA-MM. The UUAA procedure needs to be performed by 5GS with USS successfully before the connectivity for UAS services is established.

During the registration procedure as described in subclause 5.5.1.2, the UE supporting UAS services provides CAA-level UAV ID to the AMF, and the AMF may trigger the UUAA-MM procedure. If the UE supporting UAS services does not provide CAA-level UAV ID to the AMF and the network is configured to perform UUAA-MM at registration procedure, the AMF may accept the registration request and shall mark in the UE's 5GMM context that the UE is not allowed to request UAS services. If the UE wants to use the UAS services by providing the CAA-Level UAV ID later on, the UE shall perform the registration procedure for mobility and periodic registration update.

When a UE supporting UAS services requests to establish a PDU session as described in subclause 6.4.1.2 for USS communication, the UE provides CAA-level UAV ID to the network, and the SMF may trigger the UUAA-SM procedure based on the DNN and S-NSSAI combination for aerial services according to the user's subscription data and the CAA-level UAV ID provided by the UE.

If the UE does not provide CAA-level UAV ID and the user's subscription data for the UE requires the UUAA-SM, the network rejects the UE-requested PDU session establishment procedure for the UAS services.

The UE supporting UAS services shall not provide CAA-level UAV ID to the network over non-3GPP access, and the network shall not perform UUAA procedure for non-3GPP access and shall ensure that the UE is not allowed to access any aerial services in non-3GPP access.

If provided by the upper layers, the UE supporting UAS services provides to the network the USS address during the registration procedure or PDU session establishment procedure so that the network uses the information to discover the USS.

NOTE: The parameters (e.g., CAA-level UAV ID or USS address) sent by a UE supporting UAS services to the network for UAS services are included in the Service-level-AA container IE which is a non-clear-text IE.

After successful UUAA procedure, either the AMF or the SMF may initiate re-authentication of the UAV when required by the USS. If UUAA-MM fails during a re-authentication and there are PDU sessions established using UAS services, the AMF shall request the SMF to perform the release of these PDU sessions and may trigger a network-initiated de-registration procedure based on operator policy. If UUAA-SM fails during a re-authentication, the SMF shall release the PDU session related to re-authentication.

If the UUAA is revoked, the PDU session related to the UAS services shall be released by the SMF. Based on operator policy, the AMF may decide to keep the UE registered or trigger a de-registration procedure.

4.22.3 Authorization of C2 communication

The 5GS supports USS authorization of C2 communication for pairing of UAV and UAV-C. The pairing of UAV and UAV-C needs to be authorized by USS successfully before the user plane connectivity for C2 communication (over Uu or over NR-PC5) is enabled. For C2 authorization procedure, the UE supporting UAS services provides to the network with CAA-level UAV ID.

The USS authorization of UAV flight can also be performed during the C2 authorization procedure. The UE supporting UAS services provides the UAV flight authorization information to the network if provided by upper layers.

NOTE 1: The C2 authorization payload in the service-level-AA payload can include one, some or all of the pairing information for C2 communication, an indication of the request for direct C2 communication, pairing information for direct C2 communication, and the UAV flight authorization information (see subclauses 6.4.1.2 and 6.4.2.2).

The UE supporting UAS services can establish a PDU session for the C2 communication by providing the CAA-level UAV ID and the C2 authorization payload. The SMF upon reception of the UE's request for the PDU session establishment, determines that authorization is required based on the DNN and S-NSSAI combination of the PDU session is for aerial services according to user's subscription data and the CAA-level UAV ID included in the request.

If a UE supporting UAS services uses a common PDU session for both USS communication and C2 communication, the C2 communication can be authorized using UUAA-SM procedure during the PDU session establishment procedure or during the PDU session modification procedure. If the pairing of UAV and UAV-C is revoked, the network shall disable C2 communication for the PDU session. The SMF upon reception of the UE's request for the PDU session establishment, determines that authorization is required based on the DNN and S-NSSAI combination of the PDU session is for aerial services according to user's subscription data and the CAA-level UAV ID included in the request.

NOTE 2: The network can disable C2 communication for the PDU session e.g., by removing the QoS flow for C2 communication during PDU session modification procedure as described in subclauses 6.3.2.2.

If a UE supporting UAS services uses separate PDU sessions for, respectively, USS communication and C2 communication, the C2 communication is authorized using UUAA-SM during the PDU session establishment procedure. If the pairing of UAV and UAV-C is revoked, the PDU session for C2 communication shall be released by the SMF.

During the registration procedure for UAS services, direct C2 communication can be authorized as described in subclause 5.5.1.2. A UE supporting A2X over NR-PC5 can perform registration procedure for UAS services including a request for authorization of direct C2 communication by providing CAA-level UAV ID and C2 authorization payload.

4.22.4 Void

4.23 NAS over Non-Terrestrial Network

4.23.1 General

A 5GS can support 3GPP satellite NG-RAN access technology (see 3GPP TS 23.501 [8]). This subclause describes NAS-specific aspects of the 5GS features to support 3GPP satellite NG-RAN access technology.

4.23.2 List of "PLMNs not allowed to operate at the present UE location"

For 3GPP satellite NG-RAN the UE shall store a list of "PLMNs not allowed to operate at the present UE location". Each entry consists of:

- a) the PLMN identity of the PLMN which sent a message including 5GMM cause value #78 "PLMN not allowed to operate at the present UE location" via satellite NG-RAN access technology; and
- b) the geographical location, if known by the UE, where 5GMM cause value #78 was received on satellite NG-RAN access technology; and
- c) if the geographical location exists, a UE implementation specific distance value.

Before storing a new entry in the list, the UE shall delete any existing entry with the same PLMN identity. Upon storing a new entry, the UE starts a timer instance associated with the entry with an implementation specific value that shall not be set to a value smaller than the timer value indicated by the network in the Lower bound timer value IE, if any. If the Lower bound timer value IE was not provided by the network, the value of the timer shall be set based on the UE implementation.

The UE is allowed to attempt to access a PLMN via satellite NG-RAN access technology which is part of the list of "PLMNs not allowed to operate at the present UE location" only if:

- a) the current UE location is known, a geographical location is stored for the entry of this PLMN, and the distance to the current UE location is larger than a UE implementation specific value; or
- b) the access is for emergency services (see 3GPP TS 23.122 [5] for further details).

NOTE 1: When the UE is accessing network for emergency services, it is up to operator and regulatory policies whether the network needs to determine if the UE is in a location where network is not allowed to operate.

NOTE 2: While location determination is ongoing to ensure that operator and regulatory policies are met, the AMF can perform DNN-based or S-NSSAI based congestion control as specified in subclauses 5.3.10 and 5.3.11 to prevent the UE from accessing network.

The list shall accommodate three or more entries. The maximum number of entries is an implementation decision. When the list is full and a new entry has to be inserted, the oldest entry shall be deleted.

Each entry shall be removed if for the entry:

- a) the UE successfully registers via satellite NG-RAN access technology to the PLMN stored in the entry except when the UE registers for emergency services; or
- b) the timer instance associated with the entry expires.

The UE may delete the entry in the list, if the current UE location is known, a geographical location is stored for the entry of this PLMN, and the distance to the current UE location is larger than a UE implementation specific value.

If the UE is in 5GMM-DEREGISTERED.LIMITED-SERVICE state and an entry from the list of "PLMNs not allowed to operate at the present UE location" is removed, the UE shall perform PLMN selection according to 3GPP TS 23.122 [5].

When the UE is switched off, the UE shall keep the list of "PLMNs not allowed to operate at the present UE location" in its non-volatile memory. The UE shall delete the list of "PLMNs not allowed to operate at the present UE location" if the USIM is removed.

If the UE is switched off when the timer instance associated with the entry in the list is running, the UE shall behave as follows when the UE is switched on and the USIM in the UE remains the same:

let t_1 be the time remaining for timer instance associated with the entry in the list to timeout at switch off and let t be the time elapsed between switch off and switch on. If t_1 is greater than t , then the timer shall be restarted with the value $t_1 - t$. If t_1 is equal to or less than t , then the timer need not be restarted and considered expired. If the UE is not capable of determining t , then the UE shall restart the timer with the value t_1 .

4.23.3 5GS mobility management via a satellite NG-RAN cell

For 5GS mobility management via a satellite NG-RAN cell the UE shall apply the value of the applicable NAS timer indicated in table 10.2.1 for access via a satellite NG-RAN cell.

NOTE 1: The applied NAS timer values are based on the current satellite NG-RAN access RAT type determined based on information from lower layers.

The NAS timer value obtained by the UE is used as described in the appropriate procedure subclause of this specification. The NAS timer value shall be calculated at start of a NAS procedure, and shall not be re-calculated until the NAS procedure is completed, restarted or aborted.

The access via a satellite NG-RAN cell by a UE is indicated to the AMF by lower layers and shall be stored by the AMF. When an AMF that supports access via satellite NG-RAN cells performs NAS signalling with a UE via satellite NG-RAN cells, the AMF shall calculate the value of the applicable NAS timer indicated in table 10.2.2 for access via a satellite NG-RAN cell.

NOTE 2: The applied NAS timer values are based on the current satellite NG-RAN access RAT type determined based on information from lower layers.

The NAS timer value obtained by the network is used as described in the appropriate procedure subclause of this specification. The NAS timer value shall be calculated at start of a NAS procedure and shall not be re-calculated until the NAS procedure is completed, restarted or aborted.

4.23.4 5GS session management via a satellite NG-RAN cell

For 5GS session management via a satellite NG-RAN cell the UE shall apply the value of the applicable NAS timer indicated in table 10.3.1 for access via a satellite NG-RAN cell.

NOTE 1: The applied NAS timer values are based on the current satellite NG-RAN access RAT type determined based on information from lower layers.

The NAS timer value obtained by the UE is used as described in the appropriate procedure subclause of this specification. The NAS timer value shall be calculated at start of a NAS procedure, and shall not be re-calculated until the NAS procedure is completed, restarted or aborted.

If the use of extended NAS timer for access via a satellite NG-RAN cell is indicated by the AMF (see 3GPP TS 23.501 [8] and 3GPP TS 23.502 [9]), the SMF shall calculate the value of the applicable NAS timer indicated in table 10.3.2 for access via a satellite NG-RAN cell.

The NAS timer value obtained by the network is used as described in the appropriate procedure subclause of this specification. The NAS timer value shall be calculated at start of a NAS procedure and shall not be re-calculated until the NAS procedure is completed, restarted or aborted.

4.23.5 Handling multiple tracking area codes from the lower layers

When a UE camps on a satellite NG-RAN cell, the UE may receive multiple TACs from the lower layers. The UE shall construct TAIs from the multiple TACs (i.e. concatenate the identity of the current PLMN and each of the TACs) and select a TAI as follows:

- a) if at least one TAI belongs to the current registration area of the UE, the UE shall select a TAI which belongs to the current registration area of the UE according to the followings.

If there are multiple TAIs which belong to the current registration area of the UE, the UE shall select a TAI as follows:

- 1) if there is a TAI which belongs to the list of "allowed tracking area" (if any) and does not belong to the list of "non-allowed tracking areas" (if any), the UE shall select a TAI which belongs to the list of "allowed tracking area" (if any) and does not belong to the list of "non-allowed tracking areas" (if any). In this case, if there are multiple TAIs which belong to the list of "allowed tracking area" (if any) and does not belong to the list of "non-allowed tracking areas" (if any), then the UE shall consider each of these TAIs equal and select a TAI in an implementation-specific way (e.g. taking into account LADN service area information). If these multiple TAIs contain the previous current TAI, the current TAI can be left unchanged.
 - 2) if there is no TAI which belongs to the list of "allowed tracking area" (if any) and does not belong to the list of "non-allowed tracking areas" (if any) or neither the list of "allowed tracking area" nor the list of "non-allowed tracking areas" is available, then the UE shall consider each of these TAIs equal and select a TAI in an implementation-specific way (e.g. taking into account LADN service area information). If these multiple TAIs contain the previous current TAI, the current TAI can be left unchanged.
- b) if the current registration area is not available in the UE or no TAI belongs to the current registration area of the UE and:
- 1) there is a TAI which belongs to neither the list of "5GS forbidden tracking areas for roaming" nor the list of "5GS forbidden tracking areas for regional provision of service", the UE shall select a TAI which belongs to neither the list of "5GS forbidden tracking areas for roaming" nor the list of "5GS forbidden tracking areas for regional provision of service". In this case, if there are multiple TAIs which belong to neither the list of "5GS forbidden tracking areas for roaming" nor the list of "5GS forbidden tracking areas for regional provision of service", then the UE shall consider each of these TAIs equal and select a TAI in an implementation-specific way.
 - 2) all TAIs belong to the list of "5GS forbidden tracking areas for roaming" or the list of "5GS forbidden tracking areas for regional provision of service", then the UE shall consider each of these TAIs equal and select a TAI in an implementation-specific way.

The UE shall consider the selected TAI as the current TAI. The UE shall select a TAI when:

- a) the UE receives multiple TACs from the lower layers; or
- b) the UE has received multiple TACs from the lower layers upon starting to camping on the current cell and the registration area, the list of "allowed tracking areas", the list of "non-allowed tracking areas", the list of "5GS forbidden tracking areas for roaming", or the list of "5GS forbidden tracking areas for regional provision of service" is updated.

Handling of the list of "5GS forbidden tracking areas for roaming" and the list of "5GS forbidden tracking areas for regional provision of service" is specified in subclause 5.3.13.

4.24 Minimization of service interruption

The UE and the network may support Minimization of service interruption (MINT). MINT aims to enable a UE to obtain service from a PLMN offering disaster roaming services when a disaster condition applies to the UE determined PLMN with disaster condition.

If the UE supports MINT, the indication of whether disaster roaming is enabled in the UE, the indication of 'applicability of "lists of PLMN(s) to be used in disaster condition" provided by a VPLMN', the one or more "list of PLMN(s) to be used in disaster condition", disaster roaming wait range and disaster return wait range provisioned by the network, if available, are stored in the non-volatile memory in the ME as specified in annex C and are kept when the UE enters 5GMM-DEREGISTERED state. Annex C specifies condition under which the indication of whether disaster roaming is enabled in the UE, the indication of 'applicability of "lists of PLMN(s) to be used in disaster condition" provided by a VPLMN', the one or more "lists of PLMN(s) to be used in disaster condition", disaster roaming wait range and disaster return wait range stored in the ME are deleted.

Upon selecting a PLMN for disaster roaming as specified in 3GPP TS 23.122 [5]:

- a) if the UE does not have a stored disaster roaming wait range, the UE shall perform a registration procedure for disaster roaming services on the selected PLMN as described in subclause 5.5.1; and
- b) if the UE has a stored disaster roaming wait range, the UE shall generate a random number within the disaster roaming wait range and start a timer with the generated random number. While the timer is running, the UE shall not initiate registration on the selected PLMN except if the UE needs to request an emergency PDU session, in which case the UE shall initiate the registration procedure, set the 5GS registration type IE to "emergency registration" in the REGISTRATION REQUEST message and keep the timer running. Upon expiration of the timer, if the UE does not have an emergency PDU session, the UE shall perform a registration procedure for disaster roaming services as described in subclause 5.5.1 if still camped on the selected PLMN. If the UE has an emergency PDU session when the timer expires, the registration procedure for disaster roaming services as described in subclause 5.5.1 shall be performed after the release of the emergency PDU session, if the UE is still camped on the selected PLMN.

If the UE is switched off when the timer for disaster roaming wait range is running, the UE shall behave as follows when the UE is switched on, the USIM in the UE remains the same and the UE selects the PLMN for disaster roaming:

- let t_1 be the time remaining for the timer for disaster roaming wait range timeout at switch off and let t be the time elapsed between switch off and switch on. If t_1 is greater than t , then the timer shall be restarted with the value $t_1 - t$. If t_1 is equal to or less than t , then the timer need not be restarted. If the UE is not capable of determining t , then the UE shall restart the timer with the value t_1 .

Upon determining that a disaster condition has ended as specified in 3GPP TS 23.122 [6]:

- a) the UE shall stop the timer started with a generated random number within the disaster roaming wait range, if running;
- b) the UE shall perform PLMN selection as specified in 3GPP TS 23.122 [5], except if the UE already selected an allowable PLMN as specified in 3GPP TS 23.122 [6]; and
- c) if the UE selects the UE determined PLMN with disaster condition and has a stored disaster return wait range, which is
 - 1) provided by the PLMN providing disaster roaming services; or
 - 2) provided by the selected PLMN,

the UE shall generate a random number within the disaster return wait range, start a timer with the generated random number value and enter 5GMM-DEREGISTERED.ATTEMPTING-REGISTRATION state or 5GMM-REGISTERED.ATTEMPTING-REGISTRATION-UPDATE state, if registered. While the timer is running, the UE shall not initiate registration on the selected PLMN except if the UE needs to request an emergency PDU session, in which case the UE shall initiate the registration procedure, set the 5GS registration type IE to "emergency registration" in the REGISTRATION REQUEST message and keep the timer running. Upon expiration of the timer, if the UE does not have an emergency PDU session, the UE shall perform a registration procedure if still camped on the selected PLMN. If the UE has an emergency PDU session when the timer expires, the registration procedure as described in subclause 5.5.1 shall be performed after the release of the emergency PDU session, if the UE is still camped on the selected PLMN.

Otherwise, the UE shall perform registration procedure in the selected PLMN.

If the UE is switched off when the timer for disaster return wait range is running, the UE shall behave as follows when the UE is switched on, the USIM in the UE remains the same and the UE selects the UE determined PLMN with disaster condition:

- let t_1 be the time remaining for the timer for disaster return wait range timeout at switch off and let t be the time elapsed between switch off and switch on. If t_1 is greater than t , then the timer shall be restarted with the value $t_1 - t$. If t_1 is equal to or less than t , then the timer need not be restarted. If the UE is not capable of determining t , then the UE shall restart the timer with the value t_1 .

When the AMF assigns a registration area to the UE registered for disaster roaming services, the AMF shall only include TAIs covering the area with the disaster condition.

When the AMF determines that the disaster condition has ended and the UE which is registered for disaster roaming services has an emergency PDU session, the AMF shall initiate the generic UE configuration update procedure to indicate that the UE is registered for emergency services as described in subclause 5.4.4.2.

Interworking with EPS is not supported for UEs that are registered for disaster roaming services. When registering for disaster roaming services, the UE indicates to the network that S1 mode is not supported as described in subclause 5.5.1.2.2. While registered for disaster roaming services and upon a need to establish an emergency PDU session or perform emergency services fallback, the UE initiates the registration procedure for mobility and periodic registration update and indicates that S1 mode is supported as described in subclause 5.5.1.3.2.

If the UE is registered for disaster roaming services and the registered PLMN is removed from forbidden PLMN lists due to reasons specified in 3GPP TS 23.122 [5] subclause 4.4.6 or in 3GPP TS 23.122 [5] Annex C, then UE shall initiate the de-registration procedure and perform PLMN selection as specified in 3GPP TS 23.122 [5].

4.25 Support of MUSIM features

A network and a MUSIM UE may support one or more of the MUSIM features (i.e. the N1 NAS signalling connection release, the paging indication for voice services, the reject paging request, the paging restriction and the paging timing collision control).

If MUSIM UE supports one or more MUSIM features, the UE indicates support of one or more MUSIM features (except for the paging timing collision control) during the registration procedure. If the UE has indicated support of the N1 NAS signalling connection release or the reject paging request or both and the UE supports the paging restriction, the UE indicates support of the paging restriction.

If the UE indicates support of one or more MUSIM features and the network decides to accept one or more MUSIM features, the network indicates the support of one or more MUSIM features during the registration procedure. The network only indicates the support of the paging restriction together with the support of either N1 NAS signalling connection release or the reject paging request.

The network does not indicate support for any MUSIM feature to the UE during the registration for emergency services.

If the UE is not currently registered for emergency service and the UE receives the CONFIGURATION UPDATE COMMAND message with the 5GS registration result IE value set to "Registered for emergency services", then UE shall behave as if the network did not indicate support for any MUSIM feature in the last registration procedure. If the network has sent CONFIGURATION UPDATE COMMAND message with the 5GS registration result IE value set to "Registered for emergency services", then network shall behave as if it did not indicate support for any MUSIM feature in the last registration procedure.

If a UE stops fulfilling the condition to be considered a MUSIM UE as defined in subclause 3.1, and the UE has negotiated support of one or more MUSIM features, then the UE shall initiate a registration procedure for mobility and periodic registration update to indicate that all the MUSIM features are not supported (except for the paging timing collision control) as specified in subclause 5.5.1.3.

A MUSIM UE operating in NB-N1 mode or in WB-N1 mode CE mode B does not indicate the support for paging indication for voice services during the registration procedure towards the network.

4.26 Support for Personal IoT Network service

The 5GS can support the personal IoT network (PIN) service (see 3GPP TS 23.501 [8]).

The PIN enables the personal IoT network elements (PINEs) to communicate with each other via PIN direct communication, PIN indirect communication or PIN-DN communication. For the PIN indirect communication and PIN-DN communication, a UE acting as a PIN element with gateway capability (PEGC) enables the PINEs behind the PEGC to connect to the network and to communicate with other PINEs within the PIN or with the DN via the PDU session established for PIN. A PEGC may serve one or more PINs. The PEGC establishes only one PDU session for each PIN. The PEGC establishes different PDU sessions for different PINs based on different DNNs and S-NSSAIs. The PEGC may establish only one PDU session for multiple PINs if traffic differentiation for multiple PINs is not required in 5GS.

NOTE 1: The PIN direct communication is out of the scope of 3GPP.

The PIN, PEGC, and PINEs are managed by PIN element with management capability (PEMC) and optionally the corresponding application function. Each PIN contains at least one PEGC and at least one PEMC. The PIN architecture is captured in 3GPP TS 23.501 [8].

The 5GS supports the delivery of URSP rules which include the PIN ID to a PEGC registered to 5GS (see 3GPP TS 23.501 [8] and 3GPP TS 23.503 [10]). The 5GS is enhanced to support the PDU session management for PIN to ensure the end-to-end QoS requirement.

The end-to-end QoS requirement for each PINE over PIN indirect communication and over PIN-DN communication includes:

- a) the QoS requirement in the 3GPP access network; and
- b) the QoS requirement in the non-3GPP access network.

The N3QAI is introduced to enable a PEGC to perform the QoS differentiation for the PINEs in the non-3GPP access network. If the UE supports receiving the N3QAI, the network may provide the N3QAI associated with the QoS flow during the PDU session establishment procedure as defined in subclause 6.4.1 or during the PDU session modification procedure as defined in subclause 6.4.2.

NOTE 2: How the PEGC applies N3QAI is outside the scope of the present document.

The non-3GPP delay budget refers to the delay budget between the PEGC and the PINE in the non-3GPP access network. If the UE supports providing the non-3GPP delay budget, the UE may provide the network with the non-3GPP delay budget for the one or more QoS flows associated with the PDU sessions for a PIN during the PDU session modification procedure as defined in subclause 6.4.2. The network takes into account the received non-3GPP delay budget to ensure the end-to-end QoS requirement of a PINE.

NOTE 3: The support of a 5G-RG or a FN-RG acting as a PEGC is not specified in this release of specification.

NOTE 4: The support of redundant PDU sessions does not apply for PIN.

4.27 Mobile base station relay support

A 5GS can support a MBSR-UE and a UE accessing to MBSR (see subclause 5.35A of 3GPP TS 23.501 [8]). This subclause describes NAS-specific aspects of the 5GS features to support the authorization of the MBSR-UE, and the control of the UE access via MBSR.

The AMF authorizes the UE's request to act as a MBSR based on the subscription information. The AMF can indicate to the MBSR-UE that it is allowed or not allowed to operate as MBSR during registration procedure as specified in subclause 5.5.1.2.

Enhanced CAG information can be used for the control of UE's access via MBSR. CAG identifier is used to control the access of UE via MBSR. The 5GCN supports the UE access control based on the PLMND ID and CAG identifier broadcast by the MBSR and the CAG-ID authorized based on "Allowed CAG list" in the PLMN's entry of "CAG information list" stored in the UE. Time validity information can be provided to the UE together with the CAG identifier for accessing to MBSR in order to control that UE not accessing the MBSR cell outside of the time validity information. For the UE not supporting CAG functionality, the 5GCN can control the access of the UE with managing the forbidden tracking area.

5 Elementary procedures for 5GS mobility management

5.1 Overview

5.1.1 General

The main function of the 5GS mobility management (5GMM) sublayer is to support the identification, security, mobility of a UE as well as generic message transport.

A further function of the 5GMM sublayer is to provide connection management services to the other sublayer(s).

NOTE: In a satellite NG-RAN access, a GNSS fix time in lower layers can delay transmission of an initial UL NAS message by up to 100 seconds (GNSS cold state).

5.1.2 Types of 5GMM procedures

Depending on how they can be initiated, three types of 5GMM procedures can be distinguished:

a) 5GMM common procedures:

5GMM common procedure can always be initiated when the UE is in 5GMM-CONNECTED mode. The procedures belonging to this type are:

- 1) Initiated by the network:
 - i) network-initiated NAS transport;
 - ii) primary authentication and key agreement;
 - iii) security mode control;
 - iv) generic UE configuration update;
 - v) identification; and
 - vi) network slice-specific authentication and authorization;
- 2) Initiated by the UE:

UE-initiated NAS transport.
- 3) Initiated by the UE or the network and used to report certain error conditions detected upon receipt of 5GMM protocol data:

5GMM status.

b) 5GMM specific procedures:

At any time only one UE initiated 5GMM specific procedure can be running for each of the access network(s) that the UE is camping in. The procedures belonging to this type are:

- 1) Initiated by the UE and used e.g. to register to the network for 5GS services and establish a 5GMM context, to update the location/parameter(s) of the UE:

registration.
- 2) Initiated by the UE or the network and used to deregister from the network for 5GS services and to release a 5GMM context:

de-registration.
- 3) Initiated by the UE and used to deregister from the network for 5GS services and to release a 5GMM context:

eCall inactivity procedure.

c) 5GMM connection management procedures:

- 1) Initiated by the UE and used to establish a secure connection to the network or to request the resource reservation for sending data, or both:

service request.

The service request procedure can only be initiated if no UE initiated 5GMM specific procedure is ongoing for each of the access network(s) that the UE is camping in.

- 2) Initiated by the network and used to request the establishment of an N1 NAS signalling connection or to request re-establishment of user-plane resources for the PDU session(s) associated with 3GPP access or to

request re-establishment of user-plane resources of the PDU session(s) associated with non-3GPP access over 3GPP access; not applicable for the non-3GPP access network:

paging.

- 3) Initiated by the network and used to request re-establishment of user-plane resources of the PDU session(s) associated with non-3GPP access over 3GPP access or to deliver 5GSM downlink signalling messages associated with non-3GPP access over 3GPP access, when the UE is in 5GMM-CONNECTED mode over 3GPP access and in 5GMM-IDLE mode over non-3GPP access; or

Initiated by the network and used to request re-establishment of user-plane resources of the PDU session(s) associated with 3GPP access over 3GPP access or to deliver downlink signalling associated with 3GPP access over 3GPP access, when the UE is in 5GMM-CONNECTED mode over non-3GPP access, and when the UE is in 5GMM-IDLE mode over 3GPP access and not in MICO mode:

notification.

NOTE 1: In NB-N1 mode, the UE NAS using 5GS services with control plane CIoT 5GS optimization can wait for the lower layers to complete the transmission of the previous UL NAS TRANSPORT messages carrying control plane user data before providing subsequent NAS messages. Other implementations are possible.

NOTE 2: When providing NAS messages to the lower layers for transmission, the UE NAS using 5GS services with control plane CIoT 5GS optimization can prioritize sending NAS signalling messages over the UL NAS TRANSPORT messages carrying control plane user data. How the UE performs this prioritization is implementation specific.

5.1.3 5GMM sublayer states

5.1.3.1 General

In the following subclauses, the 5GS mobility management (5GMM) sublayer of the UE and the network is described by means of different state machines. The 5GMM sublayer states is managed per access type independently, i.e. 3GPP access or non-3GPP access. In subclause 5.1.3.2, the states of the 5GMM sublayer are introduced.

5.1.3.2 5GMM sublayer states

5.1.3.2.1 5GMM sublayer states in the UE

5.1.3.2.1.1 General

In the following subclauses, the possible 5GMM sublayer states of the UE are described and shown in Figure 5.1.3.2.1.1.1.

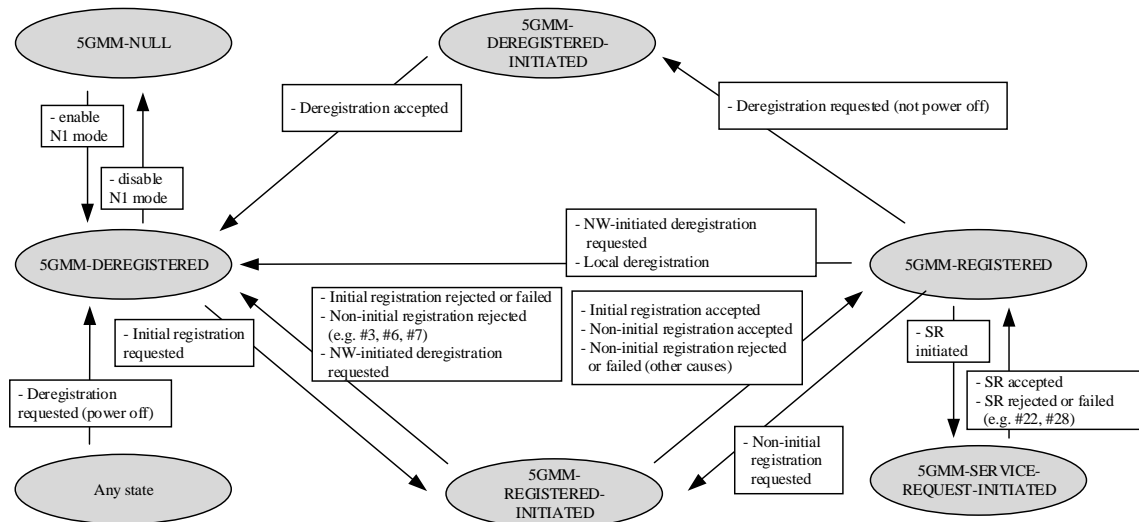

NOTE: Not all possible transitions are shown in this figure.

Figure 5.1.3.2.1.1.1: 5GMM main states in the UE

5.1.3.2.1.2 Main states

5.1.3.2.1.2.1 5GMM-NUL

5GS services are disabled in the UE. No 5GS mobility management function shall be performed in this state.

5.1.3.2.1.2.2 5GMM-DEREGISTERED

In the state 5GMM-DEREGISTERED, no 5GMM context has been established and the UE location is unknown to the network and hence it is unreachable by a network. In order to establish a 5GMM context, the UE shall start the initial registration procedure.

5.1.3.2.1.2.3 5GMM-REGISTERED-INITIATED

A UE enters the state 5GMM-REGISTERED-INITIATED after it has started the initial registration procedure or the registration procedure for mobility and periodic registration update, and is waiting for a response from the network.

5.1.3.2.1.2.4 5GMM-REGISTERED

In the state 5GMM-REGISTERED, a 5GMM context has been established. Additionally, one or more PDU session(s) may be established at the UE. The UE may initiate the non-initial registration procedure for mobility and periodic registration update and the service request procedure. The UE in the state 5GMM-REGISTERED over non-3GPP access shall not initiate the periodic registration update procedure.

5.1.3.2.1.2.5 5GMM-DEREGISTERED-INITIATED

A UE enters the state 5GMM-DEREGISTERED-INITIATED after it has requested release of the 5GMM context by starting the de-registration procedure and is waiting for a response from the network.

5.1.3.2.1.2.6 5GMM-SERVICE-REQUEST-INITIATED

A UE enters the state 5GMM-SERVICE-REQUEST-INITIATED after it has started the service request procedure and is waiting for a response from the network.

5.1.3.2.1.3 Substates of state 5GMM-DEREGISTERED

5.1.3.2.1.3.1 General

The state 5GMM-DEREGISTERED is subdivided into a number of substates as described in this subclause. The following substates are not applicable to non-3GPP access:

- a) 5GMM-DEREGISTERED.PLMN-SEARCH;
- b) 5GMM-DEREGISTERED.NO-CELL-AVAILABLE; and
- c) 5GMM-DEREGISTERED.eCALL-INACTIVE.

Valid subscriber data are available for the UE before it enters the substates, except for the substate 5GMM-DEREGISTERED.NO-SUPI.

5.1.3.2.1.3.2 5GMM-DEREGISTERED.NORMAL-SERVICE

The substate 5GMM-DEREGISTERED.NORMAL-SERVICE is chosen in the UE when a suitable cell has been found and the PLMN, SNPN, or tracking area is not in the forbidden list.

5.1.3.2.1.3.3 5GMM-DEREGISTERED.LIMITED-SERVICE

The substate 5GMM-DEREGISTERED.LIMITED-SERVICE is chosen in the UE, when it is known that a selected cell for 3GPP access or TA for non-3GPP access is unable to provide normal service (e.g. the selected cell over 3GPP access is in a forbidden PLMN or SNPN or is in a forbidden tracking area or TA for non-3GPP access is forbidden) or the selected cell is a CAG cell for which none of CAG-ID(s) is authorized based on the "Allowed CAG list" in the entry of the "CAG information list" for the PLMN, or the selected cell is a non-CAG cell in a PLMN for which there exists an "indication that the UE is only allowed to access 5GS via CAG cells" in the entry of the "CAG information list" for the PLMN, or the selected cell is a CAG cell belonging to a PLMN and the "CAG information list" does not contain an entry for the PLMN.

5.1.3.2.1.3.4 5GMM-DEREGISTERED.ATTEMPTING-REGISTRATION

The substate 5GMM-DEREGISTERED.ATTEMPTING-REGISTRATION is chosen in the UE if the initial registration procedure failed due to a missing response from the network or due to the circumstances described in subclauses 5.2.2.3.7, 5.5.1.2.4, 5.5.1.2.5, 5.5.1.2.7, 5.5.1.3.4, 5.5.2.3.2 and 5.5.2.3.4.

5.1.3.2.1.3.5 5GMM-DEREGISTERED.PLMN-SEARCH

The substate 5GMM-DEREGISTERED.PLMN-SEARCH is chosen in the UE, if the UE is searching for PLMNs or SNPNS. This substate is left either when a cell has been selected (the new substate is NORMAL-SERVICE or LIMITED-SERVICE) or when it has been concluded that no cell is available at the moment (the new substate is NO-CELL-AVAILABLE).

This substate is not applicable to non-3GPP access.

5.1.3.2.1.3.6 5GMM-DEREGISTERED.NO-SUPI

The substate 5GMM-DEREGISTERED.NO-SUPI is chosen in the UE, if the N1 mode is enabled and the UE has no valid subscriber data available (USIM not available, the USIM is considered invalid by the UE or an entry of the "list of subscriber data" with the SNPN identity of the SNPN is considered invalid by the UE).

5.1.3.2.1.3.7 5GMM-DEREGISTERED.NO-CELL-AVAILABLE

No 5G cell can be selected. This substate is entered either after a first intensive search failed when in substate 5GMM-DEREGISTERED.PLMN-SEARCH or unavailability period is activated for 3GPP access. Cells are searched for at a low rhythm. No 5GS services are offered.

This substate is not applicable to non-3GPP access.

5.1.3.2.1.3.8 5GMM-DEREGISTERED.eCALL-INACTIVE

The substate 5GMM-DEREGISTERED.eCALL-INACTIVE is chosen in the UE when:

- a) the UE is configured for eCall only mode as specified in 3GPP TS 31.102 [22];
- b) timer T3444 and timer T3445 have expired or are not running;
- c) a PLMN has been selected as specified in 3GPP TS 23.122 [5];
- d) the UE does not need to perform an eCall over IMS; and
- e) the UE does not need to perform a call to a non-emergency MSISDN or URI for test or terminal reconfiguration service.

In this substate, the UE shall not initiate any signalling towards the network, except to originate an eCall over IMS, or a call to a non-emergency MSISDN or URI for test or terminal reconfiguration service.

This substate is not applicable to non-3GPP access.

5.1.3.2.1.3.9 5GMM-DEREGISTERED.INITIAL-REGISTRATION-NEEDED

Valid subscriber data are available for the UE and for some reason a registration procedure for initial registration has to be performed as soon as possible. This substate can be entered if the access is barred due to unified access control, (see subclause 4.5.4) or if the network rejects the N1 NAS signalling connection establishment.

5.1.3.2.1.4 Substates of state 5GMM-REGISTERED

5.1.3.2.1.4.1 General

The state 5GMM-REGISTERED is subdivided into a number of substates as described in this subclause. The following substates are not applicable to non-3GPP access:

- a) 5GMM-REGISTERED.PLMN-SEARCH;
- b) 5GMM-REGISTERED.NON-ALLOWED-SERVICE; and
- c) 5GMM-REGISTERED.NO-CELL-AVAILABLE.

5.1.3.2.1.4.2 5GMM-REGISTERED.NORMAL-SERVICE

The substate 5GMM-REGISTERED.NORMAL-SERVICE is chosen by the UE as the primary substate when the UE enters the state 5GMM-REGISTERED, and:

- for 3GPP access, the cell the UE selected is known to be in an allowed area (see subclause 5.3.5.2); or
- for wireline access, the wireline access service area restrictions are not enforced.

5.1.3.2.1.4.3 5GMM-REGISTERED.NON-ALLOWED-SERVICE

The substate 5GMM-REGISTERED.NON-ALLOWED-SERVICE is chosen in the UE, if:

- for 3GPP access, the cell the UE selected is known to be in a non-allowed area (see subclause 5.3.5.2); or
- for wireline access, the wireline access service area restrictions are enforced.

This substate is applicable only to 3GPP access and to wireline access.

5.1.3.2.1.4.4 5GMM-REGISTERED.ATTEMPTING-REGISTRATION-UPDATE

The substate 5GMM-REGISTERED.ATTEMPTING-REGISTRATION-UPDATE is chosen by the UE if the registration procedure for mobility and periodic registration update failed due to a missing response from the network, or due to the circumstances described in subclauses 5.3.9, 5.5.1.3.5 and 5.5.1.3.7. No 5GMM procedure except registration procedure for mobility and periodic registration update (i.e. the 5GS registration type IE set to "mobility

registration updating" or "periodic registration updating" in the REGISTRATION REQUEST message) and de-registration procedure, shall be initiated by the UE in this substate. No data shall be sent or received.

NOTE 1: The registration procedure for mobility and periodic registration update over non-3GPP access can be triggered by, e.g. the change of S1 UE network capability or renegotiating some parameters.

NOTE 2: This substate is entered irrespective whether:

- a) the UE is camped on a cell which is in the registration area, and the current TAI is not in the list of "allowed tracking areas"; or
- b) the current TAI is in the list of "non-allowed tracking areas".

5.1.3.2.1.4.5 5GMM-REGISTERED.LIMITED-SERVICE

The substate 5GMM-REGISTERED.LIMITED-SERVICE is chosen in the UE, if the cell the UE selected is known not to be able to provide normal service.

NOTE: When the UE is registered to the network via CAG cell and none of the CAG-ID(s) supported by the current CAG cell is authorized based on the "Allowed CAG list" of the entry for the registered PLMN in the received "CAG information list", then the cell the UE selected is not able to provide normal service.

5.1.3.2.1.4.6 5GMM-REGISTERED.PLMN-SEARCH

The substate 5GMM-REGISTERED.PLMN-SEARCH is chosen in the UE, while the UE is searching for PLMNs or SNPNs.

This substate is not applicable to non-3GPP access.

5.1.3.2.1.4.7 5GMM-REGISTERED.NO-CELL-AVAILABLE

5G coverage has been lost, MICO mode is active in the UE or unavailability period is activated for 3GPP access. If MICO mode is active, the UE can deactivate MICO mode at any time by activating the AS layer when the UE needs to send mobile originated signalling or user data. Otherwise, the UE shall not initiate any 5GMM procedure except for cell and PLMN reselection.

This substate is not applicable to non-3GPP access.

5.1.3.2.1.4.8 5GMM-REGISTERED.UPDATE-NEEDED

This state can be entered if the UE has to perform a registration procedure for mobility and periodic registration update but:

- a) the access is barred due to unified access control when in 3GPP access;
- b) the network rejects the N1 NAS signalling connection establishment when in 3GPP access or in non-3GPP access; or
- c) the UE in 5GMM-CONNECTED mode with RRC inactive indication receives an indication from the lower layers that the resumption of the RRC connection has failed and for access is barred for all categories except categories '0' and '2' as specified in subclause 5.3.1.4.

No 5GMM procedure except:

- a) registration procedure for mobility and periodic registration update;
- b) service request procedure as a response to paging or notification; and
- c) de-registration procedure

shall be initiated by the UE in this substate.

NOTE: This substate is entered irrespective whether:

- a) the UE is camped on a cell which is in the registration area, and the current TAI is not in the list of "allowed tracking areas"; or
- b) the current TAI is in the list of "non-allowed tracking areas".

5.1.3.2.2 5GS update status in the UE

In order to describe the detailed UE behaviour, the 5GS update (5U) status pertaining to a specific subscriber is defined.

If the UE is not operating in SNPN access operation mode (see 3GPP TS 23.501 [8]), the 5GS update status is stored in a non-volatile memory in the USIM if the corresponding file is present in the USIM, else in the non-volatile memory in the ME, as described in annex C.

If the UE is operating in SNPN access operation mode, the 5GS update status for each SNPN whose SNPN identity is included in the "list of subscriber data" configured in the ME (see 3GPP TS 23.122 [5]) is stored in the non-volatile memory in the ME as described in annex C.

The 5GS update status value is changed only after the execution of a registration, network-initiated de-registration, 5GS based primary authentication and key agreement, service request, paging procedure or due to change in the current TAI which does not belong to the current registration area while T3346 is running.

5U1: UPDATED

The last registration attempt was successful.

5U2: NOT UPDATED

The last registration or service request attempt failed procedurally, e.g. no response or reject message was received from the AMF.

5U3: ROAMING NOT ALLOWED

The last registration, service request, or registration for mobility or periodic registration update attempt was correctly performed, but the answer from the AMF was negative (because of roaming or subscription restrictions).

5.1.3.2.3 5GMM sublayer states in the network side

5.1.3.2.3.1 General

In the following subclauses, the possible 5GMM sublayer states of the network are described and shown in Figure 5.1.3.2.3.1.1.

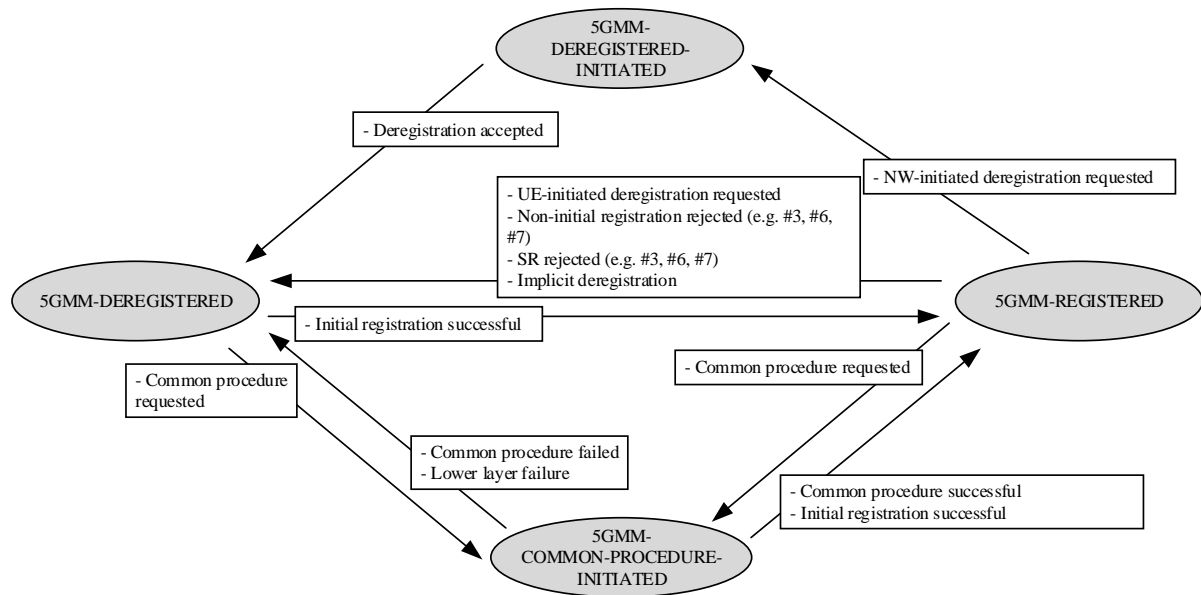

NOTE: Not all possible transitions are shown in this figure.

Figure 5.1.3.2.3.1.1: 5GMM main states in the network

5.1.3.2.3.2 5GMM-DEREGISTERED

In the state 5GMM-DEREGISTERED, no 5GMM context has been established or the 5GMM context is marked as deregistered. The UE is deregistered. The network may answer to an initial registration procedure initiated by the UE. The network may also answer to a de-registration procedure initiated by the UE.

5.1.3.2.3.3 5GMM-COMMON-PROCEDURE-INITIATED

The network enters the state 5GMM-COMMON-PROCEDURE-INITIATED, after it has started a common 5GMM procedure and is waiting for a response from the UE.

5.1.3.2.3.4 5GMM-REGISTERED

In the state 5GMM-REGISTERED, a 5GMM context has been established. Additionally, one or more PDU session(s) may be established at the network.

5.1.3.2.3.5 5GMM-DEREGISTERED-INITIATED

The network enters the state 5GMM-DEREGISTERED-INITIATED after it has started a de-registration procedure and is waiting for a response from the UE.

5.1.4 Coordination between 5GMM and EMM

5.1.4.1 General

If both 5GMM and EMM are enabled, a UE, operating in single-registration mode, shall maintain one common registration for 5GMM for 3GPP access and EMM.

Coordination between 5GMM for 3GPP access and EMM for a UE, which is capable of N1 mode and S1 mode and operates in dual-registration mode, is not needed, except as specified in subclause 4.8.3.

The coordination between 5GMM for 3GPP access and EMM in subclauses 5.1.4.2 and 5.1.4.3 only applies to the UEs operating in single-registration mode.

Regarding the coordination of "SIM/USIM considered invalid" and "USIM considered invalid for 5GS services" between the various mobility management entities see subclause 5.1.5.

5.1.4.2 Coordination between 5GMM for 3GPP access and EMM with N26 interface

A UE that is not registered shall be in state EMM-DEREGISTERED and state 5GMM-DEREGISTERED for 3GPP access.

In N1 mode, upon successful completion of a registration procedure over 3GPP access, the UE operating in single-registration mode shall enter substates 5GMM-REGISTERED.NORMAL-SERVICE or 5GMM-REGISTERED.NON-ALLOWED-SERVICE as described in subclause 5.3.5.2 for 3GPP access and EMM-REGISTERED.NO-CELL-AVAILABLE. The UE shall reset the registration attempt counter for 3GPP access and the attach attempt counter (see 3GPP TS 24.301 [15]).

At inter-system change from S1 mode to N1 mode, the UE shall enter substates 5GMM-REGISTERED.NORMAL-SERVICE or 5GMM-REGISTERED.NON-ALLOWED-SERVICE as described in subclause 5.3.5.2 for 3GPP access and EMM-REGISTERED.NO-CELL-AVAILABLE and initiate a registration procedure for mobility and periodic registration update over 3GPP access indicating "mobility registration updating" in the 5GS registration type IE of the REGISTRATION REQUEST message (see subclause 5.5.1.3).

In S1 mode, upon successful completion of an attach or tracking area updating procedure, the UE operating in single-registration mode shall enter substates 5GMM-REGISTERED.NO-CELL-AVAILABLE for 3GPP access and EMM-REGISTERED.NORMAL-SERVICE. The UE shall reset the registration attempt counter for 3GPP access and the attach attempt counter or tracking area updating attempt counter (see 3GPP TS 24.301 [15]).

At inter-system change from N1 mode to S1 mode when there is no active PDU session for which interworking with EPS is supported as specified in subclause 6.1.4.1, and EMM-REGISTERED without PDN connection is not supported by the UE or the MME, the UE shall enter state 5GMM-DEREGISTERED for 3GPP access and state EMM-DEREGISTERED and then initiate the EPS attach procedure. If EMM-REGISTERED without PDN connection is supported by the UE and the MME, the UE shall enter substates EMM-REGISTERED.NORMAL-SERVICE and 5GMM-REGISTERED.NO-CELL-AVAILABLE for 3GPP access and initiate a tracking area updating procedure.

At inter-system change from N1 mode to S1 mode when there is at least one active PDU session for which interworking with EPS is supported as specified in subclause 6.1.4.1, the UE shall enter substates EMM-REGISTERED.NORMAL-SERVICE and 5GMM-REGISTERED.NO-CELL-AVAILABLE for 3GPP access and initiate a tracking area updating procedure (see 3GPP TS 24.301 [15]).

5.1.4.3 Coordination between 5GMM for 3GPP access and EMM without N26 interface

A UE operating in the single-registration mode that is not registered over 3GPP access shall be in state EMM-DEREGISTERED and in state 5GMM-DEREGISTERED for 3GPP access.

In N1 mode, upon successful completion of a registration procedure over 3GPP access, the UE operating in the single-registration mode shall enter substates 5GMM-REGISTERED.NORMAL-SERVICE or 5GMM-REGISTERED.NON-ALLOWED-SERVICE as described in subclause 5.3.5.2 for 3GPP access and EMM-REGISTERED.NO-CELL-AVAILABLE.

At inter-system change from N1 mode to S1 mode in 5GMM-IDLE mode, the UE shall behave as specified in subclause 4.8.2.3.

In S1 mode, upon successful completion of an attach or tracking area updating procedure, the UE operating in the single-registration mode shall enter substates 5GMM-REGISTERED.NO-CELL-AVAILABLE for 3GPP access and EMM-REGISTERED.NORMAL-SERVICE.

At inter-system change from S1 mode to N1 mode in 5GMM-IDLE mode, the UE operating in the single-registration mode:

- a) if the UE is registered for normal service in S1 mode, the UE shall enter substates EMM-REGISTERED.NO-CELL-AVAILABLE and 5GMM-REGISTERED.NORMAL-SERVICE for 3GPP access and then initiate the registration procedure for mobility and periodic registration update over 3GPP access indicating "mobility registration updating" in the 5GS registration type IE of the REGISTRATION REQUEST message (see subclause 5.5.1.3); or
- b) if the UE is registered for emergency bearer services in S1 mode, the UE shall initiate the initial registration for emergency services.

5.1.5 Coordination between 5GMM and GMM

Coordination between 5GMM and GMM states is not required.

Regardless whether the UE is operating in single-registration mode or dual-registration mode,

- a) if the UE considers the SIM/USIM invalid for any of: 3GPP access in N1 mode, S1 mode, A/Gb mode or Iu mode, then it considers the SIM/USIM invalid for all of them; and
- b) if the UE considers the USIM invalid for 5GS services for any of: 3GPP access in N1 mode, S1 mode, A/Gb mode or Iu mode, then it considers the USIM invalid for 5GS services for all of them.

5.2 Behaviour of the UE in state 5GMM-DEREGISTERED and state 5GMM-REGISTERED

5.2.1 General

In this subclause, the detailed behaviour of the UE in the states 5GMM-DEREGISTERED and 5GMM-REGISTERED is described.

5.2.2 UE behaviour in state 5GMM-DEREGISTERED

5.2.2.1 General

The state 5GMM-DEREGISTERED is entered in the UE, when:

- a) the de-registration is performed either by the UE or by the network (see subclause 5.5.2);
- b) the registration request is rejected by the AMF (see subclause 5.5.1.2.5 and 5.5.1.3.5);
- c) the service request is rejected by the AMF (see subclause 5.6.1);
- d) the UE is switched on; or
- e) the UE registered for emergency services is in 5GMM-IDLE mode and its periodic registration update timer expires (see subclause 5.3.7).

In state 5GMM-DEREGISTERED, the UE shall behave according to the substate as explained in subclause 5.2.2.3.

5.2.2.2 Primary substate selection

5.2.2.2.1 Selection of the substate after power on

For a UE configured for eCall only mode as specified in 3GPP TS 31.102 [22], timers T3444 and T3445 are considered to have expired at power on. When the UE is switched on, the substate shall be PLMN-SEARCH if the USIM is available and valid or there are valid entries in the "list of subscriber data". See 3GPP TS 23.122 [5] for further details.

The substate chosen after PLMN-SEARCH, following power on is:

- a) if no cell can be selected, the substate shall be NO-CELL-AVAILABLE;
- b) if the UE is not operating in SNPN access operation mode, and no USIM is present, or the USIM is considered invalid by the UE, the substate shall be NO-SUPI;
- c) if the UE is operating in SNPN access operation mode, and:
 - 1) the selected entry in the "list of subscriber data" does not contain subscription identifier, and no USIM is present, or the USIM is considered invalid by the UE; or
 - 2) no valid entry in the "list of subscriber data" exists;

the substate shall be NO-SUPI;

d) if a suitable cell has been found:

- 1) the PLMN identity of the cell is not in one of the forbidden PLMN lists;
- 2) the SNPN is not an SNPN selected for localized services in SNPN (see 3GPP TS 23.122 [5]), the UE is not to perform initial registration for onboarding services in SNPN, and the SNPN identity of the cell is not in one of the "permanently forbidden SNPNs" list or the "temporarily forbidden SNPNs" list which are, if the MS supports access to an SNPN using credentials from a credentials holder, equivalent SNPNs or both, associated with the selected entry of the "list of subscriber data" or the selected PLMN subscription ;
- 3) the SNPN is an SNPN selected for localized services in SNPN (see 3GPP TS 23.122 [5]), and the SNPN identity of the cell is not in one of the "permanently forbidden SNPNs for access for localized services in SNPN" list or "temporarily forbidden SNPNs for access for localized services in SNPN" list, associated with the selected entry of the "list of subscriber data" or the selected PLMN subscription; or
- 4) the UE is to perform initial registration for onboarding services in SNPN and the SNPN identity of the cell is not in the "permanently forbidden SNPNs for onboarding services in SNPN" list and the "temporarily forbidden SNPNs for onboarding services in SNPN" list;

and the tracking area is not in one of the lists of 5GS forbidden tracking areas, then the substate shall be NORMAL-SERVICE;

- e) if the selected cell is known not to be able to provide normal service, then the UE shall enter the substate LIMITED-SERVICE;
- f) if the UE is in manual network selection mode and no cell of the selected PLMN or SNPN has been found, the UE shall enter the substate NO-CELL-AVAILABLE; and
- g) if the UE is configured for eCall only mode as specified in 3GPP TS 31.102 [22], the substate shall be eCALL-INACTIVE.

5.2.2.3 Detailed description of UE behaviour in state 5GMM-DEREGISTERED

5.2.2.3.1 NORMAL-SERVICE

The UE shall initiate an initial registration procedure if the timer T3346 is not running. If timer T3346 is running, the UE shall initiate an initial registration procedure on the expiry of timer T3346.

The UE may initiate an initial registration procedure for emergency services or for a UE configured for high priority access in selected PLMN or SNPN, even if timer T3346 is running.

5.2.2.3.2 LIMITED-SERVICE

The UE shall initiate an initial registration procedure when entering a cell which provides normal service.

The UE may initiate initial registration for emergency services.

5.2.2.3.3 ATTEMPTING-REGISTRATION

The UE in 3GPP access:

- a) shall initiate an initial registration procedure on the expiry of timers T3502, T3511 or T3346;
- b) may initiate an initial registration procedure for emergency services even if timers T3502, T3511 or T3346 are running;
- b1) may initiate an initial registration procedure even if timer T3502, T3346 or T3447 is running, if the UE is a UE configured for high priority access in selected PLMN;
- b2) may initiate an initial registration procedure even if timer T3502, T3346 is running, if the UE is a UE configured for high priority access in selected SNPN;

- c) shall initiate an initial registration procedure when entering a new PLMN or SNPN, except if:
- i) timer T3346 is running and the new PLMN or SNPN is equivalent to the PLMN or SNPN where the UE started timer T3346;
 - ii) the PLMN identity of the new cell is in the forbidden PLMN lists;
 - iii) the SNPN is not an SNPN selected for localized services in SNPN (see 3GPP TS 23.122 [5]), the UE is not to perform initial registration for onboarding services in SNPN, the SNPN identity of the new cell is in the "permanently forbidden SNPNs" list or the "temporarily forbidden SNPNs" list which are, if the MS supports access to an SNPN using credentials from a credentials holder, equivalent SNPNs or both, associated with the selected entry of the "list of subscriber data" or the selected PLMN subscription;
 - iv) the SNPN is an SNPN selected for localized services in SNPN (see 3GPP TS 23.122 [5]), the SNPN identity of the new cell is in the "permanently forbidden SNPNs for access for localized services in SNPN" list or the "temporarily forbidden SNPNs for access for localized services in SNPN" list, associated with the selected entry of the "list of subscriber data" or the selected PLMN subscription;
 - v) the UE is to perform initial registration for onboarding services in SNPN, the SNPN identity of the new cell is in the "permanently forbidden SNPNs for onboarding services in SNPN" list or the "temporarily forbidden SNPNs for onboarding services in SNPN" list; or
 - vi) the current TAI is in one of the lists of 5GS forbidden tracking areas;
- d) shall initiate an initial registration procedure when the current TAI has changed, if timer T3346 is not running,
- 1) the PLMN identity of the new cell is not in one of the forbidden PLMN lists;
 - 2) the SNPN is not an SNPN selected for localized services in SNPN (see 3GPP TS 23.122 [5]), the UE is not to perform initial registration for onboarding services in SNPN, and the SNPN identity of the new cell is in neither the "permanently forbidden SNPNs" list nor the "temporarily forbidden SNPNs" list which are, if the MS supports access to an SNPN using credentials from a credentials holder, equivalent SNPNs or both, associated with the selected entry of the "list of subscriber data" or the selected PLMN subscription;
 - 3) the SNPN is an SNPN selected for localized services in SNPN (see 3GPP TS 23.122 [5]) and the SNPN identity of the cell is in neither the "permanently forbidden SNPNs for access for localized services in SNPN" list nor the "temporarily forbidden SNPNs for access for localized services in SNPN" list, associated with the selected entry of the "list of subscriber data" or the selected PLMN subscription; or
 - 4) the UE is to perform initial registration for onboarding services in SNPN, and the SNPN identity of the cell is in neither the "permanently forbidden SNPNs for onboarding services in SNPN" list nor the "temporarily forbidden SNPNs for onboarding services in SNPN" list;
- and the current TAI is not in one of the lists of 5GS forbidden tracking areas;
- e) shall initiate an initial registration procedure if the 5GS update status is set to 5U2 NOT UPDATED, and timers T3511, T3502 and T3346 are not running;
- f) may initiate an initial registration procedure for UE in NB-N1 mode upon receiving a request from upper layers to transmit user data related to an exceptional event and the UE is allowed to use exception data reporting (see the ExceptionDataReportingAllowed leaf of the NAS configuration MO in 3GPP TS 24.368 [17]) or the USIM file EF_{NASCONFIG} in 3GPP TS 31.102 [22]) if timer T3346 is not already running for "MO exception data" and even if timer T3502 or timer T3511 is running; and
- g) may initiate an initial registration procedure with 5GS registration type IE set to "initial registration" for initiating of an emergency PDU session, upon request of the upper layers to establish the emergency PDU session.

The UE in non-3GPP access:

- a) shall initiate an initial registration procedure on the expiry of timers T3502, T3511 or T3346;
- b) may initiate an initial registration procedure for emergency services even if timers T3502, T3511 or T3346 are running;

- b1) may initiate an initial registration procedure even if timer T3502 or T3346 is running if the UE is a UE configured for high priority access in selected PLMN;
- c) shall initiate an initial registration procedure when entering a new PLMN or SNPN, except if timer T3346 is running and the new PLMN or SNPN is equivalent to the PLMN or SNPN where the UE started timer T3346;
- d) shall initiate an initial registration procedure if the 5GS update status is set to 5U2 NOT UPDATED, and timers T3511, T3502 and T3346 are not running; and
- e) may initiate an initial registration procedure with 5GS registration type IE set to "initial registration" for initiating of an emergency PDU session, upon request of the upper layers to establish the emergency PDU session.

5.2.2.3.4 PLMN-SEARCH

The UE shall perform PLMN selection or SNPN selection. If a new PLMN or SNPN is selected, the UE shall reset the registration attempt counter and initiate the registration procedure for initial registration (see subclause 5.5.1.2.2).

If the selected cell in the new PLMN is known not to be able to provide normal service, the UE may initiate the registration procedure for initial registration for emergency services.

5.2.2.3.5 NO-SUPI

The UE may initiate the registration procedure for initial registration for emergency services.

5.2.2.3.6 NO-CELL-AVAILABLE

The UE shall perform cell selection and choose an appropriate substate when a cell is found.

5.2.2.3.7 eCALL-INACTIVE

The UE camps on a suitable cell or an acceptable cell in a PLMN selected as specified in 3GPP TS 23.122 [5] but initiates no 5GMM signalling with the network and ignores any paging requests.

The UE shall leave substate 5GMM-DEREGISTERED.eCALL-INACTIVE state only when one of the following events occur:

- a) if the USIM is removed, the UE enters substate 5GMM-DEREGISTERED.NO-SUPI;
- b) if coverage is lost, the UE enters substate 5GMM-DEREGISTERED.PLMN-SEARCH;
- c) if the UE is deactivated (e.g. powered off) by the user, the UE enters state 5GMM-NULL;
- d) if the UE receives a request from upper layers to establish an eCall over IMS, the UE enters state 5GMM-DEREGISTERED.ATTEMPTING-REGISTRATION. The UE then uses the relevant 5GMM and 5GSM procedures to establish the eCall over IMS at the earliest opportunity; or
- e) if the UE receives a request from upper layers to establish a call to an HPLMN designated non-emergency MSISDN or URI for test or terminal reconfiguration service, the UE enters state 5GMM-DEREGISTERED.ATTEMPTING-REGISTRATION. Once the registration procedure is completed, the UE uses the relevant 5GMM and 5GSM procedures to establish the non-emergency call.

5.2.2.3.8 INITIAL-REGISTRATION-NEEDED

The UE shall initiate the initial registration procedure, if still needed, as soon as the access is allowed in the selected cell for the UE.

The UE may initiate registration procedure for emergency services.

5.2.2.4 Substate when back to state 5GMM-DEREGISTERED from another 5GMM state

When returning to state 5GMM-DEREGISTERED, the UE shall select a cell as specified in 3GPP TS 38.304 [28] or 3GPP TS 36.304 [25C].

The substate depends on the result of the cell selection procedure, the outcome of the previously performed 5GMM specific procedures, on the 5GS update status of the UE, on the tracking area data stored in the UE, on the presence of the USIM, on the UE configuration and on the reason for moving to 5GMM-DEREGISTERED:

- a) If no cell has been found, the substate is NO-CELL-AVAILABLE, until a cell is found;
- b) If no USIM is present or if the inserted USIM is considered invalid by the UE, the substate shall be NO-SUPI;
- c) If a suitable cell has been found and the PLMN or tracking area is not in one of the forbidden lists, the substate shall be NORMAL-SERVICE;
- d) If an initial registration shall be performed (e.g. network-requested re-registration), the substate shall be ATTEMPTING-REGISTRATION;
- e) If a PLMN reselection or SNPN reselection (according to 3GPP TS 23.122 [5]) is needed, the substate shall be PLMN-SEARCH;
- f) If the selected cell is known not to be able to provide normal service, the substate shall be LIMITED-SERVICE; and
- g) If the UE is configured for eCall only mode as specified in 3GPP TS 31.102 [22], T3444 and T3445 have expired or are not running, and substate PLMN-SEARCH is not required, the substate shall be eCALL-INACTIVE.

5.2.3 UE behaviour in state 5GMM-REGISTERED

5.2.3.1 General

The state 5GMM-REGISTERED is entered at the UE, when the initial registration procedure is performed by the UE (see subclause 5.5.1.2.2).

In state 5GMM-REGISTERED, the UE shall behave according to the substate as explained in subclause 5.2.3.2.

5.2.3.2 Detailed description of UE behaviour in state 5GMM-REGISTERED

5.2.3.2.1 NORMAL-SERVICE

The UE:

- a) shall initiate the mobility or the registration procedure for periodic registration update (according to conditions given in subclause 5.5.1.3.2), except that the registration procedure for periodic registration update shall not be initiated over non-3GPP access;
- b) shall initiate the service request procedure (according to conditions given in subclause 5.6.1);
- c) shall respond to paging;

NOTE 1: Paging is not supported over non-3GPP access.

NOTE 2: As an implementation option, the MUSIM UE is allowed to not respond to paging based on the information available in the paging message, e.g. voice service indication.

- d) if configured for eCall only mode as specified in 3GPP TS 31.102 [22], shall perform the eCall inactivity procedure at expiry of timer T3444 or timer T3445 (see subclause 5.5.3); and
- e) shall initiate a registration procedure for mobility and periodic registration update on the expiry of timer T3511; and

- f) if acting as a 5G ProSe UE-to-network relay UE as specified in 3GPP 24.554 [19E], shall initiate the authentication and key agreement procedure (according to the conditions given in subclause 5.5.4).

5.2.3.2.2 NON-ALLOWED-SERVICE

The UE shall behave as specified in subclause 5.3.5.

The UE in 5GMM-REGISTERED.NON-ALLOWED-SERVICE substate, if configured for eCall only mode as specified in 3GPP TS 31.102 [22], shall perform the eCall inactivity procedure at expiry of timer T3444 or timer T3445 (see subclause 5.5.3).

5.2.3.2.3 ATTEMPTING-REGISTRATION-UPDATE

The UE in 3GPP access:

- a) shall not send any user data;
- b) shall initiate a registration procedure for mobility and periodic registration update on the expiry of timers T3502, T3511, T3346 or discontinuous coverage maximum time offset timer;
- c) shall initiate a registration procedure for mobility and periodic registration update when entering a new PLMN or SNPN, if timer T3346 is running and the new PLMN or SNPN is not equivalent to the PLMN or SNPN where the UE started timer T3346, the PLMN identity of the new cell is not in the forbidden PLMN lists, and the current TAI is not in one of the lists of 5GS forbidden tracking areas;
- d) shall initiate a registration procedure for mobility and periodic registration update when the current TAI has changed, if timer T3346 is not running and:
 - 1) the PLMN identity of the new cell is not in one of the forbidden PLMN lists;
 - 2) the SNPN is not an SNPN selected for localized services in SNPN (see 3GPP TS 23.122 [5]), the UE is not registered for onboarding services in SNPN, and the SNPN identity of the new cell is in neither the "permanently forbidden SNPNs" list nor the "temporarily forbidden SNPNs" list which are, if the UE supports access to an SNPN using credentials from a credentials holder, equivalent SNPNs or both, associated with the selected entry of the "list of subscriber data" or the selected PLMN subscription;
 - 3) the SNPN is an SNPN selected for localized services in SNPN (see 3GPP TS 23.122 [5]), and the SNPN identity of the new cell is in neither the "permanently forbidden SNPNs for access for localized services in SNPN" list nor the "temporarily forbidden SNPNs for access for localized services in SNPN" list, associated with the selected entry of the "list of subscriber data" or the selected PLMN subscription; or
 - 4) the UE is registered for onboarding services in SNPN, and the SNPN identity of the cell is in neither the "permanently forbidden SNPNs for onboarding services in SNPN" list nor the "temporarily forbidden SNPNs for onboarding services in SNPN" list;and the current TAI is not in one of the lists of 5GS forbidden tracking areas;
- e) may initiate a registration procedure for mobility and periodic registration update upon request of the upper layers to establish an emergency PDU session or perform emergency service fallback;
- e1) may initiate a registration procedure for mobility and periodic registration update upon request of the upper layers to establish a PDU session, even if timer T3502, T3346 or T3447 is running, if the UE is a UE configured for high priority access in the selected PLMN;
- e2) may initiate a registration procedure for mobility and periodic registration update upon request of the upper layers to establish a PDU session, even if timer T3502, T3346 is running, if the UE is a UE configured for high priority access in selected SNPN;
- f) may perform de-registration locally and initiate a registration procedure for initial registration for emergency services even if timer T3346 is running;
- g) shall initiate registration procedure for mobility and periodic registration update upon reception of paging, or upon reception of NOTIFICATION message with access type indicating 3GPP access;

NOTE: As an implementation option, the MUSIM UE is allowed to not respond to paging based on the information available in the paging message, e.g. voice service indication.

- h) may initiate a registration procedure for mobility and periodic registration update upon request for an MMTEL voice call, MMTEL video call, or an MO IMS registration related signalling from the upper layers, and none of the following conditions is met:
- 1) timer T3346 is running;
 - 2) the UE has stored a list of "non-allowed tracking areas" and the current TAI is in the list of "non-allowed tracking areas"; or
 - 3) the UE has stored a list of "allowed tracking areas", the UE is camped on a cell which is in the registration area and the current TAI is not in the list of "allowed tracking areas";
- i) shall initiate a registration procedure for mobility and periodic registration update if the 5GS update status is set to 5U2 NOT UPDATED, and timers T3511, T3502 and T3346 are not running;
- j) if configured for eCall only mode as specified in 3GPP TS 31.102 [22], shall perform the eCall inactivity procedure at expiry of timer T3444 or timer T3445 (see subclause 5.5.3);
- k) may initiate a registration procedure for mobility and periodic registration update for UE in NB-N1 mode upon receiving a request from upper layers to transmit user data related to an exceptional event and the UE is allowed to use exception data reporting (see the ExceptionDataReportingAllowed leaf of the NAS configuration MO in 3GPP TS 24.368 [17]) or the USIM file EF_{NASCONFIG} in 3GPP TS 31.102 [22]) if timer T3346 is not already running for "MO exception data" and even if timer T3502 or timer T3511 is running;
- l) shall not initiate the signalling for the de-registration procedure with de-registration type "normal de-registration" unless the current TAI is part of the TAI list; and
- m) shall initiate a registration procedure for mobility and periodic registration update if the UE supports the reconnection to the network due to RAN timing synchronization status change and receives an indication of a change in the RAN timing synchronization status, even if timer T3502 is running.

The UE in non-3GPP access:

- a) shall not send any user data;
- b) shall initiate the registration procedure for mobility and periodic registration update on the expiry of timers T3502, T3511 or T3346;
- c) may initiate a registration procedure for mobility registration update upon request of the upper layers to establish an emergency PDU session;
- c1) may initiate a registration procedure for mobility and periodic registration update upon request of the upper layers to establish a PDU session, if the UE is a UE configured for high priority access in selected PLMN even if timer T3346 or T3502 is running;
- d) may perform de-registration locally and initiate a registration procedure for initial registration for emergency services even if timer T3346 is running;
- e) may initiate a registration procedure for mobility and periodic registration update upon request for an MMTEL voice call, MMTEL video call, or an MO IMS registration related signalling from the upper layers, if timer T3346 is not running;
- f) shall initiate a registration procedure for mobility and periodic registration update if the 5GS update status is set to 5U2 NOT UPDATED, and timers T3511, T3502 and T3346 are not running; and
- g) shall not initiate the signalling for the de-registration procedure unless timer T3346 is running.

5.2.3.2.4 LIMITED-SERVICE

The UE:

- a) shall perform cell selection/reselection;

- b) may perform de-registration locally and initiate an initial registration for emergency services; and
- c) if configured for eCall only mode as specified in 3GPP TS 31.102 [22], shall perform the eCall inactivity procedure at expiry of timer T3444 or timer T3445 (see subclause 5.5.3).

5.2.3.2.5 PLMN-SEARCH

The UE shall perform PLMN selection or SNPN selection. If a new PLMN is selected, the UE shall reset the registration attempt counter and initiate a registration procedure for mobility and periodic registration update (see subclause 5.5.1.3). If a new SNPN is selected, the UE shall reset the registration attempt counter and initiate a mobility registration update if the UE supports access to an SNPN using credentials from a credentials holder or when the SNPNs are equivalent SNPNs or both (see subclause 4.14.2) and the last registered SNPN and the newly selected SNPN are both identified by globally-unique SNPN identities. Otherwise the UE, may perform de-registration locally and shall initiate a registration procedure for initial registration (see subclause 5.5.1.2.2). If the selected cell in the new PLMN is known not to be able to provide normal service, the UE may perform de-registration locally and initiate an initial registration for emergency services.

5.2.3.2.6 NO-CELL-AVAILABLE

The UE shall perform cell selection and choose an appropriate substate when a cell is found.

5.2.3.2.7 UPDATE-NEEDED

The UE:

- a) shall not send any user data;
- b) shall not send signalling information, unless it is a service request as a response to paging or to initiate signalling for emergency services or emergency services fallback;
- c) shall perform cell selection/reselection;
- d) shall enter the appropriate new substate as soon as the lower layers indicate that the barring is alleviated for the access category with which the access attempt for the registration procedure for mobility and periodic registration update was associated and, if still needed, start the registration procedure for mobility and periodic registration update or the signalling for the de-registration procedure (see subclauses 5.5.1.3.7, item 1, and 5.5.2.2.6, item b); and
- e) if configured for eCall only mode as specified in 3GPP TS 31.102 [22], shall perform the eCall inactivity procedure at expiry of timer T3444 or T3445 (see subclause 5.5.3).

5.3 General on elementary 5GMM procedures

5.3.1 5GMM modes and N1 NAS signalling connection

5.3.1.1 Establishment of the N1 NAS signalling connection

When the UE is in 5GMM-IDLE mode over 3GPP access and needs to transmit an initial NAS message, the UE shall request the lower layer to establish an RRC connection. Upon indication from the lower layers that the RRC connection has been established, the UE shall consider that the N1 NAS signalling connection over 3GPP access is established and enter 5GMM-CONNECTED mode over 3GPP access.

When the UE is in 5GMM-IDLE mode over non-3GPP access, and the UE receives an indication from the lower layers of non-3GPP access, that the access stratum connection is established between the UE and the network, the UE shall send an initial NAS message, consider the N1 NAS signalling connection is established and enter 5GMM-CONNECTED mode over non-3GPP access.

Initial NAS messages are:

- a) REGISTRATION REQUEST message;

- b) DEREGISTRATION REQUEST message;
- c) SERVICE REQUEST message; and
- d) CONTROL PLANE SERVICE REQUEST.

If the UE is capable of both N1 mode and S1 mode and lower layers provide an indication that the current E-UTRA cell is connected to both EPC and 5GCN, for the routing of the REGISTRATION REQUEST message during the initial registration procedure to the appropriate core network (EPC or 5GCN), the UE NAS provides the lower layers with the selected core network type information.

For the routing of the initial NAS message to the appropriate AMF, if the UE holds a 5G-GUTI or 4G-GUTI, the UE NAS provides the lower layers with the UE identity according to the following rules:

- a) if the registration procedure for mobility and periodic registration update was triggered due to the last CONFIGURATION UPDATE COMMAND message containing the Configuration update indication IE with the Registration bit set to "registration requested" and including:
 - 1) no other parameters;
 - 2) one or both of the Allowed NSSAI IE and the Configured NSSAI IE; or
 - 3) the Network slicing indication IE with the Network slicing subscription change indication set to "Network slicing subscription changed";

the UE NAS shall not provide the lower layers with the 5G-S-TMSI or the registered GUAMI;

- b) if the service request procedure was initiated over non-3GPP access, the UE NAS shall provide the lower layers with the registered GUAMI, but shall not provide the lower layers with the 5G-S-TMSI;
- c) if the initial NAS message other than the SERVICE REQUEST or CONTROL PLANE SERVICE REQUEST message was initiated over untrusted non-3GPP access, the UE NAS shall provide the lower layers with the GUAMI of the 5G-GUTI that the UE NAS has selected as specified in the subclause 5.5.1.2.2 and 5.5.1.3.2, but shall not provide the lower layers with the 5G-S-TMSI;

if the initial NAS message other than the SERVICE REQUEST or CONTROL PLANE SERVICE REQUEST message was initiated over trusted non-3GPP access, the UE NAS shall provide the lower layers with the 5G-GUTI, if available, otherwise shall provide the lower layers with the SUCI;

if the UE is the 5G-RG and the initial NAS message other than the SERVICE REQUEST or CONTROL PLANE SERVICE REQUEST message was initiated over wireline access, the UE NAS shall provide the lower layers with the GUAMI of the 5G-GUTI that the UE NAS has selected as specified in the subclause 5.5.1.2.2 and 5.5.1.3.2, if available, otherwise shall not provide the lower layers with any UE identity;

- d) if the UE does not hold a 5G-GUTI that was previously assigned by the same PLMN with which the UE is performing the registration procedure and if:
 - 1) the UE operating in the single-registration mode performs a registration procedure for mobility and periodic registration update indicating "mobility registration updating" following an inter-system change from S1 mode to N1 mode; or
 - 2) the UE which was previously registered in S1 mode before entering state EMM-DEREGISTERED, performs an initial registration procedure, the UE has received the interworking without N26 interface indicator set to "interworking without N26 interface not supported" from the network, and the UE holds a 4G-GUTI;

then the UE NAS provides the lower layers with a GUAMI part of the 5G-GUTI mapped from 4G-GUTI as specified in 3GPP TS 23.003 [4] with an indication that the GUAMI is mapped from EPS; or

- e) otherwise:
 - 1) if the tracking area of the current cell is in the registration area, the UE NAS shall provide the lower layers with the 5G-S-TMSI, but shall not provide the registered GUAMI to the lower layers; or
 - 2) if the tracking area of the current cell is not in the registration area, the UE NAS shall provide the lower layers with the GUAMI of the 5G-GUTI that the UE NAS has selected as specified in the subclauses 5.5.1.2.2 and 5.5.1.3.2, but shall not provide the lower layers with the 5G-S-TMSI.

For 3GPP access, if:

- a) the UE is operating in single-registration mode, the UE does not hold a 5G-GUTI and the UE does not hold a 4G-GUTI; or
- b) the UE is operating in dual-registration mode and the UE does not hold a 5G-GUTI;

the UE NAS does not provide the lower layers with the 5G-S-TMSI or the registered GUAMI.

For untrusted non-3GPP access, if the UE does not hold a 5G-GUTI and the UE does not hold a 4G-GUTI, the UE NAS does not provide the lower layers with the 5G-S-TMSI or the registered GUAMI. For trusted non-3GPP access, if the UE does not hold a 5G-GUTI and the UE does not hold a 4G-GUTI, the UE NAS provides the lower layers with the SUCI.

For 3GPP access, if a UE operating as an IAB-node performs a registration procedure or service request procedure (see 3GPP TS 23.501 [8]), the UE NAS shall indicate to the lower layers that the establishment of the NAS signalling connection is for a UE operating as an IAB-node.

The UE NAS also provides the lower layers with the identity of the selected PLMN (see 3GPP TS 38.331 [30]) if the UE is not operating in SNPN access operation mode. If the UE is operating in SNPN access operation mode, the UE NAS provides the lower layers with the SNPN identity of the selected SNPN. In a shared network, the UE shall choose one of the PLMN identity(ies) or SNPN identity(ies) as specified in 3GPP TS 23.122 [5] and 3GPP TS 24.502 [18].

The UE NAS layer may provide the lower layers with an NSSAI as specified in subclause 4.6.2.3.

If the UE performs initial registration for onboarding services in SNPN or is registered for onboarding services in SNPN, the UE NAS layer shall provide the lower layers with an indication that the connection is for onboarding.

5.3.1.2 Re-establishment of the N1 NAS signalling connection

When the UE in 5GMM-CONNECTED mode over 3GPP access receives a fallback indication from lower layers, and the UE has no pending NAS procedure and no pending uplink user data for PDU session(s) with user-plane resources already established, the UE shall:

- a) enter 5GMM-IDLE mode; and
- b) initiate the registration procedure for mobility and periodic registration update and include the Uplink data status IE in the REGISTRATION REQUEST message indicating the PDU session(s) for which user-plane resources were active prior to receiving the fallback indication, if any (see subclause 5.5.1.3 for further details).

When the UE in 5GMM-CONNECTED mode over 3GPP access receives a fallback indication from lower layers, and the UE has pending uplink user data for PDU session(s) with user-plane resources already established but no pending NAS procedure, the UE shall:

- a) enter 5GMM-IDLE mode; and
- b) initiate the service request procedure and include the Uplink data status IE in the SERVICE REQUEST message or the CONTROL PLANE SERVICE REQUEST message indicating the PDU session(s) for which user-plane resources were active prior to receiving the fallback indication (see subclause 5.6.1 for further details).

When the UE in 5GMM-CONNECTED mode over 3GPP access receives a fallback indication from lower layers, and the UE has a pending registration procedure, a service request procedure, or a de-registration procedure, the UE shall:

- a) enter 5GMM-IDLE mode;
- b) proceed with the pending procedure; and
- c) if the pending procedure is a service request or registration procedure and the SERVICE REQUEST message, the CONTROL PLANE SERVICE REQUEST message or the REGISTRATION REQUEST message does not include UE request type IE with Request type value set to "NAS signalling connection release", the UE shall include the Uplink data status IE in the SERVICE REQUEST message, the CONTROL PLANE SERVICE REQUEST message, or in the REGISTRATION REQUEST message, indicating the PDU session(s) for which user-plane resources were not active prior to receiving a fallback indication from the lower layers and the UE has pending user data to be sent over 3GPP access, if any, and the PDU session(s) for which user-plane resources were active prior to receiving the fallback indication, if any (see subclauses 5.5.1.3 and 5.6.1 for further details).

When the UE in 5GMM-CONNECTED mode over 3GPP access receives a fallback indication from lower layers, and the UE has a pending NAS procedure other than a registration procedure, a service request procedure, or a de-registration procedure, the UE shall:

- a) enter 5GMM-IDLE mode;
- b) initiate the service request procedure and include the Uplink data status IE in the SERVICE REQUEST message or the CONTROL PLANE SERVICE REQUEST message indicating the PDU session(s) for which user-plane resources were active prior to receiving the fallback indication, if any (see subclause 5.6.1 for further details); and
- c) upon successful service request procedure completion, proceed with any pending procedure.

When the UE in 5GMM-CONNECTED mode over 3GPP access receives a fallback indication from lower layers, and the UE has no pending NAS procedure and no pending uplink user data for PDU session(s) with user-plane resources already established, and the UE was using network resources for 5G ProSe direct discovery over PC5 or 5G ProSe direct communication over PC5 (see 3GPP TS 23.304 [6E]), the UE shall:

- a) enter 5GMM-IDLE mode; and
- b) initiate the service request procedure and include the Uplink data status IE in the SERVICE REQUEST message or the CONTROL PLANE SERVICE REQUEST message indicating the PDU session(s) for which user-plane resources were active prior to receiving the fallback indication, if any (see subclause 5.6.1 for further details).

The UE which supports S-NSSAI location validity information, and which has received S-NSSAI location validity information from the AMF, shall include the Uplink data status IE in the REGISTRATION REQUEST message, the SERVICE REQUEST message, or the CONTROL PLANE SERVICE REQUEST message, to indicate the PDU session(s) for which user-plane resources were active prior to receiving the fallback indication, as described above, only if the UE is inside the NS-AoS with respect to the S-NSSAI which is associated with a PDU session.

The cases above apply when the UE is in an allowed area or when the UE is not in a non-allowed area.

When the UE:

- a) is in a non-allowed area or is not in an allowed area;
- b) is in 5GMM-CONNECTED mode over 3GPP access;
- c) receives a fallback indication from lower layers; and
- d) does not have signalling pending,

the UE shall:

- a) enter 5GMM-IDLE mode; and
- b) initiate the registration procedure for mobility and periodic registration update. The UE shall not include the Uplink data status IE in the REGISTRATION REQUEST message except if the PDU session for which user-plane resources were active is an emergency PDU session, or if the UE is configured for high priority access in selected PLMN or SNPN.

In the above cases when the UE receives a fallback indication from lower layers, if the UE is in non-allowed area or not in allowed area, the UE shall behave as specified in subclause 5.3.5.

5.3.1.3 Release of the N1 NAS signalling connection

The signalling procedure for the release of the N1 NAS signalling connection is initiated by the network.

In N1 mode, upon indication from lower layers that the access stratum connection has been released, the UE shall enter 5GMM-IDLE mode and consider the N1 NAS signalling connection released.

If the UE in 3GPP access is configured for eCall only mode as specified in 3GPP TS 31.102 [22] then:

- if the N1 NAS signalling connection that was released had been established for eCall over IMS was released, the UE shall start timer T3444; and

- if the N1 NAS signalling connection that was released had been established for a call to an HPLMN designated non-emergency MSISDN or URI for test or terminal reconfiguration service was released, the UE shall start timer T3445.

The UE shall start the timer T3447 if not already running when the N1 NAS signalling connection is released as specified in subclause 5.3.17.

To allow the network to release the N1 NAS signalling connection, the UE:

- a) shall start the timer T3540 if the UE receives any of the 5GMM cause values #7, #11, #12, #13, #15, #27, #31, #62, #72, #73, #74, #75, #76, #78 and the UE does not consider the received 5GMM cause value as abnormal case as specified in subclauses 5.5.1.2.7, 5.5.1.3.7 and 5.5.2.3.4;
- a1) shall start the timer T3540 if the UE receives a SERVICE REJECT, case i) in subclause 5.6.1.7 is applicable and the procedure was started from 5GMM-IDLE mode;
- b) shall start the timer T3540 for a UE in 3GPP access if:
 - 1) the UE receives a REGISTRATION ACCEPT message which does not include a Pending NSSAI IE or UE radio capability ID deletion indication IE;
 - 2) the UE has set the Follow-on request indicator to "No follow-on request pending" in the REGISTRATION REQUEST message;
 - 3) the UE has not included the Uplink data status IE in the REGISTRATION REQUEST message, or the UE has included the Uplink data status IE in the REGISTRATION REQUEST message but the REGISTRATION ACCEPT message indicates that no user-plane resources of any PDU sessions are to be re-established;
 - 4) the UE has not included the Allowed PDU session status IE or has included the Allowed PDU session status IE indicating there is no PDU session(s) for which the UE allowed the user-plane resource to be re-established over 3GPP access in the REGISTRATION REQUEST message, or the UE has included the Allowed PDU session status IE in the REGISTRATION REQUEST message but the REGISTRATION ACCEPT message does not indicate that any user-plane resources of any PDU sessions are to be re-established;
 - 5) the registration procedure has been initiated in 5GMM-IDLE mode, or the UE has set Request type to "NAS signalling connection release" in the UE request type IE in the REGISTRATION REQUEST message and the N1 NAS signalling connection release bit is set to "N1 NAS signalling connection release supported" in the 5GS network feature support IE of the REGISTRATION ACCEPT message;
 - 6) the user-plane resources for PDU sessions have not been set up, except for the case the UE has set Request type to "NAS signalling connection release" in the UE request type IE in the REGISTRATION REQUEST message and the N1 NAS signalling connection release bit is set to "N1 NAS signalling connection release supported" in the 5GS network feature support IE of the REGISTRATION ACCEPT message;
 - 7) the UE need not request resources for V2X communication over PC5 reference point (see 3GPP TS 23.287 [6C]);
 - 8) void;
 - 9) the UE need not request resources for 5G ProSe direct discovery over PC5 or 5G ProSe direct communication over PC5 (see 3GPP TS 23.304 [6E]); and
 - 10) the UE need not request resources for A2X communication over PC5 reference point (see 3GPP TS 23.256 [6AB]);

NOTE 1: The lower layers indicate when the user-plane resources for PDU sessions are successfully established or released.

- b1) may start the timer T3540 at completion of the registration procedure if the UE has included unavailability information and has not included a start of the unavailability period in the REGISTRATION REQUEST message;
- c) shall start the timer T3540 if the UE receives a REGISTRATION REJECT message indicating:

the 5GMM cause value #9 or #10;

d) shall start the timer T3540 if the UE receives a SERVICE REJECT message indicating:

the 5GMM cause value #9, #10; or

the 5GMM cause value #28 and with no emergency PDU session has been established;

e) shall start the timer T3540 if:

1) the UE receives a CONFIGURATION UPDATE COMMAND message containing the Configuration update indication IE with the Registration bit set to "registration requested" and with:

i) either new allowed NSSAI information or new configured NSSAI information or both included;

ii) the network slicing subscription change indication; or

iii) no other parameters; and

2) the user-plane resources for PDU sessions have not been set up;

f) shall start the timer T3540 for a UE in 3GPP access if:

1) the UE receives a SERVICE ACCEPT message;

2) for the case that the UE sent the:

i) SERVICE REQUEST message, the UE did not set the Service type IE to "signalling" or "high priority access", the UE has not included the Uplink data status IE in the SERVICE REQUEST message, or the UE has included the Uplink data status IE in the SERVICE REQUEST message but the SERVICE ACCEPT message indicates that no user-plane resources of any PDU sessions are to be re-established; or

ii) CONTROL PLANE SERVICE REQUEST message, the UE did not set the Control plane service type IE to "emergency services fallback", the UE has not included the Uplink data status IE in the CONTROL PLANE SERVICE REQUEST message, or the UE has included the Uplink data status IE in the CONTROL PLANE SERVICE REQUEST message but the SERVICE ACCEPT message indicates that no user-plane resources of any PDU sessions are to be re-established;

3) the UE has not included the Allowed PDU session status IE or has included the Allowed PDU session status IE indicating there is no PDU session(s) for which the UE allowed the user-plane resource to be re-established over 3GPP access in the SERVICE REQUEST message or the CONTROL PLANE SERVICE REQUEST message, or the UE has included the Allowed PDU session status IE in the SERVICE REQUEST message or the CONTROL PLANE SERVICE REQUEST message but the SERVICE ACCEPT message does not indicate that any user-plane resources of any PDU sessions are to be re-established;

4) the service request procedure has been initiated in 5GMM-IDLE mode;

5) the user-plane resources for PDU sessions have not been set up;

6) the UE need not request resources for V2X communication over PC5 reference point (see 3GPP TS 23.287 [6C]);

7) the UE need not request resources for 5G ProSe direct discovery over PC5 or 5G ProSe direct communication over PC5 (see 3GPP TS 23.304 [6E]); and

8) the UE need not request resources for A2X communication over PC5 reference point (see 3GPP TS 23.256 [6AB]);

NOTE 2: The lower layers indicate when the user-plane resources for PDU sessions are successfully established or released.

g) may start the timer T3540 if the UE receives any of the 5GMM cause values #3 or #6 or if it receives an AUTHENTICATION REJECT message;

h) shall start the timer T3540 for a UE in 3GPP access upon completion of the configuration update procedure or the registration procedure if the UE does not have an emergency PDU session and:

- 1) the UE received a CONFIGURATION UPDATE COMMAND message or a REGISTRATION ACCEPT message while camping on a CAG cell and none of the CAG-ID(s) supported by the current CAG cell is authorized based on "Allowed CAG list" of the entry for the current PLMN in the received "CAG information list";
 - 2) the UE received a CONFIGURATION UPDATE COMMAND message or a REGISTRATION ACCEPT message while camping on a non-CAG cell and the entry for the current PLMN in the received "CAG information list" includes an "indication that the UE is only allowed to access 5GS via CAG cells"; or
 - 3) the UE received a CONFIGURATION UPDATE COMMAND message while camping on a CAG cell and the entry for the current PLMN is not included in the received "CAG information list"; or
- i) shall start the timer T3540 for a UE in 3GPP access if:
 - 1) the UE receives a SERVICE ACCEPT message; and
 - 2) the UE:
 - has set Request type to "NAS signalling connection release" in the UE request type IE in the SERVICE REQUEST message or CONTROL PLANE SERVICE REQUEST message; or
 - has set Request type to "Rejection of paging" in the UE request type IE in the SERVICE REQUEST message or CONTROL PLANE SERVICE REQUEST message and the UE receives a CONFIGURATION UPDATE COMMAND message;
 - j) shall start the timer T3540 if:
 - 1) the UE receives the 5GMM cause value #22 along with a T3346 value in the SERVICE REJECT message, the value indicates that the timer T3346 is neither zero nor deactivated and the service request procedure has been initiated in 5GMM-IDLE mode; or
 - 2) the UE receives the 5GMM cause value #22 along with a T3346 value in the message different from the SERVICE REJECT message, and the value indicates that the timer T3346 is neither zero nor deactivated; or
 - k) shall start the timer T3540 if the UE receives a DEREGISTRATION ACCEPT message.
 - l) shall start the timer T3540 after the completion of the de-registration procedure, if the UE receives a DEREGISTRATION REQUEST message and the de-registration type indicates "re-registration required".

Upon expiry of T3540,

- in cases a), a1), b), b1), f), g), h), i), j) and k) the UE shall locally release the established N1 NAS signalling connection;
- in cases c) and d) the UE shall locally release the established N1 NAS signalling connection and the UE shall initiate the registration procedure as described in subclause 5.5.1.3 or 5.6.1.5; or
- in case e), the UE shall locally release the established N1 NAS signalling connection and perform a new registration procedure as specified in subclause 5.5.1.3.2.
- in case l), the UE shall locally release the established N1 NAS signalling connection and initiate the registration procedure as specified in subclause 5.5.1.2.2.

In case a),

- upon receiving a request from the upper layers to perform emergency services fallback only for a UE in 3GPP access or establishing an emergency PDU session, the UE shall stop timer T3540 and shall locally release the N1 NAS signalling connection, before proceeding as specified in subclause 5.5.1.

In case b) and f),

- upon an indication from the lower layers that the user-plane resources for PDU sessions are set up, the UE shall stop timer T3540 and may send uplink signalling via the existing N1 NAS signalling connection or user data via user plane. If the uplink signalling is associated with emergency services fallback only for a UE in 3GPP access or establishing an emergency PDU session, the UE shall stop timer T3540 and send the uplink signalling via the existing N1 NAS signalling connection;

In case b), f) and i),

- upon receipt of a DEREGISTRATION REQUEST message, the UE shall stop timer T3540 and respond to the network-initiated de-registration request via the existing N1 NAS signalling connection as specified in subclause 5.5.2.3;
- upon receipt of a message of a network-initiated 5GMM common procedure except a CONFIGURATION UPDATE COMMAND message without requesting acknowledgement or a 5GMM status message, the UE shall stop timer T3540 and respond to the network-initiated 5GMM common procedure via the existing N1 NAS signalling connection as specified in subclause 5.4;
- if there is no user-plane resources established for PDU sessions, upon receiving a request from the upper layers to perform emergency services fallback only for a UE in 3GPP access or establishing an emergency PDU session, the UE shall stop timer T3540 and shall locally release the N1 NAS signalling connection, before proceeding as specified in subclause 5.6.1;
- if there is no user-plane resources established for PDU sessions, upon receiving a request from the upper layers to perform services other than emergency services fallback only for a UE in 3GPP access or establishing an emergency PDU session, the UE shall wait for the local release of the established N1 NAS signalling connection upon expiry of timer T3540 or wait for timer T3540 being stopped, before initiating NAS signalling;
- upon receipt of a DL NAS TRANSPORT message, the UE shall stop timer T3540 and may send uplink signalling via the existing N1 NAS signalling connection;
- upon reception of NOTIFICATION message as specified in subclause 5.6.3.1 case a), the UE shall stop timer T3540 and send uplink signalling via the existing N1 NAS signalling connection; or
- upon initiation of registration procedure for mobility and periodic registration update as specified in subclause 5.5.1.2.7 for cases h), i), j), subclause 5.5.1.3.7 for cases j), k) or subclause 5.5.1.3.2 for case a), the UE shall stop timer T3540.

In case c) and d),

- upon an indication from the lower layers that the access stratum connection has been released, the UE shall stop timer T3540 and perform a new registration procedure as specified in subclause 5.5.1.3.5 or 5.6.1.5.
- upon receiving a request from the upper layers to perform emergency services fallback only for a UE in 3GPP access or establishing an emergency PDU session, the UE shall stop timer T3540 and shall locally release the N1 NAS signalling connection, before proceeding as specified in subclause 5.5.1.

In case e),

- upon an indication from the lower layers that the access stratum connection has been released, the UE shall stop timer T3540 and perform a new registration procedure as specified in subclause 5.5.1.3.2.
- upon an indication from the lower layers that the user-plane resources for PDU sessions are set up, the UE shall stop timer T3540 and may send user data via user plane.

NOTE 3: In this case, the new registration procedure is performed when the UE moves to the 5GMM-IDLE mode.

- upon receiving a request from the upper layers to perform emergency services fallback only for a UE in 3GPP access or establishing an emergency PDU session, the UE shall stop timer T3540 and shall locally release the N1 NAS signalling connection, before proceeding as specified in subclause 5.5.1.

If the UE had set the Follow-on request indicator to "Follow-on request pending" in the REGISTRATION REQUEST message due to pending uplink signalling but cannot send the pending signalling due to new service area restrictions received or due to network not supporting the feature as indicated in the REGISTRATION ACCEPT message (for example UE set the "Follow-on request pending" to send SMS over NAS but AMF notified "SMS over NAS not allowed") and if there is no further pending data or signalling and user plane resources have not been set up, the UE may locally release the established N1 NAS signalling connection upon completion of the registration procedure.

NOTE 4: the UE is allowed to inform the lower layers that there is no 5GMM or 5GSM messages need to be sent over non-3GPP access if the UE receives a REGISTRATION REJECT message over non-3GPP access or a SERVICE REJECT message over non-3GPP access.

If the timer T3540 is not running when the UE enters state 5GMM-DEREGISTERED.PLMN-SEARCH or 5GMM-REGISTERED.PLMN-SEARCH, the UE may locally release the N1 NAS signalling connection.

If the timer T3540 is not running and the UE has included unavailability information and has not included the start of unavailability period:

- in the DEREGISTRATION REQUEST message, then at completion of the de-registration procedure the UE shall locally release the N1 NAS signalling connection and enter 5GMM-DEREGISTERED.NO-CELL-AVAILABLE state; or
- in the REGISTRATION REQUEST message, then at completion of the registration procedure the UE shall locally release the N1 NAS signalling connection and enter 5GMM-REGISTERED.NO-CELL-AVAILABLE state.

5.3.1.4 5GMM-CONNECTED mode with RRC inactive indication

This subclause is only applicable for UE's 5GMM mode over 3GPP access. The 5GMM-CONNECTED mode with RRC inactive indication is not supported when the UE is in NB-N1 mode.

The UE is in 5GMM-CONNECTED mode with RRC inactive indication when the UE is in:

- a) 5GMM-CONNECTED mode over 3GPP access at the NAS layer; and
- b) RRC_INACTIVE state at the AS layer (see 3GPP TS 38.300 [27]).

Unless stated otherwise, the UE behaviour in 5GMM-CONNECTED mode with RRC inactive indication follows the UE behaviour in 5GMM-CONNECTED over 3GPP access, except that:

- a) the UE shall apply the mobility restrictions; and
- b) the UE shall perform the PLMN selection procedures

as in 5GMM-IDLE mode over 3GPP access.

The UE shall transition from 5GMM-CONNECTED mode over 3GPP access to 5GMM-CONNECTED mode with RRC inactive indication upon receiving an indication from the lower layers that the RRC connection has been suspended.

NOTE 1: Any pending procedure or uplink data packet when receiving an indication from the lower layers that the RRC connection has been suspended, triggers a request to the lower layers to transition to RRC_CONNECTED state. This is also the case when the pending procedure or uplink data packet triggered a previous request to the lower layers to transition to RRC_CONNECTED state.

If the UE in 3GPP access is configured for eCall only mode as specified in 3GPP TS 31.102 [22] then:

- if the UE with the N1 NAS signalling connection established for eCall over IMS moved to 5GMM-CONNECTED mode with RRC inactive indication, the UE shall start timer T3444; and
- if the UE with the N1 NAS signalling connection established for a call to an HPLMN designated non-emergency MSISDN or URI for test or terminal reconfiguration service moved to 5GMM-CONNECTED mode with RRC inactive indication, the UE shall start timer T3445.

Upon:

- a) a trigger of a procedure which requires sending of a NAS message different from a REGISTRATION REQUEST message with the NG-RAN-RCU bit of the 5GS update type IE set to "UE radio capability update needed";
- b) an uplink user data packet to be sent for a PDU session with suspended user-plane resources;
- c) a trigger to request resources for 5G ProSe direct discovery over PC5 or 5G ProSe direct communication over PC5;
- d) a trigger to request resources for V2X communication over PC5 (see 3GPP TS 23.287 [6C]); or
- e) a trigger to request resources for A2X communication over PC5 (see 3GPP TS 23.256 [6AB]);

the UE in 5GMM-CONNECTED mode with RRC inactive indication over 3GPP access shall request the lower layers to transition to RRC_CONNECTED state (see 3GPP TS 38.300 [27]).

For case a) above, if the trigger of the procedure is to request the establishment of a PDU session associated with an S-NSSAI included in the partially allowed NSSAI, the UE shall request the lower layers to transition to RRC_CONNECTED state only if the current TA is in the list of TAs where the S-NSSAI is allowed.

For case a) above, if the trigger of the procedure is to request the establishment of a PDU session associated with an S-NSSAI which has S-NSSAI location validity information, the UE shall request the lower layers to transition to RRC_CONNECTED state only if the current cell is in the NS-AoS of the S-NSSAI.

For case b) above, the UE which supports S-NSSAI location validity information, and which has received S-NSSAI location validity information from the AMF, shall request the lower layers to transition to RRC_CONNECTED state only if the UE is inside the NS-AoS with respect to the S-NSSAI which is associated with the PDU session with suspended user-plane resources.

For case b) above, if the PDU session is associated with an S-NSSAI included in the partially allowed NSSAI, the UE shall request the lower layers to transition to RRC_CONNECTED state only if the current TA is in the list of TAs where the S-NSSAI is allowed.

NOTE 2: If the UE supports Small Data Transmission (SDT) (see 3GPP TS 38.300 [27]), the following applies:

- a) if the UE due to pending uplink NAS messages or user data packets is requesting the lower layers to transition to RRC_CONNECTED state, but has not received a response from the lower layers, the UE can send the pending NAS messages or user data packets to the lower layers, and can receive multiple downlink NAS messages or multiple downlink user data packets from the lower layers while the UE remains in 5GMM-CONNECTED mode with RRC inactive indication over 3GPP access (i.e., without transitioning to 5GMM-CONNECTED mode). When the NAS layer triggers the transmission of pending uplink NAS messages or user data packets, and if the SDT is ongoing, the NAS layer will receive the response from the lower layers only after the SDT session has completed or failed;
- b) the NAS layer is not aware of the classification of NAS messages or the user data packets as belonging to the SDT session at the lower layers; and
- c) the setting of access category and the RRC establishment cause indicated to the lower layers when sending the pending uplink user data packets while the UE remains in 5GMM-CONNECTED mode with RRC inactive indication, is left to implementation.

Upon a trigger to send a REGISTRATION REQUEST message with the NG-RAN-RCU bit of the 5GS update type IE set to "UE radio capability update needed", the UE in 5GMM-CONNECTED mode with RRC inactive indication shall move to 5GMM-IDLE mode over 3GPP access and proceed with the registration procedure for mobility and periodic registration update as specified in subclause 5.5.1.3.2.

The UE shall transition from 5GMM-CONNECTED mode with RRC inactive indication to 5GMM-CONNECTED mode over 3GPP access upon receiving an indication from the lower layers that the UE has transitioned to RRC_CONNECTED state (see 3GPP TS 38.300 [27]).

NOTE 3: The AMF can be aware of the transition between 5GMM-CONNECTED mode and 5GMM-CONNECTED mode with RRC inactive indication for a UE (see 3GPP TS 23.502 [9]).

The UE shall trigger a transition from 5GMM-CONNECTED mode with RRC inactive indication to 5GMM-IDLE mode upon selection of a PLMN or SNPN that is not an equivalent PLMN or SNPN to the registered PLMN or SNPN. The UE shall not trigger a transition from 5GMM-CONNECTED mode with RRC inactive indication to 5GMM-IDLE mode upon entering a new PLMN or SNPN which is in the list of equivalent PLMNs or SNPNs.

The UE shall trigger a transition from 5GMM-CONNECTED mode with RRC inactive indication to 5GMM-IDLE mode upon receiving REFRESH command from the UICC as specified in subclause 5.4.5.3.3.

If the UE in 5GMM-CONNECTED mode with RRC inactive indication receives an indication from the lower layers that the RRC connection has been suspended, the UE shall stay in 5GMM-CONNECTED mode with RRC inactive indication. The UE shall re-initiate any pending procedure that had triggered the request to the lower layers to transition to RRC_CONNECTED state, if still needed.

When the UE in 5GMM-CONNECTED mode with RRC inactive indication receives a fallback indication from lower layers, and the UE has no pending NAS procedure and no pending uplink user data for PDU session(s) with user-plane resources already established, the UE shall:

- a) enter 5GMM-IDLE mode; and
- b) initiate the registration procedure for mobility and periodic registration update as specified for case o) in subclause 5.5.1.3.2.

If the UE requests the lower layers to transition to RRC_CONNECTED state at initiation of a registration procedure, a service request procedure or a de-registration procedure, upon fallback indication from lower layers, the UE shall:

- enter 5GMM-IDLE mode;
- proceed with the pending procedure; and
- if the pending procedure is a service request or registration request procedure and the SERVICE REQUEST message, the CONTROL PLANE SERVICE REQUEST message or the REGISTRATION REQUEST message does not include UE request type IE with Request type value set to "NAS signalling connection release", the UE shall include the Uplink data status IE in the SERVICE REQUEST message, the CONTROL PLANE SERVICE REQUEST message or in the REGISTRATION REQUEST message, indicating the PDU session(s) without active user-plane resources for which the UE has pending user data to be sent, if any, and the PDU session(s) for which user-plane resources were active prior to receiving the fallback indication, if any (see subclauses 5.5.1.3 and 5.6.1 for further details).

If the UE requests the lower layers to transition to RRC_CONNECTED state for other reason than initiation of a registration procedure, or for other reason than a service request procedure, or for other reason than a de-registration procedure, upon fallback indication from lower layers, the UE shall:

- 1) enter 5GMM-IDLE mode;
- 2) initiate the service request procedure and include the Uplink data status IE in the SERVICE REQUEST message or the CONTROL PLANE SERVICE REQUEST message indicating the PDU session(s) for which user-plane resources were active prior to receiving the fallback indication, if any (see subclause 5.6.1 for further details). If the procedure that triggered the request to the lower layers to transition to RRC_CONNECTED state is the UE-initiated NAS transport procedure and the UE had SMS, location services message, or CIoT user data to send, the UE shall also include the SMS, location services message, or CIoT user data in the CONTROL PLANE SERVICE REQUEST message as described in subclause 5.6.1.2.2; and
- 3) upon successful service request procedure completion, proceed with any pending procedure.

If the UE in 5GMM-CONNECTED mode with RRC inactive indication receives a fallback indication from lower layers, and the UE has pending uplink user data for PDU session(s) with user-plane resources already established but no pending NAS procedure, the UE shall:

- 1) enter 5GMM-IDLE mode; and
- 2) initiate the service request procedure and include the Uplink data status IE in the SERVICE REQUEST message or the CONTROL PLANE SERVICE REQUEST message indicating the PDU session(s) for which user-plane resources were active prior to receiving the fallback indication (see subclause 5.6.1 for further details).

In the above cases when the UE receives a fallback indication from lower layers, if the UE is in non-allowed area or not in allowed area, the UE shall behave as specified in subclause 5.3.5.

If the UE in 5GMM-CONNECTED mode with RRC inactive indication receives an indication from the lower layers that the resumption of the RRC connection has failed, and:

- a) if the lower layers indicate that access barring is applicable for all access categories except categories 0 and 2, or access barring is applicable for all access categories except category 0, the UE shall:
 - 1) stay in 5GMM-CONNECTED mode with RRC inactive indication;
- b) else, the UE shall:
 - 1) enter 5GMM-IDLE mode; and

2) if the UE

- does not have pending uplink user data for PDU session(s) with user-plane resources already established, initiate the registration procedure for mobility and periodic registration update used for mobility (i.e. the 5GS registration type IE set to "mobility registration updating" in the REGISTRATION REQUEST message) for N1 NAS signalling connection recovery as specified for case f) in subclause 5.5.1.3.2; or
- has pending uplink user data for PDU session(s) with user-plane resources already established or has pending NAS procedure other than a registration, service request, or de-registration procedure, then initiate the service request procedure for N1 NAS signalling connection recovery as specified for case i) or j) in subclause 5.6.1.1.

NOTE 4: An indication from the lower layer that the RRC connection has been released with cause "RRC resume failure" can be considered as an indication that the resumption of the RRC connection has failed.

The UE shall transition from 5GMM-CONNECTED mode with RRC inactive indication to 5GMM-IDLE mode over 3GPP access upon receiving from the lower layers:

- a) indication of transition from RRC_INACTIVE state to RRC_IDLE state; or
- b) indication of cell selection to E-UTRAN or another RAT that the UE supports.

If the UE in 5GMM-CONNECTED mode with RRC inactive indication receives an indication from the lower layers about the cell (re-)selection to different RAT that the UE supports, the UE shall initiate the registration procedure for mobility or periodic registration update used for mobility (i.e. the 5GS registration type IE set to "mobility registration updating" in the REGISTRATION REQUEST message) as specified in subclause 5.5.1.3.2.

If the UE in 5GMM-CONNECTED mode with RRC inactive indication receives an indication from the lower layers of a transition from RRC_INACTIVE state to RRC_IDLE state and 5GMM-REGISTERED.LIMITED-SERVICE is entered, the UE shall subsequently upon entering state 5GMM-REGISTERED.NORMAL-SERVICE and if there is no uplink user data or signalling pending, initiate the registration procedure for mobility and periodic registration update used for mobility (i.e. the 5GS registration type IE set to "mobility registration updating" in the REGISTRATION REQUEST message) for N1 NAS signalling connection recovery as specified in subclause 5.5.1.3.2.

If the UE in 5GMM-CONNECTED mode with RRC inactive indication receives an indication from the lower layers about RAN paging and the MUSIM UE decides not to initiate the service request procedure with service type set to "mobile terminated services" or control plane service type set to "mobile terminating request" to respond to the RAN paging, the UE may initiate the service request procedure and set request type to "NAS signalling connection release" in the UE request type IE and service type to "signalling" in the SERVICE REQUEST message or set request type to "NAS signalling connection release" in the UE request type IE and control plane service type set to "mobile originating request" in the CONTROL PLANE SERVICE REQUEST message to reject the RAN paging as specified in subclause 5.6.1.2 for case o of subclause 5.6.1.1. The UE may include its paging restriction preferences in the Paging restriction IE in the SERVICE REQUEST message or CONTROL PLANE SERVICE REQUEST message as specified in subclause 5.6.1.2 for case o of subclause 5.6.1.1.

NOTE 5: The interworking between the NAS layer and the AS layer triggered by RAN paging is up to UE implementation.

NOTE 6: As an implementation option, the MUSIM UE is allowed to not respond to RAN paging based on the information available in the paging message, e.g. voice service indication.

Upon receiving AMF paging indication from the lower layers, the UE shall transition from 5GMM-CONNECTED mode with RRC inactive indication to 5GMM-IDLE mode over 3GPP access and handle the AMF paging same as the paging request received in the 5GMM-IDLE mode over 3GPP access as specified in subclause 5.6.1.

If the UE supporting the reconnection to the network due to RAN timing synchronization status change has been requested to reconnect to the network upon receiving an indication of a change in the RAN timing synchronization status (see subclauses 5.4.4.2, 5.5.1.2.4, and 5.5.1.3.4) and the UE receives an indication of a change in the RAN timing synchronization status, the UE in 5GMM-CONNECTED mode with RRC inactive indication shall request the lower layers to transition to RRC_CONNECTED state.

5.3.1.5 Suspend and resume of the N1 NAS signalling connection

Suspend of the N1 NAS signalling connection can be initiated by the network in 5GMM-CONNECTED mode when user plane CIoT 5GS optimization is used. Resume of the suspended N1 NAS signalling connection is initiated by the UE.

In the UE, when user plane CIoT 5GS optimization is used:

- Upon idle suspend indication from the lower layers, the UE shall enter 5GMM-IDLE mode with suspend indication, shall not consider the N1 NAS signalling connection released and shall not consider the secure exchange of NAS messages terminated (see subclause 4.4.2.5 and 4.4.5).
- Upon trigger of a procedure using an initial NAS message when in 5GMM-IDLE mode with suspend indication, the UE shall:
 - i) if the initial NAS message is a REGISTRATION REQUEST message with the NG-RAN-RCU bit of the 5GS update type IE set to "UE radio capability update needed", enter 5GMM-IDLE mode without suspend indication and proceed with the registration procedure; or
 - ii) otherwise, request the lower layer to resume the RRC connection.

NOTE 1: In NB-N1 mode, in the request to the lower layer the data volume information of the initial NAS message is provided to the lower layers. Interactions between the NAS and the lower layers in order to obtain the data volume information of the initial NAS message (see 3GPP TS 36.321 [25E], 3GPP TS 36.331 [25A]) is left to implementations.

- Upon indication from the lower layers that the RRC connection has been resumed when in 5GMM-IDLE mode with suspend indication, the UE shall enter 5GMM-CONNECTED mode. If the pending NAS message is:
 - i) a SERVICE REQUEST message, the service type IE is not set to "emergency services fallback", and the UE did not include the NAS message container IE in the SERVICE REQUEST message; or
 - ii) a CONTROL PLANE SERVICE REQUEST message, and the UE did not include the CIoT small data container IE or the NAS message container IE in the CONTROL PLANE SERVICE REQUEST message,

the message shall not be sent. Otherwise the UE shall cipher the message as specified in subclause 4.4.5 and send the pending initial NAS message upon entering 5GMM-CONNECTED mode;

NOTE 2: If a NAS message is discarded and not sent to the network, the uplink NAS COUNT value corresponding to that message is reused for the next uplink NAS message to be sent.

- Upon fallback indication from the lower layers at RRC connection resume when in 5GMM-IDLE mode with suspend indication, the UE shall enter 5GMM-IDLE mode without suspend indication, send any pending initial NAS message and proceed as if RRC connection establishment had been requested;
- Upon indication from the lower layers that the RRC connection resume has failed and indication from the lower layers that the RRC connection is suspended, the UE shall enter 5GMM-IDLE mode with suspend indication and restart the ongoing NAS procedure if required; and
- Upon indication from the lower layers that the RRC connection resume has failed and indication from the lower layers that the RRC connection is not idle suspended, the UE shall enter 5GMM-IDLE mode without suspend indication and restart the ongoing NAS procedure if required.

In the network, when user plane CIoT 5GS optimization is used:

- Upon idle suspend indication from the lower layers, the network shall enter 5GMM-IDLE mode with suspend indication, shall not consider the N1 NAS signalling connection released and shall not consider the secure exchange of NAS messages terminated; and
- Upon indication from the lower layers that it has received the NGAP UE context resume request message as specified in 3GPP TS 38.413 [31] when in 5GMM-IDLE mode with suspend indication, the network shall enter 5GMM-CONNECTED mode.

5.3.2 Permanent identifiers

A globally unique permanent identity, the 5G subscription permanent identifier (SUPI), is allocated to each subscriber for 5GS-based services. The IMSI, the network specific identifier, the GCI and the GLI are valid SUPI types. When the SUPI contains a network specific identifier, a GCI or a GLI, it shall take the form of a network access identifier (NAI). When the UE performs initial registration for onboarding services in SNPN or is registered for onboarding services in SNPN, the SUPI contains the onboarding SUPI derived from the default UE credentials for primary authentication. The UE derives the onboarding SUPI before or during the initial registration for onboarding services in SNPN and uses the derived onboarding SUPI in the initial registration for onboarding services in SNPN and while registered for onboarding services in SNPN.

The structure of the SUPI and its derivatives are specified in 3GPP TS 23.003 [4].

The UE provides the SUPI to the network in concealed form. The SUCI is a privacy preserving identifier containing the concealed SUPI. When the SUPI contains a network specific identifier, a GCI or a GLI, the SUCI shall take the form of an NAI as specified in 3GPP TS 23.003 [4].

A UE supporting N1 mode includes a SUCI:

- a) in the REGISTRATION REQUEST message when the UE is attempting initial registration procedure and a valid 5G-GUTI is not available;
- b) in the IDENTITY RESPONSE message, if the SUCI is requested by the network during the identification procedure; and
- c) in the DEREGISTRATION REQUEST message when the UE initiates a de-registration procedure and a valid 5G-GUTI is not available.

If the UE uses the "null-scheme" as specified in 3GPP TS 33.501 [24] to generate a SUCI, the SUCI contains the unconcealed SUPI.

When:

- not operating in SNPN access operation mode; or
- operating in SNPN access operation mode but not performing initial registration for onboarding services and not registered for onboarding services;

the UE shall use the "null-scheme" if:

- a) the home network has not provisioned the public key needed to generate a SUCI;
- b) the home network has configured "null-scheme" to be used for the UE;
- c) the UE needs to perform a registration procedure for emergency services and the USIM is still considered as valid after the failure of authentication procedure or after reception of a REGISTRATION REJECT message with the 5GMM cause #3 "Illegal UE", #6 "Illegal ME" or #7 "5GS services not allowed", or to initiate a de-registration procedure before the registration procedure for emergency services was completed successfully, and the UE does not have a valid 5G-GUTI for the selected PLMN; or
- d) the UE receives an identity request for SUCI during a registration procedure for emergency services or during a de-registration procedure that was initiated before the registration procedure for emergency services was completed successfully.

When operating in SNPN access operation mode and:

- performing initial registration for onboarding services; or
- registered for onboarding services;

the UE shall use the "null-scheme" if:

- a) the public key needed to generate a SUCI is not configured as part of the default UE credentials for primary authentication; or
- b) "null-scheme" usage is configured as part of the default UE credentials for primary authentication.

If:

- a) the UE uses the "null-scheme" as specified in 3GPP TS 33.501 [24] to generate a SUCI;
- b) the UE operates in SNPN access operation mode and:
 - 1) an indication to use anonymous SUCI which is associated with the selected entry of the "list of subscriber data", is configured in the ME, if the UE is not registering or registered for onboarding services in SNPN; or
 - 2) an indication to use anonymous SUCI which is associated with the default UE credentials for primary authentication, is configured in the ME, if the UE is registering or registered for onboarding services in SNPN;

NOTE 1: The ME can be configured with an indication to use anonymous SUCI associated with an entry of "list of subscriber data" when the EAP method associated with the credentials of the entry supports SUPI privacy at the EAP layer, or can be configured with an indication to use anonymous SUCI associated with the default UE credentials for primary authentication when the EAP method associated with the default UE credentials for primary authentication supports SUPI privacy at the EAP layer, or both.

- c) the UE does not need to perform a registration procedure for emergency services, or to initiate a de-registration procedure before the registration procedure for emergency services was completed successfully; and
- d) the UE does not receive an identity request for SUCI during a registration procedure for emergency services or during a de-registration procedure that was initiated before the registration procedure for emergency services was completed successfully;

then the UE shall use anonymous SUCI as specified in 3GPP TS 23.003 [4].

A W-AGF acting on behalf of an FN-RG shall use the "null-scheme" as specified in 3GPP TS 33.501 [24] to generate a SUCI.

A W-AGF acting on behalf of an N5GC device shall use the "null-scheme" as specified in 3GPP TS 33.501 [24] to generate a SUCI.

If the 5G-RG acting on behalf of the AUN3 device has not obtained a SUCI from the AUN3 device, the 5G-RG acting on behalf of the AUN3 device shall use the "null-scheme" as specified in 3GPP TS 33.501 [24] to generate a SUCI for the AUN3 device.

If a UE is a MUSIM UE, the UE shall use a separate permanent equipment identifier (PEI) for each USIM, if any, and each entry of "list of subscriber data", if any, the UE operates for accessing 5GS-based services; otherwise, a UE contains and uses a permanent equipment identifier (PEI) for accessing 5GS-based services. When the UE is registered with a network by using a USIM or an entry of "list of subscriber data", and has provided a PEI, then until the UE is de-registered from the network using the USIM or the entry of "list of subscriber data", the UE shall keep using that PEI in the registration using the USIM or the entry of "list of subscriber data" and shall not provide that PEI in registration using another USIM or another entry of "list of subscriber data".

In this release of the specification, the IMEI, the IMEISV, the MAC address together with the MAC address usage restriction indication and the EUI-64 are the only PEI formats supported by 5GS. The structure of the PEI and its formats are specified in 3GPP TS 23.003 [4].

Each UE supporting at least one 3GPP access technology (i.e. satellite NG-RAN, NG-RAN, satellite E-UTRAN, E-UTRAN, UTRAN or GERAN) contains a PEI in the IMEI format and shall be able to provide an IMEI and an IMEISV upon request from the network.

Each UE not supporting any 3GPP access technologies and supporting NAS over untrusted or trusted non-3GPP access shall have a PEI in the form of the Extended Unique Identifier EUI-64 [48] of the access technology the UE uses to connect to the 5GC.

A UE supporting N1 mode includes a PEI:

- a) when neither SUPI nor valid 5G-GUTI is available to use for emergency services in the REGISTRATION REQUEST message with 5GS registration type IE set to "emergency registration";
- b) when the network requests the PEI by using the identification procedure, in the IDENTITY RESPONSE message; and

- c) when the network requests the IMEISV by using the security mode control procedure, in the SECURITY MODE COMPLETE message.

Each 5G-RG supporting only wireline access and each FN-RG shall have a permanent MAC address configured by the manufacturer. For 5G-CRG, the permanent MAC address configured by the manufacturer shall be a cable modem MAC address.

When the 5G-RG contains neither an IMEI nor an IMEISV, the 5G-RG shall use as a PEI the 5G-RG's permanent MAC address configured by the manufacturer and the MAC address usage restriction indication set to "no restrictions".

The W-AGF acting on behalf of the FN-RG shall use as a PEI the MAC address provided by the FN-RG and if the MAC address provided by the FN-RG is not unique or does not correspond to the FN-RG's permanent MAC address according to W-AGF's configuration, the MAC address usage restriction indication set to "MAC address is not usable as an equipment identifier" otherwise the MAC address usage restriction indication set to "no restrictions".

The 5G-RG, when acting on behalf of an AUN3 device, shall use the MAC address provided by the AUN3 device as a PEI.

The 5G-RG containing neither an IMEI nor an IMEISV or the 5G-RG acting on behalf of the AUN3 device shall include the PEI containing the MAC address together with the MAC address usage restriction indication:

- a) when neither SUPI nor valid 5G-GUTI is available to use for emergency services in the REGISTRATION REQUEST message with 5GS registration type IE set to "emergency registration";
- b) when the network requests the PEI by using the identification procedure, in the IDENTIFICATION RESPONSE message; and
- c) when the network requests the IMEISV by using the security mode control procedure, in the SECURITY MODE COMPLETE message.

NOTE 2: In case c) above, the MAC address is provided even though AMF requests the IMEISV.

The W-AGF acting on behalf of the FN-RG shall include the PEI containing the MAC address together with the MAC address usage restriction indication:

- a) when the network requests the PEI by using the identification procedure, in the IDENTIFICATION RESPONSE message; and
- b) when the network requests the IMEISV by using the security mode control procedure, in the SECURITY MODE COMPLETE message.

NOTE 3: In case b) above, the MAC address is provided even though AMF requests the IMEISV.

The W-AGF acting on behalf of the N5GC device shall use as a PEI the MAC address provided by the N5GC device and the MAC address usage restriction indication set to "no restrictions". Based on operator policy, the W-AGF acting on behalf of the N5GC device may encode the MAC address of the N5GC device using the EUI-64 format as specified in [48] and use as a PEI the derived EUI-64.

NOTE 4: The MAC address of an N5GC device is universally/globally unique.

The AMF can request the PEI at any time by using the identification procedure.

If the TWIF acting on behalf of the N5CW device receives the decorated NAI for N5CW device as defined in subclause 28.7.7.1 or 28.7.7.2 of 3GPP TS 23.003 [4] from the N5CW device, the TWIF shall first convert the decorated NAI into an NAI as specified in TS 23.502 [9], i.e., for decorated NAI taking the form "homerealm!username@otherrealm":

- a) replace the 'otherrealm' part with the 'homerealm' part; and
- b) remove 'homerealm!'.

As a result of specified above, the converted NAI takes the form "username@homerealm". The TWIF shall include the converted NAI as a SUPI with SUPI format "network specific identifier" in the REGISTRATION REQUEST message.

5.3.3 Temporary identities

A temporary user identity for 5GS-based services, the 5G globally unique temporary identity (5G-GUTI), is used for identification within the signalling procedures. In case of PLMN the 5G-GUTI is globally unique and in case of SNPN the 5G-GUTI is unique within an SNPN. When the UE is registered to the same PLMN or SNPN over 3GPP and non-3GPP access, the UE and the AMF maintain one 5G-GUTI that is common to both 3GPP and non-3GPP access. When the UE is required to delete the 5G-GUTI according to a NAS procedure, the UE shall delete the 5G-GUTI only if it is not registered to the same PLMN or SNPN through other access. When the UE is registered to different PLMNs or SNPNS over 3GPP access and non-3GPP access, the UE maintains two 5G-GUTIs, a 5G-GUTI for the registration with a PLMN or SNPN over the 3GPP access and another 5G-GUTI for the registration with another PLMN or SNPN over the non-3GPP access. In the paging and service request procedures, a shortened form of the 5G-GUTI, the 5G S-temporary mobile subscriber identity (5G-S-TMSI), is used to enable more efficient radio signalling. The purpose of the 5G-GUTI and 5G-S-TMSI is to provide identity confidentiality, i.e., to protect a user from being identified and located by an intruder. The structure of the 5G-GUTI and its derivatives are specified in 3GPP TS 23.003 [4]. The 5G-GUTI has two main components (see 3GPP TS 23.501 [8]):

- a) the GUAMI; and
- b) the 5G-TMSI that provides an unambiguous identity of the UE within the AMF(s) identified by the GUAMI.

The 5G-S-TMSI has three main components:

- a) the AMF set ID that uniquely identifies the AMF set within the AMF region;
- b) the AMF pointer that identifies one or more AMFs within the AMF set; and
- c) the 5G-TMSI.

A UE supporting N1 mode includes a valid 5G-GUTI, if any is available, in the REGISTRATION REQUEST and DEREGISTRATION REQUEST messages. In the SERVICE REQUEST message, the UE includes a valid 5G-S-TMSI as user identity. The AMF shall assign a new 5G-GUTI for a particular UE:

- a) during a successful initial registration procedure;
- b) during a successful registration procedure for mobility registration update;
- c) after a successful service request procedure invoked as a response to a paging request from the network and before the:
 - 1) release of the N1 NAS signalling connection; or
 - 2) suspension of the N1 NAS signalling connection due to user plane CIoT 5GS optimization i.e. before the UE and the AMF enter 5GMM-IDLE mode with suspend indication;

as specified in subclause 5.4.4.1; and

- d) after the AMF receives an indication from the lower layers that it has received the NGAP UE context resume request message as specified in 3GPP TS 38.413 [31] for a UE in 5GMM-IDLE mode with suspend indication and this resumption is a response to a paging request from the network, and before the:
 - 1) release of the N1 NAS signalling connection; or
 - 2) suspension of the N1 NAS signalling connection due to user plane CIoT 5GS optimization i.e. before the UE and the AMF enter 5GMM-IDLE mode with suspend indication;

as specified in subclause 5.4.4.1.

The AMF should assign a new 5G-GUTI for a particular UE during a successful registration procedure for periodic registration update. The AMF may assign a new 5G-GUTI at any time for a particular UE by performing the generic UE configuration update procedure.

If a new 5G-GUTI is assigned by the AMF, the UE and the AMF handle the 5G-GUTI as follows:

- a) Upon receipt of a 5GMM message containing a new 5G-GUTI, the UE considers the new 5G-GUTI as valid and the old 5G-GUTI as invalid, stops timer T3519 if running, and deletes any stored SUCI. The new 5G-GUTI is

stored in a non-volatile memory in the USIM if the corresponding file is present in the USIM, else in the non-volatile memory in the ME, as described in annex C.

- b) The AMF considers the old 5G-GUTI as invalid as soon as an acknowledgement for a registration or generic UE configuration update procedure is received.

5.3.4 Registration areas

Within the 5GS, the registration area is managed independently per access type, i.e., 3GPP access or non-3GPP access. The AMF assigns a registration area to the UE during the registration procedure. A registration area is defined as a set of tracking areas and each of these tracking areas consists of one or more cells that cover a geographical area. Within the 5GS, the concept of "registration to multiple tracking areas" applies:

- a) A tracking area is identified by a TAI which is broadcast in the cells of the tracking area. The TAI is constructed from a TAC and a PLMN identity. In case of a shared network:
 - 1) one or more TACs; and
 - 2) any of the following:
 - i) multiple PLMN identities;
 - ii) multiple SNPN identities; or
 - iii) one or more PLMN identities and one or more SNPN identities;

are broadcast.

- b) In order to reduce the tracking area update signalling within the 5GS, the AMF can assign several tracking areas to the UE. These tracking areas construct a list of tracking areas which is identified by a TAI list. When generating the TAI list, the AMF shall include only TAIs that are applicable on the access where the TAI list is sent. The AMF shall be able to allocate a TAI list over different NG-RAN access technologies. The AMF shall not allocate a TAI list containing both tracking areas in NB-N1 mode and tracking areas not in NB-N1 mode.
- c) The UE considers itself registered to a list of tracking areas and does not need to trigger the registration procedure for mobility and periodic registration update used for mobility (i.e. the 5GS registration type IE set to "mobility registration updating" in the REGISTRATION REQUEST message) as long as the UE stays in one of the tracking areas of the list of tracking areas received from the AMF.
- d) The UE will consider the TAI list stored in the UE as valid, until it receives a new TAI list in the next registration procedure for mobility and periodic registration update or generic UE configuration update procedure, or the UE is commanded by the network to delete the TAI list by a reject message or it is deregistered from the 5GS. If the registration request is accepted or the TAI list is reallocated by the AMF, the AMF shall provide at least one entry in the TAI list. If the new and the old TAI list are identical, the AMF does not need to provide the new TAI list to the UE during mobility registration update or periodic registration update.
- e) The TAI list can be reallocated by the AMF.
- f) When the UE is deregistered from the 5GS, the UE shall delete the TAI list stored in the UE.
- g) The UE includes the last visited registered TAI, if available, to the AMF. The last visited registered TAI is stored in a non-volatile memory in the USIM if the corresponding file is present in the USIM, else in the non-volatile memory in the ME, as described in annex C.

5.3.5 Service area restrictions

5.3.5.1 General

Service area restrictions are applicable only to 3GPP access and to wireline access.

Subclause 5.3.5.2 applies when the UE accesses 5GCN over 3GPP access.

Subclause 5.3.5.3 applies when the 5G-RG or the W-AGF acting on behalf of an FN-CRG (or on behalf of the N5GC device) access 5GCN over wireline access.

NOTE: Service area restrictions are not applicable for the W-AGF acting on behalf of the FN-BRG.

5.3.5.2 3GPP access service area restrictions

The service area restrictions consist of tracking areas forming either an allowed area, or a non-allowed area. The tracking areas belong to the registered PLMN, its equivalent PLMNs in the registration area, or the registered SNPN. The allowed area can contain up to 16 tracking areas or include all tracking areas in the registered PLMN and its equivalent PLMN(s) in the registration area, or in the registered SNPN. The non-allowed area can contain up to 16 tracking areas. The network conveys the service area restrictions to the UE by including either an allowed area, or a non-allowed area, but not both, in the Service area list IE of a REGISTRATION ACCEPT message or a CONFIGURATION UPDATE COMMAND message.

If the network does not convey the service area restrictions to the UE in the Service area list IE of a REGISTRATION ACCEPT message, the UE shall treat all tracking areas in the registered PLMN, its equivalent PLMN(s) in the registration area, or in the registered SNPN, as allowed area and delete the stored list of "allowed tracking areas" or the stored list of "non-allowed tracking areas".

When the UE receives a Service area list IE with an allowed area indication during a registration procedure or a generic UE configuration update procedure:

- a) if the "Type of list" included in the Service area list IE does not indicate "all TAIs belonging to the PLMNs in the registration area are allowed area", the UE shall delete the old list of "allowed tracking areas" and store the tracking areas in the allowed area as the list of "allowed tracking areas". If the UE has a stored list of "non-allowed tracking areas", the UE shall delete that list; or
- b) if the "Type of list" included in the Service area list IE indicates "all TAIs belonging to the PLMNs in the registration area are allowed area", the UE shall treat all tracking areas in the registered PLMN and its equivalent PLMN(s), or in the registered SNPN, as allowed area and delete the stored list of "allowed tracking areas" or the stored list of "non-allowed tracking areas".

When the UE receives a Service area list IE with a non-allowed area indication during a registration procedure or a generic UE configuration update procedure, the UE shall delete the old list of "non-allowed tracking areas" and store the tracking areas in the non-allowed area as the list of "non-allowed tracking areas". If the UE has a stored list of "allowed tracking areas", the UE shall delete that list.

If the UE is successfully registered to a PLMN or SNPN and has a stored list of "allowed tracking areas":

- a) while the current TAI is in the list of "allowed tracking areas", the UE shall stay in, or enter, the state 5GMM-REGISTERED.NORMAL-SERVICE and is allowed to initiate any 5GMM and 5GSM procedures; and
- b) while the UE is camped on a cell which is in the registration area, and the current TAI is not in the list of "allowed tracking areas", the UE shall enter the state 5GMM-REGISTERED.NON-ALLOWED-SERVICE, and:
 - 1) if the UE is in 5GMM-IDLE mode or 5GMM-IDLE mode with suspend indication over 3GPP access, the UE:
 - i) shall not include the Uplink data status IE in the registration procedure for mobility and periodic registration update except for emergency services or for high priority access;
 - ii) shall not perform the registration procedure for mobility and periodic registration update with Follow-on request indicator set to "Follow-on request pending", except for:
 - emergency services;
 - high priority access;
 - indicating a change of 3GPP PS data off UE status;
 - sending an SOR transparent container;
 - sending a UE policy container; or
 - sending a UE parameters update transparent container;

iii) shall not initiate a service request procedure or request the lower layers to resume a suspended connection, except for:

- emergency services;
- emergency services fallback;
- high priority access;
- responding to paging;
- responding to notification received over non-3GPP access;
- indicating a change of 3GPP PS data off UE status;
- sending an SOR transparent container;
- sending a UE policy container; or
- sending a UE parameters update transparent container.

The UE shall not include the Uplink data status IE in the SERVICE REQUEST message or CONTROL PLANE SERVICE REQUEST message except for emergency services or for high priority access. In case of emergency services, the UE shall indicate that uplink data is pending only for the PDU session for emergency services;

iv) if the UE responds to a paging which includes an indication for non-3GPP access type, the UE shall include the Allowed PDU session status IE in the SERVICE REQUEST, CONTROL PLANE SERVICE REQUEST or REGISTRATION REQUEST message. For a UE with an emergency PDU session established or a UE configured for high priority access, the UE shall indicate the PDU session(s) for which the UE allows the user-plane resources to be re-established over 3GPP access in the Allowed PDU session status IE that re-establishment of the user-plane resources via 3GPP access is allowed; for all other cases, the UE shall indicate for each PDU session in the Allowed PDU session status IE that re-establishment of the user-plane resources via 3GPP access is not allowed; and

2) if the UE is in 5GMM-CONNECTED mode or 5GMM-CONNECTED mode with RRC inactive indication over 3GPP access, the UE:

- i) shall not perform the registration procedure for mobility and periodic registration update with Uplink data status IE except for emergency services or for high priority access;
- ii) shall not initiate a service request procedure except for:
 - emergency services;
 - emergency services fallback;
 - high priority access;
 - responding to paging or responding to a notification.

The UE shall not include the Uplink data status IE in the SERVICE REQUEST message or CONTROL PLANE SERVICE REQUEST message except for emergency services or for high priority access. In case of emergency services, the UE shall indicate that uplink data is pending only for the PDU session for emergency services;

iii) shall not initiate a 5GSM procedure except for:

- emergency services;
- high priority access; or
- indicating a change of 3GPP PS data off UE status;

iv) shall not perform the NAS transport procedure except for the sending:

- 5GSM messages for UE-requested 5GSM procedures allowed in iii) above;

- 5GSM messages for network-requested 5GSM procedures;
- SMS;
- an LPP message;
- a UPP-CMI container;
- an SLPP message;
- a location services message;
- an SOR transparent container;
- a UE policy container;
- a UE parameters update transparent container; or
- a CIoT user data container; and

NOTE 1: The contents of CIoT user data container can be data that is not for exception reports, or data that is for exception reports if allowed for the UE (see subclause 6.2.13).

- v) if the UE responds to a notification which includes an indication for non-3GPP access type, the UE shall include the Allowed PDU session status IE in the SERVICE REQUEST, CONTROL PLANE SERVICE REQUEST or REGISTRATION REQUEST message. For a UE with an emergency PDU session established or a UE configured for high priority access, the UE shall indicate the PDU session(s) for which the UE allows the user-plane resources to be re-established over 3GPP access in the Allowed PDU session status IE that re-establishment of the user-plane resources via 3GPP access is allowed; for all other cases, the UE shall indicate for each PDU session in the Allowed PDU session status IE that re-establishment of the user-plane resources via 3GPP access is not allowed.

If the UE is successfully registered to a PLMN or an SNPN and has a stored list of "non-allowed tracking areas":

- a) while the UE is camped on a cell which is in the registration area and the current TAI is not in the list of "non-allowed tracking areas", the UE shall stay in, or enter, the state 5GMM-REGISTERED.NORMAL-SERVICE and is allowed to initiate any 5GMM and 5GSM procedures; and
- b) while the current TAI is in the list of "non-allowed tracking areas", the UE shall enter the state 5GMM-REGISTERED.NON-ALLOWED-SERVICE, and:
 - 1) if the UE is in 5GMM-IDLE mode or 5GMM-IDLE mode with suspend indication over 3GPP access, the UE:
 - i) shall not include the Uplink data status IE in the registration procedure for mobility and periodic registration update except for emergency services or for high priority access;
 - ii) shall not perform the registration procedure for mobility and periodic registration update with Follow-on request indicator set to "Follow-on request pending", except for:
 - emergency services;
 - high priority access;
 - indicating a change of 3GPP PS data off UE status;
 - sending an SOR transparent container;
 - sending a UE policy container; or
 - sending a UE parameters update transparent container; and
 - iii) shall not initiate a service request procedure or request the lower layers to resume a suspended connection, except for:
 - emergency services;

- emergency services fallback;
- high priority access;
- responding to paging;
- responding to notification received over non-3GPP access;
- indicating a change of 3GPP PS data off UE status;
- sending an SOR transparent container;
- sending a UE policy container; or
- sending a UE parameters update transparent container.

The UE shall not include the Uplink data status IE in the SERVICE REQUEST message or CONTROL PLANE SERVICE REQUEST message except for emergency services or for high priority access. In case of emergency services, the UE shall indicate that uplink data is pending only for the PDU session for emergency services;

- iv) if the UE responds to a paging which includes an indication for non-3GPP access type, the UE shall include the Allowed PDU session status IE in the SERVICE REQUEST, CONTROL PLANE SERVICE REQUEST or REGISTRATION REQUEST message. For a UE with an emergency PDU session established or a UE configured for high priority access, the UE shall indicate the PDU session(s) for which the UE allows the user-plane resources to be re-established over 3GPP access in the Allowed PDU session status IE that re-establishment of the user-plane resources via 3GPP access is allowed; for all other cases, the UE shall indicate for each PDU session in the Allowed PDU session status IE that re-establishment of the user-plane resources via 3GPP access is not allowed; and
- 2) if the UE is in 5GMM-CONNECTED mode or 5GMM-CONNECTED mode with RRC inactive indication over 3GPP access, the UE:
 - i) shall not perform the registration procedure for mobility and periodic registration update with the Uplink data status IE except for emergency services or for high priority access;
 - ii) shall not initiate a service request procedure or request the lower layers to resume a suspended connection, except for:
 - emergency services;
 - emergency services fallback;
 - high priority access; or
 - responding to paging or responding to a notification.
- The UE shall not include the Uplink data status IE in the SERVICE REQUEST message or CONTROL PLANE SERVICE REQUEST message except for emergency services or for high priority access. In case of emergency services, the UE shall indicate that uplink data is pending only for the PDU session for emergency services;
- iii) shall not initiate a 5GSM procedure except for:
 - emergency services;
 - high priority access; or
 - indicating a change of 3GPP PS data off UE status;
 - iv) shall not perform the NAS transport procedure except for the sending:
 - 5GSM messages for UE-requested 5GSM procedures allowed in iii) above;
 - 5GSM messages for network-requested 5GSM procedures;
 - SMS;

- an LPP message;
- a UPP-CMI container;
- an SLPP message;
- a location services message;
- an SOR transparent container;
- a UE policy container;
- a UE parameters update transparent container; or
- a CIoT user data container; and

NOTE 2: The contents of CIoT user data container can be data that is not for exception reports, or data that is for exception reports if allowed for the UE (see subclause 6.2.13).

- v) if the UE responds to a notification which includes an indication for non-3GPP access type, the UE shall include the Allowed PDU session status IE in the SERVICE REQUEST, CONTROL PLANE SERVICE REQUEST or REGISTRATION REQUEST message. For a UE with an emergency PDU session established or a UE configured for high priority access, the UE shall indicate the PDU session(s) for which the UE allows the user-plane resources to be re-established over 3GPP access in the Allowed PDU session status IE that re-establishment of the user-plane resources via 3GPP access is allowed; for all other cases, the UE shall indicate for each PDU session in the Allowed PDU session status IE that re-establishment of the user-plane resources via 3GPP access is not allowed.

The list of "allowed tracking areas", as well as the list of "non-allowed tracking areas" shall be erased when:

- a) the UE is switched off; and
- b) the UICC containing the USIM is removed or an entry of the "list of subscriber data" with the SNPN identity of the SNPN is updated.

When a tracking area is added to the list of "5GS forbidden tracking areas for roaming" or to the list of "5GS forbidden tracking areas for regional provision of service" as specified in the subclauses 5.5.1.2.5 or 5.5.1.3.5, the tracking area shall be removed from the list of "allowed tracking areas" if the tracking area is already present in the list of "allowed tracking areas" and from the list of "non-allowed tracking areas" if the tracking area is already present in the list of "non-allowed tracking areas".

5.3.5.3 Wireline access service area restrictions

If:

- a) a SERVICE REJECT message with the 5GMM cause #28 "Restricted service area";
- b) a DL NAS TRANSPORT message with the Payload container type IE set to "N1 SM information" and the 5GMM cause #28 "Restricted service area"; or
- c) a REGISTRATION ACCEPT message includes the PDU session reactivation result error cause IE with the 5GMM cause #28 "Restricted service area";

is received over wireline access then the 5G-RG or the W-AGF acting on behalf of the FN-CRG (or on behalf of the N5GC device) shall start enforcing the wireline access service area restrictions and shall enter the state 5GMM-REGISTERED.NON-ALLOWED-SERVICE.

While in the state 5GMM-REGISTERED.NON-ALLOWED-SERVICE, the 5G-RG or the W-AGF acting on behalf of the FN-CRG (or on behalf of the N5GC device) shall:

- a) if in 5GMM-IDLE mode over wireline access:
 - 1) shall not perform the registration procedure for mobility and periodic registration update with Uplink data status IE except for emergency services or for high priority access; and
 - 2) shall not initiate a service request procedure except for:

- emergency services,
- emergency services fallback; or
- high priority access; and

b) if in 5GMM-CONNECTED mode over wireline access:

- 1) shall not perform the registration procedure for mobility and periodic registration update with Uplink data status IE except for:
 - emergency services;
 - emergency services fallback; or
 - high priority access;
- 2) shall not initiate a service request procedure except for emergency services, or high priority access; and
- 3) shall not initiate a 5GSM procedure except for emergency services or high priority access;

over the wireline access.

When the 5G-RG is switched off, the UICC containing the USIM is removed or the 5G-RG starts using another wireline access network, the 5G-RG shall stop enforcing the wireline access service area restrictions, if enforced.

NOTE: When the 5G-RG acting on behalf of the AUN3 device determines that the AUN3 device is switched off or the UICC containing the USIM of AUN3 device is removed, the 5G-RG acting on behalf of the AUN3 device stops enforcing the wireline access service area restrictions, if enforced.

When the W-AGF acting on behalf of the FN-CRG determines that the FN-CRG is switched off, the W-AGF acting on behalf of the FN-CRG stops enforcing the wireline access service area restrictions, if enforced.

When the W-AGF acting on behalf of the N5GC device determines that the FN-CRG serving the N5GC device is switched off, the W-AGF acting on behalf of the N5GC device stops enforcing the wireline access service area restrictions, if enforced.

5.3.6 Mobile initiated connection only mode

The UE can request the use of mobile initiated connection only (MICO) mode during the registration procedure (see 3GPP TS 23.501 [8] and 3GPP TS 23.502 [9]). The UE shall not request use of MICO mode over non-3GPP access. Furthermore, the UE in 3GPP access shall not request the use of MICO mode during:

- a) a registration procedure for initial registration for emergency services (see subclause 5.5.1.2);
- b) a registration procedure for initial registration for initiating an emergency PDU session (see subclause 5.5.1.2);
- c) a registration procedure for mobility and periodic registration update (see subclause 5.5.1.3) for initiating an emergency PDU session if the UE is in the state 5GMM-REGISTERED.ATTEMPTING-REGISTRATION-UPDATE; or
- d) a registration procedure for mobility and periodic registration update (see subclause 5.5.1.3) when the UE has an emergency PDU session established.

If the UE requests the use of MICO mode, the network can accept the use of MICO mode by providing a MICO indication when accepting the registration procedure. The UE may use MICO mode only if the network has provided the MICO indication IE during the last registration procedure. The UE may also request an active time value together with the MICO mode indication during the registration procedure. If the UE requests an active time by including an active time value, the UE may also include the Requested T3512 value IE to request a particular T3512 value to be allocated.

If the network accepts the use of MICO mode and does not include an active time value in T3324 IE to the UE, the AMF may include an "all PLMN registration area allocated" indication in the MICO indication IE to the UE. If the UE indicated the support for strictly periodic registration timer in the MICO indication IE to the network, the network may include a "strictly periodic registration timer supported" indication in the MICO indication IE to the UE.

If the UE requested the use of active time by including an active time value and the network accepts the use of MICO mode and the use of active time, the AMF shall include an active time value in the T3324 IE to the UE. If the AMF indicates active time value to the UE, AMF should not indicate "all PLMN registration area allocated" indication in the MICO indication IE to the UE. Upon entering 5GMM-IDLE mode, AMF shall start the active timer with the active time value indicated to the UE and shall consider the UE is reachable for paging as long as the timer is running. If the UE enters 5GMM-CONNECTED mode over 3GPP access when the active timer is running, the AMF shall stop the active timer.

NOTE 1: The active time value assigned by AMF can be different from the active time value requested by the UE. AMF assigns the active time value based on several factors, e.g. local configuration, expected UE behaviour, UE requested active time value, UE subscription information, network policies etc.

If the UE requested an active time and a requested T3512 value and the network accepts the use of MICO mode, the AMF shall take the UE requested T3512 value into consideration when assigning a value of timer T3512 to the UE.

If the network accepts the use of MICO mode, the UE may deactivate the AS layer and activate MICO mode by entering the state 5GMM-REGISTERED.NO-CELL-AVAILABLE if:

- a) the UE is in 5GMM-IDLE mode over 3GPP access;
- b) the UE is in the 5GMM-REGISTERED.NORMAL-SERVICE or 5GMM-REGISTERED.NON-ALLOWED-SERVICE (as described in subclause 5.3.5.2) state for 3GPP access; and
- c) no T3324 value is received from the network.

If the network accepts the use of MICO mode and indicates an active time value to the UE in a successful registration procedure, the UE shall start the timer T3324 with the value received from the network after entering 5GMM-IDLE mode over 3GPP access. At the expiry of the timer T3324, the UE may deactivate the AS layer and activate MICO mode by entering the state 5GMM-REGISTERED.NO-CELL-AVAILABLE if the UE is in the 5GMM-REGISTERED.NORMAL-SERVICE or 5GMM-REGISTERED.NON-ALLOWED-SERVICE (as described in subclause 5.3.5.2) state for 3GPP access. If the UE enters 5GMM-CONNECTED mode over 3GPP access when the timer T3324 is running, the UE shall stop the timer T3324.

When MICO mode is activated, all NAS timers are stopped and associated procedures aborted except for timers T3512, T3346, T3447, T3448, T3396, T3526, T3584, T3585, T3587 any back-off timers, T3245, T3247, any slice deregistration inactivity timers, the timer T controlling the periodic search for HPLMN or EHPLMN or higher prioritized PLMNs (see 3GPP TS 23.122 [5]) and the timer T_{SENSE} controlling the periodic search for PLMNs satisfying the operator controlled signal level threshold (see 3GPP TS 23.122 [5]).

NOTE 2: When MICO mode is activated and if the UE is also registered over the non-3GPP access, the AMF will not send a NOTIFICATION message with access type indicating 3GPP access over the non-3GPP access for PDU sessions associated with 3GPP access.

The UE may deactivate MICO mode and activate the AS layer at any time. Upon deactivating MICO mode, the UE may initiate 5GMM procedures (e.g., for the transfer of mobile originated signalling or user data).

When an emergency PDU session is successfully established after the MICO mode was enabled, the UE and the AMF shall locally disable MICO mode. The UE and the AMF shall not enable MICO mode until the AMF accepts the use of MICO mode in the next registration procedure. To enable an emergency call back, the UE should wait for a UE implementation-specific duration of time before requesting the use of MICO mode after the completion of the emergency services.

If the AMF accepts the use of MICO mode and does not indicate "strictly periodic registration timer supported" in the MICO indication IE to the UE, the AMF starts the implicit de-registration timer for 3GPP access when entering 5GMM-IDLE mode for 3GPP access. If AMF accepts the use of MICO mode and indicates "strictly periodic registration timer supported" in the MICO indication IE to the UE, AMF shall start the strictly periodic monitoring timer with T3512 value indicated in the T3512 value IE after the registration procedure is completed. The AMF shall neither stop nor reset the strictly periodic monitoring timer when the NAS signalling connection is established or released for the UE. If the strictly periodic monitoring timer expires when NAS signalling connection is established for the UE, AMF shall restart the strictly periodic monitoring timer with the T3512 value, otherwise AMF shall start the implicit de-registration timer.

When an emergency PDU session is successfully established and the MICO mode is disabled, the UE shall stop timer T3512 if running and the AMF shall stop strictly periodic monitoring timer if running. The UE and the AMF shall

behave as if no "strictly periodic registration timer supported" indication was given to the UE in the last registration attempt.

Upon successful completion of an attach procedure or tracking area updating procedure after inter-system change from N1 mode to S1 mode (see 3GPP TS 24.301 [15]), the UE operating in single-registration mode shall locally disable MICO mode. After inter-system change from S1 mode to N1 mode, the UE operating in single-registration mode may re-negotiate MICO mode with the network during the registration procedure for mobility and periodic registration update.

When MICO mode is activated for a UE that has joined one or more multicast MBS sessions, the UE may deactivate MICO mode and activate the AS layer at the MBS start time and at any of the scheduled activation times of a multicast MBS session, if any of those times are available as specified in 3GPP TS 23.247 [53].

When MICO mode is activated for a UE, the UE may deactivate MICO mode and activate the AS layer at the broadcast start time and at any of the scheduled broadcast activation times of a broadcast MBS session if any of those times are available as specified in 3GPP TS 23.247 [53].

NOTE 3: The UE can obtain via the service announcement an MBS start time, a sequence of scheduled activation times (e.g. a first time and a periodicity) or both, of a multicast MBS session as described in 3GPP TS 23.247 [53], or both, which is out of scope of this specification. Similarly, the UE can obtain via the service announcement a broadcast start time, a sequence of scheduled broadcast activation times (e.g. a first time and a periodicity) or both, of a broadcast MBS session as described in 3GPP TS 23.247 [53], which is out of scope of this specification.

NOTE 4: Deactivating MICO mode and activating the AS layer at the MBS start time and the scheduled multicast activation times of a multicast MBS session allows the UE to listen to paging for a multicast MBS session which the UE has joined and to respond to it if received. How long the UE needs to listen to paging is up to UE implementation. Similarly, deactivating MICO mode and activating the AS layer at the broadcast start time and the scheduled broadcast activation times of a broadcast MBS session allows the UE to acquire the traffic of the broadcast MBS session. If the UE fails to receive paging or data for a multicast MBS session which the UE has joined or data for a broadcast MBS session, the UE can as an implementation option initiate 5GMM procedures (e.g. for the transfer of mobile originated signalling or user data) to enter 5GMM-CONNECTED mode over 3GPP access and obtain via the service announcement a new start time, a sequence of scheduled activation times or both.

When MICO mode is activated, the UE is allowed to join one or more multicast MBS sessions. In that case, the UE can deactivate MICO mode and activate the AS layer at the MBS start time and at any of the scheduled activation times of a multicast MBS session if any of those times are available as specified in 3GPP TS 23.247 [53], and the UE joins one or more multicast MBS sessions by using the UE-requested PDU session establishment procedure or the UE-requested PDU session modification procedure (see subclauses 6.4.1.2 and 6.4.2.2).

NOTE 5: It is up to UE implementation whether to leave one or more multicast MBS sessions after each deactivation of each multicast MBS session and to re-join again at the next activation time or to keep a multicast MBS session that the UE has joined for the whole period of the session, as described in 3GPP TS 23.247 [53].

5.3.7 Handling of the periodic registration update timer and mobile reachable timer

The registration procedure for periodic registration update is used over 3GPP access to periodically notify the availability of the UE to the network. The procedure is controlled in the UE by the periodic registration update timer, T3512.

If the UE is registered over the 3GPP access, the AMF maintains an implicit de-registration timer to control when the UE is considered implicitly de-registered over the 3GPP access. If the UE is registered over the non-3GPP access, the AMF also maintains a non-3GPP implicit de-registration timer to control when the UE is considered implicitly de-registered over the non-3GPP access. The UE registered over the non-3GPP access maintains a non-3GPP de-registration timer to control when the UE is considered implicitly de-registered for the non-3GPP access.

The AMF shall start a non-3GPP implicit de-registration timer for the UE registered over non-3GPP access when the N1 NAS signalling connection over non-3GPP access is released.

The UE registered over non-3GPP access shall reset and start a non-3GPP de-registration timer when the N1 NAS signalling connection over non-3GPP access is released. The non-3GPP de-registration timer is stopped when the UE enters 5GMM-CONNECTED mode over non-3GPP access or the 5GMM-DEREGISTERED state over non-3GPP access.

The non-3GPP implicit de-registration timer shall be longer than the non-3GPP de-registration timer.

The value of timer T3512 is sent by the network to the UE in the REGISTRATION ACCEPT message. The UE shall apply this value in all tracking areas of the list of tracking areas assigned to the UE until a new value is received. The periodic registration update timer only applies to the UE registered to the 5GS services over 3GPP access.

If timer T3512 received by the UE in a REGISTRATION ACCEPT message contains an indication that the timer is deactivated or the timer value is zero, then timer T3512 is deactivated and the UE shall not perform the periodic registration update procedure.

NOTE 1: The UE does not perform the registration procedure for periodic registration update for non-3GPP access.

If during the registration procedure, the AMF does not indicate "strictly periodic registration timer supported" in the MICO indication IE to the UE, timer T3512 is reset and started with its initial value, when the UE changes from 5GMM-CONNECTED over 3GPP access to 5GMM-IDLE mode over 3GPP access. Timer T3512 is stopped when the UE enters 5GMM-CONNECTED mode over 3GPP access or the 5GMM-DEREGISTERED state over 3GPP access.

If during the registration procedure, the AMF indicates "strictly periodic registration timer supported" in the MICO indication IE to the UE, timer T3512 is started with its initial value after the completion of the registration procedure. The UE shall neither stop nor reset the timer T3512 when the UE enters 5GMM-CONNECTED or when changing from 5GMM-CONNECTED mode to 5GMM-IDLE mode. If the timer T3512 expires,

- a) the UE in 5GMM-CONNECTED mode over 3GPP access shall reset and start the timer T3512 with its initial value; or
- b) the UE in 5GMM-IDLE mode over 3GPP access shall perform the periodic registration procedure.

If the UE is registered for emergency services, and timer T3512 expires, the UE shall not initiate a periodic registration update procedure, but shall locally de-register from the network. When the UE is camping on a suitable cell, it may re-register to regain normal service.

When a UE is not registered for emergency services, and timer T3512 expires when the UE is in 5GMM-IDLE mode, the registration procedure for periodic registration update shall be started.

If the UE is not registered for emergency services, and is in a state other than 5GMM-REGISTERED.NORMAL-SERVICE or 5GMM-REGISTERED.NON-ALLOWED-SERVICE over 3GPP access when timer T3512 expires, the registration procedure for periodic registration update is delayed until the UE returns to 5GMM-REGISTERED.NORMAL-SERVICE or 5GMM-REGISTERED.NON-ALLOWED-SERVICE over 3GPP access.

NOTE 2: When the UE returns to 5GMM-REGISTERED.NORMAL-SERVICE or 5GMM-REGISTERED.NON-ALLOWED-SERVICE and it needs to initiate other 5GMM procedure than the registration procedure for periodic registration update then, based on UE implementation, the 5GMM procedure can take precedence.

The network supervises the registration procedure for periodic registration update of the UE by means of the mobile reachable timer.

If the UE is not registered for emergency services, the mobile reachable timer shall be longer than the value of timer T3512. In this case, by default, the mobile reachable timer is 4 minutes greater than the value of timer T3512.

The network behaviour upon expiry of the mobile reachable timer is network dependent, but typically the network stops sending paging messages to the UE on the first expiry, and may take other appropriate actions.

If the UE is registered for emergency services, the AMF shall set the mobile reachable timer with a value equal to timer T3512. When the mobile reachable timer expires, the AMF shall locally de-register the UE.

The mobile reachable timer shall be reset and started with the value as indicated above, when the AMF releases the NAS signalling connection for the UE. The mobile reachable timer shall be stopped when a NAS signalling connection is established for the UE.

Upon expiry of the mobile reachable timer the network shall start the implicit de-registration timer over 3GPP access. The value of the implicit de-registration timer over 3GPP access is network dependent. If MICO mode is activated, the network shall start the implicit de-registration timer over 3GPP access when the UE enters 5GMM-IDLE mode at the AMF over 3GPP access. The default value of the implicit de-registration timer over 3GPP access is 4 minutes greater than the value of timer T3512.

If the implicit de-registration timer expires before the UE contacts the network, the network shall implicitly de-register the UE. The implicit de-registration timer shall be stopped when a NAS signalling connection is established for the UE.

If the non-3GPP implicit de-registration timer expires before the UE contacts the network over the non-3GPP access, the network shall implicitly de-register the UE and enter the state 5GMM-DEREGISTERED over non-3GPP access for the UE. The non-3GPP implicit de-registration timer shall be stopped when a NAS signalling connection over non-3GPP access is established for the UE.

If the non-3GPP de-registration timer expires before the UE contacts the network over the non-3GPP access, the UE shall enter the state 5GMM-DEREGISTERED over non-3GPP access. The non-3GPP de-registration timer shall be stopped when a NAS signalling connection over non-3GPP access is established for the UE.

If the AMF provides T3346 value IE in the DEREGISTRATION REQUEST message with Access type set to "Non-3GPP access" in Deregistration type IE, REGISTRATION REJECT message during a registration procedure for mobility and periodic registration update or SERVICE REJECT message and the value of timer T3346 is greater than the value of timer T3512, the AMF sets the mobile reachable timer and the implicit de-registration timer such that the sum of the timer values is greater than the value of timer T3346.

If the AMF provides T3346 value IE in the DEREGISTRATION REQUEST message with Access type set to "3GPP access" in Deregistration type IE, REGISTRATION REJECT message during a registration procedure for mobility and periodic registration update or SERVICE REJECT message and the value of timer T3346 is greater than the value of the non-3GPP de-registration timer, the AMF sets the non-3GPP implicit de-registration timer value to be 8 minutes greater than the value of timer T3346.

If the UE receives T3346 value IE in the DEREGISTRATION REQUEST message with Access type set to "3GPP access" in Deregistration type IE, REGISTRATION REJECT message during a registration procedure for mobility and periodic registration update or SERVICE REJECT message and the value of timer T3346 is greater than the value of the non-3GPP de-registration timer, the UE sets the non-3GPP de-registration timer value to be 4 minutes greater than the value of timer T3346.

5.3.8 Handling of timer T3502

The value of timer T3502 can be sent by the network to the UE in the REGISTRATION ACCEPT message. The UE shall apply this value in all tracking areas of the registration area assigned to the UE, until a new value is received.

The value of timer T3502 can be sent by the network to the UE in the REGISTRATION REJECT message during the initial registration. If a REGISTRATION REJECT message including timer T3502 value was received integrity protected, the UE shall apply this value until a new value is received with integrity protection or a new PLMN or SNPN is selected. Otherwise, the default value of this timer is used.

The default value of this timer is also used by the UE in the following cases:

- a) REGISTRATION ACCEPT message is received without a value specified, and the 5GS registration type IE in the REGISTRATION REQUEST message is not set to "periodic registration updating";
- b) the UE does not have a stored value for this timer;
- c) a new PLMN which is not in the list of equivalent PLMNs or a new SNPN has been entered, the initial registration procedure fails, the registration attempt counter is equal to 5 and no REGISTRATION REJECT message was received from the new PLMN or SNPN;
- d) the network indicates that the timer is "deactivated"; or
- e) a new PLMN which is not in the list of equivalent PLMNs or a new SNPN has been entered, the registration procedure for mobility and periodic registration update fails and the registration attempt counter is equal to 5.

5.3.9 Handling of NAS level mobility management congestion control

The AMF may detect 5GMM signalling congestion and perform general NAS level congestion control. Under the 5GMM signalling congestion conditions the AMF may reject 5GMM signalling requests from UEs as specified in 3GPP TS 23.501 [8]. The AMF should not reject the following:

- a) requests for emergency services;
- b) requests for emergency services fallback;
- c) requests from UEs configured for high priority access in selected PLMN or SNPN;
- d) DEREGISTRATION REQUEST message;
- e) requests for mobile terminated services, triggered by paging or a notification procedure;
- f) requests for initial registration or mobility and periodic registration update, when emergency is indicated by lower layers; and
- g) requests for mobility registration update when the UE is reporting unavailability information due to discontinuous coverage.

When general NAS level congestion control is active, the AMF may include a value for the mobility management back-off timer T3346 in the reject messages. The UE starts the timer T3346 with the value received in the 5GMM reject messages. To avoid that large numbers of UEs simultaneously initiate deferred requests, the AMF should select the value for the timer T3346 for the rejected UEs so that timeouts are not synchronised.

When general NAS level congestion control is active, if the current SNPN is an SNPN selected for localized services in SNPN (see 3GPP TS 23.122 [5]), the AMF may include an appropriate cause value other than 5GMM cause #22 "congestion" (e.g., #74 "Temporarily not authorized for this SNPN") in the reject messages without including timer T3346 value, to allow the UE to enter state 5GMM-REGISTERED.PLMN-SEARCH or 5GMM-DEREGISTERED.PLMN-SEARCH and perform SNPN selection according to 3GPP TS 23.122 [5].

If the UE is registered in the same PLMN over the 3GPP access and non-3GPP access, and the UE receives the timer T3346 from the AMF, the timer T3346 shall apply to both 3GPP access and non-3GPP access.

If the UE receives the paging message or NOTIFICATION message when timer T3346 is running and the UE is registered to the same PLMN over 3GPP access and non-3GPP access, the UE shall stop the timer T3346 for both accesses and respond to the paging message or NOTIFICATION message as specified in subclause 5.6.2 and subclause 5.6.3.

NOTE 1: As an implementation option, MUSIM UE is allowed to not respond to paging based on the information available in the paging message, e.g. voice service indication.

If the timer T3346 is running when the UE enters state 5GMM-DEREGISTERED, the UE remains switched on, and the USIM in the UE remains the same, then the timer T3346 is kept running until it expires or it is stopped.

If the UE is switched off when the timer T3346 is running, the UE shall behave as follows when the UE is switched on and the USIM in the UE remains the same:

let t_1 be the time remaining for T3346 timeout at switch off and let t be the time elapsed between switch off and switch on. If t_1 is greater than t , then the timer shall be restarted with the value $t_1 - t$. If t_1 is equal to or less than t , then the timer need not be restarted. If the UE is not capable of determining t , then the UE shall restart the timer with the value t_1 .

If the UE enters a new PLMN or SNPN while timer T3346 is running, and the new PLMN or SNPN is not equivalent to the PLMN or SNPN where the UE started timer T3346, the UE shall stop timer T3346 when initiating 5GMM procedures in the new PLMN or SNPN.

After a change in registration area, if the timer T3346 is running and 5GS update status is 5U1 UPDATED then the UE shall set the 5GS update status to 5U2 NOT UPDATED and enter state 5GMM-REGISTERED.ATTEMPTING-REGISTRATION-UPDATE.

If timer T3346 is running or is deactivated, and:

- a) the UE is a UE configured for high priority access in selected PLMN or SNPN;

- b) the UE needs to initiate signalling for emergency services or emergency services fallback; or
- c) the UE needs to report unavailability information due to discontinuous coverage,

then the UE is allowed to initiate 5GMM procedures.

NOTE 2: UE can, based on implementation, restrict lower layers of non-3GPP access from establishing access stratum connection on a registered PLMN when timer T3346 is running for the same PLMN.

5.3.10 Handling of DNN based congestion control

The AMF may detect and start performing DNN based congestion control when one or more DNN congestion criteria as specified in 3GPP TS 23.501 [8] are met. If the UE does not provide a DNN for a non-emergency PDU session, then the AMF uses the selected DNN or the DNN associated with the PDU session corresponding to the 5GSM procedure.

When DNN based congestion control is activated at the AMF, the AMF performs the congestion control as specified in subclause 5.4.5 and the UE performs the congestion control as specified in subclause 5.4.5 and subclause 6.2.7.

5.3.11 Handling of S-NSSAI based congestion control

The AMF may detect and start performing S-NSSAI based congestion control when one or more S-NSSAI congestion criteria as specified in 3GPP TS 23.501 [8] are met. If the UE does not provide a DNN for a non-emergency PDU session, then the AMF uses the selected DNN or the DNN associated with the PDU session corresponding to the 5GSM procedure. If the UE does not provide an S-NSSAI for a non-emergency PDU session, then the AMF uses the selected S-NSSAI or the S-NSSAI associated with the PDU session corresponding to the 5GSM procedure.

The AMF may detect and start performing S-NSSAI based congestion control when the UE that does not support S-NSSAI location validity information requests a PDU session establishment for an S-NSSAI limited by NS-AoS and the UE is outside the NS-AoS of an S-NSSAI.

When S-NSSAI based congestion control is activated at the AMF, the AMF performs the congestion control as specified in subclause 5.4.5 and the UE performs the congestion control as specified in subclause 5.4.5 and subclause 6.2.8.

5.3.12 Handling of local emergency numbers

The additional requirements in subclause 5.3.12A apply to a UE supporting registration or attach procedures via 3GPP access and registration procedures via non-3GPP access.

In case of PLMN, the network may send a local emergency numbers list or an extended local emergency numbers list or both, in the REGISTRATION ACCEPT message, by including the Emergency number list IE and the Extended emergency number list IE, respectively. The Local emergency numbers list can be updated as described in 3GPP TS 24.301 [15], subclause 5.3.7.

In case of SNPN, the network may send an extended local emergency numbers list, in the REGISTRATION ACCEPT message, by including the Extended emergency number list IE. The network shall set the Extended Emergency Number List Validity (EENLV) field within the Extended emergency number list IE to "Extended Local Emergency Numbers List is valid only in the PLMN from which this IE is received". The UE shall consider the emergency number(s) received in the Extended emergency number list IE valid only in the SNPN from which this IE is received regardless of the received value of the EENLV field within the Extended emergency number list IE.

The UE shall store the local emergency numbers list and the extended local emergency numbers list, as provided by the network. The local emergency numbers list stored in the UE shall be replaced on each receipt of the Emergency number list IE. The extended local emergency numbers list stored in the UE shall be replaced on each receipt of the Extended emergency number list IE. The received local emergency numbers list or the received extended local emergency numbers list or both shall be provided to the upper layers.

The emergency number(s) received in the Emergency number list IE are valid only in PLMNs in the same country as the PLMN from which this IE is received. If no Emergency number list IE is contained in the REGISTRATION ACCEPT message, then the stored local emergency numbers list in the UE shall be kept, except if the UE has successfully registered to a PLMN in a country different from that of the PLMN that sent the list.

The emergency number(s) received in the Extended emergency number list IE are valid only in:

- a) PLMNs in the same country as the PLMN from which this IE is received, if the Extended Emergency Number List Validity (EENLV) field within the Extended emergency number list IE indicates "Extended Local Emergency Numbers List is valid in the country of the PLMN from which this IE is received"; and
- b) the PLMN from which this IE is received, if the EENLV field within the Extended emergency number list IE indicates "Extended Local Emergency Numbers List is valid only in the PLMN from which this IE is received"; and
- c) the SNPN from which this IE is received, regardless of the value of the EENLV field within the Extended emergency number list IE.

If no Extended Local Emergency Numbers List is contained in the REGISTRATION ACCEPT message, and the registered PLMN or the registered SNPN has not changed, then the stored Extended Local Emergency Numbers List in the UE shall be kept. If no Extended Local Emergency Numbers List is contained in the REGISTRATION ACCEPT message, but the registered PLMN or the registered SNPN has changed, then:

- a) if the last received indication in the EENLV field within the Extended emergency number list IE indicates "Extended Local Emergency Numbers List is valid only in the PLMN from which this IE is received", the stored Extended Local Emergency Numbers List in the UE shall be deleted; and
- b) if the last received indication in the EENLV field within the Extended emergency number list IE indicates "Extended Local Emergency Numbers List is valid in the country of the PLMN from which this IE is received" the list shall be kept except if the UE has successfully registered to a PLMN in a country different from that of the PLMN that sent the stored list.

NOTE: To prevent the misrouting of emergency calls, all operators within a country need to follow the regulation or agree on the setting of the Extended emergency number list IE in accordance to national agreement – either to indicate validity within a country or to indicate validity only within the PLMN.

The local emergency numbers list and the extended local emergency numbers list shall be deleted at switch off or removal of the USIM. The UE shall be able to store up to ten entries in the local emergency numbers list and up to twenty entries in the Extended local emergency numbers list, received from the network.

For the use of the local emergency numbers list and the extended local emergency numbers list by the UE see 3GPP TS 24.301 [15], subclause 5.3.7.

5.3.12A Handling of local emergency numbers received via 3GPP access and non-3GPP access

5.3.12A.1 General

The requirements in subclause 5.3.12 with the clarifications and additional conditions in subclause 5.3.12A apply to a UE supporting:

- a) attach procedures (see 3GPP TS 24.301 [15]) or registration procedures via 3GPP access; and
- b) registration procedures via non-3GPP access.

The UE shall ignore the presence or absence of local emergency numbers list, extended local emergency numbers list or both, in a REGISTRATION ACCEPT message received via non-3GPP access and keep the stored local emergency numbers list and the extended local emergency numbers list, if available, unless conditions in subclause 5.3.12A.2 are met.

For the purposes of subclause 5.3.12A, the UE is considered neither registered nor attached over 3GPP access if:

- 1) the UE supports 3GPP access to EPC, the UE does not support 3GPP access to 5GC, and:
 - a) the EMM sublayer is in the EMM-NULL state, EMM-DEREGISTERED state or EMM-DEREGISTERED-INITIATED state; or
- 2) the UE supports 3GPP access to 5GC, the UE does not support 3GPP access to EPC, and:
 - a) the 5GMM sublayer is in the 5GMM-NULL state, 5GMM-DEREGISTERED state or 5GMM-DEREGISTERED-INITIATED state; or

- 3) supports both 3GPP access to EPC and 3GPP access to 5GC, and:
 - a) the EMM sublayer is in the EMM-NULL state, EMM-DEREGISTERED state or EMM-DEREGISTERED-INITIATED state; and
 - a) the 5GMM sublayer is in the 5GMM-NULL state, 5GMM-DEREGISTERED state or 5GMM-DEREGISTERED-INITIATED state.

5.3.12A.2 Receiving a REGISTRATION ACCEPT message via non-3GPP access

If the UE can determine the current country and after switch on or after removal of the USIM, has not been registered or has not been attached via 3GPP access in the current country, then the UE shall store the local emergency numbers list or the extended local emergency numbers list or both, as provided by the network with an MCC matching the current country via non-3GPP access.

NOTE: The UE determines, as the current country, the country in which it is located in accordance with 3GPP TS 24.502 [18].

The UE shall replace a previously stored local emergency numbers list or a previously stored extended local emergency numbers list or both with a local emergency numbers list or an extended local emergency numbers list or both received in a REGISTRATION ACCEPT message via non-3GPP access, if the previously stored local emergency numbers list was also received via non-3GPP access or the previously stored extended local emergency numbers list was also received via non-3GPP access.

The UE shall replace a previously stored extended local emergency numbers list with an extended local emergency numbers list received in a REGISTRATION ACCEPT message via non-3GPP access, if:

- a) the UE is neither registered nor attached over 3GPP access;
- b) the REGISTRATION ACCEPT message is received from a PLMN different from which the stored list was received; and
- c) the stored indication in the EENLV field within the Extended emergency number list IE indicates "Extended Local Emergency Numbers List is valid only in the PLMN from which this IE is received".

If no extended local emergency numbers list is contained in a REGISTRATION ACCEPT message received via non-3GPP access and the UE is neither registered nor attached over 3GPP access, the stored extended local emergency numbers list in the UE shall be discarded if:

- a) the UE can determine the current country and the UE has successfully registered to a PLMN in the country and that country is different from that of the PLMN that sent the stored list; or
- b) the REGISTRATION ACCEPT message is received from a PLMN different from which the stored list was received, and the stored indication in the EENLV field within the Extended emergency number list IE indicates "Extended Local Emergency Numbers List is valid only in the PLMN from which this IE is received".

5.3.13 Lists of 5GS forbidden tracking areas

If the UE is not operating in SNPN access operation mode, the UE shall store a list of "5GS forbidden tracking areas for roaming", as well as a list of "5GS forbidden tracking areas for regional provision of service". Otherwise the UE shall store a list of "5GS forbidden tracking areas for roaming":

- a) per SNPN; and
- b) if the UE supports access to an SNPN using credentials from a credentials holder, equivalent SNPNs or both, per entry of the "list of subscriber data" or, if the UE supports access to an SNPN using credentials from a credentials holder, PLMN subscription;

and store a list of "5GS forbidden tracking areas for regional provision of service":

- a) per SNPN; and

- b) if the UE supports access to an SNPN using credentials from a credentials holder, equivalent SNPNS or both, per entry of the "list of subscriber data" or, if the UE supports access to an SNPN using credentials from a credentials holder, PLMN subscription.

Within the 5GS, these lists are managed independently per access type, i.e., 3GPP access or wireline access. These lists shall be erased when:

- a) the UE is switched off, the UICC containing the USIM is removed, an entry of the "list of subscriber data" with the subscribed SNPN identity identifying the current SNPN is updated or, if the UE supports access to an SNPN using credentials from a credentials holder, the entry of the "list of subscriber data" associated with the lists is updated; and
- b) periodically (with a period in the range 12 to 24 hours).

Over 3GPP access, when the lists are erased, the UE performs cell selection according to 3GPP TS 38.304 [28] or 3GPP TS 36.304 [25C]. If the UE is not operating in SNPN access operation mode a tracking area shall be removed from the list of "5GS forbidden tracking areas for roaming", as well as the list of "5GS forbidden tracking areas for regional provision of service", if the UE receives the tracking area in the TAI list or the Service area list of "allowed tracking areas" in REGISTRATION ACCEPT message or a CONFIGURATION UPDATE COMMAND message.

The UE operating in SNPN access operation mode shall remove a tracking area from the list of "5GS forbidden tracking areas for roaming" as well as the list of "5GS forbidden tracking areas for regional provision of service" for:

- a) the selected SNPN; and
- b) when the UE supports access to an SNPN using credentials from a credentials holder, equivalent SNPNS or both, for the selected entry of the "list of subscriber data" or, when the UE supports access to an SNPN using credentials from a credentials holder, the selected PLMN subscription;

if the UE receives the tracking area in the TAI list or the Service area list of "allowed tracking areas" in REGISTRATION ACCEPT message or a CONFIGURATION UPDATE COMMAND message.

The UE shall not remove the tracking area from "5GS forbidden tracking areas for roaming" or "5GS forbidden tracking areas for regional provision of service" if the UE is registered for emergency services.

In N1 mode over 3GPP access, the UE shall update the suitable list whenever a REGISTRATION REJECT, SERVICE REJECT or DEREGISTRATION REQUEST message is received with the 5GMM cause #12 "tracking area not allowed", #13 "roaming not allowed in this tracking area", #15 "no suitable cells in tracking area", or #62 "no network slices available".

In N1 mode over 3GPP access, if the UE receives the "5GS forbidden tracking areas for roaming" IE or the "5GS forbidden tracking areas for regional provision of service" IE in the REGISTRATION REJECT, SERVICE REJECT, DEREGISTRATION REQUEST, REGISTRATION ACCEPT or SERVICE ACCEPT message, the UE update the suitable list with the received TAI(s) belonging to the serving PLMN or equivalent PLMN(s) and ignore the TAI(s) which do not belong to the serving PLMN or equivalent PLMN(s) included in the IE.

If the UE receives ACTIVATE DEFAULT EPS BEARER CONTEXT REQUEST message provided with S-NSSAI and the PLMN ID in the Protocol configuration options IE or Extended protocol configuration options IE (see subclause 6.5.1.3 of 3GPP TS 24.301 [15]), the UE may remove the corresponding tracking area from the "5GS forbidden tracking areas for roaming".

Over wireline access, the 5G-RG, the W-AGF acting on behalf of an FN-RG or the W-AGF acting on behalf of an N5GC device shall update the suitable list whenever a REGISTRATION REJECT, SERVICE REJECT or DEREGISTRATION REQUEST message is received with the 5GMM cause #12 "tracking area not allowed" or #13 "roaming not allowed in this tracking area".

NOTE: In this release of the specification, for untrusted non-3GPP access and trusted non-3GPP access, neither the list of "5GS forbidden tracking areas for roaming" nor the list of "5GS forbidden tracking areas for regional provision of service" is maintained by the UE since the UE is not able to determine the corresponding TAI.

Each list shall accommodate 40 or more TAIs. When the list is full and a new entry has to be inserted, the oldest entry shall be deleted.

5.3.13A Forbidden PLMN lists

In N1 mode, two lists of forbidden PLMN are managed independently per access type, i.e., 3GPP access or non-3GPP access:

- a) the list of "forbidden PLMNs" as defined in 3GPP TS 23.122 [5] is applicable for 3GPP access in N1 mode. The same list is used by 5GMM for 3GPP access, EMM, GMM and MM (see 3GPP TS 24.301 [15] and 3GPP TS 24.008 [12]), regardless whether the UE is operating in single-registration mode or dual-registration mode.
- b) the list of "forbidden PLMNs for non-3GPP access to 5GCN" as defined in 3GPP TS 24.502 [18] is applicable for 5GMM for non-3GPP access.

The list of "forbidden PLMNs for GPRS service" as defined in 3GPP TS 23.122 [5] and 3GPP TS 24.008 [12] is applicable for 3GPP access in N1 mode. The same list is used by 5GMM for 3GPP access, EMM and GMM (see 3GPP TS 24.301 [15] and 3GPP TS 24.008 [12]), regardless whether the UE is operating in single-registration mode or dual-registration mode.

The forbidden PLMN lists shall be maintained across activation and deactivation of SNPN access operation mode.

- NOTE: On timer T3245 expiry when the UE supports access to an SNPN using credentials from a credentials holder using PLMN subscription, and the UE is operating in SNPN access operation mode, as an implementation option the UE can delete the list of "forbidden PLMNs", "forbidden PLMNs for non-3GPP access to 5GCN" and "forbidden PLMNs for GPRS service".

5.3.14 List of equivalent PLMNs

The UE shall store a list of equivalent PLMNs. These PLMNs shall be regarded by the UE as equivalent to each other for PLMN selection and cell selection/re-selection. The same list is used by 5GMM, EMM, GMM and MM (see 3GPP TS 24.301 [15] and 3GPP TS 24.008 [12]) except for the case when the UE operates in dual-registration mode (see subclause 4.8.3).

The UE shall update or delete this list at the end of each registration procedure. The stored list consists of a list of equivalent PLMNs as downloaded by the network plus the PLMN code of the registered PLMN that downloaded the list. When the UE is switched off, the UE shall keep the stored list so that it can be used for PLMN selection after switch on. The UE shall delete the stored list if the USIM is removed or when the UE registered for emergency services enters the state 5GMM-DEREGISTERED. The maximum number of possible entries in the stored list is 16.

If the UE registers to different PLMNs over 3GPP and non-3GPP accesses, the UE shall store an additional list of equivalent PLMNs associated with non-3GPP access. The UE manages the two lists of equivalent PLMNs per access type independently.

5.3.14A List of equivalent SNPNs

The UE may support equivalent SNPNs.

If the UE supports equivalent SNPNs, the ME shall store a list of equivalent SNPNs:

- a) per entry of "list of subscriber data"; or
- b) per the PLMN subscription, if the UE supports access to an SNPN using credentials from a credentials holder.

SNPNs in the list of equivalent SNPNs associated with the selected entry of "list of subscriber data" or the selected PLMN subscription shall be regarded by the UE as equivalent to each other for SNPN selection, cell selection and cell re-selection.

The list of equivalent SNPNs associated with the selected entry of "list of subscriber data" or the selected PLMN subscription is created, replaced or deleted at the end of each registration procedure. The stored list consists of a list of equivalent SNPNs as provided by the network plus the SNPN identity of the registered SNPN that provided the list.

When the UE is switched off, the UE shall keep the stored list(s) so that they can be used for SNPN selection after switch on.

The UE shall delete the stored list associated with an entry of "list of subscriber data" or the PLMN subscription, when the USIM is removed, the associated entry of "list of subscriber data" is updated, or the UE registered for emergency services enters the state 5GMM-DEREGISTERED.

The maximum number of possible entries in each stored list is 16.

NOTE 1: To enable UE mobility between the registered SNPN and an equivalent SNPN, the SNPN identity of the registered SNPN providing a list of equivalent SNPNs and the SNPN identity(ies) in the list of equivalent SNPNs are assumed to be globally-unique SNPN identities.

NOTE 2: The MS can provide the list of equivalent SNPNs associated with the selected entry of "list of subscriber data" or the selected PLMN subscription to the lower layers.

If the UE supports equivalent SNPNs and registers to different SNPNs over 3GPP and non-3GPP accesses, the UE shall store an additional list of equivalent SNPNs associated with non-3GPP access. The UE manages the two lists of equivalent SNPNs per access type independently.

5.3.15 Transmission failure abnormal case in the UE

The abnormal case 5GMM uplink message transmission failure indication by lower layers can be identified for 5GMM procedures:

When it is specified in the relevant procedure that it is up to the UE implementation to re-run the ongoing procedure that triggered that procedure, the procedure can typically be re-initiated using a retransmission mechanism of the uplink message (i.e. the one that has previously failed to be transmitted) with new sequence number and message authentication code information thus avoiding to re-start the whole procedure.

NOTE: The transmission failure can happen due to TAI change. The lower layer might take some time to read the system information and determine if the current TAI is changed. Therefore, the information of TAI change can be sent to the NAS layer a little after receiving the transmission failure indication from the lower layer. How to handle the retransmission procedure caused by the possible delayed TAI change information is up to UE implementation.

5.3.16 Extended DRX cycle for UEs in 5GMM-IDLE and 5GMM-CONNECTED mode with RRC inactive indication

Extended DRX (eDRX) cycle is supported for a UE in N1 mode. When eDRX is requested by the UE and accepted by the network:

- a) if the UE is not in NB-N1 mode, eDRX is used when the UE is in 5GMM-IDLE mode or in 5GMM-CONNECTED mode with RRC inactive indication; or
- b) if the UE is in NB-N1 mode, eDRX is used when the UE is in 5GMM-IDLE mode.

The UE may request the use of eDRX cycle during a registration procedure by including the Requested extended DRX parameters IE (see 3GPP TS 23.501 [8] and 3GPP TS 23.502 [9]). The UE shall not request the use of eDRX during a registration procedure for emergency services. The UE may use the extended idle mode DRX cycle length stored in the USIM (see 3GPP TS 31.102 [22]) when requesting the use of eDRX.

The UE and the network may negotiate eDRX parameters during a registration procedure when the UE has an emergency PDU session.

The network accepts the request to use the eDRX by providing the Negotiated extended DRX parameters IE when accepting the registration procedure. The UE shall use eDRX only if it received the Negotiated extended DRX parameters IE during the last registration procedure and the UE does not have an emergency PDU session.

NOTE 1: If the UE wants to keep using eDRX, the UE includes the Extended DRX parameters IE in each registration procedure.

If the UE received the Negotiated extended DRX parameters IE during the last registration procedure, upon successful completion of the PDU session release procedure of the emergency PDU session, the UE shall resume eDRX.

If the network has provided the Negotiated extended DRX parameters IE during the last registration procedure, upon successful completion of the PDU session release procedure of the emergency PDU session, the network shall resume eDRX.

If the UE or the network locally releases an emergency PDU session, the UE or the network shall not use eDRX until the UE receives eDRX parameters during a registration procedure with PDU session context synchronization or upon successful completion of a service request procedure with PDU session context synchronization.

If the UE did not receive the Negotiated extended DRX parameters IE, or if the UE has an emergency PDU session, the UE shall use the stored UE specific DRX parameter, if available.

If the network did not accept the request to use eDRX, or if the UE has an emergency PDU session, the network shall use the stored UE specific DRX parameter, if available.

If the network provided the Negotiated extended DRX parameters IE and also assigned a new 5G-GUTI for the UE as described in subclause 5.5.1.3.4 during the last registration procedure, the network shall use the stored UE specific DRX parameter, if available, with the old 5G-GUTI and use the eDRX provided by the network with the new 5G-GUTI until the old 5G-GUTI can be considered as invalid by the network (see subclauses 5.4.4.4 and 5.5.1.3.4).

NOTE 2: If the UE using eDRX has joined one or more multicast MBS sessions or wants to receive the traffic of broadcast MBS sessions, the upper layers of the UE provide the lower layers with the MBS start time and the scheduled activation times of the respective MBS session if any of those times are obtained via the service announcement as specified in 3GPP TS 23.247 [53]. This interaction between the upper layers and the lower layers is out of scope of the present document. If the UE fails to receive paging or data for a multicast MBS session which the UE has joined or data for a broadcast MBS session, the UE can as an implementation option initiate 5GMM procedures (e.g. for the transfer of mobile originated signalling or user data) to enter 5GMM-CONNECTED mode over 3GPP access and obtain via the service announcement a new start time, a sequence of scheduled activation times or both.

5.3.17 Service Gap Control

Service gap control (SGC) only applies to 3GPP access.

The network may control the frequency with which UEs can transition from 5GMM-IDLE mode to 5GMM-CONNECTED mode via the SGC as specified in 3GPP TS 23.501 [8] and 3GPP TS 23.502 [9]. If the network supports SGC and the service gap time value i.e. T3447 value is available in the 5GMM context of the UE, the AMF shall consider SGC as active for the UE.

The UE and the network negotiate usage of SGC during the registration procedure for initial registration and registration procedure for mobility and periodic registration update:

- a) the UE supporting SGC indicates its support in the REGISTRATION REQUEST message. If the UE supports SGC and the SGC is active for the UE, the AMF includes T3447 value IE in the REGISTRATION ACCEPT message (see subclause 5.5.1.2 and subclause 5.5.1.3). The UE stores the T3447 value; and
- b) for UEs that do not support SGC when the network rejects mobility management signalling requests because SGC is active in the network, the mechanism for general NAS level mobility management congestion control as specified in subclause 5.3.9 applies.

The network can provide a new T3447 value to the UE to be used next time it is started or stop timer T3447 in the UE if running with the Generic UE configuration update procedure as specified in subclause 5.4.4.

The UE shall start timer T3447 when the N1 NAS signalling connection is released and if:

- a) the UE supports SGC, and the T3447 value is available in the UE and does not indicate zero; and
- b) the N1 NAS signalling connection released was not established for:
 - 1) paging;
 - 2) registration procedure for initial registration with Follow-on request indicator set to "No follow-on request pending";
 - 3) registration procedure for mobility and periodic registration update with Follow-on request indicator set to "No follow-on request pending" and without Uplink data status IE included;

- 4) requests for emergency services; or
- 5) requests for exception data reporting.

If the SGC is active in the network, after the UE transitions from 5GMM-CONNECTED mode to 5GMM-IDLE mode except when the UE was in 5GMM-CONNECTED mode due to:

- a) paging;
- b) registration procedure for initial registration with Follow-on request indicator set to "No follow-on request pending";
- c) registration procedure for mobility and periodic registration update with Follow-on request indicator set to "No follow-on request pending" and without Uplink data status IE included,
- d) requests for emergency services; or
- e) requests for exception data reporting,

the network shall start timer T3447 if not already running:

- with the T3447 value available in the 5GMM context minus 4 minutes, if the UE supports SGC and the T3447 value has been sent to the UE with a non-zero value; or
- with the T3447 value available in the 5GMM context if the UE does not support SGC.

When timer T3447 is running, the network allows:

- a) requests for emergency service;
- b) requests for emergency services fallback;
- c) requests for high priority access;
- d) requests for exception data reporting;
- e) registration procedure for initial registration with Follow-on request indicator set to "No follow-on request pending";
- f) registration procedure for mobility and periodic registration update without Uplink data status IE included and with Follow-on request indicator set to "No follow-on request pending"; or
- g) service request procedure or registration procedure for mobility and periodic registration update triggered by paging and subsequent MO signalling or MO data, if any, until the UE enters 5GMM-IDLE mode.

The UE or the network with a running T3447 timer keeps the timer running when the UE transits from 5GMM-IDLE mode to 5GMM-CONNECTED mode.

NOTE: If the UE transitions from 5GMM-IDLE mode to 5GMM-CONNECTED mode due to registration procedure for initial registration with Follow-on request indicator set to "No follow-on request pending" or mobility and periodic registration update request without Uplink data status IE and with Follow-on request indicator set to "No follow-on request pending", the UE initiates no further MO signalling except for mobility and periodic registration update requests without Uplink data status and with Follow-on request indicator set to "No follow-on request pending" until the UE receives mobile terminated signalling (e.g. DL NAS TRANSPORT message for MT SMS) or MT data over user plane, or after the UE has moved to 5GMM-IDLE state and the service gap timer is not running.

If timer T3447 is running when the UE changes PLMN or enters state 5GMM-DEREGISTERED, the UE remains switched on, and the USIM in the UE remains the same, then timer T3447 is kept running until it expires.

If the AMF determines that the UE operating in single-registration mode has performed an inter-system change from N1 mode to S1 mode and the timer T3447 is running in the AMF, the AMF stops the T3447.

Upon inter-system change from S1 mode to N1 mode, if the UE supports service gap control, T3447 is running in the UE, and the T3447 value IE is included in the REGISTRATION ACCEPT message received from the AMF (see subclause 5.5.1.2 and subclause 5.5.1.3), the UE shall keep T3447 running. Additionally, the UE shall store and replace

the currently stored service gap time value with the received T3447 value. Upon expiry of the running T3447 timer, the UE shall use the new value when starting T3447 again.

If the UE is switched off when the timer T3447 is running, the UE shall behave as follows when the UE is switched on and the USIM in the UE remains the same:

- let t_1 be the time remaining for timer T3447 timeout at switch off and let t be the time elapsed between switch off and switch on. If t_1 is greater than t , then the timer shall be restarted with the value $t_1 - t$. If t_1 is equal to or less than t , then the timer need not be restarted. If the UE is not capable of determining t , then the UE shall restart the timer with the value t_1 .

5.3.18 Restriction on use of enhanced coverage

In order to deal with use of extensive resources from the network, the operator may prevent specific subscribers from using enhanced coverage (see 3GPP TS 23.501 [8]). When in NB-N1 mode, the UE shall indicate support for restriction on use of enhanced coverage. When in WB-N1 mode, the UE supporting either CE mode A or CE mode B shall indicate support for restriction on use of enhanced coverage. The UE supporting restriction on use of enhanced coverage indicates its support for restriction on use of enhanced coverage in the REGISTRATION REQUEST message. If the UE supports restriction on use of enhanced coverage, the AMF indicates in the REGISTRATION ACCEPT message (see subclause 5.5.1.2 and subclause 5.5.1.3) that:

- a) when in WB-N1 mode, whether CE mode B is restricted for the UE, or both CE mode A and CE mode B are restricted for the UE, or both CE mode A and CE mode B are not restricted for the UE; or
- b) when in NB-N1 mode, whether the use of enhanced coverage is restricted or not for the UE.

If:

- a) the use of enhanced coverage is restricted;
- b) the use of CE mode B is restricted; or
- c) the use of CE mode A and CE mode B is restricted,

the UE shall not use enhanced coverage in the registered PLMN and in any PLMN which is in the list of equivalent PLMNs.

If the UE supports CE mode B and the network determines that

- a) the use of enhanced coverage is not restricted for the UE; or
- b) CE mode B is not restricted for the UE,

the applicable NAS timer values shall be calculated by the network as described in subclause 4.19 and subclause 4.20.

For a UE that supports restriction on use of enhanced coverage or CE mode B, if:

- a) the AMF determines to enforce a change in restriction on the use of enhanced coverage or a change in the restriction on the use of CE mode B as described in 3GPP TS 23.501 [8]; and
- b) the UE is in 5GMM-CONNECTED mode and there is no ongoing registration procedure,

the AMF shall initiate the generic UE configuration update procedure to indicate registration requested and release of the N1 NAS signalling connection not requested as described in subclause 5.4.4. After the successful completion of the registration procedure for mobility registration update including change of the restriction on the use of enhanced coverage, for any SMF with which the UE has an established PDU session, the AMF updates the SMF with the indication on the use of extended NAS timer setting as described in 3GPP TS 23.501 [8] and 3GPP TS 23.502 [9].

5.3.19 Handling of congestion control for transport of user data via the control plane

The network may activate congestion control for transport of user data via the control plane, as specified in 3GPP TS 23.501 [8].

If the UE has indicated support for the control plane CIoT 5GS optimizations and the network decides to activate the congestion control for transport of user data via the control plane, the network may include a value for the control plane data back-off timer T3448 in REGISTRATION ACCEPT, SERVICE ACCEPT or SERVICE REJECT message, and shall store a control plane data back-off time on a per UE basis. The UE starts the timer T3448 with the value informed in the message. To avoid that large numbers of UEs simultaneously initiate deferred requests, the network should select the value for the timer T3448 for the informed UEs so that timeouts are not synchronised. Based on local policy, the network need not include a value for the control plane data back-off timer T3448 in REGISTRATION ACCEPT, SERVICE ACCEPT or SERVICE REJECT message to a UE configured for high priority access in selected PLMN.

The network sends REGISTRATION ACCEPT message or SERVICE ACCEPT message without T3448 value IE to stop the timer T3448 running in the UE as specified in subclause 5.5.1.3.4 and subclause 5.6.1.4.

Based on the stored control plane data back-off time for the UE, the network may reject the transfer of user data via the control plane initiated by the UE. Based on local policy, the network shall not reject the transfer of user data via the control plane initiated by a UE configured for high priority access in selected PLMN.

While the timer T3448 is running, the UE in 5GMM-IDLE mode does not initiate the transport of user data via the control plane procedure, except if the UE is allowed to use exception data reporting (see the ExceptionDataReportingAllowed leaf of the NAS configuration MO in 3GPP TS 24.368 [17] or the USIM file EF_{NASCONFIG} in 3GPP TS 31.102 [22]) and the user data is related to an exceptional event.

The UE is allowed:

- a) to respond to paging with CONTROL PLANE SERVICE REQUEST message without uplink data; or
- b) to send a CONTROL PLANE SERVICE REQUEST message for emergency services or for emergency services fallback;

even if the timer T3448 is running.

Upon entering the state 5GMM-DEREGISTERED or a new PLMN which is not equivalent to the PLMN where the UE started the timer T3448, or upon being switched off while the timer T3448 is running, the UE stops the timer T3448.

5.3.19A Specific requirements for UE configured to use timer T3245

5.3.19A.1 UE not operating in SNPN access operation mode

The following requirements apply for a UE that is configured to use timer T3245 (see 3GPP TS 24.368 [17] or 3GPP TS 31.102 [22]).

When the UE adds a PLMN identity to the "forbidden PLMN list" or sets the USIM as invalid for 5GS services for 3GPP access or non-3GPP access, and timer T3245 (see 3GPP TS 24.008 [12]) is not running, the UE shall start timer T3245 as specified in 3GPP TS 24.008 [12], subclause 4.1.1.6.

Upon expiry of the timer T3245, the UE shall erase the "forbidden PLMN list" and "forbidden PLMNs for GPRS service" list and set the USIM to valid for 5GS services for 3GPP access and non-3GPP access. When the lists are erased, the UE performs cell selection according to 3GPP TS 38.304 [28] or 3GPP TS 36.304 [25C].

If the UE is switched off when the timer T3245 is running, the UE shall behave as follows when the UE is switched on and the USIM in the UE remains the same:

- let t_1 be the time remaining for T3245 timeout at switch off and let t be the time elapsed between switch off and switch on. If t_1 is greater than t , then the timer shall be restarted with the value $t_1 - t$. If t_1 is equal to or less than t , then the UE will follow the behaviour as defined in the paragraph above upon expiry of the timer T3245. If the UE is not capable of determining t , then the UE shall restart the timer with the value t_1 .

5.3.19A.2 UE operating in SNPN access operation mode

The following requirements apply for a UE that is configured to use timer T3245 (see 3GPP TS 24.368 [17]).

When the UE adds an SNPN to the "permanently forbidden SNPNs" list or "temporarily forbidden SNPNs" list which are, if the MS supports access to an SNPN using credentials from a credentials holder, equivalent SNPNs or both, associated with the selected entry of the "list of subscriber data" or the selected PLMN subscription, or sets the selected

entry of the "list of subscriber data" or the selected PLMN subscription as invalid for 3GPP access or non-3GPP access, and timer T3245 (see 3GPP TS 24.008 [12]) is not running, the UE shall start timer T3245 with a random value, uniformly drawn from the range between 12h and 24h.

When the UE adds an SNPN to the "permanently forbidden SNPNs for access for localized services in SNPN" list or "temporarily forbidden SNPNs for access for localized services in SNPN" list which are associated with the selected entry of the "list of subscriber data" or the selected PLMN subscription for 3GPP access or non-3GPP access, and timer T3245 is not running:

- a) if there is no next valid time period for the SNPN, the UE shall start timer T3245 with a random value, uniformly drawn from the range between 12h and 24h; or
- b) if there is next valid time period for the SNPN, the UE shall start timer T3245 with a random value uniformly drawn from the range between the start time point and the end time point of the next valid time period for localized services in SNPN.

NOTE 1: The random value to calculate the value of timer T3245 can be UE implementation-specific value for the UE to perform SNPN selection for localized services in SNPN and receive localized services in the SNPN before the valid time of localized services ends.

Upon expiry of the timer T3245, the UE shall erase the "permanently forbidden SNPNs" list(s) and "temporarily forbidden SNPNs" list(s) and set the selected entry of the "list of subscriber data" or the selected PLMN subscription to valid for 3GPP access and non-3GPP access. When the lists are erased, the UE performs cell selection according to 3GPP TS 38.304 [28].

If the UE is switched off when the timer T3245 is running, the UE shall behave as follows when the UE is switched on and the selected entry of the "list of subscriber data" or the selected PLMN subscription remain the same:

- let t_1 be the time remaining for T3245 timeout at switch off and let t be the time elapsed between switch off and switch on. If t_1 is greater than t , then the timer shall be restarted with the value $t_1 - t$. If t_1 is equal to or less than t , then the UE will follow the behaviour as defined in the paragraph above upon expiry of the timer T3245. If the UE is not capable of determining t , then the UE shall restart the timer with the value t_1 .

5.3.20 Specific requirements for UE when receiving non-integrity protected reject messages

5.3.20.1 General

This subclause specifies the requirements for a UE that is not configured to use timer T3245 (see 3GPP TS 24.368 [17] or 3GPP TS 31.102 [22]) and receives a REGISTRATION REJECT or SERVICE REJECT message without integrity protection with specific 5GMM causes.

NOTE: Additional UE requirements for this case, requirements for other 5GMM causes, and requirements for the case when the UE receives an integrity protected reject message are specified in subclauses 5.5.1 and 5.6.1.

5.3.20.2 Requirements for UE in a PLMN

The UE shall maintain:

- a) a list of PLMN-specific attempt counters (see 3GPP TS 24.301 [15]). The maximum number of possible entries in the list is implementation dependent. This list is applicable to access attempts via 3GPP access only;
- b) a list of PLMN-specific attempt counters for non-3GPP access, if the UE supports non-3GPP access. The maximum number of possible entries in the list is implementation dependent. This list is applicable to access attempts via non-3GPP access only;
- c) a list of PLMN-specific N1 mode attempt counters for 3GPP access. The maximum number of possible entries in the list is implementation dependent. This list is applicable to access attempts via 3GPP access only;
- d) a list of PLMN-specific N1 mode attempt counters for non-3GPP access, if the UE supports non-3GPP access. The maximum number of possible entries in the list is implementation dependent. This list is applicable to access attempts via non-3GPP access only;

- e) one counter for "SIM/USIM considered invalid for GPRS services" events (see 3GPP TS 24.008 [12]);
- f) one counter for "USIM considered invalid for 5GS services over non-3GPP access" events, if the UE supports non-3GPP access; and
- g)- a list of PLMN-specific attempt counters for the UE determined PLMN with disaster condition, if the UE supports MINT. The maximum number of possible entries in the list is implementation dependent. This list is applicable to access attempts via 3GPP access only.

A UE supporting non-EPS services shall maintain one counter for "SIM/USIM considered invalid for non-GPRS services" events (see 3GPP TS 24.008 [12]).

The UE shall store the above lists of attempt counters and the event counters in its non-volatile memory. The UE shall erase the lists and reset the event counters to zero when the UICC containing the USIM is removed. The counter values shall not be affected by the activation or deactivation of MICO mode or power saving mode (see 3GPP TS 24.301 [15]).

The UE implementation-specific maximum value for any of the above counters shall not be greater than 10.

NOTE 1: Different counters can use different UE implementation-specific maximum values.

If the UE receives a REGISTRATION REJECT or SERVICE REJECT message without integrity protection with 5GMM cause value #3, #6, #7, #11, #12, #13, #15, #27, #31, #62, #72, #73 or #80 before the network has established secure exchange of NAS messages for the N1 NAS signalling connection, the UE shall stop timer T3510 or T3517 if running, and start timer T3247 (see 3GPP TS 24.008 [12]) with a random value uniformly drawn from the range between 30 minutes and 60 minutes, if the timer is not running, and take the following actions:

- 1) if the 5GMM cause value received is #3, #6 or #7, and:
 - a) if the 5GMM cause value is received over 3GPP access, the UE shall:
 - i) if the UE is already registered over another access:
 - store the current TAI in the list of "5GS forbidden tracking areas for roaming", memorize the current TAI was stored in the list of "5GS forbidden tracking areas for roaming" for non-integrity protected NAS reject message and enter the state 5GMM-DEREGISTERED.LIMITED-SERVICE; and
 - search for a suitable cell in another tracking area according to 3GPP TS 38.304 [28] or 3GPP TS 36.304 [25C]; or
 - ii) otherwise, if the counter for "SIM/USIM considered invalid for GPRS services" events has a value less than a UE implementation-specific maximum value,
 - set the 5GS update status to 5U3 ROAMING NOT ALLOWED (and shall store it according to subclause 5.1.3.2.2) and shall delete 5G-GUTI, last visited registered TAI, TAI list and ngKSI for 3GPP access;
 - if the 5GMM cause value received is #3 or #6, delete the list of equivalent PLMNs if any;
 - increment the counter for "SIM/USIM considered invalid for GPRS services" events;
 - if the 5GMM cause value received is #3 or #6, and if the counter for "SIM/USIM considered invalid for non-GPRS services" events has a value less than a UE implementation-specific maximum value, increment the counter;
 - if a registration procedure was performed, reset the registration attempt counter and if a service request procedure was performed, reset the service request attempt counter;
 - if the UE is operating in single-registration mode, handle the EMM parameters EMM state, EPS update status, EPS attach attempt counter, tracking area updating attempt counter or service request attempt counter, 4G-GUTI, TAI list, eKSI as specified in 3GPP TS 24.301 [15] for the case when the EPS attach, tracking area updating procedure or service request procedure is rejected with the EMM cause of the same value in a NAS message without integrity protection;
 - store the current TAI in the list of "5GS forbidden tracking areas for roaming", memorize the current TAI was stored in the list of "5GS forbidden tracking areas for roaming" for non-integrity protected NAS reject message and enter the state 5GMM-DEREGISTERED.LIMITED-SERVICE; and

- search for a suitable cell in another tracking area according to 3GPP TS 38.304 [28] or 3GPP TS 36.304 [25C]; and as a UE implementation option, the UE may perform registration attempt over the non-3GPP access, if non-3GPP access is available, and the USIM is not considered invalid for 5GS services over non-3GPP access; and

iii) otherwise proceed as specified in subclauses 5.5.1 and 5.6.1;

b) if the 5GMM cause value is received over non-3GPP access, the UE shall:

i) if the UE is already registered over another access:

- enter the state 5GMM-DEREGISTERED.LIMITED-SERVICE; and
- may perform registration attempt over the non-3GPP access if another access point for non-3GPP access is available; or

ii) otherwise, if the counter for "USIM considered invalid for 5GS services over non-3GPP access" events has a value less than a UE implementation-specific maximum value,

- set the 5GS update status to 5U3 ROAMING NOT ALLOWED (and shall store it according to subclause 5.1.3.2.2) and shall delete the 5G-GUTI, last visited registered TAI, TAI list and ngKSI for non-3GPP access;
- enter the state 5GMM-DEREGISTERED.LIMITED-SERVICE;
- increment the counter for "USIM considered invalid for 5GS services over non-3GPP access" events; and as a UE implementation option, the UE may either perform registration attempt over the non-3GPP access if another access point for non-3GPP access is available, or if 3GPP access is available, and the USIM is not considered invalid for 5GS services over 3GPP access, perform registration attempt over the 3GPP access; and

NOTE 2: How to select another access point for non-3GPP access is implementation specific.

iii) otherwise proceed as specified in subclauses 5.5.1 and 5.6.1;

2) if the 5GMM cause value received is #12, #13 or #15, the UE shall proceed as specified in subclauses 5.5.1 and 5.6.1. Additionally, the UE may:

- a) if the 5GMM cause value is received over 3GPP access, non-3GPP access is available, the UE is not registered over non-3GPP access yet, and the USIM is not considered invalid for 5GS services over non-3GPP access, perform registration attempt over the non-3GPP access; or
- b) if the 5GMM cause value is received over non-3GPP access, 3GPP access is available, the UE is not registered over 3GPP access yet, and the USIM is not considered invalid for 5GS services over 3GPP access, perform registration attempt over the 3GPP access;

3) if the 5GMM cause value received is #11 or #73 and the UE is in its HPLMN or EHPLMN:

a) if the 5GMM cause value is received over 3GPP access, the UE shall:

- set the 5GS update status to 5U3 ROAMING NOT ALLOWED (and shall store it according to subclause 5.1.3.2.2) and shall delete, the 5G-GUTI, last visited registered TAI, TAI list, ngKSI for 3GPP access and the list of equivalent PLMNs. Additionally, if a registration procedure was performed, the UE shall reset the registration attempt counter and if a service request procedure was performed, reset the service request attempt counter;
- if the 5GMM cause value received is #11 and the UE is operating in single-registration mode, handle the EMM parameters EMM state, EPS update status, EPS attach attempt counter, tracking area updating attempt counter or service request attempt counter, 4G-GUTI, TAI list, eKSI as specified in 3GPP TS 24.301 [15] for the case when the EPS attach, tracking area updating procedure or service request procedure is rejected with the EMM cause of the same value in a NAS message without integrity protection;
- if the 5GMM cause value received is #73 and the UE is operating in single-registration mode, the UE shall in addition set the EPS update status to EU3 ROAMING NOT ALLOWED and shall delete any 4G-

- GUTI, last visited registered TAI, TAI list and eKSI. Additionally, the UE shall reset the attach attempt counter or tracking area updating attempt counter, and enter the state EMM-DEREGISTERED;
- store the current TAI in the list of "5GS forbidden tracking areas for roaming", memorize the current TAI was stored in the list of "5GS forbidden tracking areas for roaming" for non-integrity protected NAS reject message and enter the state 5GMM-DEREGISTERED.LIMITED-SERVICE; and
 - search for a suitable cell in another tracking area according to 3GPP TS 38.304 [28] or 3GPP TS 36.304 [25C]; and as a UE implementation option, the UE may perform registration attempt over the non-3GPP access, if non-3GPP access is available, the UE is not registered over non-3GPP access yet, and the USIM is not considered invalid for 5GS services over non-3GPP access;
- b) if the 5GMM cause value is received over non-3GPP access, the UE shall:
- set the 5GS update status to 5U3 ROAMING NOT ALLOWED (and shall store it according to subclause 5.1.3.2.2) and shall delete the 5G-GUTI, last visited registered TAI, TAI list and ngKSI for non-3GPP access. Additionally, if a registration procedure was performed, the UE shall reset the registration attempt counter and if a service request procedure was performed, reset the service request attempt counter; and
 - enter the state 5GMM-DEREGISTERED.LIMITED-SERVICE. As a UE implementation option, the UE may perform registration attempt over the non-3GPP access if another access point for non-3GPP access is available, or if 3GPP access is available, the UE is not registered over 3GPP access yet, and the USIM is not considered invalid for 5GS services over 3GPP access, perform registration attempt over the 3GPP access;
- 4) if the 5GMM cause value received is #11 or #73 and the UE is not in its HPLMN or EHPLMN, in addition to the UE requirements specified in subclause 5.5.1 and 5.6.1:
- if the message was received via 3GPP access and if the PLMN-specific attempt counter for the PLMN sending the reject message has a value less than a UE implementation-specific maximum value, the UE shall increment the PLMN-specific attempt counter for the PLMN; or
 - if the message was received via non-3GPP access and if the PLMN-specific attempt counter for non-3GPP access for the PLMN sending the reject message has a value less than a UE implementation-specific maximum value, the UE shall increment the PLMN-specific attempt counter for non-3GPP access for the PLMN;
- 5) if the 5GMM cause value received is #27, the UE shall proceed as specified in subclauses 5.5.1 and 5.6.1. Additionally, if the PLMN-specific N1 mode attempt counter for the respective access type and for the PLMN sending the reject message has a value less than a UE implementation-specific maximum value, the UE shall increment this counter for the PLMN;
- 6) if the 5GMM cause value received is #72, the UE shall proceed as specified in subclauses 5.5.1 and 5.6.1. Additionally, if the PLMN-specific N1 mode attempt counter for non-3GPP access for the PLMN sending the reject message has a value less than a UE implementation-specific maximum value, the UE shall increment this counter for the PLMN;
- 7) if the 5GMM cause value received is #31 for a UE that has indicated support for CIoT optimizations, the UE may discard the message or alternatively the UE should:
- set the 5GS update status to 5U3 ROAMING NOT ALLOWED (and shall store it according to subclause 5.1.3.2.2);
 - store the current TAI in the list of "5GS forbidden tracking areas for roaming", memorize the current TAI was stored in the list of "5GS forbidden tracking areas for roaming" for non-integrity protected NAS reject message; and
 - search for a suitable cell in another tracking area according to 3GPP TS 38.304 [28] or 3GPP TS 36.304 [25C]; and
- 8) if the 5GMM cause value received is #62, the UE may discard the message or alternatively the UE should:
- set the 5GS update status to 5U3 ROAMING NOT ALLOWED (and shall store it according to subclause 5.1.3.2.2);

- store the current TAI in the list of "5GS forbidden tracking areas for roaming", memorize the current TAI was stored in the list of "5GS forbidden tracking areas for roaming" for non-integrity protected NAS reject message; and
 - search for a suitable cell in another tracking area according to 3GPP TS 38.304 [28] or 3GPP TS 36.304 [25C].
- 9) if the 5GMM cause value received is #80, the UE shall proceed as specified in subclauses 5.5.1. If the PLMN-specific attempt counter of the PLMN which sent the reject message for the UE determined PLMN with disaster condition has a value less than a UE implementation-specific maximum value, the UE shall increment the PLMN-specific attempt counter of the PLMN which sent the reject message for the UE determined PLMN with disaster condition.

Upon expiry of timer T3247, the UE shall:

- remove all tracking areas from the list of "5GS forbidden tracking areas for regional provision of service" and the list of "5GS forbidden tracking areas for roaming", which were stored in these lists for non-integrity protected NAS reject message;
- set the USIM to valid for 5GS services for 3GPP access, if:
 - the counter for "SIM/USIM considered invalid for GPRS services" events has a value less than a UE implementation-specific maximum value;
- set the USIM to valid for 5GS services for non-3GPP access, if:
 - the counter for "USIM considered invalid for 5GS services over non-3GPP access" events has a value less than a UE implementation-specific maximum value;
- set the USIM to valid for non-EPS services, if:
 - the counter for "SIM/USIM considered invalid for non-GPRS services" events has a value less than a UE implementation-specific maximum value;
- for each PLMN-specific attempt counter that has a value greater than zero and less than a UE implementation-specific maximum value, remove the respective PLMN from the extension of the "forbidden PLMNs" list;
- for each PLMN-specific attempt counter for non-3GPP access that has a value greater than zero and less than a UE implementation-specific maximum value, remove the respective PLMN from the list of "forbidden PLMNs for non-3GPP access to 5GCN";
- re-enable the N1 mode capability for 3GPP access and, for each PLMN-specific N1 mode attempt counter for 3GPP access that has a value greater than zero and less than a UE implementation-specific maximum value, remove the respective PLMN from the list of PLMNs where N1 mode is not allowed for 3GPP access (see 3GPP TS 23.122 [5]);
- re-enable the N1 mode capability for non-3GPP access and, for each PLMN-specific N1 mode attempt counter for non-3GPP access that has a value greater than zero and less than a UE implementation-specific maximum value, remove the respective PLMN from the list of PLMNs where N1 mode is not allowed for non-3GPP access;
- if the UE is supporting A/Gb mode or Iu mode, perform the actions as specified in 3GPP TS 24.008 [12] for the case when timer T3247 expires;
- if the UE is supporting S1 mode, perform the actions as specified in 3GPP TS 24.301 [15] for the case when timer T3247 expires;
- initiate a registration procedure, if still needed, dependent on 5GMM state and 5GS update status, or perform PLMN selection according to 3GPP TS 23.122 [5]; and
- for each PLMN-specific attempt counter of the PLMN which sent the reject message for the UE determined PLMN with disaster condition that has a value greater than zero and less than a UE implementation-specific maximum value, consider the PLMN which sent the reject message is available for disaster roaming service for the respective UE determined PLMN with disaster condition.

When the UE is switched off, the UE shall, for each PLMN-specific attempt counter that has a value greater than zero and less than the UE implementation-specific maximum value, remove the respective PLMN from the list of "forbidden PLMNs". When the USIM is removed, the UE should perform this action.

When the UE is switched off, the UE shall, for each PLMN-specific attempt counter for non-3GPP access that has a value greater than zero and less than the UE implementation-specific maximum value, remove the respective PLMN from the list of "forbidden PLMNs for non-3GPP access to 5GCN". When the USIM is removed, the UE should perform this action.

When the UE is switched off, the UE shall, for each PLMN-specific attempt counter of the PLMN which sent the reject message for the UE determined PLMN with disaster condition that has a value greater than zero and less than the UE implementation-specific maximum value, consider the PLMN is available for disaster roaming service for the respective UE determined PLMN with disaster condition. When the USIM is removed, the UE should perform this action.

NOTE 3: If the respective PLMN was stored in the extension of the "forbidden PLMNs" list, then according to 3GPP TS 23.122 [5] the UE will delete the contents of this extension when the UE is switched off or the USIM is removed.

5.3.20.3 Requirements for UE in an SNPN

If the UE is operating in SNPN access operation mode, the UE shall maintain, for each of the entries in the "list of subscriber data":

- a) one SNPN-specific attempt counter for 3GPP access. The counter is applicable to access attempts via 3GPP access only;
- b) one SNPN-specific attempt counter for non-3GPP access, if the UE supports access to SNPN over non-3GPP access. The counter is applicable in case of access to SNPN over non-3GPP access only;

NOTE 1: If the UE accesses to SNPN service directly over non-3GPP access or if the UE accesses to SNPN services via a PLMN, the SNPN-specific attempt counter for non-3GPP access is used.

- c) one counter for "the entry for the current SNPN considered invalid for 3GPP access" events; and
- d) one counter for "the entry for the current SNPN considered invalid for non-3GPP access" events, if the UE supports access to SNPN over non-3GPP access. The counter is applicable in case of access to SNPN over non-3GPP access only.

NOTE 2: If the UE accesses to SNPN service directly over non-3GPP access or if the UE accesses to SNPN services via a PLMN, the counter for "the entry for the current SNPN considered invalid for non-3GPP access" events is used. The UE shall store the above counters in its non-volatile memory. The UE shall erase the attempt counters and reset the event counters to zero when the selected entry of the "list of subscriber data" is updated or USIM is removed for the selected PLMN subscription. The counter values shall not be affected by the activation or deactivation of MICO mode or power saving mode (see 3GPP TS 24.301 [15]).

The UE implementation-specific maximum value for any of the above counters shall not be greater than 10.

NOTE 3: Different counters can use different UE implementation-specific maximum values.

If the UE receives a REGISTRATION REJECT or SERVICE REJECT message without integrity protection with 5GMM cause value #3, #6, #7, #12, #13, #15, #27, #72, #74, or #75 before the network has established secure exchange of NAS messages for the N1 NAS signalling connection, the UE shall stop timer T3510 or T3517, if running. If the SNPN sending the message is an SNPN selected for localized services in SNPN (see 3GPP TS 23.122 [5]) and there is next valid time period(s) for the SNPN, the UE shall start timer T3247 (see 3GPP TS 24.008 [12]) with a random value uniformly drawn from the range between the start time point of the next valid time period for localized services in SNPN and:

- a) for 5GMM cause value #74:
 - 1) 30 minutes after the start time point of the next valid time period for localized services in SNPN, if the next valid time period is longer than 30 minutes; or
 - 2) the end time point of the next valid time period for localized services in SNPN, if the next valid time period is not longer than 30 minutes; or

b) for other 5GMM cause values:

- 1) 60 minutes after the start time point of the next valid time period for localized services in SNPN, if the next valid time period is longer than 60 minutes; or
- 2) the end time point of the next valid time period for localized services in SNPN, if the next valid time period is not longer than 60 minutes;

otherwise between:

- a) 15 minutes and 30 minutes for 5GMM cause value #74; or
- b) 30 minutes and 60 minutes for other 5GMM cause values;

if the timer is not running, and take the following actions:

- a) if the 5GMM cause value received is #3, #6, or #7 and the UE is neither registered for onboarding services in SNPN nor performing initial registration for onboarding services in SNPN:
 - 1) if the 5GMM cause value is received over 3GPP access:
 - i) if the UE is already registered over another access, the UE shall:
 - A) store the current TAI in the list of "5GS forbidden tracking areas for roaming" for the current SNPN and, if the UE supports access to an SNPN using credentials from a credentials holder, equivalent SNPNs or both the selected entry of the "list of subscriber data" or the selected PLMN subscription, memorize the current TAI was stored in the list of "5GS forbidden tracking areas for roaming" for the current SNPN and, if the UE supports access to an SNPN using credentials from a credentials holder, equivalent SNPNs or both, the selected entry of the "list of subscriber data" or the selected PLMN subscription, for non-integrity protected NAS reject message and enter the state 5GMM-DEREGISTERED.LIMITED-SERVICE; and
 - B) search for a suitable cell in another tracking area according to 3GPP TS 38.304 [28]; or
 - ii) otherwise if the counter for "the entry for the current SNPN considered invalid for 3GPP access" events has a value less than a UE implementation-specific maximum value, the UE shall:
 - A) set the 5GS update status to 5U3 ROAMING NOT ALLOWED (and shall store it according to subclause 5.1.3.2.2) and shall delete 5G-GUTI, last visited registered TAI, TAI list, and ngKSI for 3GPP access;
 - A1) if the 5GMM cause value received is #3 or #6, delete the list of equivalent SNPNs, if any;
 - B) increment the counter for "the entry for the current SNPN considered invalid for 3GPP access" events;
 - C) reset the registration attempt counter in case of a REGISTRATION REJECT message or reset the service request attempt counter in case of a SERVICE REJECT message;
 - D) store the current TAI in the list of "5GS forbidden tracking areas for roaming" for the current SNPN and, if the UE supports access to an SNPN using credentials from a credentials holder, equivalent SNPNs or both, the selected entry of the "list of subscriber data" or the selected PLMN subscription, memorize the current TAI was stored in the list of "5GS forbidden tracking areas for roaming" for the current SNPN and, if the UE supports access to an SNPN using credentials from a credentials holder, equivalent SNPNs or both, the selected entry of the "list of subscriber data" or the selected PLMN subscription, for non-integrity protected NAS reject message, and enter the state 5GMM-DEREGISTERED.LIMITED-SERVICE; and
 - E) search for a suitable cell in another tracking area according to 3GPP TS 38.304 [28]. As a UE implementation option, if access to SNPN over non-3GPP access is available and the selected entry of the "list of subscriber data" or the selected PLMN subscription is not considered invalid for non-3GPP access, then the UE may perform registration attempt over non-3GPP access; or
 - iii) otherwise, the UE shall proceed as specified in subclauses 5.5.1 and 5.6.1;
 - 2) if the 5GMM cause value is received over non-3GPP access:

- i) if the UE is already registered over another access, the UE shall enter the state 5GMM-DEREGISTERED.LIMITED-SERVICE; or
- ii) otherwise if the counter for "the entry for the current SNPN considered invalid for non-3GPP access" events has a value less than a UE implementation-specific maximum value, the UE shall:
 - A) set the 5GS update status to 5U3 ROAMING NOT ALLOWED (and shall store it according to subclause 5.1.3.2.2) and shall delete the 5G-GUTI, last visited registered TAI, TAI list, and ngKSI for non-3GPP access;
 - B) enter the state 5GMM-DEREGISTERED.LIMITED-SERVICE; and
 - C) increment the counter for "the entry for the current SNPN considered invalid for non-3GPP access" events. As a UE implementation option, if 3GPP access is available and the selected entry of the "list of subscriber data" or the selected PLMN subscription is not considered invalid for 3GPP access, then the UE may make a registration attempt over 3GPP access; or
- iii) otherwise, the UE shall proceed as specified in subclauses 5.5.1 and 5.6.1;
- b) if the 5GMM cause value received is #12, #13, or #15, the UE shall proceed as specified in subclauses 5.5.1 and 5.6.1. Additionally:
 - 1) if the 5GMM cause value is received over 3GPP access, access to SNPN over non-3GPP access is available, the UE is not registered over non-3GPP access yet, and the selected entry of the "list of subscriber data" or the selected PLMN subscription is not considered invalid for non-3GPP access, the UE may perform registration attempt over non-3GPP access; or
 - 2) if the 5GMM cause value is received over non-3GPP access, 3GPP access is available, the UE is not registered to the current SNPN over 3GPP access yet, and the selected entry of the "list of subscriber data" or the selected PLMN subscription is not considered invalid for 3GPP access, the UE may make a registration attempt over 3GPP access;
- c) if the 5GMM cause value received is #27, the UE shall proceed as specified in subclauses 5.5.1 and 5.6.1. Additionally, if the SNPN-specific attempt counter for the respective access type and for the current SNPN has a value less than a UE implementation-specific maximum value, the UE shall increment this counter for the SNPN;
- c1) if the 5GMM cause value received is #72, the UE shall proceed as specified in subclauses 5.5.1 and 5.6.1. Additionally, if the SNPN-specific attempt counter for non-3GPP access for the current SNPN has a value less than a UE implementation-specific maximum value, the UE shall increment this counter for the SNPN; and
- d) if:
 - 1) the 5GMM cause value received is #74 or #75; or
 - 2) the 5GMM cause value received is #3, #6, or #7 and the UE is registered for onboarding services in SNPN or performing initial registration for onboarding services in SNPN;

in addition to the UE requirements specified in subclauses 5.5.1 and 5.6.1:

- 1) if the message was received via 3GPP access and if the SNPN-specific attempt counter for 3GPP access for the SNPN sending the reject message has a value less than a UE implementation-specific maximum value, the UE shall increment the SNPN-specific attempt counter for 3GPP access for the SNPN; or
- 2) if the message was received via non-3GPP access and if the SNPN-specific attempt counter for non-3GPP access for the SNPN sending the reject message has a value less than a UE implementation-specific maximum value, the UE shall increment the SNPN-specific attempt counter for non-3GPP access for the SNPN.

Upon expiry of timer T3247, the UE shall:

- a) remove, for each SNPN, all tracking areas from the list of "5GS forbidden tracking areas for regional provision of service" and the list of "5GS forbidden tracking areas for roaming" for the SNPN and, if the UE supports access to an SNPN using credentials from a credentials holder, equivalent SNPNs or both, the selected entry of the "list of subscriber data" or the selected PLMN subscription, which were stored in these lists for non-integrity protected NAS reject message;

- b) set each entry of the "list of subscriber data" or the PLMN subscription to valid for 3GPP access, if the corresponding counter for "the entry for the current SNPN considered invalid for 3GPP access" events has a value less than a UE implementation-specific maximum value;
- c) set each entry of the "list of subscriber data" or the PLMN subscription to valid for non-3GPP access, if the corresponding counter for "the entry for the current SNPN considered invalid for non-3GPP access" events has a value less than a UE implementation-specific maximum value;
- d) remove each SNPN identity from:
 - 1) the "permanently forbidden SNPNs" list for 3GPP access or "temporarily forbidden SNPNs" list for 3GPP access, which are, if the UE supports access to an SNPN using credentials from a credentials holder, equivalent SNPNs or both, associated with the selected entry of the "list of subscriber data" or the selected PLMN subscription,
 - 2) "permanently forbidden SNPNs for access for localized services in SNPN" list for 3GPP access or "temporarily forbidden SNPNs for access for localized services in SNPN" list for 3GPP access, associated with the selected entry of the "list of subscriber data" or the selected PLMN subscription; or
 - 3) "permanently forbidden SNPNs for onboarding services in SNPN" list for 3GPP access or "temporarily forbidden SNPNs for onboarding services in SNPN" list for 3GPP access;

if the corresponding SNPN-specific attempt counter for 3GPP access has a value greater than zero and less than a UE implementation-specific maximum value and the SNPN identity is included in any of the "permanently forbidden SNPNs" list for 3GPP access, "temporarily forbidden SNPNs" list for 3GPP access, "permanently forbidden SNPNs for access for localized services in SNPN" list for 3GPP access "temporarily forbidden SNPNs for access for localized services in SNPN" list for 3GPP access, "permanently forbidden SNPNs for onboarding services in SNPN" list for 3GPP access, or "temporarily forbidden SNPNs for onboarding services in SNPN" list for 3GPP access;

- remove each SNPN identity from:
 - 1) the "permanently forbidden SNPNs" list for non-3GPP access or "temporarily forbidden SNPNs" list for non-3GPP access which are, if the MS supports access to an SNPN using credentials from a credentials holder, equivalent SNPNs or both, associated with the selected entry of the "list of subscriber data" or the selected PLMN subscription, or
 - 2) "permanently forbidden SNPNs for onboarding services in SNPN" list for non-3GPP access or "temporarily forbidden SNPNs for onboarding services in SNPN" list for non-3GPP access;

if the corresponding SNPN-specific attempt counter for non-3GPP access has a value greater than zero and less than a UE implementation-specific maximum value and the SNPN identity is included in any of the "permanently forbidden SNPNs" list for non-3GPP access, "temporarily forbidden SNPNs" list for non-3GPP access, "permanently forbidden SNPNs for onboarding services in SNPN" list for non-3GPP access or "temporarily forbidden SNPNs for onboarding services in SNPN" list for non-3GPP access;

- re-enable the N1 mode capability for 3GPP access and, for each SNPN-specific attempt counter for 3GPP access that has a value greater than zero and less than a UE implementation-specific maximum value, remove the respective SNPN from the list of SNPNs for which the N1 mode capability was disabled due to receipt of a reject from the network with 5GMM cause #27 "N1 mode not allowed" (see 3GPP TS 23.122 [5]);
- re-enable the N1 mode capability for non-3GPP access and, for each SNPN-specific attempt counter for non-3GPP access that has a value greater than zero and less than a UE implementation-specific maximum value, remove the respective SNPN from the list of SNPNs for which N1 mode capability was disabled for non-3GPP access due to receipt of a reject from the network with 5GMM cause #27 "N1 mode not allowed" or 5GMM cause #72 "non-3GPP access to 5GCN not allowed"; and
- initiate a registration procedure, if still needed, dependent on 5GMM state and 5GS update status, or perform SNPN selection according to 3GPP TS 23.122 [5].

When the UE is switched off or a UICC containing the USIM is removed:

- a) for each SNPN-specific attempt counter for 3GPP access having a value greater than zero and less than the UE implementation-specific maximum value, the UE shall remove the respective SNPN identity from the "permanently forbidden SNPNs" list(s) for 3GPP access, "temporarily forbidden SNPNs" list(s) for 3GPP

access, "permanently forbidden SNPNs for access for localized services in SNPN" list(s) for 3GPP access, "temporarily forbidden SNPNs for access for localized services in SNPN" list(s) for 3GPP access, "permanently forbidden SNPNs for onboarding services in SNPN" list for 3GPP access or "temporarily forbidden SNPNs for onboarding services in SNPN" list for 3GPP access, if available; and

- b) for each SNPN-specific attempt counter for non-3GPP access having a value greater than zero and less than the UE implementation-specific maximum value, the UE shall remove the respective SNPN identity from the "permanently forbidden SNPNs" list(s) for non-3GPP access, "temporarily forbidden SNPNs" list(s) for non-3GPP access, "permanently forbidden SNPNs for onboarding services in SNPN" list for non-3GPP access or "temporarily forbidden SNPNs for onboarding services in SNPN" list for non-3GPP access, if available.

When an entry of the "list of subscriber data" is updated:

- a) if the UE does not support access to an SNPN using credentials from a credentials holder and equivalent SNPNs, and the SNPN-specific attempt counter for 3GPP access for the SNPN corresponding to the entry has a value greater than zero and less than the UE implementation-specific maximum value, the UE shall remove the SNPN identity corresponding to the entry from the "permanently forbidden SNPNs" list for 3GPP access or "temporarily forbidden SNPNs" list for 3GPP access, if available;
- b) if the UE does not support access to an SNPN using credentials from a credentials holder and equivalent SNPNs, and the SNPN-specific attempt counter for non-3GPP access for the SNPN corresponding to the entry has a value greater than zero and less than the UE implementation-specific maximum value, the UE shall remove the SNPN identity corresponding to the entry from the "permanently forbidden SNPNs" list for non-3GPP access or "temporarily forbidden SNPNs" list for non-3GPP access, if available;
- c) if the UE supports access to an SNPN using credentials from a credentials holder, equivalent SNPNs or both, and the SNPN-specific attempt counter for 3GPP access for an SNPN in the "permanently forbidden SNPNs" list for 3GPP access or "temporarily forbidden SNPNs" list for 3GPP access, associated with the entry, has a value greater than zero and less than the UE implementation-specific maximum value, the UE shall remove the SNPN identity corresponding to the SNPN from the "permanently forbidden SNPNs" list for 3GPP access or "temporarily forbidden SNPNs" list for 3GPP access, associated with the entry;
- d) if the UE supports access to an SNPN providing access for localized services in SNPN, and the SNPN-specific attempt counter for 3GPP access for an SNPN in the "permanently forbidden SNPNs for access for localized services in SNPN" list or "temporarily forbidden SNPNs for access for localized services in SNPN" list, associated with the entry, has a value greater than zero and less than the UE implementation-specific maximum value, the UE shall remove the SNPN identity corresponding to the SNPN from the "permanently forbidden SNPNs for access for localized services in SNPN" list or "temporarily forbidden SNPNs for access for localized services in SNPN" list for 3GPP access, associated with the entry; and
- e) if the UE supports access to an SNPN using credentials from a credentials holder, equivalent SNPNs or both, and the SNPN-specific attempt counter for non-3GPP access for an SNPN in the "permanently forbidden SNPNs" list for non-3GPP access or "temporarily forbidden SNPNs" list for non-3GPP access associated with the entry, has a value greater than zero and less than the UE implementation-specific maximum value, the UE shall remove the SNPN identity corresponding to the SNPN from the "permanently forbidden SNPNs" list for non-3GPP access or "temporarily forbidden SNPNs" list for non-3GPP access, associated with the entry.

5.3.21 CIoT 5GS optimizations

CIoT 5GS optimizations provide improved support of small data and SMS transfer. A UE supporting CIoT 5GS optimizations can indicate the 5GS CIoT network behaviour the UE can support and prefers to use during the registration procedure (see 3GPP TS 23.502 [9]). The UE may indicate the support for control plane CIoT 5GS optimization, user plane CIoT 5GS optimization, N3 data transfer and header compression (see subclause 9.11.3.1). Furthermore, the UE may, separately from the indication of support, indicate preference for control plane CIoT 5GS optimization or user plane CIoT 5GS optimization (see subclause 9.11.3.9A). The indication of preference is also considered as the request to use. A UE supporting CIoT EPS optimizations can also indicate the EPS CIoT network behaviour the UE can support during the registration procedure. Furthermore, the UE may, separately from the indication of support, indicate preference for control plane CIoT EPS optimization or user plane CIoT EPS optimization.

NOTE 1: CIoT 5GS optimizations are not supported by NR connected to 5GCN.

NOTE 2: If the UE does not support user plane CIoT 5GS optimization, it does not indicate preference for user plane CIoT 5GS optimization.

The UE can be in NB-N1 mode or WB-N1 mode when requesting the use of CIoT 5GS optimizations during the registration procedure. A UE in NB-N1 mode always indicates support for control plane CIoT 5GS optimization.

In NB-N1 mode, the UE, when requesting the use of CIoT 5GS optimizations, does not:

- a) request an initial registration for emergency services;
- b) request a PDU session establishment for emergency PDU session; or
- c) indicate UE's usage setting during the registration procedure.

The network does not indicate to the UE support of emergency services when the UE is in NB-N1 mode (see subclause 5.5.1.2.4 and 5.5.1.3.4).

The control plane CIoT 5GS optimization enables support of efficient transport of user data (IP, Ethernet and Unstructured) or SMS messages over control plane via the AMF without triggering user-plane resources establishment. The support of control plane CIoT 5GS optimization is mandatory for the network in NB-N1 mode and optional in WB-N1 mode. Optional header compression of IP data and Ethernet data can be applied to PDU sessions with IP PDU session type and Ethernet PDU session type that are configured to support header compression. For IP header compression, Robust Header Compression (ROHC) protocol specified in IETF RFC 5795 [39B] is used. For Ethernet header compression, Ethernet Header Compression (EHC) protocol specified in 3GPP TS 38.323 [29] is used.

For a UE that supports Location Services (LCS) notification mechanisms in N1 mode, the control plane CIoT 5GS optimization also enables the transport of location services messages from 5GMM-IDLE mode using the CONTROL PLANE SERVICE REQUEST message when location services are requested (see subclause 6.7.1 in 3GPP TS 23.273 [6B]).

The user plane CIoT 5GS optimization enables support for change from 5GMM-IDLE mode over 3GPP access to 5GMM-CONNECTED mode over 3GPP access without the need for using the service request procedure (see subclause 5.3.1.5).

If the UE supports user plane CIoT 5GS optimization, it shall also support N3 data transfer.

If the UE indicates support of one or more CIoT 5GS optimizations and the network supports one or more CIoT 5GS optimizations and decides to accept the registration request, the network indicates the supported CIoT 5GS optimizations to the UE per registration area when accepting the UE request. Network indication of support is interpreted by the UE as the acceptance to use the respective feature. After completion of the registration procedure, the UE and the network can then use the accepted CIoT 5GS optimizations for the transfer of user data (IP, Ethernet, Unstructured and SMS).

A UE in NB-N1 mode or WB-N1 mode can request the use of SMS over NAS by setting the SMS requested bit of the 5GS update type IE in the REGISTRATION REQUEST message as specified in subclauses 5.5.1.2.2 and 5.5.1.3.2.

The AMF indicates whether it allows the use of SMS over NAS for a UE in NB-N1 mode or WB-N1 mode by setting the SMS allowed bit of the 5GS registration result IE in the REGISTRATION ACCEPT message as specified in subclauses 5.5.1.2.4 and 5.5.1.3.4.

If the UE and the network support both the control plane CIoT 5GS optimization and N3 data transfer, then when receiving the UE's request for a PDU session establishment, the AMF decides whether the PDU session should be NEF PDU session or N6 PDU session as specified in 3GPP TS 23.501 [8] and then:

- a) if NEF PDU session is to be established for unstructured data type, the AMF includes control plane only indication for the requested PDU session to the SMF;
- b) if N6 PDU session is to be established and the DNN or S-NSSAI of the newly requested N6 PDU session supports interworking with EPS as specified in 3GPP TS 23.502 [9]:
 - 1) if there are existing N6 PDU sessions supporting interworking with EPS for this UE that were established with the control plane only indication, the AMF includes the control plane only indication for the newly requested N6 PDU session to the SMF; or

- 2) if there are existing N6 PDU sessions supporting interworking with EPS for this UE that were established without the control plane only indication, the AMF does not include the control plane only indication for the newly requested N6 PDU session to the SMF;
 - 3) if there is no existing N6 PDU session supporting interworking with EPS for this UE, the AMF determines whether to include the control plane only indication for the newly requested N6 PDU session to the SMF based on local policies, the UE's preferred CIoT network behaviour and the supported CIoT network behaviour; and
- c) if N6 PDU session is to be established and the DNN or S-NSSAI of the N6 PDU session does not support interworking with EPS as specified in 3GPP TS 23.502 [9], the AMF determines whether to include the control plane only indication for the newly requested N6 PDU session to the SMF based on local policies, the UE's preferred CIoT network behaviour and the supported CIoT network behaviour.

In NB-N1 mode, if the UE or the network does not support N3 data transfer, then when receiving the UE's request for a PDU session establishment, the AMF decides whether the PDU session should be NEF PDU session or N6 PDU session as specified in 3GPP TS 23.501 [8] and then includes the control plane only indication for the requested PDU session to the SMF.

If the network supports user plane CIoT 5GS optimization, it shall also support N3 data transfer.

Broadcast system information may provide information about support of CIoT 5GS optimizations (see 3GPP TS 36.331 [25A]). At reception of new broadcast system information, the lower layers deliver it to the 5GMM layer in the UE. The information provided by lower layers is per PLMN and used by the UE to determine whether certain CIoT 5GS optimizations are supported in the cell.

The UE shall not attempt to use CIoT 5GS optimizations which are indicated as not supported.

In NB-N1 mode, at any given time, there cannot be user-plane resources established for a number of PDU sessions that exceeds the UE's maximum number of supported user-plane resources. The UE in NB-N1 mode shall not:

- a) request the establishment of user-plane resources for a number of PDU sessions that exceeds the UE's maximum number of supported user-plane resources; or
- b) initiate the establishment of a new PDU session, or request the transfer of a PDU session from the non-3GPP access to the 3GPP access, if:
 - 1) the UE has indicated preference for user plane CIoT 5GS optimization;
 - 2) the network accepted the use of user plane CIoT 5GS optimization; and
 - 3) the UE currently has user-plane resources established for a number of PDU sessions that is equal to the UE's maximum number of supported user-plane resources.

The AMF enforces a limit on the number of PDU sessions with active user-plane resources for a UE in NB-N1 mode based on the UE's maximum number of supported user-plane resources as follows:

- a) there can be a maximum of one PDU session with active user-plane resources when the Multiple user-plane resources support bit is set to "Multiple user-plane resources not supported", or
- b) there can be a maximum of two PDU sessions with active user-plane resources when the Multiple user-plane resources support bit is set to "Multiple user-plane resources supported".

A PDU session for a UE in NB-N1 mode shall only have one QoS rule and that is the default QoS rule. Reflective QoS is not supported in NB-N1 mode. Reflective QoS is not applicable for a PDU session with control plane only indication.

In NB-N1 mode, when the UE requests the lower layer to establish a RRC connection and the UE requests the use of user plane CIoT 5GS optimization, the UE shall pass an indication of the requested CIoT 5GS optimizations to the lower layers. If the UE requests the use of N3 data transfer without user plane CIoT 5GS optimization, then the UE shall also pass an indication of user plane CIoT 5GS optimization to lower layers.

In WB-N1 mode, when the UE requests the lower layer to establish a RRC connection and the UE requests the use of control plane CIoT 5GS optimization or user plane CIoT 5GS optimization, the UE shall pass an indication of the requested CIoT 5GS optimizations to the lower layers.

5.3.22 Interaction between MICO mode with active time and extended idle mode DRX cycle

The UE can request the use of both MICO mode with active time and eDRX during a registration procedure but it is up to the network to decide to enable none, one of them or both (see 3GPP TS 23.501 [8]).

If the network accepts the use of both MICO mode with active time (see subclause 5.3.6) and eDRX (see subclause 5.3.16), the extended DRX parameters provided to the UE should allow for multiple paging occasions before the active timer expires.

5.3.23 Forbidden wireline access area

The AMF shall send a REGISTRATION REJECT, SERVICE REJECT or DEREGISTRATION REQUEST message over a wireline access network with the 5GMM cause #77 "wireline access area not allowed", if conditions specified in 3GPP TS 23.316 [6D] for AMF's enforcement of forbidden area are fulfilled.

If a REGISTRATION REJECT, SERVICE REJECT or DEREGISTRATION REQUEST message is received over a wireline access network with the 5GMM cause #77 "wireline access area not allowed":

- a) the 5G-RG shall not access 5GCN over the wireline access network until the 5G-RG is switched off, the UICC containing the USIM is removed, or the 5G-RG starts using another wireline access network;

NOTE: When the 5G-RG acting on behalf of the AUN3 device receives a REGISTRATION REJECT, SERVICE REJECT or DEREGISTRATION REQUEST message over a wireline access network with the 5GMM cause #77 "wireline access area not allowed", the 5G-RG acting on behalf of the AUN3 device can prevent reattempt of the same procedure until the AUN3 device is switched off or the UICC containing the USIM of the AUN3 device is removed.

- b) the W-AGF acting on behalf of the FN-CRG shall not access 5GCN until the W-AGF acting on behalf of the FN-CRG determines that the FN-CRG is switched off; and
- c) the W-AGF acting on behalf of the N5GC device shall not access 5GCN until the W-AGF acting on behalf of the FN-CRG determines that the FN-CRG serving the N5GC device is switched off.

5.3.24 WUS assistance

A UE supporting reception of WUS assistance information indicates its capability for reception of WUS assistance information during registration procedure (see 3GPP TS 23.501 [8]). The UE supporting WUS assistance information may include its UE paging probability information in the Requested WUS assistance information IE in the REGISTRATION REQUEST message (see 3GPP TS 23.501 [8]). The UE shall not include its UE paging probability information during:

- a) a registration procedure for initial registration for emergency services (see subclause 5.5.1.2);
- b) a registration procedure for initial registration for initiating an emergency PDU session (see subclause 5.5.1.2);
- c) a registration procedure for mobility and periodic registration update (see subclause 5.5.1.3) for initiating an emergency PDU session if the UE is in the state 5GMM-REGISTERED.ATTEMPTING-REGISTRATION-UPDATE; or
- d) a registration procedure for mobility and periodic registration update (see subclause 5.5.1.3) when the UE has an emergency PDU session established.

The UE and the network may negotiate the UE paging probability information during a registration procedure when the UE does not have an emergency PDU session. The UE paging probability information is an assistance information used to determine the WUS group for paging UE (see 3GPP TS 23.501 [8], 3GPP TS 36.300 [25B]).

NOTE 1: The determination of UE paging probability information is up to UE implementation.

If a UE supporting WUS assistance information did not receive the Negotiated WUS assistance information IE during the last registration procedure due to an active emergency PDU session over 3GPP access, the UE shall initiate a registration procedure for mobility and periodic registration update to request WUS assistance information after the emergency PDU session is released over 3GPP access.

If the UE does not have an emergency PDU session and the network accepts the use of the WUS assistance information for the UE, the network determines the negotiated UE paging probability information for the UE based on the requested UE paging probability information, if any, local configuration or previous statistical information for the UE, and then indicates the negotiated UE paging probability information in the Negotiated WUS assistance information IE to the UE in the REGISTRATION ACCEPT message. The network shall store the negotiated UE paging probability information in the 5GMM context of the UE for paging.

The UE shall use WUS assistance information only if the UE received the Negotiated WUS assistance information IE during the last registration procedure. If the UE did not receive the Negotiated WUS assistance information IE during the last registration procedure, the UE shall delete any existing WUS assistance information received from the network.

If the network did not accept the request to use WUS assistance information, the network shall delete the stored negotiated UE paging probability information for the UE, if available.

When an emergency PDU session is successfully established after the UE received the Negotiated WUS assistance information IE during the last registration procedure, the UE and the AMF shall not use WUS assistance information until:

- the successful completion of the PDU session release procedure of the emergency PDU session;
- the UE receives WUS assistance information during a registration procedure with PDU session status IE or upon successful completion of a service request procedure, if the UE or the network locally releases the emergency PDU session; or
- the successful completion of the handover of the emergency PDU session to non-3GPP access.

NOTE 2: WUS assistance is not supported by NR connected to 5GCN.

5.3.25 Paging Early Indication with Paging Subgrouping Assistance

A UE may indicate its capability to support NR paging subgrouping during registration procedure when the UE:

- initiates a registration procedure with 5GS registration type IE not set to "emergency registration"; and
- does not have an active emergency PDU session.

NOTE: The requirements for UE-ID based PEI are specified in 3GPP TS 38.300 [27].

If a UE supporting NR paging subgrouping did not indicate its capability to support NR paging subgrouping during the last registration procedure due to an active emergency PDU session over 3GPP access, the UE shall initiate a registration procedure for mobility and periodic registration update to indicate its capability to support NR paging subgrouping after the emergency PDU session is released over 3GPP access.

If the UE indicates support of NR paging subgrouping the UE may include its paging probability information in the Requested PEIPS assistance information IE in the REGISTRATION REQUEST message. If the UE indicates support of NR paging subgrouping and the network supports and accepts the use of the PEIPS assistance information for the UE, the network provides to the UE the Negotiated PEIPS assistance information, including the Paging subgroup ID, in the REGISTRATION ACCEPT message or the CONFIGURATION UPDATE COMMAND message. The Paging subgroup ID is used to determine the NR paging subgroup for paging the UE. The UE NAS layer shall indicate the Paging subgroup ID to the access stratum layer. The network shall store the Paging subgroup ID in the 5GMM context of the UE.

The UE shall use PEIPS assistance information only if the UE received the Negotiated PEIPS assistance information IE during the last registration procedure. If the UE did not receive the Negotiated PEIPS assistance information IE during the last registration procedure, the UE shall delete any existing PEIPS assistance information received from the network.

If the network did not accept the request to use PEIPS assistance information during the registration procedure, the network shall delete the stored PEIPS assistance information for the UE, if available.

If the UE supports the use of the PEIPS assistance information and the network supports and accepts the use of the PEIPS assistance information, the network may provide the PEIPS assistance information to the UE by including the Updated PEIPS assistance information IE in the CONFIGURATION UPDATE COMMAND message.

When an emergency PDU session is successfully established over 3GPP access after the UE received the Negotiated PEIPS assistance information IE during the last registration procedure, the UE and the AMF shall not use PEIPS assistance information until:

- the successful completion of the PDU session release procedure of the emergency PDU;
- the UE receives PEIPS assistance information during a registration procedure with PDU session status IE or upon successful completion of a service request procedure, if the UE or the network locally releases the emergency PDU session;
- the successful completion of handover of emergency PDU session to non-3GPP access; or
- the successful transfer of the emergency PDU session in 5GS to the EPS or ePDG connected to EPC.

5.3.26 Support for unavailability period

If the UE and network support unavailability period and an event is triggered in the UE making the UE unavailable for a certain period of time and the unavailability is not due to discontinuous coverage, the UE may store its 5GMM and 5GSM context in USIM or non-volatile memory in the ME to be able to reuse it after the unavailability period.

NOTE 1: How and where the UE stores its contexts depends upon the UE implementation. The UE can store some or all of its contexts in the ME or USIM using existing ME or USIM functionality.

To activate the unavailability period, either the UE provides unavailability information, including a type of unavailability, an unavailability period duration if known, and the start of the unavailability period if known, during the registration procedure or the UE includes the type of unavailability and the unavailability period duration if known, during the de-registration procedure (see 3GPP TS 23.501 [8] and 3GPP TS 23.502 [9]). The support for the unavailability period is negotiated in the registration procedure. If the UE is registered to a PLMN via a satellite NG-RAN cell, the AMF may for discontinuous coverage provide the unavailability period duration of the UE or the start of the unavailability period or both to the UE during the registration procedure. The AMF may consider the unavailability period duration provided by the UE if available and determine the unavailability period duration of the UE as described in subclause 5.5.1.2.4 and 5.5.1.3.4. The AMF may also consider the start of the unavailability period provided by the UE, if available, and determine the start of the unavailability period of the UE as described in subclause 5.5.1.3.4.

If the UE provided unavailability information in the last registration procedure for mobility registration or the de-registration procedure, the AMF considers the UE unreachable until the UE registers for a normal service. If the UE did not include a start of the unavailability period, the AMF shall consider the start of the unavailability period to be the time at which AMF received the REGISTRATION REQUEST message or the DEREGISTRATION REQUEST message from the UE. During the registration procedure, the AMF may determine the values of the negotiated extended DRX parameters, the timer T3324, and the periodic registration update timer (T3512) to be provided to the UE based on the discontinuous coverage maximum time offset, the unavailability period duration and the start of the unavailability period based on their availability. The AMF should set the value of the mobile reachable timer and implicit de-registration timer based on the unavailability period duration and the start of the unavailability period. The AMF releases the N1 signalling connection after the completion of the registration procedure in which the UE provided unavailability information without providing the start of the unavailability period.

NOTE 2: If the UE supports MUSIM and the UE is registered with the support of unavailability period, then the UE can indicate a different unavailability periods to each registered network.

If for discontinuous coverage the UE has stored a discontinuous coverage maximum time offset as described in subclause 5.4.4.3, 5.5.1.2.4, and 5.5.1.3.4, the UE shall set the discontinuous coverage maximum time offset value to a random value up to and including the stored discontinuous coverage maximum time offset for this PLMN and satellite NG-RAN RAT Type, determine a time point equal to the time when the UE is about to lose satellite coverage minus the discontinuous coverage maximum time offset value, and send the REGISTRATION REQUEST message for mobility and periodic registration update to the AMF indicating out of coverage at the determined time point.

If for discontinuous coverage the UE has stored a discontinuous coverage maximum time offset as described in subclause 5.4.4.3, 5.5.1.2.4, and 5.5.1.3.4, upon returning in coverage of a TA in the current registration area after being out of coverage due to discontinuous coverage, and in the last REGISTRATION ACCEPT message the end of unavailability period report was set to "UE needs to report end of unavailability period", the UE shall start the discontinuous coverage maximum time offset timer with a random value up to and including the stored maximum time offset value, if available, for this PLMN and NR satellite access, and starts the discontinuous coverage maximum time offset timer. The UE shall enter 5GMM-REGISTERED.ATTEMPTING-REGISTRATION-UPDATE state and shall

not initiate any NAS signalling on that NR satellite access and PLMN while the discontinuous coverage maximum time offset timer is running. The UE shall stop the discontinuous coverage maximum time offset timer and initiate NAS signalling if the UE receives paging message receives a NOTIFICATION message over non-3GPP access as described in case b) subclause 5.6.3.1, has pending emergency services, is establishing an emergency PDU session, is performing emergency services fallback procedure, or when the UE enters a TAI outside the registration area. At expiry of the discontinuous coverage maximum time offset timer, the UE shall perform a registration procedure for mobility registration update.

If the AMF sets the EUPR bit value in the Unavailability configuration IE to "UE does not need to report end of unavailability period", then upon returning to a TA in the current registration area the UE shall choose an appropriate substate of 5GMM-REGISTERED and the UE is not required to trigger the registration procedure for mobility registration update when the unavailability period duration has ended. If the AMF does not provide the Unavailability configuration IE or the AMF sets the EUPR bit value in the Unavailability configuration IE to "UE needs to report end of unavailability period", the UE should trigger registration procedure for mobility registration update when the unavailability period duration has ended.

When the unavailability period is activated, all NAS timers are stopped and associated procedures aborted except for timers T3512, T3324, T3346, T3444, T3445, T3447, T3448, T3396, T3526, T3584, T3585, T3587, any back-off timers, T3245, T3247, the timer T controlling the periodic search for HPLMN or EHPLMN or higher prioritized PLMNs, the timer T_{SENSE} controlling the periodic search for PLMNs satisfying the operator controlled signal level threshold, the timer TF, the timer TG (see 3GPP TS 23.122 [5]), the timer T_{NSU} and the timer instance associated with the entry in the list of "PLMNs not allowed to operate at the present UE location", slice deregistration inactivity timer when the UE activates the unavailability period using registration procedure, the UE shall reset the registration attempt counter and service request attempt counter.

When the UE activates the unavailability period using registration procedure without providing the start of the unavailability period, then after successful completion of the procedure the UE shall enter the state 5GMM-REGISTERED.NO-CELL-AVAILABLE and may deactivate AS layer. Otherwise, if the UE provided the start of unavailability period in the registration procedure, the UE shall enter the state 5GMM-REGISTERED.NO-CELL-AVAILABLE and may deactivate AS layer only after the UE activates the unavailability period.

When the UE activates the unavailability period using the de-registration procedure, then after successful completion of the procedure the UE shall enter the state 5GMM-DEREGISTERED.NO-CELL-AVAILABLE and deactivate the AS layer.

When the UE comes out of the unavailability period the UE shall activate the AS layer if deactivated and perform registration procedure as described in subclause 5.5.1.2.2 and 5.5.1.3.2.

5.4 5GMM common procedures

5.4.1 Primary authentication and key agreement procedure

5.4.1.1 General

The purpose of the primary authentication and key agreement procedure is to enable mutual authentication between the UE and the network and to provide keying material that can be used between the UE and network in subsequent security procedures, as specified in 3GPP TS 33.501 [24].

Two methods are defined:

- a) EAP based primary authentication and key agreement procedure.
- b) 5G AKA based primary authentication and key agreement procedure.

The UE and the AMF shall support the EAP based primary authentication and key agreement procedure and the 5G AKA based primary authentication and key agreement procedure.

5.4.1.2 EAP based primary authentication and key agreement procedure

5.4.1.2.1 General

The purpose of the EAP based primary authentication and key agreement procedure is to provide mutual authentication between the UE and the network and to agree on the keys K_{AUSF} , K_{SEAF} and K_{AMF} (see 3GPP TS 33.501 [24]).

Extensible authentication protocol (EAP) as specified in IETF RFC 3748 [34] enables authentication using various EAP methods.

EAP defines four types of EAP messages:

- a) an EAP-request message;
- b) an EAP-response message;
- c) an EAP-success message; and
- d) an EAP-failure message.

Several rounds of exchanges of an EAP-request message and a related EAP-response message can be required to achieve the authentication (see example in figure 5.4.1.2.1.1).

The EAP based primary authentication and key agreement procedure is always initiated and controlled by the network.

The EAP-request message, the ngKSI and the ABBA are transported from the network to the UE using the AUTHENTICATION REQUEST message of the EAP message reliable transport procedure.

The EAP-response message is transported from the UE to the network using the AUTHENTICATION RESPONSE message of the EAP message reliable transport procedure.

If the authentication of the UE completes successfully, the serving AMF intends to initiate a security mode control procedure after the EAP based primary authentication and key agreement procedure and the security mode control procedure intends to bring into use the partial native 5G NAS security context created by the EAP based primary authentication and key agreement procedure, then the EAP-success message and the ngKSI are transported from the network to the UE using the SECURITY MODE COMMAND message of the security mode control procedure (see subclause 5.4.2).

If the authentication of the UE completes successfully and the serving AMF does not intend to initiate a security mode control procedure bringing into use the partial native 5G NAS security context created by the EAP based primary authentication and key agreement procedure, then the EAP-success message, and the ngKSI are transported from the network to the UE using the AUTHENTICATION RESULT message of the EAP result message transport procedure.

NOTE 1: The serving AMF will not initiate a security mode control procedure after the EAP based primary authentication and key agreement procedure e.g. in case of AMF relocation during registration procedure.

If the authentication of the UE completes unsuccessfully, the EAP-failure message is transported from the network to the UE using the AUTHENTICATION RESULT message or the AUTHENTICATION REJECT message of the EAP result message transport procedure or in a response of the initial 5GMM procedure as part of which the EAP based primary authentication and key agreement procedure is performed.

The AMF shall set the authenticator retransmission timer specified in IETF RFC 3748 [34] subclause 4.3 to infinite value.

NOTE 2: The EAP message reliable transport procedure provides a reliable transport of EAP messages and therefore retransmissions at the EAP layer do not occur.

The AUSF and the AMF support exchange of EAP messages using N12.

The UE shall detect and handle any duplication of EAP message as specified in IETF RFC 3748 [34].

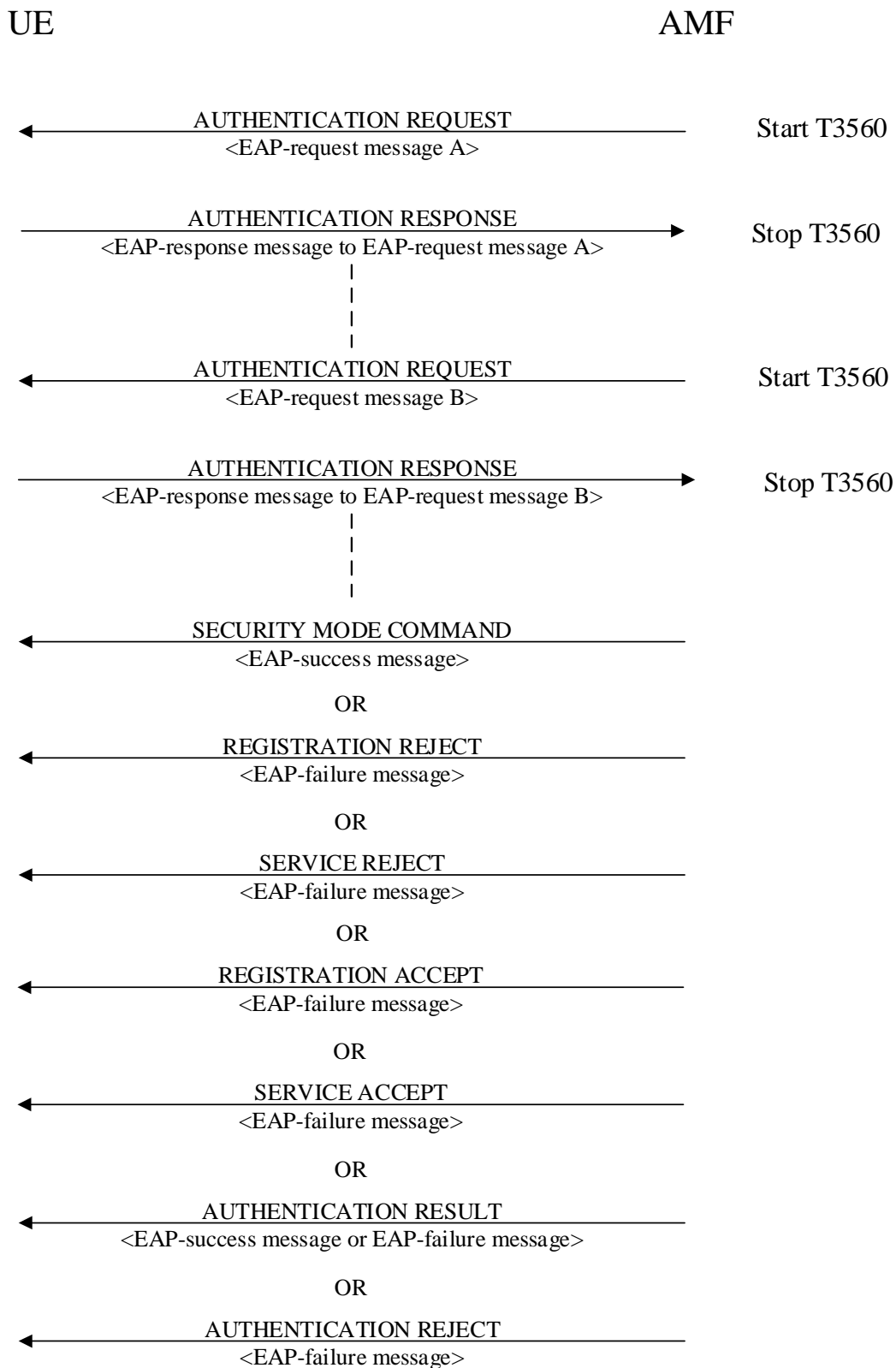

Figure 5.4.1.2.1.1: EAP based primary authentication and key agreement procedure

5.4.1.2.2 EAP-AKA' related procedures

5.4.1.2.2.1 General

The UE shall support acting as EAP-AKA' peer as specified in IETF RFC 5448 [40]. The AUSF may support acting as EAP-AKA' server as specified in IETF RFC 5448 [40]. The AAA server of the Credentials Holder (CH) or the Default Credentials Server (DCS) may support acting as EAP-AKA' server as specified in IETF RFC 5448 [40].

The EAP-AKA' enables mutual authentication of the UE and the network.

The UE can reject the EAP-request/AKA'-challenge message sent by the network. The UE shall proceed with an EAP-request/AKA'-challenge message only if a USIM is present.

During a successful EAP based primary authentication and key agreement procedure, the CK and IK are computed by the USIM. CK and IK are then used by the ME as key material to generate an EMSK or MSK.

5.4.1.2.2.2 Initiation

In order to initiate the EAP based primary authentication and key agreement procedure using EAP-AKA', the AUSF or the AAA server of the CH or the DCS shall send an EAP-request/AKA'-challenge message as specified in IETF RFC 5448 [40]. The AUSF or the AAA server of the CH or the DCS shall set the AT_KDF_INPUT attribute of the EAP-request/AKA'-challenge message to the SNN. The SNN is in format described in subclause 9.12.1. The AUSF or the AAA server of the CH or the DCS may include AT_RESULT_IND attribute in the EAP-request/AKA'-challenge message.

The network shall select an ngKSI value. If an ngKSI is contained in an initial NAS message during a 5GMM procedure, the network shall select a different ngKSI value. The network shall send the selected ngKSI value to the UE along with each EAP message. The network shall send the ABBA value as described in subclause 9.11.3.10 to the UE along with the EAP request message and EAP-success message.

Upon receiving an EAP-request/AKA'-challenge message, the UE shall check whether the UE has a USIM, shall check the key derivation function indicated in AT_KDF attributes as specified in IETF RFC 5448 [40], and if the value of the Key derivation function field within the received AT_KDF attribute, is of value 1, shall check:

- a) whether the network name field of the AT_KDF_INPUT attribute is the SNN constructed according to subclause 9.12.1; and
- b) whether the network name field of the AT_KDF_INPUT attribute matches the PLMN identity or the SNPN identity of the selected SNPN saved in the UE.

When not operating in SNPN access operation mode, the PLMN identity the UE uses for the above network name check is as follows:

- a) when the UE moves from 5GMM-IDLE mode to 5GMM-CONNECTED mode, until the first handover, the UE shall use the PLMN identity of the selected PLMN; and
- b) after handover or inter-system change to N1 mode in 5GMM-CONNECTED mode:
 - 1) if the target cell is not a shared network cell, the UE shall use the PLMN identity received as part of the broadcast system information;
 - 2) if the target cell is a shared network cell and the UE has a valid 5G-GUTI, the UE shall use the PLMN identity that is part of the 5G-GUTI; and
 - 3) if the target cell is a shared network cell and the UE has a valid 4G-GUTI, but not a valid 5G-GUTI, the UE shall use the PLMN identity that is part of the 4G-GUTI.

When operating in SNPN access operation mode, the SNPN identity the UE uses for the above network name check is the SNPN identity of the selected SNPN.

5.4.1.2.2.3 UE successfully authenticates network

If a USIM is present and the SNN check is successful, the UE shall handle the EAP-request/AKA'-challenge message as specified in IETF RFC 5448 [40]. The USIM shall derive CK and IK and compute the authentication response (RES)

using the 5G authentication challenge data received from the ME, and pass RES to the ME. The ME shall derive CK' and IK' from CK and IK, and if the UE operates in SNPN access operation mode and the credentials in the USIM contain an indication to use MSK for derivation of K_{AUSF} after success of primary authentication and key agreement procedure then derive MSK from CK' and IK' otherwise derive EMSK from CK' and IK'.

NOTE 1: When the UE is registering or registered for onboarding services in SNPN, credentials in the USIM do not contain an indication to use MSK for derivation of K_{AUSF} after success of primary authentication and key agreement procedure.

Furthermore, if the UE operates in SNPN access operation mode and the credentials in the USIM

contain an indication to use MSK for derivation of K_{AUSF} after success of primary authentication and key agreement procedure then the ME may generate a new K_{AUSF} from the MSK otherwise the ME may generate a new K_{AUSF} from the EMSK.

If the ME generates a new K_{AUSF} , the ME shall generate a new K_{SEAF} from the new K_{AUSF} , and the K_{AMF} from the ABBA received together with the EAP-request/AKA'-challenge message, and the new K_{SEAF} as described in 3GPP TS 33.501 [24], and create a partial native 5G NAS security context identified by the ngKSI value received together with the EAP-request/AKA'-challenge message in subclause 5.4.1.2.4.2 in the volatile memory of the ME. If the K_{AMF} and the partial native 5G NAS security context are created, the ME shall store the K_{AMF} in the created partial native 5G NAS security context, and shall send an EAP-response/AKA'-challenge message as specified in IETF RFC 5448 [40].

NOTE 2: Generation of the new K_{AUSF} and the new K_{SEAF} does not result into deletion of the valid K_{AUSF} and the valid K_{SEAF} , if any.

The ME shall not use the new K_{AUSF} in the verification of SOR transparent container and UE parameters update transparent container, if any are received, until receipt of an EAP-success message.

If the EAP-request/AKA'-challenge message contains AT_RESULT_IND attribute, the UE may include AT_RESULT_IND attribute in the EAP-response/AKA'-challenge message as specified in IETF RFC 5448 [40].

5.4.1.2.2.4 Errors when handling EAP-request/AKA'-challenge message

If a USIM is present, the SNN check fails or the UE does not accept AUTN during handling of the EAP-request/AKA'-challenge message as specified in IETF RFC 5448 [40], the UE shall send an EAP-response/AKA'-authentication-reject message as specified in IETF RFC 5448 [40].

If a USIM is present, the SNN check is successful but the UE detects that the sequence number in AUTN is not correct during handling of the EAP-request/AKA'-challenge message as specified in IETF RFC 5448 [40], the UE shall send an EAP-response/AKA'-synchronization-failure message as specified in IETF RFC 5448 [40].

If a USIM is present, the SNN check is successful, the sequence number in AUTN is correct and the UE detects another error during handling of the EAP-request/AKA'-challenge message as specified in IETF RFC 5448 [40], the UE shall send an EAP-response/AKA'-client-error message as specified in IETF RFC 5448 [40].

If a USIM is not present, the UE shall send an EAP-response/AKA'-client-error message as specified in IETF RFC 5448 [40].

For any of the above, the UE shall start timer T3520 when the AUTHENTICATION RESPONSE message containing the EAP-response message is sent. Furthermore, the UE shall stop any of the timers T3510, T3517 or T3521 (if they were running). Upon receiving an AUTHENTICATION REQUEST message with the EAP message IE containing an EAP-request/AKA'-challenge from the network, the UE shall stop timer T3520, if running, and then process the EAP-request/AKA'-challenge information as normal.

5.4.1.2.2.5 Network successfully authenticates UE

Upon reception of the EAP-response/AKA'-challenge message, if procedures for handling an EAP-response/AKA'-challenge message as specified in IETF RFC 5448 [40] are successful and:

- a) the AUSF acts as the EAP-AKA' server, the AUSF shall generate EMSK, the K_{AUSF} from the EMSK, and the K_{SEAF} from the K_{AUSF} as described in 3GPP TS 33.501 [24]; or

- b) the AAA server of the CH or the DCS acts as the EAP-AKA' server, the AAA server of the CH or the DCS shall generate MSK as described in 3GPP TS 33.501 [24];

and:

- a) if the AUSF or the AAA server of the CH or the DCS included the AT_RESULT_IND attribute in the EAP-request/AKA'-challenge message and the AT_RESULT_IND attribute is included in the corresponding EAP-response/AKA'-challenge message, the AUSF or the AAA server of the CH or the DCS shall send an EAP-request/AKA'-notification message as specified in IETF RFC 5448 [40]; or

- b) if the AUSF or the AAA server of the CH or the DCS:

- 1) included the AT_RESULT_IND attribute in the EAP-request/AKA'-challenge message and the AT_RESULT_IND attribute is not included in the EAP-response/AKA'-challenge message; or
- 2) did not include the AT_RESULT_IND attribute in the EAP-request/AKA'-challenge message;

then the AUSF or the AAA server of the CH or the DCS shall send an EAP-success message as specified in IETF RFC 5448 [40] and shall consider the procedure complete.

NOTE 1: When the AAA server of the CH or the DCS acts as the EAP-AKA' server, the AAA server of the CH or the DCS provides (via the NSSAAF) the MSK and the SUPI to the AUSF. Upon reception of the MSK, the AUSF generates the K_{AUSF} from the MSK, and the K_{SEAF} from the K_{AUSF} as described in 3GPP TS 33.501 [24].

NOTE 2: The AUSF provides the K_{SEAF} and optionally the SUPI (unless the SEAF provided the AUSF with the SUPI before) to the SEAF as described in 3GPP TS 33.501 [24]. Upon reception of the K_{SEAF} and optionally the SUPI, the SEAF generates the K_{AMF} based on the ABBA, the K_{SEAF} and the SUPI as described in 3GPP TS 33.501 [24] and provides ngKSI and the K_{AMF} to the AMF. Upon reception of the ngKSI and the K_{AMF} , the AMF creates a partial native 5G NAS security context identified by the ngKSI and stores the K_{AMF} in the created partial native 5G NAS security context.

5.4.1.2.2.6 UE handling EAP-AKA' notification message

Upon receiving an EAP-request/AKA'-notification message, the UE shall send an EAP-response/AKA'-notification message as specified in IETF RFC 5448 [40].

5.4.1.2.2.6A EAP based Identification initiation by the network

If the AUSF or the AAA server of the CH or the DCS decides to initiate the EAP based identification procedure, the AUSF or the AAA server of the CH or the DCS shall send an EAP-Request/Identity or EAP-Request/AKA'-Identity message as specified in IETF RFC 5448 [40].

The AMF shall encapsulate the EAP-Request/Identity or EAP-Request/AKA'-Identity message in the AUTHENTICATION REQUEST message and send it to the UE.

5.4.1.2.2.6B EAP based Identification response by the UE

Upon receipt of the AUTHENTICATION REQUEST message with EAP-Request/Identity message the UE shall send an AUTHENTICATION RESPONSE message with EAP-Response/Identity to the network. In the EAP-Response/Identity message, the UE shall provide the requested identity according to 3GPP TS 33.501 [24] annex F.2, in the UE identity in the EAP-Response/Identity message as specified in IETF RFC 5448 [40].

Upon receipt of the AUTHENTICATION REQUEST message with EAP-Request/AKA'-Identity message the UE shall send an AUTHENTICATION RESPONSE message with EAP-Response/AKA'-Identity to the network. Based on the attribute received in the EAP-Request/AKA'-Identity, the UE shall provide the requested identity according to 3GPP TS 33.501 [24] annex F.2, in the EAP-Response/AKA'-Identity message, as specified in IETF RFC 5448 [40].

If the EAP-Request/AKA'-Identity carries the AT_PERMANENT_REQ, the UE shall respond with EAP-Response/AKA'-Client-Error with the error code "unable to process packet".

5.4.1.2.2.7 Network sending EAP-success message

Upon reception of the EAP-response/AKA'-notification message, if earlier procedures for handling an EAP-request/AKA'-challenge message as specified in IETF RFC 5448 [40] were successful, the AUSF or the AAA server of the CH or the DCS shall send an EAP-success message as specified in IETF RFC 5448 [40] and shall consider the procedure complete.

NOTE: The AUSF provides the K_{SEAF} to the SEAF. Upon reception of the K_{SEAF} , the SEAF generates the K_{AMF} based on the ABBA and the K_{SEAF} as described in 3GPP TS 33.501 [24], and provides ngKSI and the K_{AMF} to the AMF. Upon reception of the ngKSI and the K_{AMF} , the AMF creates a partial native 5G NAS security context identified by the ngKSI, and stores the K_{AMF} in the created partial native 5G NAS security context.

5.4.1.2.2.8 UE handling EAP-success message

Upon receiving an EAP-success message, the ME shall:

- a) delete the valid K_{AUSF} and the valid K_{SEAF} , if any;
- b) if the ME has not generated a new K_{AUSF} and a new K_{SEAF} and has not created a partial native 5G NAS security context as described in subclause 5.4.1.2.2.3:
 - 1) if the UE operates in SNPN access operation mode and the credentials in the USIM contain an indication to use MSK for derivation of K_{AUSF} after success of primary authentication and key agreement procedure then generate a new K_{AUSF} from the MSK otherwise generate a new K_{AUSF} from the EMSK;

NOTE: When the UE is registering or registered for onboarding services in SNPN, credentials in the USIM do not contain an indication to use MSK for derivation of K_{AUSF} after success of primary authentication and key agreement procedure.

- 2) generate a new K_{SEAF} from the new K_{AUSF} , and the K_{AMF} from the ABBA that was received with the EAP-success message, and the new K_{SEAF} as described in 3GPP TS 33.501 [24];
 - 3) create a partial native 5G NAS security context identified by the ngKSI value in the volatile memory of the ME; and
 - 4) store the K_{AMF} in the created partial native 5G NAS security context; and
- c) consider the new K_{AUSF} to be the valid K_{AUSF} , and the new K_{SEAF} to be the valid K_{SEAF} , reset the SOR counter and the UE parameter update counter to zero, and store the valid K_{AUSF} , the valid K_{SEAF} , the SOR counter and the UE parameter update counter as specified in annex C, and use the valid K_{AUSF} in the verification of SOR transparent container and UE parameters update transparent container, if any are received.

The UE shall consider the procedure complete.

5.4.1.2.2.9 Network not successfully authenticates UE

Upon reception of the EAP-response/AKA'-challenge message, if procedures for handling an EAP-response/AKA'-challenge message as specified in IETF RFC 5448 [40] are not successful, the AUSF or the AAA server of the CH or the DCS shall send an EAP-request/AKA'-notification message that implies failure as specified in IETF RFC 5448 [40].

5.4.1.2.2.10 Network sending EAP-failure message

Upon reception of the EAP-response/AKA'-notification message, if earlier procedures for handling an EAP-request/AKA'-challenge message as specified in IETF RFC 5448 [40] were not successful, the AUSF or the AAA server of the CH or the DCS shall send an EAP-failure message as specified in IETF RFC 5448 [40] and shall consider the procedure complete.

If the authentication response (RES) returned by the UE in the AT_RES attribute of the EAP-response/AKA'-challenge message is not valid, the network handling depends upon the type of identity used by the UE in the initial NAS message, that is:

- a) if the 5G-GUTI was used; or

b)- if the SUCI was used.

If the 5G-GUTI was used, the network should transport the EAP-failure message in the AUTHENTICATION RESULT message of the EAP result message transport procedure, initiate an identification procedure to retrieve SUCI from the UE and restart the EAP based primary authentication and key agreement procedure with the received SUCI.

If the SUCI was used for identification in the initial NAS message or in a restarted EAP based primary authentication and key agreement procedure, or the network decides not to initiate the identification procedure to retrieve SUCI from the UE after an unsuccessful EAP based primary authentication and key agreement procedure, the network should transport the EAP-failure message in an AUTHENTICATION REJECT message of the EAP result message transport procedure.

Depending on local requirements or operator preference for emergency services, if the UE initiates a registration procedure with 5GS registration type IE set to "emergency registration" and the AMF is configured to allow emergency registration without user identity, the AMF needs not follow the procedures specified for transporting the EAP-failure message in the AUTHENTICATION REJECT message of the EAP result message transport procedure in the present subclause. The AMF may include the EAP-failure message in a response of the current 5GMM specific procedure or in the AUTHENTICATION RESULT of the EAP result message transport procedure.

5.4.1.2.2.11 UE handling EAP-failure message

Upon receiving an EAP-failure message, the UE shall delete the partial native 5G NAS security context and shall delete the new K_{AUSF} and the new K_{SEAF} , if any were created as described in subclause 5.4.1.2.2.3.

The UE shall consider the procedure complete.

If the EAP-failure message is received in an AUTHENTICATION REJECT message:

1) if the AUTHENTICATION REJECT message has been successfully integrity checked by the NAS:

- the UE shall set the update status to 5U3 ROAMING NOT ALLOWED, delete the stored 5G-GUTI, TAI list, last visited registered TAI and ngKSI;

In case of PLMN, the USIM shall be considered invalid until switching off the UE or the UICC containing the USIM is removed.

In case of SNPN, if the UE is neither registered for onboarding services in SNPN nor performing initial registration for onboarding services in SNPN and the UE does not support access to an SNPN using credentials from a credentials holder and does not support equivalent SNPNS, the selected entry of the "list of subscriber data" with the SNPN identity of the current SNPN shall be considered invalid until the UE is switched off or the entry is updated. Additionally, the UE shall consider the USIM as invalid for the current SNPN until switching off or the UICC containing the USIM is removed.

In case of SNPN, if the UE is neither registered for onboarding services in SNPN nor performing initial registration for onboarding services in SNPN and the UE supports access to an SNPN using credentials from a credentials holder, equivalent SNPNS, or both, the UE shall consider the selected entry of the "list of subscriber data" as invalid until the UE is switched off or the entry is updated. Additionally, the UE shall consider the USIM as invalid for the entry until switching off or the UICC containing the USIM is removed.

If the UE is registered for onboarding services in SNPN or is performing initial registration for onboarding services in SNPN, the UE shall store the SNPN identity in the "permanently forbidden SNPNS" for onboarding services in SNPN" list, enter state 5GMM-DEREGISTERED.PLMN-SEARCH, and perform an SNPN selection or an SNPN selection for onboarding services according to 3GPP TS 23.122 [5];

- if the UE is neither registered for onboarding services in SNPN nor performing initial registration for onboarding services in SNPN, the UE shall set:
 - i) the counter for "SIM/USIM considered invalid for GPRS services" events, the counter for "USIM considered invalid for 5GS services over non-3GPP access" events, and the counter for "SIM/USIM considered invalid for non-GPRS services" events if maintained by the UE, in case of PLMN; or
 - ii) the counter for "the entry for the current SNPN considered invalid for 3GPP access" events and the counter for "the entry for the current SNPN considered invalid for non-3GPP access" events in case of SNPN;

to UE implementation-specific maximum value.

If the UE is registered for onboarding services in SNPN or performing initial registration for onboarding services in SNPN, the UE shall set the SNPN-specific attempt counter for the current SNPN to the UE implementation-specific maximum value; and

- if the UE is operating in single-registration mode, the UE shall handle EMM parameters, 4G-GUTI, last visited registered TAI, TAI list and eKSI as specified in 3GPP TS 24.301 [15] for the case when the authentication procedure is not accepted by the network. The USIM shall be considered as invalid also for non-EPS services until switching off or the UICC containing the USIM is removed; and
- 2) if the AUTHENTICATION REJECT message is received without integrity protection, the UE shall start timer T3247 with a random value uniformly drawn from the range between 30 minutes and 60 minutes, if the timer is not running (see subclause 5.3.20).

Additionally, if the UE is neither registered for onboarding services in SNPN nor performing initial registration for onboarding services in SNPN, the UE shall:

- a) if the AUTHENTICATION REJECT message is received over 3GPP access, and the counter for "SIM/USIM considered invalid for GPRS services" events in case of PLMN or the counter for "the entry for the current SNPN considered invalid for 3GPP access" events in case of SNPN has a value less than a UE implementation-specific maximum value, proceed as specified in subclause 5.3.20, list item 1)-a) of subclause 5.3.20.2 (if the UE is not operating in SNPN access operation mode) or list item a)-1) of subclause 5.3.20.3 (if the UE is operating in SNPN access operation mode) for the case that the 5GMM cause value received is #3;
- b) if the AUTHENTICATION REJECT message is received over non-3GPP access, and the counter for "USIM considered invalid for 5GS services over non-3GPP access" events in case of PLMN or the counter for "the entry for the current SNPN considered invalid for non-3GPP access" events in case of SNPN has a value less than a UE implementation-specific maximum value, proceed as specified in subclause 5.3.20, list item 1)-b) of subclause 5.3.20.2 (if the UE is not operating in SNPN access operation mode) or list item a)-2) of subclause 5.3.20.3 (if the UE is operating in SNPN access operation mode) for the case that the 5GMM cause value received is #3;
- c) otherwise:
 - i) if the AUTHENTICATION REJECT message is received over 3GPP access:
 - The UE shall set the update status for 3GPP access to 5U3 ROAMING NOT ALLOWED, delete for 3GPP access only the stored 5G-GUTI, TAI list, last visited registered TAI and ngKSI.
 - In case of PLMN, the UE shall consider the USIM as invalid for 5GS services via 3GPP access and invalid for non-EPS service until switching off the UE or the UICC containing the USIM is removed.

In case of SNPN, if the UE does not support access to an SNPN using credentials from a credentials holder and does not support equivalent SNPNS, the UE shall consider the selected entry of the "list of subscriber data" with the SNPN identity of the current SNPN as invalid for 3GPP access until the UE is switched off or the entry is updated. Additionally, the UE shall consider the USIM as invalid for the current SNPN via 3GPP access until switching off or the UICC containing the USIM is removed.

In case of SNPN, if the UE supports access to an SNPN using credentials from a credentials holder, equivalent SNPNS, or both, the UE shall consider the selected entry of the "list of subscriber data" as invalid for 3GPP access until the UE is switched off or the entry is updated. Additionally, the UE shall consider the USIM as invalid for the entry via 3GPP access until switching off or the UICC containing the USIM is removed.

- The UE shall set:
 - the counter for "SIM/USIM considered invalid for GPRS services" events and the counter for "SIM/USIM considered invalid for non-GPRS services" events if maintained by the UE, in case of PLMN; or
 - the counter for "the entry for the current SNPN considered invalid for 3GPP access" events in case of SNPN;

to UE implementation-specific maximum value.

- If the UE is operating in single-registration mode, the UE shall handle 4G-GUTI, TAI list and eKSI as specified in 3GPP TS 24.301 [15] for the case when the authentication procedure is not accepted by the network. The USIM shall be considered as invalid also for non-EPS services until switching off or the UICC containing the USIM is removed; and
- ii) if the AUTHENTICATION REJECT message is received over non-3GPP access:
- the UE shall set the update status for non-3GPP access to 5U3 ROAMING NOT ALLOWED, delete for non-3GPP access only the stored 5G-GUTI, TAI list, last visited registered TAI and ngKSI;
 - in case of PLMN, the UE shall consider the USIM as invalid for 5GS services via non-3GPP access until switching off the UE or the UICC containing the USIM is removed.
- In case of SNPN, the UE shall consider the selected entry of the "list of subscriber data" with the SNPN identity of the current SNPN as invalid for non-3GPP access until the UE is switched off or the entry is updated. Additionally, the UE shall consider the USIM as invalid for the current SNPN and for non-3GPP access until switching off or the UICC containing the USIM is removed; and
- the UE shall set:
 - the counter for "USIM considered invalid for 5GS services over non-3GPP access" events to UE implementation-specific maximum value in case of PLMN; or
 - the counter for "the entry for the current SNPN considered invalid for non-3GPP access" events to UE implementation-specific maximum value in case of SNPN.

If the UE is registered for onboarding services in SNPN or performing initial registration for onboarding services in SNPN, the UE shall:

- a) if the SNPN-specific attempt counter for the SNPN sending the AUTHENTICATION REJECT message has a value less than a UE implementation-specific maximum value, increment the SNPN-specific attempt counter for the SNPN; or
- b) otherwise, the UE shall set the update status to 5U3.ROAMING NOT ALLOWED, delete the stored 5G-GUTI, TAI list, last visited registered TAI, and ngKSI, store the SNPN identity in the "permanently forbidden SNPNs for onboarding services in SNPN" list, enter state 5GMM-DEREGISTERED.PLMN-SEARCH, and perform an SNPN selection or an SNPN selection for onboarding services according to 3GPP TS 23.122 [5].

If the AUTHENTICATION REJECT message is received by the UE, the UE shall abort any 5GMM signalling procedure, stop any of the timers T3510, T3517, T3519 or T3521 (if they were running), enter state 5GMM-DEREGISTERED and delete any stored SUCI.

5.4.1.2.2.12 Abnormal cases in the UE

The following abnormal cases can be identified:

- a) EAP-request/AKA'-challenge message with the key derivation function indicated in AT_KDF attributes set to a value other than 1.

The UE shall act as specified in IETF RFC 5448 [40] subclause 3.2 for the case when the AUTN had been incorrect.

5.4.1.2.3 EAP-TLS related procedures

5.4.1.2.3.1 General

The UE may support acting as EAP-TLS peer as specified in 3GPP TS 33.501 [24]. The AUSF may support acting as EAP-TLS server as specified in 3GPP TS 33.501 [24]. The AAA server of the CH or the DCS may support acting as EAP server of such EAP method as specified in 3GPP TS 23.501 [8].

The EAP-TLS enables mutual authentication of the UE and the network.

When initiating an EAP based primary authentication and key agreement procedure using EAP-TLS, the network shall select an ngKSI value. If an ngKSI is contained in an initial NAS message during a 5GMM procedure, the network shall select a different ngKSI value. The network shall send the selected ngKSI value to the UE along with each EAP message. The network shall send the ABBA value as described in subclause 9.11.3.10 to the UE along with the EAP-request message and EAP-success message.

When the EAP based primary authentication and key agreement procedure uses EAP-TLS:

- a) if the UE operates in SNPN access operation mode and:
 - 1) the default UE credentials for primary authentication, if the UE is registering or registered for onboarding services in SNPN; or
 - 2) credentials in the selected entry of the "list of subscriber data", if the UE is not registering or registered for onboarding services in SNPN;

contain an indication to use MSK for derivation of K_{AUSF} after success of primary authentication and key agreement procedure then the ME shall generate MSK as described in 3GPP TS 33.501 [24] otherwise the ME shall generate EMSK as described in 3GPP TS 33.501 [24];
- b) if the AUSF acts as the EAP-TLS server, the AUSF shall generate EMSK as described in 3GPP TS 33.501 [24]; and
- c) if the AAA server of the CH or the DCS acts as the EAP-TLS server, the AAA server of the CH or the DCS shall generate MSK as described in 3GPP TS 33.501 [24].

When handling of an EAP-request message results into generation of MSK or EMSK, if the UE operates in SNPN access operation mode and:

- a) the default UE credentials for primary authentication, if the UE is registering or registered for onboarding services in SNPN; or
- b) credentials in the selected entry of the "list of subscriber data", if the UE is not registering or registered for onboarding services in SNPN;

contain an indication to use MSK for derivation of K_{AUSF} after success of primary authentication and key agreement procedure, then the ME may generate a new K_{AUSF} from the MSK otherwise the ME may generate a new K_{AUSF} from the EMSK.

If the ME generates a new K_{AUSF} , the ME shall generate a new K_{SEAF} from the new K_{AUSF} , and the K_{AMF} from the ABBA received together with the EAP-request message, and the new K_{SEAF} as described in 3GPP TS 33.501 [24], and create a partial native 5G NAS security context identified by the ngKSI value received together with the EAP-request message in subclause 5.4.1.2.4.2, in the volatile memory of the ME. If the K_{AMF} and the partial native 5G NAS security context are created, the ME shall store the K_{AMF} in the created partial native 5G NAS security context.

NOTE 1: Generation of the new K_{AUSF} and the new K_{SEAF} does not result into deletion of the valid K_{AUSF} and the valid K_{SEAF} , if any.

The ME shall not use the new K_{AUSF} in the verification of SOR transparent container and UE parameters update transparent container, if any are received, until receipt of an EAP-success message.

When the AUSF acts as the EAP-TLS server and handling of an EAP response message results into generation of EMSK, the AUSF shall generate the K_{AUSF} from the EMSK, and the K_{SEAF} from the K_{AUSF} as described in 3GPP TS 33.501 [24].

NOTE 2: When the AAA server of the CH or the DCS acts as the EAP-TLS server, the AAA server of the CH or the DCS provides (via the NSSAAF) the MSK and the SUPI to the AUSF. Upon reception of the MSK, the AUSF generates the K_{AUSF} from the MSK, and the K_{SEAF} from the K_{AUSF} as described in 3GPP TS 33.501 [24].

NOTE 3: The AUSF provides the K_{SEAF} and optionally the SUPI (unless the SEAF provided the AUSF with the SUPI before) to the SEAF as described in 3GPP TS 33.501 [24]. Upon reception of the K_{SEAF} and optionally the SUPI, the SEAF generates the K_{AMF} based on the ABBA, the K_{SEAF} and the SUPI as described in 3GPP TS 33.501 [24], and provides ngKSI and the K_{AMF} to the AMF. Upon reception of the ngKSI and the K_{AMF} , the AMF creates a partial native 5G NAS security context identified by the ngKSI, and stores the K_{AMF} in the created partial native 5G NAS security context.

If the UE does not accept the server certificate of the network, the UE shall start timer T3520 when the AUTHENTICATION RESPONSE message containing the EAP-response message is sent. Furthermore, the UE shall stop any of the retransmission timers that are running (e.g. T3510, T3517 or T3521). Upon receiving an AUTHENTICATION REQUEST message with the EAP message IE containing an EAP-request message from the network, the UE shall stop timer T3520, if running, and then process the EAP-request message as normally.

If the network does not accept the client certificate of the UE, the network handling depends upon the type of identity used by the UE in the initial NAS message, that is:

- if the 5G-GUTI was used; or
- if the SUCI was used.

If the 5G-GUTI was used, the network should transport the EAP-failure message in the AUTHENTICATION RESULT message of the EAP result message transport procedure, initiate an identification procedure to retrieve SUCI from the UE and restart the EAP based primary authentication and key agreement procedure with the received SUCI.

If the SUCI was used for identification in the initial NAS message or in a restarted EAP based primary authentication and key agreement procedure, or the network decides not to initiate the identification procedure to retrieve SUCI from the UE after an unsuccessful the EAP based primary authentication and key agreement procedure, the network should transport the EAP-failure message in an AUTHENTICATION REJECT message of the EAP result message transport procedure.

Depending on local requirements or operator preference for emergency services, if the UE initiates a registration procedure with 5GS registration type IE set to "emergency registration" and the AMF is configured to allow emergency registration without user identity, the AMF needs not follow the procedures specified for transporting the EAP-failure message in the AUTHENTICATION REJECT message of the EAP result message transport procedure in the present subclause. The AMF may include the EAP-failure message in a response of the current 5GMM specific procedure or in the AUTHENTICATION RESULT of the EAP result message transport procedure.

If the EAP-failure message is received in an AUTHENTICATION REJECT message:

- a) if the AUTHENTICATION REJECT message has been successfully integrity checked by the NAS:
 - 1) the UE shall set the update status to 5U3 ROAMING NOT ALLOWED, delete the stored 5G-GUTI, TAI list, last visited registered TAI and ngKSI.

In case of PLMN, the USIM shall be considered invalid until switching off the UE or the UICC containing the USIM is removed.

In case of SNPN, if the UE is neither registered for onboarding services in SNPN nor performing initial registration for onboarding services in SNPN and the UE does not support access to an SNPN using credentials from a credentials holder and does not support equivalent SNPNs, the selected entry of the "list of subscriber data" with the SNPN identity of the current SNPN shall be considered invalid until the UE is switched off or the entry is updated;

In case of SNPN, if the UE is neither registered for onboarding services in SNPN nor performing initial registration for onboarding services in SNPN and the UE supports access to an SNPN using credentials from a credentials holder, equivalent SNPNs, or both, the UE shall consider the selected entry of the "list of subscriber data" as invalid until the UE is switched off or the entry is updated.

If the UE is registered for onboarding services in SNPN or is performing initial registration for onboarding services in SNPN, the UE shall store the SNPN identity in the "permanently forbidden SNPNs for onboarding services in SNPN" list, enter state 5GMM-DEREGISTERED.PLMN-SEARCH, and perform an SNPN selection or an SNPN selection for onboarding services according to 3GPP TS 23.122 [5];

- 2) if the UE is neither registered for onboarding services in SNPN nor performing initial registration for onboarding services in SNPN, the UE shall set:

- i) the counter for "SIM/USIM considered invalid for GPRS services" events, the counter for "USIM considered invalid for 5GS services over non-3GPP access" events, and the counter for "SIM/USIM considered invalid for non-GPRS services" events if maintained by the UE, in case of PLMN; or
- ii) the counter for "the entry for the current SNPN considered invalid for 3GPP access" events and the counter for "the entry for the current SNPN considered invalid for non-3GPP access" events in case of SNPN;

to UE implementation-specific maximum value.

If the UE is registered for onboarding services in SNPN or performing initial registration for onboarding services in SNPN, the UE shall set the SNPN-specific attempt counter for the current SNPN to the UE implementation-specific maximum value; and

- 3) if the UE is operating in single-registration mode, the UE shall handle EMM parameters, 4G-GUTI, last visited registered TAI, TAI list and eKSI as specified in 3GPP TS 24.301 [15] for the case when the authentication procedure is not accepted by the network. The USIM shall be considered as invalid also for non-EPS services until switching off or the UICC containing the USIM is removed; and
- b) if the AUTHENTICATION REJECT message is received without integrity protection, the UE shall start timer T3247 with a random value uniformly drawn from the range between 30 minutes and 60 minutes, if the timer is not running (see subclause 5.3.20).

Additionally, if the UE is neither registered for onboarding services in SNPN nor performing initial registration for onboarding services in SNPN, the UE shall:

- 1) if the AUTHENTICATION REJECT message is received over 3GPP access, and the counter for "SIM/USIM considered invalid for GPRS services" events in case of PLMN or the counter for "the entry for the current SNPN considered invalid for 3GPP access" events in case of SNPN has a value less than a UE implementation-specific maximum value, proceed as specified in subclause 5.3.20, list item 1)-a) of subclause 5.3.20.2 (if the UE is not SNPN enabled or is not operating in SNPN access operation mode) or list item a) 1) of subclause 5.3.20.3 (if the UE is operating in SNPN access operation mode) for the case that the 5GMM cause value received is #3;
- 2) if the AUTHENTICATION REJECT message is received over non-3GPP access, and the counter for "USIM considered invalid for 5GS services over non-3GPP access" events in case of PLMN or the counter for "the entry for the current SNPN considered invalid for non-3GPP access" events in case of SNPN has a value less than a UE implementation-specific maximum value, proceed as specified in subclause 5.3.20, list item 1)-b) of subclause 5.3.20.2 (if the UE is not operating in SNPN access operation mode) or list item a)-2) of subclause 5.3.20.3 (if the UE is operating in SNPN access operation mode) for the case that the 5GMM cause value received is #3; or
- 3) otherwise:
 - i) if the AUTHENTICATION REJECT message is received over 3GPP access:

- A) the UE shall set the update status for 3GPP access to 5U3 ROAMING NOT ALLOWED, delete for 3GPP access only the stored 5G-GUTI, TAI list, last visited registered TAI and ngKSI.

In case of PLMN, the UE shall consider the USIM as invalid for 5GS services via 3GPP access and invalid for non-EPS service until switching off the UE or the UICC containing the USIM is removed.

In case of SNPN, if the UE does not support access to an SNPN using credentials from a credentials holder and does not support equivalent SNPNs, the UE shall consider the selected entry of the "list of subscriber data" with the SNPN identity of the current SNPN as invalid for 3GPP access until the UE is switched off or the entry is updated;

In case of SNPN, if the UE supports access to an SNPN using credentials from a credentials holder, equivalent SNPNs, or both, the UE shall consider the selected entry of the "list of subscriber data" as invalid for 3GPP access until the UE is switched off or the entry is updated;

- B) the UE shall set:

- the counter for "SIM/USIM considered invalid for GPRS services" events and the counter for "SIM/USIM considered invalid for non-GPRS services" events if maintained by the UE, in case of PLMN; or
- the counter for "the entry for the current SNPN considered invalid for 3GPP access" events in case of SNPN;

to UE implementation-specific maximum value; and

- C) If the UE is operating in single-registration mode, the UE shall handle 4G-GUTI, TAI list and eKSI as specified in 3GPP TS 24.301 [15] for the case when the authentication procedure is not accepted by the network. The USIM shall be considered as invalid also for non-EPS services until switching off or the UICC containing the USIM is removed; and

ii) if the AUTHENTICATION REJECT message is received over non-3GPP access:

- A) the UE shall set the update status for non-3GPP access to 5U3 ROAMING NOT ALLOWED, delete for non-3GPP access only the stored 5G-GUTI, TAI list, last visited registered TAI and ngKSI. In case of PLMN, the USIM shall be considered invalid for 5GS services via non-3GPP access until switching off the UE or the UICC containing the USIM is removed. In case of SNPN, the UE shall consider the selected entry of the "list of subscriber data" with the SNPN identity of the current SNPN shall be considered invalid for non-3GPP access until the UE is switched off or the entry is updated; and
- B) the UE shall set the counter for "USIM considered invalid for 5GS services over non-3GPP access" events in case of PLMN or the counter for "the entry for the current SNPN considered invalid for non-3GPP access" events in case of SNPN to UE implementation-specific maximum value.

If the UE is registered for onboarding services in SNPN or performing initial registration for onboarding services in SNPN, the UE shall:

- 1) if the SNPN-specific attempt counter for the SNPN sending the AUTHENTICATION REJECT message has a value less than a UE implementation-specific maximum value, increment the SNPN-specific attempt counter for the SNPN; or
- 2) otherwise, the UE shall set the update status to 5U3.ROAMING NOT ALLOWED, delete the stored 5G-GUTI, TAI list, last visited registered TAI, and ngKSI, store the SNPN identity in the "permanently forbidden SNPNs for onboarding services in SNPN" list, enter state 5GMM-DEREGISTERED.PLMN-SEARCH, and perform an SNPN selection or an SNPN selection for onboarding services according to 3GPP TS 23.122 [5].

If the AUTHENTICATION REJECT message is received by the UE, the UE shall abort any 5GMM signalling procedure, stop any of the timers T3510, T3517, T3519 or T3521 (if they were running), enter state 5GMM-DEREGISTERED and delete any stored SUCI.

Upon receiving an EAP-success message, the ME shall:

- a) delete the valid K_{AUSF} and the valid K_{SEAF} , if any;
- b) if the ME has not generated a new K_{AUSF} and a new K_{SEAF} and has not created a partial native 5G NAS security context when handling the EAP-request message which resulted into generation of EMSK or MSK as described above:
 - 1) if the UE operates in SNPN access operation mode and:
 - i) the default UE credentials for primary authentication, if the UE is registering or registered for onboarding services in SNPN; or
 - ii) credentials in the selected entry of the "list of subscriber data", if the UE is not registering or registered for onboarding services in SNPN;

contain an indication to use MSK for derivation of K_{AUSF} after success of primary authentication and key agreement procedure then generate a new K_{AUSF} from the MSK otherwise generate a new K_{AUSF} from the EMSK;

- 2) generate a new K_{SEAF} from the new K_{AUSF} , and the K_{AMF} from the ABBA that was received with the EAP-success message, and the new K_{SEAF} as described in 3GPP TS 33.501 [24];
 - 3) create a partial native 5G NAS security context identified by the ngKSI value in the volatile memory of the ME; and
 - 4) store the K_{AMF} in the created partial native 5G NAS security context; and
- c) consider the new K_{AUSF} to be the valid K_{AUSF} , and the new K_{SEAF} to be the valid K_{SEAF} , reset the SOR counter and the UE parameter update counter to zero, store the valid K_{AUSF} , the valid K_{SEAF} , the SOR counter and the UE parameter update counter as specified in annex C, and use the valid K_{AUSF} in the verification of SOR transparent container and UE parameters update transparent container, if any are received.

The UE shall consider the procedure complete.

Upon receiving an EAP-failure message, the UE shall delete the partial native 5G NAS security context and shall delete the new K_{AUSF} and the new K_{SEAF} , if any were created when handling the EAP-request message which resulted into generation of EMSK or MSK as described above.

The UE shall consider the procedure complete.

5.4.1.2.3A Procedures related to EAP methods other than EAP-AKA' and EAP-TLS

5.4.1.2.3A.1 General

This subclause applies when an EAP method:

- a) supporting mutual authentication;
- b) supporting EMSK or MSK generation; and
- c) other than EAP-AKA' and EAP-TLS;

is used for primary authentication and key agreement in an SNPN.

The UE may support acting as EAP peer of such EAP method as specified in 3GPP TS 33.501 [24]. The AUSF may support acting as EAP server of such EAP method as specified in 3GPP TS 33.501 [24]. The AAA server of the CH or the DCS may support acting as EAP server of such EAP method as specified in 3GPP TS 23.501 [8].

When initiating an EAP based primary authentication and key agreement procedure using such EAP method, the network shall select an ngKSI value. If an ngKSI is contained in an initial NAS message during a 5GMM procedure, the network shall select a different ngKSI value. The network shall send the selected ngKSI value to the UE along with each EAP message. The network shall send the ABBA value as described in subclause 9.11.3.10 to the UE along with the EAP-request message and EAP-success message.

When the EAP based primary authentication and key agreement procedure uses such EAP method:

- a) if:
 - 1) the default UE credentials for primary authentication, if the UE is registering or registered for onboarding services in SNPN; or
 - 2) credentials in the selected entry of the "list of subscriber data", if the UE is not registering or registered for onboarding services in SNPN;
 contain an indication to use MSK for derivation of K_{AUSF} after success of primary authentication and key agreement procedure then the ME shall generate MSK as described in 3GPP TS 33.501 [24] otherwise the ME shall generate EMSK as described in 3GPP TS 33.501 [24];
- b) if the AUSF acts as the EAP server, the AUSF shall generate EMSK as described in 3GPP TS 33.501 [24]; and
- c) if the AAA server of the CH or the DCS acts as the EAP server, the AAA server of the CH or the DCS shall generate MSK as described in 3GPP TS 33.501 [24].

When handling of an EAP-request message results into generation of MSK or EMSK, if:

- a) the default UE credentials for primary authentication, if the UE is registering or registered for onboarding services in SNPN; or
- b) credentials in the selected entry of the "list of subscriber data", if the UE is not registering or registered for onboarding services in SNPN;

contain an indication to use MSK for derivation of K_{AUSF} after success of primary authentication and key agreement procedure then the ME may generate a new K_{AUSF} from the MSK otherwise the ME may generate a new K_{AUSF} from the EMSK.

If the ME generates a new K_{AUSF} , the ME shall generate a new K_{SEAF} from the new K_{AUSF} , and the K_{AMF} from the ABBA received together with the EAP-request message, and the new K_{SEAF} as described in 3GPP TS 33.501 [24], and create a partial native 5G NAS security context identified by the ngKSI value received together with the EAP-request message in subclause 5.4.1.2.4.2, in the volatile memory of the ME. If the K_{AMF} and the partial native 5G NAS security context are created, the ME shall store the K_{AMF} in the created partial native 5G NAS security context.

NOTE 1: Generation of the new K_{AUSF} and the new K_{SEAF} does not result into deletion of the valid K_{AUSF} and the valid K_{SEAF} , if any.

The ME shall not use the new K_{AUSF} in the verification of SOR transparent container and UE parameters update transparent container, if any are received, until receipt of an EAP-success message.

When the AUSF acts as the EAP server and handling of an EAP response message results into generation of EMSK, the AUSF shall generate the K_{AUSF} from the EMSK, and the K_{SEAF} from the K_{AUSF} as described in 3GPP TS 33.501 [24].

NOTE 2: When the AAA server of the CH or the DCS acts as the EAP server and handling of an EAP response message results into generation of MSK, the AAA server of the CH or the DCS provides (via the NSSAAF) the MSK and the SUPI to the AUSF. Upon reception of the MSK, the AUSF generates the K_{AUSF} from the MSK, and the K_{SEAF} from the K_{AUSF} as described in 3GPP TS 33.501 [24].

NOTE 3: The AUSF provides the K_{SEAF} and optionally the SUPI (unless the SEAF provided the AUSF with the SUPI before) to the SEAF as described in 3GPP TS 33.501 [24]. Upon reception of the K_{SEAF} and optionally the SUPI, the SEAF generates the K_{AMF} based on the ABBA, the K_{SEAF} and the SUPI as described in 3GPP TS 33.501 [24], and provides ngKSI and the K_{AMF} to the AMF. Upon reception of the ngKSI and the K_{AMF} , the AMF creates a partial native 5G NAS security context identified by the ngKSI, and stores the K_{AMF} in the created partial native 5G NAS security context.

If the UE fails to authenticate the network, the UE shall start timer T3520 when the AUTHENTICATION RESPONSE message containing the EAP-response message is sent. Furthermore, the UE shall stop any of the retransmission timers that are running (e.g. T3510, T3517 or T3521). Upon receiving an AUTHENTICATION REQUEST message with the EAP message IE containing an EAP-request message from the network, the UE shall stop timer T3520, if running, and then process the EAP-request message as normally.

If the network fails to authenticate the UE, the network handling depends upon the type of identity used by the UE in the initial NAS message, that is:

- if the 5G-GUTI was used; or
- if the SUCI was used.

If the 5G-GUTI was used, the network should transport the EAP-failure message in the AUTHENTICATION RESULT message of the EAP result message transport procedure, initiate an identification procedure to retrieve SUCI from the UE and restart the EAP based primary authentication and key agreement procedure with the received SUCI.

If the SUCI was used for identification in the initial NAS message or in a restarted EAP based primary authentication and key agreement procedure, or the network decides not to initiate the identification procedure to retrieve SUCI from the UE after an unsuccessful the EAP based primary authentication and key agreement procedure, the network should transport the EAP-failure message in an AUTHENTICATION REJECT message of the EAP result message transport procedure.

If the EAP-failure message is received in an AUTHENTICATION REJECT message:

- a) if the AUTHENTICATION REJECT message has been successfully integrity checked by the NAS:

- 1) the UE shall set the update status to 5U3 ROAMING NOT ALLOWED, delete the stored 5G-GUTI, TAI list, last visited registered TAI and ngKSI.

In case of SNPN, if the UE is neither registered for onboarding services in SNPN nor performing initial registration for onboarding services in SNPN and the UE does not support access to an SNPN using credentials from a credentials holder and does not support equivalent SNPNs, the selected entry of the "list of subscriber data" with the SNPN identity of the current SNPN shall be considered invalid until the UE is switched off or the entry is updated;

In case of SNPN, if the UE is neither registered for onboarding services in SNPN nor performing initial registration for onboarding services in SNPN and the UE supports access to an SNPN using credentials from a credentials holder, equivalent SNPNs, or both, the UE shall consider the selected entry of the "list of subscriber data" as invalid until the UE is switched off or the entry is updated.

In case of SNPN, if the UE is registered for onboarding services in SNPN or is performing initial registration for onboarding services in SNPN, the UE shall store the SNPN identity in the "permanently forbidden SNPNs for onboarding services in SNPN" list, enter state 5GMM-DEREGISTERED.PLMN-SEARCH, and perform an SNPN selection or an SNPN selection for onboarding services according to 3GPP TS 23.122 [5]; and

- 2) if the UE is neither registered for onboarding services in SNPN nor performing initial registration for onboarding services in SNPN, the UE shall set the counter for "the entry for the current SNPN considered invalid for 3GPP access" events and the counter for "the entry for the current SNPN considered invalid for non-3GPP access" events in case of SNPN to UE implementation-specific maximum value.

If the UE is registered for onboarding services in SNPN or performing initial registration for onboarding services in SNPN, the UE shall set the SNPN-specific attempt counter for the current SNPN to the UE implementation-specific maximum value; and

- b) if the AUTHENTICATION REJECT message is received without integrity protection, the UE shall start timer T3247 with a random value uniformly drawn from the range between 30 minutes and 60 minutes, if the timer is not running (see subclause 5.3.20).

Additionally, if the UE is neither registered for onboarding services in SNPN nor performing initial registration for onboarding services in SNPN, the UE shall:

- 1) if the AUTHENTICATION REJECT message is received over 3GPP access, and the counter for "the entry for the current SNPN considered invalid for 3GPP access" events has a value less than a UE implementation-specific maximum value, proceed as specified in list item a) 1) of subclause 5.3.20.3 for the case that the 5GMM cause value received is #3;
- 2) if the AUTHENTICATION REJECT message is received over non-3GPP access, and the counter for "the entry for the current SNPN considered invalid for non-3GPP access" events has a value less than a UE implementation-specific maximum value, proceed as specified in list item a)-2) of subclause 5.3.20.3 for the case that the 5GMM cause value received is #3; or
- 3) otherwise:
 - i) if the AUTHENTICATION REJECT message is received over 3GPP access:
 - the UE shall set the update status for 3GPP access to 5U3 ROAMING NOT ALLOWED, delete for 3GPP access only the stored 5G-GUTI, TAI list, last visited registered TAI and ngKSI;

In case of SNPN, if the UE does not support access to an SNPN using credentials from a credentials holder and does not support equivalent SNPNs, the selected entry of the "list of subscriber data" with the SNPN identity of the current SNPN shall be considered invalid for 3GPP access until the UE is switched off or the entry is updated;

In case of SNPN, if the UE supports access to an SNPN using credentials from a credentials holder, equivalent SNPNs, or both, the UE shall consider the selected entry of the "list of subscriber data" as invalid until the UE is switched off or the entry is updated; and

- the UE shall set the counter for "the entry for the current SNPN considered invalid for 3GPP access" events to UE implementation-specific maximum value; and
- ii) if the AUTHENTICATION REJECT message is received over non-3GPP access:
 - the UE shall set the update status for non-3GPP access to 5U3 ROAMING NOT ALLOWED, delete for non-3GPP access only the stored 5G-GUTI, TAI list, last visited registered TAI and ngKSI. The selected entry of the "list of subscriber data" with the SNPN identity of the current SNPN shall be considered invalid for non-3GPP access until the UE is switched off or the entry is updated; and
 - the UE shall set the counter for "the entry for the current SNPN considered invalid for non-3GPP access" events to UE implementation-specific maximum value.

If the UE is registered for onboarding services in SNPN or performing initial registration for onboarding services in SNPN, the UE shall:

- 1) if the SNPN-specific attempt counter for the SNPN sending the AUTHENTICATION REJECT message has a value less than a UE implementation-specific maximum value, increment the SNPN-specific attempt counter for the SNPN; or
- 2) otherwise, the UE shall set the update status to 5U3.ROAMING NOT ALLOWED, delete the stored 5G-GUTI, TAI list, last visited registered TAI, and ngKSI, store the SNPN identity in the "permanently forbidden SNPNs for onboarding services in SNPN" list, enter state 5GMM-DEREGISTERED.PLMN-SEARCH, and perform an SNPN selection or an SNPN selection for onboarding services according to 3GPP TS 23.122 [5].

If the AUTHENTICATION REJECT message is received by the UE, the UE shall abort any 5GMM signalling procedure, stop any of the timers T3510, T3517, T3519 or T3521 (if they were running), enter state 5GMM-DEREGISTERED and delete any stored SUCI.

Upon receiving an EAP-success message, the ME shall:

- a) delete the valid K_{AUSF} and the valid K_{SEAF} , if any;
- b) if the ME has not generated a new K_{AUSF} and a new K_{SEAF} and has not created a partial native 5G NAS security context when handling the EAP-request message which resulted into generation of EMSK as described above:
 - 1) if:
 - i) the default UE credentials for primary authentication, if the UE is registering or registered for onboarding services in SNPN; or
 - ii) credentials in the selected entry of the "list of subscriber data", if the UE is not registering or registered for onboarding services in SNPN;

contain an indication to use MSK for derivation of K_{AUSF} after success of primary authentication and key agreement procedure then generate a new K_{AUSF} from the MSK otherwise generate a new K_{AUSF} from the EMSK;
 - 2) generate a new K_{SEAF} from the new K_{AUSF} , and the K_{AMF} from the ABBA that was received with the EAP-success message, and the K_{SEAF} as described in 3GPP TS 33.501 [24];
 - 3) create a partial native 5G NAS security context identified by the ngKSI value in the volatile memory of the ME; and
 - 4) store the K_{AMF} in the created partial native 5G NAS security context; and
- c) consider the new K_{AUSF} to be the valid K_{AUSF} , and the new K_{SEAF} to be the valid K_{SEAF} , reset the SOR counter and the UE parameter update counter to zero, store the valid K_{AUSF} , the valid K_{SEAF} , the SOR counter and the UE parameter update counter as specified in annex C, and use the valid K_{AUSF} in the verification of SOR transparent container and UE parameters update transparent container, if any are received.

The UE shall consider the procedure complete.

Upon receiving an EAP-failure message, the UE shall delete the partial native 5G NAS security context and shall delete the new K_{AUSF} and the new K_{SEAF} , if any were created when handling the EAP-request message which resulted into generation of EMSK or MSK as described above.

The UE shall consider the procedure complete.

5.4.1.2.3A.2 EAP-TTLS with two phases of authentication

The UE may support acting as EAP peer of EAP-TTLS with two phases of authentication as specified in 3GPP TS 33.501 [24] and acting as peer of a legacy authentication protocol as specified in 3GPP TS 33.501 [24]. The AUSF may support acting as EAP server of EAP-TTLS with two phases of authentication as specified in 3GPP TS 33.501 [24]. The AAA server of the CH or the DCS may support acting as a server of a legacy authentication protocol as specified in 3GPP TS 33.501 [24].

When EAP-TTLS with two phases of authentication as specified in 3GPP TS 33.501 [24] is used for primary authentication and key agreement in an SNPN:

- a) requirements in subclause 5.4.1.2.3A.1 shall apply in addition to requirements specified in 3GPP TS 33.501 [24] annex U;
- b) indication to use MSK for derivation of K_{AUSF} after success of primary authentication and key agreement procedure is not included in:
 - 1) the default UE credentials for primary authentication, if the UE is registering or registered for onboarding services in SNPN; or
 - 2) credentials in the selected entry of the "list of subscriber data", if the UE is not registering or registered for onboarding services in SNPN; and
- c) the SUPI of the UE is in the form of a SUPI with the SUPI format "network specific identifier" containing a network-specific identifier.

NOTE: Support of EAP-TTLS with two phases of authentication is based on the informative requirements as specified in 3GPP TS 33.501 [24].

5.4.1.2.3B Procedures related to EAP methods used for primary authentication of an N5GC device

5.4.1.2.3B.1 General

This subclause applies when an EAP method:

- a) supporting mutual authentication; and
- b) other than EAP-AKA',

is used for primary authentication of an N5GC device, when an W-AGF supports acting on behalf of the N5GC device, the AMF supports serving the W-AGF acting on behalf of the N5GC device and the AUSF supports authentication of the N5GC device. EAP-TLS is an example of such EAP method.

NOTE 1: Neither the N5GC device nor the AUSF derive any 5G related keys during or after the primary authentication.

The AUSF supporting authentication of the N5GC device shall support acting as EAP server of at least one such EAP method as specified in annex O of 3GPP TS 33.501 [24].

NOTE 2: The N5GC device supports acting as EAP peer of at least one such EAP method as specified in annex O of 3GPP TS 33.501 [24], which is also supported by the AUSF.

The W-AGF acting on behalf of the N5GC device provides to the N5GC device an EAP-request message, an EAP-success message or an EAP-failure message received from the network according to subclause 5.4.1.2.1 and sends to the network according to subclause 5.4.1.2.1 an EAP-response provided by the N5GC device. The N5GC device can inform the W-AGF acting on behalf of the N5GC device that the N5GC device fails to authenticate the network. Details

of communication between the N5GC device and the W-AGF acting on behalf of the N5GC device are out of scope of this specification.

When initiating an EAP based primary authentication and key agreement procedure using such EAP method, the network shall select an ngKSI value. The network shall send the selected ngKSI value to the W-AGF acting on behalf of the N5GC device along with each EAP message. The network shall send the ABBA value as described in subclause 9.11.3.10 to the W-AGF acting on behalf of the N5GC device along with the EAP-request message and EAP-success message. The W-AGF acting on behalf of the N5GC device shall not forward the ngKSI value or the ABBA value to the N5GC device.

NOTE 3: The network provides the ngKSI value and the ABBA value since the ngKSI IE and the ABBA IE are mandatory IEs in AUTHENTICATION REQUEST message. The W-AGF acting on behalf of the N5GC device does not use the ngKSI value or the ABBA value provided by the network.

If the N5GC device fails to authenticate the network, the W-AGF acting on behalf of the N5GC device shall start timer T3520 when the AUTHENTICATION RESPONSE message containing the EAP-response message is sent. Furthermore, the W-AGF acting on behalf of the N5GC device shall stop any of the retransmission timers that are running (e.g. T3510, T3517 or T3521). Upon receiving an AUTHENTICATION REQUEST message with the EAP message IE containing an EAP-request message from the network, the W-AGF acting on behalf of the N5GC device shall stop timer T3520, if running, and then provides the EAP-request message to the N5GC device as normally.

If the network fails to authenticate the N5GC device, the network handling depends upon the type of identity used by the W-AGF acting on behalf of the N5GC device in the initial NAS message, that is:

- a) if the 5G-GUTI was used; or
- b) if the SUCI was used.

If the 5G-GUTI was used, the network should transport the EAP-failure message in the AUTHENTICATION RESULT message of the EAP result message transport procedure, initiate an identification procedure to retrieve SUCI from the W-AGF acting on behalf of the N5GC device and restart the EAP based primary authentication and key agreement procedure with the received SUCI.

If the SUCI was used for identification in the initial NAS message or in a restarted EAP based primary authentication and key agreement procedure, or the network decides not to initiate the identification procedure to retrieve SUCI from the W-AGF acting on behalf of the N5GC device after an unsuccessful EAP based primary authentication and key agreement procedure, the network should transport the EAP-failure message in an AUTHENTICATION REJECT message of the EAP result message transport procedure.

If the EAP-failure message is received in an AUTHENTICATION REJECT message, the W-AGF acting on behalf of the N5GC device shall start timer T3247 with a random value uniformly drawn from the range between 30 minutes and 60 minutes, if the timer is not running (see subclause 5.3.20). Additionally, the W-AGF acting on behalf of the N5GC device shall:

- a) if the counter for "USIM considered invalid for 5GS services over non-3GPP access" events has a value less than a W-AGF implementation-specific maximum value, proceed as specified in list item 1)-b) of subclause 5.3.20.2 for the case that the 5GMM cause value received is #3; or
- b) otherwise, set the update status to 5U3 ROAMING NOT ALLOWED, delete the stored 5G-GUTI, TAI list, last visited registered TAI and ngKSI. The USIM shall be considered invalid for 5GS services via non-3GPP access until switching off or the UICC containing the USIM is removed.

If the AUTHENTICATION REJECT message is received by the W-AGF acting on behalf of the N5GC device, the W-AGF acting on behalf of the N5GC device shall abort any 5GMM signalling procedure, stop any of the timers T3510, T3517, T3519 or T3521 (if they were running), enter state 5GMM-DEREGISTERED and delete any stored SUCI.

Upon receiving an EAP-success message, the W-AGF acting on behalf of the N5GC device shall consider the procedure complete.

Upon receiving an EAP-failure message, the W-AGF acting on behalf of the N5GC device shall consider the procedure complete.

5.4.1.2.3C Procedures related to EAP methods used for primary authentication of an AUN3 device

5.4.1.2.3C.1 General

This subclause applies when an EAP method is used for primary authentication of an AUN3 device, when a 5G-RG supports acting on behalf of the AUN3 device, the AMF supports serving the 5G-RG acting on behalf of the AUN3 device and the AUSF supports authentication of the AUN3 device. EAP-AKA' and EAP-TLS are examples of such EAP method.

The AUSF supporting authentication of the AUN3 device shall support acting as EAP server of at least one such EAP method as specified in annex Z of 3GPP TS 33.501 [24].

The 5G-RG acting on behalf of the AUN3 device provides to the AUN3 device an EAP-request message, an EAP-success message or an EAP-failure message received from the network according to subclause 5.4.1.2.1 and sends to the network according to subclause 5.4.1.2.1 an EAP-response provided by the AUN3 device. Details of communication between the AUN3 device and the 5G-RG acting on behalf of the AUN3 device are out of scope of this specification.

When initiating an EAP based primary authentication and key agreement procedure using such EAP method, the network shall select an ngKSI value. The network shall send the selected ngKSI value to the 5G-RG acting on behalf of the AUN3 device along with each EAP message. The network shall send the ABBA value as described in subclause 9.11.3.10 to the 5G-RG acting on behalf of the AUN3 device along with the EAP-request message and EAP-success message. The 5G-RG acting on behalf of the AUN3 device shall not forward the ngKSI value or the ABBA value to the AUN3 device.

NOTE 1: The network provides the ngKSI value and the ABBA value since the ngKSI IE and the ABBA IE are mandatory IEs in AUTHENTICATION REQUEST message. The 5G-RG acting on behalf of the AUN3 device does not use the ngKSI value or the ABBA value provided by the network.

If the 5G-RG acting on behalf of the AUN3 device is informed by AUN3 about failure to authenticate the network, the 5G-RG acting on behalf of the AUN3 device shall start timer T3520 when the AUTHENTICATION RESPONSE message containing the EAP-response message is sent. Furthermore, the 5G-RG acting on behalf of the AUN3 device shall stop any of the retransmission timers that are running (e.g. T3510, T3517 or T3521). Upon receiving an AUTHENTICATION REQUEST message with the EAP message IE containing an EAP-request message from the network, the 5G-RG acting on behalf of the AUN3 device shall stop timer T3520, if running, and then provides the EAP-request message to the AUN3 device as normally.

If the network fails to authenticate the AUN3 device, the network handling depends upon the type of identity used by the 5G-RG acting on behalf of the AUN3 device in the initial NAS message, that is:

- a) if the 5G-GUTI was used; or
- b) if the SUCI was used.

If the 5G-GUTI was used, the network should transport the EAP-failure message in the AUTHENTICATION RESULT message as specified in the EAP result message transport procedure, initiate an identification procedure to retrieve SUCI from the 5G-RG acting on behalf of the AUN3 device and restart the EAP based primary authentication and key agreement procedure with the received SUCI.

If the SUCI was used for identification in the initial NAS message or in a restarted EAP based primary authentication and key agreement procedure, or the network decides not to initiate the identification procedure to retrieve SUCI from the 5G-RG acting on behalf of the AUN3 device after an unsuccessful EAP based primary authentication and key agreement procedure, the network should transport the EAP-failure message in an AUTHENTICATION REJECT message as specified in the EAP result message transport procedure.

If the EAP-failure message is received in an AUTHENTICATION REJECT message, the 5G-RG acting on behalf of the AUN3 device shall start timer T3247 with a random value uniformly drawn from the range between 30 minutes and 60 minutes, if the timer is not running (see subclause 5.3.20). Additionally, the 5G-RG acting on behalf of the AUN3 device shall:

- a) if the counter for "USIM considered invalid for 5GS services over non-3GPP access" events has a value less than a 5G-RG implementation-specific maximum value, proceed as specified in list item 1)-b) of subclause 5.3.20.2 for the case that the 5GMM cause value received is #3; or

- b) otherwise, set the update status to 5U3 ROAMING NOT ALLOWED, delete the stored 5G-GUTI, TAI list, last visited registered TAI and ngKSI. The USIM shall be considered invalid for 5GS services via non-3GPP access until switching off or the UICC containing the USIM is removed.

If the AUTHENTICATION REJECT message is received by the 5G-RG acting on behalf of the AUN3 device, the 5G-RG acting on behalf of the AUN3 device shall abort any 5GMM signalling procedure, stop any of the timers T3510, T3517, T3519 or T3521 (if they were running), enter state 5GMM-DEREGISTERED and delete any stored SUCI.

Upon receiving an EAP-success message from the network, the 5G-RG acting on behalf of the AUN3 device shall consider the procedure complete. The network shall provide:

- a) the Master session key, if the AUN3 device does not support 5G key hierarchy; or
b) the K_{WAGF} key, if the AUN3 device supports 5G key hierarchy;

to the 5G-RG along with the EAP-success message as specified in subclauses 5.4.1.2.5.2 and 5.4.2.2. The 5G-RG acting on behalf of the AUN3 device shall derive the Pairwise master key from the Master session key or the K_{WAGF} key as specified in subclause 7B.7 of 3GPP TS 33.501 [24]. The 5G-RG acting on behalf of the AUN3 device provides the EAP-success message to the AUN3 device.

NOTE 2: The network is aware from the AUN3 device subscription data in UDM whether the AUN3 device supports 5G key hierarchy or not as specified in subclause 7B.7 of 3GPP TS 33.501 [24].

Upon receiving an EAP-failure message from the network, the 5G-RG acting on behalf of the AUN3 device shall consider the procedure complete.

5.4.1.2.4 EAP message reliable transport procedure

5.4.1.2.4.1 General

The purpose of the EAP message reliable transport procedure is to provide a reliable transport of an EAP-request message, the ngKSI and the ABBA from the network to the UE and of an EAP-response message from the UE to the network.

The EAP message reliable transport procedure is initiated by an AUTHENTICATION REQUEST message with the EAP message IE.

5.4.1.2.4.2 EAP message reliable transport procedure initiation by the network

In order to initiate the EAP message reliable transport procedure, the AMF shall create an AUTHENTICATION REQUEST message.

The AMF shall set the EAP message IE of the AUTHENTICATION REQUEST message to the EAP-request message to be sent to the UE. The AMF shall set the ngKSI IE of the AUTHENTICATION REQUEST message to the ngKSI value selected in subclause 5.4.1.2.2.2, subclause 5.4.1.2.3.1 or subclause 5.4.1.2.3A.1. In this release of specification, the AMF shall set the ABBA IE of the AUTHENTICATION REQUEST message with the length of ABBA IE to 2 and the ABBA contents to be 2 octets in length with value 0000H as described in subclause 9.11.3.10.

The AMF shall send the AUTHENTICATION REQUEST message to the UE, and the AMF shall start timer T3560 (see example in figure 5.4.1.2.4.2.1).

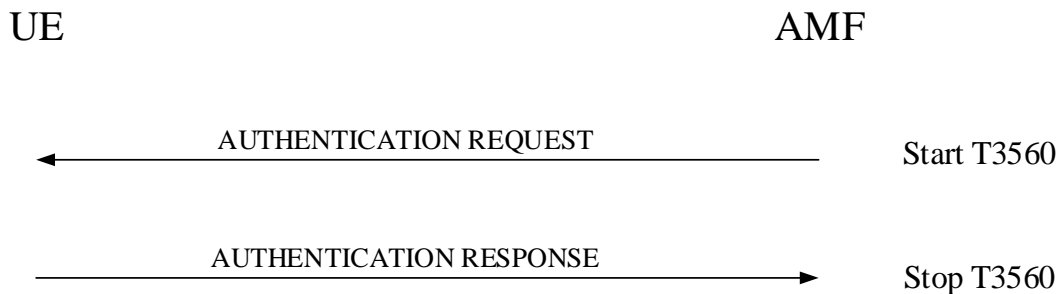

Figure 5.4.1.2.4.2.1: EAP message reliable transport procedure

Upon receipt of an AUTHENTICATION REQUEST message with the EAP message IE, the UE handles the EAP message received in the EAP message IE and the ABBA of the AUTHENTICATION REQUEST message.

5.4.1.2.4.3 EAP message reliable transport procedure accepted by the UE

The UE shall create an AUTHENTICATION RESPONSE message.

If the received EAP message is an EAP-request message, the UE shall set the EAP message IE of the AUTHENTICATION RESPONSE message to the EAP-response message responding to the received EAP-request message.

The UE shall send the AUTHENTICATION RESPONSE message to the AMF.

Upon receipt of an AUTHENTICATION RESPONSE message, the AMF shall stop timer T3560. If the EAP message IE is included in the AUTHENTICATION RESPONSE message, the AMF handles the EAP message received in the EAP message IE of the AUTHENTICATION RESPONSE message.

5.4.1.2.4.4 Abnormal cases on the network side

The following abnormal cases can be identified:

- a) Expiry of timer T3560.

The AMF shall, on the first expiry of the timer T3560, retransmit the AUTHENTICATION REQUEST message and shall reset and start timer T3560. This retransmission is repeated four times, i.e. on the fifth expiry of timer T3560, the AMF shall abort the EAP based primary authentication and key agreement procedure and any ongoing 5GMM specific procedure, and release the N1 NAS signalling connection.

- b) Lower layers indication of non-delivered NAS PDU due to handover.

If the AUTHENTICATION REQUEST message could not be delivered due to an intra AMF handover and the target TA is included in the TAI list, then upon successful completion of the intra AMF handover the AMF shall retransmit the AUTHENTICATION REQUEST message. If a failure of handover procedure is reported by the lower layer and the N1 NAS signalling connection exists, the AMF shall retransmit the AUTHENTICATION REQUEST message.

5.4.1.2.4.5 Abnormal cases in the UE

The following abnormal cases can be identified:

- a) Authentication failure (5GMM cause #71 "ngKSI already in use").

The UE shall send an AUTHENTICATION FAILURE message, with 5GMM cause #71 "ngKSI already in use", to the network and start the timer T3520 (see example in figure 5.4.1.3.7.1). Furthermore, the UE shall stop any of the retransmission timers that are running (e.g. T3510, T3517 or T3521). Upon the first receipt of an AUTHENTICATION FAILURE message from the UE with 5GMM cause #71 "ngKSI already in use", the network performs necessary actions to select a new ngKSI and send the same EAP-request message to the UE.

NOTE 1: Upon receipt of an AUTHENTICATION FAILURE message from the UE with 5GMM cause #71 "ngKSI already in use", the network can also re-initiate the EAP based primary authentication and key agreement procedure (see subclause 5.4.1.2.2.2).

Upon receiving a new AUTHENTICATION REQUEST message with the EAP message IE containing an EAP-request message from the network, the UE shall stop timer T3520, if running, process the EAP-request message as normal.

If the network is validated successfully (an AUTHENTICATION REQUEST message that contains a valid ngKSI and EAP-request message is received), the UE shall send the AUTHENTICATION RESPONSE message to the network and shall start any retransmission timers (e.g. T3510, T3517 or T3521) if they were running and stopped when the UE received the first failed AUTHENTICATION REQUEST message.

- b) Transmission failure of AUTHENTICATION RESPONSE message or AUTHENTICATION FAILURE message indication from lower layers (if the EAP based primary authentication and key agreement procedure is triggered by a registration procedure).

The UE shall stop the timer T3520, if running, and re-initiate the registration procedure.

- c) Transmission failure of AUTHENTICATION RESPONSE message or AUTHENTICATION FAILURE message indication with change in the current TAI (if the EAP based primary authentication and key agreement procedure is triggered by a service request procedure).

The UE shall stop the timer T3520, if running.

If the current TAI is not in the TAI list, the EAP based primary authentication and key agreement procedure shall be aborted and a registration procedure for mobility and periodic registration update shall be initiated.

If the current TAI is still part of the TAI list, it is up to the UE implementation how to re-run the ongoing procedure that triggered the EAP based primary authentication and key agreement procedure.

- d) Transmission failure of AUTHENTICATION RESPONSE message or AUTHENTICATION FAILURE message indication without change in the current TAI (if the authentication procedure is triggered by a service request procedure).

The UE shall stop the timer T3520, if running. It is up to the UE implementation how to re-run the ongoing procedure that triggered the EAP based primary authentication and key agreement procedure.

- e) Network failing the authentication check.

If the UE deems that the network has failed the authentication check, then it shall request RRC to locally release the RRC connection and treat the active cell as barred (see 3GPP TS 38.304 [28] or 3GPP TS 36.304 [25C]). The UE shall start any retransmission timers (e.g. T3510, T3517 or T3521), if they were running and stopped when the UE received the first AUTHENTICATION REQUEST message containing an ngKSI that was already in use.

- f) Change in the current TAI.

If that the current TAI is not in the TAI list before the AUTHENTICATION RESPONSE message is sent, the UE may discard sending the AUTHENTICATION RESPONSE message to the network and continue with the initiation of the registration procedure for mobility and periodic registration update as described in subclause 5.5.1.3.2.

For item e, if no emergency service is started or is ongoing:

The UE shall stop timer T3520, if the timer is running and the UE enters 5GMM-IDLE mode, e.g. upon detection of a lower layer failure, release of the N1 NAS signalling connection, or as the result of an inter-system change in 5GMM-CONNECTED mode from N1 mode to S1 mode.

The UE shall deem that the network has failed the authentication check or assume that the authentication is not genuine and proceed as described in item e above if any of the following occurs:

- the timer T3520 expires;
- the UE detects any combination of the EAP-based authentication failures: transmission of AUTHENTICATION FAILURE message with 5GMM cause #71 "ngKSI already in use", transmission of AUTHENTICATION RESPONSE message with an EAP-response message after detecting an error as described in subclause 5.4.1.2.2.4, with an EAP-response message after not accepting of the server certificate as described in subclause 5.4.1.2.3.1 or with an EAP-response message after failing to authenticate the network as described in subclause 5.4.1.2.3A.1, during three consecutive authentication challenges. The EAP-request/AKA'-challenge challenges shall be considered as consecutive only, if the EAP-request/AKA'-challenge challenges causing the second and third EAP-based authentication failure are received by the UE, while the timer T3520 started after the previous EAP-based authentication failure is running. Not accepting of the server certificate shall be considered as consecutive only, if the EAP-request messages causing the second and third not accepting of the server certificate are received by the UE, while the timer T3520 started after the previous EAP request message causing the previous not accepting of the server certificate is running.

NOTE 2: Reception of an EAP-failure message is not considered when determining the three consecutive authentication challenges or three consecutive not accepting of the server certificate.

For item e if there is an emergency service started or is ongoing:

The UE shall stop timer T3520, if the timer is running and the UE enters 5GMM-IDLE mode, e.g. upon detection of a lower layer failure, release of the N1 NAS signalling connection, or as the result of an inter-system change in 5GMM-CONNECTED mode from N1 mode to S1 mode.

If a UE has an emergency PDU session established or is establishing an emergency PDU session, and sends an AUTHENTICATION FAILURE message to the AMF with the 5GMM cause appropriate for this cases (i.e. #71) or an AUTHENTICATION RESPONSE message containing an EAP-response message as described in subclause 5.4.1.2.2.4, containing an EAP-response message after not accepting of the server certificate as described in subclause 5.4.1.2.3.1 or containing an EAP-response message after failing to authenticate the network as described in subclause 5.4.1.2.3A.1, and receives the SECURITY MODE COMMAND message before the timeout of timer T3520, the UE shall deem that the network has passed the authentication check successfully, stop timer T3520, respectively, and execute the security mode control procedure.

If a UE has an emergency PDU session established or is establishing an emergency PDU session when timer T3520 expires, the UE shall not deem that the network has failed the authentication check and not behave as described in item e. Instead the UE shall continue using the current security context, if any, release all non-emergency PDU sessions, if any, by initiating UE-requested PDU session release procedure. If there is an ongoing PDU session establishment procedure, the UE shall release all non-emergency PDU sessions upon completion of the PDU session establishment procedure.

The UE shall start any retransmission timers (e.g. T3510, T3517 or T3521) if:

- they were running and stopped when the UE received the AUTHENTICATION REQUEST message and detected an authentication failure; and
- the procedures associated with these timers have not yet been completed.

The UE shall consider itself to be registered for emergency services.

5.4.1.2.5 EAP result message transport procedure

5.4.1.2.5.1 General

The purpose of the EAP result message transport procedure is to provide an EAP-success message or an EAP-failure message, and ngKSI from the network to the UE, when the EAP message cannot be piggybacked by another NAS message.

The EAP result message transport procedure is initiated:

- a) by an AUTHENTICATION RESULT message with the EAP message IE carrying the EAP-success message or the EAP-failure message; or
- b) by an AUTHENTICATION REJECT message with the EAP message IE carrying the EAP-failure message.

5.4.1.2.5.2 EAP result message transport procedure initiation by the network

In order to initiate the EAP result message transport procedure, the AMF shall create an AUTHENTICATION RESULT message or an AUTHENTICATION REJECT message.

The AMF shall set the EAP message IE of the AUTHENTICATION RESULT message to an EAP-success message or an EAP-failure message to be sent to the UE. If the AUTHENTICATION RESULT message is provided to a 5G-RG that is acting on behalf of an AUN3 device and the EAP message IE is set to an EAP-success message, the AMF shall include the AUN3 device security key IE in the AUTHENTICATION RESULT message with its value set to:

- a) the Master session key, if the AUN3 device does not support 5G key hierarchy; or
- b) the K_{WAGF} key, if the AUN3 device supports 5G key hierarchy.

NOTE: The network is aware from the AUN3 device subscription data in UDM whether the AUN3 device supports 5G key hierarchy or not as specified in subclause 7B.7 of 3GPP TS 33.501 [24].

The AMF shall set the EAP message IE of the AUTHENTICATION REJECT message to an EAP-failure message to be sent to the UE. The AMF shall set the ngKSI IE of the AUTHENTICATION RESULT message or the AUTHENTICATION REJECT message to the ngKSI value selected in subclause 5.4.1.2.2.2, subclause 5.4.1.2.3.1 or subclause 5.4.1.2.3A.1.

The AMF shall send the AUTHENTICATION RESULT message or the AUTHENTICATION REJECT message to the UE (see example in figure 5.4.1.2.5.2.1).

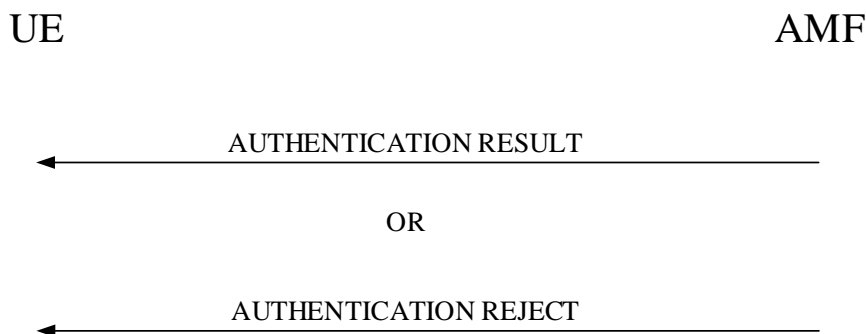

Figure 5.4.1.2.5.2.1: EAP result message transport procedure

Upon receipt of an AUTHENTICATION RESULT message or an AUTHENTICATION REJECT message with the EAP message IE, the UE handles the EAP message received in the EAP message IE and the ABBA if received of the AUTHENTICATION RESULT message or in the AUTHENTICATION REJECT message, and the 5G-RG that is acting on behalf of an AUN3 device handles the AUN3 device security key IE if received in the AUTHENTICATION RESULT message.

5.4.1.3 5G AKA based primary authentication and key agreement procedure

5.4.1.3.1 General

The purpose of the 5G AKA based primary authentication and key agreement procedure is to provide mutual authentication between the UE and the network and to agree on the keys K_{AUSF} , K_{SEAF} and K_{AMF} (see 3GPP TS 33.501 [24]). The cases when the 5G AKA based primary authentication and key agreement procedure is used are defined in 3GPP TS 33.501 [24].

The network initiates the 5G AKA based primary authentication and key agreement procedure by sending an AUTHENTICATION REQUEST message to the UE without the EAP message IE. The network shall include the ngKSI and the ABBA in AUTHENTICATION REQUEST message.

The 5G AKA based primary authentication and key agreement procedure is always initiated and controlled by the network. However, the UE can reject the 5G authentication challenge sent by the network.

The UE shall proceed with a 5G authentication challenge only if a USIM is present.

A partial native 5G NAS security context is established in the UE and the network when a 5G authentication is successfully performed. During a successful 5G AKA based primary authentication and key agreement procedure, the CK and IK are computed by the USIM. CK and IK are then used by the ME as key material to compute new keys K_{AUSF} , K_{SEAF} and K_{AMF} . K_{AMF} is stored in the 5G NAS security contexts (see 3GPP TS 33.501 [24]) of both the network and in the volatile memory of the ME while registered to the network, and is the root for the 5GS integrity protection and ciphering key hierarchy.

NOTE 1: Generation of the new K_{AUSF} and the new K_{SEAF} does not result into deletion of the valid K_{AUSF} and the valid K_{SEAF} , if any.

Upon successful completion of the 5G AKA based primary authentication, the AMF shall initiate a security mode control procedure (see subclause 5.4.2) to take the new partial native 5G NAS security context into use.

NOTE 2: The AMF immediately initiates a security mode control procedure (see subclause 5.4.2) after 5G AKA primary authentication is successful to avoid K_{AUSF} key mismatch between the UE and the network.

5.4.1.3.2 Authentication initiation by the network

The network may initiate a 5G AKA based primary authentication and key agreement procedure for a UE in 5GMM-CONNECTED mode at any time. For restrictions applicable after handover or inter-system change to N1 mode in 5GMM-CONNECTED mode, see subclause 5.5.1.3.3.

The network initiates the 5G AKA based primary authentication and key agreement procedure by sending an AUTHENTICATION REQUEST message to the UE and starting the timer T3560 (see example in figure 5.4.1.3.2.1). The AUTHENTICATION REQUEST message shall contain the parameters necessary to calculate the authentication response (see 3GPP TS 33.501 [24]). This message shall include the ngKSI that will be used by the UE and AMF to identify the K_{AMF} and the partial native security context that is created if the authentication is successful. This message shall also include the ABBA parameter. In this release of specification, the network shall set the length of ABBA IE to 2 and the ABBA contents to be 2 octets in length with value 0000H as described in subclause 9.11.3.10.

If an ngKSI is contained in an initial NAS message during a 5GMM procedure, the network shall include a different ngKSI value in the AUTHENTICATION REQUEST message when it initiates a 5G AKA based primary authentication and key agreement procedure.

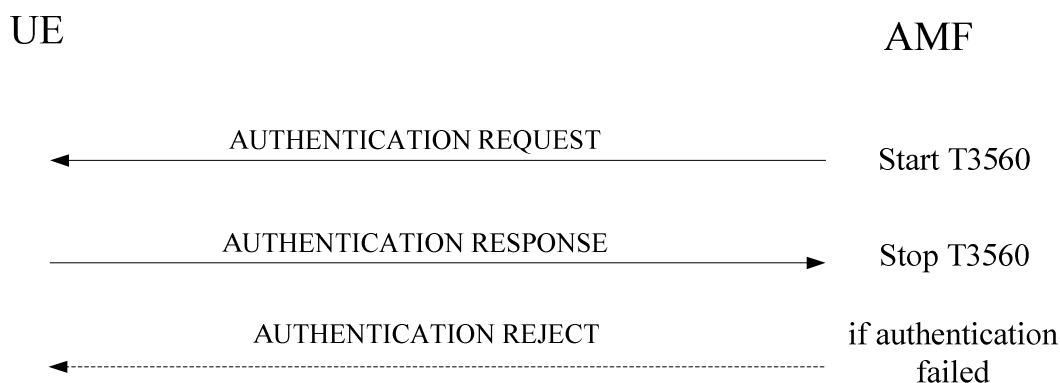

Figure 5.4.1.3.2.1: 5G AKA based primary authentication and key agreement procedure

5.4.1.3.3 Authentication response by the UE

The UE shall respond to an AUTHENTICATION REQUEST message. With the exception of the cases described in subclause 5.4.1.3.6 and 5.4.1.3.7 case 1, the UE shall process the 5G authentication challenge data and respond with an AUTHENTICATION RESPONSE message to the network.

Upon a successful 5G authentication challenge, the UE shall determine the PLMN identity in case of PLMN or the SNPN identity in case of SNPN to be used for the calculation of the new K_{AMF} from the 5G authentication challenge data according to the following rules:

- a) When the UE moves from 5GMM-IDLE mode to 5GMM-CONNECTED mode, until the first handover, the UE shall use the PLMN identity of the selected PLMN or the SNPN identity of the selected SNPN; and
- b) After handover or inter-system change to N1 mode in 5GMM-CONNECTED mode,
 - 1) if the target cell is not a shared network cell, the UE shall use the PLMN identity in case of PLMN or the SNPN identity in case of SNPN received as part of the broadcast system information;
 - 2) if the target cell is a shared network cell and the UE has a valid 5G-GUTI, the UE shall use the PLMN identity in case of PLMN or the SNPN identity in case of SNPN that is part of the 5G-GUTI; and
 - 3) if the target cell is a shared network cell and the UE has a valid 4G-GUTI, but not a valid 5G-GUTI, the UE shall use the PLMN identity that is part of the 4G-GUTI.

Upon a successful 5G authentication challenge, the new K_{AMF} calculated from the 5G authentication challenge data shall be stored in a new 5G NAS security context in the volatile memory of the ME.

The USIM will compute the authentication response (RES) using the 5G authentication challenge data received from the ME, and pass RES to the ME. From the RES, RES* is then generated according to Annex A of 3GPP TS 33.501 [24].

In order to avoid a synchronisation failure, when the UE receives an AUTHENTICATION REQUEST message, the UE shall store the received RAND together with the RES*, in the volatile memory of the ME. When the UE receives a subsequent AUTHENTICATION REQUEST message, if the stored RAND value is equal to the new received value in the AUTHENTICATION REQUEST message, then the ME shall not pass the RAND to the USIM, but shall send the AUTHENTICATION RESPONSE message with the stored RES*. If there is no valid stored RAND in the ME or the stored RAND is different from the new received value in the AUTHENTICATION REQUEST message, the ME shall pass the RAND to the USIM, shall override any previously stored RAND and RES* with the new ones and start, or reset and restart timer T3516.

The RAND and RES* values stored in the ME shall be deleted and timer T3516, if running, shall be stopped:

- a) upon receipt of a
 - 1) SECURITY MODE COMMAND message,
 - 2) SERVICE REJECT message,

- 3) REGISTRATION REJECT message,
 - 4) REGISTRATION ACCEPT message,
 - 5) AUTHENTICATION REJECT message, or
 - 6) SERVICE ACCEPT message;
- b) upon expiry of timer T3516;
- c) if the UE enters the 5GMM state 5GMM-DEREGISTERED or 5GMM-NULL; or
- d) if the UE enters 5GMM-IDLE mode.

5.4.1.3.4 Authentication completion by the network

Upon receipt of an AUTHENTICATION RESPONSE message, the network stops the timer T3560 and checks the correctness of RES* (see 3GPP TS 33.501 [24]).

If the 5G AKA based primary authentication and key agreement procedure has been completed successfully and the related ngKSI is stored in the 5G NAS security context of the network, the network shall include a different ngKSI value in the AUTHENTICATION REQUEST message when it initiates a new 5G AKA based primary authentication and key agreement procedure.

Upon receipt of an AUTHENTICATION FAILURE message, the network stops the timer T3560. In the case where the 5GMM cause #21 "synch failure" is received, the core network may renegotiate with the UDM/AUSF and provide the UE with new authentication parameters.

5.4.1.3.5 Authentication not accepted by the network

If the authentication response (RES) returned by the UE is not valid, the network response depends upon the type of identity used by the UE in the initial NAS message, that is:

- if the 5G-GUTI was used; or
- if the SUCI was used.

If the 5G-GUTI was used, the network should initiate an identification procedure to retrieve SUCI from the UE and restart the 5G AKA based primary authentication and key agreement procedure with the received SUCI.

If the SUCI was used for identification in the initial NAS message or in a restarted 5G AKA based primary authentication and key agreement procedure, or the network decides not to initiate the identification procedure to retrieve SUCI from the UE after an unsuccessful 5G AKA based primary authentication and key agreement procedure, the network should send an AUTHENTICATION REJECT message to the UE. The network shall maintain, if any, the 5GMM-context and 5G NAS security context of the UE unchanged.

Upon receipt of an AUTHENTICATION REJECT message,

- 1) if the AUTHENTICATION REJECT message has been successfully integrity checked by the NAS:

the UE shall set the update status to 5U3 ROAMING NOT ALLOWED, delete the stored 5G-GUTI, TAI list, last visited registered TAI and ngKSI.

In case of PLMN, the USIM shall be considered invalid until switching off the UE or the UICC containing the USIM is removed.

In case of SNPN, if the UE is neither registered for onboarding services in SNPN nor performing initial registration for onboarding services in SNPN and the UE does not support access to an SNPN using credentials from a credentials holder and does not support equivalent SNPNs, the entry of the "list of subscriber data" with the SNPN identity of the current SNPN shall be considered invalid until the UE is switched off or the entry is updated. Additionally, the UE shall consider the USIM as invalid for the current SNPN until switching off or the UICC containing the USIM is removed.

In case of SNPN, if the UE is neither registered for onboarding services in SNPN nor performing initial registration for onboarding services in SNPN and the UE supports access to an SNPN using credentials from

a credentials holder, equivalent SNPNs, or both, the UE shall consider the selected entry of the "list of subscriber data" as invalid for 3GPP access until the UE is switched off or the entry is updated. Additionally, the UE shall consider the USIM as invalid for the entry until switching off or the UICC containing the USIM is removed.

In case of SNPN, if the UE is registered for onboarding services in SNPN or is performing initial registration for onboarding services in SNPN, the UE shall store the SNPN identity in the "permanently forbidden SNPNs for onboarding services in SNPN" list, enter state 5GMM-DEREGISTERED.PLMN-SEARCH, and perform an SNPN selection or an SNPN selection for onboarding services according to 3GPP TS 23.122 [5]; and

- if the UE is neither registered for onboarding services in SNPN nor performing initial registration for onboarding services in SNPN, the UE shall set:
 - i) the counter for "SIM/USIM considered invalid for GPRS services" events, the counter for "USIM considered invalid for 5GS services over non-3GPP access" events, and the counter for "SIM/USIM considered invalid for non-GPRS services" events if maintained by the UE, in case of PLMN; or
 - ii) the counter for "the entry for the current SNPN considered invalid for 3GPP access" events and the counter for "the entry for the current SNPN considered invalid for non-3GPP access" events in case of SNPN;

to UE implementation-specific maximum value.

If the UE is registered for onboarding services in SNPN or performing initial registration for onboarding services in SNPN, the UE shall set the SNPN-specific attempt counter for the current SNPN to the UE implementation-specific maximum value; and

- if the UE is operating in single-registration mode, the UE shall handle EMM parameters, 4G-GUTI, last visited registered TAI, TAI list and eKSI as specified in 3GPP TS 24.301 [15] for the case when the authentication procedure is not accepted by the network. The USIM shall be considered as invalid also for non-EPS services until switching off or the UICC containing the USIM is removed; and
- 2) if the AUTHENTICATION REJECT message is received without integrity protection and if timer T3516 or T3520 is running, the UE shall start timer T3247 with a random value uniformly drawn from the range between 30 minutes and 60 minutes, if the timer is not running (see subclause 5.3.20).

Additionally, if the UE is neither registered for onboarding services in SNPN nor performing initial registration for onboarding services in SNPN, the UE shall:

- a) if the AUTHENTICATION REJECT message is received over 3GPP access, and the counter for "SIM/USIM considered invalid for GPRS services" events in case of PLMN or the counter for "the entry for the current SNPN considered invalid for 3GPP access" events in case of SNPN has a value less than a UE implementation-specific maximum value, proceed as specified in subclause 5.3.20, list item 1)-a) of subclause 5.3.20.2 (if the UE is not operating in SNPN access operation mode) or list item a)-1) of subclause 5.3.20.3 (if the UE is operating in SNPN access operation mode) for the case that the 5GMM cause value received is #3;
- b) if the AUTHENTICATION REJECT message is received over non-3GPP access, and the counter for "USIM considered invalid for 5GS services over non-3GPP access" events in case of PLMN or the counter for "the entry for the current SNPN considered invalid for non-3GPP access" events in case of SNPN has a value less than a UE implementation-specific maximum value, proceed as specified in subclause 5.3.20, list item 1)-b) of subclause 5.3.20.2 (if the UE is not operating in SNPN access operation mode) or list item a)-2) of subclause 5.3.20.3 (if the UE is operating in SNPN access operation mode) for the case that the 5GMM cause value received is #3.
- c) otherwise:
 - i) if the AUTHENTICATION REJECT message is received over 3GPP access:
 - The UE shall set the update status for 3GPP access to 5U3 ROAMING NOT ALLOWED, delete for 3GPP access only the stored 5G-GUTI, TAI list, last visited registered TAI and ngKSI.
 - In case of PLMN, the UE shall consider the USIM as invalid for 5GS services via 3GPP access and non-EPS service until switching off the UE or the UICC containing the USIM is removed.

In case of SNPN, the UE shall consider the entry of the "list of subscriber data" with the SNPN identity of the current SNPN shall be considered invalid for 3GPP access until the UE is switched off or the entry is updated. Additionally, the UE shall consider the USIM as invalid for the current SNPN via 3GPP access until switching off or the UICC containing the USIM is removed.

- The UE shall set:
 - the counter for "SIM/USIM considered invalid for GPRS services" events and the counter for "SIM/USIM considered invalid for non-GPRS services" events if maintained by the UE, in case of PLMN; or
 - the counter for "the entry for the current SNPN considered invalid for 3GPP access" events in case of SNPN;

to UE implementation-specific maximum value.

- If the UE is operating in single-registration mode, the UE shall handle 4G-GUTI, TAI list and eKSI as specified in 3GPP TS 24.301 [15] for the case when the authentication procedure is not accepted by the network. The USIM shall be considered as invalid also for non-EPS services until switching off or the UICC containing the USIM is removed; and

ii) if the AUTHENTICATION REJECT message is received over non-3GPP access:

- the UE shall set the update status for non-3GPP access to 5U3 ROAMING NOT ALLOWED, delete for non-3GPP access only the stored 5G-GUTI, TAI list, last visited registered TAI and ngKSI;
- in case of PLMN, the UE shall consider the USIM as invalid for 5GS services via non-3GPP access until switching off the UE or the UICC containing the USIM is removed.

In case of SNPN, the UE shall consider the entry of the "list of subscriber data" with the SNPN identity of the current SNPN as invalid for non-3GPP access until the UE is switched off or the entry is updated. Additionally, the UE shall consider the USIM as invalid for the current SNPN and for non-3GPP access until switching off or the UICC containing the USIM is removed; and

- the UE shall set:
 - the counter for "USIM considered invalid for 5GS services over non-3GPP access" events to UE implementation-specific maximum value in case of PLMN; or
 - the counter for "the entry for the current SNPN considered invalid for non-3GPP access" events to UE implementation-specific maximum value in case of SNPN.

If the UE is registered for onboarding services in SNPN or performing initial registration for onboarding services in SNPN, the UE shall:

- 1) if the SNPN-specific attempt counter for the SNPN sending the AUTHENTICATION REJECT message has a value less than a UE implementation-specific maximum value, increment the SNPN-specific attempt counter for the SNPN; or
- 2) otherwise, the UE shall set the update status to 5U3.ROAMING NOT ALLOWED, delete the stored 5G-GUTI, TAI list, last visited registered TAI, and ngKSI, store the SNPN identity in the "permanently forbidden SNPNs for onboarding services in SNPN" list, enter state 5GMM-DEREGISTERED.PLMN-SEARCH, and perform an SNPN selection or an SNPN selection for onboarding services according to 3GPP TS 23.122 [5].

If the AUTHENTICATION REJECT message is received by the UE, the UE shall abort any 5GMM signalling procedure, stop any of the timers T3510, T3516, T3517, T3519, T3520 or T3521 (if they were running), enter state 5GMM-DEREGISTERED and delete any stored SUCI.

Depending on local requirements or operator preference for emergency services, if the UE initiates a registration procedure with 5GS registration type IE set to "emergency registration" and the AMF is configured to allow emergency registration without user identity, the AMF needs not follow the procedures specified for the authentication failure in the present subclause. The AMF may continue a current 5GMM specific procedure.

5.4.1.3.6 Authentication not accepted by the UE

In the 5G authentication challenge, the UE shall check the 5G authentication challenge data (RAND, AUTN and ngKSI) received in the AUTHENTICATION REQUEST message to verify authenticity of the 5G core network.

The ME shall check that ngKSI received in the AUTHENTICATION REQUEST message is not already in use. The ME shall forward the RAND and AUTN to the USIM to check.

The UE may reject the core network due to an incorrect AUTN or ngKSI parameter. If the UE has to reject the 5G authentication challenge, the UE shall return AUTHENTICATION FAILURE message to the network with a cause value indicating the reason for the failure (see 3GPP TS 33.501 [24]).

Incorrect 5G authentication challenge data contains four possible causes for authentication failure:

a) MAC code failure:

If the UE finds the MAC code (supplied by the core network in the AUTN parameter) to be invalid, the UE shall send an AUTHENTICATION FAILURE message to the network, with the 5GMM cause #20 "MAC failure". The UE shall then follow the procedure described in subclause 5.4.1.3.7, item c.

b) Non-5G authentication unacceptable:

If the UE finds that the "separation bit" in the AMF field of AUTN supplied by the core network is set to 0, the UE shall send an AUTHENTICATION FAILURE message to the network, with the 5GMM cause #26 "non-5G authentication unacceptable" (see subclause 6.1.3 in 3GPP TS 33.501 [24]). The UE shall then follow the procedure described in subclause 5.4.1.3.7, item d.

c) ngKSI already in use:

If the UE detects that ngKSI received in the AUTHENTICATION REQUEST message is already in use in the UE shall send an AUTHENTICATION FAILURE message to the network, with the 5GMM cause #71 "ngKSI already in use". The UE shall then follow the procedure described in subclause 5.4.1.3.7, item e.

d) SQN failure:

If the UE finds the sequence number SQN (supplied by the core network in the AUTN parameter) to be out of range, the UE shall send an AUTHENTICATION FAILURE message to the network, with the 5GMM cause #21 "synch failure" and a re-synchronization token AUTS provided by the USIM (see 3GPP TS 33.102 [23]). The UE shall then follow the procedure described in subclause 5.4.1.3.7, item f.

If the UE returns an AUTHENTICATION FAILURE message to the network, the UE shall delete any previously stored RAND and RES* and shall stop timer T3516, if running.

If the UE has an emergency PDU session established or is establishing such a PDU session, additional UE requirements are specified in subclause 5.4.1.3.7, under "for items c, d, e and f".

5.4.1.3.7 Abnormal cases

a) Lower layer failure.

Upon detection of lower layer failure before the AUTHENTICATION RESPONSE message is received, the network shall abort the procedure.

b) Expiry of timer T3560.

The network shall, on the first expiry of the timer T3560, retransmit the AUTHENTICATION REQUEST message and shall reset and start timer T3560. This retransmission is repeated four times, i.e. on the fifth expiry of timer T3560, the network shall abort the 5G AKA based primary authentication and key agreement procedure and any ongoing 5GMM specific procedure and release the N1 NAS signalling connection.

c) Authentication failure (5GMM cause #20 "MAC failure").

The UE shall send an AUTHENTICATION FAILURE message, with 5GMM cause #20 "MAC failure" according to subclause 5.4.1.3.6, to the network and start timer T3520 (see example in figure 5.4.1.3.7.1). Furthermore, the UE shall stop any of the retransmission timers that are running (e.g. T3510, T3517 or T3521).

Upon the first receipt of an AUTHENTICATION FAILURE message from the UE with 5GMM cause #20 "MAC failure", the network may initiate the identification procedure described in subclause 5.4.3. This is to allow the network to obtain the SUCI from the UE. The network may then check that the 5G-GUTI originally used in the 5G authentication challenge corresponded to the correct SUPI. Upon receipt of the IDENTITY REQUEST message from the network, the UE shall proceed as specified in subclause 5.4.3.3.

NOTE 1: Upon receipt of an AUTHENTICATION FAILURE message from the UE with 5GMM cause #20 "MAC failure", the network may also terminate the 5G AKA based primary authentication and key agreement procedure (see subclause 5.4.1.3.5).

If the mapping of 5G-GUTI to SUPI in the network was incorrect, the network should respond by sending a new AUTHENTICATION REQUEST message to the UE. Upon receiving the new AUTHENTICATION REQUEST message from the network, the UE shall stop the timer T3520, if running, and then process the 5G challenge information as normal. If the mapping of 5G-GUTI to SUPI in the network was correct, the network should terminate the 5G AKA based primary authentication and key agreement procedure by sending an AUTHENTICATION REJECT message (see subclause 5.4.1.3.5).

If the network is validated successfully (an AUTHENTICATION REQUEST message that contains a valid SQN and MAC is received), the UE shall send the AUTHENTICATION RESPONSE message to the network and shall start any retransmission timers (e.g. T3510, T3517 or T3521) if they were running and stopped when the UE received the first failed AUTHENTICATION REQUEST message.

If the UE receives the second AUTHENTICATION REQUEST message, and the MAC value cannot be resolved, the UE shall follow the procedure specified in this subclause, item c, starting again from the beginning, or if the message contains a UMTS authentication challenge, the UE shall follow the procedure specified in item d. If the SQN is invalid, the UE shall proceed as specified in item f.

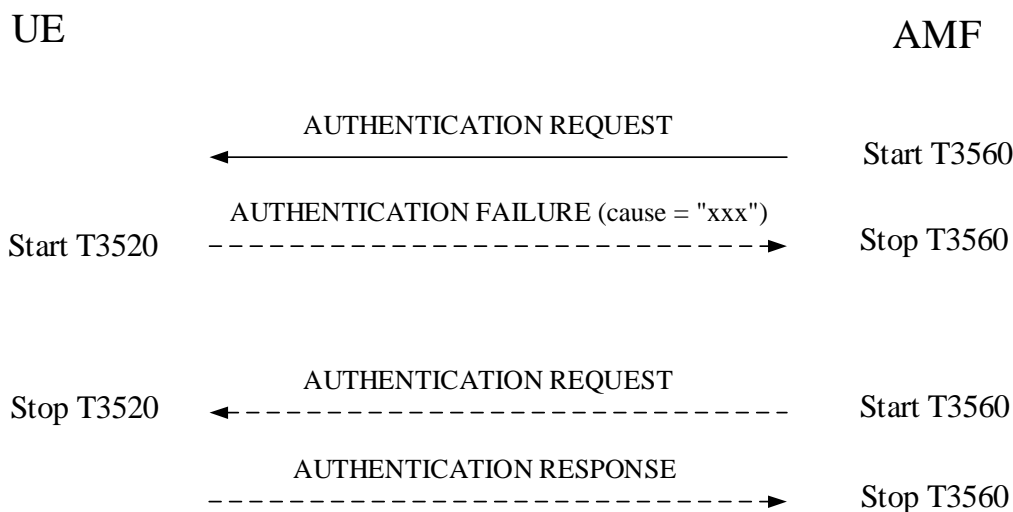

Figure 5.4.1.3.7.1: Authentication failure during 5G AKA based primary authentication and key agreement procedure

d) Authentication failure (5GMM cause #26 "non-5G authentication unacceptable").

The UE shall send an AUTHENTICATION FAILURE message, with 5GMM cause #26 "non-5G authentication unacceptable", to the network and start the timer T3520 (see example in figure 5.4.1.3.7.1). Furthermore, the UE shall stop any of the retransmission timers that are running (e.g. T3510, T3517 or T3521). Upon the first receipt of an AUTHENTICATION FAILURE message from the UE with 5GMM cause #26 "non-5G authentication unacceptable", the network may initiate the identification procedure described in subclause 5.4.3. This is to allow the network to obtain the SUCI from the UE. The network may then check that the 5G-GUTI originally used in the 5G authentication challenge corresponded to the correct SUPI. Upon receipt of the IDENTITY REQUEST message from the network, the UE shall proceed as specified in subclause 5.4.3.3.

NOTE 2: Upon receipt of an AUTHENTICATION FAILURE message from the UE with 5GMM cause #26 "non-5G authentication unacceptable", the network may also terminate the 5G AKA based primary authentication and key agreement procedure (see subclause 5.4.1.3.5).

If the mapping of 5G-GUTI to SUPI in the network was incorrect, the network should respond by sending a new AUTHENTICATION REQUEST message to the UE. Upon receiving the new AUTHENTICATION REQUEST message from the network, the UE shall stop the timer T3520, if running, and then process the 5G challenge information as normal. If the mapping of 5G-GUTI to SUPI in the network was correct, the network should terminate the 5G AKA based primary authentication and key agreement authentication procedure by sending an AUTHENTICATION REJECT message (see subclause 5.4.1.3.5).

If the network is validated successfully (an AUTHENTICATION REQUEST message that contains a valid 5G authentication challenge is received), the UE shall send the AUTHENTICATION RESPONSE message to the network and shall start any retransmission timers (e.g. T3510, T3517 or T3521) if they were running and stopped when the UE received the first failed AUTHENTICATION REQUEST message.

- e) Authentication failure (5GMM cause #71 "ngKSI already in use").

The UE shall send an AUTHENTICATION FAILURE message, with 5GMM cause #71 "ngKSI already in use", to the network and start the timer T3520 (see example in figure 5.4.1.3.7.1). Furthermore, the UE shall stop any of the retransmission timers that are running (e.g. T3510, T3517 or T3521). Upon the first receipt of an AUTHENTICATION FAILURE message from the UE with 5GMM cause #71 "ngKSI already in use", the network performs necessary actions to select a new ngKSI and send the same 5G authentication challenge to the UE.

- NOTE 3: Upon receipt of an AUTHENTICATION FAILURE message from the UE with 5GMM cause #71 "ngKSI already in use", the network may also re-initiate the 5G AKA based primary authentication and key agreement procedure (see subclause 5.4.1.3.2).

Upon receiving the new AUTHENTICATION REQUEST message from the network, the UE shall stop the timer T3520, if running, and then process the 5G challenge information as normal.

If the network is validated successfully (an AUTHENTICATION REQUEST message that contains a valid ngKSI, SQN and MAC is received), the UE shall send the AUTHENTICATION RESPONSE message to the network and shall start any retransmission timers (e.g. T3510, T3517 or T3521) if they were running and stopped when the UE received the first failed AUTHENTICATION REQUEST message.

- f) Authentication failure (5GMM cause #21 "synch failure").

The UE shall send an AUTHENTICATION FAILURE message, with 5GMM cause #21 "synch failure", to the network and start the timer T3520 (see example in figure 5.4.1.3.7.1). Furthermore, the UE shall stop any of the retransmission timers that are running (e.g. T3510, T3517 or T3521). Upon the first receipt of an AUTHENTICATION FAILURE message from the UE with the 5GMM cause #21 "synch failure", the network shall use the returned AUTS parameter from the authentication failure parameter IE in the AUTHENTICATION FAILURE message, to re-synchronise. The re-synchronisation procedure requires the AMF to delete all unused authentication vectors for that SUPI and obtain new vectors from the UDM/AUSF. When re-synchronisation is complete, the network shall initiate the 5G AKA based primary authentication and key agreement procedure. Upon receipt of the AUTHENTICATION REQUEST message, the UE shall stop the timer T3520, if running.

- NOTE 4: Upon receipt of two consecutive AUTHENTICATION FAILURE messages from the UE with 5GMM cause #21 "synch failure", the network may terminate the 5G AKA based primary authentication and key agreement procedure by sending an AUTHENTICATION REJECT message.

If the network is validated successfully (a new AUTHENTICATION REQUEST message is received which contains a valid SQN and MAC) while T3520 is running, the UE shall send the AUTHENTICATION RESPONSE message to the network and shall start any retransmission timers (e.g. T3510, T3517 or T3521), if they were running and stopped when the UE received the first failed AUTHENTICATION REQUEST message.

Upon receipt of an AUTHENTICATION REJECT message, the UE shall perform the actions as specified in subclause 5.4.1.3.5.

- g) Network failing the authentication check.

If the UE deems that the network has failed the authentication check, then it shall request RRC to locally release the RRC connection and treat the active cell as barred (see 3GPP TS 38.304 [28] or 3GPP TS 36.304 [25C]). The UE shall start any retransmission timers (e.g. T3510, T3517 or T3521), if they were running and stopped when the UE received the first AUTHENTICATION REQUEST message containing an incorrect authentication challenge data causing authentication failure.

- h) Transmission failure of AUTHENTICATION RESPONSE message or AUTHENTICATION FAILURE message indication from lower layers (if the 5G AKA based primary authentication and key agreement procedure is triggered by a registration procedure).

The UE shall stop the timer T3520, if running, and re-initiate the registration procedure.

- i) Transmission failure of AUTHENTICATION RESPONSE message or AUTHENTICATION FAILURE message indication with change in the current TAI (if the 5G AKA based primary authentication and key agreement procedure is triggered by a service request procedure).

The UE shall stop the timer T3520, if running.

If the current TAI is not in the TAI list, the 5G AKA based primary authentication and key agreement procedure shall be aborted and a registration procedure for mobility and periodic registration update shall be initiated.

If the current TAI is still part of the TAI list, it is up to the UE implementation how to re-run the ongoing procedure that triggered the 5G AKA based primary authentication and key agreement procedure.

- j) Transmission failure of AUTHENTICATION RESPONSE message or AUTHENTICATION FAILURE message indication without change in the current TAI (if the authentication procedure is triggered by a service request procedure).

The UE shall stop the timer T3520, if running. It is up to the UE implementation how to re-run the ongoing procedure that triggered the 5G AKA based primary authentication and key agreement procedure.

- k) Lower layers indication of non-delivered NAS PDU due to handover.

If the AUTHENTICATION REQUEST message could not be delivered due to an intra AMF handover and the target TA is included in the TAI list, then upon successful completion of the intra AMF handover the AMF shall retransmit the AUTHENTICATION REQUEST message. If a failure of handover procedure is reported by the lower layer and the N1 NAS signalling connection exists, the AMF shall retransmit the AUTHENTICATION REQUEST message.

- l) Change in the current TAI.

If the current TAI is not in the TAI list before the AUTHENTICATION RESPONSE message is sent, the UE may discard sending the AUTHENTICATION RESPONSE message to the network and continue with the initiation of the registration procedure for mobility and periodic registration update as described in subclause 5.5.1.3.2.

- m) AUTHENTICATION REJECT message is received without integrity protection and neither timer T3516 nor T3520 is running.

If an AUTHENTICATION REJECT message is received without integrity protection and if neither timer T3516 nor T3520 is running, then the UE shall discard the AUTHENTICATION REJECT message. Additionally, the UE may request RRC to locally release the RRC connection and treat the active cell as barred (see 3GPP TS 38.304 [28] or 3GPP TS 36.304 [25C]).

For items c, d, e, and f if no emergency service is started or is ongoing:

The UE shall stop timer T3520, if the timer is running and the UE enters 5GMM-IDLE mode, e.g. upon detection of a lower layer failure, release of the N1 NAS signalling connection, or as the result of an inter-system change in 5GMM-CONNECTED mode from N1 mode to S1 mode.

The UE shall deem that the network has failed the authentication check or assume that the authentication is not genuine and proceed as described in item g above if any of the following occurs:

- the timer T3520 expires;
- the UE detects any combination of the 5G authentication failures: 5GMM causes #20 "MAC failure", #21 "synch failure", #26 "non-5G authentication unacceptable" or #71 "ngKSI already in use", during three consecutive authentication challenges. The 5G authentication challenges shall be considered as consecutive only, if the 5G authentication challenges causing the second and third 5G authentication failure are received by the UE, while the timer T3520 started after the previous 5G authentication failure is running.

For items c, d, e, and f if there is an emergency service started or is ongoing:

The UE shall stop timer T3520, if the timer is running and the UE enters 5GMM-IDLE mode, e.g. upon detection of a lower layer failure, release of the N1 NAS signalling connection, or as the result of an inter-system change in 5GMM-CONNECTED mode from N1 mode to S1 mode.

If there is an ongoing:

- service request procedure for emergency services fallback the UE shall abort the service request procedure, stop timer T3517 and locally release any resources allocated for the service request procedure and enter state 5GMM-REGISTERED; or
- registration procedure for mobility and periodic registration update triggered upon a request from the upper layers to perform an emergency services fallback procedure the UE shall abort the registration procedure for mobility and periodic registration update, stop timer T3510 and locally release any resources allocated for the registration procedure for mobility and periodic registration update and enter the state 5GMM-REGISTERED; and

the UE shall attempt to select an E-UTRA cell connected to EPC or 5GCN according to the domain priority and selection rules specified in 3GPP TS 23.167 [6]. If the UE finds a suitable E-UTRA cell, it proceeds with the appropriate EMM or 5GMM procedures. If the UE operating in single-registration mode has changed to S1 mode, it shall disable the N1 mode capability for 3GPP access.

Depending on local requirements or operator preference for emergency services, if the UE has an emergency PDU session established or is establishing an emergency PDU session, the AMF need not follow the procedures specified for the authentication failure specified in the present subclause. The AMF may respond to the AUTHENTICATION FAILURE message by initiating the security mode control procedure selecting the "null integrity protection algorithm" 5G-IA0, "null ciphering algorithm" 5G-EA0 or may abort the 5G AKA based primary authentication and key agreement procedure and continue using the current security context, if any. The AMF shall indicate to the SMF to perform the release of all non-emergency PDU sessions, if any. If there is an ongoing PDU session establishment procedure, the AMF shall indicate to the SMF to perform the release of all non-emergency PDU sessions upon completion of the PDU session establishment procedure. The network shall behave as if the UE is registered for emergency services.

If a UE has an emergency PDU session established or is establishing an emergency PDU session and sends an AUTHENTICATION FAILURE message to the AMF with the 5GMM cause appropriate for these cases (#20, #21, #26, or #71 respectively) and receives the SECURITY MODE COMMAND message before the timeout of timer T3520, the UE shall deem that the network has passed the authentication check successfully, stop timer T3520, respectively, and execute the security mode control procedure.

If a UE has an emergency PDU session established or is establishing an emergency PDU session when timer T3520 expires, the UE shall not deem that the network has failed the authentication check and not behave as described in item g. Instead the UE shall continue using the current security context, if any, release all non-emergency PDU sessions, if any, by initiating UE-requested PDU session release procedure. If there is an ongoing PDU session establishment procedure, the UE shall release all non-emergency PDU sessions upon completion of the PDU session establishment procedure.

The UE shall start any retransmission timers (e.g. T3510, T3517 or T3521) if:

- they were running and stopped when the UE received the AUTHENTICATION REQUEST message and detected an authentication failure; and
- the procedures associated with these timers have not yet been completed.

The UE shall behave as if the UE is registered for emergency services.

5.4.2 Security mode control procedure

5.4.2.1 General

The purpose of the NAS security mode control procedure is to take a 5G NAS security context into use, and initialise and start NAS signalling security between the UE and the AMF with the corresponding 5G NAS keys and 5G NAS security algorithms.

Furthermore, the network may also initiate the security mode control procedure in the following cases:

- a)- in order to change the 5G NAS security algorithms for a current 5G NAS security context already in use;
- b) in order to change the value of uplink NAS COUNT used in the latest SECURITY MODE COMPLETE message as described in 3GPP TS 33.501 [24], subclause 6.9.4.4; and
- c) in order to provide the Selected EPS NAS security algorithms to the UE.

For restrictions concerning the concurrent running of a security mode control procedure with other security related procedures in the AS or inside the core network see 3GPP TS 33.501 [24], subclause 6.9.5.

If the security mode control procedure is initiated after successful 5G AKA based primary authentication and key agreement procedure and the security mode control procedure intends to bring into use the partial native 5G NAS security context created by the 5G AKA based primary authentication and key agreement procedure and the UE accepts received security mode command (see subclause 5.4.2.3), the ME shall:

- a) delete the valid K_{AUSF} and the valid K_{SEAF} , if any; and
- b) consider the new K_{AUSF} to be the valid K_{AUSF} , and the new K_{SEAF} to be the valid K_{SEAF} , reset the SOR counter and the UE parameter update counter to zero, and store the valid K_{AUSF} , the valid K_{SEAF} , the SOR counter and the UE parameter update counter as specified in annex C and use the valid K_{AUSF} in the verification of SOR transparent container and UE parameters update transparent container, if any are received.

NOTE: The AMF does not perform a security mode control procedure when the 5G AKA based primary authentication procedure successfully authenticates a 5G ProSe layer-3 remote UE accessing the network via a 5G ProSe layer-3 UE-to-network relay UE served by the AMF.

5.4.2.2 NAS security mode control initiation by the network

The AMF initiates the NAS security mode control procedure by sending a SECURITY MODE COMMAND message to the UE and starting timer T3560 (see example in figure 5.4.2.2).

The AMF shall reset the downlink NAS COUNT counter and use it to integrity protect the initial SECURITY MODE COMMAND message if the security mode control procedure is initiated:

- a) to take into use the security context created after a successful execution of the 5G AKA based primary authentication and key agreement procedure or the EAP based primary authentication and key agreement procedure; or
- b) upon receipt of REGISTRATION REQUEST message, if the AMF needs to create a mapped 5G NAS security context (i.e. the type of security context flag is set to "mapped security context" in the ngKSI IE included in the SECURITY MODE COMMAND message).

The AMF shall send the SECURITY MODE COMMAND message unciphered, but shall integrity protect the message with the 5G NAS integrity key based on K_{AMF} or mapped K'_{AMF} indicated by the ngKSI included in the message. The AMF shall set the security header type of the message to "integrity protected with new 5G NAS security context".

The AMF shall create a locally generated K_{AMF} and send the SECURITY MODE COMMAND message including an ngKSI value in the ngKSI IE set to "000" and 5G-IA0 and 5G-EA0 as the selected NAS security algorithms only when the security mode control procedure is initiated:

- a) during an initial registration procedure for emergency services if no valid 5G NAS security context is available;
- b) during a registration procedure for mobility and periodic registration update for a UE that has an emergency PDU session if no valid 5G NAS security context is available;
- c) during a service request procedure for a UE that has an emergency PDU session if no valid 5G NAS security context is available; or
- d) after a failed primary authentication and key agreement procedure for a UE that has an emergency PDU session or is establishing an emergency PDU session, if continued usage of a valid 5G NAS security context is not possible.

When the AMF sends the SECURITY MODE COMMAND message including an ngKSI value in the ngKSI IE set to "000" and 5G-IA0 and 5G-EA0 as the selected NAS security algorithms, if:

- a) the AMF supports N26 interface;
- b) the UE set the S1 mode bit to "S1 mode supported" in the 5GMM capability IE of the REGISTRATION REQUEST message; and
- c) the security mode control procedure is initiated during an initial registration procedure for emergency services, during a registration procedure for mobility and periodic registration update for a UE that has an emergency PDU session, or during a service request procedure for a UE that has an emergency PDU session,

the SECURITY MODE COMMAND message shall also include the Selected EPS NAS security algorithms IE. The selected EPS NAS security algorithms shall be set to EIA0 and EEA0.

The UE shall process a SECURITY MODE COMMAND message including an ngKSI value in the ngKSI IE set to "000" and 5G-IA0 and 5G-EA0 as the selected NAS security algorithms and, if accepted, create a locally generated K_{AMF} when the security mode control procedure is initiated:

- a) during an initial registration procedure for emergency services;
- b) during a registration procedure for mobility and periodic registration update for a UE that has an emergency PDU session;
- c) during a service request procedure for a UE that has an emergency PDU session; or
- d) after a primary authentication and key agreement procedure for a UE that has an emergency PDU session or is establishing an emergency PDU session.

NOTE 1: The process for creation of the locally generated K_{AMF} by the AMF and the UE is implementation dependent. The K_{AMF} is specified in 3GPP TS 33.501 [24].

Upon receipt of a REGISTRATION REQUEST message, if the AMF does not have the valid current 5G NAS security context indicated by the UE, the AMF shall either:

- a) indicate the use of the new mapped 5G NAS security context to the UE by setting the type of security context flag in the ngKSI IE to "mapped security context" and the KSI value related to the security context of the source system; or
- b) set the ngKSI value to "000" in the ngKSI IE if the AMF sets 5G-IA0 and 5G-EA0 as the selected NAS security algorithms for a UE that has an emergency PDU session.

Upon receipt of a REGISTRATION REQUEST message, if the AMF has the valid current 5G NAS security context indicated by the UE, the AMF supports N26 interface and the UE set the S1 mode bit to "S1 mode supported" in the 5GMM capability IE of the REGISTRATION REQUEST message and the UE is not registered for disaster roaming services, the AMF shall check whether the selected EPS NAS security algorithms was successfully provided to the UE. If not, the AMF shall initiate the NAS security mode control procedure by sending a SECURITY MODE COMMAND message with the Selected EPS NAS security algorithms IE to the UE.

While having a current mapped 5G NAS security context with the UE, if the AMF needs to take the native 5G NAS security context into use, the AMF shall include the ngKSI that indicates the native 5G NAS security context in the SECURITY MODE COMMAND message.

The AMF shall include the replayed security capabilities of the UE (including the security capabilities with regard to NAS, RRC and UP (user plane) ciphering as well as NAS and RRC integrity, and other possible target network security capabilities, i.e. E-UTRAN if the UE included them in the message to network), the selected 5GS ciphering and integrity algorithms and the ngKSI.

If a UE is already registered over one access to a PLMN and the AMF decides to skip primary authentication and key agreement procedure when the UE attempts to register over the other access to the same PLMN, the AMF shall take into use the UE's current 5G NAS security context over the other access that the UE is registering. In this case, SECURITY MODE COMMAND message is not sent to the UE.

If the UE is registered to the same AMF and the same PLMN over both 3GPP access and non-3GPP access, and the UE is in 5GMM-CONNECTED mode over both the 3GPP and non-3GPP accesses, then at any time the primary authentication and key agreement procedure has successfully completed over:

- a) the 3GPP access, the AMF includes the ngKSI in the SECURITY MODE COMMAND message over the 3GPP access. When the AMF sends the SECURITY MODE COMMAND message to UE over the non-3GPP access to

take into use the new 5G NAS security context, the AMF shall include the same ngKSI in the SECURITY MODE COMMAND message to identify the new 5G NAS security context; or

- b) the non-3GPP access, the AMF includes the ngKSI in the SECURITY MODE COMMAND message over the non-3GPP access. When the AMF sends the SECURITY MODE COMMAND message to UE over the 3GPP access to take into use the new 5G NAS security context, the AMF shall include the same ngKSI in the SECURITY MODE COMMAND message to identify the new 5G NAS security context.

The AMF may initiate a SECURITY MODE COMMAND in order to change the 5G security algorithms for a current 5G NAS security context already in use. The AMF re-derives the 5G NAS keys from K_{AMF} with the new 5G algorithm identities as input and provides the new 5GS algorithm identities within the SECURITY MODE COMMAND message. The AMF shall set the security header type of the message to "integrity protected with new 5G NAS security context".

If, during an ongoing registration procedure, the AMF is initiating a SECURITY MODE COMMAND (i.e. after receiving the REGISTRATION REQUEST message, but before sending a response to that message) and:

- a) the REGISTRATION REQUEST message does not successfully pass the integrity check at the AMF; or
- b) the AMF can not decipher the value part of the NAS message container IE in the REGISTRATION REQUEST message;

the AMF shall include the Additional 5G security information IE with the RINMR bit set to "Retransmission of the initial NAS message requested" in the SECURITY MODE COMMAND message requesting the UE to send the entire REGISTRATION REQUEST message in the SECURITY MODE COMPLETE message as described in 3GPP TS 33.501 [24].

If, during an ongoing deregistration procedure, the AMF is initiating a SECURITY MODE COMMAND (i.e. after receiving the DEREGISTRATION REQUEST message, but before sending a response to that message) and:

- a) the DEREGISTRATION REQUEST message does not successfully pass the integrity check at the AMF; or
- b) the AMF can not decipher the value part of the NAS message container IE in the DEREGISTRATION REQUEST message;

the AMF shall include the Additional 5G security information IE with the RINMR bit set to "Retransmission of the initial NAS message requested" in the SECURITY MODE COMMAND message requesting the UE to send the entire DEREGISTRATION REQUEST message in the SECURITY MODE COMPLETE message as described in 3GPP TS 33.501 [24].

NOTE 2: The AMF uses the UE security capability which was provided by the UE.

If, during an ongoing service request procedure for a UE with an emergency PDU session, the AMF is initiating a SECURITY MODE COMMAND (i.e. after receiving the SERVICE REQUEST message or the CONTROL PLANE SERVICE REQUEST message, but before sending a response to that message) and the SERVICE REQUEST message or the CONTROL PLANE SERVICE REQUEST message does not successfully pass the integrity check at the AMF, the AMF shall include the Additional 5G security information IE with the RINMR bit set to "Retransmission of the initial NAS message requested" in the SECURITY MODE COMMAND message requesting the UE to send the entire:

- a) SERVICE REQUEST message; or
- b) CONTROL PLANE SERVICE REQUEST message excluding non-clear-text IEs, except the Uplink data status IE if needed (see subclause 5.4.2.3);

in the SECURITY MODE COMPLETE message as described in 3GPP TS 33.501 [24].

Additionally, the AMF may request the UE to include its IMEISV in the SECURITY MODE COMPLETE message.

If the AMF supports N26 interface and the UE set the S1 mode bit to "S1 mode supported" in the 5GMM capability IE of the REGISTRATION REQUEST message and the AMF needs to provide the selected EPS NAS security algorithms to the UE, the AMF shall select ciphering and integrity algorithms to be used in the EPS and indicate them to the UE via the Selected EPS NAS security algorithms IE in the SECURITY MODE COMMAND message.

NOTE 3: The AS and NAS security capabilities are the same, i.e. if the UE supports one algorithm for NAS, the same algorithm is also supported for AS.

If the AMF performs horizontal key derivation e.g. during the mobility and periodic registration update or when the UE is already registered in the PLMN with another access type as described in 3GPP TS 33.501 [24], the AMF shall include horizontal derivation parameter in the SECURITY MODE COMMAND message.

If the security mode control procedure is initiated after successful EAP based primary authentication and key agreement procedure and the security mode control procedure intends to bring into use the partial native 5G NAS security context created by the EAP based primary authentication and key agreement procedure, the AMF shall set the EAP message IE of the SECURITY MODE COMMAND message to an EAP-success message to be sent to the UE. If the SECURITY MODE COMMAND message is provided to a 5G-RG that is acting on behalf of an AUN3 device and the EAP message IE is set to an EAP-success message, the AMF shall include the AUN3 device security key IE in the SECURITY MODE COMMAND message with its value set to:

- a) the Master session key, if the AUN3 device does not support 5G key hierarchy; or
- b) the K_{WAGF} key, if the AUN3 device supports 5G key hierarchy.

NOTE 4: The network is aware from the AUN3 device subscription data in UDM whether the AUN3 device supports 5G key hierarchy or not as specified in subclause 7B.7 of 3GPP TS 33.501 [24].

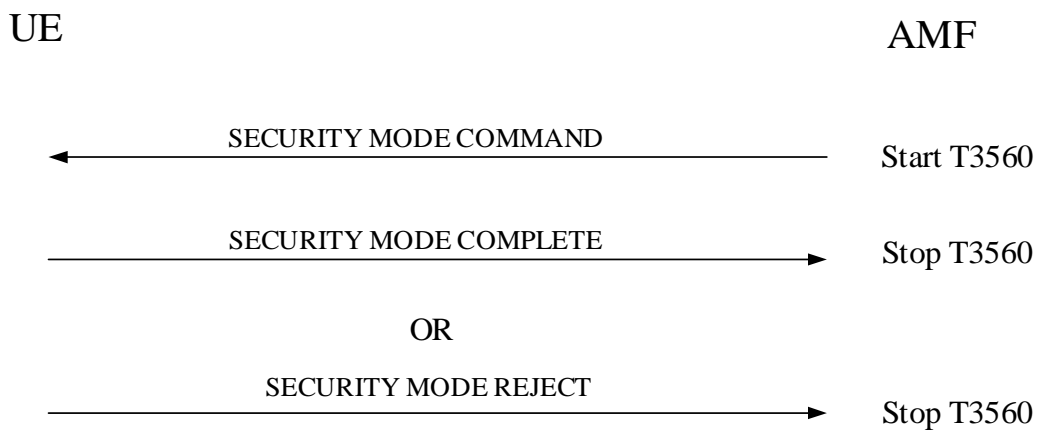

Figure 5.4.2.2: Security mode control procedure

5.4.2.3 NAS security mode command accepted by the UE

Upon receipt of the SECURITY MODE COMMAND message, the UE shall check whether the security mode command can be accepted or not. This is done by performing the integrity check of the message, and by checking that the received Replayed UE security capabilities IE has not been altered compared to the latest values that the UE sent to the network.

When the SECURITY MODE COMMAND message includes an EAP-success message the UE handles the EAP-success message and the ABBA as described in subclause 5.4.1.2.2.8, 5.4.1.2.3.1, 5.4.1.2.3A.1, 5.4.1.2.3B.1 and 5.4.1.2.3C.1.

If:

- a) the UE is registered for emergency services, performing initial registration for emergency services, establishing an emergency PDU session or has an emergency PDU session established;
- b) the W-AGF acts on behalf of the FN-RG;
- c) the W-AGF acts on behalf of the N5GC device; or
- d) the 5G-RG acts on behalf of the AUN3 device,

and the SECURITY MODE COMMAND message is received with ngKSI value "000" and 5G-IA0 and 5G-EA0 as selected 5G NAS security algorithms, the UE shall locally derive and take in use 5G NAS security context. The UE shall delete existing current 5G NAS security context.

The UE shall accept a SECURITY MODE COMMAND message indicating the "null integrity protection algorithm" 5G-IA0 as the selected 5G NAS integrity algorithm only if the message is received when

- a) the UE is registered for emergency services, performing initial registration for emergency services, establishing an emergency PDU session or has an emergency PDU session established;
- b) the W-AGF acts on behalf of the FN-RG;
- c) the W-AGF acts on behalf of the N5GC device; or
- d) the 5G-RG acts on behalf of the AUN3 device.

If the type of security context flag included in the SECURITY MODE COMMAND message is set to "native security context" and if the ngKSI matches a valid non-current native 5G NAS security context held in the UE while the UE has a mapped 5G NAS security context as the current 5G NAS security context, the UE shall take the non-current native 5G NAS security context into use which then becomes the current native 5G NAS security context and delete the mapped 5G NAS security context.

The UE shall ignore the Replayed S1 UE security capabilities IE if this IE is included in the SECURITY MODE COMMAND message.

If the SECURITY MODE COMMAND message can be accepted, the UE shall take the 5G NAS security context indicated in the message into use. The UE shall in addition reset the uplink NAS COUNT counter if:

- a) the SECURITY MODE COMMAND message is received in order to take a 5G NAS security context into use created after a successful execution of the 5G AKA based primary authentication and key agreement procedure or the EAP based primary authentication and key agreement procedure; or
- b) the SECURITY MODE COMMAND message received includes the type of security context flag set to "mapped security context" in the NAS key set identifier IE the ngKSI does not match the current 5G NAS security context, if it is a mapped 5G NAS security context.

If the SECURITY MODE COMMAND message can be accepted and a new 5G NAS security context is taken into use and SECURITY MODE COMMAND message does not indicate the "null integrity protection algorithm" 5G-IA0 as the selected NAS integrity algorithm, the UE shall:

- if the SECURITY MODE COMMAND message has been successfully integrity checked using an estimated downlink NAS COUNT equal to 0, then the UE shall set the downlink NAS COUNT of this new 5G NAS security context to 0;
- otherwise the UE shall set the downlink NAS COUNT of this new 5G NAS security context to the downlink NAS COUNT that has been used for the successful integrity checking of the SECURITY MODE COMMAND message.

If the SECURITY MODE COMMAND message includes the horizontal derivation parameter indicating "K_{AMF} derivation is required", the UE shall derive a new K'_{AMF}, as specified in 3GPP TS 33.501 [24] for K_{AMF} to K'_{AMF} derivation in mobility, and set both uplink and downlink NAS COUNTs to zero. When the new 5G NAS security context is taken into use for current access and the UE is registered with the same PLMN over the 3GPP access and the non-3GPP access:

- a) the UE is in 5GMM-IDLE mode over the non-current access, the AMF and the UE shall activate the new 5G NAS security context over the non-current access as described in 3GPP TS 33.501 [24]. The AMF and the UE shall set the downlink NAS COUNT and uplink NAS COUNT to zero for the non-current access; or
- b) the UE is in 5GMM-CONNECTED mode over the non-current access, the AMF shall send the SECURITY MODE COMMAND message over the non-current access to activate the new 5G NAS security context that was activated over the current access as described in 3GPP TS 33.501 [24]. The AMF shall include the same ngKSI in the SECURITY MODE COMMAND message to identify the new 5G NAS security context.

NOTE 1: If the UE was in 5GMM-CONNECTED mode over the non-current access when the new 5G NAS security context was taken into use for the current access and the UE enters 5GMM-IDLE mode over the non-current access before receiving a SECURITY MODE COMMAND message over the non-current access, the UE conforms to bullet a).

NOTE 2: If the UE was in 5GMM-CONNECTED mode over the non-current access when the new 5G NAS security context was taken into use and the N1 NAS signalling connection is lost over the non-current access before sending a SECURITY MODE COMMAND message over the non-current access, the AMF conforms to bullet a).

If the SECURITY MODE COMMAND message includes the horizontal derivation parameter indicating "KAMF derivation is not required" or the Additional 5G security information IE is not included in the message, the UE is registered with the same PLMN over the 3GPP access and non-3GPP access, then after the completion of a security mode control procedure over the current access:

- a) the UE is in 5GMM-IDLE mode over the non-current access, the AMF and the UE shall activate the new 5G NAS security context for the non-current access. If a primary authentication and key agreement procedure was completed before the security mode control procedure, the AMF and the UE shall set the downlink NAS COUNT and uplink NAS COUNT to zero for the non-current access, otherwise the downlink NAS COUNT and uplink NAS COUNT for the non-3GPP access are not changed; or
- b) the UE is in 5GMM-CONNECTED mode over the non-current access, the AMF shall send the SECURITY MODE COMMAND message over the non-current access to activate the new 5G NAS security context that was activated over the current access as described in 3GPP TS 33.501 [24]. The AMF shall include the same ngKSI in the SECURITY MODE COMMAND message to identify the new 5G NAS security context.

NOTE 3: If the UE was in 5GMM-CONNECTED mode over the non-current access when the new 5G NAS security context was taken into use for the current access and the UE enters 5GMM-IDLE mode over the non-current access before receiving a SECURITY MODE COMMAND message over the non-current access, the UE conforms to bullet a).

NOTE 4: If the UE was in 5GMM-CONNECTED mode over the non-current access when the new 5G NAS security context was taken into use and the N1 NAS signalling connection is lost over the non-current access before sending a SECURITY MODE COMMAND message over the non-current access, the AMF conforms to bullet a).

If the SECURITY MODE COMMAND message can be accepted, the UE shall send a SECURITY MODE COMPLETE message integrity protected with the selected 5GS integrity algorithm and the 5G NAS integrity key based on the K_{AMF} or mapped K'_{AMF} if the type of security context flag is set to "mapped security context" indicated by the ngKSI. When the SECURITY MODE COMMAND message includes the type of security context flag set to "mapped security context" in the NAS key set identifier IE, then the UE shall check whether the SECURITY MODE COMMAND message indicates the ngKSI of the current 5GS security context, if it is a mapped 5G NAS security context, in order not to re-generate the K'_{AMF} .

Furthermore, if the SECURITY MODE COMMAND message can be accepted, the UE shall cipher the SECURITY MODE COMPLETE message with the selected 5GS ciphering algorithm and the 5GS NAS ciphering key based on the K_{AMF} or mapped K'_{AMF} indicated by the ngKSI. The UE shall set the security header type of the message to "integrity protected and ciphered with new 5G NAS security context".

From this time onward the UE shall cipher and integrity protect all NAS signalling messages with the selected 5GS integrity and ciphering algorithms.

If the AMF indicated in the SECURITY MODE COMMAND message that the IMEISV is requested and:

- a) if the UE:
 - 1) supports at least one 3GPP access technology, the UE shall include its IMEISV in the IMEISV IE of the SECURITY MODE COMPLETE message; or
 - 2) does not support any 3GPP access technology (i.e. satellite NG-RAN, NG-RAN, satellite E-UTRAN, E-UTRAN, UTRAN or GERAN) and supports NAS over untrusted or trusted non-3GPP access, the UE shall include its EUI-64 in the non-IMEISV PEI IE of the SECURITY MODE COMPLETE message; or
- b) if:
 - 1) the 5G-RG contains neither an IMEISV nor an IMEI or when the 5G-RG acts on behalf of the AUN3 device; or
 - 2) when the W-AGF acts on behalf of the FN-RG (or on behalf of the N5GC device),

the 5G-RG or the W-AGF acting on behalf of the FN-RG (or on behalf of the N5GC device) shall include the MAC address and the MAC address usage restriction indication determined as specified in subclause 5.3.2 in the non-IMEISV PEI IE in the SECURITY MODE COMPLETE message.

If during an ongoing registration procedure, deregistration procedure, or service request procedure, the UE receives a SECURITY MODE COMMAND message which includes the Additional 5G security information IE with the RINMR bit set to "Retransmission of the initial NAS message requested", the UE shall include the entire unciphered REGISTRATION REQUEST message, DEREGISTRATION REQUEST message, SERVICE REQUEST message or CONTROL PLANE SERVICE REQUEST message, which the UE had previously included in the NAS message container IE of the initial NAS message (i.e. REGISTRATION REQUEST message, DEREGISTRATION REQUEST MESSAGE, SERVICE REQUEST message or CONTROL PLANE SERVICE REQUEST message, respectively), in the NAS message container IE of the SECURITY MODE COMPLETE message. The retransmitted CONTROL PLANE SERVICE REQUEST message:

- a) shall not include any non-clear-text IE, except the Uplink data status IE; and
- b) may include the Uplink data status IE.

If, prior to receiving the SECURITY MODE COMMAND message, the UE without a valid 5G NAS security context had sent a REGISTRATION REQUEST message the UE shall include the entire REGISTRATION REQUEST message in the NAS message container IE of the SECURITY MODE COMPLETE message as described in subclause 4.4.6.

If the UE operating in the single-registration mode receives the Selected EPS NAS security algorithms IE, the UE shall use the IE according to 3GPP TS 33.501 [24].

For a UE operating in single-registration mode in a network supporting N26 interface after an inter-system change from S1 mode to N1 mode in 5GMM-CONNECTED mode, the UE shall set the value of the Selected EPS NAS security algorithms IE in the 5G NAS security context to the NAS security algorithms that were received from the source MME when the UE was in S1 mode.

5.4.2.4 NAS security mode control completion by the network

The AMF shall, upon receipt of the SECURITY MODE COMPLETE message, stop timer T3560. From this time onward the AMF shall integrity protect and encipher all signalling messages with the selected 5GS integrity and ciphering algorithms.

If the SECURITY MODE COMPLETE message contains a NAS message container IE with a REGISTRATION REQUEST message, the AMF shall complete the ongoing registration procedure by considering the REGISTRATION REQUEST message contained in the NAS message container IE as the message that triggered the procedure.

If the SECURITY MODE COMPLETE message contains a NAS message container IE with a DEREGISTRATION REQUEST message, the AMF shall complete the ongoing deregistration procedure by considering the DEREGISTRATION REQUEST message contained in the NAS message container IE as the message that triggered the procedure.

If the SECURITY MODE COMPLETE message contains a NAS message container IE with a REGISTRATION REQUEST message, the 5GMM capability IE included in the REGISTRATION REQUEST message indicates "S1 mode supported" and the AMF supports N26 interface, the AMF shall initiate another NAS security mode control procedure in order to provide the selected EPS NAS security algorithms to the UE as described in subclause 5.4.2.2. This second NAS security mode control procedure should be initiated as part of 5GMM common procedures of the ongoing registration procedure.

If the SECURITY MODE COMPLETE message contains a NAS message container IE with a SERVICE REQUEST message, the AMF shall complete the ongoing service request procedure by considering the SERVICE REQUEST message contained in the NAS message container IE as the message that triggered the procedure.

If the SECURITY MODE COMPLETE message contains a NAS message container IE with a CONTROL PLANE SERVICE REQUEST message, the AMF shall complete the ongoing service request procedure by considering the CONTROL PLANE SERVICE REQUEST message contained in the NAS message container IE as the message that triggered the procedure.

5.4.2.5 NAS security mode command not accepted by the UE

If the security mode command cannot be accepted, the UE shall send a SECURITY MODE REJECT message. The SECURITY MODE REJECT message contains a 5GMM cause that typically indicates one of the following cause values:

- #23 UE security capabilities mismatch.
- #24 security mode rejected, unspecified.

If the UE detects that the received Replayed UE security capabilities IE has been altered compared to the latest values that the UE sent to the network, the UE shall set the cause value to #23 "UE security capabilities mismatch".

Upon receipt of the SECURITY MODE REJECT message, the AMF shall stop timer T3560. The AMF shall also abort the ongoing procedure that triggered the initiation of the NAS security mode control procedure.

Both the UE and the AMF shall apply the 5G NAS security context in use before the initiation of the security mode control procedure, if any, to protect the SECURITY MODE REJECT message and any other subsequent messages according to the rules in subclause 4.4.4 and 4.4.5.

5.4.2.6 Abnormal cases in the UE

The following abnormal cases can be identified:

- a) Transmission failure of SECURITY MODE COMPLETE message or SECURITY MODE REJECT message indication from lower layers (if the security mode control procedure is triggered by a registration procedure).

The UE shall abort the security mode control procedure and re-initiate the registration procedure.

- b) Transmission failure of SECURITY MODE COMPLETE message or SECURITY MODE REJECT message indication with change in the current TAI (if the security mode control procedure is triggered by a service request procedure).

If the current TAI is not in the TAI list, the security mode control procedure shall be aborted and a registration procedure shall be initiated.

If the current TAI is still part of the TAI list, the security mode control procedure shall be aborted and it is up to the UE implementation how to re-run the ongoing procedure that triggered the security mode control procedure.

- c) Transmission failure of SECURITY MODE COMPLETE message or SECURITY MODE REJECT message indication without change in the current TAI (if the security mode control procedure is triggered by a service request procedure).

The security mode control procedure shall be aborted and it is up to the UE implementation how to re-run the ongoing procedure that triggered the security mode control procedure.

5.4.2.7 Abnormal cases on the network side

The following abnormal cases can be identified:

- a) Lower layer failure before the SECURITY MODE COMPLETE or SECURITY MODE REJECT message is received.

The network shall abort the security mode control procedure.

- b) Expiry of timer T3560.

The network shall, on the first expiry of the timer T3560, retransmit the SECURITY MODE COMMAND message and shall reset and start timer T3560. This retransmission is repeated four times, i.e. on the fifth expiry of timer T3560, the procedure shall be aborted.

- c) Collision between security mode control procedure and registration, service request or de-registration procedure not indicating switch off.

The network shall abort the security mode control procedure and proceed with the UE initiated procedure.

- d) Collision between security mode control procedure and other 5GMM procedures than in item c.

The network shall progress both procedures.

- e) Lower layers indication of non-delivered NAS PDU due to handover:

If the SECURITY MODE COMMAND message could not be delivered due to an intra AMF handover and the target TA is included in the TAI list, then upon successful completion of the intra AMF handover the AMF shall retransmit the SECURITY MODE COMMAND message. If a failure of the handover procedure is reported by the lower layer and the N1 signalling connection exists, the AMF shall retransmit the SECURITY MODE COMMAND message.

5.4.3 Identification procedure

5.4.3.1 General

The purpose of this procedure is to request a particular UE to provide specific identification parameters, e.g. the SUCI, the IMEI, the IMEISV, the EUI-64 or the MAC address. The SUCI is a privacy preserving identifier containing the concealed SUPI and the IMEI, the IMEISV, the EUI-64 and the MAC address are formats of PEI.

5.4.3.2 Identification initiation by the network

The AMF initiates the identification procedure by sending an IDENTITY REQUEST message to the UE and starting timer T3570 (see example in figure 5.4.3.2.1). The IDENTITY REQUEST message specifies the requested identification parameters in the Identity type information element.

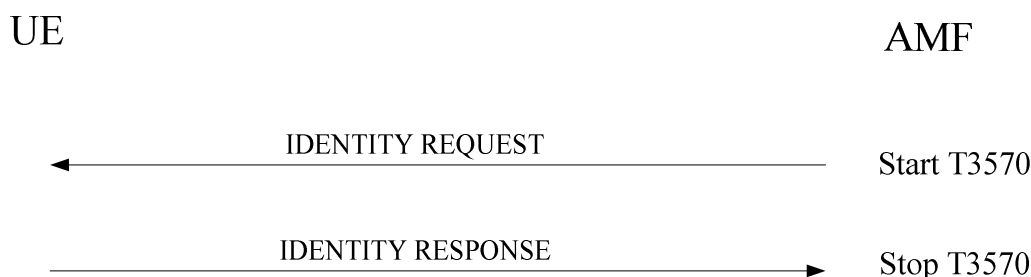

Figure 5.4.3.2.1: Identification procedure

5.4.3.3 Identification response by the UE

A UE shall be ready to respond to an IDENTITY REQUEST message at any time whilst in 5GMM-CONNECTED mode.

Upon receipt of the IDENTITY REQUEST message:

- a) if the Identity type IE in the IDENTITY REQUEST message is not set to "SUCI", the UE shall send an IDENTITY RESPONSE message to the network. The IDENTITY RESPONSE message shall contain the identification parameters as requested by the network; and
- b) if the Identity type IE in the IDENTITY REQUEST message is set to "SUCI", the UE shall:
 - 1) if timer T3519 is not running, generate a fresh SUCI as specified in 3GPP TS 33.501 [24], send an IDENTITY RESPONSE message with the SUCI, start timer T3519 and store the value of the SUCI sent in the IDENTITY RESPONSE message; and
 - 2) if timer T3519 is running, send an IDENTITY RESPONSE message with the stored SUCI.

5.4.3.4 Identification completion by the network

Upon receipt of the IDENTITY RESPONSE the network shall stop the timer T3570.

5.4.3.5 Abnormal cases in the UE

The following abnormal cases can be identified:

- a) Transmission failure of the IDENTITY RESPONSE message (if the identification procedure is triggered by a registration procedure).

The UE shall re-initiate the registration procedure.

- b) Requested identity is not available

If the UE cannot encode the requested identity in the IDENTITY RESPONSE message, e.g. because no valid USIM is available, then it shall encode the identity type as "No identity".

5.4.3.6 Abnormal cases on the network side

The following abnormal cases can be identified:

- a) Lower layer failure.

Upon detection of a lower layer failure before the IDENTITY RESPONSE is received, the network shall abort any ongoing 5GMM procedure.

- b) Expiry of timer T3570.

The network shall, on the first expiry of the timer T3570, retransmit the IDENTITY REQUEST message and reset and restart the timer T3570. This retransmission is repeated four times, i.e. on the fifth expiry of timer T3570, the network shall abort the identification procedure and any ongoing 5GMM procedure.

- c) Collision of an identification procedure with a registration procedure for initial registration.

If the network receives a REGISTRATION REQUEST message indicating either "initial registration" or "emergency registration" in the 5GS registration type IE before the ongoing identification procedure has been completed and no registration procedure is pending on the network (i.e. no REGISTRATION ACCEPT/REJECT message has still to be sent as an answer to a REGISTRATION REQUEST message), the network shall proceed with the registration procedure for initial registration.

- d) Collision of an identification procedure with a registration procedure for initial registration when the identification procedure has been caused by a registration procedure for initial registration.

If the network receives a REGISTRATION REQUEST message indicating either "initial registration" or "emergency registration" in the 5GS registration type IE before the ongoing identification procedure has been completed and a registration procedure for initial registration is pending (i.e. a REGISTRATION ACCEPT/REJECT message has to be sent as an answer to an earlier REGISTRATION REQUEST message), then:

- If one or more of the information elements in the REGISTRATION REQUEST message differ from the ones received within the previous REGISTRATION REQUEST message, the network shall proceed with the new registration procedure for initial registration; or
- If the information elements do not differ, then the network shall not treat any further this new REGISTRATION REQUEST message.

- e) Collision of an identification procedure with a registration procedure for mobility and periodic registration update.

If the network receives a REGISTRATION REQUEST message indicating either "mobility registration updating" or "periodic registration updating" in the 5GS registration type IE before the ongoing identification procedure has been completed, the network shall progress both procedures.

- f) Collision of an identification procedure with a UE initiated de-registration procedure.

If the network receives a DEREGISTRATION REQUEST message with "switch off" indication in the De-registration type IE before the ongoing identification procedure has been completed, the network shall abort the identification procedure and shall progress the UE-initiated de-registration procedure;

Else the network shall complete the identification procedure and shall respond to the UE-initiated de-registration procedure as described in subclause 5.5.2.2.

5.4.4 Generic UE configuration update procedure

5.4.4.1 General

The purpose of this procedure is to:

- a) allow the AMF to update the UE configuration for access and mobility management-related parameters decided and provided by the AMF by providing new parameter information within the command;
- b) request the UE to perform a registration procedure for mobility and periodic registration update towards the network to update access and mobility management-related parameters decided and provided by the AMF (see subclause 5.5.1.3);
- c) deliver the UAV authorization information to the UE, as described in 3GPP TS 23.256 [6AB]; or
- d) update the PEIPS assistance information in the UE (see subclause 5.3.25).

This procedure is initiated by the network and can only be used when the UE has an established 5GMM context, and the UE is in 5GMM-CONNECTED mode. When the UE is in 5GMM-IDLE mode, the AMF may use the paging or notification procedure to initiate the generic UE configuration update procedure. The AMF can request a confirmation response in order to ensure that the parameter has been updated by the UE.

This procedure shall be initiated by the network to assign a new 5G-GUTI to the UE after:

- a) a successful service request procedure invoked as a response to a paging request from the network and before the:
 - 1) release of the N1 NAS signalling connection; or
 - 2) suspension of the N1 NAS signalling connection due to user plane CIoT 5GS optimization i.e. before the UE and the AMF enter 5GMM-IDLE mode with suspend indication; or
- b) the AMF receives an indication from the lower layers that it has received the NGAP UE context resume request message as specified in 3GPP TS 38.413 [31] for a UE in 5GMM-IDLE mode with suspend indication and this resumption is a response to a paging request from the network, and before the:
 - 1) release of the N1 NAS signalling connection; or
 - 2) suspension of the N1 NAS signalling connection due to user plane CIoT 5GS optimization i.e. before the UE and the AMF enter 5GMM-IDLE mode with suspend indication.

If the service request procedure was triggered due to 5GSM downlink signalling pending, the procedure for assigning a new 5G-GUTI can be initiated by the network after the transport of the 5GSM downlink signalling.

The following parameters are supported by the generic UE configuration update procedure without the need to request the UE to perform the registration procedure for mobility and periodic registration update:

- a) 5G-GUTI;
- b) TAI list;
- c) Service area list;
- d) NITZ information;
- e) LADN information;
- e1) Extended LADN information;
- f) Rejected NSSAI;

NOTE: A cause value associated with a rejected S-NSSAI can be included in the Rejected NSSAI IE or in the Extended rejected NSSAI IE and a back-off timer value associated with rejected S-NSSAI(s) can be included in the Extended rejected NSSAI IE.

- g) void;
- h) Operator-defined access category definitions;
- i) SMS indication;
- j) "CAG information list";
- k) UE radio capability ID;
- l) 5GS registration result;
- m) Truncated 5G-S-TMSI configuration;
- n) T3447 value;
- o) "list of PLMN(s) to be used in disaster condition";
- p) disaster roaming wait range;
- q) disaster return wait range;
- r) PEIPS assistance information;
- s) Priority indicator;
- t) NSAG information;
- u) RAN timing synchronization;
- v) Alternative NSSAI;
- w) Discontinuous coverage maximum time offset
- x) void;
- y) Partially rejected NSSAI; and
- z) On-demand NSSAI.

The following parameters can be sent to the UE with or without a request to perform the registration procedure for mobility and periodic registration update:

- a) Allowed NSSAI;
- b) Configured NSSAI;
- c) Network slicing subscription change indication;
- d) NSSRG information;
- e) S-NSSAI location validity information;
- e1) S-NSSAI time validity information;
- f) feature authorization indication; and
- g) Partially allowed NSSAI.

The following parameters are sent to the UE with a request to perform the registration procedure for mobility and periodic registration update:

- a) MICO indication;
- b) UE radio capability ID deletion indication; and

- c) Additional configuration indication.

The following parameters can be included in the Service-level-AA container IE to be sent to the UE without a request to perform the registration procedure for mobility and periodic registration update:

- a) Service-level device ID;
- b) Service-level-AA payload type;
- c) Service-level-AA payload;
- d) Service-level-AA response; or
- e) Service-level-AA service status indication.

The following parameters are sent over 3GPP access only:

- a) LADN information;
 - a1) Extended LADN information;
- b) MICO indication;
- c) TAI list;
- d) Service area list;
- e) "CAG information list";
- f) UE radio capability ID;
- g) UE radio capability ID deletion indication;
- h) Truncated 5G-S-TMSI configuration;
- i) Additional configuration indication;
- j) T3447 value;
- k) Service-level-AA container;
- l) NSAG information; and
- m) RAN timing synchronization.
- o) S-NSSAI location validity information.

The following parameters are managed and sent per access type i.e., independently over 3GPP access or non-3GPP access:

- a) Allowed NSSAI;
- b) Rejected NSSAI (when the NSSAI is rejected for the current registration area or is rejected for the maximum number of UEs reached); and
- c) If the UE is not registered to the same PLMN or SNPN over 3GPP and non-3GPP access:
 - 5G-GUTI;
 - NITZ information;
 - Rejected NSSAI (when the NSSAI is rejected for the current PLMN or SNPN or rejected for the failed or revoked NSSAI);
 - Configured NSSAI;
 - NSSRG information;
 - SMS indication;

- 5GS registration result;
- PEIPS assistance information;
- MPS indicator;
- S-NSSAI time validity information;
- Alternative NSSAI; and
- MCS indicator.

If the UE is registered to the same PLMN or SNPN over 3GPP and non-3GPP access, the following parameters are managed commonly and sent over 3GPP access or non-3GPP access:

- a) 5G-GUTI;
- b) NITZ information;
- c) Rejected NSSAI (when the NSSAI is rejected for the current PLMN or SNPN or rejected for the failed or revoked NSSAI);
- d) Configured NSSAI;
- e) SMS indication; and
- f) 5GS registration result;
- g) "list of PLMN(s) to be used in disaster condition";
- h) disaster roaming wait range;
- i) disaster return wait range;
- j) PEIPS assistance information;
- k) NSSRG information;
- l) MPS indicator;
- m) S-NSSAI time validity information; and
- n) MCS indicator.

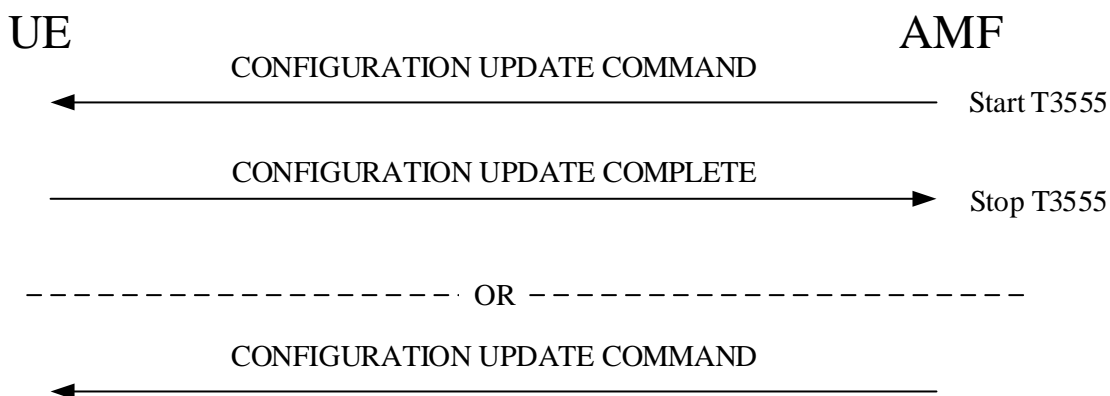

Figure 5.4.4.1.1: Generic UE configuration update procedure

5.4.4.2 Generic UE configuration update procedure initiated by the network

The AMF shall initiate the generic UE configuration update procedure by sending the CONFIGURATION UPDATE COMMAND message to the UE.

The AMF shall in the CONFIGURATION UPDATE COMMAND message either:

- a) include one or more of the following parameters: 5G-GUTI, TAI list, allowed NSSAI that may include the mapped S-NSSAI(s), LADN information, extended LADN information, service area list, MICO indication, NITZ information, configured NSSAI that may include the mapped S-NSSAI(s), NSSRG information, S-NSSAI location validity information, S-NSSAI time validity information, rejected S-NSSAI(s) in the Rejected NSSAI IE or in the Extended rejected NSSAI IE, network slicing subscription change indication, operator-defined access category definitions, SMS indication, "CAG information list", UE radio capability ID, 5GS registration result, UE radio capability ID deletion indication, truncated 5G-S-TMSI configuration, T3447 value, "list of PLMN(s) to be used in disaster condition", disaster roaming wait range, disaster return wait range, PEIPS assistance information, the priority indicator, the NSAG information, alternative NSSAI, partially allowed NSSAI, partially rejected NSSAI, on-demand NSSAI, feature authorization indication, or discontinuous coverage maximum time offset;
- b) include the Configuration update indication IE with the Registration requested bit set to "registration requested";
or
- c) include a combination of both a) and b).

If the UE is registering or registered for onboarding services in SNPN, the serving SNPN shall not provide the configured NSSAI, the allowed NSSAI or the rejected NSSAI to the UE.

If the UE supports extended rejected NSSAI, the rejected S-NSSAI(s) shall be included in the Extended rejected NSSAI IE. Otherwise, the rejected S-NSSAI(s) shall be included in the Rejected NSSAI IE.

In roaming scenarios, if the Extended rejected NSSAI IE is included in the CONFIGURATION UPDATE COMMAND message, the AMF shall provide mapped S-NSSAI(s) for the rejected NSSAI.

If an acknowledgement from the UE is requested, the AMF shall indicate "acknowledgement requested" in the Acknowledgement bit of the Configuration update indication IE in the CONFIGURATION UPDATE COMMAND message and shall start timer T3555. Acknowledgement shall be requested for all parameters except when only NITZ information is included.

To initiate parameter re-negotiation between the UE and network, the AMF shall indicate "registration requested" in the Registration requested bit of the Configuration update indication IE in the CONFIGURATION UPDATE COMMAND message.

NOTE 1: Generic UE configuration update procedure can be initiated by the AMF for updating the emergency number list, the extended emergency number list or both by indicating "registration requested" in the Registration requested bit of the Configuration update indication IE in the CONFIGURATION UPDATE COMMAND message to the UE.

If a new allowed NSSAI information or AMF re-configuration of supported S-NSSAIs requires an AMF relocation, the AMF shall indicate "registration requested" in the Registration requested bit of the Configuration update indication IE and include the Allowed NSSAI IE in the CONFIGURATION UPDATE COMMAND message.

If the AMF includes a new allowed NSSAI in the CONFIGURATION UPDATE COMMAND message and the subscription information includes the NSSRG information, then the S-NSSAIs of the allowed NSSAI shall be associated with at least one common NSSRG value. If the network has pending NSSAI, the S-NSSAIs in the pending NSSAI and allowed NSSAI shall be associated with at least one common NSSRG value.

If the AMF includes a new partially allowed NSSAI and the new partially allowed NSSAI requires an AMF relocation, the AMF shall indicate "registration requested" in the Registration requested bit of the Configuration update indication IE and include the Partially allowed NSSAI IE in the CONFIGURATION UPDATE COMMAND message.

If the AMF includes a new configured NSSAI in the CONFIGURATION UPDATE COMMAND message and the new configured NSSAI requires an AMF relocation as specified in 3GPP TS 23.501 [8], the AMF shall indicate "registration requested" in the Registration requested bit of the Configuration update indication IE in the message.

If the AMF includes a new configured NSSAI in the CONFIGURATION UPDATE COMMAND message, the subscription information includes the NSSRG information, and the UE has set the NSSRG bit in the 5GMM capability IE of the REGISTRATION REQUEST message to:

- a) "NSSRG supported", then the AMF shall include the NSSRG information in the CONFIGURATION UPDATE COMMAND message; or

- b) "NSSRG not supported", then the configured NSSAI shall include one or more S-NSSAIs each of which is associated with all the NSSRG value(s) of the default S-NSSAI(s), or the configured NSSAI shall include, based on the indication received from the UDM as specified in 3GPP TS 23.501 [8], all subscribed S-NSSAIs even if these S-NSSAIs do not share any common NSSRG value.

If the AMF needs to update the NSSRG information and the UE has set the NSSRG bit to "NSSRG supported" in the 5GMM capability IE of the REGISTRATION REQUEST message, then the AMF shall include the new NSSRG information in the CONFIGURATION UPDATE COMMAND message.

If the AMF includes a new NSSRG information in the CONFIGURATION UPDATE COMMAND message and the AMF determines that the UE needs to provide a new requested NSSAI due to no NSSRG value common to all the S-NSSAI(s) of the allowed NSSAI based on the new NSSRG information, then the CONFIGURATION UPDATE COMMAND message shall indicate "registration requested" in the Registration requested bit of the Configuration update indication IE.

If the UE supports S-NSSAI time validity information and the AMF needs to update the S-NSSAI time validity information, then the AMF shall include the new S-NSSAI time validity information in the CONFIGURATION UPDATE COMMAND message.

If the AMF needs to update the S-NSSAI location validity information toward a UE which has set the SLVI bit to "S-NSSAI location validity information supported" in the 5GMM capability IE of the REGISTRATION REQUEST message, then the AMF shall include the new S-NSSAI location validity information in the CONFIGURATION UPDATE COMMAND message.

If the CONFIGURATION UPDATE COMMAND message is initiated only due to changes to the allowed NSSAI and these changes require the UE to initiate a registration procedure, but the AMF is unable to determine an allowed NSSAI for the UE as specified in 3GPP TS 23.501 [8], then the CONFIGURATION UPDATE COMMAND message shall indicate "registration requested" in the Registration requested bit of the Configuration update indication IE, and shall not contain any other parameters.

If the slice deregistration inactivity timer has expired, the UE does not support network slice usage control and the AMF removes the on-demand S-NSSAI from the allowed NSSAI over the corresponding access type, the AMF shall include the new allowed NSSAI in the CONFIGURATION UPDATE COMMAND message.

If:

- the AMF needs to enforce a change in the restriction on the use of enhanced coverage or use of CE mode B as described in subclause 5.3.18; or
- the AMF decides to inform a UE in 5GMM-CONNECTED mode and registered for disaster roaming services, that a disaster condition is no longer applicable;

NOTE 1A: The case of the AMF triggering a generic UE configuration update procedure to inform a UE registered for disaster roaming services that a disaster condition is no longer applicable, is only applicable for a UE already in 5GMM-CONNECTED mode.

the AMF shall indicate "registration requested" in the Registration requested bit of the Configuration update indication IE and "release of N1 NAS signalling connection not required" in the Signalling connection maintain request bit of the Additional configuration indication IE in the CONFIGURATION UPDATE COMMAND message.

If a network slice-specific authentication and authorization procedure for an S-NSSAI is completed as a:

- a) success, the AMF shall include this S-NSSAI in the allowed NSSAI over the same access of the requested S-NSSAI or in the partially allowed NSSAI over 3GPP access; or
- b) failure, the AMF shall include this S-NSSAI in the rejected NSSAI for the failed or revoked NSSAI with the rejection cause "S-NSSAI not available due to the failed or revoked network slice-specific authentication and authorization" over either 3GPP access or non-3GPP access.

If authorization is revoked for an S-NSSAI that is in the current allowed NSSAI for an access type, the AMF shall:

- a) provide a new allowed NSSAI to the UE, excluding the S-NSSAI for which authorization is revoked; and

- b) provide a new rejected NSSAI for the failed or revoked NSSAI, including the S-NSSAI in the rejected NSSAI for which the authorization is revoked, with the rejection cause "S-NSSAI not available due to the failed or revoked network slice-specific authentication and authorization".

The allowed NSSAI, the partially allowed NSSAI and the rejected NSSAI shall be included in the CONFIGURATION UPDATE COMMAND message to reflect the result of the procedures subject to network slice-specific authentication and authorization.

NOTE 2: If there are multiple S-NSSAIs subject to network slice-specific authentication and authorization, it is implementation specific if the AMF informs the UE about the outcome of the procedures in one or more CONFIGURATION UPDATE COMMAND messages.

If the AMF includes the Network slicing indication IE in the CONFIGURATION UPDATE COMMAND message with the Network slicing subscription change indication set to "Network slicing subscription changed", and changes to the allowed NSSAI require the UE to initiate a registration procedure, but the AMF is unable to determine an allowed NSSAI for the UE as specified in 3GPP TS 23.501 [8], then the CONFIGURATION UPDATE COMMAND message shall additionally indicate "registration requested" in the Registration requested bit of the Configuration update indication IE and shall not include an allowed NSSAI.

If EAC mode is activated for an S-NSSAI, the AMF shall perform NSAC for the S-NSSAI subject to NSAC before such S-NSSAI is included in the allowed NSSAI in the CONFIGURATION UPDATE COMMAND message. If EAC mode is deactivated for an S-NSSAI, the AMF shall perform NSAC for the S-NSSAI subject to NSAC after such S-NSSAI is included in the allowed NSSAI in the CONFIGURATION UPDATE COMMAND message.

If the UE supports extended rejected NSSAI and the AMF determines that maximum number of UEs reached for one or more S-NSSAI(s) in the allowed NSSAI as specified in subclause 4.6.2.5, the AMF shall include the rejected NSSAI containing one or more S-NSSAIs with the rejection cause "S-NSSAI not available due to maximum number of UEs reached" in the Extended rejected NSSAI IE in the CONFIGURATION UPDATE COMMAND message. In addition, the AMF may include a back-off timer value for each S-NSSAI with the rejection cause "S-NSSAI not available due to maximum number of UEs reached" included in the Extended rejected NSSAI IE of the CONFIGURATION UPDATE COMMAND message. To avoid that large numbers of UEs simultaneously initiate deferred requests, the network should select the value for the backoff timer for each S-NSSAI for the informed UEs so that timeouts are not synchronised.

If the UE does not indicate support for extended rejected NSSAI and the maximum number of UEs has been reached, the AMF should include the rejected NSSAI containing one or more S-NSSAIs with the rejection cause "S-NSSAI not available in the current registration area" in the Rejected NSSAI IE and should not include these S-NSSAIs in the allowed NSSAI in the CONFIGURATION UPDATE COMMAND message. In addition, the AMF may based on the network policies start a local implementation specific timer for the UE per rejected S-NSSAI and upon expiration of the local implementation specific timer, the AMF may remove the rejected S-NSSAI from the rejected NSSAI and update to the UE by initiating the generic UE configuration update procedure.

NOTE 3: Based on network policies, the AMF can include the S-NSSAI(s) for which the maximum number of UEs has been reached in the rejected NSSAI with rejection causes other than "S-NSSAI not available in the current registration area".

If the UE has set the NSAG bit to "NSAG supported" in the 5GMM capability IE of the REGISTRATION REQUEST message, the AMF may include the NSAG information IE in the CONFIGURATION UPDATE COMMAND message. Up to 4 NSAG entries are allowed to be associated with a TAI list in the NSAG information IE.

NOTE 3A: How the AMF selects NSAG entries to be included in the NSAG information IE is implementation specific, e.g. take the NSAG priority and the current registration area into account.

NOTE 3B: If the NSAG for the PLMN and its equivalent PLMN(s) have different associations with S-NSSAIs, then the AMF includes a TAI list for the NSAG entry in the NSAG information IE.

If the UE supports network slice replacement and the AMF determines to provide the mapping information between the S-NSSAI to be replaced and the alternative S-NSSAI to the UE, then the AMF shall include the Alternative NSSAI IE, the Allowed NSSAI IE or the Partially allowed NSSAI IE including the alternative S-NSSAI, if not included in the current allowed NSSAI or the current partially allowed NSSAI, and the Configured NSSAI IE including the alternative S-NSSAI, if not included in the current configured NSSAI, in the CONFIGURATION UPDATE COMMAND message. If the AMF determines that the replaced S-NSSAI is available, then the AMF shall provide the updated alternative NSSAI excluding the replaced S-NSSAI and the corresponding alternative S-NSSAI in the Alternative NSSAI IE in the CONFIGURATION UPDATE COMMAND message. If the AMF determines that all the replaced S-

NSSAI(s) are available, then the AMF shall provide the Alternative NSSAI IE with Length of Alternative NSSAI contents set to 0 in the CONFIGURATION UPDATE COMMAND message. If the AMF determines that the replaced S-NSSAI is not supported due to the UE moving outside of NS-AoS of the S-NSSAI while the alternative S-NSSAI is available, then the AMF shall provide the updated allowed NSSAI and partially allowed NSSAI, if available, excluding the replaced S-NSSAI, if included, in the allowed NSSAI or partially allowed NSSAI in the CONFIGURATION UPDATE COMMAND message.

If the UE supports partial network slice and the AMF needs to update the partially allowed NSSAI, partially rejected NSSAI or both, then the AMF shall include the Partially allowed NSSAI IE, the Partially rejected NSSAI IE or both, in the CONFIGURATION UPDATE COMMAND message.

If the UE supports network slice usage control and the AMF needs to update the on-demand NSSAI, the AMF shall include the On-demand NSSAI IE in the CONFIGURATION UPDATE COMMAND message.

If the AMF needs to update the LADN information, the AMF shall include the LADN information in the LADN information IE of the CONFIGURATION UPDATE COMMAND message.

If the UE supports LADN per DNN and S-NSSAI and the AMF needs to update the extended LADN information, the AMF shall include the extended LADN information in the Extended LADN information IE of the CONFIGURATION UPDATE COMMAND message.

If:

- the UE does not support LADN per DNN and S-NSSAI;
- the UE is subscribed to the LADN DNN for a single S-NSSAI only; and
- the AMF only has the extended LADN information;

the AMF may decide to provide the LADN service area for that LADN DNN of the extended LADN information as the LADN information and include the LADN information in the LADN information IE of the CONFIGURATION UPDATE COMMAND message.

NOTE 3C: If the LADN service area is configured per DNN and S-NSSAI, in order to serve the UEs that do not support LADN per DNN and S-NSSAI, it is recommended that the LADN DNN is only served by a single S-NSSAI.

NOTE 3D: In case of the UE is subscribed to the LADN DNN for multiple S-NSSAIs, the AMF can treat this as no extended LADN information is available.

NOTE 3E: The AMF allocates the LADN service area and the TAI list associated with the S-NSSAI in the partially allowed NSSAI independently, if applicable.

If the UE does not support LADN per DNN and S-NSSAI and the AMF has neither the LADN information nor the extended LADN information, the AMF shall not provide any LADN information to the UE.

If the AMF needs to update the "CAG information list", the AMF shall include the CAG information list IE or the Extended CAG information list IE in the CONFIGURATION UPDATE COMMAND message.

NOTE 4: If the UE supports extended CAG information list, the CAG information list can be included either in the CAG information list IE or Extended CAG information list IE.

If the UE does not support extended CAG information list, the CAG information list shall not be included in the Extended CAG information list IE.

If the AMF needs to update the "CAG information list", the UE has an emergency PDU session, and the AMF can determine that the UE is in

- a) a CAG cell and none of the CAG-ID(s) supported by the CAG cell is authorized based on the "allowed CAG list" for the current PLMN in the updated "CAG information list"; or
- b) a non-CAG cell and the entry for the current PLMN in the updated "CAG information list" includes an "indication that the UE is only allowed to access 5GS via CAG cells";

the AMF may indicate to the SMF to perform a local release of:

- a) all non-emergency single access PDU sessions associated with 3GPP access;
- b) all MA PDU sessions without a PDN connection established as a user-plane resource and without user plane resources established on non-3GPP access; and
- c) the 3GPP access user plane resources of all those MA PDU sessions with user plane resources established on both accesses.

The AMF shall not indicate to the SMF to release the emergency PDU session. If the AMF indicated to the SMF to perform a local release of:

- a) all single access non-emergency PDU sessions associated with 3GPP access;
- b) all MA PDU sessions without a PDN connection established as a user-plane resource and without user plane resources established on non-3GPP access; and
- c) the 3GPP access user plane resources of all those MA PDU sessions with user plane resources established on both accesses;

the network shall behave as if the UE is registered for emergency services over 3GPP access and shall set the emergency registered bit of the 5GS registration result IE to "Registered for emergency services" in the CONFIGURATION UPDATE COMMAND message.

If the AMF is initiating the generic UE configuration update procedure to indicate to a UE which is registered for disaster roaming services, and which has an ongoing emergency PDU session, that the UE is registered for emergency services as described in subclause 4.24, the AMF shall set the emergency registered bit of the 5GS registration result IE to "Registered for emergency services" in the CONFIGURATION UPDATE COMMAND message.

If the AMF:

- updated the "CAG information list" to remove one or more CAG-ID(s) authorized based on the Allowed CAG list for the serving PLMN or an equivalent PLMN; or
- updated the "CAG information list" to set the "indication that the UE is only allowed to access 5GS via CAG cells" for the serving PLMN or an equivalent PLMN which was not set before,

then upon completion of the configuration update procedure and if the UE does not have an emergency PDU session, the AMF shall initiate the release of the N1 NAS signalling connection according to subclause 5.3.1.3.

If the AMF needs to update the truncated 5G-S-TMSI configuration for a UE in NB-N1 mode using control plane CIoT 5GS optimization, the AMF shall include the Truncated 5G-S-TMSI configuration IE in the CONFIGURATION UPDATE COMMAND message.

If the AMF includes a UE radio capability ID deletion indication IE in the CONFIGURATION UPDATE COMMAND message, the AMF shall indicate "registration requested" in the Registration requested bit of the Configuration update indication IE.

If the AMF needs to redirect the UE to EPC as described in subclause 4.8.4A.2, the AMF shall indicate "registration requested" in the Registration requested bit of the Configuration update indication IE and "release of N1 NAS signalling connection not required" in the Signalling connection maintain request bit of the Additional configuration indication IE in the CONFIGURATION UPDATE COMMAND message.

If the UE is not in NB-N1 mode and the UE supports RACS, the AMF may include either a UE radio capability ID IE or a UE radio capability ID deletion indication IE in the CONFIGURATION UPDATE COMMAND message.

During an established 5GMM context, the network may send none, one, or more CONFIGURATION UPDATE COMMAND messages to the UE. If more than one CONFIGURATION UPDATE COMMAND message is sent, the messages need not have the same content.

Upon receipt of the result of the UUAA-MM procedure from the UAS-NF, the AMF shall include:

- a) the service-level-AA response with the SLAR field set to:
 - 1) "Service level authentication and authorization was successful" if the AMF detects the UUAA-MM procedure has succeeded; or

- 2) "Service level authentication and authorization was not successful or service level authorization is revoked" if the AMF detects the UUAA-MM procedure has failed;
- b) if the CAA-Level UAV ID is provided by the UAS-NF, the service-level device ID with the value set to the CAA-Level UAV ID; and;
- c) if a payload is received from the UAS-NF:
 - 1) the service-level-AA payload with the value set to the payload; and
 - 2) if a payload type associated with the payload is received, the service-level-AA payload type with the values set to the payload type; and
 - 3) if the payload type associated with the payload is for C2 authorization payload, the service-level-AA response with C2AR field set to either "C2 authorization was successful" or "C2 authorization was not successful or C2 authorization is revoked" according to the authorization result received from the UAS-NF;

in the Service-level-AA container IE of the CONFIGURATION UPDATE COMMAND message.

NOTE 5: UAS security information can be included in the UUAA payload by the USS as specified in 3GPP TS 33.256 [24B].

NOTE 5A: The service-level-AA payload associated with the payload type "C2 authorization payload" can include pairing information for the direct C2 communication, or the security information as specified in TS 33.256 [24B], or both.

NOTE 6: If the AMF receives the HTTP code set to "4xx" or "5xx" as specified in 3GPP TS 29.500 [20AA] or the AMF detects that the UUAA-MM failure as specified in 3GPP TS 29.256 [21B], then the AMF considers the UUAA-MM procedure has failed.

If the AMF needs to deliver to the UE the UUAA revocation notification received from the UAS-NF, the AMF shall include the service-level-AA response with SLAR set to "Service level authentication and authorization was not successful or service level authorization is revoked" in the Service-level-AA container IE of the CONFIGURATION UPDATE COMMAND message.

If the UE supports UAS services and UAS services become enabled for the UE (e.g. because of the aerial subscription becomes a part of the UE subscription data retrieved from the UDM), the AMF may include the service-level-AA service status indication with UAS field set to "UAS services enabled" in the Service-level-AA container IE of the CONFIGURATION UPDATE COMMAND message.

If the UE supports MINT, the AMF may include the List of PLMNs to be used in disaster condition IE in the CONFIGURATION UPDATE COMMAND message.

If the UE supports MINT, the AMF may include the Disaster roaming wait range IE in the CONFIGURATION UPDATE COMMAND message.

If the UE supports MINT, the AMF may include the Disaster return wait range IE in the CONFIGURATION UPDATE COMMAND message.

NOTE 7: The AMF can determine the content of the "list of PLMN(s) to be used in disaster condition", the value of the disaster roaming wait range and the value of the disaster return wait range based on the network local configuration.

If the UE supports discontinuous coverage, the AMF may include the Discontinuous coverage maximum time offset IE in the CONFIGURATION UPDATE COMMAND message.

If the UE supports and the network supports and accepts the use of the PEIPS assistance information, and the AMF needs to update the PEIPS assistance information, the AMF may include the PEIPS assistance information in the Updated PEIPS assistance information IE of the CONFIGURATION UPDATE COMMAND message.

If the AMF needs to inform the UE that the use of access identity 1 is valid or is no longer valid, then,

- 1) if the UE supports MPS indicator update via the UE configuration update procedure, the AMF:
 - a) informs the UE by setting the MPS indicator bit of the Priority indicator IE to "Access identity 1 valid" or "Access identity 1 not valid" respectively, in the CONFIGURATION UPDATE COMMAND message.

Based on operator policy, the AMF sets the MPS indicator bit in the CONFIGURATION UPDATE COMMAND message based on the MPS priority information in the user's subscription context obtained from the UDM; or

- b) indicates "registration requested" in the Registration requested bit of the Configuration update indication IE in the CONFIGURATION UPDATE COMMAND message; or
- 2) if the UE supports MCS indicator update via the UE configuration update procedure, the AMF:
- a) informs the UE by setting the MCS indicator bit of the Priority indicator IE to "Access identity 2 valid" or "Access identity 2 not valid" respectively, in the CONFIGURATION UPDATE COMMAND message. Based on operator policy, the AMF sets the MCS indicator bit in the CONFIGURATION UPDATE COMMAND message based on the MCS priority information in the user's subscription context obtained from the UDM; or
 - b) indicates "registration requested" in the Registration requested bit of the Configuration update indication IE in the CONFIGURATION UPDATE COMMAND message; or
- 3) otherwise, the AMF shall indicate "registration requested" in the Registration requested bit of the Configuration update indication IE in the CONFIGURATION UPDATE COMMAND message.

If the UE has set the Reconnection to the network due to RAN timing synchronization status change (RANtiming) bit to "Reconnection to the network due to RAN timing synchronization status change supported" in the 5GMM capability IE of the REGISTRATION REQUEST message, the AMF may include the RAN timing synchronization IE with the RecReq bit set to "Reconnection requested" in the CONFIGURATION UPDATE COMMAND message.

When the UE is operating as an MBSR and its status of the MBSR authorization changes to not authorized for MBSR operation based on the UE subscription and local policy and the UE is allowed to operate as a UE, then the AMF shall include the Feature authorization indication IE in the CONFIGURATION UPDATE COMMAND message and shall set the MBSRAI field to "not authorized to operate as MBSR but allowed to operate as a UE", and the AMF can request the SMF to release the PDU session for OAM access (see 3GPP TS 23.501 [8]) provided in the serving PLMN. When the UE that was not allowed for MBSR operation becomes to be allowed for MBSR operation based on the UE subscription and local policy, then the AMF shall include the Feature authorization indication IE in the CONFIGURATION UPDATE COMMAND message and shall set the MBSRAI field to "authorized to operate as MBSR"

5.4.4.3 Generic UE configuration update accepted by the UE

Upon receiving the CONFIGURATION UPDATE COMMAND message, the UE shall stop timer T3346 if running and use the contents to update appropriate information stored within the UE.

If "acknowledgement requested" is indicated in the Acknowledgement bit of the Configuration update indication IE in the CONFIGURATION UPDATE COMMAND message, the UE shall send a CONFIGURATION UPDATE COMPLETE message.

If the UE receives a new 5G-GUTI in the CONFIGURATION UPDATE COMMAND message, the UE shall consider the new 5G-GUTI as valid, the old 5G-GUTI as invalid, stop timer T3519 if running, and delete any stored SUCI; otherwise, the UE shall consider the old 5G-GUTI as valid. The UE shall provide the 5G-GUTI to the lower layer of 3GPP access if the CONFIGURATION UPDATE COMMAND message is sent over the non-3GPP access, and the UE is in 5GMM-REGISTERED in both 3GPP access and non-3GPP access in the same PLMN.

If the UE receives a new TAI list in the CONFIGURATION UPDATE COMMAND message, the UE shall consider the new TAI list as valid and the old TAI list as invalid; otherwise, the UE shall consider the old TAI list as valid. If the registration area contains TAIs belonging to different PLMNs, which are equivalent PLMNs, and

- a) the UE already has stored allowed NSSAI for the current registration area, the UE shall store the allowed NSSAI for the current registration area in each of the allowed NSSAIs which are associated with each of the PLMNs in the registration area;
- b) the UE already has stored rejected NSSAI for the current registration area, the UE shall store the rejected NSSAI for the current registration area in each of the rejected NSSAIs which are associated with each of the PLMNs in the registration area;

- c) the UE already has stored rejected NSSAI for the failed or revoked NSSAA, the UE shall store the rejected NSSAI for the failed or revoked NSSAA in each of the rejected NSSAIs which are associated with each of the PLMNs in the registration area;
- d) the UE already has stored rejected NSSAI for the maximum number of UEs reached, the UE shall store the rejected NSSAI for the maximum number of UEs reached in each of the rejected NSSAIs which are associated with each of the PLMNs in the registration area; and
- e) the UE already has stored pending NSSAI, the UE shall store the pending NSSAI in each of the pending NSSAIs which are associated with each of the PLMNs in the registration area.

If the UE receives a new truncated 5G-S-TMSI configuration in the CONFIGURATION UPDATE COMMAND message, the UE shall consider the new truncated 5G-S-TMSI configuration as valid and the old truncated 5G-S-TMSI configuration as invalid; otherwise, the UE shall consider the old truncated 5G-S-TMSI configuration as valid.

If the UE receives a new service area list in the CONFIGURATION UPDATE COMMAND message, the UE shall consider the new service area list as valid and the old service area list as invalid; otherwise, the UE shall consider the old service area list, if any, as valid.

If the UE receives new NITZ information in the CONFIGURATION UPDATE COMMAND message, the UE considers the new NITZ information as valid and the old NITZ information as invalid; otherwise, the UE shall consider the old NITZ information as valid.

If the UE receives a LADN information IE in the CONFIGURATION UPDATE COMMAND message, the UE shall consider the old LADN information as invalid and the new LADN information as valid, if any; otherwise, the UE shall consider the old LADN information as valid.

If the UE receives an Extended LADN information IE in the CONFIGURATION UPDATE COMMAND message, the UE shall consider the old extended LADN information as invalid and the new extended LADN information as valid, if any; otherwise, the UE shall consider the old extended LADN information as valid.

If the UE receives a new allowed NSSAI for the associated access type in the CONFIGURATION UPDATE COMMAND message, the UE shall consider the new allowed NSSAI as valid for the associated access type, store the allowed NSSAI for the associated access type as specified in subclause 4.6.2.2 and consider the old allowed NSSAI for the associated access type as invalid; otherwise, the UE shall consider the old allowed NSSAI as valid for the associated access type.

If the UE receives a new configured NSSAI in the CONFIGURATION UPDATE COMMAND message, the UE shall consider the new configured NSSAI for the registered PLMN or SNPN as valid and the old configured NSSAI for the registered PLMN or SNPN as invalid; otherwise, the UE shall consider the old configured NSSAI for the registered PLMN or SNPN as valid. The UE shall store the new configured NSSAI as specified in subclause 4.6.2.2. In addition, if the CONFIGURATION UPDATE COMMAND message contains:

- a) an NSSRG information IE, the UE shall store the contents of the NSSRG information IE as specified in subclause 4.6.2.2. If the UE receives a new configured NSSAI in the CONFIGURATION UPDATE COMMAND message and no NSSRG information IE, the UE shall delete any stored NSSRG information, if any, as specified in subclause 4.6.2.2;

NOTE 1: When the UE receives the NSSRG information IE, the UE may provide the NSSRG information to lower layers for the purpose of NSAG-aware cell reselection.

- b) an S-NSSAI location validity information IE, the UE shall store the contents of the S-NSSAI location validity information IE as specified in subclause 4.6.2.2. If the UE receives a new configured NSSAI in the CONFIGURATION UPDATE COMMAND message and no S-NSSAI location validity information IE, the UE shall delete any stored S-NSSAI location validity information, if any, as specified in subclause 4.6.2.2;
- c) an S-NSSAI time validity information IE, the UE shall store the contents of the S-NSSAI time validity information IE as specified in subclause 4.6.2.2. If the UE receives a new configured NSSAI in the CONFIGURATION UPDATE COMMAND message and no S-NSSAI time validity information IE, the UE shall delete any stored S-NSSAI time validity information, if any, as specified in subclause 4.6.2.2; or
- d) an On-demand NSSAI IE, the UE shall store the contents of the On-demand NSSAI IE as specified in subclause 4.6.2.2. If the UE receives a new Configured NSSAI IE in the CONFIGURATION UPDATE COMMAND message and no On-demand NSSAI IE, the UE shall delete any stored on-demand NSSAI as

specified in subclause 4.6.2.2. The UE shall stop slice deregistration inactivity timer, if running for the S-NSSAI which is deleted from the on-demand NSSAI.

If the CONFIGURATION UPDATE COMMAND message contains Partially allowed NSSAI IE the UE shall store the contents of the Partially allowed NSSAI IE as specified in subclause 4.6.2.2. If the CONFIGURATION UPDATE COMMAND message contains Partially rejected NSSAI IE the UE shall store the contents of the Partially rejected NSSAI IE as specified in subclause 4.6.2.2.

If the UE receives the Network slicing indication IE in the CONFIGURATION UPDATE COMMAND message with the Network slicing subscription change indication set to "Network slicing subscription changed", the UE shall delete the network slicing information for each and every PLMN or SNPN except for the current PLMN or SNPN as specified in subclause 4.6.2.2 and remove all tracking areas from the list of "5GS forbidden tracking areas for roaming" which were added due to rejection of S-NSSAI due to "S-NSSAI not available in the current registration area".

If the UE receives Operator-defined access category definitions IE in the CONFIGURATION UPDATE COMMAND message and the Operator-defined access category definitions IE contains one or more operator-defined access category definitions, the UE shall delete any operator-defined access category definitions stored for the RPLMN and shall store the received operator-defined access category definitions for the RPLMN. If the UE receives the Operator-defined access category definitions IE in the CONFIGURATION UPDATE COMMAND message and the Operator-defined access category definitions IE contains no operator-defined access category definitions, the UE shall delete any operator-defined access category definitions stored for the RPLMN. If the CONFIGURATION UPDATE COMMAND message does not contain the Operator-defined access category definitions IE, the UE shall not delete the operator-defined access category definitions stored for the RPLMN.

If the UE receives the SMS indication IE in the CONFIGURATION UPDATE COMMAND message with the SMS availability indication set to:

- a) "SMS over NAS not available", the UE shall consider that SMS over NAS transport is not allowed by the network; and
- b) "SMS over NAS available", the UE may request the use of SMS over NAS transport by performing a registration procedure for mobility and periodic registration update as specified in subclause 5.5.1.3, after the completion of the generic UE configuration update procedure.

If the UE receives the CAG information list IE or the Extended CAG information list IE in the CONFIGURATION UPDATE COMMAND message, the UE shall:

- a) replace the "CAG information list" stored in the UE with the received CAG information list IE or the Extended CAG information list IE when received in the HPLMN or EHPLMN;

NOTE 2: When the UE receives the CAG information list IE or the Extended CAG information list IE in the HPLMN whose PLMN code is derived from the IMSI, the EHPLMN list is present and is not empty and the HPLMN is not present in the EHPLMN list, the UE behaves as if it receives the CAG information list IE or the Extended CAG information list IE in a VPLMN.

- b) replace the serving VPLMN's entry of the "CAG information list" stored in the UE with the serving VPLMN's entry of the received CAG information list IE or the Extended CAG information list IE when the UE receives the CAG information list IE or the Extended CAG information list IE in a serving PLMN other than the HPLMN or EHPLMN; or

NOTE 3: When the UE receives the CAG information list IE or the Extended CAG information list IE in a serving PLMN other than the HPLMN or EHPLMN, entries of a PLMN other than the serving VPLMN, if any, in the received CAG information list IE or the Extended CAG information list IE are ignored.

- c) remove the serving VPLMN's entry of the "CAG information list" stored in the UE when the UE receives the CAG information list IE or the Extended CAG information list IE in a serving PLMN other than the HPLMN or EHPLMN and the CAG information list IE or the Extended CAG information list IE does not contain the serving VPLMN's entry.

The UE shall store the "CAG information list" received in the CAG information list IE or the Extended CAG information list IE as specified in annex C.

If the received "CAG information list" includes an entry containing the identity of the current PLMN and the UE had set the CAG bit to "CAG supported" in the 5GMM capability IE of the REGISTRATION REQUEST message, the UE shall operate as follows.

- a) If the UE receives the CONFIGURATION UPDATE COMMAND message via a CAG cell, none of the CAG-ID(s) supported by the current CAG cell is authorized based on the "Allowed CAG list" of the entry for the current PLMN in the received "CAG information list", and:
- 1) the entry for the current PLMN in the received "CAG information list" does not include an "indication that the UE is only allowed to access 5GS via CAG cells", then the UE shall enter the state 5GMM-REGISTERED.LIMITED-SERVICE and shall search for a suitable cell according to 3GPP TS 38.304 [28] or 3GPP TS 36.304 [25C] with the updated "CAG information list"; or
 - 2) the entry for the current PLMN in the received "CAG information list" includes an "indication that the UE is only allowed to access 5GS via CAG cells" and:
 - i) if one or more CAG-ID(s) are authorized based on the "Allowed CAG list" of the entry for the current PLMN in the received "CAG information list", the UE shall enter the state 5GMM-REGISTERED.LIMITED-SERVICE and shall search for a suitable cell according to 3GPP TS 38.304 [28] with the updated "CAG information list"; or
 - ii) if no CAG-ID is authorized based on the "Allowed CAG list" of the entry for the current PLMN in the received "CAG information list" and:
 - A) the UE does not have an emergency PDU session, then the UE shall enter the state 5GMM-REGISTERED.PLMN-SEARCH and shall apply the PLMN selection process defined in 3GPP TS 23.122 [5] with the updated "CAG information list"; or
 - B) the UE has an emergency PDU session, then the UE shall perform a local release of all PDU sessions associated with 3GPP access except for the emergency PDU session and enter the state 5GMM-REGISTERED.LIMITED-SERVICE; or
- b) If the UE receives the CONFIGURATION UPDATE COMMAND message via a non-CAG cell and the entry for the current PLMN in the received "CAG information list" includes an "indication that the UE is only allowed to access 5GS via CAG cells" and:
- 1) if one or more CAG-ID(s) are authorized based on the "allowed CAG list" for the current PLMN in the received "CAG information list", the UE shall enter the state 5GMM-REGISTERED.LIMITED-SERVICE and shall search for a suitable cell according to 3GPP TS 38.304 [28] with the updated "CAG information list"; or
 - 2) if no CAG-ID is authorized based on the "Allowed CAG list" of the entry for the current PLMN in the received "CAG information list" and:
 - i) the UE does not have an emergency PDU session, then the UE shall enter the state 5GMM-REGISTERED.PLMN-SEARCH and shall apply the PLMN selection process defined in 3GPP TS 23.122 [5] with the updated "CAG information list"; or
 - ii) the UE has an emergency PDU session, then the UE shall perform a local release of all PDU sessions associated with 3GPP access except for the emergency PDU session and enter the state 5GMM-REGISTERED.LIMITED-SERVICE.

If the received "CAG information list" does not include an entry containing the identity of the current PLMN and the UE receives the CONFIGURATION UPDATE COMMAND message via a CAG cell, the UE shall enter the state 5GMM-REGISTERED.LIMITED-SERVICE and shall search for a suitable cell according to 3GPP TS 38.304 [28] or 3GPP TS 36.304 [25C] with the updated "CAG information list".

If the CONFIGURATION UPDATE COMMAND message indicates "registration requested" in the Registration requested bit of the Configuration update indication IE and:

- a) contains no other parameters or contains at least one of the following parameters: a new allowed NSSAI, a new partially allowed NSSAI, a new configured NSSAI, a new NSSRG information or the Network slicing subscription change indication, and:
 - 1) an emergency PDU session exists, the UE shall, after the completion of the generic UE configuration update procedure and the release of the emergency PDU session, release the existing N1 NAS signalling connection. Additionally, the UE shall:

- i) if any T_{sr}-cm timer(s) were running and have stopped, attempt to obtain service on a higher priority PLMN (see 3GPP TS 23.122 [5]); or
 - ii) in all other cases, start a registration procedure for mobility and periodic registration update as specified in subclause 5.5.1.3; or
- 2) no emergency PDU Session exists, the UE shall, after the completion of the generic UE configuration update procedure and the release of the existing N1 NAS signalling connection:
- i) if any T_{sr}-cm timer(s) were running and have stopped, attempt to obtain service on a higher priority PLMN (see 3GPP TS 23.122 [5]); or
 - ii) in all other cases, start a registration procedure for mobility and periodic registration update as specified in subclause 5.5.1.3;
- b) a MICO indication is included without a new allowed NSSAI, a new configured NSSAI, a new NSSRG information or the Network slicing subscription change indication, the UE shall, after the completion of the generic UE configuration update procedure, start a periodic registration procedure for mobility and registration update as specified in subclause 5.5.1.3 to re-negotiate MICO mode with the network;
- c) an Additional configuration indication IE is included, and:
- 1) "release of N1 NAS signalling connection not required" is indicated in the Signalling connection maintain request bit of the Additional configuration indication IE; and
 - 2) a new allowed NSSAI, a new configured NSSAI, a new NSSRG information or the Network slicing subscription change indication is not included in the CONFIGURATION UPDATE COMMAND message,
the UE shall, after the completion of the generic UE configuration update procedure, start a registration procedure for mobility and periodic registration update as specified in subclause 5.5.1.3; or
- d) a UE radio capability ID deletion indication IE set to "Network-assigned UE radio capability IDs deletion requested" is included, and:
- 1) the UE is not in NB-N1 mode;
 - 2) a new allowed NSSAI, a new configured NSSAI, a new NSSRG information or a Network slicing subscription change indication is not included; and
 - 3) the UE has set the RACS bit to "RACS supported" in the 5GMM capability IE of the REGISTRATION REQUEST message,
the UE shall, after the completion of the generic UE configuration update procedure, start a registration procedure for mobility and periodic registration update as specified in subclause 5.5.1.3.

The UE receiving the rejected NSSAI in the CONFIGURATION UPDATE COMMAND message takes the following actions based on the rejection cause in the rejected S-NSSAI(s):

"S-NSSAI not available in the current PLMN or SNPN"

The UE shall add the rejected S-NSSAI(s) in the rejected NSSAI for the current PLMN or SNPN as specified in subclause 4.6.2.2 and shall not attempt to use this S-NSSAI(s) in the current PLMN or SNPN over any access until switching off the UE, the UICC containing the USIM is removed, the entry of the "list of subscriber data" with the SNPN identity of the current SNPN is updated, or the rejected S-NSSAI(s) are removed as described in subclause 4.6.2.2.

"S-NSSAI not available in the current registration area"

The UE shall add the rejected S-NSSAI(s) in the rejected NSSAI for the current registration area as specified in subclause 4.6.2.2 and shall not attempt to use this S-NSSAI(s) in the current registration area over the current access until switching off the UE, the UE moving out of the current registration area, the UICC containing the USIM is removed, the entry of the "list of subscriber data" with the SNPN identity of the current SNPN is updated, or the rejected S-NSSAI(s) are removed as described in subclause 4.6.2.2.

"S-NSSAI not available due to the failed or revoked network slice-specific authentication and authorization"

The UE shall add the rejected S-NSSAI(s) in the rejected NSSAI for the failed or revoked NSSAI as specified in subclause 4.6.2.2 and shall not attempt to use this S-NSSAI in the current PLMN or SNPN over any access until switching off the UE, the UICC containing the USIM is removed, the entry of the "list of subscriber data" with the SNPN identity of the current SNPN is updated, or the rejected S-NSSAI(s) are removed as described in subclause 4.6.1 and 4.6.2.2.

"S-NSSAI not available due to maximum number of UEs reached"

Unless the back-off timer value received along with the S-NSSAI is zero, the UE shall add the rejected S-NSSAI(s) in the rejected NSSAI for the maximum number of UEs reached as specified in subclause 4.6.2.2 and shall not attempt to use this S-NSSAI in the current PLMN or SNPN over the current access until switching off the UE, the UICC containing the USIM is removed, the entry of the "list of subscriber data" with the SNPN identity of the current SNPN is updated, or the rejected S-NSSAI(s) are removed as described in subclauses 4.6.1 and 4.6.2.2.

NOTE 4: If the back-off timer value received along with the S-NSSAI in the rejected NSSAI for the maximum number of UEs reached is zero as specified in subclause 10.5.7.4a of 3GPP TS 24.008 [12], the UE does not consider the S-NSSAI as the rejected S-NSSAI.

If there is one or more S-NSSAIs in the rejected NSSAI with the rejection cause "S-NSSAI not available due to maximum number of UEs reached", then for each S-NSSAI, the UE shall behave as follows:

- a) stop the timer T3526 associated with the S-NSSAI, if running;
- b) start the timer T3526 with:
 - 1) the back-off timer value received along with the S-NSSAI, if back-off timer value is received along with the S-NSSAI that is neither zero nor deactivated; or
 - 2) an implementation specific back-off timer value, if no back-off timer value is received along with the S-NSSAI; and
- c) remove the S-NSSAI from the rejected NSSAI for the maximum number of UEs reached when the timer T3526 associated with the S-NSSAI expires.

If the UE receives the NSAG information IE in the CONFIGURATION UPDATE COMMAND message, the UE shall store the NSAG information as specified in subclause 4.6.2.2.

If the UE receives the Alternative NSSAI IE in the CONFIGURATION UPDATE COMMAND message, the UE shall store the alternative NSSAI as specified in subclause 4.6.2.2.

If the UE receives the On-demand NSSAI IE in the CONFIGURATION UPDATE COMMAND message, the UE shall store the on-demand NSSAI as specified in subclause 4.6.2.2.

If the UE receives a T3447 value IE in the CONFIGURATION UPDATE COMMAND message and has indicated "service gap control supported" in the REGISTRATION REQUEST, then the UE shall replace the stored T3447 value with the received value in the T3447 value IE, and if neither zero nor deactivated use the received T3447 value with the timer T3447 next time it is started. If the received T3447 value is zero or deactivated, then the UE shall stop the timer T3447 if running.

If the UE is not in NB-N1 mode, the UE has set the RACS bit to "RACS supported" in the 5GMM capability IE of the REGISTRATION REQUEST message and the CONFIGURATION UPDATE COMMAND message includes:

- a) a UE radio capability ID deletion indication IE set to "Network-assigned UE radio capability IDs deletion requested", the UE shall delete any network-assigned UE radio capability IDs associated with the RPLMN or RSNPN and, if the UE supports access to an SNPN using credentials from a credentials holder, equivalent SNPNs or both, the selected entry of the "list of subscriber data" or the selected PLMN subscription stored at the UE; or
- b) a UE radio capability ID IE, the UE shall store the UE radio capability ID as specified in annex C.

If the UE is not currently registered for emergency services and the emergency registered bit of the 5GS registration result IE in the CONFIGURATION UPDATE COMMAND message is set to "Registered for emergency services", the UE shall consider itself registered for emergency services and shall locally release all non-emergency PDU sessions, if any.

If the UE receives the service-level-AA container IE of the CONFIGURATION UPDATE COMMAND message, the UE passes it to the upper layer.

NOTE 5: The service-level-AA container IE can include a service-level-AA payload of type "C2 authorization payload" that includes pairing information for the direct C2 communication, or the security information as specified in TS 33.256 [24B], or both.

If the CONFIGURATION UPDATE COMMAND message includes the service-level-AA response in the Service-level-AA container IE with the SLAR field set to "Service level authentication and authorization was not successful or service level authorization is revoked", the UE shall forward the service-level-AA response to the upper layers, so the UUAAs authorization data is deleted as specified in 3GPP TS 33.256 [24B].

If the UE receives the List of PLMNs to be used in disaster condition IE in the CONFIGURATION UPDATE COMMAND message and the UE supports MINT, the UE shall delete the "list of PLMN(s) to be used in disaster condition" stored in the ME together with the PLMN ID of the RPLMN, if any, and may store the "list of PLMN(s) to be used in disaster condition" included in the List of PLMNs to be used in disaster condition IE in the ME together with the PLMN ID of the RPLMN.

If the UE receives the Disaster roaming wait range IE in the CONFIGURATION UPDATE COMMAND message and the UE supports MINT, the UE shall delete the disaster roaming wait range stored in the ME, if any, and store the disaster roaming wait range included in the Disaster roaming wait range IE in the ME.

If the UE receives the Disaster return wait range IE in the CONFIGURATION UPDATE COMMAND message and the UE supports MINT, the UE shall delete the disaster roaming wait range stored in the ME, if any, and store the disaster roaming wait range included in the Disaster roaming wait range IE in the ME.

If the UE receives, the Discontinuous coverage maximum time offset IE in the CONFIGURATION UPDATE COMMAND message, the UE shall replace any previously received discontinuous coverage maximum time offset value on the same satellite NG-RAN RAT type and PLMN with the latest received timer value.

If the UE receives the Updated PEIPS assistance information IE in the CONFIGURATION UPDATE COMMAND message and the UE supports NR paging subgrouping, the UE shall use the PEIPS assistance information included in the Updated PEIPS assistance information IE.

If the UE receives a CONFIGURATION UPDATE COMMAND message with the MPS indicator bit in the Priority indicator IE set to "Access identity 1 valid":

- via 3GPP access; or
- via non-3GPP access if the UE is registered to the same PLMN or SNPN over 3GPP access and non-3GPP access;

the UE shall act as a UE with access identity 1 configured for MPS, as described in subclause 4.5.2, in all NG-RAN of the registered PLMN and its equivalent PLMNs or in the case of SNPN, as described in subclause 4.5.2A, in all NG-RAN of the registered SNPN and its equivalent SNPNs.

If the UE receives a CONFIGURATION UPDATE COMMAND message with the MPS indicator bit in the Priority indicator IE set to "Access identity 1 valid":

- via non-3GPP access; or
- via 3GPP access if the UE is registered to the same PLMN or SNPN over 3GPP access and non-3GPP access;

the UE shall act as a UE with access identity 1 configured for MPS, as described in subclause 4.5.2, in non-3GPP access of the registered PLMN and its equivalent PLMNs or in the case of SNPN, as described in subclause 4.5.2A, in non-3GPP access of the registered SNPN and its equivalent SNPNs.

The MPS indicator bit in the Priority indicator IE provided in the CONFIGURATION UPDATE COMMAND message is valid:

- in all NG-RAN of the registered PLMN and its equivalent PLMNs, or in the case of SNPN in all NG-RAN of the registered SNPN and its equivalent SNPNs, until:
 - the UE receives a REGISTRATION ACCEPT message with the MPS indicator bit set to "Access identity 1 not valid" or the UE receives a CONFIGURATION UPDATE COMMAND message with the MPS indicator bit of the Priority indicator IE set to "Access identity 1 not valid":

- via 3GPP access; or
- via non-3GPP access if the UE is registered to the same PLMN or SNPN over 3GPP access and non-3GPP access; or
- the UE selects a non-equivalent PLMN (or in the case of SNPN, selects a non-equivalent SNPN); or
- in non-3GPP access of the registered PLMN and its equivalent PLMNs, or in the case of SNPN in non-3GPP access of the registered SNPN and its equivalent SNPNs, until:
 - the UE receives a REGISTRATION ACCEPT message with the MPS indicator bit set to "Access identity 1 not valid" or the UE receives a CONFIGURATION UPDATE COMMAND message with the MPS indicator bit of the Priority indicator IE set to "Access identity 1 not valid":
 - via non-3GPP access; or
 - via 3GPP access if the UE is registered to the same PLMN or SNPN over 3GPP access and non-3GPP access; or
 - the UE selects a non-equivalent PLMN (or in the case of SNPN, selects a non-equivalent SNPN).

Access identity 1 is only applicable while the UE is in N1 mode.

If the UE receives a CONFIGURATION UPDATE COMMAND message with the MCS indicator bit in the Priority indicator IE set to "Access identity 2 valid":

- via 3GPP access; or
- via non-3GPP access if the UE is registered to the same PLMN or SNPN over 3GPP access and non-3GPP access;

the UE shall act as a UE with access identity 2 configured for MCS, as described in subclause 4.5.2, in all NG-RAN of the registered PLMN and its equivalent PLMNs or in the case of SNPN, as described in subclause 4.5.2A, in all NG-RAN of the registered SNPN and its equivalent SNPNs.

If the UE receives a CONFIGURATION UPDATE COMMAND message with the MCS indicator bit in the Priority indicator IE set to "Access identity 2 valid":

- via non-3GPP access; or
- via 3GPP access if the UE is registered to the same PLMN or SNPN over 3GPP access and non-3GPP access;

the UE shall act as a UE with access identity 2 configured for MCS, as described in subclause 4.5.2, in non-3GPP access of the registered PLMN and its equivalent PLMNs or in the case of SNPN, as described in subclause 4.5.2A, in non-3GPP access of the registered SNPN and its equivalent SNPNs.

The MCS indicator bit in the Priority indicator IE provided in the CONFIGURATION UPDATE COMMAND message is valid:

- in all NG-RAN of the registered PLMN and its equivalent PLMNs, or in the case of SNPN in all NG-RAN of the registered SNPN and its equivalent SNPNs, until:
 - the UE receives a REGISTRATION ACCEPT message with the MCS indicator bit set to "Access identity 2 not valid" or the UE receives a CONFIGURATION UPDATE COMMAND message with the MCS indicator bit of the Priority indicator IE set to "Access identity 2 not valid":
 - via 3GPP access; or
 - via non-3GPP access if the UE is registered to the same PLMN or SNPN over 3GPP access and non-3GPP access; or
 - the UE selects a non-equivalent PLMN (or in the case of SNPN, selects a non-equivalent SNPN); or
- in non-3GPP access of the registered PLMN and its equivalent PLMNs, or in the case of SNPN in non-3GPP access of the registered SNPN and its equivalent SNPNs, until:

- the UE receives a REGISTRATION ACCEPT message with the MCS indicator bit set to "Access identity 2 not valid" or the UE receives a CONFIGURATION UPDATE COMMAND message with the MCS indicator bit of the Priority indicator IE set to "Access identity 2 not valid":
 - via non-3GPP access; or
 - via 3GPP access if the UE is registered to the same PLMN or SNPN over 3GPP access and non-3GPP access; or
- the UE selects a non-equivalent PLMN (or in the case of SNPN, selects a non-equivalentSNPN).

Access identity 2 is only applicable while the UE is in N1 mode.

If the UE supporting UAS services is not currently registered for UAS services and the CONFIGURATION UPDATE COMMAND message includes the service-level-AA service status indication in the Service-level-AA container IE with the UAS field set to "UAS services enabled", then the UE passes the service-level-AA service status indication to the upper layers.

If the UE supporting the reconnection to the network due to RAN timing synchronization status change receives the RAN timing synchronization IE with the RecReq bit set to "Reconnection requested" in the CONFIGURATION UPDATE COMMAND message, the UE shall operate as specified in subclauses 5.3.1.4, 5.5.1.3.2, and 5.6.1.1.

If the UE operating as MBSR receives the MBSRAI field of the Feature authorization indication IE in the CONFIGURATION UPDATE COMMAND message, the UE NAS layer informs the lower layers of the status of MBSR authorization.

5.4.4.4 Generic UE configuration update completion by the network

Upon receipt of the CONFIGURATION UPDATE COMPLETE message, the AMF shall stop the timer T3555.

If a new 5G-GUTI was included in the CONFIGURATION UPDATE COMMAND message, the AMF shall consider the new 5G-GUTI as valid and the old 5G-GUTI as invalid.

If a new TAI list was included in the CONFIGURATION UPDATE COMMAND message, the AMF shall consider the new TAI list as valid and the old TAI list as invalid.

If a new truncated 5G-S-TMSI configuration was included in the CONFIGURATION UPDATE COMMAND message, the AMF shall consider the new truncated 5G-S-TMSI configuration as valid and the old truncated 5G-S-TMSI configuration as invalid.

If a new service area list was included in the CONFIGURATION UPDATE COMMAND message, the AMF shall consider the new service area list as valid and the old service area list as invalid.

If new allowed NSSAI information was included in the CONFIGURATION UPDATE COMMAND message, the AMF shall consider the new allowed NSSAI information as valid and the old allowed NSSAI information as invalid. If new configured NSSAI information was included in the CONFIGURATION UPDATE COMMAND message, the AMF shall consider the new configured NSSAI information as valid and the old configured information as invalid. If there are active PDU sessions associated with S-NSSAI(s) not included in the new allowed NSSAI, the AMF shall notify the SMF(s) associated with these PDU sessions to initiate the network-requested PDU session release procedure according to subclause 6.3.3 in the present specification and subclause 5.15.5.2.2 in 3GPP TS 23.501 [8].

If "registration requested" was indicated in the Registration requested bit of the Configuration update indication IE in the CONFIGURATION UPDATE COMMAND message and:

- a) the CONFIGURATION UPDATE COMMAND message contained:
 - 1) an allowed NSSAI, a configured NSSAI or both;
 - 2) the Network slicing indication IE with the Network slicing subscription change indication set to "Network slicing subscription changed"; or
 - 3) no other parameters; and
- b) no emergency PDU session has been established for the UE;

then the AMF shall initiate the release of the N1 NAS signalling connection.

If a LADN information IE was included in the CONFIGURATION UPDATE COMMAND message, the AMF shall consider the old LADN information as invalid and the new LADN information as valid, if any. If an Extended LADN information IE was included in the CONFIGURATION UPDATE COMMAND message, the AMF shall consider the old extended LADN information as invalid and the new extended LADN information as valid.

If a T3447 value was included in the CONFIGURATION UPDATE COMMAND message, the AMF shall consider the T3447 value as valid and if neither zero nor deactivated use the T3447 value with the timer T3447 next time it is started. If the T3447 value included in the CONFIGURATION UPDATE COMMAND message contained an indication that the timer is deactivated or timer value zero, then the AMF shall stop the timer T3447 if running.

If a CAG information IE or an Extended CAG information IE was included in the CONFIGURATION UPDATE COMMAND message, the AMF shall consider the new "CAG information list" as valid and the old "CAG information list" as invalid.

If a UE radio capability ID IE was included in the CONFIGURATION UPDATE COMMAND message, the AMF shall consider the new UE radio capability ID as valid and the old UE radio capability ID as invalid.

If an Updated PEIPS assistance information IE was included in the CONFIGURATION UPDATE COMMAND message, the AMF shall consider the new PEIPS assistance information as valid and the old PEIPS assistance information, if any, as invalid.

5.4.4.5 Abnormal cases in the UE

The following abnormal cases can be identified:

- a) Transmission failure of the CONFIGURATION UPDATE COMPLETE message with TAI change from lower layers

If the current TAI is not in the TAI list, the generic UE configuration update procedure shall be aborted and a registration procedure for mobility and periodic registration update shall be initiated.

If the current TAI is still part of the TAI list, it is up to the UE implementation how to re-run the ongoing procedure that triggered the generic UE configuration update procedure.

- b) Transmission failure of CONFIGURATION UPDATE COMPLETE message indication without TAI change from lower layers

It is up to the UE implementation how to re-run the ongoing procedure that triggered the generic UE configuration update procedure.

- c) Generic UE configuration update and de-registration procedure collision

If the UE receives CONFIGURATION UPDATE COMMAND message after sending a DEREGISTRATION REQUEST message and the access type included in the DEREGISTRATION REQUEST message is same as the access in which the CONFIGURATION UPDATE COMMAND message is received, then the UE shall ignore the CONFIGURATION UPDATE COMMAND message and proceed with the de-registration procedure. Otherwise, the UE shall proceed with both the procedures.

- d) Void

- e) Generic UE configuration update and service request procedure collision

If the SERVICE REQUEST message does not include UE request type IE with Request type value set to "NAS signalling connection release" and the UE receives a CONFIGURATION UPDATE COMMAND message before the ongoing service request procedure has been completed, the UE shall proceed with both the procedures.

If the SERVICE REQUEST message includes UE request type IE with Request type value set to "NAS signalling connection release" and the UE receives a CONFIGURATION UPDATE COMMAND message before the ongoing service request procedure has been completed, the UE shall ignore the CONFIGURATION UPDATE COMMAND message and proceed with the service request procedure.

- f) "CAG information list" is received and the UE is operating in SNPN access operation mode

If the UE receives the CAG information list IE in the CONFIGURATION UPDATE COMMAND message and the UE is operating in SNPN access operation mode, the UE shall ignore the content of CAG information list IE.

5.4.4.6 Abnormal cases on the network side

The following abnormal cases can be identified:

- a) Expiry of timer T3555.

The network shall, on the first expiry of the timer T3555, retransmit the CONFIGURATION UPDATE COMMAND message and shall reset and start timer T3555. This retransmission is repeated four times, i.e. on the fifth expiry of timer T3555, the procedure shall be aborted. In addition, if the CONFIGURATION UPDATE COMMAND message includes the 5G-GUTI IE, the network shall behave as described in case b)-1) below.

- b) Lower layer failure.

If a lower layer failure is detected before the CONFIGURATION UPDATE COMPLETE message is received and:

- 1) if the CONFIGURATION UPDATE COMMAND message includes the 5G-GUTI IE, the old and the new 5G-GUTI shall be considered as valid until the old 5G-GUTI can be considered as invalid by the AMF. If a new TAI list was provided in the CONFIGURATION UPDATE COMMAND message, the old and new TAI list shall also be considered as valid until the old TAI list can be considered as invalid by the AMF.

Additionally, if the Updated PEIPS assistance information IE in the CONFIGURATION UPDATE COMMAND message includes a new Paging subgroup ID and the UE is previously assigned a different Paging subgroup ID then, the AMF shall consider both, the old and new Paging subgroup IDs as valid until the old Paging subgroup ID can be considered as invalid by the AMF.

During this period the AMF:

- i) may first use the old 5G-S-TMSI from the old 5G-GUTI and the old Paging subgroup ID, if any, for paging within the area defined by the old TAI list for an implementation dependent number of paging attempts for network originated transactions. If a new TAI list was provided in the CONFIGURATION UPDATE COMMAND message, the new TAI list should also be used for paging. Upon response from the UE, the AMF may re-initiate the CONFIGURATION UPDATE COMMAND. If the Updated PEIPS assistance information IE in the CONFIGURATION UPDATE COMMAND message includes a new Paging subgroup ID, then the AMF may re-initiate the CONFIGURATION UPDATE COMMAND. If the response is received from a tracking area within the old and new TAI list, the network shall re-initiate the CONFIGURATION UPDATE COMMAND message. If no response is received to the paging attempts, the network may use the new 5G-S-TMSI from the new 5G-GUTI and the new Paging subgroup ID, if any, for paging for an implementation dependent number of paging attempts. In this case, if a new TAI list was provided with new 5G-GUTI in the CONFIGURATION UPDATE COMMAND message, the new TAI list shall be used instead of the old TAI list. Upon response from the UE the AMF shall consider the new 5G-GUTI and the new PEIPS assistance information as valid and the old 5G-GUTI and the old PEIPS assistance information as invalid.
- ii) shall consider the new 5G-GUTI as valid if it is used by the UE and, additionally, the new TAI list as valid if it was provided with this 5G-GUTI in the CONFIGURATION UPDATE COMMAND message; and
- iii) may use the identification procedure followed by a new generic UE configuration update procedure if the UE uses the old 5G-GUTI; or
- 2) if the CONFIGURATION UPDATE COMMAND message does not include the 5G-GUTI IE and:
- i) the CONFIGURATION UPDATE COMMAND message does not contain the Allowed NSSAI IE, the Rejected NSSAI IE, the Extended rejected NSSAI IE, or the Updated PEIPS assistance information IE, the network shall abort the procedure; or
- ii) the CONFIGURATION UPDATE COMMAND message contains the Allowed NSSAI IE, the Rejected NSSAI IE, the Extended rejected NSSAI IE, or the Updated PEIPS assistance information IE, the network shall either abort the procedure or retransmit the CONFIGURATION UPDATE COMMAND

message on expiry of the timer T3555. The retransmission shall not be repeated more than four times. If the retransmission is repeated for four times, the network shall abort the procedure.

- c) Generic UE configuration update and UE initiated de-registration procedure collision.

If the network receives a DEREGISTRATION REQUEST message before the ongoing generic UE configuration update procedure has been completed, the network shall abort the generic UE configuration update procedure and shall progress the de-registration procedure.

- d) Generic UE configuration update and registration procedure for mobility and periodic registration update collision

If the network receives a REGISTRATION REQUEST message before the ongoing generic UE configuration update procedure has been completed, the network shall abort the generic UE configuration update procedure and shall progress the registration procedure for mobility and periodic registration update procedure.

- e) Generic UE configuration update and service request procedure collision

If the network receives a SERVICE REQUEST message before the ongoing generic UE configuration update procedure has been completed and the SERVICE REQUEST message does not include UE request type IE with Request type value set to "NAS signalling connection release", both the procedures shall be progressed.

If the network receives a SERVICE REQUEST message before the ongoing generic UE configuration update procedure has been completed and the SERVICE REQUEST message includes UE request type IE with Request type value set to "NAS signalling connection release", the network shall abort the generic UE configuration update procedure and shall progress the service request procedure.

5.4.5 NAS transport procedure(s)

5.4.5.1 General

The purpose of the NAS transport procedures is to provide a transport of payload between the UE and the AMF. The type of the payload is identified by the Payload container type IE and includes one of the following:

- a) a single 5GSM message;
- b) SMS;
- c) an LPP message (see 3GPP TS 37.355 [26]);
- c1) an SLPP message (see 3GPP TS 38.355 [26A]);
- d) an SOR transparent container;
- e) a UE policy container;
- f) a UE parameters update transparent container;
- g) a location services message (see 3GPP TS 24.080 [13A]);
- h) a CIoT user data container;
- i) a Service-level-AA container;
- j) a UPP-CMI container; or
- k) Multiple payloads.

For payload type a) to e), g) and h), along with the payload, the NAS transport procedure may transport the associated information (e.g. PDU session information for 5GSM message payload).

For payload type k), the Payload container IE consists a list of payload container entries, where each of payload container entry contains the payload and optional associated information (e.g. PDU session information for 5GSM message payload).

NOTE: Payload type can be set to "Multiple payloads" if there are more than one payloads to be transported using the NAS transport procedures.

5.4.5.2 UE-initiated NAS transport procedure

5.4.5.2.1 General

The purpose of the UE-initiated NAS transport procedure is to provide a transport of:

- a) a single 5GSM message as defined in subclause 8.3;
- b) SMS (see 3GPP TS 24.011 [13]);
- c) an LPP message;
- c1) an SLPP message;
- d) an SOR transparent container;
- e) a UE policy container;
- f) a UE parameters update transparent container;
- g) a location services message;
- h) a CIoT user data container;
- i) a Service-level-AA container;
- j) a UPP-CMI container; or
- k) multiple of the above types.

and:

- for a) to e), g) and h), optional associated payload routing information from the UE to the AMF in a 5GMM message; and
- for k), the Payload container IE consists a list of payload container entries, where each of the payload container entry contains the payload and optional associated payload routing information (e.g. PDU session information for 5GSM message payload).

5.4.5.2.2 UE-initiated NAS transport procedure initiation

In the connected mode, the UE initiates the NAS transport procedure by sending the UL NAS TRANSPORT message to the AMF, as shown in figure 5.4.5.2.2.1.

In case a) in subclause 5.4.5.2.1, the UE shall:

- include the PDU session information (PDU session ID, old PDU session ID, S-NSSAI, mapped S-NSSAI (if available in roaming scenarios), DNN, request type, alternative S-NSSAI, MA PDU session information, non-3GPP access path switching indication), if available;
- set the Payload container type IE to "N1 SM information"; and
- set the Payload container IE to the 5GSM message.

The UE shall set the PDU session ID IE to the PDU session ID. If an old PDU session ID is to be included, the UE shall set the Old PDU session ID IE to the old PDU session ID.

If an alternative S-NSSAI is to be included, the UE shall set the Alternative S-NSSAI IE to the alternative S-NSSAI and shall set the S-NSSAI IE to the S-NSSAI to be replaced.

If an S-NSSAI is to be included, the UE shall set the S-NSSAI IE to the S-NSSAI selected for the PDU session from the allowed NSSAI for the current PLMN or SNPN, associated with the mapped S-NSSAI (if available in roaming scenarios).

If a DNN is to be included, the UE shall set the DNN IE to the DNN. 5GSM procedures specified in clause 6 describe conditions for inclusion of the S-NSSAI, mapped S-NSSAI (if available in roaming scenarios), and the DNN.

If a request type is to be included, the UE shall set the Request type IE to the request type. The request type is not provided along 5GSM messages other than the PDU SESSION ESTABLISHMENT REQUEST message and the PDU SESSION MODIFICATION REQUEST message.

If an MA PDU session information is to be included, the UE shall set the MA PDU session information IE to the MA PDU session information. The MA PDU session information is not provided along 5GSM messages other than the PDU SESSION ESTABLISHMENT REQUEST message and the PDU SESSION MODIFICATION REQUEST message as specified in 3GPP TS 24.193 [13B].

If the UE supports the non-3GPP access path switching for the PDU session and the AMF has indicated its support for the non-3GPP access path switching, the UE shall include the Non-3GPP access path switching indication information element and set the NAPS bit to "non-3GPP access path switching supported". The non-3GPP access path switching indication is not provided along 5GSM messages other than the PDU SESSION ESTABLISHMENT REQUEST message.

In case b) in subclause 5.4.5.2.1, the UE shall:

- set the Payload container type IE to "SMS"; and
- set the Payload container IE to the SMS payload.

Based on the UE preferences regarding access selection for mobile originated (MO) transmission of SMS over NAS as described in 3GPP TS 23.501 [8]:

- when SMS over NAS is preferred to be sent over 3GPP access: the UE attempts to deliver MO SMS over NAS via the 3GPP access if the UE is registered over both 3GPP access and non-3GPP access. If the delivery of SMS over NAS via the 3GPP access is not available, the UE attempts to deliver MO SMS over NAS via the non-3GPP access; and
- when SMS over NAS is preferred to be sent over non-3GPP access: the UE attempts to deliver MO SMS over NAS via the non-3GPP access if the UE is registered over both 3GPP access and non-3GPP access. If the delivery of SMS over NAS via the non-3GPP access is not available, the UE attempts to deliver MO SMS over NAS via the 3GPP access.

In case c) in subclause 5.4.5.2.1, the UE shall:

- set the Payload container type IE to "LTE Positioning Protocol (LPP) message container";
- set the Payload container IE to the LPP message payload; and
- set the Additional information IE to the routing information provided by the upper layer location services application.

In case c1) in subclause 5.4.5.2.1, the UE shall:

- set the Payload container type IE to "SLPP message container";
- set the Payload container IE to the SLPP message payload; and
- set the Additional information IE to the routing information provided by the upper layer location services application.

In case d) in subclause 5.4.5.2.1, the UE:

- shall set the Payload container type IE to "SOR transparent container"; and
- shall set the Payload container IE to the UE acknowledgement due to successful reception of steering of roaming information, and;
- i) shall set the ME support of SOR-CMCI indicator to "SOR-CMCI supported by the ME" ;
- ii) shall set the ME support of SOR-SNPN-SI indicator to "SOR-SNPN-SI supported by the ME" if the UE supports access to an SNPN using credentials from a credentials holder and the UE is operating in SNPN access operation

mode or may set the ME support of SOR-SNPN-SI indicator to "SOR-SNPN-SI supported by the ME" if the UE supports access to an SNPN using credentials from a credentials holder and the UE is not operating in SNPN access operation mode; and

iii) shall set the ME support of SOR-SNPN-SI-LS indicator to "SOR-SNPN-SI-LS supported by the ME" if the UE supports access to an SNPN providing access for localized services in SNPN,

in the Payload container IE carrying the acknowledgement (see 3GPP TS 23.122 [5]).

In case e) in subclause 5.4.5.2.1, the UE shall:

- set the Payload container type IE to "UE policy container"; and
- set the contents of the Payload container IE as specified in Annex D.

In case f) in subclause 5.4.5.2.1, the UE shall:

- set the Payload container type IE to "UE parameters update transparent container"; and
- set the contents of the Payload container IE to the UE acknowledgement due to successful reception of UE parameters update data (see 3GPP TS 23.502 [9]).

In case g) in subclause 5.4.5.2.1, the UE shall:

- set the Payload container type IE to "Location services message container";
- set the Payload container IE to the Location services message payload;
- set the Additional information IE to the routing information, if preconfigured or provided by AMF in a previous procedure or provided by the upper layer location services application; and
- include the Payload container information IE with the PRU bit set to "Payload container related to PRU" if the location services message payload is related to PRU (see 3GPP TS 24.080 [13A]).

NOTE: The AMF may configure the routing information to the UE during the PRU association procedure or the PRU disassociation procedure as specified in 3GPP TS 23.273 [6B].

In case h) in subclause 5.4.5.2.1:

- if the UE is not located outside the LADN service area, the UE shall:
 - include the PDU session ID, and Release assistance indication (if available);
 - set the Payload container type IE to "CIoT user data container"; and
 - set the Payload container IE to the user data container; or
- if the UE is located outside the LADN service area, the UE shall not perform the UE-initiated NAS transport procedure to send CIoT user data via the control plane for a PDU session for LADN.

In case i) in subclause 5.4.5.2.1, the UE shall:

- set the Payload container type IE to "Service-level-AA container"; and
- set the Payload container IE to the Service-level-AA container.

In case j) in subclause 5.4.5.2.1, the UE shall:

- set the Payload container type IE to "UPP-CMI container";
- set the Payload container IE to the UPP-CMI container; and
- set the Additional information IE to the routing information, if provided by AMF in a previous procedure or provided by the upper layer location services application.

In case k) in subclause 5.4.5.2.1, the UE shall:

- set the Payload container type IE to "Multiple payloads"; and

- set each payload container entry of the Payload container IE (see subclause 9.11.3.39), as follows:
 - i) set the payload container type field of the payload container entry to a payload container type value set in the Payload container type IE as specified in cases a) to j) above;
 - ii) set the payload container entry contents field of the payload container entry to the payload container contents set in the Payload container IE as specified in cases a) to j) above, and
 - iii) set the optional IE fields, if any, to the optional associated payload routing information as specified in cases a) to j) above.



Figure 5.4.5.2.2.1: UE-initiated NAS transport procedure

5.4.5.2.3 UE-initiated NAS transport of messages accepted by the network

Upon reception of a UL NAS TRANSPORT message, if the Payload container type IE is set to:

- a) "N1 SM information", the AMF looks up a PDU session routing context for:
 - 1) the UE and the PDU session ID IE in case the Old PDU session ID IE is not included, and:

NOTE 1: If the Old PDU session ID IE is not included in the UL NAS TRANSPORT message and the AMF has received a reallocation requested indication from the SMF, the AMF needs to ignore the reallocation requested indication.

- i) if the AMF has a PDU session routing context for the PDU session ID and the UE, and the Request type IE is either not included or is included but set to other value than "initial request", "existing PDU session", "initial emergency request", "existing emergency PDU session" or "MA PDU request", the AMF shall send the 5GSM message, and the PDU session ID IE towards the SMF identified by the SMF ID of the PDU session routing context;
- ii) if the AMF has a PDU session routing context for the PDU session ID and the UE, the PDU session routing context indicates that the PDU session is not an emergency PDU session, the Request type IE is included and is set to "existing PDU session" or "MA PDU request", and the S-NSSAI associated with the PDU session identified by the PDU session ID is allowed for the target access type, the AMF shall send the 5GSM message, the PDU session ID, the S-NSSAI, the mapped S-NSSAI (in roaming scenarios), the DNN (if received) and the request type towards the SMF identified by the SMF ID of the PDU session routing context;
- iii) if the AMF does not have a PDU session routing context for the PDU session ID and the UE, and the Request type IE is included and is set to "initial request" or "MA PDU request":

- A) the AMF shall select an SMF with following handlings in case the UE is not registered for onboarding services in SNPN:

If the S-NSSAI IE is not included, the UE does not have a partially allowed NSSAI, and the allowed NSSAI contains:

- one S-NSSAI, the AMF shall use the S-NSSAI in the allowed NSSAI as the S-NSSAI. Additionally, for a UE for which the AMF has provided a NS-AoS, the AMF shall use the S-NSSAI in the allowed NSSAI if the UE is inside the NS-AoS with respect to the S-NSSAI;
- two or more S-NSSAIs and the user's subscription context obtained from UDM contains only one default S-NSSAI that is included in the allowed NSSAI, the AMF shall use the S-NSSAI in the allowed NSSAI that matches the default S-NSSAI as the S-NSSAI; or

- two or more S-NSSAIs and the user's subscription context obtained from UDM contains two or more default S-NSSAI(s) included in the allowed NSSAI, the AMF shall use an S-NSSAI in the allowed NSSAI selected based on operator policy as the S-NSSAI.

If S-NSSAI IE is not included, the UE has both a partially allowed NSSAI and an allowed NSSAI, the AMF shall select an S-NSSAI from the partially allowed NSSAI or the allowed NSSAI based on operator policy. Additionally:

- for the case when the AMF determines to use the allowed NSSAI for selecting an S-NSSAI and for a UE for which the AMF has provided a NS-AoS, the AMF shall use the S-NSSAI in the allowed NSSAI if the UE is inside the NS-AoS with respect to the S-NSSAI; or
- for the case when the AMF determines to use the partially allowed NSSAI for selecting an S-NSSAI, the AMF shall use the S-NSSAI in the partially allowed NSSAI if the current TAI is in the list of TAs where the S-NSSAI is allowed.

If the UE supports network slice replacement, the S-NSSAI or the mapped S-NSSAI (in roaming scenarios) is an S-NSSAI to be replaced and the alternative S-NSSAI is not provided by the UE, the AMF shall retrieve an alternative S-NSSAI (see subclause 5.15.19 of 3GPP TS 23.501 [8]) and initiate the generic UE configuration update procedure as specified in subclause 4.6.3.4 before proceeding with the current procedure.

If the S-NSSAI or the mapped S-NSSAI (in roaming scenarios) is an S-NSSAI to be replaced and the alternative S-NSSAI is provided by the UE, but the AMF determines that the replaced S-NSSAI is available, the AMF shall use the S-NSSAI to be replaced (see subclause 5.15.19 of 3GPP TS 23.501 [8]).

If the DNN IE is included, the AMF shall use the UE requested DNN as the DNN determined by the AMF; and

If the DNN IE is not included, and the user's subscription context obtained from UDM:

- contains the default DNN for the S-NSSAI, the AMF shall use the default DNN as the DNN determined by the AMF; and
- does not contain the default DNN for the S-NSSAI, the AMF shall use a locally configured DNN as the DNN determined by the AMF;

A1) the AMF shall select an SMF with following handlings in case the UE is registered for onboarding services in SNPN:

- if the AMF onboarding configuration data does not contain a configured SMF used for onboarding services in SNPN and contains the S-NSSAI used for onboarding services in SNPN, the AMF shall use the S-NSSAI used for onboarding services in SNPN as the S-NSSAI;
- if the AMF onboarding configuration data does not contain a configured SMF used for onboarding services in SNPN and contains the DNN used for onboarding services in SNPN, the AMF shall use the DNN used for onboarding services in SNPN as the DNN;
- if the AMF onboarding configuration data does not contain the S-NSSAI used for onboarding services in SNPN, does not contain the DNN used for onboarding services in SNPN, and contains a configured SMF used for onboarding services in SNPN, the AMF shall select the configured SMF used for onboarding services in SNPN;
- if the AMF onboarding configuration data contains the S-NSSAI used for onboarding services in SNPN, the DNN used for onboarding services in SNPN, or both, and contains a configured SMF used for onboarding services in SNPN, the AMF shall use the S-NSSAI used for onboarding services in SNPN, if any, as the S-NSSAI, and use the DNN used for onboarding services in SNPN, if any, as the DNN or shall select the configured SMF used for onboarding services in SNPN, according to local policy; and
- if the AMF onboarding configuration data contains none of the S-NSSAI used for onboarding services in SNPN, the DNN used for onboarding services in SNPN and a configured SMF used for onboarding services in SNPN, the AMF handling is implementation specific; and

NOTE 2: The AMF can e.g. use a locally configured DNN used for onboarding services in SNPN as the DNN determined by the AMF.

NOTE 3: SMF selection is outside the scope of the present document.

NOTE 4: As part of SMF selection, the PCF can provide the AMF with a DNN selected by the network different from the DNN determined by the AMF.

B) if the SMF selection is successful:

- if the DNN selected by the network is a LADN DNN, the AMF shall determine the UE presence in LADN service area (see subclause 6.2.6);
- the AMF shall store a PDU session routing context for the PDU session ID and the UE, shall set the SMF ID in the stored PDU session routing context to the SMF ID corresponding to the DNN in the user's subscription context obtained from the UDM; and
- the AMF shall send the 5GSM message, the PDU session ID, the S-NSSAI, the mapped S-NSSAI (in roaming scenarios), the DNN determined by the AMF, DNN selected by the network (if different from DNN determined by the AMF), the request type, the MA PDU session information, the non-3GPP access path switching indication, UE presence in LADN service area (if DNN received corresponds to an LADN DNN), the onboarding indication (if the UE is registered for onboarding services in SNPN), and the alternative S-NSSAI associated with the S-NSSAI to be replaced (if available) towards the SMF identified by the SMF ID of the PDU session routing context;

NOTE 5: The MA PDU session information is not sent towards the SMF if the DNN received corresponds to an LADN DNN.

iv) if the AMF does not have a PDU session routing context for the PDU session ID and the UE, the Request type IE is included and is set to "existing PDU session" or "MA PDU request", and the AMF retrieves an SMF ID associated with:

- A) the PDU session ID matching the PDU session ID received from the UE, if any; or
- B) the DNN matching the DNN received from the UE, otherwise;

such that the SMF ID includes a PLMN identity corresponding to the UE's HPLMN or the current PLMN, then:

- A) the AMF shall store a PDU session routing context for the PDU session ID and the UE, shall set the SMF ID in the stored PDU session routing context to the retrieved SMF ID; and
- B) the AMF shall send the 5GSM message, the PDU session ID, the S-NSSAI, the mapped S-NSSAI (in roaming scenarios), the DNN (if received) and the request type towards the SMF identified by the SMF ID of the PDU session routing context;

v) if the AMF does not have a PDU session routing context for the PDU session ID and the UE, the Request type IE is included and is set to "initial emergency request", and the AMF does not have a PDU session routing context for another PDU session ID of the UE indicating that the PDU session is an emergency PDU session:

- A) the AMF shall select an SMF. The AMF shall use the emergency DNN from the AMF emergency configuration data as the DNN, if configured. The AMF shall derive the SMF from the emergency DNN or use the statically configured SMF from the AMF emergency configuration data, if configured; and

B) if the SMF selection is successful:

- the AMF shall store a PDU session routing context for the PDU session ID and the UE, shall set the SMF ID in the stored PDU session routing context to the SMF ID of the selected SMF, and shall store an indication that the PDU session is an emergency PDU session in the stored PDU session routing context; and
- the AMF shall send the 5GSM message, the PDU session ID, the S-NSSAI (if configured in the AMF emergency configuration data), the DNN (if configured in the AMF emergency

configuration data), and the request type towards the SMF identified by the SMF ID of the PDU session routing context; and

- vi) if the AMF does not have a PDU session routing context for the PDU session ID and the UE, the Request type IE is included and is set to "initial emergency request", and the AMF has a PDU session routing context indicating that the PDU session is an emergency PDU session for another PDU session ID of the UE:
 - A) the AMF shall store a PDU session routing context for the PDU session ID and the UE and shall set the SMF ID in the stored PDU session routing context to the SMF ID of the PDU session routing context for the other PDU session ID of the UE; and
 - B) the AMF shall send the 5GSM message, the PDU session ID, the S-NSSAI (if configured in the AMF emergency configuration data), the DNN (if configured in the AMF emergency configuration data) and the request type towards the SMF identified by the SMF ID of the PDU session routing context; or
 - vii) if the AMF has a PDU session routing context for the PDU session ID and the UE, the PDU session routing context indicates that the PDU session is an emergency PDU session, and the Request type IE is included and is set to "existing emergency PDU session", the AMF shall send the 5GSM message, the PDU session ID, the S-NSSAI (if configured in the AMF emergency configuration data), the DNN (if configured in the AMF emergency configuration data), and the request type towards the SMF identified by the SMF ID of the PDU session routing context; and
 - viii) if the AMF does not have a PDU session routing context for the PDU session ID and the UE, the Request type IE is included and is set to "existing emergency PDU session", and the AMF retrieves an SMF ID associated with emergency services such that the SMF ID includes a PLMN identity corresponding to the current PLMN, then:
 - A) the AMF shall store a PDU session routing context for the PDU session ID and the UE, shall set the SMF ID in the stored PDU session routing context to the retrieved SMF ID; and
 - B) the AMF shall send the 5GSM message, the PDU session ID, the S-NSSAI (if configured in the AMF emergency configuration data), the DNN (if configured in the AMF emergency configuration data), and the request type towards the SMF identified by the SMF ID of the PDU session routing context; or
- 2) the UE and the Old PDU session ID IE in case the Old PDU session ID IE is included, and:
- i) the AMF has a PDU session routing context for the old PDU session ID and the UE and does not have a PDU session routing context for the PDU session ID and the UE, the Request type IE is included and is set to "initial request", and the AMF received a reallocation requested indication from the SMF indicating that the SMF is to be reused, the AMF shall store a PDU session routing context for the PDU session ID and the UE, set the SMF ID in the stored PDU session routing context to the SMF ID of the PDU session routing context for the old PDU session ID and the UE. If the DNN is a LADN DNN, the AMF shall determine the UE presence in LADN service area (see subclause 6.2.6). The AMF shall send the 5GSM message, the PDU session ID, the old PDU session ID, the S-NSSAI (if received), the mapped S-NSSAI (in roaming scenarios), the DNN, the request type, UE presence in LADN service area (if DNN received corresponds to an LADN DNN), and the alternative S-NSSAI (if received) towards the SMF identified by the SMF ID of the PDU session routing context;
 - ii) the AMF has a PDU session routing context for the old PDU session ID and the UE and does not have a PDU session routing context for the PDU session ID and the UE, the Request type IE is included and is set to "initial request", and the AMF received a reallocation requested indication from the SMF indicating that the SMF is to be reallocated:
 - A) the AMF shall select an SMF with the following handling:
 - If the S-NSSAI IE is not included and the allowed NSSAI contains:
 - one S-NSSAI, the AMF shall use the S-NSSAI in the allowed NSSAI as the S-NSSAI;
 - two or more S-NSSAIs and the user's subscription context obtained from UDM contains only one default S-NSSAI that is included in the allowed NSSAI, the AMF shall use the S-NSSAI in the allowed NSSAI that matches the default S-NSSAI; or

- two or more S-NSSAIs and the user's subscription context obtained from UDM contains two or more default S-NSSAI(s) included in the allowed NSSAI, the AMF shall use an S-NSSAI in the allowed NSSAI selected based on operator policy as the S-NSSAI.

If the DNN is a LADN DNN, the AMF shall determine the UE presence in LADN service area (see subclause 6.2.6).

B) if the SMF selection is successful:

- the AMF shall store a PDU session routing context for the PDU session ID and the UE and set the SMF ID of the PDU session routing context to the SMF ID of the selected SMF; and
- the AMF shall send the 5GSM message, the PDU session ID, the old PDU session ID, the S-NSSAI, the mapped S-NSSAI (in roaming scenarios), the DNN, the request type, the MA PDU session information, the non-3GPP access path switching indication, UE presence in LADN service area (if DNN received corresponds to an LADN DNN), and the alternative S-NSSAI (if received) towards the SMF identified by the SMF ID of the PDU session routing context for the PDU session ID and the UE;

NOTE 6: The MA PDU session information is not sent towards the SMF if the DNN received corresponds to an LADN DNN.

- b) "SMS", the AMF shall send the content of the Payload container IE to the SMSF associated with the UE;
- c) "LTE Positioning Protocol (LPP) message container", the AMF shall send the Payload container type and the content of the Payload container IE to the LMF associated with the routing information included in the Additional information IE of the UL NAS TRANSPORT message;
- c1) "SLPP message container", the AMF shall send the Payload container type and the content of the Payload container IE to the LMF associated with the routing information included in the Additional information IE of the UL NAS TRANSPORT message;
- d) "SOR transparent container", the AMF shall send the content of the Payload container IE to the UDM (see 3GPP TS 29.503 [20AB]);
- e) "UE policy container", the AMF shall send the content of the Payload container IE to the PCF.
- f) "UE parameters update transparent container", the AMF shall send the content of the Payload container IE to the UDM.
- g) "Location services message container":
 - 1) if the Additional information IE is not included in the UL NAS TRANSPORT message, the AMF shall provide the Payload container type, the content of the Payload container IE and the content of the Payload container information IE, if included, to the location services application; and
 - 2) if the Additional information IE is included in the UL NAS TRANSPORT message, the AMF shall send the Payload container type and the content of the Payload container IE and the content of the Payload container information IE, if included, to an LMF associated with routing information included in the Additional information IE of the UL NAS TRANSPORT message or to a selected LMF if the Payload container information IE is included in the UL NAS TRANSPORT message and the PRU bit of the Payload container information IE indicates "Payload container related to PRU".
- h) "CIoT user data container", the AMF shall look up a PDU session routing context for the UE and the PDU session ID, and
 - 1) send the content of the Payload container IE towards the SMF identified by the SMF ID of the PDU session routing context; and
 - 2) initiate the release of the N1 NAS signalling connection:
 - i) if the Release assistance indication IE is included in the UL NAS TRANSPORT message and the DDX field of the Release assistance indication IE indicates "No further uplink and no further downlink data transmission subsequent to the uplink data transmission is expected" and if there is no downlink signalling or downlink data for the UE; or

- ii) upon subsequent delivery of the next received downlink data transmission to the UE if the Release assistance indication IE is included in the UL NAS TRANSPORT message and the DDX field of the Release assistance indication IE indicates "Only a single downlink data transmission and no further uplink data transmission subsequent to the uplink data transmission is expected" and if there is no additional downlink signalling or downlink data for the UE.
- i) "Service-level-AA container" and the Service-level-AA container is included in the Payload container IE of the UL NAS TRANSPORT message, and the Service-level device ID included in the Service-level-AA container is set to a CAA-level UAV ID, the AMF shall send the content of the Payload container IE to the UAS-NF corresponding to the CAA-level UAV ID. If the Service-level device ID is not included in the Service-level-AA container and a CAA-level UAV ID is included in the 5GMM context of the UE, then the AMF shall send the content of the Payload container IE to the UAS-NF corresponding to the CAA-level UAV ID included in the 5GMM context of the UE.
- j) "UPP-CMI container":
 - 1) if the Additional information IE is not included in the UL NAS TRANSPORT message, the AMF shall provide the Payload container type and the content of the Payload container IE to the location services application; or
 - 2) if the Additional information IE is included in the UL NAS TRANSPORT message, the AMF shall send the Payload container type and the content of the Payload container IE to an LMF associated with routing information included in the Additional information IE of the UL NAS TRANSPORT message.

NOTE 7: LMF selection for user plane positioning is outside the scope of the present document.

- k) "Multiple payloads", the AMF shall first decode the content of the Payload container IE (see subclause 9.11.3.39) to obtain the number of payload container entries and for each payload container entry, the AMF shall:
 - i) decode the payload container type field;
 - ii) decode the optional IE fields and the payload container contents field in the payload container entry; and
 - iii) handle the content of each payload container entry the same as the content of the Payload container IE and the associated optional IEs as specified in bullets a) to j) above according to the payload container type field.

5.4.5.2.4 UE-initiated NAS transport of messages not accepted by the network

Upon reception of an UL NAS TRANSPORT message, if the Payload container type IE is set to "N1 SM information" and the UE is not configured for high priority access in selected PLMN or SNPN, and:

- a) if the Request type IE is set to "initial request", "existing PDU session" or "MA PDU request";
 - 1) DNN based congestion control is activated for the DNN included in the UL NAS TRANSPORT message, or DNN based congestion control is activated for the selected DNN in case of no DNN included in the UL NAS TRANSPORT message, e.g. configured by operation and maintenance, the AMF shall send back to the UE the 5GSM message which was not forwarded, a back-off timer value and 5GMM cause #22 "congestion" as specified in subclause 5.4.5.3.1 case f);
 - 2) S-NSSAI and DNN based congestion control is activated for the S-NSSAI and DNN included in the UL NAS TRANSPORT message, or S-NSSAI and DNN based congestion control is activated for the S-NSSAI included in the UL NAS TRANSPORT message and the selected DNN in case of no DNN included in the UL NAS TRANSPORT message, or S-NSSAI and DNN based congestion control is activated for the selected S-NSSAI in case of no S-NSSAI included in the UL NAS TRANSPORT message and the DNN included in the UL NAS TRANSPORT message, or S-NSSAI and DNN based congestion control is activated for the selected S-NSSAI and the selected DNN in case of no S-NSSAI and no DNN included in the UL NAS TRANSPORT message, e.g. configured by operation and maintenance, the AMF shall send back to the UE the 5GSM message which was not forwarded, a back-off timer value and 5GMM cause #67 "insufficient resources for specific slice and DNN" as specified in subclause 5.4.5.3.1 case f);
 - 3) S-NSSAI only based congestion control is activated for the S-NSSAI included in the UL NAS TRANSPORT message, or S-NSSAI based congestion control is activated for the selected S-NSSAI in case of no S-NSSAI included in the UL NAS TRANSPORT message, e.g. configured by operation and maintenance, the AMF

shall send back to the UE the 5GSM message which was not forwarded, a back-off timer value and 5GMM cause #69 "insufficient resources for specific slice" as specified in subclause 5.4.5.3.1 case f);

- b) void;
- c) if the Request type IE is set to "modification request" and the PDU session is not an emergency PDU session;
 - 1) DNN based congestion control is activated for the stored DNN, e.g. configured by operation and maintenance, the AMF shall send back to the UE the 5GSM message which was not forwarded, a back-off timer value and 5GMM cause #22 "congestion" as specified in subclause 5.4.5.3.1 case f);
 - 2) S-NSSAI and DNN based congestion control is activated for the stored S-NSSAI and DNN, e.g. configured by operation and maintenance, the AMF shall send back to the UE the 5GSM message which was not forwarded, a back-off timer value and 5GMM cause #67 "insufficient resources for specific slice and DNN" as specified in subclause 5.4.5.3.1 case f);
 - 3) S-NSSAI only based congestion control is activated for the stored S-NSSAI, e.g. configured by operation and maintenance, the AMF shall send back to the UE the 5GSM message which was not forwarded, a back-off timer value and 5GMM cause #69 "insufficient resources for specific slice" as specified in subclause 5.4.5.3.1 case f); or
- d) the timer T3447 is running and the UE does not support service gap control:
 - 1) the Request type IE:
 - i) is set to "initial request";
 - ii) is set to "existing PDU session"; or
 - iii) is set to "modification request" and the PDU session being modified is a non-emergency PDU session;
 - 2) the current NAS signalling connection was not triggered by paging; and
 - 3) mobile terminated signalling has not been sent or no user-plane resources have been established for any PDU session after the establishment of the current NAS signalling connection,

the AMF shall send back to the UE the message which was not forwarded, send the 5GMM cause #22 "Congestion", and may include a back-off timer set to the remaining time of the timer T3447 as specified in subclause 5.4.5.3.1 case f).

Upon reception of a UL NAS TRANSPORT message, if the Payload container type IE is set to "N1 SM information", the Request type IE is set to "initial request", "existing PDU session" or "MA PDU request", and the AMF determines that the PLMN's maximum number of PDU sessions has already been reached for the UE, the AMF shall send back to the UE the 5GSM message which was not forwarded and 5GMM cause #65 "maximum number of PDU sessions reached" as specified in subclause 5.4.5.3.1 case h).

Upon reception of a UL NAS TRANSPORT message, if the Payload container type IE is set to "N1 SM information", the Request type IE is set to "initial request", and

- a) the UE is in NB-N1 mode;
- b) the UE has indicated preference for user plane CIoT 5GS optimization;
- c) the network accepted the use of user plane CIoT 5GS optimization; and
- d) the AMF determines that there are user-plane resources established for a number of PDU sessions that is equal to the UE's maximum number of supported user-plane resources (see 3GPP TS 23.501 [8]),

the AMF shall either:

- a) send back to the UE the message which was not forwarded as specified in in subclause 5.4.5.3.1 case h1); or
- b) proceed with the PDU session establishment and include the Control Plane CIoT 5GS Optimisation indication or Control Plane Only indicator to the SMF.

Upon reception of a UL NAS TRANSPORT message, if the Payload container type IE is set to "N1 SM information", the Request type IE is set to "initial request", and

- a) the UE does not support S-NSSAI location validity information;
- b) the S-NSSAI is subject to NS-AoS; and
- c) the AMF determines that the UE is not in the NS-AoS,

the AMF may send back to the UE the message which was not forwarded as specified in subclause 5.4.5.3.1 case h6), include the 5GMM cause #69 "insufficient resources for specific slice", and include a back-off timer.

Upon reception of an UL NAS TRANSPORT message, if the Payload container type IE is set to "CIoT user data container", the UE is not configured for high priority access in selected PLMN, and:

- a) the timer T3447 is running and the UE does not support service gap control;
- b) the current NAS signalling connection was not triggered by paging; and
- c) mobile terminated signalling has not been sent or no user-plane resources have been established for any PDU session after the establishment of the current NAS signalling connection;

the AMF shall send back to the UE the CIoT user data which was not forwarded, send the 5GMM cause #22 "Congestion", and include a back-off timer set to the remaining time of the timer T3447 as specified in subclause 5.4.5.3.1 case l2).

Upon reception of a UL NAS TRANSPORT message, if the Payload container type IE is set to "N1 SM information", the Request type IE is set to "existing PDU session", and

- a) the UE is in NB-N1 mode;
- b) the UE has indicated preference for user plane CIoT 5GS optimization;
- c) the network accepted the use of user plane CIoT 5GS optimization; and
- d) the AMF determines that there are user-plane resources established for a number of PDU sessions that equals to the UE's maximum number of supported user-plane resources (see 3GPP TS 23.501 [8]),

the AMF shall send back to the UE the message which was not forwarded as specified in in subclause 5.4.5.3.1 case h1).

Upon reception of an UL NAS TRANSPORT message, if the Payload container type IE is set to "N1 SM information", the Request type IE is set to "initial request" or "modification request", the associated S-NSSAI that the AMF determined through the S-NSSAI IE or the PDU session ID IE is an S-NSSAI for which the AMF is performing NSSAA, and the AMF determines to not forward the 5GSM message to the SMF based on local policy, the AMF shall send back to the UE the 5GSM message which was not forwarded as specified in subclause 5.4.5.3.1 case h2).

Upon reception of an UL NAS TRANSPORT message, if the Payload container type IE is set to "SMS", "LTE Positioning Protocol (LPP) message container" or "UPP-CMI container" or "SLPP message container", the UE is not configured for high priority access in selected PLMN, and:

- a) the timer T3447 is running and the UE does not support service gap control;
- b) the current NAS signalling connection was not triggered by paging; and
- c) mobile terminated signalling has not been sent or no user-plane resources have been established for any PDU session after the establishment of the current NAS signalling connection;

the AMF shall abort the procedure.

NOTE 1: In this state the NAS signalling connection can be released by the network.

Upon reception of an UL NAS TRANSPORT message, if the Payload container type IE is set to "N1 SM information", the Request type IE is set to "initial request", and:

- a) the determined DNN, S-NSSAI or both DNN and S-NSSAI are identified for UAS services; and
- b) the UE is marked in the UE's 5GMM context that it is not allowed to request UAS services;

the AMF shall send back to the UE the 5GSM message which was not forwarded as specified in subclause 5.4.5.3.1 case h4).

NOTE 2: The UE marked in the UE's 5GMM context as not allowed to request UAS services happens in the case that the UUAA-MM procedure needs to be performed during the registration procedure according to operator policy.

5.4.5.2.5 Abnormal cases on the network side

The following abnormal cases in AMF are identified:

- a) If the Payload container type IE is set to "N1 SM information" and:
 - 1) if the Old PDU session ID IE is not included in the UL NAS TRANSPORT message, the AMF does not have a PDU session routing context for the PDU session ID and the UE, the Request type IE is set to "initial request" or "MA PDU request", and the SMF selection fails, then the AMF shall send back to the UE the 5GSM message which was not forwarded as specified in subclause 5.4.5.3.1 case e) or case f);
 - 2) if the Old PDU session ID IE is included in the UL NAS TRANSPORT message, the AMF has a PDU session routing context for the old PDU session ID and the UE and does not have a PDU session routing context for the PDU session ID and the UE, the Request type IE is set to "initial request", the AMF received a reallocation requested indication from the SMF indicating that the SMF is to be reallocated, and the SMF selection fails, then the AMF shall send back to the UE the 5GSM message which was not forwarded as specified in subclause 5.4.5.3.1 case e) or case f);
 - 3) if the AMF does not have a PDU session routing context for the PDU session ID and the UE, the Request type IE is set to "existing PDU session" or "MA PDU request", and the user's subscription context obtained from the UDM does not contain an SMF ID for the PDU session ID matching the PDU session ID received from the UE or for the DNN matching the DNN received from the UE such that the SMF ID includes a PLMN identity corresponding to the UE's HPLMN or the current PLMN or the PLMN ID part of the current SNPN, then the AMF may send back to the UE the 5GSM message which was not forwarded as specified in subclause 5.4.5.3.1 case e) or case f).
 - 4) if the Old PDU session ID IE is included in the UL NAS TRANSPORT message, and the AMF has a PDU session routing context for the old PDU session ID and the UE and does not have a PDU session routing context for the PDU session ID and the UE, the Request type IE is set to "initial request" and the AMF has not received a reallocation requested indication, the AMF should select an SMF with following handlings:
 - i) if the S-NSSAI IE is not included and the allowed NSSAI contains:
 - A) one S-NSSAI, the AMF shall use the S-NSSAI in the allowed NSSAI as the S-NSSAI;
 - B) two or more S-NSSAIs and the user's subscription context obtained from UDM contains only one default S-NSSAI that is included in the allowed NSSAI, the AMF shall use the S-NSSAI in the allowed NSSAI as the S-NSSAI; or
 - C) two or more S-NSSAIs and the user's subscription context obtained from UDM contains two or more default S-NSSAI(s) included in the allowed NSSAI, the AMF shall use an S-NSSAI in the allowed NSSAI selected based on operator policy as the S-NSSAI;
 - ii) if the DNN IE is not included, and the user's subscription context obtained from UDM:
 - A) contains the default DNN for the S-NSSAI, the AMF shall use the default DNN as the DNN; and
 - B) does not contain the default DNN for the S-NSSAI, the AMF shall use a locally configured DNN as the DNN;
 - iii) if the DNN selected by the network is a LADN DNN, the AMF shall determine the UE presence in LADN service area (see subclause 6.2.6);
 - iv) if the SMF selection is successful, the AMF should store a PDU session routing context for the PDU session ID and the UE, set the SMF ID in the stored PDU session routing context to the selected SMF ID, and forward the 5GSM message, the PDU session ID, the old PDU session ID, the S-NSSAI, the mapped S-NSSAI (in roaming scenarios), the DNN determined by the AMF, DNN selected by the network (if different from DNN determined by the AMF), the request type and UE presence in LADN service area (if

DNN selected by the network corresponds to an LADN DNN) towards the SMF ID of the PDU session routing context; and

- v) if the SMF selection fails, then the AMF shall send back to the UE the 5GSM message which was not forwarded as specified in subclause 5.4.5.3.1 case e) or case f);
- 5) if the AMF has a PDU session routing context for the PDU session ID and the UE, the PDU session routing context indicates that the PDU session is an emergency PDU session, the Request type IE is set to "initial emergency request", the AMF should forward the 5GSM message, the PDU session ID, the S-NSSAI (if configured in the AMF emergency configuration data), the DNN (if configured in the AMF emergency configuration data) and the request type towards the SMF ID of the PDU session routing context;
- 6) if the Request type IE is set to "initial emergency request" and the S-NSSAI or the DNN is received, the AMF ignores the received S-NSSAI or the DNN and uses the emergency DNN from the AMF emergency configuration data, if any;
- 7) if the AMF does not have a PDU session routing context for the PDU session ID and the UE, and the Request type IE of the UL NAS TRANSPORT message is either not provided or is provided but set to other value than "initial request", "existing PDU session", "initial emergency request", "existing emergency PDU session" and "MA PDU request", then the AMF may send back to the UE the 5GSM message which was not forwarded as specified in subclause 5.4.5.3.1 case e) or case f);
- 8) if the AMF unsuccessfully attempted to forward the 5GSM message, the PDU session ID, the S-NSSAI, the mapped S-NSSAI (in roaming scenarios), the DNN and the request type (if received) towards a SMF ID, then the AMF may send back to the UE the 5GSM message which was not forwarded as specified in subclause 5.4.5.3.1 case e) or case f).
- 9) if the Old PDU session ID IE is included in the UL NAS TRANSPORT message, the AMF does not have a PDU session routing context for the old PDU session ID and the UE, the AMF does not have a PDU session routing context for the PDU session ID and the UE, the Request type IE is set to "initial request", the AMF should select an SMF with following handlings:
 - i) if the S-NSSAI IE is not included and the allowed NSSAI contains:
 - A) one S-NSSAI, the AMF shall use the S-NSSAI in the allowed NSSAI as the S-NSSAI;
 - B) two or more S-NSSAIs and the user's subscription context obtained from UDM contains only one default S-NSSAI that is included in the allowed NSSAI, the AMF shall use the default S-NSSAI in the allowed NSSAI as the S-NSSAI; or
 - C) two or more S-NSSAIs and the user's subscription context obtained from UDM contains two or more default S-NSSAI(s) included in the allowed NSSAI, the AMF shall use an S-NSSAI in the allowed NSSAI selected based on operator policy as the S-NSSAI.
 - ii) if the DNN IE is not included, and the user's subscription context obtained from UDM:
 - A) contains the default DNN for the S-NSSAI, the AMF shall use the default DNN as the DNN; and
 - B) does not contain the default DNN for the S-NSSAI, the AMF shall use a locally configured DNN as the DNN;
 - iii) if the DNN selected by the network is a LADN DNN, the AMF shall determine the UE presence in LADN service area (see subclause 6.2.6);
 - iv) if the SMF selection is successful, the AMF should store a PDU session routing context for the PDU session ID and the UE, set the SMF ID in the stored PDU session routing context to the selected SMF ID, and forward the 5GSM message, the PDU session ID, the old PDU session ID, the S-NSSAI, the mapped S-NSSAI (in roaming scenarios), the DNN determined by the AMF, DNN selected by the network (if different from DNN determined by the AMF), the request type and UE presence in LADN service area (if DNN selected by the network corresponds to an LADN DNN) towards the SMF ID of the PDU session routing context; and
 - v) if the SMF selection fails, then the AMF shall send back to the UE the 5GSM message which was not forwarded as specified in subclause 5.4.5.3.1 case e) or case f);

- 10) if the AMF has a PDU session routing context for the PDU session ID and the UE, the PDU session routing context indicates that the PDU session is not an emergency PDU session, and the Request type IE is included and is set to "existing emergency PDU session", the AMF may send back to the UE the 5GSM message which was not forwarded as specified in subclause 5.4.5.3.1 case e) or case f);
- 11) if the AMF has a PDU session routing context for the PDU session ID and the UE, the PDU session routing context indicates that the PDU session is an emergency PDU session, and the Request type IE is included and is set to "existing PDU session", the AMF may forward the 5GSM message, the PDU session ID, the S-NSSAI (if configured in the AMF emergency configuration data), the DNN (if configured in the AMF emergency configuration data), and the request type towards the SMF identified by the SMF ID of the PDU session routing context;
- 12) if the AMF has a PDU session routing context for the PDU session ID and the UE, the Request type IE is set to "initial request", then the AMF shall perform a local release of the PDU session identified by the PDU session ID and shall request the SMF to perform a local release of the PDU session, and proceed as specified in subclause 5.4.5.2.3;
- 13) if the Request type IE is set to "initial request" or "modification request", and the S-NSSAI IE contains an S-NSSAI that is not allowed by the network, then the AMF shall send back to the UE the 5GSM message which was not forwarded as specified in subclause 5.4.5.3.1 case e), case f) or h4);
- 14) if the Request type IE is set to "existing PDU session", the AMF has a PDU session routing context for the PDU session ID and the UE, the PDU session routing context indicates that the PDU session is not an emergency PDU session, and the S-NSSAI associated with the PDU session identified by the PDU session ID is not allowed for the target access type, the AMF shall send back to the UE the 5GSM message which was not forwarded as specified in subclause 5.4.5.3.1 case e), case f) or h4);
- 15) if the Request type IE is set to "initial request", "existing PDU session", "modification request" or "MA PDU request", the UE is not configured for high priority access in selected PLMN or SNPN, and the UE is in non-allowed area or is not in allowed area, the AMF shall send back to the UE the 5GSM message which was not forwarded, and 5GMM cause #28 "Restricted service area" as specified in subclause 5.4.5.3.1 case i);
- 15a) if the Request type IE is set to "initial request" or "initial emergency request" and the AMF determines that the UE has registered to a PLMN via a satellite NG-RAN cell that is not allowed to operate at the present UE location, then the AMF may send back to the UE the 5GSM message which was not forwarded as specified in subclause 5.4.5.3.1 case i1); and
- 16) if the Request type IE is set to "initial request" or "MA PDU request", the AMF is pending the receipt of a REGISTRATION REQUEST message indicating "mobility registration updating" in the 5GS registration type IE, and an emergency PDU session exists for the UE (see subclause 5.4.4.3), the AMF shall send back to the UE the 5GSM message which was not forwarded as specified in subclause 5.4.5.3.1 case e) or case f);
- 17) if the timer T3447 is running and the UE supports service gap control and:
 - i) the Request type IE:
 - A) is set to "initial request";
 - B) is set to "existing PDU session"; or
 - C) is set to "modification request" and the PDU session being modified is a non-emergency PDU session;
 - ii) the UE is not configured for high priority access in selected PLMN;
 - iii) the current NAS signalling connection was not triggered by paging; and
 - iv) mobile terminated signalling has not been sent or no user-plane resources have been established for any PDU session after the establishment of the current NAS signalling connection,then the AMF shall send back to the UE the 5GSM message which was not forwarded as specified in subclause 5.4.5.3.1 case e) or case f);
- 18) if the AMF has a PDU session routing context for the PDU session ID and the UE, the Request type IE is not included, the UE is not configured for high priority access in selected PLMN or SNPN, and the PDU session

is not an emergency PDU session, then the AMF shall forward the 5GSM message, and the PDU session ID IE towards the SMF identified by the SMF ID of the PDU session routing context with:

- i) an exemptionInd attribute indicating "message was exempted from the DNN based congestion activated in the AMF" as specified in 3GPP TS 29.502 [20A], if DNN based congestion control is activated for the selected DNN;
 - ii) an exemptionInd attribute indicating "message was exempted from the S-NSSAI and DNN based congestion activated in the AMF" as specified in 3GPP TS 29.502 [20A], if S-NSSAI and DNN based congestion control is activated for the selected S-NSSAI and the selected DNN; or
 - iii) an exemptionInd attribute indicating "message was exempted from the S-NSSAI only based congestion activated in the AMF" as specified in 3GPP TS 29.502 [20A], if S-NSSAI only based congestion control is activated for the selected S-NSSAI;
- 19) if the Request type IE is set to "MA PDU request" and the S-NSSAI IE contains an S-NSSAI that is not allowed by the network on neither access, then the AMF shall send to the UE the 5GSM message which was not forwarded as specified in subclause 5.4.5.3.1 case e) or case f);
- 20) if the Request type IE is set to "initial request" and the UE is registered for emergency services over the current access, then the AMF may send back to the UE the 5GSM message which was not forwarded as specified in subclause 5.4.5.3.1 case e) or case f); and
- 21) if the Request type IE is set to "existing PDU session", the UE is attempting to transfer a PDU session from 3GPP access to non-3GPP access, and the PDU session is associated with control plane only indication then the AMF shall send back to the UE the 5GSM message which was not forwarded as specified in subclause 5.4.5.3.1 case e).
- 22) if the Request type IE is set to "MA PDU request" and the UE requested DNN corresponds to an LADN DNN, the AMF shall send back to the UE the 5GSM message which was not forwarded and 5GMM cause #90 "payload was not forwarded" as specified in subclause 5.4.5.3.1 case hx).
- 23) if the Request type IE is set to "initial request", the UE requested DNN corresponds to an LADN DNN, and the MA PDU session information IE is included, the AMF shall not forward the MA PDU session information towards the SMF.
- 24) if the Request type IE is set to "modification request", the DNN associated with the PDU session corresponds to an LADN DNN, and MA PDU session information IE is included, the AMF shall not forward the MA PDU session information towards the SMF.
- b) If the Payload container type IE is set to "SMS" and:
- 1) the AMF does not have an SMSF address associated with the UE;
 - 2) the AMF cannot forward the content of the Payload container IE to the SMSF associated with the SMSF address available in the AMF; or
 - 3) the AMF determines that the UE has registered to a PLMN via a satellite NG-RAN cell that is not allowed to operate at the present UE location;
- then the AMF shall abort the procedure.
- c) If the Payload container type IE is set to "LTE Positioning Protocol (LPP) message container" or "SLPP message container" and:
- 1) if the Additional information IE is not included in the UL NAS TRANSPORT message;
 - 2) the AMF cannot forward the content of the Payload container IE to the LMF associated with the routing information included in the Additional information IE; or
 - 3) the AMF determines that the UE has registered to a PLMN via a satellite NG-RAN cell that is not allowed to operate at the present UE location;
- then the AMF shall abort the procedure.
- d) If the Payload container type IE is set to "UE policy container" and:

- 1) the AMF does not have a PCF address associated with the UE;
- 2) the AMF cannot forward the content of the Payload container IE to the PCF associated with the PCF address available in the AMF; or
- 3) the AMF determines that the UE has registered to a PLMN via a satellite NG-RAN cell that is not allowed to operate at the present UE location;

then the AMF shall abort the procedure.

e) If the Payload container type IE is set to "Location services message container" and:

- 1) if the Additional information IE is included in the UL NAS TRANSPORT message and the AMF cannot forward the content of the Payload container IE to an LMF associated with the routing information included in the Additional information IE;
- 2) the AMF determines that the UE has registered to a PLMN via a satellite NG-RAN cell that is not allowed to operate at the present UE location;
- 3) the AMF determines that the payload container content is related to PRU and the UE has not a valid PRU subscription information; or
- 4) any combination of bullets 1 to 3,

then the AMF shall abort the procedure.

f) If the Payload container type IE is set to "SMS" or "LTE Positioning Protocol (LPP) message container" or "SLPP message container":

- 1) the timer T3447 is running and the UE supports service gap control;
- 2) the UE is not configured for high priority access in selected PLMN;
- 3) the current NAS signalling connection was not triggered by paging; and
- 4) mobile terminated signalling has not been sent or no user-plane resources have been established for any PDU session after the establishment of the current NAS signalling connection,

the AMF shall abort the procedure.

NOTE: In this state the N1 NAS signalling connection can be released by the network.

g) If the Payload container type IE is set to "CIoT user data container" and:

- 1) if the AMF does not have a PDU session routing context for the PDU session ID and the UE; or
- 2) if the AMF unsuccessfully attempted to forward the user data container and the PDU session ID,

then the AMF may send back to the UE the CIoT user data container which was not forwarded as specified in subclause 5.4.5.3.1 case 11).

h) If the Payload container type IE is set to "CIoT user data container":

- 1) if the timer T3447 is running and the UE supports service gap control;
- 2) the UE is not configured for high priority access in selected PLMN;
- 3) the current N1 NAS signalling connection was not triggered by paging; and
- 4) mobile terminated signalling has not been sent or no user-plane resources have been established for any PDU session after the establishment of the current NAS signalling connection,

then the AMF shall send back to the UE the CIoT user data container which was not forwarded as specified in subclause 5.4.5.3.1 case 11).

i) If the Payload container type IE is set to "SOR transparent container", "UE parameters update transparent container", or "Service-level-AA container", and the AMF determines that the UE has registered to a PLMN via

a satellite NG-RAN cell that is not allowed to operate at the present UE location, then the AMF shall abort the procedure.

- j) If the Payload container type IE is set to "UPP-CMI container" and:
- 1) the AMF cannot forward the content of the Payload container IE to the LMF associated with the routing information included in the Additional information IE; or
 - 2) the AMF determines that the UE has registered to a PLMN via a satellite NG-RAN cell that is not allowed to operate at the present UE location;
- then the AMF shall abort the procedure.

5.4.5.2.6 Abnormal cases in the UE

The following abnormal cases can be identified:

- a) The lower layers indicate that the access attempt is barred.

The UE shall not start the UE-initiated NAS transport procedure. The UE stays in the current serving cell and applies the normal cell reselection process.

If the access category for the access attempt is 6 due to a request from upper layers to send a mobile originated SMS over NAS and the UE is registered to the network via both 3GPP access and non-3GPP access, the UE may transmit the UL NAS TRANSPORT message via non-3GPP access, if available.

Otherwise, the UE-initiated NAS transport procedure is started, if still needed, when the lower layers indicate that the barring is alleviated for the access category with which the access attempt was associated.

- aa) The lower layers indicate that:

- 1) access barring is applicable for all access categories except categories 0 and 2 and the access category with which the access attempt was associated is other than 0 and 2; or
- 2) access barring is applicable for all access categories except category 0 and the access category with which the access attempt was associated is other than 0.

The UE shall proceed as specified for case a. For additional UE requirements see subclause 4.5.5.

- b) If the Payload container type IE is set to "N1 SM information", the Request type IE is set to "initial request" or "MA PDU request" and registration procedure for mobility and periodic registration update is pending due to receipt by the UE of new network slicing information via the generic UE configuration update procedure with re-registration request; and an emergency PDU session exists then:

- 1) The UE shall not send the UL NAS TRANSPORT message; and
- 2) The UL NAS TRANSPORT message can be sent, if still necessary, after a successful procedure for mobility and periodic registration update.

- c) Transmission failure of the UL NAS TRANSPORT message with change in the current TAI.

If the current TAI is not in the TAI list, the UE-initiated NAS transport procedure shall be aborted and a registration procedure for mobility and periodic registration update shall be initiated. The UL NAS TRANSPORT message can be sent, if still necessary, after a successful procedure for mobility and periodic registration update.

If:

- 1) the current TAI is still part of the TAI list;
- 2) the UL NAS TRANSPORT message is sent to transport a 5GSM message associated with an S-NSSAI included in the partially allowed NSSAI; and
- 3) the current TAI is not in the list of TAs where the S-NSSAI is allowed,

then the UE-initiated NAS transport procedure shall be aborted.

Otherwise, it is up to the UE implementation how to re-run the ongoing procedure that triggered the UE-initiated NAS transport procedure.

- d) Transmission failure of the UL NAS TRANSPORT message indication without change in the current TAI.

It is up to the UE implementation how to re-run the ongoing procedure that triggered the UE-initiated NAS transport procedure.

- e) Void.

- f) Timer T3447 is running.

The UE shall not send the UL NAS TRANSPORT message unless:

- 1) the Payload container type IE is set to "N1 SM information" and:

- i) the Request type IE is set to:

A) "initial emergency request";

B) "existing emergency PDU session"; or

C) "modification request" and the PDU session being modified is an emergency PDU session (see error cases described in subclause 6.4.1.3 and subclause 6.3.2.3); or

- ii) the Request type IE is not included and the PDU session modification procedure is used to indicate a change of 3GPP PS data off UE status for a PDU session;

- 2) the UE is a UE configured for high priority access in selected PLMN;

- 3) a paging request triggered the establishment of the current NAS signalling connection; or

- 4) the UE in 5GMM-CONNECTED mode receives mobile terminated signalling or downlink data over the user-plane.

The UL NAS TRANSPORT message can be sent, if still necessary, when timer T3447 expires or timer T3447 is stopped.

- g) The lower layers indicate that the RRC connection has been suspended.

The UE shall abort the UE-initiated NAS transport procedure.

- h) Timer T3346 is running.

The UE shall not send the UL NAS TRANSPORT message unless:

- 1) the Payload container type IE is set to "N1 SM information" and:

- i) the Request type IE is set to:

A) "initial emergency request";

B) "existing emergency PDU session"; or

C) "modification request" and the PDU session being modified is an emergency PDU session; or

- ii) the Request type IE is not included and the PDU session modification procedure is used to indicate a change of 3GPP PS data off UE status for a PDU session; or

- 2) the UE is a UE configured for high priority access in selected PLMN or SNPN.

The UL NAS TRANSPORT message can be sent, if still necessary, when timer T3346 expires.

- i) NAS MAC calculation indication from lower layers.

If lower layers indicate to calculate an NAS MAC, the UE shall calculate an NAS MAC as specified in 3GPP TS 33.501 [24] and then provide the calculated NAS MAC and 5 least significant bits of the uplink NAS

COUNT used to calculate the NAS MAC to lower layers (see 3GPP TS 36.331 [25A]). The UE shall increase the uplink NAS COUNT by one after the calculation of the NAS MAC.

5.4.5.3 Network-initiated NAS transport procedure

5.4.5.3.1 General

The purpose of the network-initiated NAS transport procedure is to provide a transport of:

- a) a single 5GSM message;
- b) SMS;
- c) an LPP message;
- c1) an SLPP message;
- d) an SOR transparent container;
- e) a single uplink 5GSM message which was not forwarded due to routing failure;
- f) a single uplink 5GSM message which was not forwarded due to congestion control;
- g) a UE policy container;
- h) a single uplink 5GSM message which was not forwarded, because the PLMN's maximum number of PDU sessions has been reached;
- h1) a single uplink 5GSM message which was not forwarded, because the maximum number of PDU sessions with active user-plane resources has been reached;
- h2) a single uplink 5GSM message which was not forwarded, because of ongoing network slice-specific authentication and authorization procedure for the S-NSSAI that is requested;
- h3) a single uplink 5GSM message which was not forwarded, because the UE requested to establish an MA PDU session for LADN DNN;
- h4) a single uplink 5GSM message which was not forwarded, because the maximum number of UEs for a network slice has been reached;
- h5) a single uplink 5GSM message which was not forwarded because the UE is marked in the UE's 5GMM context that it is not allowed to request UAS services;
- h6) a single uplink 5GSM message was not forwarded, because the UE not supporting S-NSSAI location validity information requested forwarding of an 5GSM message with Request type IE is set to "initial request" when not in the NS-AoS of the related S-NSSAI;
- i) a single uplink 5GSM message which was not forwarded due to service area restrictions;
- i1) a single uplink 5GSM message which was not forwarded because the UE is registered to a PLMN via a satellite NG-RAN cell that is not allowed to operate at the present UE location;
- j) a UE parameters update transparent container;
- k) a location services message;
- l) a CIoT user data container;
- l1) a single uplink CIoT user data container or control plane user data which was not forwarded due to routing failure;
- l2) a single uplink CIoT user data container which was not forwarded due to congestion control;
- m) a service-level-AA container;
- m1) an event notification for upper layers;

- m2) a UPP-CMI container;
- m3) a single UPP-CMI container which was not forwarded due to user plane positioning not authorized; or
- n) multiple of the above types.

from the AMF to the UE in a 5GMM message.

5.4.5.3.2 Network-initiated NAS transport procedure initiation

In 5GMM-CONNECTED mode, the AMF initiates the NAS transport procedure by sending the DL NAS TRANSPORT message, as shown in figure 5.4.5.3.2.1.

In case a) in subclause 5.4.5.3.1, i.e. upon reception from an SMF of a 5GSM message without an N1 SM delivery skip allowed indication for a UE or a 5GSM message with an N1 SM delivery skip allowed indication for a UE in the 5GMM-CONNECTED mode, the AMF shall:

- a) include the PDU session information (PDU session ID) in the PDU session ID IE;
- b) set the Payload container type IE to "N1 SM information"; and
- c) set the Payload container IE to the 5GSM message.

In case b) in subclause 5.4.5.3.1, i.e. upon reception from an SMSF of an SMS payload, the AMF shall:

- a) set the Payload container type IE to "SMS";
- b) set the Payload container IE to the SMS payload; and
- c) select the access type to deliver the DL NAS TRANSPORT message as follows in case the access type selection is required:
 - 1) if the UE to receive the DL NAS TRANSPORT message is registered to the network via both 3GPP access and non-3GPP access, the 5GMM context of the UE indicates that SMS over NAS is allowed, the UE is in MICO mode, and the UE is in 5GMM-IDLE mode for 3GPP access and in 5GMM-CONNECTED mode for non-3GPP access, then the AMF selects non-3GPP access. Otherwise, the AMF selects either 3GPP access or non-3GPP access.

If the delivery of the DL NAS TRANSPORT message over 3GPP access has failed, the AMF may re-send the DL NAS TRANSPORT message over the non-3GPP access.

If the delivery of the DL NAS TRANSPORT message over non-3GPP access has failed, the AMF may re-send the DL NAS TRANSPORT message over the 3GPP access; and

- 2) otherwise, the AMF selects 3GPP access.

NOTE 1: The AMF selects an access type between 3GPP access and non-3GPP access based on operator policy.

In case c) in subclause 5.4.5.3.1 i.e. upon reception from an LMF of an LPP message payload, the AMF shall:

- a) set the Payload container type IE to "LTE Positioning Protocol (LPP) message container";
- b) set the Payload container IE to the LPP message payload received from the LMF;
- c) set the Additional information IE to an LCS correlation identifier received from the LMF from which the LPP message was received.

NOTE 2: The LCS Correlation Identifier is assigned originally by the AMF except for LPP message transfer associated with event reporting for periodic or triggered location as described in subclause 6.3.1 of 3GPP TS 23.273 [6B], where the LMF assigns the correlation identifier. AMF and LMF assigned correlation identifiers can be distinguished by an implementation specific convention (e.g. use of a different number of octets) to enable an AMF to distinguish one from the other when received in the Additional Information IE in an UL NAS Transport message.

In case c1) in subclause 5.4.5.3.1 i.e. upon reception from an LMF of an SLPP message payload, the AMF shall:

- a) set the Payload container type IE to "SLPP message container";
- b) set the Payload container IE to the SLPP message payload received from the LMF; and
- c) set the Additional information IE to an LCS correlation identifier received from the LMF from which the SLPP message was received.

In case d) in subclause 5.4.5.3.1 i.e. upon reception of a steering of roaming information (see 3GPP TS 23.122 [5]) from the UDM to be forwarded to the UE, the AMF shall:

- a) set the Payload container type IE to "SOR transparent container"; and
- b) set the Payload container IE to the steering of roaming information received from the UDM (see 3GPP TS 29.503 [20AB]).

In case e) in subclause 5.4.5.3.1, i.e. upon sending a single uplink 5GSM message which was not forwarded due to routing failure, the AMF shall:

- a) include the PDU session ID in the PDU session ID IE;
- b) set the Payload container type IE to "N1 SM information";
- c) set the Payload container IE to the 5GSM message which was not forwarded;
- d) set the 5GMM cause IE to the 5GMM cause #90 "payload was not forwarded" or 5GMM cause #91 "DNN not supported or not subscribed in the slice".

The AMF sets the 5GMM cause IE to the 5GMM cause #91 "DNN not supported or not subscribed in the slice", if the 5GSM message could not be forwarded since SMF selection fails because:

- 1) the DNN is not supported in the slice identified by the S-NSSAI used by the AMF; or
- 2) neither the DNN provided by the UE nor the wildcard DNN are in the subscribed DNN list of the UE for the S-NSSAI used by the AMF.

Otherwise, the AMF sets the 5GMM cause IE to the 5GMM cause #90 "payload was not forwarded"; and

- e) optionally include the Back-off timer value IE if the 5GMM cause IE is set to 5GMM cause #91 "DNN not supported or not subscribed in the slice" due to the DNN is not supported in the slice.

In case f) in subclause 5.4.5.3.1, i.e. upon sending a single uplink 5GSM message which was not forwarded due to congestion control, the AMF shall:

- a) include the PDU session ID in the PDU session ID IE;
- b) set the Payload container type IE to "N1 SM information";
- c) set the Payload container IE to the 5GSM message which was not forwarded;
- d) set the 5GMM cause IE to the 5GMM cause #22 "Congestion", the 5GMM cause #67 "insufficient resources for specific slice and DNN" or the 5GMM cause #69 "insufficient resources for specific slice"; and
- e) include the Back-off timer value IE.

In case g) in subclause 5.4.5.3.1, i.e. upon reception of a UE policy container from the PCF to be forwarded to the UE, the AMF shall:

- a) set the Payload container type IE to "UE policy container"; and
- b) set the Payload container IE to the UE policy container received from the PCF.

In case h) in subclause 5.4.5.3.1, i.e. upon sending a single uplink 5GSM message which was not forwarded, because the PLMN's maximum number of PDU sessions has been reached, the AMF shall:

- a) include the PDU session ID in the PDU session ID IE;
- b) set the Payload container type IE to "N1 SM information";

- c) set the Payload container IE to the 5GSM message which was not forwarded; and
- d) set the 5GMM cause IE to the 5GMM cause #65 "maximum number of PDU sessions reached".

In case h1) in subclause 5.4.5.3.1, i.e. upon sending a single uplink 5GSM message which was not forwarded, because the maximum number of PDU sessions with active user-plane resources has been reached, the AMF shall:

- a) include the PDU session ID in the PDU session ID IE;
- b) set the Payload container type IE to "N1 SM information";
- c) set the Payload container IE to the 5GSM message which was not forwarded; and
- d) set the 5GMM cause IE to the 5GMM cause #92 "insufficient user-plane resources for the PDU session".

In case h2) in subclause 5.4.5.3.1, i.e. upon sending a single uplink 5GSM message which was not forwarded because the UE requested to establish a PDU session associated with an S-NSSAI or to modify a PDU session associated with an S-NSSAI for which:

- a) the AMF is performing network slice-specific authentication and authorization and determined to reject the request based on local policy; or
- b) the network slice-specific authentication and authorization has failed or the authorization has been revoked;

the AMF shall:

- a) include the PDU session ID in the PDU session ID IE;
- b) set the Payload container type IE to "N1 SM information";
- c) set the Payload container IE to the 5GSM message which was not forwarded; and
- d) set the 5GMM cause IE to the 5GMM cause #90 "payload was not forwarded".

In case h3) in subclause 5.4.5.3.1, i.e. upon sending a single uplink 5GSM message which was not forwarded because the UE requested to establish an MA PDU session for LADN DNN, the AMF shall:

- a) include the PDU session ID in the PDU session ID IE;
- b) set the Payload container type IE to "N1 SM information";
- c) set the Payload container IE to the 5GSM message which was not forwarded; and
- d) set the 5GMM cause IE to the 5GMM cause #90 "payload was not forwarded".

In case h4) in subclause 5.4.5.3.1, i.e. upon sending a single uplink 5GSM message which was not forwarded, because the maximum number of UEs for a network slice has been reached, the AMF shall:

- a) include the PDU session ID in the PDU session ID IE;
- b) set the Payload container type IE to "N1 SM information";
- c) set the Payload container IE to the 5GSM message which was not forwarded;
- d) set the 5GMM cause IE to the 5GMM cause #69 "insufficient resources for specific slice"; and
- e) include the Back-off timer value IE.

For case h5) in subclause 5.4.5.3.1, i.e. upon sending a single uplink 5GSM message which was not forwarded because the UE is marked in the UE's 5GMM context that it is not allowed to request UAS services, the AMF shall:

- a) include the PDU session ID in the PDU session ID IE;
- b) set the Payload container type IE to "N1 SM information";
- c) set the Payload container IE to the 5GSM message which was not forwarded; and
- d) set the 5GMM cause IE to the 5GMM cause #79 "UAS services not allowed".

For case h6) in subclause 5.4.5.3.1, i.e. upon sending a single uplink 5GSM message which was not forwarded because the UE not supporting S-NSSAI location validity information requested forwarding of an 5GSM message with Request type IE is set to "initial request" when not in the NS-AoS of the related S-NSSAI, the AMF shall:

- a) include the PDU session ID in the PDU session ID IE;
- b) set the Payload container type IE to "N1 SM information";
- c) set the Payload container IE to the 5GSM message which was not forwarded;
- d) set the 5GMM cause IE to the 5GMM cause #69 "insufficient resources for specific slice"; and
- e) include the Back-off timer value IE.

In case i) in subclause 5.4.5.3.1, i.e. upon sending a single uplink 5GSM message which was not forwarded due to service area restrictions, the AMF shall:

- a) include the PDU session ID in the PDU session ID IE;
- b) set the Payload container type IE to "N1 SM information";
- c) set the Payload container IE to the 5GSM message which was not forwarded; and
- d) set the 5GMM cause IE to the 5GMM cause #28 "Restricted service area".

In case i1) in subclause 5.4.5.3.1, i.e. upon sending a single uplink 5GSM message which was not forwarded because the UE is registered to a PLMN via a satellite NG-RAN cell that is not allowed to operate at the present UE location, the AMF shall:

- a) include the PDU session ID in the PDU session ID IE;
- b) set the Payload container type IE to "N1 SM information";
- c) set the Payload container IE to the 5GSM message which was not forwarded; and
- d) set the 5GMM cause IE to the 5GMM cause #78 "PLMN not allowed to operate at the present UE location".

In case j) in subclause 5.4.5.3.1 i.e. upon reception of UE parameters update data (see 3GPP TS 23.502 [9]) from the UDM to be forwarded to the UE, the AMF shall:

- a) set the Payload container type IE to "UE parameters update transparent container"; and
- b) set the contents of the Payload container IE to the UE parameters update data (see 3GPP TS 23.502 [9]) received from the UDM.

For case k) in subclause 5.4.5.3.1 upon reception from a location services application of a Location services message payload, the AMF shall:

- a) set the Payload container type IE to "Location services message container"; and
- b) set the Payload container IE to the Location services message payload.

For case k) in subclause 5.4.5.3.1 upon reception from an LMF of a Location services message payload, the AMF shall:

- a) set the Payload container type IE to "Location services message container";
- b) set the Payload container IE to the Location services message payload; and
- c) set the Additional information IE to routing information associated with the LMF from which the Location services message payload was received.

NOTE 3: Case k) in subclause 5.4.5.3.1 supports transport of a Location services message container between a UE and an AMF and between a UE and an LMF. For transport between a UE and an LMF, the Additional information IE is included and provides routing information for the LMF. For transport between a UE and an AMF, the Additional information IE is not included.

In case l) in subclause 5.4.5.3.1, i.e. upon reception from an SMF of a user data container payload, the AMF shall:

- a) include the PDU session ID in the PDU session ID IE;
- b) set the Payload container type IE to "CIoT user data container"; and
- c) set the Payload container IE to the user data container.

For case 11) in subclause 5.4.5.3.1, i.e. upon sending a single uplink CIoT user data container or control plane user data which was not forwarded due to routing failure, the AMF shall:

- a) include the PDU session ID in the PDU session ID IE;
- b) set the Payload container type IE to "CIoT user data container";
- c) set the Payload container IE to the CIoT user data container or control plane user data which was not forwarded; and
- d) set the 5GMM cause IE to the 5GMM cause #90 "payload was not forwarded".

NOTE 4: For case 11) in subclause 5.4.5.3.1, this is also applied for a single uplink CIoT user data container or control plane user data in the CONTROL PLANE SERVICE REQUEST message which was not forwarded due to routing failure.

For case 12) in subclause 5.4.5.3.1, i.e. upon sending a single uplink CIoT user data container which was not forwarded due to congestion control, the AMF shall:

- a) include the PDU session ID in the PDU session ID IE;
- b) set the Payload container type IE to "CIoT user data container";
- c) set the Payload container IE to the CIoT user data container which was not forwarded;
- d) set the 5GMM cause IE to the 5GMM cause #22 "Congestion", the 5GMM cause #67 "insufficient resources for specific slice and DNN" or the 5GMM cause #69 "insufficient resources for specific slice", and include the Back-off timer value IE.

In case m) in subclause 5.4.5.3.1, during UUAA-MM procedure, if the AMF receives the UUAA payload from the UAS-NF, the AMF shall:

- a) include the service-level-AA payload with the value set to the payload; and
- b) if a payload type associated with the payload is received, include the service-level-AA payload type with the value set to the payload type

In case m1) in subclause 5.4.5.3.1, i.e. if the AMF needs to send an event notification indicator for upper layers to the UE which set the "EventNotification" bit of the 5GMM capability IE in the last REGISTRATION REQUEST message to "Event notification supported", the AMF shall:

- a) set the Payload container type IE to "Event notification"; and
- b) set the Payload container IE to the event notification indicator.

In case m2) in subclause 5.4.5.3.1, i.e. upon reception from an LMF of a UPP-CMI container, the AMF shall:

- a) set the Payload container type IE to "UPP-CMI container";
- b) set the Payload container IE to the UPP-CMI container received from the LMF; and
- c) set the Additional information IE to routing information associated with the LMF from which the UPP-CMI container was received.

For case m3) in subclause 5.4.5.3.1, i.e. upon sending a single UPP-CMI container which was not forwarded due to user plane positioning not authorized, the AMF shall:

- a) set the Payload container type IE to "UPP-CMI container";
- b) set the Payload container IE to the UPP-CMI container which was not forwarded; and

- c) set the 5GMM cause IE to the 5GMM cause #94 "User plane positioning not authorized".

In case n) in subclause 5.4.5.3.1, the AMF shall:

- a) set the Payload container type IE to "Multiple payloads";
- b) set each payload container entry of the Payload container IE (see subclause 9.11.3.39) as follows:
 - i) set the payload container type field of the payload container entry to a payload container type value set in the Payload container type IE as specified for cases a) to m3) above;
 - ii) set the payload container entry contents field of the payload container entry to the payload container contents set in the Payload container IE as specified for cases a) to m3) above;
 - iii) set the optional IE fields, if any, to the optional associated information as specified for cases a) to m3) above.



Figure 5.4.5.3.2.1: Network-initiated NAS transport procedure

5.4.5.3.3 Network-initiated NAS transport of messages accepted by the UE

Upon reception of a DL NAS TRANSPORT message, the UE shall stop the timer T3346 if running.

Upon reception of a DL NAS TRANSPORT message, if the Payload container type IE is set to:

- a) "N1 SM information" and the 5GMM cause IE is not included in the DL NAS TRANSPORT message, the 5GSM message in the Payload container IE and the PDU session ID are handled in the 5GSM procedures specified in clause 6;
- b) "SMS", the UE shall forward the content of the Payload container IE to the SMS stack entity;
- c) "LTE Positioning Protocol (LPP) message container", the UE shall forward the payload container type, the content of the Payload container IE and the routing information included in the Additional information IE to the upper layer location services application;
- c1) "SLPP message container", the UE shall forward the payload container type, the content of the Payload container IE and the routing information included in the Additional information IE to the upper layer location services application;
- d) "SOR transparent container" and if the Payload container IE:
 - 1) successfully passes the integrity check (see 3GPP TS 33.501 [24]), the ME shall store the received SOR counter as specified in annex C and proceed as follows:
 - i) If the Payload container IE indicates a list of preferred PLMN/access technology combinations is provided and the list type indicates "PLMN ID and access technology list", then the ME shall replace the highest priority entries in the "Operator Controlled PLMN Selector with Access Technology" list stored in the ME;
 - ii) If the list type indicates "secured packet", then the ME shall behave as if a SMS is received with protocol identifier set to SIM data download, data coding scheme set to class 2 message and SMS payload as secured packet contents of SOR transparent container IE. The SMS payload is forwarded to UICC as specified in 3GPP TS 23.040 [4A];

- iii) If the Payload container IE includes SOR-SNPN-SI, the ME shall replace SOR-SNPN-SI of the selected entry of the "list of subscriber data" or associated with the selected PLMN subscription, as specified in 3GPP TS 23.122 [5] with the received SOR-SNPN-SI;
- iv) If the SOR-CMCI is present, in plain text, and the Store SOR-CMCI in ME indicator is set to "Store SOR-CMCI in ME" then the UE shall store or delete the SOR-CMCI in the non-volatile memory of the ME as described in annex C.1;and
- v) If the Payload container IE includes SOR-SNPN-SI-LS, the ME shall replace SOR-SNPN-SI-LS of the selected entry of the "list of subscriber data" or associated with the selected PLMN subscription, as specified in 3GPP TS 23.122 [5] with the received SOR-SNPN-SI-LS;

If the ACK bit of the SOR header for SOR data type in the SOR transparent container is set to "acknowledgement requested" and the list type indicates:

- A) "PLMN ID and access technology list"; or
- B) "secured packet" and the ME receives status bytes from the UICC indicating that the UICC has received the secured packet successfully;

then the ME shall send an acknowledgement in the Payload container IE of an UL NAS TRANSPORT message with Payload type IE set to "SOR transparent container" as specified in subclause 5.4.5.2.2. In the Payload container IE carrying the acknowledgement, the UE shall set the ME support of SOR-CMCI indicator to "SOR-CMCI supported by the ME". Additionally, if the UE supports access to an SNPN using credentials from a credentials holder and the UE is not operating in SNPN access operation mode, the UE may set the ME support of SOR-SNPN-SI indicator to "SOR-SNPN-SI supported by the ME". Additionally, if the UE supports access to an SNPN providing access for localized services in SNPN, the UE shall set the ME support of SOR-SNPN-SI-LS indicator to "SOR-SNPN-SI-LS supported by the ME".

The UE shall proceed with the behaviour as specified in 3GPP TS 23.122 [5] annex C; or

- 2) does not successfully pass the integrity check (see 3GPP TS 33.501 [24]) then the UE shall discard the content of the payload container IE and proceed with the behaviour as specified in 3GPP TS 23.122 [5] annex C.
- e) Void;
- f) Void;
- g) "N1 SM information" and:
 - 1) the 5GMM cause IE is set to the 5GMM cause #22 "Congestion", the UE passes to the 5GSM sublayer an indication that the 5GSM message was not forwarded due to DNN based congestion control along with the 5GSM message from the Payload container IE of the DL NAS TRANSPORT message, and the time value from the Back-off timer value IE;
 - 2) the 5GMM cause IE is set to the 5GMM cause #28 "Restricted service area", the UE passes to the 5GSM sublayer an indication that the 5GSM message was not forwarded due to service area restrictions along with the 5GSM message from the Payload container IE of the DL NAS TRANSPORT message, enters the state 5GMM-REGISTERED.NON-ALLOWED-SERVICE and, if the DL NAS TRANSPORT message is received over 3GPP access, performs the registration procedure for mobility and periodic registration update without waiting for the release of the N1 NAS signalling connection (see subclauses 5.3.5 and 5.5.1.3);
 - 3) the 5GMM cause IE is set to the 5GMM cause #65 "maximum number of PDU sessions reached", the UE passes to the 5GSM sublayer an indication that the 5GSM message was not forwarded because the PLMN's maximum number of PDU sessions has been reached, along with the 5GSM message from the Payload container IE of the DL NAS TRANSPORT message;
 - 4) the 5GMM cause IE is set to the 5GMM cause #67 "insufficient resources for specific slice and DNN", the UE passes to the 5GSM sublayer an indication that the 5GSM message was not forwarded due to S-NSSAI and DNN based congestion control along with the 5GSM message from the Payload container IE of the DL NAS TRANSPORT message, and the time value from the Back-off timer value IE;
 - 5) the 5GMM cause IE is set to the 5GMM cause #69 "insufficient resources for specific slice", the UE passes to the 5GSM sublayer an indication that the 5GSM message was not forwarded due to S-NSSAI only based

congestion control along with the 5GSM message from the Payload container IE of the DL NAS TRANSPORT message, and the time value from the Back-off timer value IE;

- 5a) the 5GMM cause IE is set to the 5GMM cause #78 "PLMN not allowed to operate at the present UE location", the UE shall consider as an abnormal case and treat it as unexpected cause and behave as specified in case g1) if this cause value is received from a non-satellite NG-RAN cell, otherwise, the UE passes to the 5GSM sublayer an indication that the 5GSM message was not forwarded because the UE is registered to a PLMN via a satellite NG-RAN cell that is not allowed to operate at the present UE location along with the 5GSM message from the Payload container IE of the DL NAS TRANSPORT message.

Additionally, if the cause is received from a satellite NG-RAN cell, the UE shall not send the UL NAS TRANSPORT message to transport any of the data types listed in subclause 5.4.5.2.1. The UE shall delete last visited registered TAI and TAI list. If the UE is not registering or has not registered to the same PLMN over non-3GPP access, the UE shall additionally delete 5G-GUTI and ngKSI. The UE shall store the PLMN identity and, if it is known, the current geographical location in the list of "PLMNs not allowed to operate at the present UE location" and shall start a corresponding timer instance (see subclause 4.23.2). The UE shall enter state 5GMM-DEREGISTERED.PLMN-SEARCH and perform a PLMN selection according to 3GPP TS 23.122 [5];

If the message was received via satellite NG-RAN access and the UE is operating in single-registration mode, the UE shall delete any 4G-GUTI, last visited registered TAI, TAI list and eKSI. Additionally, the UE shall enter the state EMM-DEREGISTERED.

- 6) the 5GMM cause IE is set to the 5GMM cause #90 "payload was not forwarded", the UE passes to the 5GSM sublayer an indication that the 5GSM message was not forwarded due to routing failure along with the 5GSM message from the Payload container IE of the DL NAS TRANSPORT message. The UE shall ignore the Back-off timer value IE, if any;
- 7) the 5GMM cause IE is set to the 5GMM cause #91 "DNN not supported or not subscribed in the slice", the UE passes to the 5GSM sublayer an indication that the 5GSM message was not forwarded because the DNN is not supported or not subscribed in a slice along with the 5GSM message from the Payload container IE of the DL NAS TRANSPORT message, and the time value from the Back-off timer value IE, if any;
- 8) the 5GMM cause IE is set to the 5GMM cause #92 "insufficient user-plane resources for the PDU session", the UE passes to the 5GSM sublayer an indication that the 5GSM message was not forwarded due to insufficient user-plane resources along with the 5GSM message from the Payload container IE of the DL NAS TRANSPORT message.
- 9) the 5GMM cause IE is set to the 5GMM cause #79 "UAS services not allowed", the UE passes to the 5GSM sublayer an indication that the 5GSM message was not forwarded because the UE is marked in the UE's 5GMM context that it is not allowed to request UAS services along with the 5GSM message from the Payload container IE of the DL NAS TRANSPORT message.

g1) "N1 SM information" and:

- 1) the 5GMM cause IE is set to the 5GMM cause other than any of the cause values specified in bullet g) above, the UE passes to the 5GSM sublayer an indication that the 5GSM message was not forwarded due to unexpected cause along with the 5GSM message from the Payload container IE of the DL NAS TRANSPORT message;
- h) "UE policy container", the UE policy container in the Payload container IE is handled in the UE policy delivery procedures specified in Annex D;
- i) "UE parameters update transparent container" and if the Payload container IE
- 1) successfully passes the integrity check (see 3GPP TS 33.501 [24]), the ME shall store the received UE parameter update counter as specified in annex C and proceed as follows:
- i) if the UE parameters update list includes a UE parameters update data set with UE parameters update data set type indicating "Routing indicator update data",
- A) the ME shall behave as if an SMS is received with protocol identifier set to SIM data download, data coding scheme set to class 2 message and SMS payload as secured packet contents of UE parameters update transparent container IE. The SMS payload is forwarded to UICC as specified in 3GPP TS 23.040 [4A];

- B) if the ACK bit of the UE parameters update header in the UE parameters update transparent container is set to "acknowledgment requested" and if the ME receives status bytes from the UICC indicating that the UICC has received the secured packet successfully, the ME shall send an acknowledgement in the Payload container IE of an UL NAS TRANSPORT message with Payload type IE set to "UE parameters update transparent container" as specified in subclause 5.4.5.2.2; and
- C) if the ME receives a REFRESH command from the UICC as specified in 3GPP TS 31.111 [22A] and if the REG bit of the UE parameters update header in the UE parameters update transparent container IE is set to "re-registration requested", and:
- C1) the UE is registered over 3GPP access, then the UE shall wait until the emergency services over 3GPP access, if any, are completed, enter 5GMM-IDLE mode over 3GPP access or 5GMM-CONNECTED mode with RRC inactive indication, perform a de-registration procedure, and then delete its 5G-GUTI if the UE is registered to different PLMN or SNPN on non-3GPP access or the UE is not registered over non-3GPP access, or wait until the de-registration procedure over non-3GPP access specified in case C2) or C3) is completed before deleting its 5G-GUTI if the UE is registered to same PLMN or SNPN on non-3GPP access, and then initiate a registration procedure for initial registration as specified in subclause 5.5.1.2;
 - C2) the UE is registered over non-3GPP access and does not have emergency services ongoing over non-3GPP access, then the UE shall locally release the N1 NAS signalling connection and enter 5GMM-IDLE mode over non-3GPP access, perform a de-registration procedure, and then delete its 5G-GUTI if the UE is registered to different PLMN or SNPN on 3GPP access or the UE is not registered over 3GPP access, or wait until the de-registration procedure over 3GPP access specified in case C1) is completed before deleting its 5G-GUTI if the UE is registered to same PLMN or SNPN on 3GPP access, and then initiate a registration procedure for initial registration as specified in subclause 5.5.1.2; and
 - C3) the UE is registered over non-3GPP access and has an emergency services ongoing over non-3GPP access, then the UE shall wait until the emergency services are completed before locally releasing the N1 NAS signalling connection and enter 5GMM-IDLE mode over non-3GPP access, perform a de-registration procedure, and then delete its 5G-GUTI if the UE is registered to different PLMN or SNPN on 3GPP access or if the UE is not registered over 3GPP access, or wait until the de-registration procedure over 3GPP access specified in case C1) is completed before deleting its 5G-GUTI if the UE is registered to same PLMN or SNPN on 3GPP access, and then initiate a registration procedure for initial registration as specified in subclause 5.5.1.2.
- ii) if the UE parameters update list includes a UE parameters update data set with UE parameters update data set type indicating "Default configured NSSAI update data",
- A) if the ACK bit of the UE parameters update header in the UE parameters update transparent container is set to "acknowledgment requested" and if the UE parameters update list does not include a UE parameters update data set with UE parameters update data set type indicating "Routing indicator update data", the ME shall send an acknowledgement in the Payload container IE of an UL NAS TRANSPORT message with Payload type IE set to "UE parameters update transparent container" as specified in subclause 5.4.5.2.2
 - B) the ME shall replace the stored default configured NSSAI with the default configured NSSAI included in the default configured NSSAI update data. In case of SNPN, the ME shall replace the stored default configured NSSAI associated with the selected entry of the "list of subscriber data" or the PLMN subscription with the default configured NSSAI included in the default configured NSSAI update data; and
 - C) if the REG bit of the UE parameters update header in the UE parameters update transparent container is set to "re-registration requested" and the UE parameters update list does not include a UE parameters update data set with UE parameters update data set type indicating "Routing indicator update data", the UE shall wait until it enters 5GMM-IDLE mode and then the UE shall initiate a registration procedure for mobility registration update as specified in subclause 5.5.1.3.

if the UE parameters update list does not include a UE parameters update data set with UE parameters update data set type indicating "Routing indicator update data", the UE used the old default configured NSSAI to create the requested NSSAI in a REGISTRATION REQUEST message, because the UE does not have a configured NSSAI for the current PLMN or SNPN, and the UE has an stored allowed NSSAI for the current PLMN or SNPN which contains one or more S-NSSAIs that are not included in

the new default configured NSSAI, the UE shall wait until it enters 5GMM-IDLE mode and then the UE shall initiate a registration procedure for mobility and periodic registration update as specified in subclause 5.5.1.3; and

- iii) if the UE parameters update list includes a UE parameters update data set with UE parameters update data set type indicating "Disaster roaming information update data",
 - A) if the ACK bit of the UE parameters update header in the UE parameters update transparent container is set to "acknowledgment requested" and if the UE parameters update list does not include a UE parameters update data set with UE parameters update data set type indicating "Routing indicator update data" or a UE parameters update data set with UE parameters update data set type indicating "Default configured NSSAI update data", the ME shall send an acknowledgement in the Payload container IE of an UL NAS TRANSPORT message with Payload type IE set to "UE parameters update transparent container" as specified in subclause 5.4.5.2.2;
 - B) the UE shall delete the indication of whether disaster roaming is enabled in the UE stored in the ME, if any, and store the indication of whether disaster roaming is enabled in the UE included in the disaster roaming information update data in the ME;
 - C) the UE shall delete the indication of applicability of "lists of PLMN(s) to be used in disaster condition" provided by a VPLMN' stored in the ME, if any, and store the indication of 'applicability of "lists of PLMN(s) to be used in disaster condition" provided by a VPLMN' included in the disaster roaming information update data in the ME; and
 - D) if the REG bit of the UE parameters update header in the UE parameters update transparent container is set to "re-registration requested" and the UE parameters update list does not include a UE parameters update data set with UE parameters update data set type indicating "Routing indicator update data", the UE shall wait until it enters 5GMM-IDLE mode and then the UE shall initiate a registration procedure for mobility registration update as specified in subclause 5.5.1.3.
- iv) if the UE parameters update list includes a UE parameters update data set with UE parameters update data set type indicating "ME routing indicator update data":
 - A) if the ACK bit of the UE parameters update header in the UE parameters update transparent container is set to "acknowledgment requested" and the UE parameters update list does not include a UE parameters update data set with UE parameters update data set type indicating "Default configured NSSAI update data", the ME shall send an acknowledgement in the Payload container IE of an UL NAS TRANSPORT message with Payload type IE set to "UE parameters update transparent container" as specified in subclause 5.4.5.2.2;
 - B) the UE shall set or replace the routing indicator of the selected entry of the "list of subscriber data" with the routing indicator included in the ME routing indicator update data; and
 - C) if the REG bit of the UE parameters update header in the UE parameters update transparent container IE is set to "re-registration requested", and:
 - C1) the UE is registered over 3GPP access and is not registered over non-3GPP access, then the UE shall wait until the emergency services over 3GPP access, if any, are completed, enter 5GMM-IDLE mode over 3GPP access or 5GMM-CONNECTED mode with RRC inactive indication, perform a de-registration procedure, delete its 5G-GUTI, and then initiate a registration procedure for initial registration as specified in subclause 5.5.1.2;
 - C2) the UE is registered over non-3GPP access and is not registered over 3GPP access, then the UE shall locally release the N1 NAS signalling connection and enter 5GMM-IDLE mode over non-3GPP access, perform a de-registration procedure, delete its 5G-GUTI, and then initiate a registration procedure for initial registration as specified in subclause 5.5.1.2; or
 - C3) the UE is registered over 3GPP access and non-3GPP access to same SNPN, then the UE shall wait until the emergency services over 3GPP access, if any, are completed, enter 5GMM-IDLE mode over 3GPP access or 5GMM-CONNECTED mode with RRC inactive indication over 3GPP access, perform a de-registration procedure over 3GPP access, locally release the N1 NAS signalling connection and enter 5GMM-IDLE mode over non-3GPP access, perform a de-registration procedure over non-3GPP access, delete its 5G-GUTI and then initiate a registration procedure for initial registration as specified in subclause 5.5.1.2.

- 2) does not successfully pass the integrity check (see 3GPP TS 33.501 [24]) then the UE shall discard the content of the payload container IE;
- j) "Location services message container" and the 5GMM cause IE is not included in the DL NAS TRANSPORT message, the UE shall forward the payload container type, the content of the Payload container IE and the routing information in the Additional information IE if included to the upper layer location services application;
- k) "CIoT user data container" and the 5GMM cause IE is not included in the DL NAS TRANSPORT message, the UE shall forward the content of the Payload container IE and the PDU session ID to the 5GSM sublayer;
- l) "CIoT user data container" and:
 - 1) the 5GMM cause IE is set to the 5GMM cause #22 "Congestion", the UE passes to the 5GSM sublayer an indication that the CIoT user data was not forwarded due to DNN based congestion control along with the CIoT user data from the Payload container IE of the DL NAS TRANSPORT message, and the time value from the Back-off timer value IE;
 - 2) the 5GMM cause IE is set to the 5GMM cause #67 "insufficient resources for specific slice and DNN", the UE passes to the 5GSM sublayer an indication that the CIoT user data was not forwarded due to S-NSSAI and DNN based congestion control along with the CIoT user data from the Payload container IE of the DL NAS TRANSPORT message, and the time value from the Back-off timer value IE;
 - 3) the 5GMM cause IE is set to the 5GMM cause #69 "insufficient resources for specific slice", the UE passes to the 5GSM sublayer an indication that the CIoT user data was not forwarded due to S-NSSAI only based congestion control along with the CIoT user data from the Payload container IE of the DL NAS TRANSPORT message, and the time value from the Back-off timer value IE; or
 - 4) the 5GMM cause IE is set to the 5GMM cause #90 "payload was not forwarded", the UE passes to the 5GSM sublayer an indication that the user data container was not forwarded due to routing failure along with the user data container from the Payload container IE and the PDU session ID from the PDU session ID IE of the DL NAS TRANSPORT message;
- m) "service-level-AA container", the UE shall forward the content of the Payload container IE to the upper layers;
- m1) "Event notification", the UE shall forward the received event notification indicator(s) to the upper layers (see 3GPP TS 23.216 [6A] and 3GPP TS 24.237 [14AA] for the "SRVCC handover cancelled, IMS session re-establishment required" indicator);
- m2) "UPP-CMI container" and the 5GMM cause IE is not included in the DL NAS TRANSPORT message, the UE shall forward the payload container type, the content of the Payload container IE and the routing information included in the Additional information IE to the upper layer location services application for user plane connection management for user plane positioning;

NOTE 2: The user plane connection establishment for user plane positioning connection management is specified in 3GPP TS 24.572 [64].

- m3) "UPP-CMI container" and the 5GMM cause IE is set to the 5GMM cause #94 "User plane positioning not authorized", the UE passes to the upper layer location services application an indication that user plane positioning is not authorized by the network; or
- n) "Multiple payloads", the UE shall first decode the content of the Payload container IE (see subclause 9.11.3.39) to obtain the number of payload container entries and for each payload container entry, the UE shall:
 - 1) decode the payload container type field;
 - 2) decode the optional IE fields and the payload container contents field in the payload container entry; and
 - 3) handle the content of each payload container entry the same as the content of the Payload container IE and the associated optional IEs as specified in bullets a) to m3) above according to the payload container type field.

5.4.6 5GMM status procedure

5.4.6.1 General

The purpose of the 5GMM status procedure is to report at any time in the 5GMM STATUS message certain error conditions detected upon receipt of 5GMM protocol data in the AMF or in the UE. The 5GMM STATUS message can be sent by both the AMF and the UE (see example in figure 5.4.6.1).

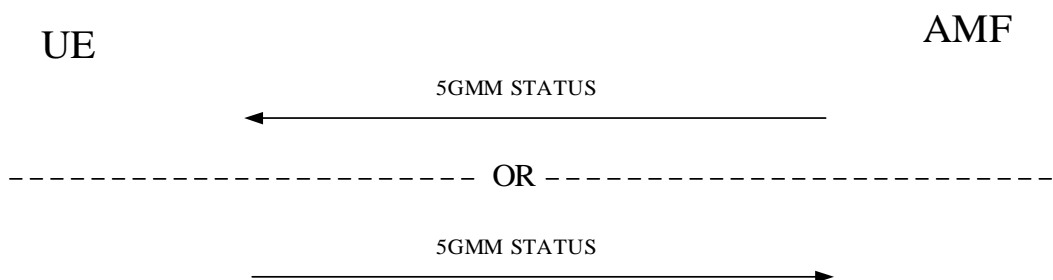

Figure 5.4.6.1: 5GMM status procedure

5.4.6.2 5GMM status received in the UE

On receipt of a 5GMM STATUS message, no state transition and no specific action shall be taken as seen from the radio interface, i.e. local actions are possible. The local actions to be taken by UE on receipt of a 5GMM STATUS message are implementation dependent.

5.4.6.3 5GMM status received in the network

On receipt of a 5GMM STATUS message in the AMF, no state transition and no specific action shall be taken as seen from the radio interface, i.e. local actions are possible. The local actions to be taken by the AMF on receipt of a 5GMM STATUS message are implementation dependent.

5.4.7 Network slice-specific authentication and authorization procedure

5.4.7.1 General

The purpose of the network slice-specific authentication and authorization procedure is to enable the authentication, authorization and accounting server (AAA-S) via the Network Slice Specific and SNPN Authentication and Authorization Function (NSSAAF) to (re-)authenticate or (re-)authorize the upper layers of the UE.

The network slice-specific authentication and authorization procedure can be invoked for a UE supporting network slice-specific authentication and authorization procedure and for a HPLMN S-NSSAI or an SNPN S-NSSAI (see subclauses 5.15.10 and 5.30.2.9 in 3GPP TS 23.501 [8] and subclause 4.2.9.2 of 3GPP TS 23.502 [9]).

The network (re-)authenticates the UE using the EAP as specified in IETF RFC 3748 [34].

EAP has defined four types of EAP messages:

- a) an EAP-request message;
- b) an EAP-response message;
- c) an EAP-success message; and
- d) an EAP-failure message.

The EAP-request message is transported from the network to the UE using the NETWORK SLICE-SPECIFIC AUTHENTICATION COMMAND message of the network slice-specific EAP message reliable transport procedure.

The EAP-response message to the EAP-request message is transported from the UE to the network using the NETWORK SLICE-SPECIFIC AUTHENTICATION COMPLETE message of the network slice-specific EAP message reliable transport procedure.

If the (re-)authentication of the UE completes successfully or unsuccessfully, the EAP-success message or the EAP-failure message, respectively, is transported from the network to the UE using the NETWORK SLICE-SPECIFIC AUTHENTICATION RESULT message of the network slice-specific result message transport procedure.

There can be several rounds of exchange of an EAP-request message and a related EAP-response message for the AAA-S via the NSSAAF to complete the (re-)authentication and (re-)authorization of the request for an S-NSSAI (see example in figure 5.4.7.1.1).

The AMF shall set the authenticator retransmission timer specified in subclause 4.3 of IETF RFC 3748 [34] to infinite value.

NOTE: The network slice-specific authentication and authorization procedure provides a reliable transport of EAP messages and therefore retransmissions at the EAP layer of the AMF do not occur.

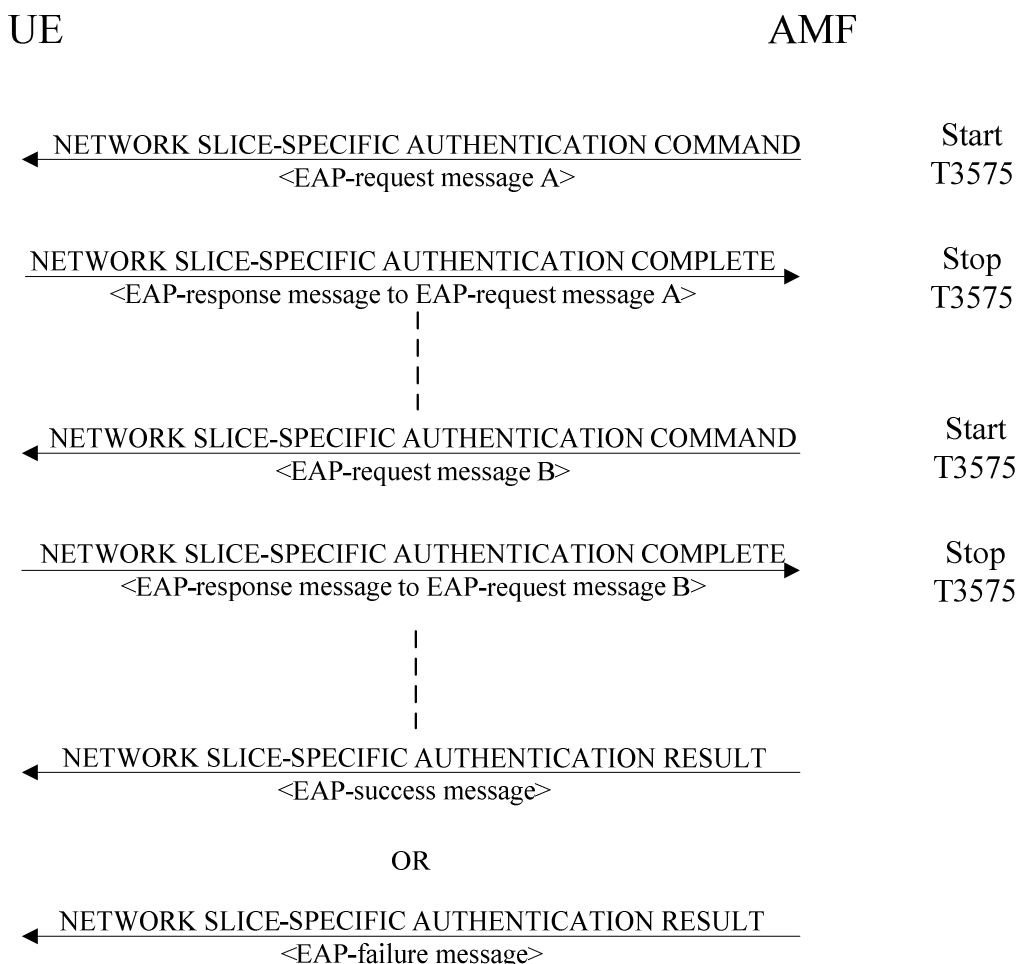

Figure 5.4.7.1.1: Network slice-specific authentication and authorization procedure

5.4.7.2 Network slice-specific EAP message reliable transport procedure

5.4.7.2.1 Network slice-specific EAP message reliable transport procedure initiation

In order to initiate the network slice-specific EAP message reliable transport procedure, the AMF shall create a NETWORK SLICE-SPECIFIC AUTHENTICATION COMMAND message.

The AMF shall set the EAP message IE of the NETWORK SLICE-SPECIFIC AUTHENTICATION COMMAND message to the EAP-request message which is generated by the AMF or provided by the AAA-S via the NSSAAF.

The AMF shall set the S-NSSAI IE of the NETWORK SLICE-SPECIFIC AUTHENTICATION COMMAND message to the HPLMN S-NSSAI or the SNPN S-NSSAI to which the EAP-request message is related.

The AMF shall send the NETWORK SLICE-SPECIFIC AUTHENTICATION COMMAND message and start timer T3575 per S-NSSAI (see example in figure 5.4.7.1.1).

Upon receipt of a NETWORK SLICE-SPECIFIC AUTHENTICATION COMMAND message, the UE shall stop timer T3346 if running. The UE shall pass:

- a) the EAP-request message received in the EAP message IE; and
- b) the HPLMN S-NSSAI or the SNPN S-NSSAI in the S-NSSAI IE;

to the upper layers. Apart from this action, the network slice-specific authentication and authorization procedure is transparent to the 5GMM layer of the UE.

5.4.7.2.2 Network slice-specific EAP message reliable transport procedure accepted by the UE

When the upper layers provide an EAP-response message associated with the HPLMN S-NSSAI or the SNPN S-NSSAI, the UE shall create a NETWORK SLICE-SPECIFIC AUTHENTICATION COMPLETE message.

The UE shall set the EAP message IE of the NETWORK SLICE-SPECIFIC AUTHENTICATION COMPLETE message to the EAP-response message.

The UE shall set the S-NSSAI IE of the NETWORK SLICE-SPECIFIC AUTHENTICATION COMPLETE message to the HPLMN S-NSSAI or the SNPN S-NSSAI associated with the EAP-response message.

The UE shall send the NETWORK SLICE-SPECIFIC AUTHENTICATION COMPLETE message. Apart from this action, the network slice-specific authentication and authorization procedure is transparent to the 5GMM layer of the UE.

Upon receipt of a NETWORK SLICE-SPECIFIC AUTHENTICATION COMPLETE message, the AMF shall stop timer T3575 and:

- a) pass the EAP-response message received in the EAP message IE of the NETWORK SLICE-SPECIFIC AUTHENTICATION COMPLETE message associated with the HPLMN S-NSSAI or the SNPN S-NSSAI in the S-NSSAI IE to the upper layers; or
- b) provide the EAP-response message received in the EAP message IE of the NETWORK SLICE-SPECIFIC AUTHENTICATION COMPLETE message associated with the HPLMN S-NSSAI or the SNPN S-NSSAI in the S-NSSAI IE to the AAA-S via the NSSAAF.

5.4.7.2.3 Abnormal cases on the network side

The following abnormal cases can be identified:

- a) T3575 expiry

The AMF shall, on the first expiry of the timer T3575, retransmit the NETWORK SLICE-SPECIFIC AUTHENTICATION COMMAND message and shall reset and start timer T3575. This retransmission is repeated four times, i.e. on the fifth expiry of timer T3575, the AMF shall abort the network slice-specific authentication and authorization procedure for the S-NSSAI. The AMF shall consider that the network slice-specific authentication and authorization procedure for the S-NSSAI is completed as a failure.

b) Lower layers indication of non-delivered NAS PDU due to handover

If the NETWORK SLICE-SPECIFIC AUTHENTICATION COMMAND message could not be delivered due to an intra AMF handover and the target TAI is included in the TAI list, then upon successful completion of the intra AMF handover the AMF shall retransmit the NETWORK SLICE-SPECIFIC AUTHENTICATION COMMAND message. If a failure of handover procedure is reported by the lower layer and the N1 NAS signalling connection exists, the AMF shall retransmit the NETWORK SLICE-SPECIFIC AUTHENTICATION COMMAND message.

c) Network slice-specific authentication and authorization procedure and de-registration procedure collision

If the network receives a DEREGISTRATION REQUEST message before the ongoing network slice-specific authentication and authorization procedure has been completed and the access type included in the DEREGISTRATION REQUEST message is the same as the one for which the network slice-specific authentication and authorization procedure is ongoing, the network shall abort the network slice-specific authentication and authorization procedure and shall progress the UE-initiated de-registration procedure. The AMF may initiate the network slice-specific authentication and authorization procedure for the S-NSSAI which is completed as a failure, if available. If the access type included in the DEREGISTRATION REQUEST message is different from the one for which the network slice-specific authentication and authorization procedure is ongoing, the network shall proceed with both procedures.

d) Network slice-specific authentication and authorization procedure and service request procedure collision

If the network receives a SERVICE REQUEST message or a CONTROL PLANE SERVICE REQUEST message before the ongoing network slice-specific authentication and authorization procedure has been completed and the SERVICE REQUEST message or the CONTROL PLANE SERVICE REQUEST message includes the UE request type IE with the Request type value set to "NAS signalling connection release", the network shall abort the network slice-specific authentication and authorization procedure and shall progress the service request procedure.

If the network receives a SERVICE REQUEST message or a CONTROL PLANE SERVICE REQUEST message before the ongoing network slice-specific authentication and authorization procedure has been completed and the SERVICE REQUEST message or the CONTROL PLANE SERVICE REQUEST message does not include UE request type IE with the Request type value set to "NAS signalling connection release", both procedures shall be progressed.

e) Network slice-specific authentication and authorization procedure and registration procedure for mobility and periodic registration update collision

If the network receives a REGISTRATION REQUEST message before the ongoing network slice-specific authentication and authorization procedure has been completed, and the REGISTRATION REQUEST message includes the Unavailability information IE without start of the unavailability period or the request type IE with the Request type value set to "NAS signalling connection release", the network shall abort the network slice-specific authentication and authorization procedure and shall progress the registration procedure for mobility and periodic registration update procedure.

If the network receives a REGISTRATION REQUEST message before the ongoing network slice-specific authentication and authorization procedure has been completed, and the REGISTRATION REQUEST message includes neither the Unavailability information IE nor the request type IE with the Request type value set to "NAS signalling connection release", both procedures shall be progressed.

5.4.7.2.4 Abnormal cases in the UE

The following abnormal cases can be identified:

a) Transmission failure of the NETWORK SLICE-SPECIFIC AUTHENTICATION COMPLETE message with change in the current TAI

If the current TAI is not in the TAI list, the network slice-specific authentication and authorization procedure shall be aborted and:

- if the UE is in 5GMM-REGISTERED state, a registration procedure for mobility and periodic registration update indicating "mobility registration updating" in the 5GS registration type IE of the REGISTRATION REQUEST message shall be initiated; and

- otherwise a registration procedure for initial registration shall be initiated.
- b) Transmission failure of NETWORK SLICE-SPECIFIC AUTHENTICATION COMPLETE message indication without change in the current TAI

It is up to the UE implementation how to re-run the ongoing procedure that triggered the network slice-specific authentication and authorization procedure.

- c) Network slice-specific authentication and authorization procedure and de-registration procedure collision

If the UE receives NETWORK SLICE-SPECIFIC AUTHENTICATION COMMAND message after sending a DEREGISTRATION REQUEST message and the access type included in the DEREGISTRATION REQUEST message is the same as the access in which the NETWORK SLICE-SPECIFIC AUTHENTICATION COMMAND message is received, then the UE shall ignore the NETWORK SLICE-SPECIFIC AUTHENTICATION COMMAND message and proceed with the de-registration procedure. Otherwise, the UE shall proceed with both procedures.

- d) Network slice-specific authentication and authorization procedure and service request procedure collision

If the SERVICE REQUEST message or the CONTROL PLANE SERVICE REQUEST message includes the UE request type IE with the Request type value set to "NAS signalling connection release" and the UE receives a NETWORK SLICE-SPECIFIC AUTHENTICATION COMMAND message before the ongoing service request procedure has been completed, the UE shall ignore the NETWORK SLICE-SPECIFIC AUTHENTICATION COMMAND message and proceed with the service request procedure.

If the SERVICE REQUEST message or the CONTROL PLANE SERVICE REQUEST message does not include the UE request type IE with the Request type value set to "NAS signalling connection release" and the UE receives a NETWORK SLICE-SPECIFIC AUTHENTICATION COMMAND message before the ongoing service request procedure has been completed, the UE shall proceed with both procedures.

- e) Network slice-specific authentication and authorization procedure and registration procedure for mobility and periodic registration update collision

If the REGISTRATION REQUEST message includes the Unavailability information IE without start of the unavailability period and the UE receives a NETWORK SLICE-SPECIFIC AUTHENTICATION COMMAND message before the ongoing registration procedure for mobility and periodic registration update has been completed, the UE shall ignore the NETWORK SLICE-SPECIFIC AUTHENTICATION COMMAND message and proceed with the registration procedure for mobility and periodic registration update procedure.

If the REGISTRATION REQUEST message does not include the Unavailability information IE and the UE receives a NETWORK SLICE-SPECIFIC AUTHENTICATION COMMAND message before the ongoing registration procedure for mobility and periodic registration update has been completed, the UE shall proceed with both procedures.

5.4.7.3 Network slice-specific EAP result message transport procedure

5.4.7.3.1 Network slice-specific EAP result message transport procedure initiation

In order to initiate the network slice-specific EAP result message transport procedure, the AMF shall create a NETWORK SLICE-SPECIFIC AUTHENTICATION RESULT message.

The AMF shall set the EAP message IE of the NETWORK SLICE-SPECIFIC AUTHENTICATION RESULT message to the EAP-success or EAP-failure message provided by the AAA-S via the NSSAAF.

The AMF shall set the S-NSSAI IE of the NETWORK SLICE-SPECIFIC AUTHENTICATION RESULT message to the HPLMN S-NSSAI or the SNPN S-NSSAI to which the EAP-success or EAP-failure message is related.

The AMF shall send the NETWORK SLICE-SPECIFIC AUTHENTICATION RESULT message. The AMF shall retain the authentication result for the UE and the HPLMN S-NSSAI or the SNPN S-NSSAI while the UE is registered to the PLMN (see subclause 5.15.10 in 3GPP TS 23.501 [8]).

Upon receipt of a NETWORK SLICE-SPECIFIC AUTHENTICATION RESULT message, the UE shall pass:

- a) the EAP-success or EAP-failure message received in the EAP message IE; and

- b) the HPLMN S-NSSAI or the SNPN S-NSSAI in the S-NSSAI IE;

to the upper layers. Apart from this action, the network slice-specific authentication and authorization procedure is transparent to the 5GMM layer of the UE.

5.5 5GMM specific procedures

5.5.1 Registration procedure

5.5.1.1 General

The registration procedure is always initiated by the UE and used for initial registration as specified in subclause 5.5.1.2.2 or mobility and periodic registration update as specified in subclause 5.5.1.3.2.

When the UE needs to initiate registration over both 3GPP access and non-3GPP access in the same PLMN (e.g. the 3GPP access and the selected N3IWF are located in the same PLMN), the UE:

- a) in 5GMM-REGISTERED-INITIATED over 3GPP access shall not initiate registration over non-3GPP access; or
- b) in 5GMM-REGISTERED-INITIATED over non-3GPP access shall not initiate registration over 3GPP access.

NOTE 1: To which access (i.e. 3GPP access or non-3GPP access) the UE initiates registration first is up to UE implementation.

When the UE is registered with a PLMN over a non-3GPP access, the AMF and the UE maintain:

- a) registration state and state machine over non-3GPP access;
- b) 5G NAS security context;
- c) 5G-GUTI;
- d) registration area for non-3GPP access, which is associated with a single TAI; and
- e) non-3GPP de-registration timer in the UE and non-3GPP implicit de-registration timer in the AMF.

A registration attempt counter is used to limit the number of subsequently rejected registration attempts. The registration attempt counter shall be incremented as specified in subclause 5.5.1.2.7 or subclause 5.5.1.3.7. Depending on the value of the registration attempt counter, specific actions shall be performed. The registration attempt counter shall be reset when:

- the UE is powered on;
- a USIM is inserted;
- a registration procedure is successfully completed;
- an EPS attach, combined EPS attach procedure, a normal or periodic tracking area updating or a combined tracking area updating procedure is successfully completed in S1 mode and the UE is operating in single-registration mode. In this case, the UE shall reset the registration attempt counter for 3GPP access;

NOTE 2: The registration attempt counter for non-3GPP access is not impacted by the EPS attach and the combined EPS attach procedure.

- a registration procedure is rejected with cause #11, #12, #13, #15, #27, #31, #62, #72, #73, #74, #75, #76, #77 or #78;
- a registration procedure is rejected with cause #3, #6 or #7, the REGISTRATION REJECT message is received without integrity protection and the counter for "SIM/USIM considered invalid for GPRS services" events has a value less than a UE implementation-specific maximum value.
- a network initiated de-registration procedure is completed with cause #11, #12, #13, #15, #27; #62, #72, #74, #75, #76, #77 or #78; or

- a new PLMN or SNPN is selected.

Additionally, the registration attempt counter shall be reset when the UE is in substate 5GMM-DEREGISTERED.ATTEMPTING-REGISTRATION or 5GMM-REGISTERED.ATTEMPTING-REGISTRATION-UPDATE, and:

- the current TAI is changed;
- timer T3502 expires; or
- timer T3346 is started.

When the registration attempt counter is reset, the UE shall stop timer T3519 if running, and delete any stored SUCI.

The lower layers indicate to NAS whether the network supports emergency services for the UE in limited service state (see 3GPP TS 38.331 [30]). This information is taken into account when deciding whether to initiate an initial registration for emergency services.

5.5.1.2 Registration procedure for initial registration

5.5.1.2.1 General

This procedure can be used by a UE for initial registration for 5GS services.

When the UE initiates the registration procedure for initial registration, the UE shall indicate "initial registration" in the 5GS registration type IE. When the UE initiates the registration procedure for emergency services, the UE shall indicate "emergency registration" in the 5GS registration type IE. When the UE initiates the initial registration for onboarding services in SNPN, the UE shall indicate "SNPN onboarding registration" in the 5GS registration type IE. When the UE initiates the initial registration procedure for disaster roaming services, the UE shall indicate "disaster roaming initial registration" in the 5GS registration type IE.

If the MUSIM UE initiates the registration procedure for initial registration and indicates "emergency registration" in the 5GS registration type IE in the REGISTRATION REQUEST message, the network shall not indicate the support of:

- the N1 NAS signalling connection release;
- the paging indication for voice services;
- the reject paging request; or
- the paging restriction;

in the REGISTRATION ACCEPT message.

5.5.1.2.2 Initial registration initiation

The UE in state 5GMM-DEREGISTERED shall initiate the registration procedure for initial registration by sending a REGISTRATION REQUEST message to the AMF,

- a) when the UE performs initial registration for 5GS services;
- b) when the UE performs initial registration for emergency services;
- c) when the UE performs initial registration for SMS over NAS;
- d) when the UE moves from GERAN to NG-RAN coverage or the UE moves from a UTRAN to NG-RAN coverage and the following applies:
 - 1) the UE initiated a GPRS attach or routing area updating procedure while in A/Gb mode or Iu mode; or
 - 2) the UE has performed 5G-SRVCC from NG-RAN to UTRAN as specified in 3GPP TS 23.216 [6A], and since then the UE did not perform a successful EPS attach or tracking area updating procedure in S1 mode or registration procedure in N1 mode;

- e) when the UE performs initial registration for onboarding services in SNPN;
- f) when the UE performs initial registration for disaster roaming services; and
- g) when the UE performs initial registration to come out of unavailability period and resume normal services;

with the following clarifications to initial registration for emergency services:

- a) the UE shall not initiate an initial registration for emergency services over the current access, if the UE is already registered for emergency services over the non-current access, unless the initial registration has to be initiated to perform handover of an existing emergency PDU session from the non-current access to the current access; and

NOTE 1: Transfer of an existing emergency PDU session between 3GPP access and non-3GPP access is needed e.g. if the UE determines that the current access is no longer available.

- b) the UE can only initiate an initial registration for emergency services over non-3GPP access if it cannot register for emergency services over 3GPP access.

The UE initiates the registration procedure for initial registration by sending a REGISTRATION REQUEST message to the AMF, starting timer T3510. If timer T3502 is currently running, the UE shall stop timer T3502. If timer T3511 is currently running, the UE shall stop timer T3511.

During initial registration the UE handles the 5GS mobile identity IE in the following order:

- a) if:
 - 1) the UE:
 - i) was previously registered in S1 mode before entering state EMM-DEREGISTERED; and
 - ii) has received an "interworking without N26 interface not supported" indication from the network; and
 - 2) EPS security context and a valid native 4G-GUTI are available;

then the UE shall create a 5G-GUTI mapped from the valid native 4G-GUTI as specified in 3GPP TS 23.003 [4] and indicate the mapped 5G-GUTI in the 5GS mobile identity IE. The UE shall include the UE status IE with the EMM registration status set to "UE is not in EMM-REGISTERED state" and shall include an ATTACH REQUEST message as specified in 3GPP TS 24.301 [15] in the EPS NAS message container IE.

Additionally, if the UE holds a valid 5G-GUTI, the UE shall include the 5G-GUTI in the Additional GUTI IE in the REGISTRATION REQUEST message in the following order:

- 1) a valid 5G-GUTI that was previously assigned by the same PLMN with which the UE is performing the registration, if available;
 - 2) a valid 5G-GUTI that was previously assigned by an equivalent PLMN, if available; and
 - 3) a valid 5G-GUTI that was previously assigned by any other PLMN, if available;
- b) if:
 - 1) the UE is registering with a PLMN and the UE holds a valid 5G-GUTI that was previously assigned, over 3GPP access or non-3GPP access, by the same PLMN with which the UE is performing the registration, the UE shall indicate the 5G-GUTI in the 5GS mobile identity IE; or
 - 2) the UE is registering with a SNPN, the UE holds a valid 5G-GUTI that was previously assigned, over 3GPP access or non-3GPP access, by the same SNPN with which the UE is performing the registration, and the UE is not initiating the initial registration for onboarding services in SNPN, the UE shall indicate the 5G-GUTI in the 5GS mobile identity IE;
 - c) if:
 - 1) the UE is registering with a PLMN and the UE holds a valid 5G-GUTI that was previously assigned, over 3GPP access or non-3GPP access, by an equivalent PLMN, the UE shall indicate the 5G-GUTI in the 5GS mobile identity IE; or

- 2) the UE is registering with an SNPN, the UE holds a valid 5G-GUTI that was previously assigned, over 3GPP access or non-3GPP access, by an equivalent SNPN identified by a globally unique SNPN identity, and the UE is not initiating the initial registration for onboarding services in SNPN, the UE shall indicate the 5G-GUTI in the 5GS mobile identity IE and shall additionally include the NID of the equivalent SNPN in the NID IE;
- d) if:
- 1) the UE is registering with a PLMN and the UE holds a valid 5G-GUTI that was previously assigned, over 3GPP access or non-3GPP access, by any other PLMN, the UE shall indicate the 5G-GUTI in the 5GS mobile identity IE; or
 - 2) the UE is registering with an SNPN, the UE holds a valid 5G-GUTI that was previously assigned, over 3GPP access or non-3GPP access, by any other SNPN identified by a globally unique SNPN identity, and the UE is not initiating the initial registration for onboarding services in SNPN, the UE shall indicate the 5G-GUTI in the 5GS mobile identity IE and shall additionally include the NID of the other SNPN in the NID IE;
- e) if a SUCI other than an onboarding SUCI is available, and the UE is not initiating the initial registration for onboarding services in SNPN, the UE shall include the SUCI other than an onboarding SUCI in the 5GS mobile identity IE;
- f) if the UE does not hold a valid 5G-GUTI or SUCI other than an onboarding SUCI, and is initiating the initial registration for emergency services, the PEI shall be included in the 5GS mobile identity IE; and
- g) if the UE is initiating the initial registration for onboarding services in SNPN, an onboarding SUCI shall be included in the 5GS mobile identity IE.

NOTE 2: The AMF in ON-SNPN uses the onboarding SUCI as specified in 3GPP TS 23.501 [8].

If the SUCI is included in the 5GS mobile identity IE and the timer T3519 is not running, the UE shall start timer T3519 and store the value of the SUCI sent in the REGISTRATION REQUEST message. The UE shall include the stored SUCI in the REGISTRATION REQUEST message while timer T3519 is running.

If the UE is operating in the dual-registration mode and it is in EMM state EMM-REGISTERED, the UE shall include the UE status IE with the EMM registration status set to "UE is in EMM-REGISTERED state".

NOTE 3: Inclusion of the UE status IE with this setting corresponds to the indication that the UE is "moving from EPC" as specified in 3GPP TS 23.502 [9].

NOTE 4: The value of the 5GMM registration status included by the UE in the UE status IE is not used by the AMF.

If the last visited registered TAI is available, the UE shall include the last visited registered TAI in the REGISTRATION REQUEST message.

NOTE 5: The AMF can use the last visited registered TAI included in the REGISTRATION REQUEST message, if available, in the procedure of slice-based N3IWF selection as specified in 3GPP TS 23.502 [9] when the registration procedure is performed over non-3gpp access.

If the UE requests the use of SMS over NAS, the UE shall include the 5GS update type IE in the REGISTRATION REQUEST message with the SMS requested bit set to "SMS over NAS supported". When the 5GS update type IE is included in the REGISTRATION REQUEST for reasons other than requesting the use of SMS over NAS, and the UE does not need to register for SMS over NAS, the UE shall set the SMS requested bit of the 5GS update type IE to "SMS over NAS not supported" in the REGISTRATION REQUEST message.

If the UE supports MICO mode and requests the use of MICO mode, then the UE shall include the MICO indication IE in the REGISTRATION REQUEST message. If the UE requests to use an active time value, it shall include the active time value in the T3324 IE in the REGISTRATION REQUEST message. If the UE includes the T3324 IE, it may also request a particular T3512 value by including the Requested T3512 IE in the REGISTRATION REQUEST message. Additionally, if the UE supports strictly periodic registration timer, the UE shall set the Strictly Periodic Registration Timer Indication bit of the MICO indication IE in the REGISTRATION REQUEST message to "strictly periodic registration timer supported".

If the UE needs to use the UE specific DRX parameters, the UE shall include the Requested DRX parameters IE in the REGISTRATION REQUEST message.

If the UE is in NB-N1 mode and if the UE needs to use the UE specific DRX parameters for NB-N1 mode, the UE shall include the Requested NB-N1 mode DRX parameters IE in the REGISTRATION REQUEST message.

If the UE supports eDRX and requests the use of eDRX, the UE shall include the Requested extended DRX parameters IE in the REGISTRATION REQUEST message.

If the UE needs to request LADN information for specific LADN DNN(s) or indicates a request for LADN information as specified in 3GPP TS 23.501 [8], the UE shall include the LADN indication IE in the REGISTRATION REQUEST message and:

- request specific LADN DNNs by including a LADN DNN value in the LADN indication IE for each LADN DNN for which the UE requests LADN information; or
- to indicate a request for LADN information by not including any LADN DNN value in the LADN indication IE.

The UE shall include the requested NSSAI containing the S-NSSAI(s) corresponding to the slice(s) to which the UE intends to register with and shall include the mapped S-NSSAI(s) for the requested NSSAI, if available, in the REGISTRATION REQUEST message. If the UE has allowed NSSAI or configured NSSAI or both for the current PLMN or SNPN, the requested NSSAI shall be either:

- a) the configured NSSAI for the current PLMN or SNPN, or a subset thereof as described below;
- b) the allowed NSSAI for the current PLMN or SNPN, or a subset thereof as described below; or
- c) the allowed NSSAI for the current PLMN or SNPN, or a subset thereof as described below, plus the configured NSSAI for the current PLMN or SNPN, or a subset thereof as described below.

If both the S-NSSAI to be replaced and the alternative S-NSSAI are included in the configured NSSAI, and the UE needs to request the S-NSSAI to be replaced, the UE shall include the S-NSSAI to be replaced in the requested NSSAI.

If the UE supports the S-NSSAI time validity information, S-NSSAI time validity information is available for an S-NSSAI, and the S-NSSAI time validity information indicates that the S-NSSAI is not available, the UE shall not include the S-NSSAI in the Requested NSSAI IE of the REGISTRATION REQUEST message. If the UE has S-NSSAI time validity information over the other access in the same PLMN and the S-NSSAI time validity information indicates that the S-NSSAI is not available, the UE shall not include the S-NSSAI in the Requested NSSAI IE of the REGISTRATION REQUEST message for the current access type.

If the UE has neither allowed NSSAI for the current PLMN or SNPN nor configured NSSAI for the current PLMN or SNPN and has a default configured NSSAI, the UE shall:

- a) include the S-NSSAI(s) in the Requested NSSAI IE of the REGISTRATION REQUEST message using the default configured NSSAI; and
- b) include the Network slicing indication IE with the Default configured NSSAI indication bit set to "Requested NSSAI created from default configured NSSAI" in the REGISTRATION REQUEST message.

If the UE has no allowed NSSAI for the current PLMN or SNPN, no configured NSSAI for the current PLMN or SNPN, and no default configured NSSAI, the UE shall not include a requested NSSAI in the REGISTRATION REQUEST message.

If all the S-NSSAI(s) corresponding to the slice(s) to which the UE intends to register are included in the pending NSSAI, the UE shall not include a requested NSSAI in the REGISTRATION REQUEST message.

The subset of configured NSSAI provided in the requested NSSAI consists of one or more S-NSSAIs in the configured NSSAI applicable to the current PLMN or SNPN, where any included S-NSSAI is:

- a) neither in the rejected NSSAI nor associated to an S-NSSAI in the rejected NSSAI. If the UE is inside the NS-AoS of an S-NSSAI in the rejected NSSAI with a rejection cause value set to "S-NSSAI not available in the current registration area", the S-NSSAI may be included in the requested NSSAI; or
- b) in the partially rejected NSSAI and the current TAI is not in the list of TAs for which the S-NSSAI is rejected. If the UE is inside the NS-AoS of an S-NSSAI in the partially rejected NSSAI and the current TAI is in the list of TAs for which the S-NSSAI is rejected, the S-NSSAI may be included in the requested NSSAI.

In addition, if the NSSRG information is available, the subset of configured NSSAI provided in the requested NSSAI shall be associated with at least one common NSSRG value. The UE may also include in the requested NSSAI, the S-

NSSAI(s) which were added to configured NSSAI in S1 mode and for which the associated NSSRG information is not available. If the UE is in 5GMM-REGISTERED state over the other access and has already an allowed NSSAI for the other access in the same PLMN or in different PLMNs, all the S-NSSAI(s) in the requested NSSAI for the current access shall share at least an NSSRG value common to all the S-NSSAI(s) of the allowed NSSAI for the other access. If the UE is simultaneously performing the registration procedure on the other access in different PLMNs, the UE shall include S-NSSAIs that share at least a common NSSRG value across all access types. If the UE has pending NSSAI which the UE is still interested in using, then S-NSSAIs in the pending NSSAI and requested NSSAI shall be associated with at least one common NSSRG value.

NOTE 6: If the UE has stored mapped S-NSSAI(s) for the rejected NSSAI, and one or more S-NSSAIs in the stored mapped S-NSSAI(s) for the configured NSSAI are not included in the stored mapped S-NSSAI(s) for the rejected NSSAI, then a S-NSSAI in the configured NSSAI associated to one or more of these mapped S-NSSAI(s) for the configured NSSAI are available to be included in the requested NSSAI together with their mapped S-NSSAI.

NOTE 7: If one or more mapped S-NSSAIs in the stored mapped S-NSSAI(s) for the configured NSSAI are not included in the stored rejected NSSAI for the failed or revoked NSSAI, a S-NSSAI in the configured NSSAI associated to one or more of these mapped S-NSSAI(s) for the configured NSSAI are available to be included in the registration request together with their mapped S-NSSAI.

NOTE 8: There is no need to consider the case that the UE is simultaneously performing the registration procedure on the other access in the same PLMN, due to that the UE is not allowed to initiate the registration procedure over one access when the registration over the other access to the same PLMN is going on.

The subset of allowed NSSAI provided in the requested NSSAI consists of one or more S-NSSAIs in the allowed NSSAI for the current PLMN.

NOTE 9: How the UE selects the subset of configured NSSAI or allowed NSSAI to be provided in the requested NSSAI is implementation specific. The UE can take preferences indicated by the upper layers (e.g. policies like URSP, applications) and UE local configuration into account.

NOTE 10: The number of S-NSSAI(s) included in the requested NSSAI cannot exceed eight.

If the UE initiates an initial registration for onboarding services in SNPN, the UE shall not include the Requested NSSAI IE in the REGISTRATION REQUEST message.

If the UE supports NSAG, the UE shall set the NSAG bit to "NSAG supported" in the 5GMM capability IE of the REGISTRATION REQUEST message. If the UE supports sending of REGISTRATION COMPLETE message for acknowledging the reception of NSAG information IE in the REGISTRATION ACCEPT message, the UE shall set the RCMAN bit to "Sending of REGISTRATION COMPLETE message for NSAG information supported" in the 5GMM capability IE of the REGISTRATION REQUEST message.

If the UE initiates an initial registration for emergency services or needs to prolong the established NAS signalling connection after the completion of the initial registration procedure (e.g. due to uplink signalling pending), the UE shall set the Follow-on request indicator to "Follow-on request pending".

NOTE 11: The UE does not have to set the Follow-on request indicator to 1, even if the UE has to request resources for V2X communication over PC5 reference point, 5G ProSe direct discovery over PC5, 5G ProSe direct communication over PC5 or A2X communication over PC5 reference point.

If the UE supports S1 mode and the UE has not disabled its E-UTRA capability and the 5GS registration type IE in the REGISTRATION REQUEST message is not set to "disaster roaming initial registration", the UE shall:

- set the S1 mode bit to "S1 mode supported" in the 5GMM capability IE of the REGISTRATION REQUEST message;
- include the S1 UE network capability IE in the REGISTRATION REQUEST message; additionally, if the UE supports EPS-UPIP, the UE shall set the EPS-UPIP bit to "EPS-UPIP supported" in the S1 UE network capability IE in the REGISTRATION REQUEST message; and
- if the UE supports sending an ATTACH REQUEST message containing a PDN CONNECTIVITY REQUEST message with request type set to "handover" to transfer a PDU session from N1 mode to S1 mode, set the HO attach bit to "attach request message containing PDN connectivity request with request type set to handover to transfer PDU session from N1 mode to S1 mode supported" in the 5GMM capability IE of the REGISTRATION REQUEST message.

If the UE supports the LTE positioning protocol (LPP) in N1 mode as specified in 3GPP TS 37.355 [26], the UE shall set the LPP bit to "LPP in N1 mode supported" in the 5GMM capability IE of the REGISTRATION REQUEST message.

If the UE supports the Location Services (LCS) notification mechanisms in N1 mode as specified in 3GPP TS 23.273 [6B], the UE shall set the 5G-LCS bit to "LCS notification mechanisms supported" in the 5GMM capability IE of the REGISTRATION REQUEST message.

If the UE supports the user plane positioning using LCS-UPP as specified in 3GPP TS 23.273 [6B], the UE shall set the LCS-UPP bit to "LCS-UPP user plane positioning supported" in the 5GMM capability IE of the REGISTRATION REQUEST message.

If the UE supports the user plane positioning using SUPL as described in 3GPP TS 38.305 [67] and 3GPP TS 23.271 [68], the UE shall set the SUPL bit to "SUPL user plane positioning supported" in the 5GMM capability IE of the REGISTRATION REQUEST message.

If the UE supports network verified UE location over satellite NG-RAN as specified in 3GPP TS 23.501 [8], the UE shall set the NVL-SATNR bit to "Network verified UE location over satellite NG-RAN supported" in the 5GMM capability IE of the REGISTRATION REQUEST message.

If the UE is in NB-N1 mode, then the UE shall set the Control plane CIoT 5GS optimization bit to "Control plane CIoT 5GS optimization supported" in the 5GMM capability IE of the REGISTRATION REQUEST message. If the UE is capable of NB-S1 mode, then the UE shall set the Control plane CIoT EPS optimization bit to "Control plane CIoT EPS optimization supported" in the S1 UE network capability IE of the REGISTRATION REQUEST message.

If the UE supports N3 data transfer and multiple user-plane resources in NB-N1 mode (see 3GPP TS 36.306 [25D], 3GPP TS 36.331 [25A]), then the UE shall set the Multiple user-plane resources support bit to "Multiple user-plane resources supported" in the 5GMM capability IE of the REGISTRATION REQUEST message.

If the UE supports 5G-SRVCC from NG-RAN to UTRAN as specified in 3GPP TS 23.216 [6A], the UE shall:

- set the 5G-SRVCC from NG-RAN to UTRAN capability bit to "5G-SRVCC from NG-RAN to UTRAN supported" in the 5GMM capability IE of the REGISTRATION REQUEST message; and
- include the Mobile station classmark 2 IE and the Supported codecs IE in the REGISTRATION REQUEST message.

If the UE supports service gap control, then the UE shall set the SGC bit to "service gap control supported" in the 5GMM capability IE of the REGISTRATION REQUEST message.

If the UE supports the restriction on use of enhanced coverage, the UE shall set the RestrictEC bit to "Restriction on use of enhanced coverage supported" in the 5GMM capability IE of the REGISTRATION REQUEST message.

If the UE supports network slice-specific authentication and authorization, the UE shall set the NSSAA bit to "network slice-specific authentication and authorization supported" in the 5GMM capability IE of the REGISTRATION REQUEST message.

If the UE supports CAG feature, the UE shall set the CAG bit to "CAG Supported" in the 5GMM capability IE of the REGISTRATION REQUEST message.

If the UE supports extended CAG information list, the UE shall set the Ex-CAG bit to "Extended CAG information list supported" in the 5GMM capability IE of the REGISTRATION REQUEST message.

If the UE supports enhanced CAG information, the UE shall set the ECI bit to "enhanced CAG information supported" in the 5GMM capability IE of the REGISTRATION REQUEST message.

If the UE supports network slice replacement, the UE shall set the NSR bit to "network slice replacement supported" in the 5GMM capability IE of the REGISTRATION REQUEST message.

If the UE supports sending of REGISTRATION COMPLETE message for acknowledging the reception of Negotiated PEIPS assistance information IE in the REGISTRATION ACCEPT message, the UE shall set the RCMP bit to "Sending of REGISTRATION COMPLETE message for negotiated PEIPS assistance information supported" in the 5GMM capability IE of the REGISTRATION REQUEST message.

When the UE is not in NB-N1 mode, if the UE supports RACS, the UE shall:

- a) set the RACS bit to "RACS supported" in the 5GMM capability IE of the REGISTRATION REQUEST message;
- b) if the UE has an applicable network-assigned UE radio capability ID for the current UE radio configuration in the selected PLMN or SNPN, include the applicable network-assigned UE radio capability ID in the UE radio capability ID IE of the REGISTRATION REQUEST message; and
- c) if the UE:
 - 1) does not have an applicable network-assigned UE radio capability ID for the current UE radio configuration in the selected PLMN or SNPN; and
 - 2) has an applicable manufacturer-assigned UE radio capability ID for the current UE radio configuration, include the applicable manufacturer-assigned UE radio capability ID in the UE radio capability ID IE of the REGISTRATION REQUEST message.

If the UE has one or more stored UE policy sections:

- identified by a UPSI with the PLMN ID part indicating the HPLMN or the selected PLMN; or
- identified by a UPSI with the PLMN ID part indicating the PLMN ID part of the SNPN identity of the selected SNPN and associated with the NID of the selected SNPN;

then the UE shall set the Payload container type IE to "UE policy container" and include the UE STATE INDICATION message (see annex D) in the Payload container IE of the REGISTRATION REQUEST message.

If the UE does not have any stored UE policy section:

- identified by a UPSI with the PLMN ID part indicating the HPLMN or the selected PLMN; or
- identified by a UPSI with the PLMN ID part indicating the PLMN ID part of the SNPN identity of the selected SNPN and associated with the NID of the selected SNPN;

and the UE needs to send a UE policy container to the network, then the UE shall set the Payload container type IE to "UE policy container" and include the UE STATE INDICATION message (see annex D) in the Payload container IE of the REGISTRATION REQUEST message.

NOTE 12: In this version of the protocol, the UE can only include the Payload container IE in the REGISTRATION REQUEST message to carry a payload of type "UE policy container".

If the UE does not have a valid 5G NAS security context, the UE shall send the REGISTRATION REQUEST message without including the NAS message container IE. The UE shall include the entire REGISTRATION REQUEST message (i.e. containing cleartext IEs and non-cleartext IEs, if any) in the NAS message container IE that is sent as part of the SECURITY MODE COMPLETE message as described in subclauses 4.4.6 and 5.4.2.3.

If the UE has a valid 5G NAS security context and the UE needs to send non-cleartext IEs, the UE shall send a REGISTRATION REQUEST message including the NAS message container IE as described in subclause 4.4.6. If the UE does not need to send non-cleartext IEs, the UE shall send a REGISTRATION REQUEST message without including the NAS message container IE.

If the UE supports ciphered broadcast assistance data and needs to obtain new ciphering keys, the UE shall include the Additional information requested IE with the CipherKey bit set to "ciphering keys for ciphered broadcast assistance data requested" in the REGISTRATION REQUEST message.

The UE shall set the WUSA bit to "WUS assistance information reception supported" in the 5GMM capability IE if the UE supports WUS assistance information. The UE may include its UE paging probability information in the Requested WUS assistance information IE if the UE has set the WUSA bit to "WUS assistance information reception supported" in the 5GMM capability IE and the UE is not performing the initial registration for emergency services.

The UE shall set the NR-PSSI bit to "NR paging subgrouping supported" in the 5GMM capability IE if the UE supports PEIPS assistance information and the 5GS registration type IE in the REGISTRATION REQUEST message is not set to "emergency registration". The UE may include its UE paging probability information in the Requested PEIPS assistance information IE if the UE has set the NR-PSSI bit to "NR paging subgrouping supported" in the 5GMM capability IE.

If the REGISTRATION REQUEST message includes a NAS message container IE, the AMF shall process the REGISTRATION REQUEST message that is obtained from the NAS message container IE as described in subclause 4.4.6.

If the UE supports V2X as specified in 3GPP TS 24.587 [19B], the UE shall set the V2X bit to "V2X supported" in the 5GMM capability IE of the REGISTRATION REQUEST message. If the UE supports V2X communication over E-UTRA-PC5 as specified in 3GPP TS 24.587 [19B], the UE shall set the V2XCEPC5 bit to "V2X communication over E-UTRA-PC5 supported" in the 5GMM capability IE of the REGISTRATION REQUEST message. If the UE supports V2X communication over NR-PC5 as specified in 3GPP TS 24.587 [19B], the UE shall set the V2XCNPC5 bit to "V2X communication over NR-PC5 supported" in the 5GMM capability IE of the REGISTRATION REQUEST message.

The UE shall set the ER-NSSAI bit to "Extended rejected NSSAI supported" in the 5GMM capability IE of the REGISTRATION REQUEST message.

If the UE supports the NSSRG, then the UE shall set the NSSRG bit to "NSSRG supported" in the 5GMM capability IE of the REGISTRATION REQUEST message.

If the W-AGF acting on behalf of an N5GC device initiates an initial registration as specified in 3GPP TS 23.316 [6D], the W-AGF acting on behalf of the N5GC device shall include the N5GC indication IE with the N5GC device indication bit set to "N5GC device registration is requested" in the REGISTRATION REQUEST message.

If the 5G-RG acting on behalf of an AUN3 device initiates an initial registration as specified in 3GPP TS 23.316 [6D], the 5G-RG acting on behalf of an AUN3 device shall include the AUN3 indication IE with the AUN3 device indication bit set to "AUN3 device registration is requested" in the REGISTRATION REQUEST message.

If the UE supports UAS services, the UE shall set the UAS bit to "UAS services supported" in the 5GMM capability IE of the REGISTRATION REQUEST message. If the UE supports A2X over E-UTRA-PC5 as specified in 3GPP TS 24.577 [60], the UE shall set the A2XEPC5 bit to "A2X over E-UTRA-PC5 supported" in the 5GMM capability IE of the REGISTRATION REQUEST message. If the UE supports A2X over NR-PC5 as specified in 3GPP TS 24.577 [60], the UE shall set the A2XNPC5 bit to "A2X over NR-PC5 supported" in the 5GMM capability IE of the REGISTRATION REQUEST message. If the UE supports A2X over Uu as specified in 3GPP TS 24.577 [60], the UE shall set the A2X-Uu bit to "A2X over Uu supported" in the 5GMM capability IE of the REGISTRATION REQUEST message.

When the UE supporting UAS services initiates an initial registration for UAS services, the UE shall include the service-level device ID in the Service-level-AA container IE of the REGISTRATION REQUEST message and set the value to the CAA-level UAV ID. The UE shall include the service-level-AA server address in the Service-level-AA container IE of the REGISTRATION REQUEST message and set the value to the USS address, if it is provided by the upper layers. The UE shall include the service-level-AA payload in the Service-level-AA container IE of the REGISTRATION REQUEST message and shall set the service-level-AA payload type, if the service-level-AA payload is provided by upper layers.

NOTE 13: The service-level-AA payload can be of type "C2 authorization payload". The C2 authorization payload can include one or both of an indication of the request for direct C2 communication and pairing information for direct C2 communication.

If the UE supports 5G ProSe direct discovery as specified in 3GPP TS 24.554 [19E], the UE shall set the 5G ProSe-dd bit to "5G ProSe direct discovery supported" in the 5GMM capability IE of the REGISTRATION REQUEST message. If the UE supports 5G ProSe direct communication as specified in 3GPP TS 24.554 [19E], the UE shall set the 5G ProSe-dc bit to "5G ProSe direct communication supported" in the 5GMM capability IE of the REGISTRATION REQUEST message. If the UE supports acting as 5G ProSe layer-2 UE-to-network relay UE as specified in 3GPP TS 24.554 [19E], the UE shall set the 5G ProSe-l2relay bit to "Acting as a 5G ProSe layer-2 UE-to-network relay UE supported" in the 5GMM capability IE of the REGISTRATION REQUEST message. If the UE supports acting as 5G ProSe layer-3 UE-to-network relay UE as specified in 3GPP TS 24.554 [19E], the UE shall set the 5G ProSe-l3relay bit to "Acting as a 5G ProSe layer-3 UE-to-network relay UE supported" in the 5GMM capability IE of the REGISTRATION REQUEST message. If the UE supports acting as 5G ProSe layer-2 UE-to-network remote UE as specified in 3GPP TS 24.554 [19E], the UE shall set the 5G ProSe-l2rmt bit to "Acting as a 5G ProSe layer-2 UE-to-network remote UE supported" in the 5GMM capability IE of the REGISTRATION REQUEST message. If the UE supports acting as 5G ProSe layer-3 UE-to-network remote UE as specified in 3GPP TS 24.554 [19E], the UE shall set the 5G ProSe-l3rmt bit to "Acting as a 5G ProSe layer-3 UE-to-network remote UE supported" in the 5GMM capability IE of the REGISTRATION REQUEST message. If the UE supports acting as 5G ProSe layer-2 UE-to-UE relay UE as specified in 3GPP TS 24.554 [19E], the UE shall set the 5G ProSe-l2U2U relay bit to "Acting as a 5G ProSe layer-2 UE-to-UE relay UE supported" in the 5GMM capability IE of the REGISTRATION REQUEST message. If the UE

supports acting as 5G ProSe layer-3 UE-to-UE relay UE as specified in 3GPP TS 24.554 [19E], the UE shall set the 5G ProSe-l3U2U relay bit to "Acting as a 5G ProSe layer-3 UE-to-UE relay UE supported" in the 5GMM capability IE of the REGISTRATION REQUEST message. If the UE supports acting as 5G ProSe layer-2 end UE as specified in 3GPP TS 24.554 [19E], the UE shall set the 5G ProSe-l2end bit to "Acting as a 5G ProSe layer-2 end UE supported" in the 5GMM capability IE of the REGISTRATION REQUEST message. If the UE supports acting as 5G ProSe layer-3 end UE as specified in 3GPP TS 24.554 [19E], the UE shall set the 5G ProSe-l3end bit to "Acting as a 5G ProSe layer-3 end UE supported" in the 5GMM capability IE of the REGISTRATION REQUEST message.

If the MUSIM UE supports the N1 NAS signalling connection release, then the UE shall set the N1 NAS signalling connection release bit to "N1 NAS signalling connection release supported" in the 5GMM capability IE of the REGISTRATION REQUEST message otherwise the UE shall not set the N1 NAS signalling connection release bit to "N1 NAS signalling connection release supported" in the 5GMM capability IE of the REGISTRATION REQUEST message.

If the MUSIM UE supports the paging indication for voice services, then the UE shall set the paging indication for voice services bit to "paging indication for voice services supported" in the 5GMM capability IE of the REGISTRATION REQUEST message otherwise the UE shall not set the paging indication for voice services bit to "paging indication for voice services supported" in the 5GMM capability IE of the REGISTRATION REQUEST message.

If the MUSIM UE supports the reject paging request, then the UE shall set the reject paging request bit to "reject paging request supported" in the 5GMM capability IE of the REGISTRATION REQUEST message otherwise the UE shall not set the reject paging request bit to "reject paging request supported" in the 5GMM capability IE of the REGISTRATION REQUEST message.

If the MUSIM UE sets:

- the reject paging request bit to "reject paging request supported";
- the N1 NAS signalling connection release bit to "N1 NAS signalling connection release supported"; or
- both of them;

and supports the paging restriction, then the UE shall set the paging restriction bit to "paging restriction supported" in the 5GMM capability IE of the REGISTRATION REQUEST message otherwise the UE shall not set the paging restriction bit to "paging restriction supported" in the 5GMM capability IE of the REGISTRATION REQUEST message.

If the UE supports MINT, the UE shall set the MINT bit to "MINT supported" in the 5GMM capability IE of the REGISTRATION REQUEST message.

If the UE supports slice-based N3IWF selection, the UE shall set the SBNS bit to "Slice-based N3IWF selection supported" in the 5GMM capability IE of the REGISTRATION REQUEST message.

If the UE supports slice-based TNGF selection, the UE shall set the SBTS bit to "Slice-based TNGF selection supported" in the 5GMM capability IE of the REGISTRATION REQUEST message.

If the UE initiates the registration procedure for disaster roaming services, the UE has determined the UE determined PLMN with disaster condition as specified in 3GPP TS 23.122 [5] and:

- a) the UE determined PLMN with disaster condition is the HPLMN and:
 - 1) the Additional GUTI IE is included in the REGISTRATION REQUEST message and does not contain a valid 5G-GUTI that was previously assigned by the HPLMN; or
 - 2) the Additional GUTI IE is not included in the REGISTRATION REQUEST message and the 5GS mobile identity IE contains neither the SUCI nor a valid 5G-GUTI that was previously assigned by the HPLMN; or
- b) the UE determined PLMN with disaster condition is not the HPLMN and:
 - 1) the Additional GUTI IE is included in the REGISTRATION REQUEST message and does not contain a valid 5G-GUTI that was previously assigned by the UE determined PLMN with disaster condition; or
 - 2) the Additional GUTI IE is not included in the REGISTRATION REQUEST message and the 5GS mobile identity IE does not contain a valid 5G-GUTI that was previously assigned by the UE determined PLMN with disaster condition;

the UE shall include in the REGISTRATION REQUEST message the UE determined PLMN with disaster condition IE indicating the UE determined PLMN with disaster condition.

NOTE 14: If the UE initiates the registration procedure for disaster roaming services, and the UE determined PLMN with disaster condition cannot be determined when an NG-RAN cell of the PLMN broadcasts the disaster related indication as specified in 3GPP TS 23.122 [5], the UE does not include in the REGISTRATION REQUEST message the UE determined PLMN with disaster condition IE but includes the Additional GUTI IE or the 5GS mobile identity IE or both as specified in subclauses 5.5.1.2.2.

If the UE supports event notification, the UE shall set the EventNotification bit to "Event notification supported" in the 5GMM capability IE of the REGISTRATION REQUEST message.

If the UE supports access to an SNPN using credentials from a credentials holder and:

- a) the UE is in its HPLMN or EHPLMN or the subscribed SNPN; or
- b) the UE is in a non-subscribed SNPN and supports equivalent SNPNS;

the UE shall set the SSNPNSI bit to "SOR-SNPN-SI supported" in the 5GMM capability IE of the REGISTRATION REQUEST message.

If the UE supports equivalent SNPNS, the UE shall set the ESI bit to "equivalent SNPNS supported" in the 5GMM capability IE of the REGISTRATION REQUEST message.

If the UE supports the unavailability period, the UE shall set the UN-PER bit to "unavailability period supported" in the 5GMM capability IE of the REGISTRATION REQUEST message.

If the UE supports the reconnection to the network due to RAN timing synchronization status change, the UE shall set the Reconnection to the network due to RAN timing synchronization status change (RANtiming) bit to "Reconnection to the network due to RAN timing synchronization status change supported" in the 5GMM capability IE of the REGISTRATION REQUEST message.

If the UE supports LADN per DNN and S-NSSAI, the UE shall set the LADN-DS bit to "LADN per DNN and S-NSSAI supported" in the 5GMM capability IE of the REGISTRATION REQUEST message.

If the UE supports MPS indicator update via the UE configuration update procedure, the UE shall set the MPSIU bit to "MPS indicator update supported" in the 5GMM capability IE of the REGISTRATION REQUEST message.

If the UE supports MCS indicator update via the UE configuration update procedure, the UE shall set the MCSIU bit to "MCS indicator update supported" in the 5GMM capability IE of the REGISTRATION REQUEST message.

If the UE supports ranging and sidelink positioning as specified in 3GPP TS 24.514 [62] and supports:

- a) V2X communication over PC5 as specified in 3GPP TS 24.587 [19B];
- b) 5G ProSe direct discovery and 5G ProSe direct communication as specified in 3GPP TS 24.554 [19E]; or
- c) both a) and b),

the UE shall set

- a) the RSLP bit to "Ranging and sidelink positioning supported";
- b) the RSLPL bit to "Ranging and sidelink positioning for located UE supported";
- c) the RSLPS bit to "Ranging and sidelink positioning for SL positioning server UE supported"; or
- d) any combination of a), b) and c), in the 5GMM capability IE of the REGISTRATION REQUEST message.

If the UE supports the partial network slice, the UE shall set the PNS bit to "Partial network slice supported" in the 5GMM capability IE of the REGISTRATION REQUEST message.

If the UE supports network slice usage control, the UE shall set the NSUC bit to "Network slice usage control supported" in the 5GMM capability IE of the REGISTRATION REQUEST message.

If the UE supports the S-NSSAI time validity information, the UE shall set the TempNS bit to "S-NSSAI time validity information supported" in the 5GMM capability IE of the REGISTRATION REQUEST message.

If the UE supports the S-NSSAI location validity information, the UE shall set the SLVI bit to "S-NSSAI location validity information supported" in the 5GMM capability IE of the REGISTRATION REQUEST message.

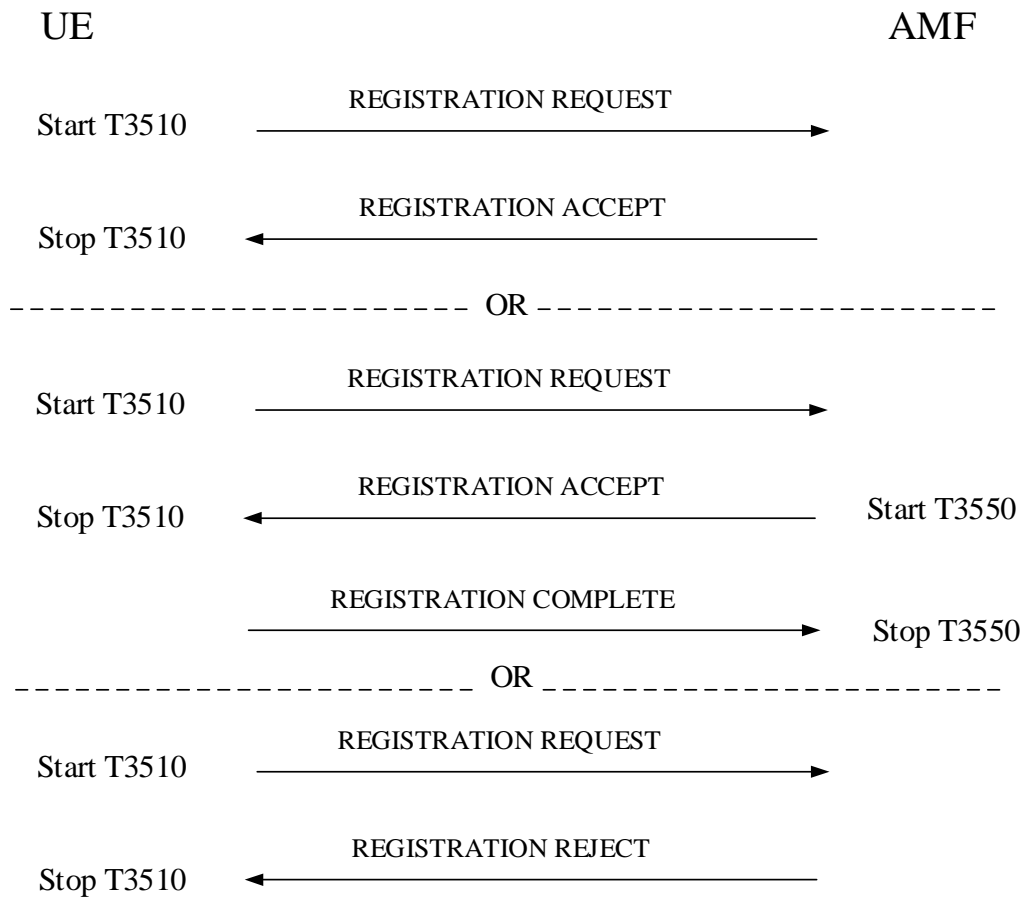

Figure 5.5.1.2.2.1: Registration procedure for initial registration

5.5.1.2.3 5GMM common procedure initiation

The network may initiate 5GMM common procedures, e.g. the identification, authentication and security procedures during the registration procedure, depending on the information received in the REGISTRATION REQUEST message.

If two NAS security mode control procedures are needed to signal an entire unciphered REGISTRATION REQUEST message followed by signalling of selected EPS NAS security algorithms, both NAS security mode control procedures should be initiated as part of 5GMM common procedures of the ongoing registration procedure (see subclause 5.4.2.4).

During a registration procedure with 5GS registration type IE set to "emergency registration", if the AMF is configured to support emergency registration for unauthenticated SUCIs, the AMF may choose to skip the authentication procedure even if no 5G NAS security context is available and proceed directly to the execution of the security mode control procedure.

5.5.1.2.4 Initial registration accepted by the network

During a registration procedure with 5GS registration type IE set to "emergency registration", the AMF shall not check for mobility and access restrictions, regional restrictions or subscription restrictions, or CAG restrictions when processing the REGISTRATION REQUEST message.

If the initial registration request is accepted by the network, the AMF shall send a REGISTRATION ACCEPT message to the UE.

NOTE 0: If the AMF receives the initial registration request over non-3GPP access and detects that the N3IWF used by the UE is compatible with only part of the allowed NSSAI and the UE has not indicated its support for slice-based N3IWF selection in the REGISTRATION REQUEST message, the AMF accepts the initial registration request.

NOTE 0A: If the AMF receives the initial registration request over non-3GPP access and detects that the TNGF used by the UE is compatible with only part of the allowed NSSAI and the UE has not indicated its support for slice-based TNGF selection in the REGISTRATION REQUEST message, the AMF accepts the initial registration request.

For each of the information elements: 5GMM capability, S1 UE network capability, and UE security capability, the AMF shall store all octets received from the UE in the REGISTRATION REQUEST message, up to the maximum length defined for the respective information element.

NOTE 1: This information is forwarded to the new AMF during inter-AMF handover or to the new MME during inter-system handover to S1 mode.

The AMF shall assign and include a TAI list as a registration area the UE is registered to in the REGISTRATION ACCEPT message. The AMF shall not assign a TAI list containing both tracking areas in NB-N1 mode and tracking areas not in NB-N1 mode. The UE, upon receiving a REGISTRATION ACCEPT message, shall delete its old TAI list and store the received TAI list. If the REGISTRATION REQUEST message was received over non-3GPP access, the AMF shall include a single TAI in the TAI list.

NOTE 2: For non-3GPP access, the operator can allocate a TAI per N3IWF, TNGF, TWIF or W-AGF. Each N3IWF, TNGF, TWIF or W-AGF is locally configured with a TAI. Each N3IWF, TNGF, TWIF or W-AGF can be configured with its own TAI value, or with the same TAI value as other N3IWFs, TNGFs, TWIFs or W-AGFs.

NOTE 3: When assigning the TAI list, the AMF can take into account the eNodeB's capability of support of CIoT 5GS optimization.

The AMF may include service area restrictions in the Service area list IE in the REGISTRATION ACCEPT message. The UE, upon receiving a REGISTRATION ACCEPT message with the service area restrictions shall act as described in subclause 5.3.5.

The AMF may also include a list of equivalent PLMNs in the REGISTRATION ACCEPT message. Each entry in the list contains a PLMN code (MCC+MNC). The UE shall store the list as provided by the network, and if the initial registration procedure is not for emergency services, the UE shall remove from the list any PLMN code that is already in the forbidden PLMN list as specified in subclause 5.3.13A. In addition, the UE shall add to the stored list the PLMN code of the registered PLMN that sent the list. The UE shall replace the stored list on each receipt of the REGISTRATION ACCEPT message. If the REGISTRATION ACCEPT message does not contain a list, then the UE shall delete the stored list. The AMF of a PLMN shall not include a list of equivalent SNPNs.

If the ESI bit of the 5GMM capability IE of the REGISTRATION REQUEST message is set to "equivalent SNPNs supported", the AMF of a SNPN may include a list of equivalent SNPNs in the REGISTRATION ACCEPT message. If the initial registration request is for onboarding services in SNPN, the AMF shall not include a list of equivalent SNPNs in the REGISTRATION ACCEPT message. Each entry in the list contains an SNPN identity. The UE shall store the list as provided by the network. If the initial registration procedure is not for emergency services and is not the initial registration for onboarding services in SNPN, the UE shall remove from the list any SNPN identity that is already in:

- the "permanently forbidden SNPNs" list or the "temporarily forbidden SNPNs" list, if the SNPN is not an SNPN selected for localized services in SNPN (see 3GPP TS 23.122 [5]); or
- the "permanently forbidden SNPNs for access for localized services in SNPN" list or the "temporarily forbidden SNPNs for access for localized services in SNPN" list, if the SNPN is an SNPN selected for localized services in SNPN (see 3GPP TS 23.122 [5]).

The UE shall add to the stored list the SNPN identity of the registered SNPN that sent the list. The UE shall replace the stored list on each receipt of the REGISTRATION ACCEPT message. If the REGISTRATION ACCEPT message does not contain a list, then the UE shall delete the stored list. The AMF of an SNPN shall not include a list of equivalent PLMNs.

NOTE 3A: If N1 mode was disabled for an SNPN due to reception of 5GMM cause #27 or #62, the UE implementation ensures that it does not register to this SNPN due to being part of the list of "equivalent SNPNS" received while registered in another SNPN.

If the initial registration procedure is not for emergency services, the UE is not registered for disaster roaming services, and if the PLMN identity of the registered PLMN is a member of the forbidden PLMN list as specified in subclause 5.3.13A, any such PLMN identity shall be deleted from the corresponding list(s).

If the Service area list IE is not included in the REGISTRATION ACCEPT message, any tracking area in the registered PLMN and its equivalent PLMN(s) in the registration area, or in the registered SNPN, is considered as an allowed tracking area as described in subclause 5.3.5.

If the REGISTRATION REQUEST message contains the LADN indication IE, based on the LADN indication IE, UE subscription information, UE location and local configuration about LADN and:

- if the LADN indication IE includes requested LADN DNNs, the UE subscribed DNN list includes the requested LADN DNNs or the wildcard DNN, and the LADN service area of the requested LADN DNN has an intersection with the current registration area, the AMF shall determine the requested LADN DNNs included in the LADN indication IE as LADN DNNs for the UE;
- if no requested LADN DNNs included in the LADN indication IE and the wildcard DNN is included in the UE subscribed DNN list, the AMF shall determine the LADN DNN(s) configured in the AMF whose LADN service area has an intersection with the current registration area as LADN DNNs for the UE; or
- if no requested LADN DNNs included in the LADN indication IE and the wildcard DNN is not included in the UE subscribed DNN list, or if the UE subscribed DNN list does not include any of the DNN's in the LADN indication IE, the AMF shall determine the LADN DNN(s) included in the UE subscribed DNN list whose LADN service area has an intersection with the current registration area as LADN DNNs for the UE.

If the LADN indication IE is not included in the REGISTRATION REQUEST message, the AMF shall determine the LADN DNN(s) included in the UE subscribed DNN list whose service area has an intersection with the current registration area as LADN DNNs for the UE, except for the wildcard DNN included in the UE subscribed DNN list.

If the UE supports WUS assistance information and the AMF supports and accepts the use of WUS assistance information for the UE, then the AMF shall determine the negotiated UE paging probability information for the UE, store it in the 5GMM context of the UE, and if the UE is not performing the initial registration for emergency services, the AMF shall include it in the Negotiated WUS assistance information IE in the REGISTRATION ACCEPT message. The AMF may consider the UE paging probability information received in the Requested WUS assistance information IE when determining the negotiated UE paging probability information for the UE.

NOTE 4: Besides the UE paging probability information requested by the UE, the AMF can take local configuration or previous statistical information for the UE into account when determining the negotiated UE paging probability information for the UE.

If the UE sets the NR-PSSI bit to "NR paging subgrouping supported" in the 5GMM capability IE in the REGISTRATION REQUEST message and the AMF supports and accepts the use of PEIPS assistance information for the UE, then the AMF shall determine the Paging subgroup ID for the UE, store it in the 5GMM context of the UE, and shall include it in the Negotiated PEIPS assistance information IE in the REGISTRATION ACCEPT message or in the Updated PEIPS assistance information IE in the CONFIGURATION UPDATE COMMAND message as part of the registration procedure. The AMF may consider the UE paging probability information received in the Requested PEIPS assistance information IE when determining the Paging subgroup ID for the UE.

NOTE 5: Besides the UE paging probability information when provided by the UE, the AMF can also take local configuration, whether the UE is likely to receive IMS voice over PS session calls, UE mobility pattern or previous statistical information for the UE or information provided by the NG-RAN into account when determining the Paging subgroup ID for the UE.

If the UE set the UN-PER bit to "unavailability period supported" in the 5GMM capability IE in the REGISTRATION REQUEST message and the AMF supports and accepts the use of unavailability period for the UE, then the AMF shall set the UN-PER bit to "unavailability period supported" in the SGS network feature support IE in the REGISTRATION ACCEPT message. Furthermore, if the AMF is able to determine an unavailability period duration for the UE based on satellite coverage availability information (see 3GPP TS 23.401 [7]), the AMF shall store the determined unavailability period duration and provide the determined unavailability period duration to the UE by including the unavailability period duration in the Unavailability configuration IE in the REGISTRATION ACCEPT message. If the AMF is able to

determine the start of unavailability period based on satellite coverage availability information (see 3GPP TS 23.401 [7]), the AMF shall store the determined start of unavailability period and provide the determined start of unavailability period to the UE by including the start of unavailability period in the Unavailability configuration IE in the REGISTRATION ACCEPT message. The AMF may determine the periodic registration update timer value based on the network determined unavailability period duration, a network determined start of the unavailability period or a discontinuous coverage maximum time offset value or any combination of them.

The AMF shall include the LADN information which consists of the determined LADN DNNs for the UE and LADN service area(s) available in the current registration area in the LADN information IE of the REGISTRATION ACCEPT message.

If the UE has set the LADN-DS bit to "LADN per DNN and S-NSSAI supported" in the 5GMM capability IE of the REGISTRATION REQUEST message and the extended LADN information is available for the UE, the AMF shall include the extended LADN information which consists of the determined LADN DNNs for the UE, the S-NSSAIs associated with the determined LADN DNNs for the UE and in the allowed NSSAI or partially allowed NSSAI, and LADN service area(s) available in the current registration area in the Extended LADN information IE in the Registration accept type 6 IE container IE of the REGISTRATION ACCEPT message.

NOTE 5A0: The AMF allocates the LADN service area and the TAI list associated with the S-NSSAI in the partially allowed NSSAI independently, if applicable.

If:

- a) the UE does not support LADN per DNN and S-NSSAI;
- b) the UE is subscribed to the LADN DNN for a single S-NSSAI only; and
- c) the AMF has the extended LADN information but no LADN information;

the AMF may decide to provide the LADN service area for that LADN DNN of the extended LADN information as the LADN information and include the LADN information in the LADN information IE of the REGISTRATION ACCEPT message.

NOTE 5A: If the LADN service area is configured per DNN and S-NSSAI, in order to serve the UEs that do not support LADN per DNN and S-NSSAI, it is recommended that the LADN DNN is only served by a single S-NSSAI.

NOTE 5B: For the case when the UE is subscribed to the LADN DNN for multiple S-NSSAIs, the AMF can treat this as no extended LADN information is available.

If the UE does not support LADN per DNN and S-NSSAI and the AMF has neither the LADN information nor the extended LADN information, the AMF shall not provide any LADN information to the UE.

The UE, upon receiving the REGISTRATION ACCEPT message with the LADN information, shall store the received LADN information. The UE, upon receiving the REGISTRATION ACCEPT message with the Extended LADN information in the Registration accept type 6 IE container IE, shall store the received extended LADN information. If there exists one or more LADN DNNs which are included in the LADN indication IE of the REGISTRATION REQUEST message and are not included in the LADN information IE and Extended LADN information IE in the Registration accept type 6 IE container IE of the REGISTRATION ACCEPT message, the UE considers such LADN DNNs as not available in the current registration area.

The 5G-GUTI reallocation shall be part of the initial registration procedure. During the initial registration procedure, if the AMF has not allocated a new 5G-GUTI by the generic UE configuration update procedure, the AMF shall include in the REGISTRATION ACCEPT message the new assigned 5G-GUTI together with the assigned TAI list.

If the UE has set the CAG bit to "CAG supported" in the 5GMM capability IE of the REGISTRATION REQUEST message and the AMF needs to update the "CAG information list" stored in the UE, the AMF shall include the CAG information list IE or the Extended CAG information list IE in the REGISTRATION ACCEPT message.

NOTE 6: The "CAG information list" can be provided by the AMF and include no entry if no "CAG information list" exists in the subscription.

NOTE 7: If the UE supports extended CAG information list, the CAG information list can be included either in the CAG information list IE or Extended CAG information list IE.

If the UE does not support extended CAG information list, the CAG information list shall not be included in the Extended CAG information list IE.

If a 5G-GUTI or the SOR transparent container IE is included in the REGISTRATION ACCEPT message, the AMF shall start timer T3550 and enter state 5GMM-COMMON-PROCEDURE-INITIATED as described in subclause 5.1.3.2.3.3.

If the Operator-defined access category definitions IE, the Extended emergency number list IE, the CAG information list IE or the Extended CAG information list IE are included in the REGISTRATION ACCEPT message, the AMF shall start timer T3550 and enter state 5GMM-COMMON-PROCEDURE-INITIATED as described in subclause 5.1.3.2.3.3.

If the UE has set the RCMAP bit to "Sending of REGISTRATION COMPLETE message for negotiated PEIPS assistance information supported" in the 5GMM capability IE of the REGISTRATION REQUEST message and if the Negotiated PEIPS assistance information IE is included in the REGISTRATION ACCEPT message, the AMF shall start timer T3550 and enter state 5GMM-COMMON-PROCEDURE-INITIATED as described in subclause 5.1.3.2.3.3.

If the UE is not in NB-N1 mode and the UE has set the RACS bit to "RACS supported" in the 5GMM Capability IE of the REGISTRATION REQUEST message, the AMF may include either a UE radio capability ID IE or a UE radio capability ID deletion indication IE in the REGISTRATION ACCEPT message. If the UE radio capability ID IE or the UE radio capability ID deletion indication IE is included in the REGISTRATION ACCEPT message, the AMF shall start timer T3550 and enter state 5GMM-COMMON-PROCEDURE-INITIATED as described in subclause 5.1.3.2.3.3.

The AMF shall include the MICO indication IE in the REGISTRATION ACCEPT message only if the MICO indication IE was included in the REGISTRATION REQUEST message, the AMF supports and accepts the use of MICO mode. If the AMF supports and accepts the use of MICO mode, the AMF may indicate "all PLMN registration area allocated" in the MICO indication IE in the REGISTRATION ACCEPT message. If "all PLMN registration area allocated" is indicated in the MICO indication IE, the AMF shall not assign and include the TAI list in the REGISTRATION ACCEPT message. If the REGISTRATION ACCEPT message included an MICO indication IE indicating "all PLMN registration area allocated", the UE shall treat all TAIs in the current PLMN as a registration area and delete its old TAI list. If "strictly periodic registration timer supported" is indicated in the MICO indication IE in the REGISTRATION REQUEST message, the AMF may indicate "strictly periodic registration timer supported" in the MICO indication IE in the REGISTRATION ACCEPT message.

The AMF shall include an active time value in the T3324 IE in the REGISTRATION ACCEPT message if the UE requested an active time value in the REGISTRATION REQUEST message and the AMF accepts the use of MICO mode and the use of active time.

If the AMF supports and accepts the use of MICO, and the UE included the Requested T3512 value IE in the REGISTRATION REQUEST message, then the AMF shall take into account the T3512 value requested when providing the T3512 value IE in the REGISTRATION ACCEPT message.

NOTE 7A: The T3512 value assigned to the UE by AMF can be different from the T3512 value requested by the UE. AMF can take several factors into account when assigning the T3512 value, e.g. local configuration, expected UE behaviour, UE requested T3512 value, UE subscription data, network policies.

The AMF shall include the T3512 value IE in the REGISTRATION ACCEPT message only if the REGISTRATION REQUEST message was sent over the 3GPP access.

The AMF shall include the non-3GPP de-registration timer value IE in the REGISTRATION ACCEPT message only if the REGISTRATION REQUEST message was sent over the non-3GPP access.

If the UE requests "control plane CIoT 5GS optimization" in the 5GS update type IE, indicates support of control plane CIoT 5GS optimization in the 5GMM capability IE and the AMF decides to accept the requested CIoT 5GS optimization and the registration request, the AMF shall indicate "control plane CIoT 5GS optimization supported" in the 5GS network feature support IE of the REGISTRATION ACCEPT message.

The AMF may include the T3447 value IE set to the service gap time value in the REGISTRATION ACCEPT message if:

- the UE has indicated support for service gap control in the REGISTRATION REQUEST message; and
- a service gap time value is available in the 5GMM context.

If there is a running T3447 timer in the AMF and the Follow-on request indicator is set to "Follow-on request pending" in the REGISTRATION REQUEST message, the AMF shall ignore the flag and proceed as if the flag was not received except for the following cases:

- a) the UE is configured for high priority access in the selected PLMN; or
- b) the 5GS registration type IE in the REGISTRATION REQUEST message is set to "emergency registration".

If the UE has indicated support for the control plane CIoT 5GS optimizations, and the AMF decides to activate the congestion control for transport of user data via the control plane, then the AMF shall include the T3448 value IE in the REGISTRATION ACCEPT message.

If:

- the UE in NB-N1 mode is using control plane CIoT 5GS optimization; and
- the network is configured to provide the truncated 5G-S-TMSI configuration for control plane CIoT 5GS optimizations;

the AMF shall include the Truncated 5G-S-TMSI configuration IE in the REGISTRATION ACCEPT message and set the "Truncated AMF Set ID value" and the "Truncated AMF Pointer value" in the Truncated 5G-S-TMSI configuration IE based on network policies. The AMF shall start timer T3550 and enter state 5GMM-COMMON-PROCEDURE-INITIATED as described in subclause 5.1.3.2.3.3.

If the UE has included the service-level device ID set to the CAA-level UAV ID in the Service-level-AA container IE of the REGISTRATION REQUEST message, and if:

- the UE has a valid aerial UE subscription information;
- the UUAA procedure is to be performed during the registration procedure according to operator policy;
- there is no valid successful UUAA result for the UE in the UE 5GMM context; and
- the REGISTRATION REQUEST message was not received over non-3GPP access,

then the AMF shall initiate the UUAA-MM procedure with the UAS-NF as specified in 3GPP TS 23.256 [6AB] and shall include a service-level-AA pending indication in the Service-level-AA container IE of the REGISTRATION ACCEPT message. The AMF shall store in the UE 5GMM context that a UUAA procedure is pending. The AMF shall start timer T3550 and enter state 5GMM-COMMON-PROCEDURE-INITIATED as described in subclause 5.1.3.2.3.3. If the REGISTRATION REQUEST message was received over non-3GPP access, the AMF shall not initiate UUAA-MM procedure.

If the UE has included the service-level device ID set to the CAA-level UAV ID in the Service-level-AA container IE of the REGISTRATION REQUEST message, and if:

- the UE has a valid aerial UE subscription information;
- the UUAA procedure is to be performed during the registration procedure according to operator policy; and
- there is a valid successful UUAA result for the UE in the UE 5GMM context,

then the AMF shall include a service-level-AA response in the Service-level-AA container IE of the REGISTRATION ACCEPT message and set the SLAR field in the service-level-AA response to "Service level authentication and authorization was successful".

If the AMF determines that the UUAA-MM procedure needs to be performed for a UE, the AMF has not received the service-level device ID set to the CAA-level UAV ID in the Service-level-AA container IE of the REGISTRATION REQUEST message from the UE and the AMF decides to accept the UE to be registered for other services than UAS services based on the user's subscription data and the operator policy, the AMF shall accept the initial registration request and shall mark in the UE's 5GMM context that the UE is not allowed to request UAS services.

If the UE supports MINT, the AMF may include the List of PLMNs to be used in disaster condition IE in the REGISTRATION ACCEPT message.

If the UE supports MINT, the AMF may include the Disaster roaming wait range IE in the REGISTRATION ACCEPT message.

If the UE supports MINT, the AMF may include the Disaster return wait range IE in the REGISTRATION ACCEPT message.

NOTE 8: The AMF can determine the contents of the "list of PLMN(s) to be used in disaster condition", the value of the disaster roaming wait range and the value of the disaster return wait range based on the network local configuration.

If the AMF received the list of TAIs from the satellite NG-RAN as described in 3GPP TS 23.501 [8], and determines that, by UE subscription and operator's preferences, any but not all TAIs in the received list of TAIs is forbidden for roaming or for regional provision of service, the AMF shall include the TAI(s) in:

- a) the Forbidden TAI(s) for the list of "5GS forbidden tracking areas for roaming" IE; or
- b) the Forbidden TAI(s) for the list of "5GS forbidden tracking areas for regional provision of service" IE; or
- c) both;

in the REGISTRATION ACCEPT message.

NOTE 9: Void.

If the UE has set the Reconnection to the network due to RAN timing synchronization status change (RANtiming) bit to "Reconnection to the network due to RAN timing synchronization status change supported" in the 5GMM capability IE of the REGISTRATION REQUEST message, the AMF may include the RAN timing synchronization IE with the RecReq bit set to "Reconnection requested" in the REGISTRATION ACCEPT message.

If the AMF receives the initial registration request along with the mobile IAB-indication over N2 reference point (see TS 38.413 [31]) from UE and the UE is authorized to operate as an MBSR based on the subscription information and local policy (see 3GPP TS 23.501 [8]), the AMF shall include the Feature authorization indication IE in the REGISTRATION ACCEPT message and shall set the MBSRAI field to "authorized to operate as MBSR". If the AMF receives the initial registration request along with the mobile IAB-indication over N2 reference point (see TS 38.413 [31]) from UE and the UE is not authorized to operate as an MBSR based on the subscription information and local policy but can operate as a UE, the AMF shall include the Feature authorization indication IE in the REGISTRATION ACCEPT message and shall set the MBSRAI field to "not authorized to operate as MBSR but allowed to operate as a UE".

If the UE supports user plane positioning using LCS-UPP, SUPL, or both, the AMF shall set the LCS-UPP bit, the SUPL bit, or both in the 5GS network feature support IE of the REGISTRATION ACCEPT message as specified in 3GPP TS 24.572 [64].

Upon receipt of the REGISTRATION ACCEPT message, the UE shall reset the registration attempt counter, enter state 5GMM-REGISTERED and set the 5GS update status to 5U1 UPDATED.

If the UE receives the REGISTRATION ACCEPT message from a PLMN, then the UE shall reset the PLMN-specific attempt counter for that PLMN for the specific access type for which the message was received. The UE shall also reset the PLMN-specific N1 mode attempt counter for that PLMN for the specific access type for which the message was received. If the message was received via 3GPP access, the UE shall reset the counter for "SIM/USIM considered invalid for GPRS services" events and the counter for "SIM/USIM considered invalid for non-GPRS services" events, if any. If the message was received via non-3GPP access, the UE shall reset the counter for "USIM considered invalid for 5GS services over non-3GPP" events.

If the UE receives the REGISTRATION ACCEPT message from an SNPN, then the UE shall reset the SNPN-specific attempt counter for the current SNPN for the specific access type for which the message was received. If the message was received via 3GPP access, the UE shall reset the counter for "the entry for the current SNPN considered invalid for 3GPP access" events. If the message was received via non-3GPP access, the UE shall reset the counter for "the entry for the current SNPN considered invalid for non-3GPP access" events.

If the REGISTRATION ACCEPT message included a T3512 value IE, the UE shall use the value in the T3512 value IE as periodic registration update timer (T3512).

If the REGISTRATION ACCEPT message include a T3324 value IE, the UE shall use the value in the T3324 value IE as active timer (T3324).

If the REGISTRATION ACCEPT message included a non-3GPP de-registration timer value IE, the UE shall use the value in non-3GPP de-registration timer value IE as non-3GPP de-registration timer.

If the REGISTRATION ACCEPT message contained a 5G-GUTI, the UE shall return a REGISTRATION COMPLETE message to the AMF to acknowledge the received 5G-GUTI, stop timer T3519 if running, and delete any stored SUCI. The UE shall provide the 5G-GUTI to the lower layer of 3GPP access if the REGISTRATION ACCEPT message is sent over the non-3GPP access, and the UE is in 5GMM-REGISTERED in both 3GPP access and non-3GPP access in the same PLMN.

If the REGISTRATION ACCEPT message contains

- a) the Network slicing indication IE with the Network slicing subscription change indication set to "Network slicing subscription changed";
- b) a Configured NSSAI IE with a new configured NSSAI for the current PLMN or SNPN and optionally the mapped S-NSSAI(s) for the configured NSSAI for the current PLMN or SNPN;
- c) an NSSRG information IE with a new NSSRG information;
- d) an Alternative NSSAI IE with a new alternative NSSAI;
- e) an S-NSSAI location validity information in the Registration accept type 6 IE container IE with a new S-NSSAI location validity information;
- f) an S-NSSAI time validity information IE with a new S-NSSAI time validity information; or
- g) an On-demand NSSAI IE with a new on-demand NSSAI or an updated slice deregistration inactivity timer value,

the UE shall return a REGISTRATION COMPLETE message to the AMF to acknowledge the successful update of the network slicing information. If the UE has set the RCMAN bit to "Sending of REGISTRATION COMPLETE message for NSAG information supported" in the 5GMM capability IE of the REGISTRATION REQUEST message and if REGISTRATION ACCEPT message contains the NSAG information IE, the UE shall return REGISTRATION COMPLETE message to the AMF to acknowledge the reception of the NSAG information IE.

NOTE 9A: When the UE receives the NSSRG information IE, the UE may provide the NSSRG information to lower layers for the purpose of NSAG-aware cell reselection.

If the REGISTRATION ACCEPT message contains the CAG information list IE or the Extended CAG information list IE and the UE had set the CAG bit to "CAG supported" in the 5GMM capability IE of the REGISTRATION REQUEST message, the UE shall:

- a) replace the "CAG information list" stored in the UE with the received CAG information list IE or the Extended CAG information list IE when received in the HPLMN or EHPLMN;

NOTE 10: When the UE receives the CAG information list IE or the Extended CAG information list IE in the HPLMN whose PLMN code is derived from the IMSI, the EHPLMN list is present and is not empty and the HPLMN is not present in the EHPLMN list, the UE behaves as if it receives the CAG information list IE or the Extended CAG information list IE in a VPLMN.

- b) replace the serving VPLMN's entry of the "CAG information list" stored in the UE with the serving VPLMN's entry of the received CAG information list IE or the Extended CAG information list IE when the UE receives the CAG information list IE or the Extended CAG information list IE in a serving PLMN other than the HPLMN or EHPLMN; or

NOTE 11: When the UE receives the CAG information list IE or the Extended CAG information list IE in a serving PLMN other than the HPLMN or EHPLMN, entries of a PLMN other than the serving VPLMN, if any, in the received CAG information list IE or the Extended CAG information list IE are ignored.

- c) remove the serving VPLMN's entry of the "CAG information list" stored in the UE when the UE receives the CAG information list IE or the Extended CAG information list IE in a serving PLMN other than the HPLMN or EHPLMN and the CAG information list IE or the Extended CAG information list IE does not contain the serving VPLMN's entry.

The UE shall store the "CAG information list" received in the CAG information list IE or the Extended CAG information list IE as specified in annex C.

If the received "CAG information list" includes an entry containing the identity of the registered PLMN, the UE shall operate as follows:

- a) if the UE receives the REGISTRATION ACCEPT message via a CAG cell, none of the CAG-ID(s) supported by the current CAG cell is authorized based on the "Allowed CAG list" of the entry for the registered PLMN in the received "CAG information list", and:
- 1) the entry for the registered PLMN in the received "CAG information list" does not include an "indication that the UE is only allowed to access 5GS via CAG cells", then the UE shall enter the state 5GMM-REGISTERED.LIMITED-SERVICE and shall search for a suitable cell according to 3GPP TS 38.304 [28] or 3GPP TS 36.304 [25C] with the updated "CAG information list"; or
 - 2) the entry for the registered PLMN in the received "CAG information list" includes an "indication that the UE is only allowed to access 5GS via CAG cells" and:
 - i) if one or more CAG-ID(s) are authorized based on the "Allowed CAG list" of the entry for the registered PLMN in the received "CAG information list", the UE shall enter the state 5GMM-REGISTERED.LIMITED-SERVICE and shall search for a suitable cell according to 3GPP TS 38.304 [28] with the updated "CAG information list"; or
 - ii) if no CAG-ID is authorized based on the "Allowed CAG list" of the entry for the registered PLMN in the received "CAG information list", the UE has not set the 5GS registration type IE in the REGISTRATION REQUEST message to "emergency registration", and the initial registration was not initiated to perform handover of an existing emergency PDU session from the non-current access to the current access, then the UE shall enter the state 5GMM-REGISTERED.PLMN-SEARCH and shall apply the PLMN selection process defined in 3GPP TS 23.122 [5] with the updated "CAG information list"; or
- b) if the UE receives the REGISTRATION ACCEPT message via a non-CAG cell and the entry for the registered PLMN in the received "CAG information list" includes an "indication that the UE is only allowed to access 5GS via CAG cells" and:
- 1) if one or more CAG-ID(s) are authorized based on the "allowed CAG list" for the registered PLMN in the received "CAG information list", the UE shall enter the state 5GMM-REGISTERED.LIMITED-SERVICE and shall search for a suitable cell according to 3GPP TS 38.304 [28] with the updated "CAG information list"; or
 - 2) if no CAG-ID is authorized based on the "Allowed CAG list" of the entry for the registered PLMN in the received "CAG information list", the UE has not set the 5GS registration type IE in the REGISTRATION REQUEST message to "emergency registration", and the initial registration was not initiated to perform handover of an existing emergency PDU session from the non-current access to the current access, then the UE shall enter the state 5GMM-REGISTERED.PLMN-SEARCH and shall apply the PLMN selection process defined in 3GPP TS 23.122 [5] with the updated "CAG information list".

If the received "CAG information list" does not include an entry containing the identity of the registered PLMN and the UE receives the REGISTRATION ACCEPT message via a CAG cell, the UE shall enter the state 5GMM-REGISTERED.LIMITED-SERVICE and shall search for a suitable cell according to 3GPP TS 38.304 [28] or 3GPP TS 36.304 [25C] with the updated "CAG information list".

If the REGISTRATION ACCEPT message contains the Operator-defined access category definitions IE, the Extended emergency number list IE, the CAG information list IE or the Extended CAG information list IE, the UE shall return a REGISTRATION COMPLETE message to the AMF to acknowledge reception of the operator-defined access category definitions, the extended local emergency numbers list or the "CAG information list".

If the UE has set the RCMAP bit to "Sending of REGISTRATION COMPLETE message for negotiated PEIPS parameters supported" in the 5GMM capability IE of the REGISTRATION REQUEST message and if REGISTRATION ACCEPT message contains the Negotiated PEIPS assistance information IE, the UE shall return REGISTRATION COMPLETE message to the AMF to acknowledge the reception of the Negotiated PEIPS assistance information IE.

If the REGISTRATION ACCEPT message contains the UE radio capability ID IE or the UE radio capability ID deletion indication IE, the UE shall return a REGISTRATION COMPLETE message to the AMF to acknowledge reception of the UE radio capability ID IE or the UE radio capability ID deletion indication IE.

Upon receiving a REGISTRATION COMPLETE message, the AMF shall stop timer T3550 and change to state 5GMM-REGISTERED. The 5G-GUTI, if sent in the REGISTRATION ACCEPT message, shall be considered as valid, the PEIPS assistance information, if sent in the REGISTRATION ACCEPT message, shall be considered as valid, and the UE radio capability ID, if sent in the REGISTRATION ACCEPT, shall be considered as valid.

If the 5GS update type IE was included in the REGISTRATION REQUEST message with the SMS requested bit set to "SMS over NAS supported", and SMSF selection is successful, then the AMF shall send the REGISTRATION ACCEPT message after the SMSF has confirmed that the activation of the SMS service was successful. When sending the REGISTRATION ACCEPT message, the AMF shall:

- a) set the SMS allowed bit of the 5GS registration result IE to "SMS over NAS allowed" in the REGISTRATION ACCEPT message, if the UE has set the SMS requested bit of the 5GS update type IE to "SMS over NAS supported" in the REGISTRATION REQUEST message and the network allows the use of SMS over NAS for the UE; and
- b) store the SMSF address and the value of the SMS allowed bit of the 5GS registration result IE in the UE 5GMM context and consider the UE available for SMS over NAS.

If:

- a) the SMSF selection in the AMF is not successful;
- b) the SMS activation via the SMSF is not successful;
- c) the AMF does not allow the use of SMS over NAS;
- d) the SMS requested bit of the 5GS update type IE was set to "SMS over NAS not supported" in the REGISTRATION REQUEST message; or
- e) the 5GS update type IE was not included in the REGISTRATION REQUEST message;

then the AMF shall set the SMS allowed bit of the 5GS registration result IE to "SMS over NAS not allowed" in the REGISTRATION ACCEPT message.

When the UE receives the REGISTRATION ACCEPT message, if the UE is also registered over another access to the same PLMN, the UE considers the value indicated by the SMS allowed bit of the 5GS registration result IE as applicable for both accesses over which the UE is registered.

The AMF shall include the 5GS registration result IE in the REGISTRATION ACCEPT message. If the 5GS registration result value in the 5GS registration result IE indicates:

- a) "3GPP access", the UE:
 - shall consider itself as being registered to 3GPP access; and
 - if in 5GMM-REGISTERED state over non-3GPP access and on the same PLMN or SNPN as 3GPP access, shall enter state 5GMM-DEREGISTERED.ATTEMPTING-REGISTRATION over non-3GPP access and set the 5GS update status to 5U2 NOT UPDATED over non-3GPP access; or
- b) "Non-3GPP access", the UE:
 - shall consider itself as being registered to non-3GPP access; and
 - if in the 5GMM-REGISTERED state over 3GPP access and is on the same PLMN or SNPN as non-3GPP access, shall enter the state 5GMM-DEREGISTERED.ATTEMPTING-REGISTRATION over 3GPP access and set the 5GS update status to 5U2 NOT UPDATED over 3GPP access; or
- c) "3GPP access and non-3GPP access", the UE shall consider itself as being registered to both 3GPP access and non-3GPP access.

In roaming scenarios, the AMF shall provide mapped S-NSSAI(s) for the configured NSSAI, the allowed NSSAI, the partially allowed NSSAI, the rejected NSSAI (if Extended rejected NSSAI IE is used), the partially rejected NSSAI, the pending NSSAI or NSSRG information when included in the REGISTRATION ACCEPT message.

The AMF shall include the allowed NSSAI for the current PLMN or SNPN and shall include the mapped S-NSSAI(s) for the allowed NSSAI contained in the requested NSSAI from the UE if available, in the REGISTRATION ACCEPT message if the UE included the requested NSSAI in the REGISTRATION REQUEST message and the AMF allows one or more S-NSSAIs in the requested NSSAI. Additionally, if the AMF allows one or more subscribed S-NSSAIs for the UE, the AMF may include the allowed subscribed S-NSSAI(s) in the allowed NSSAI in the REGISTRATION ACCEPT message.

The AMF may also include rejected NSSAI in the REGISTRATION ACCEPT message if the initial registration request is not for onboarding services in SNPN. If the UE has set the ER-NSSAI bit to "Extended rejected NSSAI supported" in the 5GMM capability IE of the REGISTRATION REQUEST message, the rejected NSSAI shall be included in the Extended rejected NSSAI IE in the REGISTRATION ACCEPT message; otherwise the rejected NSSAI shall be included in the Rejected NSSAI IE in the REGISTRATION ACCEPT message. If the initial registration request is for onboarding services in SNPN, the AMF shall not include rejected NSSAI in the REGISTRATION ACCEPT message.

If the UE has indicated the support for partial network slice and the AMF determines one or more S-NSSAI(s) in the requested NSSAI are to be included in the partially rejected NSSAI as specified in subclause 4.6.2.11, the AMF shall include the Partially rejected NSSAI IE in the Registration accept type 6 IE container IE of the REGISTRATION ACCEPT message.

If the UE receives the Partially rejected NSSAI IE in the Registration accept type 6 IE container IE of the REGISTRATION ACCEPT message, the UE shall store the partially rejected NSSAI as specified in subclause 4.6.2.2.

If the UE has set the ER-NSSAI bit to "Extended rejected NSSAI supported" in the 5GMM capability IE of the REGISTRATION REQUEST message, the rejected NSSAI contains S-NSSAI(s) which was included in the requested NSSAI but rejected by the network associated with rejection cause(s); otherwise the rejected NSSAI contains S-NSSAI(s) which was included in the requested NSSAI but rejected by the network associated with rejection cause(s) with the following restrictions:

- a) rejected NSSAI for the current PLMN or SNPN shall not include an S-NSSAI for the current PLMN or SNPN which is associated to multiple mapped S-NSSAIs and some of these but not all mapped S-NSSAIs are not allowed; and
- b) rejected NSSAI for the current registration area shall not include an S-NSSAI for the current PLMN or SNPN which is associated to multiple mapped S-NSSAIs and some of these but not all mapped S-NSSAIs are not allowed.

NOTE 12: The UE that does not support extended rejected NSSAI can avoid requesting an S-NSSAI associated with a mapped S-NSSAI, which was included in the previous requested NSSAI but neither in the allowed NSSAI nor in the rejected NSSAI in the consequent registration procedures.

If the UE indicated the support for network slice-specific authentication and authorization, and if the Requested NSSAI IE includes one or more S-NSSAIs subject to network slice-specific authentication and authorization, the AMF shall in the REGISTRATION ACCEPT message include:

- a) the allowed NSSAI containing the S-NSSAI(s) or the mapped S-NSSAI(s), if any:
 - 1) which are not subject to network slice-specific authentication and authorization and are allowed by the AMF; or
 - 2) for which the network slice-specific authentication and authorization has been successfully performed;
- aa) the partially allowed NSSAI containing the S-NSSAI(s) or the mapped S-NSSAI(s), if any:
 - 1) which are not subject to network slice-specific authentication and authorization and are allowed by the AMF; or
 - 2) for which the network slice-specific authentication and authorization has been successfully performed;
- b) optionally, the rejected NSSAI;
- ba) optionally, the partially rejected NSSAI;
- c) pending NSSAI containing one or more S-NSSAIs for which network slice-specific authentication and authorization (except for re-NSSAA) will be performed or is ongoing, and one or more S-NSSAIs from the pending NSSAI which the AMF provided to the UE during the previous registration procedure for which network slice-specific authentication and authorization will be performed or is ongoing, if any; and
- d) the "NSSAA to be performed" indicator in the 5GS registration result IE set to indicate that the network slice-specific authentication and authorization procedure will be performed by the network, if the allowed NSSAI is not included in the REGISTRATION ACCEPT message.

If the initial registration request is not for onboarding services in SNPN, the UE indicated the support for network slice-specific authentication and authorization, and:

- a) the UE did not include the requested NSSAI in the REGISTRATION REQUEST message or none of the S-NSSAIs in the requested NSSAI in the REGISTRATION REQUEST message are allowed;
- b) all default S-NSSAIs are subject to network slice-specific authentication and authorization; and
- c) the network slice-specific authentication and authorization procedure has not been successfully performed for any of the default S-NSSAIs,

the AMF shall in the REGISTRATION ACCEPT message include:

- a) the "NSSAA to be performed" indicator in the 5GS registration result IE to indicate that the network slice-specific authentication and authorization procedure will be performed by the network;
- b) pending NSSAI containing one or more default S-NSSAIs for which network slice-specific authentication and authorization will be performed or is ongoing and one or more S-NSSAIs from the pending NSSAI which the AMF provided to the UE during the previous registration procedure for which network slice-specific authentication and authorization will be performed or is ongoing (if any);
- c) optionally, the rejected NSSAI; and
- e) optionally, the partially rejected NSSAI.

If the initial registration request is not for onboarding services in SNPN, the UE indicated the support for network slice-specific authentication and authorization, and:

- a) the UE did not include the requested NSSAI in the REGISTRATION REQUEST message or none of the S-NSSAIs in the requested NSSAI in the REGISTRATION REQUEST message are allowed; and
- b) one or more default S-NSSAIs are not subject to network slice-specific authentication and authorization or the network slice-specific authentication and authorization procedure has been successfully performed for one or more default S-NSSAIs;

the AMF shall in the REGISTRATION ACCEPT message include:

- a) pending NSSAI containing one or more default S-NSSAIs for which network slice-specific authentication and authorization will be performed or is ongoing (if any) and one or more S-NSSAIs from the pending NSSAI which the AMF provided to the UE during the previous registration procedure for which network slice-specific authentication and authorization will be performed or is ongoing (if any);
- b) allowed NSSAI containing S-NSSAI(s) for the current PLMN each of which corresponds to a default S-NSSAI which are not subject to network slice-specific authentication and authorization or for which the network slice-specific authentication and authorization has been successfully performed;
- c) allowed NSSAI containing one or more default S-NSSAIs, as the mapped S-NSSAI(s) for the allowed NSSAI in roaming scenarios, which are not subject to network slice-specific authentication and authorization or for which the network slice-specific authentication and authorization has been successfully performed; and
- d) optionally, the rejected NSSAI.

If the UE did not include the requested NSSAI in the REGISTRATION REQUEST message or none of the S-NSSAIs in the requested NSSAI in the REGISTRATION REQUEST message are allowed, the allowed NSSAI shall not contain default S-NSSAI(s) that are subject to NSAC. If the subscription information includes the NSSRG information, the S-NSSAIs of the allowed NSSAI shall be associated with at least one common NSSRG value.

When the REGISTRATION ACCEPT message includes a pending NSSAI, the pending NSSAI shall contain all S-NSSAIs for which network slice-specific authentication and authorization (except for re-NSSAA) will be performed or is ongoing from the requested NSSAI of the REGISTRATION REQUEST message that was received over the 3GPP access, non-3GPP access, or both the 3GPP access and non-3GPP access.

If the UE supports extended rejected NSSAI and the AMF determines that maximum number of UEs reached for one or more S-NSSAI(s) in the requested NSSAI as specified in subclause 4.6.2.5, the AMF shall include the rejected NSSAI containing one or more S-NSSAIs with the rejection cause "S-NSSAI not available due to maximum number of UEs reached" in the Extended rejected NSSAI IE in the REGISTRATION ACCEPT message. In addition, the AMF may include a back-off timer value for each S-NSSAI with the rejection cause "S-NSSAI not available due to maximum number of UEs reached" included in the Extended rejected NSSAI IE of the REGISTRATION ACCEPT message. To

avoid that large numbers of UEs simultaneously initiate deferred requests, the network should select the value for the backoff timer for each S-NSSAI for the informed UEs so that timeouts are not synchronised.

If the UE does not indicate support for extended rejected NSSAI and the maximum number of UEs has been reached, the AMF should include the rejected NSSAI containing one or more S-NSSAIs with the rejection cause "S-NSSAI not available in the current registration area" in the Rejected NSSAI IE and should not include these S-NSSAIs in the allowed NSSAI in the REGISTRATION ACCEPT message.

NOTE 13: Based on network policies, the AMF can include the S-NSSAI(s) for which the maximum number of UEs has been reached in the rejected NSSAI with rejection causes other than "S-NSSAI not available in the current registration area".

If the UE indicates support for network slice usage control and the AMF determines to provide on-demand NSSAI, the AMF shall include the On-demand NSSAI IE in the REGISTRATION ACCEPT message. In addition, the AMF shall start timer T3550 and enter state 5GMM-COMMON-PROCEDURE-INITIATED as described in subclause 5.1.3.2.3.3.

If the UE receives the On-demand NSSAI IE in the REGISTRATION ACCEPT message, the UE shall store the on-demand NSSAI as specified in subclause 4.6.2.2.

If the AMF has a new configured NSSAI for the current PLMN or SNPN, the AMF shall include the configured NSSAI for the current PLMN or SNPN in the REGISTRATION ACCEPT message.

NOTE 13A: A new configured NSSAI can be available at the AMF following an indication that the subscription data for network slicing has changed.

The AMF may include a new configured NSSAI for the current PLMN or SNPN in the REGISTRATION ACCEPT message if:

- a) the REGISTRATION REQUEST message did not include the requested NSSAI and the initial registration request is not for onboarding services in SNPN;
- b) the REGISTRATION REQUEST message included the requested NSSAI containing an S-NSSAI that is not valid in the serving PLMN or SNPN;
- c) the REGISTRATION REQUEST message included the requested NSSAI containing S-NSSAI(s) with incorrect mapped S-NSSAI(s);
- d) the REGISTRATION REQUEST message included the Network slicing indication IE with the Default configured NSSAI indication bit set to "Requested NSSAI created from default configured NSSAI";
- e) the S-NSSAIs of the requested NSSAI in the REGISTRATION REQUEST message are not associated with any common NSSRG value, except for the case that the AMF, based on the indication received from the UDM as specified in 3GPP TS 23.501 [8], has provided all subscribed S-NSSAIs in the configured NSSAI to a UE who does not support NSSRG; or

NOTE 14: If the S-NSSAIs of the requested NSSAI in the REGISTRATION REQUEST message are not associated with any common NSSRG value, it is possible that at least one of the S-NSSAIs is not included in any of new allowed NSSAI, new (extended) rejected NSSAI (if applicable), and new pending NSSAI (if applicable).

- f) the UE is in 5GMM-REGISTERED state over the other access and the S-NSSAIs of the requested NSSAI in the REGISTRATION REQUEST message over the current access and the allowed NSSAI over the other access are not associated with any common NSSRG value.

If the REGISTRATION REQUEST message includes a requested NSSAI containing an S-NSSAI, the S-NSSAI time validity information, if available, indicates that the S-NSSAI is not available (see 3GPP TS 23.501 [8]), the TempNS bit of the 5GMM capability IE in the REGISTRATION REQUEST message is set to:

- a) "S-NSSAI time validity information supported", and the S-NSSAI time validity information indicates that the S-NSSAI will:
 - 1) become available again, then the AMF shall send a configured NSSAI and S-NSSAI time validity information; or
 - 2) not become available again, then the AMF shall send a configured NSSAI not including the S-NSSAI in the new configured NSSAI; or

- b) "S-NSSAI time validity information not supported", then the AMF shall send the S-NSSAI in a rejected NSSAI for the current registration area.

If a new configured NSSAI for the current PLMN is included in the REGISTRATION ACCEPT message, the subscription information includes the NSSRG information, and the NSSRG bit in the 5GMM capability IE of the REGISTRATION REQUEST message is set to:

- a) "NSSRG supported", then the AMF shall include the NSSRG information in the REGISTRATION ACCEPT message; or
- b) "NSSRG not supported", then the configured NSSAI shall include one or more S-NSSAIs each of which is associated with all the NSSRG value(s) of the default S-NSSAI(s), or the configured NSSAI shall include, based on the indication received from the UDM as specified in 3GPP TS 23.501 [8], all subscribed S-NSSAIs even if these S-NSSAIs do not share any common NSSRG value.

If the AMF needs to update the NSSRG information and the UE has set the NSSRG bit to "NSSRG supported" in the 5GMM capability IE of the REGISTRATION REQUEST message, then the AMF shall include the new NSSRG information in the REGISTRATION ACCEPT message. In addition, the AMF shall start timer T3550 and enter state 5GMM-COMMON-PROCEDURE-INITIATED as described in subclause 5.1.3.2.3.3.

If the UE supports S-NSSAI time validity information and the AMF needs to update the S-NSSAI time validity information, then the AMF shall include the S-NSSAI time validity information IE in the REGISTRATION ACCEPT message. In addition, the AMF shall start timer T3550 and enter state 5GMM-COMMON-PROCEDURE-INITIATED as described in subclause 5.1.3.2.3.3.

If the UE supports S-NSSAI location validity information and the AMF needs to update the S-NSSAI location validity information, then the AMF shall include the new S-NSSAI location validity information in the Registration accept type 6 IE container IE of the REGISTRATION ACCEPT message. In addition, the AMF shall start timer T3550 and enter state 5GMM-COMMON-PROCEDURE-INITIATED as described in subclause 5.1.3.2.3.3.

If the UE has set the NSAG bit to "NSAG supported" in the 5GMM capability IE of the REGISTRATION REQUEST message over 3GPP access, the AMF may include the NSAG information IE in the REGISTRATION ACCEPT message. Up to 4 NSAG entries are allowed to be associated with a TAI list in the NSAG information IE. If the UE has set the RCMAN bit to "Sending of REGISTRATION COMPLETE message for NSAG information supported" in the 5GMM capability IE of the REGISTRATION REQUEST message and if the NSAG information IE is included in the REGISTRATION ACCEPT message, the AMF shall start timer T3550 and enter state 5GMM-COMMON-PROCEDURE-INITIATED as described in subclause 5.1.3.2.3.3.

NOTE 14A: How the AMF selects NSAG entries to be included in the NSAG information IE is implementation specific, e.g. take the NSAG priority and the current registration area into account.

NOTE 14B: If the NSAG for the PLMN and its equivalent PLMN(s) have different associations with S-NSSAIs, then the AMF includes a TAI list for the NSAG entry in the NSAG information IE.

If the UE receives the NSAG information IE in the REGISTRATION ACCEPT message, the UE shall store the NSAG information as specified in subclause 4.6.2.2.

If the UE supports network slice replacement and the AMF determines to provide the mapping information between the S-NSSAI to be replaced and the alternative S-NSSAI to the UE, then the AMF shall include the Alternative NSSAI IE, the Allowed NSSAI IE or the Partially allowed NSSAI IE including the alternative S-NSSAI, if not included in the current allowed NSSAI or the current partially allowed NSSAI, and the Configured NSSAI IE including the alternative S-NSSAI, if not included in the current configured NSSAI, in the REGISTRATION ACCEPT message. If the AMF determines that the replaced S-NSSAI is available, then the AMF shall provide the updated alternative NSSAI excluding the replaced S-NSSAI and the corresponding alternative S-NSSAI in the Alternative NSSAI IE in the REGISTRATION ACCEPT message. If the AMF determines that all the replaced S-NSSAI(s) are available, then the AMF shall provide the Alternative NSSAI IE with Length of Alternative NSSAI contents set to 0 in the REGISTRATION ACCEPT message. In addition, the AMF shall start timer T3550 and enter state 5GMM-COMMON-PROCEDURE-INITIATED as described in subclause 5.1.3.2.3.3. If the AMF determines that the replaced S-NSSAI is not supported due to the UE moving outside of NS-AoS of the S-NSSAI while the alternative S-NSSAI is available, then the AMF shall provide the updated allowed NSSAI and partially allowed NSSAI, if available, excluding the replaced S-NSSAI, if included, in the allowed NSSAI or partially allowed NSSAI in the REGISTRATION ACCEPT message.

If the UE receives the Alternative NSSAI IE in the REGISTRATION ACCEPT message, the UE shall store the alternative NSSAI as specified in subclause 4.6.2.2.

If the UE has indicated the support for partial network slice and the AMF determines one or more S-NSSAI(s) in the requested NSSAI are to be included in the partially allowed NSSAI as specified in subclause 4.6.2.11, the AMF shall include the Partially allowed NSSAI IE in the Registration accept type 6 IE container IE of the REGISTRATION ACCEPT message.

If the UE receives the Partially allowed NSSAI IE in the Registration accept type 6 IE container IE of the REGISTRATION ACCEPT message, the UE shall store the partially allowed NSSAI as specified in subclause 4.6.2.2.

If the UE requests ciphering keys for ciphered broadcast assistance data in the REGISTRATION REQUEST message and the AMF has valid ciphering key data applicable to the UE's subscription and current tracking area, then the AMF shall include the ciphering key data in the Ciphering key data IE of the REGISTRATION ACCEPT message.

The AMF shall include the Network slicing indication IE with the Network slicing subscription change indication set to "Network slicing subscription changed" in the REGISTRATION ACCEPT message if the UDM has indicated that the subscription data for network slicing has changed. In this case the AMF shall start timer T3550 and enter state 5GMM-COMMON-PROCEDURE-INITIATED as described in subclause 5.1.3.2.3.3.

The UE that has indicated the support for network slice-specific authentication and authorization receiving the pending NSSAI in the REGISTRATION ACCEPT message shall store the S-NSSAI(s) in the pending NSSAI as specified in subclause 4.6.2.2. If the registration area contains TAIs belonging to different PLMNs, which are equivalent PLMNs, the UE shall store the received pending NSSAI for each of the equivalent PLMNs as specified in subclause 4.6.2.2. If the pending NSSAI is not included in the REGISTRATION ACCEPT message and the "NSSAA to be performed" indicator is not set to "Network slice-specific authentication and authorization is to be performed" in the 5GS registration result IE of the REGISTRATION ACCEPT message, then the UE shall delete the pending NSSAI for the current PLMN and its equivalent PLMN(s) or SNPN, if existing, as specified in subclause 4.6.2.2.

The UE receiving the rejected NSSAI in the REGISTRATION ACCEPT message takes the following actions based on the rejection cause in the rejected S-NSSAI(s):

"S-NSSAI not available in the current PLMN or SNPN"

The UE shall add the rejected S-NSSAI(s) in the rejected NSSAI for the current PLMN or SNPN as specified in subclause 4.6.2.2 and shall not attempt to use this S-NSSAI(s) in the current PLMN or SNPN over any access until switching off the UE, the UICC containing the USIM is removed, the entry of the "list of subscriber data" with the SNPN identity of the current SNPN is updated, or the rejected S-NSSAI(s) are removed as described in subclause 4.6.2.2.

"S-NSSAI not available in the current registration area"

The UE shall add the rejected S-NSSAI(s) in the rejected NSSAI for the current registration area as specified in subclause 4.6.2.2 and shall not attempt to use this S-NSSAI(s) in the current registration area over the current access until switching off the UE, the UE moving out of the current registration area, the UICC containing the USIM is removed, the entry of the "list of subscriber data" with the SNPN identity of the current SNPN is updated, or the rejected S-NSSAI(s) are removed as described in subclause 4.6.2.2.

"S-NSSAI not available due to the failed or revoked network slice-specific authentication and authorization"

The UE shall store the rejected S-NSSAI(s) in the rejected NSSAI for the failed or revoked NSSAA as specified in subclause 4.6.2.2 and shall not attempt to use this S-NSSAI in the current PLMN or SNPN over any access until switching off the UE, the UICC containing the USIM is removed, the entry of the "list of subscriber data" with the SNPN identity of the current SNPN is updated, or the rejected S-NSSAI(s) are removed as described in subclause 4.6.1 and 4.6.2.2.

"S-NSSAI not available due to maximum number of UEs reached"

Unless the back-off timer value received along with the S-NSSAI is zero, the UE shall add the rejected S-NSSAI(s) in the rejected NSSAI for the maximum number of UEs reached as specified in subclause 4.6.2.2 and shall not attempt to use this S-NSSAI in the current PLMN or SNPN over the current access until switching off the UE, the UICC containing the USIM is removed, the entry of the "list of subscriber data" with the SNPN identity of the current SNPN is updated, or the rejected S-NSSAI(s) are removed as described in subclauses 4.6.1 and 4.6.2.2.

NOTE 15: If the back-off timer value received along with the S-NSSAI in the rejected NSSAI for the maximum number of UEs reached is zero as specified in subclause 10.5.7.4a of 3GPP TS 24.008 [12], the UE does not consider the S-NSSAI as the rejected S-NSSAI.

If there is one or more S-NSSAIs in the rejected NSSAI with the rejection cause "S-NSSAI not available due to maximum number of UEs reached", then for each S-NSSAI, the UE shall behave as follows:

- a) stop the timer T3526 associated with the S-NSSAI, if running;
- b) start the timer T3526 with:
 - 1) the back-off timer value received along with the S-NSSAI, if a back-off timer value is received along with the S-NSSAI that is neither zero nor deactivated; or
 - 2) an implementation specific back-off timer value, if no back-off timer value is received along with the S-NSSAI; and
- c) remove the S-NSSAI from the rejected NSSAI for the maximum number of UEs reached when the timer T3526 associated with the S-NSSAI expires.

If the UE sets the NSSAA bit in the 5GMM capability IE to "Network slice-specific authentication and authorization not supported", and:

- a) if the Requested NSSAI IE only includes the S-NSSAI(s) subject to network slice-specific authentication and authorization and one or more default S-NSSAIs (containing one or more S-NSSAIs each of which may be associated with a new S-NSSAI) which are not subject to network slice-specific authentication and authorization are available, the AMF shall in the REGISTRATION ACCEPT message include:
 - 1) the allowed NSSAI or the partially allowed NSSAI containing S-NSSAI(s) for the current PLMN or SNPN each of which corresponds to a default S-NSSAI which are not subject to network slice-specific authentication and authorization;
 - 2) the allowed NSSAI or the partially allowed NSSAI containing the default S-NSSAIs, as the mapped S-NSSAI(s) for the allowed NSSAI in roaming scenarios, which are not subject to network slice-specific authentication and authorization; and
 - 3) the rejected NSSAI containing the S-NSSAI(s) subject to network slice specific authentication and authorization with the rejection cause indicating "S-NSSAI not available in the current PLMN or SNPN", except if the UE has not set the ER-NSSAI bit to "Extended rejected NSSAI supported" in the 5GMM capability IE of the REGISTRATION REQUEST message and the S-NSSAI(s) is associated to multiple mapped S-NSSAIs and some of these but not all mapped S-NSSAIs are subject to NSSAA; or
- b) if the Requested NSSAI IE includes one or more S-NSSAIs subject to network slice-specific authentication and authorization, the AMF shall in the REGISTRATION ACCEPT message include:
 - 1) the allowed NSSAI or the partially allowed NSSAI containing the S-NSSAI(s) or the mapped S-NSSAI(s) which are not subject to network slice-specific authentication and authorization; and
 - 2) the rejected NSSAI containing:
 - i) the S-NSSAI(s) subject to network slice specific authentication and authorization with the rejection cause indicating "S-NSSAI not available in the current PLMN or SNPN", except if the UE has not set the ER-NSSAI bit to "Extended rejected NSSAI supported" in the 5GMM capability IE of the REGISTRATION REQUEST message and the S-NSSAI is associated to multiple mapped S-NSSAIs and some of these but not all mapped S-NSSAIs are subject to NSSAA; and
 - ii) the S-NSSAI(s) which was included in the requested NSSAI but rejected by the network associated with the rejection cause indicating "S-NSSAI not available in the current PLMN or SNPN" or the rejection cause indicating "S-NSSAI not available in the current registration area", if any.

If the UE does not indicate support for network slice-specific authentication and authorization, the initial registration request is not for onboarding services in SNPN, and if:

- a) the UE did not include the requested NSSAI in the REGISTRATION REQUEST message; or
- b) none of the S-NSSAIs in the requested NSSAI in the REGISTRATION REQUEST message are allowed;

and one or more default S-NSSAIs (containing one or more S-NSSAIs each of which may be associated with a new S-NSSAI) which are not subject to network slice-specific authentication and authorization are available, the AMF shall:

- a) put the allowed S-NSSAI(s) for the current PLMN or SNPN each of which corresponds to a default S-NSSAI and not subject to network slice-specific authentication and authorization in the allowed NSSAI of the REGISTRATION ACCEPT message;
- b) put the default S-NSSAIs and not subject to network slice-specific authentication and authorization, as the mapped S-NSSAI(s) for the allowed NSSAI in roaming scenarios, in the allowed NSSAI of the REGISTRATION ACCEPT message; and
- c) determine a registration area such that all S-NSSAIs of the allowed NSSAI are available in the registration area.

If the REGISTRATION ACCEPT message contains the Network slicing indication IE with the Network slicing subscription change indication set to "Network slicing subscription changed", the UE shall delete the network slicing information for each and every PLMN or SNPN except for the current PLMN or SNPN as specified in subclause 4.6.2.2 and remove all tracking areas from the list of "5GS forbidden tracking areas for roaming" which were added due to rejection of S-NSSAI due to "S-NSSAI not available in the current registration area".

If the REGISTRATION ACCEPT message contains the allowed NSSAI, then the UE shall store the included allowed NSSAI together with the PLMN identity of the registered PLMN or the SNPN identity of the registered SNPN and the registration area as specified in subclause 4.6.2.2. If the registration area contains TAIs belonging to different PLMNs, which are equivalent PLMNs, the UE shall store the received allowed NSSAI in each of allowed NSSAIs which are associated with each of the PLMNs.

If the REGISTRATION ACCEPT message contains a configured NSSAI IE with a new configured NSSAI for the current PLMN or SNPN and optionally the mapped S-NSSAI(s) for the configured NSSAI for the current PLMN or SNPN, the UE shall store the contents of the configured NSSAI IE as specified in subclause 4.6.2.2. In addition, if the REGISTRATION ACCEPT message contains:

- a) an NSSRG information IE, the UE shall store the contents of the NSSRG information IE as specified in subclause 4.6.2.2. If the UE receives a new configured NSSAI in the REGISTRATION ACCEPT message and no NSSRG information IE, the UE shall delete any stored NSSRG information, if any, as specified in subclause 4.6.2.2;
- b) an S-NSSAI location validity information in the Registration accept type 6 IE container IE, the UE shall store the contents of the S-NSSAI location validity information as specified in subclause 4.6.2.2. If the UE receives a Configured NSSAI IE in the REGISTRATION ACCEPT message and no S-NSSAI location validity information, the UE shall delete any stored S-NSSAI location validity information as specified in subclause 4.6.2.2;
- c) an S-NSSAI time validity information IE, the UE shall store the contents of the S-NSSAI time validity information IE as specified in subclause 4.6.2.2. If the UE receives a Configured NSSAI IE in the REGISTRATION ACCEPT message and no S-NSSAI time validity information IE, the UE shall delete any stored S-NSSAI time validity information as specified in subclause 4.6.2.2; or
- d) an On-demand NSSAI IE, the UE shall store the contents of the On-demand NSSAI IE as specified in subclause 4.6.2.2. If the UE receives a Configured NSSAI IE in the REGISTRATION ACCEPT message and no On-demand NSSAI IE, the UE shall delete any stored on-demand NSSAI as specified in subclause 4.6.2.2. The UE shall stop slice deregistration inactivity timer, if running for the S-NSSAI which is deleted from the on-demand NSSAI.

If the REGISTRATION ACCEPT message:

- a) includes the 5GS registration result IE with the "NSSAA to be performed" indicator set to "Network slice-specific authentication and authorization is to be performed";
- b) includes a pending NSSAI;
- c) does not include an allowed NSSAI; and
- d) does not include an partially allowed NSSAI,

the UE shall delete the stored allowed NSSAI, if any, as specified in subclause 4.6.2.2, and the UE:

- a) shall not initiate a 5GSM procedure except for emergency services ; and
- b) shall not initiate a service request procedure except for cases f), i), m) and o) in subclause 5.6.1.1;
- c) shall not initiate an NAS transport procedure except for sending SMS, an LPP message, a UPP-CMI container, an SLPP message, a location service message, an SOR transparent container, a UE policy container, a UE parameters update transparent container or a CIoT user data container;

until the UE receives an allowed NSSAI, a partially allowed NSSAI, or both.

If the UE included S1 mode supported indication in the REGISTRATION REQUEST message, the AMF supporting interworking with EPS shall set the IWK N26 bit to either:

- a) "interworking without N26 interface not supported" if the AMF supports N26 interface; or
- b) "interworking without N26 interface supported" if the AMF does not support N26 interface

in the 5GS network feature support IE in the REGISTRATION ACCEPT message.

The UE supporting S1 mode shall operate in the mode for interworking with EPS as follows:

- a) if the IWK N26 bit in the 5GS network feature support IE is set to "interworking without N26 interface not supported", the UE shall operate in single-registration mode;
- b) if the IWK N26 bit in the 5GS network feature support IE is set to "interworking without N26 interface supported" and the UE supports dual-registration mode, the UE may operate in dual-registration mode; or

NOTE 16: The registration mode used by the UE is implementation dependent.

- c) if the IWK N26 bit in the 5GS network feature support IE is set to "interworking without N26 interface supported" and the UE only supports single-registration mode, the UE shall operate in single-registration mode.

The UE shall store the received interworking without N26 interface indicator for interworking with EPS as specified in annex C.1 and treat it as valid in the entire PLMN and its equivalent PLMN(s).

The network informs the UE about the support of specific features, such as IMS voice over PS session, location services (5G-LCS), emergency services, emergency services fallback, ATSSS and non-3GPP access path switching, in the 5GS network feature support information element. In a UE with IMS voice over PS session capability, the IMS voice over PS session indicator, the Emergency services support indicator, and the Emergency services fallback indicator shall be provided to the upper layers. The upper layers take the IMS voice over PS session indicator into account when selecting the access domain for voice sessions or calls. In a UE with LCS capability, location services indicator (5G-LCS) shall be provided to the upper layers. When initiating an emergency call, the upper layers also take the IMS voice over PS session indicator, the Emergency services support indicator, and the Emergency services fallback indicator into account for the access domain selection. In a UE with the capability for ATSSS, the network support for ATSSS shall be provided to the upper layers. If the UE receives the 5GS network feature support IE with the ATSSS support indicator set to "ATSSS not supported", the UE shall perform a local release of the MA PDU session, if any. In a UE that supports non-3GPP access path switching, the network support for non-3GPP access path switching shall be provided to the upper layers. If the UE receives the 5GS network feature support IE with the non-3GPP access path switching bit set to "non-3GPP access path switching not supported", the UE shall not perform the registration procedure for mobility registration update for non-3GPP access path switching.

NOTE 17: If the UE is registered to different PLMNs over 3GPP and non-3GPP accesses, the UE uses the capability received over non-3GPP access to determine whether to initiate the registration procedure for mobility registration update for non-3GPP path switching.

The AMF shall set the EMF bit in the 5GS network feature support IE to:

- a) "Emergency services fallback supported in NR connected to 5GCN and E-UTRA connected to 5GCN" if the network supports the emergency services fallback procedure when the UE is in an NR cell connected to 5GCN or an E-UTRA cell connected to 5GCN;
- b) "Emergency services fallback supported in NR connected to 5GCN only" if the network supports the emergency services fallback procedure when the UE is in an NR cell connected to 5GCN and does not support the emergency services fallback procedure when the UE is in an E-UTRA cell connected to 5GCN;

- c) "Emergency services fallback supported in E-UTRA connected to 5GCN only" if the network supports the emergency services fallback procedure when the UE is in an E-UTRA cell connected to 5GCN and does not support the emergency services fallback procedure when the UE is in an NR cell connected to 5GCN; or
- d) "Emergency services fallback not supported" if network does not support the emergency services fallback procedure when the UE is in any cell connected to 5GCN.

NOTE 18: If the emergency services are supported in neither the EPS nor the 5GS homogeneously, based on operator policy, the AMF will set the EMF bit in the 5GS network feature support IE to "Emergency services fallback not supported".

NOTE 19: Even though the AMF's support of emergency services fallback is indicated per RAT, the UE's support of emergency services fallback is not per RAT, i.e. the UE's support of emergency services fallback is the same for both NR connected to 5GCN and E-UTRA connected to 5GCN.

Access identity 1 is only applicable while the UE is in N1 mode. Access identity 2 is only applicable while the UE is in N1 mode.

When the UE is registered to the same PLMN or SNPN over 3GPP and non-3GPP access, the UE and the AMF maintain one MPS indicator and one MCS indicator that are common to both 3GPP and non-3GPP access. When the UE is registered to different PLMNs or SNPNS over 3GPP access and non-3GPP access, the UE maintains two MPS indicators and two MCS indicators separately for different accesses i.e., an MPS indicator and an MCS indicator for the 3GPP access and another MPS indicator and an MCS indicator for the non-3GPP access. For both 3GPP and non-3GPP access, the access identity is determined according to subclause 4.5.2:

- if the UE is not operating in SNPN access operation mode:
 - a) the network informs the UE that the use of access identity 1 is valid in the RPLMN or equivalent PLMN by setting the MPS indicator bit of the 5GS network feature support IE to "Access identity 1 valid", in the REGISTRATION ACCEPT message. Based on operator policy, the AMF sets the MPS indicator bit in the REGISTRATION ACCEPT message based on the MPS priority information in the user's subscription context obtained from the UDM;
 - b) upon receiving a REGISTRATION ACCEPT message with the MPS indicator bit set to "Access identity 1 valid":
 - via 3GPP access; or
 - via non-3GPP access if the UE is registered to the same PLMN over 3GPP access and non-3GPP access;

the UE shall act as a UE with access identity 1 configured for MPS, as described in subclause 4.5.2, in all NG-RAN of the registered PLMN and its equivalent PLMNs. The MPS indicator bit in the 5GS network feature support IE provided in the REGISTRATION ACCEPT message is valid in all NG-RAN of the registered PLMN and its equivalent PLMNs until the UE receives a REGISTRATION ACCEPT message or a CONFIGURATION UPDATE COMMAND message with the MPS indicator bit set to "Access identity 1 not valid":

 - via 3GPP access; or
 - via non-3GPP access if the UE is registered to the same PLMN over 3GPP access and non-3GPP access;

or

until the UE selects a non-equivalent PLMN over 3GPP access;
 - b1) upon receiving a REGISTRATION ACCEPT message with the MPS indicator bit set to "Access identity 1 valid":
 - via non-3GPP access; or
 - via 3GPP access if the UE is registered to the same PLMN over 3GPP access and non-3GPP access;

the UE shall act as a UE with access identity 1 configured for MPS, as described in subclause 4.5.2, in non-3GPP access of the registered PLMN and its equivalent PLMNs. The MPS indicator bit in the 5GS network feature support IE provided in the REGISTRATION ACCEPT message is valid in non-3GPP access of the registered PLMN and its equivalent PLMNs until the UE receives a REGISTRATION ACCEPT message or

- a CONFIGURATION UPDATE COMMAND message with the MPS indicator bit set to "Access identity 1 not valid":
- via non-3GPP access; or
 - via 3GPP access if the UE is registered to the same PLMN over 3GPP access and non-3GPP access; or until the UE selects a non-equivalent PLMN over non-3GPP access;
- c) the network informs the UE that the use of access identity 2 is valid in the RPLMN or equivalent PLMN by setting the MCS indicator bit of the 5GS network feature support IE to "Access identity 2 valid", in the REGISTRATION ACCEPT message. Based on operator policy, the AMF sets the MCS indicator bit in the REGISTRATION ACCEPT message based on the MCS priority information in the user's subscription context obtained from the UDM;
- d) upon receiving a REGISTRATION ACCEPT message with the MCS indicator bit set to "Access identity 2 valid":
- via 3GPP access; or
 - via non-3GPP access if the UE is registered to the same PLMN over 3GPP access and non-3GPP access;
- the UE shall act as a UE with access identity 2 configured for MCS, as described in subclause 4.5.2, in all NG-RAN of the registered PLMN and its equivalent PLMNs. The MCS indicator bit in the 5GS network feature support IE provided in the REGISTRATION ACCEPT message is valid in all NG-RAN of the registered PLMN and its equivalent PLMNs until the UE receives a REGISTRATION ACCEPT message or a CONFIGURATION UPDATE COMMAND message with the MCS indicator bit set to "Access identity 2 not valid":
- via 3GPP access; or
 - via non-3GPP access if the UE is registered to the same PLMN over 3GPP access and non-3GPP access; or until the UE selects a non-equivalent PLMN over 3GPP access; and
- d1) upon receiving a REGISTRATION ACCEPT message with the MCS indicator bit set to "Access identity 2 valid":
- via non-3GPP access; or
 - via 3GPP access if the UE is registered to the same PLMN over 3GPP access and non-3GPP access;
- the UE shall act as a UE with access identity 2 configured for MCS, as described in subclause 4.5.2, in non-3GPP access of the registered PLMN and its equivalent PLMNs. The MCS indicator bit in the 5GS network feature support IE provided in the REGISTRATION ACCEPT message is valid in non-3GPP access of the registered PLMN and its equivalent PLMNs until the UE receives a REGISTRATION ACCEPT message or a CONFIGURATION UPDATE COMMAND message with the MCS indicator bit set to "Access identity 2 not valid":
- via non-3GPP access; or
 - via 3GPP access if the UE is registered to the same PLMN over 3GPP access and non-3GPP access; or until the UE selects a non-equivalent PLMN over non-3GPP access; or
- if the UE is operating in SNPN access operation mode:
 - a) the network informs the UE that the use of access identity 1 is valid in the RSNPN or equivalent SNPN by setting the MPS indicator bit of the 5GS network feature support IE to "Access identity 1 valid", in the REGISTRATION ACCEPT message. Based on operator policy, the AMF sets the MPS indicator bit in the REGISTRATION ACCEPT message based on the MPS priority information in the user's subscription context obtained from the UDM;
 - b) upon receiving a REGISTRATION ACCEPT message with the MPS indicator bit set to "Access identity 1 valid":

- via 3GPP access; or
- via non-3GPP access if the UE is registered to the same SNPN over 3GPP access and non-3GPP access;

the UE shall act as a UE with access identity 1 configured for MPS, as described in subclause 4.5.2A, in all NG-RAN of the registered SNPN and its equivalent SNPNs. The MPS indicator bit in the 5GS network feature support IE provided in the REGISTRATION ACCEPT message is valid in all NG-RAN of the registered SNPN and its equivalent SNPNs until the UE receives a REGISTRATION ACCEPT message or a CONFIGURATION UPDATE COMMAND message with the MPS indicator bit set to "Access identity 1 not valid":

- via 3GPP access; or
- via non-3GPP access if the UE is registered to the same SNPN over 3GPP access and non-3GPP access;
or

until the UE selects a non-equivalent SNPN over 3GPP access;

b1) upon receiving a REGISTRATION ACCEPT message with the MPS indicator bit set to "Access identity 1 valid":

- via non-3GPP access; or
- via 3GPP access if the UE is registered to the same SNPN over 3GPP access and non-3GPP access;

the UE shall act as a UE with access identity 1 configured for MPS, as described in subclause 4.5.2A, in non-3GPP access of the registered SNPN and its equivalent SNPNs. The MPS indicator bit in the 5GS network feature support IE provided in the REGISTRATION ACCEPT message is valid in non-3GPP access of the registered SNPN and its equivalent SNPNs until the UE receives a REGISTRATION ACCEPT message or a CONFIGURATION UPDATE COMMAND message with the MPS indicator bit set to "Access identity 1 not valid";

- via non-3GPP access; or
- via 3GPP access if the UE is registered to the same SNPN over 3GPP access and non-3GPP access; or

until the UE selects a non-equivalent SNPN over non-3GPP access;

c) the network informs the UE that the use of access identity 2 is valid in the RSNPN or equivalent SNPN by setting the MCS indicator bit of the 5GS network feature support IE to "Access identity 2 valid", in the REGISTRATION ACCEPT message. Based on operator policy, the AMF sets the MCS indicator bit in the REGISTRATION ACCEPT message based on the MCS priority information in the user's subscription context obtained from the UDM;

d) upon receiving a REGISTRATION ACCEPT message with the MCS indicator bit set to "Access identity 2 valid":

- via 3GPP access; or
- via non-3GPP access if the UE is registered to the same SNPN over 3GPP access and non-3GPP access;

the UE shall act as a UE with access identity 2 configured for MCS, as described in subclause 4.5.2A, in all NG-RAN of the registered SNPN and its equivalent SNPNs. The MCS indicator bit in the 5GS network feature support IE provided in the REGISTRATION ACCEPT message is valid in all NG-RAN of the registered SNPN and its equivalent SNPNs until the UE receives a REGISTRATION ACCEPT message or a CONFIGURATION UPDATE COMMAND message with the MCS indicator bit set to "Access identity 2 not valid":

- via 3GPP access; or
- via non-3GPP access if the UE is registered to the same SNPN over 3GPP access and non-3GPP access;
or

until the UE selects a non-equivalent SNPN over 3GPP access; and

d1) upon receiving a REGISTRATION ACCEPT message with the MCS indicator bit set to "Access identity 2 valid":

- via non-3GPP access; or
- via 3GPP access if the UE is registered to the same SNPN over 3GPP access and non-3GPP access;

the UE shall act as a UE with access identity 2 configured for MCS, as described in subclause 4.5.2A, in non-3GPP access of the registered SNPN and its equivalent SNPNs. The MCS indicator bit in the 5GS network feature support IE provided in the REGISTRATION ACCEPT message is valid in non-3GPP access of the registered SNPN and its equivalent SNPNs until the UE receives a REGISTRATION ACCEPT message or a CONFIGURATION UPDATE COMMAND message with the MCS indicator bit set to "Access identity 2 not valid":

- via non-3GPP access; or
- via 3GPP access if the UE is registered to the same SNPN over 3GPP access and non-3GPP access; or until the UE selects a non-equivalent SNPN over non-3GPP access.

If the UE indicates support for restriction on use of enhanced coverage in the REGISTRATION REQUEST message and:

- a) in WB-N1 mode, the AMF decides to restrict the use of CE mode B for the UE, then the AMF shall set the RestrictEC bit to "CE mode B is restricted";
- b) in WB-N1 mode, the AMF decides to restrict the use of both CE mode A and CE mode B for the UE, then the AMF shall set the RestrictEC bit to " Both CE mode A and CE mode B are restricted"; or
- c) in NB-N1 mode, the AMF decides to restrict the use of enhanced coverage for the UE, then the AMF shall set the RestrictEC bit to "Use of enhanced coverage is restricted",

in the 5GS network feature support IE in the REGISTRATION ACCEPT message.

If the UE indicates support of the N1 NAS signalling connection release in the REGISTRATION REQUEST message and the network decides to accept the N1 NAS signalling connection release, then the AMF shall set the N1 NAS signalling connection release bit to "N1 NAS signalling connection release supported" in the 5GS network feature support IE of the REGISTRATION ACCEPT message.

If the UE indicates support of the paging indication for voice services in the REGISTRATION REQUEST message and the network decides to accept the paging indication for voice services, then the AMF shall set the paging indication for voice services bit to "paging indication for voice services supported" in the 5GS network feature support IE of the REGISTRATION ACCEPT message. Upon receipt of REGISTRATION ACCEPT message with the paging indication for voice services bit set to "paging indication for voice services supported", the UE NAS layer informs the lower layers that paging indication for voice services is supported. Otherwise, the UE NAS layer informs the lower layers that paging indication for voice services is not supported.

If the UE indicates support of the reject paging request in the REGISTRATION REQUEST message and the network decides to accept the reject paging request, then the AMF shall set the reject paging request bit to "reject paging request supported" in the 5GS network feature support IE of the REGISTRATION ACCEPT message.

If the UE indicates support of the paging restriction in the REGISTRATION REQUEST message, and the AMF sets:

- the reject paging request bit to "reject paging request supported";
- the N1 NAS signalling connection release bit to "N1 NAS signalling connection release supported"; or
- both of them;

in the 5GS network feature support IE of the REGISTRATION ACCEPT message, and the network decides to accept the paging restriction, then the AMF shall set the paging restriction bit to "paging restriction supported" in the 5GS network feature support IE of the REGISTRATION ACCEPT message.

If the UE indicates support of ranging and sidelink positioning in the REGISTRATION REQUEST message and the network supports and accepts the use of ranging and sidelink positioning, the AMF shall set the ranging and sidelink

positioning support bit to "Ranging and sidelink positioning supported" in the 5GS network feature support IE of the REGISTRATION ACCEPT message.

If the UE has set the Follow-on request indicator to "Follow-on request pending" in the REGISTRATION REQUEST message, or the network has downlink signalling pending, the AMF shall not immediately release the NAS signalling connection after the completion of the registration procedure.

If the UE is authorized to use V2X communication over PC5 reference point based on:

- a) at least one of the following bits in the 5GMM capability IE of the REGISTRATION REQUEST message set by the UE, or already stored in the 5GMM context in the AMF during the previous registration procedure as follows:
 - 1) the V2XCEPC5 bit to "V2X communication over E-UTRA-PC5 supported"; or
 - 2) the V2XCNPC5 bit to "V2X communication over NR-PC5 supported"; and
- b) the user's subscription context obtained from the UDM as defined in 3GPP TS 23.287 [6C];

the AMF should not immediately release the NAS signalling connection after the completion of the registration procedure.

If the UE is authorized to use A2X communication over PC5 reference point based on:

- a) at least one of the following bits in the 5GMM capability IE of the REGISTRATION REQUEST message set by the UE, or already stored in the 5GMM context in the AMF during the previous registration procedure as follows:
 - 1) the A2XEPC5 bit to "A2X over E-UTRA-PC5 supported"; or
 - 2) the A2XNPC5 bit to "A2X over NR-PC5 supported"; and
- b) the user's subscription context obtained from the UDM as defined in 3GPP TS 23.256 [6C];

the AMF should not immediately release the NAS signalling connection after the completion of the registration procedure.

If the UE is authorized to use 5G ProSe services based on:

- a) at least one of the following bits in the 5GMM capability IE of the REGISTRATION REQUEST message set by the UE, or already stored in the 5GMM context in the AMF during the previous registration procedure as follows:
 - 1) the 5G ProSe direct discovery bit to "5G ProSe direct discovery supported"; or
 - 2) the 5G ProSe direct communication bit to "5G ProSe direct communication supported"; and
- b) the user's subscription context obtained from the UDM as defined in 3GPP TS 23.304 [6E];

the AMF should not immediately release the NAS signalling connection after the completion of the registration procedure.

If the Requested DRX parameters IE was included in the REGISTRATION REQUEST message, the AMF shall include the Negotiated DRX parameters IE in the REGISTRATION ACCEPT message and replace any stored Negotiated DRX parameter and use it for the downlink transfer of signalling and user data. The AMF may set the Negotiated DRX parameters IE based on the received Requested DRX parameters IE and operator policy if available.

If the Requested NB-N1 mode DRX parameters IE was included in the REGISTRATION REQUEST message, the AMF shall include the Negotiated NB-N1 mode DRX parameters IE in the REGISTRATION ACCEPT message and replace any stored Negotiated NB-N1 mode DRX parameters and use it for the downlink transfer of signalling and user data in NB-N1 mode. The AMF may set the Negotiated NB-N1 mode DRX parameters IE based on the received Requested NB-N1 mode DRX parameters IE and operator policy if available.

The AMF shall include the Negotiated extended DRX parameters IE in the REGISTRATION ACCEPT message only if the Requested extended DRX parameters IE was included in the REGISTRATION REQUEST message, and the AMF supports and accepts the use of eDRX. The AMF may set the Negotiated extended DRX parameters IE based on the

received Requested extended DRX parameters IE, operator policy, information from NG-RAN and the user's subscription context obtained from the UDM if available.

If:

- a) the UE's USIM is configured with indication that the UE is to receive the SOR transparent container IE, the SOR transparent container IE included in the REGISTRATION ACCEPT message does not successfully pass the integrity check (see 3GPP TS 33.501 [24]); and
- b) if the UE attempts obtaining service on another PLMNs as specified in 3GPP TS 23.122 [5] annex C;

then the UE shall locally release the established N1 NAS signalling connection after sending a REGISTRATION COMPLETE message.

If:

- a) the UE's USIM is configured with indication that the UE is to receive the SOR transparent container IE, the SOR transparent container IE is not included in the REGISTRATION ACCEPT message; and
- b) the UE attempts obtaining service on another PLMNs as specified in 3GPP TS 23.122 [5] annex C;

then the UE shall locally release the established N1 NAS signalling connection.

If:

- a) the UE operates in SNPN access operation mode;
- b) the ME is configured to indicate that the UE shall expect to receive the steering of roaming information during initial registration procedure for the selected entry of the "list of subscriber data" or the selected PLMN subscription;
- c) the SOR transparent container IE included in the REGISTRATION ACCEPT message does not successfully pass the integrity check (see 3GPP TS 33.501 [24]); and
- d) the UE attempts obtaining service on another SNPN as specified in 3GPP TS 23.122 [5] annex C;

then the UE shall locally release the established N1 NAS signalling connection after sending a REGISTRATION COMPLETE message.

If:

- a) the UE operates in SNPN access operation mode;
- b) the ME is configured to indicate that the UE shall expect to receive the steering of roaming information during initial registration procedure for the selected entry of the "list of subscriber data" or the selected PLMN subscription;
- c) the SOR transparent container IE is not included in the REGISTRATION ACCEPT message; and
- d) the UE attempts obtaining service on another SNPN as specified in 3GPP TS 23.122 [5] annex C;

then the UE shall locally release the established N1 NAS signalling connection.

If the REGISTRATION ACCEPT message includes the SOR transparent container IE and the SOR transparent container IE successfully passes the integrity check (see 3GPP TS 33.501 [24]), the ME shall store the received SOR counter as specified in annex C and proceed as follows:

- a) the UE shall proceed with the behaviour as specified in 3GPP TS 23.122 [5] annex C; and
- b) if the registration procedure is performed over 3GPP access and the UE attempts obtaining service on another PLMNs or SNPNs as specified in 3GPP TS 23.122 [5] annex C, then the UE may locally release the established N1 NAS signalling connection after sending a REGISTRATION COMPLETE message. Otherwise the UE shall send a REGISTRATION COMPLETE message and not release the current N1 NAS signalling connection locally. If an acknowledgement is requested in the SOR transparent container IE of the REGISTRATION ACCEPT message, the UE acknowledgement is included in the SOR transparent container IE of the REGISTRATION COMPLETE message. In the SOR transparent container IE carrying the acknowledgement, the UE shall set the ME support of SOR-CMCI indicator to "SOR-CMCI supported by the ME". Additionally, if

the UE supports access to an SNPN using credentials from a credentials holder and the UE is not operating in SNPN access operation mode, the UE may set the ME support of SOR-SNPN-SI indicator to "SOR-SNPN-SI supported by the ME". Additionally, if the UE supports access to an SNPN providing access for localized services in SNPN, the UE shall set the ME support of SOR-SNPN-SI-LS indicator to "SOR-SNPN-SI-LS supported by the ME"

If the SOR transparent container IE successfully passes the integrity check (see 3GPP TS 33.501 [24]) and:

- a) the list type indicates:
 - 1) "PLMN ID and access technology list", and the SOR transparent container IE indicates a list of preferred PLMN/access technology combinations is provided, then the ME shall replace the highest priority entries in the "Operator Controlled PLMN Selector with Access Technology" list stored in the ME and shall proceed with the behaviour as specified in 3GPP TS 23.122 [5] annex C; or
 - 2) "secured packet", then the ME shall behave as if a SMS is received with protocol identifier set to SIM data download, data coding scheme set to class 2 message and SMS payload as secured packet contents of SOR transparent container IE. The SMS payload is forwarded to UICC as specified in 3GPP TS 23.040 [4A] and the ME shall proceed with the behaviour as specified in 3GPP TS 23.122 [5] annex C; or
- b) the list type indicates "PLMN ID and access technology list" and the SOR transparent container IE indicates "HPLMN indication that 'no change of the "Operator Controlled PLMN Selector with Access Technology" list stored in the UE is needed and thus no list of preferred PLMN/access technology combinations is provided"', the UE operates in SNPN access operation mode and the SOR transparent container IE includes SOR-SNPN-SI, the ME shall replace SOR-SNPN-SI of the selected entry of the "list of subscriber data" or associated with the selected PLMN subscription, as specified in 3GPP TS 23.122 [5] with the received SOR-SNPN-SI. Additionally, if the SOR transparent container IE includes SOR-SNPN-SI-LS, the ME shall replace SOR-SNPN-SI-LS of the selected entry of the "list of subscriber data" or associated with the selected PLMN subscription, as specified in 3GPP TS 23.122 [5] with the received SOR-SNPN-SI-LS.

If the SOR-CMCI is present and the Store SOR-CMCI in ME indicator is set to "Store SOR-CMCI in ME" then the UE shall store or delete the SOR-CMCI in the non-volatile memory of the ME as described in annex C.1.

The UE shall proceed with the behaviour as specified in 3GPP TS 23.122 [5] annex C.

If the SOR transparent container IE does not pass the integrity check successfully, then the UE shall discard the content of the SOR transparent container IE.

If required by operator policy, the AMF shall include the NSSAI inclusion mode IE in the REGISTRATION ACCEPT message (see table 4.6.2.3.1 of subclause 4.6.2.3). Upon receipt of the REGISTRATION ACCEPT message:

- a) if the message includes the NSSAI inclusion mode IE, the UE shall operate in the NSSAI inclusion mode indicated in the NSSAI inclusion mode IE over the current access within the current PLMN and its equivalent PLMN(s), if any, or the current SNPN, in the current registration area; or
- b) otherwise:
 - 1) if the UE has NSSAI inclusion mode for the current PLMN or SNPN and access type stored in the UE, the UE shall operate in the stored NSSAI inclusion mode;
 - 2) if the UE does not have NSSAI inclusion mode for the current PLMN or SNPN and the access type stored in the UE and if the UE is performing the registration procedure over:
 - i) 3GPP access, the UE shall operate in NSSAI inclusion mode D in the current PLMN or SNPN and the current access type;
 - ii) untrusted non-3GPP access, the UE shall operate in NSSAI inclusion mode B in the current PLMN and the current access type; or
 - iii) trusted non-3GPP access, the UE shall operate in NSSAI inclusion mode D in the current PLMN and the current access type; or
 - 3) if the 5G-RG does not have NSSAI inclusion mode for the current PLMN and wireline access stored in the 5G-RG, and the 5G-RG is performing the registration procedure over wireline access, the 5G-RG shall operate in NSSAI inclusion mode B in the current PLMN and the current access type.

The AMF may include operator-defined access category definitions in the REGISTRATION ACCEPT message.

If the UE receives Operator-defined access category definitions IE in the REGISTRATION ACCEPT message and the Operator-defined access category definitions IE contains one or more operator-defined access category definitions, the UE shall delete any operator-defined access category definitions stored for the RPLMN and shall store the received operator-defined access category definitions for the RPLMN. If the UE receives the Operator-defined access category definitions IE in the REGISTRATION ACCEPT message and the Operator-defined access category definitions IE contains no operator-defined access category definitions, the UE shall delete any operator-defined access category definitions stored for the RPLMN. If the REGISTRATION ACCEPT message does not contain the Operator-defined access category definitions IE, the UE shall not delete the operator-defined access category definitions stored for the RPLMN.

If the UE has indicated support for service gap control in the REGISTRATION REQUEST message and:

- the REGISTRATION ACCEPT message contains the T3447 value IE, then the UE shall store the new T3447 value, erase any previous stored T3447 value if exists and use the new T3447 value with the timer T3447 next time it is started; or
- the REGISTRATION ACCEPT message does not contain the T3447 value IE, then the UE shall erase any previous stored T3447 value if exists and stop the timer T3447 if running.

If the T3448 value IE is present in the received REGISTRATION ACCEPT message and the value indicates that this timer is neither zero nor deactivated, the UE shall:

- a) stop timer T3448 if it is running; and
- b) start timer T3448 with the value provided in the T3448 value IE.

If the UE is using 5GS services with control plane CIoT 5GS optimization, the T3448 value IE is present in the REGISTRATION ACCEPT message and the value indicates that this timer is either zero or deactivated, the UE shall ignore the T3448 value IE and proceed as if the T3448 value IE was not present.

If the REGISTRATION ACCEPT message contains the Truncated 5G-S-TMSI configuration IE, then the UE shall store the included truncated 5G-S-TMSI configuration and return a REGISTRATION COMPLETE message to the AMF to acknowledge reception of the truncated 5G-S-TMSI configuration.

NOTE 20: The UE provides the truncated 5G-S-TMSI configuration to the lower layers.

If the UE is not in NB-N1 mode, the UE has set the RACS bit to "RACS supported" in the 5GMM Capability IE of the REGISTRATION REQUEST message and the REGISTRATION ACCEPT message includes:

- a) a UE radio capability ID deletion indication IE set to "Network-assigned UE radio capability IDs deletion requested", the UE shall delete any network-assigned UE radio capability IDs associated with the RPLMN or RSNPN and, if the UE supports access to an SNPN using credentials from a credentials holder, equivalent SNPNs or both, the selected entry of the "list of subscriber data" or the selected PLMN subscription stored at the UE, then the UE shall, after the completion of the ongoing registration procedure, initiate a registration procedure for mobility and periodic registration update as specified in subclause 5.5.1.3.2 over the existing N1 NAS signalling connection; or
- b) a UE radio capability ID IE, the UE shall store the UE radio capability ID as specified in annex C.

If the UE has included the service-level device ID set to the CAA-level UAV ID in the Service-level-AA container IE of the REGISTRATION REQUEST message and the REGISTRATION ACCEPT message contains the service-level-AA pending indication in the Service-level-AA container IE, the UE shall return a REGISTRATION COMPLETE message to the AMF to acknowledge reception of the service-level-AA pending indication, and the UE shall not attempt to perform another registration procedure for UAS services until the UUAA-MM procedure is completed, or to establish a PDU session for USS communication or a PDU session for C2 communication until the UUAA-MM procedure is completed successfully.

If the UE has included the service-level device ID set to the CAA-level UAV ID in the Service-level-AA container IE of the REGISTRATION REQUEST message and the REGISTRATION ACCEPT message does not contain the service-level-AA pending indication in the Service-level-AA container IE, the UE shall consider the UUAA-MM procedure is not triggered.

If the REGISTRATION REQUEST message includes the 5GS registration type IE set to "SNPN onboarding registration" or the network determines that the UE's subscription only allows for configuration of SNPN subscription parameters in PLMN via the user plane, the AMF may start an implementation specific timer for onboarding services when the network considers that the UE is in 5GMM-REGISTERED (i.e. the network receives the REGISTRATION COMPLETE message from UE).

NOTE 21: If the AMF considers that the UE is in 5GMM-IDLE, when the implementation specific timer for onboarding services expires and the network considers that the UE is still in state 5GMM-REGISTERED, the AMF can locally de-register the UE; or if the UE is in 5GMM-CONNECTED, the AMF can initiate the network-initiated de-registration procedure (see subclause 5.5.2.3).

NOTE 22: The value of the implementation specific timer for onboarding services needs to be large enough to allow a UE to complete the configuration of one or more entries of the "list of subscriber data" taking into consideration that configuration of SNPN subscription parameters in PLMN via the user plane or onboarding services in SNPN involves third party entities outside of the operator's network.

If the UE receives the List of PLMNs to be used in disaster condition IE in the REGISTRATION ACCEPT message and the UE supports MINT, the UE shall delete the "list of PLMN(s) to be used in disaster condition" stored in the ME together with the PLMN ID of the RPLMN, if any, and may store the "list of PLMN(s) to be used in disaster condition" included in the List of PLMNs to be used in disaster condition IE in the ME together with the PLMN ID of the RPLMN.

If the UE receives the Disaster roaming wait range IE in the REGISTRATION ACCEPT message and the UE supports MINT, the UE shall delete the disaster roaming wait range stored in the ME, if any, and store the disaster roaming wait range included in the Disaster roaming wait range IE in the ME.

If the UE receives the Disaster return wait range IE in the REGISTRATION ACCEPT message and the UE supports MINT, the UE shall delete the disaster return wait range stored in the ME, if any, and store the disaster return wait range included in the Disaster return wait range IE in the ME.

If the 5GS registration type IE in the REGISTRATION REQUEST message is set to "disaster roaming initial registration" and:

- a) the UE determined PLMN with disaster condition IE is included in the REGISTRATION REQUEST message, the AMF shall determine the PLMN with disaster condition in the UE determined PLMN with disaster condition IE;
- b) the UE determined PLMN with disaster condition IE is not included in the REGISTRATION REQUEST message and the Additional GUTI IE is included in the REGISTRATION REQUEST message and contains 5G-GUTI of a PLMN of the country of the PLMN providing disaster roaming services, the AMF shall determine the PLMN with disaster condition in the PLMN identity of the 5G-GUTI;
- c) the UE determined PLMN with disaster condition IE and the Additional GUTI IE are not included in the REGISTRATION REQUEST message and:
 - 1) the 5GS mobile identity IE contains 5G-GUTI of a PLMN of the country of the PLMN providing disaster roaming services, the AMF shall determine the PLMN with disaster condition in the PLMN identity of the 5G-GUTI; or
 - 2) the 5GS mobile identity IE contains SUCI of a PLMN of the country of the PLMN providing disaster roaming services, the AMF shall determine the PLMN with disaster condition in the PLMN identity of the SUCI; or
- d) the UE determined PLMN with disaster condition IE is not included in the REGISTRATION REQUEST message, NG-RAN of the PLMN providing disaster roaming services broadcasts disaster roaming indication and:
 - 1) the Additional GUTI IE is included in the REGISTRATION REQUEST message and contains 5G-GUTI of a PLMN of a country other than the country of the PLMN providing disaster roaming services; or
 - 2) the Additional GUTI IE is not included and the 5GS mobile identity IE contains 5G-GUTI or SUCI of a PLMN of a country other than the country of the PLMN providing disaster roaming services;

the AMF shall determine the PLMN with disaster condition based on the disaster roaming agreement arrangement between mobile network operators.

NOTE 23: The disaster roaming agreement arrangement between mobile network operators is out of scope of 3GPP.

If the AMF determines that a disaster condition applies to the PLMN with disaster condition, and the UE is allowed to be registered for disaster roaming services, the AMF shall set the Disaster roaming registration result value bit in the 5GS registration result IE to "no additional information" in the REGISTRATION ACCEPT message. If the AMF determines that the UE can be registered to the PLMN for normal service, the AMF shall set the Disaster roaming registration result value bit in the 5GS registration result IE to "request for registration for disaster roaming services accepted as registration not for disaster roaming services" in the REGISTRATION ACCEPT message.

If the UE indicates "disaster roaming initial registration" in the 5GS registration type IE in the REGISTRATION REQUEST message and the 5GS registration result IE value in the REGISTRATION ACCEPT message is set to:

- a) "request for registration for disaster roaming service accepted as registration not for disaster roaming services", the UE shall consider itself registered for normal service. If the PLMN identity of the registered PLMN is a member of the forbidden PLMN list as specified in subclause 5.3.13A, any such PLMN identity shall be deleted from the corresponding list(s). If UE supports S1 mode, the UE shall initiate the registration procedure for mobility and periodic registration update and indicate that S1 mode is supported as described in subclause 5.5.1.3.2; or
- b) "no additional information", the UE shall consider itself registered for disaster roaming services.

If the UE receives the forbidden TAI(s) for the list of "5GS forbidden tracking areas for roaming" IE in the REGISTRATION ACCEPT message, the UE shall store the TAI(s) belonging to the serving PLMN or equivalent PLMN(s) and ignore the TAI(s) which do not belong to the serving PLMN or equivalent PLMN(s) included in the IE, if not already stored, into the list of "5GS forbidden tracking areas for roaming".

If the UE receives the forbidden TAI(s) for the list of "5GS forbidden tracking areas for regional provision of service" IE in the REGISTRATION ACCEPT message, the UE shall store the TAI(s) belonging to the serving PLMN or equivalent PLMN(s) and ignore the TAI(s) which do not belong to the serving PLMN or equivalent PLMN(s) included in the IE, if not already stored, into the list of "5GS forbidden tracking areas for regional provision of service".

If the UE supporting the reconnection to the network due to RAN timing synchronization status change receives the RAN timing synchronization IE with the RecReq bit set to "Reconnection requested" in the REGISTRATION ACCEPT message, the UE shall operate as specified in subclauses 5.3.1.4, 5.5.1.3.2 and 5.6.1.1.

If the UE supports discontinuous coverage, the AMF may include the Discontinuous coverage maximum time offset IE in the REGISTRATION ACCEPT message.

If the UE receives the Discontinuous coverage maximum time offset IE in the REGISTRATION ACCEPT message, the UE shall replace any previously received discontinuous coverage maximum time offset value on the same satellite NG-RAN RAT type and PLMN with the latest received timer value.

If the UE receives the Unavailability configuration IE in the REGISTRATION ACCEPT message, the UE shall consider that the corresponding unavailability type is "unavailability due to discontinuous coverage". A UE that does not implement this unavailability type may ignore the Unavailability configuration IE provided by the AMF. If the EUPR bit is set to "UE does not need to report end of unavailability period", the UE is not required to initiate the registration procedure for mobility registration update when the unavailability period duration has ended.

If the UE receives the Unavailability configuration IE with a value of the unavailability period duration in the REGISTRATION ACCEPT, then the UE may either:

- a) delete a UE determined value and start using the received unavailability period duration value; or
- b) use a UE determined value. If the UE receives the Unavailability configuration IE with a value of the start of the unavailability period in the REGISTRATION ACCEPT message, then the UE may either:
 - a) delete a UE determined value and start using the received start of the unavailability period value; or
 - b) use a UE determined value.

NOTE 24: The UE can consider the received value from the network when determining the value for unavailability period duration and the start of the unavailability period.

If the UE operating as MBSR receives the MBSRAI field of the Feature authorization indication IE in the REGISTRATION ACCEPT message, the UE NAS layer informs the lower layers of the status of MBSR authorization as specified in subclause 5.35A.4 of 3GPP TS 23.501 [8].

5.5.1.2.5 Initial registration not accepted by the network

If the initial registration request cannot be accepted by the network, the AMF shall send a REGISTRATION REJECT message to the UE including an appropriate 5GMM cause value.

If the initial registration request is rejected due to general NAS level mobility management congestion control, the network shall set the 5GMM cause value to #22 "congestion" and assign a value for back-off timer T3346.

If the initial registration request is rejected due to general NAS level mobility management congestion control for the SNPN selected for localized services in SNPN (see 3GPP TS 23.122 [5]), the network may set an appropriate cause value other than 5GMM cause value to #22 "congestion" and does not assign a value for back-off timer T3346.

In NB-N1 mode, if the registration request is rejected due to operator determined barring (see 3GPP TS 29.503 [20AB]), the network shall set the 5GMM cause value to #22 "congestion" and assign a value for back-off timer T3346.

If the REGISTRATION REJECT message with 5GMM cause #76 or #78 was received without integrity protection, then the UE shall discard the message. If the REGISTRATION REJECT message with 5GMM cause #62 was received without integrity protected, the behaviour of the UE is specified in subclause 5.3.20.2.

Based on operator policy, if the initial registration request is rejected due to core network redirection for CIoT optimizations, the network shall set the 5GMM cause value to #31 "Redirection to EPC required".

NOTE 1: The network can take into account the UE's S1 mode capability, the EPS CIoT network behaviour supported by the UE or the EPS CIoT network behaviour supported by the EPC to determine the rejection with the 5GMM cause value #31 "Redirection to EPC required".

If the initial registration request is rejected because:

- a) all the S-NSSAI(s) included in the requested NSSAI are rejected; and
- b) the UE set the NSSAA bit in the 5GMM capability IE to:
 - 1) "Network slice-specific authentication and authorization supported" and:
 - i) void;
 - ii) all default S-NSSAIs are not allowed; or
 - iii) network slice-specific authentication and authorization has failed or been revoked for all default S-NSSAIs and based on network local policy, the network decides not to initiate the network slice-specific re-authentication and re-authorization procedures for any default S-NSSAI requested by the UE; or
 - 2) "Network slice-specific authentication and authorization not supported" and all default S-NSSAIs are either not allowed or are subject to network slice-specific authentication and authorization;
 - i) void
 - ii) void

the network shall set the 5GMM cause value of the REGISTRATION REJECT message to #62 "No network slices available".

If the 5GMM cause value is set to #62 "No network slices available", the network shall include, in the rejected NSSAI of the REGISTRATION REJECT message, all the S-NSSAI(s) which were included in the requested NSSAI.

If the UE has set the ER-NSSAI bit to "Extended rejected NSSAI supported" in the 5GMM capability IE of the REGISTRATION REQUEST message, the rejected S-NSSAI(s) shall be included in the Extended rejected NSSAI IE of the REGISTRATION REJECT message. Otherwise, the rejected S-NSSAI(s) shall be included in the Rejected NSSAI IE of the REGISTRATION REJECT message.

In roaming scenarios, if the Extended rejected NSSAI IE is included in the REGISTRATION REJECT message, the AMF shall provide mapped S-NSSAI(s) for the rejected NSSAI.

If the UE supports extended rejected NSSAI and the AMF determines that maximum number of UEs reached for one or more S-NSSAIs in the requested NSSAI as specified in subclause 4.6.2.5, the AMF shall include the rejected NSSAI containing one or more S-NSSAIs with the rejection cause "S-NSSAI not available due to maximum number of UEs reached" in the Extended rejected NSSAI IE in the REGISTRATION REJECT message. In addition, the AMF may include a back-off timer value for each S-NSSAI with the rejection cause "S-NSSAI not available due to maximum number of UEs reached" in the Extended rejected NSSAI IE of the REGISTRATION REJECT message.

If the AMF receives the initial registration request along with the authenticated indication over N2 reference point on non-3GPP access and does not receive the indication that authentication by the home network is not required over N12 reference point, or the 5G-RG acting on behalf of an AUN3 device is not allowed to access 5GS as specified in 3GPP TS 23.316 [6D], the network shall set the 5GMM cause value to #72 "Non-3GPP access to 5GCN not allowed".

If the initial registration request from a UE supporting CAG is rejected due to CAG restrictions, the network shall set the 5GMM cause value to #76 "Not authorized for this CAG or authorized for CAG cells only" and should include the "CAG information list" in the CAG information list IE or the Extended CAG information list IE in the REGISTRATION REJECT message.

NOTE 2: The network cannot be certain that "CAG information list" stored in the UE is updated as result of sending of the REGISTRATION REJECT message with the CAG information list IE or the Extended CAG information list IE, as the REGISTRATION REJECT message is not necessarily delivered to the UE (e.g. due to abnormal radio conditions).

NOTE 3: The "CAG information list" can be provided by the AMF and include no entry if no "CAG information list" exists in the subscription.

NOTE 4: If the UE supports extended CAG information list, the CAG information list can be included either in the CAG information list IE or Extended CAG information list IE.

NOTE 4A: It is unexpected for network to send REGISTRATION REJECT message to the UE with 5GMM cause value #76 in non-CAG cell and not indicate "Indication that the UE is only allowed to access 5GS via CAG cells" for the serving PLMN in the Extended CAG information list or the CAG information list.

If the UE does not support extended CAG information list, the CAG information list shall not be included in the Extended CAG information list IE.

If the initial registration request from a UE not supporting CAG is rejected due to CAG restrictions, the network shall operate as described in bullet j) of subclause 5.5.1.2.8.

If the UE's initial registration request is via a satellite NG-RAN cell and the network using the User Location Information provided by the NG-RAN, see 3GPP TS 38.413 [31], is able to determine that the UE is in a location where the network is not allowed to operate, the network shall set the 5GMM cause value in the REGISTRATION REJECT message to #78 "PLMN not allowed to operate at the present UE location".

NOTE 5: When the UE is accessing network for emergency services, it is up to operator and regulatory policies whether the network needs to determine if the UE is in a location where network is not allowed to operate.

NOTE 5A: While location determination is ongoing to ensure that operator and regulatory policies are met, the AMF can perform DNN-based or S-NSSAI based congestion control as specified in subclauses 5.3.10 and 5.3.11 to prevent the UE from accessing network.

If the AMF receives the initial registration request including the service-level device ID set to the CAA-level UAV ID in the Service-level-AA container IE and the AMF determines that the UE is not allowed to use UAS services via 5GS based on the user's subscription data and the operator policy, the AMF shall return a REGISTRATION REJECT message with 5GMM cause #79 "UAS services not allowed".

If the UE initiates the registration procedure for disaster roaming services and the AMF determines that it does not support providing disaster roaming services for the determined PLMN with disaster condition to the UE, then the AMF shall send a REGISTRATION REJECT message with 5GMM cause #80 "Disaster roaming for the determined PLMN with disaster condition not allowed".

If the AMF receives the initial registration request over non-3GPP access and detects that the N3IWF used by the UE is not compatible with the allowed NSSAI and the UE has indicated its support for slice-based N3IWF selection in the REGISTRATION REQUEST message, the AMF may send a REGISTRATION REJECT message with 5GMM cause #81 "Selected N3IWF is not compatible with the allowed NSSAI" and may provide information for a suitable N3IWF in the REGISTRATION REJECT message indicating the suitable N3IWF that is compatible with the requested NSSAI.

If the AMF receives the initial registration request over non-3GPP access and detects that the TNGF used by the UE is not compatible with the allowed NSSAI and the UE has indicated its support for slice-based TNGF selection in the REGISTRATION REQUEST message, the AMF may send a REGISTRATION REJECT message with 5GMM cause #82 "Selected TNGF is not compatible with the allowed NSSAI" and may provide information for a suitable TNAN in the TNAN information IE in the REGISTRATION REJECT message indicating the suitable TNGF that is compatible with the requested NSSAI.

If the AMF received multiple TAIs from the satellite NG-RAN as described in 3GPP TS 23.501 [8], and determines that, by UE subscription and operator's preferences, all of the received TAIs are forbidden for roaming or for regional provision of service, the AMF shall include the TAI(s) in:

- a) the Forbidden TAI(s) for the list of "5GS forbidden tracking areas for roaming" IE; or
- b) the Forbidden TAI(s) for the list of "5GS forbidden tracking areas for regional provision of service" IE; or
- c) both;

in the REGISTRATION REJECT message.

Regardless of the 5GMM cause value received in the REGISTRATION REJECT message via satellite NG-RAN,

- if the UE receives the Forbidden TAI(s) for the list of "5GS forbidden tracking areas for roaming" IE in the REGISTRATION REJECT message, the UE shall store the TAI(s) belonging to the serving PLMN or equivalent PLMN(s) and ignore the TAI(s) which do not belong to the serving PLMN or equivalent PLMN(s) included in the IE, if not already stored, into the list of "5GS forbidden tracking areas for roaming"; and
- if the UE receives the Forbidden TAI(s) for the list of "5GS forbidden tracking areas for regional provision of service" IE in the REGISTRATION REJECT message, the UE shall store the TAI(s) belonging to the serving PLMN or equivalent PLMN(s) and ignore the TAI(s) which do not belong to the serving PLMN or equivalent PLMN(s) included in the IE, if not already stored, into the list of "5GS forbidden tracking areas for regional provision of service".

Furthermore, the UE shall take the following actions depending on the 5GMM cause value received in the REGISTRATION REJECT message.

#3 (Illegal UE); or

#6 (Illegal ME).

The UE shall set the 5GS update status to 5U3 ROAMING NOT ALLOWED (and shall store it according to subclause 5.1.3.2.2) and shall delete any 5G-GUTI, last visited registered TAI, TAI list and ngKSI.

In case of PLMN, the UE shall consider the USIM as invalid for 5GS services until switching off, the UICC containing the USIM is removed or the timer T3245 expires as described in subclause 5.3.19A.1;

In case of SNPN, if the UE is not performing initial registration for onboarding services in SNPN and the UE does not support access to an SNPN using credentials from a credentials holder and does not support equivalent SNPNs, the UE shall consider the selected entry of the "list of subscriber data" with the SNPN identity of the current SNPN as invalid until the UE is switched off, the entry is updated or the timer T3245 expires as described in subclause 5.3.19A.2. In case of SNPN, if the UE is not performing initial registration for onboarding services in SNPN and the UE supports access to an SNPN using credentials from a credentials holder, equivalent SNPNs, or both, the UE shall consider the selected entry of the "list of subscriber data" as invalid for 3GPP access until the UE is switched off, the entry is updated or the timer T3245 expires as described in subclause 5.3.19A.2. Additionally, if EAP based primary authentication and key agreement procedure using EAP-AKA' or 5G AKA based primary authentication and key agreement procedure was performed in the current SNPN, the UE shall consider the USIM as invalid for the current SNPN until switching off, the UICC containing the USIM is removed or the timer T3245 expires as described in subclause 5.3.19A.2.

If the UE is not performing initial registration for onboarding services in SNPN, the UE shall delete the list of equivalent PLMNs (if any) or the list of equivalent SNPNS (if any), and enter the state 5GMM-DEREGISTERED.NO-SUPI. If the message has been successfully integrity checked by the NAS, then the UE shall:

- 1) set the counter for "SIM/USIM considered invalid for GPRS services" events and the counter for "USIM considered invalid for 5GS services over non-3GPP access" events in case of PLMN if the UE maintains these counters; or
- 2) set the counter for "the entry for the current SNPN considered invalid for 3GPP access" events and the counter for "the entry for the current SNPN considered invalid for non-3GPP access" events in case of SNPN if the UE maintains these counters;

to a UE implementation-specific maximum value.

If the message was received via 3GPP access and the UE is operating in single-registration mode, the UE shall handle the EMM parameters EMM state, EPS update status, 4G-GUTI, last visited registered TAI, TAI list and eKSI as specified in 3GPP TS 24.301 [15] for the case when the EPS attach request procedure is rejected with the EMM cause with the same value. The USIM shall be considered as invalid also for non-EPS services until switching off, the UICC containing the USIM is removed or the timer T3245 expires as described in subclause 5.3.7a in 3GPP TS 24.301 [15]. If the message has been successfully integrity checked by the NAS and the UE maintains a counter for "SIM/USIM considered invalid for non-GPRS services", then the UE shall set this counter to a UE implementation-specific maximum value.

If the UE is performing initial registration for onboarding services in SNPN, the UE shall reset the registration attempt counter, store the SNPN identity in the "permanently forbidden SNPNS for onboarding services in SNPN" list, enter state 5GMM-DEREGISTERED.PLMN-SEARCH, and perform an SNPN selection or an SNPN selection for onboarding services according to 3GPP TS 23.122 [5]. If the message has been successfully integrity checked by the NAS, the UE shall set the SNPN-specific attempt counter for the current SNPN to the UE implementation-specific maximum value.

If the message has been successfully integrity checked by the NAS and the UE also supports the registration procedure over the other access, the UE shall in addition handle 5GMM parameters and 5GMM state for this access, as described for this 5GMM cause value.

#7 (5GS services not allowed).

The UE shall set the 5GS update status to 5U3 ROAMING NOT ALLOWED (and shall store it according to subclause 5.1.3.2.2) and shall delete any 5G-GUTI, last visited registered TAI, TAI list and ngKSI.

In case of PLMN, the UE shall consider the USIM as invalid for 5GS services until switching off, the UICC containing the USIM is removed or the timer T3245 expires as described in subclause 5.3.19A.1;

In case of SNPN, if the UE is not performing initial registration for onboarding services in SNPN and the UE does not support access to an SNPN using credentials from a credentials holder and does not support equivalent SNPNS, the UE shall consider the selected entry of the "list of subscriber data" with the SNPN identity of the current SNPN as invalid for 5GS services until the UE is switched off, the entry is updated or the timer T3245 expires as described in subclause 5.3.19A.2. In case of SNPN, if the UE is not performing initial registration for onboarding services in SNPN and the UE supports access to an SNPN using credentials from a credentials holder, equivalent SNPNS, or both, the UE shall consider the selected entry of the "list of subscriber data" as invalid for 3GPP access until the UE is switched off, the entry is updated or the timer T3245 expires as described in subclause 5.3.19A.2. Additionally, if EAP based primary authentication and key agreement procedure using EAP-AKA' or 5G AKA based primary authentication and key agreement procedure was performed in the current SNPN, the UE shall consider the USIM as invalid for the current SNPN until switching off, the UICC containing the USIM is removed or the timer T3245 expires as described in subclause 5.3.19A.2.

If the UE is not performing initial registration for onboarding services in SNPN, the UE shall enter the state 5GMM-DEREGISTERED.NO-SUPI. If the message has been successfully integrity checked by the NAS, then the UE shall:

- 1) set the counter for "SIM/USIM considered invalid for GPRS services" events and the counter for "USIM considered invalid for 5GS services over non-3GPP access" events in case of PLMN if the UE maintains these counters; or

- 2) set the counter for "the entry for the current SNPN considered invalid for 3GPP access" events and the counter for "the entry for the current SNPN considered invalid for non-3GPP access" events in case of SNPN if the UE maintains these counters;

to a UE implementation-specific maximum value.

If the message was received via 3GPP access and the UE is operating in single-registration mode, the UE shall handle the EMM parameters EMM state, EPS update status, 4G-GUTI, last visited registered TAI, TAI list and eKSI as specified in 3GPP TS 24.301 [15] for the case when the EPS attach request procedure is rejected with the EMM cause with the same value.

If the UE is performing initial registration for onboarding services in SNPN, the UE shall reset the registration attempt counter, store the SNPN identity in the "permanently forbidden SNPNs for onboarding services in SNPN" list, enter state 5GMM-DEREGISTERED.PLMN-SEARCH, and perform an SNPN selection or an SNPN selection for onboarding services according to 3GPP TS 23.122 [5]. If the message has been successfully integrity checked by the NAS, the UE shall set the SNPN-specific attempt counter for the current SNPN to the UE implementation-specific maximum value.

If the message has been successfully integrity checked by the NAS and the UE also supports the registration procedure over the other access, the UE shall in addition handle 5GMM parameters and 5GMM state for this access, as described for this 5GMM cause value.

#10 (Implicitly de-registered).

5GMM cause #10 is only applicable when received from a wireline access network by the 5G-RG acting on behalf of the AUN3 device and indicates that there is no 5G-RG connected to the same wireline. 5GMM cause #10 received when the 5G-RG is not acting on behalf of the AUN3 or received from a 5G access network other than a wireline access network is considered as abnormal cases and the behaviour of the UE is specified in subclause 5.5.1.2.7.

When received over wireline access network, the 5G-RG acting on behalf of the AUN3 device shall abort the initial registration procedure that was initiated on behalf of the AUN3 device. The 5G-RG shall set its 5GS update status to 5U2 NOT UPDATED (and shall store it according to subclause 5.1.3.2.2), shall delete its 5G-GUTI, last visited registered TAI, TAI list, ngKSI, and shall reset its registration attempt counter, and shall enter the state 5GMM-DEREGISTERED.

#11 (PLMN not allowed).

This cause value received from a cell belonging to an SNPN and the UE is operating in SNPN access operation mode is considered as an abnormal case and the behaviour of the UE is specified in subclause 5.5.1.2.7.

The UE shall set the 5GS update status to 5U3 ROAMING NOT ALLOWED (and shall store it according to subclause 5.1.3.2.2) and shall delete any 5G-GUTI, last visited registered TAI, TAI list and ngKSI. The UE shall delete the list of equivalent PLMNs and reset the registration attempt counter and store the PLMN identity in the forbidden PLMN list as specified in subclause 5.3.13A and if the UE is configured to use timer T3245 then the UE shall start timer T3245 and proceed as described in subclause 5.3.19A.1. For 3GPP access the UE shall enter state 5GMM-DEREGISTERED.PLMN-SEARCH and perform a PLMN selection according to 3GPP TS 23.122 [5], and for non-3GPP access the UE shall enter state 5GMM-DEREGISTERED.LIMITED-SERVICE and perform network selection as defined in 3GPP TS 24.502 [18]. If the message has been successfully integrity checked by the NAS and the UE maintains the PLMN-specific attempt counter and the PLMN-specific attempt counter for non-3GPP access for that PLMN, the UE shall set the PLMN-specific attempt counter and the PLMN-specific attempt counter for non-3GPP access for that PLMN to the UE implementation-specific maximum value.

If the message was received via 3GPP access and the UE is operating in single-registration mode, the UE shall in addition handle the EMM parameters EMM state, EPS update status, 4G-GUTI, last visited registered TAI, TAI list, eKSI and attach attempt counter as specified in 3GPP TS 24.301 [15] for the case when the EPS attach request procedure is rejected with the EMM cause with the same value.

If the message has been successfully integrity checked by the NAS and the UE also supports the registration procedure over the other access to the same PLMN, the UE shall in addition handle 5GMM parameters and 5GMM state for this access, as described for this 5GMM cause value.

#12 (Tracking area not allowed).

The UE shall set the 5GS update status to 5U3 ROAMING NOT ALLOWED (and shall store it according to subclause 5.1.3.2.2) and shall delete last visited registered TAI and TAI list. If the UE is not registering or has not registered to the same PLMN over both 3GPP access and non-3GPP access, the UE shall additionally delete 5G-GUTI and ngKSI. Additionally, the UE shall reset the registration attempt counter.

If:

- 1) the UE is not operating in SNPN access operation mode and the Forbidden TAI(s) for the list of "5GS forbidden tracking areas for regional provision of service" IE is not included in the REGISTRATION REJECT message, the UE shall store the current TAI in the list of "5GS forbidden tracking areas for regional provision of service" and enter the state 5GMM-DEREGISTERED.LIMITED-SERVICE. If the REGISTRATION REJECT message is not integrity protected, the UE shall memorize the current TAI was stored in the list of "5GS forbidden tracking areas for regional provision of service" for non-integrity protected NAS reject message; or
- 2) the UE is operating in SNPN access operation mode, the UE shall store the current TAI in the list of "5GS forbidden tracking areas for regional provision of service" for the current SNPN and the selected entry of the "list of subscriber data" or the selected PLMN subscription, and enter the state 5GMM-DEREGISTERED.LIMITED-SERVICE. If the REGISTRATION REJECT is not integrity protected, the UE shall memorize the current TAI was stored in the list of "5GS forbidden tracking areas for regional provision of service" for the current SNPN and the selected entry of the "list of subscriber data" or the selected PLMN subscription, for non-integrity protected NAS reject message.

If the message was received via 3GPP access and the UE is operating in single-registration mode, the UE shall handle the EMM parameters EMM state, EPS update status, 4G-GUTI, last visited registered TAI, TAI list, eKSI and attach attempt counter as specified in 3GPP TS 24.301 [15] for the case when the EPS attach request procedure is rejected with the EMM cause with the same value.

#13 (Roaming not allowed in this tracking area).

The UE shall set the 5GS update status to 5U3 ROAMING NOT ALLOWED (and shall store it according to subclause 5.1.3.2.2) and shall delete last visited registered TAI and TAI list. If the UE is not registering or has not registered to the same PLMN over both 3GPP access and non-3GPP access, the UE shall additionally delete 5G-GUTI, ngKSI and the list of equivalent PLMNs (if available) or the list of equivalent SNPNs (if available). Additionally, the UE shall reset the registration attempt counter.

If:

- 1) the UE is not operating in SNPN access operation mode and the Forbidden TAI(s) for the list of "5GS forbidden tracking areas for roaming" IE is not included in the REGISTRATION REJECT message, the UE shall store the current TAI in the list of "5GS forbidden tracking areas for roaming" and enter the state 5GMM-DEREGISTERED.LIMITED-SERVICE or optionally 5GMM-DEREGISTERED.PLMN-SEARCH. If the REGISTRATION REJECT message is not integrity protected, the UE shall memorize the current TAI was stored in the list of "5GS forbidden tracking areas for roaming" for non-integrity protected NAS reject message; or
- 2) the UE is operating in SNPN access operation mode, the UE shall store the current TAI in the list of "5GS forbidden tracking areas for roaming" for the current SNPN and the selected entry of the "list of subscriber data" or the selected PLMN subscription, and enter the state 5GMM-DEREGISTERED.LIMITED-SERVICE or optionally 5GMM-DEREGISTERED.PLMN-SEARCH. If the REGISTRATION REJECT message is not integrity protected, the UE shall memorize the current TAI was stored in the list of "5GS forbidden tracking areas for roaming" for the current SNPN and the selected entry of the "list of subscriber data" or the selected PLMN subscription, for non-integrity protected NAS reject message.

For 3GPP access, if the UE is registered in S1 mode and operating in dual-registration mode, the PLMN that the UE chooses to register in is specified in subclause 4.8.3. Otherwise the UE shall perform a PLMN selection or SNPN selection according to 3GPP TS 23.122 [5].

For non-3GPP access, the UE shall perform network selection as defined in 3GPP TS 24.502 [18].

If the message was received via 3GPP access and the UE is operating in single-registration mode, the UE shall handle the EMM parameters EMM state, EPS update status, 4G-GUTI, last visited registered TAI, TAI list, eKSI and attach attempt counter as specified in 3GPP TS 24.301 [15] for the case when the EPS attach request procedure is rejected with the EMM cause with the same value.

#15 (No suitable cells in tracking area).

The UE shall set the 5GS update status to 5U3 ROAMING NOT ALLOWED (and shall store it according to subclause 5.1.3.2.2) and shall delete any last visited registered TAI and TAI list. If the UE is not registering or has not registered to the same PLMN over both 3GPP access and non-3GPP access, the UE shall additionally delete 5G-GUTI and ngKSI. Additionally, the UE shall reset the registration attempt counter.

If:

- 1) the UE is not operating in SNPN access operation mode and the Forbidden TAI(s) for the list of "5GS forbidden tracking areas for roaming" IE is not included in the REGISTRATION REJECT message, the UE shall store the current TAI in the list of "5GS forbidden tracking areas for roaming" and enter the state 5GMM-DEREGISTERED.LIMITED-SERVICE. If the REGISTRATION REJECT message is not integrity protected, the UE shall memorize the current TAI was stored in the list of "5GS forbidden tracking areas for roaming" for non-integrity protected NAS reject message; or
- 2) the UE is operating in SNPN access operation mode, the UE shall store the current TAI in the list of "5GS forbidden tracking areas for roaming" for the current SNPN and the selected entry of the "list of subscriber data" or the selected PLMN subscription, and enter the state 5GMM-DEREGISTERED.LIMITED-SERVICE. If the REGISTRATION REJECT message is not integrity protected, the UE shall memorize the current TAI was stored in the list of "5GS forbidden tracking areas for roaming" for the current SNPN and the selected entry of the "list of subscriber data" or the selected PLMN subscription, for non-integrity protected NAS reject message.

Additionally, the UE shall:

- 1) if the Extended 5GMM cause IE with value "Satellite NG-RAN not allowed in PLMN" is included in the REGISTRATION REJECT message,
 - i) the message has been successfully integrity checked by the NAS; and the UE is configured for "Satellite Disabling Allowed for 5GMM cause #15" as specified in 3GPP TS 24.368 [17] or 3GPP TS 31.102 [22], then the UE shall disable satellite NG-RAN capability (see subclause 4.9.4); or
 - ii) otherwise, the UE shall ignore the Extended 5GMM cause IE; and
- 2) search for a suitable cell in another tracking area according to 3GPP TS 38.304 [28] or 3GPP TS 36.304 [25C].

If the message was received via 3GPP access and the UE is operating in single-registration mode, the UE shall handle the EMM parameters EMM state, EPS update status, 4G-GUTI, last visited registered TAI, TAI list, eKSI and attach attempt counter as specified in 3GPP TS 24.301 [15] for the case when the EPS attach request procedure is rejected with the EMM cause with the same value.

If received over non-3GPP access the cause shall be considered as an abnormal case and the behaviour of the UE for this case is specified in subclause 5.5.1.2.7.

#22 (Congestion).

If the T3346 value IE is present in the REGISTRATION REJECT message and the value indicates that this timer is neither zero nor deactivated, the UE shall proceed as described below; otherwise it shall be considered as an abnormal case and the behaviour of the UE for this case is specified in subclause 5.5.1.2.7.

The UE shall abort the initial registration procedure, set the 5GS update status to 5U2 NOT UPDATED, reset the registration attempt counter and enter state 5GMM-DEREGISTERED.ATTEMPTING-REGISTRATION.

The UE shall stop timer T3346 if it is running.

If the REGISTRATION REJECT message is integrity protected, the UE shall start timer T3346 with the value provided in the T3346 value IE.

If the REGISTRATION REJECT message is not integrity protected, the UE shall start timer T3346 with a random value from the default range specified in 3GPP TS 24.008 [12].

The UE stays in the current serving cell and applies the normal cell reselection process. The initial registration procedure is started if still needed when timer T3346 expires or is stopped.

If the message was received via 3GPP access and the UE is operating in single-registration mode, the UE shall handle the EMM parameters EMM state, EPS update status, and attach attempt counter as specified in 3GPP TS 24.301 [15] for the case when the EPS attach request procedure is rejected with the EMM cause with the same value.

If the UE is registering for onboarding services in SNPN, the UE may enter the state 5GMM-DEREGISTERED.PLMN-SEARCH and perform an SNPN selection or an SNPN selection for onboarding services according to 3GPP TS 23.122 [5].

#27 (N1 mode not allowed).

The UE shall set the 5GS update status to 5U3 ROAMING NOT ALLOWED (and shall store it according to subclause 5.1.3.2.2) and shall delete any 5G-GUTI, last visited registered TAI, TAI list and ngKSI. Additionally, the UE shall reset the registration attempt counter and shall enter the state 5GMM-DEREGISTERED.LIMITED-SERVICE. If the message has been successfully integrity checked by the NAS, the UE shall set:

- 1) the PLMN-specific N1 mode attempt counter for 3GPP access and the PLMN-specific N1 mode attempt counter for non-3GPP access for that PLMN in case of PLMN; or
- 2) the SNPN-specific attempt counter for 3GPP access for the current SNPN in case of SNPN and the SNPN-specific attempt counter for non-3GPP access for the current SNPN;

to the UE implementation-specific maximum value.

The UE shall disable the N1 mode capability for the specific access type for which the message was received (see subclause 4.9).

If the message has been successfully integrity checked by the NAS, the UE shall disable the N1 mode capability also for the other access type (see subclause 4.9).

If the message was received via 3GPP access and the UE is operating in single-registration mode, the UE shall in addition set the EPS update status to EU3 ROAMING NOT ALLOWED and shall delete any 4G-GUTI, last visited registered TAI, TAI list and eKSI. Additionally, the UE shall reset the attach attempt counter and enter the state EMM-DEREGISTERED.

#31 (Redirection to EPC required).

5GMM cause #31 received by a UE that has not indicated support for CIoT optimizations or not indicated support for S1 mode or received by a UE over non-3GPP access is considered as an abnormal case and the behaviour of the UE is specified in subclause 5.5.1.2.7.

This cause value received from a cell belonging to an SNPN and the UE is operating in SNPN access operation mode is considered as an abnormal case and the behaviour of the UE is specified in subclause 5.5.1.2.7.

The UE shall set the 5GS update status to 5U3 ROAMING NOT ALLOWED (and shall store it according to subclause 5.1.3.2.2) and shall delete any 5G-GUTI, last visited registered TAI, TAI list and ngKSI. Additionally, the UE shall reset the registration attempt counter.

The UE shall enable the E-UTRA capability if it was disabled, disable the N1 mode capability for 3GPP access (see subclause 4.9.2) and enter the 5GMM-DEREGISTERED.NO-CELL-AVAILABLE.

If the message was received via 3GPP access and the UE is operating in single-registration mode, the UE shall handle the EMM parameters EMM state, EPS update status, 4G-GUTI, TAI list, eKSI and attach attempt counter as specified in 3GPP TS 24.301 [15] for the case when the EPS attach procedure is rejected with the EMM cause with the same value.

#36 (IAB-node operation not authorized).

This cause value is only applicable when received over 3GPP access by a UE operating as an IAB-node. This cause value received from a 5G access network other than 3GPP access or received by a UE not operating as an IAB-node is considered as an abnormal case and the behaviour of the UE is specified in subclause 5.5.1.2.7.

The UE shall set the 5GS update status to 5U3 ROAMING NOT ALLOWED (and shall store it according to subclause 5.1.3.2.2) and shall delete any 5G-GUTI, last visited registered TAI, TAI list and ngKSI.

If:

- 1) the UE is not operating in SNPN access operation mode,
 - i) the UE shall delete the list of equivalent PLMNs and reset the registration attempt counter and store the PLMN identity in the forbidden PLMN list as specified in subclause 5.3.13A and if the UE is configured to use timer T3245 then the UE shall start timer T3245 and proceed as described in subclause 5.3.19a.1. The UE shall enter state 5GMM-DEREGISTERED.PLMN-SEARCH and perform a PLMN selection according to 3GPP TS 23.122 [5]. If the message has been successfully integrity checked by the NAS and the UE maintains the PLMN-specific attempt counter for 3GPP access for that PLMN, the UE shall set the PLMN-specific attempt counter for 3GPP access for that PLMN to the UE implementation-specific maximum value; and
 - ii) If the UE is operating in single-registration mode, the UE shall in addition handle the EMM parameters EMM state, EPS update status, 4G-GUTI, last visited registered TAI, TAI list, eKSI and attach attempt counter as specified in 3GPP TS 24.301 [15] for the case when the EPS attach request procedure is rejected with the EMM cause with the same value; or
- 2) the UE is operating in SNPN access operation mode,
 - i) the UE shall delete the list of equivalent SNPNs (if available). The UE shall reset the registration attempt counter and store the SNPN identity in the "temporarily forbidden SNPNs" list for 3GPP access and, if the UE supports access to an SNPN using credentials from a credentials holder, equivalent SNPNs or both, the selected entry of the "list of subscriber data" or the selected PLMN subscription. The UE shall enter state 5GMM-DEREGISTERED.PLMN-SEARCH and perform an SNPN selection according to 3GPP TS 23.122 [5]. If the message has been successfully integrity checked by the NAS, the UE shall set the SNPN attempt counter for 3GPP access for the current SNPN to the UE implementation-specific maximum value.

#62 (No network slices available).

The UE shall abort the initial registration procedure, set the 5GS update status to 5U2 NOT UPDATED and enter state 5GMM-DEREGISTERED. ATTEMPTING-REGISTRATION or 5GMM-DEREGISTERED.PLMN-SEARCH. Additionally, the UE shall reset the registration attempt counter.

The UE receiving the rejected NSSAI in the REGISTRATION REJECT message takes the following actions based on the rejection cause in the rejected S-NSSAI(s):

"S-NSSAI not available in the current PLMN or SNPN"

The UE shall store the rejected S-NSSAI(s) in the rejected NSSAI for the current PLMN or SNPN as specified in subclause 4.6.2.2 and shall not attempt to use this S-NSSAI(s) in the current PLMN or SNPN over any access until switching off the UE, the UICC containing the USIM is removed, an entry of the "list of subscriber data" with the SNPN identity of the current SNPN is updated, or the rejected S-NSSAI(s) are removed as described in subclause 4.6.2.2.

"S-NSSAI not available in the current registration area"

The UE shall store the rejected S-NSSAI(s) in the rejected NSSAI for the current registration area as described in subclause 4.6.2.2 and shall not attempt to use this S-NSSAI(s) in the current registration area over the current access until switching off the UE, the UE moving out of the current registration area, the UICC containing the USIM is removed, the entry of the "list of subscriber data" with the SNPN identity of the current SNPN is updated, or the rejected S-NSSAI(s) are removed as described in subclause 4.6.2.2.

"S-NSSAI not available due to the failed or revoked network slice-specific authentication and authorization"

The UE shall store the rejected S-NSSAI(s) in the rejected NSSAI for the failed or revoked NSSAI as specified in subclause 4.6.2.2 and shall not attempt to use this S-NSSAI in the current PLMN or SNPN over any access until switching off the UE, the UICC containing the USIM is removed, the entry of the "list of subscriber data" with the SNPN identity of the current SNPN is updated, or the rejected S-NSSAI(s) are removed as described in subclause 4.6.1 and 4.6.2.2.

"S-NSSAI not available due to maximum number of UEs reached"

Unless the back-off timer value received along with the S-NSSAI is zero, the UE shall add the rejected S-NSSAI(s) in the rejected NSSAI for the maximum number of UEs reached as specified in

subclause 4.6.2.2 and shall not attempt to use this S-NSSAI in the current PLMN or SNPN over the current access until switching off the UE, the UICC containing the USIM is removed, the entry of the "list of subscriber data" with the SNPN identity of the current SNPN is updated, or the rejected S-NSSAI(s) are removed as described in subclauses 4.6.1 and 4.6.2.2.

NOTE 6: If the back-off timer value received along with the S-NSSAI in the rejected NSSAI for the maximum number of UEs reached is zero as specified in subclause 10.5.7.4a of 3GPP TS 24.008 [12], the UE does not consider the S-NSSAI as the rejected S-NSSAI.

If there is one or more S-NSSAIs in the rejected NSSAI with the rejection cause "S-NSSAI not available due to maximum number of UEs reached", then for each S-NSSAI, the UE shall behave as follows:

- a) stop the timer T3526 associated with the S-NSSAI, if running;
- b) start the timer T3526 with:
 - 1) the back-off timer value received along with the S-NSSAI, if a back-off timer value is received along with the S-NSSAI that is neither zero nor deactivated; or
 - 2) an implementation specific back-off timer value, if no back-off timer value is received along with the S-NSSAI; and
- c) remove the S-NSSAI from the rejected NSSAI for the maximum number of UEs reached when the timer T3526 associated with the S-NSSAI expires.

If the UE has an allowed NSSAI or configured NSSAI and:

- 1) at least one S-NSSAI of the allowed NSSAI or configured NSSAI is not included in the rejected NSSAI the UE may stay in the current serving cell, apply the normal cell reselection process and start an initial registration with a requested NSSAI that includes any S-NSSAI from the allowed NSSAI or the configured NSSAI that is not in the rejected NSSAI.
- 2) all the S-NSSAI(s) in the allowed NSSAI and configured NSSAI are rejected and at least one S-NSSAI is rejected due to "S-NSSAI not available in the current registration area" and:
 - i) the REGISTRATION REJECT message is integrity protected, the UE is not operating in SNPN access operation mode and the Forbidden TAI(s) for the list of "5GS forbidden tracking areas for roaming" IE is not included in the REGISTRATION REJECT message, then the UE shall store the current TAI in the list of "5GS forbidden tracking areas for roaming", memorize the current TAI was stored in the list of "5GS forbidden tracking areas for roaming" for S-NSSAI is rejected due to "S-NSSAI not available in the current registration area" and enter the state 5GMM-DEREGISTERED.LIMITED-SERVICE. The UE shall search for a suitable cell in another tracking area according to 3GPP TS 38.304 [28] or 3GPP TS 36.304 [25C]; or
 - ii) the REGISTRATION REJECT message is integrity protected and the UE is operating in SNPN access operation mode, then the UE shall store the current TAI in the list of "5GS forbidden tracking areas for roaming", memorize the current TAI was stored in the list of "5GS forbidden tracking areas for roaming" for S-NSSAI is rejected due to "S-NSSAI not available in the current registration area" for the current SNPN and, if the UE supports access to an SNPN using credentials from a credentials holder, equivalent SNPNs or both, the selected entry of the "list of subscriber data" or the selected PLMN subscription, and enter the state 5GMM-DEREGISTERED.LIMITED-SERVICE. The UE shall search for a suitable cell in another tracking area according to 3GPP TS 38.304 [28] or 3GPP TS 36.304 [25C].
- 3) otherwise, the UE may perform a PLMN selection or SNPN selection according to 3GPP TS 23.122 [5] and additionally, the UE may disable the N1 mode capability for the current PLMN or SNPN if the UE does not have an allowed NSSAI and each S-NSSAI in the configured NSSAI, if available, was rejected with cause "S-NSSAI not available in the current PLMN or SNPN" or "S-NSSAI not available due to the failed or revoked network slice-specific authentication and authorization" as described in subclause 4.9.

If the UE has neither allowed NSSAI for the current PLMN or SNPN nor configured NSSAI for the current PLMN or SNPN and,

- 1) if at least one S-NSSAI in the default configured NSSAI is not rejected, the UE may stay in the current serving cell, apply the normal cell reselection process, and start an initial registration with a requested NSSAI with that default configured NSSAI; or

- 2) if all the S-NSSAI(s) in the default configured NSSAI are rejected and at least one S-NSSAI is rejected due to "S-NSSAI not available in the current registration area",
 - i) if the REGISTRATION REJECT message is integrity protected and the UE is not operating in SNPN access operation mode, the UE shall store the current TAI in the list of "5GS forbidden tracking areas for roaming" and enter the state 5GMM-DEREGISTERED.LIMITED-SERVICE. The UE shall search for a suitable cell in another tracking area according to 3GPP TS 38.304 [28] or 3GPP TS 36.304 [25C]; or
 - ii) if the REGISTRATION REJECT message is integrity protected and the UE is operating in SNPN access operation mode, the UE shall store the current TAI in the list of "5GS forbidden tracking areas for roaming" for the current SNPN and, if the UE supports access to an SNPN using credentials from a credentials holder, equivalent SNPNs or both, the selected entry of the "list of subscriber data" or the selected PLMN subscription, and enter the state 5GMM-DEREGISTERED.LIMITED-SERVICE. The UE shall search for a suitable cell in another tracking area according to 3GPP TS 38.304 [28] or 3GPP TS 36.304 [25C].
- 3) otherwise, the UE may perform a PLMN selection or SNPN selection according to 3GPP TS 23.122 [5] and additionally, the UE may disable the N1 mode capability for the current PLMN or SNPN if each S-NSSAI in the default configured NSSAI was rejected with cause "S-NSSAI not available in the current PLMN or SNPN" or "S-NSSAI not available due to the failed or revoked network slice-specific authentication and authorization" as described in subclause 4.9.

If

- 1) the UE has allowed NSSAI for the current PLMN or SNPN or configured NSSAI for the current PLMN or SNPN or both and all the S-NSSAIs included in the allowed NSSAI or the configured NSSAI or both are rejected; or
- 2) the UE has neither allowed NSSAI for the current PLMN or SNPN nor configured NSSAI for the current PLMN or SNPN and all the S-NSSAIs included in the default configured NSSAI are rejected,

and the UE has rejected NSSAI for the maximum number of UEs reached, and the UE wants to obtain services in the current serving cell without performing a PLMN selection or SNPN selection, the UE may stay in the current serving cell and attempt to use the rejected S-NSSAI(s) for the maximum number of UEs reached in the current serving cell after the rejected S-NSSAI(s) are removed as described in subclause 4.6.2.2.

If the message was received via 3GPP access and the UE is operating in single-registration mode, the UE shall in addition set the EPS update status to EU2 NOT UPDATED, reset the attach attempt counter and enter the state EMM-DEREGISTERED.

#72 (Non-3GPP access to 5GCN not allowed).

When received over non-3GPP access the UE shall set the 5GS update status to 5U3 ROAMING NOT ALLOWED (and shall store it according to subclause 5.1.3.2.2) and shall delete last visited registered TAI and TAI list. If the UE is not registering or has not registered to the same PLMN over 3GPP access, the UE shall additionally delete 5G-GUTI and ngKSI. Additionally, the UE shall reset the registration attempt counter and enter the state 5GMM-DEREGISTERED. If the message has been successfully integrity checked by the NAS, the UE shall set:

- 1) the PLMN-specific N1 mode attempt counter for non-3GPP access for that PLMN in case of PLMN: or
- 2) the SNPN-specific attempt counter for non-3GPP access for that SNPN in case of SNPN;

to the UE implementation-specific maximum value.

NOTE 7: The 5GMM sublayer states, the 5GMM parameters and the registration status are managed per access type independently, i.e. 3GPP access or non-3GPP access (see subclauses 4.7.2 and 5.1.3).

The UE shall disable the N1 mode capability for non-3GPP access (see subclause 4.9.3).

As an implementation option, the UE may enter the state 5GMM-DEREGISTERED.PLMN-SEARCH in order to perform a PLMN selection according to 3GPP TS 23.122 [5].

If received over 3GPP access the cause shall be considered as an abnormal case and the behaviour of the UE for this case is specified in subclause 5.5.1.2.7.

#73 (Serving network not authorized).

This cause value received from a cell belonging to an SNPN and the UE is operating in SNPN access operation mode is considered as an abnormal case and the behaviour of the UE is specified in subclause 5.5.1.2.7.

The UE shall set the 5GS update status to 5U3 ROAMING NOT ALLOWED (and shall store it according to subclause 5.1.3.2.2) and shall delete any 5G-GUTI, last visited registered TAI, TAI list and ngKSI. The UE shall delete the list of equivalent PLMNs, reset the registration attempt counter, store the PLMN identity in the forbidden PLMN list as specified in subclause 5.3.13A. For 3GPP access the UE shall enter state 5GMM-DEREGISTERED.PLMN-SEARCH in order to perform a PLMN selection according to 3GPP TS 23.122 [5], and for non-3GPP access the UE shall enter state 5GMM-DEREGISTERED.LIMITED-SERVICE and perform network selection as defined in 3GPP TS 24.502 [18]. If the message has been successfully integrity checked by the NAS, the UE shall set the PLMN-specific attempt counter and the PLMN-specific attempt counter for non-3GPP access for that PLMN to the UE implementation-specific maximum value.

If the message was received via 3GPP access and the UE is operating in single-registration mode, the UE shall in addition set the EPS update status to EU3 ROAMING NOT ALLOWED and shall delete any 4G-GUTI, last visited registered TAI, TAI list and eKSI. Additionally, the UE shall reset the attach attempt counter and enter the state EMM-DEREGISTERED.

#74 (Temporarily not authorized for this SNPN).

5GMM cause #74 is only applicable when received from a cell belonging to an SNPN and the UE is operating in SNPN access operation mode. 5GMM cause #74 received from a cell not belonging to an SNPN is considered as an abnormal case and the behaviour of the UE is specified in subclause 5.5.1.2.7.

The UE shall set the 5GS update status to 5U3 ROAMING NOT ALLOWED (and shall store it according to subclause 5.1.3.2.2) and shall delete any 5G-GUTI, last visited registered TAI, TAI list, ngKSI and the list of equivalent SNPNs (if available). The UE shall reset the registration attempt counter and store the SNPN identity in the "temporarily forbidden SNPNs" list or "temporarily forbidden SNPNs for access for localized services in SNPN" list if the SNPN is an SNPN selected for localized services in SNPN (see 3GPP TS 23.122 [5]) for the specific access type for which the message was received and the selected entry of the "list of subscriber data" or the selected PLMN subscription or in the "temporarily forbidden SNPNs for onboarding services in SNPN" list, if the UE is performing initial registration for onboarding services in SNPN, for the specific access type for which the message was received. If the UE supports access to an SNPN using credentials from a credentials holder, the UE shall store the SNPN identity in the "temporarily forbidden SNPNs" list along with the GIN(s) broadcasted by the SNPN if any, for the selected entry of the "list of subscriber data" or the selected PLMN subscription. If the UE supports access to an SNPN providing access for localized services in SNPN and the access for localized services in SNPN has been enabled, the UE shall store the SNPN identity in the list of "temporarily forbidden SNPNs for access for localized services in SNPN" (if the SNPN is an SNPN selected for localized services in SNPN (see 3GPP TS 23.122 [5]) along with the GIN(s) broadcasted by the SNPN if any, for the selected entry of the "list of subscriber data" or the selected PLMN subscription. If the registration request is not for onboarding services in SNPN, for 3GPP access the UE shall enter state 5GMM-DEREGISTERED.PLMN-SEARCH and perform an SNPN selection according to 3GPP TS 23.122 [5] and for non-3GPP access the UE shall enter state 5GMM-DEREGISTERED.LIMITED-SERVICE and perform network selection as defined in 3GPP TS 24.502 [18]. If the registration request is for onboarding services in SNPN, the UE shall enter state 5GMM-DEREGISTERED.PLMN-SEARCH and perform an SNPN selection or an SNPN selection for onboarding services according to 3GPP TS 23.122 [5]. If the message has been successfully integrity checked by the NAS, the UE shall set the SNPN-specific attempt counter for 3GPP access and the SNPN-specific attempt counter for non-3GPP access for the current SNPN to the UE implementation-specific maximum value.

If the message has been successfully integrity checked by the NAS and the UE also supports the registration procedure over the other access to the same SNPN, the UE shall in addition handle 5GMM parameters and 5GMM state for this access, as described for this 5GMM cause value.

#75 (Permanently not authorized for this SNPN).

5GMM cause #75 is only applicable when received from a cell belonging to an SNPN with a globally-unique SNPN identity and the UE is operating in SNPN access operation mode. 5GMM cause #75 received from a cell not belonging to an SNPN or a cell belonging to an SNPN with a non-globally-unique SNPN identity is considered as an abnormal case and the behaviour of the UE is specified in subclause 5.5.1.2.7.

The UE shall set the 5GS update status to 5U3 ROAMING NOT ALLOWED (and shall store it according to subclause 5.1.3.2.2) and shall delete any 5G-GUTI, last visited registered TAI, TAI list ngKSI and the list of equivalent SNPNs (if available). The UE shall reset the registration attempt counter and store the SNPN identity in the "permanently forbidden SNPNs" list or "permanently forbidden SNPNs for access for localized services in SNPN" list if the SNPN is an SNPN selected for localized services in SNPN (see 3GPP TS 23.122 [5]) for the specific access type for which the message was received and the selected entry of the "list of subscriber data" or the selected PLMN subscription, or in the "permanently forbidden SNPNs for onboarding services in SNPN" list, if the UE is performing initial registration for onboarding services in SNPN, for the specific access type for which the message was received. If the UE supports access to an SNPN using credentials from a credentials holder, the UE shall store the SNPN identity in the "permanently forbidden SNPNs" list along with the GIN(s) broadcasted by the SNPN if any, for the selected entry of the "list of subscriber data" or the selected PLMN subscription. If the UE supports access to an SNPN providing access for localized services in SNPN and the access for localized services in SNPN has been enabled, the UE shall store the SNPN identity in the list of "permanently forbidden SNPNs for access for localized services in SNPN" (if the SNPN is an SNPN selected for localized services in SNPN (see 3GPP TS 23.122 [5]) along with the GIN(s) broadcasted by the SNPN if any, for the selected entry of the "list of subscriber data" or the selected PLMN subscription. If the registration request is not for onboarding services in SNPN, for 3GPP access the UE shall enter state 5GMM-DEREGISTERED.PLMN-SEARCH and perform an SNPN selection according to 3GPP TS 23.122 [5] and for non-3GPP access the UE shall enter state 5GMM-DEREGISTERED.LIMITED-SERVICE and perform network selection as defined in 3GPP TS 24.502 [18]. If the registration request is for onboarding services in SNPN, the UE shall enter state 5GMM-DEREGISTERED.PLMN-SEARCH and perform an SNPN selection or an SNPN selection for onboarding services according to 3GPP TS 23.122 [5]. If the message has been successfully integrity checked by the NAS, the UE shall set the SNPN-specific attempt counter for 3GPP access and the SNPN-specific attempt counter for non-3GPP access for the current SNPN to the UE implementation-specific maximum val If the message has been successfully integrity checked by the NAS and the UE also supports the registration procedure over the other access to the same SNPN, the UE shall in addition handle 5GMM parameters and 5GMM state for this access, as described for this 5GMM cause value.

#76 (Not authorized for this CAG or authorized for CAG cells only).

This cause value received via non-3GPP access or from a cell belonging to an SNPN and the UE is operating in SNPN access operation mode is considered as an abnormal case and the behaviour of the UE is specified in subclause 5.5.1.2.7.

The UE shall set the 5GS update status to 5U3 ROAMING NOT ALLOWED, store the 5GS update status according to subclause 5.1.3.2.2, and reset the registration attempt counter.

If 5GMM cause #76 is received from:

- 1) a CAG cell, and if the UE receives a "CAG information list" in the CAG information list IE or the Extended CAG information list IE included in the REGISTRATION REJECT message, the UE shall:
 - i) replace the "CAG information list" stored in the UE with the received CAG information list IE or the Extended CAG information list IE when received in the HPLMN or EHPLMN;
 - ii) replace the serving VPLMN's entry of the "CAG information list" stored in the UE with the serving VPLMN's entry of the received CAG information list IE or the Extended CAG information list IE when the UE receives the CAG information list IE or the Extended CAG information list IE in a serving PLMN other than the HPLMN or EHPLMN; or

NOTE 8: When the UE receives the CAG information list IE or the Extended CAG information list IE in a serving PLMN other than the HPLMN or EHPLMN, entries of a PLMN other than the serving VPLMN, if any, in the received CAG information list IE or the Extended CAG information list IE are ignored.

- iii) remove the serving VPLMN's entry of the "CAG information list" stored in the UE when the UE receives the CAG information list IE or the Extended CAG information list IE in a serving PLMN other than the HPLMN or EHPLMN and the CAG information list IE or the Extended CAG information list IE does not contain the serving VPLMN's entry.

Otherwise, then the UE shall delete the CAG-ID(s) of the cell from the "allowed CAG list" for the current PLMN, if the CAG-ID(s) are authorized based on the "allowed CAG list". In the case the "allowed CAG list" for the current PLMN only contains a range of CAG-IDs, how the UE deletes the CAG-ID(s) of the cell from the "allowed CAG list" for the current PLMN is up to UE implementation. In addition:

- i) if the entry in the "CAG information list" for the current PLMN does not include an "indication that the UE is only allowed to access 5GS via CAG cells" or if the entry in the "CAG information list" for the current PLMN includes an "indication that the UE is only allowed to access 5GS via CAG cells" and one or more CAG-ID(s) are authorized based on the updated "allowed CAG list" for the current PLMN, then the UE shall enter the state 5GMM-DEREGISTERED.LIMITED-SERVICE and shall search for a suitable cell according to 3GPP TS 38.304 [28] or 3GPP TS 36.304 [25C] with the updated "CAG information list";
 - ii) if the entry in the "CAG information list" for the current PLMN includes an "indication that the UE is only allowed to access 5GS via CAG cells" and no CAG-ID is authorized based on the updated "allowed CAG list" for the current PLMN, then the UE shall enter the state 5GMM-DEREGISTERED.PLMN-SEARCH and shall apply the PLMN selection process defined in 3GPP TS 23.122 [5] with the updated "CAG information list"; or
 - iii) if the "CAG information list" does not include an entry for the current PLMN, then the UE shall enter the state 5GMM-DEREGISTERED.LIMITED-SERVICE and shall search for a suitable cell according to 3GPP TS 38.304 [28] or 3GPP TS 36.304 [25C] with the updated "CAG information list".
- 2) a non-CAG cell, and if the UE receives a "CAG information list" in the CAG information list IE or the Extended CAG information list IE included in the REGISTRATION REJECT message, the UE shall:
- i) replace the "CAG information list" stored in the UE with the received CAG information list IE or the Extended CAG information list IE when received in the HPLMN or EHPLMN;
 - ii) replace the serving VPLMN's entry of the "CAG information list" stored in the UE with the serving VPLMN's entry of the received CAG information list IE or the Extended CAG information list IE when the UE receives the CAG information list IE or the Extended CAG information list IE in a serving PLMN other than the HPLMN or EHPLMN; or

NOTE 9: When the UE receives the CAG information list IE or the Extended CAG information list IE in a serving PLMN other than the HPLMN or EHPLMN, entries of a PLMN other than the serving VPLMN, if any, in the received CAG information list IE or the Extended CAG information list IE are ignored.

- iii) remove the serving VPLMN's entry of the "CAG information list" stored in the UE when the UE receives the CAG information list IE or the Extended CAG information list IE in a serving PLMN other than the HPLMN or EHPLMN and the CAG information list IE or the Extended CAG information list IE does not contain the serving VPLMN's entry.

Otherwise, the UE shall store an "indication that the UE is only allowed to access 5GS via CAG cells" in the entry of the "CAG information list" for the current PLMN, if any. If the "CAG information list" stored in the UE does not include the current PLMN's entry, the UE shall add an entry for the current PLMN to the "CAG information list" and store an "indication that the UE is only allowed to access 5GS via CAG cells" in the entry of the "CAG information list" for the current PLMN. If the UE does not have a stored "CAG information list", the UE shall create a new "CAG information list" and add an entry with an "indication that the UE is only allowed to access 5GS via CAG cells" for the current PLMN.

In addition:

- i) if one or more CAG-ID(s) are authorized based on the "allowed CAG list" for the current PLMN, then the UE shall enter the state 5GMM-DEREGISTERED.LIMITED-SERVICE and shall search for a suitable cell according to 3GPP TS 38.304 [28] with the updated CAG information; or
- ii) if no CAG-ID is authorized based on the "allowed CAG list" for the current PLMN, then the UE shall enter the state 5GMM-DEREGISTERED.PLMN-SEARCH and shall apply the PLMN selection process defined in 3GPP TS 23.122 [5] with the updated "CAG information list".

If the message was received via 3GPP access and the UE is operating in single-registration mode, the UE shall in addition set the EPS update status to EU3 ROAMING NOT ALLOWED, reset the attach attempt counter and enter the state EMM-DEREGISTERED.

#77 (Wireline access area not allowed).

5GMM cause #77 is only applicable when received from a wireline access network by the 5G-RG or the W-AGF acting on behalf of the FN-CRG. 5GMM cause #77 received from a 5G access network other than a wireline

access network and 5GMM cause #77 received by the W-AGF acting on behalf of the FN-BRG are considered as abnormal cases and the behaviour of the UE is specified in subclause 5.5.1.2.7.

When received over wireline access network, the 5G-RG and the W-AGF acting on behalf of the FN-CRG shall set the 5GS update status to 5U3 ROAMING NOT ALLOWED (and shall store it according to subclause 5.1.3.2.2), shall delete 5G-GUTI, last visited registered TAI, TAI list and ngKSI, shall reset the registration attempt counter, shall enter the state 5GMM-DEREGISTERED and shall act as specified in subclause 5.3.23.

NOTE 10: The 5GMM sublayer states, the 5GMM parameters and the registration status are managed per access type independently, i.e. 3GPP access or non-3GPP access (see subclauses 4.7.2 and 5.1.3).

#78 (PLMN not allowed to operate at the present UE location).

This cause value received from a non-satellite NG-RAN cell is considered as an abnormal case and the behaviour of the UE is specified in subclause 5.5.1.2.7.

The UE shall set the 5GS update status to 5U3 ROAMING NOT ALLOWED (and shall store it according to subclause 5.1.3.2.2) and shall delete last visited registered TAI and TAI list. If the UE is not registering or has not registered to the same PLMN over non-3GPP access, the UE shall additionally delete 5G-GUTI and ngKSI. Additionally, the UE shall reset the registration attempt counter. The UE shall store the PLMN identity and, if it is known, the current geographical location in the list of "PLMNs not allowed to operate at the present UE location" and shall start a corresponding timer instance (see subclause 4.23.2). The UE shall enter state 5GMM-DEREGISTERED.PLMN-SEARCH and perform a PLMN selection according to 3GPP TS 23.122 [5].

If the message was received via 3GPP access and the UE is operating in single-registration mode, the UE shall handle the EMM parameters EMM state, EPS update status, 4G-GUTI, TAI list, eKSI and attach attempt counter as specified in 3GPP TS 24.301 [15] for the case when the EPS attach procedure is rejected with the EMM cause with the same value.

#79 (UAS services not allowed).

This cause value received when the UE did not include the service-level device ID set to the CAA-level UAV ID in the Service-level-AA container IE of REGISTRATION REQUEST message is considered as an abnormal case and the behaviour of the UE is specified in subclause 5.5.1.2.7.

The UE shall abort the initial registration procedure, set the 5GS update status to 5U2 NOT UPDATED and enter state 5GMM-DEREGISTERED. ATTEMPTING-REGISTRATION or 5GMM-DEREGISTERED.PLMN-SEARCH. Additionally, the UE shall reset the registration attempt counter. If the UE re-attempt the registration procedure to the current PLMN, the UE shall not include the service-level device ID set to the CAA-level UAV ID in the Service-level-AA container IE of REGISTRATION REQUEST message unless the UE receives a CONFIGURATION UPDATE COMMAND message including the service-level-AA service status indication in the Service-level-AA container IE with the UAS field set to "UAS services enabled".

If the message was received via 3GPP access and the UE is operating in single-registration mode, the UE shall in addition set the EPS update status to EU2 NOT UPDATED, reset the attach attempt counter and enter the state EMM-DEREGISTERED.

#80 (Disaster roaming for the determined PLMN with disaster condition not allowed).

This cause value received via non-3GPP access or from a cell belonging to an SNPN and the UE is operating in SNPN access operation mode or when the UE did not indicate "disaster roaming initial registration" in the 5GS registration type IE in the REGISTRATION REQUEST message is considered as an abnormal case and the behaviour of the UE is specified in subclause 5.5.1.2.7.

The UE shall abort the initial registration procedure, set the 5GS update status to 5U2 NOT UPDATED, enter state 5GMM-DEREGISTERED. PLMN-SEARCH and shall delete any 5G-GUTI, last visited registered TAI, TAI list and ngKSI. Additionally, the UE shall reset the registration attempt counter. The UE shall not attempt to register for disaster roaming services on this PLMN for the UE determined PLMN with disaster condition for a period in the range of 12 to 24 hours. The UE shall not attempt to register for disaster roaming services on this PLMN for a period in the range of 3 to 10 minutes. The UE shall perform PLMN selection as described in 3GPP TS 23.122 [6]. If the message has been successfully integrity checked by the NAS and the UE maintains the PLMN-specific attempt counter of the PLMN which sent the reject message for the UE determined PLMN with disaster condition, the UE shall set the PLMN-specific attempt counter of the PLMN which sent the reject

message for the UE determined PLMN with disaster condition to the UE implementation-specific maximum value.

If the message was received via 3GPP access and the UE is operating in single-registration mode, the UE shall in addition set the EPS update status to EU2 NOT UPDATED, reset the attach attempt counter and enter the state EMM-DEREGISTERED.

#81 (Selected N3IWF is not compatible with the allowed NSSAI).

This cause value received when the UE does not access 5GCN over non-3GPP access using the N3IWF or has not indicated support for slice-based N3IWF selection in the REGISTRATION REQUEST message is considered as an abnormal case and the behaviour of the UE is specified in subclause 5.5.1.2.7.

The UE shall abort the initial registration procedure, set the 5GS update status to 5U2 NOT UPDATED and enter state 5GMM-DEREGISTERED. ATTEMPTING-REGISTRATION or 5GMM-DEREGISTERED.PLMN-SEARCH. Additionally, the UE shall reset the registration attempt counter. If the N3IWF identifier IE is included in the REGISTRATION REJECT message and the UE supports slice-based N3IWF selection, the UE may use the provided N3IWF identifier IE in N3IWF selection as specified in 3GPP TS 24.502 [18] prior to an immediate consecutive initial registration attempt to the network, otherwise the UE shall ignore the N3IWF identifier IE. Additionally, if the UE selects a new N3IWF and a new initial registration attempt is performed, the UE shall delete any 5G-GUTI, last visited registered TAI, TAI list and ngKSI.

#82 (Selected TNGF is not compatible with the allowed NSSAI).

This cause value received when the UE does not access 5GCN over non-3GPP access using the TNGF or has not indicated support for slice-based TNGF selection in the REGISTRATION REQUEST message is considered as an abnormal case and the behaviour of the UE is specified in subclause 5.5.1.2.7.

The UE shall abort the initial registration procedure, set the 5GS update status to 5U2 NOT UPDATED and enter state 5GMM-DEREGISTERED. ATTEMPTING-REGISTRATION or 5GMM-DEREGISTERED.PLMN-SEARCH. Additionally, the UE shall reset the registration attempt counter. If the TNAN information IE is included in the REGISTRATION REJECT message and the UE supports slice-based TNGF selection, the UE may use the provided TNAN information IE in TNAN selection as specified in 3GPP TS 24.502 [18] prior to an immediate consecutive registration attempt to the network, otherwise the UE shall ignore the TNAN information IE. Additionally, if the UE selects a new TNAN and a new initial registration attempt is performed, the UE shall delete any 5G-GUTI, last visited registered TAI, TAI list and ngKSI.

Other values are considered as abnormal cases. The behaviour of the UE in those cases is specified in subclause 5.5.1.2.7.

5.5.1.2.6 Initial registration for emergency services not accepted by the network

Upon receiving the REGISTRATION REJECT message including 5GMM cause #5 "PEI not accepted", the UE shall enter the state 5GMM-DEREGISTERED.NO-SUPI. If the REGISTRATION REJECT message is received,

- over 3GPP access; or
- over non-3GPP access and is integrity protected;

and the UE also supports the registration procedure over the other access, the UE shall in addition handle 5GMM parameters and 5GMM state for this access, as described for this 5GMM cause value.

Upon receiving the REGISTRATION REJECT message including 5GMM cause value which is not #5 "PEI not accepted", the UE shall perform the actions as described in subclause 5.5.1.2.5 with the following addition: the UE shall inform the upper layers of the failure of the procedure.

NOTE 1: This can result in the upper layers requesting implementation specific mechanisms, e.g. procedures specified in 3GPP TS 24.229 [14] can result in the emergency call being attempted to another IP-CAN.

If the initial registration request for emergency services fails due to abnormal cases, the UE shall perform the actions as described in subclause 5.5.1.2.7 and inform the upper layers of the failure to access the network or the failure of the procedure.

NOTE 2: This can result in the upper layers requesting other implementation specific mechanisms, e.g. procedures specified in 3GPP TS 24.229 [14] can result in the emergency call being attempted to another IP-CAN.

In a shared network, upon receiving the REGISTRATION REJECT message, the UE shall perform the actions as described in subclause 5.5.1.2.5, and shall:

- a) inform the upper layers of the failure of the procedure; or

NOTE 3: The upper layers can request implementation specific mechanisms, e.g. procedures specified in 3GPP TS 24.229 [14] that can result in the emergency call being attempted to another IP-CAN.

- b) attempt to perform a PLMN or SNPN selection in the shared network and, if an initial registration for emergency services was not already attempted with the selected PLMN or SNPN and the REGISTRATION REQUEST message, for which the REGISTRATION REJECT message was received, is:
 - not for sending a PDU SESSION ESTABLISHMENT REQUEST message with request type set to "existing emergency PDU session", initiate an initial registration for emergency services with the selected PLMN or SNPN; or
 - for sending a PDU SESSION ESTABLISHMENT REQUEST message with request type set to "existing emergency PDU session", and:
 - i) the selected PLMN is an equivalent PLMN or the selected SNPN is an equivalent SNPN, initiate an initial registration for emergency services with the selected PLMN or SNPN; and
 - ii) the selected PLMN is not an equivalent PLMN or the selected SNPN is not an equivalent SNPN, perform a PLMN or SNPN selection and initiate an initial registration for emergency services with the selected PLMN or SNPN if an initial registration for emergency services was not already attempted with the selected PLMN or SNPN.

In a shared network, if the initial registration request for emergency services fails due to abnormal cases, the UE shall perform the actions as described in subclause 5.5.1.2.7 and shall:

- a) inform the upper layers of the failure of the procedure; or

NOTE 4: The upper layers can request implementation specific mechanisms, e.g. procedures specified in 3GPP TS 24.229 [14] that can result in the emergency call being attempted to another IP-CAN.

- b) attempt to perform a PLMN or SNPN selection in the shared network and, if an initial registration for emergency services was not already attempted with the selected PLMN or SNPN and the REGISTRATION REQUEST message is:
 - not for sending a PDU SESSION ESTABLISHMENT REQUEST message with request type set to "existing emergency PDU session", initiate an initial registration for emergency services with the selected PLMN or SNPN; or
 - for sending a PDU SESSION ESTABLISHMENT REQUEST message with request type set to "existing emergency PDU session", and:
 - i) the selected PLMN is an equivalent PLMN or the selected SNPN is an equivalent SNPN, initiate an initial registration for emergency services with the selected PLMN or SNPN; and
 - ii) the selected PLMN is not an equivalent PLMN or the selected SNPN is not an equivalent SNPN, perform a PLMN or SNPN selection and initiate an initial registration for emergency services with the selected PLMN or SNPN if an initial registration for emergency services was not already attempted with the selected PLMN or SNPN.

5.5.1.2.6A Initial registration for initiating an emergency PDU session not accepted by the network

If the network cannot accept an initial registration request with 5GS registration type IE set to "initial registration" and for sending a PDU SESSION ESTABLISHMENT REQUEST message with request type set to "initial emergency request", the UE shall perform the procedures as described in subclause 5.5.1.2.5. Then if the UE is in the same selected PLMN or SNPN where the last initial registration request was attempted, the UE shall:

- a) inform the upper layers of the failure of the procedure; or

NOTE 1: This can result in the upper layers requesting implementation specific mechanisms, e.g. procedures specified in 3GPP TS 24.229 [14] can result in the emergency call being attempted to another IP-CAN.

b) attempt initial registration for emergency services.

If the network cannot accept an initial registration request with 5GS registration type IE set to "initial registration", for establishing an emergency PDU session and the PDU session needs to be established due to handover of an existing PDN connection for emergency bearer services, the UE shall perform the procedures as described in subclause 5.5.1.2.5. Then if the UE is in the same selected PLMN or equivalent PLMN or the same selected SNPN or equivalent SNPN, where the last initial registration request was attempted, the UE shall attempt initial registration for emergency services.

If the initial registration request, with 5GS registration type IE set to "initial registration" and for initiating an emergency PDU session, fails due to abnormal case b) in subclause 5.5.1.2.7, the UE shall perform the actions as described in subclause 5.5.1.2.7 and inform the upper layers of the failure to access the network.

NOTE 2: This can result in the upper layers requesting implementation specific mechanisms, e.g. procedures specified in 3GPP TS 24.229 [14] can result in the emergency call being attempted to another IP-CAN.

If the initial registration request, with 5GS registration type IE set to "initial registration" and for initiating an emergency PDU session, fails due to abnormal cases c), d) or e) in subclause 5.5.1.2.7, the UE shall perform the actions as described in subclause 5.5.1.2.7. Then if the UE is in:

- a) the same selected PLMN or SNPN where the last initial registration request was attempted and the PDU session does not need to be established due to handover of an existing PDN connection for emergency bearer services, the UE shall:
- inform the upper layers of the failure of the procedure; or

NOTE 3: This can result in the upper layers requesting implementation specific mechanisms, e.g. procedures specified in 3GPP TS 24.229 [14] can result in the emergency call being attempted to another IP-CAN.

- attempt initial registration for emergency services; or
- b) the same selected PLMN or equivalent PLMN or the same selected SNPN or equivalent SNPN, where the last initial registration request was attempted and the PDU session needs to be established due to handover of an existing PDN connection for emergency bearer services, attempt initial registration for emergency services.

5.5.1.2.7 Abnormal cases in the UE

The following abnormal cases can be identified:

- a) Timer T3346 is running.

The UE shall not start the registration procedure for initial registration unless:

- 1) the UE is a UE configured for high priority access in selected PLMN or SNPN;
- 2) the UE needs to perform the registration procedure for initial registration for emergency services;
- 3) the UE receives a DEREGISTRATION REQUEST message with the "re-registration required" indication;
- 4) the UE in NB-N1 mode is requested by the upper layer to transmit user data related to an exceptional event and:
 - the UE is allowed to use exception data reporting (see the ExceptionDataReportingAllowed leaf of the NAS configuration MO in 3GPP TS 24.368 [17] or the USIM file EF_{NASCONFIG} in 3GPP TS 31.102 [22]); and
 - timer T3346 was not started when N1 NAS signalling connection was established with RRC establishment cause set to "mo-ExceptionData"; or
- 5) the UE needs to perform the registration procedure with 5GS registration type IE set to "initial registration" for initiating of an emergency PDU session, upon request of the upper layers to establish the emergency PDU session.

The UE stays in the current serving cell and applies the normal cell reselection process.

NOTE 1: It is considered an abnormal case if the UE needs to initiate a registration procedure for initial registration while timer T3346 is running independent on whether timer T3346 was started due to an abnormal case or a non-successful case.

b) The lower layers indicate that the access attempt is barred.

The UE shall not start the initial registration procedure. The UE stays in the current serving cell and applies the normal cell reselection process. Receipt of the access barred indication shall not trigger the selection of a different core network type (EPC or 5GCN).

The initial registration procedure is started, if still needed, when the lower layers indicate that the barring is alleviated for the access category with which the access attempt was associated.

ba) The lower layers indicate that:

- 1) access barring is applicable for all access categories except categories 0 and 2 and the access category with which the access attempt was associated is other than 0 and 2; or
- 2) access barring is applicable for all access categories except category 0 and the access category with which the access attempt was associated is other than 0.

If the REGISTRATION REQUEST message has not been sent, the UE shall proceed as specified for case b. If the REGISTRATION REQUEST message has been sent, the UE shall proceed as specified for case e and, additionally, the registration procedure for initial registration is started, if still needed, when the lower layers indicate that the barring is alleviated for the access category with which the access attempt was associated.

c) T3510 timeout.

The UE shall abort the registration procedure for initial registration and the NAS signalling connection, if any, shall be released locally if the initial registration request is neither for emergency services nor for initiating a PDU session for emergency services with request type set to "existing emergency PDU session". The UE shall proceed as described below.

d) REGISTRATION REJECT message, other 5GMM cause values than those treated in subclause 5.5.1.2.5, and cases of 5GMM cause values #10, #11, #15, #22, #31, #72, #73, #74, #75, #76, #77, #78, #79, #80, #81 and #82, if considered as abnormal cases according to subclause 5.5.1.2.5.

If the registration request is neither an initial registration request for emergency services nor an initial registration request for initiating a PDU session for emergency services with request type set to "existing emergency PDU session", upon reception of the 5GMM causes #95, #96, #97, #99 and #111 the UE should set the registration attempt counter to 5.

The UE shall proceed as described below.

e) Lower layer failure or release of the NAS signalling connection received from lower layers before the REGISTRATION ACCEPT or REGISTRATION REJECT message is received.

The UE shall abort the registration procedure for initial registration and proceed as described below.

f) UE initiated de-registration required.

The registration procedure for initial registration shall be aborted, and the UE initiated de-registration procedure shall be performed. The UE shall populate the 5GS mobile identity IE in the DEREGISTRATION REQUEST message with the same UE identity as used in the REGISTRATION REQUEST message for the aborted initial registration procedure. If the de-registration is due to USIM removal and T3519 is not running, the UE may perform a local de-registration.

g) De-registration procedure collision.

If the UE receives a DEREGISTRATION REQUEST message from the network in state 5GMM-REGISTERED-INITIATED the de-registration procedure shall be aborted and the initial registration procedure shall be progressed.

NOTE 2: The above collision case is valid if the DEREGISTRATION REQUEST message indicates the access type over which the initial registration procedure is attempted otherwise both the procedures are progressed.

h) Change in the current TAI.

If the current TAI is changed before the registration procedure for initial registration is completed, the registration procedure for initial registration shall be aborted and re-initiated immediately.

If the REGISTRATION COMPLETE message needs to be sent and a tracking area border is crossed when the REGISTRATION ACCEPT message has been received but before a REGISTRATION COMPLETE message is sent and:

- 1) if the current TAI is in the TAI list, the UE sends the REGISTRATION COMPLETE message to the network; and
- 2) otherwise, the registration procedure for initial registration shall be aborted and the registration procedure for mobility registration update shall be initiated.

If a 5G-GUTI was allocated during the registration procedure, this 5G-GUTI shall be used in the registration procedure.

i) Transmission failure of REGISTRATION COMPLETE message indication with change in the current TAI.

- 1) If the current TAI is still part of the TAI list, the UE resends the REGISTRATION COMPLETE message to the network; and
- 2) otherwise, the registration procedure for initial registration shall be aborted and the registration procedure for mobility registration update shall be initiated.

j) Transmission failure of REGISTRATION COMPLETE message indication without change in the current TAI from lower layers.

It is up to the UE implementation how to re-run the ongoing procedure.

k) Transmission failure of REGISTRATION REQUEST message indication from the lower layers.

The registration procedure for initial registration shall be aborted and re-initiated immediately.

l) Timer T3447 is running.

The UE shall not start the registration procedure for initial registration with Follow-on request indicator set to "Follow-on request pending" unless:

- 1) the UE is a UE configured for high priority access in selected PLMN; or
- 2) the UE needs to perform the registration procedure for initial registration for emergency services.

The UE stays in the current serving cell and applies the normal cell reselection process. The registration procedure for initial registration is started, if still necessary, when timer T3447 expires or timer T3447 is stopped.

m) UE is not registered to the access other than the access the REGISTRATION ACCEPT message is received and the 5GS registration result value in the 5GS registration result IE value in the REGISTRATION ACCEPT message is set to "3GPP access and non-3GPP access".

The UE shall consider itself as being registered to only the access where the REGISTRATION ACCEPT message is received.

n) Access for localized services in current SNPN is no longer allowed.

If the initial registration request is neither for emergency services nor for initiating a PDU session for emergency services with request type set to "existing emergency PDU session", the selected SNPN is an SNPN selected for localized services in SNPN (see 3GPP TS 23.122 [5]) and:

- 1) access for localized services in SNPN is disabled; or

2) the validity information for the selected SNPN is no longer met;

the UE shall reset the registration attempt counter, stop T3510, abort the registration procedure for initial registration, locally release the NAS signalling connection, if any, and enter state 5GMM-DEREGISTERED.LIMITED-SERVICE or 5GMM-DEREGISTERED.PLMN-SEARCH in order to perform SNPN selection according to 3GPP TS 23.122 [5].

For the cases c, d and e, the UE shall proceed as follows:

Timer T3510 shall be stopped if still running.

If the registration procedure is neither an initial registration for emergency services nor for establishing an emergency PDU session with registration type not set to "emergency registration", the registration attempt counter shall be incremented, unless it was already set to 5.

If the registration attempt counter is less than 5:

- if the initial registration request is not for emergency services, timer T3511 is started and the state is changed to 5GMM-DEREGISTERED.ATTEMPTING-REGISTRATION. When timer T3511 expires the registration procedure for initial registration shall be restarted, if still required.

If the registration attempt counter is equal to 5

- the UE shall delete TAI list and last visited registered TAI, start timer T3502 if the value of the timer as indicated by the network is not zero and shall set the 5GS update status to 5U2 NOT UPDATED. If the UE is not registering or has not registered to the same PLMN over both 3GPP access and non-3GPP access, the UE shall additionally delete 5G-GUTI, ngKSI and list of equivalent PLMNs (if any) or list of equivalent SNPNS (if any). The state is changed to 5GMM-DEREGISTERED.ATTEMPTING-REGISTRATION or optionally to 5GMM-DEREGISTERED.PLMN-SEARCH in order to perform a PLMN selection, SNPN selection or SNPN selection for onboarding services according to 3GPP TS 23.122 [5].
- if the value of T3502 as indicated by the network is zero, the UE shall perform the actions defined for the expiry of the timer T3502.
- if the procedure is performed via 3GPP access and the UE is operating in single-registration mode:
 - the UE shall in addition handle the EMM parameters EPS update status, EMM state, 4G-GUTI, TAI list, last visited registered TAI, list of equivalent PLMNs and eKSI as specified in 3GPP TS 24.301 [15] for the abnormal cases when an EPS attach procedure fails and the attach attempt counter is equal to 5; and
 - the UE shall attempt to select E-UTRAN radio access technology and proceed with appropriate EMM specific procedures. Additionally, The UE may disable the N1 mode capability as specified in subclause 4.9.

5.5.1.2.8 Abnormal cases on the network side

The following abnormal cases can be identified:

a) Lower layer failure

If a lower layer failure occurs before the REGISTRATION COMPLETE message has been received from the UE and timer T3550 is running, the AMF shall locally abort the registration procedure for initial registration, enter state 5GMM-REGISTERED and shall not resend the REGISTRATION ACCEPT message. If a new 5G-GUTI was assigned to the UE in the registration procedure for initial registration, the AMF shall consider both the old and the new 5G-GUTI as valid until the old 5G-GUTI can be considered as invalid by the AMF or the 5GMM context which has been marked as deregistered in the AMF is released. If the old 5G-GUTI was allocated by an AMF other than the current AMF, the current AMF does not need to retain the old 5G-GUTI. During this period the network may use the identification procedure followed by a generic UE configuration update procedure if the old 5G-GUTI is used by the UE in a subsequent message.

b) Protocol error

If the REGISTRATION REQUEST message is received with a protocol error, the AMF shall return a REGISTRATION REJECT message with one of the following 5GMM cause values:

- #96 invalid mandatory information;
- #99 information element non-existent or not implemented;
- #100 conditional IE error; or
- #111 protocol error, unspecified.

c) T3550 time-out

On the first expiry of the timer, the AMF shall retransmit the REGISTRATION ACCEPT message and shall reset and restart timer T3550.

This retransmission is repeated four times, i.e. on the fifth expiry of timer T3550, the registration procedure for initial registration shall be aborted and the AMF enters state 5GMM-REGISTERED. If a new 5G-GUTI was allocated in the REGISTRATION ACCEPT message, the AMF shall consider both the old and the new 5G-GUTIs as valid until the old 5G-GUTI can be considered as invalid by the AMF or the 5GMM context which has been marked as de-registered in the AMF is released. If the old 5G-GUTI was allocated by an AMF other than the current AMF, the current AMF does not need to retain the old 5G-GUTI. During this period, if the old 5G-GUTI is used by the UE in a subsequent message, the AMF acts as specified for case a) above.

d) REGISTRATION REQUEST message received after the REGISTRATION ACCEPT message has been sent and before the REGISTRATION COMPLETE message is received, if the REGISTRATION COMPLETE message is expected.

- 1) If one or more of the information elements in the REGISTRATION REQUEST message differ from the ones received within the previous REGISTRATION REQUEST message, the previously initiated the registration procedure for initial registration shall be aborted if the REGISTRATION COMPLETE message has not been received and the new registration procedure for initial registration shall be progressed; or
- 2) if the information elements do not differ, then the REGISTRATION ACCEPT message shall be resent and the timer T3550 shall be restarted. In that case, the retransmission counter related to T3550 is not incremented.

e) More than one REGISTRATION REQUEST message with 5GS registration type IE set to "initial registration" received and no REGISTRATION ACCEPT message or REGISTRATION REJECT message has been sent.

- 1) If one or more of the information elements in the REGISTRATION REQUEST message with 5GS registration type IE set to "initial registration" differs from the ones received within the previous REGISTRATION REQUEST message with 5GS registration type IE set to "initial registration", the previously initiated the registration procedure for initial registration shall be aborted and the new the registration procedure for initial registration shall be executed;
- 2) if the information elements do not differ, then the network shall continue with the previous the registration procedure for initial registration and shall ignore the second REGISTRATION REQUEST message.

f) REGISTRATION REQUEST message with 5GS registration type IE set to "initial registration" received in state 5GMM-REGISTERED.

If a REGISTRATION REQUEST message with 5GS registration type IE set to "initial registration" is received in state 5GMM-REGISTERED the network may initiate the 5GMM common procedures; if it turned out that the REGISTRATION REQUEST message was sent by a genuine UE that has already been registered, the 5GMM context, if any, are deleted and the new REGISTRATION REQUEST is progressed, otherwise if network considers REGISTRATION REQUEST message was not sent by a genuine UE based on authentication procedure the network shall maintain the 5GMM-context, if any, unchanged.

NOTE 1: The network can determine that the UE is genuine by executing the authentication procedure as described in subclause 5.4.1.

g) REGISTRATION REQUEST message with 5GS registration type IE set to "mobility registration updating" or "periodic registration updating" received before REGISTRATION COMPLETE message, if the REGISTRATION COMPLETE message is expected.

Timer T3550 shall be stopped. The allocated 5G-GUTI in the registration procedure for initial registration shall be considered as valid and the registration procedure for mobility and periodic registration update shall be progressed as described in subclause 5.5.1.3.

- h) DEREGISTRATION REQUEST message received before REGISTRATION COMPLETE message, if the REGISTRATION COMPLETE message is expected.

The AMF shall abort the registration procedure for initial registration and shall progress the de-registration procedure as described in subclause 5.5.2.2.

- i) UE security capabilities invalid or unacceptable

If the REGISTRATION REQUEST message is received with invalid or unacceptable UE security capabilities (e.g. no 5GS encryption algorithms (all bits zero), no 5GS integrity algorithms (all bits zero), mandatory 5GS encryption algorithms not supported or mandatory 5GS integrity algorithms not supported, etc.), the AMF shall return a REGISTRATION REJECT message.

NOTE 2: 5GMM cause value to be used in REGISTRATION REJECT message is up to the network implementation.

- j) Based on operator policy, if the initial registration request from a UE not supporting CAG is rejected due to CAG restrictions, the network shall reject the initial registration with a 5GMM cause value other than the 5GMM cause #76 (Not authorized for this CAG or authorized for CAG cells only).

NOTE 3: 5GMM cause #7 (5GS services not allowed), 5GMM cause #11 (PLMN not allowed), 5GMM cause #27 (N1 mode not allowed), 5GMM cause #73 (Serving network not authorized) can be used depending on the subscription of the UE and whether the UE roams or not.

5.5.1.3 Registration procedure for mobility and periodic registration update

5.5.1.3.1 General

This procedure is used by a UE for both mobility and periodic registration update of 5GS services. This procedure, when used for periodic registration update of 5GS services, is performed only in 3GPP access.

This procedure used for periodic registration update of 5GS services is controlled in the UE by timer T3512. When timer T3512 expires, the registration procedure for mobility and periodic registration update is started. Start and reset of timer T3512 is described in subclause 10.2.

If the MUSIM UE is registered for emergency services and initiates a registration procedure for mobility and periodic registration update, the network shall not indicate the support of:

- the NAS signalling connection release;
- the paging indication for voice services;
- the reject paging request; or
- the paging restriction;

in the REGISTRATION ACCEPT message.

5.5.1.3.2 Mobility and periodic registration update initiation

The UE in state 5GMM-REGISTERED shall initiate the registration procedure for mobility and periodic registration update by sending a REGISTRATION REQUEST message to the AMF,

- a) when the UE detects that the current TAI is not in the list of tracking areas that the UE previously registered in the AMF;
- b) when the periodic registration updating timer T3512 expires in 5GMM-IDLE mode and the UE is not registered for emergency services (see subclause 5.3.7);

- c) when the UE receives a CONFIGURATION UPDATE COMMAND message indicating "registration requested" in the Registration requested bit of the Configuration update indication IE as specified in subclauses 5.4.4.3;
- d) when the UE in state 5GMM-REGISTERED.ATTEMPTING-REGISTRATION-UPDATE either receives a paging or the UE receives a NOTIFICATION message with access type indicating 3GPP access over the non-3GPP access for PDU sessions associated with 3GPP access;

NOTE 1: As an implementation option, MUSIM UE is allowed to not respond to paging based on the information available in the paging message, e.g. voice service indication.

- e) upon inter-system change from S1 mode to N1 mode and if the UE previously had initiated an attach procedure or a tracking area updating procedure when in S1 mode;
- f) when the UE receives an indication of "RRC Connection failure" from the lower layers and does not have signalling pending (i.e. when the lower layer requests NAS signalling connection recovery) except for the case specified in subclause 5.3.1.4;
- g) when the UE changes the 5GMM capability or the S1 UE network capability or both;
- h) when the UE's usage setting changes;
- i) when the UE needs to change the slice(s) it is currently registered to;

NOTE 1A: The UE can after the completion of the ongoing registration procedure, initiate another registration procedure for mobility registration update to request more slices.

- j) when the UE changes the UE specific DRX parameters;
- k) when the UE in state 5GMM-REGISTERED.ATTEMPTING-REGISTRATION-UPDATE receives a request from the upper layers to establish an emergency PDU session or perform emergency services fallback;
- l) when the UE needs to register for SMS over NAS, indicate a change in the requirements to use SMS over NAS, or de-register from SMS over NAS;
- m) when the UE needs to indicate PDU session status to the network after performing a local release of PDU session(s) as specified in subclauses 6.4.1.5 and 6.4.3.5;
- n) when the UE in 5GMM-IDLE mode changes the radio capability for NG-RAN or E-UTRAN;
- o) when the UE receives a fallback indication from the lower layers and does not have signalling pending, see subclauses 5.3.1.4 and 5.3.1.2);
- p) void;
- q) when the UE needs to request new LADN information;
- r) when the UE needs to request the use of MICO mode or needs to stop the use of MICO mode or to request the use of new T3324 value or new T3512 value;
- s) when the UE in 5GMM-CONNECTED mode with RRC inactive indication enters a cell in the current registration area belonging to an equivalent PLMN of the registered PLMN and not belonging to the registered PLMN;
- t) when the UE receives over 3GPP access a SERVICE REJECT message or a DL NAS TRANSPORT message, with the 5GMM cause value set to #28 "Restricted service area";
- u) when the UE needs to request the use of eDRX, when a change in the eDRX usage conditions at the UE requires different extended DRX parameters, or needs to stop the use of eDRX;

NOTE 2: A change in the eDRX usage conditions at the UE can include e.g. a change in the UE configuration, a change in requirements from upper layers or the battery running low at the UE.

- v) when the UE supporting 5G-SRVCC from NG-RAN to UTRAN changes the mobile station classmark 2 or the supported codecs;

- w) when the UE in state 5GMM-REGISTERED.ATTEMPTING-REGISTRATION-UPDATE decides to request new network slices after being rejected due to no allowed network slices requested, or request S-NSSAI(s) which have been removed from the rejected NSSAI for the maximum number of UEs reached;
 - x) when the UE is not in NB-N1 mode and the UE has received a UE radio capability ID deletion indication IE set to "Network-assigned UE radio capability IDs deletion requested";
 - y) when the UE receives a REGISTRATION REJECT message with 5GMM cause values #3, #6 or #7 without integrity protection over another access;
 - z) when the UE needs to request new ciphering keys for ciphered broadcast assistance data;
 - za) when due to manual CAG selection the UE has selected a CAG-ID which is not a CAG-ID authorized based on the "allowed CAG list" for the selected PLMN or a CAG-ID in a PLMN for which the entry in the "CAG information list" does not exist or when the UE has selected, without selecting a CAG-ID, a PLMN for which the entry in the "CAG information list" includes an "indication that the UE is only allowed to access 5GS via CAG cells";
 - zb) when the UE needs to start, stop or change the conditions for using the WUS assistance information or PEIPS assistance information;
 - zc) when the UE changes the UE specific DRX parameters in NB-N1 mode;
 - zd) when the UE in 5GMM-CONNECTED mode with RRC inactive indication enters a new cell with different RAT in current TAI list or not in current TAI list;
 - ze) when the UE enters state 5GMM-REGISTERED.NORMAL-SERVICE or 5GMM-REGISTERED.NON-ALLOWED-SERVICE (as described in subclause 5.3.5.2) over 3GPP access after the UE has sent a NOTIFICATION RESPONSE message over non-3GPP access in response to reception of a NOTIFICATION message over non-3GPP access as specified in subclause 5.6.3.1;
 - zf) when the UE supporting UAS services is not registered for UAS services and needs to register to the 5GS for UAS services;
 - zg) when the UE supporting MINT needs to perform the registration procedure for mobility and periodic registration update to register to the PLMN offering disaster roaming;
 - zh) when the MUSIM UE supporting the paging timing collision control needs to request a new 5G-GUTI assignment and the UE is not registered for emergency services;
- NOTE 3: Based on implementation, the MUSIM UE can request a new 5G-GUTI assignment (e.g. when the lower layers request to modify the timing of the paging occasions).
- zi) when the network supports the paging restriction and the MUSIM UE in state 5GMM-REGISTERED.NON-ALLOWED-SERVICE needs to requests the network to remove the paging restriction;
 - zj) when the UE changes the 5GS Preferred CIoT network behaviour or the EPS Preferred CIoT network behaviour;
 - zk) when the UE that has entered 5GMM-REGISTERED.NO-CELL-AVAILABLE and it has one or more S-NSSAI(s) in pending NSSAI, finds a suitable cell according to 3GPP TS 38.304 [28];
 - zl) when the UE is registered for disaster roaming services and receives a request from the upper layers to establish an emergency PDU session or perform emergency services fallback;

zm1) when the UE needs to provide the unavailability information or to update the unavailability information;

zm2) void;

NOTE 3A: How UE determines that it is about to lose satellite coverage is an implementation option.

zn) when the UE needs to come out of unavailability period and resume normal services;

zo) when the UE in state 5GMM-REGISTERED.ATTEMPTING-REGISTRATION-UPDATE, the UE supports the reconnection to the network due to RAN timing synchronization status change has been requested to reconnect to the network upon receiving an indication of a change in the RAN timing synchronization status (see

subclauses 5.4.4.2, 5.5.1.2.4, and 5.5.1.3.4), and the UE receives an indication of a change in the RAN timing synchronization status; or

zp) when the UE that supports non-3GPP access path switching needs to trigger non-3GPP access path switching from the old non-3GPP access to the new non-3GPP access that is in the same PLMN.

NOTE 4: Non-3GPP access path switching from a non-3GPP access to a wireline access, or from a wireline access to a non-3GPP access, is not specified in this release of the specification.

zq) if the UE moves from a tracking area for which the TAI is configured for partially rejected NSSAI to another tracking area within the registration area with aTAI for which the S-NSSAI(s) is supported and the UE still needs to request that S-NSSAI(s).

NOTE 4A: The UEs that do not initiate the registration procedure for mobility and periodic registration update in the case above will not receive service for the S-NSSAI(s) that are configured to support the S-NSSAI(s) in the tracking areas supporting the S-NSSAI(s). Operators are recommended to consider the impact of such a configuration, of having partially rejected NSSAI applicable in some tracking areas within a registration area, as it requires the UE to perform mobility and periodic registration update procedure upon mobility within the same registration area.

If case b is the only reason for initiating the registration procedure for mobility and periodic registration update, the UE shall indicate "periodic registration updating" in the 5GS registration type IE; otherwise, if the UE initiates the registration procedure for mobility and periodic registration update due to case zg, the UE shall indicate "disaster roaming mobility registration updating" in the 5GS registration type IE; otherwise the UE shall indicate "mobility registration updating".

If case zl is the reason for initiating the registration procedure for mobility and periodic registration update and if the UE supports S1 mode and the UE has not disabled its E-UTRA capability, the UE shall:

- set the S1 mode bit to "S1 mode supported" in the 5GMM capability IE of the REGISTRATION REQUEST message; and
- include the S1 UE network capability IE in the REGISTRATION REQUEST message;

If the UE which is not registered for disaster roaming services indicates "mobility registration updating" in the 5GS registration type IE and the UE supports S1 mode and the UE has not disabled its E-UTRA capability, the UE shall:

- set the S1 mode bit to "S1 mode supported" in the 5GMM capability IE of the REGISTRATION REQUEST message;
- include the S1 UE network capability IE in the REGISTRATION REQUEST message additionally, if the UE supports EPS-UPIP, the UE shall set the EPS-UPIP bit to "EPS-UPIP supported" in the S1 UE network capability IE in the REGISTRATION REQUEST message; and
- if the UE supports sending an ATTACH REQUEST message containing a PDN CONNECTIVITY REQUEST message with request type set to "handover" to transfer a PDU session from N1 mode to S1 mode, set the HO attach bit to "attach request message containing PDN connectivity request with request type set to handover to transfer PDU session from N1 mode to S1 mode supported" in the 5GMM capability IE of the REGISTRATION REQUEST message.

If the UE supports the LTE positioning protocol (LPP) in N1 mode as specified in 3GPP TS 37.355 [26], the UE shall set the LPP bit to "LPP in N1 mode supported" in the 5GMM capability IE of the REGISTRATION REQUEST message.

If the UE supports the Location Services (LCS) notification mechanisms in N1 mode as specified in 3GPP TS 23.273 [6B], the UE shall set the 5G-LCS bit to "LCS notification mechanisms supported" in the 5GMM capability IE of the REGISTRATION REQUEST message.

If the UE supports the user plane positioning using LCS-UPP as specified in 3GPP TS 23.273 [6B], the UE shall set the LCS-UPP bit to "LCS-UPP user plane positioning supported" in the 5GMM capability IE of the REGISTRATION REQUEST message.

If the UE supports the user plane positioning using SUPL as specified in 3GPP TS 38.305 [67] and 3GPP TS 23.271 [68], the UE shall set the SUPL bit to "SUPL user plane positioning supported" in the 5GMM capability IE of the REGISTRATION REQUEST message.

If the UE supports network verified UE location over satellite NG-RAN as specified in 3GPP TS 23.501 [8], the UE shall set the NVL-SATNR bit to "Network verified UE location over satellite NG-RAN supported" in the 5GMM capability IE of the REGISTRATION REQUEST message.

For all cases except case b, when the UE is not in NB-N1 mode and the UE supports RACS, the UE shall set the RACS bit to "RACS supported" in the 5GMM capability IE of the REGISTRATION REQUEST message.

If the UE supports 5G-SRVCC from NG-RAN to UTRAN as specified in 3GPP TS 23.216 [6A], the UE shall set:

- the 5G-SRVCC from NG-RAN to UTRAN capability bit to "5G-SRVCC from NG-RAN to UTRAN supported" in the 5GMM capability IE of the REGISTRATION REQUEST message for all cases except case b; and
- include the Mobile station classmark 2 IE and the Supported codecs IE in the REGISTRATION REQUEST message for all cases except case b.

If the UE supports the restriction on use of enhanced coverage, the UE shall set the RestrictEC bit to "Restriction on use of enhanced coverage supported" in the 5GMM capability IE of the REGISTRATION REQUEST message.

If the UE supports network slice-specific authentication and authorization, the UE shall set the NSSAA bit to "network slice-specific authentication and authorization supported" in the 5GMM capability IE of the REGISTRATION REQUEST message for all cases except case b.

If the UE supports CAG feature, the UE shall set the CAG bit to "CAG Supported" in the 5GMM capability IE of the REGISTRATION REQUEST message.

If the UE supports extended CAG information list, the UE shall set the Ex-CAG bit to "Extended CAG information list supported" in the 5GMM capability IE of the REGISTRATION REQUEST message.

If the UE supports enhanced CAG information, the UE shall set the ECI bit to "enhanced CAG information supported" in the 5GMM capability IE of the REGISTRATION REQUEST message.

If the UE supports sending of REGISTRATION COMPLETE message for acknowledging the reception of Negotiated PEIPS assistance information IE, the UE shall set the RCMAP bit to "Sending of REGISTRATION COMPLETE message for negotiated PEIPS assistance information supported" in the 5GMM capability IE of the REGISTRATION REQUEST message.

If the UE operating in the single-registration mode performs inter-system change from S1 mode to N1 mode and:

- a) has one or more stored UE policy sections identified by a UPSI with the PLMN ID part indicating the HPLMN or the selected PLMN, the UE shall set the Payload container type IE to "UE policy container" and include the UE STATE INDICATION message (see annex D) in the Payload container IE of the REGISTRATION REQUEST message; or
- b) does not have any stored UE policy section identified by a UPSI with the PLMN ID part indicating the HPLMN or the selected PLMN, and the UE needs to send a UE policy container to the network, the UE shall set the Payload container type IE to "UE policy container" and include the UE STATE INDICATION message (see annex D) in the Payload container IE of the REGISTRATION REQUEST message.

NOTE 5: In this version of the protocol, the UE can only include the Payload container IE in the REGISTRATION REQUEST message to carry a payload of type "UE policy container".

The UE in state 5GMM-REGISTERED shall initiate the registration procedure for mobility and periodic registration update by sending a REGISTRATION REQUEST message to the AMF when the UE needs to request the use of SMS over NAS transport or the current requirements to use SMS over NAS transport change in the UE. The UE shall set the SMS requested bit of the 5GS update type IE in the REGISTRATION REQUEST message as specified in subclause 5.5.1.2.2.

When initiating a registration procedure for mobility and periodic registration update and the UE needs to send the 5GS update type IE for a reason different than indicating a change in requirement to use SMS over NAS, the UE shall set the SMS requested bit of the 5GS update type IE in the REGISTRATION REQUEST message to the same value as indicated by the UE in the last REGISTRATION REQUEST message.

If the UE no longer requires the use of SMS over NAS, then the UE shall include the 5GS update type IE in the REGISTRATION REQUEST message with the SMS requested bit set to "SMS over NAS not supported".

After sending the REGISTRATION REQUEST message to the AMF the UE shall start timer T3510. If timer T3502 is currently running, the UE shall stop timer T3502. If timer T3511 is currently running, the UE shall stop timer T3511.

If the last visited registered TAI is available, the UE shall include the last visited registered TAI in the REGISTRATION REQUEST message.

The UE shall handle the 5GS mobile identity IE in the REGISTRATION REQUEST message as follows:

- a) if the UE is operating in the single-registration mode, performs inter-system change from S1 mode to N1 mode, and the UE holds a valid native 4G-GUTI, the UE shall create a 5G-GUTI mapped from the valid native 4G-GUTI as specified in 3GPP TS 23.003 [4] and indicate the mapped 5G-GUTI in the 5GS mobile identity IE. Additionally, if the UE holds a valid 5G-GUTI, the UE shall include the 5G-GUTI in the Additional GUTI IE in the REGISTRATION REQUEST message in the following order:

- 1) a valid 5G-GUTI that was previously assigned by the same PLMN with which the UE is performing the registration, if available;
- 2) a valid 5G-GUTI that was previously assigned by an equivalent PLMN, if available; and
- 3) a valid 5G-GUTI that was previously assigned by any other PLMN, if available; and

NOTE 6: The 5G-GUTI included in the Additional GUTI IE is a native 5G-GUTI.

- b) for all other cases, if the UE holds a valid 5G-GUTI, the UE shall indicate the 5G-GUTI in the 5GS mobile identity IE. If the UE is registering with an SNPN and the valid 5G-GUTI was previously assigned by another SNPN, the UE shall additionally include the NID of the other SNPN in the NID IE.

If the UE does not operate in SNPN access operation mode, holds two valid native 5G-GUTIs assigned by PLMNs and:

- 1) one of the valid native 5G-GUTI was assigned by the PLMN with which the UE is performing the registration, then the UE shall indicate the valid native 5G-GUTI assigned by the PLMN with which the UE is performing the registration. In addition, the UE shall include the other valid native 5G-GUTI in the Additional GUTI IE; or
- 2) none of the valid native 5G-GUTI was assigned by the PLMN with which the UE is performing the registration, then the UE shall indicate the valid native 5G-GUTI assigned over the same access via which the UE is performing the registration.

If the UE supports MICO mode and requests the use of MICO mode, then the UE shall include the MICO indication IE in the REGISTRATION REQUEST message. If the UE requests to use an active time value, it shall include the active time value in the T3324 IE in the REGISTRATION REQUEST message. If the UE includes the T3324 IE, it may also request a particular T3512 value by including the Requested T3512 IE in the REGISTRATION REQUEST message. Additionally, if the UE supports strictly periodic registration timer, the UE shall set the Strictly Periodic Registration Timer Indication bit of the MICO indication IE in the REGISTRATION REQUEST message to "strictly periodic registration timer supported". If the UE needs to stop the use of MICO mode, then the UE shall not include the MICO indication IE in the REGISTRATION REQUEST message.

If the UE needs to use or change the UE specific DRX parameters, the UE shall include the Requested DRX parameters IE in the REGISTRATION REQUEST message for all cases except case b).

If the UE is in NB-N1 mode and if the UE needs to use or change the UE specific DRX parameters for NB-N1 mode, the UE shall include the Requested NB-N1 mode DRX parameters IE in the REGISTRATION REQUEST message for all cases except case b).

If the UE supports eDRX and requests the use of eDRX, the UE shall include the Requested extended DRX parameters IE in the REGISTRATION REQUEST message.

If the UE needs to request LADN information for specific LADN DNN(s) or indicates a request for LADN information as specified in 3GPP TS 23.501 [8], the UE shall include the LADN indication IE in the REGISTRATION REQUEST message and:

- request specific LADN DNNs by including a LADN DNN value in the LADN indication IE for each LADN DNN for which the UE requests LADN information; or
- to indicate a request for LADN information by not including any LADN DNN value in the LADN indication IE.

If the UE is initiating the registration procedure for mobility and periodic registration update, the UE may include the Uplink data status IE to indicate which PDU session(s) is:

- not associated with control plane only indication;
- associated with the access type the REGISTRATION REQUEST message is sent over; and
- have pending user data to be sent over user plane or are associated with active multicast MBS session(s).

If the UE has one or more active always-on PDU sessions associated with the access type over which the REGISTRATION REQUEST message is sent and the user-plane resources for these PDU sessions are not established, and for cases triggering the REGISTRATION REQUEST message except b), the UE shall include the Uplink data status IE and indicate that the UE has pending user data to be sent for those PDU sessions. If the UE is located outside the LADN service area and inside the registration area assigned by the network, the UE shall not include the PDU session for LADN in the Uplink data status IE. If the S-NSSAI associated with the PDU session is:

- a) included in the partially allowed NSSAI and the TA where the UE is currently camped is not in list of TAs for which the S-NSSAI is allowed; or
- b) included in the S-NSSAI location validity information and the UE is outside the NS-AoS of the S-NSSAI;

then the UE shall not indicate those PDU session(s), including always-on PDU session(s), in Uplink data status IE in the REGISTRATION REQUEST message. If the UE is in a non-allowed area or is not in an allowed area as specified in subclause 5.3.5, and the UE is in the registration area assigned by the network, the UE shall not include the Uplink data status IE except for emergency services or for high priority access. If the MUSIM UE requests the network to release the NAS signalling connection, the UE shall not include the Uplink data status IE in the REGISTRATION REQUEST message.

If the UE has one or more active PDU sessions which are not accepted by the network as always-on PDU sessions and no uplink user data pending to be sent for those PDU sessions, the UE shall not include those PDU sessions in the Uplink data status IE in the REGISTRATION REQUEST message.

When the registration procedure for mobility and periodic registration update is initiated in 5GMM-IDLE mode, the UE may include a PDU session status IE in the REGISTRATION REQUEST message, indicating:

- a) which single access PDU sessions associated with the access type the REGISTRATION REQUEST message is sent over are not inactive in the UE; and
- b) which MA PDU sessions are not inactive and having the corresponding user plane resources being established or established in the UE on the access the REGISTRATION REQUEST message is sent over.

If the UE received a paging message with the access type indicating non-3GPP access, the UE shall include the Allowed PDU session status IE in the REGISTRATION REQUEST message. If the UE has PDU session(s) over non-3GPP access, where

- a) the associated S-NSSAI(s) are included in the allowed NSSAI for 3GPP access or the partially allowed NSSAI for 3GPP access and the TAI where the UE is currently camped is in the list of TAs for which the S-NSSAI is allowed; and
- b) the UE is currently camped inside the NS-AoS of the S-NSSAI, if the S-NSSAI location validity information is available,

the UE shall indicate the PDU session(s) for which the UE allows to re-establish the user-plane resources over 3GPP access in the Allowed PDU session status IE; otherwise, the UE shall not indicate any PDU session(s) in the Allowed PDU session status IE. If the UE is in a non-allowed area or the UE is not in an allowed area, the UE shall set the Allowed PDU session status IE as specified in subclause 5.3.5.2.

When the Allowed PDU session status IE is included in the REGISTRATION REQUEST message, the UE shall indicate that a PDU session is not allowed to be transferred to the 3GPP access if the 3GPP PS data off UE status is "activated" for the corresponding PDU session and the UE is not using the PDU session to send uplink IP packets for any of the 3GPP PS data off exempt services (see subclause 6.2.10).

If the UE operating in the single-registration mode performs inter-system change from S1 mode to N1 mode, the UE:

- a) shall include the UE status IE with the EMM registration status set to "UE is in EMM-REGISTERED state" in the REGISTRATION REQUEST message;

NOTE 7: Inclusion of the UE status IE with this setting corresponds to the indication that the UE is "moving from EPC" as specified in 3GPP TS 23.502 [9], subclause 4.11.1.3.3 and 4.11.2.3.

NOTE 8: The value of the 5GMM registration status included by the UE in the UE status IE is not used by the AMF.

- b) may include the PDU session status IE in the REGISTRATION REQUEST message indicating the status of the PDU session(s) mapped during the inter-system change from S1 mode to N1 mode from the PDN connection(s) for which the EPS indicated that interworking to 5GS is supported, if any (see subclause 6.1.4.1);
- c) shall include a TRACKING AREA UPDATE REQUEST message as specified in 3GPP TS 24.301 [15] in the EPS NAS message container IE in the REGISTRATION REQUEST message if the registration procedure is initiated in 5GMM-IDLE mode and the UE has received an "interworking without N26 interface not supported" indication from the network;
- c1) may include a TRACKING AREA UPDATE REQUEST message as specified in 3GPP TS 24.301 [15] in the EPS NAS message container IE in the REGISTRATION REQUEST message if the registration procedure is initiated in 5GMM-IDLE mode and the UE has received an "interworking without N26 interface supported" indication from the network; and
- d) shall include an EPS bearer context status IE in the REGISTRATION REQUEST message indicating which EPS bearer contexts are active in the UE, if the UE has locally deactivated EPS bearer context(s) for which interworking to 5GS is supported while the UE was in S1 mode without notifying the network.

For a REGISTRATION REQUEST message with a 5GS registration type IE indicating "mobility registration updating", if the UE:

- a) is in NB-N1 mode and:
 - 1) the UE needs to change the slice(s) it is currently registered to within the same registration area; or
 - 2) the UE has entered a new registration area; or
- b) is not in NB-N1 mode and is not registered for onboarding services in SNPN;

the UE shall include the Requested NSSAI IE containing the S-NSSAI(s) corresponding to the network slices to which the UE intends to register and associated mapped S-NSSAI(s), if available, in the REGISTRATION REQUEST message as described in this subclause. When the UE is entering a visited PLMN and intends to register to the slices for which the UE has only HPLMN S-NSSAI(s) available, the UE shall include these HPLMN S-NSSAI(s) in the Requested mapped NSSAI IE. When the UE is entering an EHPLMN whose PLMN code is not derived from the IMSI and intends to register to the slices for which the UE has only HPLMN S-NSSAI(s) available, the UE shall include HPLMN S-NSSAI(s) in the Requested mapped NSSAI IE. The sum of number of S-NSSAI values in the Requested NSSAI IE and number of S-NSSAI values in the Requested mapped NSSAI IE shall not exceed eight.

NOTE 9: The REGISTRATION REQUEST message can include both the Requested NSSAI IE and the Requested mapped NSSAI IE as described below.

If the UE is registered for onboarding services in SNPN, the UE shall not include the Requested NSSAI IE in the REGISTRATION REQUEST message.

If the UE has allowed NSSAI or configured NSSAI or both for the current PLMN, the Requested NSSAI IE shall include either:

- a) the configured NSSAI for the current PLMN or SNPN, or a subset thereof as described below;
- b) the allowed NSSAI for the current PLMN or SNPN, or a subset thereof as described below; or
- c) the allowed NSSAI for the current PLMN or SNPN, or a subset thereof as described below, plus the configured NSSAI for the current PLMN or SNPN, or a subset thereof as described below;

In addition, the Requested NSSAI IE shall include S-NSSAI(s) applicable in the current PLMN or SNPN, and if available the associated mapped S-NSSAI(s) for:

- a) each PDN connection that is established in S1 mode when the UE is operating in the single-registration mode and the UE is performing an inter-system change from S1 mode to N1 mode; or

b) each active PDU session.

If the UE does not have S-NSSAI(s) applicable in the current PLMN or SNPN, then the Requested mapped NSSAI IE shall include HPLMN S-NSSAI(s) (e.g. mapped S-NSSAI(s), if available) for:

- a) each PDN connection established in S1 mode when the UE is operating in the single-registration mode and the UE is performing an inter-system change from S1 mode to N1 mode to a visited PLMN; or
- b) each active PDU session when the UE is performing mobility from N1 mode to N1 mode to a visited PLMN.

NOTE 10: The Requested NSSAI IE is used instead of Requested mapped NSSAI IE in REGISTRATION REQUEST message when the UE enters HPLMN and the EHPLMN list is not present or is empty; or when the UE enters a PLMN whose PLMN code is derived from the IMSI and the EHPLMN list is not empty. The Requested mapped NSSAI IE is used when the UE enters an EHPLMN whose PLMN code is not derived from the IMSI.

If both the S-NSSAI to be replaced and the alternative S-NSSAI are included in the configured NSSAI, and the UE needs to request the S-NSSAI to be replaced, the UE shall include the S-NSSAI to be replaced in the Requested NSSAI IE or the Requested mapped NSSAI IE.

For a REGISTRATION REQUEST message with a 5GS registration type IE indicating "mobility registration updating", if the UE is in NB-N1 mode and the procedure is initiated for all cases except case a), c), e), i), s), t), w), and x), the REGISTRATION REQUEST message shall not include the Requested NSSAI IE.

If the UE has:

- no allowed NSSAI for the current PLMN or SNPN;
- no configured NSSAI for the current PLMN or SNPN;
- neither active PDU session(s) nor PDN connection(s) to transfer associated with an S-NSSAI applicable in the current PLMN or SNPN; and
- neither active PDU session(s) nor PDN connection(s) to transfer associated with mapped S-NSSAI(s);

and has a default configured NSSAI, then the UE shall:

- a) include the S-NSSAI(s) in the Requested NSSAI IE of the REGISTRATION REQUEST message using the default configured NSSAI; and
- b) include the Network slicing indication IE with the Default configured NSSAI indication bit set to "Requested NSSAI created from default configured NSSAI" in the REGISTRATION REQUEST message.

If the UE has:

- no allowed NSSAI for the current PLMN or SNPN;
- no configured NSSAI for the current PLMN or SNPN;
- neither active PDU session(s) nor PDN connection(s) to transfer associated with an S-NSSAI applicable in the current PLMN or SNPN
- neither active PDU session(s) nor PDN connection(s) to transfer associated with mapped S-NSSAI(s); and
- no default configured NSSAI,

the UE shall include neither Requested NSSAI IE nor Requested mapped NSSAI IE in the REGISTRATION REQUEST message.

If all the S-NSSAI(s) corresponding to the slice(s) to which the UE intends to register are included in the pending NSSAI, the UE shall not include a requested NSSAI in the REGISTRATION REQUEST message.

When the UE storing a pending NSSAI intends to register to additional S-NSSAI(s) over the same access type, the UE shall send the requested NSSAI containing the additional S-NSSAI(s) that the UE intends to register to in the REGISTRATION REQUEST message. The requested NSSAI shall not include any S-NSSAI from the pending NSSAI.

The subset of configured NSSAI provided in the requested NSSAI consists of one or more S-NSSAIs in the configured NSSAI applicable to the current PLMN or SNPN, where any included S-NSSAI is neither in the rejected NSSAI nor associated to an S-NSSAI in the rejected NSSAI. If the UE is inside the NS-AoS of an S-NSSAI in the rejected NSSAI with a rejection cause value set to "S-NSSAI not available in the current registration area", the S-NSSAI may be included in the requested NSSAI.

For case zq, the subset of configured NSSAI provided in the requested NSSAI consists of one or more S-NSSAIs in the configured NSSAI applicable to the current PLMN or SNPN, where any included S-NSSAI is in the partially rejected NSSAI and the current TAI is in the list of TAs for which the S-NSSAI is not rejected. If the UE is inside the NS-AoS of an S-NSSAI in the partially rejected NSSAI and the current TAI is in the list of TAs for which the S-NSSAI is rejected, the S-NSSAI may be included in the requested NSSAI.

In addition, if the NSSRG information is available, the subset of configured NSSAI provided in the requested NSSAI shall be associated with at least one common NSSRG value. The UE may also include in the requested NSSAI included in the Requested NSSAI IE or the Requested mapped NSSAI IE or both, the S-NSSAI(s) which were added to configured NSSAI in S1 mode and for which the associated NSSRG information is not available. If the UE is in 5GMM-REGISTERED state over the other access and has already an allowed NSSAI for the other access in the same PLMN or in different PLMNs, all the S-NSSAI(s) in the requested NSSAI included in the Requested NSSAI IE or the Requested mapped NSSAI IE or both for the current access shall share at least an NSSRG value common to all the S-NSSAI(s) of the allowed NSSAI for the other access. If the UE is simultaneously performing the registration procedure on the other access in different PLMNs, the UE shall include S-NSSAIs that share at least a common NSSRG value across all access types. If the UE has pending NSSAI which the UE is still interested in using, then S-NSSAIs in the pending NSSAI and requested NSSAI shall be associated with at least one common NSSRG value.

NOTE 11: If the UE has stored mapped S-NSSAI(s) for the rejected NSSAI, and one or more S-NSSAIs in the stored mapped S-NSSAI(s) for the configured NSSAI are not included in the stored mapped S-NSSAI(s) for the rejected NSSAI, then a S-NSSAI in the configured NSSAI associated to one or more of these mapped S-NSSAI(s) for the configured NSSAI are available to be included in the requested NSSAI together with their mapped S-NSSAI.

NOTE 12: If one or more mapped S-NSSAIs in the stored mapped S-NSSAI(s) for the configured NSSAI are not included in the stored rejected NSSAI for the failed or revoked NSSAI, a S-NSSAI in the configured NSSAI associated to one or more of these mapped S-NSSAI(s) for the configured NSSAI are available to be included in the registration request together with their mapped S-NSSAI.

NOTE 13: There is no need to consider the case that the UE is simultaneously performing the registration procedure on the other access in the same PLMN, due to that the UE is not allowed to initiate the registration procedure over one access when the registration over the other access to the same PLMN is going on.

If:

- a) the UE is registered to current PLMN over the other access and has NSSRG information available;
- b) the UE is attempting mobility registration to the same current PLMN from other PLMN in the current access;
and
- c) the UE has PDU session(s) or PDN connection(s) associated with NSSAI not sharing part of NSSRG available of the current PLMN;

then the UE locally releases these PDU session(s) or PDN connection(s), as the NSSAI for these PDU session(s) or PDN connection(s) will not be included in the requested or the requested mapped NSSAI in the current PLMN due to its lack of association to the common NSSRG of the current PLMN.

The subset of allowed NSSAI provided in the requested NSSAI consists of one or more S-NSSAIs in the allowed NSSAI for this PLMN.

If the UE supports the S-NSSAI time validity information, S-NSSAI time validity information is available for an S-NSSAI, and the S-NSSAI time validity information indicates that the S-NSSAI is not available, the UE shall not include the S-NSSAI in the Requested NSSAI IE of the REGISTRATION REQUEST message. If the UE has S-NSSAI time validity information over the other access in the same PLMN and the S-NSSAI time validity information indicates that the S-NSSAI is not available, the UE shall not include the S-NSSAI in the Requested NSSAI IE of the REGISTRATION REQUEST message for the current access type.

NOTE 14: How the UE selects the subset of configured NSSAI or allowed NSSAI to be provided in the requested NSSAI is implementation specific. The UE can take preferences indicated by the upper layers (e.g. policies like URSP, applications) and UE local configuration into account.

NOTE 14A: If the UE determines the on-demand S-NSSAI for a PDU session establishment as specified in subclause 4.2.2 of 3GPP TS 24.526 [19], the UE includes the on-demand S-NSSAI in the requested NSSAI during the registration procedure.

NOTE 15: The number of S-NSSAI(s) included in the requested NSSAI cannot exceed eight.

If the UE supports NSAG, the UE shall set the NSAG bit to "NSAG supported" in the 5GMM capability IE of the REGISTRATION REQUEST message. If the UE supports sending of REGISTRATION COMPLETE message for acknowledging the reception of NSAG information IE in the REGISTRATION ACCEPT message, the UE shall set the RCMAN bit to "Sending of REGISTRATION COMPLETE message for NSAG information supported" in the 5GMM capability IE of the REGISTRATION REQUEST message.

If the UE supports the unavailability period, the UE shall set the UN-PER bit to "unavailability period supported" in the 5GMM capability IE of the REGISTRATION REQUEST message.

If the UE supports network slice replacement, the UE shall set the NSR bit to "network slice replacement supported" in the 5GMM capability IE of the REGISTRATION REQUEST message.

For case zm1, if the network indicated support for the unavailability period in the last registration procedure, the UE shall include the Unavailability information IE in the REGISTRATION REQUEST message. If the UE did not include a start of the unavailability period in the Unavailability information IE, the UE shall set the Follow-on request indicator to "No follow-on request pending" in the REGISTRATION REQUEST message and shall not include the Uplink data status IE or the Allowed PDU session status IE in the REGISTRATION REQUEST message even if the UE has one or more active always-on PDU sessions associated with the 3GPP access. If the UE includes the Unavailability information IE to indicate the type of the unavailability and the UE will be unavailable due to NR satellite access discontinuous coverage, the UE shall set the Unavailability type bit to "unavailability due to discontinuous coverage" in the Unavailability information IE.

For case zm1, the UE should initiate the registration procedure for mobility and periodic registration update only if the UE can determine, based on its implementation, that there is enough time to complete the procedure before the start of the unavailability period.

NOTE 15A: If the UE is unable to store its 5GMM and 5GSM contexts, the UE triggers the de-registration procedure. Ability to store the 5GMM information for UEs not operating in SNPN access operation mode as described in Annex C.1 does not imply the ability to store the 5GMM and 5GSM contexts.

NOTE 15B: If the UE is able to store its 5GMM and 5GSM contexts, the UE can store the 5GMM and 5GSM contexts even if the registration procedure for mobility and periodic registration update is not completed successfully.

The UE shall set the Follow-on request indicator to "Follow-on request pending", if the UE:

- a) initiates the registration procedure for mobility and periodic registration update upon request of the upper layers to establish an emergency PDU session;
- b) initiates the registration procedure for mobility and periodic registration update upon receiving a request from the upper layers to perform emergency services fallback; or
- c) needs to prolong the established NAS signalling connection after the completion of the registration procedure for mobility and periodic registration update (e.g. due to uplink signalling pending but no user data pending).

NOTE 16: The UE does not have to set the Follow-on request indicator to 1 even if the UE has to request resources for V2X communication over PC5 reference point, 5G ProSe direct discovery over PC5, 5G ProSe direct communication over PC5 or ranging and sidelink positioning or A2X communication over PC5 reference point.

For case n, the UE shall include the 5GS update type IE in the REGISTRATION REQUEST message with the NG-RAN-RCU bit set to "UE radio capability update needed". Additionally, if the UE is not in NB-N1 mode, the UE supports RACS and the UE has an applicable UE radio capability ID for the new UE radio configuration in the serving PLMN or SNPN, the UE shall include the applicable UE radio capability ID in the UE radio capability ID of the REGISTRATION REQUEST message.

NOTE 16A: For cases n, if the UE supports RACS irrespective whether the UE has an applicable UE radio capability ID for the new UE radio configuration in the selected PLMN the 5GS update type IE in the REGISTRATION REQUEST message with the NG-RAN-RCU bit is set to "UE radio capability update needed".

If the UE is in the 5GMM-CONNECTED mode and the UE changes the radio capability for NG-RAN or E-UTRAN, the UE may locally release the established N1 NAS signalling connection and enter the 5GMM-IDLE mode. Then, the UE shall initiate the registration procedure for mobility and periodic registration update including the 5GS update type IE in the REGISTRATION REQUEST message with the NG-RAN-RCU bit set to " UE radio capability update needed".

For case o, the UE shall include the Uplink data status IE in the REGISTRATION REQUEST message indicating the PDU session(s) without active user-plane resources for which the UE has pending user data to be sent, if any, and the PDU session(s) for which user-plane resources were active prior to receiving the fallback indication, if any. If the UE has joined one or more multicast MBS session and was in 5GMM-CONNECTED mode with RRC inactive indication before receiving the fallback indication from the lower layers, the UE shall include the Uplink data status IE in the REGISTRATION REQUEST message indicating the PDU session(s) that are associated to the one or more multicast MBS session. If the UE is in a non-allowed area or if the UE is not in allowed area, the UE shall not include the Uplink data status IE in REGISTRATION REQUEST message, except if the PDU session for which user-plane resources were active prior to receiving the fallback indication is an emergency PDU session, or if the UE is configured for high priority access in the selected PLMN or SNPN as specified in subclause 5.3.5.

For case f-, the UE shall include the Uplink data status IE in the REGISTRATION REQUEST message indicating the PDU session(s) for which the UE has uplink user data pending and the PDU session(s) for which user-plane resources were active prior to receiving "RRC Connection failure" indication from the lower layers, if any. If the UE has joined one or more multicast MBS session and was in 5GMM-CONNECTED mode with RRC inactive indication before receiving the indication of "RRC Connection failure" from the lower layers or before receiving the indication that the resumption of the RRC connection has failed from the lower layers, the UE shall include the Uplink data status IE in the REGISTRATION REQUEST message indicating the PDU session(s) that are associated to the one or more multicast MBS session. If the UE is in non-allowed area or not in allowed area, the UE shall not include the Uplink data status IE in REGISTRATION REQUEST message, except that the PDU session for which user-plane resources were active prior to receiving the "RRC Connection failure" indication is emergency PDU session, or that the UE is configured for high priority access in selected PLMN or SNPN, as specified in subclause 5.3.5.

If the UE supports service gap control, then the UE shall set the SGC bit to "service gap control supported" in the 5GMM capability IE of the REGISTRATION REQUEST message.

For cases a, x or if the UE operating in the single-registration mode performs inter-system change from S1 mode to N1 mode, the UE shall:

- a) if the UE has an applicable network-assigned UE radio capability ID for the current UE radio configuration in the selected PLMN or SNPN, include the applicable network-assigned UE radio capability ID in the UE radio capability ID IE of the REGISTRATION REQUEST message; and
- b) if the UE:
 - 1) does not have an applicable network-assigned UE radio capability ID for the current UE radio configuration in the selected PLMN or SNPN; and
 - 2) has an applicable manufacturer-assigned UE radio capability ID for the current UE radio configuration, include the applicable manufacturer-assigned UE radio capability ID in the UE radio capability ID IE of the REGISTRATION REQUEST message.

For all cases except cases b and z, if the UE supports ciphered broadcast assistance data and the UE needs to obtain new ciphering keys, the UE shall include the Additional information requested IE with the CipherKey bit set to "ciphering keys for ciphered broadcast assistance data requested" in the REGISTRATION REQUEST message.

For case z, the UE shall include the Additional information requested IE with the CipherKey bit set to "ciphering keys for ciphered broadcast assistance data requested" in the REGISTRATION REQUEST message.

For case a, if the UE supports ciphered broadcast assistance data and the UE detects that one or more ciphering keys stored at the UE is not applicable in the current TAI, the UE should include the Additional information requested IE

with the CipherKey bit set to "ciphering keys for ciphered broadcast assistance data requested" in the REGISTRATION REQUEST message.

For case b, if the UE supports ciphered broadcast assistance data and the remaining validity time for one or more ciphering keys stored at the UE is less than timer T3512, the UE should include the Additional information requested IE with the CipherKey bit set to "ciphering keys for ciphered broadcast assistance data requested" in the REGISTRATION REQUEST message.

The UE shall set the WUSA bit to "WUS assistance information reception supported" in the 5GMM capability IE if the UE supports WUS assistance information. The UE may include its UE paging probability information in the Requested WUS assistance information IE if the UE has set the WUSA bit to "WUS assistance information reception supported" in the 5GMM capability IE and does not have an active emergency PDU session.

The UE shall set the NR-PSSI bit to "NR paging subgrouping supported" in the 5GMM capability IE if the UE supports PEIPS assistance information, is not registered for emergency services and does not have an active emergency PDU session. The UE may include its UE paging probability information in the Requested PEIPS assistance information IE if the UE has set the NR-PSSI bit to "NR paging subgrouping supported" in the 5GMM capability IE.

If the network supports the N1 NAS signalling connection release, and the MUSIM UE requests the network to release the NAS signalling connection, the UE shall set Request type to "NAS signalling connection release" in the UE request type IE, set the Follow-on request indicator to "No follow-on request pending" and, if the network supports the paging restriction, may set the paging restriction preference in the Paging restriction IE in the REGISTRATION REQUEST message. In addition, the UE shall not include the Uplink data status IE or the Allowed PDU session status IE in the REGISTRATION REQUEST message even if the UE has one or more active always-on PDU sessions associated with the 3GPP access.

NOTE 17: If the network has already indicated support for N1 NAS signalling connection release in the current stored registration area and the UE doesn't have an emergency PDU session established, the MUSIM UE is allowed to request the network to release the NAS signalling connection during registration procedure for mobility and periodic registration update that is due to mobility outside the registration area even before detecting whether the network supports the N1 NAS signalling connection release in the current TAI.

NOTE 18: If the network has already indicated support for paging restriction in the current stored registration area and the UE doesn't have an emergency PDU session established, the MUSIM UE is allowed to include paging restriction together with the request to the network to release the NAS signalling connection during registration procedure for mobility and periodic registration update that is due to mobility outside the registration area even before detecting whether the network supports the paging restriction in the current TAI.

For case zi, the UE shall not include the Paging restriction IE in the REGISTRATION REQUEST message. If the UE is in 5GMM-IDLE mode and the network supports the N1 NAS signalling connection release, the UE may include the UE request type IE and set Request type to "NAS signalling connection release" to remove the paging restriction and request the release of the NAS signalling connection at the same time. In addition, the UE shall not include the Uplink data status IE in the REGISTRATION REQUEST message.

If the UE does not have a valid 5G NAS security context and the UE is sending the REGISTRATION REQUEST message after an inter-system change from S1 mode to N1 mode in 5GMM-IDLE mode, the UE shall send the REGISTRATION REQUEST message without including the NAS message container IE. The UE shall include the entire REGISTRATION REQUEST message (i.e. containing cleartext IEs and non-cleartext IEs, if any) in the NAS message container IE that is sent as part of the SECURITY MODE COMPLETE message as described in subclauses 4.4.6 and 5.4.2.3.

If the UE indicates "mobility registration updating" in the 5GS registration type IE and supports V2X as specified in 3GPP TS 24.587 [19B], the UE shall set the V2X bit to "V2X supported" in the 5GMM capability IE of the REGISTRATION REQUEST message. If the UE indicates "mobility registration updating" in the 5GS registration type IE and supports V2X communication over E-UTRA-PC5 as specified in 3GPP TS 24.587 [19B], the UE shall set the V2XCEPC5 bit to "V2X communication over E-UTRA-PC5 supported" in the 5GMM capability IE of the REGISTRATION REQUEST message. If the UE indicates "mobility registration updating" in the 5GS registration type IE and supports V2X communication over NR-PC5 as specified in 3GPP TS 24.587 [19B], the UE shall set the V2XCNPC5 bit to "V2X communication over NR-PC5 supported" in the 5GMM capability IE of the REGISTRATION REQUEST message.

The UE shall send the REGISTRATION REQUEST message including the NAS message container IE as described in subclause 4.4.6:

- a) when the UE is sending the message from 5GMM-IDLE mode, the UE has a valid 5G NAS security context, and needs to send non-plaintext IEs; or
- b) when the UE is sending the message after an inter-system change from S1 mode to N1 mode in 5GMM-IDLE mode and the UE has a valid 5G NAS security context and needs to send non-plaintext IEs.

The UE with a valid 5G NAS security context shall send the REGISTRATION REQUEST message without including the NAS message container IE when the UE does not need to send non-plaintext IEs and the UE is sending the message:

- a) from 5GMM-IDLE mode; or
- b) after an inter-system change from S1 mode to N1 mode in 5GMM-IDLE mode.

If the UE is sending the REGISTRATION REQUEST message after an inter-system change from S1 mode to N1 mode in 5GMM-CONNECTED mode and the UE needs to send non-plaintext IEs, the UE shall cipher the NAS message container IE using the mapped 5G NAS security context and send the REGISTRATION REQUEST message including the NAS message container IE as described in subclause 4.4.6. If the UE does not need to send non-plaintext IEs, the UE shall send the REGISTRATION REQUEST message without including the NAS message container IE.

If the REGISTRATION REQUEST message includes a NAS message container IE, the AMF shall process the REGISTRATION REQUEST message that is obtained from the NAS message container IE as described in subclause 4.4.6.

If the UE is in NB-N1 mode, then the UE shall set the Control plane CIoT 5GS optimization bit to "Control plane CIoT 5GS optimization supported" in the 5GMM capability IE of the REGISTRATION REQUEST message. For all cases except case b, if the UE is capable of NB-S1 mode, then the UE shall set the Control plane CIoT EPS optimization bit to "Control plane CIoT EPS optimization supported" in the S1 UE network capability IE of the REGISTRATION REQUEST message.

If the registration procedure for mobility and periodic registration update is initiated and there is request from the upper layers to perform "emergency services fallback" pending, the UE shall send a REGISTRATION REQUEST message without an Uplink data status IE.

If the UE supports N3 data transfer and multiple user-plane resources in NB-N1 mode (see 3GPP TS 36.306 [25D], 3GPP TS 36.331 [25A]), then the UE shall set the Multiple user-plane resources support bit to "Multiple user-plane resources supported" in the 5GMM capability IE of the REGISTRATION REQUEST message.

The UE shall set the ER-NSSAI bit to "Extended rejected NSSAI supported" in the 5GMM capability IE of the REGISTRATION REQUEST message.

If the UE supports the NSSRG, then the UE shall set the NSSRG bit to "NSSRG supported" in the 5GMM capability IE of the REGISTRATION REQUEST message.

For case zf, the UE shall include the service-level device ID in the Service-level-AA container IE of the REGISTRATION REQUEST message and set the value to the CAA-level UAV ID. The UE shall include the service-level-AA server address in the Service-level-AA container IE of the REGISTRATION REQUEST message and set the value to the USS address, if it is provided by the upper layers. The UE shall include the service-level-AA payload in the Service-level-AA container IE of the REGISTRATION REQUEST message and shall set the service-level-AA payload type, if the service-level-AA payload is provided by upper layers.

NOTE 18: The service-level-AA payload can be of type "C2 authorization payload". The C2 authorization payload can include one or both of an indication of the request for direct C2 communication and pairing information for direct C2 communication.

If the UE supports 5G ProSe direct discovery as specified in 3GPP TS 24.554 [19E], the UE shall set the 5G ProSe-dd bit to "5G ProSe direct discovery supported" in the 5GMM capability IE of the REGISTRATION REQUEST message. If the UE supports 5G ProSe direct communication as specified in 3GPP TS 24.554 [19E], the UE shall set the 5G ProSe-dc bit to "5G ProSe discovery communication supported" in the 5GMM capability IE of the REGISTRATION REQUEST message. If the UE supports acting as 5G ProSe layer-2 UE-to-network relay UE as specified in 3GPP TS 24.554 [19E], the UE shall set the 5G ProSe-l2relay bit to "Acting as a 5G ProSe layer-2 UE-to-network relay UE supported" in the 5GMM capability IE of the REGISTRATION REQUEST message. If the UE supports acting as 5G ProSe layer-3 UE-to-network relay UE as specified in 3GPP TS 24.554 [19E], the UE shall set the 5G ProSe-l3relay

bit to "Acting as a 5G ProSe layer-3 UE-to-network relay UE supported" in the 5GMM capability IE of the REGISTRATION REQUEST message. If the UE supports acting as 5G ProSe layer-2 UE-to-network remote UE as specified in 3GPP TS 24.554 [19E], the UE shall set the 5G ProSe-l2rmt bit to "Acting as a 5G ProSe layer-2 UE-to-network remote UE supported" in the 5GMM capability IE of the REGISTRATION REQUEST message. If the UE supports acting as 5G ProSe layer-3 UE-to-network remote UE as specified in 3GPP TS 24.554 [19E], the UE shall set the 5G ProSe-l3rmt bit to "Acting as a 5G ProSe layer-3 UE-to-network remote UE supported" in the 5GMM capability IE of the REGISTRATION REQUEST message. If the UE supports acting as 5G ProSe layer-2 UE-to-UE relay UE as specified in 3GPP TS 24.554 [19E], the UE shall set the 5G ProSe-l2U2U relay bit to "Acting as a 5G ProSe layer-2 UE-to-UE relay UE supported" in the 5GMM capability IE of the REGISTRATION REQUEST message. If the UE supports acting as 5G ProSe layer-3 UE-to-UE relay UE as specified in 3GPP TS 24.554 [19E], the UE shall set the 5G ProSe-l3U2U relay bit to "Acting as a 5G ProSe layer-3 UE-to-UE relay UE supported" in the 5GMM capability IE of the REGISTRATION REQUEST message. If the UE supports acting as 5G ProSe layer-2 end UE as specified in 3GPP TS 24.554 [19E], the UE shall set the 5G ProSe-l2end bit to "Acting as a 5G ProSe layer-2 end UE supported" in the 5GMM capability IE of the REGISTRATION REQUEST message. If the UE supports acting as 5G ProSe layer-3 end UE as specified in 3GPP TS 24.554 [19E], the UE shall set the 5G ProSe-l3end bit to "Acting as a 5G ProSe layer-3 end UE supported" in the 5GMM capability IE of the REGISTRATION REQUEST message.

For all cases except case b, if the MUSIM UE supports the N1 NAS signalling connection release, then the UE shall set the N1 NAS signalling connection release bit to "N1 NAS signalling connection release supported" in the 5GMM capability IE of the REGISTRATION REQUEST message otherwise the UE shall not set the N1 NAS signalling connection release bit to "N1 NAS signalling connection release supported" in the 5GMM capability IE of the REGISTRATION REQUEST message.

For all cases except case b, if the MUSIM UE supports the paging indication for voice services, then the UE shall set the paging indication for voice services bit to "paging indication for voice services supported" in the 5GMM capability IE of the REGISTRATION REQUEST message otherwise the UE shall not set the paging indication for voice services bit to "paging indication for voice services supported" in the 5GMM capability IE of the REGISTRATION REQUEST message.

For all cases except case b, if the MUSIM UE supports the reject paging request, then the UE shall set the reject paging request bit to "reject paging request supported" in the 5GMM capability IE of the REGISTRATION REQUEST message otherwise the UE shall not set the reject paging request bit to "reject paging request supported" in the 5GMM capability IE of the REGISTRATION REQUEST message.

For all cases except case b, if the MUSIM UE sets:

- the reject paging request bit to "reject paging request supported";
- the N1 NAS signalling connection release bit to "N1 NAS signalling connection release supported"; or
- both of them;

and supports the paging restriction, then the UE shall set the paging restriction bit to "paging restriction supported" in the 5GMM capability IE of the REGISTRATION REQUEST message otherwise the UE shall not set the paging restriction bit to "paging restriction supported" in the 5GMM capability IE of the REGISTRATION REQUEST message.

If the UE supports MINT, the UE shall set the MINT bit to "MINT supported" in the 5GMM capability IE of the REGISTRATION REQUEST message.

If the UE supports slice-based N3IWF selection, the UE shall set the SBNS bit to "Slice-based N3IWF selection supported" in the 5GMM capability IE of the REGISTRATION REQUEST message.

If the UE supports slice-based TNGF selection, the UE shall set the SBTS bit to "Slice-based TNGF selection supported" in the 5GMM capability IE of the REGISTRATION REQUEST message.

If the UE supports UAS services, the UE shall set the UAS bit to "UAS services supported" in the 5GMM capability IE of the REGISTRATION REQUEST message. If the UE supports A2X over E-UTRA-PC5 as specified in 3GPP TS 24.577 [60], the UE shall set the A2XEPC5 bit to "A2X over E-UTRA-PC5 supported" in the 5GMM capability IE of the REGISTRATION REQUEST message. If the UE supports A2X over NR-PC5 as specified in 3GPP TS 24.577 [60], the UE shall set the A2XNPC5 bit to "A2X over NR-PC5 supported" in the 5GMM capability IE of the REGISTRATION REQUEST message. If the UE supports A2X over Uu as specified in 3GPP TS 24.577 [60], the UE shall set the A2X-Uu bit to "A2X over Uu supported" in the 5GMM capability IE of the REGISTRATION REQUEST message.

For case zg, if the UE has determined the UE determined PLMN with disaster condition as specified in 3GPP TS 23.122 [5], and:

- a) the UE determined PLMN with disaster condition is the HPLMN and:
 - 1) the Additional GUTI IE is included in the REGISTRATION REQUEST message and does not contain a valid 5G-GUTI that was previously assigned by the HPLMN; or
 - 2) the Additional GUTI IE is not included in the REGISTRATION REQUEST message and the 5GS mobile identity IE contains neither the SUCI nor a valid 5G-GUTI that was previously assigned by the HPLMN; or
- b) the UE determined PLMN with disaster condition is not the HPLMN and:
 - 1) the Additional GUTI IE is included in the REGISTRATION REQUEST message and does not contain a valid 5G-GUTI that was previously assigned by the UE determined PLMN with disaster condition; or
 - 2) the Additional GUTI IE is not included in the REGISTRATION REQUEST message and the 5GS mobile identity IE does not contain a valid 5G-GUTI that was previously assigned by the UE determined PLMN with disaster condition;

the UE shall include in the REGISTRATION REQUEST message the UE determined PLMN with disaster condition IE indicating the UE determined PLMN with disaster condition.

NOTE 19: If the UE initiates the registration procedure for disaster roaming services, and the UE determined PLMN with disaster condition cannot be determined when an NG-RAN cell of the PLMN broadcasts the disaster related indication as specified in 3GPP TS 23.122 [5], the UE does not include in the REGISTRATION REQUEST message the UE determined PLMN with disaster condition IE but includes the Additional GUTI IE or the 5GS mobile identity IE or both as specified in subclauses 5.5.1.2.2.

For case zh the UE shall indicate "mobility registration updating" in the 5GS registration type IE of the REGISTRATION REQUEST message.

For case zp, the UE shall send the REGISTRATION REQUEST message over the new non-3GPP access. The UE shall include the Uplink data status IE in the REGISTRATION REQUEST message indicating the MA PDU session ID(s) or the single access PDU session ID(s) whose user plane resources are to be switched from the old non-3GPP access to the new non-3GPP access or to be established over the new non-3GPP access, if any. If the UE requests the network to keep using the user plane resources of the old non-3GPP access during path switching to the new non-3GPP access, the UE shall include the Non-3GPP path switching information IE in the REGISTRATION REQUEST message and set the NSONR bit to "non-3GPP path switching while using old non-3GPP resources requested".

If the UE supports event notification, the UE shall set the EventNotification bit to "Event notification supported" in the 5GMM capability IE of the REGISTRATION REQUEST message.

If the UE supports access to an SNPN using credentials from a credentials holder and:

- a) the UE is in its HPLMN or EHPLMN or the subscribed SNPN; or
- b) the UE is in a non-subscribed SNPN and supports equivalent SNPNs;

the UE shall set the SSNPNSI bit to "SOR-SNPN-SI supported" in the 5GMM capability IE of the REGISTRATION REQUEST message.

If the UE supports equivalent SNPNs, the UE shall set the ESI bit to "equivalent SNPNs supported" in the 5GMM capability IE of the REGISTRATION REQUEST message. If the UE supports LADN per DNN and S-NSSAI, the UE shall set the LADN-DS bit to "LADN per DNN and S-NSSAI supported" in the 5GMM capability IE of the REGISTRATION REQUEST message.

If the UE supports the reconnection to the network due to RAN timing synchronization status change, the UE shall set the Reconnection to the network due to RAN timing synchronization status change (RANtiming) bit to "Reconnection to the network due to RAN timing synchronization status change supported" in the 5GMM capability IE of the REGISTRATION REQUEST message.

If the UE supports MPS indicator update via the UE configuration update procedure, the UE shall set the MPSIU bit to "MPS indicator update supported" in the 5GMM capability IE of the REGISTRATION REQUEST message.

If the UE supports MCS indicator update via the UE configuration update procedure, the UE shall set the MCSIU bit to "MCS indicator update supported" in the 5GMM capability IE of the REGISTRATION REQUEST message.

If the UE supports ranging and sidelink positioning as specified in 3GPP TS 24.514 [62] and supports:

- a) V2X communication over PC5 as specified in 3GPP TS 24.587 [19B];
- b) 5G ProSe direct discovery and 5G ProSe direct communication as specified in 3GPP TS 24.554 [19E]; or
- c) both a) and b),

the UE shall set

- a) the RSLP bit to "Ranging and sidelink positioning supported";
- b) the RSLPL bit to "Ranging and sidelink positioning for located UE supported";
- c) the RSLPS bit to "Ranging and sidelink positioning for SL positioning server UE supported"; or
- d) any combination of a), b) and c), in the 5GMM capability IE of the REGISTRATION REQUEST message.

If the UE supports the partial network slice, the UE shall set the PNS bit to "Partial network slice supported" in the 5GMM capability IE of the REGISTRATION REQUEST message.

If the UE supports network slice usage control, the UE shall set the NSUC bit to "Network slice usage control supported" in the 5GMM capability IE of the REGISTRATION REQUEST message.

If the UE supports the S-NSSAI time validity information, the UE shall set the TempNS bit to "S-NSSAI time validity information supported" in the 5GMM capability IE of the REGISTRATION REQUEST message.

If the UE supports the S-NSSAI location validity information, the UE shall set the SLVI bit to "S-NSSAI location validity information supported" in the 5GMM capability IE of the REGISTRATION REQUEST message.

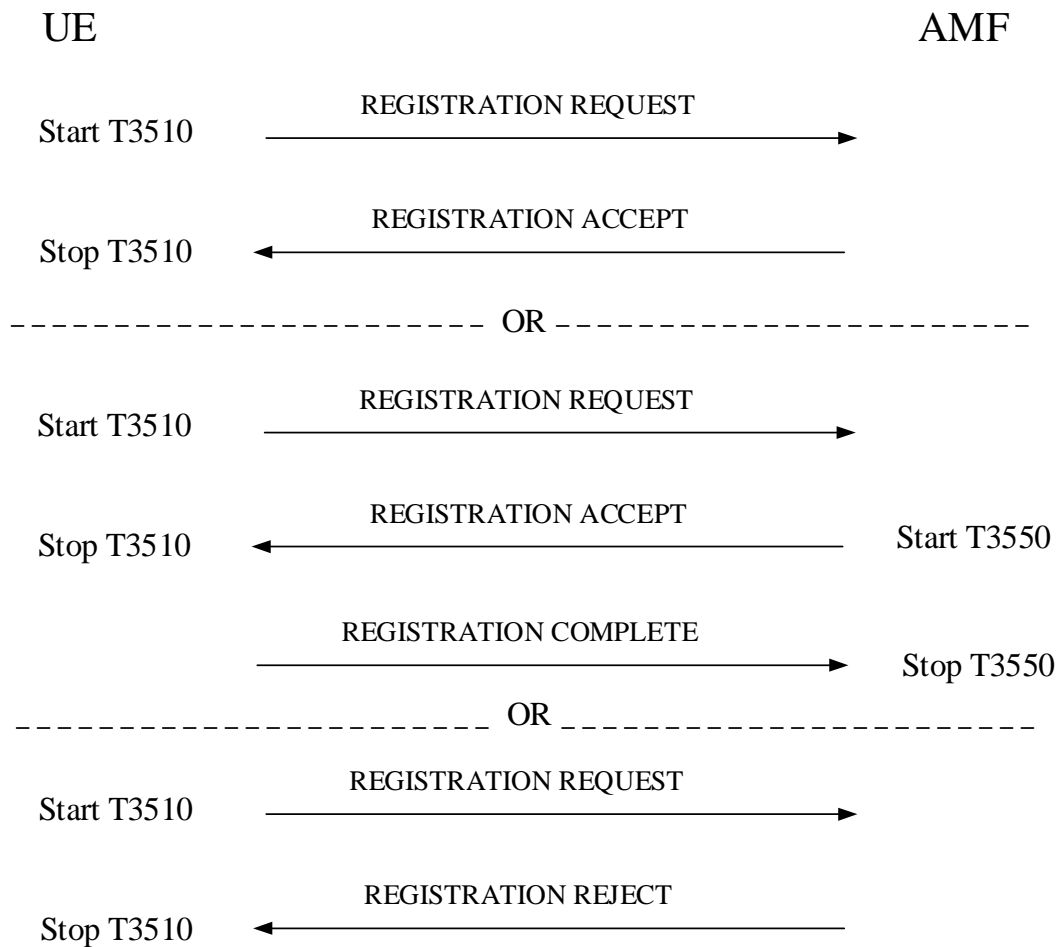

Figure 5.5.1.3.2.1: Registration procedure for mobility and periodic registration update

5.5.1.3.3 5GMM common procedure initiation

The AMF may initiate 5GMM common procedures, e.g. the identification, authentication and security procedures during the registration procedure, depending on the information received in the REGISTRATION REQUEST message.

The AMF may be configured to skip the authentication procedure even if no 5GS security context is available and proceed directly to the execution of the security mode control procedure as specified in subclause 5.4.2, during the registration procedure for mobility and periodic registration update for a UE that has only an emergency PDU session.

The AMF shall not initiate a 5GMM authentication procedure before completion of the registration procedure for mobility and periodic registration update, if the following conditions apply:

- a) the UE initiated the registration procedure for mobility and periodic registration update after handover or inter-system change to N1 mode in 5GMM-CONNECTED mode;
- b) the target cell is a shared network cell; and
- c.1) the UE has provided its 5G-GUTI in the 5GS mobile identity IE or the Additional GUTI IE in the REGISTRATION REQUEST message, and the PLMN identity included in the 5G-GUTI is different from the selected PLMN identity of the target cell; or
- c.2) the UE has included the 5G-GUTI mapped from the 4G-GUTI in the 5GS mobile identity IE and not included an Additional GUTI IE in the REGISTRATION REQUEST message, and the PLMN identity included in the 5G-GUTI is different from the selected PLMN identity of the target cell.

5.5.1.3.4 Mobility and periodic registration update accepted by the network

If the registration update request has been accepted by the network, the AMF shall send a REGISTRATION ACCEPT message to the UE.

NOTE 0: If the AMF receives the registration update request over non-3GPP access and detects that the N3IWF used by the UE is compatible with only part of the allowed NSSAI and the UE has not indicated its support for slice-based N3IWF selection in the REGISTRATION REQUEST message, the AMF accepts the registration update request.

NOTE 0A: If the AMF receives the registration update request over non-3GPP access and detects that the TNGF used by the UE is compatible with only part of the allowed NSSAI and the UE has not indicated its support for slice-based TNGF selection in the REGISTRATION REQUEST message, the AMF accepts the registration update request.

If timer T3513 is running in the AMF, the AMF shall stop timer T3513 if a paging request was sent with the access type indicating non-3GPP and the REGISTRATION REQUEST message includes the Allowed PDU session status IE.

If timer T3565 is running in the AMF, the AMF shall stop timer T3565 when a REGISTRATION REQUEST message is received.

For each of the information elements: 5GMM capability, S1 UE network capability, and UE security capability, the AMF shall store all octets received from the UE in the REGISTRATION REQUEST message, up to the maximum length defined for the respective information element.

NOTE 1: This information is forwarded to the new AMF during inter-AMF handover or to the new MME during inter-system handover to S1 mode.

The 5G-GUTI reallocation shall be part of the registration procedure for mobility registration update. The 5G-GUTI reallocation should be part of the registration procedure for periodic registration update. During the registration procedure for mobility registration update, if the AMF has not allocated a new 5G-GUTI by the generic UE configuration update procedure, the AMF shall include in the REGISTRATION ACCEPT message the new assigned 5G-GUTI.

If the UE has set the CAG bit to "CAG supported" in the 5GMM capability IE of the REGISTRATION REQUEST message and the AMF needs to update the "CAG information list" stored in the UE, the AMF shall include the CAG information list IE or the Extended CAG information list IE in the REGISTRATION ACCEPT message.

NOTE 2: The "CAG information list" can be provided by the AMF and include no entry if no "CAG information list" exists in the subscription.

NOTE 2A: If the UE supports extended CAG information list, the CAG information list can be included either in the CAG information list IE or Extended CAG information list IE.

If the UE does not support extended CAG information list, the CAG information list shall not be included in the Extended CAG information list IE.

If a 5G-GUTI or the SOR transparent container IE is included in the REGISTRATION ACCEPT message, the AMF shall start timer T3550 and enter state 5GMM-COMMON-PROCEDURE-INITIATED as described in subclause 5.1.3.2.3.3.

If the Operator-defined access category definitions IE or the Extended emergency number list IE, the CAG information list IE or the Extended CAG information list IE are included in the REGISTRATION ACCEPT message, the AMF shall start timer T3550 and enter state 5GMM-COMMON-PROCEDURE-INITIATED as described in subclause 5.1.3.2.3.3.

If the UE has set the RCMP bit to "Sending of REGISTRATION COMPLETE message for negotiated PEIPS assistance information supported" in the 5GMM capability IE of the REGISTRATION REQUEST message and if the PEIPS assistance information IE is included in the REGISTRATION ACCEPT message, the AMF shall start timer T3550 and enter state 5GMM-COMMON-PROCEDURE-INITIATED as described in subclause 5.1.3.2.3.3.

If the UE is not in NB-N1 mode and the UE has set the RACS bit to "RACS supported" in the 5GMM Capability IE of the REGISTRATION REQUEST message, the AMF may include either a UE radio capability ID IE or a UE radio capability ID deletion indication IE in the REGISTRATION ACCEPT message. If the UE radio capability ID IE or the UE radio capability ID deletion indication IE is included in the REGISTRATION ACCEPT message, the AMF shall start timer T3550 and enter state 5GMM-COMMON-PROCEDURE-INITIATED as described in subclause 5.1.3.2.3.3.

The AMF may include a new TAI list for the UE in the REGISTRATION ACCEPT message. The new TAI list shall not contain both tracking areas in NB-N1 mode and tracking areas not in NB-N1 mode. The UE, upon receiving a REGISTRATION ACCEPT message, shall delete its old TAI list and store the received TAI list. If there is no TAI list received, the UE shall consider the old TAI list as valid. If the registration area contains TAIs belonging to different PLMNs, which are equivalent PLMNs, and

- a) the UE already has stored allowed NSSAI for the current registration area, the UE shall store the allowed NSSAI for the current registration area in each of the allowed NSSAIs which are associated with each of the PLMNs in the registration area;
- b) the UE already has stored rejected NSSAI for the current registration area, the UE shall store the rejected NSSAI for the current registration area in each of the rejected NSSAIs which are associated with each of the PLMNs in the registration area;
- c) the UE already has stored rejected NSSAI for the failed or revoked NSSAA, the UE shall store the rejected NSSAI for the failed or revoked NSSAA in each of the rejected NSSAIs which are associated with each of the PLMNs in the registration area;
- d) the UE already has stored rejected NSSAI for the maximum number of UEs reached, the UE shall store the rejected NSSAI for the maximum number of UEs reached in each of the rejected NSSAIs which are associated with each of the PLMNs in the registration area;
- e) the UE already has stored pending NSSAI, the UE shall store the pending NSSAI in each of the pending NSSAIs which are associated with each of the PLMNs in the registration area; and
- f) the UE already has stored partially rejected NSSAI, the UE shall store the partially rejected NSSAI in each of the partially rejected NSSAIs which are associated with each of the PLMNs in the registration area.

NOTE 3: When assigning the TAI list, the AMF can take into account the eNodeB's capability of support of CIoT 5GS optimization.

The AMF may also include a list of equivalent PLMNs in the REGISTRATION ACCEPT message. Each entry in the list contains a PLMN code (MCC+MNC). The UE shall store the list as provided by the network, and if there is no emergency PDU session established, the UE shall remove from the list any PLMN code that is already in the forbidden PLMN list as specified in subclause 5.3.13A. If the UE is not registered for emergency services and there is an emergency PDU session established, the UE shall remove from the list of equivalent PLMNs any PLMN code present in the forbidden PLMN list as specified in subclause 5.3.13A, when the emergency PDU session is released. In addition, the UE shall add to the stored list the PLMN code of the registered PLMN that sent the list. The UE shall replace the stored list on each receipt of the REGISTRATION ACCEPT message. If the REGISTRATION ACCEPT message does not contain a list, then the UE shall delete the stored list. The AMF of a PLMN shall not include a list of equivalent SNPNs.

If the ESI bit of the 5GMM capability IE of the REGISTRATION REQUEST message is set to "equivalent SNPNs supported", the AMF of a SNPN may include a list of equivalent SNPNs in the REGISTRATION ACCEPT message. If the UE is registered for onboarding services in SNPN, the AMF shall not include a list of equivalent SNPNs in the REGISTRATION ACCEPT message. Each entry in the list contains an SNPN identity. The UE shall store the list as provided by the network. If there is no emergency PDU session established and the UE is not registered for onboarding services in SNPN, the UE shall remove from the list any SNPN identity that is already in:

- the "permanently forbidden SNPNs" list or the "temporarily forbidden SNPNs" list, if the SNPN is not an SNPN selected for localized services in SNPN (see 3GPP TS 23.122 [5]); or
- the "permanently forbidden SNPNs for access for localized services in SNPN" list or the "temporarily forbidden SNPNs for access for localized services in SNPN" list, if the SNPN is an SNPN selected for localized services in SNPN (see 3GPP TS 23.122 [5]).

If the UE is not registered for emergency services and there is an emergency PDU session established, the UE shall remove from the list of equivalent SNPNs any SNPN identity present in the "permanently forbidden SNPNs" list or the "temporarily forbidden SNPNs" list, when the emergency PDU session is released. The UE shall add to the stored list the SNPN identity of the registered SNPN that sent the list. The UE shall replace the stored list on each receipt of the REGISTRATION ACCEPT message. If the REGISTRATION ACCEPT message does not contain a list, then the UE shall delete the stored list. The AMF of an SNPN shall not include a list of equivalent PLMNs.

NOTE 3A0: If N1 mode was disabled for an SNPN due to reception of 5GMM cause #27 or #62, the UE implementation ensures that it does not register to this SNPN due to being part of the list of "equivalent SNPNs" received while registered in another SNPN.

If the UE is not registered for emergency services, and if the PLMN identity of the registered PLMN is a member of the forbidden PLMN list as specified in subclause 5.3.13A, any such PLMN identity shall be deleted from the corresponding list(s).

The AMF may include new service area restrictions in the Service area list IE in the REGISTRATION ACCEPT message. The UE, upon receiving a REGISTRATION ACCEPT message with new service area restrictions shall act as described in subclause 5.3.5.

If the Service area list IE is not included in the REGISTRATION ACCEPT message, any tracking area in the registered PLMN and its equivalent PLMN(s) in the registration area, or in the registered SNPN, is considered as an allowed tracking area as described in subclause 5.3.5.

The AMF shall include the MICO indication IE in the REGISTRATION ACCEPT message only if the MICO indication IE was included in the REGISTRATION REQUEST message, the AMF supports and accepts the use of MICO mode. If the AMF supports and accepts the use of MICO mode, the AMF may indicate "all PLMN registration area allocated" in the MICO indication IE in the REGISTRATION ACCEPT message. If "all PLMN registration area allocated" is indicated in the MICO indication IE, the AMF shall not assign and include the TAI list in the REGISTRATION ACCEPT message. If the REGISTRATION ACCEPT message includes an MICO indication IE indicating "all PLMN registration area allocated", the UE shall treat all TAIs in the current PLMN as a registration area and delete its old TAI list. If "strictly periodic registration timer supported" is indicated in the MICO indication IE in the REGISTRATION REQUEST message, the AMF may indicate "strictly periodic registration timer supported" in the MICO indication IE and may include the T3512 value IE in the REGISTRATION ACCEPT message. If the timer value received in T3512 IE is different from the already stored value of the timer T3512 and the timer T3512 is running, the UE shall restart T3512 with the new value received in the T3512 value IE.

The AMF shall include an active time value in the T3324 IE in the REGISTRATION ACCEPT message if the UE requested an active time value in the REGISTRATION REQUEST message and the AMF accepts the use of MICO mode and the use of active time.

If the UE does not include MICO indication IE in the REGISTRATION REQUEST message, then the AMF shall disable MICO mode if it was already enabled.

If the AMF supports and accepts the use of MICO, and the UE included the Requested T3512 value IE in the REGISTRATION REQUEST message, then the AMF shall take into account the T3512 value requested when providing the T3512 value IE in the REGISTRATION ACCEPT message.

NOTE 3A: The T3512 value assigned to the UE by AMF can be different from the T3512 value requested by the UE. AMF can take several factors into account when assigning the T3512 value, e.g. local configuration, expected UE behaviour, UE requested T3512 value, UE subscription data, network policies.

The AMF may include the T3512 value IE in the REGISTRATION ACCEPT message only if the REGISTRATION REQUEST message was sent over the 3GPP access.

The AMF may include the non-3GPP de-registration timer value IE in the REGISTRATION ACCEPT message only if the REGISTRATION REQUEST message was sent for the non-3GPP access.

If the UE indicates support of the N1 NAS signalling connection release in the REGISTRATION REQUEST message and the network decides to accept the N1 NAS signalling connection release, then the AMF shall set the N1 NAS signalling connection release bit to "N1 NAS signalling connection release supported" in the 5GS network feature support IE of the REGISTRATION ACCEPT message.

If the UE indicates support of the paging indication for voice services in the REGISTRATION REQUEST message and the network decides to accept the paging indication for voice services, then the AMF shall set the paging indication for voice services bit to "paging indication for voice services supported" in the 5GS network feature support IE of the REGISTRATION ACCEPT message. If the UE receives the REGISTRATION ACCEPT message with the paging indication for voice services bit set to "paging indication for voice services supported", the UE NAS layer informs the lower layers that paging indication for voice services is supported. Otherwise, the UE NAS layer informs the lower layers that paging indication for voice services is not supported.

If the UE indicates support of the reject paging request in the REGISTRATION REQUEST message and the network decides to accept the reject paging request, then the AMF shall set the reject paging request bit to "reject paging request supported" in the 5GS network feature support IE of the REGISTRATION ACCEPT message.

If the UE indicates support of the paging restriction in the REGISTRATION REQUEST message, and the AMF sets:

- the reject paging request bit to "reject paging request supported";
- the N1 NAS signalling connection release bit to "N1 NAS signalling connection release supported"; or
- both of them;

in the 5GS network feature support IE of the REGISTRATION ACCEPT message, and the network decides to accept the paging restriction, then the AMF shall set the paging restriction bit to "paging restriction supported" in the 5GS network feature support IE of the REGISTRATION ACCEPT message.

If the MUSIM UE does not include the Paging restriction IE in the REGISTRATION REQUEST message, the AMF shall delete any stored paging restriction for the UE and stop restricting paging.

If the MUSIM UE requests the release of the NAS signalling connection, by setting Request type to "NAS signalling connection release" in the UE request type IE included in the REGISTRATION REQUEST message, and the AMF supports the N1 NAS signalling connection release, the AMF shall initiate the release of the NAS signalling connection after the completion of the registration procedure for mobility and periodic registration update. If the UE requests restriction of paging by including the Paging restriction IE and the AMF supports the paging restriction, the AMF:

- if accepts the paging restriction, shall include the 5GS additional request result IE in the REGISTRATION ACCEPT message and set the Paging restriction decision to "paging restriction is accepted". The AMF shall store the paging restriction of the UE and enforce these restrictions in the paging procedure as described in subclause 5.6.2; or
- if rejects the paging restriction, shall include the 5GS additional request result IE in the REGISTRATION ACCEPT message and set the Paging restriction decision to "paging restriction is rejected", and shall discard the received paging restriction. The AMF shall delete any stored paging restriction for the UE and stop restricting paging.

If the UE requests "control plane CIoT 5GS optimization" in the 5GS update type IE, indicates support of control plane CIoT 5GS optimization in the 5GMM capability IE and the AMF decides to accept the requested CIoT 5GS optimization and the registration request, the AMF shall indicate "control plane CIoT 5GS optimization supported" in the 5GS network feature support IE of the REGISTRATION ACCEPT message.

If the UE has indicated support for the control plane CIoT 5GS optimizations, and the AMF decides to activate the congestion control for transport of user data via the control plane, then the AMF shall include the T3448 value IE in the REGISTRATION ACCEPT message.

If the AMF decides to deactivate the congestion control for transport of user data via the control plane, then the AMF shall delete the stored control plane data back-off time for the UE and the AMF shall not include timer T3448 value IE in the REGISTRATION ACCEPT message.

If:

- the UE in NB-N1 mode is using control plane CIoT 5GS optimization; and
- the network is configured to provide the truncated 5G-S-TMSI configuration for control plane CIoT 5GS optimizations;

the AMF shall include the Truncated 5G-S-TMSI configuration IE in the REGISTRATION ACCEPT message and set the "Truncated AMF Set ID value" and the "Truncated AMF Pointer value" in the Truncated 5G-S-TMSI configuration IE based on network policies. The AMF shall start timer T3550 and enter state 5GMM-COMMON-PROCEDURE-INITIATED as described in subclause 5.1.3.2.3.3.

For inter-system change from S1 mode to N1 mode in 5GMM-IDLE mode, if the UE has included a ngKSI indicating a current 5G NAS security context in the REGISTRATION REQUEST message by which the REGISTRATION REQUEST message is integrity protected, the AMF shall take one of the following actions:

- a) if the AMF retrieves the current 5G NAS security context as indicated by the ngKSI and 5G-GUTI sent by the UE, the AMF shall integrity check the REGISTRATION REQUEST message using the current 5G NAS security

context and integrity protect the REGISTRATION ACCEPT message using the current 5G NAS security context;

- b) if the AMF cannot retrieve the current 5G NAS security context as indicated by the ngKSI and 5G-GUTI sent by the UE, the AMF shall treat the REGISTRATION REQUEST message fails the integrity check and take actions as specified in subclause 4.4.4.3; or
- c) if the UE has not included an Additional GUTI IE, the AMF may treat the REGISTRATION REQUEST message as in the previous item, i.e. as if it cannot retrieve the current 5G NAS security context.

NOTE 4: The handling described above at failure to retrieve the current 5G NAS security context or if no Additional GUTI IE was provided does not preclude the option for the AMF to perform a primary authentication and key agreement procedure and create a new native 5G NAS security context.

For inter-system change from S1 mode to N1 mode in 5GMM-CONNECTED mode, the AMF shall integrity check REGISTRATION REQUEST message using the current K'_{AMF} as derived when triggering the handover to N1 mode (see subclause 4.4.2.2). The AMF shall verify the received UE security capabilities in the REGISTRATION REQUEST message. The AMF shall then take one of the following actions:

- a) if the REGISTRATION REQUEST does not contain a valid KSI_{AMF} in the Non-current native NAS key set identifier IE, the AMF shall remove the non-current native 5G NAS security context, if any, for any 5G-GUTI for this UE. The AMF shall then integrity protect and cipher the REGISTRATION ACCEPT message using the security context based on K'_{AMF} and take the mapped 5G NAS security context into use; or
- b) if the REGISTRATION REQUEST contains a valid KSI_{AMF} in the Non-current native NAS key set identifier IE and:
 - 1) the AMF decides to take the native 5G NAS security context into use, the AMF shall initiate a security mode control procedure to take the corresponding native 5G NAS security context into use and then integrity protect and cipher the REGISTRATION ACCEPT message using the corresponding native 5G NAS security context; and
 - 2) otherwise, the AMF shall then integrity protect and cipher the REGISTRATION ACCEPT message using the security context based on K'_{AMF} and take the mapped 5G NAS security context into use.

NOTE 5: In above bullet b), it is recommended for the AMF to initiate a security mode control procedure to take the corresponding native 5G NAS security context into use.

If the UE has included the service-level device ID set to the CAA-level UAV ID in the Service-level-AA container IE of the REGISTRATION REQUEST message, and if:

- the UE has a valid aerial UE subscription information; and
- the UUAA procedure is to be performed during the registration procedure according to operator policy; and
- there is no valid successful UUAA result for the UE in the UE 5GMM context,

then the AMF shall initiate the UUAA-MM procedure with the UAS-NF as specified in 3GPP TS 23.256 [6AB] and shall include a service-level-AA pending indication in the Service-level-AA container IE of the REGISTRATION ACCEPT message. The AMF shall store in the UE 5GMM context that a UUAA procedure is pending. The AMF shall start timer T3550 and enter state 5GMM-COMMON-PROCEDURE-INITIATED as described in subclause 5.1.3.2.3.3.

If the UE has included the service-level device ID set to the CAA-level UAV ID in the Service-level-AA container IE of the REGISTRATION REQUEST message, and if:

- the UE has a valid aerial UE subscription information;
- the UUAA procedure is to be performed during the registration procedure according to operator policy; and
- there is a valid successful UUAA result for the UE in the UE 5GMM context,

then the AMF shall include a service-level-AA response in the Service-level-AA container IE of the REGISTRATION ACCEPT message and set the SLAR field in the service-level-AA response to "Service level authentication and authorization was successful".

If the AMF determines that the UUA-MM procedure needs to be performed for a UE, the AMF has not received the service-level device ID set to the CAA-level UAV ID in the Service-level-AA container IE of the REGISTRATION REQUEST message from the UE and the AMF decides to accept the UE to be registered for other services than UAS services based on the user's subscription data and the operator policy, the AMF shall accept the registration update request and shall mark in the UE's 5GMM context that the UE is not allowed to request UAS services.

If the UE supports MINT, the AMF may include the List of PLMNs to be used in disaster condition IE in the REGISTRATION ACCEPT message.

If the UE supports MINT, the AMF may include the Disaster roaming wait range IE in the REGISTRATION ACCEPT message.

If the UE supports MINT, the AMF may include the Disaster return wait range IE in the REGISTRATION ACCEPT message.

NOTE 6: The AMF can determine the content of the "list of PLMN(s) to be used in disaster condition", the value of the disaster roaming wait range and the value of the disaster return wait range based on the network local configuration.

If the AMF received the list of TAIs from the satellite NG-RAN as described in 3GPP TS 23.501 [8], and determines that, by UE subscription and operator's preferences, any but not all TAIs in the received list of TAIs is forbidden for roaming or for regional provision of service, the AMF shall include the TAI(s) in:

- a) the Forbidden TAI(s) for the list of "5GS forbidden tracking areas for roaming" IE; or
- b) the Forbidden TAI(s) for the list of "5GS forbidden tracking areas for regional provision of service" IE; or
- c) both;

in the REGISTRATION ACCEPT message.

NOTE 7A: Void.

If the UE has set the Reconnection to the network due to RAN timing synchronization status change (RANtiming) bit to "Reconnection to the network due to RAN timing synchronization status change supported" in the 5GMM capability IE of the REGISTRATION REQUEST message, the AMF may include the RAN timing synchronization IE with the RecReq bit set to "Reconnection requested" in the REGISTRATION ACCEPT message.

If the AMF receives the mobility and periodic registration request along with along with the mobile IAB-indication over N2 reference point (see TS 38.413 [31]) from an UE and the UE is authorized to operate as an MBSR based on the subscription information and local policy (see 3GPP TS 23.501 [8]), the AMF shall include the Feature authorization indication IE in the REGISTRATION ACCEPT message and shall set the MBSRAI field to "authorized to operate as MBSR". If the AMF receives the mobility and periodic registration request along with along with the mobile IAB-indication over N2 reference point (see TS 38.413 [31]) from a UE and the UE is not authorized operate as an MBSR based on the subscription information and local policy but can operate as a UE, the AMF shall include the Feature authorization indication IE in the REGISTRATION ACCEPT message and shall set the MBSRAI field to "not authorized to operate as MBSR but allowed to operate as a UE".

If the UE supports user plane positioning using LCS-UPP, SUPL, or both, the AMF shall set the LCS-UPP bit, the SUPL bit, or both in the 5GS network feature support IE of the REGISTRATION ACCEPT message as specified in 3GPP TS 24.572 [64].

Upon receipt of the REGISTRATION ACCEPT message, the UE shall reset the registration attempt counter and service request attempt counter, enter state 5GMM-REGISTERED and set the 5GS update status to 5U1 UPDATED.

If the UE receives the REGISTRATION ACCEPT message from a PLMN, then the UE shall reset the PLMN-specific attempt counter for that PLMN for the specific access type for which the message was received. The UE shall also reset the PLMN-specific N1 mode attempt counter for that PLMN for the specific access type for which the message was received. If the message was received via 3GPP access, the UE shall reset the counter for "SIM/USIM considered invalid for GPRS services" events and the counter for "SIM/USIM considered invalid for non-GPRS services", if any. If the message was received via non-3GPP access, the UE shall reset the counter for "USIM considered invalid for 5GS services over non-3GPP" events.

If the UE receives the REGISTRATION ACCEPT message from an SNPN, then the UE shall reset the SNPN-specific attempt counter for the current SNPN for the specific access type for which the message was received. If the message

was received via 3GPP access, the UE shall reset the counter for "the entry for the current SNPN considered invalid for 3GPP access" events. If the message was received via non-3GPP access, the UE shall reset the counter for "the entry for the current SNPN considered invalid for non-3GPP access" events.

If the REGISTRATION ACCEPT message included a T3512 value IE, the UE shall use the value in T3512 value IE as periodic registration update timer (T3512). If the T3512 value IE is not included, the UE shall use the value currently stored, e.g. from a prior REGISTRATION ACCEPT message.

If the REGISTRATION ACCEPT message include a T3324 value IE, the UE shall use the value in the T3324 value IE as active time timer (T3324). If the REGISTRATION ACCEPT message does not include a T3324 value IE, UE shall not start the timer T3324 until a new value is received from the network.

If the REGISTRATION ACCEPT message included a non-3GPP de-registration timer value IE, the UE shall use the value in non-3GPP de-registration timer value IE as non-3GPP de-registration timer. If non-3GPP de-registration timer value IE is not included, the UE shall use the value currently stored, e.g. from a prior REGISTRATION ACCEPT message. If non-3GPP de-registration timer value IE is not included and there is no stored non-3GPP de-registration timer value in the UE, the UE shall use the default value of the non-3GPP de-registration timer.

If the REGISTRATION ACCEPT message contains a 5G-GUTI, the UE shall return a REGISTRATION COMPLETE message to the AMF to acknowledge the received 5G-GUTI, stop timer T3519 if running, and delete any stored SUCI. The UE shall provide the 5G-GUTI to the lower layer of 3GPP access if the REGISTRATION ACCEPT message is sent over the non-3GPP access, and the UE is in 5GMM-REGISTERED in both 3GPP access and non-3GPP access in the same PLMN.

If the REGISTRATION ACCEPT message contains

- a) the Network slicing indication IE with the Network slicing subscription change indication set to "Network slicing subscription changed";
- b) a Configured NSSAI IE with a new configured NSSAI for the current PLMN or SNPN and optionally the mapped S-NSSAI(s) for the configured NSSAI for the current PLMN or SNPN;
- c) an NSSRG information IE with a new NSSRG information;
- d) an Alternative NSSAI IE with a new alternative NSSAI;
- e) an S-NSSAI location validity information in the Registration accept type 6 IE container IE with a new S-NSSAI location validity information;
- f) an S-NSSAI time validity information IE with a new S-NSSAI time validity information; or
- g) an On-demand NSSAI IE with a new on-demand NSSAI or an updated slice deregistration inactivity timer value,

the UE shall return a REGISTRATION COMPLETE message to the AMF to acknowledge the successful update of the network slicing information. If the UE has set the RCMAN bit to "Sending of REGISTRATION COMPLETE message for NSAG information supported" in the 5GMM capability IE of the REGISTRATION REQUEST message and if REGISTRATION ACCEPT message contains the NSAG information IE, the UE shall return REGISTRATION COMPLETE message to the AMF to acknowledge the reception of the NSAG information IE.

NOTE 7B: When the UE receives the NSSRG information IE, the UE may provide the NSSRG information to lower layers for the purpose of NSAG-aware cell reselection.

If the REGISTRATION ACCEPT message contains the CAG information list IE or the Extended CAG information list IE and the UE had set the CAG bit to "CAG supported" in the 5GMM capability IE of the REGISTRATION REQUEST message, the UE shall:

- a) replace the "CAG information list" stored in the UE with the received CAG information list IE or the Extended CAG information list IE when received in the HPLMN or EHPLMN;
- b) replace the serving VPLMN's entry of the "CAG information list" stored in the UE with the serving VPLMN's entry of the received CAG information list IE or the Extended CAG information list IE when the UE receives the CAG information list IE or the Extended CAG information list IE in a serving PLMN other than the HPLMN or EHPLMN; or

NOTE 7: When the UE receives the CAG information list IE or the Extended CAG information list IE in a serving PLMN other than the HPLMN or EHPLMN, entries of a PLMN other than the serving VPLMN, if any, in the received CAG information list IE or the Extended CAG information list IE are ignored.

- c) remove the serving VPLMN's entry of the "CAG information list" stored in the UE when the UE receives the CAG information list IE or the Extended CAG information list IE in a serving PLMN other than the HPLMN or EHPLMN and the CAG information list IE or the Extended CAG information list IE does not contain the serving VPLMN's entry.

The UE shall store the "CAG information list" received in the CAG information list IE or the Extended CAG information list IE as specified in annex C.

If the received "CAG information list" includes an entry containing the identity of the registered PLMN, the UE shall operate as follows.

- a) if the UE receives the REGISTRATION ACCEPT message via a CAG cell, none of the CAG-ID(s) supported by the current CAG cell is authorized based on the "Allowed CAG list" of the entry for the registered PLMN in the received "CAG information list", and:
 - 1) the entry for the registered PLMN in the received "CAG information list" does not include an "indication that the UE is only allowed to access 5GS via CAG cells", then the UE shall enter the state 5GMM-REGISTERED.LIMITED-SERVICE and shall search for a suitable cell according to 3GPP TS 38.304 [28] or 3GPP TS 36.304 [25C] with the updated "CAG information list"; or
 - 2) the entry for the registered PLMN in the received "CAG information list" includes an "indication that the UE is only allowed to access 5GS via CAG cells" and:
 - i) if one or more CAG-ID(s) are authorized based on the "Allowed CAG list" of the entry for the registered PLMN in the received "CAG information list", the UE shall enter the state 5GMM-REGISTERED.LIMITED-SERVICE and shall search for a suitable cell according to 3GPP TS 38.304 [28] with the updated "CAG information list"; or
 - ii) if no CAG-ID is authorized based on the "Allowed CAG list" of the entry for the registered PLMN in the received "CAG information list" and:
 - A) the UE does not have an emergency PDU session, then the UE shall enter the state 5GMM-REGISTERED.PLMN-SEARCH and shall apply the PLMN selection process defined in 3GPP TS 23.122 [5] with the updated "CAG information list"; or
 - B) the UE has an emergency PDU session, then the UE shall perform a local release of all PDU sessions associated with 3GPP access except for the emergency PDU session and enter the state 5GMM-REGISTERED.LIMITED-SERVICE; or
- b) if the UE receives the REGISTRATION ACCEPT message via a non-CAG cell and the entry for the registered PLMN in the received "CAG information list" includes an "indication that the UE is only allowed to access 5GS via CAG cells" and:
 - 1) if one or more CAG-ID(s) are authorized based on the "allowed CAG list" for the registered PLMN in the received "CAG information list", the UE shall enter the state 5GMM-REGISTERED.LIMITED-SERVICE and shall search for a suitable cell according to 3GPP TS 38.304 [28] with the updated "CAG information list"; or
 - 2) if no CAG-ID is authorized based on the "Allowed CAG list" of the entry for the registered PLMN in the received "CAG information list" and:
 - i) the UE does not have an emergency PDU session, then the UE shall enter the state 5GMM-REGISTERED.PLMN-SEARCH and shall apply the PLMN selection process defined in 3GPP TS 23.122 [5] with the updated "CAG information list"; or
 - ii) the UE has an emergency PDU session, then the UE shall perform a local release of all PDU sessions associated with 3GPP access except for the emergency PDU session and enter the state 5GMM-REGISTERED.LIMITED-SERVICE.

If the received "CAG information list" does not include an entry containing the identity of the registered PLMN and the UE receives the REGISTRATION ACCEPT message via a CAG cell, the UE shall enter the state 5GMM-

REGISTERED.LIMITED-SERVICE and shall search for a suitable cell according to 3GPP TS 38.304 [28] or 3GPP TS 36.304 [25C] with the updated "CAG information list".

If the REGISTRATION ACCEPT message contains the Operator-defined access category definitions IE, the Extended emergency number list IE, the CAG information list IE or the Extended CAG information list IE, the UE shall return a REGISTRATION COMPLETE message to the AMF to acknowledge reception of the operator-defined access category definitions or the extended local emergency numbers list or the CAG information list.

If the UE has set the RCMAP bit to " Sending of REGISTRATION COMPLETE message for negotiated PEIPS assistance information supported " in the 5GMM capability IE of the REGISTRATION REQUEST message and if REGISTRATION ACCEPT message contains the Negotiated PEIPS assistance information IE, the UE shall return a REGISTRATION COMPLETE message to the AMF to acknowledge reception of the Negotiated PEIPS assistance information IE.

If the REGISTRATION ACCEPT message contains the UE radio capability ID IE or the UE radio capability ID deletion indication IE, the UE shall return a REGISTRATION COMPLETE message to the AMF to acknowledge reception of the UE radio capability ID IE or the UE radio capability ID deletion indication IE.

If the T3448 value IE is present in the received REGISTRATION ACCEPT message and the value indicates that this timer is neither zero nor deactivated, the UE shall:

- a) stop timer T3448 if it is running; and
- b) start timer T3448 with the value provided in the T3448 value IE.

If the UE is using 5GS services with control plane CIoT 5GS optimization, the T3448 value IE is present in the REGISTRATION ACCEPT message and the value indicates that this timer is either zero or deactivated, the UE shall ignore the T3448 value IE and proceed as if the T3448 value IE was not present.

If the UE in 5GMM-IDLE mode initiated the registration procedure for mobility and periodic registration update and the REGISTRATION ACCEPT message does not include the T3448 value IE and if timer T3448 is running, then the UE shall stop timer T3448.

Upon receiving a REGISTRATION COMPLETE message, the AMF shall stop timer T3550 and change to state 5GMM-REGISTERED. The 5G-GUTI, if sent in the REGISTRATION ACCEPT message, shall be considered as valid, the PEIPS assistance information, if sent in the REGISTRATION ACCEPT message, shall be considered as valid, and the UE radio capability ID, if sent in the REGISTRATION ACCEPT message, shall be considered as valid.

If the 5GS update type IE was included in the REGISTRATION REQUEST message with the SMS requested bit set to "SMS over NAS supported" and:

- a) the SMSF address is stored in the UE 5GMM context and:
 - 1) the UE is considered available for SMS over NAS; or
 - 2) the UE is considered not available for SMS over NAS and the SMSF has confirmed that the activation of the SMS service is successful; or
- b) the SMSF address is not stored in the UE 5GMM context, the SMSF selection is successful and the SMSF has confirmed that the activation of the SMS service is successful;

then the AMF shall set the SMS allowed bit of the 5GS registration result IE in the REGISTRATION ACCEPT message as specified in subclause 5.5.1.2.4. If the UE 5GMM context does not contain an SMSF address or the UE is not considered available for SMS over NAS, then the AMF shall:

- a) store the SMSF address in the UE 5GMM context if not stored already; and
- b) store the value of the SMS allowed bit of the 5GS registration result IE in the UE 5GMM context and consider the UE available for SMS over NAS.

If SMSF selection in the AMF or SMS activation via the SMSF is not successful, or the AMF does not allow the use of SMS over NAS, then the AMF shall set the SMS allowed bit of the 5GS registration result IE to "SMS over NAS not allowed" in the REGISTRATION ACCEPT message.

If the 5GS update type IE was included in the REGISTRATION REQUEST message with the SMS requested bit set to "SMS over NAS not supported" or the 5GS update type IE was not included in the REGISTRATION REQUEST message, then the AMF shall:

- a) mark the 5GMM context to indicate that the UE is not available for SMS over NAS; and

NOTE 8: The AMF can notify the SMSF that the UE is deregistered from SMS over NAS based on local configuration.

- b) set the SMS allowed bit of the 5GS registration result IE to "SMS over NAS not allowed" in the REGISTRATION ACCEPT message.

When the UE receives the REGISTRATION ACCEPT message, if the UE is also registered over another access to the same PLMN, the UE considers the value indicated by the SMS allowed bit of the 5GS registration result IE as applicable for both accesses over which the UE is registered.

If the 5GS update type IE was included in the REGISTRATION REQUEST message with the NG-RAN-RCU bit set to "UE radio capability update needed", the AMF shall delete the stored UE radio capability information or the UE radio capability ID, if any.

The AMF shall include the 5GS registration result IE in the REGISTRATION ACCEPT message. If the 5GS registration result value in the 5GS registration result IE indicates:

- a) "3GPP access", the UE:
 - 1) shall consider itself as being registered to 3GPP access; and
 - 2) if in 5GMM-REGISTERED state over non-3GPP access and on the same PLMN or SNPN as 3GPP access, shall enter state 5GMM-DEREGISTERED.ATTEMPTING-REGISTRATION over non-3GPP access and set the 5GS update status to 5U2 NOT UPDATED over non-3GPP access; or
- b) "Non-3GPP access", the UE:
 - 1) shall consider itself as being registered to non-3GPP access; and
 - 2) if in the 5GMM-REGISTERED state over 3GPP access and is on the same PLMN or SNPN as non-3GPP access, shall enter the state 5GMM-DEREGISTERED.ATTEMPTING-REGISTRATION over 3GPP access and set the 5GS update status to 5U2 NOT UPDATED over 3GPP access; or
- c) "3GPP access and non-3GPP access", the UE shall consider itself as being registered to both 3GPP access and non-3GPP access.

If the UE is not currently registered for emergency services and the emergency registered bit of the 5GS registration result IE in the REGISTRATION ACCEPT message is set to "Registered for emergency services", the UE shall consider itself registered for emergency services and shall locally release all non-emergency PDU sessions, if any.

In roaming scenarios, the AMF shall provide mapped S-NSSAI(s) for the configured NSSAI, the allowed NSSAI, the partially allowed NSSAI, the rejected NSSAI (if Extended rejected NSSAI IE is used), the partially rejected NSSAI, the pending NSSAI or NSSRG information when included in the REGISTRATION ACCEPT message.

The AMF shall include the allowed NSSAI for the current PLMN or SNPN, in roaming scenarios, and shall include the mapped S-NSSAI(s) for the allowed NSSAI contained in the requested NSSAI (i.e. Requested NSSAI IE or Requested mapped NSSAI IE) from the UE, in the REGISTRATION ACCEPT message if the UE included the requested NSSAI in the REGISTRATION REQUEST message and the AMF allows one or more S-NSSAIs for the current PLMN or SNPN in the Requested NSSAI IE or one or more mapped S-NSSAIs in the Requested NSSAI IE or Requested mapped NSSAI IE. Additionally, if the AMF allows one or more subscribed S-NSSAIs for the UE, the AMF may include the allowed subscribed S-NSSAI(s) in the allowed NSSAI in the REGISTRATION ACCEPT message. The S-NSSAI associated with each of the active PDN connections for which interworking to 5GS is supported, shall be included in the allowed NSSAI if the UE included the UE status IE with the EMM registration status set to "UE is in EMM-REGISTERED state" in the REGISTRATION REQUEST message and the AMF supports N26 interface.

The AMF may also include rejected NSSAI in the REGISTRATION ACCEPT message if the UE is not registered for onboarding services in SNPN. If the UE has set the ER-NSSAI bit to "Extended rejected NSSAI supported" in the 5GMM capability IE of the REGISTRATION REQUEST message, the rejected NSSAI shall be included in the Extended rejected NSSAI IE in the REGISTRATION ACCEPT message; otherwise the rejected NSSAI shall be

included in the Rejected NSSAI IE in the REGISTRATION ACCEPT message. If the UE is registered for onboarding services in SNPN, the AMF shall not include rejected NSSAI in the REGISTRATION ACCEPT message.

If the UE has indicated the support for partial network slice and the AMF determines one or more S-NSSAI(s) in the requested NSSAI are to be included in the partially rejected NSSAI as specified in subclause 4.6.2.11, the AMF shall include the Partially rejected NSSAI IE in the Registration accept type 6 IE container IE of the REGISTRATION ACCEPT message.

If the UE receives the Partially rejected NSSAI IE in the Registration accept type 6 IE container IE of the REGISTRATION ACCEPT message, the UE shall store the partially rejected NSSAI as specified in subclause 4.6.2.2.

If the UE has set the ER-NSSAI bit to "Extended rejected NSSAI supported" in the 5GMM capability IE of the REGISTRATION REQUEST message, the rejected NSSAI contains S-NSSAI(s) which was included in the requested NSSAI but rejected by the network associated with rejection cause(s); otherwise the rejected NSSAI contains S-NSSAI(s) which was included in the requested NSSAI but rejected by the network associated with rejection cause(s) with the following restrictions:

- a) rejected NSSAI for the current PLMN or SNPN shall not include an S-NSSAI for the current PLMN or SNPN which is associated to multiple mapped S-NSSAIs and some of these but not all mapped S-NSSAIs are not allowed; and
- b) rejected NSSAI for the current registration area shall not include an S-NSSAI for the current PLMN or SNPN which is associated to multiple mapped S-NSSAIs and some of these but not all mapped S-NSSAIs are not allowed.

NOTE 9: The UE that does not support extended rejected NSSAI can avoid requesting an S-NSSAI associated with a mapped S-NSSAI, which was included in the previous requested NSSAI but neither in the allowed NSSAI nor in the rejected NSSAI in the consequent registration procedures.

If the UE indicated the support for network slice-specific authentication and authorization, and if the requested NSSAI (i.e. the Requested NSSAI IE or the Requested mapped NSSAI IE) includes one or more S-NSSAIs subject to network slice-specific authentication and authorization, the AMF shall in the REGISTRATION ACCEPT message include:

- a) the allowed NSSAI containing the S-NSSAI(s) or the mapped S-NSSAI(s), if any:
 - 1) which are not subject to network slice-specific authentication and authorization and are allowed by the AMF; or
 - 2) for which the network slice-specific authentication and authorization has been successfully performed;
- aa) the partially allowed NSSAI containing the S-NSSAI(s) or the mapped S-NSSAI(s), if any:
 - 1) which are not subject to network slice-specific authentication and authorization and are allowed by the AMF; or
 - 2) for which the network slice-specific authentication and authorization has been successfully performed;
- b) optionally, the rejected NSSAI;
- ba) optionally, the partially rejected NSSAI;
- c) pending NSSAI containing one or more S-NSSAIs for which network slice-specific authentication and authorization (except for re-NSSAA) will be performed or is ongoing, and one or more S-NSSAIs from the pending NSSAI which the AMF provided to the UE during the previous registration procedure for which network slice-specific authentication and authorization will be performed or is ongoing, if any; and
- d) the "NSSAA to be performed" indicator in the 5GS registration result IE set to indicate that the network slice-specific authentication and authorization procedure will be performed by the network, if the allowed NSSAI is not included in the REGISTRATION ACCEPT message.

If the UE is not registered for onboarding services in SNPN, the UE indicated the support for network slice-specific authentication and authorization, and:

- a) the UE did not include the requested NSSAI in the REGISTRATION REQUEST message or none of the S-NSSAIs in the requested NSSAI in the REGISTRATION REQUEST message are allowed;

- b) all default S-NSSAIs are subject to network slice-specific authentication and authorization; and
- c) the network slice-specific authentication and authorization procedure has not been successfully performed for any of the default S-NSSAIs,

the AMF shall in the REGISTRATION ACCEPT message include:

- a) the "NSSAA to be performed" indicator in the 5GS registration result IE to indicate that the network slice-specific authentication and authorization procedure will be performed by the network; and
- b) pending NSSAI containing one or more default S-NSSAIs for which network slice-specific authentication and authorization will be performed or is ongoing and one or more S-NSSAIs from the pending NSSAI which the AMF provided to the UE during the previous registration procedure for which network slice-specific authentication and authorization will be performed or is ongoing (if any); and
- c) optionally, the rejected NSSAI.

If the UE is not registered for onboarding services in SNPN, the UE indicated the support for network slice-specific authentication and authorization, and:

- a) the UE did not include the requested NSSAI in the REGISTRATION REQUEST message or none of the S-NSSAIs in the requested NSSAI in the REGISTRATION REQUEST message are allowed; and
- b) one or more default S-NSSAIs are not subject to network slice-specific authentication and authorization or the network slice-specific authentication and authorization procedure has been successfully performed for one or more default S-NSSAIs;

the AMF shall in the REGISTRATION ACCEPT message include:

- a) pending NSSAI containing one or more default S-NSSAIs for which network slice-specific authentication and authorization will be performed or is ongoing (if any) and one or more S-NSSAIs from the pending NSSAI which the AMF provided to the UE during the previous registration procedure for which network slice-specific authentication and authorization will be performed or is ongoing (if any);
- b) allowed NSSAI containing S-NSSAI(s) for the current PLMN or SNPN each of which corresponds to a default S-NSSAI which are not subject to network slice-specific authentication and authorization or for which the network slice-specific authentication and authorization has been successfully performed;
- c) allowed NSSAI containing one or more default S-NSSAIs, as the mapped S-NSSAI(s) for the allowed NSSAI in roaming scenarios, which are not subject to network slice-specific authentication and authorization or for which the network slice-specific authentication and authorization has been successfully performed; and
- d) optionally, the rejected NSSAI; and
- e) optionally, the partially rejected NSSAI.

If the UE did not include the requested NSSAI in the REGISTRATION REQUEST message or none of the S-NSSAIs in the requested NSSAI in the REGISTRATION REQUEST message are allowed, the allowed NSSAI shall not contain default S-NSSAI(s) that are subject to NSAC. If the subscription information includes the NSSRG information, the S-NSSAIs of the allowed NSSAI shall be associated with at least one common NSSRG value. If the network has pending NSSAI, the S-NSSAIs in the pending NSSAI and allowed NSSAI shall be associated with at least one common NSSRG value.

When the REGISTRATION ACCEPT includes a pending NSSAI, the pending NSSAI shall contain all S-NSSAIs for which network slice-specific authentication and authorization (except for re-NSSAA) will be performed or is ongoing from the requested NSSAI of the REGISTRATION REQUEST message that was received over the 3GPP access, non-3GPP access, or both the 3GPP access and non-3GPP access.

If the UE supports extended rejected NSSAI and the AMF determines that maximum number of UEs reached for all S-NSSAIs in the requested NSSAI as specified in subclause 4.6.2.5, the AMF shall include the rejected NSSAI containing one or more S-NSSAIs with the rejection cause "S-NSSAI not available due to maximum number of UEs reached" in the Extended rejected NSSAI IE in the REGISTRATION ACCEPT message. In addition, the AMF may include a back-off timer value for each S-NSSAI with the rejection cause "S-NSSAI not available due to maximum number of UEs reached" included in the Extended rejected NSSAI IE of the REGISTRATION ACCEPT message. To avoid that large

numbers of UEs simultaneously initiate deferred requests, the network should select the value for the backoff timer for each S-NSSAI for the informed UEs so that timeouts are not synchronised.

If the UE does not indicate support for extended rejected NSSAI and the maximum number of UEs has been reached, the AMF should include the rejected NSSAI containing one or more S-NSSAIs with the rejection cause "S-NSSAI not available in the current registration area" in the Rejected NSSAI IE and should not include these S-NSSAIs in the allowed NSSAI in the REGISTRATION ACCEPT message.

NOTE 10: Based on network policies, the AMF can include the S-NSSAI(s) for which the maximum number of UEs has been reached in the rejected NSSAI with rejection causes other than "S-NSSAI not available in the current registration area".

If the UE indicates support for network slice usage control and the AMF determines to provide the on-demand NSSAI, the AMF shall include the On-demand NSSAI IE in the REGISTRATION ACCEPT message. In addition, the AMF shall start timer T3550 and enter state 5GMM-COMMON-PROCEDURE-INITIATED as described in subclause 5.1.3.2.3.3.

If the UE receives the On-demand NSSAI IE in the REGISTRATION ACCEPT message, the UE shall store the on-demand NSSAI as specified in subclause 4.6.2.2.

If the AMF has a new configured NSSAI for the current PLMN or SNPN, the AMF shall include the configured NSSAI for the current PLMN or SNPN in the REGISTRATION ACCEPT message.

NOTE 10A: A new configured NSSAI can be available at the AMF following an indication that the subscription data for network slicing has changed.

The AMF may include a new configured NSSAI for the current PLMN or SNPN in the REGISTRATION ACCEPT message if:

- a) the REGISTRATION REQUEST message did not include a requested NSSAI and the UE is not registered for onboarding services in SNPN;
- b) the REGISTRATION REQUEST message included a requested NSSAI containing an S-NSSAI that is not valid in the serving PLMN or SNPN;
- c) the REGISTRATION REQUEST message included a requested NSSAI containing an S-NSSAI with incorrect mapped S-NSSAI(s);
- d) the REGISTRATION REQUEST message included the Network slicing indication IE with the Default configured NSSAI indication bit set to "Requested NSSAI created from default configured NSSAI";
- e) the REGISTRATION REQUEST message included the requested mapped NSSAI;
- f) the S-NSSAIs of the requested NSSAI in the REGISTRATION REQUEST message are not associated with any common NSSRG value, except for the case that the AMF, based on the indication received from the UDM as specified in 3GPP TS 23.501 [8], has provided all subscribed S-NSSAIs in the configured NSSAI to a UE who does not support NSSRG;

NOTE 11: If the S-NSSAIs of the requested NSSAI in the REGISTRATION REQUEST message are not associated with any common NSSRG value, it is possible that at least one of the S-NSSAIs is not included in any of new allowed NSSAI, new (extended) rejected NSSAI (if applicable), and new pending NSSAI (if applicable).

- g) the UE is in 5GMM-REGISTERED state over the other access and the S-NSSAIs of the requested NSSAI in the REGISTRATION REQUEST message over the current access and the allowed NSSAI over the other access are not associated with any common NSSRG value;
- h) the REGISTRATION REQUEST message included a 5GS mobile identity IE containing a mapped 5G-GUTI and did not include an Additional GUTI IE; or
- i) the REGISTRATION REQUEST message included an Additional GUTI IE containing a valid native 5G-GUTI which was not allocated by the current PLMN or SNPN.

If the REGISTRATION REQUEST message includes a requested NSSAI containing an S-NSSAI, the S-NSSAI time validity information, if available, indicates that the S-NSSAI is not available (see 3GPP TS 23.501 [8]), the TempNS bit of the 5GMM capability IE in the REGISTRATION REQUEST message is set to:

- a) "S-NSSAI time validity information supported", and the S-NSSAI time validity information indicates that the S-NSSAI will:
 - 1) become available again, then the AMF shall send a configured NSSAI and S-NSSAI time validity information; or
 - 2) not become available again, then the AMF shall send a configured NSSAI not including the S-NSSAI in the new configured NSSAI; or
- b) "S-NSSAI time validity information not supported", then the AMF shall send the S-NSSAI in a rejected NSSAI for the current registration area.

If a new configured NSSAI for the current PLMN or SNPN is included and the UE is roaming, the AMF shall also include the mapped S-NSSAI(s) for the configured NSSAI for the current PLMN or SNPN in the REGISTRATION ACCEPT message. In this case the AMF shall start timer T3550 and enter state 5GMM-COMMON-PROCEDURE-INITIATED as described in subclause 5.1.3.2.3.3.

If a new configured NSSAI for the current PLMN or SNPN is included, the subscription information includes the NSSRG information, and the NSSRG bit in the 5GMM capability IE of the REGISTRATION REQUEST message is set to:

- a) "NSSRG supported", then the AMF shall include the NSSRG information in the REGISTRATION ACCEPT message; or
- b) "NSSRG not supported", then the configured NSSAI shall include S-NSSAIs each of which is associated with all the NSSRG value(s) of the default S-NSSAI(s), or the configured NSSAI shall include, based on the indication received from the UDM as specified in 3GPP TS 23.501 [8], all subscribed S-NSSAIs even if these S-NSSAIs do not share any common NSSRG value.

If the AMF needs to update the NSSRG information and the UE has set the NSSRG bit to "NSSRG supported" in the 5GMM capability IE of the REGISTRATION REQUEST message, then the AMF shall include the new NSSRG information in the REGISTRATION ACCEPT message. In addition, the AMF shall start timer T3550 and enter state 5GMM-COMMON-PROCEDURE-INITIATED as described in subclause 5.1.3.2.3.3.

If the UE supports S-NSSAI time validity information and the AMF needs to update the S-NSSAI time validity information, then the AMF shall include the S-NSSAI time validity information IE in the REGISTRATION ACCEPT message. In addition, the AMF shall start timer T3550 and enter state 5GMM-COMMON-PROCEDURE-INITIATED as described in subclause 5.1.3.2.3.3.

If the UE supports S-NSSAI location validity information and the AMF needs to update the S-NSSAI location validity information, then the AMF shall include the S-NSSAI location validity information IE in the Registration accept type 6 IE container IE of the REGISTRATION ACCEPT message. In addition, the AMF shall start timer T3550 and enter state 5GMM-COMMON-PROCEDURE-INITIATED as described in subclause 5.1.3.2.3.3.

The AMF shall include the Network slicing indication IE with the Network slicing subscription change indication set to "Network slicing subscription changed" in the REGISTRATION ACCEPT message if the UDM has indicated that the subscription data for network slicing has changed. In this case the AMF shall start timer T3550 and enter state 5GMM-COMMON-PROCEDURE-INITIATED as described in subclause 5.1.3.2.3.3.

If the S-NSSAI(s) associated with the existing PDU session(s) of the UE is not included in the requested NSSAI (i.e. Requested NSSAI IE or Requested mapped NSSAI IE) of the REGISTRATION REQUEST message, the AMF shall perform a local release of the PDU session(s) associated with the S-NSSAI(s) except for a PDU session associated with DNN and S-NSSAI in the AMF onboarding configuration data and shall request the SMF to perform a local release of those PDU session(s).

The UE that has indicated the support for network slice-specific authentication and authorization receiving the pending NSSAI in the REGISTRATION ACCEPT message shall store the S-NSSAI(s) in the pending NSSAI as specified in subclause 4.6.2.2. If the registration area contains TAIs belonging to different PLMNs, which are equivalent PLMNs, the UE shall store the received pending NSSAI for each of the equivalent PLMNs as specified in subclause 4.6.2.2. If the pending NSSAI is not included in the REGISTRATION ACCEPT message and the "NSSAA to be performed" indicator is not set to "Network slice-specific authentication and authorization is to be performed" in the 5GS registration result IE of the REGISTRATION ACCEPT message, then the UE shall delete the pending NSSAI for the current PLMN and its equivalent PLMN(s) or SNPN, if existing, as specified in subclause 4.6.2.2.

The UE receiving the rejected NSSAI in the REGISTRATION ACCEPT message takes the following actions based on the rejection cause in the rejected S-NSSAI(s):

"S-NSSAI not available in the current PLMN or SNPN"

The UE shall add the rejected S-NSSAI(s) in the rejected NSSAI for the current PLMN or SNPN as specified in subclause 4.6.2.2 and shall not attempt to use this S-NSSAI(s) in the current PLMN or SNPN over any access until switching off the UE, the UICC containing the USIM is removed, the entry of the "list of subscriber data" with the SNPN identity of the current SNPN is updated, or the rejected S-NSSAI(s) are removed as described in subclause 4.6.2.2.

"S-NSSAI not available in the current registration area"

The UE shall add the rejected S-NSSAI(s) in the rejected NSSAI for the current registration area as specified in subclause 4.6.2.2 and shall not attempt to use this S-NSSAI(s) in the current registration area over the current until switching off the UE, the UE moving out of the current registration area, the UICC containing the USIM is removed, the entry of the "list of subscriber data" with the SNPN identity of the current SNPN is updated, or the rejected S-NSSAI(s) are removed as described in subclause 4.6.2.2.

"S-NSSAI not available due to the failed or revoked network slice-specific authentication and authorization"

The UE shall store the rejected S-NSSAI(s) in the rejected NSSAI for the failed or revoked NSSAA as specified in subclause 4.6.2.2 and shall not attempt to use this S-NSSAI in the current PLMN or SNPN over any access until switching off the UE, the UICC containing the USIM is removed, the entry of the "list of subscriber data" with the SNPN identity of the current SNPN is updated, or the rejected S-NSSAI(s) are removed as described in subclause 4.6.1 and 4.6.2.2.

"S-NSSAI not available due to maximum number of UEs reached"

Unless the back-off timer value received along with the S-NSSAI is zero, the UE shall add the rejected S-NSSAI(s) in the rejected NSSAI for the maximum number of UEs reached as specified in subclause 4.6.2.2 and shall not attempt to use this S-NSSAI in the current PLMN or SNPN over the current access until switching off the UE, the UICC containing the USIM is removed, the entry of the "list of subscriber data" with the SNPN identity of the current SNPN is updated, or the rejected S-NSSAI(s) are removed as described in subclauses 4.6.1 and 4.6.2.2.

NOTE 12: If the back-off timer value received along with the S-NSSAI in the rejected NSSAI for the maximum number of UEs reached is zero as specified in subclause 10.5.7.4a of 3GPP TS 24.008 [12], the UE does not consider the S-NSSAI as the rejected S-NSSAI.

If there is one or more S-NSSAIs in the rejected NSSAI with the rejection cause "S-NSSAI not available due to maximum number of UEs reached", then for each S-NSSAI, the UE shall behave as follows:

- a) stop the timer T3526 associated with the S-NSSAI, if running;
- b) start the timer T3526 with:
 - 1) the back-off timer value received along with the S-NSSAI, if a back-off timer value is received along with the S-NSSAI that is neither zero nor deactivated; or
 - 2) an implementation specific back-off timer value, if no back-off timer value is received along with the S-NSSAI; and
- c) remove the S-NSSAI from the rejected NSSAI for the maximum number of UEs reached when the timer T3526 associated with the S-NSSAI expires.

If the UE sets the NSSAA bit in the 5GMM capability IE to "Network slice-specific authentication and authorization not supported", and:

- a) if the Requested NSSAI IE only includes the S-NSSAI(s) subject to network slice-specific authentication and authorization and one or more default S-NSSAIs (containing one or more S-NSSAIs each of which may be associated with a new S-NSSAI) which are not subject to network slice-specific authentication and authorization are available, the AMF shall in the REGISTRATION ACCEPT message include:

- 1) the allowed NSSAI or the partially allowed NSSAI containing S-NSSAI(s) for the current PLMN or SNPN each of which corresponds to a default S-NSSAI which are not subject to network slice-specific authentication and authorization;
 - 2) the allowed NSSAI or the partially allowed NSSAI containing the default S-NSSAIs, as the mapped S-NSSAI(s) for the allowed NSSAI in roaming scenarios, which are not subject to network slice-specific authentication and authorization; and
 - 3) the rejected NSSAI containing the S-NSSAI(s) subject to network slice specific authentication and authorization with the rejection cause indicating "S-NSSAI not available in the current PLMN or SNPN", except if the UE has not set the ER-NSSAI bit to "Extended rejected NSSAI supported" in the 5GMM capability IE of the REGISTRATION REQUEST message and the S-NSSAI(s) is associated to multiple mapped S-NSSAIs and some of these but not all mapped S-NSSAIs are subject to NSSAA; or
- b) if the Requested NSSAI IE includes one or more S-NSSAIs subject to network slice-specific authentication and authorization, the AMF shall in the REGISTRATION ACCEPT message include:
- 1) the allowed NSSAI or the partially allowed NSSAI containing the S-NSSAI(s) or the mapped S-NSSAI(s) which are not subject to network slice-specific authentication and authorization; and
 - 2) the rejected NSSAI containing:
 - i) the S-NSSAI(s) subject to network slice specific authentication and authorization with the rejection cause indicating "S-NSSAI not available in the current PLMN or SNPN", except if the UE has not set the ER-NSSAI bit to "Extended rejected NSSAI supported" in the 5GMM capability IE of the REGISTRATION REQUEST message and the S-NSSAI(s) is associated to multiple mapped S-NSSAIs and some of these but not all mapped S-NSSAIs are subject to NSSAA; and
 - ii) the S-NSSAI(s) which was included in the requested NSSAI but rejected by the network associated with the rejection cause indicating "S-NSSAI not available in the current PLMN or SNPN" or the rejection cause indicating "S-NSSAI not available in the current registration area", if any.

For a REGISTRATION REQUEST message with a 5GS registration type IE indicating "mobility registration updating", if the UE does not indicate support for network slice-specific authentication and authorization, the UE is not registered for onboarding services in SNPN, and:

- a) the UE is not in NB-N1 mode; and
- b) if:
 - 1) the UE did not include the requested NSSAI in the REGISTRATION REQUEST message; or
 - 2) none of the S-NSSAIs in the requested NSSAI in the REGISTRATION REQUEST message are allowed;

and one or more default S-NSSAIs which are not subject to network slice-specific authentication and authorization are available, the AMF shall:

- a) put the allowed S-NSSAI(s) for the current PLMN or SNPN each of which corresponds to a default S-NSSAI and not subject to network slice-specific authentication and authorization in the allowed NSSAI of the REGISTRATION ACCEPT message;
- b) put the default S-NSSAIs and not subject to network slice-specific authentication and authorization, as the mapped S-NSSAI(s) for the allowed NSSAI in roaming scenarios, in the allowed NSSAI of the REGISTRATION ACCEPT message; and
- c) determine a registration area such that all S-NSSAIs of the allowed NSSAI are available in the registration area.

During a registration procedure for mobility and periodic registration update for which the 5GS registration type IE indicates:

- a) "periodic registration updating"; or
- b) "mobility registration updating" and the UE is in NB-N1 mode;

and the UE is not registered for onboarding services in SNPN, the AMF:

- a) may provide a new allowed NSSAI, a new partially allowed NSSAI, or both to the UE;
- b) shall provide a pending NSSAI to the UE if the UE has indicated the support for network slice-specific authentication and authorization and there are S-NSSAIs for which network slice-specific authentication and authorization (except for re-NSSAA) will be performed or is ongoing for the current PLMN or SNPN; or
- c) may provide both a new allowed NSSAI and a pending NSSAI to the UE;

in the REGISTRATION ACCEPT message. Additionally, if a pending NSSAI is provided without an allowed NSSAI and no S-NSSAI is currently allowed for the UE, the REGISTRATION ACCEPT message shall include the 5GS registration result IE with the "NSSAA to be performed" indicator set to "Network slice-specific authentication and authorization is to be performed".

If the REGISTRATION ACCEPT message contains the Network slicing indication IE with the Network slicing subscription change indication set to "Network slicing subscription changed", the UE shall delete the network slicing information for each and every PLMN or SNPN except for the current PLMN or SNPN as specified in subclause 4.6.2.2 and remove all tracking areas from the list of "5GS forbidden tracking areas for roaming" which were added due to rejection of S-NSSAI due to "S-NSSAI not available in the current registration area".

If the REGISTRATION ACCEPT message contains the allowed NSSAI, then the UE shall store the included allowed NSSAI together with the PLMN identity of the registered PLMN or the SNPN identity of the registered SNPN and the registration area as specified in subclause 4.6.2.2. If the registration area contains TAIs belonging to different PLMNs, which are equivalent PLMNs, the UE shall store the received allowed NSSAI in each of allowed NSSAIs which are associated with each of the PLMNs.

For each of the PDU session(s) active in the UE:

- a) if the allowed NSSAI contains an HPLMN S-NSSAI (e.g., mapped S-NSSAI, in roaming scenarios) matching to the HPLMN S-NSSAI of the PDU session, the UE shall locally update the S-NSSAI associated with the PDU session to the corresponding S-NSSAI received in the allowed NSSAI;
- b) if the allowed NSSAI does not contain an HPLMN S-NSSAI (e.g., mapped S-NSSAI, in roaming scenarios) matching to the HPLMN S-NSSAI of the PDU session, the UE may perform a local release of the PDU session except for an emergency PDU session, if any, and except for a PDU session established when the UE is registered for onboarding services in SNPN, if any; and
- c) if the partially allowed NSSAI contains an S-NSSAI associated with a PDU session, and the UE is in the TA where the S-NSSAI is not supported:
 - 1) the UE may initiate:
 - i) the PDU session release procedure; or
 - ii) the PDU session modification procedure to set the 3GPP PS data off status to "deactivated" as specified in 3GPP TS 24.008 [13]; and
 - 2) the SMF may initiate the PDU session release procedure.

NOTE 13: According to 3GPP TS 23.501 [8], also the AMF will determine which PDU sessions can no longer be supported based on the new allowed NSSAI, and it will cause a release on the UE side either by indicating in the PDU session status IE which PDU sessions are inactive on the network side or by triggering the SMF to initiate a release via 5GSM signalling.

If the REGISTRATION ACCEPT message contains a configured NSSAI IE with a new configured NSSAI for the current PLMN or SNPN and optionally the mapped S-NSSAI(s) for the configured NSSAI for the current PLMN or SNPN, the UE shall store the contents of the configured NSSAI IE as specified in subclause 4.6.2.2. In addition, if the REGISTRATION ACCEPT message contains:

- a) an NSSRG information IE, the UE shall store the contents of the NSSRG information IE as specified in subclause 4.6.2.2. If the UE receives a Configured NSSAI IE in the REGISTRATION ACCEPT message and no NSSRG information IE, the UE shall delete any stored NSSRG information, if any, as specified in subclause 4.6.2.2;
- b) an S-NSSAI location validity information IE in the Registration accept type 6 IE container IE, the UE shall store the contents of the S-NSSAI location validity information as specified in subclause 4.6.2.2. If the UE receives a

Configured NSSAI IE in the REGISTRATION ACCEPT message and no S-NSSAI location validity information IE, the UE shall delete any stored S-NSSAI location validity information as specified in subclause 4.6.2.2;

- c) an S-NSSAI time validity information IE, the UE shall store the contents of the S-NSSAI time validity information IE as specified in subclause 4.6.2.2. If the UE receives a Configured NSSAI IE in the REGISTRATION ACCEPT message and no S-NSSAI time validity information IE, the UE shall delete any stored S-NSSAI time validity information as specified in subclause 4.6.2.2; or
- d) an On-demand NSSAI IE, the UE shall store the contents of the On-demand NSSAI IE as specified in subclause 4.6.2.2. If the UE receives a Configured NSSAI IE in the REGISTRATION ACCEPT message and no On-demand NSSAI IE, the UE shall delete any stored on-demand NSSAI as specified in subclause 4.6.2.2. The UE shall stop any slice deregistration inactivity timer associated with an S-NSSAI which is deleted from the on-demand NSSAI.

If the UE has set the NSAG bit to "NSAG supported" in the 5GMM capability IE of the REGISTRATION REQUEST message over 3GPP access, the AMF may include the NSAG information IE in the REGISTRATION ACCEPT message. Up to 4 NSAG entries are allowed to be associated with a TAI list in the NSAG information IE. If the UE has set the RCMAN bit to "Sending of REGISTRATION COMPLETE message for NSAG information supported" in the 5GMM capability IE of the REGISTRATION REQUEST message and if the NSAG information IE is included in the REGISTRATION ACCEPT message, the AMF shall start timer T3550 and enter state 5GMM-COMMON-PROCEDURE-INITIATED as described in subclause 5.1.3.2.3.3.

NOTE 13A: How the AMF selects NSAG entries to be included in the NSAG information IE is implementation specific, e.g. take the NSAG priority and the current registration area into account.

NOTE 13B: If the NSAG for the PLMN and its equivalent PLMN(s) have different associations with S-NSSAIs, then the AMF includes a TAI list for the NSAG entry in the NSAG information IE.

NOTE 13C: If the NSAG for the PLMN and its equivalent PLMN(s) have different associations with S-NSSAIs, then the AMF includes a TAI list for the NSAG entry in the NSAG information IE.

If the UE receives the NSAG information IE in the REGISTRATION ACCEPT message, the UE shall store the NSAG information as specified in subclause 4.6.2.2.

If the UE supports network slice replacement and the AMF determines to provide the mapping information between the S-NSSAI to be replaced and the alternative S-NSSAI to the UE, then the AMF shall include the Alternative NSSAI IE, the Allowed NSSAI IE or the Partially allowed NSSAI IE including the alternative S-NSSAI, if not included in the current allowed NSSAI or the current partially allowed NSSAI, and the Configured NSSAI IE including the alternative S-NSSAI, if not included in the current configured NSSAI, in the REGISTRATION ACCEPT message. If the AMF determines that the replaced S-NSSAI is available, then the AMF shall provide the updated alternative NSSAI excluding the replaced S-NSSAI and the corresponding alternative S-NSSAI in the Alternative NSSAI IE in the REGISTRATION ACCEPT message. If the AMF determines that all the replaced S-NSSAI(s) are available, then the AMF shall provide the Alternative NSSAI IE with Length of Alternative NSSAI contents set to 0 in the REGISTRATION ACCEPT message. If the AMF determines that the replaced S-NSSAI is not supported due to the UE moving outside of NS-AoS of the S-NSSAI while the alternative S-NSSAI is available, then the AMF shall provide the updated allowed NSSAI and partially allowed NSSAI, if available, excluding the replaced S-NSSAI, if included, in the allowed NSSAI or partially allowed NSSAI in the REGISTRATION ACCEPT message. In addition, the AMF shall start timer T3550 and enter state 5GMM-COMMON-PROCEDURE-INITIATED as described in subclause 5.1.3.2.3.3.

If the UE receives the Alternative NSSAI IE in the REGISTRATION ACCEPT message, the UE shall store the alternative NSSAI as specified in subclause 4.6.2.2.

If the UE has indicated the support for partial network slice and the AMF determines one or more S-NSSAI(s) in the requested NSSAI are to be included in the partially allowed NSSAI as specified in subclause 4.6.2.11, the AMF shall include the Partially allowed NSSAI IE in the Registration accept type 6 IE container IE of the REGISTRATION ACCEPT message.

If the UE receives the Partially allowed NSSAI IE in the Registration accept type 6 IE container IE of the REGISTRATION ACCEPT message, the UE shall store the partially allowed NSSAI as specified in subclause 4.6.2.2.

If the REGISTRATION ACCEPT message:

- a) includes the 5GS registration result IE with the "NSSAA to be performed" indicator set to "Network slice-specific authentication and authorization is to be performed";
- b) includes a pending NSSAI;
- c) does not include an allowed NSSAI;
- d) does not include a partially allowed NSSAI;

the UE:

- a) shall not perform the registration procedure for mobility and periodic registration update with the Uplink data status IE except for emergency services;
- b) shall not initiate a service request procedure except for emergency services, for responding to paging or notification over non-3GPP access, for cases f), i), m) and o) in subclause 5.6.1.1;
- c) shall not initiate a 5GSM procedure except for emergency services, indicating a change of 3GPP PS data off UE status, or to request the release of a PDU session; and
- d) shall not initiate the NAS transport procedure except for sending a CIoT user data container, SMS, an LPP message, a UPP-CMI container, an SLPP message, a location services message, an SOR transparent container, a UE policy container or a UE parameters update transparent container;

until the UE receives an allowed NSSAI, a partially allowed NSSAI, or both.

During a registration procedure for mobility and periodic registration update for which the 5GS registration type IE indicates:

- a) "mobility registration updating" and the UE is in NB-N1 mode; or
- b) "periodic registration updating";

if the REGISTRATION ACCEPT message includes the 5GS registration result IE with the "NSSAA to be performed" indicator not set to "Network slice-specific authentication and authorization is to be performed" and the message does not contain an allowed NSSAI and no new allowed NSSAI, the UE shall consider the previously received allowed NSSAI as valid.

During a registration procedure for mobility and periodic registration update for which the 5GS registration type IE indicates:

- a) "mobility registration updating"; or
- b) "periodic registration updating";

if the REGISTRATION ACCEPT message includes the 5GS registration result IE with the "NSSAA to be performed" indicator set to "Network slice-specific authentication and authorization is to be performed" and the message contains a pending NSSAI, the UE shall delete any stored allowed NSSAI as specified in subclause 4.6.2.2.

If the Uplink data status IE is included in the REGISTRATION REQUEST message:

- a) if the AMF determines that the UE is in non-allowed area or is not in allowed area, and the PDU session(s) indicated by the Uplink data status IE is non-emergency PDU session(s) or the UE is not configured for high priority access in selected PLMN or SNPN, the AMF shall include the PDU session reactivation result IE in the REGISTRATION ACCEPT message indicating that user-plane resources for the corresponding PDU session(s) cannot be re-established, and shall include the PDU session reactivation result error cause IE with the 5GMM cause set to #28 "Restricted service area";
- b) otherwise, the AMF shall:
 - 1) indicate the SMF to re-establish the user-plane resources for the corresponding PDU session;
 - 2) include PDU session reactivation result IE in the REGISTRATION ACCEPT message to indicate the user-plane resources re-establishment result of the PDU sessions for which the UE requested to re-establish the user-plane resources; and

- 3) determine the UE presence in LADN service area (see subclause 6.2.6) and forward the UE presence in LADN service area towards the SMF, if the corresponding PDU session is a PDU session for LADN.

If the Uplink data status IE is not included in the REGISTRATION REQUEST message and the REGISTRATION REQUEST message is sent for the trigger d) in subclause 5.5.1.3.2, the AMF may indicate the SMF to re-establish the user-plane resources for the PDU sessions.

If the registration procedure for mobility registration update is triggered for non-3GPP access path switching from the old non-3GPP access to the new non-3GPP access and there are:

- a) one or more single access PDU sessions whose user plane resources are associated to the old non-3GPP access but whose PDU session ID(s) are not indicated in the Uplink data status IE in the REGISTRATION REQUEST message; or
- b) one or more MA PDU sessions whose PDU session ID(s) are not indicated in the Uplink data status IE in the REGISTRATION REQUEST message;

the AMF shall not release those PDU session(s) and shall release the user plane resources of the old non-3GPP access of those PDU session(s), so that the UE or the network can re-establish user-plane resources on the new non-3GPP access by triggering a service request procedure.

If a PDU session status IE is included in the REGISTRATION REQUEST message:

- a) for single access PDU sessions, the AMF shall:
 - 1) perform a local release of all those PDU sessions which are not in 5GSM state PDU SESSION INACTIVE on the AMF side associated with the access type the REGISTRATION REQUEST message is sent over, but are indicated by the UE as being in 5GSM state PDU SESSION INACTIVE. If any of those PDU sessions is associated with one or more MBS multicast sessions, the SMF shall consider the UE as removed from the associated multicast MBS sessions; and
 - 2) include a PDU session status IE in the REGISTRATION ACCEPT message to indicate which PDU sessions associated with the access type the REGISTRATION ACCEPT message is sent over are not in 5GSM state PDU SESSION INACTIVE in the AMF; and
- b) for MA PDU sessions:
 - 1) for all those PDU sessions which are not in 5GSM state PDU SESSION INACTIVE and have user plane resources being established or established on the access the REGISTRATION REQUEST message is sent over on the AMF side, but are indicated by the UE as no user plane resources are being established or established:
 - i) for PDU sessions having user plane resources being established or established only on the access the REGISTRATION REQUEST message is sent over, the AMF shall perform a local release of all those PDU sessions. If the MA PDU session is associated with one or more multicast MBS sessions, the SMF shall consider the UE as removed from the associated multicast MBS sessions; and
 - ii) for PDU sessions having user plane resources being established or established on both accesses, the AMF shall perform a local release on the user plane resources associated with the access type the REGISTRATION REQUEST message is sent over. If the REGISTRATION REQUEST message is sent over 3GPP access and the MA PDU session is associated with one or more multicast MBS sessions, the SMF shall consider the UE as removed from the associated multicast MBS sessions; and
 - 2) the AMF shall include a PDU session status IE in the REGISTRATION ACCEPT message to indicate which MA PDU sessions having the corresponding user plane resources are being established or established on the AMF side on the access the REGISTRATION ACCEPT message is sent over.

If the Allowed PDU session status IE is included in the REGISTRATION REQUEST message, the AMF shall:

- a) for a 5GSM message from each SMF that has indicated pending downlink signalling only, forward the received 5GSM message via 3GPP access to the UE after the REGISTRATION ACCEPT message is sent;
- b) for each SMF that has indicated pending downlink data only:

- 1) notify the SMF that reactivation of the user-plane resources for the corresponding PDU session(s) associated with non-3GPP access cannot be performed if the corresponding PDU session ID(s) are not indicated in the Allowed PDU session status IE; and
 - 2) notify the SMF that reactivation of the user-plane resources for the corresponding PDU session(s) associated with non-3GPP access can be performed if the corresponding PDU session ID(s) are indicated in the Allowed PDU session status IE.
- c) for each SMF that have indicated pending downlink signalling and data:
- 1) notify the SMF that reactivation of the user-plane resources for the corresponding PDU session(s) associated with non-3GPP access cannot be performed if the corresponding PDU session ID(s) are not indicated in the Allowed PDU session status IE;
 - 2) notify the SMF that reactivation of the user-plane resources for the corresponding PDU session(s) associated with non-3GPP access can be performed if the corresponding PDU session ID(s) are indicated in the Allowed PDU session status IE; and
 - 3) discard the received 5GSM message for PDU session(s) associated with non-3GPP access; and
- d) include the PDU session reactivation result IE in the REGISTRATION ACCEPT message to indicate the successfully re-established user-plane resources for the corresponding PDU sessions, if any.

If the PDU session reactivation result IE is included in the REGISTRATION ACCEPT message indicating that the user-plane resources have been successfully reactivated for a PDU session that was indicated by the UE in the Allowed PDU session status IE as allowed to be re-established over 3GPP access, the UE considers the corresponding PDU session to be associated with the 3GPP access. If the user-plane resources of a PDU session have been successfully reactivated over the 3GPP access, the AMF and SMF update the associated access type of the corresponding PDU session.

If the PDU session reactivation result IE is included in the REGISTRATION ACCEPT message indicating that the user-plane resources cannot be established for a PDU session that was indicated by the UE in the Allowed PDU session status IE as allowed to be re-established over 3GPP access, the UE considers the corresponding PDU session to be associated with the non-3GPP access.

If an EPS bearer context status IE is included in the REGISTRATION REQUEST message, the AMF handles the received EPS bearer context status IE as specified in 3GPP TS 23.502 [9].

If the EPS bearer context status information is generated for the UE during the inter-system change from S1 mode to N1 mode as specified in 3GPP TS 23.502 [9] and the AMF supports N26 interface, the AMF shall include an EPS bearer context status IE in the REGISTRATION ACCEPT message to indicate the UE which mapped EPS bearer contexts are active in the network.

If the user-plane resources cannot be established for a PDU session, the AMF shall include the PDU session reactivation result IE in the REGISTRATION ACCEPT message indicating that user-plane resources for the corresponding PDU session cannot be re-established, and:

- a) if the user-plane resources cannot be established because the SMF indicated to the AMF that the UE is located out of the LADN service area (see 3GPP TS 29.502 [20A]), the AMF shall include the PDU session reactivation result error cause IE with the 5GMM cause set to #43 "LADN not available";
- b) if the user-plane resources cannot be established because the SMF indicated to the AMF that only prioritized services are allowed (see 3GPP TS 29.502 [20A]), the AMF shall include the PDU session reactivation result error cause IE with the 5GMM cause set to #28 "restricted service area";
- c) if the user-plane resources cannot be established because the SMF indicated to the AMF that the resource is not available in the UPF (see 3GPP TS 29.502 [20A]), the AMF shall include the PDU session reactivation result error cause IE with the 5GMM cause set to #92 "insufficient user-plane resources for the PDU session";
- d) if the user-plane resources cannot be established because the SMF indicated to the AMF that the S-NSSAI associated with the PDU session is unavailable due to NSAC (see 3GPP TS 29.502 [20A]), the AMF shall include the PDU session reactivation result error cause IE with the 5GMM cause set to #69 "insufficient resources for specific slice";

- e) if the user-plane resources cannot be established because the AMF determines that the UE is outside the NS-AoS of an S-NSSAI, the AMF may include the PDU session reactivation result error cause IE with the 5GMM cause set to #69 "insufficient resources for specific slice" to indicate the cause of failure to re-establish the user-plane resources; or
- f) otherwise, the AMF may include the PDU session reactivation result error cause IE to indicate the cause of failure to re-establish the user-plane resources.

NOTE 14: It is up to UE implementation when to re-send a request for user-plane re-establishment for the associated PDU session after receiving a PDU session reactivation result error cause IE with a 5GMM cause set to #92 "insufficient user-plane resources for the PDU session".

NOTE 15: The UE can locally start a back-off timer after receiving a PDU session reactivation result error cause IE with a 5GMM cause set to #69 "insufficient resources for specific slice". The value of the back-off timer is up to UE implementation. Upon expiry of the back-off timer, the UE can re-send a request for user-plane re-establishment for the associated PDU session.

If the AMF needs to initiate PDU session status synchronization the AMF shall include a PDU session status IE in the REGISTRATION ACCEPT message to indicate the UE:

- which single access PDU sessions associated with the access the REGISTRATION ACCEPT message is sent over are not in 5GSM state PDU SESSION INACTIVE in the AMF; and
- which MA PDU sessions are not in 5GSM state PDU SESSION INACTIVE and having user plane resources established in the AMF on the access the REGISTRATION ACCEPT message is sent over.

The AMF may include the LADN information IE in the REGISTRATION ACCEPT message as described in subclause 5.5.1.2.4. The UE, upon receiving the REGISTRATION ACCEPT message with the LADN information IE, shall delete its old LADN information (if any) and store the received new LADN information.

If the UE has set the LADN-DS bit to "LADN per DNN and S-NSSAI supported" in the 5GMM capability IE of the REGISTRATION REQUEST message, the AMF may include the Extended LADN information IE in the Registration accept type 6 IE container IE in the REGISTRATION ACCEPT message as described in subclause 5.5.1.2.4. The UE, upon receiving the REGISTRATION ACCEPT message with the Registration accept type 6 IE container IE which includes the Extended LADN information IE, shall delete its old extended LADN information (if any) and store the received new extended LADN information.

NOTE 15A0: The AMF allocates the LADN service area and the TAI list associated with the S-NSSAI in the partially allowed NSSAI independently, if applicable.

If:

- the UE does not support LADN per DNN and S-NSSAI;
- the UE is subscribed to the LADN DNN for a single S-NSSAI only; and
- the AMF has the extended LADN information but no LADN information;

the AMF may decide to provide the LADN service area for that LADN DNN of the extended LADN information as the LADN information and include the LADN information in the LADN information IE of the REGISTRATION ACCEPT message.

NOTE 15A: If the LADN service area is configured per DNN and S-NSSAI, in order to serve the UEs that do not support LADN per DNN and S-NSSAI, it is recommended that the LADN DNN is only served by a single S-NSSAI.

NOTE 15B: In case of the UE is subscribed to the LADN DNN for multiple S-NSSAIs, the AMF can treat this as no extended LADN information is available.

If the UE does not support LADN per DNN and S-NSSAI and the AMF has neither the LADN information nor the extended LADN information, the AMF shall not provide any LADN information to the UE.

If the AMF does not include:

- the LADN information IE; or

- the Extended LADN information IE in the Registration accept type 6 IE container IE,

in the REGISTRATION ACCEPT message during registration procedure for mobility and periodic registration update, the UE shall delete its old LADN information or old extended LADN information respectively.

If the PDU session status IE is included in the REGISTRATION ACCEPT message:

- a) for single access PDU sessions, the UE shall perform a local release of all those PDU sessions associated with the access type the REGISTRATION ACCEPT message is sent over which are not in 5GSM state PDU SESSION INACTIVE or PDU SESSION ACTIVE PENDING on the UE side, but are indicated by the AMF as being in 5GSM state PDU SESSION INACTIVE. If a locally released PDU session is associated with one or more multicast MBS sessions, the UE shall locally leave the associated multicast MBS sessions; and
- b) for MA PDU sessions, for all those PDU sessions which are not in 5GSM state PDU SESSION INACTIVE and have the corresponding user plane resources being established or established in the UE on the access the REGISTRATION ACCEPT message is sent over, but are indicated by the AMF as no user plane resources are being established or established:
 - 1) for MA PDU sessions having the corresponding user plane resources being established or established only on the access the REGISTRATION ACCEPT message is sent over, the UE shall perform a local release of those MA PDU sessions. If a locally released MA PDU session is associated with one or more multicast MBS sessions, the UE shall locally leave the associated multicast MBS sessions; and
 - 2) for MA PDU sessions having user plane resources being established or established on both accesses, the UE shall perform a local release on the user plane resources on the access the REGISTRATION ACCEPT message is sent over. If the user plane resources over 3GPP access are released and the MA PDU session is associated with one or more multicast MBS sessions, the UE shall locally leave the associated multicast MBS sessions.

If:

- a) the UE included a PDU session status IE in the REGISTRATION REQUEST message;
- b) the UE is operating in the single-registration mode;
- c) the UE is performing inter-system change from S1 mode to N1 mode in 5GMM-IDLE mode; and
- d) the UE has received the IWK N26 bit set to "interworking without N26 interface supported";

the UE shall ignore the PDU session status IE if received in the REGISTRATION ACCEPT message.

If the EPS bearer context status IE is included in the REGISTRATION ACCEPT message, the UE shall locally delete all those QoS flow descriptions and all associated QoS rules, if any, which are associated with inactive EPS bearer contexts as indicated by the AMF in the EPS bearer context status IE.

If the UE included S1 mode supported indication in the REGISTRATION REQUEST message, the AMF supporting interworking with EPS shall set the IWK N26 bit to either:

- a) "interworking without N26 interface not supported" if the AMF supports N26 interface; or
- b) "interworking without N26 interface supported" if the AMF does not support N26 interface

in the 5GS network feature support IE in the REGISTRATION ACCEPT message.

The UE supporting S1 mode shall operate in the mode for inter-system interworking with EPS as follows:

- a) if the IWK N26 bit in the 5GS network feature support IE is set to "interworking without N26 interface not supported", the UE shall operate in single-registration mode;
- b) if the IWK N26 bit in the 5GS network feature support IE is set to "interworking without N26 interface supported" and the UE supports dual-registration mode, the UE may operate in dual-registration mode; or

NOTE 16: The registration mode used by the UE is implementation dependent.

- c) if the IWK N26 bit in the 5GS network feature support IE is set to "interworking without N26 interface supported" and the UE only supports single-registration mode, the UE shall operate in single-registration mode.

The UE shall store the received interworking without N26 interface indicator for inter-system change with EPS as specified in annex C.1 and treat it as valid in the entire PLMN and its equivalent PLMN(s).

The network informs the UE about the support of specific features, such as IMS voice over PS session, location services (5G-LCS), emergency services, emergency services fallback, ATSSS and non-3GPP access path switching, in the 5GS network feature support information element. In a UE with IMS voice over PS session capability, the IMS voice over PS session indicator, Emergency services support indicator and Emergency services fallback indicator shall be provided to the upper layers. The upper layers take the IMS voice over PS session indicator into account when selecting the access domain for voice sessions or calls. When initiating an emergency call, the upper layers take the IMS voice over PS session indicator, Emergency services support indicator and Emergency services fallback indicator into account for the access domain selection. When the UE determines via the IMS voice over PS session indicator that the network does not support IMS voice over PS sessions in N1 mode, then the UE shall not perform a local release of any persistent PDU session if the AMF does not indicate that the PDU session is in 5GSM state PDU SESSION INACTIVE via the PDU session status IE. When the UE determines via the Emergency services support indicator that the network does not support emergency services in N1 mode, then the UE shall not perform a local release of any emergency PDU session if user-plane resources associated with that emergency PDU session are established if the AMF does not indicate that the PDU session is in 5GSM state PDU SESSION INACTIVE via the PDU session status IE. In a UE with LCS capability, location services indicators (5G-LCS) shall be provided to the upper layers. In a UE with the capability for ATSSS, the network support for ATSSS shall be provided to the upper layers. If the UE receives the 5GS network feature support IE with the ATSSS support indicator set to "ATSSS not supported", the UE shall perform a local release of the MA PDU session, if any. If a locally released MA PDU session is associated with one or more multicast MBS sessions, the UE shall locally leave the associated multicast MBS sessions. In a UE that supports non-3GPP access path switching, the network support for non-3GPP access path switching shall be provided to the upper layers. If the UE receives the 5GS network feature support IE with the non-3GPP access path switching bit set to "non-3GPP access path switching not supported", the UE shall not perform the registration procedure for mobility registration update for non-3GPP access path switching.

NOTE 16A: If the UE is registered to different PLMNs over 3GPP and non-3GPP accesses, the UE uses the capability received over non-3GPP access to determine whether to initiate the registration procedure for mobility registration update for non-3GPP path switching.

The AMF shall set the EMF bit in the 5GS network feature support IE to:

- a) "Emergency services fallback supported in NR connected to 5GCN and E-UTRA connected to 5GCN" if the network supports the emergency services fallback procedure when the UE is in an NR cell connected to 5GCN or an E-UTRA cell connected to 5GCN;
- b) "Emergency services fallback supported in NR connected to 5GCN only" if the network supports the emergency services fallback procedure when the UE is in an NR cell connected to 5GCN and does not support the emergency services fallback procedure when the UE is in an E-UTRA cell connected to 5GCN;
- c) "Emergency services fallback supported in E-UTRA connected to 5GCN only" if the network supports the emergency services fallback procedure when the UE is in an E-UTRA cell connected to 5GCN and does not support the emergency services fallback procedure when the UE is in an NR cell connected to 5GCN; or
- d) "Emergency services fallback not supported" if network does not support the emergency services fallback procedure when the UE is in any cell connected to 5GCN.

NOTE 17: If the emergency services are supported in neither the EPS nor the 5GS homogeneously, based on operator policy, the AMF will set the EMF bit in the 5GS network feature support IE to "Emergency services fallback not supported".

NOTE 18: Even though the AMF's support of emergency services fallback is indicated per RAT, the UE's support of emergency services fallback is not per RAT, i.e. the UE's support of emergency services fallback is the same for both NR connected to 5GCN and E-UTRA connected to 5GCN.

If the UE indicates support for restriction on use of enhanced coverage in the REGISTRATION REQUEST message and:

- a) in WB-N1 mode, the AMF decides to restrict the use of CE mode B for the UE, then the AMF shall set the RestrictEC bit to "CE mode B is restricted";
- b) in WB-N1 mode, the AMF decides to restrict the use of both CE mode A and CE mode B for the UE, then the AMF shall set the RestrictEC bit to "Both CE mode A and CE mode B are restricted"; or

- c) in NB-N1 mode, the AMF decides to restrict the use of enhanced coverage for the UE, then the AMF shall set the RestrictEC bit to "Use of enhanced coverage is restricted",

in the 5GS network feature support IE in the REGISTRATION ACCEPT message.

Access identity 1 is only applicable while the UE is in N1 mode. Access identity 2 is only applicable while the UE is in N1 mode.

When the UE is registered to the same PLMN or SNPN over 3GPP and non-3GPP access, the UE and the AMF maintain one MPS indicator and one MCS indicator that are common to both 3GPP and non-3GPP access. When the UE is registered to different PLMNs or SNPNS over 3GPP access and non-3GPP access, the UE maintains two MPS indicators and two MCS indicators separately for different accesses i.e., an MPS indicator and an MCS indicator for the 3GPP access and another MPS indicator and an MCS indicator for the non-3GPP access. For both 3GPP and non-3GPP access, the access identity is determined according to subclause 4.5.2:

- if the UE is not operating in SNPN access operation mode:

- a) the network informs the UE that the use of access identity 1 is valid in the RPLMN or equivalent PLMN by setting the MPS indicator bit of the 5GS network feature support IE to "Access identity 1 valid", in the REGISTRATION ACCEPT message. Based on operator policy, the AMF sets the MPS indicator bit in the REGISTRATION ACCEPT message based on the MPS priority information in the user's subscription context obtained from the UDM;
- b) upon receiving a REGISTRATION ACCEPT message with the MPS indicator bit set to "Access identity 1 valid":

- via 3GPP access; or
- via non-3GPP access if the UE is registered to the same PLMN over 3GPP access and non-3GPP access;

the UE shall act as a UE with access identity 1 configured for MPS, as described in subclause 4.5.2, in all NG-RAN of the registered PLMN and its equivalent PLMNs. The MPS indicator bit in the 5GS network feature support IE provided in the REGISTRATION ACCEPT message is valid in all NG-RAN of the registered PLMN and its equivalent PLMNs until the UE receives a REGISTRATION ACCEPT message or a CONFIGURATION UPDATE COMMAND message with the MPS indicator bit set to "Access identity 1 not valid":

- via 3GPP access; or
- via non-3GPP access if the UE is registered to the same PLMN over 3GPP access and non-3GPP access;
or

until the UE selects a non-equivalent PLMN over 3GPP access;

- b1) upon receiving a REGISTRATION ACCEPT message with the MPS indicator bit set to "Access identity 1 valid":

- via non-3GPP access; or
- via 3GPP access if the UE is registered to the same PLMN over 3GPP access and non-3GPP access;

the UE shall act as a UE with access identity 1 configured for MPS, as described in subclause 4.5.2, in non-3GPP access of the registered PLMN and its equivalent PLMNs. The MPS indicator bit in the 5GS network feature support IE provided in the REGISTRATION ACCEPT message is valid in non-3GPP access of the registered PLMN and its equivalent PLMNs until the UE receives a REGISTRATION ACCEPT message or a CONFIGURATION UPDATE COMMAND message with the MPS indicator bit set to "Access identity 1 not valid":

- via non-3GPP access; or
- via 3GPP access if the UE is registered to the same PLMN over 3GPP access and non-3GPP access; or

until the UE selects a non-equivalent PLMN over non-3GPP access;

- c) during ongoing active PDU sessions that were set up relying on the MPS indicator bit being set to "Access identity 1 valid", if the network indicates in a registration update that the MPS indicator bit is reset to

"Access identity 1 not valid", then the UE shall no longer act as a UE with access identity 1 configured for MPS as described in subclause 4.5.2 unless the USIM contains a valid configuration for access identity 1 in RPLMN or equivalent PLMN. In the UE, the ongoing active PDU sessions are not affected by the change of the MPS indicator bit;

- d) the network informs the UE that the use of access identity 2 is valid in the RPLMN or equivalent PLMN by setting the MCS indicator bit of the 5GS network feature support IE to "Access identity 2 valid", in the REGISTRATION ACCEPT message. Based on operator policy, the AMF sets the MCS indicator bit in the REGISTRATION ACCEPT message based on the MCS priority information in the user's subscription context obtained from the UDM;

- e) upon receiving a REGISTRATION ACCEPT message with the MCS indicator bit set to "Access identity 2 valid":

- via 3GPP access; or
- via non-3GPP access if the UE is registered to the same PLMN over 3GPP access and non-3GPP access;

the UE shall act as a UE with access identity 2 configured for MCS, as described in subclause 4.5.2, in all NG-RAN of the registered PLMN and its equivalent PLMNs. The MCS indicator bit in the 5GS network feature support IE provided in the REGISTRATION ACCEPT message is valid in all NG-RAN of the registered PLMN and its equivalent PLMNs until the UE receives a REGISTRATION ACCEPT message or a CONFIGURATION UPDATE COMMAND message with the MCS indicator bit set to "Access identity 2 not valid":

- via 3GPP access; or
- via non-3GPP access if the UE is registered to the same PLMN over 3GPP access and non-3GPP access; or

until the UE selects a non-equivalent PLMN over 3GPP access;

- e1) upon receiving a REGISTRATION ACCEPT message with the MCS indicator bit set to "Access identity 2 valid":

- via non-3GPP access; or
- via 3GPP access if the UE is registered to the same PLMN over 3GPP access and non-3GPP access;

the UE shall act as a UE with access identity 2 configured for MCS, as described in subclause 4.5.2, in non-3GPP access of the registered PLMN and its equivalent PLMNs. The MCS indicator bit in the 5GS network feature support IE provided in the REGISTRATION ACCEPT message is valid in non-3GPP access of the registered PLMN and its equivalent PLMNs until the UE receives a REGISTRATION ACCEPT message or a CONFIGURATION UPDATE COMMAND message with the MCS indicator bit set to "Access identity 2 not valid":

- via non-3GPP access; or
- via 3GPP access if the UE is registered to the same PLMN over 3GPP access and non-3GPP access; or

until the UE selects a non-equivalent PLMN over non-3GPP access; and

- f) during ongoing active PDU sessions that were set up relying on the MCS indicator bit being set to "Access identity 2 valid", if the network indicates in a registration update that the MCS indicator bit is reset to "Access identity 2 not valid", then the UE shall no longer act as a UE with access identity 2 configured for MCS as described in subclause 4.5.2 unless the USIM contains a valid configuration for access identity 2 in RPLMN or equivalent PLMN. In the UE, the ongoing active PDU sessions are not affected by the change of the MCS indicator bit; or

- if the UE is operating in SNPN access operation mode:

- a) the network informs the UE that the use of access identity 1 is valid in the RSNPN or equivalent SNPN by setting the MPS indicator bit of the 5GS network feature support IE to "Access identity 1 valid", in the REGISTRATION ACCEPT message. Based on operator policy, the AMF sets the MPS indicator bit in the REGISTRATION ACCEPT message based on the MPS priority information in the user's subscription context obtained from the UDM;

- b) upon receiving a REGISTRATION ACCEPT message with the MPS indicator bit set to "Access identity 1 valid":
- via 3GPP access; or
 - via non-3GPP access if the UE is registered to the same SNPN over 3GPP access and non-3GPP access;
- the UE shall act as a UE with access identity 1 configured for MPS, as described in subclause 4.5.2A, in all NG-RAN of the registered SNPN and its equivalent SNPNs. The MPS indicator bit in the 5GS network feature support IE provided in the REGISTRATION ACCEPT message is valid in all NG-RAN of the registered SNPN and its equivalent SNPNs until the UE receives a REGISTRATION ACCEPT message or a CONFIGURATION UPDATE COMMAND message with the MPS indicator bit set to "Access identity 1 not valid":
- via 3GPP access; or
 - via non-3GPP access if the UE is registered to the same SNPN over 3GPP access and non-3GPP access; or
- until the UE selects a non-equivalent SNPN over 3GPP access;
- b1) upon receiving a REGISTRATION ACCEPT message with the MPS indicator bit set to "Access identity 1 valid":
- via non-3GPP access; or
 - via 3GPP access if the UE is registered to the same SNPN over 3GPP access and non-3GPP access;
- the UE shall act as a UE with access identity 1 configured for MPS, as described in subclause 4.5.2A, in non-3GPP access of the registered SNPN and its equivalent SNPNs. The MPS indicator bit in the 5GS network feature support IE provided in the REGISTRATION ACCEPT message is valid in non-3GPP access of the registered SNPN and its equivalent SNPNs until the UE receives a REGISTRATION ACCEPT message or a CONFIGURATION UPDATE COMMAND message with the MPS indicator bit set to "Access identity 1 not valid":
- via non-3GPP access; or
 - via 3GPP access if the UE is registered to the same SNPN over 3GPP access and non-3GPP access; or
- until the UE selects a non-equivalent SNPN over non-3GPP access;
- c) during ongoing active PDU sessions that were set up relying on the MPS indicator bit being set to "Access identity 1 valid", if the network indicates in a registration update that the MPS indicator bit is reset to "Access identity 1 not valid", then the UE shall no longer act as a UE with access identity 1 configured for MPS as described in subclause 4.5.2A unless the unified access control configuration in the "list of subscriber data" stored in the ME (see 3GPP TS 23.122 [5]) indicates the UE is configured for access identity 1 in the RSNPN or equivalent SNPN. In the UE, the ongoing active PDU sessions are not affected by the change of the MPS indicator bit;
- d) the network informs the UE that the use of access identity 2 is valid in the RSNPN or equivalent SNPN by setting the MCS indicator bit of the 5GS network feature support IE to "Access identity 2 valid", in the REGISTRATION ACCEPT message. Based on operator policy, the AMF sets the MCS indicator bit in the REGISTRATION ACCEPT message based on the MCS priority information in the user's subscription context obtained from the UDM;
- e) upon receiving a REGISTRATION ACCEPT message with the MCS indicator bit set to "Access identity 2 valid":
- via 3GPP access; or
 - via non-3GPP access if the UE is registered to the same SNPN over 3GPP access and non-3GPP access;
- the UE shall act as a UE with access identity 2 configured for MCS, as described in subclause 4.5.2A, in all NG-RAN of the registered SNPN and its equivalent SNPNs. The MCS indicator bit in the 5GS network feature support IE provided in the REGISTRATION ACCEPT message is valid in all NG-RAN of the registered SNPN and its equivalent SNPNs until the UE receives a REGISTRATION ACCEPT message or a

CONFIGURATION UPDATE COMMAND message with the MCS indicator bit set to "Access identity 2 not valid":

- via 3GPP access; or
- via non-3GPP access if the UE is registered to the same SNPN over 3GPP access and non-3GPP access; or

until the UE selects a non-equivalent SNPN;

e1) upon receiving a REGISTRATION ACCEPT message with the MCS indicator bit set to "Access identity 2 valid":

- via non-3GPP access; or
- via 3GPP access if the UE is registered to the same SNPN over 3GPP access and non-3GPP access;

the UE shall act as a UE with access identity 2 configured for MCS, as described in subclause 4.5.2A, in non-3GPP access of the registered SNPN and its equivalent SNPNs. The MCS indicator bit in the 5GS network feature support IE provided in the REGISTRATION ACCEPT message is valid in non-3GPP access of the registered SNPN and its equivalent SNPNs until the UE receives a REGISTRATION ACCEPT message or a CONFIGURATION UPDATE COMMAND message with the MCS indicator bit set to "Access identity 2 not valid":

- via non-3GPP access; or
- via 3GPP access if the UE is registered to the same SNPN over 3GPP access and non-3GPP access; or

until the UE selects a non-equivalent SNPN over non-3GPP access; and

f) during ongoing active PDU sessions that were set up relying on the MCS indicator bit being set to "Access identity 2 valid", if the network indicates in a registration update that the MCS indicator bit is reset to "Access identity 2 not valid", then the UE shall no longer act as a UE with access identity 2 configured for MCS as described in subclause 4.5.2A unless the unified access control configuration in the "list of subscriber data" stored in the ME (see 3GPP TS 23.122 [5]) indicates the UE is configured for access identity 2 in the RSNPN or equivalent SNPN. In the UE, the ongoing active PDU sessions are not affected by the change of the MCS indicator bit.

If the UE has set the Follow-on request indicator to "Follow-on request pending" in the REGISTRATION REQUEST message, or the network has downlink signalling pending, the AMF shall not immediately release the NAS signalling connection after the completion of the registration procedure.

If the UE is authorized to use V2X communication over PC5 reference point based on:

- a) at least one of the following bits in the 5GMM capability IE of the REGISTRATION REQUEST message set by the UE, or already stored in the 5GMM context in the AMF during the previous registration procedure as follows:
 - 1) the V2XCEPC5 bit to "V2X communication over E-UTRA-PC5 supported"; or
 - 2) the V2XCNPC5 bit to "V2X communication over NR-PC5 supported"; and
- b) the user's subscription context obtained from the UDM as defined in 3GPP TS 23.287 [6C];

the AMF should not immediately release the NAS signalling connection after the completion of the registration procedure.

If the UE is authorized to use A2X communication over PC5 reference point based on:

- a) at least one of the following bits in the 5GMM capability IE of the REGISTRATION REQUEST message set by the UE, or already stored in the 5GMM context in the AMF during the previous registration procedure as follows:
 - 1) the A2XEPC5 bit to "A2X over E-UTRA-PC5 supported"; or
 - 2) the A2XNPC5 bit to "A2X over NR-PC5 supported"; and

- b) the user's subscription context obtained from the UDM as defined in 3GPP TS 23.256 [6C];

the AMF should not immediately release the NAS signalling connection after the completion of the registration procedure.

If the UE is authorized to use 5G ProSe services based on:

- a) at least one of the following bits in the 5GMM capability IE of the REGISTRATION REQUEST message set by the UE, or already stored in the 5GMM context in the AMF during the previous registration procedure as follows:
- 1) the 5G ProSe direct discovery bit to "5G ProSe direct discovery supported"; or
 - 2) the 5G ProSe direct communication bit to "5G ProSe direct communication supported"; and
- b) the user's subscription context obtained from the UDM as defined in 3GPP TS 23.304 [6E];

the AMF should not immediately release the NAS signalling connection after the completion of the registration procedure.

If the UE indicates support of ranging and sidelink positioning in the REGISTRATION REQUEST message and the network supports and accepts the use of ranging and sidelink positioning, the AMF shall set the ranging and sidelink positioning support bit to "Ranging and sidelink positioning supported" in the 5GS network feature support IE of the REGISTRATION ACCEPT message.

If the UE has included the Non-3GPP path switching information IE in the REGISTRATION REQUEST message with the NSONR bit set to "non-3GPP path switching while using old non-3GPP resources requested" and the AMF supports non-3GPP path switching while using old non-3GPP resources, the AMF shall not release the user plane resources of the old non-3GPP access of the PDU sessions supporting non-3GPP access path switching and whose PDU session IDs are included in the Uplink data status IE of the REGISTRATION REQUEST message until the user plane resources of the new non-3GPP access are established. Otherwise, the AMF shall release the user plane resources of the old non-3GPP access before proceeding with the registration procedure.

If the UE has triggered the registration procedure for mobility registration update for non-3GPP access path switching from the old non-3GPP access to the new non-3GPP access and the UE receives the REGISTRATION ACCEPT message over the new non-3GPP access, the UE shall consider itself as de-registered for 5GS services over the old non-3GPP access.

If the Requested DRX parameters IE was included in the REGISTRATION REQUEST message, the AMF shall include the Negotiated DRX parameters IE in the REGISTRATION ACCEPT message and replace any stored Negotiated DRX parameter and use it for the downlink transfer of signalling and user data. The AMF may set the Negotiated DRX parameters IE based on the received Requested DRX parameters IE and operator policy if available.

If the Requested NB-N1 mode DRX parameters IE was included in the REGISTRATION REQUEST message and replace any stored Negotiated NB-N1 mode DRX parameters and use it for the downlink transfer of signalling and user data in NB-N1 mode, the AMF shall include the Negotiated NB-N1 mode DRX parameters IE in the REGISTRATION ACCEPT message. The AMF may set the Negotiated NB-N1 mode DRX parameters IE based on the received Requested NB-N1 mode DRX parameters IE and operator policy if available.

The AMF shall include the Negotiated extended DRX parameters IE in the REGISTRATION ACCEPT message only if the Requested extended DRX parameters IE was included in the REGISTRATION REQUEST message, and the AMF supports and accepts the use of eDRX. The AMF may set the Negotiated extended DRX parameters IE based on the received Requested extended DRX parameters IE, operator policy, information from NG-RAN and the user's subscription context obtained from the UDM if available.

If the network cannot derive the UE's identity from the 5G-GUTI because of e.g. no matching identity/context in the network, failure to validate the UE's identity due to integrity check failure of the received message, the AMF may operate as described in subclause 5.5.1.2.4 and include a PDU session status IE indicating all PDU sessions are in 5GSM state PDU SESSION INACTIVE in the AMF. If the UE included in the REGISTRATION REQUEST message the UE status IE with the EMM registration status set to "UE is in EMM-REGISTERED state" and the AMF does not support N26 interface, the AMF shall operate as described in subclause 5.5.1.2.4.

If the UE has indicated support for service gap control in the REGISTRATION REQUEST message, a service gap time value is available in the 5GMM context, the AMF may include the T3447 value IE set to the service gap time value in the REGISTRATION ACCEPT message.

If the UE requests ciphering keys for ciphered broadcast assistance data in the REGISTRATION REQUEST message and the AMF has valid ciphering key data applicable to the UE's subscription and current tracking area, then the AMF shall include the ciphering key data in the Ciphering key data IE of the REGISTRATION ACCEPT message.

If the UE supports WUS assistance information and the AMF supports and accepts the use of WUS assistance information for the UE, then the AMF shall determine the negotiated UE paging probability information for the UE, store it in the 5GMM context of the UE, and if the UE does not have an active emergency PDU session, the AMF shall include it in the Negotiated WUS assistance information IE in the REGISTRATION ACCEPT message. The AMF may consider the UE paging probability information received in the Requested WUS assistance information IE when determining the negotiated UE paging probability information for the UE.

NOTE 19: Besides the UE paging probability information requested by the UE, the AMF can take local configuration or previous statistical information for the UE into account when determining the negotiated UE paging probability information for the UE.

If the UE sets the NR-PSSI bit to "NR paging subgrouping supported" in the 5GMM capability IE in the REGISTRATION REQUEST message and the AMF supports and accepts the use of PEIPS assistance information for the UE, then the AMF shall determine the Paging subgroup ID for the UE, store it in the 5GMM context of the UE, and include it in the Negotiated PEIPS assistance information IE in the REGISTRATION ACCEPT message or in the Updated PEIPS assistance information IE in the CONFIGURATION UPDATE COMMAND message as part of the registration procedure. The AMF may consider the UE paging probability information received in the Requested PEIPS assistance information IE when determining the Paging subgroup ID for the UE.

NOTE 20: Besides the UE paging probability information when provided by the UE, the AMF can also take local configuration, whether the UE is likely to receive IMS voice over PS session calls, UE mobility pattern or previous statistical information for the UE or information provided by the NG-RAN into account when determining the Paging subgroup ID for the UE.

If the UE sets the UN-PER bit to "unavailability period supported" in the 5GMM capability IE in the REGISTRATION REQUEST message and the AMF supports and accepts the use of unavailability period for the UE, then the AMF shall set the UN-PER bit to "unavailability period supported" in the 5GS network feature support IE in the REGISTRATION ACCEPT message.

If the UE sets the Unavailability type to "unavailability due to UE reasons" in the Unavailability information IE in the REGISTRATION REQUEST message, then the AMF shall:

a1) determine the Unavailability period duration value as:

- A value that was provided by the UE; or
- A value that was determined by the AMF; and

a2) determine the Start of the unavailability period value as:

- A value that was provided by the UE; or
- A value that was determined by the AMF; and

the AMF shall store the Start of unavailability period value and the Unavailability period duration. When the time of the Start of unavailability period arrives, the AMF shall consider the UE as unreachable until the UE registers for normal service;

b) store the received unavailability period duration, if any and the received start of unavailability period, if any;

c) the AMF shall determine whether the UE is required to perform the registration procedure when the unavailability period has ended and set the EURP bit to "UE needs to report end of unavailability period" or "UE does not need to report end of unavailability period" in the Unavailability configuration IE in the REGISTRATION ACCEPT message; and

d) release the signalling connection immediately after the completion of the registration procedure.

If the UE sets the Unavailability type to "unavailability due to discontinuous coverage" in the Unavailability information IE and the UE provides the Unavailability information IE in the REGISTRATION REQUEST message then:

- a) if the AMF is able to determine an unavailability period duration for the UE based on satellite coverage availability information (see 3GPP TS 23.401 [7]) and the value of the Unavailability information IE in the REGISTRATION REQUEST message if available, the AMF shall store the determined unavailability period duration and provide the expected unavailability period duration to the UE by including the Unavailability period duration in the Unavailability configuration IE in the REGISTRATION ACCEPT message. If the AMF is able to determine the start of the unavailability period based on satellite coverage availability information and the value of the Unavailability information IE in the REGISTRATION REQUEST message if available, the AMF shall store the determined start of the unavailability period and provide the expected start of the unavailability period to the UE by including the start of the unavailability period in the Unavailability configuration IE in the REGISTRATION ACCEPT message; and
- b1) the AMF shall determine the unavailability period duration value as:
- A value that was provided by the UE; or
 - A value that was determined by the AMF based on satellite coverage availability information; and
- b2) the AMF shall determine the start of the unavailability period value as:
- A value that was provided by the UE; or
 - A value that was determined by the AMF based on satellite coverage availability information; and
- the AMF shall store the unavailability period duration and the start of unavailability period value. When the unavailability period starts, the AMF shall consider the UE as unreachable until the UE registers for normal service again;
- c) the AMF shall determine whether the UE is required to perform the registration procedure in NG-RAN satellite access when the unavailability period has ended and set the EURP bit to "UE needs to report end of unavailability period" or "UE does not need to report end of unavailability period" in the Unavailability configuration IE in the REGISTRATION ACCEPT message.

The AMF may determine the periodic registration update timer value based on the stored value of the received unavailability period duration if any, the received Start of unavailability period if any, the network determined unavailability period duration if any and the network determined Start of unavailability period if any. If the UE does not provide the Unavailability information IE in the REGISTRATION REQUEST message, the AMF shall delete any stored value of the Unavailability information IE if exists.

If the 5GS registration type IE in the REGISTRATION REQUEST message indicates "periodic registration updating" the AMF shall not include the Unavailability configuration IE in the REGISTRATION ACCEPT message.

If the UE receives the Unavailability configuration IE with a value of the unavailability period duration in the REGISTRATION ACCEPT message, then the UE may either:

- a) delete a UE determined value and start using the received value; or
- b) use a UE determined value.

If the UE receives the Unavailability configuration IE with a value of the start of the unavailability period in the REGISTRATION ACCEPT message, then the UE may either:

- a) delete a UE determined value and start using the received value; or
- b) use a UE determined value.

NOTE 20a: The UE can consider the received value from the network when determining the value for unavailability period duration and the start of the unavailability period.

If due to regional subscription restrictions or access restrictions the UE is not allowed to access the TA or due to CAG restrictions the UE is not allowed to access the cell, but the UE has an emergency PDU session established, the AMF may accept the REGISTRATION REQUEST message and indicate to the SMF to perform a local release of all non-emergency PDU sessions (associated with 3GPP access if it is due to CAG restrictions) and informs the UE via the PDU session status IE in the REGISTRATION ACCEPT message. The AMF shall not indicate to the SMF to release the emergency PDU session. If the AMF indicated to the SMF to perform a local release of all non-emergency PDU sessions (associated with 3GPP access if it is due to CAG restrictions), the network shall behave as if the UE is

registered for emergency services and shall set the emergency registered bit of the 5GS registration result IE to "Registered for emergency services" in the REGISTRATION ACCEPT message.

If the REGISTRATION ACCEPT message includes the PDU session reactivation result error cause IE with the 5GMM cause set to #28 "Restricted service area", the UE shall enter the state 5GMM-REGISTERED.NON-ALLOWED-SERVICE and behave as specified in subclause 5.3.5.

If the REGISTRATION ACCEPT message includes the SOR transparent container IE and:

- a) the SOR transparent container IE does not successfully pass the integrity check (see 3GPP TS 33.501 [24]); and
- b) if the UE attempts obtaining service on another PLMNs or SNPNs as specified in 3GPP TS 23.122 [5] annex C;

then the UE shall release locally the established NAS signalling connection after sending a REGISTRATION COMPLETE message.

If the REGISTRATION ACCEPT message includes the SOR transparent container IE and the SOR transparent container IE successfully passes the integrity check (see 3GPP TS 33.501 [24]), the ME shall store the received SOR counter as specified in annex C and proceed as follows:

- a) the UE shall proceed with the behaviour as specified in 3GPP TS 23.122 [5] annex C; and
- b) if the registration procedure is performed over 3GPP access and the UE attempts obtaining service on another PLMNs or SNPNs as specified in 3GPP TS 23.122 [5] annex C then the UE may release locally the established NAS signalling connection after sending a REGISTRATION COMPLETE message. Otherwise the UE shall send a REGISTRATION COMPLETE message and not release the current N1 NAS signalling connection locally. If an acknowledgement is requested in the SOR transparent container IE of the REGISTRATION ACCEPT message, the UE acknowledgement is included in the SOR transparent container IE of the REGISTRATION COMPLETE message. In the SOR transparent container IE carrying the acknowledgement, the UE shall set the ME support of SOR-CMCI indicator to "SOR-CMCI supported by the ME". Additionally, if the UE supports access to an SNPN using credentials from a credentials holder and the UE is not operating in SNPN access operation mode, the UE may set the ME support of SOR-SNPN-SI indicator to "SOR-SNPN-SI supported by the ME". Additionally, if the UE supports access to an SNPN providing access for localized services in SNPN, the UE shall set the ME support of SOR-SNPN-SI-LS indicator to "SOR-SNPN-SI-LS supported by the ME".

If the SOR transparent container IE successfully passes the integrity check (see 3GPP TS 33.501 [24]), and:

- a) the SOR transparent container IE indicates a list of preferred PLMN/access technology combinations is provided and the list type indicates "PLMN ID and access technology list", then the ME shall replace the highest priority entries in the "Operator Controlled PLMN Selector with Access Technology" list stored in the ME and shall proceed with the behaviour as specified in 3GPP TS 23.122 [5] annex C.

If the SOR-CMCI is present and the Store SOR-CMCI in ME indicator is set to "Store SOR-CMCI in ME" then the UE shall store or delete the SOR-CMCI in the non-volatile memory of the ME as described in annex C.1;

- b) the list type indicates "secured packet", then the ME shall behave as if a SMS is received with protocol identifier set to SIM data download, data coding scheme set to class 2 message and SMS payload as secured packet contents of SOR transparent container IE. The SMS payload is forwarded to UICC as specified in 3GPP TS 23.040 [4A]; or
- c) the SOR transparent container IE indicates "HPLMN indication that 'no change of the "Operator Controlled PLMN Selector with Access Technology" list stored in the UE is needed and thus no list of preferred PLMN/access technology combinations is provided"', the UE operates in SNPN access operation mode and the SOR transparent container IE includes SOR-SNPN-SI, the ME shall replace SOR-SNPN-SI of the selected entry of the "list of subscriber data" or associated with the selected PLMN subscription, as specified in 3GPP TS 23.122 [5] with the received SOR-SNPN-SI. Additionally, if the SOR transparent container IE includes SOR-SNPN-SI-LS, the ME shall replace SOR-SNPN-SI-LS of the selected entry of the "list of subscriber data" or associated with the selected PLMN subscription, as specified in 3GPP TS 23.122 [5] with the received SOR-SNPN-SI-LS.

If the SOR-CMCI is present and the Store SOR-CMCI in ME indicator is set to "Store SOR-CMCI in ME" then the UE shall store or delete the SOR-CMCI in the non-volatile memory of the ME as described in annex C.1;

and the UE shall proceed with the behaviour as specified in 3GPP TS 23.122 [5] annex C.

If the SOR transparent container IE does not pass the integrity check successfully, then the UE shall discard the content of the SOR transparent container IE.

If required by operator policy, the AMF shall include the NSSAI inclusion mode IE in the REGISTRATION ACCEPT message (see table 4.6.2.3.1 of subclause 4.6.2.3). Upon receipt of the REGISTRATION ACCEPT message:

- a) if the message includes the NSSAI inclusion mode IE, the UE shall operate in the NSSAI inclusion mode indicated in the NSSAI inclusion mode IE over the current access within the current PLMN and its equivalent PLMN(s), if any, or the current SNPN, in the current registration area; or
- b) otherwise:
 - 1) if the UE has NSSAI inclusion mode for the current PLMN or SNPN and access type stored in the UE, the UE shall operate in the stored NSSAI inclusion mode;
 - 2) if the UE does not have NSSAI inclusion mode for the current PLMN or SNPN and the access type stored in the UE and if the UE is performing the registration procedure over:
 - i) 3GPP access, the UE shall operate in NSSAI inclusion mode D in the current PLMN or SNPN and the current access type;
 - ii) untrusted non-3GPP access, the UE shall operate in NSSAI inclusion mode C in the current PLMN and the current access type; or
 - iii) trusted non-3GPP access, the UE shall operate in NSSAI inclusion mode D in the current PLMN and the current access type; or
 - 3) if the 5G-RG does not have NSSAI inclusion mode for the current PLMN and wireline access stored in the 5G-RG, and the 5G-RG is performing the registration procedure over wireline access, the 5G-RG shall operate in NSSAI inclusion mode B in the current PLMN and the current access type.

The AMF may include operator-defined access category definitions in the REGISTRATION ACCEPT message.

If there is a running T3447 timer in the AMF and the Uplink data status IE is included or the Follow-on request indicator is set to "Follow-on request pending" in the REGISTRATION REQUEST message, the AMF shall ignore the Uplink data status IE or that the Follow-on request indicator is set to "Follow-on request pending" and proceed as if the Uplink data status IE was not received or the Follow-on request indicator was not set to "Follow-on request pending" except for the following case:

- the PDU session indicated by the Uplink data status IE is emergency PDU session;
- the UE is configured for high priority access in selected PLMN;
- the REGISTRATION REQUEST message is as a paging response; or
- the UE is establishing an emergency PDU session or performing emergency services fallback.

If the UE receives Operator-defined access category definitions IE in the REGISTRATION ACCEPT message and the Operator-defined access category definitions IE contains one or more operator-defined access category definitions, the UE shall delete any operator-defined access category definitions stored for the RPLMN and shall store the received operator-defined access category definitions for the RPLMN. If the UE receives the Operator-defined access category definitions IE in the REGISTRATION ACCEPT message and the Operator-defined access category definitions IE contains no operator-defined access category definitions, the UE shall delete any operator-defined access category definitions stored for the RPLMN. If the REGISTRATION ACCEPT message does not contain the Operator-defined access category definitions IE, the UE shall not delete the operator-defined access category definitions stored for the RPLMN.

If the UE has indicated support for service gap control in the REGISTRATION REQUEST message and:

- the REGISTRATION ACCEPT message contains the T3447 value IE, then the UE shall store the new T3447 value, erase any previous stored T3447 value if exists and use the new T3447 value with the timer T3447 next time it is started; or
- the REGISTRATION ACCEPT message does not contain the T3447 value IE, then the UE shall erase any previous stored T3447 value if exists and stop the timer T3447 if running.

If the REGISTRATION ACCEPT message contains the Truncated 5G-S-TMSI configuration IE, then the UE shall store the included truncated 5G-S-TMSI configuration and return a REGISTRATION COMPLETE message to the AMF to acknowledge reception of the truncated 5G-S-TMSI configuration.

NOTE 21: The UE provides the truncated 5G-S-TMSI configuration to the lower layers.

If the UE is not in NB-N1 mode, the UE has set the RACS bit to "RACS supported" in the 5GMM Capability IE of the REGISTRATION REQUEST message, and the REGISTRATION ACCEPT message includes:

- a) a UE radio capability ID deletion indication IE set to "Network-assigned UE radio capability IDs deletion requested", the UE shall delete any network-assigned UE radio capability IDs associated with the RPLMN or RSNPN and, if the UE supports access to an SNPN using credentials from a credentials holder, equivalent SNPNs or both, the selected entry of the "list of subscriber data" or the selected PLMN subscription stored at the UE, then the UE shall initiate a registration procedure for mobility and periodic registration update as specified in subclause 5.5.1.3.2 over the existing N1 NAS signalling connection; or
- b) a UE radio capability ID IE, the UE shall store the UE radio capability ID as specified in annex C.

If the registration procedure for mobility and periodic registration update was initiated and there is a request from the upper layers to perform "emergency services fallback" pending, the UE shall restart the service request procedure after the successful completion of the mobility and periodic registration update.

When AMF re-allocation occurs in the registration procedure for mobility and periodic registration update, if the new AMF receives in the 5GMM context of the UE the indication that the UE is registered for onboarding services in SNPN, the new AMF may start an implementation specific timer for onboarding services when the registration procedure for mobility and periodic registration update is successfully completed.

If the UE has included the service-level device ID set to the CAA-level UAV ID in the Service-level-AA container IE of the REGISTRATION REQUEST message and the REGISTRATION ACCEPT message contains the service-level-AA pending indication in the Service-level-AA container IE, the UE shall return a REGISTRATION COMPLETE message to the AMF to acknowledge reception of the service-level-AA pending indication, and the UE shall not attempt to perform another registration procedure for UAS services until the UUAA-MM procedure is completed, or to establish a PDU session for USS communication or a PDU session for C2 communication until the UUAA-MM procedure is completed successfully.

If the UE has included the service-level device ID set to the CAA-level UAV ID in the Service-level-AA container IE of the REGISTRATION REQUEST message and the REGISTRATION ACCEPT message does not contain the service-level-AA pending indication in the Service-level-AA container IE, the UE shall consider the UUAA-MM procedure is not triggered.

If the UE is registered for onboarding services in SNPN or the network determines that the UE's subscription only allows for configuration of SNPN subscription parameters in PLMN via the user plane, the AMF may start an implementation specific timer for onboarding services, if not running already, when the network considers that the UE is in 5GMM-REGISTERED (i.e. the network receives the REGISTRATION COMPLETE message from UE).

NOTE 22: If the AMF considers that the UE is in 5GMM-IDLE, when the implementation specific timer for onboarding services expires and the network considers that the UE is still in state 5GMM-REGISTERED, the AMF can locally de-register the UE; or if the UE is in 5GMM-CONNECTED, the AMF can initiate the network-initiated de-registration procedure (see subclause 5.5.2.3).

NOTE 23: The value of the implementation specific timer for onboarding services needs to be large enough to allow a UE to complete the configuration of one or more entries of the "list of subscriber data" taking into consideration that configuration of SNPN subscription parameters in PLMN via the user plane or onboarding services in SNPN involves third party entities outside of the operator's network.

If the UE receives the List of PLMNs to be used in disaster condition IE in the REGISTRATION ACCEPT message and the UE supports MINT, the UE shall delete the "list of PLMN(s) to be used in disaster condition" stored in the ME together with the PLMN ID of the RPLMN, if any, and may store the "list of PLMN(s) to be used in disaster condition" included in the List of PLMNs to be used in disaster condition IE in the ME together with the PLMN ID of the RPLMN.

If the UE receives the Disaster roaming wait range IE in the REGISTRATION ACCEPT message and the UE supports MINT, the UE shall delete the disaster roaming wait range stored in the ME, if any, and store the disaster roaming wait range included in the Disaster roaming wait range IE in the ME.

If the UE receives the Disaster return wait range IE in the REGISTRATION ACCEPT message and the UE supports MINT, the UE shall delete the disaster return wait range stored in the ME, if any, and store the disaster return wait range stored included in the Disaster return wait range IE in the ME.

If the 5GS registration type IE is set to "disaster roaming mobility registration updating" and:

- a) the UE determined PLMN with disaster condition IE is included in the REGISTRATION REQUEST message, the AMF shall determine the PLMN with disaster condition in the UE determined PLMN with disaster condition IE;
- b) the UE determined PLMN with disaster condition IE is not included in the REGISTRATION REQUEST message and the Additional GUTI IE is included in the REGISTRATION REQUEST message and contains 5G-GUTI of a PLMN of the country of the PLMN providing disaster roaming, the AMF shall determine the PLMN with disaster condition in the PLMN identity of the 5G-GUTI;
- c) the UE determined PLMN with disaster condition IE and the Additional GUTI IE are not included in the REGISTRATION REQUEST message and:
 - 1) the 5GS mobile identity IE contains 5G-GUTI of a PLMN of the country of the PLMN providing disaster roaming, the AMF shall determine the PLMN with disaster condition in the PLMN identity of the 5G-GUTI; or
 - 2) the 5GS mobile identity IE contains SUCI of a PLMN of the country of the PLMN providing disaster roaming, the AMF shall determine the PLMN with disaster condition in the PLMN identity of the SUCI; or
- d) the UE determined PLMN with disaster condition IE is not included in the REGISTRATION REQUEST message, NG-RAN of the PLMN providing disaster roaming broadcasts disaster roaming indication and:
 - the Additional GUTI IE is included in the REGISTRATION REQUEST message and contains 5G-GUTI of a PLMN of a country other than the country of the PLMN providing disaster roaming; or
 - the Additional GUTI IE is not included and the 5GS mobile identity IE contains 5G-GUTI or SUCI of a PLMN of a country other than the country of the PLMN providing disaster roaming;

the AMF shall determine the PLMN with disaster condition based on the disaster roaming agreement arrangement between mobile network operators.

NOTE 24: The disaster roaming agreement arrangement between mobile network operators is out scope of 3GPP.

If the AMF determines that a disaster condition applies to the PLMN with disaster condition, and the UE is allowed to be registered for disaster roaming services, the AMF shall set the Disaster roaming registration result value bit in the 5GS registration result IE to "no additional information" in the REGISTRATION ACCEPT message. If the AMF determines that the UE can be registered to the PLMN for normal service, the AMF shall set the Disaster roaming registration result value bit in the 5GS registration result IE to "request for registration for disaster roaming service accepted as registration not for disaster roaming service" in the REGISTRATION ACCEPT message.

If the UE indicates "disaster roaming mobility registration updating" in the 5GS registration type IE in the REGISTRATION REQUEST message and the 5GS registration result IE value in the REGISTRATION ACCEPT message is set to:

- "request for registration for disaster roaming service accepted as registration not for disaster roaming service", the UE shall consider itself registered for normal service. If the PLMN identity of the registered PLMN is a member of the forbidden PLMN list as specified in subclause 5.3.13A, any such PLMN identity shall be deleted from the corresponding list(s). If UE supports S1 mode, the UE shall initiate the registration procedure for mobility and periodic registration update and indicate that S1 mode is supported as described in subclause 5.5.1.3.2; or
- "no additional information", the UE shall consider itself registered for disaster roaming.

If the UE receives the Forbidden TAI(s) for the list of "5GS forbidden tracking areas for roaming" IE in the REGISTRATION ACCEPT message and the TAI(s) included in the IE is not part of the list of "5GS forbidden tracking areas for roaming", the UE shall store the TAI(s) belonging to the serving PLMN or equivalent PLMN(s) and ignore the TAI(s) which do not belong to the serving PLMN or equivalent PLMN(s) included in the IE into the list of "5GS forbidden tracking areas for roaming" and remove the TAI(s) from the stored TAI list if present.

If the UE receives the Forbidden TAI(s) for the list of "5GS forbidden tracking areas for regional provision of service" IE in the REGISTRATION ACCEPT message and the TAI(s) included in the IE is not part of the list of "5GS forbidden tracking areas for regional provision of service", the UE shall store the TAI(s) belonging to the serving PLMN or equivalent PLMN(s) and ignore the TAI(s) which do not belong to the serving PLMN or equivalent PLMN(s) included in the IE into the list of "5GS forbidden tracking areas for regional provision of service" and remove the TAI(s) from the stored TAI list if present.

If the ESI bit of the 5GMM capability IE of the REGISTRATION REQUEST message is set to "equivalent SNPNs supported", and the serving SNPN changes, the AMF shall indicate the NID of the serving SNPN in the REGISTRATION ACCEPT message. The UE shall determine the SNPN identity of the RSNPN from the NID received in the REGISTRATION ACCEPT message and the MCC and the MNC of the new 5G-GUTI.

If the UE supporting the reconnection to the network due to RAN timing synchronization status change receives the RAN timing synchronization IE with the RecReq bit set to "Reconnection requested" in the REGISTRATION ACCEPT message, the UE shall operate as specified in subclauses 5.3.1.4, 5.5.1.3.2 and 5.6.1.1.

If the UE supports discontinuous coverage, the AMF may include the Discontinuous coverage maximum time offset IE in the REGISTRATION ACCEPT message.

If the UE receives, the Discontinuous coverage maximum time offset IE in the REGISTRATION ACCEPT message, the UE shall replace any previously received maximum time offset value on the same satellite NG-RAN RAT type and PLMN with the latest received timer value.

If the AMF includes Unavailability configuration IE in the REGISTRATION ACCEPT message and sets the EUPR bit to "UE does not need to report end of unavailability", the UE is not required to initiate the registration procedure for mobility registration update when the unavailability period duration has ended. If the UE does not receive the Unavailability configuration IE or the EUPR bit is set to "UE needs to report end of unavailability period", the UE should trigger registration procedure for mobility registration update when the unavailability period duration has ended. If the UE has stored a discontinuous coverage maximum time offset timer value, upon returning to coverage after being out of coverage due to discontinuous coverage, the UE starts a timer with a random value up to the discontinuous coverage maximum time offset value and the UE should trigger the registration procedure for mobility registration update at the expiry of this timer.

If the UE operating as MBSR receives the MBSRAI field of the Feature authorization indication IE in the REGISTRATION ACCEPT message, the UE NAS layer informs the lower layers of the status of MBSR authorization as specified in subclause 5.35A.4 of 3GPP TS 23.501 [8].

5.5.1.3.5 Mobility and periodic registration update not accepted by the network

If the mobility and periodic registration update request cannot be accepted by the network, the AMF shall send a REGISTRATION REJECT message to the UE including an appropriate 5GMM cause value.

If the mobility and periodic registration update request is rejected due to general NAS level mobility management congestion control, the network shall set the 5GMM cause value to #22 "congestion" and assign a value for back-off timer T3346.

If the mobility and periodic registration update request is rejected due to general NAS level mobility management congestion control for the SNPN selected for localized services in SNPN (see 3GPP TS 23.122 [5]), the network may set an appropriate cause value other than 5GMM cause value to #22 "congestion" and does not assign a value for back-off timer T3346.

In NB-N1 mode, if the mobility and periodic registration update request is rejected due to operator determined barring (see 3GPP TS 29.503 [20AB]), the network shall set the 5GMM cause value to #22 "congestion" and assign a value for back-off timer T3346.

When the UE performs inter-system change from S1 mode to N1 mode, if the AMF is informed that verification of the integrity protection of the TRACKING AREA UPDATE REQUEST message included by the UE in the EPS NAS message container IE of the REGISTRATION REQUEST message has failed in the MME, then:

- a) If the AMF can retrieve the current 5G NAS security context as indicated by the ngKSI and 5G-GUTI sent by the UE, the AMF shall proceed as specified in subclause 5.5.1.3.4;
- b) if the AMF cannot retrieve the current 5G NAS security context as indicated by the ngKSI and 5G-GUTI sent by the UE, or the ngKSI or 5G-GUTI was not sent by the UE, the AMF may initiate the identification procedure by

sending the IDENTITY REQUEST message with the "Type of identity" of the 5GS identity type IE set to "SUCI" before taking actions as specified in subclause 4.4.4.3; or

- c) If the AMF needs to reject the mobility and periodic registration update procedure, the AMF shall send REGISTRATION REJECT message including 5GMM cause #9 "UE identity cannot be derived by the network".

If the REGISTRATION REJECT message with 5GMM cause #76 or #78 was received without integrity protection, then the UE shall discard the message. If the REGISTRATION REJECT message with 5GMM cause #62 was received without integrity protected, the behaviour of the UE is specified in subclause 5.3.20.2.

Based on operator policy, if the mobility and periodic registration update request is rejected due to core network redirection for CIoT optimizations, the network shall set the 5GMM cause value to #31 "Redirection to EPC required".

NOTE 1: The network can take into account the UE's S1 mode capability, the EPS CIoT network behaviour supported by the UE or the EPS CIoT network behaviour supported by the EPC to determine the rejection with the 5GMM cause value #31 "Redirection to EPC required".

If the mobility and periodic registration update request is rejected because:

- a) all the S-NSSAI(s) included in the requested NSSAI (i.e. Requested NSSAI IE or Requested mapped NSSAI IE) are rejected;
- b) the UE set the NSSAA bit in the 5GMM capability IE to:
 - 1) "Network slice-specific authentication and authorization supported" and;
 - i) void;
 - ii) all default S-NSSAIs are not allowed; or
 - iii) network slice-specific authentication and authorization has failed or been revoked for all default S-NSSAIs and based on network local policy, the network decides not to initiate the network slice-specific re-authentication and re-authorization procedures for any default S-NSSAI requested by the UE; or
 - 2) "Network slice-specific authentication and authorization not supported" and all subscribed default S-NSSAIs marked as default are either not allowed or are subject to network slice-specific authentication and authorization; and
 - i) void; or
 - ii) void; and
- c) no emergency PDU session has been established for the UE;

the network shall set the 5GMM cause value of the REGISTRATION REJECT message to #62 "No network slices available" and shall include, in the rejected NSSAI of the REGISTRATION REJECT message, all the S-NSSAI(s) which were included in the requested NSSAI.

If the UE has set the ER-NSSAI bit to "Extended rejected NSSAI supported" in the 5GMM capability IE of the REGISTRATION REQUEST message, the rejected S-NSSAI(s) shall be included in the Extended rejected NSSAI IE of the REGISTRATION REJECT message. Otherwise, the rejected S-NSSAI(s) shall be included in the Rejected NSSAI IE of the REGISTRATION REJECT message.

In roaming scenarios, if the Extended rejected NSSAI IE is included in the REGISTRATION REJECT message, the AMF shall provide mapped S-NSSAI(s) for the rejected NSSAI.

If the UE supports extended rejected NSSAI and the AMF determines that maximum number of UEs reached for one or more S-NSSAI(s) in the requested NSSAI as specified in subclause 4.6.2.5, the AMF shall include the rejected NSSAI containing one or more S-NSSAIs with the rejection cause "S-NSSAI not available due to maximum number of UEs reached" in the Extended rejected NSSAI IE in the REGISTRATION REJECT message. In addition, the AMF may include a back-off timer value for each S-NSSAI with the rejection cause "S-NSSAI not available due to maximum number of UEs reached" in the Extended rejected NSSAI IE of the REGISTRATION REJECT message.

If the mobility and periodic registration update request from a UE supporting CAG is rejected due to CAG restrictions, the network shall set the 5GMM cause value to #76 "Not authorized for this CAG or authorized for CAG cells only"

and should include the "CAG information list" in the CAG information list IE or the Extended CAG information list IE in the REGISTRATION REJECT message.

NOTE 2: The network cannot be certain that "CAG information list" stored in the UE is updated as result of sending of the REGISTRATION REJECT message with the CAG information list IE or the Extended CAG information list IE, as the REGISTRATION REJECT message is not necessarily delivered to the UE (e.g due to abnormal radio conditions).

NOTE 3: The "CAG information list" can be provided by the AMF and include no entry if no "CAG information list" exists in the subscription.

NOTE 3A: If the UE supports extended CAG information list, the CAG information list can be included either in the CAG information list IE or Extended CAG information list IE.

NOTE 3B: It is unexpected for network to send REGISTRATION REJECT message to the UE with 5GMM cause value #76 in non-CAG cell and not indicate "Indication that the UE is only allowed to access 5GS via CAG cells" for the serving PLMN in the Extended CAG information list or the CAG information list.

If the UE does not support extended CAG information list, the CAG information list shall not be included in the Extended CAG information list IE.

If the mobility and periodic registration update request from a UE not supporting CAG is rejected due to CAG restrictions, the network shall operate as described in bullet i) of subclause 5.5.1.3.8.

If the UE's mobility and periodic registration update request is via a satellite NG-RAN cell and the network determines that the UE is in a location where the network is not allowed to operate, see 3GPP TS 23.502 [9], the network shall set the 5GMM cause value in the REGISTRATION REJECT message to #78 "PLMN not allowed at the present UE location".

NOTE 4: When the UE is accessing network for emergency services, it is up to operator and regulatory policies whether the network needs to determine if the UE is in a location where network is not allowed to operate.

NOTE 4A: While location determination is ongoing to ensure that operator and regulatory policies are met, the AMF can perform DNN-based or S-NSSAI based congestion control as specified in subclauses 5.3.10 and 5.3.11 to prevent the UE from accessing network.

If the AMF receives the mobility and periodic registration update request including the service-level device ID set to the CAA-level UAV ID in the Service-level-AA container IE and the AMF determines that the UE is not allowed to use UAS services via 5GS based on the user's subscription data and the operator policy, the AMF shall return a REGISTRATION REJECT message with 5GMM cause #79 "UAS services not allowed".

If the mobility and periodic registration update request from a UE supporting MINT is rejected due to a disaster condition no longer being applicable in the current location of the UE, the network shall set the 5GMM cause value to #11 "PLMN not allowed" or #13 "Roaming not allowed in this tracking area" and may include a disaster return wait range in the Disaster return wait range IE in the REGISTRATION REJECT message.

If the UE initiates the registration procedure for disaster roaming and the AMF determines that it does not support providing disaster roaming services for the determined PLMN with disaster condition to the UE, then the AMF shall send a REGISTRATION REJECT message with 5GMM cause #80 "Disaster roaming for the determined PLMN with disaster condition not allowed".

If the AMF receives the mobility and periodic registration update request over non-3GPP access and detects that the N3IWF used by the UE is not compatible with the allowed NSSAI and the UE has indicated its support for slice-based N3IWF selection in the REGISTRATION REQUEST message, the AMF may send a REGISTRATION REJECT message with 5GMM cause #81 "Selected N3IWF is not compatible with the allowed NSSAI" and may provide information for a suitable N3IWF in the REGISTRATION REJECT message indicating the suitable N3IWF that is compatible with the requested NSSAI.

If the AMF receives the mobility and periodic registration update request over non-3GPP access and detects that the TNGF used by the UE is not compatible with the allowed NSSAI and the UE has indicated its support for slice-based TNGF selection in the REGISTRATION REQUEST message, the AMF may send a REGISTRATION REJECT message with 5GMM cause #82 "Selected TNGF is not compatible with the allowed NSSAI" and may provide information for a suitable TNAN in the TNAN information IE in the REGISTRATION REJECT message indicating the suitable TNGF that is compatible with the requested NSSAI.

If the AMF received multiple TAIs from the satellite NG-RAN as described in 3GPP TS 23.501 [8], and determines that, by UE subscription and operator's preferences, all of the received TAIs are forbidden for roaming or for regional provision of service, the AMF shall include the TAI(s) in:

- a) the Forbidden TAI(s) for the list of "5GS forbidden tracking areas for roaming" IE; or
- b) the Forbidden TAI(s) for the list of "5GS forbidden tracking areas for regional provision of service" IE; or
- c) both;

in the REGISTRATION REJECT message.

Regardless of the 5GMM cause value received in the REGISTRATION REJECT message via satellite NG-RAN,

- if the UE receives the Forbidden TAI(s) for the list of "5GS forbidden tracking areas for roaming" IE in the REGISTRATION REJECT message and if the TAI(s) included in the IE is not part of the list of "5GS forbidden tracking areas for roaming", the UE shall store the TAI(s) belonging to the serving PLMN or equivalent PLMN(s) and ignore the TAI(s) which do not belong to the serving PLMN or equivalent PLMN(s) included in the IE, if not already stored, into the list of "5GS forbidden tracking areas for roaming"; and
- if the UE receives the Forbidden TAI(s) for the list of "5GS forbidden tracking areas for regional provision of service" IE in the REGISTRATION REJECT message and if the TAI(s) included in the IE is not part of the list of "5GS forbidden tracking areas for regional provision of service", the UE shall store the TAI(s) belonging to the serving PLMN or equivalent PLMN(s) and ignore the TAI(s) which do not belong to the serving PLMN or equivalent PLMN(s) included in the IE, if not already stored, into the list of "5GS forbidden tracking areas for regional provision of service".

In a shared network, the UE shall construct the TAI of the cell from one of the PLMN identities as specified in 3GPP TS 23.122 [5] and the TAC received on the broadcast system information. Whenever a REGISTRATION REJECT message is received by the UE:

- with the 5GMM cause #11 "PLMN not allowed", the chosen PLMN identity shall be stored in the "forbidden PLMN list" and if the UE is configured to use timer T3245 (see 3GPP TS 24.368 [17] or 3GPP TS 31.102 [22]) then the UE shall start timer T3245 and proceed as described in subclause 5.3.19A;
- with the 5GMM cause #12 "tracking area not allowed", #13 "roaming not allowed in this tracking area", #15 "no suitable cells in tracking Area", or #62 "No network slices available", the constructed TAI shall be stored in the suitable list; or
- as a response to registration procedure for mobility registration update initiated in 5GMM-CONNECTED mode, the UE need not update forbidden lists with the selected PLMN identity or the constructed TAI, respectively.

In a shared network, the UE shall construct the TAI of the cell from one of the SNPN identities as specified in 3GPP TS 23.122 [5] constructing the TAI from the PLMN identity part of the SNPN identity and the TAC received on the broadcast system information. Whenever a REGISTRATION REJECT message is received by the UE:

- with the 5GMM cause #74 "Temporarily not authorized for this SNPN", the chosen SNPN identity shall be stored in the "temporarily forbidden SNPNs" list, "temporarily forbidden SNPNs for access for localized services in SNPN" list if the SNPN is an SNPN selected for localized services in SNPN (see 3GPP TS 23.122 [5]) or "temporarily forbidden SNPNs for onboarding services in SNPN" list if the UE is registered for onboarding services in SNPN and if the UE is configured to use timer T3245 (see 3GPP TS 24.368 [17] or 3GPP TS 31.102 [22]) then the UE shall start timer T3245 and proceed as described in subclause 5.3.19A;
- with the 5GMM cause #75 "Permanently not authorized for this SNPN", the chosen SNPN identity shall be stored in the "permanently forbidden SNPNs", "permanently forbidden SNPNs for access for localized services in SNPN" list if the SNPN is an SNPN selected for localized services in SNPN (see 3GPP TS 23.122 [5]) for the selected entry of the "list of subscriber data" or the selected PLMN subscription or "permanently forbidden SNPNs for onboarding services in SNPN" if the UE is registered for onboarding services in SNPN and if the UE is configured to use timer T3245 (see 3GPP TS 24.368 [17] or 3GPP TS 31.102 [22]) then the UE shall start timer T3245 and proceed as described in subclause 5.3.19A;
- with the 5GMM cause #12 "tracking area not allowed", #13 "roaming not allowed in this tracking area", #15 "no suitable cells in tracking Area", or #62 "No network slices available", the constructed TAI shall be stored in the suitable list; or

- as a response to registration procedure for mobility registration update initiated in 5GMM-CONNECTED mode, the UE need not update forbidden lists with the selected SNPN identity or the constructed TAI, respectively.

Furthermore, the UE shall take the following actions depending on the 5GMM cause value received in the REGISTRATION REJECT message.

#3 (Illegal UE); or

#6 (Illegal ME).

The UE shall set the 5GS update status to 5U3 ROAMING NOT ALLOWED (and shall store it according to subclause 5.1.3.2.2) and shall delete any 5G-GUTI, last visited registered TAI, TAI list and ngKSI.

In case of PLMN, the UE shall consider the USIM as invalid for 5GS services until switching off, the UICC containing the USIM is removed or the timer T3245 expires as described in subclause 5.3.19a.1.

In case of SNPN, if the UE is not registered for onboarding services in SNPN and the UE does not support access to an SNPN using credentials from a credentials holder and does not support equivalent SNPNS, the UE shall consider the selected entry of the "list of subscriber data" with the SNPN identity of the current SNPN as invalid until the UE is switched off, the entry is updated or the timer T3245 expires as described in subclause 5.3.19a.2. In case of SNPN, if the UE supports access to an SNPN using credentials from a credentials holder, equivalent SNPNS, or both, the UE shall consider the selected entry of the "list of subscriber data" as invalid for 3GPP access until the UE is switched off, the entry is updated or the timer T3245 expires as described in subclause 5.3.19a.2. Additionally, if EAP based primary authentication and key agreement procedure using EAP-AKA' or 5G AKA based primary authentication and key agreement procedure was performed in the current SNPN, the UE shall consider the USIM as invalid for the current SNPN until switching off, the UICC containing the USIM is removed or the timer T3245 expires as described in subclause 5.3.19a.2.

If the UE is not registered for onboarding services in SNPN, the UE shall delete the list of equivalent PLMNs (if any) or the list of equivalent SNPNS (if any), and shall move to 5GMM-DEREGISTERED.NO-SUPI state. If the message has been successfully integrity checked by the NAS, then the UE shall:

- 1) set the counter for "SIM/USIM considered invalid for GPRS services" events and the counter for "USIM considered invalid for 5GS services over non-3GPP access" events to UE implementation-specific maximum value in case of PLMN if the UE maintains these counters;
- 2) set the counter for "the entry for the current SNPN considered invalid for 3GPP access" events and the counter for "the entry for the current SNPN considered invalid for non-3GPP access" events to UE implementation-specific maximum value in case of SNPN if the UE maintains these counters; and

If the message was received via 3GPP access and the UE is operating in single-registration mode, the UE shall handle the EMM parameters EMM state, EPS update status, 4G-GUTI, last visited registered TAI, TAI list and eKSI as specified in 3GPP TS 24.301 [15] for the case when the normal tracking area updating procedure is rejected with the EMM cause with the same value. The USIM shall be considered as invalid also for non-EPS services until switching off or the UICC containing the USIM is removed or the timer T3245 expires as described in subclause 5.3.7a of 3GPP TS 24.301 [15]. If the UE is in EMM-REGISTERED state, the UE shall move to EMM-DEREGISTERED state. If the message has been successfully integrity checked by the NAS and the UE maintains a counter for "SIM/USIM considered invalid for non-GPRS services", then the UE shall set this counter to UE implementation-specific maximum value.

If the UE is registered for onboarding services in SNPN, the UE shall reset the registration attempt counter, store the SNPN identity in the "permanently forbidden SNPNS for onboarding services in SNPN" list, enter state 5GMM-DEREGISTERED.PLMN-SEARCH, and perform an SNPN selection or an SNPN selection for onboarding services according to 3GPP TS 23.122 [5]. If the message has been successfully integrity checked by the NAS, the UE shall set the SNPN-specific attempt counter for the current SNPN to the UE implementation-specific maximum value.

If the message has been successfully integrity checked by the NAS and the UE also supports the registration procedure over the other access, the UE shall in addition handle 5GMM parameters and 5GMM state for this access, as described for this 5GMM cause value.

#7 (5GS services not allowed).

The UE shall set the 5GS update status to 5U3 ROAMING NOT ALLOWED (and shall store it according to subclause 5.1.3.2.2) and shall delete any 5G-GUTI, last visited registered TAI, TAI list and ngKSI.

In case of PLMN, the UE shall consider the USIM as invalid for 5GS services until switching off, the UICC containing the USIM is removed or the timer T3245 expires as described in subclause 5.3.19a.1;

In case of SNPN, if the UE is not registered for onboarding services in SNPN and the UE does not support access to an SNPN using credentials from a credentials holder and does not support equivalent SNPNS, the UE shall consider the selected entry of the "list of subscriber data" with the SNPN identity of the current SNPN as invalid for 5GS services until the UE is switched off, the entry is updated or the timer T3245 expires as described in subclause 5.3.19a.2. In case of SNPN, if the UE is not registered for onboarding services in SNPN and the UE supports access to an SNPN using credentials from a credentials holder, equivalent SNPNS, or both, the UE shall consider the selected entry of the "list of subscriber data" as invalid for 3GPP access until the UE is switched off, the entry is updated or the timer T3245 expires as described in subclause 5.3.19a.2. Additionally, if EAP based primary authentication and key agreement procedure using EAP-AKA' or 5G AKA based primary authentication and key agreement procedure was performed in the current SNPN, the UE shall consider the USIM as invalid for the current SNPN until switching off or the UICC containing the USIM is removed or the timer T3245 expires as described in subclause 5.3.19a.2.

If the UE is not registered for onboarding services in SNPN, the UE shall move to 5GMM-DEREGISTERED.NO-SUPI state. If the message has been successfully integrity checked by the NAS, then the UE shall:

- 1) set the counter for "SIM/USIM considered invalid for GPRS services" events and the counter for "USIM considered invalid for 5GS services over non-3GPP access" events to UE implementation-specific maximum value in case of PLMN if the UE maintains these counters;
- 2) set the counter for "the entry for the current SNPN considered invalid for 3GPP access" events and the counter for "the entry for the current SNPN considered invalid for non-3GPP access" events to UE implementation-specific maximum value in case of SNPN if the UE maintains these counters; and

If the message was received via 3GPP access and the UE is operating in single-registration mode, the UE shall handle the EMM parameters EMM state, EPS update status, 4G-GUTI, last visited registered TAI, TAI list and eKSI as specified in 3GPP TS 24.301 [15] for the case when the normal tracking area updating procedure is rejected with the EMM cause with the same value.

If the UE is registered for onboarding services in SNPN, the UE shall reset the registration attempt counter, store the SNPN identity in the "permanently forbidden SNPNS for onboarding services in SNPN" list, enter state 5GMM-DEREGISTERED.PLMN-SEARCH, and perform an SNPN selection or an SNPN selection for onboarding services according to 3GPP TS 23.122 [5]. If the message has been successfully integrity checked by the NAS, the UE shall set the SNPN-specific attempt counter for the current SNPN to the UE implementation-specific maximum value.

If the message has been successfully integrity checked by the NAS and the UE also supports the registration procedure over the other access, the UE shall in addition handle 5GMM parameters and 5GMM state for this access, as described for this 5GMM cause value.

#9 (UE identity cannot be derived by the network).

The UE shall set the 5GS update status to 5U2 NOT UPDATED (and shall store it according to subclause 5.1.3.2.2) and shall delete any 5G-GUTI, last visited registered TAI, TAI list and ngKSI. The UE shall enter the state 5GMM-DEREGISTERED.

If the UE has initiated the registration procedure in order to enable performing the service request procedure for emergency services fallback, the UE shall attempt to select an E-UTRA cell connected to EPC or 5GCN according to the domain priority and selection rules specified in 3GPP TS 23.167 [6]. If the UE finds a suitable E-UTRA cell, it then proceeds with the appropriate EMM or 5GMM procedures. If the UE operating in single-registration mode has changed to S1 mode, it shall disable the N1 mode capability for 3GPP access.

If the rejected request was neither for initiating an emergency PDU session nor for emergency services fallback, the UE shall subsequently, automatically initiate the initial registration procedure.

NOTE 5: User interaction is necessary in some cases when the UE cannot re-establish the PDU session(s) automatically.

If the message was received via 3GPP access and the UE is operating in single-registration mode, the UE shall handle the EMM parameters EMM state, EPS update status, 4G-GUTI, last visited registered TAI, TAI list and eKSI as specified in 3GPP TS 24.301 [15] for the case when the normal tracking area updating procedure is rejected with the EMM cause with the same value.

#10 (implicitly de-registered).

The UE shall enter the state 5GMM-DEREGISTERED.NORMAL-SERVICE. The UE shall delete any mapped 5G NAS security context or partial native 5G NAS security context.

If the UE has initiated the registration procedure in order to enable performing the service request procedure for emergency services fallback, the UE shall attempt to select an E-UTRA cell connected to EPC or 5GCN according to the domain priority and selection rules specified in 3GPP TS 23.167 [6]. If the UE finds a suitable E-UTRA cell, it then proceeds with the appropriate EMM or 5GMM procedures. If the UE operating in single-registration mode has changed to S1 mode, it shall disable the N1 mode capability for 3GPP access.

If the rejected request was neither for initiating an emergency PDU session nor for emergency services fallback, the UE shall perform a new registration procedure for initial registration.

NOTE 6: User interaction is necessary in some cases when the UE cannot re-establish the PDU session(s) automatically.

If the message was received via 3GPP access and the UE is operating in single-registration mode, the UE shall handle the EMM state as specified in 3GPP TS 24.301 [15] for the case when the normal tracking area updating procedure is rejected with the EMM cause with the same value.

#11 (PLMN not allowed).

This cause value received from a cell belonging to an SNPN and the UE is operating in SNPN access operation mode is considered as an abnormal case and the behaviour of the UE is specified in subclause 5.5.1.3.7.

The UE shall set the 5GS update status to 5U3 ROAMING NOT ALLOWED (and shall store it according to subclause 5.1.3.2.2) and shall delete any 5G-GUTI, last visited registered TAI, TAI list and ngKSI. The UE shall store the PLMN identity in the forbidden PLMN list as specified in subclause 5.3.13A and if the UE is configured to use timer T3245 then the UE shall start timer T3245 and proceed as described in subclause 5.3.19a.1, delete the list of equivalent PLMNs, reset the registration attempt counter. For 3GPP access, the UE shall enter the state 5GMM-DEREGISTERED.PLMN-SEARCH and perform a PLMN selection according to 3GPP TS 23.122 [5]. For non-3GPP access the UE shall enter state 5GMM-DEREGISTERED.LIMITED-SERVICE and perform network selection as defined in 3GPP TS 24.502 [18]. If the message has been successfully integrity checked by the NAS and the UE maintains the PLMN-specific attempt counter and the PLMN-specific attempt counter for non-3GPP access for that PLMN, the UE shall set the PLMN-specific attempt counter and the PLMN-specific attempt counter for non-3GPP access for that PLMN to the UE implementation-specific maximum value.

If the message was received via 3GPP access and the UE is operating in single-registration mode, the UE shall in addition handle the EMM parameters EMM state, EPS update status, 4G-GUTI, last visited registered TAI, TAI list, eKSI and tracking area updating attempt counter as specified in 3GPP TS 24.301 [15] for the case when the normal tracking area updating procedure is rejected with the EMM cause with the same value.

If the message has been successfully integrity checked by the NAS and the UE also supports the registration procedure over the other access to the same PLMN, the UE shall in addition handle 5GMM parameters and 5GMM state for this access, as described for this 5GMM cause value.

If the UE receives the Disaster return wait range IE in the REGISTRATION REJECT message and the UE supports MINT, the UE shall delete the disaster return wait range stored in the ME, if any, and store the disaster return wait range included in the Disaster return wait range IE in the ME.

#12 (Tracking area not allowed).

The UE shall set the 5GS update status to 5U3 ROAMING NOT ALLOWED (and shall store it according to subclause 5.1.3.2.2) and shall delete last visited registered TAI and TAI list. If the UE is not registering or has not registered to the same PLMN over both 3GPP access and non-3GPP access, the UE shall additionally delete 5G-GUTI and ngKSI. Additionally, the UE shall reset the registration attempt counter.

If:

- 1) the UE is not operating in SNPN access operation mode and the Forbidden TAI(s) for the list of "5GS forbidden tracking areas for regional provision of service" IE is not included in the REGISTRATION REJECT message, the UE shall store the current TAI in the list of "5GS forbidden tracking areas for regional provision of service" and enter the state 5GMM-DEREGISTERED.LIMITED-SERVICE. If the REGISTRATION REJECT message is not integrity protected, the UE shall memorize the current TAI was stored in the list of "5GS forbidden tracking areas for regional provision of service" for non-integrity protected NAS reject message; or
- 2) the UE is operating in SNPN access operation mode, the UE shall store the current TAI in the list of "5GS forbidden tracking areas for regional provision of service" for the current SNPN and the selected entry of the "list of subscriber data" or the selected PLMN subscription, and enter the state 5GMM-DEREGISTERED.LIMITED-SERVICE. If the REGISTRATION REJECT message is not integrity protected, the UE shall memorize the current TAI was stored in the list of "5GS forbidden tracking areas for regional provision of service" for the current SNPN and the selected entry of the "list of subscriber data" or the selected PLMN subscription, for non-integrity protected NAS reject message.

If the message was received via 3GPP access and the UE is operating in single-registration mode, the UE shall handle the EMM parameters EMM state, EPS update status, 4G-GUTI, last visited registered TAI, TAI list, eKSI and tracking area updating attempt counter as specified in 3GPP TS 24.301 [15] for the case when the normal tracking area updating procedure is rejected with the EMM cause with the same value.

#13 (Roaming not allowed in this tracking area).

The UE shall set the 5GS update status to 5U3 ROAMING NOT ALLOWED (and shall store it according to subclause 5.1.3.2.2). If the UE is not registering or has not registered to the same PLMN over both 3GPP access and non-3GPP access the UE shall delete the list of equivalent PLMNs (if available) or the list of equivalent SNPNs (if available). The UE shall reset the registration attempt counter. For 3GPP access the UE shall change to state 5GMM-REGISTERED.PLMN-SEARCH, and for non-3GPP access the UE shall change to state 5GMM-REGISTERED.LIMITED-SERVICE.

If the UE is registered in S1 mode and operating in dual-registration mode, the PLMN that the UE chooses to register in is specified in subclause 4.8.3. Otherwise if:

- 1) the UE is not operating in SNPN access operation mode and the Forbidden TAI(s) for the list of "5GS forbidden tracking areas for roaming" IE is not included in the REGISTRATION REJECT message, the UE shall store the current TAI in the list of "5GS forbidden tracking areas for roaming" and shall remove the current TAI from the stored TAI list if present. If the REGISTRATION REJECT message is not integrity protected, the UE shall memorize the current TAI was stored in the list of "5GS forbidden tracking areas for roaming" for non-integrity protected NAS reject message; or
- 2) the UE is operating in SNPN access operation mode, the UE shall store the current TAI in the list of "5GS forbidden tracking areas for roaming" for the current SNPN and the selected entry of the "list of subscriber data" or the selected PLMN subscription. If the REGISTRATION REJECT message is not integrity protected, the UE shall memorize the current TAI was stored in the list of "5GS forbidden tracking areas for roaming" for the current SNPN and the selected entry of the "list of subscriber data" or the selected PLMN subscription, for non-integrity protected NAS reject message.

For 3GPP access the UE shall perform a PLMN selection or SNPN selection according to 3GPP TS 23.122 [5], and for non-3GPP access the UE shall perform network selection as defined in 3GPP TS 24.502 [18].

If the message was received via 3GPP access and the UE is operating in single-registration mode, the UE shall handle the EMM parameters EMM state, EPS update status and tracking area updating attempt counter as specified in 3GPP TS 24.301 [15] for the case when the normal tracking area updating procedure is rejected with the EMM cause with the same value.

If the UE receives the Disaster return wait range IE in the REGISTRATION REJECT message and the UE supports MINT, the UE shall delete the disaster return wait range stored in the ME, if any, and store the disaster return wait range included in the Disaster return wait range IE in the ME.

#15 (No suitable cells in tracking area).

The UE shall set the 5GS update status to 5U3 ROAMING NOT ALLOWED (and shall store it according to subclause 5.1.3.2.2). The UE shall reset the registration attempt counter. Additionally, the UE shall enter the state 5GMM-REGISTERED.LIMITED-SERVICE and:

- 1) if the Extended 5GMM cause IE with value "Satellite NG-RAN not allowed in PLMN" is included in the REGISTRATION REJECT message,
 - i) the message has been successfully integrity checked by the NAS and the UE is configured for "Satellite Disabling Allowed for 5GMM cause #15" as specified in 3GPP TS 24.368 [17] or 3GPP TS 31.102 [22], then the UE shall disable satellite NG-RAN capability (see subclause 4.9.4); or
 - ii) otherwise, the UE shall ignore the Extended 5GMM cause IE; and
- 2) if the UE has initiated the registration procedure in order to enable performing the service request procedure for emergency services fallback, the UE shall attempt to select an E-UTRA cell connected to the EPC or the 5GCN according to the emergency services support indicator (see 3GPP TS 36.331 [25A]). If the UE finds a suitable E-UTRA cell, it then proceeds with the appropriate EMM or 5GMM procedures. If the UE operating in single-registration mode has changed to S1 mode, it shall disable the N1 mode capability for 3GPP access; otherwise, the UE shall search for a suitable cell in another tracking area according to 3GPP TS 38.304 [28] or 3GPP TS 36.304 [25C].

If:

- 1) the UE is not operating in SNPN access operation mode and the Forbidden TAI(s) for the list of "5GS forbidden tracking areas for roaming" IE is not included in the REGISTRATION REJECT message, the UE shall store the current TAI in the list of "5GS forbidden tracking areas for roaming" and shall remove the current TAI from the stored TAI list, if present. If the REGISTRATION REJECT message is not integrity protected, the UE shall memorize the current TAI was stored in the list of "5GS forbidden tracking areas for roaming" for non-integrity protected NAS reject message; or
- 2) the UE is operating in SNPN access operation mode, the UE shall store the current TAI in the list of "5GS forbidden tracking areas for roaming" for the current SNPN and the selected entry of the "list of subscriber data" or the selected PLMN subscription, and shall remove the current TAI from the stored TAI list, if present. If the REGISTRATION REJECT message is not integrity protected, the UE shall memorize the current TAI was stored in the list of "5GS forbidden tracking areas for roaming" for the current SNPN and the selected entry of the "list of subscriber data" or the selected PLMN subscription, for non-integrity protected NAS reject message.

If the message was received via 3GPP access and the UE is operating in single-registration mode, the UE shall handle the EMM parameters EMM state, EPS update status and tracking area updating attempt counter as specified in 3GPP TS 24.301 [15] for the case when the normal tracking area updating procedure is rejected with the EMM cause with the same value.

If received over non-3GPP access the cause shall be considered as an abnormal case and the behaviour of the UE for this case is specified in subclause 5.5.1.3.7.

#22 (Congestion).

If the T3346 value IE is present in the REGISTRATION REJECT message and the value indicates that this timer is neither zero nor deactivated, the UE shall proceed as described below, otherwise it shall be considered as an abnormal case and the behaviour of the UE for this case is specified in subclause 5.5.1.3.7.

The UE shall abort the registration procedure for mobility and periodic registration update. If the rejected request was not for initiating an emergency PDU session, the UE shall set the 5GS update status to 5U2 NOT UPDATED, reset the registration attempt counter and change to state 5GMM-REGISTERED.ATTEMPTING-REGISTRATION-UPDATE.

The UE shall stop timer T3346 if it is running.

If the REGISTRATION REJECT message is integrity protected, the UE shall start timer T3346 with the value provided in the T3346 value IE.

If the REGISTRATION REJECT message is not integrity protected, the UE shall start timer T3346 with a random value from the default range specified in 3GPP TS 24.008 [12].

The UE stays in the current serving cell and applies the normal cell reselection process. The registration procedure for mobility and periodic registration update is started, if still necessary, when timer T3346 expires or is stopped.

If the message was received via 3GPP access and the UE is operating in single-registration mode, the UE shall handle the EMM parameters EMM state, EPS update status and tracking area updating attempt counter as specified in 3GPP TS 24.301 [15] for the case when the normal tracking area updating procedure is rejected with the EMM cause with the same value.

If the registration procedure for mobility and periodic registration update was initiated for an MO MMTEL voice call (i.e. access category 4), or an MO MMTEL video call (i.e. access category 5), or an MO IMS registration related signalling (i.e. access category 9) or for NAS signalling connection recovery during an ongoing MO MMTEL voice call (i.e. access category 4), or during an ongoing MO MMTEL video call (i.e. access category 5) or during an ongoing MO IMS registration related signalling (i.e. access category 9), then a notification that the request was not accepted due to network congestion shall be provided to upper layers.

NOTE 8: Upper layers specified in 3GPP TS 24.173 [13C] and 3GPP TS 24.229 [14] handle the notification that the request was not accepted due to network congestion.

If the UE is registered for onboarding services in SNPN, the UE may enter the state 5GMM-DEREGISTERED.PLMN-SEARCH and perform an SNPN selection or an SNPN selection for onboarding services according to 3GPP TS 23.122 [5].

#27 (N1 mode not allowed).

The UE shall set the 5GS update status to 5U3 ROAMING NOT ALLOWED (and shall store it according to subclause 5.1.3.2.2). Additionally, the UE shall reset the registration attempt counter and shall enter the state 5GMM-REGISTERED.LIMITED-SERVICE. If the message has been successfully integrity checked by the NAS, the UE shall set:

- 1) the PLMN-specific N1 mode attempt counter for 3GPP access and the PLMN-specific N1 mode attempt counter for non-3GPP access for that PLMN in case of PLMN; or
- 2) the SNPN-specific attempt counter for 3GPP access for the current SNPN and the SNPN-specific attempt counter for non-3GPP access for the current SNPN in case of SNPN;

to the UE implementation-specific maximum value.

The UE shall disable the N1 mode capability for the specific access type for which the message was received (see subclause 4.9).

If the message has been successfully integrity checked by the NAS, the UE shall disable the N1 mode capability also for the other access type (see subclause 4.9).

If the message was received via 3GPP access and the UE is operating in single-registration mode, the UE shall in addition set the EPS update status to EU3 ROAMING NOT ALLOWED. Additionally, the UE shall reset the tracking area updating attempt counter and enter the state EMM-REGISTERED.

#31 (Redirection to EPC required).

5GMM cause #31 received by a UE that has not indicated support for CIoT optimizations or not indicated support for S1 mode or received by a UE over non-3GPP access is considered an abnormal case and the behaviour of the UE is specified in subclause 5.5.1.3.7.

This cause value received from a cell belonging to an SNPN and the UE is operating in SNPN access operation mode is considered as an abnormal case and the behaviour of the UE is specified in subclause 5.5.1.3.7.

The UE shall set the 5GS update status to 5U3 ROAMING NOT ALLOWED (and shall store it according to subclause 5.1.3.2.2). The UE shall reset the registration attempt counter and enter the state 5GMM-REGISTERED.LIMITED-SERVICE.

The UE shall enable the E-UTRA capability if it was disabled and disable the N1 mode capability for 3GPP access (see subclause 4.9.2).

If the message was received via 3GPP access and the UE is operating in single-registration mode, the UE shall handle the EMM parameters EMM state, EPS update status, and tracking area updating attempt counter as specified in 3GPP TS 24.301 [15] for the case when the normal tracking area updating procedure is rejected with the EMM cause with the same value.

#62 (No network slices available).

The UE shall abort the registration procedure for mobility and periodic registration update procedure, set the 5GS update status to 5U2 NOT UPDATED and enter state 5GMM-REGISTERED.ATTEMPTING-REGISTRATION-UPDATE. Additionally, the UE shall reset the registration attempt counter.

The UE receiving the rejected NSSAI in the REGISTRATION REJECT message takes the following actions based on the rejection cause in the rejected S-NSSAI(s):

"S-NSSAI not available in the current PLMN or SNPN"

The UE shall add the rejected S-NSSAI(s) in the rejected NSSAI for the current PLMN or SNPN as specified in subclause 4.6.2.2 and shall not attempt to use this S-NSSAI(s) in the current PLMN or SNPN over any access until switching off the UE, the UICC containing the USIM is removed, an entry of the "list of subscriber data" with the SNPN identity of the current SNPN is updated, or the rejected S-NSSAI(s) are removed as described in subclause 4.6.2.2.

"S-NSSAI not available in the current registration area"

The UE shall add the rejected S-NSSAI(s) in the rejected NSSAI for the current registration area as specified in subclause 4.6.2.2 and shall not attempt to use this S-NSSAI(s) in the current registration area over the current access until switching off the UE, the UE moving out of the current registration area, the UICC containing the USIM is removed, an entry of the "list of subscriber data" with the SNPN identity of the current SNPN is updated, or the rejected S-NSSAI(s) are removed as described in subclause 4.6.2.2.

"S-NSSAI not available due to the failed or revoked network slice-specific authentication and authorization"

The UE shall store the rejected S-NSSAI(s) in the rejected NSSAI for the failed or revoked NSSAI as specified in subclause 4.6.2.2 and shall not attempt to use this S-NSSAI in the current PLMN or SNPN over any access until switching off the UE, the UICC containing the USIM is removed, the entry of the "list of subscriber data" with the SNPN identity of the current SNPN is updated, or the rejected S-NSSAI(s) are removed as described in subclause 4.6.1 and 4.6.2.2.

"S-NSSAI not available due to maximum number of UEs reached"

Unless the back-off timer value received along with the S-NSSAI is zero, the UE shall add the rejected S-NSSAI(s) in the rejected NSSAI for the maximum number of UEs reached as specified in subclause 4.6.2.2 and shall not attempt to use this S-NSSAI in the current PLMN or SNPN over the current access until switching off the UE, the UICC containing the USIM is removed, the entry of the "list of subscriber data" with the SNPN identity of the current SNPN is updated, or the rejected S-NSSAI(s) are removed as described in subclauses 4.6.1 and 4.6.2.2.

NOTE 8: If the back-off timer value received along with the S-NSSAI in the rejected NSSAI for the maximum number of UEs reached is zero as specified in subclause 10.5.7.4a of 3GPP TS 24.008 [12], the UE does not consider the S-NSSAI as the rejected S-NSSAI.

If there is one or more S-NSSAIs in the rejected NSSAI with the rejection cause "S-NSSAI not available due to maximum number of UEs reached", then for each S-NSSAI, the UE shall behave as follows:

- a) stop the timer T3526 associated with the S-NSSAI, if running;
- b) start the timer T3526 with:
 - 1) the back-off timer value received along with the S-NSSAI, if a back-off timer value is received along with the S-NSSAI that is neither zero nor deactivated; or
 - 2) an implementation specific back-off timer value, if no back-off timer value is received along with the S-NSSAI; and
- c) remove the S-NSSAI from the rejected NSSAI for the maximum number of UEs reached when the timer T3526 associated with the S-NSSAI expires.

If the UE has an allowed NSSAI or configured NSSAI and:

- 1) at least S-NSSAI of the allowed NSSAI or configured NSSAI is not included in the rejected NSSAI, the UE may stay in the current serving cell, apply the normal cell reselection process and start a registration procedure for mobility and periodic registration update with a requested NSSAI that includes any S-NSSAI from the allowed S-NSSAI or the configured NSSAI that is not in the rejected NSSAI.

- 2) all the S-NSSAI(s) in the allowed NSSAI and configured NSSAI are rejected and at least one S-NSSAI is rejected due to "S-NSSAI not available in the current registration area" and:
 - i) the REGISTRATION REJECT message is integrity protected, the UE is not operating in SNPN access operation mode and the Forbidden TAI(s) for the list of "5GS forbidden tracking areas for roaming" IE is not included in the REGISTRATION REJECT message and the REGISTRATION REJECT message is received from one of the TAI(s) in the current registration area, the UE shall store the TAI(s) belonging to the registration area in the list of "5GS forbidden tracking areas for roaming". If the REGISTRATION REJECT message is received from a TAI not in the current registration area, the UE shall store the current TAI in the list of "5GS forbidden tracking areas for roaming". The UE shall enter the state 5GMM-REGISTERED.LIMITED-SERVICE. The UE shall search for a suitable cell in another tracking area according to 3GPP TS 38.304 [28] or 3GPP TS 36.304 [25C]; or
 - ii) the REGISTRATION REJECT message is integrity protected and the UE is operating in SNPN access operation mode and the REGISTRATION REJECT message is received from one of the TAI(s) in the current registration area, the UE shall store the TAI(s) belonging to current registration area in the list of "5GS forbidden tracking areas for roaming" for the current SNPN. If the REGISTRATION REJECT message is received from a TAI not in the current registration area, the UE shall store the current TAI in the list of "5GS forbidden tracking areas for roaming". If the UE supports access to an SNPN using credentials from a credentials holder, equivalent SNPNs or both, the selected entry of the "list of subscriber data" or the selected PLMN subscription, and enter the state 5GMM-REGISTERED.LIMITED-SERVICE. The UE shall search for a suitable cell in another tracking area according to 3GPP TS 38.304 [28] or 3GPP TS 36.304 [25C].
- 3) otherwise, the UE may perform a PLMN selection or SNPN selection according to 3GPP TS 23.122 [5] and additionally, the UE may disable the N1 mode capability for the current PLMN or SNPN if the UE does not have an allowed NSSAI and each S-NSSAI in the configured NSSAI, if available, was rejected with cause "S-NSSAI not available in the current PLMN or SNPN" or "S-NSSAI not available due to the failed or revoked network slice-specific authentication and authorization" as described in subclause 4.9.

If the UE has neither allowed NSSAI for the current PLMN or SNPN nor configured NSSAI for the current PLMN or SNPN and,

- 1) if at least one S-NSSAI in the default configured NSSAI is not rejected, the UE may stay in the current serving cell, apply the normal cell reselection process, and start a registration procedure for mobility and periodic registration update with a requested NSSAI with that default configured NSSAI; or
- 2) if all the S-NSSAI(s) in the default configured NSSAI are rejected and at least one S-NSSAI is rejected due to "S-NSSAI not available in the current registration area",
 - i) if the REGISTRATION REJECT message is integrity protected and the UE is not operating in SNPN access operation mode and the REGISTRATION REJECT message is received from one of the TAI(s) in the current registration area, the UE shall store the TAI(s) belonging to current registration area in the list of "5GS forbidden tracking areas for roaming". If the REGISTRATION REJECT message is received from a TAI not in the current registration area, the UE shall store the current TAI in the list of "5GS forbidden tracking areas for roaming". The UE shall memorize the TAI(s) was stored in the list of "5GS forbidden tracking areas for roaming" for S-NSSAI is rejected due to "S-NSSAI not available in the current registration area" and enter the state 5GMM-REGISTERED.LIMITED-SERVICE. The UE shall search for a suitable cell in another tracking area according to 3GPP TS 38.304 [28] or 3GPP TS 36.304 [25C]; or
 - ii) If the REGISTRATION REJECT message is integrity protected and the UE is operating in SNPN access operation mode and the REGISTRATION REJECT message is received from one of the TAI(s) in the current registration area, the UE shall store the TAI(s) belonging to current registration area in the list of "5GS forbidden tracking areas for roaming". If the REGISTRATION REJECT message is received from a TAI not in the current registration area, the UE shall store the current TAI in the list of "5GS forbidden tracking areas for roaming". The UE shall memorize the TAI(s) was stored in the list of "5GS forbidden tracking areas for roaming" for S-NSSAI is rejected due to "S-NSSAI not available in the current registration area" for the current SNPN and, if the UE supports access to an SNPN using credentials from a credentials holder, equivalent SNPNs or both, the selected entry of the "list of subscriber data" or the selected PLMN subscription, and enter the state 5GMM-REGISTERED.LIMITED-SERVICE. The UE shall search for a suitable cell in another tracking area according to 3GPP TS 38.304 [28] or 3GPP TS 36.304 [25C].

- 3) otherwise, the UE may perform a PLMN selection or SNPN selection according to 3GPP TS 23.122 [5] and additionally, the UE may disable the N1 mode capability for the current PLMN or SNPN if each S-NSSAI in the default configured NSSAI was rejected with cause "S-NSSAI not available in the current PLMN or SNPN" or "S-NSSAI not available due to the failed or revoked network slice-specific authentication and authorization" as described in subclause 4.9.

If

- 1) the UE has allowed NSSAI for the current PLMN or SNPN or configured NSSAI for the current PLMN or SNPN or both and all the S-NSSAIs included in the allowed NSSAI or the configured NSSAI or both are rejected; or
- 2) the UE has neither allowed NSSAI for the current PLMN or SNPN nor configured NSSAI for the current PLMN or SNPN and all the S-NSSAIs included in the default configured NSSAI are rejected,

and the UE has rejected NSSAI for the maximum number of UEs reached, and the UE wants to obtain services in the current serving cell without performing a PLMN selection or SNPN selection, the UE may stay in the current serving cell and attempt to use the rejected S-NSSAI(s) for the maximum number of UEs reached in the current serving cell after the rejected S-NSSAI(s) are removed as described in subclause 4.6.2.2.

If the message was received via 3GPP access and the UE is operating in single-registration mode, the UE shall in addition set the EPS update status to EU2 NOT UPDATED, reset the tracking area updating attempt counter and enter the state EMM-REGISTERED.

#72 (Non-3GPP access to 5GCN not allowed).

When received over non-3GPP access the UE shall set the 5GS update status to 5U3 ROAMING NOT ALLOWED (and shall store it according to subclause 5.1.3.2.2) and shall delete last visited registered TAI and TAI list. If the UE is not registering or has not registered to the same PLMN over both 3GPP access and non-3GPP access, the UE shall additionally delete 5G-GUTI and ngKSI. Additionally, the UE shall reset the registration attempt counter and enter the state 5GMM-DEREGISTERED. If the message has been successfully integrity checked by the NAS, the UE shall set:

- 1) the PLMN-specific N1 mode attempt counter for non-3GPP access for that PLMN in case of PLMN; or
- 2) the SNPN-specific attempt counter for non-3GPP access for that SNPN in case of SNPN;

to the UE implementation-specific maximum value.

NOTE 10: The 5GMM sublayer states, the 5GMM parameters and the registration status are managed per access type independently, i.e. 3GPP access or non-3GPP access (see subclauses 4.7.2 and 5.1.3).

The UE shall disable the N1 mode capability for non-3GPP access (see subclause 4.9.3).

As an implementation option, the UE may enter the state 5GMM-DEREGISTERED.PLMN-SEARCH in order to perform a PLMN selection according to 3GPP TS 23.122 [5].

If received over 3GPP access the cause shall be considered as an abnormal case and the behaviour of the UE for this case is specified in subclause 5.5.1.3.7.

#73 (Serving network not authorized).

This cause value received from a cell belonging to an SNPN and the UE is operating in SNPN access operation mode is considered as an abnormal case and the behaviour of the UE is specified in subclause 5.5.1.3.7.

The UE shall set the 5GS update status to 5U3 ROAMING NOT ALLOWED (and shall store it according to subclause 5.1.3.2.2) and shall delete any 5G-GUTI, last visited registered TAI, TAI list and ngKSI. The UE shall delete the list of equivalent PLMNs, reset the registration attempt counter, store the PLMN identity in the forbidden PLMN list as specified in subclause 5.3.13A. For 3GPP access the UE shall enter state 5GMM-DEREGISTERED.PLMN-SEARCH in order to perform a PLMN selection according to 3GPP TS 23.122 [5], and for non-3GPP access the UE shall enter state 5GMM-DEREGISTERED.LIMITED-SERVICE and perform network selection as defined in 3GPP TS 24.502 [18]. If the message has been successfully integrity checked by the NAS, the UE shall set the PLMN-specific attempt counter and the PLMN-specific attempt counter for non-3GPP access for that PLMN to the UE implementation-specific maximum value.

If the message was received via 3GPP access and the UE is operating in single-registration mode, the UE shall in addition set the EPS update status to EU3 ROAMING NOT ALLOWED and shall delete any 4G-GUTI, last visited registered TAI, TAI list and eKSI. Additionally, the UE shall reset the tracking area updating attempt counter and enter the state EMM-DEREGISTERED.

#74 (Temporarily not authorized for this SNPN).

5GMM cause #74 is only applicable when received from a cell belonging to an SNPN and the UE is operating in SNPN access operation mode. 5GMM cause #74 received from a cell not belonging to an SNPN is considered as an abnormal case and the behaviour of the UE is specified in subclause 5.5.1.3.7.

The UE shall set the 5GS update status to 5U3 ROAMING NOT ALLOWED (and shall store it according to subclause 5.1.3.2.2) and shall delete any 5G-GUTI, last visited registered TAI, TAI list ngKSI and the list of equivalent SNPNs (if available). The UE shall reset the registration attempt counter and store the SNPN identity in the "temporarily forbidden SNPNs" list or "temporarily forbidden SNPNs for access for localized services in SNPN" list if the SNPN is an SNPN selected for localized services in SNPN (see 3GPP TS 23.122 [5]) for the specific access type for which the message was received and the selected entry of the "list of subscriber data" or the selected PLMN subscription, or in the "temporarily forbidden SNPNs for onboarding services in SNPN" list, if the UE is registered for onboarding services in SNPN, for the specific access type for which the message was received. If the UE supports access to an SNPN using credentials from a credentials holder, the UE shall store the SNPN identity in the "temporarily forbidden SNPNs" list along with the GIN(s) broadcasted by the SNPN if any, for the selected entry of the "list of subscriber data" or the selected PLMN subscription. If the UE supports access to an SNPN providing access for localized services in SNPN and the access for localized services in SNPN has been enabled, the UE shall store the SNPN identity in the list of "temporarily forbidden SNPNs for access for localized services in SNPN" (if the SNPN is an SNPN selected for localized services in SNPN (see 3GPP TS 23.122 [5]) along with the GIN(s) broadcasted by the SNPN if any, for the selected entry of the "list of subscriber data" or the selected PLMN subscription. If the UE is not registered for onboarding services in SNPN, for 3GPP access the UE shall enter state 5GMM-DEREGISTERED.PLMN-SEARCH and perform an SNPN selection according to 3GPP TS 23.122 [5] and for non-3GPP access the UE shall enter the state 5GMM-DEREGISTERED.LIMITED-SERVICE and perform network selection as defined in 3GPP TS 24.502 [18]. If the UE is registered for onboarding services in SNPN, the UE shall enter state 5GMM-DEREGISTERED.PLMN-SEARCH and perform an SNPN selection or an SNPN selection for onboarding services according to 3GPP TS 23.122 [5]. If the message has been successfully integrity checked by the NAS, the UE shall set the SNPN-specific attempt counter for 3GPP access and the SNPN-specific attempt counter for non-3GPP access for the current SNPN to the UE implementation-specific maximum value.

If the message has been successfully integrity checked by the NAS and the UE also supports the registration procedure over the other access to the same SNPN, the UE shall in addition handle 5GMM parameters and 5GMM state for this access, as described for this 5GMM cause value.

#75 (Permanently not authorized for this SNPN).

5GMM cause #75 is only applicable when received from a cell belonging to an SNPN with a globally-unique SNPN identity and the UE is operating in SNPN access operation mode. 5GMM cause #75 received from a cell not belonging to an SNPN or a cell belonging to an SNPN with a non-globally-unique SNPN identity is considered as an abnormal case and the behaviour of the UE is specified in subclause 5.5.1.3.7.

The UE shall set the 5GS update status to 5U3 ROAMING NOT ALLOWED (and shall store it according to subclause 5.1.3.2.2) and shall delete any 5G-GUTI, last visited registered TAI, TAI list ngKSI and the list of equivalent SNPNs (if available). The UE shall reset the registration attempt counter and store the SNPN identity in the "permanently forbidden SNPNs" or "permanently forbidden SNPNs for access for localized services in SNPN" list if the SNPN is an SNPN selected for localized services in SNPN (see 3GPP TS 23.122 [5]) list for the specific access type for which the message was received and the selected entry of the "list of subscriber data" or the selected PLMN subscription, or in the "permanently forbidden SNPNs for onboarding services in SNPN" list, if the UE is registered for onboarding services in SNPN, for the specific access type for which the message was received. If the UE supports access to an SNPN using credentials from a credentials holder, the UE shall store the SNPN identity in the "permanently forbidden SNPNs" list along with the GIN(s) broadcasted by the SNPN if any, for the selected entry of the "list of subscriber data" or the selected PLMN subscription. If the UE supports access to an SNPN providing access for localized services in SNPN and the access for localized services in SNPN has been enabled, the UE shall store the SNPN identity in the list of "permanently forbidden SNPNs for access for localized services in SNPN" (if the SNPN is an SNPN selected for localized services in SNPN (see 3GPP TS 23.122 [5]) along with the GIN(s) broadcasted by the SNPN if any, for the selected entry of the "list of subscriber data" or the selected PLMN subscription. If the UE is not registered for onboarding

services in SNPN, for 3GPP access the UE shall enter state 5GMM-DEREGISTERED.PLMN-SEARCH and perform an SNPN selection according to 3GPP TS 23.122 [5] and for non-3GPP access the UE shall enter the state 5GMM-DEREGISTERED.LIMITED-SERVICE and perform network selection as defined in 3GPP TS 24.502 [18]. If the UE is registered for onboarding services in SNPN, the UE shall enter state 5GMM-DEREGISTERED.PLMN-SEARCH and perform an SNPN selection or an SNPN selection for onboarding services according to 3GPP TS 23.122 [5]. If the message has been successfully integrity checked by the NAS, the UE shall set the SNPN-specific attempt counter for 3GPP access and the SNPN-specific attempt counter for non-3GPP access for the current SNPN to the UE implementation-specific maximum value.

If the message has been successfully integrity checked by the NAS and the UE also supports the registration procedure over the other access to the same SNPN, the UE shall in addition handle 5GMM parameters and 5GMM state for this access, as described for this 5GMM cause value.

#76 (Not authorized for this CAG or authorized for CAG cells only).

This cause value received via non-3GPP access or from a cell belonging to an SNPN and the UE is operating in SNPN access operation mode is considered as an abnormal case and the behaviour of the UE is specified in subclause 5.5.1.3.7.

The UE shall set the 5GS update status to 5U3.ROAMING NOT ALLOWED, store the 5GS update status according to subclause 5.1.3.2.2, and reset the registration attempt counter.

If 5GMM cause #76 is received from:

- 1) a CAG cell, and if the UE receives a "CAG information list" in the CAG information list IE or the Extended CAG information list IE included in the REGISTRATION REJECT message, the UE shall:
 - i) replace the "CAG information list" stored in the UE with the received CAG information list IE or the Extended CAG information list IE when received in the HPLMN or EHPLMN;
 - ii) replace the serving VPLMN's entry of the "CAG information list" stored in the UE with the serving VPLMN's entry of the received CAG information list IE or the Extended CAG information list IE when the UE receives the CAG information list IE or the Extended CAG information list IE in a serving PLMN other than the HPLMN or EHPLMN; or

NOTE 10: When the UE receives the CAG information list IE or the Extended CAG information list IE in a serving PLMN other than the HPLMN or EHPLMN, entries of a PLMN other than the serving VPLMN, if any, in the received CAG information list IE or the Extended CAG information list IE are ignored.

- iii) remove the serving VPLMN's entry of the "CAG information list" stored in the UE when the UE receives the CAG information list IE or the Extended CAG information list IE in a serving PLMN other than the HPLMN or EHPLMN and the CAG information list IE or the Extended CAG information list IE does not contain the serving VPLMN's entry.

Otherwise, the UE shall delete the CAG-ID(s) of the cell from the "allowed CAG list" for the current PLMN, if the CAG-ID(s) are authorized based on the "Allowed CAG list". In the case the "allowed CAG list" for the current PLMN only contains a range of CAG-IDs, how the UE deletes the CAG-ID(s) of the cell from the "allowed CAG list" for the current PLMN is up to UE implementation. In addition:

- i) if the entry in the "CAG information list" for the current PLMN does not include an "indication that the UE is only allowed to access 5GS via CAG cells" or if the entry in the "CAG information list" for the current PLMN includes an "indication that the UE is only allowed to access 5GS via CAG cells" and one or more CAG-ID(s) are authorized based on the updated "allowed CAG list" for the current PLMN, then the UE shall enter the state 5GMM-REGISTERED.LIMITED-SERVICE and shall search for a suitable cell according to 3GPP TS 38.304 [28] or 3GPP TS 36.304 [25C] with the updated "CAG information list";
 - ii) if the entry in the "CAG information list" for the current PLMN includes an "indication that the UE is only allowed to access 5GS via CAG cells" and no CAG-ID is authorized based on the updated "allowed CAG list" for the current PLMN, then the UE shall enter the state 5GMM-REGISTERED.PLMN-SEARCH and shall apply the PLMN selection process defined in 3GPP TS 23.122 [5] with the updated "CAG information list"; or

- iii) if the "CAG information list" does not include an entry for the current PLMN, then the UE shall enter the state 5GMM-REGISTERED.LIMITED-SERVICE and shall search for a suitable cell according to 3GPP TS 38.304 [28] or 3GPP TS 36.304 [25C] with the updated "CAG information list".
- 2) a non-CAG cell, and if the UE receives a "CAG information list" in the CAG information list IE or the Extended CAG information list IE included in the REGISTRATION REJECT message, the UE shall:
 - i) replace the "CAG information list" stored in the UE with the received CAG information list IE or the Extended CAG information list IE when received in the HPLMN or EHPLMN;
 - ii) replace the serving VPLMN's entry of the "CAG information list" stored in the UE with the serving VPLMN's entry of the received CAG information list IE or the Extended CAG information list IE when the UE receives the CAG information list IE or the Extended CAG information list IE in a serving PLMN other than the HPLMN or EHPLMN; or

NOTE 11: When the UE receives the CAG information list IE or the Extended CAG information list IE in a serving PLMN other than the HPLMN or EHPLMN, entries of a PLMN other than the serving VPLMN, if any, in the received CAG information list IE or the Extended CAG information list IE are ignored.

- iii) remove the serving VPLMN's entry of the "CAG information list" stored in the UE when the UE receives the CAG information list IE or the Extended CAG information list IE in a serving PLMN other than the HPLMN or EHPLMN and the CAG information list IE or the Extended CAG information list IE does not contain the serving VPLMN's entry.

Otherwise, the UE shall store an "indication that the UE is only allowed to access 5GS via CAG cells" in the entry of the "CAG information list" for the current PLMN, if any. If the "CAG information list" stored in the UE does not include the current PLMN's entry, the UE shall add an entry for the current PLMN to the "CAG information list" and store an "indication that the UE is only allowed to access 5GS via CAG cells" in the entry of the "CAG information list" for the current PLMN. If the UE does not have a stored "CAG information list", the UE shall create a new "CAG information list" and add an entry with an "indication that the UE is only allowed to access 5GS via CAG cells" for the current PLMN.

In addition:

- i) if one or more CAG-ID(s) are authorized based on the "allowed CAG list" for the current PLMN, then the UE shall enter the state 5GMM-REGISTERED.LIMITED-SERVICE and shall search for a suitable cell according to 3GPP TS 38.304 [28] with the updated CAG information; or
- ii) if no CAG-ID is authorized based on the "allowed CAG list" for the current PLMN, then the UE shall enter the state 5GMM-REGISTERED.PLMN-SEARCH and shall apply the PLMN selection process defined in 3GPP TS 23.122 [5] with the updated "CAG information list".

If the message was received via 3GPP access and the UE is operating in single-registration mode, the UE shall in addition set the EPS update status to EU3 ROAMING NOT ALLOWED, reset the tracking area updating attempt counter and enter the state EMM-REGISTERED.

#77 (Wireline access area not allowed).

5GMM cause #77 is only applicable when received from a wireline access network by the 5G-RG or the W-AGF acting on behalf of the FN-CRG (or on behalf of the N5GC device). 5GMM cause #77 received from a 5G access network other than a wireline access network and 5GMM cause #77 received by the W-AGF acting on behalf of the FN-BRG are considered as abnormal cases and the behaviour of the UE is specified in subclause 5.5.1.3.7.

When received over wireline access network, the 5G-RG and the W-AGF acting on behalf of the FN-CRG (or on behalf of the N5GC device) shall set the 5GS update status to 5U3 ROAMING NOT ALLOWED (and shall store it according to subclause 5.1.3.2.2), shall delete 5G-GUTI, last visited registered TAI, TAI list and ngKSI, shall reset the registration attempt counter, shall enter the state 5GMM-DEREGISTERED and shall act as specified in subclause 5.3.23.

NOTE 12: The 5GMM sublayer states, the 5GMM parameters and the registration status are managed per access type independently, i.e. 3GPP access or non-3GPP access (see subclauses 4.7.2 and 5.1.3).

#78 (PLMN not allowed to operate at the present UE location).

This cause value received from a non-satellite NG-RAN cell is considered as an abnormal case and the behaviour of the UE is specified in subclause 5.5.1.3.7.

The UE shall set the 5GS update status to 5U3 ROAMING NOT ALLOWED (and shall store it according to subclause 5.1.3.2.2) and shall delete last visited registered TAI and TAI list. If the UE is not registering or has not registered to the same PLMN over both 3GPP access and non-3GPP access, the UE shall additionally delete 5G-GUTI and ngKSI. Additionally, the UE shall reset the registration attempt counter. The UE shall store the PLMN identity and, if it is known, the current geographical location in the list of "PLMNs not allowed to operate at the present UE location" and shall start a corresponding timer instance (see subclause 4.23.2). The UE shall enter state 5GMM-DEREGISTERED.PLMN-SEARCH and perform a PLMN selection according to 3GPP TS 23.122 [5].

If the message was received via 3GPP access and the UE is operating in single-registration mode, the UE shall handle the EMM parameters EMM state, EPS update status, and tracking area updating attempt counter as specified in 3GPP TS 24.301 [15] for the case when the normal tracking area updating procedure is rejected with the EMM cause with the same value.

#79 (UAS services not allowed).

This cause value received when the UE did not include the service-level device ID set to the CAA-level UAV ID in the Service-level-AA container IE of REGISTRATION REQUEST message is considered as an abnormal case and the behaviour of the UE is specified in subclause 5.5.1.3.7.

The UE shall abort the registration procedure for mobility and periodic registration update procedure, set the 5GS update status to 5U2 NOT UPDATED and enter state 5GMM-REGISTERED.ATTEMPTING-REGISTRATION-UPDATE. Additionally, the UE shall reset the registration attempt counter. The UE may re-attempt the registration procedure to the current PLMN for services other than UAS services and shall not include the service-level device ID set to the CAA-level UAV ID in the Service-level-AA container IE of REGISTRATION REQUEST message unless the UE receives a CONFIGURATION UPDATE COMMAND message including the service-level-AA service status indication in the Service-level-AA container IE with the UAS field set to "UAS services enabled".

If the message was received via 3GPP access and the UE is operating in single-registration mode, the UE shall in addition set the EPS update status to EU2 NOT UPDATED, reset the tracking area updating attempt counter and enter the state EMM-REGISTERED.

#80 (Disaster roaming for the determined PLMN with disaster condition not allowed).

This cause value received via non-3GPP access or from a cell belonging to an SNPN and the UE is operating in SNPN access operation mode or when the UE did not indicate "disaster roaming mobility registration updating" in the 5GS registration type IE in the REGISTRATION REQUEST message is considered as an abnormal case and the behaviour of the UE is specified in subclause 5.5.1.3.7.

The UE shall abort the registration procedure for mobility and periodic registration update procedure, set the 5GS update status to 5U2 NOT UPDATED and enter state 5GMM-REGISTERED.PLMN-SEARCH. Additionally, the UE shall reset the registration attempt counter. The UE shall not attempt to register for disaster roaming on this PLMN for the UE determined PLMN with disaster condition for a period in the range of 12 to 24 hours. The UE shall not attempt to register for disaster roaming on this PLMN for a period in the range of 3 to 10 minutes. The UE shall perform PLMN selection as described in 3GPP TS 23.122 [6]. If the message has been successfully integrity checked by the NAS and the UE maintains the PLMN-specific attempt counter of the PLMN which sent the reject message for the UE determined PLMN with disaster condition, the UE shall set the PLMN-specific attempt counter of the PLMN which sent the reject message for the UE determined PLMN with disaster condition to the UE implementation-specific maximum value.

If the message was received via 3GPP access and the UE is operating in single-registration mode, the UE shall in addition set the EPS update status to EU2 NOT UPDATED, reset the tracking area updating attempt counter and enter the state EMM-REGISTERED.

#81 (Selected N3IWF is not compatible with the allowed NSSAI).

This cause value received when the UE does not access 5GCN over non-3GPP access using the N3IWF or has not indicated support for slice-based N3IWF selection in the REGISTRATION REQUEST message is considered as an abnormal case and the behaviour of the UE is specified in subclause 5.5.1.3.7.

The UE shall abort the registration procedure for mobility and periodic registration update procedure, set the 5GS update status to 5U2 NOT UPDATED and enter state 5GMM-DEREGISTERED.ATTEMPTING-REGISTRATION or 5GMM-DEREGISTERED.PLMN-SEARCH. Additionally, the UE shall reset the registration attempt counter. If the N3IWF identifier IE is included in the REGISTRATION REJECT message and the UE supports slice-based N3IWF selection, the UE may use the provided N3IWF identifier IE in N3IWF selection as specified in 3GPP TS 24.502 [18] prior to an immediate consecutive initial registration attempt to the network, otherwise the UE shall ignore the N3IWF identifier IE. Additionally, if the UE selects a new N3IWF and a new initial registration attempt is performed, the UE shall delete any 5G-GUTI, last visited registered TAI, TAI list and ngKSI.

#82 (Selected TNGF is not compatible with the allowed NSSAI).

This cause value received when the UE does not access 5GCN over non-3GPP access using the TNGF or has not indicated support for slice-based TNGF selection in the REGISTRATION REQUEST message is considered as an abnormal case and the behaviour of the UE is specified in subclause 5.5.1.3.7.

The UE shall abort the registration procedure for mobility and periodic registration update procedure, set the 5GS update status to 5U2 NOT UPDATED and enter state 5GMM-DEREGISTERED.ATTEMPTING-REGISTRATION or 5GMM-DEREGISTERED.PLMN-SEARCH. Additionally, the UE shall reset the registration attempt counter. If the TNAN information IE is included in the REGISTRATION REJECT message and the UE supports slice-based TNGF selection, the UE may use the provided TNAN information IE in TNAN selection as specified in 3GPP TS 24.502 [18] prior to an immediate consecutive registration attempt to the network, otherwise the UE shall ignore the TNAN information IE. Additionally, if the UE selects a new TNAN and a new initial registration attempt is performed, the UE shall delete any 5G-GUTI, last visited registered TAI, TAI list and ngKSI.

Other values are considered as abnormal cases. The behaviour of the UE in those cases is specified in subclause 5.5.1.3.7.

5.5.1.3.6 Mobility and periodic registration update for initiating an emergency PDU session not accepted by the network

If the mobility and periodic registration update request for initiating an emergency PDU session cannot be accepted by the network, the UE shall perform the procedures as described in subclause 5.5.1.3.5. If the mobility and periodic registration update request for initiating an emergency PDU session fails due to receiving the AUTHENTICATION REJECT message, the UE shall perform the procedures as described in subclauses 5.4.1.2.2.11, 5.4.1.2.3.1, 5.4.1.2.3A.1 or 5.4.1.3.5. Then if the UE is in the same selected PLMN where the last mobility and periodic registration update request was attempted, the UE shall:

- a) inform the upper layers of the failure of the procedure; or

NOTE 1: This can result in the upper layers requesting implementation specific mechanisms, e.g. procedures specified in 3GPP TS 24.229 [14] can result in the emergency call being attempted to another IP-CAN.

- b) perform de-registration locally, if not de-registered already, and attempt initial registration for emergency services.

If the mobility and periodic registration update request for initiating an emergency PDU session fails due to abnormal case b) in subclause 5.5.1.3.7, the UE shall perform the actions as described in subclause 5.5.1.3.7 and inform the upper layers of the failure to access the network.

NOTE 2: This can result in the upper layers requesting implementation specific mechanisms, e.g. procedures specified in 3GPP TS 24.229 [14] can result in the emergency call being attempted to another IP-CAN.

If the mobility and periodic registration update request for initiating an emergency PDU session fails due to abnormal cases c), d), e) or g) in subclause 5.5.1.3.7, the UE shall perform the procedures as described in subclause 5.5.1.3.7. Then if the UE is in the same selected PLMN where the last mobility and periodic registration update request was attempted, the UE shall:

- a) inform the upper layers of the failure of the procedure; or

NOTE 3: This can result in the upper layers requesting implementation specific mechanisms, e.g. procedures specified in 3GPP TS 24.229 [14] can result in the emergency call being attempted to another IP-CAN.

- b) perform de-registration locally, if not de-registered already, and attempt initial registration for emergency services.

5.5.1.3.6A Mobility and periodic registration update for an emergency services fallback not accepted by the network

If the mobility and periodic registration update request triggered upon receiving a request from the upper layers to perform an emergency services fallback:

- fails due to an abnormal case described in subclause 5.5.1.3.7, the UE shall perform the procedures as described in subclause 5.5.1.3.7;
- cannot be accepted by the network as described in subclause 5.5.1.3.5, the UE shall perform the procedures as described in subclause 5.5.1.3.5; or
- fails due to receiving the AUTHENTICATION REJECT message, the UE shall perform the procedures as described in subclauses 5.4.1.2.2.11, 5.4.1.2.3.1, 5.4.1.2.3A.1 or 5.4.1.3.5.

If the mobility and periodic registration update request triggered upon receiving a request from the upper layers to perform an emergency services fallback fails due to abnormal case b) in subclause 5.5.1.3.7, the UE shall inform the upper layers of the failure to access the network.

NOTE 1: This can result in the upper layers requesting implementation specific mechanisms, e.g. procedures specified in 3GPP TS 24.229 [14] can result in the emergency call being attempted to another IP-CAN.

If the mobility and periodic registration update request triggered upon receiving a request from the upper layers to perform an emergency services fallback fails due to abnormal cases c), d), e) or g), cannot be accepted or fails due to receiving the AUTHENTICATION REJECT message and the UE does not attempt to select an E-UTRA cell connected to EPC or 5GCN as described in subclause 5.5.1.3.5 and the UE is camped on NR or E-UTRA cell connected to 5GCN in the same PLMN where the last mobility and periodic registration update request was attempted, the UE shall inform the upper layers of the failure of the procedure.

NOTE 2: This can result in the upper layers requesting implementation specific mechanisms, e.g. procedures specified in 3GPP TS 24.229 [14] can result in the emergency call being attempted to another IP-CAN.

5.5.1.3.7 Abnormal cases in the UE

The following abnormal cases can be identified:

- a) Timer T3346 is running.

The UE shall not start the registration procedure for mobility and periodic registration update unless:

- 1) the UE is in 5GMM-CONNECTED mode;
- 2) the UE received a paging;
- 3) the UE receives a NOTIFICATION message over non-3GPP access when the UE is in 5GMM-CONNECTED mode over non-3GPP access and in 5GMM-IDLE mode over 3GPP access;
- 4) the UE is a UE configured for high priority access in selected PLMN or SNPN;
- 5) the UE has an emergency PDU session established or is establishing an emergency PDU session;
- 6) the UE receives a request from the upper layers to perform emergency services fallback;
- 7) the UE receives the CONFIGURATION UPDATE COMMAND message as specified in subclause 5.4.4.3;
- 8) the UE in NB-N1 mode is requested by the upper layer to transmit user data related to an exceptional event and:
 - the UE is allowed to use exception data reporting (see the ExceptionDataReportingAllowed leaf of the NAS configuration MO in 3GPP TS 24.368 [17] or the USIM file EF_{NASCONFIG} in 3GPP TS 31.102 [22]); and

- timer T3346 was not started when N1 NAS signalling connection was established with RRC establishment cause set to "mo-ExceptionData"; or

9) the MUSIM UE needs to request a new 5G-GUTI assignment as specified in subclause 5.5.1.3.2.

The UE stays in the current serving cell and applies the normal cell reselection process.

NOTE 1: It is considered an abnormal case if the UE needs to initiate a registration procedure for mobility and periodic registration update while timer T3346 is running independent on whether timer T3346 was started due to an abnormal case or a non-successful case.

If the registration procedure for mobility and periodic registration update was initiated for an MO MMTEL voice call (i.e. access category 4), for an MO MMTEL video call (i.e. access category 5), for an MO IMS registration related signalling (i.e. access category 9) or for NAS signalling connection recovery during an ongoing MO MMTEL voice call (i.e. access category 4), or during an MO MMTEL video call (i.e. access category 5) or during an ongoing MO IMS registration related signalling (i.e. access category 9), then a notification that the procedure was not initiated due to network congestion shall be provided to upper layers.

b) The lower layers indicate that the access attempt is barred.

The UE shall not start the registration procedure for mobility and periodic registration update. The UE stays in the current serving cell and applies the normal cell reselection process. Receipt of the access barred indication shall not trigger the selection of a different core network type (EPC or 5GCN).

The registration procedure for mobility and periodic registration update is started, if still needed, when the lower layers indicate that the barring is alleviated for the access category with which the access attempt was associated.

ba) The lower layers indicate that:

- 1) access barring is applicable for all access categories except categories 0 and 2 and the access category with which the access attempt was associated is other than 0 and 2; or
- 2) access barring is applicable for all access categories except category 0 and the access category with which the access attempt was associated is other than 0.

If the REGISTRATION REQUEST message has not been sent, the UE shall proceed as specified for case b. If the REGISTRATION REQUEST message has been sent, the UE shall proceed as specified for case e and, additionally, the registration procedure for mobility and periodic registration update is started, if still needed, when the lower layers indicate that the barring is alleviated for the access category with which the access attempt was associated. For additional UE requirements for both cases see subclause 4.5.5.

c) T3510 timeout.

The UE shall abort the registration update procedure and the N1 NAS signalling connection, if any, shall be released locally.

If the UE has initiated the registration procedure in order to enable performing the service request procedure for emergency services fallback, the UE shall inform the upper layers of the failure of the emergency services fallback (see 3GPP TS 24.229 [14]). Otherwise, the UE shall proceed as described below.

d) REGISTRATION REJECT message, other 5GMM cause values than those treated in subclause 5.5.1.3.5, and cases of 5GMM cause values #11, #15, #22, #31, #72, #73, #74, #75, #76, #77, #78, #79, #80, #81 and #82, if considered as abnormal cases according to subclause 5.5.1.3.5.

Upon reception of the 5GMM causes #95, #96, #97, #99 and #111 the UE should set the registration attempt counter to 5.

The UE shall proceed as described below.

e) Lower layer failure, release of the NAS signalling connection received from lower layers or the lower layers indicate that the RRC connection has been suspended without a cell change before the REGISTRATION ACCEPT or REGISTRATION REJECT message is received.

The UE shall abort the registration procedure and proceed as described below.

f) Change in the current TAI.

If the current TAI is changed before the registration procedure for mobility and periodic registration update is completed, the registration procedure for mobility and periodic registration update shall be aborted and re-initiated immediately. The UE shall set the 5GS update status to 5U2 NOT UPDATED.

- g) Registration procedure for mobility and periodic registration update and de-registration procedure collision.

If the UE receives a DEREGISTRATION REQUEST message without 5GMM cause value #11, #12, #13 or #15 before the registration procedure for mobility and periodic registration update has been completed, the registration procedure for mobility and periodic registration update shall be aborted and the de-registration procedure shall be progressed.

If the UE receives a DEREGISTRATION REQUEST message with 5GMM cause value #11, #12, #13 or #15 before the registration procedure for mobility and periodic registration update has been completed, the registration procedure for mobility and periodic registration update shall be progressed and the de-registration procedure shall be aborted.

NOTE 2: The registration procedure for mobility and periodic registration update shall be aborted only if the DEREGISTRATION REQUEST message indicates in the access type that the access in which the registration procedure for mobility and periodic registration update was attempted shall be de-registered. Otherwise both the procedures shall be progressed.

- h) Void

- i) Transmission failure of REGISTRATION REQUEST message indication from the lower layers or the lower layers indicate that the RRC connection has been suspended with a cell change.

The registration procedure for mobility and periodic registration update shall be aborted and re-initiated immediately. The UE shall set the 5GS update status to 5U2 NOT UPDATED.

- j) Transmission failure of REGISTRATION COMPLETE message indication with change in the current TAI.

If the current TAI is not in the TAI list, the registration procedure for mobility and periodic registration update shall be aborted and re-initiated immediately. The UE shall set the 5GS update status to 5U2 NOT UPDATED.

If the current TAI is still part of the TAI list, it is up to the UE implementation how to re-run the ongoing procedure.

- k) Transmission failure of REGISTRATION COMPLETE message indication without change in the current TAI.

It is up to the UE implementation how to re-run the ongoing procedure.

- l) UE-initiated de-registration required.

De-registration due to removal of USIM or entry update in the "list of subscriber data" or due to switch off:

The registration procedure for mobility and periodic registration update shall be aborted, and the UE initiated de-registration procedure shall be performed. The UE shall populate the 5GS mobile identity IE in the DEREGISTRATION REQUEST message with the same UE identity as used in the REGISTRATION REQUEST message for the aborted mobility and periodic registration update procedure.

De-registration not due to removal of USIM or entry update in the "list of subscriber data" and not due to switch off:

the UE initiated de-registration procedure shall be initiated after successful completion of the registration procedure for mobility and periodic registration update.

- m) Timer T3447 is running

The UE shall not start any registration procedure for mobility and registration update with Uplink data status IE or Follow-on request indicator set to "Follow-on request pending" unless:

- 1) the UE received a paging;
- 2) the UE is a UE configured for high priority access in selected PLMN;
- 3) the UE has an emergency PDU session established or is establishing an emergency PDU session;

- 4) the UE receives a request from the upper layers to perform emergency services fallback; or
- 5) the MUSIM UE needs to request a new 5G-GUTI assignment as specified in subclause 5.5.1.3.2.

The UE stays in the current serving cell and applies the normal cell reselection process. The mobility and periodic registration update procedure is started, if still necessary, when timer T3447 expires or timer T3447 is stopped.

n) Timer T3448 is running

The UE in 5GMM-IDLE mode shall not start any mobility and periodic registration update procedure with Follow-on request indicator set to "Follow-on request pending" unless:

- 1) the UE is a UE configured for high priority access in selected PLMN;
- 2) the UE which is only using 5GS services with control plane CIoT 5GS optimization received a paging request;
- 3) the UE in NB-N1 mode is requested by the upper layer to transmit user data related to an exceptional event and the UE is allowed to use exception data reporting (see the ExceptionDataReportingAllowed leaf of the NAS configuration MO in 3GPP TS 24.368 [17] or the USIM file EF_{NASCONFIG} in 3GPP TS 31.102 [22]);
- 4) the UE has an emergency PDU session established or is establishing an emergency PDU session; or
- 5) the UE receives a request from the upper layers to perform emergency services fallback.

The UE stays in the current serving cell and applies the normal cell reselection process. The mobility and periodic registration update procedure is started, if still necessary, when timer T3448 expires.

o) UE is not registered to the access other than the access the REGISTRATION ACCEPT message is received and the 5GS registration result value in the 5GS registration result IE value in the REGISTRATION ACCEPT message is set to "3GPP access and non-3GPP access".

The UE shall consider itself as being registered to only the access where the REGISTRATION ACCEPT message is received.

p) Access for localized services in current SNPN is no longer allowed.

If the mobility and periodic registration update is not for initiating an emergency PDU session, the registered SNPN is an SNPN selected for localized services in SNPN (see 3GPP TS 23.122 [5]) and:

- access for localized services in SNPN is disabled; or
- the validity information for the selected SNPN is no longer met;

the UE shall reset the registration attempt counter, stop T3510, abort the registration procedure for mobility and periodic registration update, locally release the NAS signalling connection, if any, and enter state 5GMM-REGISTERED.LIMITED-SERVICE or 5GMM-REGISTERED.PLMN-SEARCH in order to perform SNPN selection according to 3GPP TS 23.122 [5].

For the cases c, d and e the UE shall proceed as follows:

Timer T3510 shall be stopped if still running.

If the registration procedure is not for initiating an emergency PDU session, the registration attempt counter shall be incremented, unless it was already set to 5.

If the registration attempt counter is less than 5:

- if the TAI of the current serving cell is not included in the TAI list or the 5GS update status is different to 5U1 UPDATED or if the registration procedure was triggered due to cases c, g, n, v in subclause 5.5.1.3.2, the UE shall start timer T3511, shall set the 5GS update status to 5U2 NOT UPDATED and change to state 5GMM-REGISTERED.ATTEMPTING-REGISTRATION-UPDATE. When timer T3511 expires, the registration update procedure is triggered again.
- if the TAI of the current serving cell is included in the TAI list, the 5GS update status is equal to 5U1 UPDATED, and the UE is not performing the registration procedure after an inter-system change from S1

mode to N1 mode, the UE shall keep the 5GS update status to 5U1 UPDATED and enter state 5GMM-REGISTERED.NORMAL-SERVICE or 5GMM-REGISTERED.NON-ALLOWED-SERVICE (as described in subclause 5.3.5.2). The UE shall start timer T3511. If in addition the REGISTRATION REQUEST message did not include the MICO indication IE or the Extended DRX IE, and:

- the REGISTRATION REQUEST message indicated "periodic registration updating";
- the registration procedure was initiated to recover the NAS signalling connection due to "RRC Connection failure" from the lower layers; or
- the registration procedure was initiated by the UE in 5GMM-CONNECTED mode with RRC inactive indication entering a cell in the current registration area belonging to an equivalent PLMN of the registered PLMN and not belonging to the registered PLMN,

and none of the other reasons for initiating the registration updating procedure listed in subclause 5.5.1.3.2 was applicable, the timer T3511 may be stopped when the UE enters 5GMM-CONNECTED mode.

- if the TAI of the current serving cell is included in the TAI list, the 5GS update status is equal to 5U1 UPDATED and the UE is performing the registration procedure after an inter-system change from S1 mode to N1 mode, the UE shall change the 5GS update status to 5U2 NOT UPDATED and enter state 5GMM-REGISTERED.ATTEMPTING-REGISTRATION-UPDATE. The UE shall start timer T3511.
- If the procedure is performed via 3GPP access and the UE is operating in single-registration mode, the UE shall in addition handle the EPS update status as specified in 3GPP TS 24.301 [15] for the abnormal cases when a normal or periodic tracking area updating procedure fails and the tracking area attempt counter is less than 5 and the EPS update status is different from EU1 UPDATED.

If the registration attempt counter is equal to 5

- the UE shall start timer T3502 if the value of the timer as indicated by the network is not zero, shall set the 5GS update status to 5U2 NOT UPDATED.
- the UE shall delete the list of equivalent PLMNs (if any) or the list of equivalent SNPNs (if any) if the UE is not registering or has not registered to the same PLMN over both 3GPP access and non-3GPP access, and shall change to state 5GMM-REGISTERED.ATTEMPTING-REGISTRATION-UPDATE or optionally to 5GMM-REGISTERED.PLMN-SEARCH in order to perform a PLMN selection, SNPN selection or SNPN selection for onboarding services according to 3GPP TS 23.122 [5].
- if the value of T3502 as indicated by the network is zero, the UE shall perform the actions defined for the expiry of the timer T3502.

NOTE 3: For case e) if the lower layer failure is on a cell which was selected due to network slice-based cell reselection (see 3GPP TS 23.501 [8]), the UE can as an implementation option change the S-NSSAI(s) in the requested NSSAI to try and find a suitable NR cell.

- if the procedure is performed via 3GPP access and the UE is operating in single-registration mode:
 - the UE shall in addition handle the EPS update status as specified in 3GPP TS 24.301 [15] for the abnormal cases when a normal or periodic tracking area updating procedure fails and the tracking area attempt counter is equal to 5; and
 - if the UE does not change to state 5GMM-REGISTERED.PLMN-SEARCH, the UE shall attempt to select E-UTRAN radio access technology. The UE may disable the N1 mode capability as specified in subclause 4.9.

5.5.1.3.8 Abnormal cases on the network side

The following abnormal cases can be identified:

a) Lower layer failure

If a lower layer failure occurs before the message REGISTRATION COMPLETE has been received from the UE and timer T3550 is running, the AMF shall abort the procedure, enter 5GMM-IDLE mode.

If a new 5G-GUTI was assigned to the UE in the REGISTRATION ACCEPT message, the AMF shall consider both, the old and new 5G-GUTIs as valid until the old 5G-GUTI can be considered as invalid by the AMF. If a new TAI list was provided in the REGISTRATION ACCEPT message, both the old and new TAI lists shall also be considered valid until the old TAI list can be considered invalid by the AMF. If the old 5G-GUTI was allocated by an AMF other than the current AMF, the current AMF does not need to retain the old 5G-GUTI.

Additionally, if the REGISTRATION ACCEPT message includes:

1) Negotiated PEIPS assistance information IE:

- i) containing a new Paging subgroup ID and the UE is previously assigned a different Paging subgroup ID then, the AMF shall consider both, the old and new Paging subgroup IDs as valid until the old Paging subgroup ID can be considered as invalid by the AMF; or

NOTE 0: If the UE was not previously assigned a paging subgroup ID by the AMF, then AMF informs RAN about the new PEIPS assistance information, i.e., paging subgroup ID and it is up to RAN how to handle the old information at RAN and new information from AMF so that the paging is not missed.

- ii) containing no Paging subgroup ID or no Negotiated PEIPS assistance information IE, then the AMF shall delete any old Paging subgroup ID stored in the 5GMM context of the UE.

2) Negotiated WUS assistance information IE:

- i) containing a new UE paging probability information value and the UE is previously assigned a different UE paging probability information value then, the AMF shall consider both, the old and new UE paging probability information values as valid until the old UE paging probability information value can be considered as invalid by the AMF; or
- ii) containing no UE paging probability information value or no Negotiated WUS assistance information IE, then the AMF shall delete any old UE paging probability information value stored in the 5GMM context of the UE.

During this period:

1) if the new 5G-GUTI is used by the UE in a subsequent message, then:

- i) the AMF shall consider the old 5G-GUTI as invalid and, additionally, the old TAI list as invalid if a new TAI list was provided with the new 5G-GUTI in the REGISTRATION ACCEPT message;
- ii) if the AMF assigns a new Paging subgroup ID to the UE in the REGISTRATION ACCEPT message, then, the AMF shall consider the new Paging subgroup ID as valid and the old Paging subgroup ID, if any, as invalid; and
- iii) if the AMF assigns a new UE paging probability information value in the Negotiated WUS assistance information IE to the UE in the REGISTRATION ACCEPT message, then, the AMF shall consider the new UE paging probability information value as valid and the old UE paging probability information value, if any, as invalid.

2) if the old 5G-GUTI is used by the UE in a subsequent message, the AMF may use the identification procedure followed by a generic UE configuration update procedure. If the AMF in the REGISTRATION ACCEPT message:

- i) assigns a new Paging subgroup ID to the UE, then, the AMF shall include the PEIPS assistance information; or
- ii) does not assign a Paging subgroup ID to the UE then, the AMF shall not include the PEIPS assistance information;

and initiate the generic UE configuration update procedure; and

3) if the UE needs to be paged:

- i) if in the REGISTRATION ACCEPT message a new Paging subgroup ID in the Negotiated PEIPS assistance information IE is assigned to the UE:

- that previously has no Paging subgroup ID assigned then, the AMF shall use the new Paging subgroup ID for paging the UE;
 - that is same as the old Paging subgroup ID then, the AMF shall use the same Paging subgroup ID for paging the UE; or
 - that is different than the old Paging subgroup ID then, the AMF may first use the old Paging subgroup ID followed by the new Paging subgroup ID for paging the UE.
- ii) if in the REGISTRATION ACCEPT message a new UE paging probability information value in the Negotiated WUS assistance information IE is assigned to the UE:
- that previously has no UE paging probability information value assigned then, the AMF shall use the new UE paging probability information value for paging the UE;
 - that is same as the old UE paging probability information value then, the AMF shall use the same UE paging probability information value for paging the UE; or
 - that is different than the old UE paging probability information value then, the AMF may first use the old UE paging probability information value followed by the new UE paging probability information value for paging the UE.
- iii) the AMF selects the 5G-GUTI and TAI list as follows:
- the AMF may first use the old 5G-S-TMSI from the old 5G-GUTI for paging within the area defined by the old TAI list for an implementation dependent number of paging attempts using the selected Paging subgroup ID or the selected UE paging probability information value in the WUS assistance information IE. If a new TAI list was provided in the REGISTRATION ACCEPT message, the new TAI list should also be used for paging. Upon response from the UE, the AMF may initiate the generic UE configuration update procedure. If the response is received from a tracking area within the old and new TAI list, the network shall initiate the generic UE configuration update procedure. If in the REGISTRATION ACCEPT message a new Paging subgroup ID was assigned to the UE that is different than the old Paging subgroup ID then the network shall initiate the generic UE configuration update procedure; and
 - if no response is received to the paging attempts using the old 5G-S-TMSI from the old 5G-GUTI and the old Paging subgroup ID or the old UE paging probability information value in the WUS assistance information IE, the AMF may use the new 5G-S-TMSI from the new 5G-GUTI and the new Paging subgroup ID or the new UE paging probability information value in the WUS assistance information IE, if any, for paging, for an implementation dependent number of paging attempts. In this case, if a new TAI list was provided with the new 5G-GUTI in the REGISTRATION ACCEPT message, the new TAI list shall be used instead of the old TAI list.

b) Protocol error.

If the REGISTRATION REQUEST message has been received with a protocol error, the AMF shall return a REGISTRATION REJECT message with one of the following 5GMM cause values:

- #96 invalid mandatory information;
- #99 information element non-existent or not implemented;
- #100 conditional IE error; or
- #111 protocol error, unspecified.

c) T3550 time out.

On the first expiry of the timer, the AMF shall retransmit the REGISTRATION ACCEPT message and shall reset and restart timer T3550. The retransmission is performed four times, i.e. on the fifth expiry of timer T3550, the registration procedure for mobility and periodic registration update procedure is aborted.

During this period the AMF acts as described for case a) above.

- d) REGISTRATION REQUEST with 5GS registration type IE set to "mobility registration updating" or "periodic registration updating" received after the REGISTRATION ACCEPT message has been sent and before the REGISTRATION COMPLETE message is received, if the REGISTRATION COMPLETE message is expected.
- 1) If one or more of the information elements in the REGISTRATION REQUEST message differ from the ones received within the previous REGISTRATION REQUEST message, the previously initiated registration procedure for mobility and periodic registration update shall be aborted if the REGISTRATION COMPLETE message has not been received and the new registration procedure for mobility and periodic registration update shall be progressed; or
 - 2) if the information elements do not differ, then the REGISTRATION ACCEPT message shall be resent and timer T3550 shall be restarted. In that case, the retransmission counter related to timer T3550 is not incremented.
- e) More than one REGISTRATION REQUEST message with 5GS registration type IE set to "mobility registration updating" or "periodic registration updating" received and neither REGISTRATION ACCEPT message nor REGISTRATION REJECT message has been sent.
- 1) If one or more of the information elements in the REGISTRATION REQUEST message differs from the ones received within the previous REGISTRATION REQUEST message, the previously initiated registration procedure for mobility and periodic registration update shall be aborted and the new registration procedure for mobility and periodic registration update shall be progressed; or
 - 2) if the information elements do not differ, then the network shall continue with the previous registration procedure for mobility and periodic registration update and shall not treat any further this REGISTRATION REQUEST message.
- f) Lower layers indication of non-delivered NAS PDU due to handover.

If the REGISTRATION ACCEPT message or REGISTRATION REJECT message could not be delivered due to an intra AMF handover and the target TA is included in the TAI list, then upon successful completion of the intra AMF handover the AMF shall retransmit the REGISTRATION ACCEPT message or REGISTRATION REJECT message. If a failure of the handover procedure is reported by the lower layer and the N1 NAS signalling connection exists, the AMF shall retransmit the REGISTRATION ACCEPT message or REGISTRATION REJECT message.

- g) DEREGISTRATION REQUEST message received before REGISTRATION COMPLETE message is received, if the REGISTRATION COMPLETE message is expected.

If the De-registration type IE is set to "switch off":

The AMF shall abort the signalling for the registration procedure for mobility and periodic registration update towards the UE and shall progress the de-registration procedure as described in subclause 5.5.2.2.

NOTE 1: Internally in the AMF, before processing the de-registration request, the AMF can perform the necessary signalling procedures for the registration procedure for mobility and periodic registration update before progressing the de-registration procedure.

If the De-registration type IE is set to other type than "switch off":

The AMF shall proceed with registration procedure for mobility and periodic registration update and shall progress the de-registration procedure after successful completion of the registration procedure for mobility and periodic registration update.

- h) If the REGISTRATION REQUEST message with 5GS registration type IE indicating "periodic registration updating" is received by the new AMF which does not have the 5GMM context data related to the subscription, the new AMF may send the REGISTRATION REJECT message with 5GMM cause #10 "implicitly de-registered".
- i) Based on operator policy, if the mobility and periodic registration update request from a UE not supporting CAG is rejected due to CAG restrictions, the network shall reject the mobility and periodic registration update request with a 5GMM cause value other than the 5GMM cause #76 (Not authorized for this CAG or authorized for CAG cells only).

NOTE 2: 5GMM cause #7 (5GS services not allowed), 5GMM cause #11 (PLMN not allowed), 5GMM cause #27 (N1 mode not allowed), 5GMM cause #73 (Serving network not authorized) can be used depending on the subscription of the UE and whether the UE roams or not.

5.5.2 De-registration procedure

5.5.2.1 General

The de-registration procedure is used:

- a) by the UE to de-register for 5GS services over 3GPP access when the UE is registered over 3GPP access;
- b) by the UE to de-register for 5GS services over non-3GPP access when the UE is registered over non-3GPP access;
- c) by the UE to de-register for 5GS services over 3GPP access, non-3GPP access or both when the UE is registered in the same PLMN over both accesses;
- d) by the network to inform the UE that it is deregistered for 5GS services over 3GPP access when the UE is registered over 3GPP access;
- e) by the network to inform the UE that it is deregistered for 5GS services over non-3GPP access when the UE is registered over non-3GPP access;
- f) by the network to inform the UE that it is deregistered for 5GS services over 3GPP access, non-3GPP access or both when the UE is registered in the same PLMN over both accesses;
- g) by the network to inform the UE to re-register to the network;
- h) by the network to inform the UE supporting UAS service that it is deregistered for UAS services in 5GS; and
- i) by the network to inform the UE operating as MBSR that it is deregistered for MBSR in 5GS.

The de-registration procedure with appropriate de-registration type shall be invoked by the UE:

- a) if the UE is switched off;
- b) as part of the eCall inactivity procedure defined in subclause 5.5.3; and
- c) as part of USIM removal.

The de-registration procedure with appropriate de-registration type shall be invoked by the network:

- a) if the network informs whether the UE should re-register to the network.

The de-registration procedure with appropriate access type shall be invoked by the UE:

- a) to de-register for 5GS services over 3GPP access when the UE is registered over 3GPP access;
- b) to de-register for 5GS services over non-3GPP access when the UE is registered over non-3GPP access;
- c) to de-register for 5GS services over 3GPP access, non-3GPP access or both when the UE is registered in the same PLMN over both accesses;
- d) to de-register for 5GS services over 3GPP access, if the UE is registered for disaster roaming over 3GPP access and has successfully registered over non-3GPP access on another PLMN; or
- e) to de-register for 5GS services if an event is triggered in the UE that would make the UE unavailable for a certain period of time and the UE is not able to store its 5GMM and 5GSM context.

NOTE 1: If the UE is able to store its 5GMM and 5GSM contexts, the UE triggers the registration procedure for mobility and periodic registration update.

The de-registration procedure with appropriate access type shall be invoked by the network:

- a) if the network needs to inform the UE that it is deregistered over 3GPP access when the UE is registered over 3GPP access;
- b) if the network needs to inform the UE that it is deregistered over non-3GPP access when the UE is registered over non-3GPP access; or
- c) if the network needs to inform the UE that it is deregistered over 3GPP access, non-3GPP access or both when the UE is registered in the same PLMN over both accesses.

If the de-registration procedure is triggered due to USIM removal, the UE shall indicate "switch off" in the de-registration type IE.

If the de-registration procedure is requested by the network for a UE that has an emergency PDU session, the AMF shall not send a DEREGISTRATION REQUEST message to the UE and indicate to the SMF to release all non-emergency PDU sessions as specified in 3GPP TS 23.502 [9].

If the de-registration procedure for 5GS services is performed, a local release of the PDU sessions over the indicated access(es), if any, for this particular UE is performed. If a PDU session that will be released is associated with one or more multicast MBS sessions, the UE is considered as removed from the associated multicast MBS sessions.

The UE is allowed to initiate the de-registration procedure even if the timer T3346 is running.

NOTE 2: When the UE has no PDU sessions over non-3GPP access, or the UE moves all the PDU sessions over a non-3GPP access to a 3GPP access, the UE and the AMF need not initiate de-registration over the non-3GPP access.

The AMF shall provide the UE with a non-3GPP de-registration timer.

When the AMF enters the state 5GMM-DEREGISTERED for 3GPP access, the AMF shall delete the stored UE radio capability information or the UE radio capability ID, if any.

When upper layers indicate that emergency services are no longer required, the UE if still registered for emergency services, may perform UE-initiated de-registration procedure followed by a re-registration to regain normal services, if the UE is in or moves to a suitable cell.

If the UE is registered for onboarding services in SNPN, after completing the configuration of one or more entries of the "list of subscriber data", the UE should perform UE-initiated de-registration procedure. To prevent the UE registered for onboarding services in SNPN from staying on the ON-SNPN or to prevent a UE whose subscription only allows for configuration of SNPN subscription parameters in PLMN via the user plane, from staying registered indefinitely, when an implementation specific timer expires:

- if the AMF considers that the UE is in 5GMM-IDLE, the AMF shall locally de-registers the UE; or
- if the UE is in 5GMM-CONNECTED, the AMF shall initiate the network-initiated de-registration procedure (see subclause 5.5.2.3).

NOTE 3: The value of the implementation specific timer for onboarding services needs to be large enough to allow a UE to complete the configuration of one or more entries of the "list of subscriber data" taking into consideration that configuration of SNPN subscription parameters in PLMN via the user plane or onboarding services in SNPN involves third party entities outside of the operator's network.

NOTE 4: How to determine the completion of the configuration of one or more entries of the "list of subscriber data" is UE implementation specific.

If the de-registration procedure is not due to switch off and upper layers request establishing an emergency PDU session before the de-registration procedure has been completed, the UE shall abort the de-registration procedure, perform local de-registration and initiate a registration procedure.

If the UE in 5GMM-CONNECTED mode determines to obtain service on a higher priority PLMN due to SOR, then based on the conditions as specified in 3GPP TS 23.122 [5] annex C, where applicable, the UE shall perform UE-initiated de-registration procedure.

If the UE is registered for disaster roaming services, and the UE receives an indication of whether disaster roaming is enabled in the UE set to "Disaster roaming is disabled in the UE" in a UE parameters update transparent container, the UE shall perform UE-initiated de-registration procedure.

5.5.2.2 UE-initiated de-registration procedure

5.5.2.2.1 UE-initiated de-registration procedure initiation

The de-registration procedure is initiated by the UE by sending a DEREGISTRATION REQUEST message (see example in figure 5.5.2.2.1). The De-registration type IE included in the message indicates whether the de-registration procedure is due to a "switch off" or not. The access type included in the message indicates whether the de-registration procedure is:

- a) for 5GS services over 3GPP access when the UE is registered over 3GPP access;
- b) for 5GS services over non-3GPP access when the UE is registered over non-3GPP access; or
- c) for 3GPP access, non-3GPP access or both when the UE is registered in the same PLMN over both accesses.

If the UE has a valid 5G-GUTI, the UE shall populate the 5GS mobile identity IE with the valid 5G-GUTI.

NOTE 1: In some abnormal cases, the 5G-GUTI can be a 5G-GUTI mapped from a valid native 4G-GUTI (see subclause 5.5.1.2.7, item f and subclause 5.5.1.3.7, item l).

If the UE does not have a valid 5G-GUTI, the UE shall populate the 5GS mobile identity IE with its SUCI as follows:

- a) if timer T3519 is not running and the de-registration is not due to USIM removal, generate a fresh SUCI as specified in 3GPP TS 33.501 [24], send a DEREGISTRATION REQUEST message with the SUCI, start timer T3519 and store the value of the SUCI sent in the DEREGISTRATION REQUEST message; and
- b) if timer T3519 is running, send a DEREGISTRATION REQUEST message with the stored SUCI.

If the UE does not have a valid 5G-GUTI and it does not have a valid SUCI, then the UE shall populate the 5GS mobile identity IE with its PEI.

NOTE 2: During the initial registration for emergency services when the UE (with no USIM or invalid USIM) is in 5GMM-REGISTERED-INITIATED state, the UE has neither a valid 5G-GUTI nor a valid SUCI.

If the de-registration request is not due to switch off and the UE is in the state 5GMM-REGISTERED or 5GMM-REGISTERED-INITIATED, timer T3521 shall be started in the UE after the DEREGISTRATION REQUEST message has been sent. The UE shall enter the state 5GMM-DEREGISTERED-INITIATED.

If the UE is to be switched off, the UE shall try for a period of 5 seconds to send the DEREGISTRATION REQUEST message. During this period, the UE may be switched off as soon as the DEREGISTRATION REQUEST message has been sent.

If the network indicated support for the unavailability period in the last registration procedure; and an event is triggered in the UE that would make the UE unavailable for a certain period, the use of unavailability period is not due to NR satellite access discontinuous coverage and the UE is unable to store its 5GMM and 5GSM contexts, the UE shall include the unavailability period duration in the Unavailability information IE, set the Unavailability type to "unavailability due to UE reasons" and set the De-registration type to "Normal de-registration" in the DEREGISTRATION REQUEST message. The UE shall start the timer T3521 and enter the state 5GMM-DEREGISTERED-INITIATED.

If the UE is sending the DEREGISTRATION REQUEST message from 5GMM-IDLE mode and the UE needs to send non-clear-text IEs, the UE shall send the DEREGISTRATION REQUEST message including the NAS message container IE as described in subclause 4.4.6.

The 5G-RG shall not initiate the de-registration procedure for itself until it successfully de-registers all the AUN3 devices connected to it, if any, by initiating the de-registration procedure on behalf of the AUN3 device.

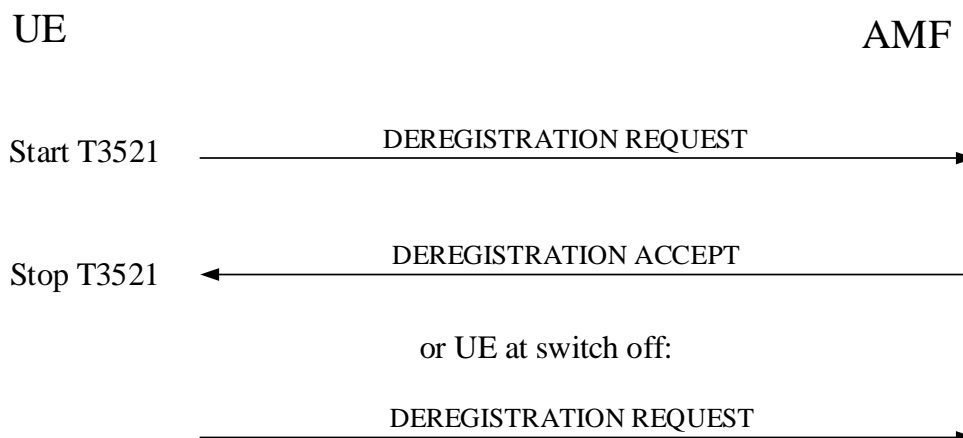

Figure 5.5.2.2.1.1: UE-initiated de-registration procedure

5.5.2.2.2 UE-initiated de-registration procedure completion

When the Deregistration Request message is received by the AMF, the AMF shall send a Deregistration Accept message to the UE, if the De-registration type IE does not indicate "switch off". Otherwise, the procedure is completed when the AMF receives the Deregistration Request message.

The UE, when receiving the Deregistration Accept message, shall stop timer T3521, stop timer T3519 if running, and delete any stored SUCI.

5.5.2.2.3 UE-initiated de-registration procedure completion for 5GS services over 3GPP access

If the access type in the Deregistration Request message indicates that the de-registration procedure is for 3GPP access, the AMF shall trigger the SMF to perform a local release of the PDU session(s) established over 3GPP access, if any, for this UE. The UE shall perform a local release of the PDU session(s) established over 3GPP access, if any. If a PDU session is associated with one or more multicast MBS sessions, the UE shall locally leave the associated multicast MBS sessions and the SMF shall consider the UE as removed from the associated multicast MBS sessions. If there is an MA PDU session with user plane resources established on both 3GPP access and non-3GPP access in the same PLMN or in different PLMNs, the AMF shall trigger SMF to perform release of user plane resources on 3GPP access, and the UE shall consider the user plane resources on 3GPP access as released. If there is an MA PDU session with user plane resources established on 3GPP access only, the AMF shall trigger the SMF to perform a local release of the MA PDU session, and the UE shall perform a local release of the MA PDU session. If the MA PDU session is associated with one or more MBS multicast sessions, the UE shall locally leave the associated MBS multicast sessions. The UE is marked as inactive in the AMF for 5GS services for 3GPP access. The AMF shall enter the state 5GMM-DEREGISTERED for 3GPP access.

If the UE supports N1 mode only and the de-registration request is not due to switch off, then:

- a) if the de-registration procedure was performed due to disabling of 5GS services, then the UE shall enter the 5GMM-NULL state for 3GPP access;
- b) otherwise, the UE shall enter the 5GMM-DEREGISTERED state for 3GPP access.

NOTE: Case b) is applicable when the UE is also registered over non-3GPP access.

If the access type indicates that the de-registration procedure is for 3GPP access or for 3GPP access and non-3GPP access, and the UE is operating in single-registration mode, it shall additionally proceed as specified in 3GPP TS 24.301 [15], subclause 5.5.2.2.2, for the case when the UE receives an EMM message DETACH ACCEPT. Furthermore, if the UE supports A/Gb or Iu mode and the de-registration procedure was not performed due to the last T309 timer expiry or stopped (see 3GPP TS 23.122 [5]), it shall disable the N1 mode capability for 3GPP access.

5.5.2.2.4 UE-initiated de-registration procedure completion for 5GS services over non-3GPP access

If the access type in the DEREGISTRATION REQUEST indicates that the de-registration procedure is for non-3GPP access, the AMF shall trigger SMF to perform a local release of the PDU session(s) established over non-3GPP access, if any, for this UE. The UE shall perform a local release of the PDU session(s) established over non-3GPP access, if any. If there is an MA PDU session with user plane resources established on both 3GPP access and non-3GPP access in the same PLMN or in different PLMNs, the AMF shall trigger SMF to perform release of user plane resources on non-3GPP access, and the UE shall consider the user plane resources on non-3GPP access as released. If there is an MA PDU session with a PDN connection as a user-plane resource and user plane resources established on non-3GPP access, the AMF shall trigger SMF to perform release of user plane resources on non-3GPP access, and the UE shall consider the user plane resources on non-3GPP access as released. If the UE has an MA PDU session with user plane resources established on non-3GPP access only, the AMF shall trigger the SMF to perform a local release of the MA PDU session, and the UE shall perform a local release of the MA PDU session. The UE is marked as inactive in the AMF for 5GS services for non-3GPP access. The AMF shall enter the state 5GMM-DEREGISTERED over non-3GPP access.

If the de-registration request is not due to switch off, the UE shall:

- a) if the de-registration procedure was performed due to disabling of 5GS services, enter the 5GMM-NULL state for non-3GPP access;
- b) otherwise, enter the 5GMM-DEREGISTERED state for non-3GPP access.

NOTE: Case b) is applicable when the UE is also registered over 3GPP access.

5.5.2.2.5 UE-initiated de-registration procedure completion for 5GS services over both 3GPP access and non-3GPP access

If the access type in the DEREGISTRATION REQUEST indicates that the de-registration procedure is for both 3GPP access and non-3GPP access when the UE is registered in the same PLMN over both accesses, the descriptions for UE-initiated de-registration procedure completion for 5GS services over 3GPP access and over non-3GPP access, as specified in subclauses 5.5.2.2.3 and 5.5.2.2.4, shall be followed.

5.5.2.2.6 Abnormal cases in the UE

The following abnormal cases can be identified:

- a) Lower layer failure or release of the N1 NAS signalling connection before reception of DEREGISTRATION ACCEPT message.

The de-registration procedure shall be aborted and the UE proceeds as follows:

- 1) if the de-registration procedure was performed due to disabling of 5GS services, the UE shall enter the 5GMM-NULL state; or
- 2) if the de-registration type "normal de-registration" was requested for reasons other than disabling of 5GS services, the UE shall enter the 5GMM-DEREGISTERED state.

- b) The lower layers indicate that the access attempt is barred.

The UE shall not start the signalling for the de-registration procedure. The UE stays in the current serving cell and applies the normal cell reselection process. Receipt of the access barred indication shall not trigger the selection of a different core network type (EPC or 5GCN).

The UE may perform a local de-registration either immediately or after an implementation-dependent time.

The signalling for the de-registration procedure is started, if still needed, when the lower layers indicate that the barring is alleviated for the access category with which the access attempt was associated.

- ba) The lower layers indicate that:

- 1) access barring is applicable for all access categories except categories 0 and 2 and the access category with which the access attempt was associated is other than 0 and 2; or

- 2) access barring is applicable for all access categories except category 0 and the access category with which the access attempt was associated is other than 0.

If the DEREGISTRATION REQUEST message has not been sent, the UE shall proceed as specified for case b.
If the DEREGISTRATION REQUEST message has been sent, the UE shall proceed as specified for case a.

c) T3521 timeout.

If the de-registration procedure was performed based on conditions specified in 3GPP TS 23.122 [5] annex C, on the expiry of timer T3521 the de-registration procedure shall be aborted and the UE shall locally release the established N1 NAS signalling connection and enter the 5GMM-DEREGISTERED state.

Otherwise, on the first four expiries of the timer, the UE shall retransmit the DEREGISTRATION REQUEST message and shall reset and restart timer T3521. On the fifth expiry of timer T3521, the de-registration procedure shall be aborted and the UE proceeds as follows:

- 1) if the de-registration procedure was performed due to disabling of 5GS services, the UE shall enter the 5GMM-NULL state; or
- 2) if the de-registration type "normal de-registration" was requested for reasons other than disabling of 5GS services, the UE shall enter the 5GMM-DEREGISTERED state.

d) De-registration procedure collision.

De-registration containing de-registration type "switch off":

- If the UE receives a DEREGISTRATION REQUEST message before the UE-initiated de-registration procedure has been completed, this message shall be ignored and the UE-initiated de-registration procedure shall continue.

Otherwise:

- If the UE receives a DEREGISTRATION REQUEST message before the UE-initiated de-registration procedure has been completed, it shall treat the message as specified in subclause 5.5.2.3.2 with the following modification:
 - If the DEREGISTRATION REQUEST message received by the UE contains de-registration type "re-registration required", and the UE-initiated de-registration procedure is with de-registration type "normal de-registration":
 - If the access type included in the DEREGISTRATION REQUEST message sent by the UE is same as access type sent by the network, the UE need not initiate the registration procedure for initial registration; or
 - If the access type included in the DEREGISTRATION REQUEST message sent by the UE is not same as access type sent by the network, the UE shall initiate the registration procedure for initial registration for the access type not indicated in the DEREGISTRATION REQUEST message sent by the UE but indicated by the network.

e) De-registration and 5GMM common procedure collision.

De-registration containing de-registration type "switch off":

- If the UE receives a message used in a 5GMM common procedure before the de-registration procedure has been completed, this message shall be ignored and the de-registration procedure shall continue.

Otherwise:

- If the UE receives a CONFIGURATION UPDATE COMMAND message before the de-registration procedure has been completed, the UE shall ignore the CONFIGURATION UPDATE COMMAND message and proceed with the de-registration procedure;
- If the UE receives a message used in a 5GMM common procedure other than a CONFIGURATION UPDATE COMMAND message before the de-registration procedure has been completed, both the 5GMM common procedure and the de-registration procedure shall continue; or

- If the UE receives a DL NAS TRANSPORT message containing payload container type "Service-level-AA container" before the de-registration procedure has been completed, this message shall be ignored and the de-registration procedure shall continue.

f) Change in the current TAI.

If that the current TAI is not in the stored TAI list before the UE-initiated de-registration procedure is completed, the UE proceeds as follows:

- 1) if the de-registration procedure was initiated for reasons other than removal of the USIM, the UE is to be switched off or due to the last T₃₅₂₁ timer expiry or stopped (see 3GPP TS 23.122 [5]), the de-registration procedure shall be aborted and re-initiated after successfully performing a registration procedure for mobility or periodic update used for mobility (i.e. the 5GS registration type IE set to "mobility registration updating" in the REGISTRATION REQUEST message); or
 - 2) if the de-registration procedure was initiated due to removal of the USIM or the UE is to be switched off or due to the last T₃₅₂₁ timer expiry or stopped (see 3GPP TS 23.122 [5]), the UE shall abort the de-registration procedure, perform a local de-registration and enter the state 5GMM-DEREGISTERED.
- g) Transmission failure of DEREGISTRATION REQUEST message indication with change in the current TAI.

If the current TAI is not in the TAI list, the UE proceeds as follows:

- 1) if the de-registration procedure was initiated for reasons other than removal of the USIM, the UE is to be switched off or due to the last T₃₅₂₁ timer expiry or stopped (see 3GPP TS 23.122 [5]), the de-registration procedure shall be aborted and re-initiated after successfully performing a registration procedure for mobility or periodic update; or
- 2) if the de-registration procedure was initiated due to removal of the USIM or the UE is to be switched off or due to the last T₃₅₂₁ timer expiry or stopped (see 3GPP TS 23.122 [5]), the UE shall abort the de-registration procedure, perform a local de-registration and enter the state 5GMM-DEREGISTERED.

If the current TAI is still part of the TAI list, the UE shall restart the de-registration procedure.

h) Transmission failure of DEREGISTRATION REQUEST message indication without change in the current TAI.

The UE shall restart the de-registration procedure.

i) The lower layers indicate that the RRC connection has been suspended.

De-registration containing de-registration type "switch off":

- The UE may perform a local de-registration either immediately or after an implementation-dependent time.

Otherwise:

- The UE shall wait for an implementation-dependent time and shall restart the de-registration procedure, if still needed, upon expiry of the implementation-dependent time.

For the cases a, f, g and i:

- Timer T₃₅₂₁ shall be stopped if still running.

5.5.2.2.7 Abnormal cases in the network side

The following abnormal cases can be identified:

- a) De-registration request received in a cell belonging to an SNPN with a non-globally-unique SNPN identity for which the UE has no valid subscription

If the UE initiates a de-registration procedure in a cell belonging to an SNPN with a non-globally-unique SNPN identity for which the UE has no valid subscription, and the de-registration procedure is not due to "switch off", the network shall initiate the de-registration procedure. The AMF shall send a DEREGISTRATION REQUEST message including the 5GMM cause #74 "Temporarily not authorized for this SNPN".

- b) De-registration request received in a cell belonging to an SNPN with a globally-unique SNPN identity for which the UE has no valid subscription

If the UE initiates a de-registration procedure in a cell belonging to an SNPN with a globally-unique SNPN identity for which the UE has no valid subscription, and the de-registration procedure is not due to "switch off", the network shall initiate the de-registration procedure. The AMF shall send a DEREGISTRATION REQUEST message including the 5GMM cause #75 "Permanently not authorized for this SNPN".

- c) De-registration request received in a CAG cell and none of the CAG ID broadcasted by the CAG cell is authorized based on the UE's "allowed CAG list" for the current PLMN

If the UE initiates a de-registration procedure in a CAG cell and none of the CAG ID broadcasted by the CAG cell is authorized based on the UE's "allowed CAG list" for the current PLMN and the de-registration procedure is not due to "switch off", the AMF shall initiate the de-registration procedure. The AMF shall send a DEREGISTRATION REQUEST message including the 5GMM cause #76 "Not authorized for this CAG or authorized for CAG cells only" if the UE supports CAG. Otherwise, the network shall operate as described in bullet g) of subclause 5.5.2.3.5.

- d) De-registration request received in a non-CAG cell from a UE whose "CAG information list" includes an entry associated with the current PLMN, where the entry contains an "indication that the UE is only allowed to access 5GS via CAG cells"

If the UE initiates a de-registration procedure in a non-CAG cell from a UE whose "CAG information list" includes an entry associated with the current PLMN, where the entry contains an "indication that the UE is only allowed to access 5GS via CAG cells" and the de-registration procedure is not due to "switch off", the AMF shall initiate the de-registration procedure. The AMF shall send a DEREGISTRATION REQUEST message including the 5GMM cause #76 "Not authorized for this CAG or authorized for CAG cells only" if the UE supports CAG. Otherwise, the network shall operate as described in bullet g) of subclause 5.5.2.3.5.

- e) De-registration and registration procedure for initial registration collision

If the network receives a REGISTRATION REQUEST message indicating either "initial registration" or "emergency registration" in the 5GS registration type IE from the UE before the UE-initiated de-registration procedure, which is not due to switch off, has been completed, the network shall abort the de-registration procedure and the registration procedure shall be progressed.

5.5.2.3 Network-initiated de-registration procedure

5.5.2.3.1 Network-initiated de-registration procedure initiation

The network initiates the de-registration procedure by sending a DEREGISTRATION REQUEST message to the UE (see example in figure 5.5.2.3.1.1).

NOTE 1: If the AMF performs a local de-registration, it will inform the UE with a 5GMM messages (e.g. SERVICE REJECT message or REGISTRATION REJECT message) with 5GMM cause #10 "implicitly de-registered" only when the UE initiates a 5GMM procedure.

The network may include a 5GMM cause IE to specify the reason for the DEREGISTRATION REQUEST message. The network shall start timer T3522. The network shall indicate whether re-registration is needed or not in the De-registration type IE. The network shall also indicate via the access type whether the de-registration procedure is:

- a) for 3GPP access only;
- b) for non-3GPP access only; or
- c) for 3GPP access, non-3GPP access or both when the UE is registered in the same PLMN for both accesses.

If the network de-registration is triggered due to network slice-specific authentication and authorization failure or revocation as specified in subclause 4.6.2.4, then the network shall set the 5GMM cause value to #62 "No network slices available" in the DEREGISTRATION REQUEST message. In addition, if the UE supports extended rejected NSSAI, the AMF shall include the Extended rejected NSSAI IE in the DEREGISTRATION REQUEST message; otherwise, the AMF shall include the Rejected NSSAI IE in the DEREGISTRATION REQUEST message.

In roaming scenarios, if the Extended rejected NSSAI IE is included in the DEREGISTRATION REQUEST message, the AMF shall provide mapped S-NSSAI(s) for the rejected NSSAI.

If the UE supports extended rejected NSSAI and the network de-registration is triggered due to mobility management based network slice admission control as specified in subclause 4.6.2.5, then the network shall set the 5GMM cause value to #62 "No network slices available" in the DEREGISTRATION REQUEST message. In addition, the network may include a back-off timer value for each S-NSSAI with the rejection cause "S-NSSAI not available due to maximum number of UEs reached" in the Extended rejected NSSAI IE of the DEREGISTRATION REQUEST message.

If the network de-registration is triggered for a UE supporting CAG due to CAG restrictions, the network shall set the 5GMM cause value to #76 "Not authorized for this CAG or authorized for CAG cells only" and should include the "CAG information list" in the CAG information list IE or the Extended CAG information list IE in the DEREGISTRATION REQUEST message.

NOTE 2: If the UE supports extended CAG information list, the CAG information list can be included either in the CAG information list IE or Extended CAG information list IE.

NOTE 3: It is unexpected for network to send REGISTRATION REJECT message to the UE with 5GMM cause value #76 in non-CAG cell and not indicate "Indication that the UE is only allowed to access 5GS via CAG cells" for the serving PLMN in the Extended CAG information list or the CAG information list.

If the network de-registration is triggered for a UE not supporting CAG due to CAG restrictions, the network shall operate as described in bullet g) of subclause 5.5.2.3.5.

If the network de-registration is triggered because the network determines that the UE is in a location where the network is not allowed to operate, see 3GPP TS 23.502 [9], the network shall set the 5GMM cause value in the DEREGISTRATION REQUEST message to #78 "PLMN not allowed to operate at the present UE location".

If the network de-registration is triggered due to:

- a) an unsuccessful outcome of an ongoing UUA-MM procedure;
- b) an UUA revocation notification received from the UAS-NF for a UE supporting UAS service requesting UAS services; or
- c) the UE not allowed to use UAS services via 5GS due to a change of the aerial UE subscription information,

then the network shall set the 5GMM cause value in the DEREGISTRATION REQUEST message to #79 "UAS services not allowed".

NOTE 4: If the UE supporting UAS service has requested other services than UAS services, or if there are other ongoing network slice-specific authentication and authorization on pending NSSAIs, it is then an operator policy or configuration decision whether to keep the UE supporting UAS service registered to the network, but that UE supporting UAS services is not allowed to access UAS services via 5GS as specified in 3GPP TS 23.256 [6AB].

If the network de-registration is triggered for a UE supporting MINT due to a disaster condition no longer being applicable in the current location of the UE, the network shall set the 5GMM cause value to #11 "PLMN not allowed" and may include a disaster return wait range in the Disaster return wait range IE in the DEREGISTRATION REQUEST message.

If the network de-registration is triggered because the AMF determines that, by UE subscription and operator's preferences, all of the TAIs received from the satellite NG-RAN are forbidden for roaming or for regional provision of service, the AMF shall include the TAI(s) in:

- a) the Forbidden TAI(s) for the list of "5GS forbidden tracking areas for roaming" IE; or
- b) the Forbidden TAI(s) for the list of "5GS forbidden tracking areas for regional provision of service" IE; or
- c) both;

in the DEREGISTRATION REQUEST message.

If the network de-registration is triggered because the AMF determines that the UE operating as an IAB-node by subscription is not authorized for IAB-node operation, the AMF shall set the 5GMM cause value to #36 "IAB-node operation not authorized" in the DEREGISTRATION REQUEST message.

If the network de-registration is triggered for a UE operating as MBSR due to the UE no longer being allowed to operate as MBSR based on the UE subscription and the local policy, and:

- a) if the UE is allowed to operate as a UE, then the network shall indicate "re-registration required" in the De-registration type IE of the DEREGISTRATION REQUEST message; or
- b) if the UE is not allowed to operate as a UE, then the network shall indicate "re-registration not required" in the De-registration type IE of the DEREGISTRATION REQUEST message based on the local policy.

If the network de-registration is triggered due to the UE that was not allowed for MBSR operation becoming allowed to operate as MBSR based on the UE subscription and the local policy, then the network shall indicate "re-registration required" in the De-registration type IE of the DEREGISTRATION REQUEST message.

The AMF shall trigger the SMF to release locally the PDU session(s) over the indicated access(es), if any, for the UE and enter state 5GMM-DEREGISTERED-INITIATED. If a PDU session is associated with one or more multicast MBS sessions, the SMF shall consider the UE as removed from the associated multicast MBS sessions.

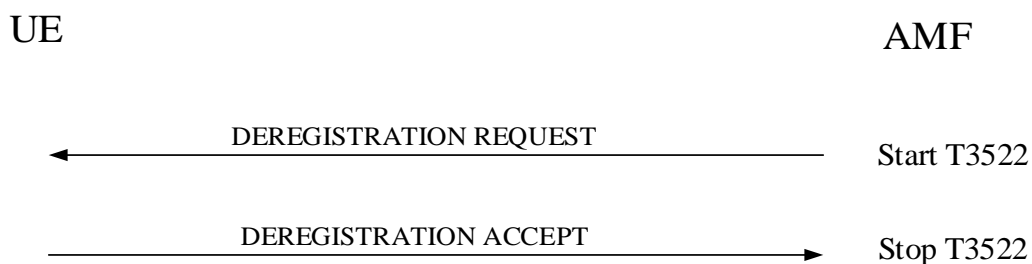

Figure 5.5.2.3.1.1: Network-initiated de-registration procedure

5.5.2.3.2 Network-initiated de-registration procedure completion by the UE

Upon receiving the DEREGISTRATION REQUEST message, if the DEREGISTRATION REQUEST message indicates "re-registration required" and the de-registration request is for 3GPP access, the UE shall perform a local release of the PDU sessions over 3GPP access, if any. If a PDU session is associated with one or more multicast MBS sessions, the UE shall locally leave the associated multicast MBS sessions. If there is an MA PDU session with user plane resources established on both 3GPP access and non-3GPP access in the same PLMN or in different PLMNs, the UE shall perform a local release of the user plane resources on 3GPP access. If there is an MA PDU session with user plane resources established on 3GPP access only, the UE shall perform a local release of the MA PDU session. If the MA PDU session is associated with one or more multicast MBS sessions, the UE shall locally leave the associated multicast MBS sessions. The UE shall stop the timer(s) T3346, T3396, T3584, T3585 and 5GSM back-off timer(s) not related to congestion control (see subclause 6.2.12), if running. If the UE is operating in single-registration mode, the UE shall also stop the ESM back-off timer(s) not related to congestion control (see subclause 6.3.6 in 3GPP TS 24.301 [15]), if running. The UE shall send a DEREGISTRATION ACCEPT message to the network and enter the state 5GMM-DEREGISTERED for 3GPP access. Furthermore, the UE shall, after the completion of the de-registration procedure, and the release of the existing NAS signalling connection, if any T_{sr-cm} timer(s) were running and have stopped, the UE shall attempt to obtain service on a higher priority PLMN (see 3GPP TS 23.122 [5]) on 3GPP access, otherwise initiate an initial registration. The UE should also re-establish any previously established PDU sessions over 3GPP access. For any previously established MA PDU sessions with user plane resources established on both accesses the UE should also re-establish the user plane resources over 3GPP access, and for any previously established MA PDU sessions with user plane resources established only on the 3GPP access the UE should re-establish the MA PDU session over 3GPP access.

Upon receiving the DEREGISTRATION REQUEST message, if the DEREGISTRATION REQUEST message indicates "re-registration required" and the de-registration request is for non-3GPP access, the UE shall perform a local release of the PDU sessions over non-3GPP access, if any. If there is an MA PDU session with user plane resources established on both 3GPP access and non-3GPP access in the same PLMN or in different PLMNs, the UE shall perform a local release of the user plane resources on non-3GPP access. If there is an MA PDU session with a PDN connection as a user-plane resource and user plane resources established on non-3GPP access, the UE shall perform a local release of the user plane resources on non-3GPP access. If there is an MA PDU session with user plane resources established on non-3GPP access only, the UE shall perform a local release of the MA PDU session. The UE shall stop the timer(s) T3346, T3396, T3584 and T3585, if it is running. The UE shall send a DEREGISTRATION ACCEPT message to the

network and enter the state 5GMM-DEREGISTERED for non-3GPP access. Furthermore, the UE shall, after the completion of the de-registration procedure, and the release of the existing NAS signalling connection, initiate an initial registration over non-3GPP. The UE should also re-establish any previously established PDU sessions over non-3GPP access. For any previously established MA PDU sessions with user plane resources established on both accesses the UE should also re-establish the user plane resources over non-3GPP access, and for any previously established MA PDU sessions with user plane resources established only on the non-3GPP access the UE should re-establish the MA PDU session over non-3GPP access, and for any previously established MA PDU sessions with a PDN connection as a user-plane resource and user plane resources established on non-3GPP access the UE should re-establish the user plane resources over non-3GPP access.

Upon receiving the DEREGISTRATION REQUEST message, if the DEREGISTRATION REQUEST message indicates "re-registration required" and the de-registration request is for both 3GPP access and non-3GPP access when the UE is registered in the same PLMN for both accesses, the UE shall perform a local release of the MA PDU sessions and PDU sessions over both 3GPP access and non-3GPP access, if any. If an MA PDU session or a PDU sessions is associated with one or more multicast MBS sessions, the UE shall locally leave the associated multicast MBS sessions. The UE shall stop the timer(s) T3346, T3396, T3584 and T3585, if it is running. The UE shall send a DEREGISTRATION ACCEPT message to the network and enter the state 5GMM-DEREGISTERED for both 3GPP access and non-3GPP access. Furthermore, the UE shall, after the completion of the de-registration procedure, and the release of the existing NAS signalling connection, if any Tsor-cm timer(s) were running and have stopped, the UE shall attempt to obtain service on a higher priority PLMN (see 3GPP TS 23.122 [5]) on 3GPP access, otherwise initiate an initial registration over both 3GPP access and non-3GPP access. The UE should also re-establish any previously established PDU sessions over both 3GPP access and non-3GPP access. For any previously established MA PDU sessions the UE should also re-establish the MA PDU session and the user plane resources which were established previously.

NOTE 1: When the de-registration type indicates "re-registration required", user interaction is necessary in some cases when the UE cannot re-establish the PDU session (s), if any, automatically.

Upon receiving the DEREGISTRATION REQUEST message, if the DEREGISTRATION REQUEST message indicates "re-registration not required" and the de-registration request is for 3GPP access, the UE shall perform a local release of the PDU sessions over 3GPP access, if any. If a PDU session is associated with one or more multicast MBS sessions, the UE shall locally leave the associated multicast MBS sessions. If there is an MA PDU session with user plane resources established on both 3GPP access and non-3GPP access in the same PLMN or in different PLMNs, the UE shall perform a local release of the user plane resources on 3GPP access. If there is an MA PDU session with user plane resources established on 3GPP access only, the UE shall perform a local release of the MA PDU session. If the MA PDU session is associated with one or more multicast MBS sessions, the UE shall locally leave the associated multicast MBS sessions. The UE shall send a DEREGISTRATION ACCEPT message to the network and enter the state 5GMM-DEREGISTERED for 3GPP access.

Upon receiving the DEREGISTRATION REQUEST message, if the DEREGISTRATION REQUEST message indicates "re-registration not required" and the de-registration request is for non-3GPP access, the UE shall perform a local release of the PDU sessions over non-3GPP access, if any. If there is an MA PDU session with user plane resources established on both 3GPP access and non-3GPP access in the same PLMN or in different PLMNs, the UE shall perform a local release of the user plane resources on non-3GPP access. If there is an MA PDU session with a PDN connection as a user-plane resource and user plane resources established on non-3GPP access, the UE shall perform a local release of the user plane resources on non-3GPP access. If there is an MA PDU session with user plane resources established on non-3GPP access only, the UE shall perform a local release of the MA PDU session. The UE shall send a DEREGISTRATION ACCEPT message to the network and enter the state 5GMM-DEREGISTERED for non-3GPP access.

Upon receiving the DEREGISTRATION REQUEST message, if the DEREGISTRATION REQUEST message indicates "re-registration not required" and the de-registration request is for both 3GPP access and non-3GPP access when the UE is registered in the same PLMN for both accesses, the UE shall perform a local release of the MA PDU sessions and PDU sessions over both 3GPP access and non-3GPP access, if any. If an MA PDU session or a PDU session is associated with one or more multicast MBS sessions, the UE shall locally leave the associated multicast MBS sessions. The UE shall send a DEREGISTRATION ACCEPT message to the network and enter the state 5GMM-DEREGISTERED for both 3GPP access and non-3GPP access.

Upon receiving the DEREGISTRATION REQUEST message, if the DEREGISTRATION REQUEST message includes the rejected NSSAI, the UE takes the following actions based on the rejection cause in the rejected S-NSSAI(s):

"S-NSSAI not available in the current PLMN or SNPN"

The UE shall store the rejected S-NSSAI(s) in the rejected NSSAI for the current PLMN or SNPN as specified in subclause 4.6.2.2 and shall not attempt to use this S-NSSAI in the current PLMN or SNPN over any access until switching off the UE, the UICC containing the USIM is removed, an entry of the "list of subscriber data" with the SNPN identity of the current SNPN is updated, if the UE does not support access to an SNPN using credentials from a credentials holder and equivalent SNPNs, the selected entry of the "list of subscriber data" is updated, if the UE supports access to an SNPN using credentials from a credentials holder, equivalent SNPNs or both or the rejected S-NSSAI(s) are removed as described in subclause 4.6.2.2.

"S-NSSAI not available in the current registration area"

The UE shall store the rejected S-NSSAI(s) in the rejected NSSAI for the current registration area as described in subclause 4.6.2.2 and shall not attempt to use this S-NSSAI(s) in the current registration area over the current access until switching off the UE, the UE moving out of the current registration area, the UICC containing the USIM is removed, an entry of the "list of subscriber data" with the SNPN identity of the current SNPN is updated, or the rejected S-NSSAI(s) are removed as described in subclause 4.6.2.2.

"S-NSSAI not available due to the failed or revoked network slice-specific authentication and authorization"

The UE shall store the rejected S-NSSAI(s) in the rejected NSSAI for the failed or revoked NSSAI as specified in subclause 4.6.2.2 and shall not attempt to use this S-NSSAI in the current PLMN or SNPN over any access until switching off the UE, the UICC containing the USIM is removed, the entry of the "list of subscriber data" with the SNPN identity of the current SNPN is updated, or the rejected S-NSSAI(s) are removed as described in subclause 4.6.1 and 4.6.2.2.

"S-NSSAI not available due to maximum number of UEs reached"

Unless the back-off timer value received along with the S-NSSAI is zero, the UE shall add the rejected S-NSSAI(s) in the rejected NSSAI for the maximum number of UEs reached as specified in subclause 4.6.2.2 and shall not attempt to use this S-NSSAI in the current PLMN or SNPN over the current access until switching off the UE, the UICC containing the USIM is removed, the entry of the "list of subscriber data" with the SNPN identity of the current SNPN is updated, or the rejected S-NSSAI(s) are removed as described in subclauses 4.6.1 and 4.6.2.2.

NOTE 2: If the back-off timer value received along with the S-NSSAI in the rejected NSSAI for the maximum number of UEs reached is zero as specified in subclause 10.5.7.4a of 3GPP TS 24.008 [12], the UE does not consider the S-NSSAI as the rejected S-NSSAI.

If there is one or more S-NSSAIs in the rejected NSSAI with the rejection cause "S-NSSAI not available due to maximum number of UEs reached", then for each S-NSSAI, the UE shall behave as follows:

- a) stop the timer T3526 associated with the S-NSSAI, if running;
- b) start the timer T3526 with:
 - 1) the back-off timer value received along with the S-NSSAI, if a back-off timer value is received along with the S-NSSAI that is neither zero nor deactivated; or
 - 2) an implementation specific back-off timer value, if no back-off timer value is received along with the S-NSSAI; and
- c) remove the S-NSSAI from the rejected NSSAI for the maximum number of UEs reached when the timer T3526 associated with the S-NSSAI expires.

Upon sending a DEREGISTRATION ACCEPT message for the 5G-RG, the UE shall delete the rejected NSSAI as specified in subclause 4.6.2.2.

NOTE 2A: The 5G-RG can identify whether the received DEREGISTRATION REQUEST message is targeting the 5G-RG or an AUN3 device behind the 5G-RG via W-CP protocol as specified in 3GPP TS 23.316 [6D].

Regardless of the 5GMM cause value received in the DEREGISTRATION REQUEST message via satellite NG-RAN,

- if the UE receives the Forbidden TAI(s) for the list of "5GS forbidden tracking areas for roaming" IE in the DEREGISTRATION REQUEST message, the UE shall store the TAI(s) belonging to the serving PLMN or

equivalent PLMN(s) and ignore the TAI(s) which do not belong to the serving PLMN or equivalent PLMN(s) included in the IE, if not already stored, into the list of "5GS forbidden tracking areas for roaming"; and

- if the UE receives the Forbidden TAI(s) for the list of "5GS forbidden tracking areas for regional provision of service" IE in the DEREGISTRATION REQUEST message, the UE shall store the TAI(s) belonging to the serving PLMN or equivalent PLMN(s) and ignore the TAI(s) which do not belong to the serving PLMN or equivalent PLMN(s) included in the IE, if not already stored, into the list of "5GS forbidden tracking areas for regional provision of service".

Upon receiving the DEREGISTRATION REQUEST message, the 5G-RG shall delete the contexts of the AUN3 devices behind the 5G-RG, if any.

If the de-registration type indicates "re-registration required", then the UE shall ignore the 5GMM cause IE if received.

If the de-registration type indicates "re-registration not required", the UE shall take the actions depending on the received 5GMM cause value:

#3 (Illegal UE);

#6 (Illegal ME)

The UE shall set the 5GS update status to 5U3 ROAMING NOT ALLOWED (and shall store it according to subclause 5.1.3.2.2) and shall delete any 5G-GUTI, last visited registered TAI, TAI list and ngKSI.

- In case of PLMN, the UE shall consider the USIM as invalid for 5GS services until switching off, the UICC containing the USIM is removed or the timer T3245 expires as described in subclause 5.3.19A.1;

In case of SNPN, if the UE is not registered for onboarding services in SNPN and the UE does not support access to an SNPN using credentials from a credentials holder and does not support equivalent SNPNS, the UE shall consider the selected entry of the "list of subscriber data" with the SNPN identity of the current SNPN as invalid until the UE is switched off, the entry is updated or the timer T3245 expires as described in subclause 5.3.19A.2. In case of SNPN, if the UE supports access to an SNPN using credentials from a credentials holder, equivalent SNPNS, or both, the UE shall consider the selected entry of the "list of subscriber data" as invalid for 3GPP access until the UE is switched off, the entry is updated or the timer T3245 expires as described in subclause 5.3.19A.2. Additionally, if EAP based primary authentication and key agreement procedure using EAP-AKA' or 5G AKA based primary authentication and key agreement procedure was performed in the current SNPN, the UE shall consider the USIM as invalid for the current SNPN until switching off, the UICC containing the USIM is removed or the timer T3245 expires as described in subclause 5.3.19A.2.

If the UE is not registered for onboarding services in SNPN, the UE shall delete the list of equivalent PLMNs (if any) or the list of equivalent SNPNS (if any), and shall enter the state 5GMM-DEREGISTERED.NO-SUPI.

If the de-registration request is for 3GPP access only or for both 3GPP access and non-3GPP access and the UE is operating in single-registration mode, the UE shall handle the EMM parameters EMM state, EPS update status, 4G-GUTI, TAI list and eKSI as specified in 3GPP TS 24.301 [15] for the case when a DETACH REQUEST is received with the EMM cause with the same value and with detach type set to "re-attach not required". The USIM shall be considered as invalid also for non-EPS services until switching off or the UICC containing the USIM is removed or the timer T3245 expires as described in subclause 5.3.7a in 3GPP TS 24.301 [15].

If the UE is registered for onboarding services in SNPN, the UE shall reset the registration attempt counter, store the SNPN identity in the "permanently forbidden SNPN for onboarding services in SNPN" list, enter state 5GMM-DEREGISTERED.PLMN-SEARCH, and perform an SNPN selection or an SNPN selection for onboarding services according to 3GPP TS 23.122 [5].

If the UE also supports the registration procedure over the other access, the UE shall in addition handle 5GMM parameters and 5GMM state for this access, as described for this 5GMM cause value.

#7 (5GS services not allowed).

The UE shall set the 5GS update status to 5U3 ROAMING NOT ALLOWED (and shall store it according to subclause 5.1.3.2.2) and shall delete any 5G-GUTI, last visited registered TAI, TAI list and ngKSI.

In case of PLMN, the UE shall consider the USIM as invalid for 5GS services until switching off, the UICC containing the USIM is removed or the timer T3245 expires as described in subclause 5.3.19A.1;

In case of SNPN, if the UE is not registered for onboarding services in SNPN and the UE does not support access to an SNPN using credentials from a credentials holder and does not support equivalent SNPNs, the UE shall consider the selected entry of the "list of subscriber data" with the SNPN identity of the current SNPN as invalid for 5GS services until the UE is switched off, or the entry is updated or the timer T3245 expires as described in subclause 5.3.19A.2. In case of SNPN, if the UE is not registered for onboarding services in SNPN and the UE supports access to an SNPN using credentials from a credentials holder, equivalent SNPNs, or both, the UE shall consider the selected entry of the "list of subscriber data" as invalid for 3GPP access until the UE is switched off, the entry is updated or the timer T3245 expires as described in subclause 5.3.19A.2. Additionally, if EAP based primary authentication and key agreement procedure using EAP-AKA' or 5G AKA based primary authentication and key agreement procedure was performed in the current SNPN, the UE shall consider the USIM as invalid for the current SNPN until switching off, the UICC containing the USIM is removed or the timer T3245 expires as described in subclause 5.3.19A.2.

If the UE is not registered for onboarding services in SNPN, the UE shall enter the state 5GMM-DEREGISTERED.NO-SUPI.

If the de-registration request is for 3GPP access only or for both 3GPP access and non-3GPP access and the UE is operating in single-registration mode, the UE shall handle the EMM parameters EMM state, EPS update status, 4G-GUTI, last visited registered TAI, TAI list and eKSI as specified in 3GPP TS 24.301 [15] for the case when a DETACH REQUEST is received with the EMM cause with the same value and with detach type set to "re-attach not required".

If the UE is registered for onboarding services in SNPN, the UE shall reset the registration attempt counter, store the SNPN identity in the "permanently forbidden SNPNs for onboarding services in SNPN" list, enter state 5GMM-DEREGISTERED.PLMN-SEARCH, and perform an SNPN selection or an SNPN selection for onboarding services according to 3GPP TS 23.122 [5].

If the UE also supports the registration procedure over the other access, the UE shall in addition handle 5GMM parameters and 5GMM state for this access, as described for this 5GMM cause value.

#11 (PLMN not allowed).

This cause value received from a cell belonging to an SNPN and the UE is operating in SNPN access operation mode is considered as an abnormal case and the behaviour of the UE is specified in subclause 5.5.2.3.4.

The UE shall set the 5GS update status to 5U3 ROAMING NOT ALLOWED (and shall store it according to subclause 5.1.3.2.2) and shall delete any 5G-GUTI, last visited registered TAI, TAI list and ngKSI. The UE shall delete the list of equivalent PLMNs, shall reset the registration attempt counter. For 3GPP access the UE shall enter the state 5GMM-DEREGISTERED.PLMN-SEARCH, and for non-3GPP access the UE shall enter state 5GMM-DEREGISTERED.LIMITED-SERVICE.

The UE shall store the PLMN identity in the forbidden PLMN list as specified in subclause 5.3.13A and if the UE is configured to use timer T3245 then the UE shall start timer T3245 and proceed as described in subclause 5.3.19A.1.

For 3GPP access the UE shall perform a PLMN selection according to 3GPP TS 23.122 [5], and for non-3GPP access the UE shall perform network selection as defined in 3GPP TS 24.502 [18].

If the de-registration request is for 3GPP access only or for both 3GPP access and non-3GPP access and the UE is operating in single-registration mode, the UE shall handle the EMM parameters EMM state, EPS update status, 4G-GUTI, last visited registered TAI, TAI list, eKSI and attach attempt counter as specified in 3GPP TS 24.301 [15] for the case when a DETACH REQUEST is received with the EMM cause with the same value and with detach type set to "re-attach not required".

If the UE also supports the registration procedure over the other access to the same PLMN, the UE shall in addition handle 5GMM parameters and 5GMM state for this access, as described for this 5GMM cause value.

If the UE receives the Disaster return wait range IE in the DEREGISTRATION REQUEST message and the UE supports MINT, the UE shall delete the disaster return wait range stored in the ME, if any, and store the disaster return wait range included in the Disaster return wait range IE in the ME.

#12 (Tracking area not allowed).

The UE shall set the 5GS update status to 5U3 ROAMING NOT ALLOWED (and shall store it according to subclause 5.1.3.2.2) and shall delete last visited registered TAI and TAI list. If the UE is not registering or has

not registered to the same PLMN over both 3GPP access and non-3GPP access, the UE shall additionally delete 5G-GUTI and ngKSI. The UE shall reset the registration attempt counter and shall enter the state 5GMM-DEREGISTERED.LIMITED-SERVICE.

If the UE is not operating in SNPN access operation mode and the Forbidden TAI(s) for the list of "5GS forbidden tracking areas for regional provision of service" IE is not included in the DEREGISTRATION REQUEST message, the UE shall store the current TAI in the list of "5GS forbidden tracking areas for regional provision of service". Otherwise, the UE shall store the current TAI in the list of "5GS forbidden tracking areas for regional provision of service" for the current SNPN and the selected entry of the "list of subscriber data" or the selected PLMN subscription.

If the de-registration request is for 3GPP access only or for both 3GPP access and non-3GPP access and the UE is operating in single-registration mode, the UE shall handle the EMM parameters, EMM state, EPS update status, 4G-GUTI, last visited registered TAI, TAI list, eKSI and attach attempt counter as specified in 3GPP TS 24.301 [15] for the case when a DETACH REQUEST is received with the EMM cause with the same value and with detach type set to "re-attach not required".

#13 (Roaming not allowed in this tracking area).

The UE shall set the 5GS update status to 5U3 ROAMING NOT ALLOWED (and shall store it according to subclause 5.1.3.2.2) and shall delete last visited registered TAI and TAI list. If the UE is not registering or has not registered to the same PLMN over both 3GPP access and non-3GPP access, the UE shall additionally delete 5G-GUTI, ngKSI, and the list of equivalent PLMNs (if available) or the list of equivalent SNPNs (if available). The UE shall reset the registration attempt counter. For 3GPP access the UE shall change to state 5GMM-DEREGISTERED.PLMN-SEARCH, and for non-3GPP access the UE shall change to state 5GMM-DEREGISTERED.LIMITED-SERVICE.

If the UE is not operating in SNPN access operation mode and the Forbidden TAI(s) for the list of "5GS forbidden tracking areas for roaming" IE is not included in the DEREGISTRATION REQUEST message, the UE shall store the current TAI in the list of "5GS forbidden tracking areas for roaming". Otherwise, the UE shall store the current TAI in the list of "5GS forbidden tracking areas for roaming" for the current SNPN and the selected entry of the "list of subscriber data" or the selected PLMN subscription.

For 3GPP access the UE shall perform a PLMN selection or SNPN selection according to 3GPP TS 23.122 [5], and for non-3GPP access the UE shall perform network selection as defined in 3GPP TS 24.502 [18].

If the de-registration request is for 3GPP access only or for both 3GPP access and non-3GPP access and the UE is operating in single-registration mode, the UE shall handle the EMM parameters EMM state, EPS update status, 4G-GUTI, last visited registered TAI, TAI list, eKSI and attach attempt counter as specified in 3GPP TS 24.301 [15] for the case when a DETACH REQUEST is received with the EMM cause with the same value and with detach type set to "re-attach not required".

#15 (No suitable cells in tracking area).

The UE shall set the 5GS update status to 5U3 ROAMING NOT ALLOWED (and shall store it according to subclause 5.1.3.2.2) and shall delete any last visited registered TAI and TAI list. If the UE is not registering or has not registered to the same PLMN over both 3GPP access and non-3GPP access, the UE shall additionally delete 5G-GUTI and ngKSI. The UE shall reset the registration attempt counter and shall enter the state 5GMM-DEREGISTERED.LIMITED-SERVICE.

If the UE is not operating in SNPN access operation mode and the Forbidden TAI(s) for the list of "5GS forbidden tracking areas for roaming" IE is not included in the DEREGISTRATION REQUEST message, the UE shall store the current TAI in the list of "5GS forbidden tracking areas for roaming". Otherwise, the UE shall store the current TAI in the list of "5GS forbidden tracking areas for roaming" for the current SNPN and the selected entry of the "list of subscriber data" or the selected PLMN subscription.

The UE shall search for a suitable cell in another tracking area according to 3GPP TS 38.304 [28] or 3GPP TS 36.304 [25C].

If the de-registration request is for 3GPP access only or for both 3GPP access and non-3GPP access and the UE is operating in single-registration mode, the UE shall handle the EMM parameters EMM state, EPS update status, 4G-GUTI, last visited registered TAI, TAI list, eKSI and attach attempt counter as specified in 3GPP TS 24.301 [15] for the case when a DETACH REQUEST is received with the EMM cause with the same value and with detach type set to "re-attach not required".

If received over non-3GPP access and de-registration request is for non-3GPP access only, the cause shall be considered as an abnormal case and the behaviour of the UE for this case is specified in subclause 5.5.2.3.4.

#22 (Congestion).

If the T3346 value IE is present in the DEREGISTRATION REQUEST message and the value indicates that this timer is neither zero nor deactivated, the UE shall proceed as described below, otherwise it shall be considered as an abnormal case and the behaviour of the UE for this case is specified in subclause 5.5.2.3.4.

The UE shall stop timer T3346 if it is running, set the 5GS update status to 5U2 NOT UPDATED, reset the registration attempt counter and enter the state 5GMM-DEREGISTERED.ATTEMPTING-REGISTRATION.

The UE shall start timer T3346 with the value provided in the T3346 value IE.

If the de-registration request is for 3GPP access only or for both 3GPP access and non-3GPP access and the UE is operating in the single-registration mode, the UE shall set the EPS update status to EU2 NOT UPDATED, reset the attach attempt counter and shall enter the state EMM-DEREGISTERED.

#27 (N1 mode not allowed).

The UE shall set the 5GS update status to 5U3 ROAMING NOT ALLOWED (and shall store it according to subclause 5.1.3.2.2) and shall delete any 5G-GUTI, last visited registered TAI, TAI list and ngKSI. Additionally, the UE shall reset the registration attempt counter and shall enter the state 5GMM-DEREGISTERED.LIMITED-SERVICE.

The UE shall disable the N1 mode capability for both 3GPP access and non-3GPP access (see subclause 4.9).

If the de-registration request is for 3GPP access only or for both 3GPP access and non-3GPP access and the UE is operating in single-registration mode, the UE shall in addition set the EPS update status to EU3 ROAMING NOT ALLOWED and shall delete any 4G-GUTI, last visited registered TAI, TAI list and eKSI. Additionally, the UE shall reset the attach attempt counter and enter the state EMM-DEREGISTERED.

#36 (IAB-node operation not authorized).

This cause value is only applicable when received over 3GPP access by a UE operating as an IAB-node. This cause value received from a 5G access network other than 3GPP access or received by a UE not operating as an IAB-node is considered as an abnormal case and the behaviour of the UE is specified in subclause 5.5.2.3.4.

The UE shall set the 5GS update status to 5U3 ROAMING NOT ALLOWED (and shall store it according to subclause 5.1.3.2.2) and shall delete any 5G-GUTI, last visited registered TAI, TAI list and ngKSI.

If:

- 1) the UE is not operating in SNPN access operation mode,
 - i) the UE shall delete the list of equivalent PLMNs and reset the registration attempt counter and store the PLMN identity in the forbidden PLMN list as specified in subclause 5.3.13A and if the UE is configured to use timer T3245 then the UE shall start timer T3245 and proceed as described in subclause 5.3.19a.1. The UE shall enter state 5GMM-DEREGISTERED.PLMN-SEARCH and perform a PLMN selection according to 3GPP TS 23.122 [5]; and
 - ii) If the UE is operating in single-registration mode, the UE shall in addition handle the EMM parameters EMM state, EPS update status, 4G-GUTI, last visited registered TAI, TAI list, eKSI and attach attempt counter as specified in 3GPP TS 24.301 [15] for the case when DETACH REQUEST is received with the EMM cause with the same value and with detach type set to "re-attach not required"; or
- 2) the UE is operating in SNPN access operation mode,
 - i) the UE shall reset the registration attempt counter and store the SNPN identity in the "temporarily forbidden SNPNs" list for 3GPP access and, if the UE supports access to an SNPN using credentials from a credentials holder, equivalent SNPNs or both, the selected entry of the "list of subscriber data" or the selected PLMN subscription. The UE shall enter state 5GMM-DEREGISTERED.PLMN-SEARCH and perform an SNPN selection according to 3GPP TS 23.122 [5].

#62 (No network slices available).

The UE shall set the 5GS update status to 5U2 NOT UPDATED and enter state 5GMM-DEREGISTERED.NORMAL-SERVICE or 5GMM-DEREGISTERED.PLMN-SEARCH. Additionally, the UE shall reset the registration attempt counter.

The UE receiving the rejected NSSAI in the DEREGISTRATION REQUEST message takes the following actions based on the rejection cause in the rejected S-NSSAI(s):

"S-NSSAI not available in the current PLMN or SNPN"

The UE shall store the rejected S-NSSAI(s) in the rejected NSSAI for the current PLMN or SNPN as specified in subclause 4.6.2.2 and shall not attempt to use this S-NSSAI(s) in the current PLMN or SNPN over any access until switching off the UE, the UICC containing the USIM is removed, an entry of the "list of subscriber data" with the SNPN identity of the current SNPN is updated, or the rejected S-NSSAI(s) are removed as described in subclause 4.6.2.2.

"S-NSSAI not available in the current registration area"

The UE shall store the rejected S-NSSAI(s) in the rejected NSSAI for the current registration area as described in subclause 4.6.2.2 and shall not attempt to use this S-NSSAI(s) in the current registration area over the current access until switching off the UE, the UE moving out of the current registration area, the UICC containing the USIM is removed, the entry of the "list of subscriber data" with the SNPN identity of the current SNPN is updated, or the rejected S-NSSAI(s) are removed as described in subclause 4.6.2.2.

"S-NSSAI not available due to the failed or revoked network slice-specific authentication and authorization"

The UE shall store the rejected S-NSSAI(s) in the rejected NSSAI for the failed or revoked NSSAI as specified in subclause 4.6.2.2 and shall not attempt to use this S-NSSAI in the current PLMN or SNPN over any access until switching off the UE, the UICC containing the USIM is removed, the entry of the "list of subscriber data" with the SNPN identity of the current SNPN is updated, or the rejected S-NSSAI(s) are removed as described in subclause 4.6.1 and 4.6.2.2.

"S-NSSAI not available due to maximum number of UEs reached"

Unless the back-off timer value received along with the S-NSSAI is zero, the UE shall add the rejected S-NSSAI(s) in the rejected NSSAI for the maximum number of UEs reached as specified in subclause 4.6.2.2 and shall not attempt to use this S-NSSAI in the current PLMN or SNPN over the current access until switching off the UE, the UICC containing the USIM is removed, the entry of the "list of subscriber data" with the SNPN identity of the current SNPN is updated, or the rejected S-NSSAI(s) are removed as described in subclauses 4.6.1 and 4.6.2.2.

NOTE 3: If the back-off timer value received along with the S-NSSAI in the rejected NSSAI for the maximum number of UEs reached is zero as specified in subclause 10.5.7.4a of 3GPP TS 24.008 [12], the UE does not consider the S-NSSAI as the rejected S-NSSAI.

If there is one or more S-NSSAIs in the rejected NSSAI with the rejection cause "S-NSSAI not available due to maximum number of UEs reached", then for each S-NSSAI, the UE shall behave as follows:

- a) stop the timer T3526 associated with the S-NSSAI, if running;
- b) start the timer T3526 with:
 - 1) the back-off timer value received along with the S-NSSAI, if a back-off timer value is received along with the S-NSSAI that is neither zero nor deactivated; or
 - 2) an implementation specific back-off timer value, if no back-off timer value is received along with the S-NSSAI; and
- c) remove the S-NSSAI from the rejected NSSAI for the maximum number of UEs reached when the timer T3526 associated with the S-NSSAI expires.

If the UE has an allowed NSSAI or configured NSSAI that contains S-NSSAI(s) which are not included in the rejected NSSAI, the UE may stay in the current serving cell, apply the normal cell reselection process and start an initial registration with a requested NSSAI that includes any S-NSSAI from the allowed NSSAI or the configured NSSAI that is not in the rejected NSSAI. Otherwise the UE may perform a PLMN selection or SNPN

selection according to 3GPP TS 23.122 [5] and additionally, the UE may disable the N1 mode capability for the current PLMN or SNPN if the UE does not have an allowed NSSAI and each S-NSSAI in configured NSSAI, if available, was rejected with cause "S-NSSAI not available in the current PLMN or SNPN" or "S-NSSAI not available due to the failed or revoked network slice-specific authentication and authorization" as described in subclause 4.9.

If the UE has neither allowed NSSAI for the current PLMN or SNPN nor configured NSSAI for the current PLMN or SNPN and,

- 1) if at least one S-NSSAI in the default configured NSSAI is not rejected, the UE may stay in the current serving cell, apply the normal cell reselection process, and start an initial registration with a requested NSSAI with that default configured NSSAI; or
- 2) if all the S-NSSAI(s) in the default configured NSSAI are rejected and at least one S-NSSAI is rejected due to "S-NSSAI not available in the current registration area",
 - i) if the UE is not operating in SNPN access operation mode and the Forbidden TAI(s) for the list of "5GS forbidden tracking areas for roaming" IE is not included in the DEREGISTRATION REQUEST message, the UE shall store the TAI(s) belonging to current registration area in the list of "5GS forbidden tracking areas for roaming", memorize the TAI(s) belonging to current registration area were stored in the list of "5GS forbidden tracking areas for roaming" for S-NSSAI is rejected due to "S-NSSAI not available in the current registration area" and enter the state 5GMM-DEREGISTERED.LIMITED-SERVICE. The UE shall search for a suitable cell in another tracking area not belonging to current registration area according to 3GPP TS 38.304 [28] or 3GPP TS 36.304 [25C]; or
 - ii) if the UE is operating in SNPN access operation mode, the UE shall store the TAI(s) belonging to current registration area in the list of "5GS forbidden tracking areas for roaming", memorize the TAI(s) belonging to current registration area were stored in the list of "5GS forbidden tracking areas for roaming" for S-NSSAI is rejected due to "S-NSSAI not available in the current registration area" for the current SNPN and, if the UE supports access to an SNPN using credentials from a credentials holder, equivalent SNPNs or both, the selected entry of the "list of subscriber data" or the selected PLMN subscription, and enter the state 5GMM-DEREGISTERED.LIMITED-SERVICE. The UE shall search for a suitable cell in another tracking area not belonging to current registration area according to 3GPP TS 38.304 [28] or 3GPP TS 36.304 [25C].
- 3) otherwise, the UE may perform a PLMN selection or SNPN selection according to 3GPP TS 23.122 [5] and additionally, the UE may disable the N1 mode capability for the current PLMN or SNPN if each S-NSSAI in the default configured NSSAI was rejected with cause "S-NSSAI not available in the current PLMN or SNPN" or "S-NSSAI not available due to the failed or revoked network slice-specific authentication and authorization" as described in subclause 4.9.

If

- 1) the UE has allowed NSSAI for the current PLMN or SNPN or configured NSSAI for the current PLMN or SNPN or both and all the S-NSSAI(s) included in the allowed NSSAI or the configured NSSAI or both are rejected; or
- 2) the UE has neither allowed NSSAI for the current PLMN or SNPN nor configured NSSAI for the current PLMN or SNPN and all the S-NSSAI(s) included in the default configured NSSAI are rejected,

and the UE has rejected NSSAI for the maximum number of UEs reached, and the UE wants to obtain services in the current serving cell without performing a PLMN selection or SNPN selection, the UE may stay in the current serving cell and attempt to use the rejected S-NSSAI(s) for the maximum number of UEs reached in the current serving cell after the rejected S-NSSAI(s) are removed as described in subclause 4.6.2.2.

If the de-registration request is for 3GPP access only or for both 3GPP access and non-3GPP access and the UE is operating in single-registration mode, the UE shall in addition set the EPS update status to EU2 NOT UPDATED, reset the attach attempt counter and enter the state EMM-DEREGISTERED.

#72 (Non-3GPP access to 5GCN not allowed).

If received over non-3GPP access when the UE is registered over non-3GPP access, or received over 3GPP access and de-registration request is for non-3GPP access when the UE is registered in the same PLMN for both accesses, the UE shall set the 5GS update status to 5U3 ROAMING NOT ALLOWED (and shall store it

according to subclause 5.1.3.2.2) and shall delete 5G-GUTI, last visited registered TAI, TAI list and ngKSI for non-3GPP access. Additionally, the UE shall reset the registration attempt counter and enter the state 5GMM-DEREGISTERED for non-3GPP access.

NOTE 4: The 5GMM sublayer states, the 5GMM parameters and the registration status are managed per access type independently, i.e. 3GPP access or non-3GPP access (see subclauses 4.7.2 and 5.1.3).

The UE shall disable the N1 mode capability for non-3GPP access (see subclause 4.9.3).

As an implementation option, if the UE is not currently registered over 3GPP access, the UE may enter the state 5GMM-DEREGISTERED.PLMN-SEARCH in order to perform a PLMN selection according to 3GPP TS 23.122 [5].

If received over 3GPP access and de-registration request is for 3GPP access only, the cause shall be considered as an abnormal case and the behaviour of the UE for this case is specified in subclause 5.5.2.3.4.

#74 (Temporarily not authorized for this SNPN).

5GMM cause #74 is only applicable when received from a cell belonging to an SNPN and the UE is operating in SNPN access operation mode. 5GMM cause #74 received from a cell not belonging to an SNPN is considered as an abnormal case and the behaviour of the UE is specified in subclause 5.5.2.3.4.

The UE shall set the 5GS update status to 5U3 ROAMING NOT ALLOWED (and shall store it according to subclause 5.1.3.2.2) and shall delete any 5G-GUTI, last visited registered TAI, TAI list, ngKSI and the list of equivalent SNPNs (if available). The UE shall reset the registration attempt counter and shall store the SNPN identity in the "temporarily forbidden SNPNs" list or "temporarily forbidden SNPNs for access for localized services in SNPN" list if the SNPN is an SNPN selected for localized services in SNPN (see 3GPP TS 23.122 [5]) for the specific access type for which the message was received and the selected entry of the "list of subscriber data" or the selected PLMN subscription, or in the "temporarily forbidden SNPNs for onboarding services in SNPN" list, if the UE is registered for onboarding services in SNPN, for the specific access type for which the message was received. If the UE supports access to an SNPN using credentials from a credentials holder, the UE shall store the SNPN identity in the "temporarily forbidden SNPNs" list along with the GIN(s) broadcasted by the SNPN if any, for the selected entry of the "list of subscriber data" or the selected PLMN subscription. If the UE supports access to an SNPN providing access for localized services in SNPN and the access for localized services in SNPN has been enabled, the UE shall store the SNPN identity in the list of "temporarily forbidden SNPNs for access for localized services in SNPN" (if the SNPN is an SNPN selected for localized services in SNPN (see 3GPP TS 23.122 [5]) along with the GIN(s) broadcasted by the SNPN if any, for the selected entry of the "list of subscriber data" or the selected PLMN subscription. If the UE is not registered for onboarding services in SNPN, the UE shall enter state 5GMM-DEREGISTERED.PLMN-SEARCH and perform an SNPN selection according to 3GPP TS 23.122 [5]. If the UE is registered for onboarding services in SNPN, the UE shall enter state 5GMM-DEREGISTERED.PLMN-SEARCH and perform an SNPN selection or an SNPN selection for onboarding services according to 3GPP TS 23.122 [5].

#75 (Permanently not authorized for this SNPN).

5GMM cause #75 is only applicable when received from a cell belonging to an SNPN with a globally-unique SNPN identity and the UE is operating in SNPN access operation mode. 5GMM cause #75 received from a cell not belonging to an SNPN or a cell belonging to an SNPN with a non-globally-unique SNPN identity is considered as an abnormal case and the behaviour of the UE is specified in subclause 5.5.2.3.4.

The UE shall set the 5GS update status to 5U3 ROAMING NOT ALLOWED (and shall store it according to subclause 5.1.3.2.2) and shall delete any 5G-GUTI, last visited registered TAI, TAI list, ngKSI and the list of equivalent SNPNs (if available). The UE shall reset the registration attempt counter and store the SNPN identity in the "permanently forbidden SNPNs" list or "permanently forbidden SNPNs for access for localized services in SNPN" list if the SNPN is an SNPN selected for localized services in SNPN (see 3GPP TS 23.122 [5]) for the specific access type for which the message was received and the selected entry of the "list of subscriber data" or the selected PLMN subscription, or in the "permanently forbidden SNPNs for onboarding services in SNPN" list, if the UE is registered for onboarding services in SNPN, for the specific access type for which the message was received. If the UE supports access to an SNPN using credentials from a credentials holder, the UE shall store the SNPN identity in the "permanently forbidden SNPNs" list along with the GIN(s) broadcasted by the SNPN if any, for the selected entry of the "list of subscriber data" or the selected PLMN subscription. If the UE supports access to an SNPN providing access for localized services in SNPN and the access for localized services in SNPN has been enabled, the UE shall store the SNPN identity in the list of "permanently forbidden SNPNs for access for localized services in SNPN" (if the SNPN is an SNPN selected for localized services in SNPN (see

3GPP TS 23.122 [5]) along with the GIN(s) broadcasted by the SNPN if any, for the selected entry of the "list of subscriber data" or the selected PLMN subscription. If the UE is not registered for onboarding services in SNPN, the UE shall enter state 5GMM-DEREGISTERED.PLMN-SEARCH and perform an SNPN selection according to 3GPP TS 23.122 [5]. If the UE is registered for onboarding services in SNPN, the UE shall enter state 5GMM-DEREGISTERED.PLMN-SEARCH and perform an SNPN selection or an SNPN selection for onboarding services according to 3GPP TS 23.122 [5].

#76 (Not authorized for this CAG or authorized for CAG cells only).

This cause value received via non-3GPP access or from a cell belonging to an SNPN and the UE is operating in SNPN access operation mode is considered as an abnormal case and the behaviour of the UE is specified in subclause 5.5.2.3.4.

The UE shall set the 5GS update status to 5U3.ROAMING NOT ALLOWED, store the 5GS update status according to subclause 5.1.3.2.2, and reset the registration attempt counter.

If 5GMM cause #76 is received from:

- 1) a CAG cell, and if the UE receives a "CAG information list" in the CAG information list IE or the Extended CAG information list IE included in the DEREGISTRATION REQUEST message, the UE shall:
 - i) replace the "CAG information list" stored in the UE with the received CAG information list IE or the Extended CAG information list IE when received in the HPLMN or EHPLMN;
 - ii) replace the serving VPLMN's entry of the "CAG information list" stored in the UE with the serving VPLMN's entry of the received CAG information list IE or the Extended CAG information list IE when the UE receives the CAG information list IE or the Extended CAG information list IE in a serving PLMN other than the HPLMN or EHPLMN; or

NOTE 5: When the UE receives the CAG information list IE or the Extended CAG information list IE in a serving PLMN other than the HPLMN or EHPLMN, entries of a PLMN other than the serving VPLMN, if any, in the received CAG information list IE or the Extended CAG information list IE are ignored.

- iii) remove the serving VPLMN's entry of the "CAG information list" stored in the UE when the UE receives the CAG information list IE or the Extended CAG information list IE in a serving PLMN other than the HPLMN or EHPLMN and the CAG information list IE or the Extended CAG information list IE does not contain the serving VPLMN's entry.

Otherwise, the UE shall delete the CAG-ID(s) of the cell from the "allowed CAG list" for the current PLMN, if the CAG-ID(s) are authorized based on the "Allowed CAG list". In the case the "allowed CAG list" for the current PLMN only contains a range of CAG-IDs, how the UE deletes the CAG-ID(s) of the cell from the "allowed CAG list" for the current PLMN is up to UE implementation. In addition:

- i) if the entry in the "CAG information list" for the current PLMN does not include an "indication that the UE is only allowed to access 5GS via CAG cells" or if the entry in the "CAG information list" for the current PLMN includes an "indication that the UE is only allowed to access 5GS via CAG cells" and one or more CAG-ID(s) are authorized based on the updated "allowed CAG list" for the current PLMN, then the UE shall enter the state 5GMM-DEREGISTERED.LIMITED-SERVICE and shall search for a suitable cell according to 3GPP TS 38.304 [28] or 3GPP TS 36.304 [25C] with the updated "CAG information list";
 - ii) if the entry in the "CAG information list" for the current PLMN includes an "indication that the UE is only allowed to access 5GS via CAG cells" and no CAG-ID is authorized based on the updated "allowed CAG list" for the current PLMN, then the UE shall enter the state 5GMM-DEREGISTERED.PLMN-SEARCH and shall apply the PLMN selection process defined in 3GPP TS 23.122 [5] with the updated "CAG information list"; or
 - iii) if the "CAG information list" does not include an entry for the current PLMN, then the UE shall enter the state 5GMM-DEREGISTERED.LIMITED-SERVICE and shall search for a suitable cell according to 3GPP TS 38.304 [28] or 3GPP TS 36.304 [25C] with the updated "CAG information list".
- 2) a non-CAG cell, and if the UE receives a "CAG information list" in the CAG information list IE or the Extended CAG information list IE included in the DEREGISTRATION REQUEST message, the UE shall:

- i) replace the "CAG information list" stored in the UE with the received CAG information list IE or the Extended CAG information list IE when received in the HPLMN or EHPLMN;
- ii) replace the serving VPLMN's entry of the "CAG information list" stored in the UE with the serving VPLMN's entry of the received CAG information list IE or the Extended CAG information list IE when the UE receives the CAG information list IE or the Extended CAG information list IE in a serving PLMN other than the HPLMN or EHPLMN; or

NOTE 6: When the UE receives the CAG information list IE or the Extended CAG information list IE in a serving PLMN other than the HPLMN or EHPLMN, entries of a PLMN other than the serving VPLMN, if any, in the received CAG information list IE or the Extended CAG information list IE are ignored.

- iii) remove the serving VPLMN's entry of the "CAG information list" stored in the UE when the UE receives the CAG information list IE or the Extended CAG information list IE in a serving PLMN other than the HPLMN or EHPLMN and the CAG information list IE or the Extended CAG information list IE does not contain the serving VPLMN's entry.

Otherwise, the UE shall store an "indication that the UE is only allowed to access 5GS via CAG cells" in the entry of the "CAG information list" for the current PLMN, if any. If the "CAG information list" stored in the UE does not include the current PLMN's entry, the UE shall add an entry for the current PLMN to the "CAG information list" and store an "indication that the UE is only allowed to access 5GS via CAG cells" in the entry of the "CAG information list" for the current PLMN. If the UE does not have a stored "CAG information list", the UE shall create a new "CAG information list" and add an entry with an "indication that the UE is only allowed to access 5GS via CAG cells" for the current PLMN.

In addition:

- i) if one or more CAG-ID(s) are authorized based on the "allowed CAG list" for the current PLMN, then the UE shall enter the state 5GMM-DEREGISTERED.LIMITED-SERVICE and shall search for a suitable cell according to 3GPP TS 38.304 [28] with the updated CAG information; or
- ii) if no CAG-ID is authorized based on the "allowed CAG list" for the current PLMN, then the UE shall enter the state 5GMM-DEREGISTERED.PLMN-SEARCH and shall apply the PLMN selection process defined in 3GPP TS 23.122 [5] with the updated "CAG information list".

If the message was received via 3GPP access and the UE is operating in single-registration mode, the UE shall in addition set the EPS update status to EU3 ROAMING NOT ALLOWED, reset the attach attempt counter and enter the state EMM-DEREGISTERED.

#77 (Wireline access area not allowed).

5GMM cause #77 is only applicable when received from a wireline access network by the 5G-RG or the W-AGF acting on behalf of the FN-CRG (or on behalf of the N5GC device). 5GMM cause #77 received from a 5G access network other than a wireline access network and 5GMM cause #77 received by the W-AGF acting on behalf of the FN-BRG are considered as abnormal cases and the behaviour of the UE is specified in subclause 5.5.2.3.4.

When received over wireline access network, the 5G-RG and the W-AGF acting on behalf of the FN-CRG (or on behalf of the N5GC device) shall set the 5GS update status to 5U3 ROAMING NOT ALLOWED (and shall store it according to subclause 5.1.3.2.2), shall delete 5G-GUTI, last visited registered TAI, TAI list and ngKSI, shall reset the registration attempt counter, shall enter the state 5GMM-DEREGISTERED and shall act as specified in subclause 5.3.23.

NOTE 7: The 5GMM sublayer states, the 5GMM parameters and the registration status are managed per access type independently, i.e. 3GPP access or non-3GPP access (see subclauses 4.7.2 and 5.1.3).

#78 (PLMN not allowed to operate at the present UE location).

This cause value received from a non-satellite NG-RAN cell is considered as an abnormal case and the behaviour of the UE is specified in subclause 5.5.2.3.4.

The UE shall set the 5GS update status to 5U3 ROAMING NOT ALLOWED (and shall store it according to subclause 5.1.3.2.2) and shall delete last visited registered TAI and TAI list. If the UE is not registering or has not registered to the same PLMN over both 3GPP access and non-3GPP access, the UE shall additionally delete 5G-GUTI and ngKSI. Additionally, the UE shall reset the registration attempt counter. The UE shall store the

PLMN identity and, if it is known, the current geographical location in the list of "PLMNs not allowed to operate at the present UE location" and shall start a corresponding timer instance (see subclause 4.23.2). The UE shall enter state 5GMM-DEREGISTERED.PLMN-SEARCH and perform a PLMN selection according to 3GPP TS 23.122 [5].

If the de-registration request is for 3GPP access only or for both 3GPP access and non-3GPP access and the UE is operating in single-registration mode, the UE shall handle the EMM parameters EMM state, EPS update status, 4G-GUTI, last visited registered TAI, TAI list, eKSI and attach attempt counter as specified in 3GPP TS 24.301 [15] for the case when a DETACH REQUEST is received with the EMM cause with the same value and with detach type set to "re-attach not required".

#79 (UAS services not allowed).

- A UE which is not a UE supporting UAS services receiving this cause value shall consider it as an abnormal case and the behaviour of the UE is specified in subclause 5.5.2.3.4.

A UE supporting UAS service shall set the 5GS update status to 5U2 NOT UPDATED and enter state 5GMM-DEREGISTERED.NORMAL-SERVICE or 5GMM-DEREGISTERED.PLMN-SEARCH. Additionally, the UE shall reset the registration attempt counter. If the UE re-attempt the registration procedure to the current PLMN, the UE shall not include the service-level device ID set to the CAA-level UAV ID in the Service-level-AA container IE of REGISTRATION REQUEST message.

If the de-registration request is for 3GPP access only or for both 3GPP access and non-3GPP access and the UE is operating in single-registration mode, the UE shall in addition set the EPS update status to EU2 NOT UPDATED, reset the attach attempt counter and enter the state EMM-DEREGISTERED.

#93 (Onboarding services terminated).

If the UE is not registered for onboarding services in SNPN, this cause value received from a cell belonging to an SNPN and the UE is operating in SNPN access operation mode is considered as an abnormal case and the behaviour of the UE is specified in subclause 5.5.2.3.4.

If the UE is not operating in SNPN access operation mode, the UE shall enter the state 5GMM-DEREGISTERED.PLMN-SEARCH and perform a PLMN selection according to 3GPP TS 23.122 [5].

If the UE is operating in SNPN access operation mode, the UE shall enter the state 5GMM-DEREGISTERED.PLMN-SEARCH and perform an SNPN selection according to 3GPP TS 23.122 [5].

NOTE 8: In case the configuration of one or more entries of the "list of subscriber data" was not completed at the time of network-initiated de-registration procedure, the UE can retry registration after the de-registration procedure is completed.

5.5.2.3.3 Network-initiated de-registration procedure completion by the network

The network shall stop timer T3522 upon receipt of the DEREGISTRATION ACCEPT message. The network shall enter state 5GMM-DEREGISTERED for 3GPP access if the de-registration request is for 3GPP access. The network shall enter state 5GMM-DEREGISTERED for non-3GPP access if the de-registration request is for non-3GPP access. The network shall enter state 5GMM-DEREGISTERED for both 3GPP access and non-3GPP access if the de-registration request is for both 3GPP access and non-3GPP access.

5.5.2.3.4 Abnormal cases in the UE

The following abnormal cases can be identified:

- a) Transmission failure of DEREGISTRATION ACCEPT message indication from lower layers.

The de-registration procedure shall be progressed and the UE shall send the DEREGISTRATION ACCEPT message.

- b) DEREGISTRATION REQUEST, other 5GMM cause values than those treated in subclause 5.5.2.3.2, cases of 5GMM cause value#11, #15, #22, #72, #74, #75, #76, #77, #78, #79 and #93 that are considered as abnormal cases according to subclause 5.5.2.3.2 or no 5GMM cause IE is included, and the De-registration type IE indicates "re-registration not required".

The UE shall delete TAI list, last visited registered TAI and list of equivalent PLMNs (if any) or list of equivalent SNPNs (if any), shall set the 5GS update status to 5U2 NOT UPDATED and shall start timer T3502. If the UE is not registering or has not registered to the same PLMN over both 3GPP access and non-3GPP access, the UE shall additionally delete 5G-GUTI and ngKSI.

A UE not supporting S1 mode may enter the state 5GMM-DEREGISTERED.PLMN-SEARCH in order to perform a PLMN selection or SNPN selection according to 3GPP TS 23.122 [5]; otherwise the UE shall enter the state 5GMM-DEREGISTERED.ATTEMPTING-REGISTRATION.

If the de-registration request is for 3GPP access only or for both 3GPP access and non-3GPP access and the UE is operating in the single-registration mode, the UE shall:

- enter the state 5GMM-DEREGISTERED and attempt to select E-UTRAN radio access technology and proceed with the appropriate EMM specific procedures. In this case, the UE may disable the N1 mode capability (see subclause 4.9); or
- enter the state 5GMM-DEREGISTERED.PLMN-SEARCH in order to perform a PLMN selection according to 3GPP TS 23.122 [5].

If the message was received via 3GPP access and the UE is operating in the single-registration mode, the UE shall set the EPS update status to EU2 NOT UPDATED, enter the state EMM-DEREGISTERED and shall delete the EMM parameters 4G-GUTI, last visited registered TAI, TAI list and eKSI.

5.5.2.3.5 Abnormal cases in the network side

The following abnormal cases can be identified:

a) T3522 time-out

On the first expiry of the timer, the network shall retransmit the DEREGISTRATION REQUEST message and shall start timer T3522. This retransmission is repeated four times, i.e. on the fifth expiry of timer T3522, the de-registration procedure shall be aborted. The network shall change to the state 5GMM-DEREGISTERED for the access type which the de-registration procedure is intended for.

b) Lower layer failure

The de-registration procedure is aborted. The network shall change to the state 5GMM-DEREGISTERED for the access type which the de-registration procedure is intended for.

c) De-registration procedure collision

If the network receives a DEREGISTRATION REQUEST message with "switch off" indication, before the network-initiated de-registration procedure has been completed:

- If the access type included in the DEREGISTRATION REQUEST message sent by the UE is same as access type sent by the network, both procedures shall be considered completed; or
- If the access type included in the DEREGISTRATION REQUEST message sent by the UE is not same as access type sent by the network, the network shall consider UE initiated de-registration completed. The network shall re-initiate the de-registration procedure, if required, for the access type not indicated in the DEREGISTRATION REQUEST message sent by the UE.

If the network receives a DEREGISTRATION REQUEST message without "switch off" indication, before the network-initiated de-registration procedure has been completed, the network shall send a DEREGISTRATION ACCEPT message to the UE.

d) De-registration and registration procedure for initial registration collision

If the network receives a REGISTRATION REQUEST message indicating either "initial registration" or "emergency registration" in the 5GS registration type IE before the network-initiated de-registration procedure has been completed, the network shall abort the de-registration procedure and the registration procedure shall be progressed after the PDU sessions associated with the access type the REGISTRATION REQUEST message is sent over have been deleted.

NOTE 1: The above collision case is valid if the DEREGISTRATION REQUEST message indicates the access type over which the initial registration procedure is attempted otherwise both the procedures are progressed.

e) De-registration and registration procedure for mobility and periodic registration update collision

If the network sent a DEREGISTRATION REQUEST message without 5GMM cause value #11, #12, #13 or #15 and the network receives a REGISTRATION REQUEST message indicating either "mobility registration updating" or "periodic registration updating" in the 5GS registration type IE before the network-initiated de-registration procedure has been completed, the de-registration procedure shall be progressed, i.e. the REGISTRATION REQUEST message shall be ignored.

If the network sent a DEREGISTRATION REQUEST message with 5GMM cause value #11, #12, #13 or #15 and the network receives a REGISTRATION REQUEST message indicating either "mobility registration updating" or "periodic registration updating" in the 5GS registration type IE before the network-initiated de-registration procedure has been completed, the de-registration procedure shall be aborted and the registration procedure shall be progressed.

NOTE 2: The above collision case is valid if the DEREGISTRATION REQUEST message indicates the access type over which the mobility and periodic registration procedure is attempted otherwise both the procedures are progressed.

f) De-registration and service request procedure collision

If the network receives a SERVICE REQUEST message or a CONTROL PLANE SERVICE REQUEST message before the network-initiated de-registration procedure has been completed (e.g. the DEREGISTRATION REQUEST message is pending to be sent to the UE), the network shall progress the de-registration procedure.

NOTE 3: The above collision case is valid if the DEREGISTRATION REQUEST message indicates the access type over which the service request procedure is attempted otherwise both the procedures are progressed.

g) De-registration requested for a UE not supporting CAG due to CAG restrictions

Based on operator policy, if the network-initiated de-registration procedure is triggered for a UE not supporting CAG due to CAG restrictions, the network shall send the DEREGISTRATION REQUEST message including a 5GMM cause value other than the 5GMM cause #76 (Not authorized for this CAG or authorized for CAG cells only).

NOTE 4: 5GMM cause #7 (5GS services not allowed), 5GMM cause #11 (PLMN not allowed), 5GMM cause #27 (N1 mode not allowed), 5GMM cause #73 (Serving network not authorized) can be used depending on the subscription of the UE and whether the UE roams or not.

5.5.3 eCall inactivity procedure

The eCall inactivity procedure is performed only in 3GPP access and applicable only to a UE configured for eCall only mode as specified in 3GPP TS 31.102 [22]. The procedure shall be started when:

- a) the UE is in any 5GMM-REGISTERED substate except substates 5GMM-REGISTERED.PLMN-SEARCH or 5GMM-REGISTERED.NO-CELL-AVAILABLE;
- b) the UE is in 5GMM-IDLE mode or 5GMM-CONNECTED mode with RRC inactive indication; and
- c) one of the following conditions applies:
 - 1) timer T3444 expires or is found to have already expired and timer T3445 is not running;
 - 2) timer T3445 expires or is found to have already expired and timer T3444 is not running; or
 - 3) timers T3444 and T3445 expire or are found to have already expired.

The UE shall then perform the following actions:

- a) stop other running timers (e.g. T3511, T3512);

- b) if the UE is currently registered to the network for 5GS services, perform a de-registration procedure;
- c) delete any 5G-GUTI, TAI list, last visited registered TAI, list of equivalent PLMNs, and ngKSI; and
- d) enter 5GMM-DEREGISTERED.eCALL-INACTIVE state.

If the UE is configured for eCall only mode as specified in 3GPP TS 31.102 [23] and moves from GERAN or UTRAN to NG-RAN, the UE shall:

- a) if timer T3242 is running, start timer T3444 with the time left on T3242 and stop timer T3242;
- b) if timer T3243 is running, start timer T3445 with the time left on T3243 and stop timer T3243; and
- c) if timer T3242 or timer T3243 is running, perform an initial registration procedure for 5GS services.

NOTE: Timers T3242 and T3243 are specified in 3GPP TS 24.008 [12].

5.5.4 Authentication and key agreement procedure for 5G ProSe UE-to-network relay and 5G ProSe UE-to-UE relay

5.5.4.1 General

The purpose of the authentication and key agreement procedure:

- a) for 5G ProSe UE-to-network relay, is to perform the authentication for 5G ProSe remote UE initiated by the 5G ProSe UE-to-network relay UE and to agree on the $K_{\text{AUSF_P}}$ and $K_{\text{NR_ProSe}}$ when the security for 5G ProSe communication via 5G ProSe UE-to-network relay is performed over control plane as specified in 3GPP TS 33.503 [56]; or
- b) for 5G ProSe UE-to-UE relay, is to perform the authentication for 5G ProSe end UE initiated by the 5G ProSe UE-to-UE relay UE and to agree on the $K_{\text{AUSF_P}}$ and $K_{\text{NR_ProSe}}$ when the security for 5G ProSe communication via 5G ProSe UE-to-UE relay is performed over control plane as specified in 3GPP TS 33.503 [56].

The procedure as shown in figure 5.5.4.1.1 is initiated by the UE when the UE receives the ProSe direct link establishment request including the SUCI or the CP-PRUK ID of:

- a) the 5G ProSe remote UE from the 5G ProSe remote UE; or
- b) the 5G ProSe end UE from the 5G ProSe end UE,

for establishing secure PC5 unicast link as specified in 3GPP TS 24.554 [19E].

If the network decides to process the relay key request message, the EAP based authentication and key agreement procedure is initiated and controlled by the network. The exchanges of EAP messages between:

- a) the 5G ProSe remote UE and the network; or
- b) the 5G ProSe end UE and the network,

are relayed by the UE.

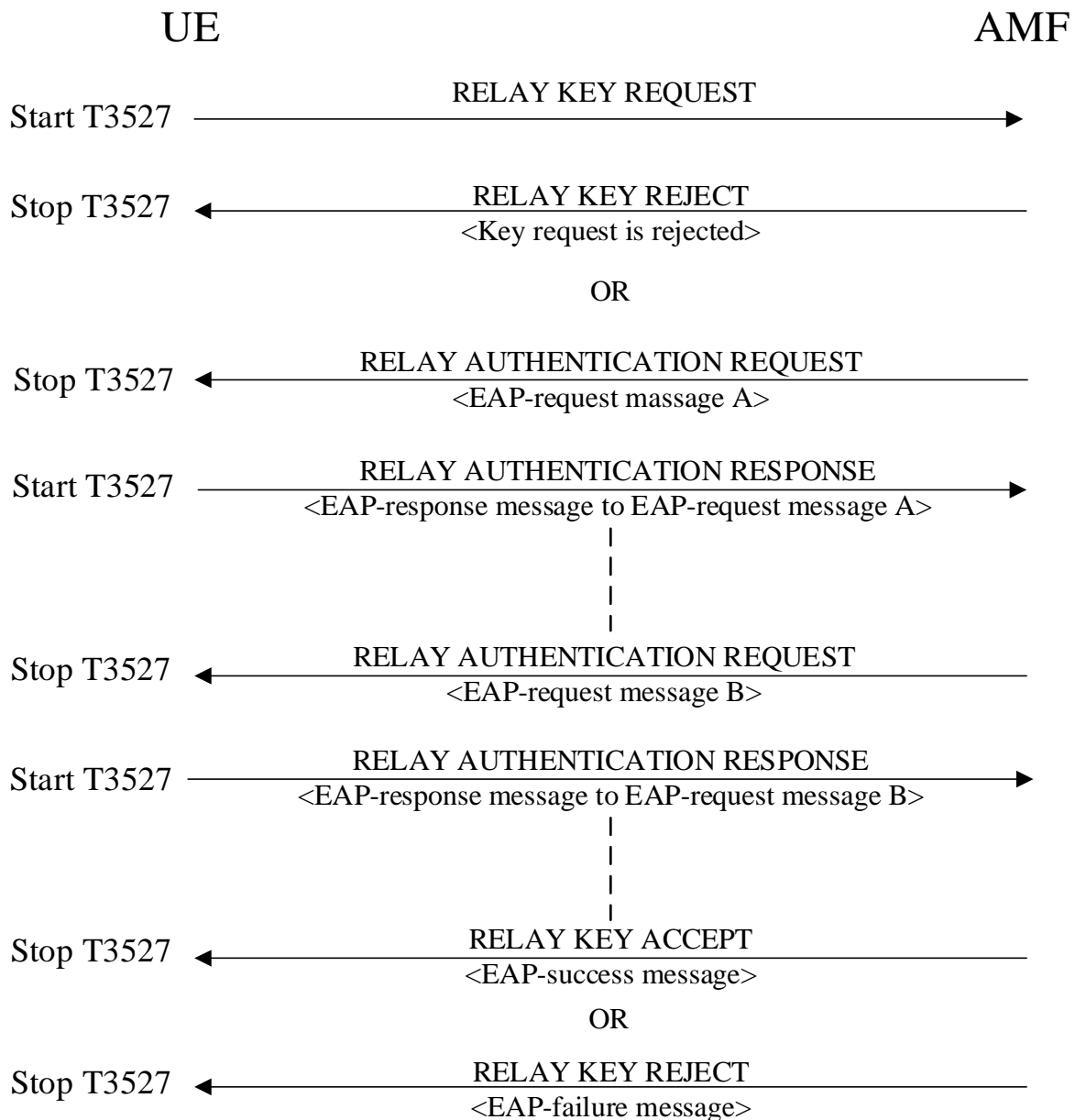

Figure 5.5.4.1.1: Authentication and key agreement procedure for 5G ProSe UE-to-network relay and 5G ProSe UE-to-UE relay

5.5.4.2 ProSe relay transaction identity (PRTI)

Upon receiving a ProSe direct link establishment request from a 5G ProSe remote UE or a 5G ProSe end UE for establishing a secure PC5 unicast link as specified in 3GPP TS 24.554 [19E], the UE shall allocate an available PRTI value for the authentication and key agreement procedure for 5G ProSe UE-to-network relay or 5G ProSe UE-to-UE relay and associate this PRTI value with the 5G ProSe remote UE or the 5G ProSe end UE.

The UE shall release the PRTI value allocated to the authentication and key agreement procedure for 5G ProSe UE-to-network relay or 5G ProSe UE-to-UE relay when the authentication and key agreement procedure for 5G ProSe UE-to-network relay or 5G ProSe UE-to-UE relay completes or is aborted.

5.5.4.3 UE-initiated authentication and key agreement procedure initiation

Upon receiving a ProSe direct link establishment request from the 5G ProSe remote UE or the 5G ProSe end UE including the SUCI or the CP-PRUK ID of the 5G ProSe remote UE or the 5G ProSe end UE, for establishing a secure PC5 unicast link as specified in 3GPP TS 24.554 [19E] when the security for 5G ProSe communication via 5G ProSe

UE-to-network relay or 5G ProSe UE-to-UE relay is performed over control plane as specified in 3GPP TS 33.503 [56], the UE shall:

- a) allocate a PRTI value as specified in subclause 5.5.4.2;
- b) create a RELAY KEY REQUEST message;
- c) set the PRTI IE of the RELAY KEY REQUEST message to the allocated PRTI value;
- d) set the relay key request parameters IE of the RELAY KEY REQUEST message with SUCI or the CP-PRUK ID, relay service code, and nonce_1 received from the of the 5G ProSe remote UE or the 5G ProSe end UE;
- e) send the RELAY KEY REQUEST message; and
- f) start the timer T3527 upon sending the RELAY KEY REQUEST message.

5.5.4.4 UE-initiated authentication and key agreement procedure accepted by the network

Upon receiving the RELAY KEY REQUEST message, the AMF processes the message and interacts with the AUSF of the 5G ProSe remote UE or the 5G ProSe end UE as specified in 3GPP TS 33.503 [56]. If EAP-AKA' authentication for the 5G ProSe remote UE or the 5G ProSe end UE is initiated by the network, the AMF shall:

- a) create a RELAY AUTHENTICATION REQUEST message;
- b) set the PRTI IE of the RELAY AUTHENTICATION REQUEST message to the PRTI value of the received RELAY KEY REQUEST message;
- c) set the EAP message IE of the RELAY AUTHENTICATION REQUEST message to EAP request message received from the AUSF; and
- d) send the RELAY AUTHENTICATION REQUEST message to the UE.

Upon receiving the RELAY AUTHENTICATION REQUEST message, the UE stops the timer T3527 and forwards the EAP message to the 5G ProSe remote UE or the 5G ProSe end UE as specified in 3GPP TS 24.554 [19E].

Upon receiving the EAP response message from the 5G ProSe remote UE or the 5G ProSe end UE as specified in 3GPP TS 24.554 [19E], the UE shall:

- a) create a RELAY AUTHENTICATION RESPONSE message;
- b) set the PRTI IE of the RELAY AUTHENTICATION RESPONSE message to the PRTI value of the received RELAY AUTHENTICATION REQUEST message;
- c) set the EAP message IE of the RELAY AUTHENTICATION RESPONSE message to EAP response message received from the 5G ProSe remote UE or the 5G ProSe end UE; and
- d) start a timer T3527 upon sending the RELAY AUTHENTICATION RESPONSE message to the AMF.

After receiving the RELAY AUTHENTICATION RESPONSE message, the AMF may send a new RELAY AUTHENTICATION REQUEST message carrying EAP request message according to further handling of EAP-AKA' authentication from the AUSF as specified in 3GPP TS 33.503 [56]. The UE repeats the handling of the RELAY AUTHENTICATION REQUEST message as described above.

Upon receiving the message from the AUSF that the authentication is successful, the AMF shall:

- a) create a RELAY KEY ACCEPT message;
- b) set the PRTI IE of the RELAY KEY ACCEPT message to the PRTI value of the RELAY KEY REQUEST message;
- c) include the EAP message IE of the RELAY KEY ACCEPT message set to EAP-success message received from the AUSF, if any;
- d) include the relay key response parameters IE of the RELAY KEY ACCEPT message set to K_{NR_ProSe} and nonce_2 received from AUSF; and

- e) include the CP-PRUK ID in the relay key response parameters IE of the RELAY KEY ACCEPT message.

Upon receiving the RELAY KEY ACCEPT message, the UE shall forward the EAP-success message, if any, and nonce_2 to the 5G ProSe remote UE or the 5G ProSe end UE as specified in 3GPP TS 24.554 [19E], and consider the authentication as completed successfully. The UE shall store the CP-PRUK ID to be used in the remote UE report procedure as specified in subclause 6.6.2.2.

5.5.4.5 UE-initiated authentication and key agreement procedure not accepted by the network

If the UE-initiated authentication and key agreement procedure is not accepted by the network, the AMF shall:

- a) create a RELAY KEY REJECT message;
- b) set the PRTI IE of the RELAY KEY REJECT message to the PRTI value of the received RELAY KEY REQUEST message if the network decides to reject the RELAY KEY REQUEST message; or

NOTE: The network decides to reject the RELAY KEY REQUEST message when e.g. the CP-PRUK is not found in the network.

set the PRTI IE of the RELAY KEY REJECT message to the PRTI value of the received RELAY AUTHENTICATION RESPONSE message and include the EAP message IE set with EAP-failure message if the AMF receives an EAP-failure message from the AUSF; and

- c) send the RELAY KEY REJECT message to the UE.

Upon receiving the RELAY KEY REJECT message, the UE shall consider the authentication has failed and perform the PC5 signalling protocol procedure as specified in subclause 7.2.2.5 of 3GPP 24.554 [19E].

5.5.4.6 Abnormal cases in the UE

The following abnormal cases in the UE can be identified:

- a) Transmission failure of RELAY KEY REQUEST message or RELAY KEY AUTHENTICATION RESPONSE message indication from lower layers.

The UE shall abort the authentication and key agreement procedure for 5G ProSe UE-to-network relay and perform the PC5 signalling protocol procedure as specified in subclause 7.2.2.5 of 3GPP 24.554 [19E].

- b) Expiry of timer T3527.

The UE shall, on the first expiry of the timer T3527, retransmit the RELAY KEY REQUEST message or the RELAY KEY AUTHENTICATION RESPONSE message and shall reset and start timer T3527. This retransmission is repeated four times, i.e. on the fifth expiry of timer T3527, the procedure shall be aborted.

- c) Collision between the authentication and key agreement procedure for 5G ProSe UE-to-network relay or 5G ProSe UE-to-UE relay and de-registration procedure.

The UE shall abort the authentication and key agreement procedure for 5G ProSe UE-to-network relay or 5G ProSe UE-to-UE relay, proceed with the network initiated de-registration procedure, and perform the PC5 signalling protocol procedure as specified in subclause 7.2.2.5 of 3GPP 24.554 [19E].

5.5.4.7 Abnormal cases on the network side

The following abnormal cases on the network side can be identified:

- a) Lower layer failure before the RELAY KEY AUTHENTICATION RESPONSE message is received.

The network shall abort the authentication and key agreement procedure for 5G ProSe UE-to-network relay or 5G ProSe UE-to-UE relay.

- b) Collision between the authentication and key agreement procedure for 5G ProSe UE-to-network relay or 5G ProSe UE-to-UE relay and de-registration procedure.

The network shall abort the authentication and key agreement procedure for 5G ProSe UE-to-network relay or 5G ProSe UE-to-UE relay and proceed with the UE-initiated de-registration procedure.

- c) Collision between the authentication and key agreement procedure for 5G ProSe UE-to-network relay or 5G ProSe UE-to-UE relay and other 5GMM procedures other than in item b.

The network shall progress both procedures.

5.6 5GMM connection management procedures

5.6.1 Service request procedure

5.6.1.1 General

The purpose of the service request procedure is to:

- a) change the 5GMM mode from 5GMM-IDLE to 5GMM-CONNECTED mode;
- b) request the establishment of user-plane resources for PDU sessions which are established without user-plane resources if the UE is not using 5GS services with control plane CIoT 5GS optimization and the 5GMM mode is the 5GMM-IDLE mode or the 5GMM-CONNECTED mode; or
- c) initiate transfer of user data via the control plane if the UE is using 5GS services with control plane CIoT 5GS optimization and the 5GMM mode is 5GMM-IDLE mode.

NOTE 1: The lower layer indicates when the user-plane resources for PDU sessions are successfully established or released.

This procedure is used when:

- the network has downlink signalling pending over 3GPP access and the UE is in 5GMM-IDLE mode over 3GPP access;
- the network has downlink signalling pending over non-3GPP access, the UE is in 5GMM-IDLE mode over non-3GPP access and in 5GMM-IDLE or 5GMM-CONNECTED mode over 3GPP access;
- the UE has uplink signalling pending over 3GPP access and the UE is in 5GMM-IDLE mode over 3GPP access;
- the network has downlink user data pending over 3GPP access and the UE is in 5GMM-IDLE mode over 3GPP access;
- the network has downlink user data pending over non-3GPP access, the UE is in 5GMM-IDLE mode over non-3GPP access and in 5GMM-IDLE or 5GMM-CONNECTED mode over 3GPP access;
- the UE has user data pending over 3GPP access and the UE is in 5GMM-IDLE or 5GMM-CONNECTED mode over 3GPP access;
- the UE has user data pending over non-3GPP access and the UE is in 5GMM-CONNECTED mode over non-3GPP access;
- the UE in 5GMM-IDLE mode over non-3GPP access, receives an indication from the lower layers of non-3GPP access, that the access stratum connection is established between the UE and the network, if T3346 is not running;
- the UE in 5GMM-IDLE or 5GMM-CONNECTED mode over 3GPP access receives a request from the upper layers to perform emergency services fallback and performs emergency services fallback as specified in subclause 4.13.4.2 of 3GPP TS 23.502 [9];
- the UE has to request resources for V2X communication over PC5;
- the UE has to request resources for 5G ProSe direct discovery over PC5 or 5G ProSe direct communication over PC5;
- the UE has to request resources for A2X communication over PC5;

NOTE 2: The purpose for the UE to request resources for V2X communication over PC5, 5G ProSe direct discovery over PC5 and 5G ProSe direct communication over PC5 can be to perform the ranging and sidelink positioning service over PC5.

- the MUSIM UE in 5GMM-IDLE mode requests the network to remove the paging restriction;
- the MUSIM UE requests the release of the NAS signalling connection or rejects the paging request from the network; or
- the UE supporting the reconnection to the network due to RAN timing synchronization status change receives an indication of a change in the RAN timing synchronization status.

This procedure shall not be used for:

- a) initiating user data transfer or CIoT user data via the control plane; or
- b) PDU session management related signalling other than for performing UE-requested PDU session release procedure related to a PDU session for LADN or for performing the UE-requested PDU session modification procedure to indicate a change of 3GPP PS data off UE status;

when the UE is located outside the LADN service area.

In NB-N1 mode, this procedure shall not be used to request the establishment of user-plane resources:

- a) for a number of PDU sessions that exceeds the UE's maximum number of supported user-plane resources if there is currently:
 - 1) no user-plane resources established for the UE;
 - 2) user-plane resources established for:
 - i) one PDU session and the Multiple user-plane resources support bit was set to "Multiple user-plane resources not supported" in the 5GMM capability IE; or
 - ii) two PDU sessions and the Multiple user-plane resources support bit was set to "Multiple user-plane resources supported" in the 5GMM capability IE; or
- b) for additional PDU sessions, if the number of PDU sessions for which user-plane resources are currently established is equal to the UE's maximum number of supported user-plane resources.

The service request procedure is initiated by the UE, however, it can be triggered by the network by means of:

- the paging procedure (see subclause 5.6.2) for the transfer of downlink signalling or user data pending over 3GPP access to a UE in 5GMM-IDLE mode over 3GPP access;
- the paging procedure (see subclause 5.6.2) for the transfer of downlink signalling or user data pending over non-3GPP access to a UE in 5GMM-IDLE mode over 3GPP access and in 5GMM-IDLE mode over non-3GPP access;
- the notification procedure (see subclause 5.6.3) for the transfer of downlink signalling or user data pending over non-3GPP access to a UE in 5GMM-CONNECTED mode over 3GPP access and in 5GMM-IDLE mode over non-3GPP access; or
- the notification procedure (see subclause 5.6.3) for the transfer of downlink signalling or user data pending over 3GPP access to a UE in 5GMM-IDLE mode over 3GPP access and in 5GMM-CONNECTED mode over non-3GPP access.

NOTE 3: In case the UE is in 5GMM-IDLE mode over 3GPP access and in 5GMM-CONNECTED mode over non-3GPP access and downlink signalling or user data pending over 3GPP access needs to be transferred, the AMF can trigger either the notification procedure or the paging procedure based on implementation.

The UE shall invoke the service request procedure when:

- a) the UE, in 5GMM-IDLE mode over 3GPP access, receives a paging request from the network;

NOTE 4: As an implementation option, the MUSIM UE is allowed to not invoke service request to respond to paging based on the information available in the paging message, e.g. voice service indication.

- b) the UE, in 5GMM-CONNECTED mode over 3GPP access, receives a notification from the network with access type indicating non-3GPP access;
- c) the UE, in 5GMM-IDLE mode over 3GPP access, has uplink signalling pending (except in case i);
- d) the UE, in 5GMM-IDLE mode over 3GPP access, has uplink user data pending (except in case j);
- e) the UE, in 5GMM-CONNECTED mode or in 5GMM-CONNECTED mode with RRC inactive indication, has user data pending due to no user-plane resources established for PDU session(s) used for user data transport;
- f) the UE in 5GMM-IDLE mode over non-3GPP access, with T3346 not active or upon expiry of T3346, receives or has already received an indication from the lower layers of non-3GPP access, that the access stratum connection is established between the UE and the network;
- g) the UE, in 5GMM-IDLE mode over 3GPP access, receives a notification from the network with access type indicating 3GPP access when the UE is in 5GMM-CONNECTED mode over non-3GPP access;
- h) the UE, in 5GMM-IDLE, 5GMM-CONNECTED mode over 3GPP access, or 5GMM-CONNECTED mode with RRC inactive indication, receives a request from the upper layers to perform emergency services fallback and performs emergency services fallback as specified in subclause 4.13.4.2 of 3GPP TS 23.502 [9];
- i) the UE, in 5GMM-CONNECTED mode over 3GPP access or in 5GMM-CONNECTED mode with RRC inactive indication, receives a fallback indication from the lower layers (see subclauses 5.3.1.2 and 5.3.1.4) and the UE has a pending NAS procedure other than a registration, service request, or de-registration procedure; the UE, in 5GMM-CONNECTED mode over 3GPP access, receives a "RRC Connection failure" from the lower layers and the UE has a pending NAS procedure other than a registration, service request, or de-registration procedure;
- j) the UE, in 5GMM-CONNECTED mode over 3GPP access or in 5GMM-CONNECTED mode with RRC inactive indication, receives a fallback indication from the lower layers (see subclauses 5.3.1.2 and 5.3.1.4) and the UE has pending uplink user data for PDU session(s) with user-plane resources already established but no pending NAS procedure; the UE, in 5GMM-CONNECTED mode over 3GPP access, receives a "RRC Connection failure" indication from the lower layers and the UE has pending uplink user data for PDU session(s) with user-plane resources already established but no pending NAS procedure;
- k) the UE, in 5GMM-CONNECTED mode and has a NAS signalling connection only, is using 5GS services with control plane CIoT 5GS optimization and has pending user data to be sent via user-plane resources;
- l) the UE in 5GMM-IDLE mode over 3GPP access has to request resources for V2X communication over PC5 (see 3GPP TS 23.287 [6C]);
- la) the UE in 5GMM-IDLE mode over 3GPP access has to request resources for A2X communication over PC5 (see 3GPP TS 23.256 [6AB]);
- m) the network supports the paging restriction, and the MUSIM UE in 5GMM-IDLE mode is requesting the network to remove the paging restriction;
- n) the UE in 5GMM-IDLE mode over 3GPP access
 - has to request resources for 5G ProSe direct discovery over PC5 or 5G ProSe direct communication over PC5 (see 3GPP TS 23.304 [6E]); or
 - acts as a 5G ProSe layer-2 UE-to-network relay UE and receives a trigger from lower layers to establish the NAS signalling connection (see 3GPP TS 23.304 [6E]);
- o) the network supports the N1 NAS signalling connection release, the MUSIM UE,
 - is in 5GMM-CONNECTED mode, requests the network to release the NAS signalling connection and, if the network supports the paging restriction, optionally includes paging restriction;
 - is in 5GMM-CONNECTED mode with RRC inactive indication, requests the network to release the NAS signalling connection and, if the network supports the paging restriction, optionally includes paging restriction; or

- is in 5GMM-CONNECTED mode with RRC inactive indication, rejects the RAN paging, requests the network to release the NAS signalling connection and, if the network supports the paging restriction, optionally includes paging restriction;
- p) the network supports the reject paging request, the MUSIM UE in 5GMM-IDLE mode when responding to paging rejects the paging request from the network, requests the network to release the NAS signalling connection and, if the network supports the paging restriction, optionally includes paging restriction; or
- q) the UE supporting the reconnection to the network due to RAN timing synchronization status change has been requested to reconnect to the network upon receiving an indication of a change in the RAN timing synchronization status (see subclauses 5.4.4.2, 5.5.1.2.4, and 5.5.1.3.4) and the UE in 5GMM-IDLE mode receives an indication of a change in the RAN timing synchronization status;

If one of the above criteria to invoke the service request procedure is fulfilled, then the service request procedure shall only be initiated by the UE when the following conditions are fulfilled:

- its 5GS update status is 5U1 UPDATED, and the TAI of the current serving cell is included in the TAI list; and
- no 5GMM specific procedure is ongoing.

The UE shall not invoke the service request procedure when the UE is in the state 5GMM-SERVICE-REQUEST-INITIATED.

The MUSIM UE shall not initiate service request procedure for requesting the network to release the N1 NAS signalling connection if the UE is registered for emergency services or if the UE has an emergency PDU session established. To enable the emergency call back, the UE shall not initiate service request procedure for requesting the network to release the NAS signalling connection for a UE implementation-specific duration of time after the completion of the emergency services.

The UE supporting S-NSSAI location validity information shall not invoke the service request procedure to establish user-plane resources for PDU sessions associated to an S-NSSAI when the UE is not in the NS-AoS of the S-NSSAI.

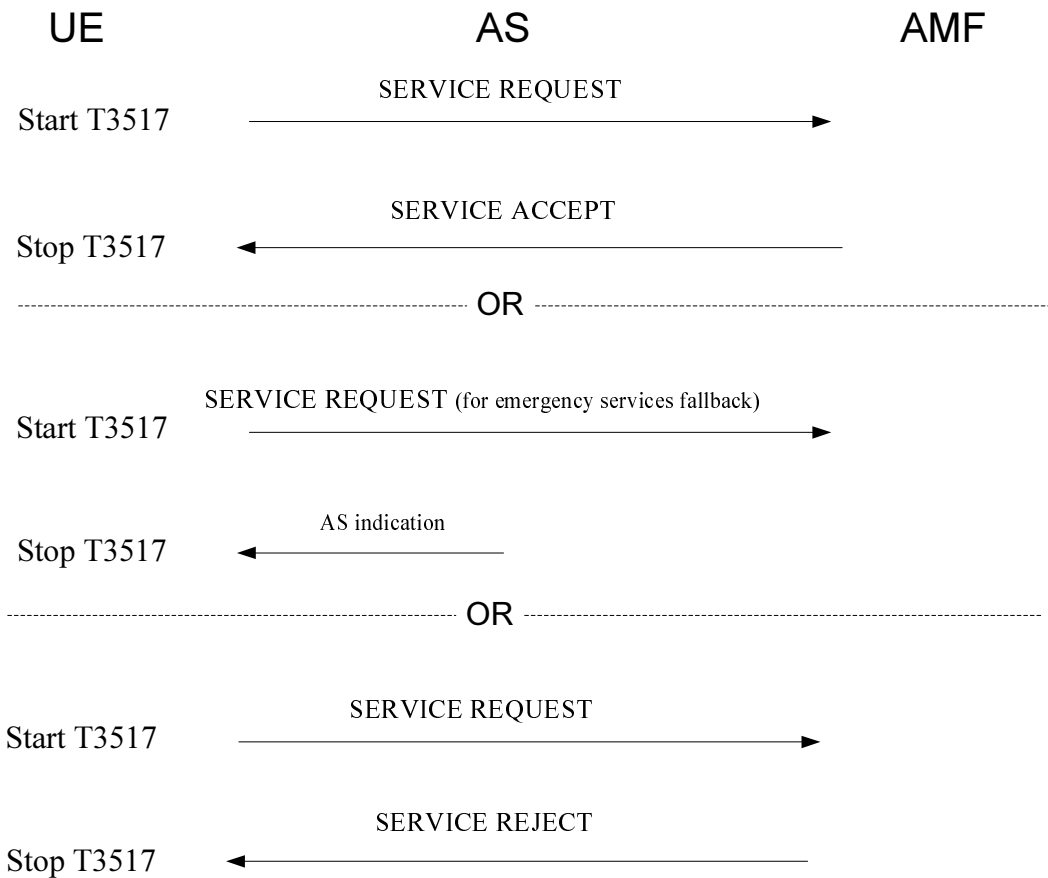

Figure 5.6.1.1.1: Service Request procedure (Part 1)

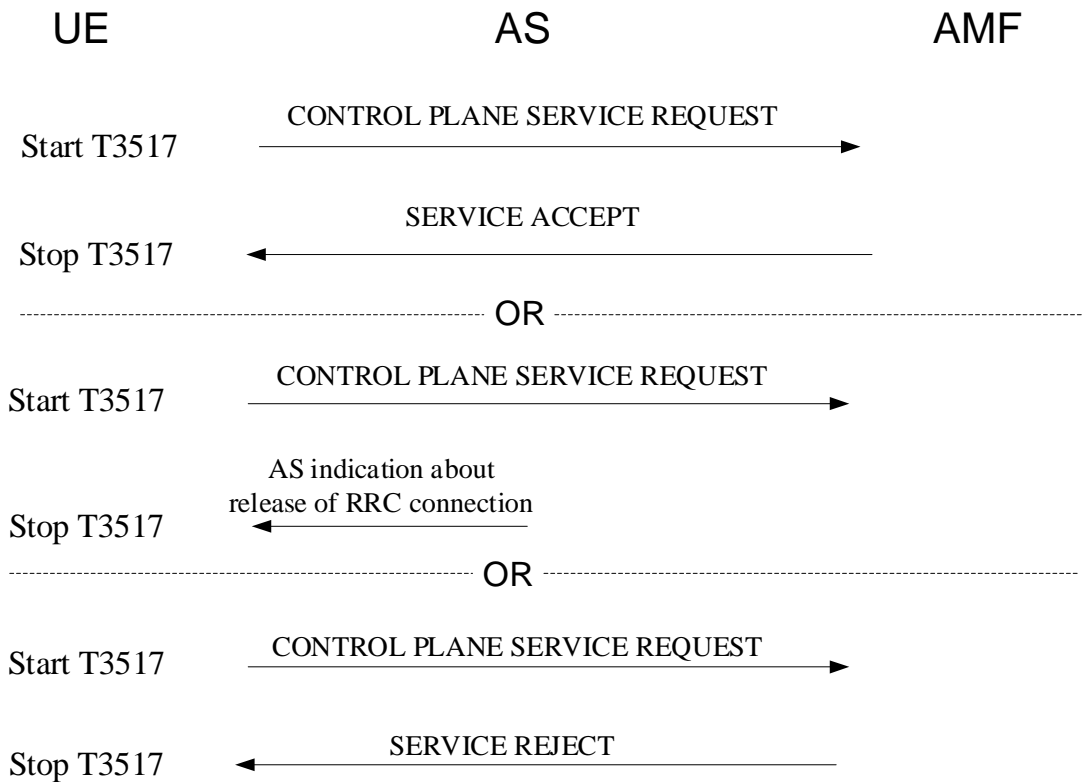

Figure 5.6.1.1.2: Service Request procedure (Part 2)

A service request attempt counter is used to limit the number of service request attempts and no response from the network. The service request attempt counter shall be incremented as specified in subclause 5.6.1.7.

The service request attempt counter shall be reset when:

- a registration procedure for mobility and periodic registration update is successfully completed;
- a service request procedure is successfully completed;
- a service request procedure is rejected as specified in subclause 5.6.1.5 or subclause 5.3.20; or
- the UE moves to 5GMM-DEREGISTERED state.

5.6.1.2 Service request procedure initiation

5.6.1.2.1 UE is not using 5GS services with control plane Clot 5GS optimization

The UE initiates the service request procedure by sending a SERVICE REQUEST message to the AMF. The UE shall start timer T3517 and enter the state 5GMM-SERVICE-REQUEST-INITIATED.

If the UE is sending the SERVICE REQUEST message from 5GMM-IDLE mode and the UE needs to send non-clear text IEs, the UE shall send the SERVICE REQUEST message including the NAS message container IE as described in subclause 4.4.6.

For cases a), b), and g) in subclause 5.6.1.1, the service type IE in the SERVICE REQUEST message shall be set to "mobile terminated services".

For cases c), d), e), f), i), j), l), la), m), n), and q) in subclause 5.6.1.1, if the UE is a UE configured for high priority access in selected PLMN or SNPN, the service type IE in the SERVICE REQUEST message shall be set to "high priority access".

For case a) in subclause 5.6.1.1:

- a) if the paging request includes an indication for non-3GPP access type, the Allowed PDU session status IE shall be included in the SERVICE REQUEST message. If the UE has PDU session(s) over non-3GPP access, where:
 - 1) the associated S-NSSAI(s) are included in the allowed NSSAI for 3GPP access or the partially allowed NSSAI for 3GPP access and the TAI where the UE is currently camped is in the list of TAs for which the S-NSSAI is allowed; and
 - 2) the UE is currently camped inside the NS-AoS of the S-NSSAI, if the S-NSSAI location validity information is available,the UE shall indicate the PDU session(s) for which the UE allows the user-plane resources to be re-established over 3GPP access in the Allowed PDU session status IE; otherwise, the UE shall not indicate any PDU session(s) in the Allowed PDU session status IE; and
- b) if the UE has uplink user data pending to be sent over 3GPP access, the Uplink data status IE shall be included in the SERVICE REQUEST message to indicate the PDU session(s) for which the UE has pending user data to be sent. Otherwise, the Uplink data status IE shall not be included in the SERVICE REQUEST message.

For case b) in subclause 5.6.1.1:

- a) the Allowed PDU session status IE shall be included in the SERVICE REQUEST message. If the UE has PDU session(s) over non-3GPP access where:
 - 1) the associated S-NSSAI(s) are included in the allowed NSSAI for 3GPP access or the partially allowed NSSAI for 3GPP access and the TAI where the UE is currently camped is in the list of TAs for which the S-NSSAI is allowed; and
 - 2) the UE is currently camped inside the NS-AoS of the S-NSSAI, if the S-NSSAI location validity information is available,

the UE shall indicate the PDU session(s) for which the UE allows the user-plane resources to be re-established over 3GPP access in the Allowed PDU session status IE; otherwise, the UE shall not indicate any PDU session(s) in the Allowed PDU session status IE; and

- b) if the UE has uplink user data pending to be sent over 3GPP access, the Uplink data status IE shall be included in the SERVICE REQUEST message to indicate the PDU session(s) for which the UE has pending user data to be sent. Otherwise, the Uplink data status IE shall not be included in the SERVICE REQUEST message.

For cases a) and b) in subclause 5.6.1.1, if the UE is in a non-allowed area or the UE is not in an allowed area, the UE shall set the Allowed PDU session status IE as specified in subclause 5.3.5.2.

When the Allowed PDU session status IE is included in the SERVICE REQUEST message, the UE shall indicate that a PDU session is not allowed to be transferred to the 3GPP access if the 3GPP PS data off UE status is "activated" for the corresponding PDU session and the UE is not using the PDU session to send uplink IP packets for any of the 3GPP PS data off exempt services (see subclause 6.2.10).

For case c) in subclause 5.6.1.1, the Uplink data status IE shall not be included in the SERVICE REQUEST message except if the UE has one or more active always-on PDU sessions associated with the access type over which the SERVICE REQUEST message is sent. If the UE is not a UE configured for high priority access in selected PLMN or SNPN and:

- a) if the SERVICE REQUEST message is triggered by a request for emergency services from the upper layer, the UE shall set the service type IE in the SERVICE REQUEST message to "emergency services"; or
- b) otherwise, the UE shall set the service type IE to "signalling".

When the UE is in a non-allowed area or is not in an allowed area as specified in subclause 5.3.5 and:

- a) if the uplink signalling pending is to indicate a change of 3GPP PS data off UE status for a PDU session, the UE shall set the service type IE in the SERVICE REQUEST message to "elevated signalling", and shall not include the Uplink data status IE in the SERVICE REQUEST message even if the UE has one or more active always-on PDU sessions associated with the access type over which the SERVICE REQUEST message is sent; or
- b) otherwise, the UE shall not initiate service request procedure except for emergency services, high priority access or responding to paging or notification.

For cases d) and e) in subclause 5.6.1.1, the Uplink data status IE shall be included in the SERVICE REQUEST message to indicate the PDU session(s) the UE has pending user data to be sent. If the UE is not a UE configured for high priority access in selected PLMN or SNPN:

- a) if there exists an emergency PDU session which is indicated in the Uplink data status IE the service type IE in the SERVICE REQUEST message shall be set to "emergency services"; or
- b) otherwise, the service type IE in the SERVICE REQUEST message shall be set to "data".

NOTE 1: For a UE in NB-N1 mode, the Uplink data status IE cannot be used to request the establishment of user-plane resources such that there will be user-plane resources established for a number of PDU sessions that exceeds the UE's maximum number of supported user-plane resources.

For case f) in subclause 5.6.1.1:

- a) if the UE has uplink user data pending to be sent, the Uplink data status IE shall be included in the SERVICE REQUEST message to indicate the PDU session(s) the UE has pending user data to be sent. If the UE is not a UE configured for high priority access in selected PLMN or SNPN, the service type IE in the SERVICE REQUEST message shall be set to "data";
- b) otherwise, if the UE is not a UE configured for high priority access in selected PLMN or SNPN, the service type IE in the SERVICE REQUEST message shall be set to "signalling".

For case g) in subclause 5.6.1.1, if the UE has uplink user data pending to be sent, the Uplink data status IE shall be included in the SERVICE REQUEST message to indicate the PDU session(s) the UE has pending user data to be sent.

For case h) in subclause 5.6.1.1, the UE shall send a SERVICE REQUEST message with service type set to "emergency services fallback" and without an Uplink data status IE.

For case i) in subclause 5.6.1.1, if the UE is not configured for high priority access in selected PLMN or SNPN, the UE shall set the Service type IE in the SERVICE REQUEST message as follows:

- a) if the pending message is an UL NAS TRANSPORT message with the Request type IE set to "initial emergency request" or "existing emergency PDU session", the UE shall set the Service type IE in the SERVICE REQUEST message to "emergency services"; or
- b) otherwise, the UE shall set the Service type IE in the SERVICE REQUEST message to "signalling".

For case j) in subclause 5.6.1.1:

- a) the UE shall include the Uplink data status IE in the SERVICE REQUEST message indicating the PDU session(s) for which the UE has uplink user data pending and the PDU session(s) for which user-plane resources were active prior to receiving the fallback indication or "RRC Connection failure" indication from the lower layers, if any; and
- b) if the UE is not a UE configured for high priority access in selected PLMN or SNPN, the UE shall set the Service type IE in the SERVICE REQUEST message as follows:
 - 1) if there is an emergency PDU session which is indicated in the Uplink data status IE, the UE shall set the Service type IE in the SERVICE REQUEST message to "emergency services"; or
 - 2) if there is no emergency PDU session which is indicated in the Uplink data status IE, the UE shall set the Service type IE in the SERVICE REQUEST message to "data".

For cases l), la, n), and q) in subclause 5.6.1.1, if the UE is not a UE configured for high priority access in selected PLMN or SNPN:

- a) if there exists an emergency PDU session which is indicated in the Uplink data status IE the service type IE in the SERVICE REQUEST message shall be set to "emergency services"; or
- b) otherwise, the service type IE in the SERVICE REQUEST message shall be set to "signalling".

For case m) in subclause 5.6.1.1, the UE shall not include the Paging restriction IE in the SERVICE REQUEST message and set Service type to "signalling". The UE may include the UE request type IE and set Request type to "NAS signalling connection release" to remove the paging restriction and request the release of the NAS signalling connection at the same time. If the UE requests the release of the NAS signalling connection, the UE shall not include the Uplink data status IE in the SERVICE REQUEST message.

For cases o) and p) in subclause 5.6.1.1, the UE shall not include the Uplink data status IE and the Allowed PDU session status IE in the SERVICE REQUEST message. Further,

- for case o) in subclause 5.6.1.1, the UE shall set Request type to "NAS signalling connection release" in the UE request type IE and Service type to "signalling";
- for case p) in subclause 5.6.1.1, the UE shall set Request type to "Rejection of paging" in the UE request type IE and Service type to "mobile terminated services"; and

may include its paging restriction preference in the Paging restriction IE in the SERVICE REQUEST message.

The UE shall include a valid 5G-S-TMSI in the 5G-S-TMSI IE of the SERVICE REQUEST message.

For all cases except cases o) and p) in subclause 5.6.1.1, if the UE has one or more active always-on PDU sessions associated with the access type over which the SERVICE REQUEST message is sent and the user-plane resources for these PDU sessions are not established:

- a) if the S-NSSAI associated with the PDU session is:
 - 1) included in the partially allowed NSSAI and the TA where the UE is currently camped is not in list of TAs for which the S-NSSAI is allowed; or
 - 2) included in the S-NSSAI location validity information and the UE is outside the NS-AoS of the S-NSSAI;

then the UE shall not indicate those PDU session(s), including always-on PDU session(s), in Uplink data status IE in the SERVICE REQUEST message; or

- b) otherwise, the UE shall include the Uplink data status IE in the SERVICE REQUEST message and indicate that the UE has pending user data to be sent for those PDU sessions.

If the UE has one or more active PDU sessions which are not accepted by the network as always-on PDU sessions and no uplink user data pending to be sent for those PDU sessions, the UE shall not include those PDU sessions in the Uplink data status IE in the SERVICE REQUEST message.

The Uplink data status IE may be included in the SERVICE REQUEST message to indicate which PDU session(s) associated with the access type the SERVICE REQUEST message is sent over have pending user data to be sent or are associated with active multicast MBS session(s). If the UE is located outside the LADN service area of a PDU session, the UE shall not include the PDU session for LADN in the Uplink data status IE.

If the UE is in a non-allowed area or the UE is not in an allowed area, the UE shall apply the restrictions for the inclusion of the Uplink data status IE specified in subclause 5.3.5.2.

The PDU session status information element may be included in the SERVICE REQUEST message to indicate:

- the single access PDU session(s) not in 5GSM state PDU SESSION INACTIVE in the UE associated with the access type the SERVICE REQUEST message is sent over; and
- the MA PDU session(s) not in 5GSM state PDU SESSION INACTIVE and having the corresponding user plane resources being established or established in the UE on the access the SERVICE REQUEST message is sent over.

If the SERVICE REQUEST message includes a NAS message container IE, the AMF shall process the SERVICE REQUEST message that is obtained from the NAS message container IE as described in subclause 4.4.6.

If the UE has an emergency PDU session over the non-current access, it shall not initiate the SERVICE REQUEST message with the service type IE set to "emergency services" over the current access, unless the SERVICE REQUEST message has to be initiated to perform handover of an existing emergency PDU session from the non-current access to the current access.

NOTE 2: Transfer of an existing emergency PDU session between 3GPP access and non-3GPP access is needed e.g. if the UE determines that the current access is no longer available.

5.6.1.2.2 UE is using 5GS services with control plane CIoT 5GS optimization

The UE shall send a CONTROL PLANE SERVICE REQUEST message, start T3517 and enter the state 5GMM-SERVICE-REQUEST-INITIATED.

For case a), and case b) in subclause 5.6.1.1, the Control plane service type of the CONTROL PLANE SERVICE REQUEST message shall indicate "mobile terminating request". If:

- a) the UE only has uplink CIoT user data or SMS to be sent, the UE shall:
- 1) if the data size is not more than 254 octets and there is no other optional IE to be included in the message:
 - i) for sending CIoT user data, set the Data type field to "control plane user data", include the PDU session ID, data, and Downlink data expected (DDX) (if available), in the CIoT small data container IE; and
 - ii) for sending SMS, set the Data type field to "SMS", include SMS in the CIoT small data container IE; and
 - 2) otherwise if the data size is more than 254 octets or there are other optional IEs to be included in the message:
 - i) for sending CIoT user data, set the Payload container type IE to "CIoT user data container", include the PDU session ID in the PDU session ID IE and include data in the Payload container IE as described in subclause 5.4.5.2.2; and
 - ii) for sending SMS, set the Payload container type IE to "SMS" and include data in the Payload container IE as described in subclause 5.4.5.2.2; and
- b) the paging request or the notification includes an indication for non-3GPP access type, the UE has at least one PDU session that is not associated with control plane only indication, the Allowed PDU session status IE shall be included in the CONTROL PLANE SERVICE REQUEST message. If the UE is in a non-allowed area or the

UE is not in an allowed area, the UE shall set the Allowed PDU session status IE as specified in subclause 5.3.5.2. If the UE has PDU session(s) over non-3GPP access where:

- 1) the associated S-NSSAI(s) are included in the allowed NSSAI for 3GPP access or the partially allowed NSSAI for 3GPP access and the TAI where the UE is currently camped is in the list of TAs for which the S-NSSAI is allowed; and
- 2) the UE is currently camped inside the NS-AoS of the S-NSSAI, if the S-NSSAI location validity information is available,

the UE shall indicate the PDU session(s) for which the UE allows the user-plane resources to be re-established over 3GPP access in the Allowed PDU session status IE; otherwise, the UE shall not indicate any PDU session(s) in the Allowed PDU session status IE.

NOTE 1: The term DDX used in the present document corresponds to the term NAS RAI used in 3GPP TS 23.502 [9].

For case c), and case d), when the UE is located outside the LADN service area, the UE shall not perform the service request procedure to send CIoT user data via the control plane for a PDU session for LADN.

For case c), and case d) if the UE has pending CIoT user data that is to be sent via the control plane in subclause 5.6.1.1, the UE shall set the Control plane service type of the CONTROL PLANE SERVICE REQUEST message to "mobile originating request". If the UE has only uplink CIoT user data, SMS or location services message to be sent, the UE shall:

- a) if the data size is not more than 254 octets, there is no other optional IE to be included in the CONTROL PLANE SERVICE REQUEST message, and the data being sent is:
 - 1) CIoT user data, set the Data type field to "control plane user data", include the PDU session ID, data, and Downlink data expected (DDX) (if available), in the CIoT small data container IE;
 - 2) location services message, set the Data type field to "Location services message container" and Downlink data expected (DDX), if available, in the CIoT small data container IE, and:
 - i) if routing information is provided by upper layers:
 - A) set the length of additional information field in the CIoT small data container IE to the length of routing information provided by upper layer location services application (see subclause 9.11.3.67), and set the additional information field in the CIoT small data container IE to the routing information provided by upper layer location services application (see subclause 9.11.3.67); or
 - B) otherwise set the length of additional information field in the CIoT small data container IE to zero. In this case the Additional information field of the CIoT small data container IE shall not be included; and
 - ii) set the Data contents field of the CIoT small data container IE to the location services message payload; or
 - 3) SMS, set the Data type field to "SMS", include SMS in the CIoT small data container IE; or
- b) otherwise if the data size is more than 254 octets or there are other optional IEs to be included in the CONTROL PLANE SERVICE REQUEST message, and the data being sent is:
 - 1) CIoT user data, set the Payload container type IE to "CIoT user data container", include the PDU session ID in the PDU session ID IE and include data in the Payload container IE as described in subclause 5.4.5.2.2;
 - 2) location services message, set the Payload container type IE to "Location services message container", include data in the Payload container IE as described in subclause 5.4.5.2.2. If the upper layer location services application provides the routing information set the Additional information IE to the routing information as described in subclause 5.4.5.2.2; or
 - 3) SMS, set the Payload container type IE to "SMS" and include data in the Payload container IE as described in subclause 5.4.5.2.2.

For case a), and case b) in subclause 5.6.1.1, if the UE has pending user data that is to be sent via the user plane, the UE shall set the Control plane service type of the CONTROL PLANE SERVICE REQUEST message to "mobile

terminating request". The UE shall include the Uplink data status IE in the CONTROL PLANE SERVICE REQUEST message to indicate which PDU session(s) have pending user data to be sent via user-plane resources.

For case c) in subclause 5.6.1.1, if the UE is in WB-N1 mode and the CONTROL PLANE SERVICE REQUEST message is triggered by a request for emergency services from the upper layer, the UE shall set the Control plane service type of the CONTROL PLANE SERVICE REQUEST message to "emergency services".

For cases d) and k), if the UE has pending user data that is to be sent via the user plane in subclause 5.6.1.1:

- a) and if there exists an emergency PDU session which is indicated in the Uplink data status IE, the UE shall set the Control plane service type of the CONTROL PLANE SERVICE REQUEST message to "emergency services";
or
- b) otherwise, the UE shall set the Control plane service type to "mobile originating request".

The UE shall include the Uplink data status IE in the CONTROL PLANE SERVICE REQUEST message to indicate which PDU session(s) have pending user data to be sent via user-plane resources or are associated with active multicast MBS session(s).

NOTE 2: For a UE in NB-N1 mode, the Uplink data status IE cannot be used to request the establishment of user-plane resources such that there will be user-plane resources established for a number of PDU sessions that exceeds the UE's maximum number of supported user-plane resources.

For case h) in subclause 5.6.1.1, if the UE is in WB-N1 mode and the UE does not have any PDU session that is associated with control plane only indication, the UE shall send a CONTROL PLANE SERVICE REQUEST message with the Control plane service type set to "emergency services fallback" and without an Uplink data status IE.

For case i) in subclause 5.6.1.1, the Control plane service type of the CONTROL PLANE SERVICE REQUEST message shall indicate "mobile originating request". If the pending message is an UL NAS TRANSPORT message with the Payload container type IE set to:

- a) "SMS", "Location services message container", or "CIoT user data container", the UE shall send the CONTROL PLANE SERVICE REQUEST and include the SMS, location services message, or CIoT user data as described in this subclause; or
- b) otherwise, the UE shall send the CONTROL PLANE SERVICE REQUEST:
 - 1) without including the CIoT small data container IE and without including the NAS message container IE if the UE has no other optional IE to be sent; or
 - 2) with the NAS message container IE if the UE has an optional IE to be sent as described in this subclause.

For case j) in subclause 5.6.1.1, the Control plane service type of the CONTROL PLANE SERVICE REQUEST message shall indicate "mobile originating request". The UE shall include the Uplink data status IE in the CONTROL PLANE SERVICE REQUEST message indicating the PDU session(s) for which user-plane resources were active prior to receiving the fallback indication, if any.

For cases o) and p) in subclause 5.6.1.1, the UE shall not include the Uplink data status IE and the Allowed PDU session status IE in the CONTROL PLANE SERVICE REQUEST message. Further,

- for case o) in subclause 5.6.1.1, the UE shall set Request type to "NAS signalling connection release" in the UE request type IE and Control plane service type to "mobile originating request";
- for case p) in subclause 5.6.1.1, the UE shall set Request type to "Rejection of paging" in the UE request type IE and Control plane service type to "mobile terminating request"; and

may include its paging restriction preferences in the Paging restriction IE in the CONTROL PLANE SERVICE REQUEST message.

For case m) in subclause 5.6.1.1, the Control plane service type of the CONTROL PLANE SERVICE REQUEST message shall indicate "mobile originating request". The UE shall not include the Paging restriction IE in the CONTROL PLANE SERVICE REQUEST message. The UE may include the UE request type IE and set Request type to "NAS signalling connection release" to remove the paging restriction and request the release of the NAS signalling connection at the same time. If the UE requests the release of the NAS signalling connection, the UE shall not include the Uplink data status IE in the SERVICE REQUEST message. For all cases, if the UE includes the Uplink data status

IE and the UE is located outside the LADN service area of a PDU session, the UE shall not include the PDU session for LADN in the Uplink data status IE.

If the UE is in a non-allowed area or the UE is not in an allowed area, the UE shall apply the restrictions for the inclusion of the Uplink data status IE specified in subclause 5.3.5.2.

The UE may include the PDU session status IE in the CONTROL PLANE SERVICE REQUEST message to indicate which PDU session(s) associated with the access type the CONTROL PLANE SERVICE REQUEST message is sent over are active in the UE.

5.6.1.3 Common procedure initiation

Upon receipt of the SERVICE REQUEST or CONTROL PLANE SERVICE REQUEST message, the AMF may initiate the common procedures e.g. the 5G AKA based primary authentication and key agreement procedure or the EAP based primary authentication and key agreement procedure.

5.6.1.4 Service request procedure accepted by the network

5.6.1.4.1 UE is not using 5GS services with control plane Clot 5GS optimization

For cases other than h) in subclause 5.6.1.1, the UE shall treat the reception of the SERVICE ACCEPT message as successful completion of the procedure. The UE shall reset the service request attempt counter, stop timer T3517 and enter the state 5GMM-REGISTERED.

For case h) in subclause 5.6.1.1,

- a) the UE shall treat the indication from the lower layers when the UE has changed to S1 mode or E-UTRA connected to 5GCN (see 3GPP TS 23.502 [9]) as successful completion of the procedure and stop timer T3517;
- b) if a UE operating in single-registration mode has changed to S1 mode, it shall disable the N1 mode capability for 3GPP access (see subclause 4.9.2); and
- c) the AMF shall not check for CAG restrictions.

If the PDU session status information element is included in the SERVICE REQUEST message, then:

- a) for single access PDU sessions, the AMF shall:
 - 1) perform a local release of all those PDU sessions which are not in 5GSM state PDU SESSION INACTIVE on the AMF side associated with the access type the SERVICE REQUEST message is sent over, but are indicated by the UE as being in 5GSM state PDU SESSION INACTIVE; and
 - 2) request the SMF to perform a local release of all those PDU sessions. If any of those PDU sessions is associated with one or more multicast MBS sessions, the SMF shall consider the UE as removed from the associated multicast MBS sessions; and
- b) for MA PDU sessions, the AMF shall:
 - 1) for MA PDU sessions having user plane resources established in the AMF only on the access the SERVICE REQUEST message is sent over, but are indicated by the UE as no user plane resources established:
 - i) for all those MA PDU sessions without a PDN connection established as a user-plane resource, perform a local release of all those MA PDU sessions and request the SMF to perform a local release of all those MA PDU sessions. If the MA PDU session is associated with one or more multicast MBS sessions, the SMF shall consider the UE as removed from the associated multicast MBS sessions; and
 - ii) for all those MA PDU sessions with a PDN connection established as a user-plane resource, perform a local release of user plane resources of all those PDU sessions on the access the SERVICE REQUEST message is sent over and request the SMF to perform a local release of user plane resources of all those PDU sessions on the access type the SERVICE REQUEST message is sent over; and
 - 2) for MA PDU sessions having user plane resources established on both accesses in the AMF, but are indicated by the UE as no user plane resources established:

- i) perform a local release of user plane resources of all those PDU sessions on the access the SERVICE REQUEST message is sent over; and
- ii) request the SMF to perform a local release of user plane resources of all those PDU sessions on the access type the SERVICE REQUEST message is sent over. If the SERVICE REQUEST message is sent over 3GPP access and the MA PDU session is associated with one or more multicast MBS sessions, the SMF shall consider the UE as removed from the associated multicast MBS sessions.

If the AMF needs to initiate PDU session status synchronization or a PDU session status IE was included in the SERVICE REQUEST message, the AMF shall include a PDU session status IE in the SERVICE ACCEPT message to indicate:

- which single access PDU sessions associated with the access type the SERVICE ACCEPT message is sent over are not in 5GSM state PDU SESSION INACTIVE in the AMF; and
- which MA PDU sessions are not in 5GSM state PDU SESSION INACTIVE and having user plane resources established in the AMF on the access the SERVICE ACCEPT message is sent over.

If the PDU session status information element is included in the SERVICE ACCEPT message, then:

- a) for single access PDU sessions, the UE shall perform a local release of all those PDU sessions which are not in 5GSM state PDU SESSION INACTIVE or PDU SESSION ACTIVE PENDING on the UE side associated with the access type the SERVICE ACCEPT message is sent over, but are indicated by the AMF as in 5GSM state PDU SESSION INACTIVE. If a locally released PDU session is associated with one or more multicast MBS sessions, the UE shall locally leave the associated multicast MBS sessions; and
- b) for MA PDU sessions, for all those PDU sessions which are not in 5GSM state PDU SESSION INACTIVE or PDU SESSION ACTIVE PENDING and have user plane resources established on the UE side associated with the access the SERVICE ACCEPT message is sent over, but are indicated by the AMF as no user plane resources established:
 - 1) for MA PDU sessions having user plane resources established only on the access type the SERVICE ACCEPT message is sent over, the UE shall perform a local release of those MA PDU sessions. If a locally released MA PDU session is associated with one or more multicast MBS sessions, the UE shall locally leave the associated multicast MBS sessions; and
 - 2) for MA PDU sessions having user plane resources established on both accesses, the UE shall perform a local release on the user plane resources on the access type the SERVICE ACCEPT message is sent over. If the user plane resources over 3GPP access are released and the MA PDU session is associated with one or more multicast MBS sessions, the UE shall locally leave the associated multicast MBS sessions.

If the Uplink data status IE is included in the SERVICE REQUEST message and the UE is:

- a) not in NB-N1 mode; or
- b) in NB-N1 mode and the UE does not indicate a request to have user-plane resources established for a number of PDU sessions that exceeds the UE's maximum number of supported user-plane resources;

the AMF shall:

- a) indicate the SMF to re-establish the user-plane resources for the corresponding PDU sessions;
- b) include the PDU session reactivation result IE in the SERVICE ACCEPT message to indicate the user-plane resources re-establishment result of the PDU sessions for which the UE requested to re-establish the user-plane resources; and
- c) determine the UE presence in LADN service area (see subclause 6.2.6) and forward the UE presence in LADN service area towards the SMF, if the corresponding PDU session is a PDU session for LADN.

If the Allowed PDU session status IE is included in the SERVICE REQUEST message, the AMF shall:

- a) for a 5GSM message from each SMF that has indicated pending downlink signalling only, forward the received 5GSM message via 3GPP access to the UE after the SERVICE ACCEPT message is sent;
- b) for each SMF that has indicated pending downlink data only:

- 1) notify the SMF that reactivation of the user-plane resources for the corresponding PDU session(s) associated with non-3GPP access cannot be performed if the corresponding PDU session ID(s) are not indicated in the Allowed PDU session status IE; and
- 2) notify the SMF that reactivation of the user-plane resources for the corresponding PDU session(s) associated with non-3GPP access can be performed if:
 - i) for a UE not in NB-N1 mode, the corresponding PDU session ID(s) are indicated in the Allowed PDU session status IE; or
 - ii) for a UE in NB-N1 mode, the corresponding PDU session ID(s) are indicated in the Allowed PDU session status IE, and the resulting number of PDU sessions with established user-plane resources does not exceed the UE's maximum number of supported user-plane resources;
- c) for each SMF that have indicated pending downlink signalling and data:
 - 1) notify the SMF that reactivation of the user-plane resources for the corresponding PDU session(s) associated with non-3GPP access cannot be performed if the corresponding PDU session ID(s) are not indicated in the Allowed PDU session status IE;
 - 2) notify the SMF that reactivation of the user-plane resources for the corresponding PDU session(s) associated with non-3GPP access can be performed if:
 - i) for a UE not in NB-N1 mode, the corresponding PDU session ID(s) are indicated in the Allowed PDU session status IE; or
 - ii) for a UE in NB-N1 mode, the corresponding PDU session ID(s) are indicated in the Allowed PDU session status IE, and the resulting number of PDU sessions with established user-plane resources does not exceed the UE's maximum number of supported user-plane resources; and
 - 3) discard the received 5GSM message for PDU session(s) associated with non-3GPP access; and
- d) include the PDU session reactivation result IE in the SERVICE ACCEPT message to indicate the successfully re-established user-plane resources for the corresponding PDU sessions, if any.

If due to regional subscription restrictions or access restrictions the UE is not allowed to access the TA or due to CAG restrictions the UE is not allowed to access the cell, but the UE has an emergency PDU session established, the AMF may accept the SERVICE REQUEST message and indicate to the SMF to perform a local release of all non-emergency PDU sessions (associated with 3GPP access if it is due to CAG restrictions) and informs the UE via the PDU session status IE in the SERVICE ACCEPT message. The AMF shall not indicate to the SMF to release the emergency PDU session. If the AMF indicated to the SMF to perform a local release of all non-emergency PDU sessions (associated with 3GPP access if it is due to CAG restrictions), the network shall behave as if the UE is registered for emergency services.

If the PDU session reactivation result IE is included in the SERVICE ACCEPT message indicating that the user-plane resources have been successfully reactivated for a PDU session that was indicated by the UE in the Allowed PDU session status IE as allowed to be re-established over 3GPP access, the UE considers the corresponding PDU session to be associated with the 3GPP access. If the user-plane resources of a PDU session have been successfully reactivated over the 3GPP access, the AMF and SMF update the associated access type of the corresponding PDU session.

If the user-plane resources cannot be established for a PDU session, the AMF shall include the PDU session reactivation result IE in the SERVICE ACCEPT message indicating that user-plane resources for the corresponding PDU session cannot be re-established, and:

- a) if the user-plane resources cannot be established because the SMF indicated to the AMF that the UE is located out of the LADN service area (see 3GPP TS 29.502 [20A]), the AMF shall include the PDU session reactivation result error cause IE with the 5GMM cause set to #43 "LADN not available";
- b) if the user-plane resources cannot be established because the SMF indicated to the AMF that only prioritized services are allowed (see 3GPP TS 29.502 [20A]), the AMF shall include the PDU session reactivation result error cause IE with the 5GMM cause set to #28 "restricted service area";
- c) if the user-plane resources cannot be established because the SMF indicated to the AMF that the resource is not available in the UPF (see 3GPP TS 29.502 [20A]), the AMF shall include the PDU session reactivation result error cause IE with the 5GMM cause set to #92 "insufficient user-plane resources for the PDU session";

- d) if the user-plane resources cannot be established because the SMF indicated to the AMF that the S-NSSAI associated with the PDU session is unavailable due to NSAC (see 3GPP TS 29.502 [20A]), the AMF shall include the PDU session reactivation result error cause IE with the 5GMM cause set to #69 "insufficient resources for specific slice";
- e) if the user-plane resources cannot be established because the AMF determines that the UE is outside the NS-AoS of an S-NSSAI, the AMF may include the PDU session reactivation result error cause IE with the 5GMM cause set to #69 "insufficient resources for specific slice" to indicate the cause of failure to re-establish the user-plane resources; or
- f) otherwise, the AMF may include the PDU session reactivation result error cause IE to indicate the cause of failure to re-establish the user-plane resources.

NOTE 1: It is up to UE implementation when to re-send a request for user-plane re-establishment for the associated PDU session after receiving a PDU session reactivation result error cause IE with a 5GMM cause set to #92 "insufficient user-plane resources for the PDU session".

NOTE 2: The UE can locally start a back-off timer after receiving a PDU session reactivation result error cause IE with a 5GMM cause set to #69 "insufficient resources for specific slice". The value of the back-off timer is up to UE implementation. Upon expiry of the back-off timer, the UE can re-send a request for user-plane re-establishment for the associated PDU session.

NOTE 3: If the UE that does not support S-NSSAI location validity information is outside the NS-AoS of an S-NSSAI, the AMF may perform congestion control and indicate PDU session reactivation result error cause IE with the 5GMM cause set to #69 "insufficient resources for specific slice".

For case a, b and e,

- if the AMF has a service area list or LADN information which is applicable to the current TAI of the UE and was not yet provided to the UE, before sending the SERVICE ACCEPT message the AMF shall initiate the generic UE configuration update procedure and include the service area list or LADN information or both in the CONFIGURATION UPDATE COMMAND message;
- if timer T3540 is not started (see subclause 5.3.1.3, item f), and the UE did not receive a CONFIGURATION UPDATE COMMAND message during the service request procedure, the UE may initiate a registration procedure for mobility or periodic registration update. If timer T3540 is started and the UE does not receive a CONFIGURATION UPDATE COMMAND message before the established N1 NAS signalling connection is released by the network or timer T3540 expires or is stopped as specified in subclause 5.3.1.3, the UE may initiate the registration procedure for mobility or periodic registration update upon release of the N1 NAS signalling connection; and
- if the AMF has S-NSSAI location validity information that is applicable to the current cell of the UE and was not yet provided to the UE, before sending the SERVICE ACCEPT message the AMF shall initiate the generic UE configuration update procedure and include the S-NSSAI location validity information in the CONFIGURATION UPDATE COMMAND message.

If the PDU session reactivation result IE is included in the SERVICE ACCEPT message indicating that the user-plane resources cannot be established for a PDU session that was indicated by the UE in the Allowed PDU session status IE as allowed to be re-established over 3GPP access, the UE considers the corresponding PDU session to be associated with the non-3GPP access.

If the MUSIM UE does not include the Paging restriction IE in the SERVICE REQUEST message, the AMF shall delete any stored paging restriction for the UE and stop restricting paging.

For case m in subclause 5.6.1.1 when the MUSIM UE sets the Request type to "NAS signalling connection release" in the SERVICE REQUEST message, the AMF shall initiate the release of the N1 NAS signalling connection after the completion of the service request procedure.

For cases o and p in subclause 5.6.1.1 when the MUSIM UE sets the Request type to "NAS signalling connection release" or to "Rejection of paging" in the UE request type IE in the SERVICE REQUEST message and if the UE requests restriction of paging by including the Paging restriction IE, the AMF:

- if accepts the paging restriction, shall include the 5GS additional request result IE in the SERVICE ACCEPT message and set the Paging restriction decision to "paging restriction is accepted". The AMF shall store the

paging restriction of the UE and enforce these restrictions in the paging procedure as described in subclause 5.6.2; or

- if rejects the paging restriction, shall include the 5GS additional request result IE in the SERVICE ACCEPT message and set the Paging restriction decision to "paging restriction is rejected", and shall discard the received paging restriction. The AMF shall delete any stored paging restriction for the UE and stop restricting paging; and

the AMF shall initiate the release of the N1 NAS signalling connection as follows:

- for case o in subclause 5.6.1.1, after the completion of the service request procedure;
- for case p in subclause 5.6.1.1, after the completion of the generic UE configuration update procedure that is triggered after the completion of the service request procedure.

If the SERVICE REQUEST message is for emergency services fallback, the AMF triggers the emergency services fallback procedure as specified in subclause 4.13.4.2 of 3GPP TS 23.502 [9].

If the UE having an emergency PDU session associated with 3GPP access sent the SERVICE REQUEST message via:

- a) a CAG cell and none of the CAG-ID(s) of the CAG cell are authorized based on the "Allowed CAG list" for the current PLMN in the UE's subscription; or
- b) a non-CAG cell in a PLMN for which the UE's subscription contains an "indication that the UE is only allowed to access 5GS via CAG cells";

the network shall accept the SERVICE REQUEST message and release all non-emergency PDU sessions associated with 3GPP access locally. The emergency PDU session associated with 3GPP access and PDU sessions associated with non-3GPP access shall not be released.

If the AMF received the list of TAIs from the satellite NG-RAN as described in 3GPP TS 23.501 [8], and determines that, by UE subscription and operator's preferences, any but not all TAIs in the received list of TAIs is forbidden for roaming or for regional provision of service, the AMF shall include the TAI(s) in:

- a) the Forbidden TAI(s) for the list of "5GS forbidden tracking areas for roaming" IE; or
- b) the Forbidden TAI(s) for the list of "5GS forbidden tracking areas for regional provision of service" IE; or
- c) both;

in the SERVICE ACCEPT message.

NOTE 9: Void.

If the UE receives the Forbidden TAI(s) for the list of "5GS forbidden tracking areas for roaming" IE in the SERVICE ACCEPT message and the TAI(s) included in the IE is not part of the list of "5GS forbidden tracking areas for roaming", the UE shall store the TAI(s) belonging to the serving PLMN or equivalent PLMN(s) and ignore the TAI(s) which do not belong to the serving PLMN or equivalent PLMN(s) included in the IE into the list of "5GS forbidden tracking areas for roaming" and remove the TAI(s) from the stored TAI list if present.

If the UE receives the Forbidden TAI(s) for the list of "5GS forbidden tracking areas for regional provision of service" IE in the SERVICE ACCEPT message and the TAI(s) included in the IE is not part of the list of "5GS forbidden tracking areas for regional provision of service", the UE shall store the TAI(s) belonging to the serving PLMN or equivalent PLMN(s) and ignore the TAI(s) which do not belong to the serving PLMN or equivalent PLMN(s) included in the IE into the list of "5GS forbidden tracking areas for regional provision of service" and remove the TAI(s) from the stored TAI list if present.

5.6.1.4.2 UE is using 5GS services with control plane Clot 5GS optimization

For case a in subclause 5.6.1.1, upon receipt of the CONTROL PLANE SERVICE REQUEST message with Control plane service type indicating "mobile terminating request", after completion of the 5GMM common procedures (if initiated) according to subclause 5.6.1.3, the AMF shall send a SERVICE ACCEPT message.

For cases c, d and m in subclause 5.6.1.1, upon receipt of the CONTROL PLANE SERVICE REQUEST message with Control plane service type indicating "mobile originating request", after completion of the 5GMM common procedures (if initiated) according to subclause 5.6.1.3, the AMF shall send a SERVICE ACCEPT message, except for case d when

the DDX field of the Release assistance indication IE or the DDX field of the CIoT small data container IE indicates "No further uplink and no further downlink data transmission subsequent to the uplink data transmission is expected".

For case a, c and d:

- a) if the CIoT small data container IE is included in the message, the AMF shall decipher the value part of the CIoT small data container IE and:
 - 1) if the Data type field indicates "control plane user data", extract the PDU session ID and data content from the CIoT small data container IE, look up a PDU session routing context for the UE and the PDU session ID, and forward the content of the CIoT small data container IE to the SMF associated with the UE. If the corresponding PDU session is a PDU session for LADN, the AMF determines the UE presence in LADN service area (see subclause 6.2.6) and forwards the UE presence in LADN service area towards the SMF;
 - 2) if the Data type field indicates "SMS", forward the content of the CIoT small data container IE to the SMSF associated with the UE; or
 - 3) if the Data type field indicates "Location services message container", and if
 - i) length of additional information field in the CIoT small data container IE is zero, forward the value of Data type field and the content of the CIoT small data container IE to the location services application; or
 - ii) otherwise forward the value of Data type field and the content of the CIoT small data container IE to the LMF associated with the routing information that is included in the additional information field of the CIoT small data container IE; or

NOTE 1: If the AMF determines there is no pending data or signalling for the UE, the AMF provides an indication of control plane CIoT 5GS Optimisation to the LMF as specified in 3GPP TS 29.518 [20B].

- b) otherwise, the AMF shall decipher the value part of NAS message container IE and:
 - 1) if the Payload container IE is included in the CONTROL PLANE SERVICE REQUEST message and if the Payload container type IE is set to "CIoT user data container", the AMF shall look up a PDU session routing context for the UE and the PDU session ID, and forward the content of the Payload container IE to the SMF associated with the UE. If the corresponding PDU session is a PDU session for LADN, the AMF determines the UE presence in LADN service area (see subclause 6.2.6) and forwards the UE presence in LADN service area towards the SMF;
 - 2) if the Payload container IE is included in the CONTROL PLANE SERVICE REQUEST message and if the Payload container type IE is set to "SMS", the AMF shall forward the content of the Payload container IE to the SMSF associated with the UE;
 - 3) if the PDU session status IE is included in the CONTROL PLANE SERVICE REQUEST message or the AMF needs to perform a PDU session status synchronization, the AMF shall include a PDU session status IE in the SERVICE ACCEPT message to indicate which PDU sessions associated with the access type the SERVICE ACCEPT message is sent over are active in the AMF;
 - 4) if the Uplink data status IE is included in the CONTROL PLANE SERVICE REQUEST message and the UE is:
 - i) not in NB-N1 mode; or
 - ii) in NB-N1 mode and the UE does not indicate a request to have user-plane resources established for a number of PDU sessions that exceeds the UE's maximum number of supported user-plane resources;
 the AMF shall:
 - i) indicate the SMF to re-establish the user-plane resources for the corresponding PDU sessions; and
 - ii) include the PDU session reactivation result IE in the SERVICE ACCEPT message to indicate the user-plane resources re-establishment result of the PDU sessions for which the UE requested to re-establish the user-plane resources;
 - 5) if the Uplink data status IE is included in the CONTROL PLANE SERVICE REQUEST, the UE is in NB-N1 mode, and the UE indicates a request to have user-plane resources established for a number of PDU sessions

that exceeds the UE's maximum number of supported user-plane resources, the AMF shall not indicate to the SMF to re-establish the user-plane resources for the corresponding PDU sessions; or

- 6) otherwise, if the Payload container IE is included in the message and if the Payload container type IE is set to "Location services message container", the AMF shall forward the Payload container type and the content of the Payload container IE to the LMF associated with the routing information included in the Additional information IE of the CONTROL PLANE SERVICE REQUEST message.

NOTE 2: If the AMF determines there is no pending data or signalling for the UE, the AMF provides an indication of control plane CIoT 5GS Optimisation to the LMF as specified in 3GPP TS 29.518 [20B].

For case k) in subclause 5.6.1.1, if the Uplink data status IE is included in the CONTROL PLANE SERVICE REQUEST message and the UE is:

- a) not in NB-N1 mode; or
- b) in NB-N1 mode and the UE does not indicate a request to have user-plane resources established for a number of PDU sessions that exceeds the UE's maximum number of supported user-plane resources,

the AMF shall:

- a) indicate the SMF to re-establish the user-plane resources for the corresponding PDU sessions; and
- b) include the PDU session reactivation result IE in the SERVICE ACCEPT message to indicate the user-plane resources re-establishment result of the PDU sessions for which the UE requested to re-establish the user-plane resources.

If the Allowed PDU session status IE is included in the CONTROL PLANE SERVICE REQUEST message, the AMF shall:

- a) for a 5GSM message from each SMF that has indicated pending downlink signalling only, forward the received 5GSM message via 3GPP access to the UE after the SERVICE ACCEPT message is sent;
- b) for each SMF that has indicated pending downlink data only:
 - 1) notify the SMF that reactivation of the user-plane resources for the corresponding PDU session(s) associated with non-3GPP access cannot be performed if the corresponding PDU session ID(s) are not indicated in the Allowed PDU session status IE; and
 - 2) notify the SMF that reactivation of the user-plane resources for the corresponding PDU session(s) associated with non-3GPP access can be performed if:
 - i) for a UE not in NB-N1 mode, the corresponding PDU session ID(s) are indicated in the Allowed PDU session status IE; or
 - ii) for a UE in NB-N1 mode, the corresponding PDU session ID(s) are indicated in the Allowed PDU session status IE and the resulting number of PDU sessions with established user-plane resources does not exceed the UE's maximum number of supported user-plane resources;
- c) for each SMF that have indicated pending downlink signalling and data:
 - 1) notify the SMF that reactivation of the user-plane resources for the corresponding PDU session(s) associated with non-3GPP access cannot be performed if the corresponding PDU session ID(s) are not indicated in the Allowed PDU session status IE;
 - 2) notify the SMF that reactivation of the user-plane resources for the corresponding PDU session(s) associated with non-3GPP access can be performed if:
 - i) for a UE not in NB-N1 mode, the corresponding PDU session ID(s) are indicated in the Allowed PDU session status IE; or
 - ii) for a UE in NB-N1 mode, the corresponding PDU session ID(s) are indicated in the Allowed PDU session status IE and the resulting number of PDU sessions with established user-plane resources does not exceed the UE's maximum number of supported user-plane resources; and
 - 3) discard the received 5GSM message for PDU session(s) associated with non-3GPP access; and

- d) include the PDU session reactivation result IE in the SERVICE ACCEPT message to indicate the successfully re-established user-plane resources for the corresponding PDU sessions, if any.

If the DDX field in the CIoT small data container IE or the DDX field of the Release assistance indication IE indicates:

- 1) "No further uplink and no further downlink data transmission subsequent to the uplink data transmission is expected" and if there is no downlink signalling or downlink data for the UE; or
- 2) "Only a single downlink data transmission and no further uplink data transmission subsequent to the uplink data transmission is expected" and upon subsequent delivery of the next received downlink data transmission to the UE and if there is no additional downlink signalling or downlink data for the UE,

the AMF initiates the release of the N1 NAS signalling connection (see 3GPP TS 23.502 [9]).

If the MUSIM UE does not include the Paging restriction IE in the CONTROL PLANE SERVICE REQUEST message, the AMF shall delete any stored paging restriction for the UE and stop restricting paging.

For case m in subclause 5.6.1.1 when the MUSIM UE sets the Request type to "NAS signalling connection release" in the CONTROL PLANE SERVICE REQUEST message, the AMF shall initiate the release of the N1 NAS signalling connection after the completion of the service request procedure.

For cases o and p in subclause 5.6.1.1 when the MUSIM UE sets the Request type to "NAS signalling connection release" or to "Rejection of paging" in the UE request type IE in the CONTROL PLANE SERVICE REQUEST message and if the UE requests restriction of paging by including the Paging restriction IE, the AMF:

- if accepts the paging restriction, shall include the 5GS additional request result IE in the SERVICE ACCEPT message and set the Paging restriction decision to "paging restriction is accepted". The AMF shall store the paging restriction of the UE and enforce these restrictions in the paging procedure as described in subclause 5.6.2; or
- if rejects the paging restriction, shall include the 5GS additional request result IE in the SERVICE ACCEPT message and set the Paging restriction decision to "paging restriction is rejected", and shall discard the received paging restriction. The AMF shall delete any stored paging restriction for the UE and stop restricting paging; and

the AMF shall send the SERVICE ACCEPT message and initiate the release of the N1 NAS signalling connection as follows:

- for case o in subclause 5.6.1.1, after the completion of the service request procedure;
- for case p in subclause 5.6.1.1, after the completion of the generic UE configuration update procedure that is triggered after the completion of the service request procedure.

Upon successful completion of the procedure, the UE shall reset the service request attempt counter, stop the timer T3517 and enter the state 5GMM-REGISTERED.

If the PDU session status information element is included in the CONTROL PLANE SERVICE REQUEST message, then the AMF:

- a) shall perform a local release of all those PDU sessions which are not in 5GSM state PDU SESSION INACTIVE on the AMF side associated with the access type the CONTROL PLANE SERVICE REQUEST message is sent over, but are indicated by the UE as being inactive, and
- b) request the SMF to perform a local release of all those PDU sessions. If any of those PDU sessions is associated with one or more multicast MBS sessions, the SMF shall consider the UE as removed from the associated multicast MBS sessions.

If the PDU session status information element is included in the SERVICE ACCEPT message, then the UE shall perform a local release of all those PDU sessions which are not in 5GSM state PDU SESSION INACTIVE or PDU SESSION ACTIVE PENDING on the UE side associated with the 3GPP access but are indicated by the AMF as being inactive. If a locally released PDU session:

- a) is associated with one or more multicast MBS sessions, the UE shall locally leave the associated multicast MBS sessions; or

- b) has the same PDU session identity value as that used by the UE in the CONTROL PLANE SERVICE REQUEST message, and the message contained CIoT user data, then the UE determines that the CIoT user data was not successfully sent.

If the user-plane resources cannot be established for a PDU session, the AMF shall include the PDU session reactivation result IE in the SERVICE ACCEPT message indicating that user-plane resources for the corresponding PDU session cannot be re-established, and:

- a) if the user-plane resources cannot be established because the SMF indicated to the AMF that the UE is located out of the LADN service area (see 3GPP TS 29.502 [20A]), the AMF shall include the PDU session reactivation result error cause IE with the 5GMM cause set to #43 "LADN not available";
- b) if the user-plane resources cannot be established because the SMF indicated to the AMF that only prioritized services are allowed (see 3GPP TS 29.502 [20A]), the AMF shall include the PDU session reactivation result error cause IE with the 5GMM cause set to #28 "restricted service area";
- c) if the user-plane resources cannot be established because:
- 1) the SMF indicated to the AMF that the resource is not available in the UPF (see 3GPP TS 29.502 [20A]); or
 - 2) the UE is in NB-N1 mode and the result will lead to user-plane resources established for more than two PDU sessions (see 3GPP TS 23.502 [9])

the AMF shall include the PDU session reactivation result error cause IE with the 5GMM cause set to #92 "insufficient user-plane resources for the PDU session":

NOTE 3: For a UE that is not in NB-N1 mode, it is up to UE implementation when to re-send a request for user-plane re-establishment for the associated PDU session after receiving a PDU session reactivation result error cause IE with a 5GMM cause set to #92 "insufficient user-plane resources for the PDU session"; or

- d) if the user-plane resources cannot be established because the AMF determines that the UE is outside the NS-AoS of an S-NSSAI, the AMF may include the PDU session reactivation result error cause IE with the 5GMM cause set to #69 "insufficient resources for specific slice" to indicate the cause of failure to re-establish the user-plane resources.

NOTE 4: If the UE that does not support S-NSSAI location validity information is outside the NS-AoS of an S-NSSAI, the AMF may perform congestion control and indicate PDU session reactivation result error cause IE with the 5GMM cause set to #69 "insufficient resources for specific slice".

For case a, b and d,

- if the AMF has a service area list or LADN information which is applicable to the current TAI of the UE and was not yet provided to the UE, before sending the SERVICE ACCEPT message the AMF shall initiate the generic UE configuration update procedure and include the service area list or LADN information or both in the CONFIGURATION UPDATE COMMAND message; and
- if timer T3540 is not started (see subclause 5.3.1.3, item f), and the UE did not receive a CONFIGURATION UPDATE COMMAND message during the service request procedure, the UE may initiate a registration procedure for mobility or periodic registration update. If timer T3540 is started and the UE does not receive a CONFIGURATION UPDATE COMMAND message before the established N1 NAS signalling connection is released by the network or timer T3540 expires or is stopped as specified in subclause 5.3.1.3, the UE may initiate the registration procedure for mobility or periodic registration update upon release of the N1 NAS signalling connection.
- if the AMF has S-NSSAI location validity information that is applicable to the current cell of the UE and was not yet provided to the UE, before sending the SERVICE ACCEPT message the AMF shall initiate the generic UE configuration update procedure and include the S-NSSAI location validity information in the CONFIGURATION UPDATE COMMAND message.

If the PDU session reactivation result IE is included in the SERVICE ACCEPT message indicating that the user-plane resources cannot be established for a PDU session that was indicated by the UE in the Allowed PDU session status IE as allowed to be re-established over 3GPP access, the UE considers the corresponding PDU session to be associated with the non-3GPP access.

For case d) in subclause 5.6.1.1, the UE shall also treat the indication from the lower layers that the RRC connection has been released as successful completion of the procedure. The UE shall reset the service request attempt counter, stop the timer T3517 and enter the state 5GMM-REGISTERED.

Upon receipt of the CONTROL PLANE SERVICE REQUEST message with uplink data:

- if the DDX field of the Release assistance indication IE or the DDX field of the CIoT small data container IE is set to "No further uplink and no further downlink data transmission subsequent to the uplink data transmission is expected" in the message;
- if the AMF decides to forward the uplink data piggybacked in the CONTROL PLANE SERVICE REQUEST message; and
- if the AMF decides to activate the congestion control for transport of user data via the control plane,

then the AMF shall send SERVICE ACCEPT message with the T3448 value IE included.

If the AMF decides to deactivate the congestion control for transport of user data via the control plane, then the AMF shall delete the stored control plane data back-off time for the UE and the AMF shall not include timer T3448 value IE in the SERVICE ACCEPT message.

If the T3448 value IE is present in the received SERVICE ACCEPT message and the value indicates that this timer is neither zero nor deactivated, the UE shall:

- a) stop timer T3448 if it is running;
- b) consider the transport of user data via the control plane as successful; and
- c) start timer T3448 with the value provided in the T3448 value IE.

If the UE is using 5GS services with control plane CIoT 5GS optimization, the T3448 value IE is present in the SERVICE ACCEPT message and the value indicates that this timer is either zero or deactivated, the UE shall ignore the T3448 value IE and proceed as if the T3448 value IE was not present.

If the UE in 5GMM-IDLE mode initiated the service request procedure by sending a CONTROL PLANE SERVICE REQUEST message and the SERVICE ACCEPT message does not include the T3448 value IE and if timer T3448 is running, then the UE shall stop timer T3448.

For case h) in subclause 5.6.1.1,

- a) the UE shall treat the indication from the lower layers when the UE has changed to S1 mode as successful completion of the procedure and stop timer T3517;
- b) if a UE operating in single-registration mode has changed to S1 mode, it shall disable the N1 mode capability for 3GPP access (see subclause 4.9.2); and
- c) the AMF shall not check for CAG restrictions.

If the CONTROL PLANE SERVICE REQUEST message is for emergency services fallback, the AMF triggers the emergency services fallback procedure as specified in subclause 4.13.4.2 of 3GPP TS 23.502 [9].

5.6.1.5 Service request procedure not accepted by the network

If the service request cannot be accepted, the network shall return a SERVICE REJECT message to the UE including an appropriate 5GMM cause value.

If the SERVICE REJECT message with 5GMM cause #76 or #78 was received without integrity protection, then the UE shall discard the message.

If the AMF needs to initiate PDU session status synchronisation or a PDU session status IE was included in the SERVICE REQUEST message, the AMF shall include a PDU session status IE in the SERVICE REJECT message to indicate which PDU sessions associated with the access type the SERVICE REJECT message is sent over are active in the AMF. If the PDU session status IE is included in the SERVICE REJECT message and if the message is integrity protected, then:

- a) for single access PDU sessions, the UE shall perform a local release of all those PDU sessions which are not in 5GSM state PDU SESSION INACTIVE or PDU SESSION ACTIVE PENDING on the UE side associated with the access type the SERVICE REJECT message is sent over, but are indicated by the AMF as being in 5GSM state PDU SESSION INACTIVE. If a locally released PDU session is associated with one or more MBS sessions, the UE shall locally leave the associated MBS multicast sessions; and
- b) for MA PDU sessions, for all those PDU sessions which are not in 5GSM state PDU SESSION INACTIVE or PDU SESSION ACTIVE PENDING and have user plane resources established on the UE side associated with the access the SERVICE REJECT message is sent over, but are indicated by the AMF as no user plane resources established:
 - 1) for MA PDU sessions having user plane resources established only on the access type the SERVICE REJECT message is sent over, the UE shall perform a local release of those MA PDU sessions. If a locally released PDU session is associated with one or more MBS sessions, the UE shall locally leave the associated MBS multicast sessions; and
 - 2) for MA PDU sessions having user plane resources established on both accesses, the UE shall perform a local release on the user plane resources on the access type the SERVICE REJECT message is sent over. If a locally released PDU session is associated with one or more MBS sessions, the UE shall locally leave the associated MBS multicast sessions.

If the service request for mobile originated services is rejected due to general NAS level mobility management congestion control, the network shall set the 5GMM cause value to #22 "congestion" and assign a value for back-off timer T3346.

If the service request for mobile originated services is rejected due to general NAS level mobility management congestion control for the SNPN selected for localized services in SNPN (see 3GPP TS 23.122 [5]), the network may set an appropriate cause value other than 5GMM cause value to #22 "congestion" and does not assign a value for back-off timer T3346.

In NB-N1 mode, if the service request for mobile originated services is rejected due to operator determined barring (see 3GPP TS 29.503 [20AB]), the network shall set the 5GMM cause value to #22 "congestion" and assign a value for back-off timer T3346.

If the service request from a UE supporting CAG is rejected due to CAG restrictions, the network shall set the 5GMM cause value to #76 "Not authorized for this CAG or authorized for CAG cells only" and should include the "CAG information list" in the CAG information list IE or the Extended CAG information list IE in the SERVICE REJECT message.

NOTE 1: The network cannot be certain that "CAG information list" stored in the UE is updated as result of sending of the SERVICE REJECT message with the CAG information list IE or the Extended CAG information list IE, as the SERVICE REJECT message is not necessarily delivered to the UE (e.g., due to abnormal radio conditions).

NOTE 2: The "CAG information list" can be provided by the AMF and include no entry if no "CAG information list" exists in the subscription.

NOTE 2A: If the UE supports extended CAG information list, the CAG information list can be included either in the CAG information list IE or Extended CAG information list IE.

NOTE 2B: It is unexpected for network to send REGISTRATION REJECT message to the UE with 5GMM cause value #76 in non-CAG cell and not indicate "Indication that the UE is only allowed to access 5GS via CAG cells" for the serving PLMN in the Extended CAG information list or the CAG information list.

If the UE does not support extended CAG information list, the CAG information list shall not be included in the Extended CAG information list IE.

If the service request from a UE not supporting CAG is rejected due to CAG restrictions, the network shall operate as described in bullet h) of subclause 5.6.1.8.

Upon receipt of the CONTROL PLANE SERVICE REQUEST message with uplink data:

- if the AMF decides to not forward the uplink data piggybacked in the CONTROL PLANE SERVICE REQUEST message; and

- if the AMF decides to activate the congestion control for transport of user data via the control plane,

then the AMF shall send a SERVICE REJECT message and set the 5GMM cause value to #22 "congestion" and assign a value for control plane data back-off timer T3448.

If the AMF determines that the UE is in a non-allowed area or is not in an allowed area as specified in subclause 5.3.5, then:

- a) if the service type IE in the SERVICE REQUEST message is set to "signalling" or "data", the AMF shall send a SERVICE REJECT message with the 5GMM cause value set to #28 "Restricted service area";
- b) otherwise, if the service type IE in the SERVICE REQUEST message is set to "mobile terminated services", "emergency services", "emergency services fallback", "high priority access" or "elevated signalling", the AMF shall continue the process as specified in subclause 5.6.1.4 unless for other reasons the service request cannot be accepted.

If the service request for mobile originated services is rejected due to service gap control as specified in subclause 5.3.17, i.e. the T3447 timer is running in AMF, the network shall set the 5GMM cause value to #22 "Congestion" and may include T3346 value IE in the SERVICE REJECT message set to the remaining time of the running T3447 timer.

Based on operator policy, if the service request procedure is rejected due to core network redirection for CIoT optimizations, the network shall set the 5GMM cause value to #31 "Redirection to EPC required".

NOTE 3: The network can take into account the UE's S1 mode capability, the EPS CIoT network behaviour supported by the UE or the EPS CIoT network behaviour supported by the EPC to determine the rejection with the 5GMM cause value #31 "Redirection to EPC required".

If the service request is via a satellite NG-RAN cell, and the network determines that the UE is in a location where the network is not allowed to operate, see 3GPP TS 23.502 [9], the network shall set the 5GMM cause value in the SERVICE REJECT message to #78 "PLMN not allowed to operate at the present UE location".

NOTE 3A: While location determination is ongoing to ensure that operator and regulatory policies are met, the AMF can perform DNN-based or S-NSSAI based congestion control as specified in subclauses 5.3.10 and 5.3.11 to prevent the UE from accessing network.

If the service request from a UE supporting MINT is rejected due to a disaster condition no longer being applicable in the current location of the UE, the network shall set the 5GMM cause value to #11 "PLMN not allowed" or #13 "Roaming not allowed in this tracking area" and may include a disaster return wait range in the Disaster return wait range IE in the SERVICE REJECT message.

On receipt of the SERVICE REJECT message, if the UE is in state 5GMM-SERVICE-REQUEST-INITIATED, the UE shall reset the service request attempt counter and stop timer T3517 if running.

If the AMF received multiple TAIs from the satellite NG-RAN as described in 3GPP TS 23.501 [8], and determines that, by UE subscription and operator's preferences, all of the received TAIs are forbidden, for roaming or for regional provision of service, the AMF shall include the TAI(s) in:

- a) the Forbidden TAI(s) for the list of "5GS forbidden tracking areas for roaming" IE; or
- b) the Forbidden TAI(s) for the list of "5GS forbidden tracking areas for regional provision of service" IE; or
- c) both;

in the SERVICE REJECT message.

Regardless of the 5GMM cause value received in the SERVICE REJECT message via satellite NG-RAN,

- if the UE receives the Forbidden TAI(s) for the list of "5GS forbidden tracking areas for roaming" IE in the SERVICE REJECT message, the UE shall store the TAI(s) belonging to the serving PLMN or equivalent PLMN(s) and ignore the TAI(s) which do not belong to the serving PLMN or equivalent PLMN(s) included in the IE, if not already stored, into the list of "5GS forbidden tracking areas for roaming"; and
- if the UE receives the Forbidden TAI(s) for the list of "5GS forbidden tracking areas for regional provision of service" IE in the SERVICE REJECT message, the UE shall store the TAI(s) belonging to the serving PLMN or equivalent PLMN(s) and ignore the TAI(s) which do not belong to the serving PLMN or equivalent PLMN(s)

included in the IE, if not already stored, into the list of "5GS forbidden tracking areas for regional provision of service".

Furthermore, the UE shall take the following actions depending on the 5GMM cause value received in the SERVICE REJECT message.

#3 (Illegal UE);

#6 (Illegal ME);

The UE shall set the 5GS update status to 5U3 ROAMING NOT ALLOWED (and shall store it according to subclause 5.1.3.2.2) and shall delete any 5G-GUTI, last visited registered TAI, TAI list and ngKSI.

In case of PLMN, the UE shall consider the USIM as invalid for 5GS services until switching off, the UICC containing the USIM is removed or the timer T3245 expires as described in subclause 5.3.19A.1;

In case of SNPN, if the UE is not registered for onboarding services in SNPN and the UE does not support access to an SNPN using credentials from a credentials holder and does not support equivalent SNPNS, the UE shall consider the selected entry of the "list of subscriber data" with the SNPN identity of the current SNPN as invalid until the UE is switched off, the entry is updated or the timer T3245 expires as described in subclause 5.3.19A.2. In case of SNPN, if the UE is not registered for onboarding services in SNPN and the UE supports access to an SNPN using credentials from a credentials holder, equivalent SNPNS, or both, the UE shall consider the selected entry of the "list of subscriber data" as invalid for 3GPP access until the UE is switched off, the entry is updated or the timer T3245 expires as described in subclause 5.3.19A.2. Additionally, if EAP based primary authentication and key agreement procedure using EAP-AKA' or 5G AKA based primary authentication and key agreement procedure was performed in the current SNPN, the UE shall consider the USIM as invalid for the current SNPN until switching off, the UICC containing the USIM is removed or the timer T3245 expires as described in subclause 5.3.19A.2.

If the UE is not registered for onboarding services in SNPN, the UE shall delete the list of equivalent PLMNs (if any) or the list of equivalent SNPNS (if any), and shall enter the state 5GMM-DEREGISTERED.NO-SUPI. If the message has been successfully integrity checked by the NAS, then the UE shall:

- 1) set the counter for "SIM/USIM considered invalid for GPRS services" events and the counter for "USIM considered invalid for 5GS services over non-3GPP access" events to UE implementation-specific maximum value in case of PLMN if the UE maintains these counters;
- 2) set the counter for "the entry for the current SNPN considered invalid for 3GPP access" events and the counter for "the entry for the current SNPN considered invalid for non-3GPP access" events to UE implementation-specific maximum value in case of SNPN if the UE maintains these counters; and

If the message was received via 3GPP access and the UE is operating in the single-registration mode, the UE shall handle the EMM parameters EMM state, EPS update status, 4G-GUTI, last visited registered TAI, TAI list and eKSI as specified in 3GPP TS 24.301 [15] for the case when the service request procedure is rejected with the EMM cause with the same value. The USIM shall be considered as invalid also for non-EPS services until switching off, the UICC containing the USIM is removed or the timer T3245 expires as described in subclause 5.3.7a in 3GPP TS 24.301 [15]. If the message has been successfully integrity checked by the NAS and the UE maintains a counter for "SIM/USIM considered invalid for non-GPRS services", then the UE shall set this counter to UE implementation-specific maximum value.

If the UE is registered for onboarding services in SNPN, the UE shall store the SNPN identity in the "permanently forbidden SNPNS for onboarding services in SNPN" list, enter state 5GMM-DEREGISTERED.PLMN-SEARCH, and perform a SNPN selection or an SNPN selection for onboarding services according to 3GPP TS 23.122 [5]. If the message has been successfully integrity checked by the NAS, the UE shall set the SNPN-specific attempt counter to the UE implementation-specific maximum value.

If the message has been successfully integrity checked by the NAS and the UE also supports the registration procedure over the other access, the UE shall in addition handle 5GMM parameters and 5GMM state for this access, as described for this 5GMM cause value.

#7 (5GS services not allowed).

The UE shall set the 5GS update status to 5U3 ROAMING NOT ALLOWED (and shall store it according to subclause 5.1.3.2.2) and shall delete any 5G-GUTI, last visited registered TAI, TAI list and ngKSI.

In case of PLMN, the UE shall consider the USIM as invalid for 5GS services until switching off, the UICC containing the USIM is removed or the timer T3245 expires as described in subclause 5.3.19A.1;

In case of SNPN, if the UE is not registered for onboarding services in SNPN and the UE does not support access to an SNPN using credentials from a credentials holder and does not support equivalent SNPNS, the UE shall consider the selected entry of the "list of subscriber data" with the SNPN identity of the current SNPN as invalid for 5GS services until the UE is switched off, the entry is updated or the timer T3245 expires as described in subclause 5.3.19A.2. In case of SNPN, if the UE is not registered for onboarding services in SNPN and the UE supports access to an SNPN using credentials from a credentials holder, equivalent SNPNS, or both, the UE shall consider the selected entry of the "list of subscriber data" as invalid for 3GPP access until the UE is switched off, the entry is updated or the timer T3245 expires as described in subclause 5.3.19A.2. Additionally, if EAP based primary authentication and key agreement procedure using EAP-AKA' or 5G AKA based primary authentication and key agreement procedure was performed in the current SNPN, the UE shall consider the USIM as invalid for the current SNPN until switching off, the UICC containing the USIM is removed or the timer T3245 expires as described in subclause 5.3.19A.2.

If the UE is not registered for onboarding services in SNPN, the UE shall enter the state 5GMM-DEREGISTERED.NO-SUPI. If the message has been successfully integrity checked by the NAS, then the UE shall:

- 1) set the counter for "SIM/USIM considered invalid for GPRS services" events and the counter for "USIM considered invalid for 5GS services over non-3GPP access" events to UE implementation-specific maximum value in case of PLMN if the UE maintains these counters; or
- 2) set the counter for "the entry for the current SNPN considered invalid for 3GPP access" events and the counter for "the entry for the current SNPN considered invalid for non-3GPP access" events to UE implementation-specific maximum value in case of SNPN if the UE maintains these counters; and

If the message was received via 3GPP access and the UE is operating in single-registration mode, the UE shall handle the EMM parameters EMM state, EPS update status, 4G-GUTI, last visited registered TAI, TAI list and eKSI as specified in 3GPP TS 24.301 [15] for the case when the service request procedure is rejected with the EMM cause with the same value.

If the UE is registered for onboarding services in SNPN, the UE shall store the SNPN identity in the "permanently forbidden SNPNS for onboarding services in SNPN" list, enter state 5GMM-DEREGISTERED.PLMN-SEARCH, and perform an SNPN selection or an SNPN selection for onboarding services according to 3GPP TS 23.122 [5]. If the message has been successfully integrity checked by the NAS, the UE shall set the SNPN-specific attempt counter to the UE implementation-specific maximum value.

If the message has been successfully integrity checked by the NAS and the UE also supports the registration procedure over the other access, the UE shall in addition handle 5GMM parameters and 5GMM state for this access, as described for this 5GMM cause value.

NOTE 4: The possibility to configure a UE so that the radio transceiver for a specific radio access technology is not active, although it is implemented in the UE, is outside the scope of the present document.

#9 (UE identity cannot be derived by the network).

The UE shall set the 5GS update status to 5U2 NOT UPDATED (and shall store it according to subclause 5.1.3.2.2) and shall delete any 5G-GUTI, last visited registered TAI, TAI list and ngKSI. The UE shall enter the state 5GMM-DEREGISTERED.

If the service request was initiated for emergency services fallback, the UE shall attempt to select an E-UTRA cell connected to EPC or 5GCN according to the domain priority and selection rules specified in 3GPP TS 23.167 [6]. If the UE finds a suitable E-UTRA cell, it then proceeds with the appropriate EMM or 5GMM procedures. If the UE operating in single-registration mode has changed to S1 mode, it shall disable the N1 mode capability for 3GPP access.

If the service request was initiated for any reason other than emergency services fallback or initiating an emergency PDU session, the UE shall perform a new initial registration procedure.

NOTE 5: User interaction is necessary in some cases when the UE cannot re-establish the PDU session(s) automatically.

If the message was received via 3GPP access and the UE is operating in the single-registration mode, the UE shall handle the EMM parameters EMM state, EPS update status, 4G-GUTI, last visited registered TAI, TAI list and eKSI as specified in 3GPP TS 24.301 [15] for the case when the service request procedure is rejected with the EMM cause with the same value.

#10 (Implicitly de-registered).

The UE shall enter the state 5GMM-DEREGISTERED.NORMAL-SERVICE. The UE shall delete any mapped 5G NAS security context or partial native 5G NAS security context.

If the service request was initiated for emergency services fallback, the UE shall attempt to select an E-UTRA cell connected to EPC or 5GCN according to the domain priority and selection rules specified in 3GPP TS 23.167 [6]. If the UE finds a suitable E-UTRA cell, it then proceeds with the appropriate EMM or 5GMM procedures. If the UE operating in single-registration mode has changed to S1 mode, it shall disable the N1 mode capability for 3GPP access.

If the rejected request was neither for initiating an emergency PDU session nor for emergency services fallback, the UE shall perform a new initial registration procedure.

NOTE 6: User interaction is necessary in some cases when the UE cannot re-establish the PDU session(s) automatically.

If the message was received via 3GPP access and the UE is operating in the single-registration mode, the UE shall handle the EMM state as specified in 3GPP TS 24.301 [15] for the case when the service request procedure is rejected with the EMM cause with the same value.

#11 (PLMN not allowed).

This cause value received from a cell belonging to an SNPN and the UE is operating in SNPN access operation mode is considered as an abnormal case and the behaviour of the UE is specified in subclause 5.6.1.7.

The UE shall set the 5GS update status to 5U3 ROAMING NOT ALLOWED (and shall store it according to subclause 5.1.3.2.2) and shall delete any 5G-GUTI, last visited registered TAI, TAI list and ngKSI. The UE shall delete the list of equivalent PLMNs and store the PLMN identity in the forbidden PLMN list as specified in subclause 5.3.13A and if the UE is configured to use timer T3245 then the UE shall start timer T3245 and proceed as described in subclause 5.3.19A.1. For 3GPP access, the UE shall enter the state 5GMM-DEREGISTERED.PLMN-SEARCH and perform a PLMN selection according to 3GPP TS 23.122 [5], and for non-3GPP access the UE shall enter state 5GMM-DEREGISTERED.LIMITED-SERVICE and perform network selection as defined in 3GPP TS 24.502 [18]. If the message has been successfully integrity checked by the NAS and the UE maintains the PLMN-specific attempt counter and the PLMN-specific attempt counter for non-3GPP access for that PLMN, the UE shall set the PLMN-specific attempt counter and the PLMN-specific attempt counter for non-3GPP access for that PLMN to the UE implementation-specific maximum value.

If the message was received via 3GPP access and the UE is operating in single-registration mode, the UE shall in addition handle the EMM parameters EMM state, EPS update status, 4G-GUTI, last visited registered TAI, TAI list and eKSI as specified in 3GPP TS 24.301 [15] for the case when the service request procedure is rejected with the EMM cause with the same value.

If the message has been successfully integrity checked by the NAS and the UE also supports the registration procedure over the other access to the same PLMN, the UE shall in addition handle 5GMM parameters and 5GMM state for this access, as described for this 5GMM cause value.

If the UE receives the Disaster return wait range IE in the SERVICE REJECT message and the UE supports MINT, the UE shall delete the disaster return wait range stored in the ME, if any, and store the disaster return wait range included in the Disaster return wait range IE in the ME.

#12 (Tracking area not allowed).

The UE shall set the 5GS update status to 5U3 ROAMING NOT ALLOWED (and shall store it according to subclause 5.1.3.2.2) and shall delete last visited registered TAI and TAI list. If the UE is not registering or has not registered to the same PLMN over both 3GPP access and non-3GPP access, the UE shall additionally delete 5G-GUTI and ngKSI.

If:

- 1) the UE is not operating in SNPN access operation mode, the UE shall store the current TAI in the list of "5GS forbidden tracking areas for regional provision of service" and enter the state 5GMM-DEREGISTERED.LIMITED-SERVICE. If the SERVICE REJECT message is not integrity protected, the UE shall memorize the current TAI was stored in the list of "5GS forbidden tracking areas for regional provision of service" for non-integrity protected NAS reject message; or
- 2) the UE is operating in SNPN access operation mode, the UE shall store the current TAI in the list of "5GS forbidden tracking areas for regional provision of service" for the current SNPN and the selected entry of the "list of subscriber data" or the selected PLMN subscription, and enter the state 5GMM-DEREGISTERED.LIMITED-SERVICE. If the SERVICE REJECT message is not integrity protected, the UE shall memorize the current TAI was stored in the list of "5GS forbidden tracking areas for regional provision of service" for the current SNPN and the selected entry of the "list of subscriber data" or the selected PLMN subscription, for non-integrity protected NAS reject message.

If the message was received via 3GPP access and the UE is operating in single-registration mode, the UE shall handle the EMM parameters EMM state, EPS update status, 4G-GUTI, last visited registered TAI, TAI list and eKSI as specified in 3GPP TS 24.301 [15] for the case when the service request procedure is rejected with the EMM cause with the same value.

#13 (Roaming not allowed in this tracking area).

The UE shall set the 5GS update status to 5U3 ROAMING NOT ALLOWED (and shall store it according to subclause 5.1.3.2.2). For 3GPP access the UE shall enter the state 5GMM-REGISTERED.PLMN-SEARCH, and for non-3GPP access the UE shall enter the state 5GMM-REGISTERED.LIMITED-SERVICE.

If:

- 1) the UE is not operating in SNPN access operation mode, the UE shall store the current TAI in the list of "5GS forbidden tracking areas for roaming" and remove the current TAI from the stored TAI list if present. If the SERVICE REJECT message is not integrity protected, the UE shall memorize the current TAI was stored in the list of "5GS forbidden tracking areas for roaming" for non-integrity protected NAS reject message; or
- 2) the UE is operating in SNPN access operation mode, the UE shall store the current TAI in the list of "5GS forbidden tracking areas for roaming" for the current SNPN and the selected entry of the "list of subscriber data" or the selected PLMN subscription, and remove the current TAI from the stored TAI list if present. If the SERVICE REJECT message is not integrity protected, the UE shall memorize the current TAI was stored in the list of "5GS forbidden tracking areas for roaming" for the current SNPN and the selected entry of the "list of subscriber data" or the selected PLMN subscription, for non-integrity protected NAS reject message.

For 3GPP access the UE shall perform a PLMN selection or SNPN selection according to 3GPP TS 23.122 [5], and for non-3GPP access the UE shall perform network selection as defined in 3GPP TS 24.502 [18].

If the message was received via 3GPP access and the UE is operating in single-registration mode, the UE shall handle the EMM parameters EMM state and EPS update status as specified in 3GPP TS 24.301 [15] for the case when the service request procedure is rejected with the EMM cause with the same value.

If the UE receives the Disaster return wait range IE in the SERVICE REJECT message and the UE supports MINT, the UE shall delete the disaster return wait range stored in the ME, if any, and store the disaster return wait range included in the Disaster return wait range IE in the ME.

#15 (No suitable cells in tracking area).

The UE shall enter the state 5GMM-REGISTERED.LIMITED-SERVICE.

If:

- 1) the UE is not operating in SNPN access operation mode, the UE shall store the current TAI in the list of "5GS forbidden tracking areas for roaming" and remove the current TAI from the stored TAI list if present. If the SERVICE REJECT message is not integrity protected, the UE shall memorize the current TAI was stored in the list of "5GS forbidden tracking areas for roaming" for non-integrity protected NAS reject message; or
- 2) the UE is operating in SNPN access operation mode, the UE shall store the current TAI in the list of "5GS forbidden tracking areas for roaming" for the current SNPN and the selected entry of the "list of subscriber data" or the selected PLMN subscription, and remove the current TAI from the stored TAI list if present. If the SERVICE REJECT message is not integrity protected, the UE shall memorize the current TAI was stored

in the list of "5GS forbidden tracking areas for roaming" for the current SNPN and the selected entry of the "list of subscriber data" or the selected PLMN subscription, for non-integrity protected NAS reject message.

If the UE initiated service request for emergency services fallback, the UE shall attempt to select an E-UTRA cell connected to the EPC or the 5GCN according to the emergency services support indicator (see 3GPP TS 36.331 [25A]). If the UE finds a suitable E-UTRA cell, it then proceeds with the appropriate EMM or 5GMM procedures. If the UE operating in single-registration mode has changed to S1 mode, it shall disable the N1 mode capability for 3GPP access.

If the service request was not initiated for emergency services fallback, the UE shall search for a suitable cell in another tracking area according to 3GPP TS 38.304 [28] or 3GPP TS 36.304 [25C].

If the message was received via 3GPP access and the UE is operating in the single-registration mode, the UE shall handle the EMM parameters EMM state and EPS update status as specified in 3GPP TS 24.301 [15] for the case when the service request procedure is rejected with the EMM cause with the same value.

If received over non-3GPP access the cause shall be considered as an abnormal case and the behaviour of the UE for this case is specified in subclause 5.6.1.7.

#22 (Congestion).

If the T3346 value IE is present in the SERVICE REJECT message and the value indicates that this timer is neither zero nor deactivated, the UE shall proceed as described below, otherwise it shall be considered as an abnormal case and the behaviour of the UE for this case is specified in subclause 5.6.1.7.

If the rejected request was not for initiating an emergency PDU session, the UE shall abort the service request procedure and enter state 5GMM-REGISTERED and stop timer T3517 if still running.

The UE shall stop timer T3346 if it is running.

If the SERVICE REJECT message is integrity protected, the UE shall start timer T3346 with the value provided in the T3346 value IE.

If the SERVICE REJECT message is not integrity protected, the UE shall start timer T3346 with a random value from the default range specified in 3GPP TS 24.008 [12].

For all other cases the UE stays in the current serving cell and applies normal cell reselection process. The service request procedure is started, if still necessary, when timer T3346 expires or is stopped.

If the message was received via 3GPP access and the UE is operating in the single-registration mode, the UE shall handle the EMM parameters EMM state and EPS update status as specified in 3GPP TS 24.301 [15] for the case when the service request procedure is rejected with the EMM cause with the same value.

If the service request procedure was initiated for an MO MMTEL voice call (i.e. access category 4), or for an MO MMTEL video call (i.e. access category 5) or for an MO IMS registration related signalling (i.e. access category 9), a notification that the service request was not accepted due to congestion shall be provided to the upper layers.

If the UE is using 5GS services with control plane CIoT 5GS optimization and if the T3448 value IE is present in the SERVICE REJECT message and the value indicates that this timer is neither zero nor deactivated, the UE shall:

- a) stop timer T3448 if it is running;
- b) consider the transport of user data via the control plane as unsuccessful; and
- c) start timer T3448:
 - 1) with the value provided in the T3448 value IE if the SERVICE REJECT message is integrity protected; or
 - 2) with a random value from the default range specified in 3GPP TS 24.301 [15] table 10.2.1 if the SERVICE REJECT message is not integrity protected.

If the UE is using 5GS services with control plane CIoT 5GS optimization, the T3448 value IE is present in the SERVICE REJECT message and the value indicates that this timer is either zero or deactivated, the UE shall ignore the T3448 value IE and:

- a) stop timer T3448 if it is running; and
- b) consider the transport of user data via the control plane as unsuccessful.

If the UE is using 5GS services with control plane CIoT 5GS optimization and if the T3448 value IE is not present in the SERVICE REJECT message, it shall be considered as an abnormal case and the behaviour of UE for this case is specified in subclause 5.6.1.7.

#27 (N1 mode not allowed).

The UE shall set the 5GS update status to 5U3 ROAMING NOT ALLOWED (and shall store it according to subclause 5.1.3.2.2) and shall enter the state 5GMM-REGISTERED.LIMITED-SERVICE. If the message has been successfully integrity checked by the NAS, the UE shall set:

- 1) the PLMN-specific N1 mode attempt counter for 3GPP access and the PLMN-specific N1 mode attempt counter for non-3GPP access for that PLMN in case of PLMN; or
- 2) the SNPN-specific attempt counter for 3GPP access for the current SNPN and the SNPN-specific attempt counter for non-3GPP access for the current SNPN in case of SNPN

to the UE implementation-specific maximum value.

The UE shall disable the N1 mode capability for the specific access type for which the message was received (see subclause 4.9).

If the message has been successfully integrity checked by the NAS, the UE shall disable the N1 mode capability also for the other access type (see subclause 4.9).

If the message was received via 3GPP access and the UE is operating in single-registration mode, the UE shall in addition set the EPS update status to EU3 ROAMING NOT ALLOWED and enter the state EMM-REGISTERED.

#28 (Restricted service area).

This cause value received from non-3GPP access other than wireline access is considered as an abnormal case, and the behaviour of the UE is specified in subclause 5.6.1.7.

The UE shall enter the state 5GMM-REGISTERED.NON-ALLOWED-SERVICE, wait for the release of the N1 NAS signalling connection and perform the registration procedure for mobility and periodic registration update if the service type IE in the SERVICE REQUEST message was not set to "elevated signalling" and the SERVICE REJECT message is received over 3GPP access (see subclause 5.3.5 and 5.5.1.3).

If the service type IE in the SERVICE REQUEST message was set to "elevated signalling", the UE shall not re-initiate service request procedure until the UE enters an allowed area or leaves a non-allowed area, except for emergency services, high priority access or responding to paging or notification.

#31 (Redirection to EPC required).

5GMM cause #31 received by a UE that has not indicated support for CIoT optimizations or received by a UE over non-3GPP access is considered an abnormal case and the behaviour of the UE is specified in subclause 5.6.1.7.

This cause value received from a cell belonging to an SNPN and the UE is operating in SNPN access operation mode is considered as an abnormal case and the behaviour of the UE is specified in subclause 5.6.1.7.

The UE shall set the 5GS update status to 5U3 ROAMING NOT ALLOWED (and shall store it according to subclause 5.1.3.2.2). The UE shall reset the service request attempt counter and enter the state 5GMM-REGISTERED.LIMITED-SERVICE.

The UE shall enable the E-UTRA capability if it was disabled and disable the N1 mode capability for 3GPP access (see subclause 4.9.2).

If the message was received via 3GPP access and the UE is operating in single-registration mode, the UE shall handle the EMM parameters, EMM state, and EPS update status as specified in 3GPP TS 24.301 [15] for the case when the service request procedure is rejected with the EMM cause with the same value.

#36 (IAB-node operation not authorized).

This cause value is only applicable when received over 3GPP access by a UE operating as an IAB-node. This cause value received from a 5G access network other than 3GPP access or received by a UE not operating as an IAB-node is considered as an abnormal case and the behaviour of the UE is specified in subclause 5.6.1.7.

The UE shall set the 5GS update status to 5U3 ROAMING NOT ALLOWED (and shall store it according to subclause 5.1.3.2.2) and shall delete any 5G-GUTI, last visited registered TAI, TAI list and ngKSI.

If:

- 1) the UE is not operating in SNPN access operation mode,
 - i) the UE shall delete the list of equivalent PLMNs and store the PLMN identity in the forbidden PLMN list as specified in subclause 5.3.13A and if the UE is configured to use timer T3245 then the UE shall start timer T3245 and proceed as described in subclause 5.3.19a.1. The UE shall enter the state 5GMM-DEREGISTERED.PLMN-SEARCH and perform a PLMN selection according to 3GPP TS 23.122 [5]. If the message has been successfully integrity checked by the NAS and the UE maintains the PLMN-specific attempt counter for 3GPP access for that PLMN, the UE shall set the PLMN-specific attempt counter for 3GPP access for that PLMN to the UE implementation-specific maximum value; and
 - ii) If the UE is operating in single-registration mode, the UE shall in addition handle the EMM parameters EMM state, EPS update status, 4G-GUTI, last visited registered TAI, TAI list and eKSI as specified in 3GPP TS 24.301 [15] for the case when the service request procedure is rejected with the EMM cause with the same value; or
- 2) the UE is operating in SNPN access operation mode,
 - i) the UE shall delete the list of equivalent SNPNS (if available). The UE shall store the SNPN identity in the "temporarily forbidden SNPNS" list for 3GPP access and, if the UE supports access to an SNPN using credentials from a credentials holder, equivalent SNPNS or both, the selected entry of the "list of subscriber data" or the selected PLMN subscription. The UE shall enter state 5GMM-DEREGISTERED.PLMN-SEARCH and perform an SNPN selection according to 3GPP TS 23.122 [5]. If the message has been successfully integrity checked by the NAS, the UE shall set the SNPN-specific attempt counter for 3GPP access for the current SNPN to the UE implementation-specific maximum value.

#72 (Non-3GPP access to 5GCN not allowed).

If the UE initiated the service request procedure over non-3GPP access, the UE shall set the 5GS update status to 5U3 ROAMING NOT ALLOWED (and shall store it according to subclause 5.1.3.2.2) and shall delete last visited registered TAI and TAI list. If the UE is not registering or has not registered to the same PLMN over both 3GPP access and non-3GPP access, the UE shall additionally delete 5G-GUTI and ngKSI. Additionally, the UE shall enter the state 5GMM-DEREGISTERED for non-3GPP access. If the message has been successfully integrity checked by the NAS, the UE shall set:

- 1) the PLMN-specific N1 mode attempt counter for non-3GPP access for that PLMN in case of PLMN; or
 - 2) the SNPN-specific attempt counter for non-3GPP access for that SNPN in case of SNPN;
- to the UE implementation-specific maximum value.

NOTE 7: The 5GMM sublayer states, the 5GMM parameters and the registration status are managed per access type independently, i.e. 3GPP access or non-3GPP access (see subclauses 4.7.2 and 5.1.3).

The UE shall disable the N1 mode capability for non-3GPP access (see subclause 4.9.3).

As an implementation option, if the UE is not currently registered over 3GPP access, the UE may enter the state 5GMM-DEREGISTERED.PLMN-SEARCH in order to perform a PLMN selection according to 3GPP TS 23.122 [5].

If received over 3GPP access the cause shall be considered as an abnormal case and the behaviour of the UE for this case is specified in subclause 5.6.1.7.

#73 (Serving network not authorized).

This cause value received from a cell belonging to an SNPN and the UE is operating in SNPN access operation mode is considered as an abnormal case and the behaviour of the UE is specified in subclause 5.6.1.7.

The UE shall set the 5GS update status to 5U3 ROAMING NOT ALLOWED (and shall store it according to subclause 5.1.3.2.2) and shall delete any 5G-GUTI, last visited registered TAI, TAI list and ngKSI. The UE shall delete the list of equivalent PLMNs, store the PLMN identity in the forbidden PLMN list as specified in subclause 5.3.13A. For 3GPP access the UE shall enter state 5GMM-DEREGISTERED.PLMN-SEARCH in order to perform a PLMN selection according to 3GPP TS 23.122 [5], and for non-3GPP access the UE shall enter state 5GMM-DEREGISTERED.LIMITED-SERVICE in order to perform network selection as defined in 3GPP TS 24.502 [18]. If the message has been successfully integrity checked by the NAS, the UE shall set the PLMN-specific attempt counter and the PLMN-specific attempt counter for non-3GPP access for that PLMN to the UE implementation-specific maximum value.

If the message was received via 3GPP access and the UE is operating in single-registration mode, the UE shall in addition set the EPS update status to EU3 ROAMING NOT ALLOWED, enter the state EMM-DEREGISTERED and shall delete any 4G-GUTI, last visited registered TAI, TAI list and eKSI.

#74 (Temporarily not authorized for this SNPN).

5GMM cause #74 is only applicable when received from a cell belonging to an SNPN and the UE is operating in SNPN access operation mode. 5GMM cause #74 received from a cell not belonging to an SNPN is considered as an abnormal case and the behaviour of the UE is specified in subclause 5.6.1.7.

The UE shall set the 5GS update status to 5U3 ROAMING NOT ALLOWED (and shall store it according to subclause 5.1.3.2.2) and shall delete any 5G-GUTI, last visited registered TAI, TAI list, ngKSI and the list of equivalent SNPNS (if available). The UE shall store the SNPN identity in the "temporarily forbidden SNPNS" list for the specific access type for which the message was received and the selected entry of the "list of subscriber data" or the selected PLMN subscription, or in the "temporarily forbidden SNPNS for onboarding services in SNPN" list, if the UE is registered for onboarding services in SNPN, for the specific access type for which the message was received. If the UE supports access to an SNPN using credentials from a credentials holder, the UE shall store the SNPN identity in the "temporarily forbidden SNPNS" list along with the GIN(s) broadcasted by the SNPN if any, for the selected entry of the "list of subscriber data" or the selected PLMN subscription. If the UE supports access to an SNPN providing access for localized services in SNPN and the access for localized services in SNPN has been enabled, the UE shall store the SNPN identity in the list of "temporarily forbidden SNPNS for access for localized services in SNPN" (if the SNPN is an SNPN selected for localized services in SNPN (see 3GPP TS 23.122 [5]) along with the GIN(s) broadcasted by the SNPN if any, for the selected entry of the "list of subscriber data" or the selected PLMN subscription. If the UE is not registered for onboarding services in SNPN, the UE shall enter state 5GMM-DEREGISTERED.PLMN-SEARCH and perform an SNPN selection according to 3GPP TS 23.122 [5]. If the UE is registered for onboarding services in SNPN, the UE shall enter state 5GMM-DEREGISTERED.PLMN-SEARCH and perform an SNPN selection or an SNPN selection for onboarding services according to 3GPP TS 23.122 [5]. If the message has been successfully integrity checked by the NAS, the UE shall set the SNPN-specific attempt counter for 3GPP access and the SNPN-specific attempt counter for non-3GPP access for the current SNPN to the UE implementation-specific maximum value.

If the message has been successfully integrity checked by the NAS and the UE also supports the registration procedure over the other access to the same SNPN, the UE shall in addition handle 5GMM parameters and 5GMM state for this access, as described for this 5GMM cause value.

#75 (Permanently not authorized for this SNPN).

5GMM cause #75 is only applicable when received from a cell belonging to an SNPN with a globally-unique SNPN identity and the UE is operating in SNPN access operation mode. 5GMM cause #75 received from a cell not belonging to an SNPN or a cell belonging to an SNPN with a non-globally-unique SNPN identity is considered as an abnormal case and the behaviour of the UE is specified in subclause 5.6.1.7.

The UE shall set the 5GS update status to 5U3 ROAMING NOT ALLOWED (and shall store it according to subclause 5.1.3.2.2) and shall delete any 5G-GUTI, last visited registered TAI, TAI list, ngKSI and the list of equivalent SNPNS (if available). The UE shall store the SNPN identity in the "permanently forbidden SNPNS" list for the specific access type for which the message was received and the selected entry of the "list of subscriber data" or the selected PLMN subscription, or in the "permanently forbidden SNPNS for onboarding services in SNPN" list, if the UE is registered for onboarding services in SNPN, for the specific access type for which the message was received. If the UE is not registered for onboarding services in SNPN, the UE shall enter state 5GMM-DEREGISTERED.PLMN-SEARCH and perform an SNPN selection according to

3GPP TS 23.122 [5]. If the UE supports access to an SNPN using credentials from a credentials holder, the UE shall store the SNPN identity in the "permanently forbidden SNPNs" list along with the GIN(s) broadcasted by the SNPN if any, for the selected entry of the "list of subscriber data" or the selected PLMN subscription. If the UE supports access to an SNPN providing access for localized services in SNPN and the access for localized services in SNPN has been enabled, the UE shall store the SNPN identity in the list of "permanently forbidden SNPNs for access for localized services in SNPN" (if the SNPN is an SNPN selected for localized services in SNPN (see 3GPP TS 23.122 [5]) along with the GIN(s) broadcasted by the SNPN if any, for the selected entry of the "list of subscriber data" or the selected PLMN subscription. If the UE is registered for onboarding services in SNPN, the UE shall enter state 5GMM-DEREGISTERED.PLMN-SEARCH and perform an SNPN selection or an SNPN selection for onboarding services according to 3GPP TS 23.122 [5]. If the message has been successfully integrity checked by the NAS, the UE shall set the SNPN-specific attempt counter for 3GPP access and the SNPN-specific attempt counter for non-3GPP access for the current SNPN to the UE implementation-specific maximum value.

If the message has been successfully integrity checked by the NAS and the UE also supports the registration procedure over the other access to the same SNPN, the UE shall in addition handle 5GMM parameters and 5GMM state for this access, as described for this 5GMM cause value.

#76 (Not authorized for this CAG or authorized for CAG cells only).

This cause value received via non-3GPP access or from a cell belonging to an SNPN and the UE is operating in SNPN access operation mode is considered as an abnormal case and the behaviour of the UE is specified in subclause 5.6.1.7.

The UE shall set the 5GS update status to 5U3.ROAMING NOT ALLOWED, store the 5GS update status according to subclause 5.1.3.2.2.

If 5GMM cause #76 is received from:

- 1) a CAG cell, and if the UE receives a "CAG information list" in the CAG information list IE or the Extended CAG information list IE included in the SERVICE REJECT message, the UE shall:
 - i) replace the "CAG information list" stored in the UE with the received "CAG information list" when received in the HPLMN or EHPLMN;
 - ii) replace the serving VPLMN's entry of the "CAG information list" stored in the UE with the serving VPLMN's entry of the received CAG information list IE or the Extended CAG information list IE when the UE receives the CAG information list IE or the Extended CAG information list IE in a serving PLMN other than the HPLMN or EHPLMN; or

NOTE 8: When the UE receives the CAG information list IE or the Extended CAG information list IE in a serving PLMN other than the HPLMN or EHPLMN, entries of a PLMN other than the serving VPLMN, if any, in the received CAG information list IE or the Extended CAG information list IE are ignored.

- iii) remove the serving VPLMN's entry of the "CAG information list" stored in the UE when the UE receives the CAG information list IE or the Extended CAG information list IE in a serving PLMN other than the HPLMN or EHPLMN and the CAG information list IE or the Extended CAG information list IE does not contain the serving VPLMN's entry.

Otherwise, the UE shall delete the CAG-ID(s) of the cell from the "allowed CAG list" for the current PLMN, if the CAG-ID(s) are authorized based on the "Allowed CAG list". In the case the "allowed CAG list" for the current PLMN only contains a range of CAG-IDs, how the UE deletes the CAG-ID(s) of the cell from the "allowed CAG list" for the current PLMN is up to UE implementation. In addition:

- i) if the entry in the "CAG information list" for the current PLMN does not include an "indication that the UE is only allowed to access 5GS via CAG cells" or if the entry in the "CAG information list" for the current PLMN includes an "indication that the UE is only allowed to access 5GS via CAG cells" and one or more CAG-ID(s) are authorized based on the updated "allowed CAG list" for the current PLMN, then the UE shall enter the state 5GMM-REGISTERED.LIMITED-SERVICE and shall search for a suitable cell according to 3GPP TS 38.304 [28] or 3GPP TS 36.304 [25C] with the updated "CAG information list";
- ii) if the entry in the "CAG information list" for the current PLMN includes an "indication that the UE is only allowed to access 5GS via CAG cells" and no CAG-ID is authorized based on the updated "allowed

CAG list" for the current PLMN, then the UE shall enter the state 5GMM-REGISTERED.PLMN-SEARCH and shall apply the PLMN selection process defined in 3GPP TS 23.122 [5] with the updated "CAG information list"; or

- iii) if the "CAG information list" does not include an entry for the current PLMN, then the UE shall enter the state 5GMM-REGISTERED.LIMITED-SERVICE and shall search for a suitable cell according to 3GPP TS 38.304 [28] or 3GPP TS 36.304 [25C] with the updated "CAG information list".
- 2) a non-CAG cell, and if the UE receives a "CAG information list" in the CAG information list IE or the Extended CAG information list IE included in the SERVICE REJECT message, the UE shall:
- i) replace the "CAG information list" stored in the UE with the received "CAG information list" when received in the HPLMN or EHPLMN;
 - ii) replace the serving VPLMN's entry of the "CAG information list" stored in the UE with the serving VPLMN's entry of the received CAG information list IE or the Extended CAG information list IE when the UE receives the CAG information list IE or the Extended CAG information list IE in a serving PLMN other than the HPLMN or EHPLMN; or

NOTE 9: When the UE receives the CAG information list IE or the Extended CAG information list IE in a serving PLMN other than the HPLMN or EHPLMN, entries of a PLMN other than the serving VPLMN, if any, in the received CAG information list IE or the Extended CAG information list IE are ignored.

- iii) remove the serving VPLMN's entry of the "CAG information list" stored in the UE when the UE receives the CAG information list IE or the Extended CAG information list IE in a serving PLMN other than the HPLMN or EHPLMN and the CAG information list IE or the Extended CAG information list IE does not contain the serving VPLMN's entry.

Otherwise, the UE shall store an "indication that the UE is only allowed to access 5GS via CAG cells" in the entry of the "CAG information list" for the current PLMN, if any. If the "CAG information list" stored in the UE does not include the current PLMN's entry, the UE shall add an entry for the current PLMN to the "CAG information list" and store an "indication that the UE is only allowed to access 5GS via CAG cells" in the entry of the "CAG information list" for the current PLMN. If the UE does not have a stored "CAG information list", the UE shall create a new "CAG information list" and add an entry with an "indication that the UE is only allowed to access 5GS via CAG cells" for the current PLMN.

In addition:

- i) if one or more CAG-ID(s) are authorized based on the "allowed CAG list" for the current PLMN, then the UE shall enter the state 5GMM-REGISTERED.LIMITED-SERVICE and shall search for a suitable cell according to 3GPP TS 38.304 [28] with the updated CAG information; or
- ii) if no CAG-ID is authorized based on the "allowed CAG list" for the current PLMN, then the UE shall enter the state 5GMM-REGISTERED.PLMN-SEARCH and shall apply the PLMN selection process defined in 3GPP TS 23.122 [5] with the updated "CAG information list".

If the message was received via 3GPP access and the UE is operating in single-registration mode, the UE shall in addition set the EPS update status to EU3 ROAMING NOT ALLOWED, reset the service request attempt counter and enter the state EMM-REGISTERED.

#77 (Wireline access area not allowed).

5GMM cause #77 is only applicable when received from a wireline access network by the 5G-RG or the W-AGF acting on behalf of the FN-CRG (or on behalf of the N5GC device). 5GMM cause #77 received from a 5G access network other than a wireline access network and 5GMM cause #77 received by the W-AGF acting on behalf of the FN-BRG are considered as abnormal cases and the behaviour of the UE is specified in subclause 5.6.1.7.

When received over wireline access network, the 5G-RG and the W-AGF acting on behalf of the FN-CRG (or on behalf of the N5GC device) shall set the 5GS update status to 5U3 ROAMING NOT ALLOWED (and shall store it according to subclause 5.1.3.2.2), shall delete 5G-GUTI, last visited registered TAI, TAI list and ngKSI, shall enter the state 5GMM-DEREGISTERED and shall act as specified in subclause 5.3.23.

NOTE 10: The 5GMM sublayer states, the 5GMM parameters and the registration status are managed per access type independently, i.e. 3GPP access or non-3GPP access (see subclauses 4.7.2 and 5.1.3).

#78 (PLMN not allowed to operate at the present UE location).

This cause value received from a non-satellite NG-RAN cell is considered as an abnormal case and the behaviour of the UE is specified in subclause 5.6.1.7.

The UE shall set the 5GS update status to 5U3 ROAMING NOT ALLOWED (and shall store it according to subclause 5.1.3.2.2) and shall delete last visited registered TAI and TAI list. If the UE is not registering or has not registered to the same PLMN over both 3GPP access and non-3GPP access, the UE shall additionally delete 5G-GUTI and ngKSI. Additionally, the UE shall reset the registration attempt counter. The UE shall store the PLMN identity and, if it is known, the current geographical location in the list of "PLMNs not allowed to operate at the present UE location" and shall start a corresponding timer instance (see subclause 4.23.2). The UE shall enter state 5GMM-DEREGISTERED.PLMN-SEARCH and perform a PLMN selection according to 3GPP TS 23.122 [5].

If the message was received via 3GPP access and the UE is operating in single-registration mode, the UE shall handle the EMM parameters EMM state, EPS update status, 4G-GUTI, last visited registered TAI, TAI list and eKSI as specified in 3GPP TS 24.301 [15] for the case when the service request procedure is rejected with the EMM cause with the same value.

5.6.1.6 Service request procedure for initiating an emergency PDU session not accepted by the network

If the service request for initiating an emergency PDU session cannot be accepted by the network, the UE shall perform the procedures as described in subclause 5.6.1.5. If the service request for initiating an emergency PDU session fails due to receiving the AUTHENTICATION REJECT message, the UE shall perform the procedures as described in subclauses 5.4.1.2.2.11, 5.4.1.2.3.1, 5.4.1.2.3A.1 or 5.4.1.3.5. Then if the UE is in the same selected PLMN where the last service request was attempted, the UE shall:

- a) inform the upper layers of the failure of the procedure; or

NOTE 1: This can result in the upper layers requesting another emergency call attempt using domain selection as specified in 3GPP TS 23.167 [6].

- b) de-register locally, if not de-registered already, attempt initial registration for emergency services.

If the service request for initiating an emergency PDU session fails due to abnormal cases a), f) or l) in subclause 5.6.1.7, the UE shall perform the procedures as described in subclause 5.6.1.7. Then if the UE is in the same selected PLMN where the last SERVICE REQUEST message was attempted, the UE shall:

- a) inform the upper layers of the failure of the procedure; or

NOTE 2: This can result in the upper layers requesting another emergency call attempt using domain selection as specified in 3GPP TS 23.167 [6] and 3GPP TS 24.229 [14].

- b) de-register locally, if not de-registered already, attempt initial registration for emergency services.

If the service request for initiating a PDU session for emergency services fails due to abnormal case b) in subclause 5.6.1.7, the UE shall perform the actions as described in subclause 5.6.1.7 and inform the upper layers of the failure to access the network.

NOTE 3: This can result in the upper layers requesting another emergency call attempt using domain selection as specified in 3GPP TS 23.167 [6].

5.6.1.6A Service request procedure for an emergency services fallback not accepted by the network

If the service request for initiating an emergency services fallback cannot be accepted by the network, the UE shall perform the procedures as described in subclause 5.6.1.5, if the service request for initiating an emergency services fallback fails due to receiving the AUTHENTICATION REJECT message, the UE shall perform the procedures as described in subclauses 5.4.1.2.2.11, 5.4.1.2.3.1, 5.4.1.2.3A.1 or 5.4.1.3.5, and if the UE does not attempt to select an E-UTRA cell connected to EPC or 5GCN as described in subclause 5.6.1.5 and is camped on NR or E-UTRA cell connected to 5GCN in the same PLMN where the last service request was attempted, the UE shall inform the upper layers of the failure of the procedure.

NOTE 1: This can result in the upper layers requesting another emergency call attempt using domain selection as specified in 3GPP TS 23.167 [6].

If the service request for initiating an emergency services fallback fails due to abnormal cases a) in subclause 5.6.1.7, the UE shall inform the upper layers of the failure of the emergency services fallback.

NOTE 2: This can result in the upper layers requesting another emergency call attempt using domain selection as specified in 3GPP TS 23.167 [6].

If the service request procedure for initiating an emergency services fallback fails due to abnormal cases other than a) in subclause 5.6.1.7, the UE may abort the service request procedure, if not aborted already and attempt to select an E-UTRA cell connected to EPC or 5GCN according to the domain priority and selection rules specified in 3GPP TS 23.167 [6]. If the UE finds a suitable E-UTRA cell, it then proceeds with the appropriate EMM or 5GMM procedures. If the UE operating in single-registration mode has changed to S1 mode, it shall disable the N1 mode capability for 3GPP access.

5.6.1.7 Abnormal cases in the UE

The following abnormal cases can be identified:

- a) T3517 expired.

The UE shall enter the state 5GMM-REGISTERED.

If the UE triggered the service request procedure in 5GMM-IDLE mode sending a:

- 1) SERVICE REQUEST message and the service type of the SERVICE REQUEST message was not set to "emergency services fallback"; or
- 2) CONTROL PLANE SERVICE REQUEST message and the control plane service type of the CONTROL PLANE SERVICE REQUEST message was not set to "emergency services fallback";

then the 5GMM sublayer shall increment the service request attempt counter, abort the procedure and release locally any resources allocated for the service request procedure. The service request attempt counter shall not be incremented, if:

- 1) the service request procedure is initiated to establish an emergency PDU session;
- 2) the UE has an emergency PDU session established;
- 3) the UE is a UE configured for high priority access in selected PLMN or SNPN;
- 4) the service request procedure is initiated in response to paging or notification from the network; or
- 5) the UE in NB-N1 mode is requested by the upper layer to transmit user data related to an exceptional event and the UE is allowed to use exception data reporting (see the ExceptionDataReportingAllowed leaf of the NAS configuration MO in 3GPP TS 24.368 [17] or the USIM file EF_{NASCONFIG} in 3GPP TS 31.102 [22]).

If the service request attempt counter is greater than or equal to 5, the UE shall start timer T3525. Additionally, if the service request procedure was initiated for an MO MMTEL voice call or for an MO MMTEL video call or for an MO IMS registration related signalling, a notification that the service request was not initiated due to the UE having started timer T3525 shall be provided to the upper layers.

NOTE 1: This can result in the upper layers requesting implementation specific mechanisms, e.g. the MMTEL voice call being attempted to another IP-CAN, or establishment of a CS voice call (if supported and not already attempted in the CS domain).

The UE shall not attempt service request until expiry of timer T3525 unless:

- 1) the service request procedure is initiated in response to paging or notification from the network;
- 2) the UE is a UE configured for high priority access in selected PLMN or SNPN;
- 3) the service request procedure is initiated to establish an emergency PDU session;
- 4) the UE has an emergency PDU session established;

- 5) the service request procedure is initiated for emergency services fallback;
- 6) the UE is registered in a new PLMN;

NOTE 2: According to Table 10.2.1, when "UE camped on a new PLMN other than the PLMN on which timer started", timer T3525 is stopped, hence this check may be skipped.

- 7) the UE in NB-N1 mode is requested by the upper layer to transmit user data related to an exceptional event and the UE is allowed to use exception data reporting (see the ExceptionDataReportingAllowed leaf of the NAS configuration MO in 3GPP TS 24.368 [17] or the USIM file EF_{NASCONFIG} in 3GPP TS 31.102 [22]); or
- 8) the UE supports the reconnection to the network due to RAN timing synchronization status change and receives an indication of a change in the RAN timing synchronization status.

NOTE 3: The NAS signalling connection can also be released if the UE deems that the network has failed the authentication check as specified in subclause 5.4.1.3.7.

If the UE triggered the service request procedure in 5GMM-CONNECTED mode sending a:

- 1) SERVICE REQUEST message and the service type of the SERVICE REQUEST message was not set to "emergency services fallback"; or
- 2) CONTROL PLANE SERVICE REQUEST message and the control plane service type of the CONTROL PLANE SERVICE REQUEST message was not set to "emergency services fallback",

the 5GMM sublayer shall abort the procedure, and stay in 5GMM-CONNECTED mode.

If the service type of the SERVICE REQUEST message was set to "emergency services fallback" or the control plane service type of the CONTROL PLANE SERVICE REQUEST message was set to "emergency services fallback" and:

- 1) the service request procedure was triggered in 5GMM-IDLE mode, the 5GMM sublayer shall abort the procedure, release locally any resources allocated for the service request procedure; or
- 2) the service request procedure was triggered in 5GMM-CONNECTED mode, the 5GMM sublayer shall abort the procedure, stay in 5GMM-CONNECTED mode.

b) The lower layers indicate that the access attempt is barred.

The UE shall not start the service request procedure. The UE stays in the current serving cell and applies the normal cell reselection process. Receipt of the access barred indication shall not trigger the selection of a different core network type (EPC or 5GCN).

The service request procedure is started, if still needed, when the lower layers indicate that the barring is alleviated for the access category with which the access attempt was associated.

ba) The lower layers indicate that:

- 1) access barring is applicable for all access categories except categories 0 and 2 and the access category with which the access attempt was associated is other than 0 and 2; or
- 2) access barring is applicable for all access categories except category 0 and the access category with which the access attempt was associated is other than 0.

If the SERVICE REQUEST message or CONTROL PLANE SERVICE REQUEST has not been sent, the UE shall proceed as specified for case b.

If the SERVICE REQUEST message or CONTROL PLANE SERVICE REQUEST has been sent:

- 1) the UE shall abort the service request procedure and stop timer T3517. The UE stays in the current serving cell and applies the normal cell reselection process; and
- 2) the service request procedure is started, if still needed, when the lower layers indicate that the barring is alleviated for the access category with which the access attempt was associated.

For additional UE requirements for both cases see subclause 4.5.5.

c) Timer T3346 is running.

The UE shall not start the service request procedure unless:

- 1) the UE receives a paging;
- 2) the UE receives a NOTIFICATION message over non-3GPP access when the UE is in 5GMM-CONNECTED mode over non-3GPP access and in 5GMM-IDLE mode over 3GPP access;
- 3) the UE receives a NOTIFICATION message over 3GPP access when the UE is in 5GMM-CONNECTED mode over 3GPP access and in 5GMM-IDLE mode over non-3GPP access;
- 4) the UE is a UE configured for high priority access in selected PLMN or SNPN;
- 5) the UE has an emergency PDU session established or is establishing an emergency PDU session;
- 6) the service request procedure is initiated for emergency services fallback;
- 7) the service request procedure is initiated for elevated signalling;
- 8) the UE in NB-N1 mode is requested by the upper layer to transmit user data related to an exceptional event and:
 - the UE is allowed to use exception data reporting (see the ExceptionDataReportingAllowed leaf of the NAS configuration MO in 3GPP TS 24.368 [17] or the USIM file EF_{NASCONFIG} in 3GPP TS 31.102 [22]); and
 - timer T3346 was not started when N1 NAS signalling connection was established with RRC establishment cause set to "mo-ExceptionData"; or
- 9) the MUSIM UE is in 5GMM-CONNECTED mode and requests the network to release the NAS signalling connection (see case o in subclause 5.6.1.1).

If the UE is in 5GMM-IDLE mode, the UE stays in the current serving cell and applies normal cell reselection process. The service request procedure is started, if still necessary, when timer T3346 expires or is stopped.

If the service request procedure was triggered for an MO MMTEL voice call (i.e. access category 4), or for an MO MMTEL video call (i.e. access category 5) or for an MO IMS registration related signalling (i.e. access category 9), a notification that the service request procedure was not initiated due to congestion shall be provided to the upper layers.

If the UE receives a paging with access type set to "Non-3GPP access" and the non-3GPP access is available and UE is in 5GMM-REGISTERED.NORMAL SERVICE over non-3GPP access, the UE shall stop timer T3346 and send the SERVICE REQUEST message over non-3GPP access.

d) Registration procedure for mobility and periodic registration update is triggered.

The UE shall abort the service request procedure, stop timer T3517, if running and perform the registration procedure for mobility and periodic registration update. The Follow-on request indicator in the REGISTRATION REQUEST message shall be handled as specified in subclause 5.5.1.3.2.

e) Switch off.

If the UE is in state 5GMM-SERVICE-REQUEST-INITIATED at switch off, the de-registration procedure shall be performed.

f) De-registration procedure collision.

If the UE receives a DEREGISTRATION REQUEST message from the network in state 5GMM-SERVICE-REQUEST-INITIATED, the UE shall progress the DEREGISTRATION REQUEST message and the service request procedure shall be aborted.

NOTE 4: The above collision case is valid if the DEREGISTRATION REQUEST message indicates the access type over which the service request procedure is attempted otherwise both the procedures are progressed.

g) Transmission failure of SERVICE REQUEST or CONTROL PLANE SERVICE REQUEST message indication with change in the current TAI.

If the current TAI is not in the TAI list, UE shall abort the service request procedure to perform the registration procedure for mobility and periodic registration update as specified in subclause 5.5.1.3.2.

If the current TAI is part of the TAI list, the UE shall restart the service request procedure unless the service request procedure is initiated for case o) or p) in subclause 5.6.1.1. For case o) and p) in subclause 5.6.1.1 the UE shall abort the service request procedure, enters state 5GMM-REGISTERED, locally release the N1 NAS signalling connection, stop timer T3517 and locally release any resources allocated for the service request procedure.

h) Transmission failure of SERVICE REQUEST or CONTROL PLANE SERVICE REQUEST message indication without change in the current TAI.

The UE shall restart the service request procedure unless the service request procedure is initiated for case o) or p) in subclause 5.6.1.1. For case o) and p) in subclause 5.6.1.1 the UE shall abort the service request procedure, enters state 5GMM-REGISTERED, locally release the N1 NAS signalling connection, stop timer T3517 and locally release any resources allocated for the service request procedure.

i) SERVICE REJECT message received with other 5GMM cause values than those treated in subclause 5.6.1.5, and cases of 5GMM cause values #11, #15, #22, #28, #31, #72, #73, #74, #75, #76, #77 and #78 that are considered as abnormal cases according to subclause 5.6.1.5.

The UE shall enter state 5GMM-REGISTERED.

The UE shall abort the service request procedure, stop timer T3517 and locally release any resources allocated for the service request procedure.

j) The UE in 5GMM-CONNECTED mode with RRC inactive indication over the 3GPP access, and in 5GMM-CONNECTED mode over non-3GPP access, receives a NOTIFICATION message over the non-3GPP access with access type indicating 3GPP access.

The UE shall transition from 5GMM-CONNECTED mode with RRC inactive indication to 5GMM-IDLE mode over 3GPP access and initiate the service request procedure over the 3GPP access.

k) Timer T3447 is running

The UE shall not start any service request procedure unless:

- 1) the UE in 5GMM-IDLE receives a paging request;
- 2) the UE is a UE configured for high priority access;
- 3) the UE has a PDU session for emergency services established or is establishing a PDU session for emergency services;
- 4) the service request procedure is initiated for emergency services fallback;
- 5) the UE in 5GMM-CONNECTED mode receives mobile terminated signalling or downlink data over the user-plane;
- 6) the service request procedure is initiated for elevated signalling; or
- 7) the MUSIM UE requests the network to release the NAS signalling connection (see case o in subclause 5.6.1.1).

The UE stays in the current serving cell and applies the normal cell reselection process. The service request procedure is started, if still necessary, when timer T3447 expires or timer T3447 is stopped.

l) Lower layer failure, release of the N1 signalling connection received from lower layers or the lower layers indicate that the RRC connection has been suspended before the service request procedure is completed or SERVICE REJECT message is received.

The UE shall abort the service request procedure, stop timer T3517, locally release any resources allocated for the service request procedure and enters state 5GMM-REGISTERED. For case m) in subclause 5.6.1.1 the UE may retry the service request procedure a certain number of times (maximum re-attempts 5).

m) Timer T3448 is running

The UE in 5GMM-IDLE mode shall not initiate the service request procedure for transport of user data via the control plane unless:

- 1) the UE is a UE configured for high priority access in selected PLMN;
- 2) the UE which is only using 5GS services with control plane ClOT 5GS optimization received a paging request;
- 3) the UE in NB-N1 mode is requested by the upper layer to transmit user data related to an exceptional event and the UE is allowed to use exception data reporting (see the ExceptionDataReportingAllowed leaf of the NAS configuration MO in 3GPP TS 24.368 [17] or the USIM file EF_{NASCONFIG} in 3GPP TS 31.102 [22]); or
- 4) the UE is initiating the service request procedure to request emergency services or emergency services fallback.

The UE stays in the current serving cell and applies the normal cell reselection process. The service request procedure is started, if still necessary, when timer T3448 expires.

- n) Access for localized services in current SNPN is no longer allowed.

If the service request procedure is not to request emergency services and there is no PDU session for emergency services, the registered SNPN is an SNPN selected for localized services in SNPN (see 3GPP TS 23.122 [5]) and:

- access for localized services in SNPN is disabled; or
- the validity information for the selected SNPN is no longer met;

then the UE shall reset the service request attempt counter, stop T3517, abort the service request procedure, locally release the NAS signalling connection, if any, and enter state 5GMM-REGISTERED.LIMITED-SERVICE or 5GMM-REGISTERED.PLMN-SEARCH in order to perform SNPN selection according to 3GPP TS 23.122 [5].

5.6.1.8 Abnormal cases on the network side

The following abnormal cases can be identified:

- a) Lower layer failure.

If a lower layer failure occurs before a SERVICE REJECT message has been sent to the UE or the service request procedure has been completed by the AMF, the AMF enters/stays in 5GMM-IDLE.

- b) Protocol error.

If the SERVICE REQUEST message or the CONTROL PLANE SERVICE REQUEST message is received with a protocol error, the AMF shall return a SERVICE REJECT message with one of the following 5GMM cause values:

- #96 invalid mandatory information;
- #99 information element non-existent or not implemented;
- #100 conditional IE error; or
- #111 protocol error, unspecified.

The AMF stays in the current 5GMM mode.

- c) More than one SERVICE REQUEST message or CONTROL PLANE SERVICE REQUEST message received before the procedure has been completed (i.e., before SERVICE REJECT message has been sent or service request procedure has been completed).

- If one or more of the information elements in the SERVICE REQUEST message or CONTROL PLANE SERVICE REQUEST message differs from the ones received within the previous SERVICE REQUEST message or CONTROL PLANE SERVICE REQUEST message, the previously initiated service request procedure shall be aborted, and the new service request procedure shall be progressed;

- If the information elements do not differ, then the AMF shall continue with the previous service request procedure and shall not treat any further this SERVICE REQUEST message or this CONTROL PLANE SERVICE REQUEST message.

- d) REGISTRATION REQUEST message received with "initial registration" or "emergency registration" in the 5GS registration type IE before a SERVICE REJECT message has been sent or the service request procedure has been completed.

If a REGISTRATION REQUEST message with "initial registration" or "emergency registration" in the 5GS registration type IE is received and the service request procedure has not been completed or a SERVICE REJECT message has not been sent, the AMF may initiate the 5GMM common procedures, e.g. the primary authentication and key agreement procedure. The AMF may e.g. after a successful primary authentication and key agreement procedure execution, abort the service request procedure, delete the 5GMM context, indicate towards the SMF that the 5GMM context has been deleted and progress the new REGISTRATION REQUEST message.

- e) REGISTRATION REQUEST message received with "mobility registration updating" or "periodic registration updating" in the 5GS registration type IE received before the service request procedure has been completed or a SERVICE REJECT message has been sent.

If a REGISTRATION REQUEST message with "mobility registration updating" or "periodic registration updating" in the 5GS registration type IE is received and the service request procedure has not been completed or a SERVICE REJECT message has not been sent, the AMF may initiate the 5GMM common procedures, e.g. the primary authentication and key agreement procedure. The AMF may e.g. after a successful primary authentication and key agreement procedure execution, abort the service request procedure and progress the new REGISTRATION REQUEST message.

- f) If a CONTROL PLANE SERVICE REQUEST message with Control plane service type indicating "mobile originating request" is received after the AMF initiated a paging procedure, the AMF shall treat this CONTROL PLANE SERVICE REQUEST as a paging response and handle the message according to subclauses 5.6.1.4 and 5.6.1.5.

- g) CONTROL PLANE SERVICE REQUEST message received with the Data type field indicates "control plane user data" in the CIoT small data container IE or received with Payload container type IE set to "CIoT user data container" and:

- 1) the AMF does not have a PDU session routing context for the PDU session ID and the UE; or
- 2) the AMF unsuccessfully attempted to forward the user data container and the PDU session ID,

then the AMF may send back to the UE the CIoT user data container or control plane user data which was not forwarded as specified in subclause 5.4.5.3.1 case 11) or case 12).

- h) Based on operator policy, if the service request from a UE not supporting CAG is rejected due to CAG restrictions, the network shall reject the service request with a 5GMM cause value other than the 5GMM cause #76 (Not authorized for this CAG or authorized for CAG cells only).

NOTE: 5GMM cause #7 (5GS services not allowed), 5GMM cause #11 (PLMN not allowed), 5GMM cause #27 (N1 mode not allowed), 5GMM cause #73 (Serving network not authorized) can be used depending on the subscription of the UE and whether the UE roams or not.

- i) CIoT user data received for a PDU session ID which is inactive in the network.

If a CONTROL PLANE SERVICE REQUEST message is received with CIoT user data for a PDU session that is inactive in the network, the AMF shall discard the CIoT user data. The AMF shall send the SERVICE ACCEPT message and indicate that this PDU session ID is inactive using the PDU session status IE.

5.6.2 Paging procedure

5.6.2.1 General

The paging procedure is performed only in 3GPP access and used by the network to request the establishment of a NAS signalling connection to the UE. The paging procedure is also used by the network to request the UE to re-establish the

user-plane resources of PDU sessions for downlink user data transport. Another purpose of the paging procedure is to request the UE to re-establish the user-plane resources of PDU session(s) associated with non-3GPP access over 3GPP access.

Additionally, the network can use the paging procedure to initiate the mobile terminating SMS.

For the UE using eDRX, the network initiates the paging procedure when NAS signalling messages or user data is pending to be sent to the UE within the paging time window and requests the lower layers to include the eDRX cycle length and paging time window length in the paging message. If NAS signalling messages or user data is pending to be sent to the UE outside the paging time window and the eDRX value that the network provides to the UE in the Negotiated extended DRX parameters IE during the last registration procedure indicates:

- a) the eDRX cycle length duration of the E-UTRA cell connected to 5GCN, is higher than 5.12 seconds; or
- b) the eDRX cycle length duration of the NR cell connected to 5GCN, is higher than 10.24 seconds,

the network initiates the paging procedure at T time ahead of the beginning of the next paging time window.

NOTE: T time is a short time period based on implementation. The operator can take possible imperfections in the synchronization between the 5GCN and the UE into account when choosing T time.

If the network detects that the pending user data to be sent to the UE is related to the voice service as specified in 3GPP TS 23.502 [9] and the network decides to initiate the paging procedure based on the stored paging restriction information, if any, the AMF should request the lower layer to include the Voice Service Indication in the paging message when the UE and the network support the paging indication for voice services.

5.6.2.2 Paging for 5GS services

5.6.2.2.1 General

The network shall initiate the paging procedure for 5GS services when NAS signalling messages or user data is pending to be sent to the UE in 5GMM-IDLE mode over 3GPP access (see example in figure 5.6.2.2.1.1) and there is no paging restriction applied in the network for that paging.

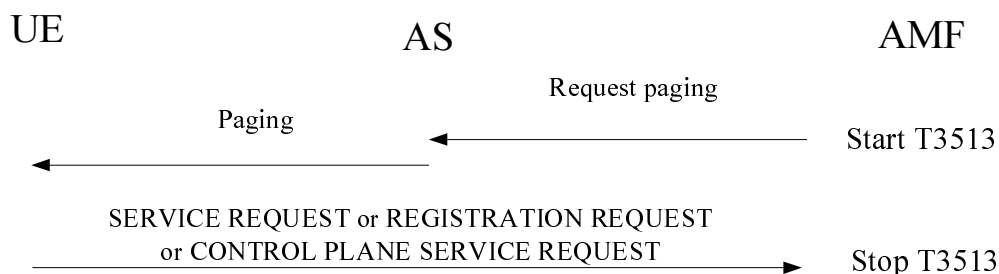

Figure 5.6.2.2.1.1: Paging procedure

To initiate the procedure the 5GMM entity in the AMF requests the lower layer to start paging and shall start timer T3513.

If downlink signalling or user data is pending to be sent over non-3GPP access, the 5GMM entity in the AMF shall indicate to the lower layer that the paging is associated to non-3GPP access.

The network shall not page the UE to re-establish user-plane resources of PDU session(s) associated with non-3GPP access over 3GPP access if all the PDU sessions of the UE that are established over the 3GPP access are associated with control plane only indication or S-NSSAI(s) associated with PDU session(s) are not in the UE's allowed NSSAI and partially allowed NSSAI for a PLMN on 3GPP access.

If the network has downlink user data pending for a UE, the AMF has stored paging restriction of the UE and the Paging restriction type in the stored paging restriction is set to:

- a) "All paging is restricted", the network should not page the UE;

- b) "All paging is restricted except for voice service", the network should page the UE only when:
 - 1) the pending downlink user data for the UE is considered as voice service related by the network;
- c) "All paging is restricted except for specified PDU session(s)", the network should page the UE only when:
 - 1) for PDU session(s) that paging is not restricted based on the stored paging restriction, the network has downlink user data pending; or
- d) "All paging is restricted except for voice service and specified PDU session(s)", the network should page the UE only when:
 - 1) the pending downlink user data for the UE is considered as voice service related by the network; or
 - 2) for PDU session(s) that paging is not restricted based on the stored paging restriction, the network has downlink user data pending.

If the network has downlink signalling pending for a UE and the AMF has stored paging restriction of the UE and the Paging restriction type in the stored paging restriction is set to:

- a) "All paging is restricted", the network should not page the UE;
- b) "All paging is restricted except for voice service", the network should page the UE only when:
 - 1) the pending downlink signalling for the UE is 5GMM signalling or 5GSM signalling of the PDU session of voice service;
- c) "All paging is restricted except for specified PDU session(s)", the network should page the UE only when:
 - 1) the pending downlink signalling for the UE is 5GMM signalling; or
 - 2) for PDU session(s) that paging is not restricted based on the stored paging restriction, the network has downlink 5GSM signalling pending; or
- d) "All paging is restricted except for voice service and specified PDU session(s)", the network should page the UE only when:
 - 1) the pending downlink signalling for the UE is 5GMM signalling or 5GSM signalling of the PDU session of voice service; or
 - 2) for PDU session(s) that paging is not restricted based on the stored paging restriction, the network has downlink 5GSM signalling pending.

NOTE 1: If the network pages the UE due to downlink signalling pending, the network initiates the release of the N1 NAS signalling connection after network-requested procedure is completed.

The 5GMM entity in the AMF may provide the lower layer with the "allowed CAG list" and an "indication that the UE is only allowed to access 5GS via CAG cells" for the current PLMN, if available, and with the "allowed CAG list" and an "indication that the UE is only allowed to access 5GS via CAG cells" per equivalent PLMN, if available. If there is an active emergency PDU session, the 5GMM entity in the AMF shall not provide the lower layer with the "allowed CAG list" and an "indication that the UE is only allowed to access 5GS via CAG cells" for the current PLMN, even if available, or with the "allowed CAG list" and an "indication that the UE is only allowed to access 5GS via CAG cells" per equivalent PLMN, even if available.

Upon reception of a paging indication, the UE shall stop the timer T3346, if running, and:

- a) if control plane CIoT 5GS optimization is not used by the UE, the UE shall:
 - 1) initiate a service request procedure over 3GPP access to respond to the paging as specified in subclauses 5.6.1.2.1 if the UE is in 5GMM-REGISTERED.NORMAL-SERVICE or 5GMM-REGISTERED.NON-ALLOWED-SERVICE (as described in subclause 5.3.5.2) state and the UE is in the 5GMM-IDLE mode without suspend indication;
 - 2) initiate a service request procedure over non-3GPP access to respond to the paging as specified in subclauses 5.6.1;

- 3) initiate a registration procedure for mobility and periodic registration update over 3GPP access to respond to the paging as specified in subclauses 5.5.1.3.2; or
 - 4) proceed as specified in subclause 5.3.1.5 if the UE is in the 5GMM-IDLE mode with suspend indication; or
- b) if control plane CIoT 5GS optimization is used by the UE, the UE shall:
- 1) initiate a service request procedure as specified in subclause 5.6.1.2.2 if the UE is in the 5GMM-IDLE mode without suspend indication;
 - 2) initiate a registration procedure for mobility and periodic registration update over 3GPP access as specified in subclauses 5.5.1.3.2; or
 - 3) proceed as specified in subclause 5.3.1.5 if the UE is in the 5GMM-IDLE mode with suspend indication.

NOTE 2: If the UE is in the 5GMM-IDLE mode without suspend indication and has an uplink user data to be sent to the network using control plane CIoT 5GS optimization when receiving the paging indication, the UE can piggyback the uplink user data during the service request procedure initiated to respond to the paging, as specified in subclause 5.6.1.2.2.

The MUSIM UE based on implementation may use the paging cause indicated by lower layers (see 3GPP TS 38.331 [30]), if any, to accept the paging, reject the paging or ignore the paging indication.

Upon reception of a paging indication, if the network supports the rejection of paging request and if a MUSIM UE decides not to accept the paging, the UE may initiate a service request procedure to reject the paging as specified in subclause 5.6.1.1.

NOTE 3: As an implementation option, MUSIM UE is allowed to not respond to paging based on the information available in the paging message, e.g. voice service indication.

If TMGI is used as paging identity and the TMGI matches with multicast MBS session which the UE has joined, the UE shall respond to the paging. Otherwise, the UE shall not respond to the paging.

The network shall stop timer T3513 for the paging procedure when an integrity-protected response is received from the UE and successfully integrity checked by the network or when the 5GMM entity in the AMF receives an indication from the lower layer that it has received the NGAP UE context resume request message as specified in 3GPP TS 38.413 [31]. If the response received is not integrity protected, or the integrity check is unsuccessful, timer T3513 for the paging procedure shall be kept running unless:

- a) the UE is registered for emergency services;
- b) the UE has an emergency PDU session; or
- c) the response received is a REGISTRATION REQUEST message for mobility and periodic registration update and the security mode control procedure or authentication procedure performed during mobility and periodic registration update has completed successfully.

Upon expiry of timer T3513, the network may reinitiate paging.

If the network, while waiting for a response to the paging sent without paging priority, receives downlink signalling or downlink data associated with priority user-plane resources for PDU sessions, the network shall stop timer T3513, and then initiate the paging procedure with paging priority.

5.6.2.2.2 Abnormal cases on the network side

The following abnormal case can be identified:

- a) Void.

5.6.2.2.3 Abnormal cases in the UE

The following abnormal cases can be identified:

- a) Paging message received with access type set to non-3GPP access while the UE is in 5GMM-CONNECTED mode over non-3GPP access.

The UE shall not respond to paging message.

- b) Paging message received with access type set to 3GPP access when UE-initiated 5GMM specific procedure or service request procedure is ongoing.

The UE shall proceed with 5GMM specific procedure or service request procedure. If for registration procedure and service request procedure lower layers indicate that the access attempt is barred, then the UE shall handle the pending paging message as specified in subclause 5.6.2.2.1. Otherwise, the UE shall ignore the paging once lower layers confirm the establishment of the signalling connection.

5.6.3 Notification procedure

5.6.3.1 General

The notification procedure is used by the network:

- a) to request the UE, by sending the NOTIFICATION message over 3GPP access, to re-establish the user-plane resources of PDU session(s) associated with non-3GPP access over 3GPP access or to deliver 5GSM downlink signalling messages associated with non-3GPP access over 3GPP access when the UE is in 5GMM-IDLE mode over non-3GPP access and in 5GMM-CONNECTED mode over 3GPP access; or
- b) to request the UE, by sending the NOTIFICATION message over non-3GPP access, to re-establish user-plane resources of the PDU session(s) or to deliver downlink signalling associated with 3GPP access over 3GPP access when the UE is in 5GMM-CONNECTED mode over non-3GPP access and:
 - 1) in 5GMM-IDLE mode over 3GPP access when the UE is not in MICO mode or when the network determines the unavailability period is not activated for the UE; or
 - 2) in 5GMM-IDLE mode with suspend indication over 3GPP access when the UE is not in MICO mode or when the network determines the unavailability period is not activated for the UE.

The network shall not use the NOTIFICATION message to re-establish user-plane resources of PDU session(s) associated with non-3GPP access over 3GPP access if all the PDU sessions of the UE that are established over the 3GPP access are associated with control plane only indication. .

The network shall not use the NOTIFICATION message over non-3GPP access, if:

- a) the MUSIM UE supports the paging indication for voice services;
- b) the network has indicated "paging indication for voice services supported" to the UE; and
- c) the AMF detects that the downlink data is related to voice service (see 3GPP TS 23.501 [8]).

5.6.3.2 Notification procedure initiation

The network shall initiate the notification procedure by sending the NOTIFICATION message to the UE and start timer T3565 (see example in figure 5.6.3.2.1).

For case a) in subclause 5.6.3.1, the NOTIFICATION message is sent from the network to the UE via 3GPP access with access type indicating non-3GPP access.

For case b) in subclause 5.6.3.1, the NOTIFICATION message is sent from the network to the UE via non-3GPP access with access type indicating 3GPP access when the UE is not in MICO mode or when the network determines the unavailability period is not activated for the UE.

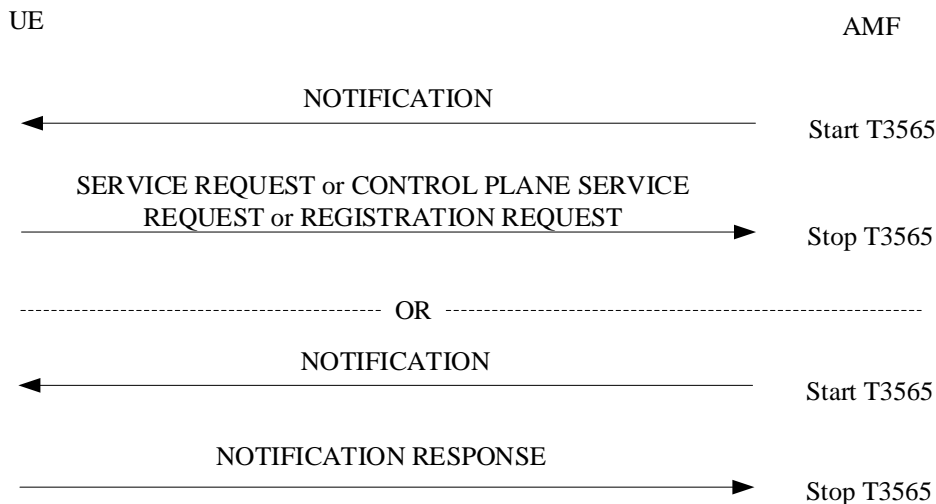

Figure 5.6.3.2.1: Notification procedure

For case b) in subclause 5.6.3.1, if the network has downlink user data pending for a UE and the AMF has stored paging restriction of the UE and the Paging restriction type in the stored paging restriction is set to:

- a) "All paging is restricted", the network should not send the NOTIFICATION message to the UE;
- b) "All paging is restricted except for voice service", the network should send the NOTIFICATION message to the UE only when the pending downlink user data for the UE is considered as voice service related by the network and the MUSIM UE does not support the paging indication for voice services or the network has not indicated "paging indication for voice services supported" to the UE;
- c) "All paging is restricted except for specified PDU session(s)", the network should send the NOTIFICATION message to the UE only when:
 - 1) for PDU session(s) that paging is not restricted based on the stored paging restriction, the network has downlink user data pending;
 - 2) for PDU session(s) that paging is not restricted based on the stored paging restriction, the network has downlink user data pending.
- d) "All paging is restricted except for voice service and specified PDU session(s)" the network should send the NOTIFICATION message to the UE only:
 - 1) when the pending downlink user data for the UE is considered as voice service related by the network and the MUSIM UE does not support the paging indication for voice services, or the network has not indicated "paging indication for voice services supported" to the UE; or
 - 2) for PDU session(s) that paging is not restricted based on the stored paging restriction, the network has downlink user data pending.

For case b) in subclause 5.6.3.1, if the network has downlink signalling pending for a UE and the AMF has stored paging restriction of the UE and the Paging restriction type in the stored paging restriction is set to:

- a) "All paging is restricted", the network should not send the NOTIFICATION message to the UE;
- b) "All paging is restricted except for voice service", then the network should send the NOTIFICATION message to the UE only when:
 - 1) the pending downlink signalling for the UE is 5GMM signalling or 5GSM signalling of the PDU session of voice service;
- c) "All paging is restricted except for specified PDU session(s)", the network should send the NOTIFICATION message to the UE only when:
 - 1) the pending downlink signalling for the UE is 5GMM signalling; or

- 2) for PDU session(s) that paging is not restricted based on the stored paging restriction, the network has downlink 5GSM signalling pending; or
- d) "All paging is restricted except for voice service and specified PDU session(s)" then the network should send the NOTIFICATION message to the UE only when:
 - 1) the pending downlink signalling for the UE is 5GMM signalling or 5GSM signalling pending of the PDU session of voice service; or
 - 2) for PDU session(s) that paging is not restricted based on the stored paging restriction, the network has downlink 5GSM signalling pending.

NOTE 1: If the network sends NOTIFICATION message to the UE due to downlink signalling pending, the network initiates the release of the N1 NAS signalling connection over 3GPP access after network-requested procedure is completed.

Upon reception of a NOTIFICATION message, the UE shall stop the timer T3346, if running.

For case a) in subclause 5.6.3.1, upon reception of NOTIFICATION message, the UE shall initiate a service request procedure over 3GPP access as specified in subclauses 5.6.1.

NOTE 2: For a UE in NB-NI mode, if there is DL user data pending for a PDU session associated with non-3GPP access then the AMF notifies the SMF that reactivation of user plane resources cannot be performed if the number of PDU sessions that currently has user-plane resources established equals to the UE's maximum number of supported user-plane resources.

For case b) in subclause 5.6.3.1, upon reception of NOTIFICATION message:

- a) if control plane CIoT 5GS optimization is not used by the UE, the UE shall:
 - 1) initiate a service request procedure over 3GPP access as specified in subclause 5.6.1.2.1, if the UE is in 5GMM-REGISTERED.NORMAL-SERVICE or 5GMM-REGISTERED.NON-ALLOWED-SERVICE (as described in subclause 5.3.5.2) state over 3GPP access or 5GMM-REGISTERED.NON-ALLOWED-SERVICE state (see subclause 5.3.5.2), and the UE is in the 5GMM-IDLE mode without suspend indication;
 - 2) initiate a registration procedure for mobility and periodic registration update over 3GPP access as specified in subclause 5.5.1.3.2, if the UE is in 5GMM-REGISTERED.ATTEMPTING-REGISTRATION-UPDATE state over 3GPP access; or
 - 3) proceed as specified in subclause 5.3.1.5 if the UE is in the 5GMM-IDLE mode with suspend indication;
- b) if control plane CIoT 5GS optimization is used by the UE, the UE shall:
 - 1) initiate a service request procedure over 3GPP access as specified in subclause 5.6.1.2.2, if the UE is in 5GMM-REGISTERED.NORMAL-SERVICE or 5GMM-REGISTERED.NON-ALLOWED-SERVICE (as described in subclause 5.3.5.2) state and the UE is in the 5GMM-IDLE mode without suspend indication;
 - 2) initiate a registration procedure for mobility and periodic registration update over 3GPP access as specified in subclause 5.5.1.3.2, if the UE is in 5GMM-REGISTERED.ATTEMPTING-REGISTRATION-UPDATE state; or
 - 3) proceed as specified in subclause 5.3.1.5 if the UE is in the 5GMM-IDLE mode with suspend indication; or
- c) if:
 - 1) the UE is in 5GMM-REGISTERED.NO-CELL-AVAILABLE state, 5GMM-REGISTERED.PLMN-SEARCH state, 5GMM-REGISTERED.LIMITED-SERVICE state or 5GMM-REGISTERED.UPDATE-NEEDED state over 3GPP access; or
 - 2) the MUSIM UE is not able to respond the NOTIFICATION message as specified in case a) and b) above, e.g., due to UE implementation constraints;

the UE shall respond with NOTIFICATION RESPONSE message over non-3GPP access indicating inability of the UE to initiate a service request procedure or a registration procedure over 3GPP access and may include the PDU session status information element to indicate:

- 1) the single access PDU session(s) not in 5GSM state PDU SESSION INACTIVE in the UE associated with the 3GPP access type; and
- 2) the MA PDU session(s) not in 5GSM state PDU SESSION INACTIVE in the UE and having user plane resources established associated with the 3GPP access type.

Upon reception of NOTIFICATION message:

For case b) in subclause 5.6.3.1, if the UE is in 5GMM-REGISTERED.NO-CELL-AVAILABLE state or 5GMM-REGISTERED.PLMN-SEARCH state and a local release was performed in the UE for the single access PDU sessions associated with the 3GPP access or for user plane resources on the 3GPP access of MA PDU sessions;

then the UE shall respond with NOTIFICATION RESPONSE message over non-3GPP access indicating with the PDU session status information element that:

- the local release of its single access PDU sessions associated with the 3GPP access was performed; and
- the local release of its 3GPP access user plane resources of MA PDU sessions was performed.

5.6.3.3 Notification procedure completion

Upon reception of SERVICE REQUEST message, CONTROL PLANE SERVICE REQUEST message or REGISTRATION REQUEST message, the AMF shall stop timer T3565 and proceed service request procedure as specified in subclauses 5.6.3.1 or registration procedure for mobility and periodic registration update as specified in subclauses 5.5.1.3. If no user-plane resources of PDU session(s) need to be re-established, the AMF should notify the SMF that the UE was reachable but did not accept to re-establish the user-plane resources of PDU session(s).

When the 5GMM entity in the AMF receives an indication from the lower layer that it has received the NGAP UE context resume request message as specified in 3GPP TS 38.413 [31], the AMF shall stop timer T3565.

Upon reception of NOTIFICATION RESPONSE message over non-3GPP access, the AMF shall stop timer T3565 and should notify the SMF that the UE is unreachable.

If the NOTIFICATION RESPONSE message includes the PDU session status information element, then:

a) for single access PDU sessions, the AMF shall:

- 1) perform a local release of all those PDU sessions which are not in 5GSM state PDU SESSION INACTIVE on the AMF side associated with 3GPP access, but are indicated by the UE in the PDU session status information element in the NOTIFICATION RESPONSE message as being in 5GSM state PDU SESSION INACTIVE; and
- 2) shall request the SMF to perform a local release of all those PDU sessions associated with 3GPP access. If any of those PDU sessions is associated with one or more multicast MBS sessions, the SMF shall consider the UE as removed from the associated multicast MBS sessions; and

b) For MA PDU sessions, the AMF shall:

- 1) for MA PDU sessions having user plane resources established only on the 3GPP access in the AMF side, but are indicated by the UE in the PDU session status information element in the NOTIFICATION RESPONSE message as no user plane resources established on the 3GPP access:
 - i) perform a local release of all those MA PDU sessions; and
 - ii) request the SMF to perform a local release of all those MA PDU sessions. If the MA PDU session is associated with one or more multicast MBS sessions, the SMF shall consider the UE as removed from the associated multicast MBS sessions; and
- 2) for MA PDU sessions having user plane resources established on both accesses in the AMF side, but are indicated by the UE in the PDU session status information element in the NOTIFICATION RESPONSE message as no user plane resources established on the 3GPP access:
 - i) perform a local release of 3GPP access user plane resources of all those MA PDU sessions; and

- ii) request the SMF to perform a local release of 3GPP access user plane resources of all those MA PDU sessions. If the MA PDU session is associated with one or more MBS sessions, the SMF shall consider the UE as removed from the associated MBS sessions.

5.6.3.4 Abnormal cases on the network side

The following abnormal cases can be identified:

- a) Expiry of timer T3565.

The network shall, on the first expiry of the timer T3565, retransmit the NOTIFICATION message and shall reset and start timer T3565. This retransmission is repeated four times, i.e. on the fifth expiry of timer T3565, the procedure shall be aborted. In addition, upon the fifth expiry of timer T3565:

For case a) in subclause 5.6.3.1, the AMF should notify the SMF that the UE is unreachable. The AMF may enter 5GMM-IDLE mode over 3GPP access.

For case b) in subclause 5.6.3.1, the AMF may either:

- 1) perform the paging procedure over the 3GPP access; or
- 2) notify the SMF that the UE is unreachable.

NOTE: Whether the AMF performs the paging procedure or notifies the SMF is up to operator's policies.

- b) De-registration procedure collision

If the network receives a DEREGISTRATION REQUEST message before it receives a SERVICE REQUEST message or REGISTRATION REQUEST message, the AMF shall stop timer T3565 and proceed de-registration procedure as specified in subclause 5.5.2.

5.6.3.5 Abnormal cases on the UE side

The following abnormal cases can be identified:

- a) NOTIFICATION message received via non-3GPP access with access type indicating 3GPP access when UE-initiated 5GMM specific procedure or service request procedure over 3GPP access is ongoing.

The UE shall proceed with 5GMM specific procedure or service request procedure. If for registration procedure and service request procedure lower layers indicate that the access attempt is barred, then the UE shall handle the pending NOTIFICATION message as specified in subclause 5.6.3.2. Otherwise, the UE shall ignore the NOTIFICATION message once lower layers confirms the establishment of the signalling connection.

- x) NOTIFICATION message received via non-3GPP access with access type indicating 3GPP access when the unavailability period is activated in the UE or the UE is about to activate unavailability period.

The UE shall respond with NOTIFICATION RESPONSE message over non-3GPP access indicating inability of the UE to initiate a service request procedure or a registration procedure over 3GPP access.

6 Elementary procedures for 5GS session management

6.1 Overview

6.1.1 General

This clause describes the procedures used for 5GS session management (5GSM) performed over an N1 NAS signalling connection.

The main function of the 5GSM sublayer is to support the PDU session handling in the UE and in the SMF (transferred via the AMF).

The 5GSM comprises procedures for:

- the authentication and authorization, establishment, modification and release of PDU sessions; and
- request for performing handover of an existing PDU session between 3GPP access and non-3GPP access, or to transfer an existing PDN connection in the EPS to the 5GS.

Each PDU session represents a PDU session established between the UE and an SMF. PDU sessions can remain established even if the radio and network resources constituting the corresponding PDU session between the UE and the SMF are temporarily released.

5GSM procedures can be performed only if a 5GMM context has been established between the UE and the AMF, and the secure exchange of NAS messages has been initiated by the AMF by use of the 5GMM procedures described in clause 5. Once the UE is successfully registered to a PLMN, a PDU session can be established. If no 5GMM context has been established, the 5GMM sublayer has to initiate the establishment of a 5GMM context by use of the 5GMM procedures as described in clause 5.

The UE can request the network to modify or release PDU sessions. The network can fulfil such a request from the UE by modifying a PDU session or releasing a PDU session using network-requested procedures (see subclause 6.3).

6.1.2 Types of 5GSM procedures

Three types of 5GSM procedures can be distinguished:

a) Procedures related to PDU sessions:

These procedures are initiated by the network and are used for authentication and authorization or manipulation of PDU sessions:

- 1) PDU authentication and authorization;
- 2) network-requested PDU session modification;
- 3) network-requested PDU session release; and
- 4) service-level authentication and authorization.

This procedure is initiated by the UE and to request for establishment of PDU sessions or to perform handover of an existing PDU session between 3GPP access and non-3GPP access, or to transfer an existing PDN connection in the EPS to the 5GS:

UE-requested PDU session establishment.

b) Transaction related procedures:

These procedures are initiated by the UE to request for handling of PDU sessions, i.e. to modify a PDU session, or to release a PDU session:

- 1) UE-requested PDU session modification; and
- 2) UE-requested PDU session release.

This procedure is initiated by the 5G ProSe UE-to-network relay UE and is used for the manipulation of PDU sessions:

- remote UE report.

A successful transaction related procedure initiated by the UE triggers the network to execute one of the following procedures related to PDU session; network-requested PDU session modification procedure or network-requested PDU session release procedure. The UE treats the start of the procedure related to the PDU session as completion of the transaction related procedure.

c) Common procedure:

The following 5GSM procedure can be related to a PDU session or to a procedure transaction:

5GSM status procedure.

6.1.3 5GSM sublayer states

6.1.3.1 General

In the following subclauses, the possible states of a PDU session in the UE and the network side are described.

6.1.3.2 5GSM sublayer states in the UE

6.1.3.2.1 Overview

In the following subclauses, the possible 5GSM sublayer states of the UE are described and shown in figure 6.1.3.2.1.1.

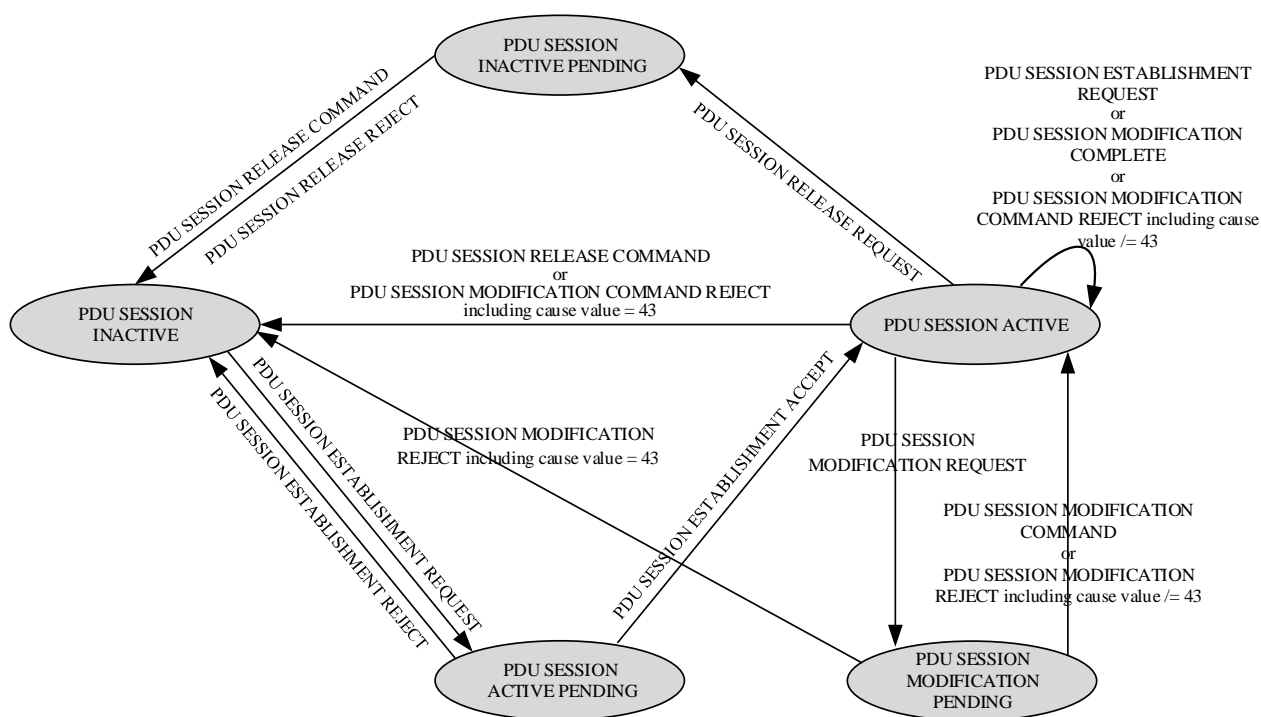

NOTE 1: Not all possible transitions are shown in this figure.

NOTE 2: Some transitions shown in this figure are not applicable to the MA PDU session.

Figure 6.1.3.2.1.1: The 5GSM sublayer states for PDU session handling in the UE (overview)

6.1.3.2.2 PDU SESSION INACTIVE

No PDU session exists.

6.1.3.2.3 PDU SESSION ACTIVE PENDING

The UE has initiated a PDU session establishment procedure towards the network and is waiting for a response from the network.

6.1.3.2.4 PDU SESSION ACTIVE

The PDU session is active in the UE.

6.1.3.2.5 PDU SESSION INACTIVE PENDING

The UE has initiated a PDU session release procedure towards the network and is waiting for a response from the network.

6.1.3.2.6 PDU SESSION MODIFICATION PENDING

The UE has initiated a PDU session modification procedure towards the network and is waiting for a response from the network.

6.1.3.2.7 PROCEDURE TRANSACTION INACTIVE

No procedure transaction exists.

6.1.3.2.8 PROCEDURE TRANSACTION PENDING

The UE has initiated a procedure transaction towards the network.

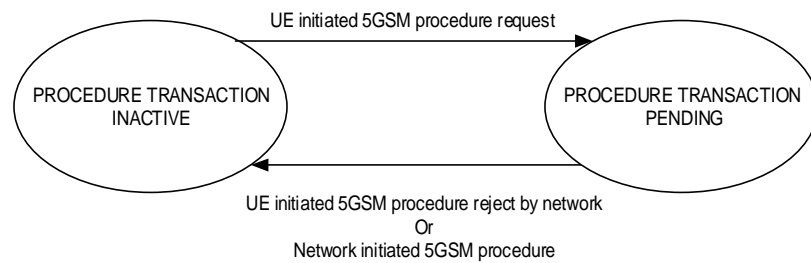
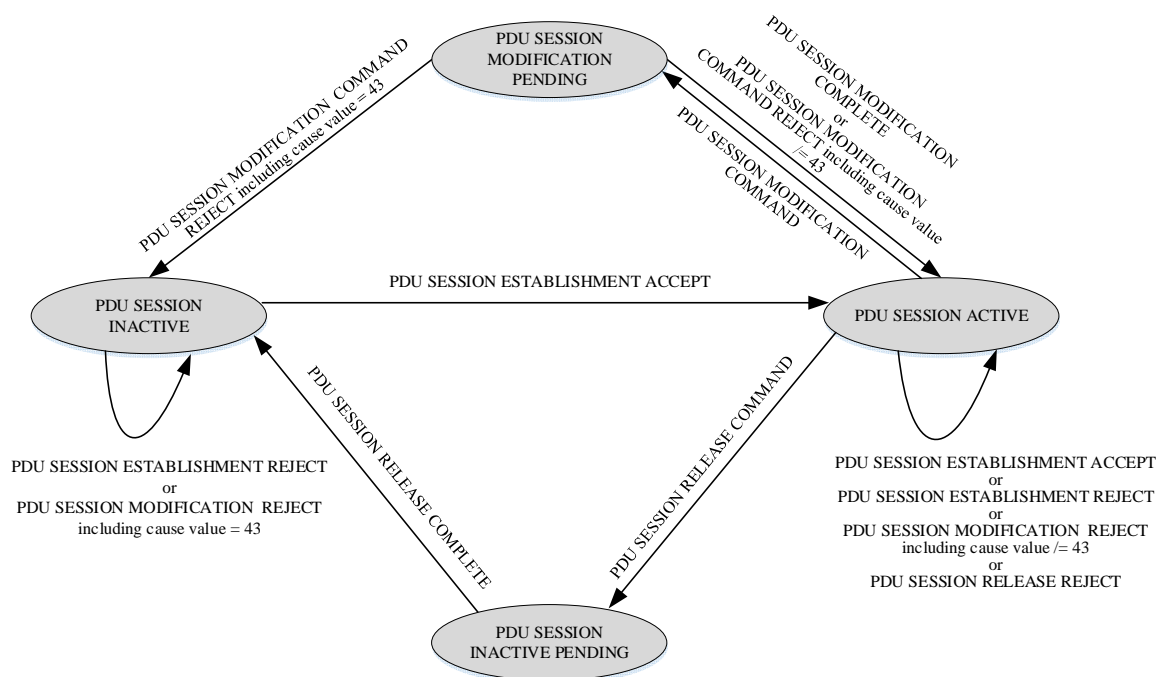

Figure 6.1.3.2.8.1: The procedure transaction states in the UE (overview)

6.1.3.3 5GSM sublayer states in the network side

6.1.3.3.1 Overview

In the following subclauses, the possible 5GSM sublayer states of the network are described and shown in Figure 6.1.3.3.1.1.



NOTE 1: Not all possible transitions are shown in this figure.

NOTE 2: Some transitions shown in this figure are not applicable to the MA PDU session.

Figure 6.1.3.3.1.1: The 5GSM sublayer states for PDU session handling in the network (overview)

6.1.3.3.2 PDU SESSION INACTIVE

No PDU session exists.

6.1.3.3.3 PDU SESSION ACTIVE

The PDU session is active in the network.

6.1.3.3.4 PDU SESSION INACTIVE PENDING

The network has initiated a PDU session release procedure towards the UE and is waiting for a response from the UE.

6.1.3.3.5 PDU SESSION MODIFICATION PENDING

The network has initiated a PDU session modification procedure towards the UE and is waiting for a response from the UE.

6.1.3.3.6 PROCEDURE TRANSACTION INACTIVE

No procedure transaction exists.

6.1.3.3.7 PROCEDURE TRANSACTION PENDING

The network has initiated a procedure transaction towards the UE.

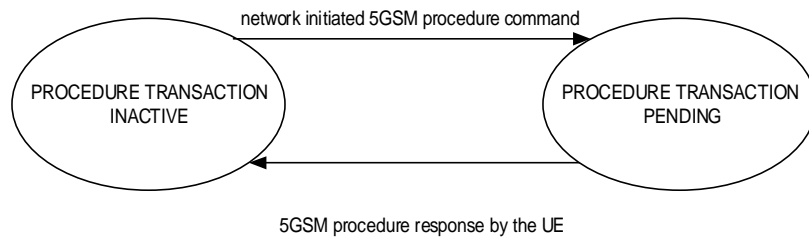

Figure 6.1.3.3.7.1: The procedure transaction states in the network (overview)

6.1.4 Coordination between 5GSM and ESM

6.1.4.1 Coordination between 5GSM and ESM with N26 interface

Interworking with EPS is supported for a PDU session, if the PDU session includes the mapped EPS bearer context(s) or has association(s) between QoS flow and mapped EPS bearer after inter-system change from S1 mode to N1 mode. The SMF shall not include any mapped EPS bearer contexts associated with a PDU session for LADN, with a PDU session which is a multi-homed IPv6 PDU session, and with a PDU session with the selected SSC mode set to "SSC mode 2" or "SSC mode 3". If the UE receives any mapped EPS bearer context for a PDU session for LADN, for a multi-homed IPv6 PDU session, or for a PDU session with the selected SSC mode set to "SSC mode 2" or "SSC mode 3", the UE may locally delete the mapped EPS bearer context. See coding of the Mapped EPS bearer contexts IE in subclause 9.11.4.8. In an MA PDU session, the UE shall have one set of the mapped EPS bearer contexts. The network can provide the set of the mapped EPS bearer contexts of the MA PDU session via either access of the MA PDU session. In an MA PDU session, the UE shall support modification or deletion via an access of a mapped EPS bearer context of the MA PDU session created via the same or the other access.

Upon inter-system change from N1 mode to S1 mode, the UE shall create the default EPS bearer context and the dedicated EPS bearer context(s) based on the parameters of the mapped EPS bearer contexts or the associations between QoS flow and mapped EPS bearer in the PDU session, if available. The EPS bearer identity assigned for the QoS flow of the default QoS rule becomes the EPS bearer identity of the default bearer in the corresponding PDN connection. If there is no EPS bearer identity assigned to the QoS flow of the default QoS rule of a PDU session associated with 3GPP access, or if there is no corresponding mapped EPS bearer contexts associated with the EPS bearer identity assigned to the QoS flow of the default QoS rule of a PDU session associated with 3GPP access:

- a) the PDU session is not an MA PDU session established over both 3GPP access and non-3GPP access, the UE shall perform a local release of the PDU session; or
- b) the PDU session is an MA PDU session established over both 3GPP access and non-3GPP access, the UE shall perform a local release of the PDU session over 3GPP access and consider that the MA PDU session is established over non-3GPP access only.

If there is no EPS bearer identity assigned to the QoS flow(s) of a PDU session associated with 3GPP access which is not associated with the default QoS rule, or if there is no corresponding mapped EPS bearer contexts associated with the EPS bearer identity assigned to the QoS flow of the non-default QoS rule of a PDU session associated with 3GPP access, unless the PDU session is an MA PDU session established over 3GPP access and over non-3GPP access, the UE shall locally delete the QoS rules and the QoS flow description(s). The UE uses the parameters from each PDU session for which interworking with EPS is supported to create corresponding default EPS bearer context and optionally dedicated EPS bearer context(s) as follows:

- a) the PDN type of the PDU session shall be mapped to the PDN type of the default EPS bearer context as follows:
 - 1) the PDN type shall be set to "non-IP" if the PDU session type is "Unstructured";
 - 2) the PDN type shall be set to "IPv4" if the PDU session type is "IPv4";
 - 3) the PDN type shall be set to "IPv6" if the PDU session type is "IPv6";
 - 4) the PDN type shall be set to "IPv4v6" if the PDU session type is "IPv4v6";

- 5) the PDN type shall be set to "non-IP" if the PDU session type is "Ethernet", and the UE, the network or both of them do not support Ethernet PDN type in S1 mode; and
 - 6) the PDN type shall be set to "Ethernet" if the PDU session type is "Ethernet" and the UE and the network support Ethernet PDN type in S1 mode;
- b) the PDU address of the PDU session shall be mapped to the PDN address of the default EPS bearer context as follows:
- 1) the PDN address of the default EPS bearer context is set to the PDU address of the PDU session, if the PDU session type is "IPv4", "IPv6" or "IPv4v6"; and
 - 2) the PDN address of the default EPS bearer context is set to zero, if the PDU session type is "Ethernet" or "Unstructured";
- c) the DNN of the PDU session shall be mapped to the APN of the default EPS bearer context, unless the PDU session is an emergency PDU session;
- d) the APN-AMBR and extended APN-AMBR received in the parameters of the default EPS bearer context of the mapped EPS bearer contexts shall be mapped to the APN-AMBR and extended APN-AMBR of the default EPS bearer context;
- e) for each PDU session in state PDU SESSION ACTIVE, PDU SESSION MODIFICATION PENDING or PDU SESSION INACTIVE PENDING:
- 1) if the UE is performing an inter-system change from N1 mode to WB-S1 mode, the UE shall set the state of the mapped EPS bearer context(s) to BEARER CONTEXT ACTIVE; or
 - 2) if the UE is performing an inter-system change from N1 mode to NB-S1 mode, for the mapped EPS bearer context corresponding to the default EPS bearer, the UE shall set the state of the mapped EPS bearer context to BEARER CONTEXT ACTIVE. Additionally, if the UE is performing an inter-system change from WB-N1 mode to NB-S1 mode, for the mapped EPS bearer context corresponding to a dedicated EPS bearer, if any, the UE shall set the state of the mapped EPS bearer context to BEARER CONTEXT INACTIVE; and
- f) for any other PDU session the UE shall set the state of the mapped EPS bearer context(s) to BEARER CONTEXT INACTIVE.

Additionally, for each mapped EPS bearer context or the association between QoS flow and mapped EPS bearer in the PDU session:

- a) the EPS bearer identity shall be set to the EPS bearer identity received in the mapped EPS bearer context, or the EPS bearer identity associated with the QoS flow;
- b) the EPS QoS parameters shall be set to the mapped EPS QoS parameters of the EPS bearer received in the mapped EPS bearer context, or the EPS QoS parameters associated with the QoS flow;
- c) the extended EPS QoS parameters shall be set to the mapped extended EPS QoS parameters of the EPS bearer received in the mapped EPS bearer context, or the extended EPS QoS parameters associated with the QoS flow; and
- d) the traffic flow template shall be set to the mapped traffic flow template of the EPS bearer received in the mapped EPS bearer context, or the stored traffic flow template associated with the QoS flow, if available.

After inter-system change from N1 mode to S1 mode, the UE shall associate the PDU session identity, the S-NSSAI, and the session-AMBR with the default EPS bearer context, and for each EPS bearer context mapped from one or more QoS flows, associate the QoS rule(s) for the QoS flow(s) and the QoS flow description(s) for the QoS flow(s) with the EPS bearer context.

If the PDU session is associated with the control plane only indication and supports interworking with EPS, after inter-system change from N1 mode to S1 mode, the UE shall associate the EPS bearer context(s) of the PDN connection corresponding to the PDU session with the control plane only indication.

If the PDU session is associated with a PDU session pair ID, after inter-system change from N1 mode to S1 mode, the UE shall associate the default EPS bearer context of the PDN connection corresponding to the PDU session with the PDU session pair ID. If the PDU session is associated with an RSN, after inter-system change from N1 mode to S1

mode, the UE shall associate the default EPS bearer context of the PDN connection corresponding to the PDU session with the RSN.

After inter-system change from N1 mode to S1 mode, if:

- a) the UE sent the URSP provisioning in EPS support indicator and received the URSP provisioning in EPS support indicator in the PDU session; or
- b) the PDU session is associated with the URSP provisioning in EPS support indicators;

the UE shall associate the default EPS bearer context of the PDN connection corresponding to the PDU session with the URSP provisioning in EPS support indicators.

After inter-system change from N1 mode to S1 mode, the UE and the SMF shall maintain the PDU session type of the PDU session until the PDN connection corresponding to the PDU session is released if the UE supports non-IP PDN type and the PDU session type is "Ethernet" or "Unstructured".

After inter-system change from N1 mode to S1 mode, the UE and the SMF shall maintain the following 5GSM attributions and capabilities associated with the PDU session until the PDN connection corresponding to the PDU session is released:

- a) the always-on PDU session indication;
- b) the maximum number of supported packet filters;
- c) the support of reflective QoS;
- d) the maximum data rate per UE for user-plane integrity protection supported by the UE for uplink and the maximum data rate per UE for user-plane integrity protection supported by the UE for downlink;
- e) the support of multi-homed IPv6 PDU session; and
- f) if the PDU session is an MA PDU session established over 3GPP access, the PDN connection of the default EPS bearer corresponding to the MA PDU session shall be considered as a user-plane resource of the MA PDU session.

After inter-system change from N1 mode to S1 mode, the UE operating in single-registration mode in a network supporting N26 interface shall deem that the following features are supported by the network on the PDN connection corresponding to the PDU session:

- a) PS data off; and
- b) Local address in TFT.

If there is a QoS flow used for IMS signalling, after inter-system change from N1 mode to S1 mode, the EPS bearer associated with the QoS flow for IMS signalling becomes the EPS bearer for IMS signalling.

When the UE is provided with a new session-AMBR in the Protocol configuration options IE or Extended protocol configuration options IE in the MODIFY EPS BEARER CONTEXT REQUEST message, the UE shall discard the corresponding association and associate the new value with the default EPS bearer context.

The network may provide the UE with one or more QoS rules by including either one QoS rules parameter, or one QoS rules with the length of two octets parameter, but not both, in the Protocol configuration options IE or Extended protocol configuration options IE in the MODIFY EPS BEARER CONTEXT REQUEST message. The network may provide the UE with one or more QoS flow descriptions corresponding to the EPS bearer context being modified, by including either one QoS flow descriptions parameter, or one QoS flow descriptions with the length of two octets parameter, but not both, in the Protocol configuration options IE or Extended protocol configuration options IE in the MODIFY EPS BEARER CONTEXT REQUEST message.

When the UE is provided with one or more QoS flow descriptions or the EPS bearer identity of an existing QoS flow description is modified in the Protocol configuration options IE or Extended protocol configuration options IE in the MODIFY EPS BEARER CONTEXT REQUEST message, the UE shall check the EPS bearer identity included in the QoS flow description; and:

- a) if the EPS bearer identity corresponds to the EPS bearer context being modified or the EPS bearer identity is not included, the UE shall store the QoS flow description and all the associated QoS rules, if any, for the EPS bearer context being modified for use during inter-system change from S1 mode to N1 mode; and
- b) otherwise the UE shall locally delete the QoS flow description and all the associated QoS rules, if any, and include a Protocol configuration options IE or Extended protocol configuration options IE with a 5GSM cause parameter set to 5GSM cause #84 "syntactical error in the QoS operation" in the MODIFY EPS BEARER CONTEXT ACCEPT message.

When the UE is provided with one or more QoS rules, or one or more QoS flow descriptions in the Protocol configuration options IE or Extended protocol configuration options IE in the MODIFY EPS BEARER CONTEXT REQUEST message, the UE shall process the QoS rules sequentially starting with the first QoS rule and shall process the QoS flow descriptions sequentially starting with the first QoS flow description. The UE shall check the QoS rules and QoS flow descriptions for different types of errors as follows:

NOTE 1: If an error is detected in a QoS rule or a QoS flow description which requires sending a Protocol configuration options IE or Extended protocol configuration options IE with a 5GSM cause value, then the QoS rules parameter, the QoS rules with the length of two octets parameter, the QoS flow descriptions parameter and the QoS flow descriptions with the length of two octets parameter included in the Protocol configuration options IE or Extended protocol configuration options IE in the MODIFY EPS BEARER CONTEXT REQUEST message are discarded, if any.

NOTE 2: If the EPS bearer context modification procedure is rejected, then the QoS rules parameter, the QoS rules with the length of two octets parameter, the QoS flow descriptions parameter and the QoS flow descriptions with the length of two octets parameter included in the Protocol configuration options IE or Extended protocol configuration options IE in the MODIFY EPS BEARER CONTEXT REQUEST message are discarded, if any.

a) Semantic errors in QoS operations:

- 1) When the rule operation is "Modify existing QoS rule and add packet filters", "Modify existing QoS rule and replace all packet filters", "Modify existing QoS rule and delete packet filters" or "Modify existing QoS rule without modifying packet filters" on the default QoS rule and the DQR bit is set to "the QoS rule is not the default QoS rule".
- 2) When the rule operation is "Modify existing QoS rule and add packet filters", "Modify existing QoS rule and replace all packet filters", "Modify existing QoS rule and delete packet filters" or "Modify existing QoS rule without modifying packet filters" on a QoS rule which is not the default QoS rule and the DQR bit is set to "the QoS rule is the default QoS rule".
- 3) When the rule operation is "Create new QoS rule" and the DQR bit is set to "the QoS rule is the default QoS rule" when there's already a default QoS rule with different QoS rule identifier.
- 4) When the rule operation is "Delete existing QoS rule" on the default QoS rule.
- 5) When the rule operation is "Create new QoS rule", "Modify existing QoS rule and add packet filters", "Modify existing QoS rule and replace all packet filters", "Modify existing QoS rule and delete packet filters", or "Modify existing QoS rule without modifying packet filters" and two or more QoS rules associated with this PDU session would have identical precedence values.
- 6) When the rule operation is "Modify existing QoS rule and delete packet filters", the QoS rule is a QoS rule of a PDU session of IPv4, IPv6, IPv4v6 or Ethernet PDU session type, and the packet filter list in the resultant QoS rule is empty.
- 7) When the rule operation is "Create new QoS rule", and there is already an existing QoS rule with the same QoS rule identifier and the existing QoS rule is associated with a QoS flow description stored for the EPS bearer context being modified or the existing QoS rule is not associated with any QoS flow description.
- 8) When the rule operation is "Modify existing QoS rule and add packet filters", "Modify existing QoS rule and replace all packet filters", "Modify existing QoS rule and delete packet filters", or "Modify existing QoS rule without modifying packet filters" and there is no existing QoS rule with the same QoS rule identifier associated with a QoS flow description stored for the EPS bearer context being modified.
- 9) When the rule operation is "Delete existing QoS rule" and there is no existing QoS rule with the same QoS rule identifier associated with a QoS flow description stored for the EPS bearer context being modified.

- 10) When the flow description operation is "Create new QoS flow description" and there is already an existing QoS flow description with the same QoS flow identifier stored for the EPS bearer context being modified.
- 11) When the flow description operation is "Modify existing QoS flow description" and there is no existing QoS flow description with the same QoS flow identifier stored for the EPS bearer context being modified.
- 12) When the flow description operation is "Delete existing QoS flow description" and there is no existing QoS flow description with the same QoS flow identifier stored for the EPS bearer context being modified.
- 13) When the UE determines that:
 - i) the default EPS bearer context is associated with one or more QoS flows but the default EPS bearer context is not associated with the default QoS rule.
 - ii) a dedicated EPS bearer context is associated with one or more QoS flows but the dedicated EPS bearer context is associated with the default QoS rule.
- 14) When the rule operation is "Create new QoS rule" and there is already an existing QoS rule with the same QoS rule identifier associated with a QoS flow description stored for an EPS bearer context different from the EPS bearer context being modified and belonging to the same PDN connection as the EPS bearer context being modified.
- 15) When the flow description operation is "Create new QoS flow description", and there is already an existing QoS flow description with the same QoS flow identifier stored for an EPS bearer context different from the EPS bearer context being modified and belonging to the same PDN connection as the EPS bearer context being modified.
- 16) When the rule operation is "Create new QoS rule", "Modify existing QoS rule and add packet filters", "Modify existing QoS rule and replace all packet filters", "Modify existing QoS rule and delete packet filters", or "Modify existing QoS rule without modifying packet filters" and the resultant QoS rule is associated with a QoS flow description stored for an EPS bearer context different from the EPS bearer context being modified.
- 17) When the rule operation is "Create new QoS rule", the DQR bit is set to "the QoS rule is not the default QoS rule", the QoS rule is provided for a PDN connection of PDN type "non-IP" and there is locally available information associated with the PDN connection that is set to "Unstructured".
- 18) When the flow description operation is "Create new QoS flow description" or "Modify existing QoS flow description", the QFI associated with the QoS flow description is not the same as the QFI of the default QoS rule, the QoS flow description is provided for a PDN connection of PDN type "non-IP" and there is locally available information associated with the PDN connection that is set to "Unstructured".
- 19) When the rule operation is "Modify existing QoS rule and add packet filters", the "packet filter list" field contains a match-all packet filter, the resultant QoS rule is the default QoS rule and there is already an existing match-all packet filter associated with the default QoS rule.
- 20) When the rule operation is "Create new QoS rule" and the DQR bit is set to "the QoS rule is not the default QoS rule", or the rule operation is "Modify existing QoS rule and add packet filters" on a QoS rule which is not the default QoS rule or "Modify existing QoS rule and replace all packet filters" on a QoS rule which is not the default QoS rule, and one match-all packet filter is to be associated with the resultant QoS rule.

In case 5, if the old QoS rule (i.e. the QoS rule that existed before the MODIFY EPS BEARER CONTEXT REQUEST message was received) is not the default QoS rule and the old QoS rule is associated with a QoS flow description stored for the EPS bearer context being modified, the UE shall not diagnose an error, shall further process the new request and, if it was processed successfully, shall delete the old QoS rule which has identical precedence value. Otherwise, the UE shall include a Protocol configuration options IE or Extended protocol configuration options IE with a 5GSM cause parameter set to 5GSM cause #83 "semantic error in the QoS operation" in the MODIFY EPS BEARER CONTEXT ACCEPT message.

In case 6, if the QoS rule is not the default QoS rule, the UE shall delete the QoS rule. If the QoS rule is the default QoS rule, the UE shall include a Protocol configuration options IE or Extended protocol configuration options IE with a 5GSM cause parameter set to 5GSM cause #83 "semantic error in the QoS operation" in the MODIFY EPS BEARER CONTEXT ACCEPT message.

In case 7, if the existing QoS rule is not the default QoS rule and the DQR bit of the new QoS rule is set to "the QoS rule is not the default QoS rule", the UE shall not diagnose an error, further process the create request and, if it was processed successfully, delete the old QoS rule (i.e. the QoS rule that existed when case 7 was detected). If the existing QoS rule is the default QoS rule or the DQR bit of the new QoS rule is set to "the QoS rule is the default QoS rule", the UE shall include a Protocol configuration options IE or Extended protocol configuration options IE with a 5GSM cause parameter set to 5GSM cause #83 "semantic error in the QoS operation" in the MODIFY EPS BEARER CONTEXT ACCEPT message.

In case 9, the UE shall not diagnose an error, further process the delete request and, if it was processed successfully, consider the respective QoS rule as successfully deleted.

In case 10, the UE shall not diagnose an error, further process the create request and, if it was processed successfully, delete the old QoS flow description (i.e. the QoS flow description that existed when case 10 was detected).

In case 12, the UE shall not diagnose an error, further process the delete request and, if it was processed successfully, consider the respective QoS flow description as successfully deleted.

Otherwise, the UE shall include a Protocol configuration options IE or Extended protocol configuration options IE with a 5GSM cause parameter set to 5GSM cause #83 "semantic error in the QoS operation" in the MODIFY EPS BEARER CONTEXT ACCEPT message.

b) Syntactical errors in QoS operations:

- 1) When the rule operation is "Create new QoS rule", "Modify existing QoS rule and add packet filters", "Modify existing QoS rule and replace all packet filters" or "Modify existing QoS rule and delete packet filters", the packet filter list in the QoS rule is empty, and the QoS rule is provided for a PDN connection of PDN type IPv4, IPv6, IPv4v6 or Ethernet, or for a PDN connection of PDN type "non-IP" and there is locally available information associated with the PDN connection that is set to "Ethernet".
- 2) When the rule operation is "Delete existing QoS rule" or "Modify existing QoS rule without modifying packet filters" with a non-empty packet filter list in the QoS rule.
- 3) When the rule operation is "Modify existing QoS rule and delete packet filters" and the packet filter to be deleted does not exist in the original QoS rule.
- 4) Void.
- 5) When there are other types of syntactical errors in the coding of the QoS rules parameter, the QoS rules with the length of two octets parameter, the QoS flow descriptions parameter or the QoS flow descriptions with the length of two octets parameter, such as a mismatch between the number of packet filters subfield, and the number of packet filters in the packet filter list when the rule operation is "delete existing QoS rule" or "create new QoS rule", or the number of packet filters subfield is larger than the maximum possible number of packet filters in the packet filter list (i.e., there is no QoS rule precedence subfield included in the QoS rule IE), the QoS Rule Identifier is set to "no QoS rule identifier assigned" when the rule operation is not "delete existing QoS rule", or the QoS flow identifier is set to "no QoS flow identifier assigned" when the flow description operation is not "Delete existing QoS flow description".
- 6) When, the
 - A) rule operation is "Create new QoS rule", "Modify existing QoS rule and add packet filters", "Modify existing QoS rule and replace all packet filters", "Modify existing QoS rule and delete packet filters" or "Modify existing QoS rule without modifying packet filters", the UE determines, by using the QoS rule's QFI as the 5QI, that there is a resulting QoS rule for a GBR QoS flow (as described in 3GPP TS 23.501 [8] table 5.7.4-1), and there is no QoS flow description with a QFI corresponding to the QFI of the resulting QoS rule.
 - B) flow description operation is "Delete existing QoS flow description", and the UE determines, by using the QoS rule's QFI as the 5QI, that there is a resulting QoS rule for a GBR QoS flow (as described in 3GPP TS 23.501 [8] table 5.7.4-1) with a QFI corresponding to the QFI of the QoS flow description that is deleted (i.e. there is no associated QoS flow description with the same QFI).
- 7) When the flow description operation is "Create new QoS flow description" or "Modify existing QoS flow description", and the UE determines that there is a QoS flow description of a GBR QoS flow (as described in 3GPP TS 23.501 [8] table 5.7.4-1) which lacks at least one of the mandatory parameters (i.e., GFBR uplink,

GFBR downlink, MFBR uplink and MFBR downlink). If the QoS flow description does not include a 5QI, the UE determines this by using the QFI as the 5QI.

- 8) When the rule operation is "Create new QoS rule", "Modify existing QoS rule and add packet filters" or "Modify existing QoS rule and replace all packet filters" with a non-empty packet filter list in the QoS rule, and the DQR bit is set to "the QoS rule is the default QoS rule", the QoS rule is provided for a PDN connection of PDN type "non-IP" and there is locally available information associated with the PDN connection that is set to "Unstructured".

In case 3 the UE shall not diagnose an error, further process the deletion request and, if no error according to items c and d was detected, consider the respective packet filter as successfully deleted.

Otherwise the UE shall include a Protocol configuration options IE or Extended protocol configuration options IE with a 5GSM cause parameter set to 5GSM cause #84 "syntactical error in the QoS operation" in the MODIFY EPS BEARER CONTEXT ACCEPT message.

NOTE 3: It is not considered an error if the UE determines that after processing all QoS operations on QoS rules and QoS flow descriptions there is a QoS flow description that is not associated with any QoS rule and the UE is not in NB-N1 mode.

NOTE 3a: An implementation that strictly follows QoS rule operation as defined in subclause 9.11.4.13 might not detect case 2).

c) Semantic errors in packet filters:

- 1) When a packet filter consists of conflicting packet filter components which would render the packet filter ineffective, i.e. no IP packet will ever fit this packet filter. How the UE determines a semantic error in a packet filter is outside the scope of the present document.

The UE shall include a Protocol configuration options IE or Extended protocol configuration options IE with a 5GSM cause parameter set to 5GSM cause #44 "semantic errors in packet filter(s)" in the MODIFY EPS BEARER CONTEXT ACCEPT message.

d) Syntactical errors in packet filters:

- 1) When the rule operation is "Modify existing QoS rule and add packet filters" or "Modify existing QoS rule and replace all packet filters", and two or more packet filters in the resultant QoS rule would have identical packet filter identifiers.
- 2) When the rule operation is "Create new QoS rule", and two or more packet filters in the resultant QoS rule would have identical packet filter identifiers.
- 3) When there are other types of syntactical errors in the coding of packet filters, such as the use of a reserved value for a packet filter component identifier.
- 4) Void.

In case 1, if two or more packet filters with identical packet filter identifiers are contained in the MODIFY EPS BEARER CONTEXT REQUEST message, the UE shall include a Protocol configuration options IE or Extended protocol configuration options IE with a 5GSM cause parameter set to 5GSM cause #45 "syntactical error in packet filter(s)" in the MODIFY EPS BEARER CONTEXT ACCEPT message. Otherwise, the UE shall not diagnose an error, further process the MODIFY EPS BEARER CONTEXT REQUEST message and, if it was processed successfully, delete the old packet filters which have the identical packet filter identifiers.

Otherwise the UE shall include a Protocol configuration options IE or Extended protocol configuration options IE with a 5GSM cause parameter set to 5GSM cause #45 "syntactical error in packet filter(s)" in the MODIFY EPS BEARER CONTEXT ACCEPT message.

If the UE detects different errors in the QoS rules and QoS flow descriptions as described in this subclause which requires sending a 5GSM cause parameter in the MODIFY EPS BEARER CONTEXT ACCEPT message, the UE shall include a single 5GSM cause parameter in the MODIFY EPS BEARER CONTEXT ACCEPT message.

NOTE 4: The 5GSM cause to use cannot be different from #44 "semantic error in packet filter(s)", #45 "syntactical errors in packet filter(s)", #83 "semantic error in the QoS operation" or #84 "syntactical error in the QoS operation". The selection of a 5GSM cause is up to UE implementation.

Upon successful completion of an EPS attach procedure or tracking area updating procedure after inter-system change from N1 mode to S1 mode (see 3GPP TS 24.301 [15]), unless the PDU session is an MA PDU session established over 3GPP access and over non-3GPP access both connected to 5GCN,

- a) the UE shall delete any UE derived QoS rules of each PDU session which has been transferred to EPS;
- b) the UE and the SMF shall perform a local release of the PDU session(s) associated with 3GPP access which have not been transferred to EPS; and
- c) the UE and the SMF shall perform a local release of QoS flow(s) which have not been transferred to EPS, of the PDU session(s) which have been transferred to EPS. The UE and the SMF shall also perform a local release of any QoS flow description not associated with any QoS rule and not associated with any mapped EPS bearer context. If there is a QoS flow description not associated with any QoS rule, but associated with a mapped EPS bearer context, and after the inter-system change from N1 mode to S1 mode the respective EPS bearer context is active, then the UE shall associate the QoS flow description with the EPS bearer context.

For PDU session(s) associated with non-3GPP access in 5GS, if present, the UE may:

- a) keep some or all of these PDU sessions still associated with non-3GPP access in 5GS, if supported;
- b) release some or all of these PDU sessions explicitly by initiating the UE requested PDU session release procedure(s); or
- c) attempt to transfer some or all of these PDU sessions from N1 mode to S1 mode by initiating the UE requested PDN connectivity procedure(s) with the PDN CONNECTIVITY REQUEST message created as follows:
 - 1) if the PDU session is an emergency PDU session, the request type shall be set to "handover of emergency bearer services". Otherwise the request type shall be set to "handover";
 - 2) the PDU session type of the PDU session shall be mapped to the PDN type of the default EPS bearer context as follows:
 - i) the PDN type shall be set to "non-IP" if the PDU session type is "Unstructured";
 - ii) the PDN type shall be set to "IPv4" if the PDU session type is "IPv4";
 - iii) the PDN type shall be set to "IPv6" if the PDU session type is "IPv6";
 - iv) the PDN type shall be set to "IPv4v6" if the PDU session type is "IPv4v6";
 - v) the PDN type shall be set to "non-IP" if the PDU session type is "Ethernet" and the UE, the network or both of them do not support Ethernet PDN type in S1 mode; and
 - vi) the PDN type shall be set to "Ethernet" if the PDU session type is "Ethernet" and the UE and the network support Ethernet PDN type in S1 mode;
 - 3) the DNN of the PDU session shall be mapped to the APN of the default EPS bearer context, unless the PDN connection is an emergency PDN connection; and
 - 4) the PDU session ID parameter in the Protocol configuration options IE or the Extended protocol configuration options IE shall be set to the PDU session identity of the PDU session.

If a PDU session associated with non-3GPP access is transferred to EPS, the UE shall associate the PDU session identity with the default EPS bearer context and shall delete any UE derived QoS rules of such PDU session.

Interworking to 5GS is supported for a PDN connection, if the corresponding default EPS bearer context includes a PDU session identity, an S-NSSAI, if the PDN connection is a non-emergency PDN connection, session AMBR and one or more QoS flow descriptions received in the Protocol configuration options IE or Extended protocol configuration options IE (see 3GPP TS 24.301 [15]), or the default EPS bearer context has association with the PDU session identity, the S-NSSAI, if the PDU session is a non-emergency PDU session, the session-AMBR and one or more QoS flow descriptions after inter-system change from N1 mode to S1 mode.

For a PDN connection established in S1 mode, to enable the UE to attempt to transfer the PDN connection from S1 mode to N1 mode in case of inter-system change, the UE shall allocate a PDU session identity, indicate the allocated PDU session identity in the PDU session ID parameter in the Protocol configuration options IE of the PDN CONNECTIVITY REQUEST message and associate the allocated PDU session identity with the default EPS bearer

context of the PDN connection. If an N5CW device supporting 3GPP access establishes a new PDN connection in S1 mode, the N5CW device supporting 3GPP access shall refrain from allocating "PDU session identity value 15".

For a PDN connection established in S1 mode, the SMF assigning the QoS rules shall consider that the UE supports 16 packet filters for the corresponding PDU session until the UE indicates a higher number (as specified in subclause 6.4.2.2).

The network may provide the UE with one or more QoS rules by including either one QoS rules parameter, or one QoS rules with the length of two octets parameter, but not both, in the Protocol configuration options IE or Extended protocol configuration options IE in the ACTIVATE DEFAULT EPS BEARER CONTEXT REQUEST or ACTIVATE DEDICATED EPS BEARER CONTEXT REQUEST message. The network may provide the UE with one or more QoS flow descriptions corresponding to the EPS bearer context being activated, by including either one QoS flow descriptions parameter, or one QoS flow descriptions with the length of two octets parameter, but not both, in the Protocol configuration options IE or Extended protocol configuration options IE in the ACTIVATE DEFAULT EPS BEARER CONTEXT REQUEST or ACTIVATE DEDICATED EPS BEARER CONTEXT REQUEST message.

When the UE is provided with one or more QoS flow descriptions in the Protocol configuration options IE or Extended protocol configuration options IE of the ACTIVATE DEFAULT EPS BEARER CONTEXT REQUEST or ACTIVATE DEDICATED EPS BEARER CONTEXT REQUEST message, the UE shall check the EPS bearer identity included in the QoS flow description; and:

- a) if the EPS bearer identity corresponds to the EPS bearer context being activated or the EPS bearer identity is not included, the UE shall store the QoS flow description and all the associated QoS rules, if any, for the EPS bearer context being activated for use during inter-system change from S1 mode to N1 mode; and
- b) otherwise the UE shall locally delete the QoS flow description and all the associated QoS rules, if any, and include a Protocol configuration options IE or Extended protocol configuration options IE with a 5GSM cause parameter set to 5GSM cause #84 "syntactical error in the QoS operation" in the ACTIVATE DEFAULT EPS BEARER CONTEXT ACCEPT or ACTIVATE DEDICATED EPS BEARER CONTEXT ACCEPT message.

When the UE is provided with one or more QoS rules, or one or more QoS flow descriptions in the Protocol configuration options IE or Extended protocol configuration options IE of the ACTIVATE DEFAULT EPS BEARER CONTEXT REQUEST or ACTIVATE DEDICATED EPS BEARER CONTEXT REQUEST message, the UE shall process the QoS rules sequentially starting with the first QoS rule and shall process the QoS flow descriptions sequentially starting with the first QoS flow description. The UE shall check QoS rules and QoS flow descriptions for different types of errors as follows:

NOTE 5: If an error is detected in a QoS rule or a QoS flow description which requires sending a Protocol configuration options IE or Extended protocol configuration options IE with a 5GSM cause value, then the QoS rules parameter, the QoS rules with the length of two octets parameter, the QoS flow descriptions parameter and the QoS flow descriptions with the length of two octets parameter included in the Protocol configuration options IE or Extended protocol configuration options IE in the ACTIVATE DEFAULT EPS BEARER CONTEXT REQUEST or ACTIVATE DEDICATED EPS BEARER CONTEXT REQUEST message are discarded, if any.

NOTE 6: If the default EPS bearer context activation procedure or the dedicated EPS bearer context activation procedure is rejected, then the QoS rules parameter, the QoS rules with the length of two octets parameter, the QoS flow descriptions parameter and the QoS flow descriptions with the length of two octets parameter included in the Protocol configuration options IE or Extended protocol configuration options IE in the ACTIVATE DEFAULT EPS BEARER CONTEXT REQUEST or ACTIVATE DEDICATED EPS BEARER CONTEXT REQUEST message are discarded, if any.

a) Semantic errors in QoS operations:

- 1) When the rule operation is "Create new QoS rule" and the DQR bit is set to "the QoS rule is the default QoS rule" when there's already a default QoS rule.
- 2) When the rule operation is received in an ACTIVATE DEFAULT EPS BEARER CONTEXT REQUEST message, the rule operation is "Create new QoS rule", and there is no rule with the DQR bit set to "the QoS rule is the default QoS rule".
- 3) When the rule operation is "Create new QoS rule" and two or more QoS rules associated with this PDU session would have identical precedence values.

- 4) When the rule operation is an operation other than "Create new QoS rule".
- 5) When the flow description operation is an operation other than "Create new QoS flow description".
- 6) When the UE determines that:
 - i) the default EPS bearer context is associated with one or more QoS flows but the default EPS bearer context is not associated with the default QoS rules.
 - ii) a dedicated EPS bearer context is associated with one or more QoS flows but the dedicated EPS bearer context is associated with the default QoS rule.
- 7) When the flow description operation is received in an ACTIVATE DEDICATED EPS BEARER CONTEXT REQUEST message, the flow description operation is "Create new QoS flow description" and there is already an existing QoS flow description with the same QoS flow identifier stored for an EPS bearer context different from the EPS bearer context being activated and belonging to the same PDN connection as the EPS bearer context being activated.
- 8) When the rule operation is received in an ACTIVATE DEDICATED EPS BEARER CONTEXT REQUEST message, the rule operation is "Create new QoS rule" and there is already an existing QoS rule with the same QoS rule identifier stored for an EPS bearer context different from the EPS bearer context being activated and belonging to the same PDN connection as the EPS bearer context being activated.
- 9) When the rule operation is received in an ACTIVATE DEDICATED EPS BEARER CONTEXT REQUEST message, the rule operation is "Create new QoS rule" and the resultant QoS rule is associated with a QoS flow description stored for an EPS bearer context different from the EPS bearer context being activated and belonging to the same PDN connection as the EPS bearer context being activated.
- 10) When the rule operation is "Create new QoS rule" and the DQR bit is set to "the QoS rule is not the default QoS rule" and one match-all packet filter is to be associated with the QoS rule.
- 11) When the flow description operation is "Create new QoS flow description" and there is already an existing QoS flow description with the same QoS flow identifier stored for the EPS bearer context being activated.
- 12) When the rule operation is "Create new QoS rule", and there is already an existing QoS rule with the same QoS rule identifier and the existing QoS rule is associated with a QoS flow description stored for the EPS bearer context being activated or the existing QoS rule is not associated with any QoS flow description.

In case 4, if the rule operation is for a non-default QoS rule, the UE shall delete the QoS rule. If the QoS rule is the default QoS rule, the UE shall include a Protocol configuration options IE or Extended protocol configuration options IE with a 5GSM cause parameter set to 5GSM cause #83 "semantic error in the QoS operation" in the ACTIVATE DEFAULT EPS BEARER CONTEXT ACCEPT or ACTIVATE DEDICATED EPS BEARER CONTEXT ACCEPT message.

In case 11, the UE shall not diagnose an error, further process the create request and, if it was processed successfully, delete the old QoS flow description (i.e. the QoS flow description that existed when case 11 was detected).

In case 12, if the existing QoS rule is not the default QoS rule and the DQR bit of the new QoS rule is set to "the QoS rule is not the default QoS rule", the UE shall not diagnose an error, further process the create request and, if it was processed successfully, delete the old QoS rule (i.e. the QoS rule that existed when case 12 was detected). If the existing QoS rule is the default QoS rule or the DQR bit of the new QoS rule is set to "the QoS rule is the default QoS rule", the UE shall include a Protocol configuration options IE or Extended protocol configuration options IE with a 5GSM cause parameter set to 5GSM cause #83 "semantic error in the QoS operation" in the ACTIVATE DEFAULT EPS BEARER CONTEXT ACCEPT or ACTIVATE DEDICATED EPS BEARER CONTEXT ACCEPT message.

Otherwise for all the cases above, the UE shall include a Protocol configuration options IE or Extended protocol configuration options IE with a 5GSM cause parameter set to 5GSM cause #83 "semantic error in the QoS operation" in the ACTIVATE DEFAULT EPS BEARER CONTEXT ACCEPT or ACTIVATE DEDICATED EPS BEARER CONTEXT ACCEPT message.

- b) Syntactical errors in QoS operations:

- 1) When the rule operation is "Create new QoS rule", the packet filter list in the QoS rule is empty, and the QoS rule is provided for a PDN connection of PDN type IPv4, IPv6, IPv4v6 or Ethernet, or for a PDN connection of PDN type "non-IP" and there is locally available information associated with the PDN connection that is set to "Ethernet".
- 2) Void.
- 3) When there are other types of syntactical errors in the coding of the QoS rules parameter, the QoS rules with the length of two octets parameter, the QoS flow descriptions parameter or the QoS flow descriptions with the length of two octets parameter, such as a mismatch between the number of packet filters subfield, and the number of packet filters in the packet filter list when the rule operation is "delete existing QoS rule" or "create new QoS rule", or the number of packet filters subfield is larger than the maximum possible number of packet filters in the packet filter list (i.e., there is no QoS rule precedence subfield included in the QoS rule IE), the QoS Rule Identifier is set to "no QoS rule identifier assigned", or the QoS flow identifier is set to "no QoS flow identifier assigned".
- 4) When, the
 - A) rule operation is "Create new QoS rule", the UE determines, by using the QoS rule's QFI as the 5QI, that there is a resulting QoS rule for a GBR QoS flow (as described in 3GPP TS 23.501 [8] table 5.7.4-1), and there is no QoS flow description with a QFI corresponding to the QFI of the resulting QoS rule.
- 5) When the flow description operation is "Create new QoS flow description", and the UE determines that there is a QoS flow description of a GBR QoS flow (as described in 3GPP TS 23.501 [8] table 5.7.4-1) which lacks at least one of the mandatory parameters (i.e., GFBR uplink, GFBR downlink, MFBR uplink and MFBR downlink). If the QoS flow description does not include a 5QI, the UE determines this by using the QFI as the 5QI.

The UE shall include a Protocol configuration options IE or Extended protocol configuration options IE with a 5GSM cause parameter set to 5GSM cause #84 "syntactical error in the QoS operation" in the ACTIVATE DEFAULT EPS BEARER CONTEXT ACCEPT or ACTIVATE DEDICATED EPS BEARER CONTEXT ACCEPT message.

NOTE 7: It is not considered an error if the UE determines that after processing all QoS operations on QoS rules and QoS flow descriptions there is a QoS flow description that is not associated with any QoS rule and the UE is not in NB-N1 mode.

c) Semantic errors in packet filters:

- 1) When a packet filter consists of conflicting packet filter components which would render the packet filter ineffective, i.e. no IP packet will ever fit this packet filter. How the UE determines a semantic error in a packet filter is outside the scope of the present document.

The UE shall include a Protocol configuration options IE or Extended protocol configuration options IE with a 5GSM cause parameter set to 5GSM cause #44 "semantic errors in packet filter(s)" in the ACTIVATE DEFAULT EPS BEARER CONTEXT ACCEPT or ACTIVATE DEDICATED EPS BEARER CONTEXT ACCEPT message.

d) Syntactical errors in packet filters:

- 1) When the rule operation is "Create new QoS rule" and two or more packet filters in the resultant QoS rule would have identical packet filter identifiers.
- 2) When there are other types of syntactical errors in the coding of packet filters, such as the use of a reserved value for a packet filter component identifier.

The UE shall delete the QoS rule and include a Protocol configuration options IE or Extended protocol configuration options IE with a 5GSM cause parameter set to 5GSM cause #45 "syntactical error in packet filter(s)" in the ACTIVATE DEFAULT EPS BEARER CONTEXT ACCEPT or ACTIVATE DEDICATED EPS BEARER CONTEXT ACCEPT message.

If the UE detects different errors in the QoS rules and QoS flow descriptions as described in this subclause which requires sending a 5GSM cause parameter in the ACTIVATE DEFAULT EPS BEARER CONTEXT ACCEPT or ACTIVATE DEDICATED EPS BEARER CONTEXT ACCEPT message, the UE shall include a single 5GSM cause

parameter in the ACTIVATE DEFAULT EPS BEARER CONTEXT ACCEPT or ACTIVATE DEDICATED EPS BEARER CONTEXT ACCEPT message.

NOTE 8: The 5GSM cause to use cannot be different from #44 "semantic error in packet filter(s)", #45 "syntactical errors in packet filter(s)", #83 "semantic error in the QoS operation" or #84 "syntactical error in the QoS operation". The selection of a 5GSM cause is up to UE implementation.

Upon inter-system change from S1 mode to N1 mode, the UE uses the parameters from the default EPS bearer context of each PDN connection for which interworking to 5GS is supported to create a corresponding PDU session associated with 3GPP access as follows, unless the PDN connection is a user-plane resource of an MA PDU session:

- a) the PDN type of the default EPS bearer context shall be mapped to the PDU session type of the PDU session as follows:
 - 1) if the PDN type is "non-IP":
 - the PDU session type is set to the locally available information associated with the PDN connection (either "Ethernet" or "Unstructured"), if available; or
 - otherwise, the PDU session type is set to "Unstructured";
 - 2) if the PDN type is "IPv4" the PDU session type is set to "IPv4";
 - 3) if the PDN type is "IPv6", the PDU session type is set to "IPv6";
 - 4) if the PDN type is "IPv4v6", the PDU session type is set to "IPv4v6"; and
 - 5) if the PDN type is "Ethernet", the PDU session type is "Ethernet";
- b) the PDN address of the default EPS bearer context shall be mapped to PDU address of the PDU session, if the PDN type is "IPv4", "IPv6" or "IPv4v6";
- c) the APN of the default EPS bearer context shall be mapped to the DNN of the PDU session, unless the PDN connection is an emergency PDN connection;
- d) for each default EPS bearer context in state BEARER CONTEXT ACTIVE the UE shall set the state of the mapped PDU session to PDU SESSION ACTIVE; and
- e) for any other default EPS bearer context the UE shall set the state of the mapped PDU session to PDU SESSION INACTIVE.

Additionally, the UE shall set:

- a) the PDU session identity of the PDU session to the PDU session identity included by the UE in the Protocol configuration options IE or Extended protocol configuration options IE in the PDN CONNECTIVITY REQUEST message, or the PDU session identity associated with the default EPS bearer context;
- b) the S-NSSAI of the PDU session to the S-NSSAI included by the network in the Protocol configuration options IE or Extended protocol configuration options IE in the ACTIVATE DEFAULT EPS BEARER REQUEST message, or the S-NSSAI associated with the default EPS bearer context, if the PDN connection is a non-emergency PDN connection;
- c) the session-AMBR of the PDU session to the session-AMBR included by the network in the Protocol configuration options IE or Extended protocol configuration options IE in the ACTIVATE DEFAULT EPS BEARER REQUEST message or the MODIFY EPS BEARER CONTEXT REQUEST message, or the session-AMBR associated with the default EPS bearer context;
- d) the SSC mode of the PDU session to "SSC mode 1"; and
- e) the always-on PDU session indication to the always-on PDU session indication maintained in the UE, if any.

Upon inter-system change from S1 mode to N1 mode, the UE shall locally release the PDN connection(s) for which interworking to 5GS is not supported.

Upon inter-system change from S1 mode to N1 mode, for each PDN connection which is a user-plane resource of MA PDU session and for which interworking to 5GS is supported, the UE shall consider that the MA PDU session is

established over 3GPP access and, unless the MA PDU session is established over non-3GPP access too, the UE shall set the session-AMBR of the PDU session to the session-AMBR included by the network in the Protocol configuration options IE or Extended protocol configuration options IE in the ACTIVATE DEFAULT EPS BEARER REQUEST message or the MODIFY EPS BEARER CONTEXT REQUEST message, or the session-AMBR associated with the default EPS bearer context of the PDN connection.

Upon inter-system change from S1 mode to N1 mode, if:

- a) the UE sent the URSP provisioning in EPS support indicator and received the URSP provisioning in EPS support indicator in the PDN connection corresponding to the PDU session; or
- b) the default EPS bearer context of the PDN connection corresponding to the PDU session is associated with the URSP provisioning in EPS support indicators;

then the UE shall associate the PDU session with the URSP provisioning in EPS support indicators.

Additionally, for each EPS bearer context of the PDN connection, the UE shall create QoS flow(s) each of which is associated with the QoS flow description received in the Protocol configuration options IE or Extended protocol configuration options IE in the ACTIVATE DEFAULT EPS BEARER REQUEST message, ACTIVATE DEDICATED EPS BEARER REQUEST message, or MODIFY EPS BEARER REQUEST message (see 3GPP TS 24.301 [15]), or the QoS flow description associated with EPS bearer context, unless:

- a) the PDU session is an MA PDU session which:
 - 1) is established over non-3GPP access; and
 - 2) has a PDN connection as a user-plane resource; and
- b) the QoS flow already exists over the non-3GPP access.

Additionally, for each EPS bearer context of the PDN connection, the UE shall create QoS rules(s), if any, each of which is associated with the QoS rule received in the Protocol configuration options IE or Extended protocol configuration options IE in the ACTIVATE DEFAULT EPS BEARER REQUEST message, ACTIVATE DEDICATED EPS BEARER REQUEST message, or MODIFY EPS BEARER CONTEXT REQUEST message (see 3GPP TS 24.301 [15]), or the QoS rules associated with EPS bearer context, unless:

- a) the PDU session is an MA PDU session which:
 - 1) is established over non-3GPP access; and
 - 2) has a PDN connection as a user-plane resource; and
- b) the QoS rule already exists over the non-3GPP access.

NOTE 9: For a QoS rule which does not exist over non-3GPP access, the UE does not create the QoS rule if the QoS rule is the default QoS rule, or the precedence value of the QoS rule equals to the precedence value of a QoS rule exists over the non-3GPP access.

Additionally, for each PDU session which was created at inter-system change from S1 mode to N1 mode from a corresponding PDN connection of the "Ethernet" PDN type, the UE shall consider that Ethernet PDN type in S1 mode is supported by the network and the SMF shall consider that Ethernet PDN type in S1 mode is supported by the UE.

The UE and the network shall locally release the PDN connection(s) and EPS bearer context(s) associated with the 3GPP access which have not been transferred to 5GS.

After inter-system change from S1 mode to N1 mode, for each QoS flow mapped from an EPS bearer context the UE shall associate the EPS bearer identity, the EPS QoS parameters, the extended EPS QoS parameters, and the traffic flow template, if available, of the EPS bearer context with the QoS flow.

After inter-system change from S1 mode to N1 mode, for each QoS flow of an MA PDU session which:

- a) is established over non-3GPP access; and
- b) has a PDN connection as a user-plane resource;

such that the QoS flow was received in the Protocol configuration options IE or Extended protocol configuration options IE in the ACTIVATE DEFAULT EPS BEARER REQUEST message, ACTIVATE DEDICATED EPS BEARER REQUEST message, MODIFY EPS BEARER CONTEXT REQUEST message, (see 3GPP TS 24.301 [15]), or associated with EPS bearer context, the UE shall associate the EPS bearer identity, the EPS QoS parameters, the extended EPS QoS parameters, and the traffic flow template, if available, of the EPS bearer context with the QoS flow.

If the EPS bearer context(s) of the PDN connection are associated with the control plane only indication, and the PDN connection supports interworking to 5GS, after inter-system change from S1 mode to N1 mode, the UE shall associate the PDU session corresponding to the PDN connection with the control plane only indication.

If the default EPS bearer context of the PDN connection is associated with the PDU session pair ID, and the PDN connection supports interworking to 5GS, after inter-system change from S1 mode to N1 mode, the UE shall associate the PDU session corresponding to the PDN connection with the PDU session pair ID. If the default EPS bearer context of the PDN connection is associated with the RSN, and the PDN connection supports interworking to 5GS, after inter-system change from S1 mode to N1 mode, the UE shall associate the PDU session corresponding to the PDN connection with the RSN.

If there is an EPS bearer used for IMS signalling, after inter-system change from S1 mode to N1 mode, the QoS flow of the default QoS rule in the corresponding PDU session is used for IMS signalling.

For a PDN connection established when in S1 mode, upon an inter-system change from S1 mode to N1 mode, if a UE-requested PDU session modification procedure has not been successfully performed yet, the SMF shall determine the always-on PDU session indication as specified in subclause 6.3.2.2.

When the UE is provided with one or more mapped EPS bearer contexts in the Mapped EPS bearer contexts IE of the PDU SESSION MODIFICATION COMMAND message, the UE shall process the mapped EPS bearer contexts sequentially starting with the first mapped EPS bearer context.

When the UE is provided with a new EPS bearer identity, a new EPS QoS parameters, a new extended EPS QoS parameters, a new APN-AMBR or a new extended APN-AMBR in the Mapped EPS bearer context IE of the PDU SESSION MODIFICATION COMMAND message for a QoS flow, the UE shall discard the corresponding association(s) and associate the new value(s) with the QoS flow.

When the UE is provided with a new traffic flow template in the Mapped EPS bearer contexts IE of the PDU SESSION MODIFICATION COMMAND message for a QoS flow, the UE shall check the traffic flow template for different types of TFT IE errors as specified in subclause 6.3.2.3.

When a QoS flow is deleted, the associated EPS bearer context information that are mapped from the deleted QoS flow shall be deleted from the UE and the network if there is no other existing QoS flow associated with this EPS bearer context. When the EPS bearer identity of a QoS flow is deleted, the associated EPS bearer context information that are mapped from the deleted EPS bearer identity shall be deleted from the UE and the network if there is no other existing QoS flow associated with this EPS bearer context. When an EPS bearer is released, all the associated QoS flow descriptions and QoS rules that are mapped from the released EPS bearer shall be deleted from the UE and the network.

NOTE 10: If T3584 is running or deactivated for the S-NSSAI and optionally the DNN combination, the UE is allowed to initiate ESM procedures in EPS with or without APN corresponding to that DNN, and if the APN is congested in EPS, the MME can send a back-off timer for the APN to the UE as specified in 3GPP TS 24.301 [15].

Upon inter-system change from N1 mode to S1 mode, if the UE has any PDU sessions associated with one or more multicast MBS sessions, the UE shall locally leave the associated multicast MBS sessions and the network shall consider the UE as removed from the associated MBS sessions.

For the case of handover of an existing PDU session from 3GPP access to non-3GPP access,

- upon receipt of the PDU SESSION ESTABLISHMENT ACCEPT message, the UE locally deletes the EPS bearer identities for the PDU session, if any (see subclause 6.4.1.3); and
- after successful handover, the network shall locally delete the EPS bearer identities for the PDU session, if any.

6.1.4.2 Coordination between 5GSM and ESM without N26 interface

When the network does not support N26 interface, the SMF does not provide the UE with the mapped EPS bearer context for a PDU session.

NOTE 1: Since the SMF does not provide the UE with the mapped EPS bearer context for a PDU session, the UE does not know whether interworking with EPS is supported for a PDU session before attempting to transfer the PDU session from N1 mode to S1 mode.

NOTE 2: It is up to UE implementation to decide which PDU session(s) to be attempted to transfer from N1 mode to S1 mode, e.g. based on UE policy or UE local configuration.

Upon inter-system change from N1 mode to S1 mode in EMM-IDLE mode, the UE shall not transfer a PDU session for LADN to EPS.

Upon inter-system change from N1 mode to S1 mode in EMM-IDLE mode, the UE shall not transfer a multi-homed IPv6 PDU session to EPS.

Upon inter-system change from N1 mode to S1 mode in EMM-IDLE mode, the UE shall not transfer a PDU session with the selected SSC mode set to "SSC mode 2" or "SSC mode 3" to EPS.

Upon inter-system change from N1 mode to S1 mode in EMM-IDLE mode, the UE shall use the parameters from each PDU session which the UE intends to transfer to EPS to create the contents of a PDN CONNECTIVITY REQUEST message as follows:

- a) if the PDU session is an emergency PDU session, the request type shall be set to "handover of emergency bearer services". Otherwise the request type shall be set to "handover";
- b) the PDU session type of the PDU session shall be mapped to the PDN type of the default EPS bearer context as follows:
 - 1) the PDN type shall be set to "non-IP" if the PDU session type is "Unstructured";
 - 2) the PDN type shall be set to "IPv4" if the PDU session type is "IPv4";
 - 3) the PDN type shall be set to "IPv6" if the PDU session type is "IPv6";
 - 4) the PDN type shall be set to "IPv4v6" if the PDU session type is "IPv4v6";
 - 5) the PDN type shall be set to "non-IP" if the PDU session type is "Ethernet" and the UE, the network or both of them do not support Ethernet PDN type in S1 mode; and
 - 6) the PDN type shall be set to "Ethernet" if the PDU session type is "Ethernet" and the UE and the network support Ethernet PDN type in S1 mode;
- c) the DNN of the PDU session shall be mapped to the APN of the default EPS bearer context, unless the PDU session is an emergency PDU session;
- d) the PDU session ID parameter in the Protocol configuration options IE or Extended protocol configuration options IE shall be set to the PDU session identity of the PDU session; and
- e) if the PDU session is an MA PDU session established over 3GPP access, the ATSSS request parameter shall be included in the Protocol configuration options IE or Extended protocol configuration options IE.

After inter-system change from N1 mode to S1 mode, the UE shall associate the PDU session identity with the default EPS bearer context. If the PDU session being transferred is a non-emergency PDU session, the UE shall in addition associate the S-NSSAI and the PLMN ID of the current PLMN with the default EPS bearer context.

Upon successful completion of an EPS attach procedure after inter-system change from N1 mode to S1 mode (see 3GPP TS 24.301 [15]), the UE shall delete any UE derived QoS rules except when the PDU session is an MA PDU session established over 3GPP access and non-3GPP access both connected to the 5GCN.

The UE shall perform a local release of the PDU session(s) and QoS flow(s) associated with the 3GPP access which have not been transferred to EPS. The UE shall also perform a local release of any QoS flow description not associated with any QoS rule.

For PDU session(s) associated with non-3GPP access in 5GS, if present, the UE may:

- a) keep some or all of these PDU sessions still associated with non-3GPP access in 5GS, if supported;

- b) release some or all of these PDU sessions explicitly by initiating the UE requested PDU session release procedure(s); or
- c) attempt to transfer some or all of these PDU sessions from N1 mode to S1 mode by initiating the UE requested PDN connectivity procedure(s) with the PDN CONNECTIVITY REQUEST message created as above.

When the network does not support N26 interface, the MME does not provide the UE with the mapped PDU session for a PDN connection but provides the UE with an S-NSSAI if the PDN connection is not for emergency bearer services. When establishing a new PDN connection in S1 mode, to enable the UE to attempt to transfer the PDN connection from S1 mode to N1 mode in case of inter-system change, the UE shall allocate a PDU session identity, indicate the allocated PDU session identity in the PDU session ID parameter in the Protocol configuration options IE of the PDN CONNECTIVITY REQUEST message and associate the allocated PDU session identity with the default EPS bearer context of the PDN connection. If an N5CW device supporting 3GPP access establishes a new PDN connection in S1 mode, the N5CW device supporting 3GPP access shall refrain from allocating "PDU session identity value 15". The network provides the UE with an S-NSSAI and the related PLMN ID in the Protocol configuration options IE or Extended protocol configuration options IE of the ACTIVATE DEFAULT EPS BEARER REQUEST message, the UE shall delete the stored S-NSSAI and the related PLMN ID, if any, and shall store the S-NSSAI and the related PLMN ID provided in the ACTIVATE DEFAULT EPS BEARER CONTEXT REQUEST message.

NOTE 3: Since the MME does not provide the UE with the mapped PDU session for a PDN connection, the UE does not know whether interworking to 5GS is supported for a PDN connection for which the UE assigned a PDU Session identity before attempting to transfer the PDN connection from S1 mode to N1 mode.

NOTE 4: It is up to UE implementation to decide which PDN connection(s) to be attempted to transfer from S1 mode to N1 mode, e.g. based on UE policy or UE local configuration.

NOTE 5: If the PDN connection has been transferred from a PDN connection established via non-3GPP access to EPC, it is possible that the network provided the S-NSSAI already during the establishment via non-3GPP access (see 3GPP TS 24.302 [16]).

Upon inter-system change from S1 mode to N1 mode in 5GMM-IDLE mode, the UE uses the parameters from the default EPS bearer context of each PDN connection which the UE intends to transfer to 5GS and for which the UE has allocated a PDU session identity to create a PDU SESSION ESTABLISHMENT REQUEST message as follows:

- a) if the PDN connection is for emergency bearer services, the request type shall be set to "existing emergency PDU session". Otherwise the request type shall be set to:
 - 1) "MA PDU request", if the PDN connection to be transferred is a user-plane resource of an MA PDU session;
or
 - 2) "existing PDU session";
- b) the PDN type of the default EPS bearer context shall be mapped to the PDU session type of the PDU session as follows:
 - 1) if the PDN type is "non-IP":
 - the PDU session type is set to the locally available information associated with the PDN connection (either "Ethernet" or "Unstructured"), if available; or
 - otherwise, the PDU session type is set to "Unstructured";
 - 2) if the PDN type is "IPv4" the PDU session type is set to "IPv4";
 - 3) if the PDN type is "IPv6", the PDU session type is set to "IPv6";
 - 4) if the PDN type is "IPv4v6", the PDU session type is set to "IPv4v6"; and
 - 5) if the PDN type is "Ethernet", the PDU session type is set to "Ethernet"; and
- c) the APN of the default EPS bearer context shall be mapped to the DNN of the PDU session, unless the PDN connection is an emergency PDN connection;

- d) the PDU session ID shall be set to the PDU session identity included by the UE in the Protocol configuration options IE or Extended protocol configuration options IE in the PDN CONNECTIVITY REQUEST message, or to the PDU session ID associated with the default EPS bearer context;
- e) if the PDU session is not an emergency PDU session, the S-NSSAI of the PDU session shall be set to the S-NSSAI included by the network in the Protocol configuration options IE or Extended protocol configuration options IE in the ACTIVATE DEFAULT EPS BEARER REQUEST message, if provided by the network, or the S-NSSAI associated with the default EPS bearer context, if available; and
- f) the SSC mode IE shall be set to "SSC mode 1".

NOTE 6: If T3584 is running or deactivated for the S-NSSAI and optionally the DNN combination, the UE is allowed to initiate ESM procedures in EPS with or without APN corresponding to that DNN, and if the APN is congested in EPS, the MME can send a back-off timer for the APN to the UE as specified in 3GPP TS 24.301 [15].

The UE shall locally release the PDN connection(s) and EPS bearer(s) associated with the 3GPP access which have not been transferred to 5GS.

Upon inter-system change from N1 mode to S1 mode, if the UE has any PDU sessions associated with one or more MBS multicast sessions, the UE shall locally leave the associated multicast MBS sessions and the network shall consider the UE as removed from the associated multicast MBS sessions.

Upon inter-system change from S1 mode to N1 mode, for the PDN connection(s) in the EPS transferred to the 5GS, if the UE supports reporting of URSP rule enforcement and is indicated to send URSP rule enforcement report to the network based on the matching URSP rule newly enforced while the UE was in S1 mode, which contains the URSP rule enforcement report indication set to "URSP rule enforcement report is required", the UE shall include the URSP rule enforcement reports IE in the PDU SESSION ESTABLISHMENT REQUEST message.

6.1.4a Coordination between 5GSM and SM

Coordination between 5GSM and SM states is not required.

After the 5G-SRVCC handover from NG-RAN to UTRAN (see 3GPP TS 23.216 [6A]), all the PDU sessions of the UE are locally released at the UE and the network. If the UE has any PDU sessions associated with one or more MBS multicast sessions, the UE shall locally leave the associated MBS multicast sessions and the network shall consider the UE as removed from the associated MBS sessions.

6.1.5 Coordination for interworking with ePDG connected to EPC

When the UE establishes a new PDN connection via an ePDG connected to EPC, to enable the transfer of the PDN connection to N1 mode over 3GPP access in case of inter-system change, the UE allocates a PDU session identity and indicates its value in the PDU session ID field in the N1_MODE_CAPABILITY Notify payload of the IKE_AUTH request message (see 3GPP TS 24.302 [16]). The network provides the UE with an S-NSSAI in the N1_MODE_INFORMATION Notify payload of the IKE_AUTH response message (see 3GPP TS 24.302 [16]).

NOTE: Interworking between N1 mode over non-3GPP access and ePDG connected to EPC is not specified in this release of the specification.

Upon inter-system change to N1 mode over 3GPP access, for PDN connection(s) established via an ePDG connected to EPC, if present, the UE may:

- a) keep some or all of these PDN connections still via ePDG connected to EPC, if supported;
- b) release some or all of these PDN connections explicitly by initiating the UE initiated tunnel disconnection procedure(s) as specified in 3GPP TS 24.302 [16]; or
- c) attempt to transfer some or all of these PDN connections to N1 mode over 3GPP access using the parameters of the PDN connection for which the UE has allocated a PDU session identity by initiating the PDU session establishment procedure(s) with the PDU SESSION ESTABLISHMENT REQUEST message created. In that case, for each and every PDN connection to be transferred:

- 1) if the PDN connection is for emergency bearer services, the request type shall be set to "existing emergency PDU session". Otherwise the request type shall be set to "existing PDU session";
- 2) if the previously allocated home address information for a PDN connection consists of an IPv4 address only for an ePDG connected to EPC according to 3GPP TS 24.302 [16], the PDU session type shall be set to "IPv4";
- 3) if the previously allocated home address information for a PDN connection consists of an IPv6 prefix only for an ePDG connected to EPC according to 3GPP TS 24.302 [16], the PDU session type shall be set to "IPv6";
- 4) if the previously allocated home address information for a PDN connection consists of both an IPv4 address and an IPv6 prefix for an ePDG connected to EPC according to 3GPP TS 24.302 [16], the PDU session type shall be set to "IPv4v6";
- 5) the APN of the PDN connection shall be mapped to the DNN of the PDU session;
- 6) the PDU session ID shall be set to the PDU session identity in the N1_MODE_CAPABILITY Notify payload of the IKE_AUTH request message establishing IPsec tunnel of the PDN connection;
- 7) if the PDN connection is not for emergency bearer services, the S-NSSAI of the PDU session shall be set to the S-NSSAI associated with the PDN connection as specified in 3GPP TS 24.302 [16]. The UE shall not request to perform handover of an existing PDN connection to N1 mode over 3GPP access if the associated S-NSSAI is not included in the allowed NSSAI for 3GPP access; and
- 8) the SSC mode IE shall be set to "SSC mode 1".

If an existing PDU session is transferred from 3GPP access to an ePDG connected to EPC connection and that existing PDU session is associated with one or more MBS sessions, the UE shall locally leave the associated multicast MBS sessions and the SMF shall consider the UE as removed from the associated multicast MBS sessions.

Upon inter-system change to N1 mode, for the PDN connection(s) via an ePDG connected to EPC transferred to the 5GS, if the UE supports reporting of URSP rule enforcement and is indicated to send URSP rule enforcement report to the network based on the matching URSP rule newly enforced while the PDN connection is via an ePDG connected to EPC, which contains the URSP rule enforcement report indication set to "URSP rule enforcement report is required", the UE shall include the URSP rule enforcement reports IE in the PDU SESSION ESTABLISHMENT REQUEST message.

6.2 General on elementary 5GSM procedures

6.2.1 Principles of PTI handling for 5GSM procedures

When the UE or the network initiates a transaction related procedure (i.e. a procedure consisting of more than one message and the messages are related), it shall include a valid PTI value in the message header of the request message or of the command message.

If a response message is sent as result of a received request message or a received command message, the sending entity shall include in the response message the PTI value received within the request message or within the command message (see examples in figure 6.2.1.1, figure 6.2.1.2, and figure 6.2.1.3).

If a command message is sent as result of a received request message, the sending entity shall include in the command message the PTI value received with the request message (see examples in figure 6.2.1.3).

If a command message is not sent as result of a received request message, the sending entity shall include in the command message the PTI value set to "no procedure transaction identity assigned" (see examples in figure 6.2.1.4).

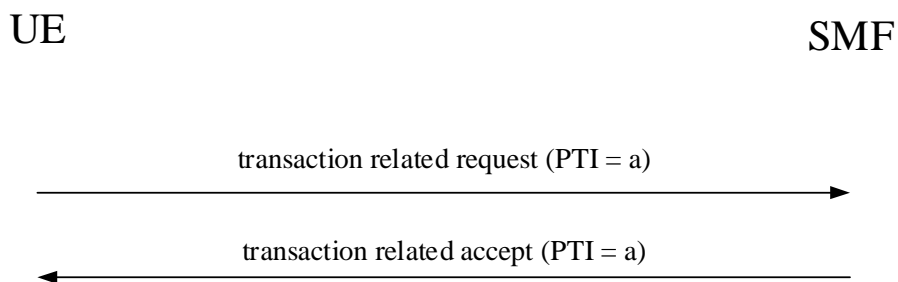

Figure 6.2.1.1: UE-requested transaction related procedure accepted by the network

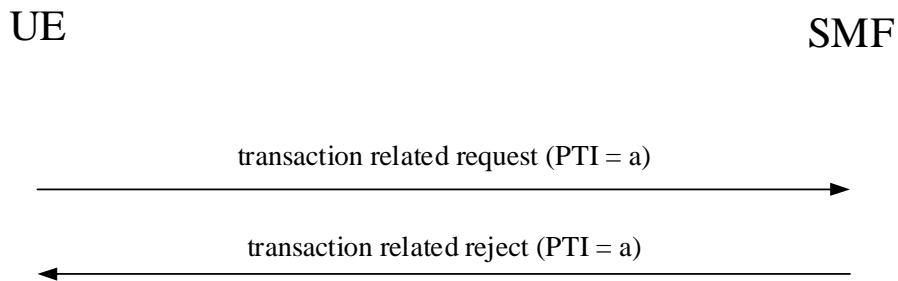

Figure 6.2.1.2: UE-requested transaction related procedure rejected by the network

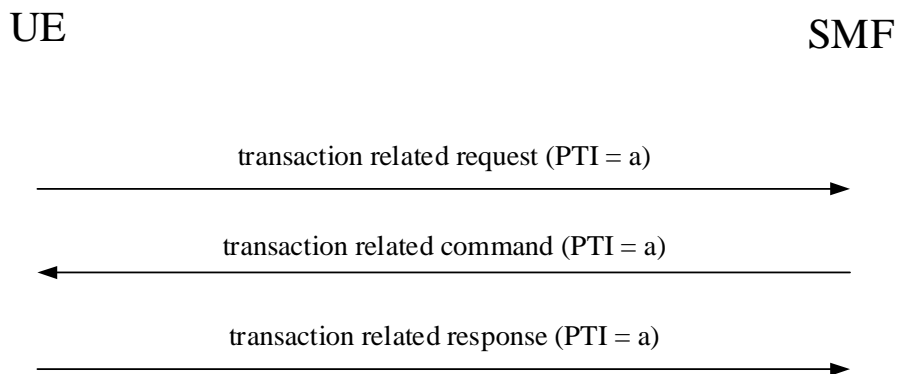

Figure 6.2.1.3: UE-requested transaction related procedure triggering a network-requested transaction related procedure

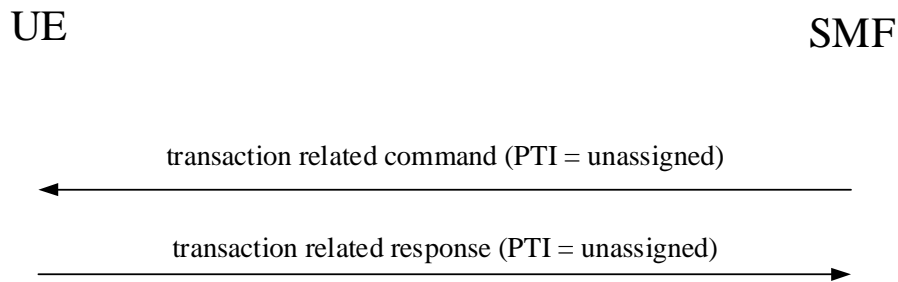

Figure 6.2.1.4: network-requested transaction related procedure not triggered by a UE-requested transaction related procedure

6.2.2 PDU session types

The following PDU Session types are supported:

- a) IPv4;
- b) IPv6;
- c) IPv4v6;
- d) Ethernet (EtherType as defined in IEEE Std 802.3 [31A]); and
- e) Unstructured.

IP address allocation for IPv4, IPv6 and IPv4v6 PDU session types is described in subclause 6.2.4.

Neither a MAC nor an IP address is allocated by the 5GCN to the UE for Ethernet PDU session type.

6.2.3 PDU session management

The SMF is responsible for the session management functions to provide the PDU connectivity service to the UE via the 5GSM signalling between UE and SMF. The session management procedures includes:

- a) the UE-requested PDU session establishment procedure;
- b) the PDU session authentication and authorization procedure;
- c) the UE-requested PDU session modification procedure;
- d) the network-requested PDU session modification procedure;
- e) the UE-requested PDU session release procedure; and
- f) the network-requested PDU session release procedure.

A UE may establish multiple PDU sessions, to the same data network or to different data networks, via 3GPP access and via non-3GPP access at the same time. It is not required for a UE to initiate the PDU session release procedure to release a PDU session associated with another access, if any, due to the reason that the UE initiates the registration procedure or PDU session establishment procedure over the current access.

NOTE: PDU session is managed independently between 3GPP access and non-3GPP access.

The session management messages between UE and SMF are transferred via AMF as specified in subclause 8.3.

6.2.4 IP address allocation

6.2.4.1 General

This clause specifies IP address allocation for the PDU session.

In this release of specification, PDU session can be initiated with one IP version, i.e. IPv4 PDU session type or IPv6 PDU session type, or with both IP versions, i.e. IPv4v6 PDU session type.

IP address allocation to the UE shall be performed by SMF based on one or both the selected IP versions and operator policies. If IPv4 PDU session type is selected, an IPv4 address is allocated to the UE. If IPv6 PDU session type is selected, an IPv6 prefix except when the SMF acts according to subclause 6.2.4.3, and an interface identifier for the IPv6 link local address are allocated to the UE. If IPv4v6 PDU session type is selected, an IPv4 address, an IPv6 prefix except when the SMF acts according to subclause 6.2.4.3 or 6.2.4.4, and an interface identifier for the IPv6 link local address are allocated to the UE. If IPv6 or IPv4v6 PDU session type is selected in a PDU session established by the W-AGF acting on behalf of the FN-RG and the PDU SESSION ESTABLISHMENT REQUEST message contains the Suggested interface identifier IE, the SMF shall allocate to the UE the interface identifier for the IPv6 link local address indicated in the Suggested interface identifier IE.

For IPv4 PDU session type and for IPv4v6 PDU session type, the UE:

- a) shall obtain an IPv4 address via:
 - 1) NAS signalling as specified in subclause 6.2.4.2; or
 - 2) DHCPv4 as specified in IETF RFC 2131 [33E]; and
- b) may obtain IPv4 configuration parameters (e.g. DNS server address) via DHCPv4 as specified in IETF RFC 2132 [33F] or may receive IPv4 configuration parameters (e.g. DNS server address) as specified in subclause 6.4.1 and subclause 6.3.2.

For IPv6 PDU session type and for IPv4v6 PDU session type, the UE:

- a) shall build an IPv6 link local address based on the allocated interface identifier for the IPv6 link local address;
- b) shall obtain /64 IPv6 prefix via IPv6 stateless address autoconfiguration as specified in 3GPP TS 23.501 [8] and IETF RFC 4862 [39], except when the 5G-RG or the W-AGF act according to subclause 6.2.4.3;
- c) may obtain IPv6 configuration parameters via stateless DHCPv6 as specified in IETF RFC 8415 [33D], except when the 5G-RG or the W-AGF act according to subclause 6.2.4.3, may receive IPv6 configuration parameters (e.g. DNS server address) as specified in subclause 6.4.1 and subclause 6.3.2, or may receive DNS server IPv6 addresses in a Router Advertisement Message as specified in IETF RFC 4861 [38B] with recursive DNS server option as specified in IETF RFC 8106 [52];and
- d) may obtain an additional IPv6 prefix for a PDU session by IPv6 prefix delegation via DHCPv6 as specified in subclause 6.2.4.2a.

6.2.4.2 IP address allocation via NAS signalling

The UE shall set the PDU session type IE in the PDU SESSION ESTABLISHMENT REQUEST message, based on its IP stack capabilities if the UE requests IP connectivity as follows:

- a) A UE:
 - 1) which is IPv6 and IPv4 capable, shall set the PDU session type IE to IPv4, IPv6 or IPv4v6 according to UE configuration or received policy.
 - 2) which is only IPv6 capable, shall set the PDU session type IE to IPv6.
 - 3) which is only IPv4 capable, shall set the PDU session type IE to IPv4.
- b) When the IP version capability of the UE is unknown in the UE (as in the case when the MT and TE are separated and the capability of the TE is not known in the MT), the UE shall set the PDU session type IE to IPv4v6.

If the UE wants to use DHCPv4 for IPv4 address assignment, it shall indicate that to the network within the Extended protocol configuration options IE in the PDU SESSION ESTABLISHMENT REQUEST.

On receipt of the PDU SESSION ESTABLISHMENT REQUEST message sent by the UE, the network when allocating an IP address shall take into account the PDU session type IE, the operator's policies of the network, and the user's subscription data and:

- a) if the network sets the Selected PDU session type IE to IPv4, the network shall include an IPv4 address in the PDU address IE;
- b) if the network sets the Selected PDU session type IE to IPv6, the network shall include an interface identifier for the IPv6 link local address in the PDU address IE; and
- c) if the network sets the Selected PDU session type IE to IPv4v6, the network shall include an IPv4 address and an interface identifier for the IPv6 link local address in the PDU address IE.

6.2.4.2a IPv6 prefix delegation via DHCPv6

In order to perform the IPv6 prefix delegation via DHCPv6, the UE shall use DHCPv6 to request additional IPv6 prefixes (i.e. prefixes shorter than the default /64 prefix) from the SMF. The UE shall act as a "Requesting Router" as described in IETF RFC 8415 [33D] and shall insert one or more identity association for prefix delegation options into a DHCPv6 Solicit message.

If the IPv6 address allocation using IPv6 stateless address autoconfiguration is used, the UE sends the DHCPv6 message to request additional IPv6 prefixes to the SMF after the PDU session establishment and IPv6 prefix allocation.

When the UE requests additional prefixes using DHCPv6, the UE may include DHCPv6 Rapid Commit option as specified in IETF RFC 8415 [33D] in a DHCPv6 Solicit message, and the UE other than the ones specified in subclause 6.2.4.3 shall include DHCPv6 OPTION_ORO option with the OPTION_PD_EXCLUDE option code as specified in IETF RFC 6603 [40A] in the DHCPv6 message.

Upon receiving one or more identity association for prefix delegation prefixes in a DHCPv6 Reply message, the UE is allowed to use the allocated additional prefixes after inter-system change from N1 mode to S1 mode or from S1 mode to N1 mode.

6.2.4.3 Additional RG related requirements for IP address allocation

If IPv6 PDU session type or IPv4v6 PDU session type is selected, an IPv6 address, one or more IPv6 prefixes or both are allocated to the 5G-RG or the W-AGF acting on behalf of the FN-RG (or on behalf of the N5GC device).

If the 5G-RG or the W-AGF acting on behalf of the FN-RG (or on behalf of the N5GC device) receives a Router Advertisement Message as specified in IETF RFC 4861 [38B] with the "Managed address configuration" flag set to zero, the 5G-RG and the W-AGF acting on behalf of the FN-RG (or on behalf of the N5GC device):

- a) shall obtain /64 IPv6 prefix via IPv6 stateless address autoconfiguration as specified in 3GPP TS 23.501 [8] and IETF RFC 4862 [39];
- b) may obtain IPv6 configuration parameters via stateless DHCPv6 as specified in IETF RFC 8415 [33D]; and
- c) may request additional IPv6 prefixes using DHCPv6. If the 5G-RG and the W-AGF acting on behalf of the FN-RG (or on behalf of the N5GC device) request IPv6 prefixes using DHCPv6, the 5G-RG and the W-AGF acting on behalf of the FN-RG (or on behalf of the N5GC device) shall act as a "Requesting Router" as described in IETF RFC 8415 [33D], shall perform procedures described in subclause 6.2.4.2a. Additionally, the 5G-RG or the W-AGF acting on behalf of the FN-RG (or on behalf of the N5GC device) may include DHCPv6 OPTION_ORO option with the OPTION_PD_EXCLUDE option code as specified in IETF RFC 6603 [40A] in the DHCP.

If the 5G-RG or the W-AGF acting on behalf of the FN-RG (or on behalf of the N5GC device) receives a Router Advertisement Message as specified in IETF RFC 4861 [38B] with the "Managed address configuration" flag set to one, the 5G-RG and the W-AGF acting on behalf of the FN-RG (or on behalf of the N5GC device):

- a) shall obtain an IPv6 address via DHCPv6 and the DHCPv6 Identity association for non-temporary addresses option as specified in IETF RFC 8415 [33D];

- b) may obtain IPv6 configuration parameters via DHCPv6 as specified in IETF RFC 8415 [33D]; and
- c) may request IPv6 prefixes using DHCPv6. If the 5G-RG and the W-AGF acting on behalf of the FN-RG (or on behalf of the N5GC device) requests IPv6 prefixes using DHCPv6, the 5G-RG and the W-AGF acting on behalf of the FN-RG (or on behalf of the N5GC device) shall act as a "Requesting Router" as described in IETF RFC 8415 [33D], shall perform procedures described in subclause 6.2.4.2a. Additionally, the 5G-RG or the W-AGF acting on behalf of the FN-RG (or on behalf of the N5GC device) may include DHCPv6 OPTION_ORO option with the OPTION_PD_EXCLUDE option code as specified in IETF RFC 6603 [40A] in the DHCP message. The 5G-RG or the W-AGF acting on behalf of the FN-RG (or on behalf of the N5GC device) may include both IA_PD option and IA_NA option to request the delegated prefix together with the IPv6 address in the same DHCPv6 message.

NOTE: The 5G-RG and the W-AGF acting on behalf of the FN-RG (or on behalf of the N5GC device) can send multiple DHCPv6 requests with different DHCPv6 Identity association for non-temporary addresses options when the 5G-RG or the FN-RG acts as a DHCP relay for devices behind the 5G-RG or the FN-RG.

The 5G-RG may obtain ACS information via DHCP as specified in subclause 3.1 of BBF TR-069 [49] or in BBF TR-369 [50] R-DIS.1 and R-DIS.2.

6.2.4.4 Additional requirements of the UE acting as 5G ProSe layer-3 UE-to-network relay UE for IP address allocation

If a UE acting as 5G ProSe layer-3 UE-to-network relay needs to indicate "IPv6 Router" or "DHCPv4 Server & IPv6 Router" in the IP address configuration IE as specified in 3GPP 24.554 [19E], the UE shall support acting as a "Requesting Router" as described in IETF RFC 8415 [33D] to request additional IPv6 prefixes (i.e. prefixes in addition to the /64 default prefix which was allocated via stateless IPv6 address autoconfiguration as specified in subclause 6.2.4.1) from the SMF as specified in subclause 5.5.2 of 3GPP TS 23.304 [6E].

When the UE acting as 5G ProSe layer-3 UE-to-network relay UE requests additional prefixes using DHCPv6, the UE shall perform procedures described in subclause 6.2.4.2a.

6.2.5 Quality of service

6.2.5.1 General

6.2.5.1.1 QoS rules

6.2.5.1.1.1 General

In a PDU session of IPv4, IPv6, IPv4v6 and Ethernet PDU session type, the NAS protocol enables different forwarding treatments of UL user data packets in one or more QoS flows based on signalled QoS rules, derived QoS rules or any combination of them.

In a PDU session of Unstructured PDU session type, all UL user data packets are associated with the same QoS flow.

6.2.5.1.1.2 Signalled QoS rules

The NAS protocol enables the network to provide the UE with signalled QoS rules associated with a PDU session.

The network can provide the UE with one or more signalled QoS rules associated with a PDU session at the PDU session establishment or at the PDU session modification.

Each signalled QoS rule contains:

- a) an indication of whether the QoS rule is the default QoS rule;
- b) a QoS rule identifier (QRI);
- c) a QoS flow identifier (QFI);
- d) optionally, a set of packet filters; and

e) a precedence value.

NOTE 1: The default QoS rule indication (DQR) of a signalled QoS rule cannot be changed.

For case d) above:

- 1) If the QoS rule is the default QoS rule of a PDU session of IPv4, IPv6, IPv4v6 or Ethernet PDU session type, the set of packet filters contains zero or more packet filters for DL direction, and may additionally contain one of the following:
 - A) a match-all packet filter for UL direction;
 - B) a match-all packet filter for UL and DL directions;
 - C) zero or more packet filters for UL direction (other than the match-all packet filter for UL direction);
 - D) zero or more packet filters for UL and DL directions (other than the match-all packet filter for UL and DL directions); or
 - E) one or more packet filters for UL direction (other than the match-all packet filter for UL direction) and one or more packet filters for UL and DL directions (other than the match-all packet filter for UL and DL directions).

The set of packet filters for the default QoS rule shall not be empty. If the default QoS rule contains a match-all packet filter, then the highest precedence value shall be used for the default QoS rule.

NOTE 1a: Set of packet filters for the default QoS rule can contain only packet filters for DL direction e.g. for determination that local preconditions are met in an IMS session (see 3GPP TS 24.229 [14]) with a receive only media.

- 2) If the QoS rule is a QoS rule of a PDU session of IPv4, IPv6, IPv4v6 or Ethernet PDU session type and is not the default QoS rule, the set of packet filters contains zero or more packet filters for the DL direction, and may additionally contain one of the following:
 - A) zero or more packet filters for UL direction (other than the match-all packet filter for UL direction); and
 - B) zero or more packet filters for both UL and DL directions (other than the match-all packet filter for UL and DL directions).

The set of packet filters for a QoS rule which is not the default QoS rule shall not be empty.

NOTE 1b: Set of packet filters for a QoS rule which is not the default QoS rule can contain only packet filters for DL direction e.g. for determination that local preconditions are met in an IMS session (see 3GPP TS 24.229 [14]) with a receive only media.

- 3) For PDU session of unstructured PDU session type, there is only one QoS rule associated with it and the set of packet filters of that QoS rule is empty.

If the UE requests a new QoS rule, it shall assign a precedence value for the signalled QoS rule which is not in the range from 70 to 99 (decimal).

NOTE 2: In this release of the specification, there is no support for a match-all packet filter for DL direction.

NOTE 3: In order to support QoS differentiation in case of access to PLMN services via an SNPN, the UE, within the SNPN, can construct packet filters based on the destination IP address to reach the N3IWF in the PLMN and the security parameters index (SPI) for the IPsec SA.

NOTE 4: In order to support QoS differentiation in case of access to SNPN services via a PLMN, the UE, within the PLMN, can construct packet filters based on the destination IP address to reach the N3IWF in the SNPN and the security parameters index (SPI) for the IPsec SA.

NOTE 5: The above described condition of assigning a precedence value for the signalled QoS rule is applied to the UE when the UE requests a QoS rule for network to bind service data flows described by the QoS rule to a dedicated QoS flow by setting the segregation bit to 1.

In NB-N1 mode, there is only one QoS rule associated with a PDU session and that is the default QoS rule. As described in 3GPP TS 23.501 [8], when the SMF determines that the UE has:

- a) moved from a tracking area in WB-N1 mode into a tracking area in NB-N1 mode;
- b) moved from a tracking area in WB-S1 mode into a tracking area in NB-N1 mode; or
- c) moved from a tracking area in NR connected to 5GCN into a tracking area in NB-N1 mode;

the SMF shall, for each PDU session that is kept active, initiate the PDU session modification procedure (see subclause 6.3.3.2) to delete every QoS rule that is not the default QoS rule, if any.

Within a PDU session:

- a) each signalled QoS rule has a unique QRI;
- b) there is at least one signalled QoS rule;
- c) one signalled QoS rule is the default QoS rule; and
- d) there can be zero, one or more signalled QoS rules associated with a given QFI.

6.2.5.1.1.3 Derived QoS rules

Derived QoS rules are applicable only for PDU session of IPv4, IPv6, IPv4v6 or Ethernet PDU session type.

The reflective QoS in the UE creates derived QoS rules associated with a PDU session based on DL user data packets received via the PDU session.

Each derived QoS rule contains:

- a) a QoS flow identifier (QFI);
- b) a packet filter for UL direction; and
- c) a precedence value of 80 (decimal).

NOTE: On the network side, the corresponding QoS rule can be associated with a different precedence value in the range from 70 to 99 (decimal).

Within a PDU session:

- a) there can be zero, one or more derived QoS rules associated with a given QFI; and
- b) there can be up to one derived QoS rule associated with a given packet filter for UL direction.

In the UE, a timer T3583 runs for each derived QoS rule.

Reflective QoS is not supported in NB-N1 mode. Reflective QoS is not applicable for a PDU session with control plane only indication.

6.2.5.1.1.4 QoS flow descriptions

The network can also provide the UE with one or more QoS flow descriptions associated with a PDU session at the PDU session establishment or at the PDU session modification.

Each QoS flow description contains:

- a) a QoS flow identifier (QFI);
- b) if the flow is a GBR QoS flow:
 - 1) Guaranteed flow bit rate (GFBR) for UL;
 - 2) Guaranteed flow bit rate (GFBR) for DL;
 - 3) Maximum flow bit rate (MFBR) for UL;

- 4) Maximum flow bit rate (MFBR) for DL; and
- 5) optionally averaging window, applicable for both UL and DL;
- c) 5QI, if the QFI is not the same as the 5QI of the QoS flow identified by the QFI; and
- d) optionally, an EPS bearer identity (EBI) if the QoS flow can be mapped to an EPS bearer as specified in subclause 4.11.1 of 3GPP TS 23.502 [9].

If the averaging window is not included in a QoS flow description for a GBR QoS flow with a 5QI indicated in 3GPP TS 23.501 [8] table 5.7.4-1, the averaging window associated with the 5QI in 3GPP TS 23.501 [8] table 5.7.4-1 applies for the averaging window.

If the averaging window is not included in a QoS flow description for a GBR QoS flow with a 5QI not indicated in 3GPP TS 23.501 [8] table 5.7.4-1, the standardized value of two seconds is used as the averaging window.

6.2.5.1.2 Session-AMBR

The NAS protocol enables the network to provide the UE with the session-AMBR associated with a PDU session.

The standardized value of two seconds is used as the averaging window for the UE's enforcement of the UL rate limitation indicated by the session-AMBR.

6.2.5.1.2A Void

6.2.5.1.3 UL user data packet matching

For PDU session of IPv4, IPv6, IPv4v6 or Ethernet PDU session type, upon receiving an UL user data packet from the upper layers for transmission via a PDU session, the UE shall attempt to associate the UL user data packet with:

- a) the QFI of a signalled QoS rule associated with the PDU session which has a set of packet filters containing a packet filter for UL direction matching the UL user data packet or containing a packet filter for both UL and DL directions matching the UL user data packet; or
- b) the QFI of a derived QoS rule associated with the PDU session which has the packet filter for UL direction matching the UL user data packet;

by evaluating the QoS rules in increasing order of their precedence values until the UL user data packet is associated with a QFI or all QoS rules are evaluated.

For PDU session of unstructured PDU session type, upon receiving an UL user data packet from the upper layers for transmission via a PDU session, the UE shall associate the UL user data packet with the QFI of the default QoS rule associated with the PDU session.

If the UL user data packet is associated with a QFI, the UE shall pass the QFI along the UL user data packet to the lower layers for transmission.

NOTE: Marking of the UL user data packet with the QFI is performed by the lower layers.

If all QoS rules are evaluated and the UL user data packet is not associated with a QFI, the UE shall discard the UL user data packet.

6.2.5.1.4 Reflective QoS

6.2.5.1.4.1 General

The UE may support reflective QoS.

If the UE supports the reflective QoS, the UE shall support the procedures in the following subclauses.

The reflective QoS is applicable in a PDU session of IPv4, IPv6, IPv4v6 and Ethernet PDU session type. The reflective QoS is not applicable in a PDU session of Unstructured PDU session type. Reflective QoS is not applicable for a PDU session with control plane only indication.

The UE may request to revoke the usage of reflective QoS for an existing PDU session for which the UE had previously indicated support for reflective QoS.

6.2.5.1.4.2 Derivation of packet filter for UL direction from DL user data packet

If the UE needs to derive a packet filter for UL direction from the DL user data packet (see subclause 6.2.5.1.4.3 and 6.2.5.1.4.4), the UE shall proceed as follows:

- a) if the received DL user data packet belongs to a PDU session of IPv4 or IPv4v6 PDU session type and is an IPv4 packet and:
 - 1) the protocol field of the received DL user data packet indicates TCP as specified in IETF RFC 793 [33];
 - 2) the protocol field of the received DL user data packet indicates UDP as specified in IETF RFC 768 [32]; or
 - 3) the protocol field of the received DL user data packet indicates ESP as specified in IETF RFC 4303 [38] and an uplink IPsec SA corresponding to a downlink IPsec SA indicated in the security parameters index field of the received DL user data packet exists;

then the packet filter for UL direction contains the following packet filter components:

- 1) an IPv4 remote address component set to the value of the source address field of the received DL user data packet;
- 2) an IPv4 local address component set to the value of the destination address field of the received DL user data packet;
- 3) a protocol identifier/next header type component set to the value of the protocol field of the received DL user data packet;
- 4) if the protocol field of the received DL user data packet indicates TCP as specified in IETF RFC 793 [33] or UDP as specified in IETF RFC 768 [32]:
 - i) a single local port type component set to the value of the destination port field of the received DL user data packet; and
 - ii) a single remote port type component set to the value of the source port field of the received DL user data packet;
- 5) if the protocol field of the received DL user data packet indicates ESP as specified in IETF RFC 4303 [38], an uplink IPsec SA corresponding to a downlink IPsec SA of the SPI in the DL user data packet exists and the SPI of the uplink IPsec SA is known to the NAS layer:
 - i) a security parameter index type component set to the security parameters index of the uplink IPsec SA corresponding to the downlink IPsec SA indicated in the security parameters index field of the received DL user data packet; and
- 6) if the protocol field of the received DL user data packet indicates UDP and the received DL user data packet contains a UDP-encapsulated ESP header as specified in IETF RFC 3948 [55], an uplink IPsec SA corresponding to a downlink IPsec SA of the SPI in the DL user data packet exists and the SPI of the uplink IPsec SA is known to the NAS layer:
 - i) a security parameter index type component set to the security parameters index of the uplink IPsec SA corresponding to the downlink IPsec SA indicated in the security parameters index field of the ESP header field of the UDP-encapsulated ESP header as specified in IETF RFC 3948 [55] of the received DL user data packet;

otherwise it is not possible to derive a packet filter for UL direction from the DL user data packet;

- b) if the received DL user data packet belongs to a PDU session of IPv6 or IPv4v6 PDU session type and is an IPv6 packet and:
 - 1) the last next header field of the received DL user data packet indicates TCP as specified in IETF RFC 793 [33];

- 2) the last next header field of the received DL user data packet indicates UDP as specified in IETF RFC 768 [32]; or
- 3) the last next header field of the received DL user data packet indicates ESP as specified in IETF RFC 4303 [38] and an uplink IPsec SA corresponding to a downlink IPsec SA indicated in the security parameters index field of the received DL user data packet exists;

then the packet filter for UL direction contains the following packet filter components:

- 1) an IPv6 remote address/prefix length component set to the value of the source address field of the received DL user data packet;
- 2) an IPv6 local address/prefix length component set to the value of the destination address field of the received DL user data packet;
- 3) a protocol identifier/next header type component set to the value of the last next header field of the received DL user data packet;
- 4) if the last next header field of the received DL user data packet indicates TCP as specified in IETF RFC 793 [33] or UDP as specified in IETF RFC 768 [32]:
 - i) a single local port type component set to the value of the destination port field of the received DL user data packet; and
 - ii) a single remote port type component set to the value of the source port field of the received DL user data packet;
- 5) if the last next header field of the received DL user data packet indicates ESP as specified in IETF RFC 4303 [38], an uplink IPsec SA corresponding to a downlink IPsec SA of the SPI in the DL user data packet exists and the SPI of the uplink IPsec SA is known to the NAS layer:
 - i) a security parameter index type component set to the security parameters index of the uplink IPsec SA corresponding to the downlink IPsec SA indicated in the security parameters index field of the received DL user data packet; and
- 6) if the last next header field of the received DL user data packet indicates UDP, and the received DL user data packet contains a UDP-encapsulated ESP header as specified in IETF RFC 3948 [55], an uplink IPsec SA corresponding to a downlink IPsec SA of the SPI in the DL user data packet exists and the SPI of the uplink IPsec SA is known to the NAS layer:
 - i) a security parameter index type component set to the security parameters index of the uplink IPsec SA corresponding to the downlink IPsec SA indicated in the security parameters index field of the ESP header field of the UDP-encapsulated ESP header as specified in IETF RFC 3948 [55] of the received DL user data packet;

otherwise it is not possible to derive a packet filter for UL direction from the DL user data packet;

- c) if the received DL user data packet belongs to a PDU session of Ethernet PDU session type, the packet filter for UL direction contains the following packet filter components:
 - 1) a destination MAC address component set to the source MAC address of the received DL user data packet;
 - 2) a source MAC address component set to the destination MAC address of the received DL user data packet;
 - 3) if one or more 802.1Q C-TAG is included in the received DL user data packet, an 802.1Q C-TAG VID component set to the outermost 802.1Q C-TAG VID of the received DL user data packet and an 802.1Q C-TAG PCP/DEI component set to the outermost 802.1Q C-TAG PCP/DEI of the received DL user data packet;
 - 4) if one or more 802.1Q S-TAG is included in the received DL user data packet, an 802.1Q S-TAG VID component set to the outermost 802.1Q S-TAG VID of the received DL user data packet and an 802.1Q S-TAG PCP/DEI component set to the outermost 802.1Q S-TAG PCP/DEI of the received DL user data packet;
 - 5) If the Ethertype field of the received DL user data packet is set to a value of 1536 or above, an Ethertype component set to the Ethertype of the received DL user data packet;

- 6) if the Ethertype field of the Ethernet frame header indicates that the data carried in the Ethernet frame is IPv4 data, the UE shall also add to the packet filter for UL direction the IP-specific components based on the contents of the IP header of the received DL user data packet as described in bullet a) above; and
- 7) if the Ethertype field of the Ethernet frame header indicates that the data carried in the Ethernet frame is IPv6 data, the UE shall also add to the packet filter for UL direction the IP-specific components based on the contents of the IP header of the received DL user data packet as described in bullet b) above; and
- d) if the received DL user data packet belongs to a PDU session of PDU session type other than Ethernet, IPv4, IPv6 and IPv4v6, it is not possible to derive a packet filter for UL direction from the DL user data packet.

6.2.5.1.4.3 Creating a derived QoS rule by reflective QoS in the UE

If the UE receives a DL user data packet marked with a QFI and an RQI, the DL user data packet belongs to a PDU session of IPv4, IPv6, IPv4v6 or Ethernet PDU session type, and the UE does not have a derived QoS rule with the same packet filter for UL direction as the packet filter for UL direction derived from the DL user data packet as specified in subclause 6.2.5.1.4.2, then the UE shall create a new derived QoS rule as follows:

- a) the QFI of the derived QoS rule is set to the received QFI;
- b) the precedence value of the derived QoS rule is set to 80 (decimal); and
- c) the packet filter for UL direction of the derived QoS rule is set to the derived packet filter for UL direction;

and the UE shall start the timer T3583 associated with the derived QoS rule with the RQ timer value last received during the UE-requested PDU session establishment procedure of the PDU session (see subclause 6.4.1) or the network-requested PDU session modification procedure of the PDU session (see subclause 6.4.2). If the RQ timer value was received neither in the UE-requested PDU session establishment procedure of the PDU session nor in any network-requested PDU session modification procedure of the PDU session, the default standardized RQ timer value is used.

6.2.5.1.4.4 Updating a derived QoS rule by reflective QoS in the UE

If the UE receives a DL user data packet associated with a QFI and an RQI, the DL user data packet belongs to a PDU session of IPv4, IPv6, IPv4v6 or Ethernet PDU session type, and the UE has a derived QoS rule with the same packet filter for UL direction as the packet filter for UL direction derived from the DL user data packet as specified in subclause 6.2.5.1.4.2:

- a) the UE shall re-start the timer T3583 associated with the derived QoS rule with the RQ timer value last received during the UE-requested PDU session establishment procedure of the PDU session (see subclause 6.4.1) or the network-requested PDU session modification procedure of the PDU session (see subclause 6.4.2). If the RQ timer value was received neither in the UE-requested PDU session establishment procedure of the PDU session nor in any network-requested PDU session modification procedure of the PDU session, the default standardized RQ timer value is used; and
- b) if the QFI value associated with the DL user data packet is different from the QFI value stored for the derived QoS rule, the UE shall replace the QFI value stored for the derived QoS rule with the new QFI value for the derived QoS rule.

6.2.5.1.4.5 Deleting a derived QoS rule in the UE

Upon expiry of timer T3583 associated with a derived QoS rule, the UE shall remove the derived QoS rule.

Upon release of the PDU session, the UE shall remove the derived QoS rule(s) associated with the PDU session.

If the network accepts the request from the UE to revoke the usage of reflective QoS and sets the value of the RQ timer to "deactivated" or zero, the UE shall remove the derived QoS rule(s) associated with the PDU session.

Upon inter-system mobility from WB-N1 mode to NB-N1 mode or from NR connected to 5GCN to NB-N1 mode, the UE shall remove the derived QoS rule(s) associated with the PDU session that is kept active.

When a derived QoS rule is deleted, the timer T3583 associated with the derived QoS rule shall be stopped.

6.2.5.1.4.6 Ignoring RQI in the UE

If the UE receives a DL user data packet marked with a QFI and an RQI and it is not possible to derive a packet filter for UL direction from the DL user data packet as specified in subclause 6.2.5.1.4.2, the UE shall ignore the RQI and shall handle the received DL user data packet.

6.2.5.2 QoS in MA PDU session

In an MA PDU session, unless it :

- a) is established over non-3GPP access; and
- b) has a PDN connection as a user-plane resource;

the UE shall have one set of QoS rules, one set of QoS flow descriptions and one session-AMBR. The network can provide the set of QoS rules, the set of QoS flow descriptions and the session-AMBR of the MA PDU session via either access of the MA PDU session. In an MA PDU session, the UE shall support:-

- modification or deletion via an access of a QoS rule or a QoS flow description; and
- modification via an access of the session-AMBR;

of the MA PDU session created via the same or the other access.

In an MA PDU session:

- a) established over non-3GPP access; and
- b) with a PDN connection as a user-plane resource;

the UE shall have two sets of QoS rules, two sets of QoS flow descriptions and two session-AMBR values - one is maintained via non-3GPP access and the other is associated with EPS bearer contexts of the PDN connection and maintained via Extended protocol configuration options IE parameters received via the PDN connection.

6.2.6 Local area data network (LADN)

The UE can receive the local area data network (LADN) information consisting of LADN DNNs and LADN service area information (a set of tracking areas that belong to the current registration area) during the registration procedure or the generic UE configuration update procedure (see subclause 5.5.1 and subclause 5.4.4).

If the UE supports LADN per DNN and S-NSSAI, the UE can additionally receive the extended local area data network (LADN) information consisting of LADN DNNs, S-NSSAIs and LADN service area information (a set of tracking areas configured per DNN and S-NSSAI that belong to the current registration area) during the registration procedure or the generic UE configuration update procedure (see subclause 5.5.1 and subclause 5.4.4).

If the UE is not operating in SNPN access operation mode, the UE considers the received LADN information or the extended LADN information to be valid only in the TAIs of the registered PLMN that are in the LADN service area information, and in the TAIs of the equivalent PLMNs if the LADN service area information includes TAIs for the equivalent PLMNs. When the AMF provides the UE with LADN service area information containing TAIs for the equivalent PLMNs, the AMF shall include these TAIs of the equivalent PLMNs in the UE's registration area.

If the UE is operating in SNPN access operation mode, the UE considers the received LADN information or the extended LADN information to be valid only in the TAIs of the registered SNPN that are in the LADN service area information.

The LADN DNN(s) received by the UE is also considered as LADN DNN(s) in the equivalent PLMNs.

The UE shall consider itself to be located inside the LADN service area based on the LADN service area information. If the UE does not have an LADN service area information for the LADN DNN, the UE shall consider itself to be located outside the LADN service area.

When the UE is located in the LADN service area and the UE is in substate 5GMM-REGISTERED.NORMAL-SERVICE, the UE may initiate:

- the UE-requested PDU session establishment procedure with an LADN DNN to establish a PDU session for LADN;
- the UE-requested PDU session establishment procedure with an LADN DNN and an S-NSSAI associated with the LADN to establish a PDU session for LADN if the extended LADN information is available at the UE;
- the UE-requested PDU session modification procedure to modify the PDU session for LADN;
- the service request procedure to re-establish the user-plane resources for the PDU session for LADN; or
- the service request procedure or the UE-initiated NAS transport procedure to send CIoT user data via the control plane for a PDU session for LADN.

NOTE 1: If the service area list for the service area restriction is available in the UE, and at least one of the LADN information or the extended LADN information are available in the UE, the service area list is evaluated before the LADN information and extended LADN information.

NOTE 1A: If the partially allowed NSSAI, the partially rejected NSSAI, or both are available in the UE, and at least one of the LADN information or the extended LADN information are available in the UE, the UE evaluates the partially allowed NSSAI and the partially rejected NSSAI before the LADN information and extended LADN information.

When the UE is located outside the LADN service area, the UE is allowed:

- to initiate the UE-requested PDU session release procedure to release a PDU session for LADN; or
- to initiate the UE-requested PDU session modification procedure to indicate a change of 3GPP PS data off UE status.

The AMF shall determine the UE presence in LADN service area as out of the LADN service area in the following cases:

- if the DNN used for the LADN is included in the LADN information and the UE is located outside the LADN service area indicated in the LADN information;
- if the DNN and the S-NSSAI used for the LADN are included in the extended LADN information and the UE is located outside the LADN service area indicated in the extended LADN information;
- if the DNN used for the LADN is included in the extended LADN information and there is no S-NSSAI provided by the UE to establish a PDU session for LADN; or
- if the DNN used for the LADN is included in the extended LADN information and the S-NSSAI provided by the UE to establish a PDU session for LADN is not associated with that LADN.

If the UE has moved out of the LADN service area:

- a) the SMF shall:
 - 1) release the PDU session for LADN; or
 - 2) release the user-plane resources for the PDU session for LADN and maintain the PDU session for LADN; according to operator's policy; and
- b) the SMF shall not initiate the transfer of CIoT user data via the control plane to the UE for the PDU session for LADN.

In case a2) and b):

- if the UE has returned to the LADN service area within a specific period of time according to operator's policy, and the network has downlink user data pending, the network re-establishes the user-plane resources for the PDU session for LADN;
- if the UE has returned to the LADN service area within a specific period of time according to operator's policy, and the network has downlink CIoT user data pending, the SMF shall initiate the CIoT user data via the control plane transfer to the UE; and

- if the UE has not returned to the LADN service area after a specific period of time according to operator's policy, the SMF may release the PDU session for LADN.

When the UE moves to 5GMM-DEREGISTERED state, the UE shall delete the stored LADN information, if any, and the stored extended LADN information, if any.

NOTE 2: In this release, LADNs apply only to 3GPP access.

Upon inter-system change from N1 mode to S1 mode in EMM-IDLE mode, the UE shall not transfer a PDU session for LADN to EPS.

If:

- a) the UE supports LADN per DNN and S-NSSAI;
- b) the UE has a PDU session established using the DNN and S-NSSAI which are not associated with any LADN service area indicated in the extended LADN information;
- c) an LADN service area is configured in the extended LADN information which is associated with the DNN and S-NSSAI of the PDU session; and
- d) the AMF determines the UE presence in LADN service area as out of the LADN service area configured in the extended LADN information;

the AMF requests the SMF to release this PDU session as specified in 3GPP TS 23.502 [9].

If:

- a) the UE supports LADN per DNN and S-NSSAI;
- b) the UE has a PDU session for LADN established; and
- c) the AMF determines that the LADN service area associated with the DNN and S-NSSAI of the PDU session for LADN is removed from the extended LADN information;

the AMF requests the SMF to release this PDU session as specified in 3GPP TS 23.502 [9].

6.2.7 Handling of DNN based congestion control

The network may detect and start performing DNN based congestion control when one or more DNN congestion criteria as specified in 3GPP TS 23.501 [8] are met. If the UE does not provide a DNN for a non-emergency PDU session, then the network uses the selected DNN.

In the UE, 5GS session management timers T3396 for DNN based congestion control are started and stopped on a per DNN basis except for an LADN DNN in case of PLMN. For an LADN DNN, 5GS session management timers T3396 for DNN based congestion control is applied to the registered PLMN and its equivalent PLMNs. In case of SNPN, if the UE does not support access to an SNPN using credentials from a credentials holder and equivalent SNPNS, in the UE, 5GS session management timers T3396 for DNN based congestion control are started and stopped on a per DNN and SNPN basis. If the UE supports access to an SNPN using credentials from a credentials holder, equivalent SNPNS or both, in the UE 5GS session management timers T3396 for DNN based congestion control are started and stopped on a per DNN, SNPN and selected entry of the "list of subscriber data" or selected PLMN subscription basis. Upon receipt of a 5GMM message or 5GSM message from the network for which the UE needs to stop the running timers T3396 associated with an LADN DNN as specified in subclause 6.3.2.3, 6.3.3.3, 6.4.1.4.2 and 6.4.2.4.2, only the running timer T3396 which is associated with the PLMN and equivalent PLMNs where the timer was started is stopped.

In an SNPN, if the UE supports equivalent SNPNS, the UE applies the timer T3396 for all the equivalent SNPNS, otherwise the UE applies the timer T3396 for the registered SNPN.

The DNN associated with T3396 is the DNN provided by the UE during the PDU session establishment. If no DNN is provided by the UE along the PDU SESSION ESTABLISHMENT REQUEST, then T3396 is associated with no DNN. For this purpose, the UE shall memorize the DNN provided to the network during the PDU session establishment. The timer T3396 associated with no DNN will never be started due to any 5GSM procedure related to an emergency PDU session. If the timer T3396 associated with no DNN is running, it does not affect the ability of the UE to request an emergency PDU session.

In a PLMN, if T3396 is running or is deactivated, then the UE is not allowed to initiate the:

- a) PDU session establishment procedure;
- b) PDU session modification procedure; or
- c) NAS transport procedure for sending CIoT user data;

for the respective DNN or without a DNN unless the UE is a UE configured for high priority access in selected PLMN or to report a change of 3GPP PS data off UE status.

In an SNPN, if T3396 is running or is deactivated for the registered SNPN, is associated with a DNN or with no DNN, with the RSNPN and, if the UE supports access to an SNPN using credentials from a credentials holder, with the selected entry of the "list of subscriber data" or the selected PLMN subscription, then the UE is not allowed to initiate the

- a) PDU session establishment procedure; or
- b) PDU session modification procedure;

for the respective DNN or without a DNN unless the UE is a UE configured for high priority access in the RSNPN or to report a change of 3GPP PS data off UE status.

In an SNPN, if the UE supports equivalent SNPNS, the timer T3396 is running or is deactivated for all the equivalent SNPNS, is associated with a DNN or no DNN, with the RSNPN or an equivalent SNPN, and with the selected entry of the "list of subscriber data" or the selected PLMN subscription, then the UE is not allowed to initiate the:

- a) PDU session establishment procedure; or
- b) PDU session modification procedure;

for the respective DNN or without a DNN unless the UE is a UE configured for high priority access in selected SNPN or to report a change of 3GPP PS data off UE status.

If the network does not include timer T3396 with 5GSM cause #26 "insufficient resources", the UE may use a local back-off timer that has exponential value or a default value, which is provisioned using implementation specific means, to:

- a) prevent sending any 5GSM procedure for the respective DNN till its expiry; and
- b) allow sending any 5GSM procedure for the respective DNN after its expiry.

6.2.8 Handling of S-NSSAI based congestion control

The network may detect and start performing S-NSSAI based congestion control when one or more S-NSSAI congestion criteria as specified in 3GPP TS 23.501 [8] are met. If the UE does not provide a DNN for a non-emergency PDU session, then the network uses the selected DNN. If the UE does not provide an S-NSSAI for a non-emergency PDU session, then the network uses the selected S-NSSAI.

In case of PLMN or SNPN, in the UE, 5GS session management timers T3584 for the S-NSSAI based congestion control are started and stopped on a per S-NSSAI, DNN and PLMN or SNPN basis. If the 5GSM congestion re-attempt indicator IE with the ABO bit set to "The back-off timer is applied in all PLMNs or equivalent SNPNS " is included in the 5GSM message with the 5GSM cause value #67 "insufficient resources for specific slice and DNN", then the UE applies the timer T3584 for all the PLMNs or all the equivalent SNPNS. Otherwise, the UE applies the timer T3584 for the registered PLMN or the registered SNPN. If the timer T3584 applies for all the PLMNs or all the equivalent SNPNS, the timer T3584 starts when the UE is registered in a VPLMN or an unsubscribed SNPN and the S-NSSAI is provided by the UE during the PDU session establishment, the timer T3584 is associated with the [mapped S-NSSAI, DNN] combination of the PDU session.

In case of PLMN or SNPN, in the UE, 5GS session management timers T3585 for the S-NSSAI based congestion control are started and stopped on a per S-NSSAI and PLMN or SNPN basis. If the 5GSM congestion re-attempt indicator IE with the ABO bit set to "The back-off timer is applied in all PLMNs or all equivalent SNPNS " is included in the 5GSM message with the 5GSM cause value #69 "insufficient resources for specific slice", then the UE applies the timer T3585 for all the PLMNs or all the equivalent SNPNS. Otherwise, the UE applies the timer T3585 for the registered PLMN or registered SNPN. If the timer T3585 applies for all the PLMNs or all the equivalent SNPNS, the timer T3585 starts when the UE is registered in a VPLMN or an unsubscribed SNPN and the S-NSSAI is provided by the UE during the PDU session establishment, the timer T3585 is associated with the mapped S-NSSAI of the PDU

session. Additionally, if the 5GSM congestion re-attempt indicator IE with the CATBO bit set to "The back-off timer is applied in the current access type" is included in the 5GSM message with the 5GSM cause value #69 "insufficient resources for specific slice", then the UE applies the timer T3585 for the current access type. Otherwise, the UE applies the timer T3585 for both 3GPP access type and non-3GPP access type and the UE shall stop any running timer T3585 for the applied PLMN or SNPN and for the access different from the access from which the message is received.

In case of SNPN, if the UE does not support access to an SNPN using credentials from a credentials holder and equivalent SNPNS, in the UE 5GS session management timers T3584 for the S-NSSAI based congestion control are started and stopped on a per S-NSSAI, DNN and SNPN basis. If the UE supports access to an SNPN using credentials from a credentials holder, equivalent SNPNS or both, in the UE 5GS session management timers T3584 for the S-NSSAI based congestion control are started and stopped on a per S-NSSAI, DNN, SNPN and selected entry of the "list of subscriber data" or selected PLMN subscription basis.

In case of SNPN, if the UE does not support access to an SNPN using credentials from a credentials holder and equivalent SNPNS, in the UE 5GS session management timers T3585 for the S-NSSAI based congestion control are started and stopped on a per S-NSSAI and SNPN basis. If the UE supports access to an SNPN using credentials from a credentials holder, equivalent SNPNS or both, in the UE 5GS session management timers T3585 for the S-NSSAI based congestion control are started and stopped on a per S-NSSAI, SNPN and selected entry of the "list of subscriber data" or selected PLMN subscription basis.

If the timer T3584 or timer T3585 was provided during the PDU session establishment procedure, the S-NSSAI associated with T3584 or T3585, respectively is the S-NSSAI, including no S-NSSAI, provided by the UE during the PDU session establishment.

If the timer T3584 is provided during the PDU session modification or PDU session release procedure, the UE behaves as follows: The DNN associated with T3584 is the DNN provided by the UE during the PDU session establishment. If no S-NSSAI but DNN is provided by the UE along the PDU SESSION ESTABLISHMENT REQUEST message, then T3584 is associated with no S-NSSAI and the DNN provided to the network during the PDU session establishment. If the PDN connection was established when in the S1 mode, then T3584 is associated with no S-NSSAI. If no DNN but S-NSSAI is provided by the UE along the PDU SESSION ESTABLISHMENT REQUEST message, then T3584 is associated with no DNN and the S-NSSAI of the PDU session. If no DNN and no S-NSSAI is provided by the UE along the PDU SESSION ESTABLISHMENT REQUEST message, then T3584 is associated with no DNN and no S-NSSAI. For this purpose, the UE shall memorize the DNN and the S-NSSAI provided to the network during the PDU session establishment. The timer T3584 associated with no DNN and an S-NSSAI will never be started due to any 5GSM procedure related to an emergency PDU session. If the timer T3584 associated with no DNN and an S-NSSAI is running, it does not affect the ability of the UE to request an emergency PDU session.

If the timer T3585 was provided during the PDU session modification or PDU session release procedure, the UE behaves as follows: if an S-NSSAI was provided by the UE during the PDU session establishment, then T3585 is associated with the S-NSSAI of the PDU session. If no S-NSSAI is provided by the UE along the PDU SESSION ESTABLISHMENT REQUEST message, then T3585 is associated with no S-NSSAI. If the PDN connection was established when in the S1 mode, then T3585 is associated with no S-NSSAI.

If T3584 is running or is deactivated, then the UE is not allowed to initiate the:

- a) PDU session establishment procedure;
- b) PDU session modification procedure; or
- c) NAS transport procedure for sending CIoT user data;

for the respective [S-NSSAI, no DNN] or [S-NSSAI, DNN] combination unless the UE is a UE configured for high priority access in selected PLMN or SNPN or to report a change of 3GPP PS data off UE status.

In a PLMN, if the timer T3584 is running or is deactivated for all the PLMNs and is associated with an S-NSSAI other than no S-NSSAI, then

- a) the UE registered in the HPLMN is not allowed to initiate the:
 - 1) PDU session establishment procedure;
 - 2) PDU session modification procedure; or
 - 3) NAS transport procedure for sending CIoT user data;

when the [S-NSSAI, no DNN] or [S-NSSAI, DNN] combination provided by the UE during the PDU session establishment is the same as the [S-NSSAI, no DNN] or [S-NSSAI, DNN] combination associated with the timer T3584 unless the UE is a UE configured for high priority access in selected PLMN or to report a change of 3GPP PS data off UE status; and

b) the UE registered in a VPLMN is not allowed to initiate the:

- 1) PDU session establishment procedure;
- 2) PDU session modification procedure; or
- 3) NAS transport procedure for sending CIoT user data;

when the [mapped S-NSSAI, no DNN] or [mapped S-NSSAI, DNN] combination provided by the UE during the PDU session establishment is the same as the [S-NSSAI, no DNN] or [S-NSSAI, DNN] combination associated with the timer T3584 unless the UE is a UE configured for high priority access in selected PLMN or to report a change of 3GPP PS data off UE status.

In a PLMN, if the timer T3584 is running or is deactivated for all the PLMNs and is associated with [no S-NSSAI, no DNN] or [no S-NSSAI, DNN] combination, then the UE is not allowed to initiate the:

- a) PDU session establishment procedure;
- b) PDU session modification procedure; or
- c) NAS transport procedure for sending CIoT user data;

for [no S-NSSAI, no DNN] or [no S-NSSAI, DNN] combination in any PLMN unless the UE is a UE configured for high priority access in selected PLMN or to report a change of 3GPP PS data off UE status.

In an SNPN, if the UE supports equivalent SNPNS, the timer T3584 is running or is deactivated for all the equivalent SNPNS, is associated with the selected entry of the "list of subscriber data" or the selected PLMN subscription, with an S-NSSAI other than no S-NSSAI, and with the RSNPN or an equivalent SNPN:

a) the UE registered in the subscribed SNPN is not allowed to initiate the:

- 1) PDU session establishment procedure; or
- 2) PDU session modification procedure;

when the [S-NSSAI, no DNN] or [S-NSSAI, DNN] combination provided by the UE during the PDU session establishment is the same as the [S-NSSAI, no DNN] or [S-NSSAI, DNN] combination associated with the timer T3584 unless the UE is a UE configured for high priority access in the RSNPN or to report a change of 3GPP PS data off UE status; and

b) the UE registered in a non-subscribed is not allowed to initiate the:

- 1) PDU session establishment procedure; or
- 2) PDU session modification procedure;

when the [mapped S-NSSAI, no DNN] or [mapped S-NSSAI, DNN] combination provided by the UE during the PDU session establishment is the same as the [S-NSSAI, no DNN] or [S-NSSAI, DNN] combination associated with the timer T3584 unless the UE is a UE configured for high priority access in RSNPN or to report a change of 3GPP PS data off UE status.

In an SNPN, if the UE supports equivalent SNPNS, the timer T3584 is running or is deactivated for all the equivalent SNPNS, is associated with the selected entry of the "list of subscriber data" or the selected PLMN subscription, with [no S-NSSAI, no DNN] or [no S-NSSAI, DNN] combination, and with the RSNPN or an equivalent SNPN, then the UE is not allowed to initiate the:

- a) PDU session establishment procedure; or
- b) PDU session modification procedure;

for [no S-NSSAI, no DNN] or [no S-NSSAI, DNN] combination unless the UE is a UE configured for high priority access in the RSPN or to report a change of 3GPP PS data off UE status.

If T3585 is running or is deactivated, then the UE is neither allowed to initiate the PDU session establishment procedure nor the PDU session modification procedure for the respective S-NSSAI unless the UE is a UE configured for high priority access in selected PLMN or SNPN or to report a change of 3GPP PS data off UE status.

In a PLMN, if the timer T3585 is running or is deactivated for all the PLMNs and is associated with an S-NSSAI other than no S-NSSAI, then

- a) the UE registered in the HPLMN is not allowed to initiate the:
 - 1) PDU session establishment procedure;
 - 2) PDU session modification procedure; or
 - 3) NAS transport procedure for sending CIoT user data;

when the S-NSSAI provided by the UE during the PDU session establishment is the same as the S-NSSAI associated with timer T3585 unless the UE is a UE configured for high priority access in selected PLMNs or to report a change of 3GPP PS data off UE status; and

- b) the UE registered in a VPLMN is not allowed to initiate the:
 - 1) PDU session establishment procedure;
 - 2) PDU session modification procedure; or
 - 3) NAS transport procedure for sending CIoT user data;

when the mapped S-NSSAI provided by the UE during the PDU session establishment is the same as the S-NSSAI associated the timer T3585 unless the UE is a UE configured for high priority access in selected PLMN or to report a change of 3GPP PS data off UE status.

In a PLMN, if the timer T3585 is running or is deactivated for all the PLMNs and is associated with no S-NSSAI, then the UE is not allowed to initiate the:

- a) PDU session establishment procedure;
- b) PDU session modification procedure;
- c) NAS transport procedure for sending CIoT user data;

for no S-NSSAI in any PLMN unless the UE is a UE configured for high priority access in selected PLMN or to report a change of 3GPP PS data off UE status. In an SNPN, if the UE supports equivalent SNPNS, the timer T3585 is running or is deactivated for all the equivalent SNPNS, is associated with the selected entry of the "list of subscriber data" or the selected PLMN subscription, with an S-NSSAI other than no S-NSSAI, and with the RSNPN or an equivalent SNPN:

- a) the UE registered in the subscribed SNPN is not allowed to initiate the:
 - 1) PDU session establishment procedure; or
 - 2) PDU session modification procedure;

when the S-NSSAI provided by the UE during the PDU session establishment is the same as the S-NSSAI associated with timer T3585 unless the UE is a UE configured for high priority access in the RSNPN or to report a change of 3GPP PS data off UE status; and

- b) the UE registered in a non-subscribed SNPN is not allowed to initiate the:
 - 1) PDU session establishment procedure; or
 - 2) PDU session modification procedure;

when the mapped S-NSSAI provided by the UE during the PDU session establishment is the same as the S-NSSAI associated the timer T3585 unless the UE is a UE configured for high priority access in the RSNPN or to report a change of 3GPP PS data off UE status.

In an SNPN, if the UE supports equivalent SNPNS, the timer T3585 is running or is deactivated for all the equivalent SNPNS, is associated with the selected entry of the "list of subscriber data" or the selected PLMN subscription, with no S-NSSAI, and with the RSNPN or an equivalent SNPN, then the UE is not allowed to initiate the:

- a) PDU session establishment procedure; or
- b) PDU session modification procedure;

for no S-NSSAI unless the UE is a UE configured for high priority access in RSNPN or to report a change of 3GPP PS data off UE status.

If the network does not include timer T3584 with 5GSM cause #67 "insufficient resources for specific slice and DNN", the UE may use a local back-off timer that has exponential value or a default value, which is provisioned using implementation specific means, to: a) prevent sending any 5GSM procedure for the respective DNN and S-NSSAI till its expiry; and b) allow sending any 5GSM procedure for the respective DNN and S-NSSAI after its expiry.

If the network does not include timer T3585 with 5GSM cause #69 "insufficient resources for specific slice", the UE may use a local back-off timer that has exponential value or a default value, which is provisioned using implementation specific means, to: a) prevent sending any 5GSM procedure for the respective S-NSSAI till its expiry; and

- b) allow sending any 5GSM procedure for the respective S-NSSAI after its expiry.

6.2.9 Interaction with upper layers

6.2.9.1 General

A 5GSM entity interacts with upper layers. Subclause 6.2.9.2 describes how the 5GSM entity interacts with upper layers with respect to the URSP. Subclause 6.2.9.3 describes how the 5GSM entity interacts with upper layers with respect to the ProSeP.

6.2.9.2 URSP

The URSP requires interaction between upper layers and the 5GSM entities in the UE (see 3GPP TS 24.526 [19] for further details). Each of the 5GSM entities in the UE shall indicate attributes (e.g. PDU session identity, SSC mode, S-NSSAI, DNN, PDU session type, access type, PDU address) of a newly established PDU session to the upper layers. If a PDU session is released, the 5GSM entity handling the PDU session shall inform the PDU session identity of the released PDU session to the upper layers. The upper layers may request a 5GSM entity:

- a) to establish a PDU session indicating one or more PDU session attributes;
- b) to release an existing PDU session; or
- c) to establish a PDU session indicating one or more PDU session attributes, and to release an existing PDU session.

6.2.9.3 ProSeP

The ProSeP requires interaction between upper layers and the 5GSM entities in the UE acting as a 5G ProSe layer-3 UE-to-network relay UE (see 3GPP TS 24.554 [19E] for further details). The upper layers may request the 5GSM entity:

- a) to establish a PDU session indicating one or more PDU session attributes; or
- b) to release the existing PDU session; or
- c) to establish a PDU session indicating one or more PDU session attributes, and to release the existing PDU session.

Each of the 5GSM entities in the UE acting as a 5G ProSe layer-3 UE-to-network relay UE shall indicate attributes (e.g. PDU session identity, SSC mode, S-NSSAI, DNN, PDU session type, access type, PDU address) of the newly

established PDU session to the upper layers. If the PDU session is released, the 5GSM entity handling the PDU session shall inform the PDU session identity of the released PDU session to the upper layers.

6.2.10 Handling of 3GPP PS data off

In case of PLMN, a UE, which supports 3GPP PS data off (see 3GPP TS 23.501 [8]), can be configured with up to two lists of 3GPP PS data off exempt services as specified in 3GPP TS 24.368 [17] or in the EF_{3GPPPSDATAOFF} USIM file as specified in 3GPP TS 31.102 [22]:

- a) a list of 3GPP PS data off exempt services to be used in the HPLMN or EHPLMN; and
- b) a list of 3GPP PS data off exempt services to be used in the VPLMN.

If only the list of 3GPP PS data off exempt services to be used in the HPLMN or EHPLMN is configured at the UE, this list shall be also used in the VPLMN.

In case of SNPN, a UE, which supports 3GPP PS data off (see 3GPP TS 23.501 [8]), can be configured with:

- a) up to two lists of 3GPP PS data off exempt services as specified in 3GPP TS 24.368 [17] for each subscribed SNPN whose entry exists in the "list of subscriber data":
 - 1) a list of 3GPP PS data off exempt services to be used in the subscribed SNPN; and
 - 2) a list of 3GPP PS data off exempt services to be used in the non-subscribed SNPN; and
- b) one list of 3GPP PS data off exempt services as specified in 3GPP TS 24.368 [17] for PLMN subscription:
 - 1) a list of 3GPP PS data off exempt services to be used in the non-subscribed SNPN.

If only the list of 3GPP PS data off exempt services to be used in the subscribed SNPN is configured for the selected entry of "list of subscriber data", this list shall be also used in the non-subscribed SNPN.

If the UE supports 3GPP PS data off, the UE shall provide the 3GPP PS data off UE status in the Extended protocol configuration options IE during UE-requested PDU session establishment procedure except for the transfer of a PDU session from non-3GPP access to 3GPP access and except for the establishment of user plane resources on the other access for the MA PDU session (see subclause 6.4.1), and during UE-requested PDU session modification procedure (see subclause 6.4.2), regardless of associated access type of the PDU session. If the UE requests a PDU session establishment procedure in order to transfer a PDU session from non-3GPP access to 3GPP access, or in order to establish user plane resources on the other access for the MA PDU session over 3GPP access or non-3GPP access, and:

- a) if the 3GPP PS data off UE status has changed since the last providing to the network, the UE shall provide the 3GPP PS data off UE status in the Extended protocol configuration options IE; or
- b) if the 3GPP PS data off UE status has not changed since the last providing to the network, the UE need not provide the 3GPP PS data off UE status.

The network shall support of 3GPP PS data off.

The UE shall indicate change of the 3GPP PS data off UE status for the PDU session by using the UE-requested PDU session modification procedure as specified in subclause 6.4.2.

When the 3GPP PS data off UE status is "activated":

- a) the UE does not send uplink IP packets via 3GPP access except:
 - 1) for those services indicated in the list of 3GPP PS data off exempt services to be used in the HPLMN or EHPLMN as specified in 3GPP TS 24.368 [17] when the UE is in its HPLMN or EHPLMN;
 - 2) for those services indicated in the list of 3GPP PS data off exempt services to be used in the subscribed SNPN, configured for the selected entry of "list of subscriber data", as specified in 3GPP TS 24.368 [17] when the UE is in the subscribed SNPN;
 - 3) for those services indicated in the list of 3GPP PS data off exempt services to be used in the HPLMN or EHPLMN when the UE is in the VPLMN, if only the list of 3GPP PS data off exempt services to be used in the HPLMN or EHPLMN is configured to the UE as specified in 3GPP TS 24.368 [17];

- 4) for those services indicated in the list of 3GPP PS data off exempt services to be used in the subscribed SNPN, configured for the selected entry of "list of subscriber data", when the UE is in a non-subscribed SNPN and only the list of 3GPP PS data off exempt services to be used in the subscribed SNPN is configured for the selected entry of "list of subscriber data" as specified in 3GPP TS 24.368 [17];
 - 5) for those services indicated in the list of 3GPP PS data off exempt services to be used in the VPLMN when the UE is in the VPLMN, if the list of 3GPP PS data off exempt services to be used in the VPLMN is configured to the UE as specified in 3GPP TS 24.368 [17];
 - 6) for those services indicated in the list of 3GPP PS data off exempt services to be used in the non-subscribed SNPN, configured for the selected entry of "list of subscriber data", when the UE is in a non-subscribed SNPN and the list of 3GPP PS data off exempt services to be used in the non-subscribed SNPN is configured for the selected entry of "list of subscriber data" as specified in 3GPP TS 24.368 [17];
 - 7) for those services indicated in the list of 3GPP PS data off exempt services to be used in the non-subscribed SNPN, configured for the selected PLMN subscription, when the UE is in the non-subscribed SNPN and the list of 3GPP PS data off exempt services to be used in the non-subscribed SNPN is configured for the selected PLMN subscription as specified in 3GPP TS 24.368 [17];
 - 8) for those services indicated in the EF_{3GPPPSDATAOFF} USIM file as specified in 3GPP TS 31.102 [22];
 - 9) any uplink traffic due to procedures specified in 3GPP TS 24.229 [14]; and
 - 10) any uplink traffic due to procedures specified in 3GPP TS 24.623 [20];
- b) the UE does not send uplink Ethernet user data packets via 3GPP access; and
 - c) the UE does not send uplink Unstructured user data packets via 3GPP access.

Otherwise the UE sends uplink user data packets without restriction.

NOTE: If the UE supports 3GPP PS data off, uplink IP packets are filtered as specified in 3GPP TS 24.229 [14] in U.3.1.5.

3GPP PS data off does not restrict sending of uplink user data packets via non-3GPP access of a single access PDU session or an MA PDU session.

6.2.11 Multi-homed IPv6 PDU session

The UE supporting IPv6 may support multi-homed IPv6 PDU session.

If the UE supports the multi-homed IPv6 PDU session:

- a) the UE shall support acting as a type C host as specified in IETF RFC 4191 [36]; and
- b) the UE indicates support of the multi-homed IPv6 PDU session:
 - 1) during the UE-requested PDU session establishment of a PDU session of "IPv6" or "IPv4v6" PDU session type; and
 - 2) during the UE-requested PDU session modification performed after an inter-system change from S1 mode to N1 mode, for a PDU session associated with a PDN connection established when in S1 mode, if the UE is a UE operating in single-registration mode in a network supporting N26 interface, the PDU session is of "IPv6" or "IPv4v6" PDU session type, and the UE has not previously successfully performed the UE-requested PDU session modification to provide this indication.

6.2.12 Handling of network rejection not due to congestion control

The network may include a back-off timer value in a 5GS session management reject message to regulate the time interval at which the UE may retry the same procedure for 5GSM cause values other than #26 "insufficient resources", #28 "unknown PDU session type", #39 "reactivation requested", #46 "out of LADN service area", #50 "PDU session type IPv4 only allowed", #51 "PDU session type IPv6 only allowed", #54 "PDU session does not exist", #57 "PDU session type IPv4v6 only allowed", #58 "PDU session type Unstructured only allowed", #61 "PDU session type Ethernet only allowed", #67 "insufficient resources for specific slice and DNN", #68 "not supported SSC mode" and

#69 "insufficient resources for specific slice". For 5GSM cause values other than #26 "insufficient resources", #28 "unknown PDU session type", #39 "reactivation requested", #46 "out of LADN service area", #54 "PDU session does not exist", #67 "insufficient resources for specific slice and DNN", #68 "not supported SSC mode", and #69 "insufficient resources for specific slice", and #86 "UAS services not allowed", the network may also include the re-attempt indicator to indicate whether the UE is allowed to re-attempt the corresponding session management procedure for the same DNN in S1 mode after inter-system change.

NOTE 1: In a PLMN, if the network includes this back-off timer value for 5GSM cause values other than #27 "missing or unknown DNN", then the UE is blocked from sending another 5GSM request for the same procedure for the same [PLMN, DNN, S-NSSAI], [PLMN, DNN, no S-NSSAI], [PLMN, no DNN, S-NSSAI], or [PLMN, no DNN, no S-NSSAI] combination for the specified duration. If the network includes this back-off timer value for 5GSM cause value #27 "missing or unknown DNN", then the UE is blocked from sending another 5GSM request for the same procedure for the same [PLMN, DNN], or [PLMN, no DNN] combination for the specified duration. In an SNPN, if the network includes this back-off timer value for 5GSM cause values other than #27 "missing or unknown DNN", then the UE is blocked from sending another 5GSM request for the same procedure for the same [SNPN, selected entry of the "list of subscriber data" or selected PLMN subscription, DNN, S-NSSAI], [SNPN, selected entry of the "list of subscriber data" or selected PLMN subscription, DNN, no S-NSSAI], [SNPN, selected entry of the "list of subscriber data" or selected PLMN subscription, no DNN, S-NSSAI], or [SNPN, selected entry of the "list of subscriber data" or selected PLMN subscription, no DNN, no S-NSSAI] combination for the specified duration. If the network includes this back-off timer value for 5GSM cause value #27 "missing or unknown DNN", then the UE is blocked from sending another 5GSM request for the same procedure for the same [SNPN, selected entry of the "list of subscriber data" or selected PLMN subscription, DNN], or [SNPN, selected entry of the "list of subscriber data" or selected PLMN subscription, no DNN] combination for the specified duration. Therefore, the operator needs to exercise caution in determining the use of this timer value.

NOTE 2: If the re-attempt indicator is not provided by the network, a UE registered in its HPLMN or in an EHPLMN can use the configured SM_RetryAtRATChange value specified in the NAS configuration MO or in the USIM NAS_{CONFIG} file to derive the re-attempt indicator as specified in subclauses 6.4.1.4.3 and 6.4.2.4.3.

If re-attempt in S1 mode is allowed for 5GSM cause values other than #27 "missing or unknown DNN", the UE shall consider the back-off timer to be applicable only to the 5GS session management in N1 mode for the rejected 5GS session management procedure and the given [PLMN, DNN, S-NSSAI], [PLMN, DNN, no S-NSSAI], [PLMN, no DNN, S-NSSAI], or [PLMN, no DNN, no S-NSSAI] combination. If re-attempt in S1 mode is allowed for 5GSM cause value #27 "missing or unknown DNN", the UE shall consider the back-off timer to be applicable only to the 5GS session management in N1 mode for the rejected 5GS session management procedure and the given [PLMN, DNN], or [PLMN, no DNN] combination. If re-attempt in S1 mode is not allowed, the UE shall consider the back-off timer to be applicable to both NAS protocols, i.e. applicable to the 5GS session management in N1 mode for the rejected 5GS session management procedure and to the EPS session management in S1 mode for the corresponding session management procedure and the given [PLMN, DNN] or [PLMN, no DNN] combination.

NOTE 3: In the present subclause the terms DNN and APN are referring to the same parameter.

In a PLMN, if the back-off timer was provided during the PDU session establishment procedure, the UE behaves as follows: for 5GSM cause values other than #27 "missing or unknown DNN", when the UE is registered in a HPLMN, the DNN and the S-NSSAI of the [PLMN, DNN, S-NSSAI] combination associated with the back-off timer is the DNN and the S-NSSAI provided by the UE when the PDU session is established. When the UE is registered in a VPLMN, the DNN and the S-NSSAI of the [PLMN, DNN, S-NSSAI] combination associated with the back-off timer is the DNN and the mapped S-NSSAI provided by the UE when the PDU session is established. For 5GSM cause value #27 "missing or unknown DNN", the DNN of the [PLMN, DNN] combination associated with the back-off timer is the DNN provided by the UE when the PDU session is established. If no DNN or no S-NSSAI was provided to the network during the PDU session establishment, then the back-off timer is associated with the [PLMN, DNN, no S-NSSAI], [PLMN, no DNN, S-NSSAI], or [PLMN, no DNN, no S-NSSAI] combination, dependent on which parameters were provided for 5GSM cause values other than #27 "missing or unknown DNN". If no DNN was provided to the network during the PDU session establishment, then the back-off timer is associated with the [PLMN, no DNN] combination for 5GSM cause value #27 "missing or unknown DNN". For this purpose, the UE shall memorize the DNN and the S-NSSAI provided to the network during the PDU session establishment.

In a PLMN, if the back-off timer was provided during the PDU session modification procedure, the UE behaves as follows: the DNN associated with the back-off timer is the DNN, including no DNN, provided by the UE when the PDU session is established. If an S-NSSAI was provided by the UE during the PDU session establishment, when the

UE is registered in a HPLMN, then the S-NSSAI associated with the back-off timer is the S-NSSAI of the PDU session. If an S-NSSAI was provided by the UE during the PDU session establishment, when the UE is registered in a VPLMN, then the S-NSSAI associated with the back-off timer is the mapped S-NSSAI of the PDU session. If no S-NSSAI was provided by the UE during the PDU session establishment, then the back-off timer is associated with no S-NSSAI. For this purpose, the UE shall memorize the DNN and the S-NSSAI provided to the network during the PDU session establishment.

In a PLMN, the back-off timer associated with the [PLMN, no DNN, no S-NSSAI], or [PLMN, no DNN] combination will never be started due to any 5GSM procedure related to an emergency PDU session. If the back-off timer associated with the [PLMN, no DNN, no S-NSSAI], or [PLMN, no DNN] combination is running, it does not affect the ability of the UE to request an emergency PDU session.

In an SNPN, the back-off timer associated with the [SNPN, selected entry of the "list of subscriber data" or selected PLMN subscription, no DNN, no S-NSSAI], or [SNPN, selected entry of the "list of subscriber data" or selected PLMN subscription, no DNN] combination will never be started due to any 5GSM procedure related to an emergency PDU session. If the back-off timer associated with the back-off timer associated with the [SNPN, selected entry of the "list of subscriber data" or selected PLMN subscription, no DNN, no S-NSSAI], or [SNPN, selected entry of the "list of subscriber data" or selected PLMN subscription, no DNN] combination, it does not affect the ability of the UE to request an emergency PDU session.

In a PLMN, the network may additionally indicate in the re-attempt indicator that a command to back-off is applicable not only for the PLMN in which the UE received the 5GS session management reject message, but for each PLMN included in the equivalent PLMN list at the time when the 5GS session management reject message was received.

In an SNPN, the network may additionally indicate in the re-attempt indicator that a command to back-off is applicable not only for the SNPN in which the UE received the 5GS session management reject message, but for each SNPN included in the equivalent SNPN list at the time when the 5GS session management reject message was received.

In a PLMN, if the back-off timer is running or is deactivated for a given [PLMN, DNN, S-NSSAI], [PLMN, DNN, no S-NSSAI], [PLMN, no DNN, S-NSSAI], [PLMN, no DNN, no S-NSSAI], [PLMN, DNN], or [PLMN, no DNN] combination, and the UE is a UE configured for high priority access in selected PLMN, then the UE is allowed to initiate 5GSM procedures for the [PLMN, DNN, S-NSSAI], [PLMN, DNN, no S-NSSAI], [PLMN, no DNN, S-NSSAI], [PLMN, no DNN, no S-NSSAI], [PLMN, DNN], or [PLMN, no DNN] combination.

In an SNPN, if the back-off timer is running or is deactivated for a given [SNPN, selected entry of the "list of subscriber data" or selected PLMN subscription, DNN, S-NSSAI], [SNPN, selected entry of the "list of subscriber data" or selected PLMN subscription, DNN, no S-NSSAI], [SNPN, selected entry of the "list of subscriber data" or selected PLMN subscription, no DNN, S-NSSAI], [SNPN, selected entry of the "list of subscriber data" or selected PLMN subscription, no DNN, no S-NSSAI], [SNPN, selected entry of the "list of subscriber data" or selected PLMN subscription, DNN], or [SNPN, selected entry of the "list of subscriber data" or selected PLMN subscription, no DNN] combination if the UE is a UE configured for high priority access in selected SNPN, then the UE is allowed to initiate 5GSM procedures for the [SNPN, selected entry of the "list of subscriber data" or selected PLMN subscription, DNN, S-NSSAI], [SNPN, selected entry of the "list of subscriber data" or selected PLMN subscription, DNN, no S-NSSAI], [SNPN, selected entry of the "list of subscriber data" or selected PLMN subscription, no DNN, S-NSSAI], [SNPN, selected entry of the "list of subscriber data" or selected PLMN subscription, no DNN, no S-NSSAI], [SNPN, selected entry of the "list of subscriber data" or selected PLMN subscription, DNN], or [SNPN, selected entry of the "list of subscriber data" or selected PLMN subscription, no DNN] combination.

The RATC bit in the re-attempt indicator IE and its derivation shall not be applicable in an SNPN.

If the network does not include a back-off timer with 5GSM cause #29 "insufficient resources", #31 "request rejected, unspecified", and #38 "network failure", the UE may use a local back-off timer that has exponential value or a default value, which is provisioned using implementation specific means, to:

- a) prevent sending the rejected 5GSM procedure for the respective DNN till its expiry; and

- b) allow sending the rejected 5GSM procedure for the respective DNN after its expiry.

6.2.13 Handling of Small data rate control

Small data rate control is applicable only to NB-N1 mode and WB-N1 mode.

Small data rate control controls the maximum number of uplink user data messages including uplink exception data reporting sent by the UE in a time interval for the PDU session in accordance with 3GPP TS 23.501 [8]. The UE shall

limit the rate at which it generates uplink user data messages to comply with the small data rate control policy. The NAS shall provide the indicated rates to upper layers for enforcement. The indicated rates in a NAS procedure applies to the PDU session the NAS procedure corresponds to, and the indicated rates are valid until a new value is indicated or the PDU session is released.

If the UE indicates support for CIoT 5GS optimizations, the network may provide the small data rate control parameters to the UE and may provide the small data rate control parameters for exception data to the UE if and only if the small data rate control parameters is provided to the UE. Small data rate control parameters and small data rate control parameters for exception data can also be provided to the UE in S1 mode as specified in 3GPP TS 24.301 [15].

If an allowed indication of additional exception reports is provided with the small data rate control parameters and:

- the additional small data rate control parameters for exception data is provided and the limit for additional rate for exception data reporting is not reached; or
- the additional small data rate control parameters for exception data is not provided,

the UE is allowed to send uplink exception reports even if the limit for the small data rate control has been reached.

During a PDU session release procedure, if the small data rate control was applied to the PDU session that is being released, the network may store the small data rate control status for the released PDU session as specified in 3GPP TS 23.501 [8].

If:

- a) the UE indicates support for CIoT 5GS optimizations; and
- b) the small data rate control status was stored for the PDU session and is still valid,

the network may provide the remaining small data rate control status as initial small data rate control parameters to the UE and initial small data rate control parameters for exception data to the UE during a subsequent PDU session establishment procedure.

If received during the establishment of a PDU session, the UE shall apply the initial small data rate control parameters and the initial small data rate control parameters for exception data for the duration of the validity period. When the validity period expires the small data rate control parameters and the small data rate control parameters for exception data shall be applied (see 3GPP TS 23.501 [8]).

NOTE 1: The HPLMN can discard or delay user data that exceeds the limit provided for small data rate control.

Upon inter-system change from N1 mode to S1 mode, the UE shall store the current small data rate control status for PDU sessions to be transferred from N1 mode to S1 mode as specified in 3GPP TS 23.501 [8].

NOTE 2: How long the UE stores the current small data rate control status is implementation specific.

Upon inter-system change from S1 mode to N1 mode, the UE shall use the stored small data rate control status, if any, to comply with the small data rate control policy for PDU sessions transferred from S1 mode to N1 mode as specified in 3GPP TS 23.501 [8], if the validity period of the stored small data rate control status has not expired.

6.2.14 Handling of Serving PLMN rate control

Serving PLMN rate control is applicable only for PDU sessions established for control plane CIoT 5GS optimization.

Serving PLMN rate control protect its AMF from the load generated by user data over control plane.

The SMF can inform the UE of any local serving PLMN rate control during the PDU session establishment procedure (see subclause 6.4.1) or the PDU session modification procedure (see subclause 6.4.2). If serving PLMN rate control is enabled, the SMF shall start the serving PLMN rate control for the PDU session when the first control plane user data is received over the PDU session. The UE shall limit the rate at which it generates uplink control plane user data to comply with the serving PLMN policy provided by the network. The indicated rate in a NAS procedure applies to the PDU session the NAS procedure corresponds to, and the indicated rate is valid until the PDU session is released.

Any Serving PLMN rate control information provided by the network to the UE is only applicable for the PLMN which provided this information. This serving PLMN rate control information shall be discarded when the UE successfully registers to another PLMN.

NOTE: The serving PLMN can discard or delay control plane user data that exceed the limit provided for Serving PLMN rate control.

6.2.15 Handling of Reliable Data Service

If the UE supports Reliable Data Service (see 3GPP TS 23.501 [8] and 3GPP TS 24.250 [14A]), the UE may request data transfer using Reliable Data Service for a PDU session in the Extended protocol configuration options IE during UE-requested PDU session establishment procedure (see subclause 6.4.1).

The Reliable Data Service may only be used with PDU sessions for which the "Control Plane CIoT 5GS Optimisation" indicator is set or with PDU sessions using the control plane CIoT 5GS optimization when the AMF does not move such PDU sessions to the user plane.

The network shall inform the UE about the acceptance of UE's request for Reliable Data Service usage during the PDU session establishment procedure (see subclause 6.4.1) in the Extended protocol configuration options IE.

If the network accepts the use of Reliable Data Service to transfer data for the specified PDU session, the UE shall use this PDU session exclusively for data transfer using Reliable Data Service; otherwise the UE shall not use this PDU session for data transfer using Reliable Data Service.

6.2.16 Handling of header compression for control plane CIoT optimizations

The UE and the SMF may use:

- IP header compression for PDU sessions of "IPv4", "IPv6" or "IPv4v6" PDU session type; and
- Ethernet header compression for PDU sessions of "Ethernet" PDU session type.

Both the UE and the AMF indicate whether header compression for control plane CIoT 5GS optimization is supported during registration procedures (see subclause 5.5.1). If both the UE and the network support header compression, the header compression configuration for each PDU session is negotiated during the PDU session establishment procedure and PDU session modification procedure as specified in subclauses 6.3.2, 6.4.1 and 6.4.2.

For IP header compression, ROHC protocol specified in IETF RFC 5795 [39B] is used. The IP header compression configuration used for IP header compression is (re-)negotiated between the UE and the SMF using the IP header compression configuration IE as specified in subclauses 6.3.2.2, 6.4.1.2, 6.4.1.3 and 6.4.2.2, respectively.

For Ethernet header compression, Ethernet Header Compression (EHC) protocol specified in 3GPP TS 38.323 [29] is used. The Ethernet header compression configuration used for Ethernet header compression is (re-)negotiated between the UE and the SMF using the Ethernet header compression configuration IE as specified in subclauses 6.3.2.2, 6.4.1.2, 6.4.1.3 and 6.4.2.2, respectively.

6.2.17 Handling of edge computing enhancements

EAS discovery, EAS rediscovery and ECS address provisioning provide enhanced edge computing support in 5GS (see 3GPP TS 23.548 [10A]).

If the network supports the session breakout connectivity model or distributed anchor connectivity model to enable edge computing enhancements and the UE generated DNS message is to be handled by an edge application server discovery function (EASDF) for EAS discovery as specified in 3GPP TS 23.548 [10A], the SMF selects the EASDF and it provides its IP address to the UE as the DNS server to be used for the PDU session in the Extended protocol configuration options IE during the UE-requested PDU session establishment procedure as described in subclause 6.4.1.3.

NOTE 1: EASDF selection is outside the scope of the present document.

If the network supports the session breakout connectivity model to enable edge computing enhancements and the UE generated DNS message is to be handled by a local DNS server for EAS discovery as specified in 3GPP TS 23.548 [10A], the SMF selects the local DNS server, obtains its IP address and can provide the IP address of the local DNS server to the UE as the DNS server to be used for the PDU session in the Extended protocol

configuration options IE during the UE-requested PDU session establishment procedure or the network-requested PDU session modification procedure as described in subclauses 6.4.1.3 and 6.3.2.2, respectively.

NOTE 2: Local DNS server selection and the acquisition of its IP address is outside the scope of the present document.

If the UE supports EAS rediscovery and the SMF decides to trigger the EAS rediscovery as specified in 3GPP TS 23.548 [10A], the SMF initiates a network-requested PDU session modification procedure to provide the EAS rediscovery information to the UE as described in subclauses 6.3.2.2. Upon receipt of the EAS rediscovery information, the UE provides the received information to the upper layers.

NOTE 3: The upper layers of the UE uses the EAS rediscovery information to trigger the EAS discovery procedure to get the new EAS information as specified in 3GPP TS 23.548 [10A].

If the UE supports ECS address provisioning over NAS as specified in 3GPP TS 23.548 [10A], the UE indicates its support of ECS configuration information provisioning over NAS in the Extended protocol configuration options IE either during the UE-requested PDU session establishment procedure as described in subclause 6.4.1.2 or while in S1 mode as described in 3GPP TS 24.301 [15], respectively.

If the UE indicated support of ECS configuration information address provisioning over NAS, the SMF can provide the ECS configuration information in the Extended protocol configuration options IE during the network-requested PDU session modification procedure, UE-requested PDU session establishment procedure or the UE-requested PDU session modification procedure as described in subclauses 6.3.2.2, 6.4.1.3 and 6.4.2.3, respectively.

NOTE 4: The SMF can obtain the ECS configuration information based on the local configuration, the UE's location, the UE's subscription information, or any combination of them.

If the UE supports the edge DNS client (EDC) as specified in 3GPP TS 23.548 [10A], the UE indicates its support of EDC in the Extended protocol configuration options IE during the UE-requested PDU session establishment procedure as described in subclause 6.4.1.2 or the UE-requested PDU session modification procedure as described in subclause 6.4.2.2.

If the UE indicates support of EDC, the SMF can indicate in the Extended protocol configuration options IE during the UE-requested PDU session establishment procedure as described in subclause 6.4.1.3 or the network-requested PDU session modification procedure as described in subclause 6.3.2.2, that the network allows the use of EDC for the applications which are mapped onto the PDU session and explicitly requested the use of EDC, or that the network requires the use of EDC for all applications mapped onto the PDU session.

6.2.18 Support of redundant PDU sessions

The 5GSM sublayer may support establishment of redundant PDU sessions (see subclause 5.33.2 of 3GPP TS 23.501 [8]).

In order to establish a set of two redundant PDU sessions, a UE can include a PDU session pair ID, an RSN, or both in a PDU SESSION ESTABLISHMENT REQUEST message for each of the two redundant PDU sessions (see subclause 6.4.1.2). The UE can set the PDU session pair ID, the RSN, or both according to URSP or UE local configuration (see 3GPP TS 24.526 [19]).

An SMF receiving a PDU session pair ID, an RSN, or both via a PDU SESSION ESTABLISHMENT REQUEST message operates as specified in subclause 5.33.2 of 3GPP TS 23.501 [8]. In addition, an SMF can handle two PDU sessions as redundant even if the UE provides neither a PDU session pair ID nor an RSN in a PDU SESSION ESTABLISHMENT REQUEST message for each of the PDU sessions (see subclause 5.33.2 of 3GPP TS 23.501 [8]).

6.2.19 Handling of maximum group data rate limitation control

The network can perform maximum group data rate limitation control to 5G VN groups as specified in 3GPP TS 23.503 [10]. If the maximum data rate of PDU sessions associated within a 5G VN group has been exceeded the maximum group data rate of the 5G VN group, the SMF may reject the PDU SESSION ESTABLISHMENT REQUEST message against the 5G VN group using S-NSSAI based congestion control as specified in subclause 6.2.8 and 6.4.1.4.2.

NOTE 1: The maximum group data rate limitation control does not apply for emergency services or for a UE configured for high priority access in selected PLMN or SNPN.

NOTE 2: The maximum group data rate limitation control is performed by the PCF.

6.2.20 Support of UL PDU set handling

If the network supports PDU set handling (see subclause 5.37.5 of 3GPP TS 23.501 [8]), based on operator policy, the SMF may provide the protocol description for UL PDU set handling in the PDU SESSION ESTABLISHMENT ACCEPT message or the PDU SESSION MODIFICATION COMMAND message to the UE. The UE can store the protocol description and may use it to identify PDUs belong to PDU sets for the uplink direction.

NOTE 1: Whether and how to use the protocol description to identify PDUs belonging to a PDU set in the uplink direction, is up to UE implementation. The use of protocol description does not impact UL user data packet matching in the UE.

NOTE 2: Whether and how to process PDUs belonging to a PDU set in the uplink direction, is up to UE implementation.

6.3 Network-requested 5GSM procedures

6.3.1 PDU session authentication and authorization procedure

6.3.1.1 General

The purpose of the PDU session authentication and authorization procedure is to enable the DN:

- a) to authenticate the upper layers of the UE, when establishing the PDU session;
- b) to authorize the upper layers of the UE, when establishing the PDU session;
- c) both of the above; or
- d) to re-authenticate the upper layers of the UE after establishment of the PDU session.

The PDU session authentication and authorization procedure can be performed only during or after the UE-requested PDU session procedure establishing a non-emergency PDU session. The PDU session authentication and authorization procedure shall not be performed during or after the UE-requested PDU session establishment procedure establishing an emergency PDU session.

The upper layers store the association between a DNN and corresponding credentials, if any, for the PDU session authentication and authorization.

If the UE is registered for onboarding services in SNPN the SMF may initiate the PDU session authentication and authorization procedure based on local policy with a DCS as specified in 3GPP TS 33.501 [24] subclause I.9.2.4.1 or a DN-AAA server as specified in 3GPP TS 33.501 [24] subclause I.9.2.4.2.

If the UE is registered for onboarding services in SNPN and the network initiates the PDU session authentication and authorization procedure, the UE shall use the default UE credentials for secondary authentication for the PDU session authentication and authorization procedure.

The network authenticates the UE using the Extensible Authentication Protocol (EAP) as specified in IETF RFC 3748 [34].

EAP has defined four types of EAP messages:

- a) an EAP-request message;
- b) an EAP-response message;
- c) an EAP-success message; and
- d) an EAP-failure message.

The EAP-request message is transported from the network to the UE using the PDU SESSION AUTHENTICATION COMMAND message of the PDU EAP message reliable transport procedure.

The EAP-response message to the EAP-request message is transported from the UE to the network using the PDU SESSION AUTHENTICATION COMPLETE message of the PDU EAP message reliable transport procedure.

If the PDU session authentication and authorization procedure is performed during the UE-requested PDU session establishment procedure:

- a) and the DN authentication of the UE completes successfully, the EAP-success message is transported from the network to the UE as part of the UE-requested PDU session establishment procedure in the PDU SESSION ESTABLISHMENT ACCEPT message.
- b) and the DN authentication of the UE completes unsuccessfully, the EAP-failure message is transported from the network to the UE as part of the UE-requested PDU session establishment procedure in the PDU SESSION ESTABLISHMENT REJECT message.

If the PDU session authentication and authorization procedure is performed after the UE-requested PDU session establishment procedure:

- a) and the DN authentication of the UE completes successfully, the EAP-success message is transported from the network to the UE using the PDU SESSION AUTHENTICATION RESULT message of the PDU EAP result message transport procedure.
- b) and the DN authentication of the UE completes unsuccessfully, the EAP-failure message is transported from the network to the UE using the PDU SESSION RELEASE COMMAND message of the network-requested PDU session release procedure.

There can be several rounds of exchange of an EAP-request message and a related EAP-response message for the DN to complete the authentication and authorization of the request for a PDU session (see example in figure 6.3.1.1).

The SMF shall set the authenticator retransmission timer specified in IETF RFC 3748 [34] subclause 4.3 to infinite value.

NOTE: The PDU session authentication and authorization procedure provides a reliable transport of EAP messages and therefore retransmissions at the EAP layer of the SMF do not occur.

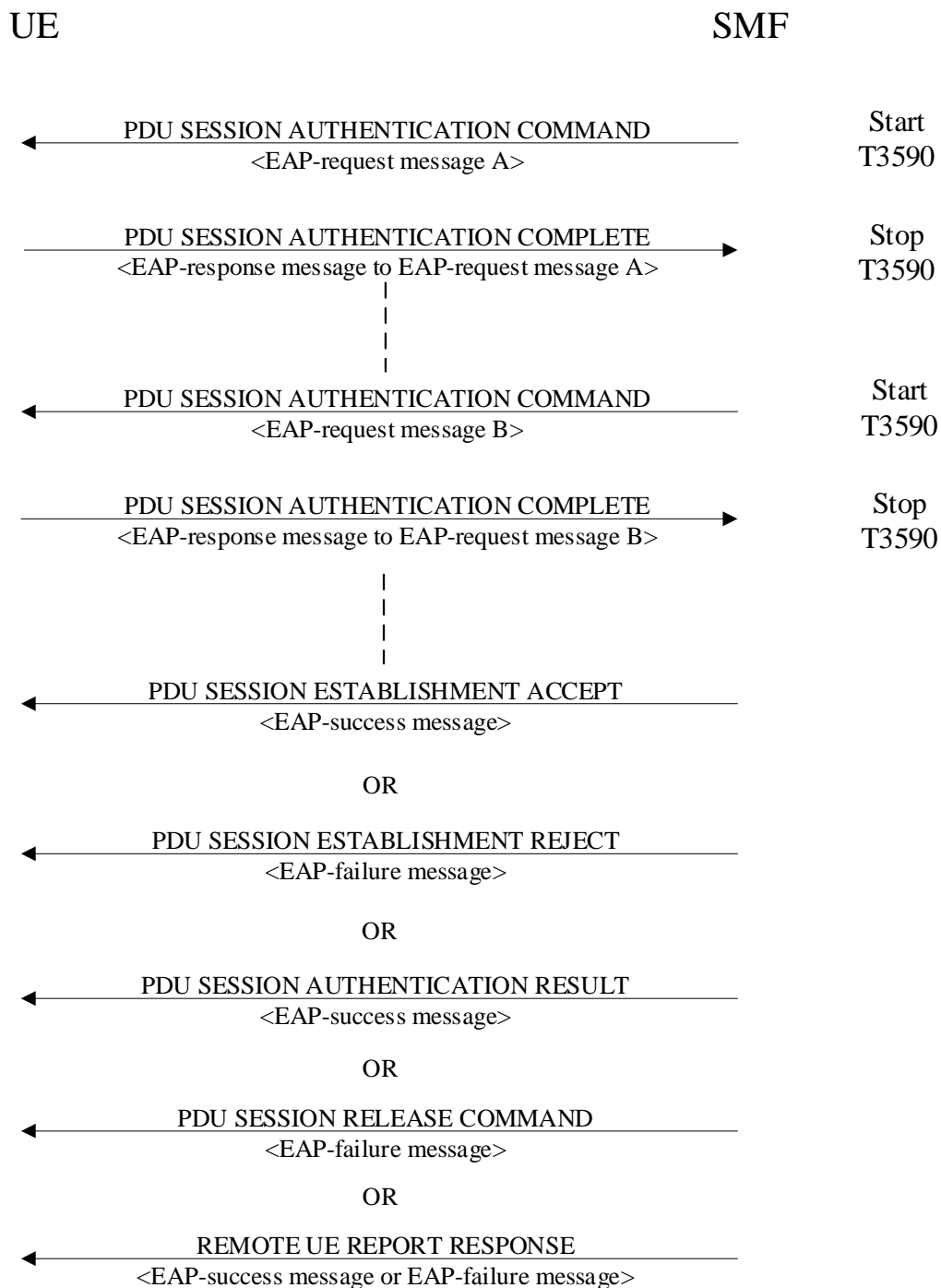

Figure 6.3.1.1: PDU session authentication and authorization procedure

6.3.1.2 PDU EAP message reliable transport procedure

6.3.1.2.1 PDU EAP message reliable transport procedure initiation

In order to initiate the PDU EAP message reliable transport procedure, the SMF shall create a PDU SESSION AUTHENTICATION COMMAND message.

The SMF shall set the PTI IE of the PDU SESSION AUTHENTICATION COMMAND message to "No procedure transaction identity assigned".

The SMF shall set the EAP message IE of the PDU SESSION AUTHENTICATION COMMAND message to the EAP-request message provided by the DN or generated locally.

The SMF shall send the PDU SESSION AUTHENTICATION COMMAND message, and the SMF shall start timer T3590 (see example in figure 6.3.1.1).

Upon receipt of the PDU SESSION AUTHENTICATION COMMAND message, if the UE provided a DNN during the PDU session establishment, the UE shall stop timer T3396, if it is running for the DNN provided by the UE. If the UE did not provide a DNN during the PDU session establishment, the UE shall stop the timer T3396 associated with no DNN if it is running. In an SNPN, the timer T3396 to be stopped includes:

- a) the timer T3396 applied for all the equivalent SNPNs, associated with the RSNPN or an equivalent SNPN, and with the selected entry of the "list of subscriber data" or the selected PLMN subscription, if running; and
- b) the timer T3396 applied for the registered SNPN, associated with the RSNPN, and, if the UE supports access to an SNPN using credentials from a credentials holder, associated with the selected entry of the "list of subscriber data" or the selected PLMN subscription, if running.

Upon receipt of the PDU SESSION AUTHENTICATION COMMAND message, if the UE provided an S-NSSAI and a DNN during the PDU session establishment, the UE shall stop timer T3584, if it is running for the [S-NSSAI of the PDU session, DNN] combination. If the UE provided a DNN but did not provide an S-NSSAI during the PDU session establishment, the UE shall stop timer T3584, if it is running for the same [no S-NSSAI, DNN] combination provided by the UE. If the UE provided an S-NSSAI but did not provide a DNN during the PDU session establishment, the UE shall stop timer T3584, if it is running for the same [S-NSSAI, no DNN] combination provided by the UE. If the UE provided neither a DNN nor an S-NSSAI during the PDU session establishment, the UE shall stop timer T3584, if it is running for the same [no S-NSSAI, no DNN] combination provided by the UE. The timer T3584 to be stopped includes:

- a) in a PLMN:
 - 1) the timer T3584 applied for all the PLMNs, if running; and
 - 2) the timer T3584 applied for the registered PLMN, if running; or
- b) in an SNPN:
 - 1) the timer T3584 applied for all the equivalent SNPNs, and associated with the RSNPN or an equivalent SNPN and with the selected entry of the "list of subscriber data" or the selected PLMN subscription, if running; and
 - 2) the timer T3584 applied for the registered SNPN, associated with the RSNPN and, if the UE supports access to an SNPN using credentials from a credentials holder, equivalent SNPNs or both, associated with the selected entry of the "list of subscriber data" or the selected PLMN subscription, if running.

Upon receipt of the PDU SESSION AUTHENTICATION COMMAND message, if the UE provided an S-NSSAI during the PDU session establishment, the UE shall stop timer T3585, if it is running for the S-NSSAI of the PDU session. If the UE did not provide an S-NSSAI during the PDU session establishment, the UE shall stop the timer T3585 associated with no S-NSSAI if it is running. The timer T3585 to be stopped includes:

- a) in a PLMN:
 - 1) the timer T3585 applied for all the PLMNs and for the access over which the PDU SESSION AUTHENTICATION COMMAND message is received, if running;
 - 2) the timer T3585 applied for all the PLMNs and for both 3GPP access type and non-3GPP access type, if running;
 - 3) the timer T3585 applied for the registered PLMN and for the access over which the PDU SESSION AUTHENTICATION COMMAND message is received, if running; and
 - 4) the timer T3585 applied for the registered PLMN and for both 3GPP access type and non-3GPP access type, if running; or
- b) in an SNPN:

- 1) the timer T3585 applied for all the equivalent SNPNs and for the access over which the PDU SESSION AUTHENTICATION COMMAND message is received, associated with the RSNPN or an equivalent SNPN and with the selected entry of the "list of subscriber data" or the selected PLMN subscription, if running;
- 2) the timer T3585 applied for all the equivalent SNPNs and for both 3GPP access type and non-3GPP access type, associated with the RSNPN or an equivalent SNPN and with the selected entry of the "list of subscriber data" or the selected PLMN subscription, if running;
- 3) the timer T3585 applied for the registered SNPN and for the access over which the PDU SESSION AUTHENTICATION COMMAND message is received, associated with the RSNPN and, if the UE supports access to an SNPN using credentials from a credentials holder, equivalent SNPNs or both, associated with the selected entry of the "list of subscriber data" or the selected PLMN subscription, if running; and
- 4) the timer T3585 applied for the registered PLMN and for both 3GPP access type and non-3GPP access type, associated with the RSNPN and, if the UE supports access to an SNPN using credentials from a credentials holder, equivalent SNPNs or both, associated with the selected entry of the "list of subscriber data" or the selected PLMN subscription, if running.

NOTE 1: Upon receipt of the PDU SESSION AUTHENTICATION COMMAND message for a PDU session, if the UE provided a DNN (or no DNN) and an S-NSSAI (or no S-NSSAI) when the PDU session is established, timer T3396 associated with the DNN (or no DNN, if no DNN was provided by the UE) is running, and timer T3584 associated with the DNN (or no DNN, if no DNN was provided by the UE) and the S-NSSAI (or no S-NSSAI, if no S-NSSAI was provided by the UE) is running, then the UE stops both the timer T3396 and the timer T3584.

NOTE 2: Upon receipt of the PDU SESSION AUTHENTICATION COMMAND message for a PDU session, if the UE provided a DNN (or no DNN) and an S-NSSAI (or no S-NSSAI) when the PDU session is established, timer T3585 associated with the S-NSSAI (or no S-NSSAI, if no S-NSSAI was provided by the UE) is running, and timer T3584 associated with the DNN (or no DNN, if no DNN was provided by the UE) and the S-NSSAI (or no S-NSSAI, if no S-NSSAI was provided by the UE) is running, then the UE stops both the timer T3585 and the timer T3584.

Upon receipt of a PDU SESSION AUTHENTICATION COMMAND message and a PDU session ID, using the NAS transport procedure as specified in subclause 5.4.5, the UE passes to the upper layers the EAP message received in the EAP message IE of the PDU SESSION AUTHENTICATION COMMAND message. Apart from this action and the stopping of timers T3396, T3584 and T3485 (if running), the authentication and authorization procedure initiated by the DN is transparent to the 5GSM layer of the UE.

6.3.1.2.2 PDU EAP message reliable transport procedure accepted by the UE

The UE shall create a PDU SESSION AUTHENTICATION COMPLETE message when the upper layers provide an EAP-response message responding to the received EAP-request message.

The UE shall set the EAP message IE of the PDU SESSION AUTHENTICATION COMPLETE message to the EAP-response message.

The UE shall transport the PDU SESSION AUTHENTICATION COMPLETE message and the PDU session ID, using the NAS transport procedure as specified in subclause 5.4.5. Apart from this action, the authentication and authorization procedure initiated by the DN is transparent to the 5GSM layer of the UE.

Upon receipt of a PDU SESSION AUTHENTICATION COMPLETE message, the SMF shall stop timer T3590 and provides the EAP message received in the EAP message IE of the PDU SESSION AUTHENTICATION COMPLETE message to the DN or handles it locally.

6.3.1.2.3 Abnormal cases on the network side

The following abnormal cases can be identified:

- a) T3590 expired.

The SMF shall, on the first expiry of the timer T3590, retransmit the PDU SESSION AUTHENTICATION COMMAND message and shall reset and start timer T3590. This retransmission is repeated four times, i.e. on the fifth expiry of timer T3590, the SMF shall abort the procedure.

- b) Collision of UE-requested PDU session release procedure and a PDU session authentication and authorization procedure.

When the SMF receives a PDU SESSION RELEASE REQUEST message during the PDU session authentication and authorization procedure, and the PDU session indicated in the PDU SESSION RELEASE REQUEST message is the PDU session that the SMF had requested to authenticate, the SMF shall abort the PDU session authentication and authorization procedure and proceed with the UE-requested PDU session release procedure.

6.3.1.2.4 Abnormal cases in the UE

The following abnormal cases can be identified:

- a) PDU session inactive for the received PDU session ID.

If the PDU session ID in the PDU SESSION AUTHENTICATION COMMAND message belongs to any PDU session in state PDU SESSION INACTIVE in the UE, the UE shall send a 5GSM STATUS message with the 5GSM cause IE set to #43 "Invalid PDU session identity".

- b) Collision of UE-requested PDU session release procedure and a PDU session authentication and authorization procedure.

When the UE receives a PDU SESSION AUTHENTICATION COMMAND message during the UE-requested PDU session release procedure, and the PDU session indicated in PDU SESSION AUTHENTICATION COMMAND message is the PDU session that the UE had requested to release, the UE shall ignore the PDU SESSION AUTHENTICATION COMMAND message and proceed with the UE-requested PDU session release procedure.

6.3.1.3 PDU EAP result message transport procedure

6.3.1.3.1 PDU EAP result message transport procedure initiation

PDU EAP result message transport procedure is initiated by the SMF if the PDU session authentication and authorization procedure is performed after the PDU session is established and the DN authentication of the UE completes successfully.

In order to initiate the PDU EAP result message transport procedure, the SMF shall create a PDU SESSION AUTHENTICATION RESULT message.

The SMF shall set the PTI IE of the PDU SESSION AUTHENTICATION RESULT message to "No procedure transaction identity assigned".

The SMF shall set the EAP message IE of the PDU SESSION AUTHENTICATION RESULT message to the EAP-success message provided by the DN.

The SMF shall send the PDU SESSION AUTHENTICATION RESULT message.

Upon receipt of a PDU SESSION AUTHENTICATION RESULT message and a PDU session ID, using the NAS transport procedure as specified in subclause 5.4.5, the UE passes to the upper layers the EAP message received in the EAP message IE of the PDU SESSION AUTHENTICATION RESULT message. Apart from this action, the authentication and authorization procedure initiated by the DN is transparent to the 5GSM layer of the UE.

6.3.1.3.2 Abnormal cases in the UE

The following abnormal cases can be identified:

- a) PDU session inactive for the received PDU session ID.

If the PDU session ID in the PDU SESSION AUTHENTICATION RESULT message belongs to any PDU session in state PDU SESSION INACTIVE in the UE, the UE shall send a 5GSM STATUS message with the 5GSM cause IE set to #43 "Invalid PDU session identity".

- b) Collision of UE-requested PDU session release procedure and a PDU EAP result message transport procedure.

When the UE receives a PDU SESSION AUTHENTICATION RESULT message during the UE-requested PDU session release procedure, and the PDU session indicated in PDU SESSION AUTHENTICATION RESULT message is the PDU session that the UE had requested to release, the UE shall ignore the PDU SESSION AUTHENTICATION RESULT message and proceed with the UE-requested PDU session release procedure.

6.3.1A Service-level authentication and authorization procedure

6.3.1A.1 General

The purpose of the service-level authentication and authorization (service-level-AA) procedure is to enable the DN using NEF services for authentication:

- a) to authenticate the upper layers of the UE, when establishing the PDU session;
- b) to authorize the upper layers of the UE, when establishing the PDU session;
- c) both of the above; or
- d) to re-authenticate the upper layers of the UE after establishment of the PDU session.

The service-level authentication and authorization procedure is used for UUAA as specified in 3GPP TS 23.256 [6AB].

NOTE 1: The authentication protocol for UUAA is out of scope of 3GPP in this release of specification.

The service-level authentication and authorization procedure can be performed only during or after the UE-requested PDU session procedure establishing a non-emergency PDU session. The service-level authentication and authorization procedure shall not be performed during or after the UE-requested PDU session establishment procedure establishing an emergency PDU session.

If the service-level authentication and authorization procedure is performed during the UE-requested PDU session establishment procedure:

- a) and the service-level-AA procedure of the UE completes successfully, the service-level-AA response is transported from the network to the UE as a part of the UE-requested PDU session establishment procedure in the PDU SESSION ESTABLISHMENT ACCEPT message; or
- b) and the service-level-AA procedure of the UE completes unsuccessfully, the service-level-AA response is transported from the network to the UE as a part of the UE-requested PDU session establishment procedure in the PDU SESSION ESTABLISHMENT REJECT message.

NOTE 2: If the SMF receives the HTTP code set to "4xx" or "5xx" as specified in 3GPP TS 29.500 [20AA] or the SMF detects a UUAA-SM failure as specified in 3GPP TS 29.256 [21B], then the SMF considers that the UUAA-SM procedure has completed unsuccessfully.

If the service-level authentication and authorization procedure is performed for the established PDU session with re-authentication purpose:

- a) and the service-level-AA procedure of the UE completes successfully, the service-level-AA response is transported from the network to the UE as a part of the network-requested PDU session modification procedure in the PDU SESSION MODIFICATION COMMAND message; or
- b) and the service-level-AA procedure of the UE completes unsuccessfully, the service-level-AA response is transported from the network to the UE as a part of the network-requested PDU session release procedure in the PDU SESSION RELEASE COMMAND message.

There can be several rounds of exchange of a service-level-AA payload for the service to complete the service-level authentication and authorization of the request for a PDU session (see example in figure 6.3.1A.1-1).

If the UE receives the service-level-AA response in the PDU SESSION ESTABLISHMENT ACCEPT message or the PDU SESSION ESTABLISHMENT REJECT message, the UE passes it to the upper layer.

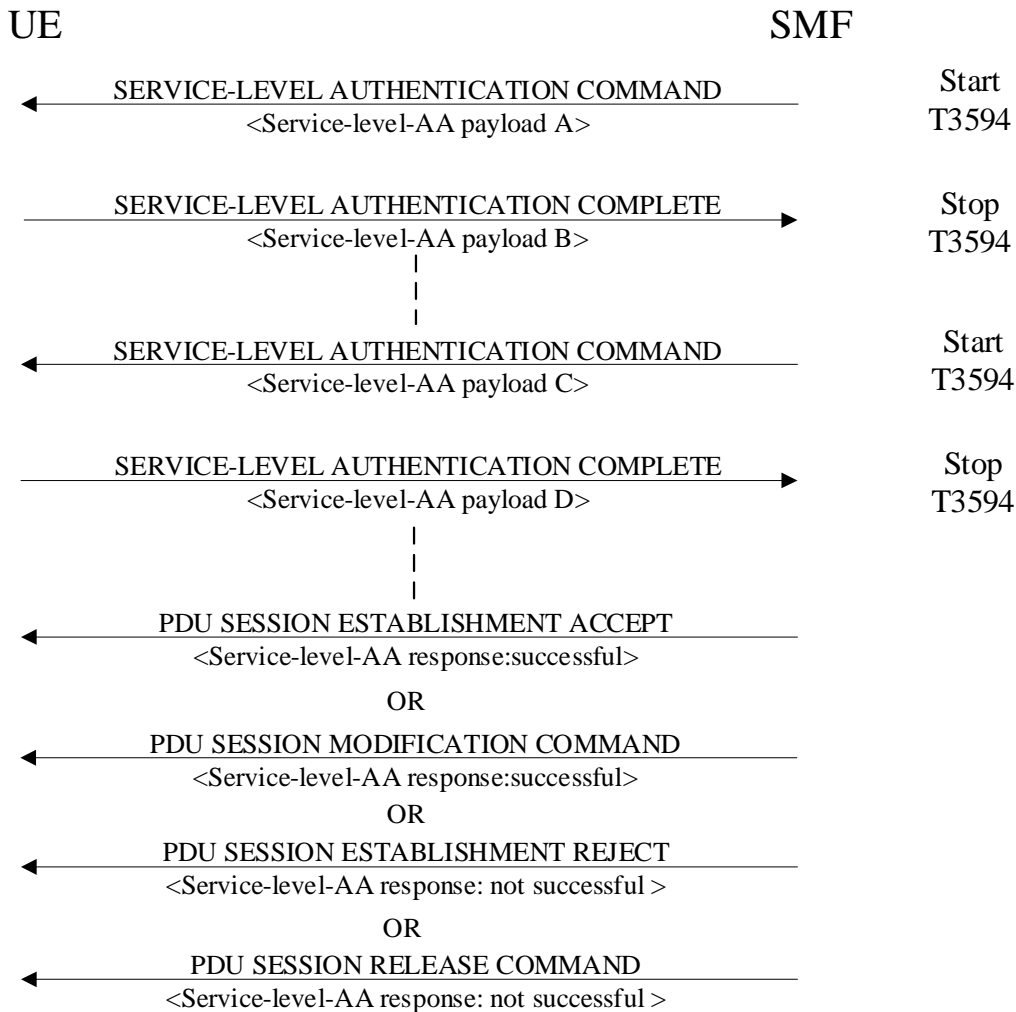

Figure 6.3.1A.1-1: Service-level authentication and authorization procedure

6.3.1A.2 Service-level authentication and authorization procedure initiation

In order to initiate the service-level authentication and authorization procedure, the SMF shall create a SERVICE-LEVEL AUTHENTICATION COMMAND message.

The SMF shall set the PTI IE of the SERVICE-LEVEL AUTHENTICATION COMMAND message to "No procedure transaction identity assigned".

The SMF shall set the service-level-AA payload in the Service-level-AA container IE of the SERVICE-LEVEL AUTHENTICATION COMMAND message to the payload provided by the DN via the NEF. If a payload type associated with the payload is provided by the DN via the NEF, the SMF shall set the service-level-AA payload type with the value set to the payload type.

NOTE 1: In case of UAAA, the service-level-AA payload is provided by the DN via the UAS-NF.

The SMF shall send the SERVICE-LEVEL AUTHENTICATION COMMAND message, and the SMF shall start timer T3594 (see example in figure 6.3.1A.1-1).

Upon receipt of the SERVICE-LEVEL AUTHENTICATION COMMAND message, if the UE provided a DNN during the PDU session establishment, the UE shall stop timer T3396, if it is running for the DNN provided by the UE. If the UE did not provide a DNN during the PDU session establishment, the UE shall stop the timer T3396 associated with no DNN if it is running. In an SNPN, the timer T3396 to be stopped includes:

- a) the timer T3396 applied for all the equivalent SNPNs, associated with the RSNPN or an equivalent SNPN, and with the selected entry of the "list of subscriber data" or the selected PLMN subscription, if running; and

- b) the timer T3396 applied for the registered SNPN, associated with the RSNPN, and, if the UE supports access to an SNPN using credentials from a credentials holder, associated with the selected entry of the "list of subscriber data" or the selected PLMN subscription, if running.

Upon receipt of the SERVICE-LEVEL AUTHENTICATION COMMAND message, if the UE provided an S-NSSAI and a DNN during the PDU session establishment, the UE shall stop timer T3584, if it is running for the [S-NSSAI of the PDU session, DNN] combination. If the UE provided a DNN but did not provide an S-NSSAI during the PDU session establishment, the UE shall stop timer T3584, if it is running for the same [no S-NSSAI, DNN] combination provided by the UE. If the UE provided an S-NSSAI but did not provide a DNN during the PDU session establishment, the UE shall stop timer T3584, if it is running for the same [S-NSSAI, no DNN] combination provided by the UE. If the UE provided neither a DNN nor an S-NSSAI during the PDU session establishment, the UE shall stop timer T3584, if it is running for the same [no S-NSSAI, no DNN] combination provided by the UE. The timer T3584 to be stopped includes:

- a) in a PLMN:
 - 1) the timer T3584 applied for all the PLMNs, if running, and
 - 2) the timer T3584 applied for the registered PLMN, if running; or
- b) in an SNPN:
 - 1) the timer T3584 applied for all the equivalent SNPNS, and associated with the RSNPN or an equivalent SNPN and with the selected entry of the "list of subscriber data" or the selected PLMN subscription, if running; and
 - 2) the timer T3584 applied for the registered SNPN, associated with the RSNPN and, if the UE supports access to an SNPN using credentials from a credentials holder, equivalent SNPNS or both, associated with the selected entry of the "list of subscriber data" or the selected PLMN subscription, if running.

Upon receipt of the SERVICE-LEVEL AUTHENTICATION COMMAND message, if the UE provided an S-NSSAI during the PDU session establishment, the UE shall stop timer T3585, if it is running for the S-NSSAI of the PDU session. If the UE did not provide an S-NSSAI during the PDU session establishment, the UE shall stop the timer T3585 associated with no S-NSSAI if it is running. The timer T3585 to be stopped includes:

- a) in a PLMN:
 - the timer T3585 applied for all the PLMNs and for the access over which the SERVICE-LEVEL AUTHENTICATION COMMAND message is received, if running;
 - the timer T3585 applied for all the PLMNs and for both 3GPP access type and non-3GPP access type, if running;
 - the timer T3585 applied for the registered PLMN and for the access over which the SERVICE-LEVEL AUTHENTICATION COMMAND message is received, if running; and
 - the timer T3585 applied for the registered PLMN and for both 3GPP access type and non-3GPP access type, if running; or
- b) in an SNPN:
 - 1) the timer T3585 applied for all the equivalent SNPNS and for the access over which the PDU SESSION AUTHENTICATION COMMAND message is received, associated with the RSNPN or an equivalent SNPN and with the selected entry of the "list of subscriber data" or the selected PLMN subscription, if running;
 - 2) the timer T3585 applied for all the equivalent SNPNS and for both 3GPP access type and non-3GPP access type, associated with the RSNPN or an equivalent SNPN and with the selected entry of the "list of subscriber data" or the selected PLMN subscription, if running;
 - 3) the timer T3585 applied for the registered SNPN and for the access over which the PDU SESSION AUTHENTICATION COMMAND message is received, associated with the RSNPN and, if the UE supports access to an SNPN using credentials from a credentials holder, equivalent SNPNS or both, associated with the selected entry of the "list of subscriber data" or the selected PLMN subscription, if running; and
 - 4) the timer T3585 applied for the registered PLMN and for both 3GPP access type and non-3GPP access type, associated with the RSNPN and, if the UE supports access to an SNPN using credentials from a credentials

holder, equivalent SNPNs or both, associated with the selected entry of the "list of subscriber data" or the selected PLMN subscription, if running.

NOTE 2: Upon receipt of the SERVICE-LEVEL AUTHENTICATION COMMAND message for a PDU session, if the UE provided a DNN (or no DNN) and an S-NSSAI (or no S-NSSAI) when the PDU session is established, timer T3396 associated with the DNN (or no DNN, if no DNN was provided by the UE) is running, and timer T3584 associated with the DNN (or no DNN, if no DNN was provided by the UE) and the S-NSSAI (or no S-NSSAI, if no S-NSSAI was provided by the UE) is running, then the UE stops both the timer T3396 and the timer T3584.

NOTE 3: Upon receipt of the SERVICE-LEVEL AUTHENTICATION COMMAND message for a PDU session, if the UE provided a DNN (or no DNN) and an S-NSSAI (or no S-NSSAI) when the PDU session is established, timer T3585 associated with the S-NSSAI (or no S-NSSAI, if no S-NSSAI was provided by the UE) is running, and timer T3584 associated with the DNN (or no DNN, if no DNN was provided by the UE) and the S-NSSAI (or no S-NSSAI, if no S-NSSAI was provided by the UE) is running, then the UE stops both the timer T3585 and the timer T3584.

Upon receipt of a SERVICE-LEVEL AUTHENTICATION COMMAND message and a PDU session ID, using the NAS transport procedure as specified in subclause 5.4.5, the UE passes to the upper layers the service-level-AA payload received in the Service-level-AA container IE of the SERVICE-LEVEL AUTHENTICATION COMMAND message. Apart from this action, the service-level authentication and authorization procedure initiated by the DN is transparent to the 5GSM layer of the UE.

6.3.1A.3 Service-level authentication and authorization procedure accepted by the UE

When the upper layers provide a service-level-AA payload, the UE shall create a SERVICE-LEVEL AUTHENTICATION COMPLETE message and set the service-level-AA payload of the Service-level-AA container IE to the service-level-AA payload received from the upper layers, and if the service-level-AA payload type is received in the SERVICE-LEVEL AUTHENTICATION COMMAND message from the SMF, set the service-level-AA payload type of the Service-level-AA container IE to the service-level-AA payload type received from the SMF.

The UE shall transport the SERVICE-LEVEL AUTHENTICATION COMPLETE message and the PDU session ID, using the NAS transport procedure as specified in subclause 5.4.5. Apart from this action, the service-level authentication and authorization procedure initiated by the DN is transparent to the 5GSM layer of the UE.

Upon receipt of a SERVICE-LEVEL AUTHENTICATION COMPLETE message, the SMF shall stop timer T3594 and provides the service-level-AA payload received in the Service-level-AA container IE of the SERVICE-LEVEL AUTHENTICATION COMPLETE message to the DN.

6.3.1A.4 Abnormal cases on the network side

The following abnormal cases can be identified:

- a) Expiry of timer T3594.

On the first expiry of the timer T3594, the SMF shall resend the SERVICE-LEVEL AUTHENTICATION COMMAND message and shall reset and restart timer T3594. This retransmission is repeated four times, i.e., on the fifth expiry of timer T3594, the SMF shall abort the procedure and send PDU SESSION ESTABLISHMENT REJECT message with the 5GSM cause #29 "user authentication or authorization failed" as specified in subclause 6.4.1.4.1.

6.3.1A.5 Abnormal cases in the UE

The following abnormal case can be identified:

- a) Collision of UE-requested PDU session release procedure and a service-level authentication and authorization procedure.

When the UE receives a SERVICE-LEVEL AUTHENTICATION COMMAND message during the UE-requested PDU session release procedure, and the PDU session indicated in SERVICE-LEVEL AUTHENTICATION COMMAND message is the PDU session that the UE has requested to release, the UE shall ignore the SERVICE-LEVEL AUTHENTICATION COMMAND message and proceed with the UE-requested PDU session release procedure.

6.3.2 Network-requested PDU session modification procedure

6.3.2.1 General

The purpose of the network-requested PDU session modification procedure is to enable the network to modify a PDU session, re-negotiate header compression configuration associated to a PDU session, convey a port management information container, to trigger EAS rediscovery, provide updated DNS server address(es) due to the newly selected local DNS server or the newly selected EASDF, provide updated ECS configuration information, remove joined UE from one or more multicast MBS sessions associated with a PDU session, update ATSSS parameters (e.g. ATSSS rules), update the MBS service area or the security information of multicast MBS session that the UE has joined or to inform about the result of service-level AA procedure or C2 authorization for UAS services.

6.3.2.2 Network-requested PDU session modification procedure initiation

In order to initiate the network-requested PDU session modification procedure, the SMF shall create a PDU SESSION MODIFICATION COMMAND message.

If the authorized QoS rules of the PDU session is modified or is marked as to be synchronised with the UE, the SMF shall set the Authorized QoS rules IE of the PDU SESSION MODIFICATION COMMAND message to the authorized QoS rules of the PDU session. The SMF shall ensure that the number of the packet filters used in the authorized QoS rules of the PDU Session does not exceed the maximum number of packet filters supported by the UE for the PDU session. The SMF may bind service data flows for which the UE has requested traffic segregation to a dedicated QoS flow for the PDU session, if possible. Otherwise the SMF may bind the service data flows to an existing QoS flow. The SMF shall use only one dedicated QoS flow for traffic segregation. If the UE has requested traffic segregation for multiple service data flows with different QoS handling, the SMF shall bind all these service data flows to a single QoS flow. If the SMF allows traffic segregation for service data flows in a QoS rule, then the SMF shall create a new authorized QoS rule for these service data flows and shall delete packet filters corresponding to these service data flows from the other authorized QoS rules.

If the authorized QoS flow descriptions of the PDU session is modified or is marked as to be synchronised with the UE, the SMF shall set the Authorized QoS flow descriptions IE of the PDU SESSION MODIFICATION COMMAND message to the authorized QoS flow descriptions of the PDU session.

If SMF creates a new authorized QoS rule for a new QoS flow, then SMF shall include the authorized QoS flow description for that QoS flow in the Authorized QoS flow descriptions IE of the PDU SESSION MODIFICATION COMMAND message, if:

- a) the newly created authorized QoS rules is for a new GBR QoS flow;
- b) the QFI of the new QoS flow is not the same as the 5QI of the QoS flow identified by the QFI;
- c) the new QoS flow can be mapped to an EPS bearer as specified in subclause 4.11.1 of 3GPP TS 23.502 [9]; or
- d) the new QoS flow is established for the PDU session used for relaying, as specified in subclause 5.6.2.1 of 3GPP TS 23.304 [6E].

NOTE 0: In cases other than above listed cases, it is up to the SMF implementation to include the authorized QoS flow description of the new QoS flow for the new authorized QoS rule in the Authorized QoS flow descriptions IE of the PDU SESSION MODIFICATION COMMAND message.

If the session-AMBR of the PDU session is modified, the SMF shall set the selected Session-AMBR IE of the PDU SESSION MODIFICATION COMMAND message to the session-AMBR of the PDU session.

If interworking with EPS is supported for the PDU session and if the mapped EPS bearer contexts of the PDU session is modified, the SMF shall set the Mapped EPS bearer contexts IE of the PDU SESSION MODIFICATION COMMAND message to the mapped EPS bearer contexts of the PDU session. If the association between a QoS flow and the mapped EPS bearer context is changed, the SMF shall set the EPS bearer identity parameter in Authorized QoS flow descriptions IE of the PDU SESSION MODIFICATION COMMAND message to the new EPS bearer identity associated with the QoS flow.

NOTE 0A: The SMF can include multiple mapped EPS bearer context fields with the same EPS bearer identity in the Mapped EPS bearer contexts IE of the PDU SESSION MODIFICATION COMMAND message in cases, e.g. the packet filters need to be modified and the modification requires more than one TFT operation codes or the mapped traffic flow template needs to be modified and the modification exceeds the maximum size of the TFT IE.

If the network-requested PDU session modification procedure is triggered by a UE-requested PDU session modification procedure and the PDU SESSION MODIFICATION REQUEST message includes a 5GSM capability IE, the SMF shall:

- a) if the RQoS bit is set to:
 - 1) "Reflective QoS supported", consider that the UE supports reflective QoS for this PDU session; or
 - 2) "Reflective QoS not supported", consider that the UE does not support reflective QoS for this PDU session; and;
- b) if the MH6-PDU bit is set to:
 - 1) "Multi-homed IPv6 PDU session supported", consider that this PDU session is supported to use multiple IPv6 prefixes; or
 - 2) "Multi-homed IPv6 PDU session not supported", consider that this PDU session is not supported to use multiple IPv6 prefixes.

If the SMF considers that reflective QoS is supported for QoS flows belonging to this PDU session, the SMF may include the RQ timer IE set to an RQ timer value in the PDU SESSION MODIFICATION COMMAND message.

If a port management information container needs to be delivered (see 3GPP TS 23.501 [8] and 3GPP TS 23.502 [9]) and the UE has set the TPMIC bit to "Transfer of port management information containers supported" in the 5GSM capability IE, the SMF shall include a Port management information container IE in the PDU SESSION MODIFICATION COMMAND message.

For a PDN connection established when in S1 mode, upon an inter-system change from S1 mode to N1 mode, if the network-requested PDU session modification procedure is triggered by a UE-requested PDU session modification procedure and a UE-requested PDU session modification procedure has not been successfully performed yet, the PDU session type is "IPv4", "IPv6", "IPv4v6" or "Ethernet" and the PDU SESSION MODIFICATION REQUEST message includes a Maximum number of supported packet filters IE, the SMF shall consider this number as the maximum number of packet filters that can be supported by the UE for this PDU session. Otherwise the SMF considers that the UE supports 16 packet filters for this PDU session.

For a PDN connection established when in S1 mode, upon an inter-system change from S1 mode to N1 mode, if the network-requested PDU session modification procedure is triggered by a UE-requested PDU session modification procedure and a UE-requested PDU session modification procedure has not been successfully performed yet, the SMF shall consider that the maximum data rate per UE for user-plane integrity protection supported by the UE for uplink and the maximum data rate per UE for user-plane integrity protection supported by the UE for downlink are valid for the lifetime of the PDU session.

For a PDN connection established when in S1 mode, upon an inter-system change from S1 mode to N1 mode, if the network-requested PDU session modification procedure is triggered by a UE-requested PDU session modification procedure and a UE-requested PDU session modification procedure has not been successfully performed yet, and the SMF determines, based on local policies or configurations in the SMF and the Always-on PDU session requested IE in the PDU SESSION MODIFICATION REQUEST message (if available), that either:

- a) the requested PDU session needs to be an always-on PDU session, the SMF shall include the Always-on PDU session indication IE in the PDU SESSION MODIFICATION COMMAND message and shall set the value to "Always-on PDU session required"; or
- b) the requested PDU session shall not be an always-on PDU session and:
 - 1) if the UE included the Always-on PDU session requested IE, the SMF shall include the Always-on PDU session indication IE in the PDU SESSION MODIFICATION COMMAND message and shall set the value to "Always-on PDU session not allowed"; or

- 2) if the UE did not include the Always-on PDU session requested IE, the SMF shall not include the Always-on PDU session indication IE in the PDU SESSION MODIFICATION COMMAND message.

For a PDN connection established when in S1 mode, upon an inter-system change from S1 mode to N1 mode, if the network-requested PDU session modification procedure is triggered by a UE-requested PDU session modification procedure, a UE-requested PDU session modification procedure has not been successfully performed yet, the UE supports EDC and the network allows the use of EDC, then the SMF shall include the Extended protocol configuration options IE in the PDU SESSION MODIFICATION COMMAND message with the EDC usage allowed indicator.

For a PDN connection established when in S1 mode, upon an inter-system change from S1 mode to N1 mode, if the network-requested PDU session modification procedure is triggered by a UE-requested PDU session modification procedure, a UE-requested PDU session modification procedure has not been successfully performed yet, the UE supports EDC and the network requires the use of EDC, then the SMF shall include the Extended protocol configuration options IE in the PDU SESSION MODIFICATION COMMAND message with the EDC usage required indicator.

If a QoS flow for URLLC is created in a PDU session and the SMF has not provided the Always-on PDU session indication IE with the value set to "Always-on PDU session required" in the UE-requested PDU session establishment procedure or a network-requested PDU session modification procedure for the PDU session, the SMF shall include the Always-on PDU session indication IE in the PDU SESSION MODIFICATION COMMAND message and shall set the value to "Always-on PDU session required".

For a PDN connection, upon an inter-system change from S1 mode to N1 mode, if the network-requested PDU session modification procedure is triggered by a UE-requested PDU session modification procedure and a UE-requested PDU session modification procedure has not been successfully performed yet, the PDU session is a single access PDU session over 3GPP access with IP PDU session type, the SMF may decide to provide the protocol description associated with the PDU session and may include the Protocol description IE in the PDU SESSION MODIFICATION COMMAND message.

If the value of the RQ timer is set to "deactivated" or has a value of zero, the UE considers that RQoS is not applied for this PDU session and remove the derived QoS rule(s) associated with the PDU session, if any.

If the network-requested PDU session modification procedure is triggered by a UE-requested PDU session modification procedure, the SMF shall set the PTI IE of the PDU SESSION MODIFICATION COMMAND message to the PTI of the PDU SESSION MODIFICATION REQUEST message received as part of the UE-requested PDU session modification procedure.

If the network-requested PDU session modification procedure is triggered by a UE-requested PDU session modification procedure and the UE has included the Requested MBS container IE in the PDU SESSION MODIFICATION REQUEST message with the MBS operation set to "Join multicast MBS session", the SMF:

- a) shall include the TMGI for the multicast MBS session IDs that the UE is allowed to join, if any, in the Received MBS container IE, shall set the MBS decision to "MBS join is accepted" for each of those Received MBS information, may include the MBS start time to indicate the time when the multicast MBS session starts, and shall include the MBS security container in each of those Received MBS information if security protection is applied for that multicast MBS session and the control plane security procedure is used as specified in annex W.4.1.2 in 3GPP TS 33.501 [24], and shall use separate QoS flows dedicated for multicast by including the Authorized QoS flow descriptions IE if no separate QoS flows dedicated for multicast exist or if the SMF wants to establish new QoS flows dedicated for multicast;

NOTE 1: The network determines whether security protection applies or not for the multicast MBS session as specified in 3GPP TS 33.501 [24].

- b) shall include the TMGI for multicast MBS session IDs that the UE is rejected to join, if any, in the Received MBS container IE, shall set the MBS decision to "MBS join is rejected" for each of those Received MBS information, shall set the Rejection cause for each of those Received MBS information with the reason of rejection and, if the Rejection cause is set to "multicast MBS session has not started or will not start soon", may include an MBS back-off timer value; and
- c) may include in the Received MBS container IE the MBS service area for each multicast MBS session and include in it the MBS TAI list, the NR CGI list or both, that identify the service area(s) for the local MBS service;

NOTE 2: For an multicast MBS session that has multiple MBS service areas, the MBS service areas are indicated to the UE using MBS service announcement as described in 3GPP TS 23.247 [53], which is out of scope of this specification.

in the PDU SESSION MODIFICATION COMMAND message. If the UE has set the Type of multicast MBS session ID to "Source specific IP multicast address" in the Requested MBS container IE for certain multicast MBS session(s) in the PDU SESSION MODIFICATION REQUEST message, the SMF shall include the Source IP address information and Destination IP address information in the Received MBS information together with the TMGI for each of those multicast MBS sessions.

NOTE 3: Including the Source IP address information and Destination IP address information in the Received MBS information in that case is to allow the UE to perform the mapping between the requested multicast MBS session ID and the provided TMGI.

NOTE 4: In SNPN, TMGI is used together with NID to identify an MBS Session.

If:

- a) the SMF wants to remove joined UE from one or more multicast MBS sessions; or
- b) the network-requested PDU session modification procedure is triggered by a UE-requested PDU session modification procedure and the UE has included the Requested MBS container IE in the PDU SESSION MODIFICATION REQUEST message with the MBS operation set to "Leave multicast MBS session",

the SMF shall include the multicast MBS session IDs that the UE is removed from, if any, in the Received MBS container IE in the PDU SESSION MODIFICATION COMMAND message and shall set the MBS decision to "Remove UE from multicast MBS session" for each of those Received MBS information. The SMF may include the updated MBS service area in each of the Received MBS information, if any. The SMF may delete the QoS flows associated for the multicast by including the Authorized QoS flow descriptions IE in the PDU SESSION MODIFICATION COMMAND message. If the UE is removed from multicast MBS session due to the MBS session release, the SMF shall set the Rejection cause to "multicast MBS session is released". The SMF shall include the Rejection cause for each of the Received MBS information, if any, and set its value with the reason of removing the UE from the corresponding multicast MBS session.

NOTE 5: based on operator's policy, e.g. after a locally configured time period, the SMF is allowed to trigger the removal of joined UE from an multicast MBS session when the UE moves outside all the MBS service area(s) of that multicast MBS session.

If the SMF wants to update the MBS security information of an multicast MBS session that the UE has joined, the SMF shall include the corresponding multicast MBS session ID and the MBS security container in the Received MBS container IE in the PDU SESSION MODIFICATION COMMAND message, and shall set the MBS Decision to "MBS security information update" in the Received MBS information.

If the SMF wants to update the MBS service area of an multicast MBS session that the UE has joined, the SMF shall include the corresponding multicast MBS session ID and the updated MBS service area in the Received MBS container IE in the PDU SESSION MODIFICATION COMMAND message, and shall set the MBS decision to "MBS service area update" in the Received MBS information.

NOTE 6: The MBS service area of an multicast MBS session is also allowed to be updated to the UE using the MBS service announcement as described in 3GPP TS 23.247 [53], which is out of scope of this specification.

If the network needs to update ATSSS parameters (see subclause 5.2.4 of 3GPP TS 24.193 [13B]), the SMF shall include the ATSSS container IE with the updates of ATSSS parameters in the PDU SESSION MODIFICATION COMMAND message.

If the network-requested PDU session modification procedure is not triggered by a UE-requested PDU session modification procedure, the SMF shall set the PTI IE of the PDU SESSION MODIFICATION COMMAND message to "No procedure transaction identity assigned".

If the selected SSC mode of the PDU session is "SSC mode 3" and the SMF requests the relocation of SSC mode 3 PDU session anchor with multiple PDU sessions as specified in 3GPP TS 23.502 [9], the SMF shall include 5GSM cause #39 "reactivation requested", in the PDU SESSION MODIFICATION COMMAND message, and may include the PDU session address lifetime in a PDU session address lifetime parameter in the Extended protocol configuration options IE of the PDU SESSION MODIFICATION COMMAND message. If the selected SSC mode of the PDU

session is "SSC mode 3", the S-NSSAI or the mapped S-NSSAI associated with the PDU session needs to be replaced and the SMF determines that the PDU session needs to be re-established on the alternative S-NSSAI, the SMF shall include the Alternative S-NSSAI IE and 5GSM cause #39 "reactivation requested" in the PDU SESSION MODIFICATION COMMAND message. If the selected SSC mode of the PDU session is "SSC mode 3", the replaced S-NSSAI is available and the SMF determines that the PDU session needs to be re-established on the replaced S-NSSAI, the SMF shall include and 5GSM cause #39 "reactivation requested" and include the replaced S-NSSAI in the PDU SESSION MODIFICATION COMMAND message.

NOTE 7: The relocation of SSC mode 3 PDU session anchor with multiple PDU sessions can also be initiated by the SMF in case of the SMF is requested by the AMF to release the PDU session due to the network slice instance of the PDU session is changed as specified in subclause 5.15.5.3 of 3GPP TS 23.501 [8].

The SMF shall send the PDU SESSION MODIFICATION COMMAND message, and the SMF shall start timer T3591 (see example in figure 6.3.2.2.1).

NOTE 8: If the SMF requests the relocation of SSC mode 3 PDU session anchor with multiple PDU sessions as specified in 3GPP TS 23.502 [9], the reallocation requested indication indicating whether the SMF is to be reallocated or the SMF is to be reused is provided to the AMF.

If the control plane CIoT 5GS optimization is enabled for a PDU session and the IP header compression configuration IE was included in the PDU SESSION ESTABLISHMENT REQUEST message or the PDU SESSION MODIFICATION REQUEST message, and the SMF supports control plane CIoT 5GS optimization and IP header compression for control plane CIoT 5GS optimization, the SMF may include the IP header compression configuration IE in the PDU SESSION MODIFICATION COMMAND message to re-negotiate IP header compression configuration associated to the PDU session.

If the control plane CIoT 5GS optimization is enabled for a PDU session and the Ethernet header compression configuration IE was included in the PDU SESSION ESTABLISHMENT REQUEST message or the PDU SESSION MODIFICATION REQUEST message, and the SMF supports control plane CIoT 5GS optimization and Ethernet header compression for control plane CIoT 5GS optimization, the SMF may include the Ethernet header compression configuration IE in the PDU SESSION MODIFICATION COMMAND message to re-configure Ethernet header compression configuration associated with the PDU session.

If the network-requested PDU session modification procedure is associated with C2 authorization procedure, the SMF shall send the PDU SESSION MODIFICATION COMMAND message by including the Service-level-AA container IE containing:

- a) the service-level-AA response with the value of C2AR field set to the "C2 authorization was successful";
- b) if a payload is provided from the UAS-NF, the service-level-AA payload with the value set to the payload; and
- c) if a payload type associated with the payload is provided from the UAS-NF, the service-level-AA payload type with the value set to the payload type; and
- d) if the CAA-level UAV ID is provided from the UAS-NF, the service-level device ID set to the CAA-level UAV ID.

NOTE 9: The C2 authorization payload in the service-level-AA payload can include one, some or all of the pairing information for C2 communication, and the pairing information for direct C2 communication,

NOTE 9A: The C2 authorization payload in the service-level-AA payload can include the security information for C2 session as specified in TS 33.256 [24B].

If the service-level-AA procedure is triggered for the established PDU session for UAS services with re-authentication purpose, and the SMF is provided by the UAS-NF with the successful UUAA-SM result, the SMF shall transmit a PDU SESSION MODIFICATION COMMAND message to the UE, where the PDU SESSION MODIFICATION COMMAND message shall include the Service-level-AA container IE containing:

- a) the service-level-AA response with the value of SLAR field set to "Service level authentication and authorization was successful";
- b) if received the CAA-level UAV ID from the UAS-NF, the service-level device ID with the value set to the CAA-level UAV ID;
- c) if received a payload from the UAS-NF, the service-level-AA payload with the value set to the payload; and

- d) if received a payload type associated with the payload, the service-level-AA payload type with the value set to the payload type.

If the SMF needs to provide new ECS configuration information to the UE and the UE has indicated support for ECS configuration information provisioning in the PDU SESSION ESTABLISHMENT REQUEST message or while in S1 mode, then the SMF may include the Extended protocol configuration options IE in the PDU SESSION MODIFICATION COMMAND message with:

- a) at least one of ECS IPv4 Address(es), ECS IPv6 Address(es), ECS FQDN(s);
- b) at least one associated ECSP identifier;
- c) optionally, spatial validity conditions associated with the ECS address;
- d) optionally, ECS authentication methods associated with the ECS address; and
- e) optionally, ECS supported PLMNs information list, including the associated ECSP information for which the EDN configuration information can be provided by the ECS.

NOTE 10: The IP address(es), FQDN(s), or both are associated with the ECSP identifier and replace previously provided ECS configuration information associated with the same ECSP identifier, if any.

If the SMF needs to provide DNS server address(es) to the UE and the UE has provided the DNS server IPv4 address request, the DNS server IPv6 address request or both of them, in the PDU SESSION ESTABLISHMENT REQUEST message or a PDU SESSION MODIFICATION REQUEST message, then the SMF shall include the Extended protocol configuration options IE in the PDU SESSION MODIFICATION COMMAND message with one or more DNS server IPv4 address(es), one or more DNS server IPv6 address(es) or both of them.

If the SMF needs to trigger EAS rediscovery and the UE has indicated support of the EAS rediscovery in the PDU SESSION ESTABLISHMENT REQUEST message or the PDU SESSION MODIFICATION REQUEST message, then the SMF shall include the Extended protocol configuration options IE in the PDU SESSION MODIFICATION COMMAND message:

- a) with the EAS rediscovery indication without indicated impact; or
- b) with the following:
 - 1) one or more EAS rediscovery indication(s) with impacted EAS IPv4 address range, if the UE supports EAS rediscovery indication(s) with impacted EAS IPv4 address range;
 - 2) one or more EAS rediscovery indication(s) with impacted EAS IPv6 address range, if the UE supports EAS rediscovery indication(s) with impacted EAS IPv6 address range;
 - 3) one or more EAS rediscovery indication(s) with impacted EAS FQDN, if the UE supports EAS rediscovery indication(s) with impacted EAS FQDN; or
 - 4) any combination of the above.

When UE has requested P-CSCF IPv6 address or P-CSCF IPv4 address and the SMF has provided P-CSCF address(es) during the PDU session establishment procedure, if the network-requested PDU session modification procedure is triggered for P-CSCF restoration, the SMF shall include the P-CSCF IP address(es) in the Extended protocol configuration options IE in the PDU SESSION MODIFICATION COMMAND message as specified in subclause 5.8.2.2 of 3GPP TS 23.380 [54].

If the S-NSSAI or the mapped S-NSSAI of the PDU session needs to be replaced and the SMF determines that the PDU session needs to be retained, the SMF shall include the Alternative S-NSSAI IE in the PDU SESSION MODIFICATION COMMAND message. If the replaced S-NSSAI is available and the SMF determines that the PDU session needs to be retained, the SMF include replaced S-NSSAI in the PDU SESSION MODIFICATION COMMAND message.

If the SMF includes the authorized QoS flow descriptions and the SMF determines to provide the N3QAI to the UE, the SMF shall include the N3QAI IE in the PDU SESSION MODIFICATION COMMAND message.

If the PDU session was a single access PDU session established over 3GPP access with IP PDU session type and based on operator policy the SMF determines to provide the protocol description for UL PDU set handling to the UE, the SMF may include the Protocol description IE in the PDU SESSION MODIFICATION COMMAND message.

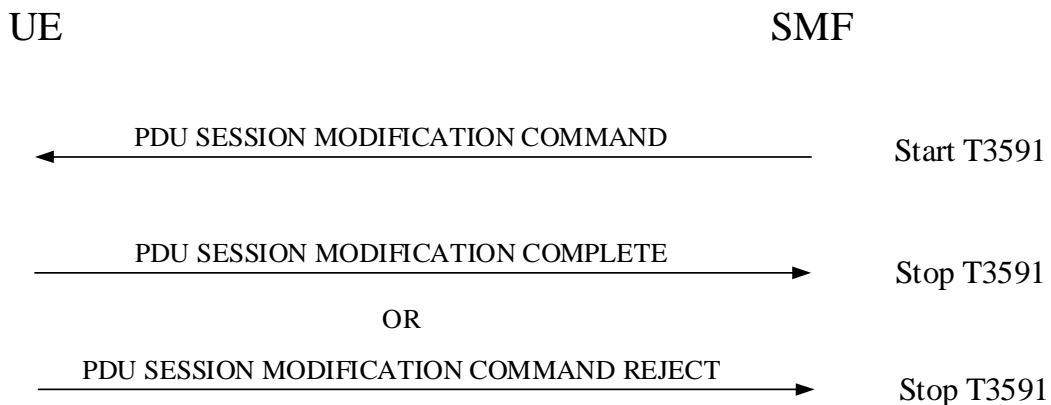

Figure 6.3.2.2.1: Network-requested PDU session modification procedure

6.3.2.3 Network-requested PDU session modification procedure accepted by the UE

Upon receipt of the PDU SESSION MODIFICATION COMMAND message, if the UE provided a DNN during the PDU session establishment, the UE shall stop timer T3396, if it is running for the DNN provided by the UE. If the UE did not provide a DNN during the PDU session establishment and the request type was different from "initial emergency request" and different from "existing emergency PDU session", the UE shall stop the timer T3396 associated with no DNN if it is running. If the PDU SESSION MODIFICATION COMMAND message was received for an emergency PDU session, the UE shall not stop the timer T3396 associated with no DNN if it is running. In an SNPN, the timer T3396 to be stopped includes:

- b) the timer T3396 applied for all the equivalent SNPNS, associated with the RSNPN or an equivalent SNPN, and with the selected entry of the "list of subscriber data" or the selected PLMN subscription, if running; and
- a) the timer T3396 applied for the registered SNPN, associated with the RSNPN, and, if the UE supports access to an SNPN using credentials from a credentials holder, associated with the selected entry of the "list of subscriber data" or the selected PLMN subscription, if running.

Upon receipt of the PDU SESSION MODIFICATION COMMAND message, if the UE provided an S-NSSAI and a DNN during the PDU session establishment, the UE shall stop timer T3584, if it is running for the [S-NSSAI of the PDU session, DNN] combination provided by the UE. If the UE provided a DNN and did not provide an S-NSSAI during the PDU session establishment, the UE shall stop timer T3584, if it is running for the same [no S-NSSAI, DNN] combination provided by the UE. If the UE provided an S-NSSAI and did not provide a DNN during the PDU session establishment, the UE shall stop timer T3584, if it is running for the same [S-NSSAI, no DNN] combination provided by the UE. If the UE provided neither a DNN nor an S-NSSAI during the PDU session establishment, the UE shall stop timer T3584, if it is running for the same [no S-NSSAI, no DNN] combination provided by the UE. The timer T3584 to be stopped includes:

- a) in a PLMN:
 - 1) the timer T3584 applied for all the PLMNs, if running; and
 - 2) the timer T3584 applied for the registered PLMN, if running; or
- b) in an SNPN:
 - 1) the timer T3584 applied for all the equivalent SNPNS, and associated with the RSNPN or an equivalent SNPN and with the selected entry of the "list of subscriber data" or the selected PLMN subscription, if running; and
 - 2) the timer T3584 applied for the registered SNPN, associated with the RSNPN and, if the UE supports access to an SNPN using credentials from a credentials holder, equivalent SNPNS or both, associated with the selected entry of the "list of subscriber data" or the selected PLMN subscription, if running.

Upon receipt of the PDU SESSION MODIFICATION COMMAND message, if the UE provided an S-NSSAI during the PDU session establishment, the UE shall stop timer T3585, if it is running for the S-NSSAI of the PDU session. If the UE did not provide an S-NSSAI during the PDU session establishment and the request type was different from "initial emergency request" and different from "existing emergency PDU session", the UE shall stop the timer T3585 associated with no S-NSSAI if it is running. The timer T3585 to be stopped includes:

a) in a PLMN:

- 1) the timer T3585 applied for all the PLMNs and for the access over which the PDU SESSION MODIFICATION COMMAND is received, if running;
- 2) the timer T3585 applied for all the PLMNs and for both 3GPP access type and non-3GPP access type, if running;
- 3) the timer T3585 applied for the registered PLMN and for the access over which the PDU SESSION MODIFICATION COMMAND is received, if running; and
- 4) the timer T3585 applied for the registered PLMN and for both 3GPP access type and non-3GPP access type, if running; or

b) in an SNPN:

- 1) the timer T3585 applied for all the equivalent SNPNS and for the access over which the PDU SESSION AUTHENTICATION COMMAND message is received, associated with the RSNPN or an equivalent SNPN and with the selected entry of the "list of subscriber data" or the selected PLMN subscription, if running;
- 2) the timer T3585 applied for all the equivalent SNPNS and for both 3GPP access type and non-3GPP access type, associated with the RSNPN or an equivalent SNPN and with the selected entry of the "list of subscriber data" or the selected PLMN subscription, if running;
- 3) the timer T3585 applied for the registered SNPN and for the access over which the PDU SESSION AUTHENTICATION COMMAND message is received, associated with the RSNPN and, if the UE supports access to an SNPN using credentials from a credentials holder, equivalent SNPNS or both, associated with the selected entry of the "list of subscriber data" or the selected PLMN subscription, if running; and
- 4) the timer T3585 applied for the registered PLMN and for both 3GPP access type and non-3GPP access type, associated with the RSNPN and, if the UE supports access to an SNPN using credentials from a credentials holder, equivalent SNPNS or both, associated with the selected entry of the "list of subscriber data" or the selected PLMN subscription, if running.

If the PDU SESSION MODIFICATION COMMAND message was received for an emergency PDU session, the UE shall not stop the timer T3585 associated with no S-NSSAI if it is running.

NOTE 1: Upon receipt of the PDU SESSION MODIFICATION COMMAND message for a PDU session, if the UE provided a DNN (or no DNN) and an S-NSSAI (or no S-NSSAI) when the PDU session is established, timer T3396 associated with the DNN (or no DNN, if no DNN was provided by the UE) is running, and timer T3584 associated with the DNN (or no DNN, if no DNN was provided by the UE) and the S-NSSAI of the PDU session (or no S-NSSAI, if no S-NSSAI was provided by the UE) is running, then the UE stops both the timer T3396 and the timer T3584.

NOTE 2: Upon receipt of the PDU SESSION MODIFICATION COMMAND message for a PDU session, if the UE provided a DNN (or no DNN) and an S-NSSAI (or no S-NSSAI) when the PDU session is established, timer T3585 associated with the S-NSSAI of the PDU session (or no S-NSSAI, if no S-NSSAI was provided by the UE) is running, and timer T3584 associated with the DNN (or no DNN, if no DNN was provided by the UE) and the S-NSSAI of the PDU session (or no S-NSSAI, if no S-NSSAI was provided by the UE) is running, then the UE stops both the timer T3585 and the timer T3584.

If the PDU SESSION MODIFICATION COMMAND message includes the Authorized QoS rules IE, the UE shall process the QoS rules sequentially starting with the first QoS rule.

If the PDU SESSION MODIFICATION COMMAND message includes the Authorized QoS rules IE with the Rule operation code is set to "Delete existing QoS rule" for one or more QoS rules, the UE shall delete the protocol descriptions associated with the QoS rules, if any.

If the PDU SESSION MODIFICATION COMMAND message includes the Mapped EPS bearer contexts IE, the UE shall process the mapped EPS bearer contexts sequentially starting with the first mapped EPS bearer context.

If the PDU SESSION MODIFICATION COMMAND message includes the Authorized QoS flow descriptions IE, the UE shall process the QoS flow descriptions sequentially starting with the first QoS flow description.

The UE shall replace the stored authorized QoS rules, authorized QoS flow descriptions and session-AMBR of the PDU session with the received value(s), if any, in the PDU SESSION MODIFICATION COMMAND message.

If the PDU SESSION MODIFICATION COMMAND message includes a Mapped EPS bearer contexts IE, the UE shall check each mapped EPS bearer context for different types of errors as follows:

NOTE 3: An error detected in a mapped EPS bearer context does not cause the UE to discard the Authorized QoS rules IE and Authorized QoS flow descriptions IE included in the PDU SESSION MODIFICATION COMMAND message, if any.

a) Semantic error in the mapped EPS bearer operation:

- 1) operation code = "Create new EPS bearer" and there is already an existing mapped EPS bearer context with the same EPS bearer identity associated with any PDU session.
- 2) operation code = "Delete existing EPS bearer" and there is no existing mapped EPS bearer context with the same EPS bearer identity associated with the PDU session that is being modified.
- 3) operation code = "Modify existing EPS bearer" and there is no existing mapped EPS bearer context with the same EPS bearer identity associated with the PDU session that is being modified.
- 4) operation code = "Create new EPS bearer" or "Modify existing EPS bearer" and the resulting mapped EPS bearer context has invalid mandatory parameters or missing mandatory parameters (e.g., mapped EPS QoS parameters or traffic flow template for a dedicated EPS bearer context).

In case 1, if the existing mapped EPS bearer context is associated with the PDU session that is being modified, the UE shall not diagnose an error, further process the create request and, if it was processed successfully, delete the old EPS bearer context.

In case 2, the UE shall not diagnose an error, further process the delete request and, if it was processed successfully, consider the mapped EPS bearer context as successfully deleted.

Otherwise, after sending the PDU SESSION MODIFICATION COMPLETE for the ongoing PDU session modification procedure, the UE shall initiate a PDU session modification procedure by sending a PDU SESSION MODIFICATION REQUEST message to delete the mapped EPS bearer context with 5GSM cause #85 "Invalid mapped EPS bearer identity".

b) if the mapped EPS bearer context includes a traffic flow template, the UE shall check the traffic flow template for different types of TFT IE errors as follows:

1) Semantic errors in TFT operations:

- i) TFT operation = "Create new TFT" when there is already an existing TFT for the EPS bearer context.
- ii) When the TFT operation is an operation other than "Create a new TFT" and there is no TFT for the EPS bearer context.
- iii) TFT operation = "Delete packet filters from existing TFT" when it would render the TFT empty.
- iv) TFT operation = "Delete existing TFT" for a dedicated EPS bearer context.

In case iv, after sending the PDU SESSION MODIFICATION COMPLETE for the ongoing PDU session modification procedure, the UE shall initiate a PDU session modification procedure by sending a PDU SESSION MODIFICATION REQUEST message to delete the mapped EPS bearer context with 5GSM cause #41 "semantic error in the TFT operation".

In the other cases the UE shall not diagnose an error and perform the following actions to resolve the inconsistency:

In case i, the UE shall further process the new activation request to create a new TFT and, if it was processed successfully, delete the old TFT.

In case ii, the UE shall:

- process the new request and if the TFT operation is "Delete existing TFT" or "Delete packet filters from existing TFT", and if no error according to items 2, 3, and 4 was detected, consider the TFT as successfully deleted;
- process the new request as an activation request, if the TFT operation is "Add packet filters in existing TFT" or "Replace packet filters in existing TFT".

In case iii, if the packet filters belong to a dedicated EPS bearer context, the UE shall process the new deletion request and, if no error according to items 2, 3, and 4 was detected, after sending the PDU SESSION MODIFICATION COMPLETE for the ongoing PDU session modification procedure, the UE shall initiate a PDU session modification procedure by sending a PDU SESSION MODIFICATION REQUEST message to delete the mapped EPS bearer context with 5GSM cause #41 "semantic error in the TFT operation".

In case iii, if the packet filters belong to the default EPS bearer context, the UE shall process the new deletion request and if no error according to items 2, 3, and 4 was detected then delete the existing TFT, this corresponds to using match-all packet filter for the default EPS bearer context.

2) Syntactical errors in TFT operations:

- i) When the TFT operation = "Create new TFT", "Add packet filters in existing TFT", "Replace packet filters in existing TFT" or "Delete packet filters from existing TFT" and the packet filter list in the TFT IE is empty.
- ii) TFT operation = "Delete existing TFT" or "No TFT operation" with a non-empty packet filter list in the TFT IE.
- iii) TFT operation = "Replace packet filters in existing TFT" when the packet filter to be replaced does not exist in the original TFT.
- iv) TFT operation = "Delete packet filters from existing TFT" when the packet filter to be deleted does not exist in the original TFT.
- v) Void.
- vi) When there are other types of syntactical errors in the coding of the TFT IE, such as a mismatch between the number of packet filters subfield, and the number of packet filters in the packet filter list.

In case iii, the UE shall not diagnose an error, further process the replace request and, if no error according to items 3 and 4 was detected, include the packet filters received to the existing TFT.

In case iv, the UE shall not diagnose an error, further process the deletion request and, if no error according to items 3 and 4 was detected, consider the respective packet filter as successfully deleted.

Otherwise, after sending the PDU SESSION MODIFICATION COMPLETE for the ongoing PDU session modification procedure, the UE shall initiate a PDU session modification procedure by sending a PDU SESSION MODIFICATION REQUEST message to delete the mapped EPS bearer context with 5GSM cause #42 "syntactical error in the TFT operation".

NOTE 3a: An implementation that strictly follows packet filter list as defined in subclause 10.5.6.12 in 3GPP TS 24.008 [12] might not detect case 2) ii).

3) Semantic errors in packet filters:

- i) When a packet filter consists of conflicting packet filter components which would render the packet filter ineffective, i.e. no IP packet will ever fit this packet filter. How the UE determines a semantic error in a packet filter is outside the scope of the present document.
- ii) When the resulting TFT, which is assigned to a dedicated EPS bearer context, does not contain any packet filter applicable for the uplink direction among the packet filters created on request from the network.

After sending the PDU SESSION MODIFICATION COMPLETE for the ongoing PDU session modification procedure, the UE shall initiate a PDU session modification procedure by sending a PDU SESSION MODIFICATION REQUEST message to delete the mapped EPS bearer context with 5GSM cause #44 "semantic errors in packet filter(s)".

4) Syntactical errors in packet filters:

- i) When the TFT operation = "Create new TFT", "Add packet filters to existing TFT", or "Replace packet filters in existing TFT" and two or more packet filters in the resultant TFT would have identical packet filter identifiers.
- ii) When the TFT operation = "Create new TFT", "Add packet filters to existing TFT" or "Replace packet filters in existing TFT", and two or more packet filters among all TFTs associated with this PDN connection would have identical packet filter precedence values.
- iii) When there are other types of syntactical errors in the coding of packet filters, such as the use of a reserved value for a packet filter component identifier.

In case i, if two or more packet filters with identical packet filter identifiers are contained in the new request, after sending the PDU SESSION MODIFICATION COMPLETE for the ongoing PDU session modification procedure, the UE shall initiate a PDU session modification procedure by sending a PDU SESSION MODIFICATION REQUEST message to delete the mapped EPS bearer context with 5GSM cause #45 "syntactical error in packet filter(s)". Otherwise, the UE shall not diagnose an error, further process the new request and, if it was processed successfully, delete the old packet filters which have the identical packet filter identifiers.

In case ii, if the old packet filters do not belong to the default EPS bearer context, the UE shall not diagnose an error, shall further process the new request and, if it was processed successfully, shall delete the old packet filters which have identical filter precedence values.

In case ii, if one or more old packet filters belong to the default EPS bearer context, after sending the PDU SESSION MODIFICATION COMPLETE for the ongoing PDU session modification procedure, the UE shall initiate a PDU session modification procedure by sending a PDU SESSION MODIFICATION REQUEST message to delete the mapped EPS bearer context with 5GSM cause #45 "syntactical errors in packet filter(s)".

Otherwise, after sending the PDU SESSION MODIFICATION COMPLETE for the ongoing PDU session modification procedure, the UE shall initiate a PDU session modification procedure by sending a PDU SESSION MODIFICATION REQUEST message to delete the mapped EPS bearer context with 5GSM cause #45 "syntactical error in packet filter(s)".

And if a new EPS bearer identity parameter in Authorized QoS flow descriptions IE is received for a QoS flow which can be transferred to EPS, the UE shall update the association between the QoS flow and the mapped EPS bearer context, based on the new EPS bearer identity and the mapped EPS bearer contexts. If the "Delete existing EPS bearer" operation code in the Mapped EPS bearer contexts IE was received, the UE shall discard the association between the QoS flow and the corresponding mapped EPS bearer context and delete the corresponding mapped EPS bearer context.

If:

- a) the UE detects different errors in the mapped EPS bearer contexts as described above which requires sending a PDU SESSION MODIFICATION REQUEST message to delete the erroneous mapped EPS bearer contexts; and
- b) optionally, if the UE detects errors in QoS rules that require to delete at least one QoS rule as described in subclause 6.3.2.4 which requires sending a PDU SESSION MODIFICATION REQUEST message to delete the erroneous QoS rules;

the UE, after sending the PDU SESSION MODIFICATION COMPLETE message for the ongoing PDU session modification procedure, may send a single PDU SESSION MODIFICATION REQUEST message to delete the erroneous mapped EPS bearer contexts, and optionally to delete the erroneous QoS rules. The UE shall include a 5GSM cause IE in the PDU SESSION MODIFICATION REQUEST message.

NOTE 4: The 5GSM cause to use cannot be different from #41 "semantic error in the TFT operation", #42 "syntactical error in the TFT operation", #44 "semantic error in packet filter(s)", #45 "syntactical errors in packet filter(s)", #83 "semantic error in the QoS operation", #84 "syntactical error in the QoS operation", or #85 "Invalid mapped EPS bearer identity". The selection of a 5GSM cause is up to UE implementation.

Upon receipt of a PDU SESSION MODIFICATION COMMAND message and a PDU session ID, using the NAS transport procedure as specified in subclause 5.4.5, if the UE accepts the PDU SESSION MODIFICATION COMMAND message, the UE considers the PDU session as modified and the UE shall create a PDU SESSION MODIFICATION COMPLETE message.

If the PDU SESSION MODIFICATION COMMAND message contains the PTI value allocated in the UE-requested PDU session modification procedure, the UE shall stop the timer T3581. The UE should ensure that the PTI value assigned to this procedure is not released immediately.

NOTE 5: The way to achieve this is implementation dependent. For example, the UE can ensure that the PTI value assigned to this procedure is not released during the time equal to or greater than the default value of timer T3591.

While the PTI value is not released, the UE regards any received PDU SESSION MODIFICATION COMMAND message with the same PTI value as a network retransmission (see subclause 7.3.1).

If the selected SSC mode of the PDU session is "SSC mode 3" and the PDU SESSION MODIFICATION COMMAND message includes 5GSM cause #39 "reactivation requested", the UE can provide to the upper layers the PDU session address lifetime if received in the PDU session address lifetime parameter of the Extended protocol configuration options IE of the PDU SESSION MODIFICATION COMMAND message. After the completion of the network-requested PDU session modification procedure:

- a) if the PDU session is an MA PDU session:
 - 1) established over both 3GPP access and non-3GPP access, and:
 - the UE is registered over both 3GPP access and non-3GPP access in the same PLMN:
 - the UE should re-initiate a UE-requested PDU session establishment procedure as specified in subclause 6.4.1 over the access the PDU SESSION MODIFICATION COMMAND message is received; or
 - the UE is registered over both 3GPP access and non-3GPP access in different PLMNs:
 - the UE should re-initiate UE-requested PDU session establishment procedures as specified in subclause 6.4.1 over both accesses. The UE should re-initiate the UE-requested PDU session establishment procedure over the access the PDU SESSION MODIFICATION COMMAND message is received first; or
 - 2) established over only single access:
 - the UE should re-initiate a UE-requested PDU session establishment procedure as specified in subclause 6.4.1 over the access the user plane resources were established; or
- b) if the PDU session is a single access PDU session:
 - the UE should re-initiate a UE-requested PDU session establishment procedure as specified in subclause 6.4.1 over the access the PDU session was associated with; and

for the re-initiated UE-requested PDU session establishment procedure(s) the UE should set a new PDU session ID different from the PDU session ID associated with the present PDU session and should set:

- a) the PDU session type to the PDU session type associated with the present PDU session;
- b) the SSC mode to the SSC mode associated with the present PDU session;
- c) the DNN to the DNN associated with the present PDU session;
- d) the S-NSSAI to:
 - 1) the S-NSSAI associated with (if available in roaming scenarios) a mapped S-NSSAI if provided in the UE-requested PDU session establishment procedure of the present PDU session; or
 - 2) the S-NSSAI received in the PDU SESSION ESTABLISHMENT ACCEPT message of the existing PDU session if the UE received the Alternative S-NSSAI IE in the PDU SESSION MODIFICATION COMMAND message; and

- e) the alternative S-NSSAI to the S-NSSAI associated with (if available in roaming scenarios) a mapped S-NSSAI if received in the Alternative S-NSSAI IE of the PDU SESSION MODIFICATION COMMAND message.

If the UE has indicated support for CIoT 5GS optimizations and receives a small data rate control parameters container in the Extended protocol configuration options IE in the PDU SESSION MODIFICATION COMMAND message, the UE shall store the small data rate control parameters value and use the stored small data rate control parameters value as the maximum allowed limit of uplink user data for the PDU session in accordance with 3GPP TS 23.501 [8]. If the UE has a previously stored small data rate control parameter value for the PDU session, the UE shall replace the stored small data rate control parameters value for the PDU session with the received small data rate control parameters value in the Extended protocol configuration options IE in the PDU SESSION MODIFICATION COMMAND message.

If the UE has indicated support for CIoT 5GS optimizations and receives an additional small data rate control parameters for exception data container in the Extended protocol configuration options IE in the PDU SESSION MODIFICATION COMMAND message, the UE shall store the additional small data rate control parameters for exception data value and use the stored additional small data rate control parameters for exception data value as the maximum allowed limit of uplink exception data for the PDU session in accordance with 3GPP TS 23.501 [8]. If the UE has a previously stored additional small data rate control parameters for exception data value for the PDU session, the UE shall replace the stored additional small data rate control parameters for exception data value for the PDU session with the received additional small data rate control parameters for exception data value in the Extended protocol configuration options IE in the PDU SESSION MODIFICATION COMMAND message.

The UE shall include the PDU session ID of the old PDU session which is about to get released in the old PDU session ID IE of the UL NAS TRANSPORT message that transports the PDU SESSION ESTABLISHMENT REQUEST message.

- NOTE 6: The UE is expected to maintain the PDU session for which the PDU SESSION MODIFICATION COMMAND message including 5GSM cause #39 "reactivation requested" is received during the time indicated by the PDU session address lifetime value or until receiving an indication from upper layers (e.g. that the old PDU session is no more needed).

If the selected PDU session type of the PDU session is "Unstructured", the UE supports inter-system change from N1 mode to S1 mode, the UE does not support establishment of a PDN connection for the PDN type set to "non-IP" in S1 mode, and the parameters list field of one or more authorized QoS flow descriptions received in the Authorized QoS flow descriptions IE of the PDU SESSION MODIFICATION COMMAND message contains an EPS bearer identity (EBI), then the UE shall locally remove the EPS bearer identity (EBI) from the parameters list field of such one or more authorized QoS flow descriptions. After sending the PDU SESSION MODIFICATION COMPLETE message for the ongoing PDU session modification procedure, the UE shall initiate a PDU session modification procedure by sending a PDU SESSION MODIFICATION REQUEST message to delete the mapped EPS bearer context with 5GSM cause #85 "Invalid mapped EPS bearer identity".

If the selected PDU session type of the PDU session is "Ethernet", the UE supports inter-system change from N1 mode to S1 mode, the UE does not support establishment of a PDN connection for the PDN type set to "non-IP" in S1 mode, the UE, the network or both of them do not support Ethernet PDN type in S1 mode, and the parameters list field of one or more authorized QoS flow descriptions received in the Authorized QoS flow descriptions IE of the PDU SESSION MODIFICATION COMMAND message contains an EPS bearer identity (EBI), the UE shall locally remove the EPS bearer identity (EBI) from the parameters list field of such one or more authorized QoS flow descriptions. After sending the PDU SESSION MODIFICATION COMPLETE message for the ongoing PDU session modification procedure, the UE shall initiate a PDU session modification procedure by sending a PDU SESSION MODIFICATION REQUEST message to delete the mapped EPS bearer context with 5GSM cause #85 "Invalid mapped EPS bearer identity".

For a UE which is registered for disaster roaming services and for a PDU session which is not a PDU session for emergency services:

- a) if the parameters list field of one or more authorized QoS flow descriptions received in the Authorized QoS flow descriptions IE of the PDU SESSION MODIFICATION COMMAND message contains an EPS bearer identity (EBI), then the UE shall locally remove the EPS bearer identity (EBI) from the parameters list field of such one or more authorized QoS flow descriptions; and
- b) the UE shall locally delete the contents of the Mapped EPS bearer contexts IE if it is received in the PDU SESSION MODIFICATION COMMAND message.

If the Always-on PDU session indication IE is included in the PDU SESSION MODIFICATION COMMAND message and:

- a) the value of the IE is set to "Always-on PDU session required", the UE shall consider the established PDU session as an always-on PDU session; or
- b) the value of the IE is set to "Always-on PDU session not allowed", the UE shall not consider the established PDU session as an always-on PDU session.

If the UE does not receive the Always-on PDU session indication IE in the PDU SESSION MODIFICATION COMMAND message:

- a) if the network-requested PDU session modification procedure is triggered by a UE-requested PDU session modification procedure upon an inter-system change from S1 mode to N1 mode for a PDN connection established when in S1 mode, the UE shall not consider the modified PDU session as an always-on PDU session; or
- b) otherwise:
 - 1) if the UE has received the Always-on PDU session indication IE with the value set to "Always-on PDU session required" for this PDU session, the UE shall consider the PDU session as an always-on PDU session; or
 - 2) otherwise the UE shall not consider the PDU session as an always-on PDU session.

If the PDU SESSION MODIFICATION COMMAND message contains a Port management information container IE, the UE shall forward the contents of the Port management information container IE to the DS-TT (see 3GPP TS 23.501 [8] and 3GPP TS 23.502 [9]).

If the UE receives a Serving PLMN rate control IE in the PDU SESSION MODIFICATION COMMAND message, the UE shall store the Serving PLMN rate control IE value, replacing any existing value, and use the stored serving PLMN rate control value as the maximum allowed limit of uplink control plane user data for the corresponding PDU session in accordance with 3GPP TS 23.501 [8].

If the PDU SESSION MODIFICATION COMMAND message includes the Received MBS container IE, for each of the Received MBS informations:

- a) if MBS decision is set to "MBS join is accepted", the UE shall consider that it has successfully joined the multicast MBS session. The UE shall store the received TMGI and shall use it for any further operation on that multicast MBS session. The UE shall store the received MBS service area associated with the received TMGI, if any, and provide the received TMGI to lower layers. The UE may provide the MBS start time if it is included in the Received MBS information to upper layers;
- b) if MBS decision is set to "MBS join is rejected", the UE shall consider the requested join as rejected. The UE shall store the received MBS service area associated with the received TMGI, if any. If the received Rejection cause is set to "User is outside of local MBS service area", the UE shall not request to join the same multicast MBS session if neither current TAI nor CGI of the current cell is part of the received MBS service area. If the received Rejection cause is set to "multicast MBS session has not started or will not start soon" and an MBS back-off timer value is included with value that indicates neither zero nor deactivated, the UE shall start a back-off timer T3587 with the value provided in the MBS back-off timer value for the received TMGI, and shall not attempt to join the multicast MBS session with the same TMGI, the Source IP address information of the TMGI, or the Destination IP address information of the TMGI until the expiry of T3587. If the MBS back-off timer value indicates that this timer is deactivated, the UE shall not attempt to join the multicast MBS session with the same TMGI until the UE is switched off, the USIM is removed, or the entry in the "list of subscriber data" for the current SNPN is updated. If the MBS back-off timer value indicates zero, the UE may attempt to join the MBS session with the same TMGI;
- c) if the MBS decision is set to "Remove UE from multicast MBS session", the UE shall consider that it has successfully left the multicast MBS session, and if the received Rejection cause is set to "multicast MBS session is released", the UE shall consider the multicast MBS session as released. Then the UE shall indicate to lower layers to delete the stored TMGI;
- d) if the MBS decision is set to "MBS service area update", the UE shall store the received MBS service area associated with the received TMGI and replace the current MBS service area with the received one. or
- e) if the MBS decision is set to "MBS security information update", the UE shall replace the current MBS security information with the MBS security information received in the MBS security container associated with the received TMGI.

If the UE has indicated support for ECS configuration information provisioning in the SESSION ESTABLISHMENT REQUEST message or while in S1 mode, then upon receiving

- a) one or more ECS IPv4 address(es), ECS IPv6 address(es), ECS FQDN(s);
- b) one or more associated ECSP identifier(s);
- c) optionally spatial validity conditions associated with the ECS address;
- d) optionally, ECS authentication methods associated with the ECS address; and
- e) optionally, ECS supported PLMNs information list, including the associated ECSP information for which the EDN configuration information can be provided by the ECS.

in the Extended protocol configuration options IE of the PDU SESSION MODIFICATION COMMAND message, then the UE shall pass them to the upper layers.

If the UE supports receiving DNS server addresses in protocol configuration options and receives one or more DNS server IPv4 address(es), one or more DNS server IPv6 address(es) or both of them, in the Extended protocol configuration options IE of the PDU SESSION MODIFICATION COMMAND message, then the UE shall pass the received DNS server IPv4 address(es), if any, and the received DNS server IPv6 address(es), if any, to upper layers.

NOTE 7: The received DNS server address(es) replace previously provided DNS server address(es), if any.

If the UE supports the EAS rediscovery and receives:

- a) the EAS rediscovery indication without indicated impact; or
- b) the following:
 - 1) one or more EAS rediscovery indication(s) with impacted EAS IPv4 address range, if supported by the UE;
 - 2) one or more EAS rediscovery indication(s) with impacted EAS IPv6 address range, if supported by the UE;
 - 3) one or more EAS rediscovery indication(s) with impacted EAS FQDN, if supported by the UE; or
 - 4) any combination of the above;

in the Extended protocol configuration options IE of the PDU SESSION MODIFICATION COMMAND message, then the UE shall pass the EAS rediscovery indication and the received impacted EAS IPv4 address range(s), if supported and included, the received EAS IPv6 address range(s), if supported and included, and the received EAS FQDN(s), if supported and included, to upper layers.

NOTE 8: The upper layers handle the EAS rediscovery indication and the impacted EAS IPv4 address range(s), if any, the impacted EAS IPv6 address range(s), if any, and the received EAS FQDN(s), if any, according to 3GPP TS 23.548 [10A].

Upon receipt of PDU SESSION MODIFICATION COMMAND message, if the network-requested PDU session modification procedure is triggered by a UE-requested PDU session modification procedure, the Service-level-AA container IE is included, then the UE shall forward the service-level-AA contents of the Service-level-AA container IE to the upper layers.

If the UE supports EDC and receives the EDC usage allowed indicator in the Extended protocol configuration options IE of the PDU SESSION MODIFICATION COMMAND message, the UE shall indicate to upper layers that network allows the use of EDC.

If the UE supports EDC and receives the EDC usage required indicator in the Extended protocol configuration options IE of the PDU SESSION MODIFICATION COMMAND message, the UE shall indicate to upper layers that network requires the use of EDC.

NOTE 9: Handling of indication that network allows the use of EDC or that network requires the use of EDC is specified in 3GPP TS 23.548 [182].

If the Alternative S-NSSAI IE is included in the PDU SESSION MODIFICATION COMMAND message, the UE shall replace the S-NSSAI or the mapped S-NSSAI associated with the PDU session according to the Alternative S-NSSAI

IE. The S-NSSAI for the established PDU session shall be the S-NSSAI to be replaced and the alternative S-NSSAI on the UE side.

If the Protocol description IE is included in the PDU SESSION MODIFICATION COMMAND message, for each existing QoS rule,

- a) for the protocol description field with the value of the length of protocol description field set to 1 for the associated QoS rule, the UE shall delete any previously stored protocol description for the QoS rule indicated by the QRI field of the protocol description field; and
- b) for the protocol description field with the value of the length of protocol description field greater than 1 for the associated QoS rule, the UE shall, store the associated protocol description if there is no stored protocol description or replace any previously stored protocol description with the new received protocol description when there is stored protocol description for the QoS rule.

The UE may use the protocol description information associated with the QoS rule(s) provided by the Protocol description IE to identify PDUs belonging to PDU sets for the uplink direction.

NOTE 10: Whether and how to use the protocol description information to identify PDU sets is up to the UE implementation.

The UE shall transport the PDU SESSION MODIFICATION COMPLETE message and the PDU session ID, using the NAS transport procedure as specified in subclause 5.4.5.

After sending the PDU SESSION MODIFICATION COMPLETE message, if the "Create new EPS bearer" operation code in the Mapped EPS bearer contexts IE was received in the PDU SESSION MODIFICATION COMMAND message and there is neither a corresponding Authorized QoS flow descriptions IE in the PDU SESSION MODIFICATION COMMAND message nor an existing QoS flow description corresponding to the EPS bearer identity included in the mapped EPS bearer context, the UE shall send a PDU SESSION MODIFICATION REQUEST message including a Mapped EPS bearer contexts IE to delete the mapped EPS bearer context.

After sending the PDU SESSION MODIFICATION COMPLETE message, if for the PDU session being modified, there are mapped EPS bearer context(s) but none of them is associated with the default QoS rule, the UE shall locally delete the mapped EPS bearer context(s) and shall locally delete the stored EPS bearer identity (EBI) in all the QoS flow descriptions of the PDU session, if any.

If a port management information container needs to be delivered (see 3GPP TS 23.501 [8] and 3GPP TS 23.502 [9]), the UE shall include a Port management information container IE in the PDU SESSION MODIFICATION COMPLETE message.

Upon receipt of a PDU SESSION MODIFICATION COMPLETE message, the SMF shall stop timer T3591 and shall consider the PDU session as modified. If the selected SSC mode of the PDU session is "SSC mode 3" and the PDU SESSION MODIFICATION COMMAND message included 5GSM cause #39 "reactivation requested", the SMF shall start timer T3593. If the PDU Session Address Lifetime value is sent to the UE in the PDU SESSION MODIFICATION COMMAND message then timer T3593 shall be started with the same value, otherwise it shall use a default value. If the PDU SESSION MODIFICATION COMPLETE message contains a Port management information container IE, the SMF shall handle the contents of the Port management information container IE as specified in 3GPP TS 23.501 [8] and 3GPP TS 23.502 [9].

6.3.2.4 Network-requested PDU session modification procedure not accepted by the UE

Upon receipt of a PDU SESSION MODIFICATION COMMAND message and a PDU session ID, using the NAS transport procedure as specified in subclause 5.4.5, if the UE rejects the PDU SESSION MODIFICATION COMMAND message, the UE shall create a PDU SESSION MODIFICATION COMMAND REJECT message.

If the PDU SESSION MODIFICATION COMMAND message contains the PTI value allocated in the UE-requested PDU session modification procedure, the UE shall stop the timer T3581. The UE should ensure that the PTI value assigned to this procedure is not released immediately.

NOTE 1: The way to achieve this is implementation dependent. For example, the UE can ensure that the PTI value assigned to this procedure is not released during the time equal to or greater than the default value of timer T3591.

While the PTI value is not released, the UE regards any received PDU SESSION MODIFICATION COMMAND message with the same PTI value as a network retransmission (see subclause 7.3.1).

The UE shall set the 5GSM cause IE of the PDU SESSION MODIFICATION COMMAND REJECT message to indicate the reason for rejecting the PDU session modification.

The 5GSM cause IE typically indicates one of the following 5GSM cause values:

- #26 insufficient resources;
- #44 semantic error in packet filter(s);
- #45 syntactical error in packet filter(s);
- #83 semantic error in the QoS operation; or
- #84 syntactical error in the QoS operation.

If the selected SSC mode of the PDU session is "SSC mode 3" and the PDU SESSION MODIFICATION COMMAND messages includes 5GSM cause #39 "reactivation requested", while the UE does not have sufficient resources for initiating the PDU session establishment procedure as specified in subclause 6.4.1 then the UE shall set cause IE to #26 "insufficient resources".

If the PDU SESSION MODIFICATION COMMAND message includes a request to add a new authorized QoS rule, or a request to modify the authorized QoS rules, or both, and the UE decides to reject the request due to e.g. the supported number of authorized QoS rules or number of packet filters associated with a PDU session having reached the maximum number, then the UE shall set the 5GSM cause IE to #26 "insufficient resources".

NOTE 2: The maximum number of supported authorized QoS rules or packet filters associated with a PDU session is implementation specific.

If the PDU SESSION MODIFICATION COMMAND message includes a request to add a new authorized QoS flow description, or a request to modify the authorized QoS flow descriptions, or both and the UE decides to reject the request due to e.g. the supported number of authorized QoS flow descriptions, then the UE shall set the 5GSM cause IE to #26 "insufficient resources".

NOTE 3: The maximum number of supported authorized QoS flow descriptions associated with a PDU session is implementation specific.

If the PDU SESSION MODIFICATION COMMAND message includes the Authorized QoS rules IE, the UE shall process the QoS rules sequentially starting with the first QoS rule. The UE shall check the QoS rule and the QoS flow description provided in the PDU SESSION MODIFICATION COMMAND message for different types of errors as follows:

NOTE 4: If an error is detected in a QoS rule or a QoS flow description which requires rejecting the PDU SESSION MODIFICATION COMMAND message, then the Authorized QoS rules IE, the Authorized QoS flow descriptions IE, the Mapped EPS bearer contexts IE and any other IE (RQ timer value IE, Always-on PDU session indication IE, etc) included in the PDU SESSION MODIFICATION COMMAND message are discarded, if any.

a) Semantic errors in QoS operations:

- 1) When the rule operation is "Modify existing QoS rule and add packet filters", "Modify existing QoS rule and replace all packet filters", "Modify existing QoS rule and delete packet filters" or "Modify existing QoS rule without modifying packet filters" on the default QoS rule and the DQR bit is set to "the QoS rule is not the default QoS rule".
- 2) When the rule operation is "Modify existing QoS rule and add packet filters", "Modify existing QoS rule and replace all packet filters", "Modify existing QoS rule and delete packet filters" or "Modify existing QoS rule without modifying packet filters" on a QoS rule which is not the default QoS rule and the DQR bit is set to "the QoS rule is the default QoS rule".
- 3) When the rule operation is "Create new QoS rule" and the DQR bit is set to "the QoS rule is the default QoS rule" when there's already a default QoS rule with different QoS rule identifier.
- 4) When the rule operation is "Delete existing QoS rule" on the default QoS rule.

- 5) When the rule operation is "Create new QoS rule", "Modify existing QoS rule and add packet filters", "Modify existing QoS rule and replace all packet filters", "Modify existing QoS rule and delete packet filters", or "Modify existing QoS rule without modifying packet filters" and two or more QoS rules associated with this PDU session would have identical precedence values, and the UE is not in NB-N1 mode.
- 6) When the rule operation is "Modify existing QoS rule and delete packet filters", the QoS rule is a QoS rule of a PDU session of IPv4, IPv6, IPv4v6 or Ethernet PDU session type, and the packet filter list in the resultant QoS rule is empty.
- 7) When the rule operation is "Create new QoS rule", there is already an existing QoS rule with the same QoS rule identifier and the UE is not in NB-N1 mode.
- 8) When the rule operation is "Modify existing QoS rule and add packet filters", "Modify existing QoS rule and replace all packet filters", "Modify existing QoS rule and delete packet filters" or "Modify existing QoS rule without modifying packet filters", the associated QoS rule does not exist and the UE is not in NB-N1 mode.
- 9) When the rule operation is different than "Delete existing QoS rule", the DQR bit of the QoS rule is set to "the QoS rule is not the default QoS rule" and the UE is in NB-N1 mode.
- 10) When the rule operation is "Create new QoS rule", the DQR bit is set to "the QoS rule is not the default QoS rule", and the PDU session type of the PDU session is "Unstructured".
- 11) When the rule operation is "Delete existing QoS rule" and there is no existing QoS rule with the same QoS rule identifier.
- 12) When the flow description operation is "Create new QoS flow description", there is already an existing QoS flow description with the same QoS flow identifier and the UE is not in NB-N1 mode.
- 13) When the flow description operation is "Modify existing QoS flow description", the associated QoS flow description does not exist and the UE is not in NB-N1 mode.
- 14) When the flow description operation is "Delete existing QoS flow description" and there is no existing QoS flow description with the same QoS flow identifier.
- 15) When the flow description operation is different than "Delete existing QoS flow description", the QFI is not the same as the QFI of the default QoS rule and the UE is in NB-N1 mode.
- 16) When the flow description operation is "Create new QoS flow description" or "Modify existing QoS flow description", the QFI associated with the QoS flow description is not the same as the QFI of the default QoS rule, and the PDU session type of the PDU session is "Unstructured".
- 17) When the rule operation is "Modify existing QoS rule and add packet filters", the "packet filter list" field contains a match-all packet filter, the resultant QoS rule is the default QoS rule and there is already an existing match-all packet filter associated with the default QoS rule.
- 18) When the rule operation is "Create new QoS rule" and the DQR bit is set to "the QoS rule is not the default QoS rule", or the rule operation is "Modify existing QoS rule and add packet filters" on a QoS rule which is not the default QoS rule or "Modify existing QoS rule and replace all packet filters" on a QoS rule which is not the default QoS rule, and one match-all packet filter is to be associated with the resultant QoS rule.

In case 4, the UE shall initiate a PDU session release procedure by sending a PDU SESSION RELEASE REQUEST message with 5GSM cause #83 "semantic error in the QoS operation".

In case 5, if the old QoS rule (i.e. the QoS rule that existed before the PDU SESSION MODIFICATION COMMAND message was received) is not the default QoS rule, the UE shall not diagnose an error, shall further process the new request and, if it was processed successfully, shall delete the old QoS rule which has identical precedence value. Furthermore, after sending the PDU SESSION MODIFICATION COMPLETE for the ongoing PDU session modification procedure, the UE shall send a PDU SESSION MODIFICATION REQUEST message with 5GSM cause #83 "semantic error in the QoS operation" to delete the QoS rule.

In case 5, if the old QoS rule (i.e. the QoS rule that existed before the PDU SESSION MODIFICATION COMMAND message was received) is the default QoS rule, the UE shall initiate a PDU session release procedure by sending a PDU SESSION RELEASE REQUEST message with 5GSM cause #83 "semantic error in the QoS operation".

In case 6, if the QoS rule is not the default QoS rule, after sending the PDU SESSION MODIFICATION COMPLETE for the ongoing PDU session modification procedure, the UE shall send a PDU SESSION MODIFICATION REQUEST message with 5GSM cause #83 "semantic error in the QoS operation" to delete the QoS rule.

In case 6, if the QoS rule is the default QoS rule, the UE shall initiate a PDU session release procedure by sending a PDU SESSION RELEASE REQUEST message with 5GSM cause #83 "semantic error in the QoS operation".

In case 7, if the existing QoS rule is not the default QoS rule and the DQR bit of the new QoS rule is set to "the QoS rule is not the default QoS rule", the UE shall not diagnose an error, further process the create request and, if it was processed successfully, delete the old QoS rule (i.e. the QoS rule that existed when case 7 was detected). If the existing QoS rule is the default QoS rule or the DQR bit of the new QoS rule is set to "the QoS rule is the default QoS rule", the UE shall reject the PDU SESSION MODIFICATION COMMAND message with 5GSM cause #83 "semantic error in the QoS operation".

In case 9 or case 10, after sending the PDU SESSION MODIFICATION COMPLETE for the ongoing PDU session modification procedure, the UE shall send a PDU SESSION MODIFICATION REQUEST message with 5GSM cause #83 "semantic error in the QoS operation" to delete the QoS rule.

In case 11, the UE shall not diagnose an error, further process the delete request and, if it was processed successfully, consider the respective QoS rule as successfully deleted.

In case 12, the UE shall not diagnose an error, further process the create request and, if it was processed successfully, delete the old QoS flow description (i.e. the QoS flow description that existed when case 12 was detected).

In case 14, the UE shall not diagnose an error, further process the delete request and, if it was processed successfully, consider the respective QoS flow description as successfully deleted.

In case 15 or case 16, after sending the PDU SESSION MODIFICATION COMPLETE for the ongoing PDU session modification procedure, the UE shall send a PDU SESSION MODIFICATION REQUEST message with 5GSM cause #83 "semantic error in the QoS operation" to delete the QoS flow description.

Otherwise, the UE shall reject the PDU SESSION MODIFICATION COMMAND message with 5GSM cause #83 "semantic error in the QoS operation".

b) Syntactical errors in QoS operations:

- 1) When the rule operation is "Create new QoS rule", "Modify existing QoS rule and add packet filters", "Modify existing QoS rule and replace all packet filters" or "Modify existing QoS rule and delete packet filters", the PDU session type of the PDU session is IPv4, IPv6, IPv4v6 or Ethernet PDU session type, and the packet filter list in the QoS rule is empty.
- 2) When the rule operation is "Delete existing QoS rule" or "Modify existing QoS rule without modifying packet filters" with a non-empty packet filter list in the QoS rule.
- 3) When the rule operation is "Modify existing QoS rule and delete packet filters" and the packet filter to be deleted does not exist in the original QoS rule.
- 4) Void.
- 5) When there are other types of syntactical errors in the coding of the Authorized QoS rules IE or the Authorized QoS flow descriptions IE, such as: a mismatch between the number of packet filters subfield and the number of packet filters in the packet filter list when the rule operation is "delete existing QoS rule" or "create new QoS rule", or the number of packet filters subfield is larger than the maximum possible number of packet filters in the packet filter list (i.e., there is no QoS rule precedence subfield included in the QoS rule IE), the QoS Rule Identifier is set to "no QoS rule identifier assigned" when the rule operation is not "delete existing QoS rule", or the QoS flow identifier is set to "no QoS flow identifier assigned" when the flow description operation is not "Delete existing QoS flow description".
- 6) When the rule operation is "Modify existing QoS rule and add packet filters" or "Modify existing QoS rule and replace all packet filters", the DQR bit is set to "the QoS rule is the default QoS rule", the PDU session type of the PDU session is "Unstructured", and the packet filter list in the QoS rule is not empty.

- 7) When, the
- A) rule operation is "Create new QoS rule", "Modify existing QoS rule and add packet filters", "Modify existing QoS rule and replace all packet filters", "Modify existing QoS rule and delete packet filters" or "Modify existing QoS rule without modifying packet filters", there is no QoS flow description with a QFI corresponding to the QFI of the resulting QoS rule and the UE determines, by using the QoS rule's QFI as the 5QI, that there is a resulting QoS rule for a GBR QoS flow (as described in 3GPP TS 23.501 [8] table 5.7.4-1).
 - B) flow description operation is "Delete existing QoS flow description", and the UE determines, by using the QoS rule's QFI as the 5QI, that there is a resulting QoS rule for a GBR QoS flow (as described in 3GPP TS 23.501 [8] table 5.7.4-1) with a QFI corresponding to the QFI of the QoS flow description that is deleted (i.e. there is no associated QoS flow description with the same QFI).
- 8) When the flow description operation is "Create new QoS flow description" or "Modify existing QoS flow description", and the UE determines that there is a QoS flow description of a GBR QoS flow (as described in 3GPP TS 23.501 [8] table 5.7.4-1) which lacks at least one of the mandatory parameters (i.e., GFBR uplink, GFBR downlink, MFBR uplink and MFBR downlink). If the QoS flow description does not include a 5QI, the UE determines this by using the QFI as the 5QI,

In case 3 the UE shall not diagnose an error, further process the deletion request and, if no error according to items c and d was detected, consider the respective packet filter as successfully deleted.

In case 6, after completion of the PDU session modification procedure, the UE shall send a PDU SESSION MODIFICATION REQUEST message with 5GSM cause #84 "syntactical error in the QoS operations" to delete all the packet filters for the default QoS rule.

In case 7, if the Authorized QoS rules IE contains at least one other valid QoS rule, the UE shall not diagnose an error and shall further process the request, if no error according to items c and d was detected. After completion of the PDU session modification procedure, if the resulting QoS rule for a GBR QoS flow which has no QoS flow description is the default QoS rule, the UE shall initiate a PDU session release procedure by sending a PDU SESSION RELEASE REQUEST message with 5GSM cause #84 "syntactical error in the QoS operation". Otherwise, the UE shall delete the QoS rule for which no corresponding QoS flow description is available and initiate UE-requested PDU session modification procedure with 5GSM cause #84 "syntactical error in the QoS operation" to delete the QoS rule for which it has deleted.

In case 8, if the default QoS rule is associated with the QoS flow description which lacks at least one of the mandatory parameters, the UE shall initiate a PDU session release procedure by sending a PDU SESSION RELEASE REQUEST message with 5GSM cause #84 "syntactical error in the QoS operation". Otherwise, if the Authorized QoS rules IE contains at least one other valid QoS rule or the QoS flow description IE contains at least one other valid QoS flow description, the UE shall not diagnose an error and shall further process the request, if no error according to items c and d was detected. After completion of the PDU session modification procedure, the UE shall delete the QoS flow description which lacks at least one of the mandatory parameters and the associated QoS rule(s), if any, and initiate UE-requested PDU session modification procedure with 5GSM cause #84 "syntactical error in the QoS operation" to delete the QoS flow description and the associated QoS rule(s), if any, which it has deleted.

Otherwise the UE shall reject the PDU SESSION MODIFICATION COMMAND message with 5GSM cause #84 "syntactical error in the QoS operation".

NOTE 5: It is not considered an error if the UE determines that after processing all QoS operations on QoS rules and QoS flow descriptions there is a QoS flow description that is not associated with any QoS rule and the UE is not in NB-N1 mode.

NOTE 5a: An implementation that strictly follows QoS rule operation as defined in subclause 9.11.4.13 might not detect case 2).

c) Semantic errors in packet filters:

- 1) When a packet filter consists of conflicting packet filter components which would render the packet filter ineffective, i.e. no IP packet will ever fit this packet filter. How the UE determines a semantic error in a packet filter is outside the scope of the present document.

The UE shall reject the PDU SESSION MODIFICATION COMMAND message with 5GSM cause #44 "semantic error in packet filter(s)".

d) Syntactical errors in packet filters:

- 1) When the rule operation is "Create new QoS rule", "Modify existing QoS rule and add packet filters" or "Modify existing QoS rule and replace all packet filters", and two or more packet filters in the resultant QoS rule would have identical packet filter identifiers.
- 2) When there are other types of syntactical errors in the coding of packet filters, such as the use of a reserved value for a packet filter component identifier.

In case 1, if two or more packet filters with identical packet filter identifiers are contained in the PDU SESSION MODIFICATION COMMAND message, the UE shall reject the PDU SESSION MODIFICATION COMMAND with 5GSM cause #45 "syntactical errors in packet filter(s)". Otherwise, the UE shall not diagnose an error, further process the PDU SESSION MODIFICATION COMMAND message and, if it was processed successfully, replace the old packet filter with the new packet filter which have the identical packet filter identifiers.

Otherwise the UE shall reject the PDU SESSION MODIFICATION COMMAND message with 5GSM cause #45 "syntactical errors in packet filter(s)".

If:

- a) the UE detects errors in QoS rules that require to delete at least one QoS rule as described above which requires sending a PDU SESSION MODIFICATION REQUEST message to delete the erroneous mapped EPS bearer contexts; and
- b) optionally, if the UE detects different errors in the mapped EPS bearer contexts as described in subclause 6.3.2.3 which requires sending a PDU SESSION MODIFICATION REQUEST message to delete the erroneous QoS rules;

the UE, after sending the PDU SESSION MODIFICATION COMPLETE message for the ongoing PDU session modification procedure, may send a single PDU SESSION MODIFICATION REQUEST message to delete the erroneous QoS rules, and optionally to delete the erroneous mapped EPS bearer contexts. The UE shall include a 5GSM cause IE in the PDU SESSION MODIFICATION REQUEST message.

NOTE 6: The 5GSM cause to use cannot be different from #41 "semantic error in the TFT operation", #42 "syntactical error in the TFT operation", #44 "semantic error in packet filter(s)", #45 "syntactical errors in packet filter(s)", #83 "semantic error in the QoS operation", #84 "syntactical error in the QoS operation", or #85 "Invalid mapped EPS bearer identity". The selection of a 5GSM cause is up to UE implementation.

The UE shall transport the PDU SESSION MODIFICATION COMMAND REJECT message and the PDU session ID, using the NAS transport procedure as specified in subclause 5.4.5.

Upon receipt of a PDU SESSION MODIFICATION COMMAND REJECT message with 5GSM cause value in state PDU SESSION MODIFICATION PENDING, the SMF shall stop timer T3591, enter the state PDU SESSION ACTIVE and abort the PDU session modification procedure.

6.3.2.5 Abnormal cases on the network side

The following abnormal cases can be identified:

- a) Expiry of timer T3591.

On the first expiry of the timer T3591, the SMF shall resend the PDU SESSION MODIFICATION COMMAND message and shall reset and restart timer T3591. This retransmission is repeated four times, i.e. on the fifth expiry of timer T3591, the SMF shall abort the procedure and enter the state PDU SESSION ACTIVE.

The SMF may continue to use the previous configuration of the PDU session or initiate the network-requested PDU session release procedure. If the SMF decides to continue to use the previous configuration of the PDU session and

- i) the Authorized QoS rules IE is included in the PDU SESSION MODIFICATION COMMAND message, the SMF may mark the corresponding authorized QoS rule(s) of the PDU session as to be synchronised with the UE; and
- ii) the Authorized QoS flow descriptions IE is included in the PDU SESSION MODIFICATION COMMAND message, the SMF may mark the corresponding authorized QoS flow description(s) of the PDU session as to be synchronised with the UE.

b) Void.

- c) Collision of UE-requested PDU session release procedure and network-requested PDU session modification procedure.

If the SMF receives a PDU SESSION RELEASE REQUEST message during the network-requested PDU session modification procedure, and the PDU session indicated in the PDU SESSION RELEASE REQUEST message is the PDU session that the SMF had requested to modify, the SMF shall abort the PDU session modification procedure and proceed with the UE-requested PDU session release procedure.

- d) Collision of UE-requested PDU session modification procedure and network-requested PDU session modification procedure.

If the network receives a PDU SESSION MODIFICATION REQUEST message during the network-requested PDU session modification procedure, and the PDU session indicated in the PDU SESSION MODIFICATION REQUEST message is the PDU session that the network had requested to modify, the network shall:

- i) if the received PDU SESSION MODIFICATION REQUEST message includes the URSP rule enforcement reports IE, ignore the PDU SESSION MODIFICATION REQUEST message received in the state PDU SESSION MODIFICATION PENDING except for the URSP rule enforcement reports IE and proceed with the network-requested PDU session modification procedure; or
- ii) otherwise, ignore the PDU SESSION MODIFICATION REQUEST message received in the state PDU SESSION MODIFICATION PENDING and proceed with the network-requested PDU session modification procedure as if no PDU SESSION MODIFICATION REQUEST message was received from the UE.

- e) 5G access network cannot forward the message.

If the SMF determines based on content of the n2SmInfo attribute specified in 3GPP TS 29.502 [20A] that the DL NAS TRANSPORT message carrying the PDU SESSION MODIFICATION COMMAND message was not forwarded to the UE by the 5G access network, then the SMF shall abort the procedure and enter the state PDU SESSION ACTIVE.

- f) 5G access network cannot forward the message due to handover.

If the SMF determines based on content of the n2SmInfo attribute specified in 3GPP TS 29.502 [20A] that the DL NAS TRANSPORT message carrying the PDU SESSION MODIFICATION COMMAND message was not forwarded to the UE by the 5G access network due to handover, then the SMF shall abort the procedure and enter the state PDU SESSION ACTIVE.

The SMF may re-initiate, up to a pre-configured number of times, the network-requested PDU session modification procedure when the SMF detects that the handover is completed successfully or has failed or at the expiry of the configured guard timer as specified in 3GPP TS 23.502 [9].

- g) Collision of re-establishment of the user-plane resources and network-requested PDU session modification procedure for the same PDU session.

If the SMF receives an indication from the AMF to re-establish the user-plane resources during the network-requested PDU session modification procedure for the same PDU session, the network shall abort the network-requested PDU session modification procedure and proceed with re-establishment of the user-plane resources for the PDU session as specified in 3GPP TS 29.502 [20A] subclause 5.2.2.3.2.2.

NOTE: After the completion of re-establishment of the user-plane resources for the PDU session, the SMF can re-initiate the network-requested PDU session modification procedure for the PDU session.

- h) Collision of UE-requested PDU session establishment procedure and network-requested PDU session modification procedure.

If the network receives a PDU SESSION ESTABLISHMENT REQUEST message with request type set to "existing PDU session" or "existing emergency PDU session" during the network-requested PDU session modification procedure, and the PDU session ID indicated in the PDU SESSION ESTABLISHMENT REQUEST message is the PDU session that the network had requested to modify, the network shall abort the network-requested PDU session modification procedure and proceed with the UE-requested PDU session establishment procedure.

6.3.2.6 Abnormal cases in the UE

The following abnormal cases can be identified:

- a) PDU session inactive for the received PDU session ID.

If the PDU session ID in the PDU SESSION MODIFICATION COMMAND message belongs to any PDU session in state PDU SESSION INACTIVE in the UE, the UE shall set the 5GSM cause IE to #43 "Invalid PDU session identity" in the 5GSM STATUS message, and set the PDU session ID to the received PDU session ID in the UL NAS TRANSPORT message as specified in subclause 5.4.5.

- b) Collision of network-requested PDU session modification procedure and UE-requested PDU session modification procedure.

If the UE receives a PDU SESSION MODIFICATION COMMAND message during the UE-requested PDU session modification procedure, the PTI IE of the PDU SESSION MODIFICATION COMMAND message is set to "No procedure transaction identity assigned", and the PDU session indicated in the PDU SESSION MODIFICATION COMMAND message is the PDU session that the UE had requested to modify, the UE shall abort internally the UE-requested PDU session modification procedure, enter the state PDU SESSION ACTIVE and proceed with the network-requested PDU session modification procedure.

- c) A semantic error in QoS operations or a semantic error in packet filters is detected in a PDU SESSION MODIFICATION COMMAND message that contains other optional information elements.

If the UE diagnoses a semantic error in QoS operations or a semantic error in packet filters in the PDU SESSION MODIFICATION COMMAND, as specified in subclause 6.3.2.4, and the message contains other optional information elements, the UE shall discard the other optional information elements and shall send the PDU SESSION MODIFICATION REJECT message as specified in subclause 6.3.2.4.

6.3.3 Network-requested PDU session release procedure

6.3.3.1 General

The purpose of the network-requested PDU session release procedure is to enable the network to release a PDU session or the user-plane resources on a single access of an MA PDU session.

6.3.3.2 Network-requested PDU session release procedure initiation

In order to initiate the network-requested PDU session release procedure, the SMF shall create a PDU SESSION RELEASE COMMAND message.

The SMF shall set the 5GSM cause IE of the PDU SESSION RELEASE COMMAND message to indicate the reason for releasing the PDU session.

The 5GSM cause IE typically indicates one of the following 5GSM cause values:

- #8 operator determined barring;
- #26 insufficient resources;
- #29 user authentication or authorization failed;
- #36 regular deactivation;
- #38 network failure;

- #39 reactivation requested;
- #46 out of LADN service area;
- #67 insufficient resources for specific slice and DNN;
- #69 insufficient resources for specific slice.

If the selected SSC mode of the PDU session is "SSC mode 2" and the SMF requests the relocation of SSC mode 2 PDU session anchor with different PDU sessions as specified in 3GPP TS 23.502 [9], the SMF shall include 5GSM cause #39 "reactivation requested". If the selected SSC mode of the PDU session is "SSC mode 2" or "SSC mode 1", the S-NSSAI or the mapped S-NSSAI of the PDU session needs to be replaced, the SMF shall include the Alternative S-NSSAI IE and 5GSM cause #39 "reactivation requested" in the PDU SESSION RELEASE COMMAND message. If the selected SSC mode of the PDU session is "SSC mode 2" or "SSC mode 1", replaced S-NSSAI is available and the SMF determines that the PDU session needs to be re-established on the replaced S-NSSAI, the SMF shall include 5GSM cause #39 "reactivation requested" and the replaced S-NSSAI in the PDU SESSION RELEASE COMMAND message.

NOTE 1: The relocation of SSC mode 2 PDU session anchor with different PDU sessions can also be initiated by the SMF in case of the SMF is requested by the AMF to release the PDU session due to the network slice instance of the PDU session is changed as specified in subclause 5.15.5.3 of 3GPP TS 23.501 [8].

If the network-requested PDU session release procedure is triggered by a UE-requested PDU session release procedure, the SMF shall set the PTI IE of the PDU SESSION RELEASE COMMAND message to the PTI of the PDU SESSION RELEASE REQUEST message received as part of the UE-requested PDU session release procedure and shall not include the Access type IE in the PDU SESSION RELEASE COMMAND.

If the network-requested PDU session release procedure is not triggered by a UE-requested PDU session release procedure, the SMF shall set the PTI IE of the PDU SESSION RELEASE COMMAND message to "No procedure transaction identity assigned".

If the PDU session ID included in PDU SESSION RELEASE COMMAND message is associated with one or more multicast MBS sessions and either the Access type IE is not included or the Access type IE indicates "3GPP access", the SMF shall consider the UE as removed from the associated multicast MBS sessions.

Based on the local policy and user's subscription data, if the SMF decides to release the PDU session after determining:

- a) the UE has moved between a tracking area in NB-N1 mode and a tracking area in WB-N1 mode;
- b) the UE has moved between a tracking area in NB-S1 mode and a tracking area in WB-N1 mode;
- c) the UE has moved between a tracking area in WB-S1 mode and a tracking area in NB-N1 mode; or
- d) a PDU session is not only for control plane CIoT 5GS optimization any more,

the SMF shall:

- a) include the 5GSM cause value #39 "reactivation requested" in the 5GSM cause IE of the PDU SESSION RELEASE COMMAND message; or
- b) include a 5GSM cause value other than #39 "reactivation requested" in the 5GSM cause IE of the PDU SESSION RELEASE COMMAND message.

NOTE 2: The included 5GSM cause value is up to the network implementation.

If the SMF receives UE presence in LADN service area from the AMF indicating that the UE is out of the LADN service area and the SMF decides to release the PDU session, the SMF shall include the 5GSM cause value #46 "out of LADN service area" in the 5GSM cause IE of the PDU SESSION RELEASE COMMAND message. Upon receipt of the 5GSM cause value #46 "out of LADN service area" in the 5GSM cause IE of the PDU SESSION RELEASE COMMAND message, the UE shall release the PDU session.

The SMF may include a Back-off timer value IE in the PDU SESSION RELEASE COMMAND message when the 5GSM cause value #26 "insufficient resources" is included in the PDU SESSION RELEASE COMMAND message. If the 5GSM cause value is #26 "insufficient resources" and the PDU SESSION RELEASE COMMAND message is sent to a UE configured for high priority access in selected PLMN or SNPN or the request type was set to "initial emergency

request" or "existing emergency PDU session" for the establishment of the PDU session, the network shall not include a Back-off timer value IE.

The SMF may include a Back-off timer value IE in the PDU SESSION RELEASE COMMAND message when the 5GSM cause value #67 "insufficient resources for specific slice and DNN" is included in the PDU SESSION RELEASE COMMAND message. If the 5GSM cause value is #67 "insufficient resources for specific slice and DNN" and the PDU SESSION RELEASE COMMAND message is sent to a UE configured for high priority access in selected PLMN or SNPN or the request type was set to "initial emergency request" or "existing emergency PDU session" for the establishment of the PDU session, the network shall not include a Back-off timer value IE.

The SMF may include a Back-off timer value IE in the PDU SESSION RELEASE COMMAND message when the 5GSM cause #69 "insufficient resources for specific slice" is included in the PDU SESSION RELEASE COMMAND message. If the 5GSM cause value is #69 "insufficient resources for specific slice" and the PDU SESSION RELEASE COMMAND message is sent to a UE configured for high priority access in selected PLMN or SNPN or the request type was set to "initial emergency request" or "existing emergency PDU session" for the establishment of the PDU session, the network shall not include a Back-off timer value IE.

The SMF should include a Back-off timer value IE in the PDU SESSION RELEASE COMMAND message when the 5GSM cause value #29 "user authentication or authorization failed" is included in the PDU SESSION RELEASE COMMAND message.

If the service-level-AA procedure is triggered for the established PDU session for UAS services with re-authentication purpose, and the SMF is informed by the UAS-NF that UUAA-SM is unsuccessful or if the SMF receives UUAA revocation notification message from the UAS-NF as described in 3GPP TS 23.256 [6AB], the SMF shall transmit the PDU SESSION RELEASE COMMAND message to the UE, including:

- a) the service-level-AA response in the Service-level-AA container IE, with the SLAR field set to the value of "Service level authentication and authorization was not successful or service level authorization is revoked"; and
- b) the 5GSM cause value #29 "user authentication or authorization failed" in the 5GSM cause IE of the PDU SESSION RELEASE COMMAND message.

If the PDU session was established for C2 communication and the SMF is informed by UAS-NF that C2 authorization is revoked, the SMF shall include:

- a) the service-level-AA response with the value of the C2AR field set to the "C2 authorization was not successful or C2 authorization is revoked" in the service-level-AA container IE of the PDU SESSION RELEASE COMMAND message, and
- b) the 5GSM cause value #29 "user authentication or authorization failed" in the 5GSM cause IE of the PDU SESSION RELEASE COMMAND message.

The SMF shall send:

- a) the PDU SESSION RELEASE COMMAND message; and
- b) the N1 SM delivery skip allowed indication:
 - 1) if the SMF allows the AMF to skip sending the N1 SM container to the UE and the 5GSM cause IE is not set to #39 "reactivation requested"; or
 - 2) if the SMF allows the AMF to skip sending the N1 SM container to the UE and the Access type IE is not included

towards the AMF, and the SMF shall start timer T3592 (see example in figure 6.3.3.2.1).

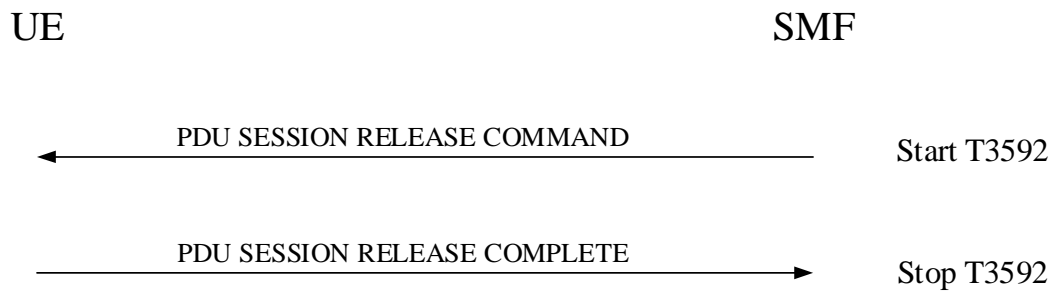

Figure 6.3.3.2.1: Network-requested PDU session release procedure

6.3.3.3 Network-requested PDU session release procedure accepted by the UE

For a single access PDU session, upon receipt of a PDU SESSION RELEASE COMMAND message and a PDU session ID, using the NAS transport procedure as specified in subclause 5.4.5, the UE considers the PDU session as released and the UE shall create a PDU SESSION RELEASE COMPLETE message.

For an MA PDU session, upon receipt of the PDU SESSION RELEASE COMMAND message, the UE shall behave as follows:

- a) if the PDU SESSION RELEASE COMMAND message includes the Access type IE and the MA PDU session has user-plane resources established on both 3GPP access and non-3GPP access, the UE shall consider the user-plane resources on the access indicated in the Access type IE as released and shall create a PDU SESSION RELEASE COMPLETE message. If the Access type IE indicates "3GPP access" and there is one or more multicast MBS sessions associated with the MA PDU session, the UE shall locally leave these associated multicast MBS sessions;
- b) if the PDU SESSION RELEASE COMMAND message includes the Access type IE and the MA PDU session has user-plane resources established on only the access indicated in the Access type IE, the UE shall consider the MA PDU session as released and shall create a PDU SESSION RELEASE COMPLETE message; and
- c) if the PDU SESSION RELEASE COMMAND message does not include the Access type IE, the UE shall consider the MA PDU session as released and shall create a PDU SESSION RELEASE COMPLETE message.

If the UE is configured with on-demand S-NSSAI including slice deregistration inactivity timer:

- a) if the PDU session associated with an on-demand S-NSSAI is released and there is no established user plane resources of an MA PDU session associated with this on-demand S-NSSAI and there is no PDU session associated with this on-demand S-NSSAI, the UE shall start the slice deregistration inactivity timer for this on-demand S-NSSAI over the corresponding access type;
- b) if the MA PDU session associated with an on-demand S-NSSAI is released:

for each registered access type, if there is no PDU session associated with this on-demand S-NSSAI and there is no established user plane resources of an MA PDU session associated with this on-demand S-NSSAI over the registered access type, the UE shall start the slice deregistration inactivity timer for this on-demand S-NSSAI over the corresponding registered access type; or
- c) if the user plane resources of an MA PDU session associated with on-demand S-NSSAI is released over the access type and there is no PDU session associated with this on-demand S-NSSAI and there is no established user plane resources of an MA PDU session associated with this on-demand S-NSSAI over the corresponding access type, then UE shall start the slice deregistration inactivity timer over the corresponding access type.

If there is one or more multicast MBS sessions associated with the PDU session the UE considers as released, the UE shall locally leave these associated multicast MBS sessions.

If the PDU SESSION RELEASE COMMAND message contains the PTI value allocated in the UE-requested PDU session release procedure, the UE shall stop the timer T3582. The UE should ensure that the PTI value assigned to this procedure is not released immediately.

NOTE 1: The way to achieve this is implementation dependent. For example, the UE can ensure that the PTI value assigned to this procedure is not released during the time equal to or greater than the default value of timer T3592.

While the PTI value is not released, the UE regards any received PDU SESSION RELEASE COMMAND message with the same PTI value as a network retransmission (see subclause 7.3.1).

If the PDU SESSION RELEASE COMMAND message includes 5GSM cause #39 "reactivation requested", then after completion of the network-requested PDU session release procedure, the UE should re-initiate the UE-requested PDU session establishment procedure as specified in subclause 6.4.1 for:

- a) the PDU session type associated with the released PDU session;
- b) the SSC mode associated with the released PDU session;
- c) the DNN associated with the released PDU session; and
- d) the S-NSSAI associated with (if available in roaming scenarios) a mapped S-NSSAI if provided in the UE-requested PDU session establishment procedure of the released PDU session. If the PDU SESSION RELEASE COMMAND message contains the Alternative S-NSSAI IE, the UE shall include both the S-NSSAI to be replaced and the alternative S-NSSAI during the UE-requested PDU session establishment procedure.

NOTE 2: User interaction is necessary in some cases when the UE cannot re-initiate the UE-requested PDU session establishment procedure automatically.

If the PDU SESSION RELEASE COMMAND message is received without the Back-off timer value IE or includes 5GSM cause #39 "reactivation requested", and the UE provided an S-NSSAI during the PDU session establishment, the UE shall stop timer T3585 if it is running for the S-NSSAI of the PDU session. If the UE did not provide an S-NSSAI during the PDU session establishment and the request type was different from "initial emergency request" and different from "existing emergency PDU session", the UE shall stop the timer T3585 associated with no S-NSSAI if it is running. If the PDU SESSION RELEASE COMMAND message was received for an emergency PDU session, the UE shall not stop the timer T3585 associated with no S-NSSAI if it is running. The timer T3585 to be stopped includes:

- a) in a PLMN:
 - 1) the timer T3585 applied for all the PLMNs and for the access over which the PDU SESSION RELEASE COMMAND is received, if running;
 - 2) the timer T3585 applied for all the PLMNs and for both 3GPP access type and non-3GPP access type, if running;
 - 3) the timer T3585 applied for the registered PLMN and for the access over which the PDU SESSION RELEASE COMMAND is received, if running; and
 - 4) the timer T3585 applied for the registered PLMN and for both 3GPP access type and non-3GPP access type, if running; or
- b) in an SNPN:
 - 1) the timer T3585 applied for all the equivalent SNPNs and for the access over which the PDU SESSION AUTHENTICATION COMMAND message is received, associated with the RSNPN or an equivalent SNPN and with the selected entry of the "list of subscriber data" or the selected PLMN subscription, if running;
 - 2) the timer T3585 applied for all the equivalent SNPNs and for both 3GPP access type and non-3GPP access type, associated with the RSNPN or an equivalent SNPN and with the selected entry of the "list of subscriber data" or the selected PLMN subscription, if running;
 - 3) the timer T3585 applied for the registered SNPN and for the access over which the PDU SESSION AUTHENTICATION COMMAND message is received, associated with the RSNPN and, if the UE supports

access to an SNPN using credentials from a credentials holder, equivalent SNPNs or both, associated with the selected entry of the "list of subscriber data" or the selected PLMN subscription, if running; and

- 4) the timer T3585 applied for the registered PLMN and for both 3GPP access type and non-3GPP access type, associated with the RSNPN and, if the UE supports access to an SNPN using credentials from a credentials holder, equivalent SNPNs or both, associated with the selected entry of the "list of subscriber data" or the selected PLMN subscription, if running.

If the PDU SESSION RELEASE COMMAND message is received without the Back-off timer value IE or includes 5GSM cause #39 "reactivation requested", and the UE provided a DNN during the PDU session establishment, the UE shall stop timer T3396 if it is running for the DNN provided by the UE. If the UE did not provide a DNN during the PDU session establishment and the request type was different from "initial emergency request" and different from "existing emergency PDU session", the UE shall stop the timer T3396 associated with no DNN if it is running. If the PDU SESSION RELEASE COMMAND message was received for an emergency PDU session, the UE shall not stop the timer T3396 associated with no DNN if it is running. In an SNPN, the timer T3396 to be stopped includes:

- a) the timer T3396 applied for all the equivalent SNPNs, associated with the RSNPN or an equivalent SNPN, and with the selected entry of the "list of subscriber data" or the selected PLMN subscription, if running; and
- b) the timer T3396 applied for the registered SNPN, associated with the RSNPN, and, if the UE supports access to an SNPN using credentials from a credentials holder, associated with the selected entry of the "list of subscriber data" or the selected PLMN subscription, if running.

If the PDU SESSION RELEASE COMMAND message is received without the Back-off timer value IE or includes 5GSM cause #39 "reactivation requested", and the UE provided an S-NSSAI and a DNN during the PDU session establishment, the UE shall stop timer T3584 if it is running for the [S-NSSAI of the PDU session, DNN] combination provided by the UE. If the UE did not provide an S-NSSAI during the PDU session establishment, the UE shall stop the timer T3584 associated with [no S-NSSAI, DNN] if it is running. If the UE did not provide a DNN during the PDU session establishment and the request type was different from "initial emergency request" and different from "existing emergency PDU session", the UE shall stop the timer T3584 associated with [S-NSSAI of the PDU session, no DNN] combination, if it is running. If the PDU SESSION RELEASE COMMAND message was received for an emergency PDU session, the UE shall not stop the timer T3584 associated with [S-NSSAI of the PDU session, no DNN] if it is running. If the UE provided neither a DNN nor an S-NSSAI during the PDU session establishment and the request type was different from "initial emergency request" and different from "existing emergency PDU session", the UE shall stop the timer T3584 associated with [no S-NSSAI, no DNN] if it is running. If the PDU SESSION RELEASE COMMAND message was received for an emergency PDU session, the UE shall not stop the timer T3584 associated with [no S-NSSAI, no DNN] if it is running. The timer T3584 to be stopped includes:

- a) in a PLMN:
 - 1) the timer T3584 applied for all the PLMNs, if running; and
 - 2) the timer T3584 applied for the registered PLMN, if running; or
- b) in an SNPN:
 - 1) the timer T3584 applied for all the equivalent SNPNs, and associated with the RSNPN or an equivalent SNPN and with the selected entry of the "list of subscriber data" or the selected PLMN subscription, if running; and
 - 2) the timer T3584 applied for the registered SNPN, associated with the RSNPN and, if the UE supports access to an SNPN using credentials from a credentials holder, equivalent SNPNs or both, associated with the selected entry of the "list of subscriber data" or the selected PLMN subscription, if running.

NOTE 3: If the PDU SESSION RELEASE COMMAND message is received without the Back-off timer value IE or includes 5GSM cause #39 "reactivation requested" for a PDU session, the UE provided a DNN (or no DNN) and an S-NSSAI (or no S-NSSAI) when the PDU session is established, timer T3396 associated with the DNN (or no DNN, if no DNN was provided by the UE) is running, and timer T3584 associated with the DNN (or no DNN, if no DNN was provided by the UE) and the S-NSSAI of the PDU session (or no S-NSSAI, if no S-NSSAI was provided by the UE) is running, then the UE stops both the timer T3396 and the timer T3584.

NOTE 4: If the PDU SESSION RELEASE COMMAND message is received without the Back-off timer value IE or includes 5GSM cause #39 "reactivation requested" for a PDU session, the UE provided a DNN (or no DNN) and an S-NSSAI of the PDU session (or no S-NSSAI) when the PDU session is established, timer T3585 associated with the S-NSSAI of the PDU session (or no S-NSSAI, if no S-NSSAI was provided by the UE) is running, and timer T3584 associated with the DNN (or no DNN, if no DNN was provided by the UE) and the S-NSSAI of the PDU session (or no S-NSSAI, if no S-NSSAI was provided by the UE) is running, then the UE stops both the timer T3585 and the timer T3584.

If the PDU SESSION RELEASE COMMAND message includes 5GSM cause #26 "insufficient resources" and the Back-off timer value IE, the UE shall ignore the 5GSM congestion re-attempt indicator IE provided by the network, if any, and the UE shall take different actions depending on the timer value received for timer T3396 in the Back-off timer value:

- a) If the timer value indicates neither zero nor deactivated and a DNN was provided during the PDU session establishment, the UE shall stop timer T3396 associated with the corresponding DNN, if it is running. If the timer value indicates neither zero nor deactivated and no DNN was provided during the PDU session establishment and the request type was different from "initial emergency request" and different from "existing emergency PDU session", the UE shall stop timer T3396 associated with no DNN if it is running. In an SNPN, the timer T3396 to be stopped includes:
 - 1) the timer T3396 applied for all the equivalent SNPNS, and associated with the RSNPN or an equivalent SNPN and with the selected entry of the "list of subscriber data" or the selected PLMN subscription, if running; and
 - 2) the timer T3396 applied for the registered SNPN, associated with the RSNPN and, if the UE supports access to an SNPN using credentials from a credentials holder, associated with the selected entry of the "list of subscriber data" or the selected PLMN subscription, if running.

The UE shall then start timer T3396 with the value provided in the Back-off timer value IE and:

- 1) shall not send a PDU SESSION ESTABLISHMENT REQUEST message or PDU SESSION MODIFICATION REQUEST message with exception of those identified in subclause 6.4.2.1, for the same DNN that was sent by the UE, until timer T3396 expires or timer T3396 is stopped; and
- 2) shall not send a PDU SESSION ESTABLISHMENT REQUEST message without an DNN and with request type different from "initial emergency request" and different from "existing emergency PDU session", or a PDU SESSION MODIFICATION REQUEST message with exception of those identified in subclause 6.4.2.1, for a non-emergency PDU session established without an DNN provided by the UE, if no DNN was provided during the PDU session establishment and the request type was different from "initial emergency request" and different from "existing emergency PDU session", until timer T3396 expires or timer T3396 is stopped.

The UE shall not stop timer T3396 upon a PLMN change, SNPN change, or inter-system change;

- b) if the timer value indicates that this timer is deactivated and a DNN was provided during the PDU session establishment, the UE shall stop timer T3396 associated with the corresponding DNN, if it is running. If the timer value indicates that this timer is deactivated and no DNN was provided during the PDU session establishment and the request type was different from "initial emergency request" and different from "existing emergency PDU session", the UE shall stop timer T3396 associated with no DNN if it is running. In an SNPN, the timer T3396 to be stopped includes:
 - 1) the timer T3396 applied for all the equivalent SNPNS, and associated with the RSNPN or an equivalent SNPN and with the selected entry of the "list of subscriber data" or the selected PLMN subscription, if running; and
 - 2) the timer T3396 applied for the registered SNPN, associated with the RSNPN and, if the UE supports access to an SNPN using credentials from a credentials holder, associated with the selected entry of the "list of subscriber data" or the selected PLMN subscription, if running.

The UE:

- 1) shall not send a PDU SESSION ESTABLISHMENT REQUEST message or PDU SESSION MODIFICATION REQUEST message with exception of those identified in subclause 6.4.2.1, for the same DNN until the UE is switched off, the USIM is removed, the entry in the "list of subscriber data" for the

current SNPN is updated, or the UE receives a PDU SESSION MODIFICATION COMMAND message for the same DNN from the network, or a PDU SESSION AUTHENTICATION COMMAND message for the same DNN, or a PDU SESSION RELEASE COMMAND message without the Back-off timer value IE or including 5GSM cause #39 "reactivation requested" for the same DNN from the network; and

- 2) shall not send a PDU SESSION ESTABLISHMENT REQUEST message without a DNN and with request type different from "initial emergency request" and different from "existing emergency PDU session", or a PDU SESSION MODIFICATION REQUEST message with exception of those identified in subclause 6.4.2.1, for a non-emergency PDU session established without a DNN provided by the UE, if no DNN was provided during the PDU session establishment and the request type was different from "initial emergency request" and different from "existing emergency PDU session", until the UE is switched off, the USIM is removed, the entry in the "list of subscriber data" for the current SNPN is updated, or the UE receives a PDU SESSION MODIFICATION COMMAND message for a non-emergency PDU session established without a DNN provided by the UE, or a PDU SESSION AUTHENTICATION COMMAND message for a non-emergency PDU session established without a DNN provided by the UE, or a PDU SESSION RELEASE COMMAND message without the Back-off timer value IE or including 5GSM cause #39 "reactivation requested" for a non-emergency PDU session established without a DNN provided by the UE.

The timer T3396 remains deactivated upon a PLMN change, SNPN change, or inter-system change; and

- c) if the timer value indicates zero, the UE:

- 1) shall stop timer T3396 associated with the corresponding DNN, if running. In an SNPN, the timer T3396 to be stopped includes:
 - i) the timer T3396 applied for all the equivalent SNPNS, and associated with the RSNPN or an equivalent SNPN and with the selected entry of the "list of subscriber data" or the selected PLMN subscription, if running; and
 - ii) the timer T3396 applied for the registered SNPN, associated with the RSNPN and, if the UE supports access to an SNPN using credentials from a credentials holder, associated with the selected entry of the "list of subscriber data" or the selected PLMN subscription, if running.

The UE may send a PDU SESSION ESTABLISHMENT REQUEST message or PDU SESSION MODIFICATION REQUEST message for the same DNN; and

- 2) if no DNN was provided during the PDU session establishment and the request type was different from "initial emergency request" and different from "existing emergency PDU session", the UE shall stop timer T3396 associated with no DNN, if running. In an SNPN, the timer T3396 to be stopped includes:
 - i) the timer T3396 applied for all the equivalent SNPNS, and associated with the RSNPN or an equivalent SNPN and with the selected entry of the "list of subscriber data" or the selected PLMN subscription, if running; and
 - ii) the timer T3396 applied for the registered SNPN, associated with the RSNPN and, if the UE supports access to an SNPN using credentials from a credentials holder, associated with the selected entry of the "list of subscriber data" or the selected PLMN subscription, if running.

The UE may send a PDU SESSION ESTABLISHMENT REQUEST message without a DNN, or a PDU SESSION MODIFICATION REQUEST message without an DNN provided by the UE.

In an SNPN, if the UE supports equivalent SNPNS, then the UE shall apply the timer T3396 for all the equivalent SNPNS. Otherwise, the UE shall apply the timer T3396 for the registered SNPN.

If the PDU SESSION RELEASE COMMAND message includes 5GSM cause #26 "insufficient resources" and the Back-off timer value IE is not included, then the UE may send a PDU SESSION ESTABLISHMENT REQUEST message or PDU SESSION MODIFICATION REQUEST message for the same DNN or without a DNN.

When the timer T3396 is running or the timer is deactivated, the UE is allowed to initiate a PDU session establishment procedure for emergency services.

If the timer T3396 is running when the UE enters state 5GMM-DEREGISTERED, the UE remains switched on, and the USIM in the UE (if any) remains the same and the entry in the "list of subscriber data" for the SNPN to which timer T3396 is associated (if any) is not updated, then timer T3396 is kept running until it expires or it is stopped.

If the UE is switched off when the timer T3396 is running, and if the USIM in the UE (if any) remains the same and the entry in the "list of subscriber data" for the SNPN to which timer T3396 is associated (if any) is not updated when the UE is switched on, the UE shall behave as follows:

- let t_1 be the time remaining for T3396 timeout at switch off and let t be the time elapsed between switch off and switch on. If t_1 is greater than t , then the timer shall be restarted with the value $t_1 - t$. If t_1 is equal to or less than t , then the timer need not be restarted. If the UE is not capable of determining t , then the UE shall restart the timer with the value t_1 .

If the 5GSM cause value is #39 "reactivation requested", the UE shall ignore the Back-off timer value IE provided by the network, if any.

If the 5GSM cause value is #67 "insufficient resources for specific slice and DNN" and the Back-off timer value IE is included, the UE shall take different actions depending on the timer value received for timer T3584 in the Back-off timer value:

- a) If the timer value indicates neither zero nor deactivated, and both an S-NSSAI and a DNN were provided by the UE during the PDU session establishment the UE shall stop timer T3584 associated with the [S-NSSAI of the PDU session, DNN] combination, if it is running. If the timer value indicates neither zero nor deactivated, an S-NSSAI and no DNN was provided during the PDU session establishment and the request type was different from "initial emergency request" and different from "existing emergency PDU session", the UE shall stop timer T3584 associated with [S-NSSAI of the PDU session, no DNN] combination, if it is running. If the timer value indicates neither zero nor deactivated, no S-NSSAI and a DNN was provided during the PDU session establishment, the UE shall stop timer T3584 associated with the [no S-NSSAI, DNN] combination, if it is running. If the timer value indicates neither zero nor deactivated and neither S-NSSAI nor DNN was provided during the PDU session establishment and the request type was different from "initial emergency request" and different from "existing emergency PDU session", the UE shall stop timer T3584 associated with the [no S-NSSAI, no DNN] combination, if it is running. The timer T3584 to be stopped includes:
 - 1) in a PLMN:
 - i) the timer T3584 applied for all the PLMNs, if running; and
 - ii) the timer T3584 applied for the registered PLMN, if running; or
 - 2) in an SNPN:
 - i) the timer T3584 applied for all the equivalent SNPNS, and associated with the RSNPN or an equivalent SNPN and with the selected entry of the "list of subscriber data" or the selected PLMN subscription, if running; and
 - ii) the timer T3584 applied for the registered SNPN, associated with the RSNPN and, if the UE supports access to an SNPN using credentials from a credentials holder, equivalent SNPNS or both, associated with the selected entry of the "list of subscriber data" or the selected PLMN subscription, if running.

The UE shall then start timer T3584 with the value provided in the Back-off timer value IE.

- 1) The UE shall not send another PDU SESSION ESTABLISHMENT REQUEST message with request type different from "initial emergency request" and different from "existing emergency PDU session", or PDU SESSION MODIFICATION REQUEST message with the exception of those identified in subclause 6.4.2.1, for the [S-NSSAI of the PDU session, DNN] combination, until timer T3584 expires or timer T3584 is stopped;
- 2) shall not send another PDU SESSION ESTABLISHMENT REQUEST message with request type different from "initial emergency request" and different from "existing emergency PDU session", or another PDU SESSION MODIFICATION REQUEST message with the exception of those identified in subclause 6.4.2.1, for the [S-NSSAI of the PDU session, no DNN] combination, if no DNN was provided during the PDU session establishment, until timer T3584 expires or timer T3584 is stopped;
- 3) shall not send another PDU SESSION ESTABLISHMENT REQUEST message, or another PDU SESSION MODIFICATION REQUEST message with the exception of those identified in subclause 6.4.2.1, for the same [no S-NSSAI, DNN] combination, if no S-NSSAI was provided during the PDU session establishment, until timer T3584 expires or timer T3584 is stopped; and

- 4) shall not send another PDU SESSION ESTABLISHMENT REQUEST message with request type different from "initial emergency request" and different from "existing emergency PDU session", or another PDU SESSION MODIFICATION REQUEST message with the exception of those identified in subclause 6.4.2.1, for the same [no S-NSSAI, no DNN] combination, if neither S-NSSAI nor DNN was provided during the PDU session establishment, until timer T3584 expires or timer T3584 is stopped.

The UE shall not stop timer T3584 upon a PLMN change, SNPN change, or inter-system change;

- b) if the timer value indicates that this timer is deactivated:
 - 1) if both S-NSSAI and DNN were provided by the UE during the PDU session establishment, the UE shall stop timer T3584 associated with the [S-NSSAI of the PDU session, DNN] combination, if running. The timer T3584 to be stopped includes:
 - i) in a PLMN:
 - A) the timer T3584 applied for all the PLMNs, if running; and
 - B) the timer T3584 applied for the registered PLMN, if running; or
 - ii) in an SNPN:
 - A) the timer T3584 applied for all the equivalent SNPNs, and associated with the RSNPN or an equivalent SNPN and with the selected entry of the "list of subscriber data" or the selected PLMN subscription, if running; and
 - B) the timer T3584 applied for the registered SNPN, associated with the RSNPN and, if the UE supports access to an SNPN using credentials from a credentials holder, equivalent SNPNs or both, associated with the selected entry of the "list of subscriber data" or the selected PLMN subscription, if running.

The UE shall not send another PDU SESSION ESTABLISHMENT REQUEST message with request type different from "initial emergency request" and different from "existing emergency PDU session", or PDU SESSION MODIFICATION REQUEST message with exception of those identified in subclause 6.4.2.1, for the [S-NSSAI of the PDU session, DNN] combination that was sent by the UE, until the UE is switched off, the USIM is removed, the entry in the "list of subscriber data" for the current SNPN is updated, or the UE receives a PDU SESSION MODIFICATION COMMAND message for the [S-NSSAI of the PDU session, DNN] combination from the network, or a PDU SESSION AUTHENTICATION COMMAND message for the [S-NSSAI of the PDU session, DNN] combination from the network, or a PDU SESSION RELEASE COMMAND message without the Back-off timer value IE or including 5GSM cause #39 "reactivation requested" for the [S-NSSAI of the PDU session, DNN] combination from the network;

- 2) if an S-NSSAI was provided but a DNN was not provided by the UE during the PDU session establishment, the UE shall stop timer T3584 associated with the [S-NSSAI of the PDU session, no DNN] combination, if running. The timer T3584 to be stopped includes:
 - i) in a PLMN:
 - A) the timer T3584 applied for all the PLMNs, if running; and
 - B) the timer T3584 applied for the registered PLMN, if running; or
 - ii) in an SNPN:
 - A) the timer T3584 applied for all the equivalent SNPNs, and associated with the RSNPN or an equivalent SNPN and with the selected entry of the "list of subscriber data" or the selected PLMN subscription, if running; and
 - B) the timer T3584 applied for the registered SNPN, associated with the RSNPN and, if the UE supports access to an SNPN using credentials from a credentials holder, equivalent SNPNs or both, associated with the selected entry of the "list of subscriber data" or the selected PLMN subscription, if running.

The UE shall not send a PDU SESSION ESTABLISHMENT REQUEST message with request type different from "initial emergency request" and different from "existing emergency PDU session", or a PDU SESSION MODIFICATION REQUEST message with exception of those identified in subclause 6.4.2.1, for the [S-NSSAI of the PDU session, no DNN] combination, if no DNN was provided during the PDU session establishment, until the UE is switched off, the USIM is removed, the entry in the "list of subscriber data" for

the current SNPN is updated, or the UE receives an PDU SESSION MODIFICATION COMMAND message for a non-emergency PDU session established for the [S-NSSAI of the PDU session, no DNN] combination from the network, or a PDU SESSION AUTHENTICATION COMMAND message for a non-emergency PDU session established the [S-NSSAI of the PDU session, DNN] combination from the network, or a PDU SESSION RELEASE COMMAND message without the Back-off timer value IE or including 5GSM cause #39 "reactivation requested" for a non-emergency PDU session established for the [S-NSSAI of the PDU session, no DNN] combination from the network;

- 3) if an S-NSSAI was not provided but a DNN was provided by the UE during the PDU session establishment, the UE shall stop timer T3584 associated with the [no S-NSSAI, DNN] combination, if running. The timer T3584 to be stopped includes:
 - i) in a PLMN:
 - A) the timer T3584 applied for all the PLMNs, if running; and
 - B) the timer T3584 applied for the registered PLMN, if running; or
 - ii) in an SNPN:
 - A) the timer T3584 applied for all the equivalent SNPNS, and associated with the RSNPN or an equivalent SNPN and with the selected entry of the "list of subscriber data" or the selected PLMN subscription, if running; and
 - B) the timer T3584 applied for the registered SNPN, associated with the RSNPN and, if the UE supports access to an SNPN using credentials from a credentials holder, equivalent SNPNS or both, associated with the selected entry of the "list of subscriber data" or the selected PLMN subscription, if running.

The UE shall not send a PDU SESSION ESTABLISHMENT REQUEST message, or a PDU SESSION MODIFICATION REQUEST message with exception of those identified in subclause 6.4.2.1, for the [no S-NSSAI, DNN], if no S-NSSAI was provided during the PDU session establishment, until the UE is switched off, the USIM is removed, the entry in the "list of subscriber data" for the current SNPN is updated, or the UE receives an PDU SESSION MODIFICATION COMMAND message for the [no S-NSSAI, DNN] combination from the network, or a PDU SESSION AUTHENTICATION COMMAND message for the [no S-NSSAI, DNN] combination from the network, or a PDU SESSION RELEASE COMMAND message without the Back-off timer value IE or including 5GSM cause #39 "reactivation requested" for the same [no S-NSSAI, DNN] combination from the network; and

- 4) if neither S-NSSAI nor DNN were provided by the UE during the PDU session establishment, the UE shall stop timer T3584 associated with the [no S-NSSAI, no DNN] combination, if running. The timer T3584 to be stopped includes:
 - i) in a PLMN:
 - A) the timer T3584 applied for all the PLMNs, if running; and
 - B) the timer T3584 applied for the registered PLMN, if running; or
 - ii) in an SNPN:
 - A) the timer T3584 applied for all the equivalent SNPNS, and associated with the RSNPN or an equivalent SNPN and with the selected entry of the "list of subscriber data" or the selected PLMN subscription, if running; and
 - B) the timer T3584 applied for the registered SNPN, associated with the RSNPN and, if the UE supports access to an SNPN using credentials from a credentials holder, equivalent SNPNS or both, associated with the selected entry of the "list of subscriber data" or the selected PLMN subscription, if running.

The UE shall not send a PDU SESSION ESTABLISHMENT REQUEST message with request type different from "initial emergency request" and different from "existing emergency PDU session", or a PDU SESSION MODIFICATION REQUEST message with exception of those identified in subclause 6.4.2.1, for the [no S-NSSAI, no DNN] combination, if neither S-NSSAI nor DNN was provided during the PDU session establishment, until the UE is switched off, the USIM is removed, the entry in the "list of subscriber data" for the current SNPN is updated, or the UE receives an PDU SESSION MODIFICATION COMMAND message for a non-emergency PDU session established for the [no S-NSSAI, no DNN] combination from the network,

or a PDU SESSION AUTHENTICATION COMMAND message for a non-emergency PDU session established for the [no S-NSSAI, no DNN] combination from the network or a PDU SESSION RELEASE COMMAND message without the Back-off timer value IE or including 5GSM cause #39 "reactivation requested" for a non-emergency PDU session established for the [no S-NSSAI, no DNN] combination from the network.

The timer T3584 remains deactivated upon a PLMN change, SNPN change, or inter-system change; and

- c) if the timer value indicates zero:
- 1) if both S-NSSAI and DNN were provided by the UE during the PDU session establishment, the UE shall stop timer T3584 associated with the [S-NSSAI of the PDU session, DNN] combination, if running. The timer T3584 to be stopped includes:
 - i) in a PLMN:
 - A) the timer T3584 applied for all the PLMNs, if running; and
 - B) the timer T3584 applied for the registered PLMN, if running; or
 - ii) in an SNPN:
 - A) the timer T3584 applied for all the equivalent SNPNS, and associated with the RSNPN or an equivalent SNPN and with the selected entry of the "list of subscriber data" or the selected PLMN subscription, if running; and
 - B) the timer T3584 applied for the registered SNPN, associated with the RSNPN and, if the UE supports access to an SNPN using credentials from a credentials holder, equivalent SNPNS or both, associated with the selected entry of the "list of subscriber data" or the selected PLMN subscription, if running.

The UE may send another PDU SESSION ESTABLISHMENT REQUEST message or PDU SESSION MODIFICATION REQUEST message for the [S-NSSAI of the PDU session, DNN] combination;

- 2) if an S-NSSAI was provided but a DNN was not provided by the UE during the PDU session establishment, the UE shall stop timer T3584 associated with the [S-NSSAI of the PDU session, no DNN] combination, if running. The timer T3584 to be stopped includes:
 - i) in a PLMN:
 - A) the timer T3584 applied for all the PLMNs, if running; and
 - B) the timer T3584 applied for the registered PLMN, if running; or
 - ii) in an SNPN:
 - A) the timer T3584 applied for all the equivalent SNPNS, and associated with the RSNPN or an equivalent SNPN and with the selected entry of the "list of subscriber data" or the selected PLMN subscription, if running; and
 - B) the timer T3584 applied for the registered SNPN, associated with the RSNPN and, if the UE supports access to an SNPN using credentials from a credentials holder, equivalent SNPNS or both, associated with the selected entry of the "list of subscriber data" or the selected PLMN subscription, if running.

The UE may send another PDU SESSION ESTABLISHMENT REQUEST message or PDU SESSION MODIFICATION REQUEST message for the [S-NSSAI of the PDU session, no DNN] combination if the request type was different from "initial emergency request" and different from "existing emergency PDU session";

- 3) if an S-NSSAI was not provided but a DNN was provided by the UE during the PDU session establishment, the UE shall stop timer T3584 associated with the [no S-NSSAI, DNN] combination, if running. The timer T3584 to be stopped includes:
 - i) in a PLMN:
 - A) the timer T3584 applied for all the PLMNs, if running; and

- B) the timer T3584 applied for the registered PLMN, if running; or
- ii) in an SNPN:
 - A) the timer T3584 applied for all the equivalent SNPNS, and associated with the RSNPN or an equivalent SNPN and with the selected entry of the "list of subscriber data" or the selected PLMN subscription, if running; and
 - B) the timer T3584 applied for the registered SNPN, associated with the RSNPN and, if the UE supports access to an SNPN using credentials from a credentials holder, equivalent SNPNS or both, associated with the selected entry of the "list of subscriber data" or the selected PLMN subscription, if running.

The UE may send another PDU SESSION ESTABLISHMENT REQUEST message, or PDU SESSION MODIFICATION REQUEST message for the [no S-NSSAI, DNN] combination; and

- 4) if neither S-NSSAI nor DNN were provided by the UE during the PDU session establishment, the UE shall stop timer T3584 associated with the [no S-NSSAI, no DNN] combination, if running. The timer T3584 to be stopped includes:
 - i) in a PLMN:
 - A) the timer T3584 applied for all the PLMNs, if running; and
 - B) the timer T3584 applied for the registered PLMN, if running; or
 - ii) in an SNPN:
 - A) the timer T3584 applied for all the equivalent SNPNS, and associated with the RSNPN or an equivalent SNPN and with the selected entry of the "list of subscriber data" or the selected PLMN subscription, if running; and
 - B) the timer T3584 applied for the registered SNPN, associated with the RSNPN and, if the UE supports access to an SNPN using credentials from a credentials holder, equivalent SNPNS or both, associated with the selected entry of the "list of subscriber data" or the selected PLMN subscription, if running.

The UE may send another PDU SESSION ESTABLISHMENT REQUEST message, or PDU SESSION MODIFICATION REQUEST message for the [no S-NSSAI, no DNN] combination if the request type was different from "initial emergency request" and different from "existing emergency PDU session".

If the 5GSM congestion re-attempt indicator IE with the ABO bit set to "The back-off timer is applied in all PLMNs or all equivalent SNPNS " is included in the PDU SESSION RELEASE COMMAND message with the 5GSM cause value #67 "insufficient resources for specific slice and DNN", then the UE shall apply the timer T3584 for all the PLMNs or all the equivalent SNPNS. Otherwise, the UE shall apply the timer T3584 for the registered PLMN or the registered SNPN.

If the 5GSM cause value is #67 "insufficient resources for specific slice and DNN" and the Back-off timer value IE is not included, then the UE may send another PDU SESSION ESTABLISHMENT REQUEST message or PDU SESSION MODIFICATION REQUEST message for the same [S-NSSAI, DNN] combination.

When the timer T3584 is running or the timer is deactivated, the UE is allowed to initiate a PDU session establishment procedure for emergency services.

If the timer T3584 is running when the UE enters state 5GMM-DEREGISTERED, the UE remains switched on, and the USIM in the UE (if any) remains the same and the entry in the "list of subscriber data" for the SNPN to which timer T3584 is associated (if any) is not updated, then timer T3584 is kept running until it expires or it is stopped.

If the UE is switched off when the timer T3584 is running, and if the USIM in the UE (if any) remains the same and the entry in the "list of subscriber data" for the SNPN to which timer T3584 is associated (if any) is not updated when the UE is switched on, the UE shall behave as follows:

- let t_1 be the time remaining for T3584 timeout at switch off and let t be the time elapsed between switch off and switch on. If t_1 is greater than t , then the timer shall be restarted with the value $t_1 - t$. If t_1 is equal to or less than t , then the timer need not be restarted. If the UE is not capable of determining t , then the UE shall restart the timer with the value t_1 .

If the 5GSM cause value is #69 "insufficient resources for specific slice" and the Back-off timer value IE is included, the UE shall take different actions depending on the timer value received for timer T3585 in the Back-off timer value:

- a) If the timer value indicates neither zero nor deactivated and an S-NSSAI was provided during the PDU session establishment, the UE shall stop timer T3585 associated with the S-NSSAI of the PDU session, if it is running. If the timer value indicates neither zero nor deactivated and no S-NSSAI was provided during the PDU session establishment and the request type was different from "initial emergency request" and different from "existing emergency PDU session", the UE shall stop timer T3585 associated with no S-NSSAI if it is running. The timer T3585 to be stopped includes:
 - 1) in a PLMN:
 - i) the timer T3585 applied for all the PLMNs and for the access over which the PDU SESSION RELEASE COMMAND is received, if running;
 - ii) the timer T3585 applied for all the PLMNs and for both 3GPP access type and non-3GPP access type, if running;
 - iii) the timer T3585 applied for the registered PLMN and for the access over which the PDU SESSION RELEASE COMMAND is received, if running; and
 - iv) the timer T3585 applied for the registered PLMN and for both 3GPP access type and non-3GPP access type, if running; or
 - 2) in an SNPN:
 - i) the timer T3585 applied for all the equivalent SNPNs and for the access over which the PDU SESSION AUTHENTICATION COMMAND message is received, associated with the RSNPN or an equivalent SNPN and with the selected entry of the "list of subscriber data" or the selected PLMN subscription, if running;
 - ii) the timer T3585 applied for all the equivalent SNPNs and for both 3GPP access type and non-3GPP access type, associated with the RSNPN or an equivalent SNPN and with the selected entry of the "list of subscriber data" or the selected PLMN subscription, if running;
 - iii) the timer T3585 applied for the registered SNPN and for the access over which the PDU SESSION AUTHENTICATION COMMAND message is received, associated with the RSNPN and, if the UE supports access to an SNPN using credentials from a credentials holder, equivalent SNPNs or both, associated with the selected entry of the "list of subscriber data" or the selected PLMN subscription, if running; and
 - iv) the timer T3585 applied for the registered PLMN and for both 3GPP access type and non-3GPP access type, associated with the RSNPN and, if the UE supports access to an SNPN using credentials from a credentials holder, equivalent SNPNs or both, associated with the selected entry of the "list of subscriber data" or the selected PLMN subscription, if running.

The UE shall then start timer T3585 with the value provided in the Back-off timer value IE and:

- 1) if an S-NSSAI was provided by the UE during the PDU session establishment, the UE shall not send another PDU SESSION ESTABLISHMENT REQUEST message, or PDU SESSION MODIFICATION REQUEST message with exception of those identified in subclause 6.4.2.1, for the S-NSSAI of the PDU session, until timer T3585 expires or timer T3585 is stopped; and
- 2) if the request type was different from "initial emergency request" and from "existing emergency PDU session", and an S-NSSAI was not provided by the UE during the PDU session establishment, the UE shall not send another PDU SESSION ESTABLISHMENT REQUEST message without an S-NSSAI and with request type different from "initial emergency request" and different from "existing emergency PDU session", or another PDU SESSION MODIFICATION REQUEST message with exception of those identified in subclause 6.4.2.1, for a non-emergency PDU session established without an S-NSSAI provided by the UE, until timer T3585 expires or timer T3585 is stopped.

The UE shall not stop timer T3585 upon a PLMN change, SNPN change, or inter-system change;

- b) if the timer value indicates that this timer is deactivated and an S-NSSAI was provided during the PDU session establishment, the UE shall stop timer T3585 associated with the S-NSSAI of the PDU session, if it is running. If

the timer value indicates that this timer is deactivated and no S-NSSAI was provided during the PDU session establishment and the request type was different from "initial emergency request" and different from "existing emergency PDU session", the UE shall stop timer T3585 associated with no S-NSSAI if it is running. The timer T3585 to be stopped includes:

- 1) in a PLMN:
 - i) the timer T3585 applied for all the PLMNs and for the access over which the PDU SESSION RELEASE COMMAND is received, if running;
 - ii) the timer T3585 applied for all the PLMNs and for both 3GPP access type and non-3GPP access type, if running;
 - iii) the timer T3585 applied for the registered PLMN and for current access type or both 3GPP access type and non-3GPP access type, if running; and
 - iv) the timer T3585 applied for the registered PLMN and for both 3GPP access type and non-3GPP access type, if running; or
- 2) in an SNPN:
 - i) the timer T3585 applied for all the equivalent SNPNs and for the access over which the PDU SESSION AUTHENTICATION COMMAND message is received, associated with the RSNPN or an equivalent SNPN and with the selected entry of the "list of subscriber data" or the selected PLMN subscription, if running;
 - ii) the timer T3585 applied for all the equivalent SNPNs and for both 3GPP access type and non-3GPP access type, associated with the RSNPN or an equivalent SNPN and with the selected entry of the "list of subscriber data" or the selected PLMN subscription, if running;
 - iii) the timer T3585 applied for the registered SNPN and for the access over which the PDU SESSION AUTHENTICATION COMMAND message is received, associated with the RSNPN and, if the UE supports access to an SNPN using credentials from a credentials holder, equivalent SNPNs or both, associated with the selected entry of the "list of subscriber data" or the selected PLMN subscription, if running; and
 - iv) the timer T3585 applied for the registered PLMN and for both 3GPP access type and non-3GPP access type, associated with the RSNPN and, if the UE supports access to an SNPN using credentials from a credentials holder, equivalent SNPNs or both, associated with the selected entry of the "list of subscriber data" or the selected PLMN subscription, if running.

In addition:

- 1) if an S-NSSAI was provided by the UE during the PDU session establishment, the UE shall not send another PDU SESSION ESTABLISHMENT REQUEST, or PDU SESSION MODIFICATION REQUEST with exception of those identified in subclause 6.4.2.1, for the S-NSSAI of the PDU session until the UE is switched off, the USIM is removed, the entry in the "list of subscriber data" for the current SNPN is updated, or a PDU SESSION MODIFICATION COMMAND message for the S-NSSAI of the PDU session from the network, or a PDU SESSION AUTHENTICATION COMMAND message for the S-NSSAI of the PDU session from the network, or a PDU SESSION RELEASE COMMAND message without the Back-off timer value IE or including 5GSM cause #39 "reactivation requested" for the S-NSSAI of the PDU session from the network; and
- 2) if the request type was different from "initial emergency request" and from "existing emergency PDU session", and an S-NSSAI was not provided by the UE during the PDU session establishment, the UE shall not send another PDU SESSION ESTABLISHMENT REQUEST message without an S-NSSAI and with request type different from "initial emergency request" and different from "existing emergency PDU session", or another PDU SESSION MODIFICATION REQUEST message with exception of those identified in subclause 6.4.2.1, for a non-emergency PDU session established without an S-NSSAI provided by the UE, until the UE is switched off, the USIM is removed, the entry in the "list of subscriber data" for the current SNPN is updated, or a PDU SESSION MODIFICATION COMMAND message for a non-emergency PDU session established without an S-NSSAI provided by the UE, or a PDU SESSION AUTHENTICATION COMMAND message for a non-emergency PDU session established without an S-NSSAI provided by the UE, or a PDU SESSION RELEASE COMMAND message without the Back-off

timer value IE or including 5GSM cause #39 "reactivation requested" for a non-emergency PDU session established without an S-NSSAI provided by the UE.

The timer T3585 remains deactivated upon a PLMN change, SNPN change, or inter-system change; and

- c) if the timer value indicates zero:
- 1) if an S-NSSAI was provided by the UE during the PDU session establishment, the UE shall stop timer T3585 associated with the S-NSSAI of the PDU session, if running. The timer T3585 to be stopped includes:
 - i) in a PLMN:
 - A) the timer T3585 applied for all the PLMNs and for the access over which the PDU SESSION RELEASE COMMAND is received, if running;
 - B) the timer T3585 applied for all the PLMNs and for the access over which the PDU SESSION RELEASE COMMAND is received, if running;
 - C) the timer T3585 applied for the registered PLMN and for current access type or both 3GPP access type and non-3GPP access type, if running; and
 - D) the timer T3585 applied for the registered PLMN and for both 3GPP access type and non-3GPP access type, if running; or
 - ii) in an SNPN:
 - A) the timer T3585 applied for all the equivalent SNPNS and for the access over which the PDU SESSION AUTHENTICATION COMMAND message is received, associated with the RSNPN or an equivalent SNPN and with the selected entry of the "list of subscriber data" or the selected PLMN subscription, if running;
 - B) the timer T3585 applied for all the equivalent SNPNS and for both 3GPP access type and non-3GPP access type, associated with the RSNPN or an equivalent SNPN and with the selected entry of the "list of subscriber data" or the selected PLMN subscription, if running;
 - C) the timer T3585 applied for the registered SNPN and for the access over which the PDU SESSION AUTHENTICATION COMMAND message is received, associated with the RSNPN and, if the UE supports access to an SNPN using credentials from a credentials holder, equivalent SNPNS or both, associated with the selected entry of the "list of subscriber data" or the selected PLMN subscription, if running; and
 - D) the timer T3585 applied for the registered PLMN and for both 3GPP access type and non-3GPP access type, associated with the RSNPN and, if the UE supports access to an SNPN using credentials from a credentials holder, equivalent SNPNS or both, associated with the selected entry of the "list of subscriber data" or the selected PLMN subscription, if running.

The UE may send another PDU SESSION ESTABLISHMENT REQUEST, or PDU SESSION MODIFICATION REQUEST message for the S-NSSAI of the PDU session; and

- 2) if no S-NSSAI was provided during the PDU session establishment and the request type was different from "initial emergency request" and different from "existing emergency PDU session", the UE shall stop timer T3585 associated with no S-NSSAI
 - i) in a PLMN:
 - A) the timer T3585 applied for all the PLMNs and for the access over which the PDU SESSION RELEASE COMMAND is received, if running,;
 - B) the timer T3585 applied for all the PLMNs and for the access over which the PDU SESSION RELEASE COMMAND is received, if running;
 - C) the timer T3585 applied for the registered PLMN and for current access type or both 3GPP access type and non-3GPP access type, if running; and
 - D) the timer T3585 applied for the registered PLMN and for both 3GPP access type and non-3GPP access type, if running; or

ii) in an SNPN:

- A) the timer T3585 applied for all the equivalent SNPNS and for the access over which the PDU SESSION AUTHENTICATION COMMAND message is received, associated with the RSNPN or an equivalent SNPN and with the selected entry of the "list of subscriber data" or the selected PLMN subscription, if running;
- B) the timer T3585 applied for all the equivalent SNPNS and for both 3GPP access type and non-3GPP access type, associated with the RSNPN or an equivalent SNPN and with the selected entry of the "list of subscriber data" or the selected PLMN subscription, if running;
- C) the timer T3585 applied for the registered SNPN and for the access over which the PDU SESSION AUTHENTICATION COMMAND message is received, associated with the RSNPN and, if the UE supports access to an SNPN using credentials from a credentials holder, equivalent SNPNS or both, associated with the selected entry of the "list of subscriber data" or the selected PLMN subscription, if running; and
- D) the timer T3585 applied for the registered PLMN and for both 3GPP access type and non-3GPP access type, associated with the RSNPN and, if the UE supports access to an SNPN using credentials from a credentials holder, equivalent SNPNS or both, associated with the selected entry of the "list of subscriber data" or the selected PLMN subscription, if running.

The UE may send another PDU SESSION ESTABLISHMENT REQUEST message without an S-NSSAI, or another PDU SESSION MODIFICATION REQUEST message without an S-NSSAI provided by the UE.

If the 5GSM congestion re-attempt indicator IE with the ABO bit set to "The back-off timer is applied in all PLMNs or all equivalent SNPNS" is included in the PDU SESSION RELEASE COMMAND message with the 5GSM cause value #69 "insufficient resources for specific slice", then the UE shall apply the timer T3585 for all the PLMNs or all the equivalent SNPNS. Otherwise, the UE shall apply the timer T3585 for the registered PLMN or the registered SNPN.

If the 5GSM cause value is #69 "insufficient resources for specific slice" and the Back-off timer value IE is not included, then the UE may send another PDU SESSION ESTABLISHMENT REQUEST message or PDU SESSION MODIFICATION REQUEST message for the same S-NSSAI or without an S-NSSAI.

When the timer T3585 is running or the timer is deactivated, the UE is allowed to initiate a PDU session establishment procedure for emergency services.

If the timer T3585 is running when the UE enters state 5GMM-DEREGISTERED, the UE remains switched on, and the USIM in the UE (if any) remains the same and the entry in the "list of subscriber data" for the SNPN to which timer T3585 is associated (if any) is not updated, then timer T3585 is kept running until it expires or it is stopped.

If the UE is switched off when the timer T3585 is running, and if the USIM in the UE (if any) remains the same and the entry in the "list of subscriber data" for the SNPN to which timer T3585 is associated (if any) is not updated when the UE is switched on, the UE shall behave as follows:

- let t_1 be the time remaining for T3585 timeout at switch off and let t be the time elapsed between switch off and switch on. If t_1 is greater than t , then the timer shall be restarted with the value $t_1 - t$. If t_1 is equal to or less than t , then the timer need not be restarted. If the UE is not capable of determining t , then the UE shall restart the timer with the value t_1 .

NOTE 5: As described in this subclause, upon PLMN change, SNPN change or inter-system change, the UE does not stop the timer T3584 or T3585. This means the timer T3584 or T3585 can still be running or be deactivated for the given 5GSM procedure, the PLMN or SNPN, the S-NSSAI and optionally the DNN combination when the UE returns to the PLMN or SNPN or when it performs inter-system change back from S1 mode to N1 mode. Thus the UE can still be prevented from sending another PDU SESSION ESTABLISHMENT REQUEST or PDU SESSION MODIFICATION REQUEST message in the PLMN for the same S-NSSAI and optionally the same DNN.

Upon PLMN change or SNPN change, if T3584 applied for the registered PLMN or the registered SNPN is running or is deactivated for an S-NSSAI, a DNN, and old PLMN or old SNPN, but T3584 is not running and is not deactivated for the S-NSSAI, the DNN, and new PLMN or new SNPN, then the UE is allowed to send a PDU SESSION ESTABLISHMENT REQUEST message for the same S-NSSAI and the same DNN in the new PLMN or new SNPN.

Upon PLMN change or SNPN change, if T3585 applied for the registered PLMN or the registered SNPN is running or is deactivated for an S-NSSAI and old PLMN or old SNPN, but T3585 is not running and is not deactivated for the S-

NSSAI and new PLMN or new SNPN, then the UE is allowed to send a PDU SESSION ESTABLISHMENT REQUEST message for the same S-NSSAI in the new PLMN or new SNPN.

Upon SNPN change, if T3584 applied for all the equivalent SNPNs is running or is deactivated for an S-NSSAI, a DNN, and old SNPN, but T3584 is not running and is not deactivated for the S-NSSAI, the DNN, and new non-equivalent SNPN, then the UE is allowed to send a PDU SESSION ESTABLISHMENT REQUEST message for the same S-NSSAI and the same DNN in the new SNPN.

Upon SNPN change, if T3585 applied for all the equivalent SNPNs is running or is deactivated for an S-NSSAI and old SNPN, but T3585 is not running and is not deactivated for the S-NSSAI and new non-equivalent SNPN, then the UE is allowed to send a PDU SESSION ESTABLISHMENT REQUEST message for the same S-NSSAI in the new SNPN.

If the PDU SESSION RELEASE COMMAND message includes 5GSM cause #29 "user authentication or authorization failed" and the Back-off timer value IE, the UE shall behave as follows:

- a) if the timer value indicates neither zero nor deactivated and:
 - 1) if the UE provided a DNN and S-NSSAI to the network during the PDU session establishment, the UE shall start the back-off timer with the value provided in the Back-off timer value IE for the PDU session establishment procedure and:
 - i) in a PLMN, [PLMN, DNN, (mapped) HPLMN S-NSSAI] combination. The UE shall not send another PDU SESSION ESTABLISHMENT REQUEST message for the same DNN and (mapped) HPLMN S-NSSAI in the current PLMN, until the back-off timer expires, the UE is switched off, or the USIM is removed; or
 - ii) in an SNPN, [SNPN, the selected entry of the "list of subscriber data" or selected PLMN subscription, DNN, (mapped) subscribed SNPN S-NSSAI] combination. The UE shall not send another PDU SESSION ESTABLISHMENT REQUEST message for the same DNN and (mapped) subscribed SNPN S-NSSAI in the current SNPN using the selected entry of the "list of subscriber data" or selected PLMN subscription, until the back-off timer expires, the UE is switched off, the USIM is removed, or the selected entry of the "list of subscriber data" is updated;
 - 2) if the UE provided a DNN to the network during the PDU session establishment, the UE shall start the back-off timer with the value provided in the Back-off timer value IE for the PDU session establishment procedure and:
 - i) in a PLMN, [PLMN, DNN] combination. The UE shall not send another PDU SESSION ESTABLISHMENT REQUEST message for the same DNN in the current PLMN, until the back-off timer expires, the UE is switched off, or the USIM is removed; or
 - ii) in an SNPN, [SNPN, the selected entry of the "list of subscriber data" or selected PLMN subscription, DNN] combination. The UE shall not send another PDU SESSION ESTABLISHMENT REQUEST message for the same DNN in the current PLMN using the selected entry of the "list of subscriber data" or selected PLMN subscription, until the back-off timer expires, the UE is switched off, the USIM is removed or the selected entry of the "list of subscriber data" is updated;
 - 3) if the UE did not provide a DNN or S-NSSAI or any of the two parameters to the network during the PDU session establishment, it shall start the back-off timer accordingly for the PDU session establishment procedure and:
 - i) in a PLMN, the [PLMN, DNN, no S-NSSAI], [PLMN, no DNN, (mapped) HPLMN S-NSSAI] or [PLMN, no DNN, no S-NSSAI] combination. Dependent on the combination, the UE shall not send another PDU SESSION ESTABLISHMENT REQUEST message for the same [PLMN, DNN, no S-NSSAI], [PLMN, no DNN, (mapped) HPLMN S-NSSAI] or [PLMN, no DNN, no S-NSSAI] combination in the current PLMN, until the back-off timer expires, the UE is switched off, or the USIM is removed; or
 - ii) in an SNPN, [SNPN, the selected entry of the "list of subscriber data" or selected PLMN subscription, DNN, no S-NSSAI], [SNPN, the selected entry of the "list of subscriber data" or selected PLMN subscription, no DNN, (mapped) subscribed SNPN S-NSSAI] or [SNPN, the selected entry of the "list of subscriber data" or selected PLMN subscription, no DNN, no S-NSSAI] combination. Dependent on the combination, the UE shall not send another PDU SESSION ESTABLISHMENT REQUEST message for the same [SNPN, the selected entry of the "list of subscriber data" or selected PLMN subscription, DNN,

- no S-NSSAI], [SNPN, the selected entry of the "list of subscriber data" or selected PLMN subscription, no DNN, (mapped) subscribed SNPN S-NSSAI] or [SNPN, the selected entry of the "list of subscriber data" or selected PLMN subscription, no DNN, no S-NSSAI] combination in the current PLMN using the selected entry of the "list of subscriber data" or selected PLMN subscription, until the back-off timer expires, the UE is switched off, the USIM is removed or the selected entry of the "list of subscriber data" is updated; or
- 4) if the UE did not provide a DNN to the network during the PDU session establishment, it shall start the back-off timer accordingly for the PDU session establishment procedure and:
 - i) in a PLMN, the [PLMN, no DNN] combination. The UE shall not send another PDU SESSION ESTABLISHMENT REQUEST message for the same [PLMN, no DNN] in the current PLMN, until the back-off timer expires, the UE is switched off, or the USIM is removed; or
 - ii) in an SNPN, [SNPN, the selected entry of the "list of subscriber data" or selected PLMN subscription, no DNN] combination. The UE shall not send another PDU SESSION ESTABLISHMENT REQUEST message for the same [SNPN, the selected entry of the "list of subscriber data" or selected PLMN subscription, no DNN] in the current SNPN using the selected entry of the "list of subscriber data" or selected PLMN subscription, until the back-off timer expires, the UE is switched off, the USIM is removed, or the selected entry of the "list of subscriber data" is updated;
 - b) if the timer value indicates that this timer is deactivated and:
 - 1) if the UE provided a DNN and S-NSSAI to the network during the PDU session establishment, the UE shall not send another PDU SESSION ESTABLISHMENT REQUEST message for:
 - i) in a PLMN, the same DNN and (mapped) HPLMN S-NSSAI in the current PLMN, until the UE is switched off, or the USIM is removed; or
 - ii) in an SNPN, the same DNN and (mapped) subscribed SNPN S-NSSAI in the current SNPN using the selected entry of the "list of subscriber data" or selected PLMN subscription, until the UE is switched off, or the USIM is removed, or the selected entry of the "list of subscriber data" is updated;
 - 2) if the UE provided a DNN to the network during the PDU session establishment, the UE shall not send another PDU SESSION ESTABLISHMENT REQUEST message for:
 - i) in a PLMN, the same DNN in the current PLMN, until the UE is switched off, or the USIM is removed; or
 - ii) in an SNPN, the same DNN in the current SNPN using the selected entry of the "list of subscriber data" or selected PLMN subscription, until the UE is switched off, or the USIM is removed, or the selected entry of the "list of subscriber data" is updated;
 - 3) if the UE did not provide a DNN or S-NSSAI or any of the two parameters to the network during the PDU session establishment, the UE shall not send another PDU SESSION ESTABLISHMENT REQUEST message for:
 - i) in a PLMN, the same [PLMN, DNN, no S-NSSAI], [PLMN, no DNN, (mapped) HPLMN S-NSSAI] or [PLMN, no DNN, no S-NSSAI] combination in the current PLMN, until the UE is switched off, or the USIM is removed; or
 - ii) in an SNPN, the same [SNPN, the selected entry of the "list of subscriber data" or selected PLMN subscription, DNN, no S-NSSAI], [SNPN, the selected entry of the "list of subscriber data" or selected PLMN subscription, no DNN, (mapped) subscribed SNPN S-NSSAI] or [SNPN, the selected entry of the "list of subscriber data" or selected PLMN subscription, no DNN, no S-NSSAI] combination in the current SNPN using the selected entry of the "list of subscriber data" or selected PLMN subscription, until the UE is switched off, or the USIM is removed, or the selected entry of the "list of subscriber data" is updated; or
 - 4) if the UE did not provide a DNN to the network during the PDU session establishment, the UE shall not send another PDU SESSION ESTABLISHMENT REQUEST message for:
 - i) in a PLMN, the same [PLMN, no DNN] in the current PLMN, until the UE is switched off, or the USIM is removed; or

- ii) in an SNPN, the same [SNPN, the selected entry of the "list of subscriber data" or selected PLMN subscription, no DNN] combination in the current SNPN using the selected entry of the "list of subscriber data" or selected PLMN subscription, until the UE is switched off, or the USIM is removed, or the selected entry of the "list of subscriber data" is updated; and
- c) if the timer value indicates zero, the UE may send another PDU SESSION ESTABLISHMENT REQUEST message:
 - 1) in a PLMN, for the same combination of [PLMN, DNN, (mapped) HPLMN S-NSSAI], [PLMN, DNN, no S-NSSAI], [PLMN, no DNN, (mapped) HPLMN S-NSSAI], or [PLMN, no DNN, no S-NSSAI] in the current PLMN; or
 - 2) in an SNPN, for the same combination of [SNPN, the selected entry of the "list of subscriber data" or selected PLMN subscription, DNN, (mapped) subscribed SNPN S-NSSAI], [SNPN, the selected entry of the "list of subscriber data" or selected PLMN subscription, DNN, no S-NSSAI], [SNPN, the selected entry of the "list of subscriber data" or selected PLMN subscription, no DNN, (mapped) subscribed SNPN S-NSSAI], or [SNPN, the selected entry of the "list of subscriber data" or selected PLMN subscription, no DNN, no S-NSSAI] in the current SNPN.

The UE shall not stop any back-off timer:

- a) upon a PLMN or SNPN change;
- b) upon an inter-system change; or
- c) upon registration over another access type.

If the PDU SESSION RELEASE COMMAND message includes:

- a) 5GSM cause #29 "user authentication or authorization failed"; and
- b) the service-level-AA response in the Service-level-AA container IE with the SLAR field set to the value of "Service level authentication and authorization was not successful or service level authorization is revoked",

the UE shall forward the service-level-AA response to the upper layers, so the UUAA authorization data is deleted as specified in 3GPP TS 33.256 [24B].

The UE shall transport the PDU SESSION RELEASE COMPLETE message and the PDU session ID, using the NAS transport procedure as specified in subclause 5.4.5.

Upon receipt of a PDU SESSION RELEASE COMPLETE message, the SMF shall stop timer T3592 and shall consider the PDU session as released.

6.3.3.4 N1 SM delivery skipped

If the PDU SESSION RELEASE COMMAND message was sent along the N1 SM delivery skip allowed indication towards AMF, then upon receipt of an indication that N1 SM delivery was skipped, the SMF shall stop timer T3592 and shall consider the PDU session as released.

6.3.3.5 Abnormal cases on the network side

The following abnormal cases can be identified:

- a) Expiry of timer T3592.

The SMF shall, on the first expiry of the timer T3592, retransmit the PDU SESSION RELEASE COMMAND message and shall reset and start timer T3592. This retransmission is repeated four times, i.e. on the fifth expiry of timer T3592, the SMF shall abort the procedure.

- b) Collision of network-requested PDU session release procedure and UE-requested PDU session modification procedure.

When the SMF receives a PDU SESSION MODIFICATION REQUEST message during the network-requested PDU session release procedure, and the PDU session indicated in PDU SESSION MODIFICATION REQUEST

message is the PDU session that the SMF had requested to release, the SMF shall ignore the PDU SESSION MODIFICATION REQUEST message and proceed with the PDU session release procedure.

- c) Collision of network-requested PDU session release procedure and UE-requested PDU session release procedure.

If the SMF receives a PDU SESSION RELEASE REQUEST message after sending a PDU SESSION RELEASE COMMAND message with the PTI IE set to "No procedure transaction identity assigned" to the UE, and the PDU session ID in the PDU SESSION RELEASE REQUEST message is the same as the PDU session ID in the PDU SESSION RELEASE COMMAND message:

- if the Access type IE is included in the PDU SESSION RELEASE COMMAND message and the PDU session is an MA PDU session and having user-plane resources established on the access different from the access indicated in the Access type IE in the PDU SESSION RELEASE COMMAND message, the SMF shall proceed both the UE-requested PDU session release procedure and network-requested PDU session release procedure;
- otherwise, the SMF shall ignore the PDU SESSION RELEASE REQUEST message and proceed with the network-requested PDU session release procedure.

- d) Collision of re-establishment of the user-plane resources and network-requested PDU session release procedure for the same PDU session.

If the SMF receives an indication from the AMF to re-establish the user-plane resources during the network-requested PDU session release procedure for the same PDU session, the SMF shall not re-establish the user-plane resources for the PDU session as specified in 3GPP TS 29.502 [20A] subclause 5.2.2.3.2.2 and proceed with the network-requested PDU session release procedure.

6.3.3.6 Abnormal cases in the UE

The following abnormal cases can be identified:

- a) PDU session inactive for the received PDU session ID.

If the PDU session ID in the PDU SESSION RELEASE COMMAND message belongs to any PDU session in state PDU SESSION INACTIVE in the UE, the UE shall include the 5GSM cause #43 "Invalid PDU session identity" in the 5GSM STATUS message, and set the PDU session ID to the received PDU session ID in the UL NAS TRANSPORT message as specified in subclause 5.4.5.

- b) User-plane resources of the MA PDU session on the access indicated in the Access type IE not established.

If the PDU session is an MA PDU session and has user-plane resources established on a single access different from the access indicated in the Access type IE, the UE shall not diagnose an error, further process the release command and consider the user-plane resources of the MA PDU session on the access indicated in the Access type IE as successfully released.

6.4 UE-requested 5GSM procedures

6.4.1 UE-requested PDU session establishment procedure

6.4.1.1 General

The purpose of the UE-requested PDU session establishment procedure is to establish a new PDU session with a DN, to perform handover of an existing PDU session between 3GPP access and non-3GPP access, to transfer an existing PDN connection in the EPS to the 5GS, to transfer an existing PDN connection in an untrusted non-3GPP access connected to the EPC to the 5GS, or to establish an MA PDU session to support ATSSS (see 3GPP TS 24.193 [13B]), or to relay the service associated with the RSC for 5G ProSe layer-3 UE-to-network relay (see 3GPP TS 24.554 [19E]). If accepted by the network, the PDU session enables exchange of PDUs between the UE and the DN.

The UE shall not request a PDU session establishment:

- a) for an LADN, if the DNN used for that LADN is included in the LADN information IE and the UE is located outside the LADN service area indicated in the LADN information IE;
- a1) for an LADN, if the DNN used for that LADN is included in the Extended LADN information IE and there is no S-NSSAI used for PDU session establishment;
- a2) for an LADN, if the DNN used for that LADN is included in the Extended LADN information IE and the S-NSSAI used for PDU session establishment is not associated with that LADN;
- a3) for an LADN, if the DNN and the S-NSSAI used for that LADN are included in the Extended LADN information IE and the UE is located outside the LADN service area indicated in the Extended LADN information IE;
- b) to transfer a PDU session from non-3GPP access to 3GPP access when the 3GPP PS data off UE status is "activated" and the UE is not using the PDU session to send uplink IP packets for any of the 3GPP PS data off exempt services (see subclause 6.2.10);
- c) when the UE is in NB-N1 mode, the UE has indicated preference for user plane CIoT 5GS optimization, the network has accepted the use of user plane CIoT 5GS optimization for the UE, and the number of PDU sessions that currently has user-plane resources established equals to the UE's maximum number of supported user-plane resources;
- d) to transfer a PDU session from 3GPP access to non-3GPP access when the UE has indicated preference for control plane CIoT 5GS optimization, the network has accepted the use of control plane CIoT 5GS optimization for the UE, and the Control plane only indication IE was received in the PDU SESSION ESTABLISHMENT ACCEPT message;
- e) to transfer a PDU session from the non-3GPP access to the 3GPP access when the UE is in NB-N1 mode, the UE has indicated preference for user plane CIoT 5GS optimization, the network has accepted the use of user plane CIoT 5GS optimization for the UE, and the number of PDU sessions that currently has user-plane resources established equals to the UE's maximum number of supported user-plane resources;
- f) associated to an S-NSSAI when the UE is not in the NS-AoS of the S-NSSAI; or
- g) associated to an S-NSSAI included in the partially allowed NSSAI when the current TA is not in the list of TAs where the S-NSSAI is allowed.

6.4.1.2 UE-requested PDU session establishment procedure initiation

In order to initiate the UE-requested PDU session establishment procedure, the UE shall create a PDU SESSION ESTABLISHMENT REQUEST message.

NOTE 0: When IMS voice is available over either 3GPP access or non-3GPP access, the "voice centric" UE in 5GMM-REGISTERED state will receive a request from upper layers to establish the PDU session for IMS signalling, if the conditions for performing an initial registration with IMS indicated in 3GPP TS 24.229 [14] subclause U.3.1.2 are satisfied.

If the UE requests to establish a new PDU session, the UE shall allocate a PDU session ID which is not currently being used by another PDU session over either 3GPP access or non-3GPP access. If the N5CW device supporting 3GPP access requests to establish a new PDU session via 3GPP access, the N5CW device supporting 3GPP access shall refrain from allocating "PDU session identity value 15". If the TWIF acting on behalf of the N5CW device requests to establish a new PDU session, the TWIF acting on behalf of the N5CW device shall allocate the "PDU session identity value 15".

The UE shall allocate a PTI value currently not used and shall set the PTI IE of the PDU SESSION ESTABLISHMENT REQUEST message to the allocated PTI value.

If the UE is registered for emergency services over the current access, the UE shall not request establishing a non-emergency PDU session over the current access. If the UE is registered for emergency services over the current access it shall not request establishing an emergency PDU session over the non-current access except if the request is for transferring the emergency PDU session to the non-current access. Before transferring an emergency PDU session from non-3GPP access to 3GPP access, or before transferring a PDN connection for emergency bearer services from untrusted non-3GPP access connected to EPC to 3GPP access, the UE shall check whether emergency services are supported in the NG-RAN cell (either an NR cell or an E-UTRA cell) on which the UE is camping.

NOTE 1: Transfer of an existing emergency PDU session or PDN connection for emergency bearer services between 3GPP access and non-3GPP access is needed e.g. if the UE determines that the current access is no longer available.

If the UE requests to establish a new emergency PDU session, the UE shall include the PDU session type IE in the PDU SESSION ESTABLISHMENT REQUEST message and shall set the IE to the IP version capability as specified in subclause 6.2.4.2.

If the UE requests to establish a new non-emergency PDU session with a DN, the UE shall include the PDU session type IE in the PDU SESSION ESTABLISHMENT REQUEST message and shall set the IE to one of the following values: "IPv4", "IPv6", "IPv4v6", "Ethernet" or "Unstructured" based on the URSP rules or based on UE local configuration (see 3GPP TS 24.526 [19]) and based on the IP version capability as specified in subclause 6.2.4.2.

NOTE 2: When the UE initiates the UE-requested PDU session establishment procedure to transfer an existing non-IP PDN connection in the EPS to the 5GS, the UE can use locally available information associated with the PDN connection to select the PDU session type between "Ethernet" and "Unstructured".

If the UE requests to establish a new non-emergency PDU session with a DN and the UE requests an SSC mode, the UE shall set the SSC mode IE of the PDU SESSION ESTABLISHMENT REQUEST message to the SSC mode. If the UE requests to establish a PDU session of "IPv4", "IPv6" or "IPv4v6" PDU session type, the UE shall either omit the SSC mode IE or set the SSC mode IE to "SSC mode 1", "SSC mode 2", or "SSC mode 3". If the UE requests to establish a PDU session of "Ethernet" or "Unstructured" PDU session type, the UE shall either omit the SSC mode IE or set the SSC mode IE to "SSC mode 1" or "SSC mode 2". If the UE requests transfer of an existing PDN connection in the EPS to the 5GS or the UE requests transfer of an existing PDN connection in an untrusted non-3GPP access connected to the EPC to the 5GS, the UE shall set the SSC mode IE to "SSC mode 1".

If the UE requests to establish a new emergency PDU session, the UE shall set the SSC mode IE of the PDU SESSION ESTABLISHMENT REQUEST message to "SSC mode 1".

A UE supporting PDU connectivity service shall support SSC mode 1 and may support SSC mode 2 and SSC mode 3 as specified in 3GPP TS 23.501 [8].

If the UE requests to establish a new non-emergency PDU session with a DN, the UE may include the SM PDU DN request container IE with a DN-specific identity of the UE complying with network access identifier (NAI) format as specified in IETF RFC 7542 [37].

NOTE 3: The UE can avoid including both the SM PDU DN request container IE and the Extended protocol configuration options IE with PAP/CHAP protocol identifiers in the PDU SESSION ESTABLISHMENT REQUEST message. The way to achieve this is implementation dependent.

If the UE requests to:

- a) establish a new PDU session;
- b) perform handover of an existing PDU session from non-3GPP access to 3GPP access;
- c) transfer an existing PDN connection in the EPS to the 5GS according to subclause 4.8.2.3.1;
- d) transfer an existing PDN connection in untrusted non-3GPP access connected to the EPC to the 5GS; or
- e) establish user plane resources over 3GPP access of an MA PDU session established over non-3GPP access only;

and the UE at the same time intends to join one or more multicast MBS sessions that is associated to the PDU session, the UE should include the Requested MBS container IE in the PDU SESSION ESTABLISHMENT REQUEST message. In that case, the UE shall set the MBS operation to "Join multicast MBS session" and include the multicast MBS session information(s) and shall set the Type of multicast MBS session ID for each of the multicast MBS session information to either "Temporary Mobile Group Identity (TMGI)" or "Source specific IP multicast address" depending on the type of the multicast MBS session ID available in the UE. Then the remaining values of each of the multicast MBS session information shall be set as following:

- a) if the Type of multicast MBS session ID is set to "Temporary Mobile Group Identity (TMGI)", the UE shall set the multicast MBS session ID to the TMGI; or

- b) if the Type of multicast MBS session ID is set to "Source specific IP multicast address for IPv4" or "Source specific IP multicast address for IPv6", the UE shall set the Source IP address information and the Destination IP address information to the corresponding values.

The UE should not request to join a multicast MBS session for local MBS service if neither current TAI nor CGI of the current cell is part of the MBS service area(s) of the multicast MBS session, if the UE has valid information of the MBS service area(s) of the multicast MBS session.

NOTE 4: The UE obtains the details of the MBS session ID(s) e.g., TMGI, Source IP address information and Destination IP address information as a pre-configuration in the UE or during the MBS service announcement, which is out of scope of this specification. Pre-configuration can be provided in one or more of the following ways:

- a) in a UE implementation-specific way (e.g. factory configuration);
- b) in the USIM (see EF_{5MBSUECONFIG} file in 3GPP TS 31.102 [22]); or
- c) in the UE pre-configuration MO for MBS (see 3GPP TS 24.575 [65]).

The UE should set the RQoS bit to "Reflective QoS supported" in the 5GSM capability IE of the PDU SESSION ESTABLISHMENT REQUEST message if the UE supports reflective QoS and:

- a) the UE requests to establish a new PDU session of "IPv4", "IPv6", "IPv4v6" or "Ethernet" PDU session type;
- b) the UE requests to transfer an existing PDN connection in the EPS of "IPv4", "IPv6", "IPv4v6" or "Ethernet" PDN type or of "Non-IP" PDN type mapping to "Ethernet" PDU session type, to the 5GS; or
- c) the UE requests to transfer an existing PDN connection in an untrusted non-3GPP access connected to the EPC of "IPv4", "IPv6" or "IPv4v6" PDN type to the 5GS.

NOTE 5: The determination to not request the usage of reflective QoS by the UE for a PDU session is implementation dependent.

The UE shall indicate the maximum number of packet filters that can be supported for the PDU session in the Maximum number of supported packet filters IE of the PDU SESSION ESTABLISHMENT REQUEST message if:

- a) the UE requests to establish a new PDU session of "IPv4", "IPv6", "IPv4v6", or "Ethernet" PDU session type, and the UE can support more than 16 packet filters for this PDU session;
- b) the UE requests to transfer an existing PDN connection in the EPS of "IPv4", "IPv6", "IPv4v6", or "Ethernet" PDN type or of "Non-IP" PDN type mapping to "Ethernet" PDU session type, to the 5GS and the UE can support more than 16 packet filters for this PDU session; or
- c) the UE requests to transfer an existing PDN connection in an untrusted non-3GPP access connected to the EPC of "IPv4", "IPv6" or "IPv4v6" PDN type to the 5GS and the UE can support more than 16 packet filters for this PDU session.

The UE shall include the Integrity protection maximum data rate IE in the PDU SESSION ESTABLISHMENT REQUEST message to indicate the maximum data rate per UE for user-plane integrity protection supported by the UE for uplink and the maximum data rate per UE for user-plane integrity protection supported by the UE for downlink.

The UE shall set the MH6-PDU bit to "Multi-homed IPv6 PDU session supported" in the 5GSM capability IE of the PDU SESSION ESTABLISHMENT REQUEST message if the UE supports multi-homed IPv6 PDU session and:

- a) the UE requests to establish a new PDU session of "IPv6" or "IPv4v6" PDU session type; or
- b) the UE requests to transfer an existing PDN connection of "IPv6" or "IPv4v6" PDN type in the EPS or in an untrusted non-3GPP access connected to the EPC to the 5GS.

The UE shall set the EPT-S1 bit to "Ethernet PDN type in S1 mode supported" in the 5GSM capability IE of the PDU SESSION ESTABLISHMENT REQUEST message if the UE supports Ethernet PDN type in S1 mode and requests "Ethernet" PDU session type.

If the UE requests to establish a new PDU session as an always-on PDU session (e.g. because the PDU session is for time synchronization or TSC), the UE shall include the Always-on PDU session requested IE and set the value of the IE to "Always-on PDU session requested" in the PDU SESSION ESTABLISHMENT REQUEST message.

NOTE 6: Determining whether a PDU session is for time synchronization or TSC is UE implementation dependent.

If the UE has an emergency PDU session, the UE shall not perform the UE-requested PDU session establishment procedure to establish another emergency PDU session. The UE may perform the UE-requested PDU session establishment procedure to transfer an existing emergency PDU session or an existing PDN connection for emergency services.

If:

- a) the UE requests to perform handover of an existing PDU session between 3GPP access and non-3GPP access;
- b) the UE requests to perform transfer an existing PDN connection in the EPS to the 5GS; or
- c) the UE requests to perform transfer an existing PDN connection in an untrusted non-3GPP access connected to the EPC to the 5GS;

the UE shall:

- a) set the PDU session ID in the PDU SESSION ESTABLISHMENT REQUEST message and in the UL NAS TRANSPORT message to the stored PDU session ID corresponding to the PDN connection; and
- b) set the S-NSSAI in the UL NAS TRANSPORT message to the stored S-NSSAI associated with the PDU session ID of a non-emergency PDU session. The UE shall not request to perform handover of an existing non-emergency PDU session:
 - 1) between 3GPP access and non-3GPP access if the S-NSSAI is not included in the allowed NSSAI for the target access; or
 - 2) from non-3GPP access to 3GPP access:
 - i) if the S-NSSAI is not in the partially allowed NSSAI for 3GPP access; or
 - ii) if the S-NSSAI is in the partially allowed NSSAI for 3GPP access but the TAI where the UE is currently camped on is not in the list of TAs for which the S-NSSAI is supported.

If the N5CW device supporting 3GPP access requests to perform handover of an existing PDU session from non-3GPP access to 3GPP access, the N5CW device supporting 3GPP access shall set the PDU session ID in the PDU SESSION ESTABLISHMENT REQUEST message and in the UL NAS TRANSPORT message to "PDU session identity value 15".

If the UE is registered to a network which supports ATSSS and the UE requests to establish a new PDU session the UE may allow the network to upgrade the requested PDU session to an MA PDU session. In order to allow the network to upgrade the requested PDU session to an MA PDU session, the UE shall set "MA PDU session network upgrade is allowed" in the MA PDU session information IE and shall set the request type to "initial request" in the UL NAS TRANSPORT message. If the UE is registered to a network which does not support ATSSS, the UE shall not perform the procedure to allow the network to upgrade the requested PDU session to an MA PDU session.

If the UE is registered to a network which supports ATSSS, the UE may request to establish an MA PDU session. If the UE requests to establish an MA PDU session, the UE shall set the request type to "MA PDU request" in the UL NAS TRANSPORT message. If the UE is registered to a network which does not support ATSSS, the UE shall not request to establish an MA PDU session.

When the UE is registered over both 3GPP access and non-3GPP access in the same PLMN and the UE requests to establish a new MA PDU session, the UE may provide an S-NSSAI in the UL NAS TRANSPORT message only if the S-NSSAI is included in the allowed NSSAIs of both accesses.

NOTE 7: If the UE requested DNN corresponds to an LADN DNN, the AMF does not forward the MA PDU session information IE to the SMF but sends the message back to the UE to inform of the unhandled request (see subclause 5.4.5.2.5).

If the UE is registered to a network which supports ATSSS and the UE has already an MA PDU session established over one access, the UE may perform the UE-requested PDU session establishment procedure to establish user-plane resources over the other access for the MA PDU session as specified in subclause 4.22 of 3GPP TS 23.502 [9] and the S-NSSAI associated with the MA PDU session is included in the allowed NSSAI of the other access. If the UE establishes user-plane resources over the other access for the MA PDU session, the UE shall:

- a) set the request type to "MA PDU request" in the UL NAS TRANSPORT message;
- b) set the PDU session ID to the stored PDU session ID corresponding to the established MA PDU session in the PDU SESSION ESTABLISHMENT REQUEST message and in the UL NAS TRANSPORT message; and
- c) set the S-NSSAI in the UL NAS TRANSPORT message to the stored S-NSSAI associated with the PDU session ID.

If the UE requests to establish a new MA PDU session or if the UE requests to establish a new PDU session and the UE allows the network to upgrade the requested PDU session to an MA PDU session, the UE shall:

- a) set the ATSSS-ST bits in the 5GSM capability IE of the PDU SESSION ESTABLISHMENT REQUEST message to indicate the ATSSS-LL and MPTCP functionalities, respectively, which the UE supports (see table 9.11.4.1.1) according to what is specified in subclause 5.32.6.1 of 3GPP TS 23.501 [8]; and
- b) set the ATSSS-LL, MPTCP and MPQUIC-UDP bits in the 5GSM capability IE of the PDU SESSION ESTABLISHMENT REQUEST message to indicate the ATSSS-LL, MPTCP and MPQUIC functionalities, respectively, which the UE supports (see table 9.11.4.1.1) according to what is specified in subclause 5.32.6.1 of 3GPP TS 23.501 [8];

NOTE 7A: Usage of the ATSSS-ST bits to indicate support for ATSSS functionality was deprecated in Rel-18 in favor of the ATSSS-LL, MPTCP and MPQUIC-UDP bits. The setting of the ATSSS-ST bits is necessary for backward compatibility with the earlier releases. The UE sets the ATSSS-ST bits in the same way as a UE from previous releases.

NOTE 8: The ATSSS Low-Layer functionality cannot be used together with the redundant steering mode. When the UE indicates that it is capable of supporting the ATSSS Low-Layer functionality with any steering mode, it implies that the UE supports the ATSSS Low-Layer functionality with any steering mode except the redundant steering mode.

- c) void;
- d) void;
- e) void;
- f) void;
- g) void;
- h) void.

If a performance measurement function in the UE can perform access performance measurements using the QoS flow of the non-default QoS rule as specified in subclause 5.32.5 of 3GPP TS 23.501 [8], the UE shall set the APMQF bit to "Access performance measurements per QoS flow supported" in the 5GSM capability IE of the PDU SESSION ESTABLISHMENT REQUEST message.

Upon receipt of a PDU SESSION ESTABLISHMENT REQUEST message for MA PDU session establishment, the SMF shall check if the ATSSS-LL, MPTCP and MPQUIC-UDP bits (if set) or the ATSSS-ST bits (if none of the ATSSS-LL, MPTCP and MPQUIC-UDP bits, respectively, is set) in the PDU SESSION ESTABLISHMENT REQUEST message indicates:

NOTE 8A: If any of the ATSSS-LL, MPTCP and MPQUIC-UDP bits, respectively, is set then the SMF ignores the ATSSS-ST bits of the 5GSM capability IE.

- a) support for any of the possible steering functionalities in addition to the ATSSS-LL functionality with only active-standby steering mode and:
 - i) if the DNN configuration allows for the indicated steering functionality(ies) and the ATSSS-LL functionality with any steering mode (i.e., any steering mode allowed for ATSSS-LL functionality) but does not allow RTT measurement without using PMF protocol, the SMF shall ensure that the established PDU session has the capability of the indicated steering functionality(ies) and the ATSSS-LL with only active-standby steering mode, load balancing steering mode or priority based steering mode steering mode in the downlink and the indicated steering functionality(ies) and the ATSSS-LL with only active-standby steering mode in the uplink;

- ii) if the DNN configuration allows for the the indicated steering functionality(ies) and the ATSSS-LL functionality with any steering mode (i.e., any steering mode allowed for ATSSS-LL functionality) and allows RTT measurement without using PMF protocol, the SMF shall ensure that the established PDU session has the capability of the indicated steering functionality(ies) and the ATSSS-LL with any steering mode (i.e., any steering mode allowed for ATSSS-LL functionality) in the downlink and the indicated steering functionality(ies) and the ATSSS-LL with only active-standby steering mode in the uplink; or
- iii) if the DNN configuration allows for the indicated steering functionality(ies) and the ATSSS-LL functionality with only active-standby steering mode, the SMF shall ensure that the established PDU session has the capability of the indicated steering functionality(ies) and the ATSSS-LL with only active-standby steering mode in the downlink and the uplink;
- b) support for ATSSS Low-Layer functionality with any steering mode allowed for ATSSS-LL and if the DNN configuration allows for the ATSSS-LL functionality with any steering mode (i.e., any steering mode allowed for ATSSS-LL functionality), the SMF shall ensure that the established PDU session has the capability of ATSSS-LL with any steering mode (i.e., any steering mode allowed for ATSSS-LL functionality) in the downlink and the uplink;
- c) void;
- d) void;
- e) void;
- f) void;
- g) void;
- h) support for any of the possible steering functionalities in addition to the ATSSS-LL functionality with any steering mode (i.e., any steering mode allowed for ATSSS-LL functionality) and if the DNN configuration does not allow for the indicated steering functionality and allows for the ATSSS-LL functionality with any steering mode (i.e., any steering mode allowed for ATSSS-LL functionality), the SMF shall ensure that the established PDU session has the capability of ATSSS-LL with any steering mode (i.e., any steering mode allowed for ATSSS-LL functionality) in the downlink and the uplink; or
- i) support for any of the possible steering functionalities in addition to at least ATSSS-LL functionality with only active-standby steering mode and if the DNN configuration does not allow for the indicated steering functionality and allows at least for the ATSSS-LL functionality with only active-standby steering mode, the SMF shall ensure that the established PDU session has the capability of ATSSS-LL with only active-standby steering mode in the downlink and the uplink.

If the UE requests to establish a new MA PDU session and the UE supports to establish a PDN connection as the user plane resource of an MA PDU session, the UE shall include the ATSSS request parameter in the Extended protocol configuration options IE of the PDU SESSION ESTABLISHMENT REQUEST message.

If the UE is registered to a network which does not support ATSSS and the UE has already an MA PDU session established over one access, the UE shall not attempt to establish user-plane resources for the MA PDU session over the network which does not support ATSSS as specified in subclause 4.22 of 3GPP TS 23.502 [9].

If the UE supports 3GPP PS data off, except for the transfer of a PDU session from non-3GPP access to 3GPP access and except for the establishment of user plane resources on the other access for the MA PDU session, the UE shall include the Extended protocol configuration options IE in the PDU SESSION ESTABLISHMENT REQUEST message and include the 3GPP PS data off UE status. The UE behaves as described in subclause 6.2.10.

If the UE supports Reliable Data Service, the UE shall include the Extended protocol configuration options IE in the PDU SESSION ESTABLISHMENT REQUEST message and include the Reliable Data Service request indicator. The UE behaves as described in subclause 6.2.15.

If the UE supports DNS over (D)TLS (see 3GPP TS 33.501 [24]), the UE shall include the Extended protocol configuration options IE in the PDU SESSION ESTABLISHMENT REQUEST message and include DNS server security information indicator and optionally, if the UE wishes to indicate which security protocol type(s) are supported by the UE, it may include the DNS server security protocol support.

NOTE 9: Support of DNS over (D)TLS is based on the requirements as specified in 3GPP TS 33.501 [24].

If:

- a) the PDU session type value of the PDU session type IE is set to "IPv4", "IPv6" or "IPv4v6";
- b) the UE indicates "Control plane CIoT 5GS optimization supported" and "IP header compression for control plane CIoT 5GS optimization supported" in the 5GMM capability IE of the REGISTRATION REQUEST message; and
- c) the network indicates "Control plane CIoT 5GS optimization supported" and "IP header compression for control plane CIoT 5GS optimization supported" in the 5GS network support feature IE of the REGISTRATION ACCEPT message;

the UE shall include the IP header compression configuration IE in the PDU SESSION ESTABLISHMENT REQUEST message.

If:

- a) the PDU session type value of the PDU session type IE is set to "Ethernet";
- b) the UE indicates "Control plane CIoT 5GS optimization supported" and "Ethernet header compression for control plane CIoT 5GS optimization supported" in the 5GMM capability IE of the REGISTRATION REQUEST message; and
- c) the network indicates "Control plane CIoT 5GS optimization supported" and "Ethernet header compression for control plane CIoT 5GS optimization supported" in the 5GS network support feature IE of the REGISTRATION ACCEPT message;

the UE shall include the Ethernet header compression configuration IE in the PDU SESSION ESTABLISHMENT REQUEST message.

If the UE supports transfer of port management information containers, the UE shall:

- a) set the TPMIC bit to "Transfer of port management information containers supported" in the 5GSM capability IE of the PDU SESSION ESTABLISHMENT REQUEST message;
- b) if the UE requests to establish a PDU session of "Ethernet" PDU session type, include the DS-TT Ethernet port MAC address IE in the PDU SESSION ESTABLISHMENT REQUEST message and set its contents to the MAC address of the DS-TT Ethernet port used for the PDU session;
- c) if the UE-DS-TT residence time is available at the UE, include the UE-DS-TT residence time IE and set its contents to the UE-DS-TT residence time; and
- d) if a Port management information container is provided by the DS-TT, include the Port management information container IE in the PDU SESSION ESTABLISHMENT REQUEST message.

NOTE 10: Only SSC mode 1 is supported for a PDU session which is for time synchronization or TSC.

If the UE supports secondary DN authentication and authorization over EPC, the UE shall set the SDNAEPC bit to "Secondary DN authentication and authorization over EPC supported" in the 5GSM capability IE of the PDU SESSION ESTABLISHMENT REQUEST message.

If the UE supporting S1 mode supports receiving QoS rules with the length of two octets or QoS flow descriptions with the length of two octets via the Extended protocol configuration options IE, the UE shall include the QoS rules with the length of two octets support indicator or the QoS flow descriptions with the length of two octets support indicator, respectively, in the Extended protocol configuration options IE in the PDU SESSION ESTABLISHMENT REQUEST message.

If the UE supports URSP provisioning in EPS, the UE shall include the URSP provisioning in EPS support indicator in the Extended protocol configuration options IE of the PDU SESSION ESTABLISHMENT REQUEST message.

If:

- the UE is operating in single-registration mode;
- the UE supports local IP address in traffic flow aggregate description and TFT filter in S1 mode; and

- the PDU session Type requested is different from "Unstructured".

the UE shall indicate the support of local address in TFT in S1 mode in the Extended protocol configuration options IE in the PDU SESSION ESTABLISHMENT REQUEST message.

If the W-AGF acting on behalf of the FN-RG requests to establish a PDU session of "IPv6" or "IPv4v6" PDU session type, the W-AGF acting on behalf of the FN-RG may include in the PDU SESSION ESTABLISHMENT REQUEST message the Suggested interface identifier IE with the PDU session type value field set to "IPv6" and containing the interface identifier for the IPv6 link local address associated with the PDU session suggested to be allocated to the FN-RG.

If the UE supports provisioning of ECS configuration information to the EEC in the UE, then the UE shall include the Extended protocol configuration options IE in the PDU SESSION ESTABLISHMENT REQUEST message and shall include the ECS configuration information provisioning support indicator.

If the UE supports receiving DNS server addresses in protocol configuration options, the UE shall include the Extended protocol configuration options IE in the PDU SESSION ESTABLISHMENT REQUEST message and in the Extended protocol configuration options IE:

- a) if the UE requests to establish a PDU session of "IPv4" or "IPv4v6" PDU session type, the UE shall include the DNS server IPv4 address request; and
- b) if the UE requests to establish a PDU session of "IPv6" or "IPv4v6" PDU session type, the UE shall include the DNS server IPv6 address request.

If the UE supporting UAS services requests to establish a PDU session for C2 communication, the UE shall include the Service-level-AA container IE in the PDU SESSION ESTABLISHMENT REQUEST message. In the Service-level-AA container IE, the UE shall include:

- a) the service-level device ID with the value set to the CAA-level UAV ID of the UE; and
- b) if available, the service-level-AA payload with the value set to the C2 authorization payload and the service-level-AA payload type with the value set to "C2 authorization payload".

NOTE 11: The C2 authorization payload in the service-level-AA payload can include one, some or all of the pairing information for C2 communication, an indication of the request for direct C2 communication, pairing information for direct C2 communication, and the UAV flight authorization information.

If the UE supports the EAS rediscovery, the UE shall include the Extended protocol configuration options IE in the PDU SESSION ESTABLISHMENT REQUEST message and shall include the EAS rediscovery support indication in the Extended protocol configuration options IE.

If the UE needs to include a PDU session pair ID based on the matching URSP rule or UE local configuration, the UE shall include the PDU session pair ID IE in the PDU SESSION ESTABLISHMENT REQUEST message. If the UE needs to include an RSN based on the matching URSP rule or UE local configuration, the UE shall include the RSN IE in the PDU SESSION ESTABLISHMENT REQUEST message.

If the UE is not registered for onboarding services in SNPN and needs PVS information, the UE shall include the Extended protocol configuration options IE in the PDU SESSION ESTABLISHMENT REQUEST message and include the PVS information request in the Extended protocol configuration options IE.

If the UE supports the EDC, the UE shall include the Extended protocol configuration options IE in the PDU SESSION ESTABLISHMENT REQUEST message and shall include the EDC support indicator in the Extended protocol configuration options IE.

If the UE supports a "destination MAC address range type" packet filter component and a "source MAC address range type" packet filter component, the UE shall include the Extended protocol configuration options IE in the PDU SESSION ESTABLISHMENT REQUEST message and shall include the MS support of MAC address range in 5GS indicator in the Extended protocol configuration options IE.

If the UE supports reporting of URSP rule enforcement and is indicated to send URSP rule enforcement report to network based on the matching URSP rule which contains the URSP rule enforcement report indication set to "URSP rule enforcement report is required", the UE shall include the URSP rule enforcement reports IE in the PDU SESSION ESTABLISHMENT REQUEST message.

The UE shall transport:

- a) the PDU SESSION ESTABLISHMENT REQUEST message;
 - b) the PDU session ID of the PDU session being established, being handed over, being transferred, or been established as an MA PDU session;
 - c) if the request type is set to:
 - 1) "initial request" or "MA PDU request" and the UE determined to establish a new PDU session or an MA PDU session based on either a URSP rule including one or more S-NSSAI(s) in the URSP (see subclause 6.2.9) or UE local configuration, according to subclause 4.2.2 of 3GPP TS 24.526 [19]:
 - i) if the UE is in the HPLMN or the subscribed SNPN, an S-NSSAI in the allowed NSSAI which corresponds to one of the S-NSSAI(s) in the matching URSP rule, if any, or else to the S-NSSAI(s) in the UE local configuration or in the default URSP rule, if any, according to the conditions given in subclause 4.2.2 of 3GPP TS 24.526 [19];
 - ii) if the UE is in a non-subscribed SNPN, the UE determined according to the conditions given in subclause 4.2.2 of 3GPP TS 24.526 [19] to establish a new PDU session or an MA PDU session based on a URSP rule including one or more S-NSSAI(s), and the URSP rule is a part of a non-subscribed SNPN signalled URSP (see 3GPP TS 24.526 [19]):
 - A) an S-NSSAI in the allowed NSSAI, which is one of the S-NSSAI(s) in the URSP rule; and
 - B) a mapped S-NSSAI associated with the S-NSSAI in A); or
 - iii) otherwise:
 - A) one of the mapped S-NSSAI(s) which is equal to one of the S-NSSAI(s) in the matching URSP rule, if any, or else to the S-NSSAI(s) in the UE local configuration or in the default URSP rule, if any, according to the conditions given in subclause 4.2.2 of 3GPP TS 24.526 [19]; and
 - B) the S-NSSAI in the allowed NSSAI associated with the S-NSSAI in A); or
 - 1a) "initial request" and the UE determined to establish a new PDU session based on the PDU session parameters for 5G ProSe layer-3 UE-to-network relay UE including an S-NSSAI in the UE policies for 5G ProSe UE-to-network relay UE as defined in 3GPP TS 24.555 [19F]:
 - i) in case of a non-roaming scenario, an S-NSSAI in the allowed NSSAI which corresponds to the S-NSSAI in the selected PDU session parameters for 5G ProSe layer-3 UE-to-network relay UE, if any; or
 - ii) in case of a roaming scenario:
 - A) one of the mapped S-NSSAI(s) which corresponds to the S-NSSAI in the selected PDU session parameters for 5G ProSe layer-3 UE-to-network relay UE, if any; and
 - B) the S-NSSAI in the allowed NSSAI associated with the S-NSSAI in A);
- NOTE 12: When the UE is roaming, an AMF compliant with earlier versions of the specification can omit providing to the UE a mapped S-NSSAI for one or more S-NSSAI(s) in the allowed NSSAI and the UE then locally sets the mapped S-NSSAI as described in subclause 4.6.2.1.
- 1b) "initial request" and the UE has the partially allowed NSSAI and determined to establish a new PDU session based on either a URSP rule including one or more S-NSSAI(s) in the URSP (see subclause 6.2.9) or UE local configuration, according to subclause 4.2.2 of 3GPP TS 24.526 [19]:
 - i) if the UE is in the HPLMN or the subscribed SNPN and the current TA is in the list of TAs for which the S-NSSAI is allowed, an S-NSSAI in the partially allowed NSSAI which corresponds to one of the S-NSSAI(s) in the matching URSP rule, if any, or else to the S-NSSAI(s) in the UE local configuration or in the default URSP rule, if any, according to the conditions given in subclause 4.2.2 of 3GPP TS 24.526 [19];
 - ii) if the UE is in the VPLMN or a non-subscribed SNPN, the UE determined according to the conditions given in subclause 4.2.2 of 3GPP TS 24.526 [19] to establish a new PDU session based on a URSP rule

including one or more S-NSSAIs, the URSP rule is a part of a non-subscribed SNPN signalled URSP (see 3GPP TS 24.526 [19]) and the current TA is in the list of TAs for which the S-NSSAI is allowed:

- A) an S-NSSAI in the partially allowed NSSAI, which is one of the S-NSSAI(s) in the URSP rule; and
 - B) a mapped S-NSSAI associated with the S-NSSAI in A); or
- 2) "existing PDU session", an S-NSSAI, which is an S-NSSAI in the allowed NSSAI associated with the PDU session and (in roaming scenarios) a mapped S-NSSAI, with exception when S-NSSAI is not provided by the network in subclause 6.1.4.2;
- c1) the alternative S-NSSAI associated with the S-NSSAI to be replaced, if an alternative S-NSSAI for the S-NSSAI or the mapped S-NSSAI exists;
- d) if the request type is set to:
- 1) "initial request" or "MA PDU request" and the UE determined to establish a new PDU session or an MA PDU session based on either a URSP rule including one or more DNNs in the URSP (see subclause 6.2.9) or UE local configuration, according to subclause 4.2.2 of 3GPP TS 24.526 [19], a DNN which corresponds to one of the DNN(s) in the matching URSP rule, if any, or else to the DNN(s) in the UE local configuration or in the default URSP rule, if any, according to the conditions given in subclause 4.2.2 of 3GPP TS 24.526 [19];
 - 1a) "initial request" and the UE determined to establish a new PDU session based on the PDU session parameters for 5G ProSe layer-3 UE-to-network relay UE including a DNN in the UE policies for 5G ProSe UE-to-network relay UE as defined in 3GPP TS 24.555 [19F], a DNN which corresponds to the DNN in the selected PDU session parameters for 5G ProSe layer-3 UE-to-network relay UE, if any; or
 - 2) "existing PDU session", a DNN which is a DNN associated with the PDU session;
- e) the request type which is set to:
- 1) "initial request", if the UE is not registered for emergency services and the UE requests to establish a new non-emergency PDU session;
 - 2) "existing PDU session", if the UE is not registered for emergency services and the UE requests:
 - i) handover of an existing non-emergency PDU session between 3GPP access and non-3GPP access;
 - ii) transfer of an existing PDN connection for non-emergency bearer services in the EPS to the 5GS; or
 - iii) transfer of an existing PDN connection for non-emergency bearer services in an untrusted non-3GPP access connected to the EPC to the 5GS;
 - 3) "initial emergency request", if the UE requests to establish a new emergency PDU session;
 - 4) "existing emergency PDU session", if the UE requests:
 - i) handover of an existing emergency PDU session between 3GPP access and non-3GPP access;
 - ii) transfer of an existing PDN connection for emergency bearer services in the EPS to the 5GS; or
 - iii) transfer of an existing PDN connection for emergency bearer services in an untrusted non-3GPP access connected to the EPC to the 5GS; or
 - 5) "MA PDU request", if:
 - i) the UE requests to establish an MA PDU session;
 - ii) the UE requests to establish user plane resources over other access of an MA PDU session established over one access only; or
 - iii) the UE performs inter-system change from S1 mode to N1 mode according to subclause 4.8.2.3.1 and requests transfer of a PDN connection which is a user plane resource of an MA PDU session; and

- f) the old PDU session ID which is the PDU session ID of the existing PDU session, if the UE initiates the UE-requested PDU session establishment procedure upon receiving the PDU SESSION MODIFICATION COMMAND messages with the 5GSM cause IE set to #39 "reactivation requested";

NOTE 13: If the PDU SESSION MODIFICATION COMMAND message included alternative S-NSSAI, the UE includes alternative S-NSSAI in the PDU SESSION ESTABLISHMENT REQUEST message for PDU session re-establishment.

using the NAS transport procedure as specified in subclause 5.4.5, and the UE shall start timer T3580 (see example in figure 6.4.1.2.1).

For bullet c) 1), if the matching URSP rule does not have an associated S-NSSAI, or if the UE does not have any matching URSP rule and there is no S-NSSAI in the UE local configuration or in the default URSP rule, the UE shall not provide any S-NSSAI in a PDU session establishment procedure.

For bullet c) 1a), if the selected PDU session parameters for 5G ProSe layer-3 UE-to-network relay UE do not have an associated S-NSSAI, the UE shall not provide any S-NSSAI in a PDU session establishment procedure.

For bullet d) 1),

- If the matching non-default URSP rule does not have an associated DNN, then the UE shall not provide any DNN in a PDU session establishment procedure;
- If the UE does not have any matching non-default URSP rule, the UE requests a connectivity that requires PAP/CHAP and the UE is configured with the default DNN for the S-NSSAI in the UE local configuration corresponding to the request, then the UE should provide such DNN in a PDU session establishment procedure;
- If the UE does not have any matching non-default URSP rule, the UE requests a connectivity that requires PAP/CHAP, the UE is not configured with the default DNN for the S-NSSAI in the UE local configuration corresponding to the request, and the application provides the DNN, then the UE shall use such DNN in a PDU session establishment procedure;
- If the UE does not have any matching non-default URSP rule, the UE requests a connectivity that does not require PAP/CHAP, the UE is not configured with the DNN for the S-NSSAI in the UE local configuration corresponding to the request, and the application provides the DNN, then the UE shall use such DNN in a PDU session establishment procedure;
- If the UE does not have any matching non-default URSP rule, the UE requests a connectivity that requires PAP/CHAP, the UE is not configured with the default DNN for the S-NSSAI in the UE local configuration corresponding to the request, the application does not provide the DNN and there is no DNN in the default URSP rule, then the UE shall not provide any DNN in a PDU session establishment procedure; or
- If the UE does not have any matching non-default URSP rule, the UE requests a connectivity that does not require PAP/CHAP, the UE is not configured with the DNN for the S-NSSAI in the UE local configuration corresponding to the request, the application does not provide the DNN and there is no DNN in the default URSP rule, then the UE shall not provide any DNN in a PDU session establishment procedure.

For bullet d) 1a), if the selected the PDU session parameters for 5G ProSe layer-3 UE-to-network relay UE do not have an associated DNN, the UE shall not provide any DNN in a PDU session establishment procedure.

If the request type is set to "initial emergency request" or "existing emergency PDU session" or the UE is registered for onboarding services in SNPN, neither DNN nor S-NSSAI is transported by the UE using the NAS transport procedure as specified in subclause 5.4.5.

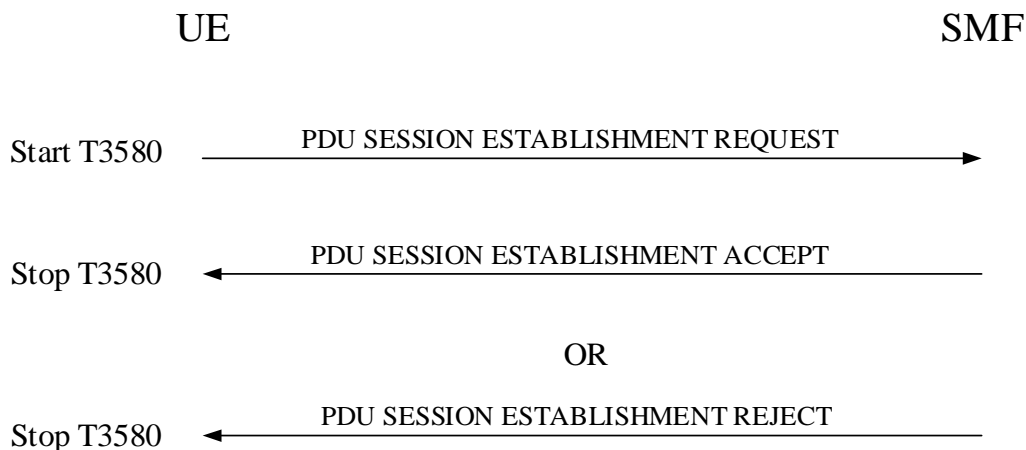

Figure 6.4.1.2.1: UE-requested PDU session establishment procedure

Upon receipt of a PDU SESSION ESTABLISHMENT REQUEST message, a PDU session ID, optionally an S-NSSAI associated with (in roaming scenarios) a mapped S-NSSAI, optionally a DNN determined by the AMF, optionally a DNN selected by the network (if different from the DNN determined by the AMF), the request type, and optionally an old PDU session ID, the SMF checks whether connectivity with the requested DN can be established. If the requested DNN is not included, the SMF shall use the default DNN.

If the PDU session being established is a non-emergency PDU session, the request type is not set to "existing PDU session" and the PDU session authentication and authorization by the external DN is required due to local policy, the SMF shall check whether the PDU SESSION ESTABLISHMENT REQUEST message includes the SM PDU DN request container IE or the Service-level-AA container IE.

If the PDU session being established is a non-emergency PDU session, the request type is not set to "existing PDU session", the SM PDU DN request container IE is included in the PDU SESSION ESTABLISHMENT REQUEST message, the PDU session authentication and authorization by the external DN is required due to local policy and user's subscription data, and:

- a) the information for the PDU session authentication and authorization by the external DN in the SM PDU DN request container IE is compliant with the local policy and user's subscription data, the SMF shall proceed with the EAP Authentication procedure specified in 3GPP TS 33.501 [24] and refrain from accepting or rejecting the PDU SESSION ESTABLISHMENT REQUEST message until the EAP Authentication procedure finalizes; or
- b) the information for the PDU session authentication and authorization by the external DN in the SM PDU DN request container IE is not compliant with the local policy and user's subscription data, the SMF shall consider it as an abnormal case and proceed as specified in subclause 6.4.1.7.

If the PDU session being established is a non-emergency PDU session, the request type is not set to "existing PDU session", the SM PDU DN request container IE is not included in the PDU SESSION ESTABLISHMENT REQUEST message and the PDU session authentication and authorization by the external DN is required due to local policy and user's subscription data, the SMF shall proceed with the EAP Authentication procedure specified in 3GPP TS 33.501 [24] and refrain from accepting or rejecting the PDU SESSION ESTABLISHMENT REQUEST message until the EAP Authentication procedure finalizes.

If the SMF receives the old PDU session ID from the AMF and a PDU session exists for the old PDU session ID, the SMF shall consider that the request for the relocation of SSC mode 3 PDU session anchor with multiple PDU sessions as specified in 3GPP TS 23.502 [9] is accepted by the UE.

If the SMF receives the onboarding indication from the AMF, the SMF shall consider that the PDU session is established for onboarding services in SNPN.

If the UE has set the TPMIC bit to "Transfer of port management information containers supported" in the 5GSM capability IE of the PDU SESSION ESTABLISHMENT REQUEST message and has included a DS-TT Ethernet port MAC address IE (if the PDU session type is "Ethernet"), the Port management information container IE, and,

optionally, the UE-DS-TT residence time IE in the PDU SESSION ESTABLISHMENT REQUEST message, the SMF shall operate as specified in 3GPP TS 23.502 [9] subclause 4.3.2.2.1.

If requested by the upper layers, the UE supporting UAS services shall initiate a request to establish a PDU session for UAS services, where the UE:

- a) shall include the service-level device ID with the value set to the CAA-level UAV ID;
- b) if provided by the upper layers, shall include the service-level-AA server address, with the value set to the USS address; and
- c) if provided by the upper layers, shall include:
 - i) the service-level-AA payload type, with the value set to "UUAA payload"; and
 - ii) the service-level-AA payload, with the value set to UUAA payload,

in the Service-level-AA container IE of the PDU SESSION ESTABLISHMENT REQUEST message.

If the PDU session being established is a non-emergency PDU session, the request type is not set to "existing PDU session", the Service-level-AA container IE is included in the PDU SESSION ESTABLISHMENT REQUEST message, and

- a) the service-level authentication and authorization by the external DN is required due to local policy;
- b) there is a valid user's subscription information for the requested DNN or for the requested DNN and S-NSSAI; and
- c) the information for the service-level authentication and authorization by the external DN in the Service-level-AA container IE includes CAA-level UAV ID,

then the SMF shall proceed with the UUAA-SM procedure as specified in 3GPP TS 23.256 [6AB] and refrain from accepting or rejecting the PDU SESSION ESTABLISHMENT REQUEST message until the service-level authentication and authorization procedure is completed.

The UE supporting UAS services shall not request a PDU session establishment procedure to the same DNN (or no DNN, if no DNN was indicated by the UE) and the same S-NSSAI (or no S-NSSAI, if no S-NSSAI was indicated by the UE) for which the UE has requested a service level authentication and authorization procedure which is ongoing.

If the PDU SESSION ESTABLISHMENT REQUEST message includes the PDU session pair ID IE, the RSN IE, or both, the SMF shall operate as specified in subclause 5.33.2 of 3GPP TS 23.501 [8].

6.4.1.3 UE-requested PDU session establishment procedure accepted by the network

If the connectivity with the requested DN is accepted by the network, the SMF shall create a PDU SESSION ESTABLISHMENT ACCEPT message.

If the UE requests establishing an emergency PDU session, the network shall not check for service area restrictions or subscription restrictions when processing the PDU SESSION ESTABLISHMENT REQUEST message.

The SMF shall set the Authorized QoS rules IE of the PDU SESSION ESTABLISHMENT ACCEPT message to the authorized QoS rules of the PDU session and may include the authorized QoS flow descriptions IE of the PDU SESSION ESTABLISHMENT ACCEPT message set to the authorized QoS flow descriptions of the PDU session.

NOTE 1: This is applicable also if the PDU session establishment procedure was initiated to perform handover of an existing PDU session between 3GPP access and non-3GPP access, and even if the authorized QoS rules and authorized QoS flow descriptions for source and target access of the handover are the same.

The SMF shall ensure that the number of the packet filters used in the authorized QoS rules of the PDU Session does not exceed the maximum number of packet filters supported by the UE for the PDU session. If the received request type is "initial emergency request", the SMF shall set the Authorized QoS flow descriptions IE according to the QoS parameters used for establishing emergency services as specified in subclause 5.16.4 of 3GPP TS 23.501 [8].

SMF shall set the Authorized QoS flow descriptions IE to the authorized QoS flow descriptions of the PDU session, if:

- a) the Authorized QoS rules IE contains at least one GBR QoS flow;
- b) the QFI is not the same as the 5QI of the QoS flow identified by the QFI;
- c) the QoS flow can be mapped to an EPS bearer as specified in subclause 4.11.1 of 3GPP TS 23.502 [9]; or
- d) the QoS flow is established for the PDU session used for relaying, as specified in subclause 5.6.2.1 of 3GPP TS 23.304 [6E].

NOTE 2: In cases other than above listed cases, it is up to the SMF implementation to include the authorized QoS flow description for the QoS flow in the Authorized QoS flow descriptions IE of the PDU SESSION ESTABLISHMENT ACCEPT message.

If interworking with EPS is supported for the PDU session, the SMF shall set in the PDU SESSION ESTABLISHMENT ACCEPT message:

- a) the Mapped EPS bearer contexts IE to the EPS bearer contexts mapped from one or more QoS flows of the PDU session; and
- b) the EPS bearer identity parameter in the Authorized QoS flow descriptions IE to the EPS bearer identity corresponding to the QoS flow, for each QoS flow which can be transferred to EPS.

If the "Create new EPS bearer" operation code in the Mapped EPS bearer contexts IE was received, and there is no corresponding Authorized QoS flow descriptions IE in the PDU SESSION ESTABLISHMENT ACCEPT message, the UE shall send a PDU SESSION MODIFICATION REQUEST message including a Mapped EPS bearer contexts IE to delete the mapped EPS bearer context. If the EPS bearer identity parameter in the Authorized QoS flow descriptions IE was received, the operation code is "Create new QoS flow description" and there is no corresponding Mapped EPS bearer contexts IE in the PDU SESSION ESTABLISHMENT ACCEPT message, the UE shall not diagnose an error, and shall keep storing the association between the QoS flow and the corresponding EPS bearer identity.

Furthermore, the SMF shall store the association between the QoS flow and the mapped EPS bearer context, for each QoS flow which can be transferred to EPS.

The SMF shall set the selected SSC mode IE of the PDU SESSION ESTABLISHMENT ACCEPT message to:

- a) the received SSC mode in the SSC mode IE included in the PDU SESSION ESTABLISHMENT REQUEST message based on one or more of the PDU session type, the subscription and the SMF configuration;
- b) either the default SSC mode for the data network listed in the subscription or the SSC mode associated with the SMF configuration, if the SSC mode IE is not included in the PDU SESSION ESTABLISHMENT REQUEST message.

NOTE 3: For bullet b), to avoid issues for UEs not supporting all SSC modes, the network operator can, in the subscription data and local configuration, include at least SSC mode 1 in the allowed SSC modes, and set the default SSC mode to "SSC mode 1" as per 3GPP TS 23.501 [8].

If the PDU session is an emergency PDU session, the SMF shall set the Selected SSC mode IE of the PDU SESSION ESTABLISHMENT ACCEPT message to "SSC mode 1". If the PDU session is a non-emergency PDU session of "Ethernet" or "Unstructured" PDU session type, the SMF shall set the Selected SSC mode IE to "SSC mode 1" or "SSC mode 2". If the PDU session is a non-emergency PDU session of "IPv4", "IPv6" or "IPv4v6" PDU session type, the SMF shall set the selected SSC mode IE to "SSC mode 1", "SSC mode 2", or "SSC mode 3".

If the PDU session is a non-emergency PDU session and the UE is not registered for onboarding services in SNPN, the SMF shall set the S-NSSAI IE of the PDU SESSION ESTABLISHMENT ACCEPT message to:

- a) the S-NSSAI of the PDU session; and
- b) the mapped S-NSSAI (in roaming scenarios).

The S-NSSAI or the mapped S-NSSAI (in roaming scenarios) of the PDU session shall be the alternative S-NSSAI if the SMF has received an alternative S-NSSAI from the AMF.

The SMF shall set the Selected PDU session type IE of the PDU SESSION ESTABLISHMENT ACCEPT message to the selected PDU session type, i.e. the PDU session type of the PDU session.

If the PDU SESSION ESTABLISHMENT REQUEST message includes a PDU session type IE set to "IPv4v6", the SMF shall select "IPv4", "IPv6" or "IPv4v6" as the Selected PDU session type. If the subscription, the SMF configuration, or both, are limited to IPv4 only or IPv6 only for the DNN selected by the network, the SMF shall include the 5GSM cause value #50 "PDU session type IPv4 only allowed", or #51 "PDU session type IPv6 only allowed", respectively, in the 5GSM cause IE of the PDU SESSION ESTABLISHMENT ACCEPT message.

If the selected PDU session type is "IPv4", the SMF shall include the PDU address IE in the PDU SESSION ESTABLISHMENT ACCEPT message and shall set the PDU address IE to an IPv4 address is allocated to the UE in the PDU session.

If the selected PDU session type is "IPv6", the SMF shall include the PDU address IE in the PDU SESSION ESTABLISHMENT ACCEPT message and shall set the PDU address IE to an interface identifier for the IPv6 link local address allocated to the UE in the PDU session.

If the selected PDU session type is "IPv4v6", the SMF shall include the PDU address IE in the PDU SESSION ESTABLISHMENT ACCEPT message and shall set the PDU address IE to an IPv4 address and an interface identifier for the IPv6 link local address, allocated to the UE in the PDU session.

If the selected PDU session type of a PDU session established by the W-AGF acting on behalf of the FN-RG is "IPv4v6" or "IPv6", the SMF shall also indicate the SMF's IPv6 link local address in the PDU address IE of the PDU SESSION ESTABLISHMENT ACCEPT message.

If the PDU session is a non-emergency PDU session and the UE is not registered for onboarding services in SNPN, the SMF shall set the DNN IE of the PDU SESSION ESTABLISHMENT ACCEPT message to the DNN determined by the AMF of the PDU session.

The SMF shall set the Session-AMBR IE of the PDU SESSION ESTABLISHMENT ACCEPT message to the Session-AMBR of the PDU session.

If the selected PDU session type is "IPv4", "IPv6", "IPv4v6" or "Ethernet" and if the PDU SESSION ESTABLISHMENT REQUEST message includes a 5GSM capability IE with the RQoS bit set to "Reflective QoS supported", the SMF shall consider that reflective QoS is supported for QoS flows belonging to this PDU session and may include the RQ timer IE set to an RQ timer value in the PDU SESSION ESTABLISHMENT ACCEPT message.

If the selected PDU session type is "IPv4", "IPv6", "IPv4v6" or "Ethernet" and if the PDU SESSION ESTABLISHMENT REQUEST message includes a Maximum number of supported packet filters IE, the SMF shall consider this number as the maximum number of packet filters that can be supported by the UE for this PDU session. Otherwise the SMF considers that the UE supports 16 packet filters for this PDU session.

The SMF shall consider that the maximum data rate per UE for user-plane integrity protection supported by the UE for uplink and the maximum data rate per UE for user-plane integrity protection supported by the UE for downlink are valid for the lifetime of the PDU session.

If the value of the RQ timer is set to "deactivated" or has a value of zero, the UE considers that RQoS is not applied for this PDU session.

NOTE 4: If the 5G core network determines that reflective QoS is to be used for a QoS flow, the SMF sends reflective QoS indication (RQI) to UPF to activate reflective QoS. If the QoS flow is established over 3GPP access, the SMF also includes reflective QoS Attribute (RQA) in QoS profile of the QoS flow during QoS flow establishment.

If the selected PDU session type is "IPv6" or "IPv4v6" and if the PDU SESSION ESTABLISHMENT REQUEST message includes a 5GSM capability IE with the MH6-PDU bit set to "Multi-homed IPv6 PDU session supported", the SMF shall consider that this PDU session is supported to use multiple IPv6 prefixes.

If the selected PDU session type is "Ethernet", the PDU SESSION ESTABLISHMENT REQUEST message includes a 5GSM capability IE with the EPT-S1 bit set to "Ethernet PDN type in S1 mode supported" and the network supports Ethernet PDN type in S1 mode, the SMF shall set the EPT-S1 bit of the 5GSM network feature support IE of the PDU SESSION ESTABLISHMENT ACCEPT message to "Ethernet PDN type in S1 mode supported".

If the AMF has indicated to the SMF that the UE supports the non-3GPP access path switching and the SMF supports the non-3GPP access path switching, the SMF shall set the NAPS bit of the 5GSM network feature support IE of the PDU SESSION ESTABLISHMENT ACCEPT message to "non-3GPP access path switching supported".

If the DN authentication of the UE was performed and completed successfully, the SMF shall set the EAP message IE of the PDU SESSION ESTABLISHMENT ACCEPT message to an EAP-success message as specified in IETF RFC 3748 [34], provided by the DN.

Based on local policies or configurations in the SMF and the Always-on PDU session requested IE in the PDU SESSION ESTABLISHMENT REQUEST message (if available), if the SMF determines that either:

- a) the requested PDU session needs to be established as an always-on PDU session (e.g. because the PDU session is for time synchronization or TSC, for URLLC, or for both), the SMF shall include the Always-on PDU session indication IE in the PDU SESSION ESTABLISHMENT ACCEPT message and shall set the value to "Always-on PDU session required"; or
- b) the requested PDU session shall not be established as an always-on PDU session and:
 - i) if the UE included the Always-on PDU session requested IE, the SMF shall include the Always-on PDU session indication IE in the PDU SESSION ESTABLISHMENT ACCEPT message and shall set the value to "Always-on PDU session not allowed"; or
 - ii) if the UE did not include the Always-on PDU session requested IE, the SMF shall not include the Always-on PDU session indication IE in the PDU SESSION ESTABLISHMENT ACCEPT message.

If the PDU session is an MA PDU session, the SMF shall include the ATSSS container IE in the PDU SESSION ESTABLISHMENT ACCEPT message. The SMF shall set the content of the ATSSS container IE as specified in 3GPP TS 24.193 [13B]. If the UE requests to establish user plane resources over the second access of an MA PDU session which has already been established over the first access and the parameters associated with ATSSS previously provided to the UE are not to be updated, the "ATSSS container contents" shall not be included in the ATSSS container IE in the PDU SESSION ESTABLISHMENT ACCEPT message.

If the PDU session is a single access PDU session containing the MA PDU session information IE with the value set to "MA PDU session network upgrade is allowed" and:

- a) if the SMF decides to establish a single access PDU session, the SMF shall not include the ATSSS container IE in the PDU SESSION ESTABLISHMENT ACCEPT message; or
- b) if the SMF decides to establish an MA PDU session, the SMF shall include the ATSSS container IE in the PDU SESSION ESTABLISHMENT ACCEPT message, which indicates to the UE that the requested single access PDU session was established as an MA PDU Session.

If the network decides that the PDU session is only for control plane CIoT 5GS optimization, the SMF shall include the control plane only indication in the PDU SESSION ESTABLISHMENT ACCEPT message.

If:

- a) the UE provided the IP header compression configuration IE in the PDU SESSION ESTABLISHMENT REQUEST message; and
- b) the SMF supports IP header compression for control plane CIoT 5GS optimization;

the SMF shall include the IP header compression configuration IE in the PDU SESSION ESTABLISHMENT ACCEPT message.

If:

- a) the UE provided the Ethernet header compression configuration IE in the PDU SESSION ESTABLISHMENT REQUEST message; and
- b) the SMF supports Ethernet header compression for control plane CIoT 5GS optimization;

the SMF shall include the Ethernet header compression configuration IE in the PDU SESSION ESTABLISHMENT ACCEPT message.

If the PDU SESSION ESTABLISHMENT REQUEST included the Requested MBS container IE with the MBS operation set to "Join MBS session", the SMF:

- a) shall include the TMGI for the multicast MBS session IDs that the UE is allowed to join, if any, in the Received MBS container IE, shall set the MBS decision to "MBS join is accepted" for each of those Received MBS

information, may include the MBS start time to indicate the time when the multicast MBS session starts and shall include the MBS security container in each of those Received MBS information if security protection is applied for that multicast MBS session and the control plane security procedure is used as specified in annex W.4.1.2 in 3GPP TS 33.501 [24], and shall use separate QoS flows dedicated for multicast by including the Authorized QoS flow descriptions IE if no separate QoS flows dedicated for multicast exist or if the SMF wants to establish new QoS flows dedicated for multicast;

NOTE 5: The network determines whether security protection applies or not for the multicast MBS session as specified in 3GPP TS 33.501 [24].

- b) shall include the TMGI for multicast MBS session IDs that the UE is not allowed to join, if any, in the Received MBS container IE, shall set the MBS decision to "MBS join is rejected" for each of those Received MBS information, shall set the Rejection cause for each of those Received MBS information with the reason of rejection, and if the Rejection cause is set to "multicast MBS session has not started or will not start soon", may include an MBS back-off timer value; and
- c) may include in the Received MBS container IE the MBS service area for each multicast MBS session and include in it the MBS TAI list, the NR CGI list or both, that identify the service area(s) for the local MBS service

NOTE 6: For an multicast MBS session that has multiple MBS service areas, the MBS service areas are indicated to the UE using MBS service announcement as described in 3GPP TS 23.247 [53], which is out of scope of this specification.

in the PDU SESSION ESTABLISHMENT ACCEPT message. If the UE has set the Type of multicast MBS session ID to "Source specific IP multicast address" in the Requested multicast MBS container IE for certain MBS session(s) in the PDU SESSION ESTABLISHMENT REQUEST message, the SMF shall include the Source IP address information and Destination IP address information in the Received MBS information together with the TMGI for each of those multicast MBS sessions.

NOTE 7: Including the Source IP address information and Destination IP address information in the Received MBS information in that case is to allow the UE to perform the mapping between the requested multicast MBS session ID and the provided TMGI.

NOTE 8: In SNPN, TMGI is used together with NID to identify an MBS Session.

If the request type is "existing PDU session", the SMF shall not perform network slice admission control for the PDU session, except for the following cases:

- a) when EPS counting is not required for the S-NSSAI of the PDU session for network slice admission control and the PDU session is established due to transfer the PDN connection from S1 mode to N1 mode in case of inter-system change; or
- b) handover of an existing PDU session between 3GPP access and non-3GPP access is performed.

The SMF shall send the PDU SESSION ESTABLISHMENT ACCEPT message.

Upon receipt of a PDU SESSION ESTABLISHMENT ACCEPT message and a PDU session ID, using the NAS transport procedure as specified in subclause 5.4.5, the UE shall stop timer T3580, shall release the allocated PTI value and shall consider that the PDU session was established.

If the PDU session establishment procedure was initiated to perform handover of an existing PDU session between 3GPP access and non-3GPP access, then upon receipt of the PDU SESSION ESTABLISHMENT ACCEPT message the UE shall locally delete any authorized QoS rules, authorized QoS flow descriptions, the session-AMBR and the parameters provided in the Protocol configuration options IE when in S1 mode or the Extended protocol configuration options IE stored for the PDU session before processing the new received authorized QoS rules, authorized QoS flow descriptions, the session-AMBR and the parameters provided in the Extended protocol configuration options IE, if any.

NOTE 9: For the case of handover from 3GPP access to non-3GPP access, deletion of the QoS flow descriptions implies deletion of the associated EPS bearer identities, if any, and according to subclause 6.1.4.1 also deletion of the associated EPS bearer contexts. Regarding the reverse direction, for PDU sessions via non-3GPP access the network does not allocate associated EPS bearer identities (see 3GPP TS 23.502 [9], subclause 4.11.1.4.1).

If the PDU session establishment procedure was initiated to perform handover of an existing PDU session from 3GPP access to non-3GPP access and that existing PDU session is associated with one or more multicast MBS sessions, the

UE shall locally leave the associated multicast MBS sessions and the SMF shall consider the UE as removed from the associated multicast MBS sessions.

For an MA PDU session already established on a single access, except for all those MA PDU sessions with a PDN connection established as a user-plane resource, upon receipt of PDU SESSION ESTABLISHMENT ACCEPT message over the other access:

- a) the UE shall delete the stored authorized QoS rules and the stored session-AMBR;
- b) if the authorized QoS flow descriptions IE is included in the PDU SESSION ESTABLISHMENT ACCEPT message, the UE shall delete the stored authorized QoS flow descriptions; and
- c) if the mapped EPS bearer contexts IE is included in the PDU SESSION ESTABLISHMENT ACCEPT message, the UE shall delete the stored mapped EPS bearer contexts.

If the UE supports network slice usage control and:

- a) a PDU session is successfully established for the on-demand S-NSSAI, the UE shall stop and reset the slice deregistration inactivity timer for the on-demand S-NSSAI over corresponding access type, if running; and
- b) an MA PDU session is successfully established for the on-demand S-NSSAI, the UE shall stop and reset the slice deregistration inactivity timer for the on-demand S-NSSAI over both 3GPP access and non-3GPP access, if running.

The UE shall store the authorized QoS rules, and the session-AMBR received in the PDU SESSION ESTABLISHMENT ACCEPT message for the PDU session. The UE shall also store the authorized QoS flow descriptions if it is included in the Authorized QoS flow descriptions IE of the PDU SESSION ESTABLISHMENT ACCEPT message for the PDU session.

If the number of the authorized QoS rules, the number of the packet filters, or the number of the authorized QoS flow descriptions associated with the PDU session have reached the maximum number supported by the UE upon receipt of a PDU SESSION ESTABLISHMENT ACCEPT message, then the UE may initiate the PDU session release procedure by sending a PDU SESSION RELEASE REQUEST message with 5GSM cause #26 "insufficient resources".

For a PDU session that is being established with the request type set to "initial request", "initial emergency request" or "MA PDU request", or a PDU session that is being transferred from EPS to 5GS and established with the request type set to "existing PDU session" or "existing emergency PDU session" or a PDU session that is being handed over between non-3GPP access and 3GPP access and established with the request type set to "existing PDU session" or "existing emergency PDU session", the UE shall verify the authorized QoS rules and the authorized QoS flow descriptions provided in the PDU SESSION ESTABLISHMENT ACCEPT message for different types of errors as follows:

- a) Semantic errors in QoS operations:
 - 1) When the rule operation is "Create new QoS rule", and the DQR bit is set to "the QoS rule is the default QoS rule" when there's already a default QoS rule.
 - 2) When the rule operation is "Create new QoS rule", and there is no rule with the DQR bit set to "the QoS rule is the default QoS rule".
 - 3) When the rule operation is "Create new QoS rule" and two or more QoS rules associated with this PDU session would have identical precedence values.
 - 4) When the rule operation is an operation other than "Create new QoS rule".
 - 5) When the rule operation is "Create new QoS rule", the DQR bit is set to "the QoS rule is not the default QoS rule", and the UE is in NB-N1 mode.
 - 6) When the rule operation is "Create new QoS rule" and there is already an existing QoS rule with the same QoS rule identifier.
 - 7) When the rule operation is "Create new QoS rule", the DQR bit is set to "the QoS rule is not the default QoS rule", and the PDU session type of the PDU session is "Unstructured".
 - 8) When the flow description operation is an operation other than "Create new QoS flow description".

- 8a) When the flow description operation is "Create new QoS flow description" and there is already an existing QoS flow description with the same QoS flow identifier.
- 9) When the flow description operation is "Create new QoS flow description", the QFI associated with the QoS flow description is not the same as the QFI of the default QoS rule and the UE is NB-N1 mode.
- 10) When the flow description operation is "Create new QoS flow description", the QFI associated with the QoS flow description is not the same as the QFI of the default QoS rule, and the PDU session type of the PDU session is "Unstructured".
- 11) When the rule operation is "Create new QoS rule" and the DQR bit is set to "the QoS rule is not the default QoS rule" and one match-all packet filter is to be associated with the QoS rule.

In case 4, case 5, or case 7 if the rule operation is for a non-default QoS rule, the UE shall send a PDU SESSION MODIFICATION REQUEST message to delete the QoS rule with 5GSM cause #83 "semantic error in the QoS operation".

In case 6, if the existing QoS rule is not the default QoS rule and the DQR bit of the new QoS rule is set to "the QoS rule is not the default QoS rule", the UE shall not diagnose an error, further process the create request and, if it was processed successfully, delete the old QoS rule (i.e. the QoS rule that existed when case 6 was detected). If the existing QoS rule is the default QoS rule or the DQR bit of the new QoS rule is set to "the QoS rule is the default QoS rule", the UE shall initiate a PDU session release procedure by sending a PDU SESSION RELEASE REQUEST message with 5GSM cause #83 "semantic error in the QoS operation".

In case 8, case 9, or case 10, the UE shall send a PDU SESSION MODIFICATION REQUEST message to delete the QoS flow description with 5GSM cause #83 "semantic error in the QoS operation".

In case 8a, the UE shall not diagnose an error, further process the create request and, if it was processed successfully, delete the old QoS flow description (i.e. the QoS flow description that existed when case 8a was detected).

Otherwise for all the cases above, the UE shall initiate a PDU session release procedure by sending a PDU SESSION RELEASE REQUEST message with 5GSM cause #83 "semantic error in the QoS operation".

b) Syntactical errors in QoS operations:

- 1) When the rule operation is "Create new QoS rule", the QoS rule is a QoS rule of a PDU session of IPv4, IPv6, IPv4v6 or Ethernet PDU session type, and the packet filter list in the QoS rule is empty.
- 2) When the rule operation is "Create new QoS rule", the DQR bit is set to "the QoS rule is the default QoS rule", the PDU session type of the PDU session is "Unstructured", and the packet filter list in the QoS rule is not empty.
- 3) When there are other types of syntactical errors in the coding of the Authorized QoS rules IE or the Authorized QoS flow descriptions IE, such as: a mismatch between the number of packet filters subfield and the number of packet filters in the packet filter list when the rule operation is create new QoS rule", or the number of packet filters subfield is larger than the maximum possible number of packet filters in the packet filter list (i.e., there is no QoS rule precedence subfield included in the QoS rule IE), the QoS Rule Identifier is set to "no QoS rule identifier assigned", or the QoS flow identifier is set to "no QoS flow identifier assigned".
- 4) When, the rule operation is "Create new QoS rule", there is no QoS flow description with a QFI corresponding to the QFI of the resulting QoS rule and the UE determines, by using the QoS rule's QFI as the 5QI, that there is a resulting QoS rule for a GBR QoS flow (as described in 3GPP TS 23.501 [8] table 5.7.4-1).
- 5) When the flow description operation is "Create new QoS flow description", and the UE determines that there is a QoS flow description of a GBR QoS flow (as described in 3GPP TS 23.501 [8] table 5.7.4-1) which lacks at least one of the mandatory parameters (i.e., GFBR uplink, GFBR downlink, MFBR uplink and MFBR downlink). If the QoS flow description does not include a 5QI, the UE determines this by using the QFI as the 5QI.

In case 1, case 3 or case 4, if the QoS rule is the default QoS rule, the UE shall initiate a PDU session release procedure by sending a PDU SESSION RELEASE REQUEST message with 5GSM cause #84 "syntactical error in the QoS operation". Otherwise, the UE shall send a PDU SESSION MODIFICATION REQUEST message

including a requested QoS rule IE, a requested QoS flow description IE or both to delete the QoS rule, the QoS flow description or both with 5GSM cause #84 "syntactical error in the QoS operation".

In case 2, if the QoS rule is the default QoS rule, the UE shall send a PDU SESSION MODIFICATION REQUEST message including a requested QoS rule IE to delete all the packet filters of the default QoS rule. The UE shall include the 5GSM cause #84 "syntactical error in the QoS operation".

In case 5, if the default QoS rule is associated with the QoS flow description which lacks at least one of the mandatory parameters, the UE shall initiate a PDU session release procedure by sending a PDU SESSION RELEASE REQUEST message with 5GSM cause #84 "syntactical error in the QoS operation". Otherwise, the UE shall send a PDU SESSION MODIFICATION REQUEST message to delete the QoS flow description which lacks at least one of the mandatory parameters and the associated QoS rule(s), if any, with 5GSM cause #84 "syntactical error in the QoS operation".

NOTE 10: It is not considered an error if the UE determines that after processing all QoS operations on QoS rules and QoS flow descriptions there is a QoS flow description that is not associated with any QoS rule and the UE is not in NB-N1 mode.

c) Semantic errors in packet filters:

- 1) When a packet filter consists of conflicting packet filter components which would render the packet filter ineffective, i.e. no IP packet will ever fit this packet filter. How the UE determines a semantic error in a packet filter is outside the scope of the present document.

If the QoS rule is the default QoS rule, the UE shall initiate a PDU session release procedure by sending a PDU SESSION RELEASE REQUEST message with 5GSM cause #44 "semantic error in packet filter(s)". Otherwise, the UE shall send a PDU SESSION MODIFICATION REQUEST message to delete the QoS rule with 5GSM cause #44 "semantic error in packet filter(s)".

d) Syntactical errors in packet filters:

- 1) When the rule operation is "Create new QoS rule" and two or more packet filters in the resultant QoS rule would have identical packet filter identifiers.
- 2) When there are other types of syntactical errors in the coding of packet filters, such as the use of a reserved value for a packet filter component identifier.

If the QoS rule is the default QoS rule, the UE shall initiate a PDU session release procedure by sending a PDU SESSION RELEASE REQUEST message with 5GSM cause #45 "syntactical errors in packet filter(s)". Otherwise, the UE shall send a PDU SESSION MODIFICATION REQUEST message to delete the QoS rule with 5GSM cause #45 "syntactical errors in packet filter(s)".

If the Always-on PDU session indication IE is included in the PDU SESSION ESTABLISHMENT ACCEPT message and:

- a) the value of the IE is set to "Always-on PDU session required", the UE shall consider the established PDU session as an always-on PDU session; or
- b) the value of the IE is set to "Always-on PDU session not allowed", the UE shall not consider the established PDU session as an always-on PDU session.

The UE shall not consider the established PDU session as an always-on PDU session if the UE does not receive the Always-on PDU session indication IE in the PDU SESSION ESTABLISHMENT ACCEPT message.

The UE shall store the mapped EPS bearer contexts, if received in the PDU SESSION ESTABLISHMENT ACCEPT message. Furthermore, the UE shall also store the association between the QoS flow and the mapped EPS bearer context, for each QoS flow which can be transferred to EPS, based on the received EPS bearer identity parameter in Authorized QoS flow descriptions IE and the mapped EPS bearer contexts. The UE shall check each mapped EPS bearer context for different types of errors as follows:

NOTE 11: An error detected in a mapped EPS bearer context does not cause the UE to discard the Authorized QoS rules IE and Authorized QoS flow descriptions IE included in the PDU SESSION ESTABLISHMENT ACCEPT, if any.

- a) Semantic error in the mapped EPS bearer operation:

- 1) When the operation code is an operation code other than "Create new EPS bearer".
- 2) When the operation code is "Create new EPS bearer" and there is already an existing mapped EPS bearer context with the same EPS bearer identity associated with any PDU session.
- 3) When the operation code is "Create new EPS bearer" and the resulting mapped EPS bearer context has invalid mandatory parameters or missing mandatory parameters (e.g., mapped EPS QoS parameters or traffic flow template for a dedicated EPS bearer context).

In case 2, if the existing mapped EPS bearer context is associated with the PDU session that is being established, the UE shall not diagnose an error, further process the create request and, if it was process successfully, delete the old EPS bearer context.

Otherwise, the UE shall initiate a PDU session modification procedure by sending a PDU SESSION MODIFICATION REQUEST message to delete the mapped EPS bearer context with 5GSM cause #85 "Invalid mapped EPS bearer identity".

- b) if the mapped EPS bearer context includes a traffic flow template, the UE shall check the traffic flow template for different types of TFT IE errors as follows:

- 1) Semantic errors in TFT operations:

- i) When the TFT operation is an operation other than "Create new TFT"

The UE shall initiate a PDU session modification procedure by sending a PDU SESSION MODIFICATION REQUEST message to delete the mapped EPS bearer context with 5GSM cause #41 "semantic error in the TFT operation".

- 2) Syntactical errors in TFT operations:

- i) When the TFT operation = "Create new TFT" and the packet filter list in the TFT IE is empty.
- ii) When there are other types of syntactical errors in the coding of the TFT IE, such as a mismatch between the number of packet filters subfield, and the number of packet filters in the packet filter list.

The UE shall initiate a PDU session modification procedure by sending a PDU SESSION MODIFICATION REQUEST message with to delete the mapped EPS bearer context 5GSM cause #42 "syntactical error in the TFT operation".

- 3) Semantic errors in packet filters:

- i) When a packet filter consists of conflicting packet filter components which would render the packet filter ineffective, i.e. no IP packet will ever fit this packet filter. How the UE determines a semantic error in a packet filter is outside the scope of the present document.
- ii) When the resulting TFT, which is assigned to a dedicated EPS bearer context, does not contain any packet filter which applicable for the uplink direction.

The UE shall initiate a PDU session modification procedure by sending a PDU SESSION MODIFICATION REQUEST message to delete the mapped EPS bearer context with 5GSM cause #44 "semantic errors in packet filter(s)".

- 4) Syntactical errors in packet filters:

- i) When the TFT operation = "Create new TFT" and two or more packet filters in the resultant TFT would have identical packet filter identifiers.
- ii) When the TFT operation = "Create new TFT" and two or more packet filters in all TFTs associated with this PDN connection would have identical packet filter precedence values.
- iii) When there are other types of syntactical errors in the coding of packet filters, such as the use of a reserved value for a packet filter component identifier.

In case ii, if the old packet filters do not belong to the default EPS bearer context, the UE shall not diagnose an error and shall delete the old packet filters which have identical filter precedence values.

In case ii, if one or more old packet filters belong to the default EPS bearer context, the UE shall initiate a PDU session modification procedure by sending a PDU SESSION MODIFICATION REQUEST message to delete the mapped EPS bearer context with 5GSM cause #45 "syntactical errors in packet filter(s)".

In cases i and iii the UE shall initiate a PDU session modification procedure by sending a PDU SESSION MODIFICATION REQUEST message to delete the mapped EPS bearer context with 5GSM cause #45 "syntactical error in packet filter(s)".

If the UE detects different errors in the mapped EPS bearer contexts, QoS rules or QoS flow descriptions, the UE may send a single PDU SESSION MODIFICATION REQUEST message to delete the erroneous mapped EPS bearer contexts, QoS rules or QoS flow descriptions. In that case, the UE shall include a single 5GSM cause in the PDU SESSION MODIFICATION REQUEST message.

NOTE 12: The 5GSM cause to use cannot be different from: #41 "semantic error in the TFT operation", #42 "syntactical error in the TFT operation", #44 "semantic error in packet filter(s)", #45 "syntactical errors in packet filter(s)", #83 "semantic error in the QoS operation", #84 "syntactical error in the QoS operation", and #85 "Invalid mapped EPS bearer identity". The selection of a 5GSM cause is up to the UE implementation.

If there are mapped EPS bearer context(s) associated with a PDU session, but none of them is associated with the default QoS rule, the UE shall initiate a PDU session modification procedure by sending a PDU SESSION MODIFICATION REQUEST message to delete the mapped EPS bearer context(s) with 5GSM cause #85 "Invalid mapped EPS bearer identity" and shall locally delete the stored EPS bearer identity (EBI) in all the QoS flow descriptions of the PDU session, if any.

The UE shall only use the Control plane CIoT 5GS optimization for this PDU session if the Control plane only indication is included in the PDU SESSION ESTABLISHMENT ACCEPT message.

If the UE requests the PDU session type "IPv4v6" and:

- a) the UE receives the selected PDU session type set to "IPv4" and does not receive the 5GSM cause value #50 "PDU session type IPv4 only allowed"; or
- b) the UE receives the selected PDU session type set to "IPv6" and does not receive the 5GSM cause value #51 "PDU session type IPv6 only allowed";

the UE may subsequently request another PDU session for the other IP version using the UE-requested PDU session establishment procedure to the same DNN (or no DNN, if no DNN was indicated by the UE) and the same S-NSSAI associated with (in roaming scenarios) a mapped S-NSSAI (or no S-NSSAI, if no S-NSSAI was indicated by the UE) with a single address PDN type (IPv4 or IPv6) other than the one already activated.

If the UE requests the PDU session type "IPv4v6", receives the selected PDU session type set to "IPv4" and the 5GSM cause value #50 "PDU session type IPv4 only allowed", the UE shall not subsequently request another PDU session using the UE-requested PDU session establishment procedure to the same DNN (or no DNN, if no DNN was indicated by the UE) and the same S-NSSAI associated with (in roaming scenarios) a mapped S-NSSAI (or no S-NSSAI, if no S-NSSAI was indicated by the UE) to obtain a PDU session type different from the one allowed by the network until any of the following conditions is fulfilled:

- a) the UE is registered to a new PLMN;
- b) the UE is switched off;
- c) the USIM is removed;
- d) the entry in the "list of subscriber data" for the current SNPN is updated if the UE does not support access to an SNPN using credentials from a credentials holder and equivalent SNPNs; or
- e) the selected entry of the "list of subscriber data" is updated or USIM is removed for the selected PLMN subscription, if the UE supports access to an SNPN using credentials from a credentials holder, equivalent SNPNs or both.

If the UE requests the PDU session type "IPv4v6", receives the selected PDU session type set to "IPv6" and the 5GSM cause value #51 "PDU session type IPv6 only allowed", the UE shall not subsequently request another PDU session using the UE-requested PDU session establishment procedure to the same DNN (or no DNN, if no DNN was indicated by the UE) and the same S-NSSAI associated with (in roaming scenarios) a mapped S-NSSAI (or no S-NSSAI, if no S-

NSSAI was indicated by the UE) to obtain a PDU session type different from the one allowed by the network until any of the following conditions is fulfilled:

- a) the UE is registered to a new PLMN;
- b) the UE is switched off;
- c) the USIM is removed
- d) the entry in the "list of subscriber data" for the current SNPN is updated if the UE does not support access to an SNPN using credentials from a credentials holder and equivalent SNPNs; or
- e) the selected entry of the "list of subscriber data" is updated or USIM is removed for the selected PLMN subscription, if the UE supports access to an SNPN using credentials from a credentials holder, equivalent SNPNs or both.

NOTE 13: For the 5GSM cause values #50 "PDU session type IPv4 only allowed", and #51 "PDU session type IPv6 only allowed", re-attempt in S1 mode for the same DNN (or no DNN, if no DNN was indicated by the UE) is only allowed using the PDU session type(s) indicated by the network.

If the selected PDU session type of the PDU session is "Unstructured" or "Ethernet", the UE supports inter-system change from N1 mode to S1 mode, the UE does not support establishment of a PDN connection for the PDN type set to "non-IP" in S1 mode, and the parameters list field of one or more authorized QoS flow descriptions received in the Authorized QoS flow descriptions IE of the PDU SESSION ESTABLISHMENT ACCEPT message contains an EPS bearer identity (EBI), then the UE shall locally remove the EPS bearer identity (EBI) from the parameters list field of such one or more authorized QoS flow descriptions. Additionally the UE shall also initiate a PDU session modification procedure by sending a PDU SESSION MODIFICATION REQUEST message to delete the mapped EPS bearer context with 5GSM cause #85 "Invalid mapped EPS bearer identity".

If the selected PDU session type of the PDU session is "Ethernet", the UE supports inter-system change from N1 mode to S1 mode, the UE does not support establishment of a PDN connection for the PDN type set to "non-IP" in S1 mode, the UE, the network or both of them do not support Ethernet PDN type in S1 mode, and the parameters list field of one or more authorized QoS flow descriptions received in the Authorized QoS flow descriptions IE of the PDU SESSION ESTABLISHMENT ACCEPT message contains an EPS bearer identity (EBI), then the UE shall locally remove the EPS bearer identity (EBI) from the parameters list field of such one or more authorized QoS flow descriptions. Additionally, the UE shall also initiate a PDU session modification procedure by sending a PDU SESSION MODIFICATION REQUEST message to delete the mapped EPS bearer context with 5GSM cause #85 "Invalid mapped EPS bearer identity".

For a UE which is registered for disaster roaming services and for a PDU session which is not a PDU session for emergency services:

- a) if the parameters list field of one or more authorized QoS flow descriptions received in the Authorized QoS flow descriptions IE of the PDU SESSION ESTABLISHMENT ACCEPT message contains an EPS bearer identity (EBI), then the UE shall locally remove the EPS bearer identity (EBI) from the parameters list field of such one or more authorized QoS flow descriptions; and
- b) the UE shall locally delete the contents of the Mapped EPS bearer contexts IE if it is received in the PDU SESSION ESTABLISHMENT ACCEPT message.

If the UE receives an IPv4 Link MTU parameter, an Ethernet Frame Payload MTU parameter, an Unstructured Link MTU parameter, or a Non-IP Link MTU parameter in the Extended protocol configuration options IE of the PDU SESSION ESTABLISHMENT ACCEPT message, the UE shall pass to the upper layer the received IPv4 link MTU size, the received Ethernet frame payload MTU size, the unstructured link MTU size, or the non-IP link MTU size.

NOTE 14: The IPv4 link MTU size corresponds to the maximum length of user data packet that can be sent either via the control plane or via N3 interface for a PDU session of the "IPv4" PDU session type.

NOTE 15: The Ethernet frame payload MTU size corresponds to the maximum length of a payload of an Ethernet frame that can be sent either via the control plane or via N3 interface for a PDU session of the "Ethernet" PDU session type.

NOTE 16: The unstructured link MTU size correspond to the maximum length of user data packet that can be sent either via the control plane or via N3 interface for a PDU session of the "Unstructured" PDU session type.

NOTE 17: A PDU session of "Ethernet" or "Unstructured" PDU session type can be transferred to a PDN connection of "non-IP" PDN type, thus the UE can request the non-IP link MTU parameter in the PDU session establishment procedure. The non-IP link MTU size corresponds to the maximum length of user data that can be sent either in the user data container in the ESM DATA TRANSPORT message or via S1-U interface as specified in 3GPP TS 24.301 [15].

If the 5G-RG receives an ACS information parameter in the Extended protocol configuration options IE of the PDU SESSION ESTABLISHMENT ACCEPT message, the 5G-RG shall pass the ACS URL in the received ACS information parameter to the upper layer.

If the UE has indicated support for CIoT 5GS optimizations and receives a small data rate control parameters container in the Extended protocol configuration options IE in the PDU SESSION ESTABLISHMENT ACCEPT message, the UE shall store the small data rate control parameters value and use the stored small data rate control parameters value as the maximum allowed limit of uplink user data for the PDU session in accordance with 3GPP TS 23.501 [8].

If the UE has indicated support for CIoT 5GS optimizations and receives an additional small data rate control parameters for exception data container in the Extended protocol configuration options IE in the PDU SESSION ESTABLISHMENT ACCEPT message, the UE shall store the additional small data rate control parameters for exception data value and use the stored additional small data rate control parameters for exception data value as the maximum allowed limit of uplink exception data for the PDU session in accordance with 3GPP TS 23.501 [8].

If the UE has indicated support for CIoT 5GS optimizations and receives an initial small data rate control parameters container or an initial additional small data rate control parameters for exception data container in the Extended protocol configuration options IE in the PDU SESSION ESTABLISHMENT ACCEPT message, the UE shall use these parameters for the newly established PDU Session. When the validity period of the initial parameters expire, the parameters received in a small data rate control parameters container or an additional small data rate control parameters for exception data container shall be used.

If the UE receives a Serving PLMN rate control IE in the PDU SESSION ESTABLISHMENT ACCEPT message, the UE shall store the Serving PLMN rate control IE value and use the stored serving PLMN rate control value as the maximum allowed limit of uplink control plane user data for the corresponding PDU session in accordance with 3GPP TS 23.501 [8].

If the UE receives an APN rate control parameters container or an additional APN rate control for exception data parameters container in the Extended protocol configuration options IE in the PDU SESSION ESTABLISHMENT ACCEPT message, the UE shall store these parameters and use them to limit the rate at which it generates uplink user data messages for the PDN connection corresponding to the PDU session if the PDU session is transferred to EPS upon inter-system change from N1 mode to S1 mode in accordance with 3GPP TS 24.301 [15]. The received APN rate control parameters and additional APN rate control for exception data parameters shall replace any previously stored APN rate control parameters and additional APN rate control for exception data parameters, respectively, for this PDN connection.

If the UE receives an initial APN rate control parameters container or an initial additional APN rate control for exception data parameters container in the Extended protocol configuration options IE in the PDU SESSION ESTABLISHMENT ACCEPT message, the UE shall store these parameters in the APN rate control status and use them to limit the rate at which it generates exception data messages for the PDN connection corresponding to the PDU session if the PDU session is transferred to EPS upon inter-system change from N1 mode to S1 mode in accordance with 3GPP TS 24.301 [15]. The received APN rate control status shall replace any previously stored APN rate control status for this PDN connection.

NOTE 18: In the PDU SESSION ESTABLISHMENT ACCEPT message, the SMF provides either APN rate control parameters container, or initial APN rate control parameters container, in the Extended protocol configuration options IE, but not both.

NOTE 19: In the PDU SESSION ESTABLISHMENT ACCEPT message, the SMF provides either additional APN rate control for exception data parameters container, or initial additional APN rate control for exception data parameters container, in the Extended protocol configuration options IE, but not both.

If the network accepts the use of Reliable Data Service to transfer data for the PDU session, the network shall include the Extended protocol configuration options IE in the PDU SESSION ESTABLISHMENT ACCEPT message and include the Reliable Data Service accepted indicator. The UE behaves as described in subclause 6.2.15.

If

- the UE indicates support of DNS over (D)TLS by providing DNS server security information indicator to the network;
- optionally, the UE indicates which security protocol type(s) are supported by the UE, by providing the DNS server security protocol support to the network; and
- the network wants to enforce the use of DNS over (D)TLS,

the network may include the Extended protocol configuration options IE in the PDU SESSION ESTABLISHMENT ACCEPT message and include the DNS server security information with length of two octets. Upon receiving the DNS server security information, the UE shall pass it to the upper layer. The UE shall use this information to send the DNS over (D)TLS (See 3GPP TS 33.501 [24]).

NOTE 20: Support of DNS over (D)TLS is based on the requirements as specified in 3GPP TS 33.501 [24] and it is implemented based on the operator requirement.

If the PDU SESSION ESTABLISHMENT REQUEST message includes the Service-level-AA container IE with the service-level device ID set to the CAA-level UAV ID, and the SMF is provided by the UAS-NF the successful UUA-SM result and the CAA-level UAV ID, the SMF shall store the successful result together with the authorized CAA-level UAV ID and transmit the PDU SESSION ESTABLISHMENT ACCEPT message to the UE, where the PDU SESSION ESTABLISHMENT ACCEPT message shall include the Service-level-AA container IE containing:

- a) the service-level-AA response, with the SLAR field set to "Service level authentication and authorization was successful";
- b) the service-level device ID with the value set to the CAA-level UAV ID; and
- c) if a payload is received from the UAS-NF, the service-level-AA payload, with the value set to the payload;
- d) if a payload type associated with the payload is received from the UAS-NF, the service-level-AA payload type with the values set to the associated payload type.

NOTE 21: UAS security information can be included in the UUA payload by the USS as specified in 3GPP TS 33.256 [24B].

If the network accepts the request of the PDU session establishment for C2 communication, the network shall send the PDU SESSION ESTABLISHMENT ACCEPT message including the Service-level-AA container IE containing:

- a) the service-level-AA response with the value of C2AR field set to the "C2 authorization was successful";
- b) if a payload is provided from the UAS-NF, the service-level-AA payload with the value set to the payload;
- c) if a payload type associated with the payload is provided from the UAS-NF, the service-level-AA payload type with the value set to the payload type; and
- d) if the CAA-level UAV ID is provided from the UAS-NF, the service-level device ID with the value set to the CAA-level UAV ID.

NOTE 22: The C2 authorization payload in the service-level-AA payload can include one or both of the C2 session security information, and pairing information for direct C2 communication.

Upon receipt of the PDU SESSION ESTABLISHMENT ACCEPT message of the PDU session for C2 communication, if the Service-level-AA container IE is included, the UE shall forward the service-level-AA contents of the Service-level-AA container IE to the upper layers.

The SMF may be configured with one or more PVS IP addresses or PVS names or both associated with the DNN and S-NSSAI used for onboarding services in SNPN, for configuration of SNPN subscription parameters in PLMN via the user plane, or for configuration of a UE via the user plane with credentials for NSSAA or PDU session authentication and authorization procedure. If the PDU session was established for onboarding services in SNPN, or the PVS information request is included in the Extended protocol configuration options IE of the PDU SESSION ESTABLISHMENT REQUEST message establishing a PDU session providing connectivity for configuration of SNPN subscription parameters in PLMN via the user plane, the network may include the Extended protocol configuration options IE in the PDU SESSION ESTABLISHMENT ACCEPT message and include the PVS IP address(es) or the PVS name(s) or both associated with the DNN and S-NSSAI of the established PDU session, if available. If the PVS information request is included in the Extended protocol configuration options IE of the PDU SESSION ESTABLISHMENT REQUEST message establishing the PDU session providing connectivity for configuration of a

UE via the user plane with credentials for PDU session authentication and authorization procedure, based on the subscribed DNN(s) and S-NSSAI(s) of the UE and the DNN and S-NSSAI of the established PDU session, the network should include the Extended protocol configuration options IE in the PDU SESSION ESTABLISHMENT ACCEPT message and include the PVS IP address(es) or the PVS name(s) or both, which are associated with the established PDU session and per subscribed DNN(s) and S-NSSAI(s) of the UE, if available. If the PVS information request is included in the Extended protocol configuration options IE of the PDU SESSION ESTABLISHMENT REQUEST message establishing the PDU session providing connectivity for configuration of a UE via the user plane with credentials for NSSAA, based on the subscribed S-NSSAI(s) of the UE and the S-NSSAI of the established PDU session, the network should include the Extended protocol configuration options IE in the PDU SESSION ESTABLISHMENT ACCEPT message and include the PVS IP address(es) or the PVS name(s) or both, which are associated with the established PDU session and per subscribed S-NSSAI(s) of the UE, if available.

NOTE 23: If the PVS information request is included in the Extended protocol configuration options IE of the PDU SESSION ESTABLISHMENT REQUEST message establishing a PDU session providing connectivity for configuration of SNPN subscription parameters in SNPN via the user plane by a UE which is not registered for onboarding services in SNPN, the SMF can include the PVS IP address(es) or the PVS name(s) or both, associated with the DNN and S-NSSAI of the established PDU session, if available, in the Extended protocol configuration options IE of the PDU SESSION ESTABLISHMENT ACCEPT message.

NOTE 24: The PVS IP address(es) or the PVS name(s) or both in the SMF can either be locally configured or provided by DCS. The SMF can send the PVS IP address(es) or the PVS name(s) or both that are available in the SMF as the PVS IP address(es) or the PVS name(s) or both to the UE, respectively. If the PDU session was established for onboarding services in SNPN not supporting localized services in SNPN, the PVS IP address(es) or the PVS name(s) or both provided by DCS takes precedence over the PVS IP address(es) or the PVS name(s) or both locally configured, respectively. If the PDU session was established for onboarding services in SNPN supporting localized services in SNPN, the SMF can include both the DCS provided PVS IP address(es) or the PVS name(s) or both associated with the DNN and S-NSSAI of the established PDU session and the locally configured PVS IP address(es) or the PVS name(s) or both associated with the DNN and S-NSSAI of the established PDU session, if available.

The UE upon receiving one or more PVS IP address(es), if any, one or more the PVS name(s), if any, or both shall pass them to the upper layers.

NOTE 25: If several PVS IP addresses, several PVS name(s), or one or more PVS IP addresses and one or more PVS name(s) are received, how the UE uses this information is up to UE implementation.

If the UE indicates support for ECS configuration information provisioning by providing the ECS configuration information provisioning support indicator in the Extended protocol configuration options IE of the PDU SESSION ESTABLISHMENT REQUEST message, then the SMF may include the Extended protocol configuration options IE in the PDU SESSION ESTABLISHMENT ACCEPT message with

- a) at least one of ECS IPv4 Address(es), ECS IPv6 Address(es), and ECS FQDN(s);
- b) at least one associated ECSP identifier;
- c) optionally, spatial validity conditions associated with the ECS address;
- d) optionally, ECS authentication methods associated with the ECS address; and
- e) optionally, ECS supported PLMNs information list, including the associated ECSP information for which the EDN configuration information can be provided by the ECS.

The UE upon receiving one or more ECS IPv4 address(es), if any, ECS IPv6 address(es), if any, or ECS FQDN(s), if any, with the associated spatial validity condition, if any, the associated ECS authentication methods, if any, ECS supported PLMNs information list, if any and an ECSP identifier shall pass them to the upper layers.

NOTE 26: The IP address(es), FQDN(s), or both are associated with the ECSP identifier and replace previously provided ECS configuration information associated with the same ECSP identifier, if any.

If the SMF needs to provide DNS server address(es) to the UE and the UE has provided the DNS server IPv4 address request, the DNS server IPv6 address request or both of them, in the PDU SESSION ESTABLISHMENT REQUEST message, then the SMF shall include the Extended protocol configuration options IE in the PDU SESSION ESTABLISHMENT ACCEPT message with one or more DNS server IPv4 address(es), one or more DNS server IPv6

address(es) or both of them. If the UE supports receiving DNS server addresses in protocol configuration options and receives one or more DNS server IPv4 address(es), one or more DNS server IPv6 address(es) or both of them, in the Extended protocol configuration options IE of the PDU SESSION ESTABLISHMENT ACCEPT message, then the UE shall pass the received DNS server IPv4 address(es), if any, and the received DNS server IPv6 address(es), if any, to upper layers.

NOTE 27: The received DNS server address(es) replace previously provided DNS server address(es), if any.

If the PDU SESSION ESTABLISHMENT ACCEPT message includes the Received MBS container IE, for each of the Received MBS information:

- a) if MBS decision is set to "MBS join is accepted", the UE shall consider that it has successfully joined the multicast MBS session. The UE shall store the received TMGI and shall use it for any further operation on that multicast MBS session. The UE shall store the received MBS service area associated with the received TMGI, if any, and provide the received TMGI to lower layers. The UE may provide the MBS start time if it is included in the Received MBS information to upper layers; or
- b) if MBS decision is set to "MBS join is rejected", the UE shall consider the requested join as rejected. The UE shall store the received MBS service area associated with the received TMGI, if any. If the received Rejection cause is set to "User is outside of local MBS service area", the UE shall not request to join the same multicast MBS session if neither current TAI nor CGI of the current cell is part of the received MBS service area. If the received Rejection cause is set to "multicast MBS session has not started or will not start soon" and an MBS back-off timer value is included with value that indicates neither zero nor deactivated, the UE shall start a back-off timer T3587 with the value provided in the MBS back-off timer value for the received TMGI, and shall not attempt to join the multicast MBS session with the same TMGI until the expiry of T3587. If the MBS back-off timer value indicates that this timer is deactivated, the UE shall not attempt to join the multicast MBS session with the same TMGI, the Source IP address information of the TMGI, or the Destination IP address information of the TMGI until the UE is switched off, the USIM is removed, or the entry in the "list of subscriber data" for the current SNPN is updated. If the MBS back-off timer value indicates zero, the UE may attempt to join the multicast MBS session with the same TMGI.

If the PDU session is established for IMS signalling and the UE has requested P-CSCF IPv6 address or P-CSCF IPv4 address, the SMF shall include P-CSCF IP address(es) in the Extended protocol configuration options IE in the PDU SESSION ESTABLISHMENT ACCEPT message.

NOTE 28: The P-CSCF selection functionality is specified in subclause 5.16.3.11 of 3GPP TS 23.501 [8].

Upon receipt of the PDU SESSION ESTABLISHMENT ACCEPT message, if the UE included the PDU session pair ID in the PDU SESSION ESTABLISHMENT REQUEST message, the UE shall associate the PDU session with the PDU session pair ID. If the UE included the RSN in the PDU SESSION ESTABLISHMENT REQUEST message, the UE shall associate the PDU session with the RSN.

If the PDU SESSION ESTABLISHMENT ACCEPT message include alternative S-NSSAI, the S-NSSAI for the established PDU session shall be the S-NSSAI to be replaced and the alternative S-NSSAI on the UE side.

If the UE supports EDC and the network allows the use of EDC, the SMF shall include the Extended protocol configuration options IE in the PDU SESSION ESTABLISHMENT ACCEPT message with the EDC usage allowed indicator. If the UE supports EDC and receives the EDC usage allowed indicator in the Extended protocol configuration options IE of the PDU SESSION ESTABLISHMENT ACCEPT message, the UE shall indicate to upper layers that network allows the use of EDC.

If the UE supports EDC and the network requires the use of EDC, the SMF shall include the Extended protocol configuration options IE in the PDU SESSION ESTABLISHMENT ACCEPT message with the EDC usage required indicator. If the UE supports EDC and receives the EDC usage required indicator in the Extended protocol configuration options IE of the PDU SESSION ESTABLISHMENT ACCEPT message, the UE shall indicate to upper layers that network requires the use of EDC.

If the PDU SESSION ESTABLISHMENT REQUEST message includes a MS support of MAC address range in 5GS indicator in the Extended protocol configuration options IE, the SMF:

- a) shall consider that the UE supports a "destination MAC address range type" packet filter component and a "source MAC address range type" packet filter component; and

- b) if the SMF supports a "destination MAC address range type" packet filter component and a "source MAC address range type" packet filter component and enables the UE to request QoS rules with a "destination MAC address range type" packet filter component and a "source MAC address range type" packet filter component, shall include the Extended protocol configuration options IE in the PDU SESSION ESTABLISHMENT ACCEPT message and shall include the Network support of MAC address range in 5GS indicator in the Extended protocol configuration options IE.

If the UE receives the 5GSM network feature support IE in the PDU SESSION ESTABLISHMENT ACCEPT message with the non-3GPP access path switching bit set to "non-3GPP access path switching supported" during the PDU session establishment procedure of any PDU session, the UE may include the NSONR bit with value set to "non-3GPP path switching while using old non-3GPP resources requested" in the Non-3GPP path switching information IE in the REGISTRATION REQUEST message while performing the registration procedure for mobility registration update for non-3GPP access path switching.

NOTE 29: If the UE is registered to different PLMNs over 3GPP and non-3GPP accesses, the UE uses the capability received over non-3GPP access to determine whether to initiate the registration procedure for mobility registration update for non-3GPP path switching.

NOTE 30: If the AMF selects an SMF not supporting non-3GPP access path switching, the non-3GPP access path switching can still be performed with the AMF triggering release of the old user plane resources before new user plane resources are established.

If the PDU SESSION ESTABLISHMENT ACCEPT message includes a Network support of MAC address range in 5GS indicator in the Extended protocol configuration options IE, the UE shall consider that the network supports a "destination MAC address range type" packet filter component and a "source MAC address range type" packet filter component.

NOTE 31: Handling of indication that network allows the use of EDC or that network requires the use of EDC is specified in 3GPP TS 23.548 [182].

If the SMF includes the authorized QoS flow descriptions and the SMF determines to provide the N3QAI to the UE, the SMF shall include the N3QAI IE in the PDU SESSION ESTABLISHMENT ACCEPT message.

If the SMF supports URSP provisioning in EPS and the URSP provisioning in EPS support indicator is included in the Extended protocol configuration options IE of the PDU SESSION ESTABLISHMENT REQUEST message, the SMF shall insert the URSP provisioning in EPS support indicator in the Extended protocol configuration options IE of the PDU SESSION ESTABLISHMENT ACCEPT message.

If the PDU session to be established is a single access PDU session over 3GPP access with IP PDU session type and based on operator policy the SMF determines to provide the protocol description for UL PDU set handling to the UE, the SMF may include the Protocol description IE in the PDU SESSION ESTABLISHMENT ACCEPT message.

If the Protocol description IE is included in the PDU SESSION ESTABLISHMENT ACCEPT message, the UE shall, for each existing QoS rule, store the associated protocol description included in the Protocol description IE. The UE may use the protocol description information associated with the QoS rule(s) provided by the Protocol description IE to identify PDUs belonging to PDU sets for the uplink direction.

NOTE 32: Whether and how to use the protocol description information to identify PDU sets is up to the UE implementation.

6.4.1.4 UE-requested PDU session establishment procedure not accepted by the network

6.4.1.4.1 General

If the connectivity with the requested DN is rejected by the network, the SMF shall create a PDU SESSION ESTABLISHMENT REJECT message.

The SMF shall set the 5GSM cause IE of the PDU SESSION ESTABLISHMENT REJECT message to indicate the reason for rejecting the PDU session establishment.

The 5GSM cause IE typically indicates one of the following SM cause values:

- #8 operator determined barring;

- #26 insufficient resources;
- #27 missing or unknown DNN;
- #28 unknown PDU session type;
- #29 user authentication or authorization failed;
- #31 request rejected, unspecified;
- #32 service option not supported;
- #33 requested service option not subscribed;
- #35 PTI already in use;
- #38 network failure;
- #39 reactivation requested;
- #46 out of LADN service area;
- #50 PDU session type IPv4 only allowed;
- #51 PDU session type IPv6 only allowed;
- #54 PDU session does not exist;
- #57: PDU session type IPv4v6 only allowed;
- #58: PDU session type Unstructured only allowed;
- #61: PDU session type Ethernet only allowed;
- #67 insufficient resources for specific slice and DNN;
- #68 not supported SSC mode;
- #69 insufficient resources for specific slice;
- #70 missing or unknown DNN in a slice;
- #82 maximum data rate per UE for user-plane integrity protection is too low;
- #86 UAS services not allowed; or
- #95 – 111 protocol errors.

If the PDU SESSION ESTABLISHMENT REQUEST message includes a PDU session type IE set to "IPv6", and the subscription, the SMF configuration, or both, are limited to IPv4 only for the requested DNN, the SMF shall include the 5GSM cause value #50 "PDU session type IPv4 only allowed" in the 5GSM cause IE of the PDU SESSION ESTABLISHMENT REJECT message.

If the PDU SESSION ESTABLISHMENT REQUEST message includes a PDU session type IE set to "IPv6", and the subscription, the SMF configuration, or both, support none of "IPv4" and "IPv6" PDU session types for the requested DNN, the SMF shall include the 5GSM cause value #28 "unknown PDU session type" in the 5GSM cause IE of the PDU SESSION ESTABLISHMENT REJECT message.

If the PDU SESSION ESTABLISHMENT REQUEST message includes a PDU session type IE set to "IPv4", and the subscription, the SMF configuration, or both, are limited to IPv6 only for the requested DNN, the SMF shall include the 5GSM cause value #51 "PDU session type IPv6 only allowed" in the 5GSM cause IE of the PDU SESSION ESTABLISHMENT REJECT message.

If the PDU SESSION ESTABLISHMENT REQUEST message includes a PDU session type IE set to "IPv4", and the subscription, the SMF configuration, or both, support none of "IPv4" and "IPv6" PDU session types for the requested DNN, the SMF shall include the 5GSM cause value #28 "unknown PDU session type" in the 5GSM cause IE of the PDU SESSION ESTABLISHMENT REJECT message.

If the PDU SESSION ESTABLISHMENT REQUEST message includes a PDU session type IE set to "IPv4v6", and the subscription, the SMF configuration, or both, support none of "IPv4v6", "IPv4" and "IPv6" PDU session types for the requested DNN, the SMF shall include the 5GSM cause value #28 "unknown PDU session type" in the 5GSM cause IE of the PDU SESSION ESTABLISHMENT REJECT message.

If the PDU SESSION ESTABLISHMENT REQUEST message includes a PDU session type IE set to "Unstructured" or "Ethernet", and the subscription, the SMF configuration, or both, do not support the PDU session type for the requested DNN, the SMF shall include the 5GSM cause value #28 "unknown PDU session type" in the 5GSM cause IE of the PDU SESSION ESTABLISHMENT REJECT message.

If the PDU SESSION ESTABLISHMENT REQUEST message is to establish an MA PDU session and includes a PDU session type IE set to "Unstructured", and the SMF configuration does not support the PDU session type, the SMF shall include the 5GSM cause value #28 "unknown PDU session type" in the 5GSM cause IE of the PDU SESSION ESTABLISHMENT REJECT message.

If the PDU SESSION ESTABLISHMENT REQUEST message contains the SSC mode IE indicating an SSC mode not supported by the subscription, the SMF configuration, or both of them, and the SMF decides to reject the PDU session establishment, the SMF shall include the 5GSM cause value #68 "not supported SSC mode" in the 5GSM cause IE and the SSC modes allowed by SMF in the Allowed SSC mode IE of the PDU SESSION ESTABLISHMENT REJECT message.

If the PDU SESSION ESTABLISHMENT REQUEST message is to establish an MA PDU session and MA PDU session is not allowed due to operator policy and subscription, and the SMF decides to reject the PDU session establishment, the SMF shall include the 5GSM cause value #33 "requested service option not subscribed" in the 5GSM cause IE of the PDU SESSION ESTABLISHMENT REJECT message.

If the PDU SESSION ESTABLISHMENT REQUEST message is identified to be for C2 communication and:

- a) does not include the Service-level-AA container IE with the service-level device ID set to the CAA-level UAV ID;
- b) does not include the Service-level-AA container IE with the service-level-AA payload and the Service-level-AA payload type; or
- c) the SMF is informed by the UAS-NF that the UAS service is not allowed,

the SMF shall reject the PDU SESSION ESTABLISHMENT REQUEST message by transmitting a PDU SESSION ESTABLISHMENT REJECT message with 5GSM cause IE set to 5GSM cause value #86 "UAS services not allowed".

In 3GPP access, if the operator's configuration requires user-plane integrity protection for the PDU session and, the maximum data rate per UE for user-plane integrity protection supported by the UE for uplink or the maximum data rate per UE for user-plane integrity protection supported by the UE for downlink, or both, are lower than required by the operator's configuration, the SMF shall include the 5GSM cause value #82 "maximum data rate per UE for user-plane integrity protection is too low" in the 5GSM cause IE of the PDU SESSION ESTABLISHMENT REJECT message.

If the UE requests a PDU session establishment for an LADN when the UE is located outside of the LADN service area, the SMF shall include the 5GSM cause value #46 "out of LADN service area" in the 5GSM cause IE of the PDU SESSION ESTABLISHMENT REJECT message.

If the DN authentication of the UE was performed with the PDU session authentication and authorization procedure and completed unsuccessfully, the SMF shall include the 5GSM cause value #29 "user authentication or authorization failed" in the 5GSM cause IE of the PDU SESSION ESTABLISHMENT REJECT message and shall set the EAP message IE of the PDU SESSION ESTABLISHMENT REJECT message to an EAP-failure message as specified in IETF RFC 3748 [34], provided by the DN.

If the DN authentication of the UE was performed with the service-level authentication and authorization procedure and completed unsuccessfully, the SMF shall include the 5GSM cause value #29 "user authentication or authorization failed" in the 5GSM cause IE of the PDU SESSION ESTABLISHMENT REJECT message and shall include the service-level-AA response provided by DN in the Service-level-AA container IE of the PDU SESSION ESTABLISHMENT REJECT message.

Based on the local policy and user's subscription data, if a PDU session is being established with the request type set to "existing PDU session" and the SMF determines the UE has:

- a) moved between a tracking area in NB-N1 mode and a tracking area in WB-N1 mode;

- b) moved between a tracking area in NB-S1 mode and a tracking area in WB-N1 mode; or
- c) moved between a tracking area in WB-S1 mode and a tracking area in NB-N1 mode,

the SMF may reject the PDU SESSION ESTABLISHMENT REQUEST message and:

- a) include the 5GSM cause value #39 "reactivation requested" in the 5GSM cause IE of the PDU SESSION ESTABLISHMENT REJECT message; or
- b) include a 5GSM cause value other than #39 "reactivation requested" in the 5GSM cause IE of the PDU SESSION ESTABLISHMENT REJECT message.

NOTE 1: The included 5GSM cause value is up to the network implementation.

If the PDU session cannot be established due to resource unavailability in the UPF, the SMF shall include the 5GSM cause value #26 "insufficient resources" in the 5GSM cause IE of the PDU SESSION ESTABLISHMENT REJECT message.

Based on the user's subscription data and the operator policy, if the SMF determines that the UAAA-SM procedure needs to be performed for a UE but the SMF does not receive the service-level device ID set to the CAA-level UAV ID in the Service-level-AA container IE of the PDU SESSION ESTABLISHMENT REQUEST message from the UE, the SMF shall include the 5GSM cause value #86 "UAS services not allowed" in the 5GSM cause IE of the PDU SESSION ESTABLISHMENT REJECT message.

The network may include a Back-off timer value IE in the PDU SESSION ESTABLISHMENT REJECT message.

If the 5GSM cause value is #26 "insufficient resources", #67 "insufficient resources for specific slice and DNN", or #69 "insufficient resources for specific slice" and the PDU SESSION ESTABLISHMENT REQUEST message was received from a UE configured for high priority access in selected PLMN or SNPN or the request type provided during the PDU session establishment is set to "initial emergency request" or "existing emergency PDU session", the network shall not include a Back-off timer value IE.

If the 5GSM cause value is #29 "user authentication or authorization failed", the network should include a Back-off timer value IE.

If the Back-off timer value IE is included and the 5GSM cause value is different from #26 "insufficient resources", #28 "unknown PDU session type", #46 "out of LADN service area", #50 "PDU session type IPv4 only allowed", #51 "PDU session type IPv6 only allowed", #54 "PDU session does not exist", #57 "PDU session type IPv4v6 only allowed", #58 "PDU session type Unstructured only allowed", #61 "PDU session type Ethernet only allowed", #67 "insufficient resources for specific slice and DNN", #68 "not supported SSC mode", and #69 "insufficient resources for specific slice", the network may include the Re-attempt indicator IE to indicate whether the UE is allowed to attempt a PDN connectivity procedure in the PLMN for the same DNN in S1 mode, whether another attempt in S1 mode or in N1 mode is allowed in an equivalent PLMN or whether another attempt in N1 mode is allowed in an equivalent SNPN.

If the 5GSM cause value is #50 "PDU session type IPv4 only allowed", #51 "PDU session type IPv6 only allowed", #57 "PDU session type IPv4v6 only allowed", #58 "PDU session type Unstructured only allowed", or #61 "PDU session type Ethernet only allowed", the network may include the Re-attempt indicator IE without Back-off timer value IE to indicate whether the UE is allowed to attempt a PDU session establishment procedure in an equivalent PLMN or equivalent SNPN in N1 mode using the same PDU session type for the same DNN (or no DNN, if no DNN was indicated by the UE) and the same S-NSSAI (or no S-NSSAI, if no S-NSSAI was indicated by the UE).

The SMF shall send the PDU SESSION ESTABLISHMENT REJECT message.

Upon receipt of a PDU SESSION ESTABLISHMENT REJECT message and a PDU session ID, using the NAS transport procedure as specified in subclause 5.4.5, the UE shall stop timer T3580 shall release the allocated PTI value and shall consider that the PDU session was not established.

If the PDU SESSION ESTABLISHMENT REQUEST message was sent with request type set to "initial emergency request" or "existing emergency PDU session" and the UE receives a PDU SESSION ESTABLISHMENT REJECT message, then the UE may:

- a) inform the upper layers of the failure of the procedure; or

NOTE 2: This can result in the upper layers requesting another emergency call attempt using domain selection as specified in 3GPP TS 23.167 [6].

- b) de-register locally, if not de-registered already, attempt initial registration for emergency services.

If the PDU SESSION ESTABLISHMENT REJECT message includes 5GSM cause #39 "reactivation requested" and the PDU session is being transferred from EPS to 5GS and established with the request type set to "existing PDU session", the UE should re-initiate the UE-requested PDU session establishment procedure as specified in subclause 6.4.1 for:

- a) the PDU session type associated with the transferred PDU session;
- b) the SSC mode associated with the transferred PDU session;
- c) the DNN associated with the transferred PDU session; and
- d) the S-NSSAI associated with (if available in roaming scenarios) a mapped S-NSSAI if provided in the UE-requested PDU session establishment procedure of the transferred PDU session.

If the PDU SESSION ESTABLISHMENT REJECT message includes 5GSM cause #86 "UAS services not allowed" and the UE has not included the service-level device ID in the Service-level-AA container IE of the PDU SESSION ESTABLISHMENT REQUEST message and set the value to the CAA-level UAV ID:

- a) the UE shall not send another PDU SESSION ESTABLISHMENT REQUEST message for UAS services without including the CAA-level UAV ID in the service-level device ID of the Service-level-AA container IE; and
- b) upon receipt of the request from the upper layers to establish a PDU session for UAS services, the UE shall initiate the UE-requested PDU session establishment procedure by including the service-level device ID in the Service-level-AA container IE of the PDU SESSION ESTABLISHMENT REQUEST message and set the value to the CAA-level UAV ID as specified in subclause 6.4.1.2.

If the 5GSM cause value is different from #26 "insufficient resources", #28 "unknown PDU session type", #39 "reactivation requested", #46 "out of LADN service area", #50 "PDU session type IPv4 only allowed", #51 "PDU session type IPv6 only allowed", #54 "PDU session does not exist", #57 "PDU session type IPv4v6 only allowed", #58 "PDU session type Unstructured only allowed", #61 "PDU session type Ethernet only allowed", #67 "insufficient resources for specific slice and DNN", #68 "not supported SSC mode", and #69 "insufficient resources for specific slice", #86 "UAS services not allowed", and #33 "requested service option not subscribed" and the PDU SESSION ESTABLISHMENT REQUEST message was received from a UE configured for high priority access in selected PLMN, the network shall not include a Back-off timer value IE.

6.4.1.4.2 Handling of network rejection due to congestion control

If:

- the 5GSM cause value #26 "insufficient resources" and the Back-off timer value IE are included in the PDU SESSION ESTABLISHMENT REJECT message; or
- an indication that the 5GSM message was not forwarded due to DNN based congestion control is received along a Back-off timer value and a PDU SESSION ESTABLISHMENT REQUEST message with the PDU session ID IE set to the PDU session ID of the PDU session;

the UE shall ignore the 5GSM congestion re-attempt indicator or the Re-attempt indicator IE provided by the network, if any, and the UE shall take different actions depending on the timer value received for timer T3396 in the Back-off timer value IE or depending on the Back-off timer value received from the 5GMM sublayer (if the UE is a UE configured for high priority access in selected PLMN or SNPN, exceptions are specified in subclause 6.2.7):

- a) If the timer value indicates neither zero nor deactivated and a DNN was provided during the PDU session establishment, the UE shall stop timer T3396 associated with the corresponding DNN, if it is running. If the timer value indicates neither zero nor deactivated and no DNN was provided during the PDU session establishment and the request type was different from "initial emergency request" and different from "existing emergency PDU session", the UE shall stop timer T3396 associated with no DNN if it is running. In an SNPN, the timer T3396 to be stopped includes:
 - 1) the timer T3396 applied for all the equivalent SNPNs, and associated with the RSNPN or an equivalent SNPN and with the selected entry of the "list of subscriber data" or the selected PLMN subscription, if running; and

- 2) the timer T3396 applied for the registered SNPN, associated with the RSNPN and, if the UE supports access to an SNPN using credentials from a credentials holder, associated with the selected entry of the "list of subscriber data" or the selected PLMN subscription, if running.

The UE shall then start timer T3396 with the value provided in the Back-off timer value IE or with the Back-off timer value received from the 5GMM sublayer and:

- 1) shall not send another PDU SESSION ESTABLISHMENT REQUEST message or PDU SESSION MODIFICATION REQUEST message with exception of those identified in subclause 6.4.2.1, for the same DNN that was sent by the UE, until timer T3396 expires or timer T3396 is stopped; and
- 2) shall not send another PDU SESSION ESTABLISHMENT REQUEST message without a DNN and with request type different from "initial emergency request" and different from "existing emergency PDU session", or another PDU SESSION MODIFICATION REQUEST message with exception of those identified in subclause 6.4.2.1, for a non-emergency PDU session established without a DNN provided by the UE, if no DNN was provided during the PDU session establishment and the request type was different from "initial emergency request" and different from "existing emergency PDU session", until timer T3396 expires or timer T3396 is stopped.

The UE shall not stop timer T3396 upon a PLMN change, SNPN change, or inter-system change;

- b) if the timer value indicates that this timer is deactivated and a DNN was provided during the PDU session establishment, the UE shall stop timer T3396 associated with the corresponding DNN, if it is running. If the timer value indicates that this timer is deactivated and no DNN was provided during the PDU session establishment and the request type was different from "initial emergency request" and different from "existing emergency PDU session", the UE shall stop timer T3396 associated with no DNN if it is running. In an SNPN, the timer T3396 to be stopped includes:
 - 1) the timer T3396 applied for all the equivalent SNPNs, and associated with the RSNPN or an equivalent SNPN and with the selected entry of the "list of subscriber data" or the selected PLMN subscription, if running; and
 - 2) the timer T3396 applied for the registered SNPN, associated with the RSNPN and, if the UE supports access to an SNPN using credentials from a credentials holder, associated with the selected entry of the "list of subscriber data" or the selected PLMN subscription, if running.

The UE:

- 1) shall not send another PDU SESSION ESTABLISHMENT REQUEST message or PDU SESSION MODIFICATION REQUEST message with exception of those identified in subclause 6.4.2.1, for the same DNN until the UE is switched off, the USIM is removed, the entry in the "list of subscriber data" for the current SNPN is updated if the UE does not support access to an SNPN using credentials from a credentials holder, or the selected entry of the "list of subscriber data" is updated if the UE supports access to an SNPN using credentials from a credentials holder, or the UE receives a PDU SESSION MODIFICATION COMMAND message for the same DNN from the network, or a PDU SESSION AUTHENTICATION COMMAND message for the same DNN from the network, or a PDU SESSION RELEASE COMMAND message without the Back-off timer value IE for the same DNN from the network; and
- 2) shall not send another PDU SESSION ESTABLISHMENT REQUEST message without a DNN and with request type different from "initial emergency request" and different from "existing emergency PDU session", or another PDU SESSION MODIFICATION REQUEST message with exception of those identified in subclause 6.4.2.1, for a non-emergency PDU session established without a DNN provided by the UE, if no DNN was provided during the PDU session establishment and the request type was different from "initial emergency request" and different from "existing emergency PDU session", until the UE is switched off, the USIM is removed, the entry in the "list of subscriber data" for the current SNPN is updated if the UE does not support access to an SNPN using credentials from a credentials holder, or the selected entry of the "list of subscriber data" is updated if the UE supports access to an SNPN using credentials from a credentials holder, or the UE receives a PDU SESSION MODIFICATION COMMAND message for a non-emergency PDU session established without a DNN provided by the UE, or a PDU SESSION AUTHENTICATION COMMAND message for a non-emergency PDU session established without a DNN provided by the UE, or a PDU SESSION RELEASE COMMAND message without the Back-off timer value IE for a non-emergency PDU session established without a DNN provided by the UE.

The timer T3396 remains deactivated upon a PLMN change, SNPN change, or inter-system change; and

c) if the timer value indicates zero, the UE:

- 1) shall stop timer T3396 associated with the corresponding DNN, if running. In an SNPN, the timer T3396 to be stopped includes:
 - i) the timer T3396 applied for all the equivalent SNPNS, and associated with the RSNPN or an equivalent SNPN and with the selected entry of the "list of subscriber data" or the selected PLMN subscription, if running; and
 - ii) the timer T3396 applied for the registered SNPN, associated with the RSNPN and, if the UE supports access to an SNPN using credentials from a credentials holder, associated with the selected entry of the "list of subscriber data" or the selected PLMN subscription, if running.

The UE may send another PDU SESSION ESTABLISHMENT REQUEST message or PDU SESSION MODIFICATION REQUEST message for the same DNN; and

- 2) if no DNN was provided during the PDU session establishment and the request type was different from "initial emergency request" and different from "existing emergency PDU session", the UE shall stop timer T3396 associated with no DNN, if running. In an SNPN, the timer T3396 to be stopped includes:
 - i) the timer T3396 applied for all the equivalent SNPNS, and associated with the RSNPN or an equivalent SNPN and with the selected entry of the "list of subscriber data" or the selected PLMN subscription, if running; and
 - ii) the timer T3396 applied for the registered SNPN, associated with the RSNPN and, if the UE supports access to an SNPN using credentials from a credentials holder, associated with the selected entry of the "list of subscriber data" or the selected PLMN subscription, if running.

The UE may send another PDU SESSION ESTABLISHMENT REQUEST message without a DNN, or another PDU SESSION MODIFICATION REQUEST message without a DNN provided by the UE.

In an SNPN, if the UE supports equivalent SNPNS, then the UE shall apply the timer T3396 for all the equivalent SNPNS. Otherwise, the UE shall apply the timer T3396 for the registered SNPN.

If the Back-off timer value IE is not included or no Back-off timer value is received from the 5GMM sublayer, then the UE may send another PDU SESSION ESTABLISHMENT REQUEST message or PDU SESSION MODIFICATION REQUEST message for the same DNN or without a DNN as specified in subclause 6.2.7.

When the timer T3396 is running or the timer is deactivated, the UE is allowed to initiate a PDU session establishment procedure for emergency services.

If the timer T3396 is running when the UE enters state 5GMM-DEREGISTERED, the UE remains switched on, and the USIM in the UE (if any) remains the same and the entry in the "list of subscriber data" to which timer T3396 is associated (if any) is not updated, then timer T3396 is kept running until it expires or it is stopped.

If the UE is switched off when the timer T3396 is running, and if the USIM in the UE (if any) remains the same and the entry in the "list of subscriber data" to which timer T3396 is associated (if any) is not updated when the UE is switched on, the UE shall behave as follows:

- let t_1 be the time remaining for T3396 timeout at switch off and let t be the time elapsed between switch off and switch on. If t_1 is greater than t , then the timer shall be restarted with the value $t_1 - t$. If t_1 is equal to or less than t , then the timer need not be restarted. If the UE is not capable of determining t , then the UE shall restart the timer with the value t_1 .

If:

- the 5GSM cause value #67 "insufficient resources for specific slice and DNN" and the Back-off timer value IE are included in the PDU SESSION ESTABLISHMENT REJECT message; or
- an indication that the 5GSM message was not forwarded due to S-NSSAI and DNN based congestion control is received along a Back-off timer value and a PDU SESSION ESTABLISHMENT REQUEST message with the PDU session ID IE set to the PDU session ID of the PDU session;

the UE shall ignore the Re-attempt indicator IE provided by the network, if any, and take different actions depending on the timer value received for timer T3584 in the Back-off timer value IE or depending on the Back-off timer value

received from the 5GMM sublayer (if the UE is a UE configured for high priority access in selected PLMN or SNPN, exceptions are specified in subclause 6.2.8):

- a) If the timer value indicates neither zero nor deactivated, the UE shall stop timer T3584 associated with the same [S-NSSAI, DNN] combination as that the UE provided during the PDU session establishment, if it is running. If the timer value indicates neither zero nor deactivated and no DNN was provided during the PDU session establishment and the request type was different from "initial emergency request" and different from "existing emergency PDU session", the UE shall stop timer T3584 associated with [S-NSSAI, no DNN] combination as that the UE provided during the PDU session establishment, if it is running. If the timer value indicates neither zero nor deactivated and no S-NSSAI was provided during the PDU session establishment, the UE shall stop timer T3584 associated with [no S-NSSAI, DNN] combination as that the UE provided during the PDU session establishment, if it is running. If the timer value indicates neither zero nor deactivated and neither S-NSSAI nor DNN was provided during the PDU session establishment and the request type was different from "initial emergency request" and different from "existing emergency PDU session", the UE shall stop timer T3584 associated with [no S-NSSAI, no DNN] combination as that the UE provided during the PDU session establishment, if it is running. The timer T3584 to be stopped includes:
 - 1) in a PLMN:
 - i) the timer T3584 applied for all the PLMNs, if running; and
 - ii) the timer T3584 applied for the registered PLMN, if running; or
 - 2) in an SNPN:
 - i) the timer T3584 applied for all the equivalent SNPNS, and associated with the RSNPN or an equivalent SNPN and with the selected entry of the "list of subscriber data" or the selected PLMN subscription, if running; and
 - ii) the timer T3584 applied for the registered SNPN, associated with the RSNPN and, if the UE supports access to an SNPN using credentials from a credentials holder, equivalent SNPNS or both, associated with the selected entry of the "list of subscriber data" or the selected PLMN subscription, if running.

The UE shall then start timer T3584 with the value provided in the Back-off timer value IE or with the Back-off timer value received from the 5GMM sublayer and:

- 1) shall not send another PDU SESSION ESTABLISHMENT REQUEST message, or PDU SESSION MODIFICATION REQUEST message with exception of those identified in subclause 6.4.2.1, for the same [S-NSSAI, DNN] combination that was sent by the UE, until timer T3584 expires or timer T3584 is stopped;
- 2) shall not send another PDU SESSION ESTABLISHMENT REQUEST message with request type different from "initial emergency request" and different from "existing emergency PDU session", or another PDU SESSION MODIFICATION REQUEST message with exception of those identified in subclause 6.4.2.1, message for the same [S-NSSAI, no DNN] combination that was sent by the UE, if no DNN was provided during the PDU session establishment, until timer T3584 expires or timer T3584 is stopped;
- 3) shall not send another PDU SESSION ESTABLISHMENT REQUEST message, or another PDU SESSION MODIFICATION REQUEST message with exception of those identified in subclause 6.4.2.1, for the same [no S-NSSAI, DNN] combination that was sent by the UE, if no S-NSSAI was provided during the PDU session establishment, until timer T3584 expires or timer T3584 is stopped; and
- 4) shall not send another PDU SESSION ESTABLISHMENT REQUEST message with request type different from "initial emergency request" and different from "existing emergency PDU session", or another PDU SESSION MODIFICATION REQUEST message with exception of those identified in subclause 6.4.2.1, for the same [no S-NSSAI, no DNN] combination that was sent by the UE, if neither S-NSSAI nor DNN was provided during the PDU session establishment, until timer T3584 expires or timer T3584 is stopped.

The UE shall not stop timer T3584 upon a PLMN change, SNPN change, or inter-system change;

- b) if the timer value indicates that this timer is deactivated, the UE:
 - 1) shall stop timer T3584 associated with the same [S-NSSAI, DNN] combination as that the UE provided during the PDU session establishment, if running. The timer T3584 to be stopped includes:
 - i) in a PLMN:

- A) the timer T3584 applied for all the PLMNs, if running; and
 - B) the timer T3584 applied for the registered PLMN, if running; or
- ii) in an SNPN:
- A) the timer T3584 applied for all the equivalent SNPNS, and associated with the RSNPN or an equivalent SNPN and with the selected entry of the "list of subscriber data" or the selected PLMN subscription, if running; and
 - B) the timer T3584 applied for the registered SNPN, associated with the RSNPN and, if the UE supports access to an SNPN using credentials from a credentials holder, equivalent SNPNS or both, associated with the selected entry of the "list of subscriber data" or the selected PLMN subscription, if running.

The UE shall not send another PDU SESSION ESTABLISHMENT REQUEST message, or PDU SESSION MODIFICATION REQUEST message with exception of those identified in subclause 6.4.2.1, for the same [S-NSSAI, DNN] combination that was sent by the UE, until the UE is switched off, the USIM is removed, the entry in the "list of subscriber data" for the current SNPN is updated if the UE does not support access to an SNPN using credentials from a credentials holder, or the selected entry of the "list of subscriber data" is updated if the UE supports access to an SNPN using credentials from a credentials holder, or the UE receives a PDU SESSION MODIFICATION COMMAND message for the same [S-NSSAI, DNN] combination from the network, or a PDU SESSION AUTHENTICATION COMMAND message for the same [S-NSSAI, DNN] combination from the network, or a PDU SESSION RELEASE COMMAND message without the Back-off timer value IE for the same [S-NSSAI, DNN] combination from the network;

- 2) shall stop timer T3584 associated with the same [S-NSSAI, no DNN] combination as that the UE provided during the PDU session establishment, if running. The timer T3584 to be stopped includes:
- i) in a PLMN:
 - A) the timer T3584 applied for all the PLMNs, if running; and
 - B) the timer T3584 applied for the registered PLMN, if running; or
 - ii) in an SNPN:
 - A) the timer T3584 applied for all the equivalent SNPNS, and associated with the RSNPN or an equivalent SNPN and with the selected entry of the "list of subscriber data" or the selected PLMN subscription, if running; and
 - B) the timer T3584 applied for the registered SNPN, associated with the RSNPN and, if the UE supports access to an SNPN using credentials from a credentials holder, equivalent SNPNS or both, associated with the selected entry of the "list of subscriber data" or the selected PLMN subscription, if running.

The UE shall not send a PDU SESSION ESTABLISHMENT REQUEST message with request type different from "initial emergency request" and different from "existing emergency PDU session", or a PDU SESSION MODIFICATION REQUEST message with exception of those identified in subclause 6.4.2.1, for the same [S-NSSAI, no DNN] combination that was sent by the UE, if no DNN was provided during the PDU session establishment, until the UE is switched off, the USIM is removed, the entry in the "list of subscriber data" for the current SNPN is updated if the UE does not support access to an SNPN using credentials from a credentials holder, or the selected entry of the "list of subscriber data" if the UE supports access to an SNPN using credentials from a credentials holder, or the UE receives an PDU SESSION MODIFICATION COMMAND message for a non-emergency PDU session established for the same [S-NSSAI, no DNN] combination from the network, or a PDU SESSION AUTHENTICATION COMMAND message for a non-emergency PDU session established for the same [S-NSSAI, DNN] combination from the network, or a PDU SESSION RELEASE COMMAND message without the Back-off timer value IE for a non-emergency PDU session established for the same [S-NSSAI, no DNN] combination from the network;

- 3) shall stop timer T3584 associated with the same [no S-NSSAI, DNN] combination as that the UE provided during the PDU session establishment, if running. The timer T3584 to be stopped includes:
- i) in a PLMN:
 - A) the timer T3584 applied for all the PLMNs, if running; and

- B) the timer T3584 applied for the registered PLMN, if running; or
- ii) in an SNPN:
 - A) the timer T3584 applied for all the equivalent SNPNs, and associated with the RSNPN or an equivalent SNPN and with the selected entry of the "list of subscriber data" or the selected PLMN subscription, if running; and
 - B) the timer T3584 applied for the registered SNPN, associated with the RSNPN and, if the UE supports access to an SNPN using credentials from a credentials holder, equivalent SNPNs or both, associated with the selected entry of the "list of subscriber data" or the selected PLMN subscription, if running.

The UE shall not send a PDU SESSION ESTABLISHMENT REQUEST message, or a PDU SESSION MODIFICATION REQUEST message with exception of those identified in subclause 6.4.2.1, for the same [no S-NSSAI, DNN] combination that was sent by the UE, if no S-NSSAI was provided during the PDU session establishment, until the UE is switched off, the USIM is removed, the entry in the "list of subscriber data" for the current SNPN is updated, or the UE receives a PDU SESSION MODIFICATION COMMAND message for the same [no S-NSSAI, DNN] combination from the network, or a PDU SESSION AUTHENTICATION COMMAND message for a non-emergency PDU session established for the same [no S-NSSAI, no DNN] combination from the network, or a PDU SESSION RELEASE COMMAND message without the Back-off timer value IE for the same [no S-NSSAI, DNN] combination from the network; and

- 4) shall stop timer T3584 associated with the same [no S-NSSAI, no DNN] combination as that the UE provided during the PDU session establishment, if running. The timer T3584 to be stopped includes:

- i) in a PLMN:
 - A) the timer T3584 applied for all the PLMNs, if running; and
 - B) the timer T3584 applied for the registered PLMN, if running; or
- ii) in an SNPN:
 - A) the timer T3584 applied for all the equivalent SNPNs, and associated with the RSNPN or an equivalent SNPN and with the selected entry of the "list of subscriber data" or the selected PLMN subscription, if running; and
 - B) the timer T3584 applied for the registered SNPN, associated with the RSNPN and, if the UE supports access to an SNPN using credentials from a credentials holder, equivalent SNPNs or both, associated with the selected entry of the "list of subscriber data" or the selected PLMN subscription, if running.

The UE shall not send a PDU SESSION ESTABLISHMENT REQUEST message with request type different from "initial emergency request" and different from "existing emergency PDU session", or a PDU SESSION MODIFICATION REQUEST message with exception of those identified in subclause 6.4.2.1, for the same [no S-NSSAI, no DNN] combination that was sent by the UE, if neither S-NSSAI nor DNN was provided during the PDU session establishment, until the UE is switched off, the USIM is removed, the entry in the "list of subscriber data" for the current SNPN is updated if the UE does not support access to an SNPN using credentials from a credentials holder, or the selected entry of the "list of subscriber data" is updated if the UE supports access to an SNPN using credentials from a credentials holder, or the UE receives a PDU SESSION MODIFICATION COMMAND message for a non-emergency PDU session established for the same [no S-NSSAI, no DNN] combination from the network or a PDU SESSION RELEASE COMMAND message without the Back-off timer value IE for a non-emergency PDU session established for the same [no S-NSSAI, no DNN] combination from the network.

The timer T3584 remains deactivated upon a PLMN change, SNPN change, or inter-system change; and

- c) if the timer value indicates zero, the UE:
 - 1) shall stop timer T3584 associated with the same [S-NSSAI, DNN] combination as that the UE provided during the PDU session establishment, if running. The timer T3584 to be stopped includes:
 - i) in a PLMN:
 - A) the timer T3584 applied for all the PLMNs, if running; and
 - B) the timer T3584 applied for the registered PLMN, if running; or

ii) in an SNPN:

- A) the timer T3584 applied for all the equivalent S-NPNs, and associated with the R-SNPN or an equivalent SNPN and with the selected entry of the "list of subscriber data" or the selected PLMN subscription, if running; and
- B) the timer T3584 applied for the registered SNPN, associated with the R-SNPN and, if the UE supports access to an SNPN using credentials from a credentials holder, equivalent S-NPNs or both, associated with the selected entry of the "list of subscriber data" or the selected PLMN subscription, if running.

The UE may send another PDU SESSION ESTABLISHMENT REQUEST message or PDU SESSION MODIFICATION REQUEST message for the same [S-NSSAI, DNN] combination;

2) shall stop timer T3584 associated with the same [S-NSSAI, no DNN] combination as that the UE provided during the PDU session establishment, if running. The timer T3584 to be stopped includes:

i) in a PLMN:

- A) the timer T3584 applied for all the PLMNs, if running; and
- B) the timer T3584 applied for the registered PLMN, if running; or

ii) in an SNPN:

- A) the timer T3584 applied for all the equivalent S-NPNs, and associated with the R-SNPN or an equivalent SNPN and with the selected entry of the "list of subscriber data" or the selected PLMN subscription, if running; and
- B) the timer T3584 applied for the registered SNPN, associated with the R-SNPN and, if the UE supports access to an SNPN using credentials from a credentials holder, equivalent S-NPNs or both, associated with the selected entry of the "list of subscriber data" or the selected PLMN subscription, if running.

The UE may send another PDU SESSION ESTABLISHMENT REQUEST message or PDU SESSION MODIFICATION REQUEST message for the same [S-NSSAI, no DNN] combination if no DNN was provided during the PDU session establishment and the request type was different from "initial emergency request" and different from "existing emergency PDU session";

3) shall stop timer T3584 associated with the same [no S-NSSAI, DNN] combination as that the UE provided during the PDU session establishment, if running. The timer T3584 to be stopped includes:

i) in a PLMN:

- A) the timer T3584 applied for all the PLMNs, if running; and
- B) the timer T3584 applied for the registered PLMN, if running; or

ii) in an SNPN:

- A) the timer T3584 applied for all the equivalent S-NPNs, and associated with the R-SNPN or an equivalent SNPN and with the selected entry of the "list of subscriber data" or the selected PLMN subscription, if running; and
- B) the timer T3584 applied for the registered SNPN, associated with the R-SNPN and, if the UE supports access to an SNPN using credentials from a credentials holder, equivalent S-NPNs or both, associated with the selected entry of the "list of subscriber data" or the selected PLMN subscription, if running.

The UE may send another PDU SESSION ESTABLISHMENT REQUEST message, or PDU SESSION MODIFICATION REQUEST message for the same [no S-NSSAI, DNN] combination if no S-NSSAI was provided during the PDU session establishment; and

4) shall stop timer T3584 associated with the same [no S-NSSAI, no DNN] combination as that the UE provided during the PDU session establishment, if running. The timer T3584 to be stopped includes:

i) in a PLMN:

- A) the timer T3584 applied for all the PLMNs, if running; and

- B) the timer T3584 applied for the registered PLMN, if running; or
- ii) in an SNPN:
 - A) the timer T3584 applied for all the equivalent SNPNs, and associated with the RSNPN or an equivalent SNPN and with the selected entry of the "list of subscriber data" or the selected PLMN subscription, if running; and
 - B) the timer T3584 applied for the registered SNPN, associated with the RSNPN and, if the UE supports access to an SNPN using credentials from a credentials holder, equivalent SNPNs or both, associated with the selected entry of the "list of subscriber data" or the selected PLMN subscription, if running.

The UE may send another PDU SESSION ESTABLISHMENT REQUEST message, or PDU SESSION MODIFICATION REQUEST message for the same [no S-NSSAI, no DNN] combination if neither S-NSSAI nor DNN was provided during the PDU session establishment and the request type was different from "initial emergency request" and different from "existing emergency PDU session".

If the 5GSM congestion re-attempt indicator IE with the ABO bit set to "The back-off timer is applied in all PLMNs or all equivalent SNPNs " is included in the PDU SESSION ESTABLISHMENT REJECT message with the 5GSM cause value #67 "insufficient resources for specific slice and DNN", then the UE shall apply the timer T3584 for all the PLMNs or all the equivalent SNPNs. Otherwise, the UE shall apply the timer T3584 for the registered PLMN.

If the Back-off timer value IE is not included or no Back-off timer value is received from the 5GMM sublayer, then the UE may send another PDU SESSION ESTABLISHMENT REQUEST message or PDU SESSION MODIFICATION REQUEST message for the same [S-NSSAI, DNN] combination, or for the same [S-NSSAI, no DNN] combination, or for the same [no S-NSSAI, DNN] combination, or for the same [no S-NSSAI, no DNN] combination as specified in subclause 6.2.8.

When the timer T3584 is running or the timer is deactivated, the UE is allowed to initiate a PDU session establishment procedure for emergency services.

If the timer T3584 is running when the UE enters state 5GMM-DEREGISTERED, the UE remains switched on, and the USIM in the UE (if any) remains the same and the entry in the "list of subscriber data" to which timer T3584 is associated (if any) is not updated, then timer T3584 is kept running until it expires or it is stopped.

If the UE is switched off when the timer T3584 is running, and if the USIM in the UE (if any) remains the same and the entry in the "list of subscriber data" to which timer T3584 is associated (if any) is not updated when the UE is switched on, the UE shall behave as follows:

- let t_1 be the time remaining for T3584 timeout at switch off and let t be the time elapsed between switch off and switch on. If t_1 is greater than t , then the timer shall be restarted with the value $t_1 - t$. If t_1 is equal to or less than t , then the timer need not be restarted. If the UE is not capable of determining t , then the UE shall restart the timer with the value t_1 .

If:

- the 5GSM cause value #69 "insufficient resources for specific slice" and the Back-off timer value IE are included in the PDU SESSION ESTABLISHMENT REJECT message; or
- an indication that the 5GSM message was not forwarded due to S-NSSAI only based congestion control is received along a Back-off timer value and a PDU SESSION ESTABLISHMENT REQUEST message with the PDU session ID IE set to the PDU session ID of the PDU session;

the UE shall ignore the Re-attempt indicator IE provided by the network, if any, and take different actions depending on the timer value received for timer T3585 in the Back-off timer value IE or depending on the Back-off timer value received from the 5GMM sublayer (if the UE is a UE configured for high priority access in selected PLMN or SNPN, exceptions are specified in subclause 6.2.8):

- a) If the timer value indicates neither zero nor deactivated and an S-NSSAI was provided during the PDU session establishment and the request type was different from "initial emergency request" and different from "existing emergency PDU session", the UE shall stop timer T3585 associated with the corresponding S-NSSAI, if it is running. If the timer value indicates neither zero nor deactivated and no S-NSSAI was provided during the PDU session establishment and the request type was different from "initial emergency request" and different from "existing emergency PDU session", the UE shall stop timer T3585 associated with no S-NSSAI if it is running. The timer T3585 to be stopped includes:

- 1) in a PLMN:
 - i)- the timer T3585 applied for all the PLMNs and for the access over which the PDU SESSION ESTABLISHMENT REJECT is received, if running;
 - ii) the timer T3585 applied for all the PLMNs and for both 3GPP access type and non-3GPP access type, if running;
 - iii) the timer T3585 applied for the registered PLMN and for the access over which the PDU SESSION ESTABLISHMENT REJECT is received, if running; and
 - iv) the timer T3585 applied for the registered PLMN and for both 3GPP access type and non-3GPP access type, if running; or
- 2) in an SNPN:
 - i) the timer T3585 applied for all the equivalent SNPNs and for the access over which the PDU SESSION AUTHENTICATION COMMAND message is received, associated with the RSNPN or an equivalent SNPN and with the selected entry of the "list of subscriber data" or the selected PLMN subscription, if running;
 - ii) the timer T3585 applied for all the equivalent SNPNs and for both 3GPP access type and non-3GPP access type, associated with the RSNPN or an equivalent SNPN and with the selected entry of the "list of subscriber data" or the selected PLMN subscription, if running;
 - iii) the timer T3585 applied for the registered SNPN and for the access over which the PDU SESSION AUTHENTICATION COMMAND message is received, associated with the RSNPN and, if the UE supports access to an SNPN using credentials from a credentials holder, equivalent SNPNs or both, associated with the selected entry of the "list of subscriber data" or the selected PLMN subscription, if running; and
 - iv) the timer T3585 applied for the registered PLMN and for both 3GPP access type and non-3GPP access type, associated with the RSNPN and, if the UE supports access to an SNPN using credentials from a credentials holder, equivalent SNPNs or both, associated with the selected entry of the "list of subscriber data" or the selected PLMN subscription, if running.

The UE shall then start timer T3585 with the value provided in the Back-off timer value IE or with the Back-off timer value received from the 5GMM sublayer and:

- 1) shall not send another PDU SESSION ESTABLISHMENT REQUEST message with request type different from "initial emergency request" and different from "existing emergency PDU session", or another PDU SESSION MODIFICATION REQUEST message with exception of those identified in subclause 6.4.2.1, for a non-emergency PDU session for the same S-NSSAI that was sent by the UE, until timer T3585 expires or timer T3585 is stopped; and
- 2) shall not send another PDU SESSION ESTABLISHMENT REQUEST message without an S-NSSAI and with request type different from "initial emergency request" and different from "existing emergency PDU session", or another PDU SESSION MODIFICATION REQUEST message with exception of those identified in subclause 6.4.2.1, for a non-emergency PDU session established without an S-NSSAI provided by the UE, if no S-NSSAI was provided during the PDU session establishment and the request type was different from "initial emergency request" and different from "existing emergency PDU session", until timer T3585 expires or timer T3585 is stopped.

The UE shall not stop timer T3585 upon a PLMN change, SNPN change, or inter-system change;

- b) if the timer value indicates that this timer is deactivated and an S-NSSAI was provided during the PDU session establishment and the request type was different from "initial emergency request" and different from "existing emergency PDU session", the UE shall stop timer T3585 associated with the corresponding S-NSSAI, if it is running. If the timer value indicates that this timer is deactivated and no S-NSSAI was provided during the PDU session establishment and the request type was different from "initial emergency request" and different from "existing emergency PDU session", the UE shall stop timer T3585 associated with no S-NSSAI if it is running. The timer T3585 to be stopped includes:

- 1) in a PLMN:

- i) the timer T3585 applied for all the PLMNs and for the access over which the PDU SESSION ESTABLISHMENT REJECT is received, if running;
 - ii) the timer T3585 applied for all the PLMNs and for both 3GPP access type and non-3GPP access type, if running;
 - iii) the timer T3585 applied for the registered PLMN and for the access over which the PDU SESSION ESTABLISHMENT REJECT is received, if running; and
 - iv) the timer T3585 applied for the registered PLMN and for both 3GPP access type and non-3GPP access type, if running; or
- 2) in an SNPN:
- i) the timer T3585 applied for all the equivalent SNPNS and for the access over which the PDU SESSION AUTHENTICATION COMMAND message is received, associated with the RSNPN or an equivalent SNPN and with the selected entry of the "list of subscriber data" or the selected PLMN subscription, if running;
 - ii) the timer T3585 applied for all the equivalent SNPNS and for both 3GPP access type and non-3GPP access type, associated with the RSNPN or an equivalent SNPN and with the selected entry of the "list of subscriber data" or the selected PLMN subscription, if running;
 - iii) the timer T3585 applied for the registered SNPN and for the access over which the PDU SESSION AUTHENTICATION COMMAND message is received, associated with the RSNPN and, if the UE supports access to an SNPN using credentials from a credentials holder, equivalent SNPNS or both, associated with the selected entry of the "list of subscriber data" or the selected PLMN subscription, if running; and
 - iv) the timer T3585 applied for the registered PLMN and for both 3GPP access type and non-3GPP access type, associated with the RSNPN and, if the UE supports access to an SNPN using credentials from a credentials holder, equivalent SNPNS or both, associated with the selected entry of the "list of subscriber data" or the selected PLMN subscription, if running.

The UE:

- 1) shall not send another PDU SESSION ESTABLISHMENT REQUEST message with request type different from "initial emergency request" and different from "existing emergency PDU session", or another PDU SESSION MODIFICATION REQUEST with exception of those identified in subclause 6.4.2.1, for a non-emergency PDU session for the same S-NSSAI until the UE is switched off, the USIM is removed, the entry in the "list of subscriber data" for the current SNPN is updated if the UE does not support access to an SNPN using credentials from a credentials holder, or the selected entry of the "list of subscriber data" is updated if the UE supports access to an SNPN using credentials from a credentials holder, or the UE receives a PDU SESSION MODIFICATION COMMAND message for a non-emergency PDU session for the same S-NSSAI from the network, or a PDU SESSION AUTHENTICATION COMMAND message for a non-emergency PDU session for the same S-NSSAI from the network, or a PDU SESSION RELEASE COMMAND message without the Back-off timer value IE for the same S-NSSAI from the network; and
- 2) shall not send another PDU SESSION ESTABLISHMENT REQUEST message without an S-NSSAI and with request type different from "initial emergency request" and different from "existing emergency PDU session", or another PDU SESSION MODIFICATION REQUEST message with exception of those identified in subclause 6.4.2.1, for a non-emergency PDU session established without an S-NSSAI provided by the UE, if no S-NSSAI was provided during the PDU session establishment and the request type was different from "initial emergency request" and different from "existing emergency PDU session", until the UE is switched off, the USIM is removed, the entry in the "list of subscriber data" for the current SNPN is updated if the UE does not support access to an SNPN using credentials from a credentials holder, or the selected entry of the "list of subscriber data" is updated if the UE supports access to an SNPN using credentials from a credentials holder, or the UE receives a PDU SESSION MODIFICATION COMMAND message for a non-emergency PDU session established without an S-NSSAI provided by the UE, or a PDU SESSION AUTHENTICATION COMMAND message for a non-emergency PDU session established without an S-NSSAI provided by the UE, or a PDU SESSION RELEASE COMMAND message without the Back-off timer value IE for a non-emergency PDU session established without an S-NSSAI provided by the UE.

The timer T3585 remains deactivated upon a PLMN change, SNPN change, or inter-system change; and

c) if the timer value indicates zero, the UE:

1) shall stop timer T3585 associated with the corresponding S-NSSAI, if running. The timer T3585 to be stopped includes:

i) in a PLMN:

- A) the timer T3585 applied for all the PLMNs and for the access over which the PDU SESSION RELEASE COMMAND is received, if running;
- B) the timer T3585 applied for all the PLMNs and for the access over which the PDU SESSION RELEASE COMMAND is received, if running;
- C) the timer T3585 applied for the registered PLMN and for current access type or both 3GPP access type and non-3GPP access type, if running; and
- D) the timer T3585 applied for the registered PLMN and for both 3GPP access type and non-3GPP access type, if running; or

ii) in an SNPN:

- A) the timer T3585 applied for all the equivalent SNPNS and for the access over which the PDU SESSION AUTHENTICATION COMMAND message is received, associated with the RSNPN or an equivalent SNPN and with the selected entry of the "list of subscriber data" or the selected PLMN subscription, if running;
- B) the timer T3585 applied for all the equivalent SNPNS and for both 3GPP access type and non-3GPP access type, associated with the RSNPN or an equivalent SNPN and with the selected entry of the "list of subscriber data" or the selected PLMN subscription, if running;
- C) the timer T3585 applied for the registered SNPN and for the access over which the PDU SESSION AUTHENTICATION COMMAND message is received, associated with the RSNPN and, if the UE supports access to an SNPN using credentials from a credentials holder, equivalent SNPNS or both, associated with the selected entry of the "list of subscriber data" or the selected PLMN subscription, if running; and
- D) the timer T3585 applied for the registered PLMN and for both 3GPP access type and non-3GPP access type, associated with the RSNPN and, if the UE supports access to an SNPN using credentials from a credentials holder, equivalent SNPNS or both, associated with the selected entry of the "list of subscriber data" or the selected PLMN subscription, if running.

The UE may send another PDU SESSION ESTABLISHMENT REQUEST message or PDU SESSION MODIFICATION REQUEST message for the same S-NSSAI; and

2) if no S-NSSAI was provided during the PDU session establishment and the request type was different from "initial emergency request" and different from "existing emergency PDU session", the UE shall stop timer T3585 associated with no S-NSSAI, if running. The timer T3585 to be stopped includes:

i) in a PLMN:

- A) the timer T3585 applied for all the PLMNs and for the access over which the PDU SESSION RELEASE COMMAND is received, if running;
- B) the timer T3585 applied for all the PLMNs and for the access over which the PDU SESSION RELEASE COMMAND is received, if running;
- C) the timer T3585 applied for the registered PLMN and for current access type or both 3GPP access type and non-3GPP access type, if running; and
- D) the timer T3585 applied for the registered PLMN and for both 3GPP access type and non-3GPP access type, if running; or

ii) in an SNPN:

- A) the timer T3585 applied for all the equivalent SNPNs and for the access over which the PDU SESSION AUTHENTICATION COMMAND message is received, associated with the RSNPN or an equivalent SNPN and with the selected entry of the "list of subscriber data" or the selected PLMN subscription, if running;
- B) the timer T3585 applied for all the equivalent SNPNs and for both 3GPP access type and non-3GPP access type, associated with the RSNPN or an equivalent SNPN and with the selected entry of the "list of subscriber data" or the selected PLMN subscription, if running;
- C) the timer T3585 applied for the registered SNPN and for the access over which the PDU SESSION AUTHENTICATION COMMAND message is received, associated with the RSNPN and, if the UE supports access to an SNPN using credentials from a credentials holder, equivalent SNPNs or both, associated with the selected entry of the "list of subscriber data" or the selected PLMN subscription, if running; and
- D) the timer T3585 applied for the registered PLMN and for both 3GPP access type and non-3GPP access type, associated with the RSNPN and, if the UE supports access to an SNPN using credentials from a credentials holder, equivalent SNPNs or both, associated with the selected entry of the "list of subscriber data" or the selected PLMN subscription, if running.

The UE may send another PDU SESSION ESTABLISHMENT REQUEST message without an S-NSSAI, or another PDU SESSION MODIFICATION REQUEST message without an S-NSSAI provided by the UE.

If the 5GSM congestion re-attempt indicator IE with the ABO bit set to "The back-off timer is applied in all PLMNs or equivalent SNPNs " is included in the PDU SESSION ESTABLISHMENT REJECT message with the 5GSM cause value #69 "insufficient resources for specific slice", then the UE shall apply the timer T3585 for all the PLMNs or all the equivalent SNPNs. Otherwise, the UE shall apply the timer T3585 for the registered PLMN or the registered SNPN. Additionally, if the 5GSM congestion re-attempt indicator IE with the CATBO bit set to "The back-off timer is applied in the current access type" is included in the PDU SESSION ESTABLISHMENT REJECT message with the 5GSM cause value #69 "insufficient resources for specific slice", then the UE shall apply the timer T3585 for the current access type. Otherwise, the UE shall apply the timer T3585 for both 3GPP access type and non-3GPP access type and the UE shall stop any running timer T3585 for the applied PLMN or SNPN and for the access different from the access from which the PDU SESSION ESTABLISHMENT REJECT message is received.

If the Back-off timer value IE is not included or no Back-off timer value is received from the 5GMM sublayer, then the UE may send another PDU SESSION ESTABLISHMENT REQUEST message or PDU SESSION MODIFICATION REQUEST message for the same S-NSSAI or without an S-NSSAI as specified in subclause 6.2.8.

When the timer T3585 is running or the timer is deactivated, the UE is allowed to initiate a PDU session establishment procedure for emergency services.

If the timer T3585 is running when the UE enters state 5GMM-DEREGISTERED, the UE remains switched on, and the USIM in the UE (if any) remains the same and the entry in the "list of subscriber data" to which timer T3585 is associated (if any) is not updated, then timer T3585 is kept running until it expires or it is stopped.

If the UE is switched off when the timer T3585 is running, and if the USIM in the UE (if any) remains the same and the entry in the "list of subscriber data" to which timer T3585 is associated (if any) is not updated when the UE is switched on, the UE shall behave as follows:

let t_1 be the time remaining for T3585 timeout at switch off and let t be the time elapsed between switch off and switch on. If t_1 is greater than t , then the timer shall be restarted with the value $t_1 - t$. If t_1 is equal to or less than t , then the timer need not be restarted. If the UE is not capable of determining t , then the UE shall restart the timer with the value t_1 .

NOTE: As described in this subclause, upon PLMN change, SNPN change or inter-system change, the UE does not stop the timer T3584 or T3585. This means the timer T3584 or T3585 can still be running or be deactivated for the given 5GSM procedure, the PLMN or SNPN, the S-NSSAI and optionally the DNN combination when the UE returns to the PLMN or SNPN or when it performs inter-system change back from S1 mode to N1 mode. Thus the UE can still be prevented from sending another PDU SESSION ESTABLISHMENT REQUEST or PDU SESSION MODIFICATION REQUEST message in the PLMN or SNPN for the same S-NSSAI and optionally the same DNN.

Upon PLMN change or SNPN change, if T3584 applied for the registered PLMN or the registered SNPN is running or is deactivated for an S-NSSAI, a DNN, and old PLMN or old SNPN, but T3584 is not running and is not deactivated for

the S-NSSAI, the DNN, and new PLMN or new SNPN, then the UE is allowed to send a PDU SESSION ESTABLISHMENT REQUEST message for the same S-NSSAI and the same DNN in the new PLMN or new SNPN.

Upon PLMN change or SNPN change, if T3585 applied for the registered PLMN or the registered SNPN is running or is deactivated for an S-NSSAI and old PLMN or old SNPN, but T3585 is not running and is not deactivated for the S-NSSAI and new PLMN or new SNPN, then the UE is allowed to send a PDU SESSION ESTABLISHMENT REQUEST message for the same S-NSSAI in the new PLMN or new SNPN.

Upon SNPN change, if T3585 applied for all the equivalent SNPNs is running or is deactivated for an S-NSSAI and old SNPN, but T3585 is not running and is not deactivated for the S-NSSAI and new non-equivalent SNPN, then the UE is allowed to send a PDU SESSION ESTABLISHMENT REQUEST message for the same S-NSSAI in the new SNPN.

6.4.1.4.3 Handling of network rejection not due to congestion control

If the 5GSM cause value is different from #26 "insufficient resources", #28 "unknown PDU session type", #39 "reactivation requested", #46 "out of LADN service area", #50 "PDU session type IPv4 only allowed", #51 "PDU session type IPv6 only allowed", #54 "PDU session does not exist", #57 "PDU session type IPv4v6 only allowed", #58 "PDU session type Unstructured only allowed", #61 "PDU session type Ethernet only allowed", #67 "insufficient resources for specific slice and DNN", #68 "not supported SSC mode", and #69 "insufficient resources for specific slice", #86 "UAS services not allowed", and #33 "requested service option not subscribed" upon sending PDU SESSION ESTABLISHMENT REQUEST to establish an MA PDU session, and the Back-off timer value IE is included, the UE shall behave as follows: (if the UE is a UE configured for high priority access in selected PLMN or SNPN, exceptions are specified in subclause 6.2.12):

- a) if the timer value indicates neither zero nor deactivated and:
 - 1) if the UE provided a DNN and S-NSSAI to the network during the PDU session establishment and the 5GSM cause value is different from #27 "missing or unknown DNN", the UE shall start the back-off timer with the value provided in the Back-off timer value IE for the PDU session establishment procedure and:
 - i) in a PLMN, [PLMN, DNN, (mapped) HPLMN S-NSSAI] combination. The UE shall not send another PDU SESSION ESTABLISHMENT REQUEST message for the same DNN and (mapped) HPLMN S-NSSAI in the current PLMN, until the back-off timer expires, the UE is switched off, or the USIM is removed; or
 - ii) in an SNPN, [SNPN, selected entry of the "list of subscriber data" or selected PLMN subscription, DNN, (mapped) subscribed SNPN S-NSSAI] combination. The UE shall not send another PDU SESSION ESTABLISHMENT REQUEST message for the same DNN and (mapped) subscribed SNPN S-NSSAI in the current SNPN using the selected entry of the "list of subscriber data" or selected PLMN subscription, until the back-off timer expires, the UE is switched off, the USIM is removed, or the selected entry of the "list of subscriber data" is updated;
 - 2) if the UE provided a DNN to the network during the PDU session establishment and the 5GSM cause value is #27 "missing or unknown DNN", the UE shall start the back-off timer with the value provided in the Back-off timer value IE for the PDU session establishment procedure and:
 - i) in a PLMN, [PLMN, DNN] combination. The UE shall not send another PDU SESSION ESTABLISHMENT REQUEST message for the same DNN in the current PLMN, until the back-off timer expires, the UE is switched off, or the USIM is removed; or
 - ii) in an SNPN, [SNPN, selected entry of the "list of subscriber data" or selected PLMN subscription, DNN] combination. The UE shall not send another PDU SESSION ESTABLISHMENT REQUEST message for the same DNN in the current SNPN using the selected entry of the "list of subscriber data" or selected PLMN subscription, until the back-off timer expires, the UE is switched off, the USIM is removed, or the selected entry of the "list of subscriber data" is updated;
 - 3) if the UE did not provide a DNN or S-NSSAI or any of the two parameters to the network during the PDU session establishment and the 5GSM cause value is different from #27 "missing or unknown DNN", it shall start the back-off timer accordingly for the PDU session establishment procedure and:
 - i) in a PLMN, [PLMN, DNN, no S-NSSAI], [PLMN, no DNN, (mapped) HPLMN S-NSSAI] or [PLMN, no DNN, no S-NSSAI] combination. Dependent on the combination, the UE shall not send another PDU SESSION ESTABLISHMENT REQUEST message for the same [PLMN, DNN, no S-NSSAI], [PLMN,

no DNN, (mapped) HPLMN S-NSSAI] or [PLMN, no DNN, no S-NSSAI] combination in the current PLMN, until the back-off timer expires, the UE is switched off, or the USIM is removed; or

- ii) in an SNPN, [SNPN, selected entry of the "list of subscriber data" or selected PLMN subscription, DNN, no S-NSSAI], [SNPN, selected entry of the "list of subscriber data" or selected PLMN subscription, no DNN, (mapped) subscribed SNPN S-NSSAI] or [SNPN, selected entry of the "list of subscriber data" or selected PLMN subscription, no DNN, no S-NSSAI] combination. Dependent on the combination, the UE shall not send another PDU SESSION ESTABLISHMENT REQUEST message for the same [SNPN, selected entry of the "list of subscriber data" or selected PLMN subscription, DNN, no S-NSSAI], [SNPN, selected entry of the "list of subscriber data" or selected PLMN subscription, no DNN, (mapped) subscribed SNPN S-NSSAI] or [SNPN, selected entry of the "list of subscriber data" or selected PLMN subscription, no DNN, no S-NSSAI] combination in the current PLMN using the selected entry of the "list of subscriber data" or selected PLMN subscription, until the back-off timer expires, the UE is switched off, the USIM is removed or the selected entry of the "list of subscriber data" is updated; or
- 4) if the UE did not provide a DNN to the network during the PDU session establishment and the 5GSM cause value is #27 "missing or unknown DNN", it shall start the back-off timer accordingly for the PDU session establishment procedure and:
- i) in a PLMN, [PLMN, no DNN] combination. The UE shall not send another PDU SESSION ESTABLISHMENT REQUEST message for the same [PLMN, no DNN] in the current PLMN, until the back-off timer expires, the UE is switched off, or the USIM is removed; or
 - ii) in an SNPN, [SNPN, selected entry of the "list of subscriber data" or selected PLMN subscription, no DNN] combination. The UE shall not send another PDU SESSION ESTABLISHMENT REQUEST message for the same [SNPN, selected entry of the "list of subscriber data" or selected PLMN subscription, no DNN] in the current PLMN, using the selected entry of the "list of subscriber data" or selected PLMN subscription, until the back-off timer expires, the UE is switched off, the USIM is removed or the selected entry of the "list of subscriber data" is updated;
- b) if the timer value indicates that this timer is deactivated and:
- 1) if the UE provided a DNN and S-NSSAI to the network during the PDU session establishment and the 5GSM cause value is different from #27 "missing or unknown DNN", the UE shall not send another PDU SESSION ESTABLISHMENT REQUEST message for:
 - i) in a PLMN, the same DNN and (mapped) HPLMN S-NSSAI in the current PLMN, until the UE is switched off, or the USIM is removed; or
 - ii) in an SNPN, the same DNN and (mapped) subscribed SNPN S-NSSAI in the current SNPN using the selected entry of the "list of subscriber data" or selected PLMN subscription, until the UE is switched off, the USIM is removed, or the selected entry of the "list of subscriber data" is updated;
 - 2) if the UE provided a DNN to the network during the PDU session establishment and the 5GSM cause value is #27 "missing or unknown DNN", the UE shall not send another PDU SESSION ESTABLISHMENT REQUEST message for:
 - i) in a PLMN, the same DNN in the current PLMN, until the UE is switched off, or the USIM is removed; or
 - ii) in an SNPN, the same DNN in the current SNPN using the selected entry of the "list of subscriber data" or selected PLMN subscription, until the UE is switched off, the USIM is removed, or the selected entry of the "list of subscriber data" is updated;
 - 3) if the UE did not provide a DNN or S-NSSAI or any of the two parameters to the network during the PDU session establishment and the 5GSM cause value is different from #27 "missing or unknown DNN", the UE shall not send another PDU SESSION ESTABLISHMENT REQUEST message for:
 - i) in a PLMN, the same [PLMN, DNN, no S-NSSAI], [PLMN, no DNN, (mapped) HPLMN S-NSSAI] or [PLMN, no DNN, no S-NSSAI] combination in the current PLMN, until the UE is switched off, or the USIM is removed; or
 - ii) in an SNPN, the same [SNPN, the selected entry of the "list of subscriber data" or selected PLMN subscription, DNN, no S-NSSAI], [SNPN, the selected entry of the "list of subscriber data" or selected PLMN subscription, no DNN, (mapped) subscribed SNPN S-NSSAI] or [SNPN, the selected entry of the

"list of subscriber data" or selected PLMN subscription, no DNN, no S-NSSAI] combination in the current SNPN using the selected entry of the "list of subscriber data" or selected PLMN subscription, until the UE is switched off, the USIM is removed, or the selected entry of the "list of subscriber data" is updated; or

- 4) if the UE did not provide a DNN to the network during the PDU session establishment and the 5GSM cause value is #27 "missing or unknown DNN", the UE shall not send another PDU SESSION ESTABLISHMENT REQUEST message for:
 - i) in a PLMN, the same [PLMN, no DNN] in the current PLMN, until the UE is switched off, or the USIM is removed; or
 - ii) in an SNPN, the same [SNPN, the selected entry of the "list of subscriber data" or selected PLMN subscription, no DNN] in the current SNPN using the selected entry of the "list of subscriber data" or selected PLMN subscription, until the UE is switched off, the USIM is removed, or the selected entry of the "list of subscriber data" is updated; and
- c) if the timer value indicates zero and the 5GSM cause value is different from #27 "missing or unknown DNN", the UE may send another PDU SESSION ESTABLISHMENT REQUEST message for:
 - 1) in a PLMN, the same combination of [PLMN, DNN, (mapped) HPLMN S-NSSAI], [PLMN, DNN, no S-NSSAI], [PLMN, no DNN, (mapped) HPLMN S-NSSAI], or [PLMN, no DNN, no S-NSSAI] in the current PLMN. If the timer value indicates zero and the 5GSM cause value is #27 "missing or unknown DNN", the UE may send another PDU SESSION ESTABLISHMENT REQUEST message for the same combination of [PLMN, DNN], or [PLMN, no DNN] in the current PLMN; or
 - 2) in an SNPN, the same combination of [SNPN, the selected entry of the "list of subscriber data" or selected PLMN subscription, DNN, (mapped) subscribed SNPN S-NSSAI], [SNPN, the selected entry of the "list of subscriber data" or selected PLMN subscription, DNN, no S-NSSAI], [SNPN, the selected entry of the "list of subscriber data" or selected PLMN subscription, no DNN, (mapped) subscribed S-NSSAI], or [SNPN, the selected entry of the "list of subscriber data" or selected PLMN subscription, no DNN, no S-NSSAI] in the current SNPN using the selected entry of the "list of subscriber data" or selected PLMN subscription. If the timer value indicates zero and the 5GSM cause value is #27 "missing or unknown DNN", the UE may send another PDU SESSION ESTABLISHMENT REQUEST message for the same combination of [SNPN, the selected entry of the "list of subscriber data" or selected PLMN subscription, DNN], or [SNPN, the selected entry of the "list of subscriber data" or selected PLMN subscription, no DNN] in the current SNPN using the selected entry of the "list of subscriber data" or selected PLMN subscription.

If the Back-off timer value IE is not included, then the UE shall ignore the Re-attempt indicator IE provided by the network in the PDU SESSION ESTABLISHMENT REJECT message, if any.

- a) Additionally, if the 5GSM cause value is #8 "operator determined barring", #32 "service option not supported", #33 "requested service option not subscribed" upon sending PDU SESSION ESTABLISHMENT REQUEST not to establish an MA PDU session, or #70 "missing or unknown DNN in a slice", then:
 - 1) the UE not operating in SNPN access operation mode shall proceed as follows:
 - i) if the UE is registered in the HPLMN or in a PLMN that is within the EHPLMN list, the UE shall behave as described above in the present subclause using the configured SM Retry Timer value as specified in 3GPP TS 24.368 [17] or in USIM file NAS_{CONFIG} as specified in 3GPP TS 31.102 [22], if available, as back-off timer value; and

NOTE 1: The way to choose one of the configured SM Retry Timer values for back-off timer value is up to UE implementation if the UE is configured with:

- an SM Retry Timer value in ME as specified in 3GPP TS 24.368 [17]; and
- an SM Retry Timer value in USIM file NAS_{CONFIG} as specified in 3GPP TS 31.102 [22].

- ii) otherwise, if the UE is not registered in its HPLMN or in a PLMN that is within the EHPLMN list, or if the SM Retry Timer value is not configured, the UE shall behave as described above in the present subclause, using the default value of 12 minutes for the back-off timer; or
- 2) the UE operating in SNPN access operation mode shall proceed as follows:
 - i) if:

- A) the SM Retry Timer value for the current SNPN as specified in 3GPP TS 24.368 [17] is available; or
- B) the UE used the USIM for registration to the current SNPN and the SM Retry Timer value in USIM file NAS_{CONFIG} as specified in 3GPP TS 31.102 [22] is available;

then the UE shall behave as described above in the present subclause using the configured SM Retry Timer value as back-off timer value; or

NOTE 2: The way to choose one of the configured SM Retry Timer values for back-off timer value is up to UE implementation if both conditions in bullets A) and B) above are satisfied.

- ii) otherwise, the UE shall behave as described above in the present subclause, using the default value of 12 minutes for the back-off timer.

b) For 5GSM cause value #27 "missing or unknown DNN", then:

1) the UE not operating in SNPN access operation mode shall proceed as follows:

- i) if the UE is registered in the HPLMN or in a PLMN that is within the EHPLMN list, the UE shall start the back-off timer with the configured SM Retry Timer value as specified in 3GPP TS 24.368 [17] or in USIM file NAS_{CONFIG} as specified in 3GPP TS 31.102 [22], if available, as back-off timer value for the PDU session establishment procedure and the [PLMN, DNN] or [PLMN, no DNN] combination. The UE shall not send another PDU SESSION ESTABLISHMENT REQUEST message for the same DNN in the current PLMN, until the back-off timer expires, the UE is switched off or the USIM is removed; and

NOTE 3: The way to choose one of the configured SM Retry Timer values for back-off timer value is up to UE implementation if the UE is configured with:

- an SM Retry Timer value in ME as specified in 3GPP TS 24.368 [17]; and
- an SM Retry Timer value in USIM file NAS_{CONFIG} as specified in 3GPP TS 31.102 [22].

- ii) otherwise, if the UE is not registered in its HPLMN or in a PLMN that is within the EHPLMN list, or if the SM Retry Timer value is not configured, the UE shall start the back-off timer with the default value of 12 minutes as back-off timer value for the PDU session establishment procedure and the [PLMN, DNN] or [PLMN, no DNN] combination. The UE shall not send another PDU SESSION ESTABLISHMENT REQUEST message for the same DNN in the current PLMN, until the back-off timer expires, the UE is switched off or the USIM is removed; or

2) the UE operating in SNPN access operation mode shall proceed as follows:

i) if:

- A) the SM Retry Timer value for the current SNPN as specified in 3GPP TS 24.368 [17] is available; or
- B) the UE used the USIM for registration to the current SNPN and the SM Retry Timer value in USIM file NAS_{CONFIG} as specified in 3GPP TS 31.102 [22] is available;

then:

the UE shall start the back-off timer with the configured SM Retry Timer value as back-off timer value for the PDU session establishment procedure and the [SNPN, selected entry of the "list of subscriber data" or selected PLMN subscription, DNN] or [SNPN, selected entry of the "list of subscriber data" or selected PLMN subscription, no DNN] combination. The UE shall not send another PDU SESSION ESTABLISHMENT REQUEST message for the same DNN in the current SNPN using the selected entry in the "list of subscriber data" or selected PLMN subscription, until the back-off timer expires, the UE is switched off, the UICC containing the USIM is removed or the selected entry of the "list of subscriber data" is updated; or

NOTE 4: The way to choose one of the configured SM Retry Timer values for back-off timer value is up to UE implementation if both conditions in bullets A) and B) above are satisfied.

ii) otherwise:

- the UE shall start the back-off timer with the default value of 12 min as back-off timer value for the PDU session establishment procedure and the [SNPN, selected entry of the "list of subscriber data" or selected PLMN subscription, DNN] or [SNPN, selected entry in the "list of subscriber data" or selected PLMN subscription, no DNN] combination. The UE shall not send another PDU SESSION

ESTABLISHMENT REQUEST message for the same DNN in the current SNPN using the selected entry of the "list of subscriber data", until the back-off timer expires, the UE is switched off, the UICC containing the USIM is removed or the selected entry of the "list of subscriber data" is updated; and

- c) For 5GSM cause values different from #8 "operator determined barring", #27 "missing or unknown DNN", #32 "service option not supported", #33 "requested service option not subscribed" and #70 "missing or unknown DNN in a slice", the UE behaviour regarding the start of a back-off timer is specified in subclause 6.2.12.

The UE shall not stop any back-off timer:

- a) upon a PLMN or SNPN change;
- b) upon an inter-system change; or
- c) upon registration over another access type.

If the network indicates that a back-off timer for the PDU session establishment procedure is deactivated, then it remains deactivated;

- a) upon a PLMN or SNPN change;
- b) upon an inter-system change; or
- c) upon registration over another access type.

NOTE 5: This means the back-off timer can still be running or be deactivated for the given 5GSM procedure when the UE returns to the PLMN or SNPN or when it performs inter-system change back from S1 mode to N1 mode. Thus, the UE can still be prevented from sending another PDU SESSION ESTABLISHMENT REQUEST message for the combination of [PLMN, DNN, (mapped) HPLMN S-NSSAI], [PLMN, DNN, no S-NSSAI], [PLMN, no DNN, (mapped) HPLMN S-NSSAI], [PLMN, no DNN, no S-NSSAI], [PLMN, DNN], or [PLMN, no DNN] in the PLMN, or for the combination of [SNPN, the selected entry of the "list of subscriber data" or selected PLMN subscription, DNN, (mapped) subscribed S-NSSAI], [SNPN, the selected entry of the "list of subscriber data" or selected PLMN subscription, DNN, no S-NSSAI], [SNPN, the selected entry of the "list of subscriber data" or selected PLMN subscription, no DNN, (mapped) subscribed S-NSSAI], [SNPN, the selected entry of the "list of subscriber data" or selected PLMN subscription, no DNN, no S-NSSAI], [SNPN, the selected entry of the "list of subscriber data" or selected PLMN subscription, DNN], or [SNPN, the selected entry of the "list of subscriber data" or selected PLMN subscription, no DNN] in the SNPN.

If the back-off timer is started upon receipt of a PDU SESSION ESTABLISHMENT REJECT (i.e. the timer value was provided by the network, a configured value is available or the default value is used as explained above) or the back-off timer is deactivated, the UE behaves as follows:

- a) after a PLMN or SNPN change:
 - 1) the UE may send a PDU SESSION ESTABLISHMENT REQUEST message for:
 - i) in a PLMN, the combination of [new PLMN, DNN, (mapped) HPLMN S-NSSAI], [new PLMN, DNN, no S-NSSAI], [new PLMN, no DNN, (mapped) HPLMN S-NSSAI], or [new PLMN, no DNN, no S-NSSAI] in the new PLMN, if the back-off timer is not running and is not deactivated for the PDU session establishment procedure and the combination of [new PLMN, DNN, (mapped) HPLMN S-NSSAI], [new PLMN, DNN, no S-NSSAI], [new PLMN, no DNN, (mapped) HPLMN S-NSSAI], or [new PLMN, no DNN, no S-NSSAI]; or
 - ii) in an SNPN, the combination of [new SNPN, the selected entry of the "list of subscriber data" or selected PLMN subscription, DNN, (mapped) subscribed SNPN S-NSSAI], [new SNPN, the selected entry of the "list of subscriber data" or selected PLMN subscription, DNN, no S-NSSAI], [new PLMN, the selected entry of the "list of subscriber data" or selected PLMN subscription, no DNN, (mapped) subscribed SNPN S-NSSAI], or [new SNPN, the selected entry of the "list of subscriber data" or selected PLMN subscription, no DNN, no S-NSSAI] in the new SNPN, if the back-off timer is not running and is not deactivated for the PDU session establishment procedure and the combination of [new SNPN, the selected entry of the "list of subscriber data" or selected PLMN subscription, DNN, (mapped) subscribed SNPN S-NSSAI], [new SNPN, the selected entry of the "list of subscriber data" or selected PLMN subscription, DNN, no S-NSSAI], [new SNPN, the selected entry of the "list of subscriber data" or

selected PLMN subscription, no DNN, (mapped) subscribed SNPN S-NSSAI], or [new SNPN, the selected entry of the "list of subscriber data" or selected PLMN subscription, no DNN, no S-NSSAI];

- 2) as an implementation option, for the 5GSM cause value #8 "operator determined barring", #32 "service option not supported", #33 "requested service option not subscribed" and #70 "missing or unknown DNN in a slice", if the network does not include a Re-attempt indicator IE, the UE may decide not to automatically send another PDU SESSION ESTABLISHMENT REQUEST message for:
 - i) in a PLMN, the same combination of [PLMN, DNN, (mapped) HPLMN S-NSSAI], [PLMN, DNN, no S-NSSAI], [PLMN, no DNN, (mapped) HPLMN S-NSSAI], or [PLMN, no DNN, no S-NSSAI] using the same PDU session type if the UE is registered to a new PLMN which is in the list of equivalent PLMNs; or
 - ii) in an SNPN, if the UE supports equivalent S-NPNs, the same combination of [SNPN, the selected entry of the "list of subscriber data" or selected PLMN subscription, DNN, (mapped) subscribed SNPN S-NSSAI], [SNPN, the selected entry of the "list of subscriber data" or selected PLMN subscription, DNN, no S-NSSAI], [SNPN, the selected entry of the "list of subscriber data" or selected PLMN subscription, no DNN, (mapped) subscribed SNPN S-NSSAI], or [SNPN, the selected entry of the "list of subscriber data" or selected PLMN subscription, no DNN, no S-NSSAI] using the same PDU session type and using the selected entry of the "list of subscriber data" or selected PLMN subscription, if the UE is registered to a new SNPN which is in the list of equivalent S-NPNs; and
- 3) as an implementation option, for the 5GSM cause value #27 "missing or unknown DNN", if the network does not include a Re-attempt indicator IE, the UE may decide not to automatically send another PDU SESSION ESTABLISHMENT REQUEST message for:
 - i) in a PLMN, the same combination of [PLMN, DNN] or [PLMN, no DNN] using the same PDU session type if the UE is registered to a new PLMN which is in the list of equivalent PLMNs; or
 - ii) in an SNPN, if the UE supports equivalent S-NPNs, the same combination of [SNPN, the selected entry of the "list of subscriber data" or selected PLMN subscription, DNN] or [SNPN, the selected entry of the "list of subscriber data" or selected PLMN subscription, no DNN] using the same PDU session type if the UE is registered to a new SNPN which is in the list of equivalent S-NPNs; or
- b) if the network does not include the Re-attempt indicator IE to indicate whether re-attempt in S1 mode is allowed, or the UE ignores the Re-attempt indicator IE, e.g. because the Back-off timer value IE is not included, then:
 - 1) if the UE is registered in its HPLMN or in a PLMN that is within the EHPLMN list and the back-off timer is running for the combination of [PLMN, DNN, (mapped) HPLMN S-NSSAI] or [PLMN, DNN, no S-NSSAI], the UE shall apply the configured SM_RetryAtRATChange value as specified in 3GPP TS 24.368 [17] or in USIM file NAS_{CONFIG} as specified in 3GPP TS 31.102 [22], if available, to determine whether the UE may attempt a PDN connectivity procedure for the same [PLMN, DNN] combination in S1 mode. If the back-off timer is running for the combination of [PLMN, no DNN, (mapped) HPLMN S-NSSAI] or [PLMN, no DNN, no S-NSSAI], the same applies for the PDN connectivity procedure for the [PLMN, no DNN] combination in S1 mode accordingly; and

NOTE 6: The way to choose one of the configured SM_RetryAtRATChange values for back-off timer value is up to UE implementation if the UE is configured with:

- an SM_RetryAtRATChange value in ME as specified in 3GPP TS 24.368 [17]; and
 - an SM_RetryAtRATChange value in USIM file NAS_{CONFIG} as specified in 3GPP TS 31.102 [22].
- 2) if the UE is not registered in its HPLMN or in a PLMN that is within the EHPLMN list, or if the NAS configuration MO as specified in 3GPP TS 24.368 [17] is not available and the value for inter-system change is not configured in the USIM file NAS_{CONFIG}, then the UE behaviour regarding a PDN connectivity procedure for the same [PLMN, DNN] or [PLMN, no DNN] combination in S1 mode is unspecified; and
- c) if the network includes the Re-attempt indicator IE indicating that re-attempt in an equivalent PLMN or SNPN is not allowed, then depending on the timer value received in the Back-off timer value IE, for:
- 1) in a PLMN, each combination of a PLMN from the equivalent PLMN list and the respective [DNN, (mapped) HPLMN S-NSSAI], [DNN, no S-NSSAI], [no DNN, (mapped) HPLMN S-NSSAI], or [no DNN, no S-NSSAI] combination, the UE shall start a back-off timer for the PDU session establishment procedure with the value provided by the network, or deactivate the respective back-off timer as follows:

- i) if the Re-attempt indicator IE additionally indicates that re-attempt in S1 mode is allowed, the UE shall start or deactivate the back-off timer for N1 mode only; and
 - ii) otherwise, the UE shall start or deactivate the back-off timer for S1 and N1 mode; or
- 2) in a SNPN, if the UE supports equivalent SNPNS, each combination of a SNPN from the equivalent SNPN list and the respective [the selected entry of the "list of subscriber data" or selected PLMN subscription, DNN, (mapped) subscribed SNPN S-NSSAI], [the selected entry of the "list of subscriber data" or selected PLMN subscription, DNN, no S-NSSAI], [the selected entry of the "list of subscriber data" or selected PLMN subscription, no DNN, (mapped) subscribed SNPN S-NSSAI], or [the selected entry of the "list of subscriber data" or selected PLMN subscription, no DNN, no S-NSSAI] combination, the UE shall start a back-off timer for the PDU session establishment procedure with the value provided by the network, or deactivate the respective back-off timer, for N1 mode.

If the back-off timer for a [PLMN, DNN] or [PLMN, no DNN] combination, was started or deactivated in S1 mode upon receipt of PDN CONNECTIVITY REJECT message (see 3GPP TS 24.301 [15]) and the network indicated that re-attempt in N1 mode is allowed, then this back-off timer does not prevent the UE from sending a PDU SESSION ESTABLISHMENT REQUEST message in this PLMN for the same DNN, or without DNN, after inter-system change to N1 mode. If the network indicated that re-attempt in N1 mode is not allowed, the UE shall not send any PDU SESSION ESTABLISHMENT REQUEST message in this PLMN for the same DNN in combination with any S-NSSAI or without S-NSSAI, or in this PLMN without DNN in combination with any S-NSSAI or without S-NSSAI, after inter-system change to N1 mode until the timer expires, the UE is switched off or the USIM is removed.

NOTE 7: The back-off timer is used to describe a logical model of the required UE behaviour. This model does not imply any specific implementation, e.g. as a timer or timestamp.

NOTE 8: Reference to back-off timer in this section can either refer to use of timer T3396 or to use of a different packet system specific timer within the UE. Whether the UE uses T3396 as a back-off timer or it uses different packet system specific timers as back-off timers is left up to UE implementation.

When the back-off timer is running or the timer is deactivated, the UE is allowed to initiate a PDU session establishment procedure if the procedure is for emergency services.

If the 5GSM cause value is #28 "unknown PDU session type" and the PDU SESSION ESTABLISHMENT REQUEST message contained a PDU session type IE indicating a PDU session type, the UE shall ignore the Back-off timer value IE and Re-attempt indicator IE provided by the network, if any. The UE may send another PDU SESSION ESTABLISHMENT REQUEST message to establish a new PDU session with the PDU session type IE indicating another PDU session type, e.g. using another value which can be used for the rejected component in another route selection descriptor, if any, as specified in 3GPP TS 24.526 [19]. The behaviour of the UE for 5GSM cause value #28 also applies if the PDU session is a MA PDU Session.

If the 5GSM cause value is #39 "reactivation requested", the UE shall ignore the Back-off timer value IE and Re-attempt indicator IE provided by the network, if any.

NOTE 9: Further UE behaviour upon receipt of 5GSM cause value #39 is up to the UE implementation.

If the 5GSM cause value is #46 "out of LADN service area", the UE shall ignore the Back-off timer value IE and Re-attempt indicator IE provided by the network, if any. If the UE is not located inside the LADN service area, the UE shall not send another PDU SESSION ESTABLISHMENT REQUEST message or another PDU SESSION MODIFICATION REQUEST message except for indicating a change of 3GPP PS data off UE status for the LADN DNN provided by the UE during the PDU session establishment procedure until the LADN information for the specific LADN DNN or the extended LADN information for the specific LADN DNN and S-NSSAI is updated as described in subclause 5.4.4 and subclause 5.5.1. If the UE is not located inside the LADN service area, the UE shall not indicate the PDU session(s) for the LADN DNN provided by the UE during the PDU session establishment procedure in the Uplink data status IE included in the SERVICE REQUEST message until the LADN information for the specific LADN DNN or the extended LADN information for the specific LADN DNN and S-NSSAI is updated as described in subclause 5.4.4 and subclause 5.5.1.

NOTE 10: Based on UE implementation, the UE locating inside the LADN service area can send another PDU SESSION ESTABLISHMENT REQUEST message or PDU SESSION MODIFICATION REQUEST message for the LADN DNN which was rejected with the 5GSM cause value #46 "out of LADN service area".

NOTE 10A: If the UE does not receive a CONFIGURATION UPDATE COMMAND message with new LADN information within an implementation dependent time, the UE can request this information by initiating a registration procedure for mobility or periodic registration update (see subclause 5.5.1.3.2, item q).

If the 5GSM cause value is #50 "PDU session type IPv4 only allowed", #51 "PDU session type IPv6 only allowed", #57 "PDU session type IPv4v6 only allowed", #58 "PDU session type Unstructured only allowed", or #61 "PDU session type Ethernet only allowed", the UE shall ignore the Back-off timer value IE provided by the network, if any. The UE shall evaluate the URSP rules if available as specified in 3GPP TS 24.526 [19]. The UE shall not subsequently send another PDU SESSION ESTABLISHMENT REQUEST message for:

- a) in a PLMN, the same DNN (or no DNN, if no DNN was indicated by the UE) and the same (mapped) HPLMN S-NSSAI (or no S-NSSAI, if no S-NSSAI was indicated by the UE) to obtain a PDU session type different from the one allowed by the network until any of the following conditions is fulfilled:
 - 1) the UE is registered to a new PLMN which was not in the list of equivalent PLMNs at the time when the PDU SESSION ESTABLISHMENT REJECT message was received;
 - 2) the UE is registered to a new PLMN which was in the list of equivalent PLMNs at the time when the PDU SESSION ESTABLISHMENT REJECT message was received, and either the network did not include a Re-attempt indicator IE in the PDU SESSION ESTABLISHMENT REJECT message or the Re-attempt indicator IE included in the message indicated that re-attempt in an equivalent PLMN is allowed;
 - 3) the UE is switched off; or
 - 4) the USIM is removed; or
- b) in an SNPN, the same DNN (or no DNN, if no DNN was indicated by the UE) and the same (mapped) subscribed SNPN S-NSSAI (or no S-NSSAI, if no S-NSSAI was indicated by the UE), using the selected entry of the "list of subscriber data" or selected PLMN subscription until any of the following conditions is fulfilled:
 - 1) the UE is registered to a new SNPN which was not in the list of equivalent S-NPNs at the time when the PDU SESSION ESTABLISHMENT REJECT message was received;
 - 2) the UE is registered to a new SNPN which was in the list of equivalent S-NPNs at the time when the PDU SESSION ESTABLISHMENT REJECT message was received, and either the network did not include a Re-attempt indicator IE in the PDU SESSION ESTABLISHMENT REJECT message or the Re-attempt indicator IE included in the message indicated that re-attempt in an equivalent SNPN is allowed;
 - 3) the UE is switched off;
 - 4) the USIM is removed; or
 - 5) the selected entry of the "list of subscriber data" is updated.

For the 5GSM cause values #50 "PDU session type IPv4 only allowed", #51 "PDU session type IPv6 only allowed", #57 "PDU session type IPv4v6 only allowed", #58 "PDU session type Unstructured only allowed", and #61 "PDU session type Ethernet only allowed", the UE shall ignore the value of the RATC bit in the Re-attempt indicator IE provided by the network, if any.

NOTE 11: For the 5GSM cause values #50 "PDU session type IPv4 only allowed", #51 "PDU session type IPv6 only allowed", #57 "PDU session type IPv4v6 only allowed", #58 "PDU session type Unstructured only allowed", and #61 "PDU session type Ethernet only allowed", re-attempt in S1 mode for the same DNN (or no DNN, if no DNN was indicated by the UE) is only allowed using the PDU session type(s) indicated by the network.

If the 5GSM cause value is #54 "PDU session does not exist", the UE shall ignore the Back-off timer value IE and Re-attempt indicator IE provided by the network, if any. If the PDU session establishment procedure is to perform handover of an existing PDU session between 3GPP access and non-3GPP access, the UE shall release locally the existing PDU session with the PDU session ID included in the PDU SESSION ESTABLISHMENT REJECT message. The UE may initiate another UE-requested PDU session establishment procedure with the request type set to "initial request" in the subsequent PDU SESSION ESTABLISHMENT REQUEST message to establish a PDU session with:

- a) in a PLMN, the same DNN (or no DNN, if no DNN was indicated by the UE) and the same (mapped) HPLMN S-NSSAI (or no S-NSSAI, if no S-NSSAI was indicated by the UE); or

- b) in an SNPN, the same DNN (or no DNN, if no DNN was indicated by the UE) and the same (mapped) subscribed SNPN S-NSSAI (or no S-NSSAI, if no S-NSSAI was indicated by the UE) using the selected entry of the "list of subscriber data" or selected PLMN subscription.

NOTE 12: User interaction is necessary in some cases when the UE cannot re-establish the PDU session(s) automatically.

If the 5GSM cause value is #68 "not supported SSC mode", the UE shall ignore the Back-off timer value IE and Re-attempt indicator IE provided by the network, if any. The UE shall evaluate the URSP rules if available as specified in 3GPP TS 24.526 [19]. The UE shall not subsequently send another PDU SESSION ESTABLISHMENT REQUEST message for:

- a) in a PLMN, the same DNN (or no DNN, if no DNN was indicated by the UE) and the same (mapped) HPLMN S-NSSAI (or no S-NSSAI, if no S-NSSAI was indicated by the UE) using the same SSC mode or an SSC mode which was not included in the Allowed SSC mode IE until any of the following conditions is fulfilled:
 - 1) the UE is registered to a new PLMN which was not in the list of equivalent PLMNs at the time when the PDU SESSION ESTABLISHMENT REJECT message was received;
 - 2) the SSC mode which is used to access to the DNN (or no DNN, if no DNN was indicated by the UE) and the (mapped) HPLMN S-NSSAI (or no S-NSSAI, if no S-NSSAI was indicated by the UE) is changed by the UE which subsequently requests a new SSC mode in the Allowed SSC mode IE or no SSC mode;
 - 3) the UE is switched off; or
 - 4) the USIM is removed; or
- b) in an SNPN, the same DNN (or no DNN, if no DNN was indicated by the UE) and the same subscribed SNPN S-NSSAI (or no S-NSSAI, if no S-NSSAI was indicated by the UE) using the same SSC mode or an SSC mode which was not included in the Allowed SSC mode IE, using the selected entry of the "list of subscriber data" or selected PLMN subscription until any of the following conditions is fulfilled:
 - 1) the UE is registered to a new SNPN which was not in the list of equivalent S-NPNs at the time when the PDU SESSION ESTABLISHMENT REJECT message was received;
 - 2) the SSC mode which is used to access to the DNN (or no DNN, if no DNN was indicated by the UE) and the (mapped) subscribed SNPN S-NSSAI (or no S-NSSAI, if no S-NSSAI was indicated by the UE) is changed by the UE which subsequently requests a new SSC mode in the Allowed SSC mode IE or no SSC mode;
 - 3) the UE is switched off;
 - 4) the USIM is removed, or
 - 5) the selected entry of the "list of subscriber data" is updated.

If the UE receives the 5GSM cause value is #33 "requested service option not subscribed" upon sending PDU SESSION ESTABLISHMENT REQUEST to establish an MA PDU session, the UE shall ignore the Back-off timer value IE and Re-attempt indicator IE provided by the network, if any. The UE shall evaluate URSP rules, if available, as specified in 3GPP TS 24.526 [19] and the UE may send PDU SESSION ESTABLISHMENT REQUEST after evaluating those URSP rules.

If the 5GSM cause value is #86 "UAS services not allowed", the UE shall ignore the Back-off timer value IE and Re-attempt indicator IE provided by the network, if any, and shall behave as specified in subclause 6.4.1.4.1.

Upon receipt of an indication from 5GMM sublayer that the 5GSM message was not forwarded because the DNN is not supported or not subscribed in a slice along with a PDU SESSION ESTABLISHMENT REQUEST message with the PDU session ID IE set to the PDU session ID of the PDU session, the UE shall stop timer T3580, shall abort the procedure and shall behave as follows:

- a) if the timer value indicates neither zero nor deactivated, the UE shall start the back-off timer with the value received from the 5GMM sublayer for the PDU session establishment procedure and:
 - 1) in a PLMN, the [PLMN, DNN, S-NSSAI] combination or the [PLMN, DNN, no S-NSSAI] combination, if no S-NSSAI was provided during the PDU session establishment. The UE shall not send another PDU SESSION ESTABLISHMENT REQUEST message in the PLMN for the same DNN and the same S-NSSAI

that were sent by the UE, or for the same DNN and no S-NSSAI if S-NSSAI that was not sent by the UE, until:

- i) the back-off timer expires;
 - ii) the UE is switched off;
 - iii) the USIM is removed; or
 - iv) the DNN is included in the LADN information or extended LADN information and the network provides the LADN information or extended LADN information during the registration procedure or the generic UE configuration update procedure; or
- 2) in an SNPN, the [SNPN, the selected entry of the "list of subscriber data" or selected PLMN subscription, DNN, S-NSSAI] combination or the [SNPN, the selected entry of the "list of subscriber data" or selected PLMN subscription, DNN, no S-NSSAI] combination, if no S-NSSAI was provided during the PDU session establishment. The UE shall not send another PDU SESSION ESTABLISHMENT REQUEST message in the SNPN for the same DNN and the same S-NSSAI that were sent by the UE, or for the same DNN and no S-NSSAI if S-NSSAI that was not sent by the UE, using the selected entry of the "list of subscriber data" or selected PLMN subscription, until:
- i) the back-off timer expires;
 - ii) the UE is switched off;
 - iii) the USIM is removed; or
 - iv) the selected entry of the "list of subscriber data" is updated; or
 - v) the DNN is included in the LADN information or extended LADN information and the network provides the LADN information or extended LADN information during the registration procedure or the generic UE configuration update procedure;
- b) if the timer value is not received from the 5GMM sublayer or the timer value indicates that this timer is deactivated, the UE shall not send another PDU SESSION ESTABLISHMENT REQUEST message
- 1) in the PLMN for the same DNN and the same S-NSSAI that were sent by the UE, or for the same DNN and no S-NSSAI if S-NSSAI that was not sent by the UE, until:
 - i) the UE is switched off;
 - ii) the USIM is removed; or
 - iii) the DNN is included in the LADN information or extended LADN information and the network provides the LADN information or extended LADN information during the registration procedure or the generic UE configuration update procedure; and
 - 2) in the SNPN, for the same DNN and the same S-NSSAI that were sent by the UE, or for the same DNN and no S-NSSAI if S-NSSAI that was not sent by the UE, using the selected entry of the "list of subscriber data" or selected PLMN subscription, until:
 - i) the UE is switched off;
 - ii) the USIM is removed;
 - iii) the selected entry of the "list of subscriber data" is updated; or
 - iii) the DNN is included in the LADN information or extended LADN information and the network provides the LADN information or extended LADN information during the registration procedure or the generic UE configuration update procedure; and
- c) if the timer value indicates zero, the UE may send another PDU SESSION ESTABLISHMENT REQUEST message for:
- 1) in a PLMN, the same combination of [PLMN, DNN, S-NSSAI], [PLMN, DNN, no S-NSSAI] in the current PLMN; or

- 2) in an SNPN, the same combination of [SNPN, the selected entry of the "list of subscriber data" or selected PLMN subscription, DNN, S-NSSAI], [SNPN, the selected entry of the "list of subscriber data" or selected PLMN subscription, DNN, no S-NSSAI] in the current SNPN.

6.4.1.5 Handling the maximum number of established PDU sessions

The maximum number of PDU sessions which a UE can establish in a PLMN or SNPN is limited by whichever is the lowest of: the maximum number of PDU session IDs allowed by the protocol (as specified in 3GPP TS 24.007 [11] subclause 11.2.3.1b), the PLMN's or SNPN's maximum number of PDU sessions and the UE's implementation-specific maximum number of PDU sessions.

If during a UE-requested PDU session establishment procedure the 5GSM sublayer in the UE receives an indication that the 5GSM message was not forwarded because:

- a) the PLMN's maximum number of PDU sessions has been reached, then the UE determines the PLMN's maximum number of PDU sessions as the number of active PDU sessions it has; or
- b) the SNPN's maximum number of PDU sessions has been reached, then the UE determines the SNPN's maximum number of PDU sessions as the number of active PDU sessions it has and associates the determined maximum number of PDU sessions with:
 - 1) the entry in the "list of subscriber data" for the current SNPN if the UE does not support access to an SNPN using credentials from a credentials holder and equivalent SNPNS; or
 - 2) the selected entry of the "list of subscriber data" or the selected PLMN subscription if the UE supports access to an SNPN using credentials from a credentials holder, equivalent SNPNS or both.

NOTE 1: In some situations, when attempting to establish multiple PDU sessions, the number of active PDU sessions that the UE has when 5GMM cause #65 is received is not equal to the maximum number of PDU sessions reached in the network.

NOTE 2: When the network supports emergency services, it is not expected that 5GMM cause #65 is returned by the network when the UE requests an emergency PDU session.

NOTE 3: The network maintains only one maximum number of PDU sessions for a PLMN regardless of which access the PDU session exists in.

NOTE 3a: When the UE is registered on the same PLMN for both 3GPP access and non-3GPP access, the UE maintains single maximum number of PDU sessions for respective PLMN. When the UE is registered on two different PLMNs over 3GPP access and non-3GPP access, the UE maintains maximum number of PDU sessions for a PLMN separately for each PLMN.

NOTE 4: An MA PDU session which (only) has a PDN connection established as a user-plane resource is counted as an active PDU session when determining the PLMN's maximum number of PDU sessions.

The PLMN's maximum number of PDU sessions applies to the PLMN in which the 5GMM cause #65 "maximum number of PDU sessions reached" is received. When the UE is switched off or when the USIM is removed, the UE shall clear all previous determinations representing PLMN's maximum number of PDU sessions.

The SNPN's maximum number of PDU sessions applies to the SNPN in which the 5GMM cause #65 "maximum number of PDU sessions reached" is received. When the UE is switched off, the UE shall clear all previous determinations representing SNPN's maximum number of PDU sessions. In addition:

- a) if the UE does not support access to an SNPN using credentials from a credentials holder and equivalent SNPNS, and the entry in the "list of subscriber data" for the current SNPN is updated, then the UE shall clear all previous determinations representing SNPN's maximum number of PDU sessions associated with the entry in the "list of subscriber data" for the current SNPN; and
- b) if the UE supports access to an SNPN using credentials from a credentials holder, equivalent SNPNS or both, and:
 - 1) the selected entry of the "list of subscriber data" is updated, then UE shall clear all previous determinations representing SNPN's maximum number of PDU sessions associated with the selected entry in the "list of subscriber data"; or

- 2) the USIM associated with the selected PLMN subscription is removed, then UE shall clear all previous determinations representing SNPN's maximum number of PDU sessions associated with the selected PLMN subscription.

Upon successful registration with a new PLMN or SNPN, the UE may clear previous determinations representing any PLMN's or SNPN's maximum number(s) of PDU sessions, if the previous PLMN or SNPN is not registered over both 3GPP access and non-3GPP access.

If the maximum number of established PDU sessions is reached at the UE and the upper layers of the UE request connectivity to a DNN the UE shall not send a PDU SESSION ESTABLISHMENT REQUEST message unless an established PDU session is released. If the UE needs to release an established PDU session, choosing which PDU session to release is implementation specific, however the UE shall not release the emergency PDU session.

If the UE needs to release a PDU session in order to request an emergency PDU session, it shall either perform a local release of a PDU session or release a PDU session via explicit signalling. If the UE performs a local release, the UE shall:

- a) if the PDU session is an MA PDU session:
 - 1) perform a registration procedure for mobility and periodic registration update to indicate PDU session status to the network over each access that user plane resources have been established; and
 - 2) perform a normal and periodic tracking area updating to indicate EPS bearer context status to the network as specified in subclause 5.5.3.2.2 of 3GPP TS 24.301 [15] when a PDN connection has been established as a user plane resource; or
- b) if the PDU session is a single access PDU session, perform a registration procedure for mobility and periodic registration update to indicate PDU session status to the network over the access the PDU session is associated with.

6.4.1.5A Handling the maximum number of allowed active user-plane resources for PDU sessions of UEs in NB-N1 mode

For a UE in NB-N1 mode, the UE's maximum number of supported user-plane resources is two (as defined in 3GPP TS 36.300 [25B]) when the UE sets the Multiple user-plane resources support bit to "Multiple user-plane resources supported" during the registration procedure for initial registration or for mobility and periodic registration update, and one otherwise.

For a UE operating in NB-N1 mode, if:

- a) the UE's maximum number of supported user-plane resources is one, then only one PDU session can have active user-plane resources even though that UE might have established more than one PDU session; or
- b) the UE's maximum number of supported user-plane resources is two, then only two PDU sessions can have active user-plane resources even though that UE might have established more than two PDU sessions.

When the maximum number of active user-plane resources is reached and upper layers request for more user-plane resources for PDU sessions other than the PDU sessions with those active user-plane resources, the UE can choose to release one or more of the PDU sessions with active user-plane resources to cater for the upper layer request. The choice of which PDU sessions to be released is implementation specific. However if there is a PDU session with an active user-plane that is used for exception data reporting (see subclause 6.2.13), that PDU session shall not be released.

If the maximum number of active user-plane resources is reached and the upper layers of the UE request user-plane resources for exception data reporting (see subclause 6.2.13), the UE shall release a PDU session that has user-plane resources to cater for the request for exception data reporting. The choice of which PDU session to be released is implementation specific.

If the UE decides to release one or more active user-plane resources to cater for upper layer request, the UE shall release the PDU session via explicit 5GSM signalling.

6.4.1.6 Abnormal cases in the UE

The following abnormal cases can be identified:

a) Expiry of timer T3580

The UE shall, on the first expiry of the timer T3580:

- if the PDU SESSION ESTABLISHMENT REQUEST message was sent with request type set to "initial emergency request" or "existing emergency PDU session", then the UE may:
 - a) inform the upper layers of the failure of the procedure; or

NOTE 1: This can result in the upper layers requesting another emergency call attempt using domain selection as specified in 3GPP TS 23.167 [6].

- b) de-register locally, if not de-registered already, attempt initial registration for emergency services.

If the UE sent the PDU SESSION ESTABLISHMENT REQUEST message in order to perform a handover of an existing emergency PDU session between 3GPP access and non-3GPP access, the UE shall consider that the emergency PDU session is associated with the source access type.

- otherwise, retransmit the PDU SESSION ESTABLISHMENT REQUEST message and the PDU session information which was transported together with the initial transmission of the PDU SESSION ESTABLISHMENT REQUEST message and shall reset and start timer T3580, if still needed. This retransmission can be repeated up to four times, i.e. on the fifth expiry of timer T3580, the UE shall abort the procedure, release the allocated PTI and enter the state PROCEDURE TRANSACTION INACTIVE. If the UE sent the PDU SESSION ESTABLISHMENT REQUEST message in order to perform a handover of an existing non-emergency PDU session between 3GPP access and non-3GPP access, the UE shall consider that the PDU session is associated with the source access type.
- b) Upon receiving an indication that the 5GSM message was not forwarded due to routing failure along with a PDU SESSION ESTABLISHMENT REQUEST message with the PDU session ID IE set to the same value as the PDU session ID that was sent by the UE, the UE shall stop timer T3580 and shall abort the procedure. If the UE sent the PDU SESSION ESTABLISHMENT REQUEST message in order to perform a handover of an existing PDU session between 3GPP access and non-3GPP access, the UE shall consider that the PDU session is associated with the source access type.
- b1) Upon receiving an indication that the 5GSM message was not forwarded due to service area restrictions along with a PDU SESSION ESTABLISHMENT REQUEST message with the PDU session ID IE set to the same value as the PDU session ID that was sent by the UE, the UE shall stop timer T3580 and shall abort the procedure. If the UE sent the PDU SESSION ESTABLISHMENT REQUEST message in order to perform a handover of an existing PDU session between 3GPP access and non-3GPP access, the UE shall consider that the PDU session is associated with the source access type.
- b2) Upon receiving an indication that the 5GSM message was not forwarded because the UE is registered to a PLMN via a satellite NG-RAN cell that is not allowed to operate at the present UE location along with a PDU SESSION ESTABLISHMENT REQUEST message with the PDU session ID IE set to the same value as the PDU session ID that was sent by the UE, the UE shall stop timer T3580 and shall abort the procedure.
- b3) Upon receiving an indication that the 5GSM message was not forwarded because the UE is marked in the UE's 5GMM context that it is not allowed to request UAS services along with a PDU SESSION ESTABLISHMENT REQUEST message with the PDU session ID IE set to the same value as the PDU session ID that was sent by the UE, the UE shall stop timer T3580 and shall abort the procedure. The UE shall not trigger the PDU session establishment procedure until the UE is deregistered from the PLMN.
- b4) Upon receiving an indication that the 5GSM message was not forwarded because the PLMN's maximum number of PDU sessions has been reached along with a PDU SESSION ESTABLISHMENT REQUEST message with the PDU session ID IE set to the same value as the PDU session ID that was sent by the UE, the UE shall stop timer T3580 and shall abort the procedure.
- b5) Upon receiving an indication that the 5GSM message was not forwarded due to unexpected cause along with a PDU SESSION ESTABLISHMENT REQUEST message with the PDU session ID IE set to the same value as the PDU session ID that was sent by the UE, the UE shall stop timer T3580 and shall abort the procedure.
- c) Collision of UE-requested PDU session establishment procedure and network-requested PDU session release procedure.

If the UE receives a PDU SESSION RELEASE COMMAND message after sending a PDU SESSION ESTABLISHMENT REQUEST message to the network, and the PDU session ID in the PDU SESSION RELEASE COMMAND message is the same as the PDU session ID in the PDU SESSION ESTABLISHMENT REQUEST message:

- i) if the UE-requested PDU session establishment procedure was to request the establishment of user plane resources on the second access for an MA PDU session established on a first access and the Access type IE is not included in PDU SESSION RELEASE COMMAND or the Access type IE included in PDU SESSION RELEASE COMMAND indicates the first access, the UE shall proceed with the network-requested PDU session release procedure, abort the UE-requested PDU session establishment procedure, stop timer T3580, release the allocated PTI and enter the state PROCEDURE TRANSACTION INACTIVE;
 - ii) if the PDU SESSION ESTABLISHMENT REQUEST message was sent with request type set to "existing PDU session" or "existing emergency PDU session" in order to perform a handover of an existing PDU session between 3GPP access and non-3GPP access, the UE shall abort the PDU session establishment procedure and proceed with the network-requested PDU session release procedure; or
 - iii) otherwise, the UE shall ignore the PDU SESSION RELEASE COMMAND message and proceed with the UE-requested PDU session establishment procedure.
- d) Inter-system change from N1 mode to S1 mode triggered during UE-requested PDU session establishment procedure.

If the UE-requested PDU session establishment procedure is triggered for handover of an existing PDU session from non-3GPP access to 3GPP access, and the inter-system change from N1 mode to S1 mode is triggered by the NG-RAN and the UE did not receive response to PDU session establishment request, then the UE shall abort the procedure, stop timer T3580, and notify the upper layer of the handover failure.

NOTE 2: This can result in the upper layer requesting re-initiation of handover from non-3GPP access to 3GPP access after the inter-system change is completed, if still required.

- e) For an MA PDU session established on a single access, upon receipt of a PDU SESSION ESTABLISHMENT ACCEPT message over the other access, if any value of the selected PDU session type, selected SSC mode, 5GSM cause, PDU address, S-NSSAI, DNN IEs in the PDU SESSION ESTABLISHMENT ACCEPT message is different from the corresponding stored value, the UE shall perform a local release of the MA PDU session, and perform the registration procedure for mobility and periodic registration update with a REGISTRATION REQUEST message including the PDU session status IE over both accesses.
- f) For an MA PDU session has a PDN connection as a user-plane resource, upon receipt of a PDU SESSION ESTABLISHMENT ACCEPT message over non-3GPP access, if any value of the selected PDU session type, selected SSC mode, 5GSM cause, PDU address, S-NSSAI, DNN IEs in the PDU SESSION ESTABLISHMENT ACCEPT message is different from the corresponding stored mapped value, the UE shall perform a local release of the MA PDU session, perform the registration procedure for mobility and periodic registration update with a REGISTRATION REQUEST message including the PDU session status IE over non-3GPP access, and perform the tracking area updating procedure as specified in subclause 5.5.3.2.2 of 3GPP TS 24.301 [15] with a TRACKING AREA UPDATE REQUEST message including EPS bearer context status IE.
- g) Collision of UE-requested PDU session establishment procedure initiated to perform handover of an existing PDU session from non-3GPP access to 3GPP access and a notification from the network with access type indicating non-3GPP access.

If the UE receives a notification from the network with access type indicating non-3GPP access after sending a PDU SESSION ESTABLISHMENT REQUEST message to perform handover of an existing PDU session from non-3GPP access to 3GPP access, the UE shall abort the PDU session establishment procedure, stop timer T3580, proceed with the service request procedure to perform handover of existing PDU session(s) from non-3GPP access to 3GPP access.

- h) Collision of UE-requested PDU session establishment procedure and N1 NAS signalling connection release

The UE may immediately retransmit the PDU SESSION ESTABLISHMENT REQUEST message and stop, reset and restart timer T3580, if the following conditions apply:

- 1) The original UE-requested PDU session establishment procedure was initiated over an existing N1 NAS signalling connection;

- 2) the previous transmission of the PDU SESSION ESTABLISHMENT REQUEST message was not initiated due to timer T3580 expiry; and
 - 3) no 5GSM message related to the PDU session (e.g. PDU SESSION AUTHENTICATION COMMAND message) was received after the PDU SESSION ESTABLISHMENT REQUEST message was transmitted.
- i) Collision of UE-requested PDU session establishment procedure and network-requested PDU session modification procedure

If the UE receives a PDU SESSION MODIFICATION COMMAND message after sending a PDU SESSION ESTABLISHMENT REQUEST message to the network, and the PDU session ID in the PDU SESSION MODIFICATION COMMAND message is the same as the PDU session ID in the PDU SESSION ESTABLISHMENT REQUEST message:

- i) if the UE-requested PDU session establishment procedure was to request the establishment of user plane resources on the second access for an MA PDU session established on a first access, the UE shall proceed with both the UE-requested PDU session establishment procedure and the network-requested PDU session modification procedure; or
- ii) if the PDU SESSION ESTABLISHMENT REQUEST message was sent with request type set to "existing PDU session" or "existing emergency PDU session" in order to perform a handover of an existing PDU session between 3GPP access and non-3GPP access, the UE shall proceed with the UE-requested PDU session establishment procedure and abort the network-requested PDU session modification procedure.

6.4.1.7 Abnormal cases on the network side

The following abnormal cases can be identified:

- a) If the received request type is "initial emergency request" and there is an existing emergency PDU session for the UE, regardless whether the PDU session ID in the PDU SESSION ESTABLISHMENT REQUEST message is identical to the PDU session ID of the existing PDU session, the SMF shall locally release the existing emergency PDU session and proceed the new PDU SESSION ESTABLISHMENT REQUEST message
- b) The information for the PDU session authentication and authorization by the external DN in the SM PDU DN request container IE is not compliant with local policy and user's subscription data

If the PDU session being established is a non-emergency PDU session, the request type is not set to "existing PDU session", the PDU session authentication and authorization by the external DN is required due to local policy and user's subscription data and the information for the PDU session authentication and authorization by the external DN in the SM PDU DN request container IE is not compliant with the local policy and user's subscription data, the SMF shall reject the PDU session establishment request including the 5GSM cause #29 "user authentication or authorization failed", in the PDU SESSION ESTABLISHMENT REJECT message.

- c) UE-requested PDU session establishment with request type set to "initial request" for an existing PDU session:
If the SMF receives a PDU SESSION ESTABLISHMENT REQUEST message with a PDU session ID identical to the PDU session ID of an existing PDU session and with request type set to "initial request", the SMF shall locally release the existing PDU session and proceed with the PDU session establishment procedure.
- d) UE-requested PDU session establishment with request type "existing PDU session" or "existing emergency PDU session" for a PDU session that does not exist:
If the SMF receives a PDU SESSION ESTABLISHMENT REQUEST message with request type set to "existing PDU session" or "existing emergency PDU session", and the SMF does not have any information about that PDU session, then the SMF shall reject the PDU session establishment procedure with the 5GSM cause set to #54 "PDU session does not exist" in the PDU SESSION ESTABLISHMENT REJECT message.

- e) 5G access network cannot forward the message:

If the SMF determines based on content of the n2SmInfo attribute specified in 3GPP TS 29.502 [20A] that the DL NAS TRANSPORT message carrying the PDU SESSION ESTABLISHMENT ACCEPT was not forwarded to the UE by the 5G access network, then the SMF shall reject the PDU session establishment procedure with the 5GSM cause set to #26 "insufficient resources" in the PDU SESSION ESTABLISHMENT REJECT message.

- f) UE-requested MA PDU session establishment with unspecified steering functionality and steering mode:

If the SMF receives the PDU SESSION ESTABLISHMENT REQUEST message for an MA PDU session including the 5GSM capability information element that does not indicate support for any steering functionality or steering mode, the SMF shall reject the PDU session establishment procedure with the 5GSM cause set to #95 "Semantically incorrect message" in the PDU SESSION ESTABLISHMENT REJECT message.

6.4.2 UE-requested PDU session modification procedure

6.4.2.1 General

The purpose of the UE-requested PDU session modification procedure is:

- a) to enable the UE to request modification of a PDU session;
- b) to indicate a change of 3GPP PS data off UE status for a PDU session;
- c) to revoke the previously indicated support for reflective QoS;
- d) to request specific QoS handling and segregation of service data flows;
- e) to indicate to the network the relevant 5GSM parameters and capabilities (e.g. the UE's 5GSM capabilities, whether the UE supports more than 16 packet filters, the maximum data rate per UE for user-plane integrity protection supported by the UE for uplink, the maximum data rate per UE for user-plane integrity protection supported by the UE for downlink and whether the UE requests the PDU session to be an always-on PDU session in the 5GS) for a PDN connection established when in S1 mode, after an inter-system change from S1 mode to N1 mode, if the UE is a UE operating in single-registration mode in a network supporting N26 interface and the UE has not previously successfully performed the UE-requested PDU session modification to indicate to the network the relevant 5GSM parameters and capabilities;
- f) to delete one or more mapped EPS bearer contexts;
- g) to convey a port management information container;
- h) to re-negotiate header compression configuration associated to a PDU session using control plane ClIoT 5GS optimization; or
- i) to enable the UE to request to join or leave one or more multicast MBS sessions associated with a PDU session.
- j) to send the URSP rule enforcement report to the network associated to:
 - 1) an established PDU session; or
 - 2) a PDN connection, after an inter-system change from S1 mode to N1 mode, if the UE is a UE operating in single-registration mode in a network supporting N26 interface.

NOTE 1: The case c), d), e), f) and g) do not apply to PDU sessions associated with the control plane only indication.

NOTE 2: For case e), the procedure is attempted after the first inter-system change from S1 mode to N1 mode.

When the UE-requested PDU session modification procedure is used to indicate a change of 3GPP PS data off UE status for a PDU session (see subclause 6.2.10), the UE shall initiate the UE-requested PDU session modification procedure even if the UE is outside the LADN service area or the timer T3396, T3584, T3585 or the back-off timer is running or is deactivated.

If the UE needs to revoke the previously indicated support for reflective QoS for a PDU session and timer T3396, T3584, T3585 or the back-off timer is running or is deactivated, the UE shall not initiate the UE-requested PDU session modification procedure and shall instead initiate the UE-requested PDU session release procedure.

If the UE needs to initiate the UE-requested PDU session modification procedure to indicate to the network the relevant 5GSM parameters and capabilities (e.g. the UE's 5GSM capabilities, whether the UE supports more than 16 packet filters, the maximum data rate per UE for user-plane integrity protection supported by the UE for uplink, the maximum data rate per UE for user-plane integrity protection supported by the UE for downlink and whether the UE requests the PDU session to be an always-on PDU session in the 5GS) for a PDN connection established when in S1 mode, after an inter-system change from S1 mode to N1 mode, the UE is a UE operating in single-registration mode in the network

supporting N26 interface, the UE has not previously successfully performed the UE-requested PDU session modification to indicate to the network the relevant 5GSM parameters and capabilities, and:

- a) timer T3396, T3584, T3585 or the back-off timer is running, the UE shall initiate the UE-requested PDU session modification procedure after expiry of timer T3396, T3584 or T3585 or after expiry of the back-off timer; or
- b) the UE is in substate 5GMM-REGISTERED.NON-ALLOWED-SERVICE and has not performed the the UE-requested PDU session modification procedure (see subclause 5.3.5), the UE shall initiate the UE-requested PDU session modification procedure after entering substate 5GMM-REGISTERED.NORMAL-SERVICE.

6.4.2.2 UE-requested PDU session modification procedure initiation

In order to initiate the UE-requested PDU session modification procedure, the UE shall create a PDU SESSION MODIFICATION REQUEST message.

The UE shall allocate a PTI value currently not used and shall set the PTI IE of the PDU SESSION MODIFICATION REQUEST message to the allocated PTI value.

The UE shall not perform the UE-requested PDU session modification procedure for an emergency PDU session, except for a procedure initiated according to subclause 6.4.2.1, item e) only, and for the error cases described in subclause 6.4.1.3 and subclause 6.3.2.3.

The UE shall not perform the UE-requested PDU session modification procedure for a PDU session for LADN when the UE is located outside the LADN service area except for indicating a change of 3GPP PS data off UE status.

If the UE requests a specific QoS handling and the PDU session is not associated with the control plane only indication, the UE shall include the Requested QoS rules IE indicating requested QoS rules or the Requested QoS flow descriptions IE indicating requested QoS flow descriptions or both for the specific QoS handling. The Requested QoS rules IE includes the packet filters which describe the service data flows requested by the UE. The specific QoS parameters requested by the UE are specified in the Requested QoS flow descriptions IE. If the UE requests the network to bind specific service data flows to a dedicated QoS flow, the UE shall create a new QoS rule by setting the rule operation code to "Create new QoS rule" and shall set the segregation bit to "Segregation requested" for the corresponding QoS rule in the Requested QoS rules IE. The UE shall set the QRI values to "no QoS rule identifier assigned" in the Requested QoS rules IE, if the QoS rules are newly created; otherwise, the UE shall set the QRI values to those of the existing QoS rules for which the specific QoS handling applies. The UE shall set the QFI values to "no QoS flow identifier assigned" in the Requested QoS flow descriptions IE, if the QoS flow descriptions are newly created; otherwise, the UE shall set the QFI values to the QFIs of the existing QoS flow descriptions for which the specific QoS handling applies. The UE shall not request to create more than one QoS flow in a UE-requested PDU session modification procedure. If the SMF receives a PDU SESSION MODIFICATION REQUEST message with a Requested QoS rules IE containing more than one QoS rule with the rule operation code set to "Create new QoS rule", the SMF shall assign the same QFI to all the QoS rules which are created.

If the UE requests to join or leave one or more multicast MBS sessions associated with a PDU session, the UE shall include the Requested MBS container IE in the PDU SESSION MODIFICATION REQUEST message and shall set the MBS operation to "Join multicast MBS session" for the join case or to "Leave MBS session" for the leave case. The UE shall include the multicast MBS session information(s) and shall set the Type of multicast MBS session ID for each of the multicast MBS session information to either "Temporary Mobile Group Identity (TMGI)" or "Source specific IP multicast address" depending on the type of the multicast MBS session ID available in the UE. Then the remaining values of each of the multicast MBS session informations shall be set as following:

- a) if the Type of multicast MBS session ID is set to "Temporary Mobile Group Identity (TMGI)", the UE shall set the multicast MBS session ID to the TMGI; or
- b) if the Type of multicast MBS session ID is set to "Source specific IP multicast address for IPv4" or "Source specific IP multicast address for IPv6", the UE shall set the Source IP address information and the Destination IP address information to the corresponding values.

The UE should not request to join a multicast MBS session for local MBS service if neither current TAI nor CGI of the current cell is part of the MBS service area(s) of the multicast MBS session, if the UE has valid information of the MBS service area(s) of the multicast MBS session.

NOTE 1: The UE obtains the details of the multicast MBS session ID(s) e.g, TMGI, Source IP address information and Destination IP address information as a pre-configuration in the UE or during the MBS service announcement which is out of scope of this specification. Pre-configuration can be provided in one or more of the following ways:

- a) in a UE implementation-specific way (e.g. factory configuration);
- b) in the USIM (see EF_{5MBSUECONFIG} file in 3GPP TS 31.102 [22]); or
- c) in the UE pre-configuration MO for MBS (see 3GPP TS 24.575 [65]).

For a PDN connection established when in S1 mode, after an inter-system change from S1 mode to N1 mode, if the UE is a UE operating in single-registration mode in a network supporting N26 interface, the PDU session is of "IPv4", "IPv6", "IPv4v6", or "Ethernet" PDU session type, the PDU session is not associated with the control plane only indication:

- a) the UE is performing the PDU session modification procedure to indicate the support of reflective QoS and the UE has not previously successfully performed the UE-requested PDU session modification to provide this indication, the UE shall set the RQoS bit to "Reflective QoS supported" in the 5GSM capability IE of the PDU SESSION MODIFICATION REQUEST message; or
- b) the UE is performing the PDU session modification procedure to indicate that reflective QoS is not supported and the UE has not previously successfully performed the UE-requested PDU session modification to provide this indication, the UE shall set the RQoS bit to "Reflective QoS not supported" in the 5GSM capability IE of the PDU SESSION MODIFICATION REQUEST message.

If the UE is performing the PDU session modification procedure to revoke the previously indicated support of reflective QoS and the PDU session is not associated with the control plane only indication, the UE shall set the RQoS bit to "Reflective QoS not supported" in the 5GSM capability IE of the PDU SESSION MODIFICATION REQUEST message. The UE shall not indicate support for reflective QoS for this PDU Session for the remaining lifetime of the PDU Session.

NOTE 2: The determination to revoke the usage of reflective QoS by the UE for a PDU session is implementation dependent.

For a PDN connection established when in S1 mode, after an inter-system change from S1 mode to N1 mode, if the UE is a UE operating in single-registration mode in a network supporting N26 interface, the PDU session is of "IPv6" or "IPv4v6" PDU session type, the PDU session is not associated with the control plane only indication:

- a) the UE is performing the PDU session modification procedure to indicate the support of Multi-homed IPv6 PDU session and the UE has not previously successfully performed the UE-requested PDU session modification to provide this indication, the UE shall set the MH6-PDU bit to "Multi-homed IPv6 PDU session supported" in the 5GSM capability IE of the PDU SESSION MODIFICATION REQUEST message; or
- b) the UE is performing the PDU session modification procedure to indicate that Multi-homed IPv6 PDU session is not supported and the UE has not previously successfully performed the UE-requested PDU session modification to provide this indication, the UE shall set the MH6-PDU bit to "Multi-homed IPv6 PDU session not supported" in the 5GSM capability IE of the PDU SESSION MODIFICATION REQUEST message.

For a PDN connection established when in S1 mode, after an inter-system change from S1 mode to N1 mode, if the UE is a UE operating in single-registration mode in a network supporting N26 interface, the PDU session is of "IPv4", "IPv6", "IPv4v6", or "Ethernet" PDU session type, the PDU session is not associated with the control plane only indication, the UE supports more than 16 packet filters for this PDU session, and the UE has not previously successfully performed the UE-requested PDU session modification to provide this indication, the UE shall indicate the maximum number of packet filters supported for the PDU session in the Maximum number of supported packet filters IE of the PDU SESSION MODIFICATION REQUEST message.

For a PDN connection established when in S1 mode, after an inter-system change from S1 mode to N1 mode, if the UE is a UE operating in single-registration mode in a network supporting N26 interface, the PDU session is not associated with the control plane only indication, and the UE has not previously successfully performed the UE-requested PDU session modification to include the Integrity protection maximum data rate IE in the PDU SESSION MODIFICATION REQUEST message, the UE shall include the Integrity protection maximum data rate IE in the PDU SESSION MODIFICATION REQUEST message.

If the UE is performing the PDU session modification procedure

- a) to request the deletion of a non-default QoS rule due to errors in QoS operations or packet filters;
- b) to request the deletion of a QoS flow description due to errors in QoS operations; or
- c) to request the deletion of a mapped EPS bearer context due to errors in mapped EPS bearer operation, TFT operation or packet filters,

the UE shall include the 5GSM cause IE in the PDU SESSION MODIFICATION REQUEST message as described in subclauses 6.3.2.3, 6.3.2.4 and 6.4.1.3.

When the UE-requested PDU session modification procedure is used to indicate a change of 3GPP PS data off UE status for a PDU session, the UE shall include the Extended protocol configuration options IE in the PDU SESSION MODIFICATION REQUEST message and setting the 3GPP PS data off UE status.

For a PDN connection established when in S1 mode, after an inter-system change from S1 mode to N1 mode, if the UE is a UE operating in single-registration mode in a network supporting N26 interface, the PDU session is not associated with the control plane only indication, the UE requests the PDU session to be an always-on PDU session in the 5GS and the UE has not previously successfully performed the UE-requested PDU session modification to request this, the UE shall include the Always-on PDU session requested IE and set the value of the IE to "Always-on PDU session requested" in the PDU SESSION MODIFICATION REQUEST message.

If the UE supports transfer of port management information containers, the UE shall set the TPMIC bit to "Transfer of port management information containers supported" in the 5GSM capability IE of the PDU SESSION MODIFICATION REQUEST message.

If a port management information container needs to be delivered (see 3GPP TS 23.501 [8] and 3GPP TS 23.502 [9]), the UE shall include a Port management information container IE in the PDU SESSION MODIFICATION REQUEST message.

To request re-negotiation of IP header compression configuration, the UE shall include the IP header compression configuration IE in the PDU SESSION MODIFICATION REQUEST message if the network indicated "Control plane CIoT 5GS optimization supported" and "IP header compression for control plane CIoT 5GS optimization supported" in the 5GS network support feature support IE.

To request re-negotiation of Ethernet header compression configuration, the UE shall include the Ethernet header compression configuration IE in the PDU SESSION MODIFICATION REQUEST message if the network indicated "Control plane CIoT 5GS optimization supported" and "Ethernet header compression for control plane CIoT 5GS optimization supported" in the 5GS network support feature support IE.

After an inter-system change from S1 mode to N1 mode, if:

- a) the UE is operating in single-registration mode in the network supporting N26 interface;
- b) the PDU session type value of the PDU session type IE is set to "IPv4", "IPv6" or "IPv4v6";
- c) the UE indicates "Control plane CIoT 5GS optimization supported" and "IP header compression for control plane CIoT 5GS optimization supported" in the 5GMM capability IE of the REGISTRATION REQUEST message; and
- d) the network indicates "Control plane CIoT 5GS optimization supported" and "IP header compression for control plane CIoT 5GS optimization supported" in the 5GS network support feature IE of the REGISTRATION ACCEPT message;

the UE shall initiate the PDU session modification procedure to negotiate the IP header compression configuration and include the IP header compression configuration IE in the PDU SESSION MODIFICATION REQUEST message.

The UE shall include the Service-level-AA container IE in the PDU SESSION MODIFICATION REQUEST message, when requesting to modify an established PDU session for C2 communication. In the Service-level-AA container IE, the UE shall include:

- a) the service-level device ID with the value set to the CAA-level UAV ID of the UE; and
- b) if available, the service-level-AA payload with the value set to the C2 authorization payload and the service-level-AA payload type with the value set to "C2 authorization payload".

NOTE 3: The C2 authorization payload in the service-level-AA payload can include one, some or all of the pairing information for C2 communication, an indication of the request for direct C2 communication, pairing information for direct C2 communication, and the UAV flight authorization information.

The UE may include the Non-3GPP delay budget IE in the PDU SESSION MODIFICATION REQUEST message, when requesting to modify an established PDU session for PIN-DN communication or PIN indirect communication.

NOTE 3A: The Non-3GPP delay budget IE can assist the network in providing specific QoS handling for a set of packet filter(s) for the PDU session as specified in subclause 5.44.3.4 of 3GPP TS 23.501 [8].

After an inter-system change from S1 mode to N1 mode, if:

- a) the UE is operating in single-registration mode in a network that supports N26 interface;
- b) the PDU session type value of the PDU session type IE is set to "Ethernet";
- c) the UE indicates "Control plane CIoT 5GS optimization supported" and "Ethernet header compression for control plane CIoT 5GS optimization supported" in the 5GMM capability IE of the REGISTRATION REQUEST message; and
- d) the network indicates "Control plane CIoT 5GS optimization supported" and "Ethernet header compression for control plane CIoT 5GS optimization supported" in the 5GS network support feature IE of the REGISTRATION ACCEPT message;

the UE shall initiate the PDU session modification procedure to negotiate the Ethernet header compression configuration and include the Ethernet header compression configuration IE in the PDU SESSION MODIFICATION REQUEST message.

For a PDN connection established when in S1 mode, after an inter-system change from S1 mode to N1 mode, and if the UE is a UE operating in single-registration mode in a network supporting N26 interface, and the UE supports receiving DNS server addresses in protocol configuration options and the UE has not previously successfully performed the UE-requested PDU session modification to indicate this support, the UE shall include the Extended protocol configuration options IE in the PDU SESSION MODIFICATION REQUEST message and:

- a) if the PDU session is of "IPv4" or "IPv4v6" PDU session type, the UE shall include the DNS server IPv4 address request; and
- b) if the PDU session is of "IPv6" or "IPv4v6" PDU session type, the UE shall include the DNS server IPv6 address request.

For a PDN connection established when in S1 mode, after an inter-system change from S1 mode to N1 mode, and if the UE is a UE operating in single-registration mode in a network supporting N26 interface, and the UE supports the EAS rediscovery and the UE has not previously successfully performed the UE-requested PDU session modification to indicate this support, the UE shall include the Extended protocol configuration options IE in the PDU SESSION MODIFICATION REQUEST message and shall include the EAS rediscovery support indication in the Extended protocol configuration options IE.

For a PDN connection established when in S1 mode, after an inter-system change from S1 mode to N1 mode, and if the UE is a UE operating in single-registration mode in a network supporting N26 interface, and the UE supports the EDC and the UE has not previously successfully performed the UE-requested PDU session modification to indicate this support, then the UE shall include the Extended protocol configuration options IE in the PDU SESSION MODIFICATION REQUEST message and shall include the EDC support indicator in the Extended protocol configuration options IE.

If the UE supports reporting of URSP rule enforcement and is indicated to send URSP rule enforcement report to network based on the matching URSP rule which contains the URSP rule enforcement report indication set to "URSP rule enforcement report is required", the URSP rule enforcement report is associated to:

- a) an established PDU session; or
- b) a PDN connection, after an inter-system change from S1 mode to N1 mode, and if the UE is a UE operating in single-registration mode in a network supporting N26 interface, the matching URSP rule is newly enforced while the UE was in S1 mode,

then the UE shall include the URSP rule enforcement reports IE in the PDU SESSION MODIFICATION REQUEST message.

The UE shall transport:

- a) the PDU SESSION MODIFICATION REQUEST message;
- b) the PDU session ID; and
- c) if the UE-requested PDU session modification:
 - 1) is not initiated to indicate a change of 3GPP PS data off UE status associated to a PDU session, then the request type set to "modification request"; and
 - 2) is initiated to indicate a change of 3GPP PS data off UE status associated to a PDU session, then without transporting the request type;

using the NAS transport procedure as specified in subclause 5.4.5, and the UE shall start timer T3581 (see example in figure 6.4.2.2.1).

For a PDN connection established when in S1 mode and not associated with the control plane only indication, after inter-system change from S1 mode to N1 mode, if the UE is registered in a network supporting the ATSSS,

- a) the UE may request to modify a PDU session to an MA PDU session; or
- b) the UE may allow the network to upgrade the PDU session to an MA PDU session. In order for the UE to allow the network to upgrade the PDU session to an MA PDU session, the UE shall set "MA PDU session network upgrade is allowed" in the MA PDU session information IE and set the request type to "modification request" in the UL NAS TRANSPORT message.

NOTE 4: If the DNN corresponds to an LADN DNN, the AMF does not forward the MA PDU session information IE to the SMF but sends the message back to the UE to inform of the unhandled request (see subclause 5.4.5.2.5).

In case the UE executes case a) or b), the UE shall:

- 1) set the ATSSS-ST bits in the 5GSM capability IE of the PDU SESSION MODIFICATION REQUEST message to indicate the ATSSS-LL and MPTCP functionalities, respectively, which the UE supports (see table 9.11.4.1.1) according to what is specified in subclause 5.32.6.1 of 3GPP TS 23.501 [8]; and
- 2) set the ATSSS-LL, MPTCP and MPQUIC-UDP bits in the 5GSM capability IE of the PDU SESSION MODIFICATION REQUEST message to indicate the ATSSS-LL, MPTCP and MPQUIC functionalities, respectively, which the UE supports (see table 9.11.4.1.1) according to what is specified in subclause 5.32.6.1 of 3GPP TS 23.501 [8].

NOTE 4A: Usage of the ATSSS-ST bits to indicate support for ATSSS functionality was deprecated in Rel-18 in favor of the ATSSS-LL, MPTCP and MPQUIC-UDP bits. The setting of the ATSSS-ST field in the 5GSM capability IE bits is necessary for backward compatibility with the earlier releases. The UE sets the ATSSS-ST field in the same way as a UE from previous releases.

NOTE 5: The ATSSS Low-Layer functionality cannot be used together with the redundant steering mode. When the UE indicates that it is capable of supporting the ATSSS Low-Layer functionality with any steering mode, it implies that the UE supports the ATSSS Low-Layer functionality with any steering mode except the redundant steering mode.

- 3) void;
- 4) void;
- 5) void;
- 6) void;
- 7) void;
- 8) void.

If a performance measurement function in the UE can perform access performance measurements using the QoS flow of the non-default QoS rule as specified in subclause 5.32.5 of 3GPP TS 23.501 [8], the UE shall set the APMQF bit to "Access performance measurements per QoS flow supported" in the 5GSM capability IE of the PDU SESSION MODIFICATION REQUEST message.

Upon receipt of a PDU SESSION MODIFICATION REQUEST message for MA PDU session modification, the SMF shall check if the ATSSS-LL, MPTCP and MPQUIC-UDP bits (if set) or the ATSSS-ST field in the 5GSM capability IE (if none of the ATSSS-LL, MPTCP and MPQUIC-UDP bits is set) in the PDU SESSION MODIFICATION REQUEST message, indicates:

NOTE 5A: If any of the ATSSS-LL, MPTCP and MPQUIC-UDP bits, respectively, is set, then the SMF ignores the ATSSS-ST bits of the 5GSM capability IE.

- a) support for any of the possible steering functionalities in addition to the ATSSS-LL functionality with only active-standby steering mode and:
 - i) if the DNN configuration allows for the indicated steering functionality(ies) and the ATSSS-LL functionality with any steering mode (i.e., any steering mode allowed for ATSSS-LL functionality) but does not allow RTT measurement without using PMF protocol, the SMF shall ensure that the modified PDU session has the capability of the indicated steering functionality(ies) and the ATSSS-LL with only active-standby steering mode, load balancing steering mode or priority based steering mode in the downlink and the indicated steering functionality(ies) and the ATSSS-LL with only active-standby steering mode in the uplink;
 - ii) if the DNN configuration allows for the the indicated steering functionality(ies) and the ATSSS-LL functionality with any steering mode (i.e., any steering mode allowed for ATSSS-LL functionality) and allows RTT measurement without using PMF protocol, the SMF shall ensure that the modified PDU session has the capability of the indicated steering functionality(ies) and the ATSSS-LL with any steering mode (i.e., any steering mode allowed for ATSSS-LL functionality) in the downlink and the indicated steering functionality(ies) and the ATSSS-LL with only active-standby steering mode in the uplink; or
 - iii) if the DNN configuration allows for the indicated steering functionality(ies) and the ATSSS-LL functionality with only active-standby steering mode, the SMF shall ensure that the modified PDU session has the capability of the indicated steering functionality(ies) and the ATSSS-LL with only active-standby steering mode in the downlink and the uplink;
- b) support for ATSSS Low-Layer functionality with any steering mode allowed for ATSSS-LL and if the DNN configuration allows for the ATSSS-LL functionality with any steering mode (i.e., any steering mode allowed for ATSSS-LL functionality), the SMF shall ensure that the modified PDU session has the capability of ATSSS-LL with any steering mode (i.e., any steering mode allowed for ATSSS-LL functionality) in the downlink and the uplink;
- c) void;
- d) void
- e) void;
- f) void;
- g) void;
- h) support for any of the possible steering functionalities in addition to the ATSSS-LL functionality with any steering mode (i.e., any steering mode allowed for ATSSS-LL functionality) and if the DNN configuration does not allow for the indicated steering functionality and allows for the ATSSS-LL functionality with any steering mode (i.e., any steering mode allowed for ATSSS-LL functionality), the SMF shall ensure that the established PDU session has the capability of ATSSS-LL with any steering mode (i.e., any steering mode allowed for ATSSS-LL functionality) in the downlink and the uplink; or
- i) support for any of the possible steering functionalities in addition to at least ATSSS-LL functionality with only active-standby steering mode and if the DNN configuration does not allow for the indicated steering functionality and allows for the ATSSS-LL functionality with only active-standby steering mode, the SMF shall ensure that the established PDU session has the capability of ATSSS-LL with only active-standby steering mode in the downlink and the uplink.

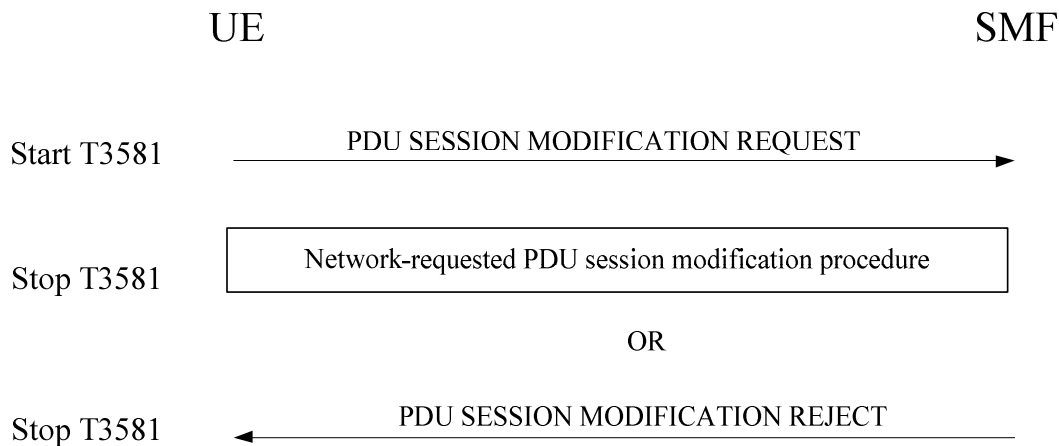

Figure 6.4.2.2.1: UE-requested PDU session modification procedure

6.4.2.3 UE-requested PDU session modification procedure accepted by the network

Upon receipt of a PDU SESSION MODIFICATION REQUEST message, if the SMF accepts the request to modify the PDU session, the SMF shall perform the network-requested PDU session modification procedure as specified in subclause 6.3.2.

If the PDU SESSION MODIFICATION REQUEST message contains a Port management information container IE, the SMF shall handle the contents of the Port management information container IE as specified in 3GPP TS 23.501 [8] and 3GPP TS 23.502 [9].

6.4.2.4 UE-requested PDU session modification procedure not accepted by the network

6.4.2.4.1 General

Upon receipt of a PDU SESSION MODIFICATION REQUEST message, if the SMF does not accept the request to modify the PDU session, the SMF shall create a PDU SESSION MODIFICATION REJECT message.

The SMF shall set the 5GSM cause IE of the PDU SESSION MODIFICATION REJECT message to indicate the reason for rejecting the PDU session modification.

The 5GSM cause IE typically indicates one of the following SM cause values:

- #26 insufficient resources;
- #29 user authentication or authorization failed;
- #31 request rejected, unspecified;
- #32 service option not supported;
- #33 requested service option not subscribed;
- #35 PTI already in use;
- #37 5GS QoS not accepted;
- #43 Invalid PDU session identity;
- #44 Semantic errors in packet filter(s);
- #45 Syntactical error in packet filter(s);

- #46 out of LADN service area;
- #59 unsupported 5QI value;
- #67 insufficient resources for specific slice and DNN;
- #69 insufficient resources for specific slice;
- #83 Semantic error in the QoS operation;
- #84 Syntactical error in the QoS operation; or
- #95 – 111 protocol errors.

If the UE requests a PDU session modification for an LADN when the UE is located outside of the LADN service area, the SMF shall include the 5GSM cause value #46 "out of LADN service area" in the 5GSM cause IE of the PDU SESSION MODIFICATION REJECT message.

If the Extended protocol configuration options IE of the PDU SESSION MODIFICATION REQUEST message indicates 3GPP PS data off UE status and the SMF detects the change of the 3GPP PS data off UE status, the SMF shall not include the 5GSM cause value #26 "insufficient resources", the 5GSM cause value #67 "insufficient resources for specific slice and DNN", the 5GSM cause value #69 "insufficient resources for specific slice" and the 5GSM cause value #46 "out of LADN service area" in the 5GSM cause IE of the PDU SESSION MODIFICATION REJECT message.

If the UE initiates UE-requested PDU session modification procedure to modify the PDU session transferred from EPS to an MA PDU session with the Request type IE set to "MA PDU request" in the UL NAS TRANSPORT message as specified in 3GPP TS 24.193 [13B] and the SMF determines, based on operator policy and subscription information, that the PDU SESSION MODIFICATION REQUEST message is to be rejected, the SMF shall include the 5GSM cause value #33 "requested service option not subscribed" in the 5GSM cause IE of the PDU SESSION MODIFICATION REJECT message.

NOTE: If the SMF determines, based on operator policy and subscription information, that the PDU SESSION MODIFICATION REQUEST message is to be accepted as single access PDU session, the ATSSS container IE cannot be included in the PDU SESSION MODIFICATION COMMAND message.

The network may include a Back-off timer value IE in the PDU SESSION MODIFICATION REJECT message.

If the 5GSM cause value is #26 "insufficient resources", #67 "insufficient resources for specific slice and DNN", or #69 "insufficient resources for specific slice" and the PDU SESSION MODIFICATION REQUEST message was received from a UE configured for high priority access in selected PLMN or SNPN or the request type provided during the PDU session establishment is set to "initial emergency request" or "existing emergency PDU session", the network shall not include a Back-off timer value IE.

The SMF shall send the PDU SESSION MODIFICATION REJECT message.

Upon receipt of a PDU SESSION MODIFICATION REJECT message and a PDU session ID, using the NAS transport procedure as specified in subclause 5.4.5, the UE shall stop timer T3581, release the allocated PTI value, and enter the state PROCEDURE TRANSACTION INACTIVE.

If the PDU SESSION MODIFICATION REQUEST message was sent with the Requested MBS container IE included and the MBS operation set to "Join MBS session", and the UE receives a PDU SESSION MODIFICATION REJECT message, then the UE shall consider the requested MBS join as rejected.

If the PDU SESSION MODIFICATION REQUEST message was sent with the Requested MBS container IE included and the MBS operation set to "Leave MBS session", and the UE receives a PDU SESSION MODIFICATION REJECT message, then the UE shall locally leave the multicast MBS session(s) corresponding to the TMGI(s) in the Requested MBS container IE of the PDU SESSION MODIFICATION REQUEST message.

6.4.2.4.2 Handling of network rejection due to congestion control

If:

- the 5GSM cause value #26 "insufficient resources" and the Back-off timer value IE are included in the PDU SESSION MODIFICATION REJECT message; or

- an indication that the 5GSM message was not forwarded due to DNN based congestion control is received along a Back-off timer value and a PDU SESSION MODIFICATION REQUEST message with the PDU session ID IE set to the PDU session ID of the PDU session;

the UE shall ignore the Re-attempt indicator IE or the 5GSM congestion re-attempt indicator IE provided by the network, if any, and the UE shall take different actions depending on the timer value received for timer T3396 in the Back-off timer value IE or depending on the Back-off timer value received from the 5GMM sublayer (if the UE is a UE configured for high priority access in selected PLMN or SNPN, exceptions are specified in subclause 6.2.7):

- a) If the timer value indicates neither zero nor deactivated and a DNN was provided during the PDU session establishment, the UE shall stop timer T3396 associated with the corresponding DNN, if it is running. If the timer value indicates neither zero nor deactivated and no DNN was provided during the PDU session establishment and the request type was different from "initial emergency request" and different from "existing emergency PDU session", the UE shall stop timer T3396 associated with no DNN if it is running. In an SNPN, the timer T3396 to be stopped includes:
 - 1) the timer T3396 applied for all the equivalent SNPNS, and associated with the RSNPN or an equivalent SNPN and with the selected entry of the "list of subscriber data" or the selected PLMN subscription, if running; and
 - 2) the timer T3396 applied for the registered SNPN, associated with the RSNPN and, if the UE supports access to an SNPN using credentials from a credentials holder, associated with the selected entry of the "list of subscriber data" or the selected PLMN subscription, if running.

The UE shall then start timer T3396 with the value provided in the Back-off timer value IE or with the Back-off timer value received from the 5GMM sublayer and:

- 1) shall not send another PDU SESSION ESTABLISHMENT REQUEST message, or PDU SESSION MODIFICATION REQUEST message with exception of those identified in subclause 6.4.2.1, for the same DNN that was sent by the UE, until timer T3396 expires or timer T3396 is stopped; and
- 2) shall not send another PDU SESSION ESTABLISHMENT REQUEST message without a DNN and with request type different from "initial emergency request" and different from "existing emergency PDU session", or another PDU SESSION MODIFICATION REQUEST message with exception of those identified in subclause 6.4.2.1, for a non-emergency PDU session established without a DNN provided by the UE, if no DNN was provided during the PDU session establishment and the request type was different from "initial emergency request" and different from "existing emergency PDU session", until timer T3396 expires or timer T3396 is stopped.

The UE shall not stop timer T3396 upon a PLMN change, SNPN change, or inter-system change.

- b) if the timer value indicates that this timer is deactivated and a DNN was provided during the PDU session establishment, the UE shall stop timer T3396 associated with the corresponding DNN, if it is running. If the timer value indicates that this timer is deactivated and no DNN was provided during the PDU session establishment and the request type was different from "initial emergency request" and different from "existing emergency PDU session", the UE shall stop timer T3396 associated with no DNN if it is running. In an SNPN, the timer T3396 to be stopped includes:
 - 1) the timer T3396 applied for all the equivalent SNPNS, and associated with the RSNPN or an equivalent SNPN and with the selected entry of the "list of subscriber data" or the selected PLMN subscription, if running; and
 - 2) the timer T3396 applied for the registered SNPN, associated with the RSNPN and, if the UE supports access to an SNPN using credentials from a credentials holder, associated with the selected entry of the "list of subscriber data" or the selected PLMN subscription, if running.

The UE:

- 1) shall not send another PDU SESSION ESTABLISHMENT REQUEST message or PDU SESSION MODIFICATION REQUEST with exception of those identified in subclause 6.4.2.1, for the same DNN until the UE is switched off, the USIM is removed, the entry in the "list of subscriber data" for the current SNPN is updated, or the UE receives a PDU SESSION MODIFICATION COMMAND message for the same DNN from the network, or a PDU SESSION AUTHENTICATION COMMAND message for the same DNN from

the network, or a PDU SESSION RELEASE COMMAND message without the Back-off timer value IE for the same DNN from the network; and

- 2) shall not send another PDU SESSION ESTABLISHMENT REQUEST message without a DNN and with request type different from "initial emergency request" and different from "existing emergency PDU session", or another PDU SESSION MODIFICATION REQUEST message with exception of those identified in subclause 6.4.2.1, for a non-emergency PDU session established without a DNN provided by the UE, if no DNN was provided during the PDU session establishment and the request type was different from "initial emergency request" and different from "existing emergency PDU session", until the UE is switched off, the USIM is removed, the entry in the "list of subscriber data" for the current SNPN is updated, or the UE receives a PDU SESSION MODIFICATION COMMAND message for a non-emergency PDU session established without a DNN provided by the UE, a PDU SESSION AUTHENTICATION COMMAND message for a non-emergency PDU session established without a DNN provided by the UE, or a PDU SESSION RELEASE COMMAND message without the Back-off timer value IE for a non-emergency PDU session established without a DNN provided by the UE.

The timer T3396 remains deactivated upon a PLMN change, SNPN change, or inter-system change.

c) if the timer value indicates zero, the UE:

- 1) shall stop timer T3396 associated with the corresponding DNN, if running. In an SNPN, the timer T3396 to be stopped includes:
 - i) the timer T3396 applied for all the equivalent SNPNs, and associated with the RSNPN or an equivalent SNPN and with the selected entry of the "list of subscriber data" or the selected PLMN subscription, if running; and
 - ii) the timer T3396 applied for the registered SNPN, associated with the RSNPN and, if the UE supports access to an SNPN using credentials from a credentials holder, associated with the selected entry of the "list of subscriber data" or the selected PLMN subscription, if running.

The UE may send another PDU SESSION ESTABLISHMENT REQUEST message or PDU SESSION MODIFICATION REQUEST message for the same DNN; and

- 2) if no DNN was provided during the PDU session establishment and the request type was different from "initial emergency request" and different from "existing emergency PDU session", the UE shall stop timer T3396 associated with no DNN, if running. In an SNPN, the timer T3396 to be stopped includes:
 - i) the timer T3396 applied for all the equivalent SNPNs, and associated with the RSNPN or an equivalent SNPN and with the selected entry of the "list of subscriber data" or the selected PLMN subscription, if running; and
 - ii) the timer T3396 applied for the registered SNPN, associated with the RSNPN and, if the UE supports access to an SNPN using credentials from a credentials holder, associated with the selected entry of the "list of subscriber data" or the selected PLMN subscription, if running.

The UE may send another PDU SESSION ESTABLISHMENT REQUEST message without a DNN, or another PDU SESSION MODIFICATION REQUEST message without a DNN provided by the UE.

In an SNPN, if the UE supports equivalent SNPNs then the UE shall apply the timer T3396 for all the equivalent SNPNs. Otherwise, the UE shall apply the timer T3396 for the registered SNPN.

If the Back-off timer value IE is not included or no Back-off timer value is received from the 5GMM sublayer, then the UE may send another PDU SESSION ESTABLISHMENT REQUEST message or PDU SESSION MODIFICATION REQUEST message for the same DNN or without a DNN as specified in subclause 6.2.7.

If the timer T3396 is running when the UE enters state 5GMM-DEREGISTERED, the UE remains switched on, and the USIM in the UE (if any) remains the same and the entry in the "list of subscriber data" for the SNPN to which timer T3396 is associated (if any) is not updated, then timer T3396 is kept running until it expires or it is stopped

When the timer T3396 is running or the timer is deactivated, the UE is allowed to initiate a PDU session establishment procedure for emergency services.

If the UE is switched off when the timer T3396 is running, and if the USIM in the UE (if any) remains the same and the entry in the "list of subscriber data" for the SNPN to which timer T3396 is associated (if any) is not updated when the UE is switched on, the UE shall behave as follows:

- let $t1$ be the time remaining for T3396 timeout at switch off and let t be the time elapsed between switch off and switch on. If $t1$ is greater than t , then the timer shall be restarted with the value $t1 - t$. If $t1$ is equal to or less than t , then the timer need not be restarted. If the UE is not capable of determining t , then the UE shall restart the timer with the value $t1$.

If the UE is a UE operating in single-registration mode in a network supporting N26 interface and the PDU SESSION MODIFICATION REQUEST message was sent for a PDN connection established when in S1 mode after an inter-system change from S1 mode to N1 mode and timer T3396 associated with the corresponding DNN (or no DNN) is running, then the UE shall re-initiate the UE-requested PDU session modification procedure after expiry of timer T3396.

If:

- the 5GSM cause value #67 "insufficient resources for specific slice and DNN" and the Back-off timer value IE are included in the PDU SESSION MODIFICATION REJECT message; or
- an indication that the 5GSM message was not forwarded due to S-NSSAI and DNN based congestion control is received along a Back-off timer value and a PDU SESSION MODIFICATION REQUEST message with the PDU session ID IE set to the PDU session ID of the PDU session;

the UE shall ignore the Re-attempt indicator IE provided by the network, if any, and take different actions depending on the timer value received for timer T3584 in the Back-off timer value IE or depending on the Back-off timer value received from the 5GMM sublayer (if the UE is a UE configured for high priority access in selected PLMN or SNPN, exceptions are specified in subclause 6.2.8):

- a) If the timer value indicates neither zero nor deactivated, and both an S-NSSAI and a DNN were provided by the UE during the PDU session establishment, the UE shall stop timer T3584 associated with the [S-NSSAI of the PDU session, DNN] combination, if it is running. If the timer value indicates neither zero nor deactivated, an S-NSSAI and no DNN was provided during the PDU session establishment and the request type was different from "initial emergency request" and different from "existing emergency PDU session", the UE shall stop timer T3584 associated with [S-NSSAI of the PDU session, no DNN] combination, if it is running. If the timer value indicates neither zero nor deactivated, no S-NSSAI and a DNN was provided during the PDU session establishment, the UE shall stop timer T3584 associated with the [no S-NSSAI, DNN] combination, if it is running. If the timer value indicates neither zero nor deactivated and neither S-NSSAI nor DNN was provided during the PDU session establishment and the request type was different from "initial emergency request" and different from "existing emergency PDU session", the UE shall stop timer T3584 associated with the [no S-NSSAI, no DNN] combination, if it is running. The timer T3584 to be stopped includes:
 - 1) in a PLMN:
 - i) the timer T3584 applied for all the PLMNs, if running; and
 - ii) the timer T3584 applied for the registered PLMN, if running; or
 - 2) in an SNPN:
 - i) the timer T3584 applied for all the equivalent SNPNS, and associated with the RSNPN or an equivalent SNPN and with the selected entry of the "list of subscriber data" or the selected PLMN subscription, if running; and
 - ii) the timer T3584 applied for the registered SNPN, associated with the RSNPN and, if the UE supports access to an SNPN using credentials from a credentials holder, equivalent SNPNS or both, associated with the selected entry of the "list of subscriber data" or the selected PLMN subscription, if running.

The UE shall then start timer T3584 with the value provided in the Back-off timer value IE or with the Back-off timer value received from the 5GMM sublayer and:

- 1) shall not send another PDU SESSION ESTABLISHMENT REQUEST message or PDU SESSION MODIFICATION REQUEST message with the exception of those identified in subclause 6.4.2.1, for the [S-NSSAI, DNN] combination, until timer T3584 expires or timer T3584 is stopped;

- 2) shall not send another PDU SESSION ESTABLISHMENT REQUEST message with request type different from "initial emergency request" and different from "existing emergency PDU session", or another PDU SESSION MODIFICATION REQUEST message with the exception of those identified in subclause 6.4.2.1, for the [S-NSSAI of the PDU session, no DNN] combination, if no DNN was provided during the PDU session establishment, until timer T3584 expires or timer T3584 is stopped;
- 3) shall not send another PDU SESSION ESTABLISHMENT REQUEST message, or another PDU SESSION MODIFICATION REQUEST message with the exception of those identified in subclause 6.4.2.1, for the [no S-NSSAI, DNN] combination, if no S-NSSAI was provided during the PDU session establishment, until timer T3584 expires or timer T3584 is stopped; and
- 4) shall not send another PDU SESSION ESTABLISHMENT REQUEST message with request type different from "initial emergency request" and different from "existing emergency PDU session", or another PDU SESSION MODIFICATION REQUEST message with the exception of those identified in subclause 6.4.2.1, for the [no S-NSSAI, no DNN] combination, if neither S-NSSAI nor DNN was provided during the PDU session establishment, until timer T3584 expires or timer T3584 is stopped.

The UE shall not stop timer T3584 upon a PLMN change, SNPN change, or inter-system change;

b) if the timer value indicates that this timer is deactivated:

- 1) if both S-NSSAI and DNN were provided by the UE during the PDU session establishment, the UE shall stop timer T3584 associated with the [S-NSSAI of the PDU session, DNN] combination, if running. The timer T3584 to be stopped includes:
 - i) in a PLMN:
 - A) the timer T3584 applied for all the PLMNs, if running; and
 - B) the timer T3584 applied for the registered PLMN, if running; or
 - ii) in an SNPN:
 - A) the timer T3584 applied for all the equivalent SNPNS, and associated with the RSNPN or an equivalent SNPN and with the selected entry of the "list of subscriber data" or the selected PLMN subscription, if running; and
 - B) the timer T3584 applied for the registered SNPN, associated with the RSNPN and, if the UE supports access to an SNPN using credentials from a credentials holder, equivalent SNPNS or both, associated with the selected entry of the "list of subscriber data" or the selected PLMN subscription, if running.

The UE shall not send another PDU SESSION ESTABLISHMENT REQUEST message or PDU SESSION MODIFICATION REQUEST message with exception of those identified in subclause 6.4.2.1, for the [S-NSSAI of the PDU session, DNN] combination that was sent by the UE, until the UE is switched off, the USIM is removed, the entry in the "list of subscriber data" for the current SNPN is updated, or the UE receives a PDU SESSION MODIFICATION COMMAND message for the [S-NSSAI of the PDU session, DNN] combination from the network, or a PDU SESSION AUTHENTICATION COMMAND message for the [S-NSSAI of the PDU session, DNN] combination from the network, or a PDU SESSION RELEASE COMMAND message without the Back-off timer value IE for the [S-NSSAI of the PDU session, DNN] combination from the network;

- 2) if an S-NSSAI was provided but a DNN was not provided by the UE during the PDU session establishment, the UE shall stop timer T3584 associated with the [S-NSSAI of the PDU session, no DNN] combination, if running. The timer T3584 to be stopped includes:
 - i) in a PLMN:
 - A) the timer T3584 applied for all the PLMNs, if running; and
 - B) the timer T3584 applied for the registered PLMN, if running; or
 - ii) in an SNPN:
 - A) the timer T3584 applied for all the equivalent SNPNS, and associated with the RSNPN or an equivalent SNPN and with the selected entry of the "list of subscriber data" or the selected PLMN subscription, if running; and

- B) the timer T3584 applied for the registered SNPN, associated with the RSNPN and, if the UE supports access to an SNPN using credentials from a credentials holder, equivalent SNPNS or both, associated with the selected entry of the "list of subscriber data" or the selected PLMN subscription, if running.

The UE shall not send a PDU SESSION ESTABLISHMENT REQUEST message with request type different from "initial emergency request" and different from "existing emergency PDU session", or a PDU SESSION MODIFICATION REQUEST message with exception of those identified in subclause 6.4.2.1, for the [S-NSSAI of the PDU session, no DNN] combination, if no DNN was provided during the PDU session establishment, until the UE is switched off, the USIM is removed, the entry in the "list of subscriber data" for the current SNPN is updated, or the UE receives a PDU SESSION MODIFICATION COMMAND message for a non-emergency PDU session established for the [S-NSSAI of the PDU session, no DNN] combination from the network, or a PDU SESSION AUTHENTICATION COMMAND message for a non-emergency PDU session established for the [S-NSSAI of the PDU session, no DNN] combination from the network, or a PDU SESSION RELEASE COMMAND message without the Back-off timer value IE for a non-emergency PDU session established for the [S-NSSAI of the PDU session, no DNN] combination from the network;

- 3) if an S-NSSAI was not provided but a DNN was provided by the UE during the PDU session establishment, the UE shall stop timer T3584 associated with the [no S-NSSAI, DNN] combination, if running. The timer T3584 to be stopped includes:
 - i) in a PLMN:
 - A) the timer T3584 applied for all the PLMNs, if running; and
 - B) the timer T3584 applied for the registered PLMN, if running; or
 - ii) in an SNPN:
 - A) the timer T3584 applied for all the equivalent SNPNS, and associated with the RSNPN or an equivalent SNPN and with the selected entry of the "list of subscriber data" or the selected PLMN subscription, if running; and
 - B) the timer T3584 applied for the registered SNPN, associated with the RSNPN and, if the UE supports access to an SNPN using credentials from a credentials holder, equivalent SNPNS or both, associated with the selected entry of the "list of subscriber data" or the selected PLMN subscription, if running.

The UE shall not send a PDU SESSION ESTABLISHMENT REQUEST message, or a PDU SESSION MODIFICATION REQUEST message with exception of those identified in subclause 6.4.2.1, for the [no S-NSSAI, DNN] combination, if no S-NSSAI was provided during the PDU session establishment, until the UE is switched off, the USIM is removed, the entry in the "list of subscriber data" for the current SNPN is updated, or the UE receives a PDU SESSION MODIFICATION COMMAND message for the [no S-NSSAI, DNN] combination from the network, or a PDU SESSION AUTHENTICATION COMMAND message for the [no S-NSSAI, DNN] combination from the network, or a PDU SESSION RELEASE COMMAND message without the Back-off timer value IE for the [no S-NSSAI, DNN] combination from the network; and

- 4) if neither S-NSSAI nor DNN were provided by the UE during the PDU session establishment, the UE shall stop timer T3584 associated with the [no S-NSSAI, no DNN] combination, if running. The timer T3584 to be stopped includes:
 - i) in a PLMN:
 - A) the timer T3584 applied for all the PLMNs, if running; and
 - B) the timer T3584 applied for the registered PLMN, if running; or
 - ii) in an SNPN:
 - A) the timer T3584 applied for all the equivalent SNPNS, and associated with the RSNPN or an equivalent SNPN and with the selected entry of the "list of subscriber data" or the selected PLMN subscription, if running; and
 - B) the timer T3584 applied for the registered SNPN, associated with the RSNPN and, if the UE supports access to an SNPN using credentials from a credentials holder, equivalent SNPNS or both, associated with the selected entry of the "list of subscriber data" or the selected PLMN subscription, if running.

The UE shall not send a PDU SESSION ESTABLISHMENT REQUEST message with request type different from "initial emergency request" and different from "existing emergency PDU session", or a PDU SESSION MODIFICATION REQUEST message with exception of those identified in subclause 6.4.2.1, for the [no S-NSSAI, no DNN] combination, if neither S-NSSAI nor DNN was provided during the PDU session establishment, until the UE is switched off, the USIM is removed, the entry in the "list of subscriber data" for the current SNPN is updated, or the UE receives a PDU SESSION MODIFICATION COMMAND message for a non-emergency PDU session established for the [no S-NSSAI, no DNN] combination from the network, or a PDU SESSION AUTHENTICATION COMMAND message for a non-emergency PDU session established for the [no S-NSSAI, no DNN] combination from the network, or a PDU SESSION RELEASE COMMAND message without the Back-off timer value IE for a non-emergency PDU session established for the [no S-NSSAI, no DNN] combination from the network.

The timer T3584 remains deactivated upon a PLMN change, SNPN change, or inter-system change; and

- c) if the timer value indicates zero:
- 1) if both S-NSSAI and DNN were provided by the UE during the PDU session establishment, the UE shall stop timer T3584 associated with the [S-NSSAI of the PDU session, DNN] combination, if running. The timer T3584 to be stopped includes:
 - i) in a PLMN:
 - A) the timer T3584 applied for all the PLMNs, if running; and
 - B) the timer T3584 applied for the registered PLMN, if running; or
 - ii) in an SNPN:
 - A) the timer T3584 applied for all the equivalent SNPNs, and associated with the RSNPN or an equivalent SNPN and with the selected entry of the "list of subscriber data" or the selected PLMN subscription, if running; and
 - B) the timer T3584 applied for the registered SNPN, associated with the RSNPN and, if the UE supports access to an SNPN using credentials from a credentials holder, equivalent SNPNs or both, associated with the selected entry of the "list of subscriber data" or the selected PLMN subscription, if running.

The UE may send another PDU SESSION ESTABLISHMENT REQUEST message or PDU SESSION MODIFICATION REQUEST message for the [S-NSSAI of the PDU session, DNN] combination;

- 2) if an S-NSSAI was provided but a DNN was not provided by the UE during the PDU session establishment, the UE shall stop timer T3584 associated with the [S-NSSAI of the PDU session, no DNN] combination, if running. The timer T3584 to be stopped includes:
 - i) in a PLMN:
 - A) the timer T3584 applied for all the PLMNs, if running; and
 - B) the timer T3584 applied for the registered PLMN, if running; or
 - ii) in an SNPN:
 - A) the timer T3584 applied for all the equivalent SNPNs, and associated with the RSNPN or an equivalent SNPN and with the selected entry of the "list of subscriber data" or the selected PLMN subscription, if running; and
 - B) the timer T3584 applied for the registered SNPN, associated with the RSNPN and, if the UE supports access to an SNPN using credentials from a credentials holder, equivalent SNPNs or both, associated with the selected entry of the "list of subscriber data" or the selected PLMN subscription, if running.

The UE may send another PDU SESSION ESTABLISHMENT REQUEST message, or PDU SESSION MODIFICATION REQUEST message for the [S-NSSAI of the PDU session, no DNN] combination if the request type was different from "initial emergency request" and different from "existing emergency PDU session";

- 3) if an S-NSSAI was not provided but a DNN was provided by the UE during the PDU session establishment, the UE shall stop timer T3584 associated with the [no S-NSSAI, DNN] combination, if running. The timer T3584 to be stopped includes:
- i) in a PLMN:
 - A) the timer T3584 applied for all the PLMNs, if running; and
 - B) the timer T3584 applied for the registered PLMN, if running; or
 - ii) in an SNPN:
 - A) the timer T3584 applied for all the equivalent SNPNS, and associated with the RSNPN or an equivalent SNPN and with the selected entry of the "list of subscriber data" or the selected PLMN subscription, if running; and
 - B) the timer T3584 applied for the registered SNPN, associated with the RSNPN and, if the UE supports access to an SNPN using credentials from a credentials holder, equivalent SNPNS or both, associated with the selected entry of the "list of subscriber data" or the selected PLMN subscription, if running.

The UE may send another PDU SESSION ESTABLISHMENT REQUEST message, or PDU SESSION MODIFICATION REQUEST message for the [no S-NSSAI, DNN] combination; and

- 4) if neither S-NSSAI nor DNN were provided by the UE during the PDU session establishment, the UE shall stop timer T3584 associated with the [no S-NSSAI, no DNN] combination, if running. The timer T3584 to be stopped includes:
- i) in a PLMN:
 - A) the timer T3584 applied for all the PLMNs, if running; and
 - B) the timer T3584 applied for the registered PLMN, if running; or
 - ii) in an SNPN:
 - A) the timer T3584 applied for all the equivalent SNPNS, and associated with the RSNPN or an equivalent SNPN and with the selected entry of the "list of subscriber data" or the selected PLMN subscription, if running; and
 - B) the timer T3584 applied for the registered SNPN, associated with the RSNPN and, if the UE supports access to an SNPN using credentials from a credentials holder, equivalent SNPNS or both, associated with the selected entry of the "list of subscriber data" or the selected PLMN subscription, if running.

The UE may send another PDU SESSION ESTABLISHMENT REQUEST message, or PDU SESSION MODIFICATION REQUEST message for the [no S-NSSAI, no DNN] combination and the request type was different from "initial emergency request" and different from "existing emergency PDU session".

If the 5GSM congestion re-attempt indicator IE with the ABO bit set to "The back-off timer is applied in all PLMNs or all equivalent SNPNS" is included in the PDU SESSION MODIFICATION REJECT message with the 5GSM cause value #67 "insufficient resources for specific slice and DNN", then the UE shall apply the timer T3584 for all the PLMNs or all the equivalent SNPNS. Otherwise, the UE shall apply the timer T3584 for the registered PLMN or the registered SNPN.

If the Back-off timer value IE is not included or no Back-off timer value is received from the 5GMM sublayer, then the UE may send another PDU SESSION ESTABLISHMENT REQUEST message or PDU SESSION MODIFICATION REQUEST message for the same [S-NSSAI, DNN] combination, or for the same [S-NSSAI, no DNN] combination, or for the same [no S-NSSAI, DNN] combination, or for the same [no S-NSSAI, no DNN] combination as specified in subclause 6.2.8.

When the timer T3584 is running or the timer is deactivated, the UE is allowed to initiate a PDU session establishment procedure for emergency services.

If the timer T3584 is running when the UE enters state 5GMM-DEREGISTERED, the UE remains switched on, and the USIM in the UE (if any) remains the same and the entry in the "list of subscriber data" for the SNPN to which timer T3584 is associated (if any) is not updated, then timer T3584 is kept running until it expires or it is stopped.

If the UE is switched off when the timer T3584 is running, and if the USIM in the UE (if any) remains the same and the entry in the "list of subscriber data" for the SNPN to which timer T3584 is associated (if any) is not updated when the UE is switched on, the UE shall behave as follows:

- let t_1 be the time remaining for T3584 timeout at switch off and let t be the time elapsed between switch off and switch on. If t_1 is greater than t , then the timer shall be restarted with the value $t_1 - t$. If t_1 is equal to or less than t , then the timer need not be restarted. If the UE is not capable of determining t , then the UE shall restart the timer with the value t_1 .

If the UE is a UE operating in single-registration mode in a network supporting N26 interface and the PDU SESSION MODIFICATION REQUEST message was sent for a PDN connection established when in S1 mode after an inter-system change from S1 mode to N1 mode and timer T3584 associated with the corresponding [no S-NSSAI, DNN] combination or [no S-NSSAI, no DNN] combination is running, then the UE shall re-initiate the UE-requested PDU session modification procedure after expiry of timer T3584.

If:

- the 5GSM cause value #69 "insufficient resources for specific slice" and the Back-off timer value IE are included in the PDU SESSION MODIFICATION REJECT message; or
- an indication that the 5GSM message was not forwarded due to S-NSSAI only based congestion control is received along a Back-off timer value and a PDU SESSION MODIFICATION REQUEST message with the PDU session ID IE set to the PDU session ID of the PDU session;

the UE shall ignore the bit "RATC" and the bit "EPLMNC" in the Re-attempt indicator IE provided by the network, if any, and take different actions depending on the timer value received for timer T3585 in the Back-off timer value IE or depending on the Back-off timer value received from the 5GMM sublayer (if the UE is a UE configured for high priority access in selected PLMN or SNPN, exceptions are specified in subclause 6.2.8):

- a) If the timer value indicates neither zero nor deactivated and an S-NSSAI was provided during the PDU session establishment and the request type was different from "initial emergency request" and different from "existing emergency PDU session", the UE shall stop timer T3585 associated with the S-NSSAI of the PDU session, if it is running. If the timer value indicates neither zero nor deactivated and no S-NSSAI was provided during the PDU session establishment and the request type was different from "initial emergency request" and different from "existing emergency PDU session", the UE shall stop timer T3585 associated with no S-NSSAI if it is running. The timer T3585 to be stopped includes:
 - 1) in a PLMN:
 - i) the timer T3585 applied for all the PLMNs and for the access over which the PDU SESSION MODIFICATION REJECT is received, if running;
 - ii) the timer T3585 applied for all the PLMNs and for both 3GPP access type and non-3GPP access type, if running;
 - iii) the timer T3585 applied for the registered PLMN and for the access over which the PDU SESSION MODIFICATION REJECT is received, if running; and
 - iv)- the timer T3585 applied for the registered PLMN and for both 3GPP access type and non-3GPP access type, if running; or
 - 2) in an SNPN:
 - i) the timer T3585 applied for all the equivalent SNPNS and for the access over which the PDU SESSION AUTHENTICATION COMMAND message is received, associated with the RSNPN or an equivalent SNPN and with the selected entry of the "list of subscriber data" or the selected PLMN subscription, if running;
 - ii) the timer T3585 applied for all the equivalent SNPNS and for both 3GPP access type and non-3GPP access type, associated with the RSNPN or an equivalent SNPN and with the selected entry of the "list of subscriber data" or the selected PLMN subscription, if running;
 - iii) the timer T3585 applied for the registered SNPN and for the access over which the PDU SESSION AUTHENTICATION COMMAND message is received, associated with the RSNPN and, if the UE supports access to an SNPN using credentials from a credentials holder, equivalent SNPNS or both,

associated with the selected entry of the "list of subscriber data" or the selected PLMN subscription, if running; and

- iv) the timer T3585 applied for the registered PLMN and for both 3GPP access type and non-3GPP access type, associated with the RSNPN and, if the UE supports access to an SNPN using credentials from a credentials holder, equivalent SNPNS or both, associated with the selected entry of the "list of subscriber data" or the selected PLMN subscription, if running.

The UE shall then start timer T3585 with the value provided in the Back-off timer value IE or with the Back-off timer value received from the 5GMM sublayer and:

- 1) if an S-NSSAI was provided by the UE during the PDU session establishment, the UE shall not send another PDU SESSION ESTABLISHMENT REQUEST message with request type different from "initial emergency request" and different from "existing emergency PDU session", or another PDU SESSION MODIFICATION REQUEST message with exception of those identified in subclause 6.4.2.1, for a non-emergency PDU session for the S-NSSAI of the PDU session, until timer T3585 expires or timer T3585 is stopped; and
- 2) if the request type was different from "initial emergency request" and from "existing emergency PDU session", and an S-NSSAI was not provided by the UE during the PDU session establishment, the UE shall not send another PDU SESSION ESTABLISHMENT REQUEST message without an S-NSSAI and with request type different from "initial emergency request" and different from "existing emergency PDU session", or another PDU SESSION MODIFICATION REQUEST message with exception of those identified in subclause 6.4.2.1, for a non-emergency PDU session established without an S-NSSAI provided by the UE, until timer T3585 expires or timer T3585 is stopped.

The UE shall not stop timer T3585 upon a PLMN change, SNPN change, or inter-system change;

- b) if the timer value indicates that this timer is deactivated and an S-NSSAI was provided during the PDU session establishment and the request type was different from "initial emergency request" and different from "existing emergency PDU session", the UE shall stop timer T3585 associated with the S-NSSAI of the PDU session, if it is running. If the timer value indicates that this timer is deactivated and no S-NSSAI was provided during the PDU session establishment and the request type was different from "initial emergency request" and different from "existing emergency PDU session", the UE shall stop timer T3585 associated with no S-NSSAI if it is running. The timer T3585 to be stopped includes:
 - 1) in a PLMN:
 - i) the timer T3585 applied for all the PLMNs and for the access over which the PDU SESSION MODIFICATION REJECT is received, if running;
 - ii) the timer T3585 applied for all the PLMNs and for both 3GPP access type and non-3GPP access type, if running;
 - iii) the timer T3585 applied for the registered PLMN and for the access over which the PDU SESSION MODIFICATION REJECT is received, if running; and
 - iv) the timer T3585 applied for the registered PLMN and for both 3GPP access type and non-3GPP access type, if running; or
 - 2) in an SNPN:
 - i) the timer T3585 applied for all the equivalent SNPNS and for the access over which the PDU SESSION AUTHENTICATION COMMAND message is received, associated with the RSNPN or an equivalent SNPN and with the selected entry of the "list of subscriber data" or the selected PLMN subscription, if running;
 - ii) the timer T3585 applied for all the equivalent SNPNS and for both 3GPP access type and non-3GPP access type, associated with the RSNPN or an equivalent SNPN and with the selected entry of the "list of subscriber data" or the selected PLMN subscription, if running;
 - iii) the timer T3585 applied for the registered SNPN and for the access over which the PDU SESSION AUTHENTICATION COMMAND message is received, associated with the RSNPN and, if the UE supports access to an SNPN using credentials from a credentials holder, equivalent SNPNS or both, associated with the selected entry of the "list of subscriber data" or the selected PLMN subscription, if running; and

- iv) the timer T3585 applied for the registered PLMN and for both 3GPP access type and non-3GPP access type, associated with the RSNPN and, if the UE supports access to an SNPN using credentials from a credentials holder, equivalent SNPNS or both, associated with the selected entry of the "list of subscriber data" or the selected PLMN subscription, if running.

In addition:

- 1) if an S-NSSAI was provided by the UE during the PDU session establishment, the UE shall not send another PDU SESSION ESTABLISHMENT REQUEST message with request type different from "initial emergency request" and different from "existing emergency PDU session", or another PDU SESSION MODIFICATION REQUEST with exception of those identified in subclause 6.4.2.1, for a non-emergency PDU session for the S-NSSAI of the PDU session until the UE is switched off, the USIM is removed, the entry in the "list of subscriber data" for the current SNPN is updated, or the UE receives a PDU SESSION MODIFICATION COMMAND message for a non-emergency PDU session for the S-NSSAI of the PDU session from the network, or a PDU SESSION AUTHENTICATION COMMAND message for a non-emergency PDU session for the S-NSSAI of the PDU session from the network, or a PDU SESSION RELEASE COMMAND message without the Back-off timer value IE for the S-NSSAI of the PDU session from the network; and
- 2) if the request type was different from "initial emergency request" and from "existing emergency PDU session", and an S-NSSAI was not provided by the UE during the PDU session establishment, the UE shall not send another PDU SESSION ESTABLISHMENT REQUEST message without an S-NSSAI and with request type different from "initial emergency request" and different from "existing emergency PDU session", or another PDU SESSION MODIFICATION REQUEST message with exception of those identified in subclause 6.4.2.1, for a non-emergency PDU session established without an S-NSSAI provided by the UE, until the UE is switched off, the USIM is removed, the entry in the "list of subscriber data" for the current SNPN is updated, or the UE receives a PDU SESSION MODIFICATION COMMAND message for a non-emergency PDU session established without an S-NSSAI provided by the UE, or a PDU SESSION AUTHENTICATION COMMAND message for a non-emergency PDU session established without an S-NSSAI provided by the UE, or a PDU SESSION RELEASE COMMAND message without the Back-off timer value IE for a non-emergency PDU session established without an S-NSSAI provided by the UE.

The timer T3585 remains deactivated upon a PLMN change, SNPN change, or inter-system change; and

- c) if the timer value indicates zero:

- 1) if an S-NSSAI was provided by the UE during the PDU session establishment, the UE shall stop timer T3585 associated with the S-NSSAI of the PDU session, if running. The timer T3585 to be stopped includes:
 - i) in a PLMN:
 - A) including the timer T3585 applied for all the PLMNs and for the access over which the PDU SESSION RELEASE COMMAND is received, if running;
 - B) the timer T3585 applied for all the PLMNs and for the access over which the PDU SESSION RELEASE COMMAND is received, if running;
 - C) the timer T3585 applied for the registered PLMN and for current access type or both 3GPP access type and non-3GPP access type, if running; and
 - D) the timer T3585 applied for the registered PLMN and for both 3GPP access type and non-3GPP access type, if running; or
 - ii) in an SNPN:
 - A) the timer T3585 applied for all the equivalent SNPNS and for the access over which the PDU SESSION AUTHENTICATION COMMAND message is received, associated with the RSNPN or an equivalent SNPN and with the selected entry of the "list of subscriber data" or the selected PLMN subscription, if running;
 - B) the timer T3585 applied for all the equivalent SNPNS and for both 3GPP access type and non-3GPP access type, associated with the RSNPN or an equivalent SNPN and with the selected entry of the "list of subscriber data" or the selected PLMN subscription, if running;
 - C) the timer T3585 applied for the registered SNPN and for the access over which the PDU SESSION AUTHENTICATION COMMAND message is received, associated with the RSNPN and, if the UE

supports access to an SNPN using credentials from a credentials holder, equivalent SNPNs or both, associated with the selected entry of the "list of subscriber data" or the selected PLMN subscription, if running; and

- D) the timer T3585 applied for the registered PLMN and for both 3GPP access type and non-3GPP access type, associated with the RSNPN and, if the UE supports access to an SNPN using credentials from a credentials holder, equivalent SNPNs or both, associated with the selected entry of the "list of subscriber data" or the selected PLMN subscription, if running.

The UE may send another PDU SESSION ESTABLISHMENT REQUEST message or PDU SESSION MODIFICATION REQUEST message for the S-NSSAI of the PDU session; and

- 2) if no S-NSSAI was provided during the PDU session establishment and the request type was different from "initial emergency request" and different from "existing emergency PDU session", the UE shall stop timer T3585 associated with no S-NSSAI. The timer T3585 to be stopped includes:
 - i) in a PLMN:
 - A) the timer T3585 applied for all the PLMNs and for the access over which the PDU SESSION RELEASE COMMAND is received, if running;
 - B) the timer T3585 applied for all the PLMNs and for the access over which the PDU SESSION RELEASE COMMAND is received, if running;
 - C) the timer T3585 applied for the registered PLMN and for current access type or both 3GPP access type and non-3GPP access type, if running; and
 - D) the timer T3585 applied for the registered PLMN and for both 3GPP access type and non-3GPP access type, if running; or
 - ii) in an SNPN:
 - A) the timer T3585 applied for all the equivalent SNPNs and for the access over which the PDU SESSION AUTHENTICATION COMMAND message is received, associated with the RSNPN or an equivalent SNPN and with the selected entry of the "list of subscriber data" or the selected PLMN subscription, if running;
 - B) the timer T3585 applied for all the equivalent SNPNs and for both 3GPP access type and non-3GPP access type, associated with the RSNPN or an equivalent SNPN and with the selected entry of the "list of subscriber data" or the selected PLMN subscription, if running;
 - C) the timer T3585 applied for the registered SNPN and for the access over which the PDU SESSION AUTHENTICATION COMMAND message is received, associated with the RSNPN and, if the UE supports access to an SNPN using credentials from a credentials holder, equivalent SNPNs or both, associated with the selected entry of the "list of subscriber data" or the selected PLMN subscription, if running; and
 - D) the timer T3585 applied for the registered PLMN and for both 3GPP access type and non-3GPP access type, associated with the RSNPN and, if the UE supports access to an SNPN using credentials from a credentials holder, equivalent SNPNs or both, associated with the selected entry of the "list of subscriber data" or the selected PLMN subscription, if running.

The UE may send another PDU SESSION ESTABLISHMENT REQUEST message without an S-NSSAI, or another PDU SESSION MODIFICATION REQUEST message without an S-NSSAI provided by the UE.

If the 5GSM congestion re-attempt indicator IE with the ABO bit set to "The back-off timer is applied in all PLMNs or all SNPNs" is included in the PDU SESSION MODIFICATION REJECT message with the 5GSM cause value #69 "insufficient resources for specific slice", then the UE shall apply the timer T3585 for all the PLMNs or all the equivalent SNPNs. Otherwise, the UE shall apply the timer T3585 for the registered PLMN or the registered SNPN.

If the Back-off timer value IE is not included or no Back-off timer value is received from the 5GMM sublayer, then the UE may send another PDU SESSION ESTABLISHMENT REQUEST message or PDU SESSION MODIFICATION REQUEST message for the same S-NSSAI or without an S-NSSAI as specified in subclause 6.2.8.

When the timer T3585 is running or the timer is deactivated, the UE is allowed to initiate a PDU session establishment procedure for emergency services.

If the timer T3585 is running when the UE enters state 5GMM-DEREGISTERED, the UE remains switched on, and the USIM in the UE (if any) remains the same and the entry in the "list of subscriber data" for the SNPN to which timer T3585 is associated (if any) is not updated, then timer T3585 is kept running until it expires or it is stopped.

If the UE is switched off when the timer T3585 is running, and if the USIM in the UE (if any) remains the same and the entry in the "list of subscriber data" for the SNPN to which timer T3585 is associated (if any) is not updated when the UE is switched on, the UE shall behave as follows:

- let t_1 be the time remaining for T3585 timeout at switch off and let t be the time elapsed between switch off and switch on. If t_1 is greater than t , then the timer shall be restarted with the value $t_1 - t$. If t_1 is equal to or less than t , then the timer need not be restarted. If the UE is not capable of determining t , then the UE shall restart the timer with the value t_1 .

If the UE is a UE operating in single-registration mode in a network supporting N26 interface and the PDU SESSION MODIFICATION REQUEST message was sent for a PDN connection established when in S1 mode after an inter-system change from S1 mode to N1 mode and timer T3585 associated with no S-NSSAI is running, then the UE shall re-initiate the UE-requested PDU session modification procedure after expiry of timer T3585.

NOTE 3: As described in this subclause, upon PLMN change, SNPN change, or inter-system change, the UE does not stop the timer T3584 or T3585. This means the timer T3584 or T3585 can still be running or be deactivated for the given 5GSM procedure, the PLMN, the S-NSSAI and optionally the DNN combination when the UE returns to the PLMN or when it performs inter-system change back from S1 mode to N1 mode. Thus the UE can still be prevented from sending another PDU SESSION ESTABLISHMENT REQUEST or PDU SESSION MODIFICATION REQUEST message in the PLMN for the same S-NSSAI and optionally the same DNN.

Upon PLMN change or SNPN change, if T3584 applied for the registered PLMN or the registered SNPN is running or is deactivated for an S-NSSAI, a DNN, and old PLMN or old SNPN, but T3584 is not running and is not deactivated for the S-NSSAI, the DNN, and new PLMN or new SNPN, then the UE is allowed to send a PDU SESSION ESTABLISHMENT REQUEST message for the same S-NSSAI and the same DNN in the new PLMN or new SNPN.

Upon PLMN change or SNPN change, if T3585 applied for the registered PLMN or the registered SNPN is running or is deactivated for an S-NSSAI and old PLMN or old SNPN, but T3585 is not running and is not deactivated for the S-NSSAI and new PLMN or new SNPN, then the UE is allowed to send a PDU SESSION ESTABLISHMENT REQUEST message for the same S-NSSAI in the new PLMN or new SNPN.

Upon SNPN change, if T3585 applied for all the equivalent SNPNs is running or is deactivated for an S-NSSAI and old SNPN, but T3585 is not running and is not deactivated for the S-NSSAI and new non-equivalent SNPN, then the UE is allowed to send a PDU SESSION ESTABLISHMENT REQUEST message for the same S-NSSAI in the new SNPN.

6.4.2.4.3 Handling of network rejection not due to congestion control

If the 5GSM cause value is different from #26 "insufficient resources", #37 "5GS QoS not accepted", #44 "Semantic errors in packet filter(s)", #45 "Syntactical error in packet filter(s)", #46 "out of LADN service area", #59 "unsupported 5QI value", #67 "insufficient resources for specific slice and DNN", #69 "insufficient resources for specific slice", #83 "Semantic error in the QoS operation", and #84 "Syntactical error in the QoS operation", and the Back-off timer value IE is included, the UE shall behave as follows: (if the UE is a UE configured for high priority access in selected PLMN or SNPN, exceptions are specified in subclause 6.2.12):

- a) if the timer value indicates neither zero nor deactivated and:
 - 1) if the UE provided DNN and S-NSSAI to the network during the PDU session establishment, the UE shall start the back-off timer with the value provided in the Back-off timer value IE for the PDU session modification procedure and:
 - i) in a PLMN, [PLMN, DNN, (mapped) HPLMN S-NSSAI of the PDU session] combination. The UE shall not send another PDU SESSION MODIFICATION REQUEST message with exception of those identified in subclause 6.4.2.1, for the same DNN and the (mapped) HPLMN S-NSSAI of the PDU session in the current PLMN, until the back-off timer expires, the UE is switched off, or the USIM is removed; or

- ii) in an SNPN, [SNPN, selected entry of the "list of subscriber data" or selected PLMN subscription, DNN, (mapped) subscribed SNPN S-NSSAI] combination. The UE shall not send another PDU SESSION MODIFICATION REQUEST message with exception of those identified in subclause 6.4.2.1, for the same DNN and (mapped) subscribed SNPN S-NSSAI of the PDU session in the current SNPN using the selected entry of the "list of subscriber data" or selected PLMN subscription, until the back-off timer expires, the UE is switched off, the USIM is removed, or the selected entry of the "list of subscriber data" is updated;
- 2) if the UE did not provide a DNN or S-NSSAI or any of the two parameters to the network during the PDU session establishment, it shall start the back-off timer accordingly for the PDU session modification procedure and:
- i) in a PLMN, [PLMN, DNN, no S-NSSAI], [PLMN, no DNN, (mapped) HPLMN S-NSSAI of the PDU session] or [PLMN, no DNN, no S-NSSAI] combination. Dependent on the combination, the UE shall not send another PDU SESSION MODIFICATION REQUEST message with exception of those identified in subclause 6.4.2.1, for the same [PLMN, DNN, no S-NSSAI], [PLMN, no DNN, (mapped) HPLMN S-NSSAI of the PDU session] or [PLMN, no DNN, no S-NSSAI] combination in the current PLMN, until the back-off timer expires, the UE is switched off, or the USIM is removed; or
 - ii) in an SNPN, [SNPN, selected entry of the "list of subscriber data" or selected PLMN subscription, DNN, no S-NSSAI], [SNPN, selected entry of the "list of subscriber data" or selected PLMN subscription, no DNN, (mapped) subscribed SNPN S-NSSAI of the PDU session] or [SNPN, selected entry of the "list of subscriber data" or selected PLMN subscription, no DNN, no S-NSSAI] combination. Dependent on the combination, the UE shall not send another PDU SESSION MODIFICATION REQUEST message with exception of those identified in subclause 6.4.2.1, for the same [SNPN, selected entry of the "list of subscriber data" or selected PLMN subscription, DNN, no S-NSSAI], [SNPN, selected entry of the "list of subscriber data" or selected PLMN subscription, no DNN, (mapped) subscribed SNPN S-NSSAI of the PDU session] or [SNPN, selected entry of the "list of subscriber data" or selected PLMN subscription, no DNN, no S-NSSAI] combination in the current SNPN, until the back-off timer expires, the UE is switched off, the USIM is removed, or the selected entry in the "list of subscriber data" is updated;
- b) if the timer value indicates that this timer is deactivated and:
- 1) if the UE provided DNN and S-NSSAI to the network during the PDU session establishment, the UE shall not send another PDU SESSION MODIFICATION REQUEST message with exception of those identified in subclause 6.4.2.1, for:
 - i) in a PLMN, the same DNN and the (mapped) HPLMN S-NSSAI of the PDU session in the current PLMN, until the UE is switched off, or the USIM is removed; or
 - ii) in an SNPN, the same DNN and the (mapped) subscribed SNPN S-NSSAI of the PDU session in the current SNPN using the selected entry of the "list of subscriber data" or selected PLMN subscription, until the UE is switched off, or the USIM is removed, or the selected entry in the "list of subscriber data";
 - 2) if the UE did not provide a DNN or S-NSSAI or any of the two parameters to the network during the PDU session establishment, the UE shall not send another PDU SESSION MODIFICATION REQUEST message with exception of those identified in subclause 6.4.2.1, for:
 - i) in a PLMN; the same [PLMN, DNN, no S-NSSAI], [PLMN, no DNN, (mapped) HPLMN S-NSSAI of the PDU session] or [PLMN, no DNN, no S-NSSAI] combination in the current PLMN, until the UE is switched off, or the USIM is removed; or
 - ii) in an SNPN, the same [SNPN, the selected entry of the "list of subscriber data" or selected PLMN subscription, DNN, no S-NSSAI], [SNPN, the selected entry of the "list of subscriber data" or selected PLMN subscription, no DNN, (mapped) subscribed SNPN S-NSSAI of the PDU session] or [SNPN, the selected entry of the "list of subscriber data" or selected PLMN subscription, no DNN, no S-NSSAI] combination in the current SNPN using the selected entry of the "list of subscriber data" or selected PLMN subscription, until the UE is switched off, the USIM is removed, or the selected entry in the "list of subscriber data" is updated; and
- c) if the timer value indicates zero, the UE may send another PDU SESSION MODIFICATION REQUEST message for:

- 1) in a PLMN, the same combination of [PLMN, DNN, (mapped) HPLMN S-NSSAI of the PDU session], [PLMN, DNN, no S-NSSAI], [PLMN, no DNN, (mapped) HPLMN S-NSSAI of the PDU session], or [PLMN, no DNN, no S-NSSAI] in the current PLMN; or
- 2) in an SNPN, the same combination of [SNPN, the selected entry of the "list of subscriber data" or selected PLMN subscription, DNN, (mapped) subscribed SNPN S-NSSAI of the PDU session], [SNPN, the selected entry of the "list of subscriber data" or selected PLMN subscription, DNN, no S-NSSAI], [SNPN, the selected entry of the "list of subscriber data" or selected PLMN subscription, no DNN, (mapped) subscribed SNPN S-NSSAI of the PDU session], or [SNPN, the selected entry of the "list of subscriber data" or selected PLMN subscription, no DNN, no S-NSSAI] in the current SNPN.

If the Back-off timer value IE is not included, then the UE shall ignore the Re-attempt indicator IE provided by the network in the PDU SESSION MODIFICATION REJECT message, if any.

- a) Additionally, if the 5GSM cause value is #32 "service option not supported", or #33 "requested service option not subscribed", then:
 - 1) the UE not operating in SNPN access operation mode shall proceed as follows:
 - i) if the UE is registered in the HPLMN or in a PLMN that is within the EHPLMN list, the UE shall behave as described above in the present subclause using the configured SM Retry Timer value as specified in 3GPP TS 24.368 [17] or in USIM file NAS_{CONFIG} as specified in 3GPP TS 31.102 [22], if available, as back-off timer value; and

NOTE 1: The way to choose one of the configured SM Retry Timer values for back-off timer value is up to UE implementation if the UE is configured with:

- an SM Retry Timer value in the ME as specified in 3GPP TS 24.368 [17]; and
- an SM Retry Timer value in USIM file NAS_{CONFIG} as specified in 3GPP TS 31.102 [22].

- ii) otherwise, if the UE is not registered in its HPLMN or in a PLMN that is within the EHPLMN list, or if the SM Retry Timer value is not configured, the UE shall behave as described above in the present subclause, using the default value of 12 minutes for the back-off timer; or

- 2) the UE operating in SNPN access operation mode shall proceed as follows:

- i) if:

- A) the SM Retry Timer value for the current SNPN as specified in 3GPP TS 24.368 [17] is available; or
- B) the SM Retry Timer value in USIM file NAS_{CONFIG} as specified in 3GPP TS 31.102 [22] is available and the UE used the USIM for registration to the current SNPN;

then the UE shall behave as described above in the present subclause using the configured SM Retry Timer value as back-off timer value; or

NOTE 2: The way to choose one of the configured SM Retry Timer values for back-off timer value is up to UE implementation if both conditions in bullets A) and B) above are satisfied.

- ii) otherwise, the UE shall behave as described above in the present subclause, using the default value of 12 minutes for the back-off timer.

- b) For 5GSM cause values different from #32 "service option not supported", or #33 "requested service option not subscribed", the UE behaviour regarding the start of a back-off timer is specified in subclause 6.2.12.

The UE shall not stop any back-off timer:

- a) upon a PLMN or SNPN change;
- b) upon an inter-system change; or
- c) upon registration over another access type.

If the network indicates that a back-off timer for the PDU session modification procedure is deactivated, then it remains deactivated:

- a) upon a PLMN or SNPN change;

- b) upon an inter-system change; or
- c) upon registration over another access type.

NOTE 3: This means the back-off timer can still be running or be deactivated for the given 5GSM procedure when the UE returns to the PLMN or SNPN or when it performs inter-system change back from S1 mode to N1 mode. Thus the UE can still be prevented from sending another PDU SESSION MODIFICATION REQUEST message for the combination of [PLMN, DNN, (mapped) HPLMN S-NSSAI of the PDU session], [PLMN, DNN, no S-NSSAI], [PLMN, no DNN, (mapped) HPLMN S-NSSAI of the PDU session], or [PLMN, no DNN, no S-NSSAI] in the PLMN, or for the combination of [SNPN, the selected entry of the "list of subscriber data" or selected PLMN subscription, DNN, (mapped) subscribed S-NSSAI], [SNPN, the selected entry of the "list of subscriber data" or selected PLMN subscription, DNN, no S-NSSAI], [SNPN, the selected entry of the "list of subscriber data" or selected PLMN subscription, no DNN, (mapped) subscribed S-NSSAI], or [SNPN, the selected entry of the "list of subscriber data" or selected PLMN subscription, no DNN, no S-NSSAI] in the SNPN.

If the back-off timer is started upon receipt of a PDU SESSION MODIFICATION REJECT (i.e. the timer value was provided by the network, a configured value is available or the default value is used as explained above) or the back-off timer is deactivated, the UE behaves as follows:

- a) after a PLMN or SNPN change the UE may send a PDU SESSION MODIFICATION REQUEST message for:
 - 1) in a PLMN, the combination of [new PLMN, DNN, (mapped) HPLMN S-NSSAI of the PDU session], [new PLMN, DNN, no S-NSSAI], [new PLMN, no DNN, (mapped) HPLMN S-NSSAI of the PDU session], or [new PLMN, no DNN, no S-NSSAI] in the new PLMN, if the back-off timer is not running and is not deactivated for the PDU session modification procedure and the combination of [new PLMN, DNN, (mapped) HPLMN S-NSSAI of the PDU session], [new PLMN, DNN, no S-NSSAI], [new PLMN, no DNN, (mapped) HPLMN S-NSSAI of the PDU session], or [new PLMN, no DNN, no S-NSSAI]; or
 - 2) in an SNPN, the combination of [new SNPN, the selected entry of the "list of subscriber data" or selected PLMN subscription, DNN, (mapped) subscribed SNPN S-NSSAI of the PDU session], [new SNPN, the selected entry of the "list of subscriber data" or selected PLMN subscription, DNN, no S-NSSAI], [new SNPN, the selected entry of the "list of subscriber data" or selected PLMN subscription, no DNN, (mapped) subscribed SNPN S-NSSAI of the PDU session], or [new SNPN, the selected entry of the "list of subscriber data" or selected PLMN subscription, no DNN, no S-NSSAI] in the new SNPN, if the back-off timer is not running and is not deactivated for the PDU session modification procedure and the combination of [new SNPN, the selected entry of the "list of subscriber data" or selected PLMN subscription, DNN, (mapped) subscribed SNPN S-NSSAI of the PDU session], [new SNPN, the selected entry of the "list of subscriber data" or selected PLMN subscription, DNN, no S-NSSAI], [new SNPN, the selected entry of the "list of subscriber data" or selected PLMN subscription, no DNN, (mapped) subscribed SNPN S-NSSAI of the PDU session], or [new SNPN, the selected entry of the "list of subscriber data" or selected PLMN subscription, no DNN, no S-NSSAI];

Furthermore, as an implementation option, for the 5GSM cause value #32 "service option not supported" or #33 "requested service option not subscribed", if the network does not include a Re-attempt indicator IE, the UE may decide not to automatically send another PDU SESSION MODIFICATION REQUEST message:

- 1) in a PLMN, the same combination of [PLMN, DNN, (mapped) HPLMN S-NSSAI of the PDU session], [PLMN, DNN, no S-NSSAI], [PLMN, no DNN, (mapped) HPLMN S-NSSAI of the PDU session], or [PLMN, no DNN, no S-NSSAI], if the UE is registered to a new PLMN which is in the list of equivalent PLMNs; or
 - 2) in an SNPN, if the UE supports equivalent SNPNS, the same combination of [SNPN, the selected entry of the "list of subscriber data" or selected PLMN subscription, DNN, (mapped) subscribed SNPN S-NSSAI of the PDU session], [SNPN, the selected entry of the "list of subscriber data" or selected PLMN subscription, DNN, no S-NSSAI], [SNPN, the selected entry of the "list of subscriber data" or selected PLMN subscription, no DNN, (mapped) subscribed SNPN S-NSSAI of the PDU session], or [SNPN, the selected entry of the "list of subscriber data" or selected PLMN subscription, no DNN, no S-NSSAI], if the UE is registered to a new SNPN which is in the list of equivalent SNPNS.
- b) if the network does not include the Re-attempt indicator IE to indicate whether re-attempt in S1 mode is allowed, or the UE ignores the Re-attempt indicator IE, e.g. because the Back-off timer value IE is not included, then:

- 1) if the UE is registered in its HPLMN or in a PLMN that is within the EHPLMN list and the back-off timer is running for the combination of [PLMN, DNN, (mapped) HPLMN S-NSSAI of the PDU session] or [PLMN DNN, no S-NSSAI], the UE shall apply the configured SM_RetryAtRATChange value as specified in 3GPP TS 24.368 [17] or in USIM file NAS_{CONFIG} as specified in 3GPP TS 31.102 [22], if available, to determine whether the UE may attempt an EPS bearer resource allocation procedure or an EPS bearer resource modification procedure for the same [PLMN, DNN] combination in S1 mode; and

NOTE 4: The way to choose one of the configured SM_RetryAtRATChange values for back-off timer value is up to UE implementation if the UE is configured with:

- an SM_RetryAtRATChange value in ME as specified in 3GPP TS 24.368 [17]; and
 - an SM_RetryAtRATChange value in USIM file NAS_{CONFIG} as specified in 3GPP TS 31.102 [22].
- 2) if the UE is not registered in its HPLMN or in a PLMN that is within the EHPLMN list, or if the NAS configuration MO as specified in 3GPP TS 24.368 [17] is not available and the value for inter-system change is not configured in the USIM file NAS_{CONFIG}, then the UE behaviour regarding an EPS bearer resource allocation procedure or an EPS bearer resource modification procedure for the same [PLMN, DNN] combination in S1 mode is unspecified; and
- c) if the network includes the Re-attempt indicator IE indicating that re-attempt in an equivalent PLMN or equivalent SNPN is not allowed, then depending on the timer value received in the Back-off timer value IE, for:
- 1) in a PLMN, each combination of a PLMN from the equivalent PLMN list and the respective [DNN, (mapped) HPLMN S-NSSAI of the PDU session], [DNN, no S-NSSAI], [no DNN, (mapped) HPLMN S-NSSAI of the PDU session], or [no DNN, no S-NSSAI] combination, the UE shall start a back-off timer for the PDU session modification procedure with the value provided by the network, or deactivate the respective back-off timer as follows:
 - i) if the Re-attempt indicator IE additionally indicates that re-attempt in S1 mode is allowed, the UE shall start or deactivate the back-off timer for N1 mode only; and
 - ii) otherwise, the UE shall start or deactivate the back-off timer for S1 and N1 mode
 - 2) in a SNPN, if the UE supports equivalent SNPNS, each combination of a SNPN from the equivalent SNPN list and the respective [the selected entry of the "list of subscriber data" or selected PLMN subscription, DNN, (mapped) subscribed SNPN S-NSSAI of the PDU session], [the selected entry of the "list of subscriber data" or selected PLMN subscription, DNN, no S-NSSAI], [the selected entry of the "list of subscriber data" or selected PLMN subscription, no DNN, (mapped) subscribed SNPN S-NSSAI of the PDU session], or [the selected entry of the "list of subscriber data" or selected PLMN subscription, no DNN, no S-NSSAI] combination, the UE shall start a back-off timer for the PDU session modification procedure with the value provided by the network, or deactivate the respective back-off timer, for N1 mode in an SNPN.

If the back-off timer for a [PLMN, DNN] or [PLMN, no DNN] combination was started or deactivated in S1 mode upon receipt of BEARER RESOURCE ALLOCATION REJECT message or BEARER RESOURCE MODIFICATION REJECT message (see 3GPP TS 24.301 [15]) and the network indicated that re-attempt in N1 mode is allowed, then this back-off timer does not prevent the UE from sending a PDU SESSION MODIFICATION REQUEST message in this PLMN for the same DNN after inter-system change to N1 mode. If the network indicated that re-attempt in N1 mode is not allowed, the UE shall not send any PDU SESSION MODIFICATION REQUEST message with exception of those identified in subclause 6.4.2.1, in this PLMN for the same DNN in combination with any S-NSSAI or without S-NSSAI, after inter-system change to N1 mode until the timer expires, the UE is switched off or the USIM is removed.

NOTE 5: The back-off timer is used to describe a logical model of the required UE behaviour. This model does not imply any specific implementation, e.g. as a timer or timestamp.

NOTE 6: Reference to back-off timer in this section can either refer to use of timer T3396 or to use of a different packet system specific timer within the UE. Whether the UE uses T3396 as a back-off timer or it uses different packet system specific timers as back-off timers is left up to UE implementation.

If the 5GSM cause value is #46 "out of LADN service area", the UE shall ignore the Back-off timer value IE and Re-attempt indicator IE provided by the network, if any. If the UE is not located inside the LADN service area, the UE shall not send another PDU SESSION MODIFICATION REQUEST message except for indicating a change of 3GPP PS data off UE status or another PDU SESSION ESTABLISHMENT REQUEST message for the LADN DNN provided by the UE during the PDU session establishment procedure until the LADN information for the specific LADN DNN or the extended LADN information for the specific LADN DNN and S-NSSAI is updated as described in subclause 5.4.4 and subclause 5.5.1. If the UE is not located inside the LADN service area, the UE shall not indicate the

PDU session(s) for the LADN DNN provided by the UE during the PDU session establishment procedure in the Uplink data status IE included in the SERVICE REQUEST message until the LADN information for the specific LADN DNN or the extended LADN information for the specific LADN DNN and S-NSSAI is provided by network as described in subclause 5.4.4 and subclause 5.5.1.

NOTE 7: Based on UE implementation, the UE locating inside the LADN service area can send another PDU SESSION ESTABLISHMENT REQUEST message or PDU SESSION MODIFICATION REQUEST message for the LADN DNN which was rejected with the 5GSM cause value #46 "out of LADN service area".

NOTE 7A: If the UE does not receive a CONFIGURATION UPDATE COMMAND message with new LADN information within an implementation dependent time, the UE can request this information by initiating a registration procedure for mobility or periodic registration update (see subclause 5.5.1.3.2, item q).

If the 5GSM cause value is #37 "5GS QoS not accepted", #44 "Semantic errors in packet filter(s)", #45 "Syntactical error in packet filter(s)", #59 "unsupported 5QI value", #83 "Semantic error in the QoS operation" or #84 "Syntactical error in the QoS operation", the UE shall ignore the Back-off timer value IE and Re-attempt indicator IE provided by the network, if any. The UE should pass the corresponding error cause to the upper layers.

NOTE 8: How to solve the issues of not accepted 5GS QoS and unsupported 5QI value in the upper layers is UE implementation specific.

6.4.2.5 Abnormal cases in the UE

The following abnormal cases can be identified:

a) Expiry of timer T3581.

The UE shall, on the first expiry of the timer T3581, retransmit the PDU SESSION MODIFICATION REQUEST message and the PDU session information which was transported together with the initial transmission of the PDU SESSION MODIFICATION REQUEST message and shall reset and start timer T3581. This retransmission is repeated four times, i.e. on the fifth expiry of timer T3581, the UE shall abort the procedure and shall release the allocated PTI.

b) Invalid PDU session identity.

Upon receipt of the PDU SESSION MODIFICATION REJECT message including 5GSM cause #43 "invalid PDU session identity", the UE shall perform a local release of the existing PDU session and shall stop the timer T3581.

c) Collision of network-requested PDU session release procedure and UE-requested PDU session modification procedure.

If the UE receives a PDU SESSION RELEASE COMMAND message during the UE-requested PDU session modification procedure, and the PDU session indicated in the PDU SESSION RELEASE COMMAND message is the PDU session that the UE had requested to modify, the UE shall abort the PDU session modification procedure and proceed with the network-requested PDU session release procedure.

d) Handling DL user data packets marked with RQI when UE has already revoked the usage of reflective QoS

If the UE receives a DL user data packet marked with a RQI and the DL user data packet belongs to a PDU session of IPv4, IPv6, IPv4v6 or Ethernet PDU session type for which the UE has already revoked the usage of reflective QoS, then the UE shall ignore the RQI and shall handle the received DL user data packet.

e) Collision of network-requested PDU session modification procedure and UE-requested PDU session modification procedure.

The handling of the same abnormal case as described in subclause 6.3.2.6 applies.

f) Upon receiving an indication that the 5GSM message was not forwarded due to service area restrictions along with a PDU SESSION MODIFICATION REQUEST message with the PDU session ID IE set to the same value as the PDU session ID that was sent by the UE, the UE shall abort the procedure and shall stop the timer T3581.

- g) Upon receiving an indication that the 5GSM message was not forwarded due to routing failure along with a PDU SESSION MODIFICATION REQUEST message with the PDU session ID IE set to the same value as the PDU session ID that was sent by the UE, the UE shall stop timer T3581 and shall abort the procedure.
- ga) Upon receiving an indication that the 5GSM message was not forwarded because the UE accessing via a satellite NG-RAN cell is informed that the PLMN is not allowed to operate at the present UE location along with a PDU SESSION MODIFICATION REQUEST message with the PDU session ID IE set to the same value as the PDU session ID that was sent by the UE, the UE shall stop timer T3581 and shall abort the procedure.
- gb) Upon receiving an indication that the 5GSM message was not forwarded due to unexpected cause along with a PDU SESSION MODIFICATION REQUEST message with the PDU session ID IE set to the same value as the PDU session ID that was sent by the UE, the UE shall stop timer T3581 and shall abort the procedure.
- h) Collision of UE-requested PDU session modification procedure and N1 NAS signalling connection release

The UE may immediately retransmit the PDU SESSION MODIFICATION REQUEST message and stop, reset and restart timer T3581, if the following conditions apply:

- 1) The original UE-requested PDU session modification procedure was initiated over an existing N1 NAS signalling connection; and
 - 2) the previous transmission of the PDU SESSION MODIFICATION REQUEST message was not initiated due to timer T3581 expiry.
- i) Rejection of a UE-requested PDU session modification procedure when the UE has initiated the procedure to delete one or more non-default QoS rules for the PDU session:

Upon receipt of a PDU SESSION MODIFICATION REJECT message with 5GSM cause value #31 "request rejected, unspecified", if the UE had initiated deletion of one or more non-default QoS rules for the PDU session, as an implementation option,

- 1) it may perform a local release of the PDU session and shall stop the timer T3581. In order to synchronize the PDU session context with the AMF, the UE shall perform the registration procedure for mobility and periodic registration update with a REGISTRATION REQUEST message including the PDU session status IE; or
- 2) it shall stop the timer T3581 and initiate the UE-requested PDU session release procedure.

NOTE: The UE can delay the release of the PDU session until there is no pending data transferred through the other QoS flows of the PDU session.

6.4.2.6 Abnormal cases on the network side

The following abnormal cases can be identified:

- a) If the PDU session is an emergency PDU session and the 5GSM cause IE is not included in the PDU SESSION MODIFICATION REQUEST message which is not triggered according to subclause 6.4.2.1, item e), or is set to a 5GSM cause other than the 5GSM causes #41, #42, #44, #45, #83, #84, and #85, the SMF shall reject the PDU SESSION MODIFICATION REQUEST message with 5GSM cause #31 "request rejected, unspecified".

- b) PDU session inactive for the received PDU session identity.

If the PDU session ID in the PDU SESSION MODIFICATION REQUEST message belongs to any PDU session in state PDU SESSION INACTIVE in the SMF, the SMF shall set the 5GSM cause IE to #43 "Invalid PDU session identity" in the PDU SESSION MODIFICATION REJECT message.

- c) Collision of network-requested PDU session modification procedure and UE-requested PDU session modification procedure.

The handling of the same abnormal case as described in subclause 6.3.2.5 applies.

- d) AMF provides a "message was exempted from the DNN based congestion activated in the AMF" but the UE-requested PDU session modification procedure is not exempt from DNN based congestion control.

If the SMF receives an exemptionInd attribute indicating "message was exempted from the DNN based congestion activated in the AMF" as specified in 3GPP TS 29.502 [20A], and the Extended protocol configuration options IE of the PDU SESSION MODIFICATION REQUEST message does not indicate 3GPP PS data off UE status, then the SMF shall set the 5GSM cause #26 "insufficient resources" in the PDU SESSION MODIFICATION REJECT message.

- e) AMF provides a "message was exempted from the S-NSSAI and DNN based congestion activated in the AMF" but the UE-requested PDU session modification procedure is not exempt from S-NSSAI only based congestion control.

If the SMF receives an exemptionInd attribute indicating "message was exempted from the S-NSSAI and DNN based congestion activated in the AMF" as specified in 3GPP TS 29.502 [20A], and the Extended protocol configuration options IE of the PDU SESSION MODIFICATION REQUEST message does not indicate 3GPP PS data off UE status, then the SMF shall set the 5GSM cause #67 "insufficient resources for specific slice and DNN" in the PDU SESSION MODIFICATION REJECT message.

- f) AMF provides a "message was exempted from the S-NSSAI only based congestion activated in the AMF" but the UE-requested PDU session modification procedure is not exempt from S-NSSAI only based congestion control.

If the SMF receives an exemptionInd attribute indicating "message was exempted from the S-NSSAI only based congestion activated in the AMF" as specified in 3GPP TS 29.502 [20A], and the Extended protocol configuration options IE of the PDU SESSION MODIFICATION REQUEST message does not indicate 3GPP PS data off UE status, then the SMF shall set the 5GSM cause #69 "insufficient resources for specific slice" in the PDU SESSION MODIFICATION REJECT message.

- g) 5G access network cannot forward the message.

If the SMF determines based on content of the n2SmInfo attribute specified in 3GPP TS 29.502 [20A] that the DL NAS TRANSPORT message carrying the PDU SESSION MODIFICATION COMMAND message was not forwarded to the UE by the 5G access network due to a cause other than handover procedure in progress, then the SMF shall reject the UE-requested PDU session modification procedure with an appropriate 5GSM cause value in the PDU SESSION MODIFICATION REJECT message.

NOTE: The use of an appropriate 5GSM cause value is implementation specific.

- h) UE-requested MA PDU session modification with unspecified steering functionality and steering mode:

If the SMF receives the PDU SESSION MODIFICATION REQUEST message for an MA PDU session including the 5GSM capability information element that does not indicate support for any steering functionality or steering mode, the SMF shall reject the PDU session modification procedure with the 5GSM cause set to #95 "Semantically incorrect message" in the PDU SESSION MODIFICATION REJECT message.

6.4.3 UE-requested PDU session release procedure

6.4.3.1 General

The purpose of the UE-requested PDU session release procedure is to enable by the UE to request a release of a PDU session.

The UE is allowed to initiate the PDU session release procedure even if the timer T3396 is running.

The UE is allowed to initiate the PDU session release procedure even if the timer T3584 is running.

The UE is allowed to initiate the PDU session release procedure even if the timer T3585 is running.

The UE is allowed to initiate the PDU session release procedure even if the UE is outside the LADN service area.

6.4.3.2 UE-requested PDU session release procedure initiation

In order to initiate the UE-requested PDU session release procedure, the UE shall create a PDU SESSION RELEASE REQUEST message.

The UE may set the 5GSM cause IE of the PDU SESSION RELEASE REQUEST message to indicate the reason for releasing the PDU session.

The 5GSM cause IE typically indicates one of the following 5GSM cause values:

- #26 insufficient resources;
- #36 regular deactivation;
- #44 Semantic errors in packet filter(s);
- #45 Syntactical error in packet filter(s);
- #83 Semantic error in the QoS operation;
- #84 Syntactical error in the QoS operation;
- #96 Invalid mandatory information.

The UE shall allocate a PTI value currently not used and shall set the PTI IE of the PDU SESSION RELEASE REQUEST message to the allocated PTI value.

The UE shall transport the PDU SESSION RELEASE REQUEST message and the PDU session ID, using the NAS transport procedure as specified in subclause 5.4.5, and the UE shall start timer T3582 (see example in figure 6.4.3.2.1).

If the UE is releasing the PDU session due to:

- a) errors in QoS operations or packet filters; or
- b) the number of the authorized QoS rules, the number of the packet filters, or the number of the authorized QoS flow descriptions associated with the PDU session have reached the maximum number supported by the UE,

the UE shall include the 5GSM cause IE in the PDU SESSION RELEASE REQUEST message as described in subclauses 6.3.2.4 and 6.4.1.3.

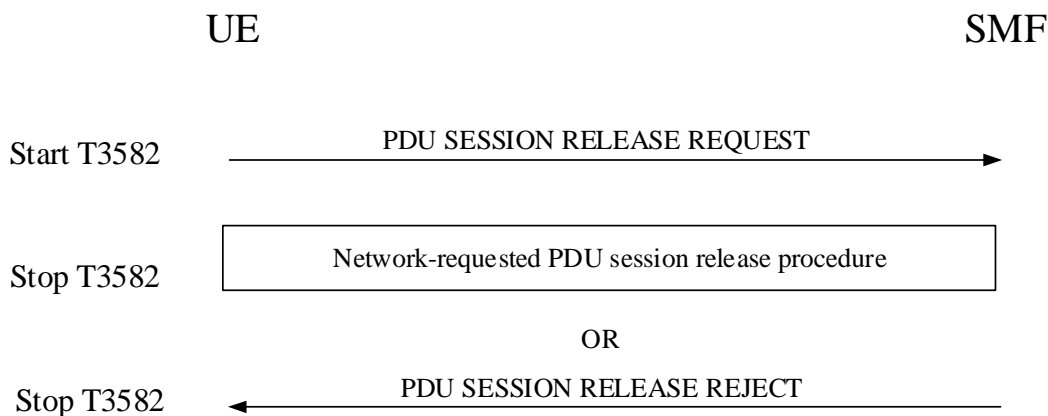

Figure 6.4.3.2.1: UE-requested PDU session release procedure

6.4.3.3 UE-requested PDU session release procedure accepted by the network

Upon receipt of a PDU SESSION RELEASE REQUEST message and a PDU session ID, if the SMF accepts the request to release the PDU session, and shall perform the network-requested PDU session release procedure as specified in subclause 6.3.3.

6.4.3.4 UE-requested PDU session release procedure not accepted by the network

Upon receipt of a PDU SESSION RELEASE REQUEST message, if the SMF does not accept the request to release the PDU session, the SMF shall create a PDU SESSION RELEASE REJECT message.

The SMF shall set the 5GSM cause IE of the PDU SESSION RELEASE REJECT message to indicate the reason for rejecting the PDU session release.

The 5GSM cause IE typically indicates one of the following SM cause values:

- #35 PTI already in use; or
- #43 Invalid PDU session identity; or
- #95 – 111: protocol errors.

The SMF shall send the PDU SESSION RELEASE REJECT message.

Upon receipt of a PDU SESSION RELEASE REJECT message and a PDU session ID, using the NAS transport procedure as specified in subclause 5.4.5, the UE shall stop timer T3582, release the allocated PTI value and locally release the PDU session. If there is one or more multicast MBS sessions associated with the PDU session, the UE shall locally leave the associated multicast MBS sessions.

6.4.3.5 Abnormal cases in the UE

The following abnormal cases can be identified:

- a) Expiry of timer T3582.

The UE shall, on the first expiry of the timer T3582, retransmit the PDU SESSION RELEASE REQUEST message and the PDU session information which was transported together with the initial transmission of the PDU SESSION RELEASE REQUEST message and shall reset and start timer T3582. This retransmission is repeated four times, i.e. on the fifth expiry of timer T3582, the UE shall abort the procedure, release the allocated PTI, perform a local release of the PDU session, and perform the registration procedure for mobility and periodic registration update by sending a REGISTRATION REQUEST message including the PDU session status IE over each access that user plane resources have been established if the PDU session is an MA PDU session, or over the access the PDU session is associated with if the PDU session is a single access PDU session. If there is one or more multicast MBS sessions associated with the PDU session, the UE shall locally leave the associated multicast MBS sessions.

- b) Collision of UE-requested PDU session release procedure and network-requested PDU session modification procedure.

When the UE receives a PDU SESSION MODIFICATION COMMAND message during the UE-requested PDU session release procedure, and the PDU session indicated in PDU SESSION MODIFICATION COMMAND message is the PDU session that the UE had requested to release, the UE shall ignore the PDU SESSION MODIFICATION COMMAND message and proceed with the PDU session release procedure.

- c) Collision of UE-requested PDU session release procedure and network-requested PDU session release procedure.

When the UE receives a PDU SESSION RELEASE COMMAND message with the PTI IE set to "No procedure transaction identity assigned" during the UE-requested PDU session release procedure, the PDU session indicated in the PDU SESSION RELEASE COMMAND message is the same as the PDU session that the UE requests to release:

- if the Access type IE is included in the PDU SESSION RELEASE COMMAND message and the PDU session is an MA PDU session and having user-plane resources established on the access different from the access indicated in the Access type IE in the PDU SESSION RELEASE COMMAND message, the UE shall proceed both the UE-requested PDU session release procedure and network-requested PDU session release procedure; or
- otherwise, the UE shall abort the UE-requested PDU session release procedure and shall stop the timer T3582 and proceed with the network-requested PDU session release procedure.

NOTE 1: Whether the UE ignores the 5GSM cause #39 "reactivation requested" if received in the PDU SESSION RELEASE COMMAND is up to the UE implementation.

- d) Receipt of an indication that the 5GSM message was not forwarded due to routing failure

Upon receiving an indication that the 5GSM message was not forwarded due to routing failure along with a PDU SESSION RELEASE REQUEST message with the PDU session ID IE set to the same value as the PDU session ID that was sent by the UE, the UE shall stop timer T3582, abort the procedure, release the allocated PTI, perform a local release of the PDU session, and perform the registration procedure for mobility and periodic registration update by sending a REGISTRATION REQUEST message including the PDU session status IE over each access that user plane resources have been established if the PDU session is an MA PDU session, or over the access the PDU session is associated with if the PDU session is a single access PDU session. If there is one or more multicast MBS sessions associated with the released PDU session, the UE shall locally leave the associated multicast MBS sessions.

- e) PDU session release signalling restricted due to service area restriction

The UE may delay the release of the PDU session until the UE is not restricted by service area restrictions, or it may release the allocated PTI, perform a local release of the PDU session, and include the PDU session status IE over each access that user plane resources have been established if the PDU session is an MA PDU session, or over the access the PDU session is associated with if the PDU session is a single access PDU when performing the next registration procedure. If the UE performs the local release of the PDU session and there is one or more multicast MBS sessions associated with the released PDU session, the UE shall locally leave the associated multicast MBS sessions.

- f) Collision of UE-requested PDU session release procedure and N1 NAS signalling connection release

The UE may immediately retransmit the PDU SESSION RELEASE REQUEST message and stop, reset and restart timer T3582, if the following conditions apply:

- 1) The original UE-requested PDU session release procedure was initiated over an existing N1 NAS signalling connection; and
- 2) the previous transmission of the PDU SESSION RELEASE REQUEST message was not initiated due to timer T3582 expiry.

- g) Receipt of an indication that the 5GSM message was not forwarded due to the PLMN is not allowed to operate at the present UE location

Upon receiving an indication that the 5GSM message was not forwarded because the UE accessing via a satellite NG-RAN cell is informed that the PLMN is not allowed to operate at the present UE location along with a PDU SESSION RELEASE REQUEST message with the PDU session ID IE set to the same value as the PDU session ID that was sent by the UE, the UE shall stop timer T3582, abort the procedure and locally release the PDU session.

- ga) Upon receiving an indication that the 5GSM message was not forwarded due to unexpected cause along with a PDU SESSION RELEASE REQUEST message with the PDU session ID IE set to the same value as the PDU session ID that was sent by the UE, the UE shall stop timer T3582, abort the procedure and locally release the PDU session.

6.4.3.6 Abnormal cases on the network side

The following abnormal cases can be identified:

- a) PDU session inactive for the received PDU session identity.

If the PDU session ID in the PDU SESSION RELEASE REQUEST message belongs to any PDU session in state PDU SESSION INACTIVE in the SMF, the SMF shall send the PDU SESSION RELEASE REJECT message to the UE with the 5GSM cause #43 "Invalid PDU session identity".

6.5 5GSM status procedure

6.5.1 General

The purpose of the sending of the 5GSM STATUS message is to report at any time certain error conditions detected upon receipt of 5GSM protocol data. The 5GSM STATUS message can be sent by both the network and the UE (see example in figure 6.5.1.1).

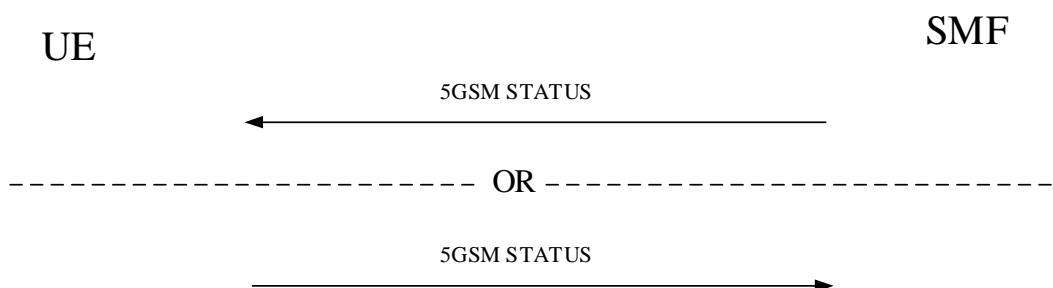

Figure 6.5.1.1: 5GSM status procedure

6.5.2 5GSM status received in the UE

If the 5GSM entity of the UE receives a 5GSM STATUS message the UE shall take different actions depending on the received 5GSM cause value:

#47 PTI mismatch.

The UE shall abort any ongoing 5GSM procedure related to the received PTI value and stop any related timer.

#81 invalid PTI value.

The UE shall abort any ongoing 5GSM procedure related to the received PTI value and stop any related timer.

#97 Message type non-existent or not implemented.

The UE shall abort any ongoing 5GSM procedure related to the PTI or PDU session ID and stop any related timer.

On receipt of a 5GSM STATUS message with any other 5GSM cause value no state transition and no specific action shall be taken as seen from the radio interface, i.e. local actions are possible.

6.5.3 5GSM status received in the SMF

If the SMF receives a 5GSM STATUS message the SMF shall take different actions depending on the received 5GSM cause value:

#43 invalid PDU session identity.

The SMF shall abort any ongoing 5GSM procedure related to the PTI or PDU session ID, stop any related timer and locally release the PDU session indicated in the 5GSM STATUS message.

#47 PTI mismatch.

The SMF shall abort any ongoing 5GSM procedure related to the received PTI value and stop any related timer.

If the PTI indicated in the 5GSM STATUS message is related to a PDU SESSION ESTABLISHMENT ACCEPT message, the SMF shall perform a local release of the PDU session indicated in the PDU SESSION ESTABLISHMENT ACCEPT message.

#81 invalid PTI value.

The SMF shall abort any ongoing 5GSM procedure related to the received PTI value and stop any related timer.

#96 invalid mandatory information.

The SMF shall abort any ongoing 5GSM procedure related to the PTI or PDU session ID and stop any related timer.

#97 message type non-existent or not implemented.

The SMF shall abort any ongoing 5GSM procedure related to the PTI or PDU session ID and stop any related timer.

The local actions to be taken by the SMF on receipt of a 5GSM STATUS message with any other 5GSM cause value are implementation dependent.

6.6 Miscellaneous procedures

6.6.1 Exchange of extended protocol configuration options

The UE and the SMF can exchange protocol configuration options via 5GSM procedures.

The protocol configuration options shall be exchanged via the Extended protocol configuration options IE.

6.6.2 Remote UE report procedure

6.6.2.1 General

The purpose of the 5G ProSe remote UE report procedure is for a UE acting as a 5G ProSe layer-3 UE-to-network UE relay to notify the network that a 5G ProSe remote UE is connected to the 5G ProSe layer-3 UE-to-network relay UE or disconnected from the 5G ProSe layer-3 UE-to-network relay UE as specified in 3GPP TS 23.304 [6E].

The UE does not initiate the remote UE report procedure if the timer T3396 is running.

The UE does not initiate the remote UE report procedure if the timer T3584 is running.

The UE does not initiate the remote UE report procedure if the timer T3585 is running.

6.6.2.2 Remote UE report procedure initiation

In order to initiate the 5G ProSe remote UE report procedure, the UE shall create a REMOTE UE REPORT message.

The UE shall include information of newly connected or disconnected 5G ProSe remote UEs to the network in the REMOTE UE REPORT message by setting the values of the Remote UE context connected IE or the Remote UE context disconnected IE to the 5G ProSe remote UE identities that are being connected or disconnected, respectively.

The UE shall set the Remote UE ID with:

- a) the UP-PRUK ID of the 5G ProSe remote UE, if the security for 5G ProSe communication via 5G ProSe UE-to-network relay is performed over user plane as specified in 3GPP TS 33.503 [56];
- b) the CP-PRUK ID of the 5G ProSe remote UE, if the security for 5G ProSe communication via 5G ProSe UE-to-network relay is performed over control plane as specified in 3GPP TS 33.503 [56]; or
- c) the PEI of the 5G ProSe remote UE, if the RSC is specific for emergency services as specified in 3GPP TS 24.554 [19E], and the 5G ProSe remote UE is identified by a PEI.

If the UE sets the Remote UE ID with the PRUK ID of the 5G ProSe remote UE and the UP-PRUK ID is in 64-bit string format, the UE shall include the HPLMN ID of the 5G ProSe remote UE.

If the UE allocated an IPv4 address to a 5G ProSe remote UE and enabled UDP usage to the 5G ProSe remote UE, the UE shall include in the REMOTE UE REPORT message the UDP port range assigned to the 5G ProSe remote UE in the NAT function of 5G ProSe layer-3 UE-to-network relay. If the UE allocated an IPv4 address to a 5G ProSe remote UE and enabled TCP usage to the 5G ProSe remote UE, the UE shall include in the REMOTE UE REPORT message the TCP port range assigned to the 5G ProSe remote UE in the NAT function of 5G ProSe layer-3 UE-to-network relay.

The UE shall set the PDU session ID IE to the value of the PDU session associated with the 5G ProSe remote UE connected to the 5G ProSe layer-3 UE-to-network relay UE or disconnected from the 5G ProSe layer-3 UE-to-network relay UE.

The UE shall allocate a PTI value currently not used and shall set the PTI IE of the REMOTE UE REPORT message to the allocated PTI value.

The UE shall transport the REMOTE UE REPORT message and the PDU session ID, using the NAS transport procedure as specified in subclause 5.4.5, and the UE shall start timer T3586 (see example in figure 6.6.2.2.1).

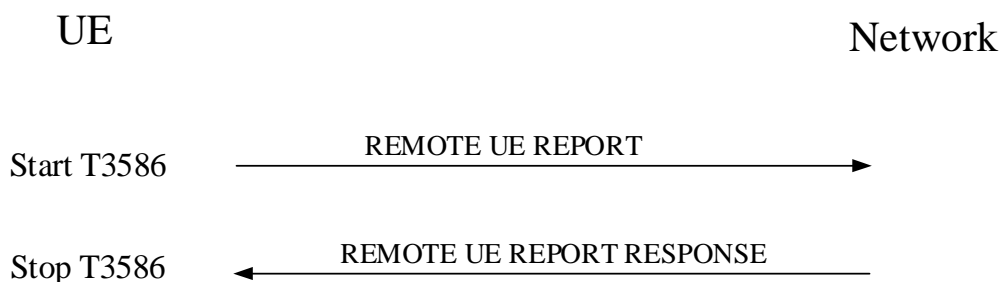

Figure 6.6.2.2.1: Remote UE report procedure

6.6.2.3 Remote UE report procedure accepted by the network

Upon receipt of the REMOTE UE REPORT message, the SMF shall send a REMOTE UE REPORT RESPONSE message to the UE. The SMF shall include the PTI from the REMOTE UE REPORT message.

The SMF shall set the EAP message IE to an EAP-success message or an EAP-failure message to be sent to the 5G ProSe layer-3 remote UE if the EAP-success message or the EAP-failure message is received from the DN.

Upon receipt of the REMOTE UE REPORT RESPONSE message, the UE shall stop timer T3586 and enter the state PROCEDURE TRANSACTION INACTIVE.

6.6.2.4 Abnormal cases in the UE

The following abnormal cases can be identified:

a) Expiry of timer T3586:

On the first expiry of the timer T3586, the UE shall resend the REMOTE UE REPORT message and shall reset and restart timer T3586. This retransmission is repeated two times, i.e. on the third expiry of timer T3586, the UE shall abort the procedure and release any resources for this procedure.

NOTE: After the abortion of the remote UE report procedure, the remote UE report procedure for the remote UE(s) can be restarted and how to restart the procedure is left to UE implementation.

b) Collision of network-requested PDU session release procedure and remote UE report procedure:

If the UE receives a PDU SESSION RELEASE COMMAND message during the remote UE report procedure, and the PDU session indicated in the PDU SESSION RELEASE COMMAND message is the PDU session ID that the UE had indicated in the REMOTE UE REPORT message, the UE shall abort the remote UE report procedure and proceed with the network-requested PDU session release procedure.

c) Collision of remote UE report procedure and N1 NAS signalling connection release:

The UE may immediately retransmit the REMOTE UE REPORT message and stop, reset and restart timer T3586, if following conditions apply:

- 1) the original REMOTE UE REPORT was initiated over an existing N1 NAS signalling connection; and
- 2) the previous transmission of the REMOTE UE REPORT message was not initiated due to timer T3586 expiry.

6.6.2.5 Abnormal cases on the network side

The following abnormal cases have been identified:

- a) Collision of network-requested PDU session release procedure and remote UE report procedure:

If the SMF receives a REMOTE UE REPORT message during a network-requested PDU session release procedure, and the PDU session indicated in the PDU SESSION RELEASE COMMAND message is the PDU session ID that is in the REMOTE UE REPORT message, the SMF shall abort the remote UE report procedure and proceed with the network-requested PDU session release procedure.

- b) PDU session inactive for the received PDU session identity:

If the PDU session ID in the REMOTE UE REPORT message belongs to any PDU session in state PDU SESSION INACTIVE in the SMF, the SMF shall send the 5GSM STATUS message to the UE with the 5GSM cause #43 "Invalid PDU session identity".

7 Handling of unknown, unforeseen, and erroneous protocol data

7.1 General

The procedures specified in the present document apply to those messages which pass the checks described in this subclause.

This subclause also specifies procedures for the handling of unknown, unforeseen, and erroneous protocol data by the receiving entity. These procedures are called "error handling procedures", but in addition to providing recovery mechanisms for error situations they define a compatibility mechanism for future extensions of the protocols.

Subclauses 7.1 to 7.8 shall be applied in order of precedence.

Detailed error handling procedures in the network are implementation dependent and may vary from PLMN to PLMN. However, when extensions of this protocol are developed, networks are assumed to have the error handling which is indicated in this subclause as mandatory ("shall") and that is indicated as strongly recommended ("should").

Also, the error handling of the network is only considered as mandatory or strongly recommended when certain thresholds for errors are not reached during a dedicated connection.

For definition of semantical and syntactical errors see 3GPP TS 24.007 [11], subclause 11.4.2.

7.2 Message too short or too long

7.2.1 Message too short

When a message is received that is too short to contain a complete message type information element, that message shall be ignored, cf. 3GPP TS 24.007 [11].

7.2.2 Message too long

The maximum size of a NAS message for NR connected to 5GCN is specified in 3GPP TS 38.323 [29].

The maximum size of a NAS message for E-UTRA connected to 5GCN is specified 3GPP TS 36.323 [25].

The maximum size of a NAS message for non-3GPP access connected to 5GCN is specified in 3GPP TS 24.502 [18]

7.3 Unknown or unforeseen procedure transaction identity or PDU Session identity

7.3.1 Procedure transaction identity

The following network procedures shall apply for handling an unknown, erroneous, or unforeseen PTI received in a 5GSM message:

- a) In case the network receives a PDU SESSION MODIFICATION COMPLETE, a PDU SESSION RELEASE COMPLETE message or a PDU SESSION MODIFICATION COMMAND REJECT message in which the PTI value is an assigned or unassigned value that does not match any PTI in use, the network shall respond with a 5GSM STATUS message including 5GSM cause #47 "PTI mismatch".
- b) In case the network receives a PDU SESSION AUTHENTICATION COMPLETE message or a SERVICE-LEVEL AUTHENTICATION COMPLETE message in which the PTI value is an assigned value, the network shall respond with a 5GSM STATUS message including 5GSM cause #81 "invalid PTI value".
- c) In case the network receives a PDU SESSION ESTABLISHMENT REQUEST message, a PDU SESSION MODIFICATION REQUEST message or a PDU SESSION RELEASE REQUEST message in which the PTI value is an unassigned value, the network shall respond with a 5GSM STATUS message including 5GSM cause #81 "invalid PTI value".
- d) In case the network receives a 5GSM message in which the PTI value is a reserved value, the network shall ignore the message.

The following UE procedures shall apply for handling an unknown, erroneous, or unforeseen PTI received in a 5GSM message:

- a) In case the UE receives a PDU SESSION MODIFICATION COMMAND message or a PDU SESSION MODIFICATION REJECT message in which the PTI value is an assigned value that does not match any PTI in use:
 - 1) if the UE detects that this PDU SESSION MODIFICATION COMMAND message is a network retransmission of an already accepted request (see subclause 6.3.2.3), the UE shall respond with a PDU SESSION MODIFICATION COMPLETE message;
 - 2) if the UE detects that this PDU SESSION MODIFICATION COMMAND message is a network retransmission of an already rejected request (see subclause 6.3.2.4), the UE shall respond with a PDU SESSION MODIFICATION COMAND REJECT message; or
 - 3) otherwise, the UE shall respond with a 5GSM STATUS message including 5GSM cause #47 "PTI mismatch".
- b) In case the UE receives a PDU SESSION RELEASE COMMAND message or a PDU SESSION RELEASE REJECT message in which the PTI value is an assigned value that does not match any PTI in use:
 - 1) if the UE detects that this PDU SESSION RELEASE COMMAND message is a network retransmission of an already accepted request (see subclause 6.3.3.3), the UE shall respond with a PDU SESSION RELEASE COMPLETE message; or
 - 2) otherwise, the UE shall respond with a 5GSM STATUS message including 5GSM cause #47 "PTI mismatch".
- c) In case the UE receives a PDU SESSION ESTABLISHMENT ACCEPT message or a PDU SESSION ESTABLISHMENT REJECT message in which the PTI value is an assigned value that does not match any PTI in use:
 - 1) the UE shall respond with a 5GSM STATUS message including 5GSM cause #47 "PTI mismatch".

- d) In case the UE receives a PDU SESSION AUTHENTICATION COMMAND message, a PDU SESSION AUTHENTICATION RESULT message or a SERVICE-LEVEL AUTHENTICATION COMMAND message in which the PTI value is an assigned value, the UE shall respond with a 5GSM STATUS message including 5GSM cause #81 "invalid PTI value".
- e) In case the UE receives a PDU SESSION ESTABLISHMENT ACCEPT message, a PDU SESSION ESTABLISHMENT REJECT message, a PDU SESSION MODIFICATION REJECT message or a PDU SESSION RELEASE REJECT message in which the PTI value is an unassigned value, the UE shall ignore the message.
- f) In case the UE receives a 5GSM message in which the PTI value is a reserved value, the UE shall ignore the message.

7.3.2 PDU Session identity

The following network procedures shall apply for handling an unknown, erroneous, or unforeseen PDU session identity received in the header of a 5GSM message (specified as the header of a standard L3 message, see 3GPP TS 24.007 [11]):

- a) If the network receives a PDU SESSION MODIFICATION REQUEST message which includes an unassigned or reserved PDU session identity value, the network shall respond with a PDU SESSION MODIFICATION REJECT message including 5GSM cause #43 "invalid PDU session identity".
- b) If the network receives PDU SESSION RELEASE REQUEST message which includes an unassigned or reserved PDU session identity value, the network shall respond with a PDU SESSION RELEASE REJECT message including 5GSM cause #43 "invalid PDU session identity".
- c) Upon receipt of an UL NAS TRANSPORT message, the network takes the following actions:
 - 1) If the Request type IE is set to "initial request" or "initial emergency request" and the message includes a reserved PDU session identity value, the network shall respond with a DL NAS TRANSPORT message with 5GMM cause #90 "payload was not forwarded";
 - 2) otherwise, if the message includes an unassigned or reserved PDU session identity value, the network shall respond with a DL NAS TRANSPORT message with 5GMM cause #90 "payload was not forwarded".
- d) If the network receives a 5GSM message other than those listed in items a) through c) above in which the message includes a reserved PDU session identity value or an assigned value that does not match an existing PDU session, the network shall ignore the message.

The following UE procedures shall apply for handling an unknown, erroneous, or unforeseen PDU session identity received in the header of a 5GSM message:

- a) If the UE receives a 5GSM message which includes an unassigned or reserved PDU session identity value, the UE shall ignore the message.
- b) If the UE receives a 5GSM message which includes a PDU session identity belonging to any PDU session in state PDU SESSION INACTIVE in the UE, the UE shall respond with a 5GSM STATUS message including 5GSM cause #43 "invalid PDU session identity".

7.4 Unknown or unforeseen message type

If UE receives a 5GMM message or 5GSM message with message type not defined for the extended protocol discriminator (EPD) or not implemented by the receiver, it shall return a status message (5GMM STATUS or 5GSM STATUS depending on the EPD) with cause #97 "message type non-existent or not implemented".

If the network receives a 5GMM or 5GSM message with message type not defined for the EPD or not implemented by the receiver in a protocol state where reception of an unsolicited message with the given EPD from the UE is not foreseen in the protocol, the network actions are implementation dependent. Otherwise, if the network receives a message with message type not defined for the EPD or not implemented by the receiver, it shall ignore the message except that it should return a status message (5GMM STATUS or 5GSM STATUS depending on the EPD) with cause #97 "message type non-existent or not implemented".

NOTE: A message type not defined for the EPD in the given direction is regarded by the receiver as a message type not defined for the EPD, see 3GPP TS 24.007 [11].

If the UE receives a message not compatible with the protocol state, the UE shall return a status message (5GMM STATUS or 5GSM STATUS depending on the EPD) with cause #98 "message type not compatible with protocol state".

If the network receives a message not compatible with the protocol state, the network actions are implementation dependent.

7.5 Non-semantical mandatory information element errors

7.5.1 Common procedures

When on receipt of a message,

- a) an "imperative message part" error; or
- b) a "missing mandatory IE" error

is diagnosed or when a message containing:

- a) a syntactically incorrect mandatory IE;
- b) an IE with an IEI unknown in the message, but encoded as "comprehension required" (see 3GPP TS 24.007 [11]); or
- c) an out of sequence IE encoded as "comprehension required" (see 3GPP TS 24.007 [11]) is received,

the UE shall proceed as follows:

If the message is not one of the messages listed in the UE procedures in subclause 7.5.3, item a), b) or c), the UE shall return a status message (5GMM STATUS or 5GSM STATUS depending on the EPD) with cause #96 "invalid mandatory information";

the network shall proceed as follows:

If the message is not one of the messages listed in the network procedures in subclause 7.5.3, item a), b) or c), the network shall either:

- 1) try to treat the message (the exact further actions are implementation dependent); or
- 2) ignore the message except that it should return a status message (5GMM STATUS or 5GSM STATUS depending on the EPD) with cause #96 "invalid mandatory information".

7.5.2 5GS mobility management

No exceptional cases are described for 5GS mobility management messages.

No semantical or syntactical diagnosis other than presence and length shall be performed on the EPS NAS message container information element in the REGISTRATION REQUEST message.

7.5.3 5GS session management

The following UE procedures shall apply for handling an error encountered with a mandatory information element in a 5GSM message:

- a) If the message is a PDU SESSION ESTABLISHMENT ACCEPT, the UE shall initiate PDU session release procedure by sending a PDU SESSION RELEASE REQUEST message with 5GSM cause #96 "invalid mandatory information".
- b) Void.

- c) If the message is a PDU SESSION RELEASE COMMAND, a PDU SESSION RELEASE COMPLETE message with 5GSM cause #96 "invalid mandatory information" shall be returned.

The following network procedures shall apply for handling an error encountered with a mandatory information element in a 5GSM message:

- a) If the message is a PDU SESSION ESTABLISHMENT REQUEST, a PDU SESSION ESTABLISHMENT REJECT message with 5GSM cause #96 "invalid mandatory information" shall be returned.
- b) If the message is a PDU SESSION MODIFICATION REQUEST, a PDU SESSION MODIFICATION REJECT message with 5GSM cause #96 "invalid mandatory information" shall be returned.
- c) If the message is a PDU SESSION RELEASE REQUEST, a PDU SESSION RELEASE REJECT message with 5GSM cause #96 "invalid mandatory information" shall be returned.

7.6 Unknown and unforeseen IEs in the non-imperative message part

7.6.1 IEs unknown in the message

The UE shall ignore all IEs with an IEI unknown in a message which are not encoded as "comprehension required" (see 3GPP TS 24.007 [11]).

The network shall take the same approach.

7.6.2 Out of sequence IEs

The UE shall ignore all out of sequence IEs in a message which are not encoded as "comprehension required" (see 3GPP TS 24.007 [11]).

The network should take the same approach.

7.6.3 Repeated IEs

If an information element with format T, TV, TLV, or TLV-E is repeated in a message in which repetition of the information element is not specified in clause 8 and clause 9 of the present document, the UE shall handle only the contents of the information element appearing first and shall ignore all subsequent repetitions of the information element. When repetition of information elements is specified, the UE shall handle only the contents of specified repeated information elements. If the limit on repetition of information elements is exceeded, the UE shall handle the contents of information elements appearing first up to the limit of repetitions and shall ignore all subsequent repetitions of the information element.

The network should follow the same procedures.

7.6.4 Unknown and unforeseen IEs in a Type 6 IE container information element

7.6.4.1 IEs unknown in the Type 6 IE container information element

The UE shall ignore all IEs with an IEI unknown in a Type 6 IE container information element which are not encoded as "comprehension required" (see 3GPP TS 24.007 [11]).

The network shall take the same approach.

- NOTE: The set of IEIs defined for a Type 6 IE container information element is independent of the set of IEIs defined for other parts of the message. Therefore, an IE can be unknown in a Type 6 IE container information element, even if an IE with the same IEI is known in other parts of the message, and vice versa.

7.6.4.2 Out of sequence IEs

The UE shall ignore all out of sequence IEs in a Type 6 IE container information element which are not encoded as "comprehension required" (see 3GPP TS 24.007 [11]).

The network should take the same approach.

7.6.4.3 Repeated IEs

If an information element with format TLV-E is repeated in a Type 6 IE container information element in which repetition of the information element is not specified in clause 8 and clause 9 of the present document, the UE shall handle only the contents of the information element appearing first and shall ignore all subsequent repetitions of the information element. When repetition of information elements in the Type 6 IE container information element is specified, the UE shall handle only the contents of specified repeated information elements. If the limit on repetition of information elements is exceeded, the UE shall handle the contents of information elements appearing first up to the limit of repetitions and shall ignore all subsequent repetitions of the information element.

The network should follow the same procedures.

7.7 Non-imperative message part errors

This category includes:

- a) syntactically incorrect optional IEs; and
- b) conditional IE errors.

7.7.1 Syntactically incorrect optional IEs

The UE shall treat all optional IEs that are syntactically incorrect in a message as not present in the message.

The network shall take the same approach.

7.7.2 Conditional IE errors

When upon receipt of a 5GMM or 5GSM message the UE diagnoses a "missing conditional IE" error or an "unexpected conditional IE" error, or when it receives a 5GMM or 5GSM message containing at least one syntactically incorrect conditional IE, the UE shall ignore the message and shall return a status message (5GMM STATUS or 5GSM STATUS depending on the EPD) with cause #100 "conditional IE error".

When the network receives a message and diagnoses a "missing conditional IE" error or an "unexpected conditional IE" error or when it receives a message containing at least one syntactically incorrect conditional IE, the network shall either:

- a) try to treat the message (the exact further actions are implementation dependent); or
- b) ignore the message except that it should return a status message (5GMM STATUS or 5GSM STATUS depending on the EPD) with cause #100 "conditional IE error".

7.7.3 Errors in a Type 6 IE container information element

7.7.3.1 Syntactically incorrect optional IEs

The UE shall treat all optional IEs that are syntactically incorrect in a Type 6 IE container information element as not present in the Type 6 IE container information element.

The network shall take the same approach.

EXAMPLE 1: If the Type 6 IE container information element includes 2 type 6 information elements, and the first one is syntactically incorrect, the receiver ignores the first information element and continues with the processing of the second one.

EXAMPLE 2: If the remaining value part of a Type 6 IE container information element is too short to contain a complete type 6 information element, the receiver ignores these octets and continues with the processing of the octets following the Type 6 IE container information element, if there are any.

7.7.3.2 Conditional IE errors

When upon receipt of a 5GMM or 5GSM message the UE diagnoses a "missing conditional IE" error or an "unexpected conditional IE" error for the contents of a Type 6 IE container information element, or when it receives a 5GMM or 5GSM message with a Type 6 IE container information element containing at least one syntactically incorrect conditional IE, the UE shall ignore the message and shall return a status message (5GMM STATUS or 5GSM STATUS depending on the EPD) with cause #100 "conditional IE error".

When the network receives a message and diagnoses a "missing conditional IE" error or an "unexpected conditional IE" error for the contents of a Type 6 IE container information element or when it receives a message with a Type 6 IE container information element containing at least one syntactically incorrect conditional IE, the network shall either:

- a) try to treat the message (the exact further actions are implementation dependent); or
- b) ignore the message except that it should return a status message (5GMM STATUS or 5GSM STATUS depending on the EPD) with cause #100 "conditional IE error".

7.8 Messages with semantically incorrect contents

When a message with semantically incorrect contents is received, the UE shall perform the foreseen reactions of the procedural part of the present document (i.e. of clauses 5, 6). If, however no such reactions are specified, the UE shall ignore the message except that it shall return a status message (5GMM STATUS or 5GSM STATUS depending on the EPD) with cause #95 "semantically incorrect message".

The network should follow the same procedure except that a status message is not normally transmitted.

8 Message functional definitions and contents

8.1 Overview

This clause defines the structure of the messages of the Layer 3 (L3) protocols defined in the present document. These are standard L3 messages as defined in 3GPP TS 24.007 [12].

Each definition given in the present clause includes:

- a) a brief description of the message direction and use, including whether the message has:
 1. Local significance, i.e. relevant only on the originating or terminating access;
 2. Access significance, i.e. relevant in the originating and terminating access, but not in the network;
 3. Dual significance, i.e. relevant in either the originating or terminating access and in the network; or
 4. Global significance, i.e. relevant in the originating and terminating access and in the network.
- b) a table listing the Information Elements (IE) known in the message and the order of their appearance in the message. All IEs that may be repeated are explicitly indicated (The V, LV and LV-E formatted IEs, which compose the imperative part of the message, occur before the T, TV, TLV and TLV-E formatted IEs which compose the non-imperative part of the message, see 3GPP TS 24.007 [12]). In a (maximal) sequence of consecutive IEs with half octet length, the first IE with half octet length occupies bits 1 to 4 of octet N, the second IE bits 5 to 8 of octet N, the third IE bits 1 to 4 of octet N+1 etc. Such a sequence always has an even number of elements.

For each information element the table indicates:

1. The Information Element Identifier (IEI), in hexadecimal notation, if the IE has format T, TV, TLV or TLV-E. If the IEI has half octet length, it is specified by a notation representing the IEI as a hexadecimal digit followed by a "-" (example: B-).

NOTE 1: The same IEI can be used for different information element types in different messages of the same protocol.

NOTE 2: If a message includes a Type 6 IE container information element, then the same IEI can be used for different information element types in the Type 6 IE container information element and in other parts of the same message.

2. The name of the information element (which may give an idea of the semantics of the element). The name of the information element followed by "IE" or "information element" is used in this technical report as reference to the information element within a message.
 3. The name of the type of the information element (which indicates the coding of the value part of the IE), and generally, the referenced subclause of clause 9 of the present document describing the value part of the information element.
 4. The presence requirement indication (M, C, or O) for the IE as defined in 3GPP TS 24.007 [12].
 5. The format of the information element (T, V, TV, LV, TLV, LV-E or TLV-E) as defined in 3GPP TS 24.007 [12].
 6. The length of the information element (or permissible range of lengths), in octets, in the message, where "?" means that the maximum length of the IE is only constrained by link layer protocol. This indication is non-normative.
- c) subclauses specifying, where appropriate, conditions for IEs with presence requirement C or O in the relevant message which together with other conditions specified in the present document define when the information elements shall be included or not, what non-presence of such IEs means, and – for IEs with presence requirement C – the static conditions for presence or non-presence of the IEs or for both cases (see 3GPP TS 24.007 [12]).

8.2 5GS mobility management messages

8.2.1 Authentication request

8.2.1.1 Message definition

The AUTHENTICATION REQUEST message is sent by the AMF to the UE to initiate authentication of the UE identity. See table 8.2.1.1.1.

Message type: AUTHENTICATION REQUEST

Significance: dual

Direction: network to UE

Table 8.2.1.1.1: AUTHENTICATION REQUEST message content

IEI	Information Element	Type/Reference	Presence	Format	Length
	Extended protocol discriminator	Extended protocol discriminator 9.2	M	V	1
	Security header type	Security header type 9.3	M	V	1/2
	Spare half octet	Spare half octet 9.5	M	V	1/2
	Authentication request message identity	Message type 9.7	M	V	1
	ngKSI	NAS key set identifier 9.11.3.32	M	V	1/2
	Spare half octet	Spare half octet 9.5	M	V	1/2
	ABBA	ABBA 9.11.3.10	M	LV	3-n
21	Authentication parameter RAND (5G authentication challenge)	Authentication parameter RAND 9.11.3.16	O	TV	17
20	Authentication parameter AUTN (5G authentication challenge)	Authentication parameter AUTN 9.11.3.15	O	TLV	18
78	EAP message	EAP message 9.11.2.2	O	TLV-E	7-1503

8.2.1.2 Authentication parameter RAND

Authentication parameter RAND IE is included if the AUTHENTICATION REQUEST message is used in a 5G AKA authentication procedure.

8.2.1.3 Authentication parameter AUTN

Authentication parameter AUTN IE is included if the AUTHENTICATION REQUEST message is used in a 5G AKA authentication procedure.

8.2.1.4 Void

8.2.1.5 EAP message

EAP message IE is included if the AUTHENTICATION REQUEST message is used in an EAP based primary authentication and key agreement procedure.

8.2.2 Authentication response

8.2.2.1 Message definition

The AUTHENTICATION RESPONSE message is sent by the UE to the AMF to deliver a calculated authentication response to the network. See table 8.2.2.1.1.

Message type: AUTHENTICATION RESPONSE

Significance: dual

Direction: UE to network

Table 8.2.2.1.1: AUTHENTICATION RESPONSE message content

IEI	Information Element	Type/Reference	Presence	Format	Length
	Extended protocol discriminator	Extended protocol discriminator 9.2	M	V	1
	Security header type	Security header type 9.3	M	V	1/2
	Spare half octet	Spare half octet 9.5	M	V	1/2
	Authentication response message identity	Message type 9.7	M	V	1
2D	Authentication response parameter	Authentication response parameter 9.11.3.17	O	TLV	18
78	EAP message	EAP message 9.11.2.2	O	TLV-E	7-1503

8.2.2.2 Authentication response parameter

This IE is included if the message is sent in a 5G AKA based primary authentication and key agreement procedure.

8.2.2.3 EAP message

EAP message IE is included if the EAP message received in a related AUTHENTICATION REQUEST message was an EAP-request.

8.2.3 Authentication result

8.2.3.1 Message definition

The AUTHENTICATION RESULT message is sent by the AMF to the UE to provide result of EAP authentication of the UE identity. See table 8.2.3.1.1.

Message type: AUTHENTICATION RESULT

Significance: dual

Direction: network to UE

Table 8.2.3.1.1: AUTHENTICATION RESULT message content

IEI	Information Element	Type/Reference	Presence	Format	Length
	Extended protocol discriminator	Extended protocol discriminator 9.2	M	V	1
	Security header type	Security header type 9.3	M	V	1/2
	Spare half octet	Spare half octet 9.5	M	V	1/2
	Authentication result message identity	Message type 9.7	M	V	1
	ngKSI	NAS key set identifier 9.11.3.32	M	V	1/2
	Spare half octet	Spare half octet 9.5	M	V	1/2
	EAP message	EAP message 9.11.2.2	M	LV-E	6-1502
38	ABBA	ABBA 9.11.3.10	O	TLV	4-n
55	AUN3 device security key	AUN3 device security key 9.11.3.107	O	TLV	36-n

NOTE: It is possible for AMFs compliant with version 18.3.0 or 18.3.1 of this specification to send the AUN3 device security key IE with a fixed length of 66 octets.

8.2.3.2 ABBA

This IE shall be included if the message contains an EAP message IE with an EAP-success message.

8.2.3.3 AUN3 device security key

This IE shall be included when the AUTHENTICATION RESULT message is provided to a 5G-RG that is acting on behalf of an AUN3 device if the EAP message IE is set to an EAP-success message.

8.2.4 Authentication failure

8.2.4.1 Message definition

The AUTHENTICATION FAILURE message is sent by the UE to the AMF to indicate that authentication of the network has failed. See table 8.2.4.1.1.

Message type: AUTHENTICATION FAILURE

Significance: dual

Direction: UE to network

Table 8.2.4.1.1: AUTHENTICATION FAILURE message content

IEI	Information Element	Type/Reference	Presence	Format	Length
	Extended protocol discriminator	Extended protocol discriminator 9.2	M	V	1
	Security header type	Security header type 9.3	M	V	1/2
	Spare half octet	Spare half octet 9.5	M	V	1/2
	Authentication failure message identity	Message type 9.7	M	V	1
	5GMM cause	5GMM cause 9.11.3.2	M	V	1
30	Authentication failure parameter	Authentication failure parameter 9.11.3.14	O	TLV	16

8.2.4.2 Authentication failure parameter

This IE shall be included in a 5G AKA based primary authentication and key agreement procedure if and only if the 5GMM cause was #21 "synch failure". It shall include the response to the authentication challenge from the USIM, which is made up of the AUTS parameter (see 3GPP TS 33.501 [24]).

8.2.5 Authentication reject

8.2.5.1 Message definition

The AUTHENTICATION REJECT message is sent by the AMF to the UE to indicate that the authentication procedure has failed and that the UE shall abort all activities. See table 8.2.5.1.1.

Message type: AUTHENTICATION REJECT

Significance: dual

Direction: network to UE

Table 8.2.5.1.1: AUTHENTICATION REJECT message content

IEI	Information Element	Type/Reference	Presence	Format	Length
	Extended protocol discriminator	Extended protocol discriminator 9.2	M	V	1
	Security header type	Security header type 9.3	M	V	1/2
	Spare half octet	Spare half octet 9.5	M	V	1/2
	Authentication reject message identity	Message type 9.7	M	V	1
78	EAP message	EAP message 9.11.2.2	O	TLV-E	7-1503

8.2.5.2 EAP message

EAP message IE is included if the AUTHENTICATION REJECT message is used to convey EAP-failure message.

8.2.6 Registration request

8.2.6.1 Message definition

The REGISTRATION REQUEST message is sent by the UE to the AMF. See table 8.2.6.1.1.

Message type: REGISTRATION REQUEST

Significance: dual

Direction: UE to network

Table 8.2.6.1.1: REGISTRATION REQUEST message content

IEI	Information Element	Type/Reference	Presence	Format	Length
	Extended protocol discriminator	Extended Protocol discriminator 9.2	M	V	1
	Security header type	Security header type 9.3	M	V	1/2
	Spare half octet	Spare half octet 9.5	M	V	1/2
	Registration request message identity	Message type 9.7	M	V	1
	5GS registration type	5GS registration type 9.11.3.7	M	V	1/2
	ngKSI	NAS key set identifier 9.11.3.32	M	V	1/2
	5GS mobile identity	5GS mobile identity 9.11.3.4	M	LV-E	6-n
C-	Non-current native NAS key set identifier	NAS key set identifier 9.11.3.32	O	TV	1
10	5GMM capability	5GMM capability 9.11.3.1	O	TLV	3-15
2E	UE security capability	UE security capability 9.11.3.54	O	TLV	4-10
2F	Requested NSSAI	NSSAI 9.11.3.37	O	TLV	4-74
52	Last visited registered TAI	5GS tracking area identity 9.11.3.8	O	TV	7
17	S1 UE network capability	S1 UE network capability 9.11.3.48	O	TLV	4-15
40	Uplink data status	Uplink data status 9.11.3.57	O	TLV	4-34
50	PDU session status	PDU session status 9.11.3.44	O	TLV	4-34
B-	MICO indication	MICO indication 9.11.3.31	O	TV	1
2B	UE status	UE status 9.11.3.56	O	TLV	3
77	Additional GUTI	5GS mobile identity 9.11.3.4	O	TLV-E	14
25	Allowed PDU session status	Allowed PDU session status 9.11.3.13	O	TLV	4-34
18	UE's usage setting	UE's usage setting 9.11.3.55	O	TLV	3
51	Requested DRX parameters	5GS DRX parameters 9.11.3.2A	O	TLV	3
70	EPS NAS message container	EPS NAS message container 9.11.3.24	O	TLV-E	4-n
74	LADN indication	LADN indication 9.11.3.29	O	TLV-E	3-811
8-	Payload container type	Payload container type 9.11.3.40	O	TV	1
7B	Payload container	Payload container 9.11.3.39	O	TLV-E	4-65538
9-	Network slicing indication	Network slicing indication 9.11.3.36	O	TV	1
53	5GS update type	5GS update type 9.11.3.9A	O	TLV	3
41	Mobile station classmark 2	Mobile station classmark 2 9.11.3.31C	O	TLV	5
42	Supported codecs	Supported codec list 9.11.3.51A	O	TLV	5-n
71	NAS message container	NAS message container 9.11.3.33	O	TLV-E	4-n
60	EPS bearer context status	EPS bearer context status 9.11.3.23A	O	TLV	4
6E	Requested extended DRX parameters	Extended DRX parameters 9.11.3.26A	O	TLV	3-4

6A	T3324 value	GPRS timer 3 9.11.2.5	O	TLV	3
67	UE radio capability ID	UE radio capability ID 9.11.3.68	O	TLV	3-n
35	Requested mapped NSSAI	Mapped NSSAI 9.11.3.31B	O	TLV	3-42
48	Additional information requested	Additional information requested 9.11.3.12A	O	TLV	3
1A	Requested WUS assistance information	WUS assistance information 9.11.3.71	O	TLV	3-n
A-	N5GC indication	N5GC indication 9.11.3.72	O	TV	1
30	Requested NB-N1 mode DRX parameters	NB-N1 mode DRX parameters 9.11.3.73	O	TLV	3
29	UE request type	UE request type 9.11.3.76	O	TLV	3
28	Paging restriction	Paging restriction 9.11.3.77	O	TLV	3-35
72	Service-level-AA container	Service-level-AA container 9.11.2.10	O	TLV-E	4-65538
32	NID	NID 9.11.3.79	O	TLV	8
16	UE determined PLMN with disaster condition	PLMN identity 9.11.3.85	O	TLV	5
2A	Requested PEIPS assistance information	PEIPS assistance information 9.11.3.80	O	TLV	3-n
3B	Requested T3512 value	GPRS timer 3 9.11.2.5	O	TLV	3
3C	Unavailability information	Unavailability information 9.11.2.20	O	TLV	3-9
3F	Non-3GPP path switching information	Non-3GPP path switching information 9.11.3.102	O	TLV	3
56	AUN3 indication	AUN3 indication 9.11.3.104	O	TLV	3

8.2.6.2 Non-current native NAS key set identifier

The UE shall include this IE if the UE has a valid non-current native 5G NAS security context when the UE performs an inter-system change from S1 mode to N1 mode in 5GMM-CONNECTED mode and the UE uses a mapped 5G NAS security context to protect the REGISTRATION REQUEST message.

8.2.6.3 5GMM capability

The UE shall include this IE, unless the UE performs a periodic registration updating procedure.

8.2.6.4 UE security capability

The UE shall include this IE, unless the UE performs a periodic registration updating procedure.

8.2.6.5 Requested NSSAI

This IE shall be included by the UE when performing the registration procedure if the 5GS registration type IE indicates:

- a) "initial registration", according to the conditions specified in subclause 5.5.1.2.2; or
- b) "mobility registration updating", according to the conditions specified in subclause 5.5.1.3.2.

8.2.6.6 Last visited registered TAI

This IE shall be included if the UE holds a valid last visited registered TAI.

8.2.6.7 S1 UE network capability

A UE supporting S1 mode shall include this IE, unless the UE performs a periodic registration updating procedure.

8.2.6.8 Uplink data status

This IE shall be included if the UE has uplink user data pending to be sent or the UE has active multicast MBS session(s), unless the UE performs a periodic registration updating procedure.

8.2.6.9 PDU session status

This IE shall be included when the UE needs to indicate the PDU sessions that are associated with the access type that the message is sent over, that are active within the UE.

8.2.6.10 MICO indication

The UE may include this IE to request the use of MICO mode.

8.2.6.11 UE status

This IE shall be included if the UE in single-registration mode performs the registration procedure due to inter-system change from S1 mode to N1 mode or if the UE in dual-registration mode and EMM state EMM-REGISTERED performs initial registration.

8.2.6.12 Additional GUTI

This IE shall be included:

- a) if the UE performs the registration procedure due to inter-system change from S1 mode to N1 mode, the UE operates in single-registration mode and the UE has a valid 5G-GUTI; or
- b) the UE holds two valid native 5G-GUTIs and one of the valid native 5G-GUTI was assigned by the PLMN with which the UE is performing the registration.

8.2.6.13 Allowed PDU session status

This IE shall be included if the REGISTRATION REQUEST message is sent as a response to paging with the access type indicating non-3GPP access.

8.2.6.14 UE's usage setting

This IE shall be included if the UE supports IMS voice.

8.2.6.15 Requested DRX parameters

If the UE wants to use or change the UE specific DRX parameters, the UE shall include the Requested DRX parameters IE in the REGISTRATION REQUEST message.

8.2.6.16 EPS NAS message container

The UE operating in the single-registration mode shall include this information element as specified in subclause 5.5.1.3.2 if the UE performs mobility from S1 mode to N1 mode in 5GMM-IDLE mode. The content of this message container is the complete integrity protected TRACKING AREA UPDATE REQUEST message, using EPS security context.

The UE performing initial registration shall include this information element if

- a) the UE:
 - 1) was previously registered in S1 mode before entering state EMM-DEREGISTERED; and

- 2) has received an "interworking without N26 interface not supported" indication from the network; and
- b) EPS security context and a valid 4G-GUTI are available.

The content of this message container is the complete integrity protected ATTACH REQUEST message, using EPS security context.

8.2.6.17 LADN indication

The UE shall include this information element when the UE needs to request LADN information for specific LADN DNN(s) or to indicate a request for LADN information.

8.2.6.17A Payload container type

This IE shall be included if the UE includes the Payload container IE.

NOTE: In this version of the protocol, the Payload container type IE in the REGISTRATION REQUEST message is set to "UE policy container" as described in subclauses 5.5.1.2.2 and 5.5.1.3.2.

8.2.6.18 Payload container

Within a PLMN, this IE shall be included if:

- a) the UE has one or more stored UE policy sections identified by a UPSI with the PLMN ID part indicating the HPLMN or the selected PLMN for the registration procedure for mobility and periodic registration update due to inter-system change from S1 mode to N1 mode of a UE operating in the single-registration mode or for the registration procedure for initial registration; or
- b) the UE does not have any stored UE policy section identified by a UPSI with the PLMN ID part indicating the HPLMN or the selected PLMN for the registration procedure for mobility and periodic registration update due to inter-system change from S1 mode to N1 mode of a UE operating in the single-registration mode or for the registration procedure for initial registration and the UE needs to send a UE policy container to the network.

Within an SNPN, this IE shall be included if:

- a) the UE has one or more stored UE policy sections for the selected SNPN for the registration procedure for initial registration; or
- b) the UE does not have any UE policy section for the selected SNPN for the registration procedure for initial registration and the UE needs to send a UE policy container to the network.

8.2.6.19 Network slicing indication

This IE shall be included when a requested NSSAI is included in the REGISTRATION REQUEST message and the requested NSSAI is created from the default configured NSSAI.

8.2.6.20 5GS update type

This IE shall be included when the UE is performing the registration procedure to indicate any of the following:

- a) the UE requests the use of SMS over NAS or there is a change in the UE's requirements to use SMS over NAS;
- b) a change in the UE's radio capability for NG-RAN; or
- c) the UE requests CIoT 5GS optimizations.

8.2.6.21 NAS message container

This IE shall be included if the UE is sending a REGISTRATION REQUEST message as an initial NAS message, the UE has a valid 5G NAS security context and the UE needs to send non-clear-text IEs.

8.2.6.22 Requested extended DRX parameters

The UE shall include this IE if the UE needs to use extended DRX or change the extended DRX parameters.

8.2.6.23 EPS bearer context status

The UE shall include this IE if the UE operating in the single-registration mode performs inter-system change from S1 mode to N1 mode and the UE has locally deactivated EPS bearer context(s) for which interworking to 5GS is supported while the UE was in S1 mode without notifying the network.

8.2.6.24 T3324 value

The UE may include this IE during the registration update procedure if it requests to use MICO mode and use the active time timer.

8.2.6.25 Mobile station classmark 2

This IE shall be included if the UE supports 5G-SRVCC from NG-RAN to UTRAN (see 3GPP TS 23.216 [6A]).

8.2.6.26 Supported codecs

This IE shall be included if the UE supports 5G-SRVCC from NG-RAN to UTRAN.

8.2.6.27 UE radio capability ID

This IE shall be included if the UE is not in NB-N1 mode, the UE supports RACS and the UE needs to signal a UE radio capability ID to the network.

8.2.6.28 Requested mapped NSSAI

This IE shall be included by the UE when the UE has a PDN connection or a PDU session to transfer to visited PLMN associated only with an S-NSSAI that is applicable in the HPLMN as specified in subclause 5.5.1.3.2.

8.2.6.29 Additional information requested

The UE shall include this IE if the UE supports ciphered broadcast assistance data and the UE needs to obtain new ciphering keys for ciphered broadcast assistance data.

8.2.6.30 Requested WUS assistance information

The UE may include this IE if:

- the UE supports WUS assistance information;
- the UE is not performing initial registration for emergency services; and
- the UE does not have an active emergency PDU session.

8.2.6.31 Void

8.2.6.32 N5GC indication

This IE shall be included in the REGISTRATION REQUEST message when the W-AGF is acting on behalf of an N5GC device.

8.2.6.33 Requested NB-N1 mode DRX parameters

The UE shall include this IE if the UE wants to use or change the UE specific DRX parameters for NB-N1 mode.

8.2.6.34 UE request type

The UE shall include this IE if the MUSIM UE requests the release of the NAS signalling connection.

8.2.6.35 Paging restriction

The UE shall include this IE if the Request type is set to "NAS signalling connection release" in the UE request type IE and the UE requests the network to restrict paging.

8.2.6.35 Service-level-AA container

The UE shall include this IE if the UE supporting UAS services requests a registration for UAS services.

8.2.6.36 NID

The UE shall include this IE if the 5G-GUTI in the 5GS mobile identity IE was assigned by an SNPN other than the SNPN with which the UE is registering.

8.2.6.37 UE determined PLMN with disaster condition

The UE shall include this IE when the UE needs to indicate the UE determined PLMN with disaster condition determined as specified in 3GPP TS 23.122 [5].

8.2.6.38 Requested PEIPS assistance information

The UE may include this IE if the UE supports NR paging subgrouping, the UE is not performing initial registration for emergency services, is not registered for emergency services and does not have an active emergency PDU session.

8.2.6.39 Requested T3512 value

The UE may include this IE during the registration procedure if it requests to use MICO mode and T3324 IE is included, to request a particular T3512 timer value.

8.2.6.40 Unavailability information

This IE shall be included if an event is triggered in the UE that would make the UE unavailable for a certain period.

8.2.6.41 Non-3GPP path switching information

The UE may include this IE during the registration procedure for mobility registration update if it requests from the network to keep using the user plane resources of the old non-3GPP access during path switching to the new non-3GPP access.

8.2.6.42 AUN3 indication

This IE shall be included in the REGISTRATION REQUEST message when the 5G-RG is acting on behalf of an AUN3 device.

8.2.7 Registration accept

8.2.7.1 Message definition

The REGISTRATION ACCEPT message is sent by the AMF to the UE. See table 8.2.7.1.1.

Message type: REGISTRATION ACCEPT

Significance: dual

Direction: network to UE

Table 8.2.7.1.1: REGISTRATION ACCEPT message content

IEI	Information Element	Type/Reference	Presence	Format	Length
	Extended protocol discriminator	Extended protocol discriminator 9.2	M	V	1
	Security header type	Security header type 9.3	M	V	1/2
	Spare half octet	Spare half octet 9.5	M	V	1/2
	Registration accept message identity	Message type 9.7	M	V	1
	5GS registration result	5GS registration result 9.11.3.6	M	LV	2
77	5G-GUTI	5GS mobile identity 9.11.3.4	O	TLV-E	14
4A	Equivalent PLMNs	PLMN list 9.11.3.45	O	TLV	5-47
54	TAI list	5GS tracking area identity list 9.11.3.9	O	TLV	9-114
15	Allowed NSSAI	NSSAI 9.11.3.37	O	TLV	4-74
11	Rejected NSSAI	Rejected NSSAI 9.11.3.46	O	TLV	4-42
31	Configured NSSAI	NSSAI 9.11.3.37	O	TLV	4-146
21	5GS network feature support	5GS network feature support 9.11.3.5	O	TLV	3-6
50	PDU session status	PDU session status 9.11.3.44	O	TLV	4-34
26	PDU session reactivation result	PDU session reactivation result 9.11.3.42	O	TLV	4-34
72	PDU session reactivation result error cause	PDU session reactivation result error cause 9.11.3.43	O	TLV-E	5-515
79	LADN information	LADN information 9.11.3.30	O	TLV-E	13-1715
B-	MICO indication	MICO indication 9.11.3.31	O	TV	1
9-	Network slicing indication	Network slicing indication 9.11.3.36	O	TV	1
27	Service area list	Service area list 9.11.3.49	O	TLV	6-114
5E	T3512 value	GPRS timer 3 9.11.2.5	O	TLV	3
5D	Non-3GPP de-registration timer value	GPRS timer 2 9.11.2.4	O	TLV	3
16	T3502 value	GPRS timer 2 9.11.2.4	O	TLV	3
34	Emergency number list	Emergency number list 9.11.3.23	O	TLV	5-50
7A	Extended emergency number list	Extended emergency number list 9.11.3.26	O	TLV-E	7-65538
73	SOR transparent container	SOR transparent container 9.11.3.51	O	TLV-E	20-n
78	EAP message	EAP message 9.11.2.2	O	TLV-E	7-1503
A-	NSSAI inclusion mode	NSSAI inclusion mode 9.11.3.37A	O	TV	1
76	Operator-defined access category definitions	Operator-defined access category definitions 9.11.3.38	O	TLV-E	3-8323
51	Negotiated DRX parameters	5GS DRX parameters 9.11.3.2A	O	TLV	3
D-	Non-3GPP NW policies	Non-3GPP NW provided policies 9.11.3.36A	O	TV	1
60	EPS bearer context status	EPS bearer context status 9.11.3.23A	O	TLV	4

6E	Negotiated extended DRX parameters	Extended DRX parameters 9.11.3.26A	O	TLV	3-4
6C	T3447 value	GPRS timer 3 9.11.2.5	O	TLV	3
6B	T3448 value	GPRS timer 2 9.11.2.4	O	TLV	3
6A	T3324 value	GPRS timer 3 9.11.2.5	O	TLV	3
67	UE radio capability ID	UE radio capability ID 9.11.3.68	O	TLV	3-n
E-	UE radio capability ID deletion indication	UE radio capability ID deletion indication 9.11.3.69	O	TV	1
39	Pending NSSAI	NSSAI 9.11.3.37	O	TLV	4-146
74	Ciphering key data	Ciphering key data 9.11.3.18C	O	TLV-E	34-n
75	CAG information list	CAG information list 9.11.3.18A	O	TLV-E	3-n
1B	Truncated 5G-S-TMSI configuration	Truncated 5G-S-TMSI configuration 9.11.3.70	O	TLV	3
1C	Negotiated WUS assistance information	WUS assistance information 9.11.3.71	O	TLV	3-n
29	Negotiated NB-N1 mode DRX parameters	NB-N1 mode DRX parameters 9.11.3.73	O	TLV	3
68	Extended rejected NSSAI	Extended rejected NSSAI 9.11.3.75	O	TLV	5-90
7B	Service-level-AA container	Service-level-AA container 9.11.2.10	O	TLV-E	4-65538
33	Negotiated PEIPS assistance information	PEIPS assistance information 9.11.3.80	O	TLV	3-n
35	5GS additional request result	5GS additional request result 9.11.3.81	O	TLV	3
70	NSSRG information	NSSRG information 9.11.3.82	O	TLV-E	7-4099
14	Disaster roaming wait range	Registration wait range 9.11.3.84	O	TLV	4
2C	Disaster return wait range	Registration wait range 9.11.3.84	O	TLV	4
13	List of PLMNs to be used in disaster condition	List of PLMNs to be used in disaster condition 9.11.3.83	O	TLV	2-n
1D	Forbidden TAI(s) for the list of "5GS forbidden tracking areas for roaming"	5GS tracking area identity list 9.11.3.9	O	TLV	9-114
1E	Forbidden TAI(s) for the list of "5GS forbidden tracking areas for regional provision of service"	5GS tracking area identity list 9.11.3.9	O	TLV	9-114
71	Extended CAG information list	Extended CAG information list 9.11.3.86	O	TLV-E	3-n
7C	NSAG information	NSAG information 9.11.3.87	O	TLV-E	9-3143
3D	Equivalent SNPNs	SNPN list 9.11.3.92	O	TLV	11-137
32	NID	NID 9.11.3.79	O	TLV	8
7D	Registration accept type 6 IE container	Type 6 IE container 9.11.3.98	O	TLV-E	6-65538
4B	RAN timing synchronization	RAN timing synchronization 9.11.3.95	O	TLV	3
4C	Alternative NSSAI	Alternative NSSAI 9.11.3.97	O	TLV	2-146
4F	Maximum time offset	GPRS timer 3 9.11.2.5	O	TLV	3

5B	S-NSSAI time validity information	S-NSSAI time validity information 9.11.3.101	O	TLV	23-257
3C	Unavailability configuration	Unavailability configuration 9.11.2.21	O	TLV	3-6
5C	Feature authorization indication	Feature authorization indication 9.11.3.105	O	TLV	3-257
61	On-demand NSSAI	On-demand NSSAI 9.11.3.108	O	TLV	5-210

8.2.7.2 5G-GUTI

This IE may be included to assign a 5G-GUTI to a UE.

8.2.7.3 Equivalent PLMNs

This IE may be included in order to assign an equivalent PLMNs list to a UE.

8.2.7.4 TAI list

This IE may be included to assign a TAI list to a UE.

8.2.7.5 Allowed NSSAI

This IE shall be included:

- a) if:
 - 1) one or more S-NSSAIs in the requested NSSAI of the REGISTRATION REQUEST message are allowed by the AMF for a network not supporting NSSAA;
 - 2) one or more S-NSSAIs in the requested NSSAI of the REGISTRATION REQUEST message are not subject to network slice-specific authentication and authorization and are allowed by the AMF; or
 - 3) the network slice-specific authentication and authorization has been successfully performed for one or more S-NSSAIs in the requested NSSAI of the REGISTRATION REQUEST message; or
- b) if the initial registration request is not for onboarding services in SNPN or the UE is not registered for onboarding services in SNPN, the requested NSSAI was not included in the REGISTRATION REQUEST message or none of the requested NSSAI are allowed; and
 - 1) the network does not support NSSAA; or
 - 2) the network has one or more default S-NSSAIs which are not subject to network slice-specific authentication and authorization.

8.2.7.6 Rejected NSSAI

The network may include this IE to inform the UE of one or more S-NSSAIs that were included in the requested NSSAI in the REGISTRATION REQUEST message but were rejected by the network.

8.2.7.7 Configured NSSAI

The network may include this IE if the network needs to provide the UE with a new configured NSSAI for the current PLMN or SNPN and the UE is neither registering nor registered for onboarding services in SNPN.

8.2.7.8 5GS network feature support

The network may include this IE to inform the UE of the support of certain features. If this IE is not included then the UE shall interpret this as a receipt of an information element with all bits of the value part coded as zero.

8.2.7.9 PDU session status

This IE shall be included when the network needs to indicate the PDU sessions that are associated with the access type the message is sent over, that are active in the network.

8.2.7.10 PDU session reactivation result

This IE shall be included:

- if the Uplink data status IE is included in the REGISTRATION REQUEST message; or
- if the Allowed PDU session status IE is included in the REGISTRATION REQUEST message and there is at least one PDU session indicated in the Allowed PDU session status IE for which the user-plane resources can be re-established over 3GPP access.

8.2.7.11 PDU session reactivation result error cause

This IE may be included, if the PDU session reactivation result IE is included and there exist one or more PDU sessions for which the user-plane resources cannot be re-established, to indicate the cause of failure to re-establish the user-plane resources.

8.2.7.12 LADN information

The network shall include this IE if there are valid LADN service area(s) for the subscribed DNN(s) of the UE in the current registration area.

8.2.7.13 MICO indication

The network shall include the MICO indication IE if:

- a)- the UE included the MICO indication IE in the REGISTRATION REQUEST message; and
- b) the network supports and accepts the use of MICO mode.

8.2.7.14 Network slicing indication

This IE shall be included if the user's network slicing subscription has changed in the UDM of a PLMN or an SNPN.

8.2.7.15 Service area list

This IE may be included to assign new service area restrictions to the UE.

8.2.7.16 T3512 value

The AMF shall include this IE during a registration procedure over 3GPP access when the 5GS registration type IE does not indicate "periodic registration updating". The AMF may include this IE during the mobility and periodic registration update procedure over 3GPP access when the 5GS registration type IE indicates "periodic registration updating".

8.2.7.17 Non-3GPP de-registration timer value

This IE may be included if the network needs to indicate to the UE registered over non-3GPP access the value of a non-3GPP de-registration timer value.

8.2.7.18 T3502 value

This IE may be included to indicate a value for timer T3502.

8.2.7.19 Emergency number list

This IE may be sent by the network. If this IE is sent, the contents of this IE indicates a list of emergency numbers valid within the same country as in the PLMN from which this IE is received.

8.2.7.20 Extended emergency number list

This IE may be sent by the network. If this IE is sent, the contents of this IE indicates a list of emergency numbers (with URN information) valid within the same country as in the PLMN from which this IE is received or valid only in the PLMN or SNPN from which this IE is received.

8.2.7.21 SOR transparent container

This IE may be sent by the network.

8.2.7.22 EAP message

EAP message IE is included if the REGISTRATION ACCEPT message is sent as part of registration for emergency services and is used to convey EAP-failure message.

8.2.7.23 NSSAI inclusion mode

This IE shall be included if required by operatory policy.

8.2.7.24 Operator-defined access category definitions

This IE may be included to assign new operator-defined access category definitions to the UE or delete the operator-defined access category definitions at the UE side.

8.2.7.25 Negotiated DRX parameters

The network shall include this IE if the Requested DRX parameters IE was included in the REGISTRATION REQUEST message.

8.2.7.26 Non-3GPP NW policies

The AMF shall not include this IE during a registration procedure over non-3GPP access.

This IE is included if the network needs to indicate whether emergency numbers provided via non-3GPP access can be used to initiate UE detected emergency calls (see 3GPP TS 24.302 [16]). If this IE is not included then the UE shall interpret this as a receipt of an information element with all bits of the value part coded as zero.

NOTE: In this version of the specification, this IE is applicable in case the UE is connected to a PLMN using an ePDG as specified in 3GPP TS 24.302 [16].

8.2.7.27 Negotiated extended DRX parameters

The network shall include the Negotiated extended DRX parameters IE if:

- the UE included the Requested extended DRX parameters IE in the REGISTRATION REQUEST message; and
- the network supports eDRX and accepts the use of eDRX.

8.2.7.28 T3447 value

The network may include T3447 value IE if:

- the UE has indicated support for service gap control in the REGISTRATION REQUEST message; and
- the 5GMM context contains a service gap time value.

8.2.7.29 T3448 value

The network may include this IE if the congestion control for transport of user data via the control plane is active and the UE supports the control plane CIoT 5GS optimizations.

8.2.7.30 T3324 value

The AMF shall include this IE if the UE has requested active time value in the REGISTRATION REQUEST message and the AMF decides to accept the use of MICO mode and the use of the active time.

8.2.7.31 EPS bearer context status

This IE shall be included when the network generated an EPS bearer context status information for the UE during the inter-system change from S1 mode to N1 mode and the network supports N26 interface.

8.2.7.32 UE radio capability ID

This IE may be included if the UE is not in NB-N1 mode, both the UE and the network support RACS and the network needs to assign a network-assigned UE radio capability ID to the UE.

8.2.7.33 UE radio capability ID deletion indication

This IE may be included if the UE is not in NB-N1 mode, both the UE and the network support RACS and the network needs to trigger the UE to delete all network-assigned UE radio capability IDs stored at the UE for the serving PLMN or SNPN.

8.2.7.34 Pending NSSAI

The network may include this IE to inform the UE of one or more S-NSSAIs that are pending as the network slice-specific authentication and authorization procedure is not completed.

8.2.7.35 Ciphering key data

This IE is included if the network needs to send ciphering key data to the UE for ciphered broadcast assistance data.

8.2.7.36 CAG information list

This IE may be included to assign a new "CAG information list" to the UE or delete the "CAG information list" at the UE side.

8.2.7.37 Truncated 5G-S-TMSI configuration

The network shall include this IE if:

- the UE is in NB-N1 mode;
- the UE requests "control plane CIoT 5GS optimization" in the 5GS update type IE of REGISTRATION REQUEST message;
- the AMF decides to accept the requested CIoT 5GS optimization; and
- the network is configured to provide the truncated 5G-S-TMSI configuration for control plane CIoT 5GS optimizations.

8.2.7.38 Negotiated NB-N1 mode DRX parameters

The network shall include the Negotiated NB-N1 mode DRX parameters IE if the requested NB-N1 mode DRX parameters IE was included in the REGISTRATION REQUEST message.

8.2.7.39 Negotiated WUS assistance information

The network shall include the Negotiated WUS assistance information IE if:

- the UE supports WUS assistance information;
- the AMF supports and accepts the use of WUS assistance information;
- the UE is not performing the initial registration for emergency services; and
- the UE does not have an active emergency PDU session.

8.2.7.40 Extended rejected NSSAI

If the UE supports Extended rejected NSSAI, the network may include this IE to inform the UE of one or more S-NSSAIs that were included in the requested NSSAI in the REGISTRATION REQUEST message but were rejected by the network.

8.2.7.41 Service-level-AA container

The network shall include this IE if the UUAA procedure is triggered for the UE supporting UAS services. The network may include this IE if there is a valid successful UUAA result for the UE in the UE 5GMM context upon a registration for UAS services is requested from the UE.

8.2.7.42 Negotiated PEIPS assistance information

The network shall include the Negotiated PEIPS assistance information IE if:

- the UE supports NR paging subgrouping;
- the AMF supports and accepts the use of PEIPS assistance information for the UE; and
- the UE is not performing initial registration for emergency services and does not have an active emergency PDU session.

8.2.7.43 5GS additional request result

The network may include this IE to inform the UE about the result of additional request.

8.2.7.44 NSSRG information

This IE may be included to provide NSSRG information associated with the configured NSSAI.

8.2.7.45 Disaster roaming wait range

This IE may be included to assign a new disaster roaming wait range to the UE.

8.2.7.46 Disaster return wait range

This IE may be included to assign a new disaster return wait range to the UE.

8.2.7.47 List of PLMNs to be used in disaster condition

This IE may be included by an allowed PLMN to assign a new "list of PLMN(s) to be used in disaster condition" associated with the serving PLMN to the UE.

8.2.7.48 Forbidden TAI(s) for the list of "5GS forbidden tracking areas for roaming"

This IE is included to indicate the forbidden TAI(s) to be stored in the list of "5GS forbidden tracking areas for roaming". This IE is included only if the message is sent via satellite NG-RAN access.

8.2.7.49 Forbidden TAI(s) for the list of "5GS forbidden tracking areas for regional provision of service"

This IE is included to indicate the forbidden TAI(s) to be stored in the list of "5GS forbidden tracking areas for regional provision of service". This IE is included only if the message is sent via satellite NG-RAN access.

8.2.7.50 Extended CAG information list

If the UE supports Extended CAG information list, the network may include this IE to assign a new "CAG information list" to the UE or delete the "CAG information list" at the UE side.

8.2.7.51 NSAG information

If the UE has set the NSAG bit to "NSAG supported" in the 5GMM capability IE of the REGISTRATION REQUEST message over 3GPP access, the network may include this IE to provide NSAG information to the UE. Otherwise, the network shall not include this IE (see the 'comprehension required' scheme in subclause 11.2.5 of 3GPP TS 24.007 [11]).

8.2.7.52 Equivalent SNPNs

This IE may be included in order to assign an equivalent SNPNs list to a UE, by an AMF of an SNPN.

8.2.7.53 NID

This IE shall be included if the UE supports equivalent SNPNs and the serving SNPN changes.

8.2.7.54 Registration accept type 6 IE container

8.2.7.54.1 General

This information element may be included only if the network knows that the UE will not treat this IE as unknown 'comprehension required' IE. Otherwise, the network shall not include this IE (see the 'comprehension required' scheme in subclause 11.2.5 of 3GPP TS 24.007 [11]).

In this version of the specification, only the transfer of the information elements specified in table 8.2.7.54.1.1 is supported in the Registration accept type 6 IE container information element in the present message. For the handling of an information element with an IEI not listed in table 8.2.7.54.1.1, i.e., with an IEI unknown in the Registration accept type 6 IE container information element, see subclause 7.6.4.1.

Table 8.2.7.54.1.1: Information elements and IEIs for the Registration accept type 6 IE container

IEI	Information Element	Type/Reference	Presence	Format	Length
01	Extended LADN information	Extended LADN information 9.11.3.96	O	TLV-E	15-1787
02	S-NSSAI location validity information	S-NSSAI location validity information 9.11.3.100	O	TLV-E	17-38611
03	Partially allowed NSSAI	Partial NSSAI 9.11.3.103	O	TLV-E	3-808
04	Partially rejected NSSAI	Partial NSSAI 9.11.3.103	O	TLV-E	3-808

8.2.7.54.2 Extended LADN information

The network shall include this IE if the UE supports LADN per DNN and S-NSSAI and there are valid LADN service area(s) for the subscribed DNN(s) of the UE and S-NSSAI associated with the LADN in the current registration area.

8.2.7.54.3 S-NSSAI location validity information

The network may include this IE to update the S-NSSAI location validity information.

8.2.7.54.4 Void

Void.

8.2.7.54.5 Partially allowed NSSAI

The network may include this IE to assign a partially allowed NSSAI to the UE.

8.2.7.54.6 Partially rejected NSSAI

The network may include this IE to assign a partially rejected NSSAI to the UE.

8.2.7.55 RAN timing synchronization

This IE may be included to provide information related to the RAN timing synchronization to a UE which has set the Reconnection to the network due to RAN timing synchronization status change (RANtiming) bit to "Reconnection to the network due to RAN timing synchronization status change supported" in the 5GMM capability IE of the REGISTRATION REQUEST message.

8.2.7.56 Alternative NSSAI

The network may include this IE to provide the alternative NSSAI to the UE.

8.2.7.57 Maximum time offset

This IE may be included to provide the UE with a maximum waiting time after return from discontinuous coverage.

8.2.7.58 S-NSSAI time validity information

If the UE supports S-NSSAI time validity information, the network may include this IE to update the S-NSSAI time validity information.

8.2.7.59 Unavailability configuration

The network should include this IE if the network needs to provide parameters related to unavailability period to the UE.

8.2.7.60 Feature authorization indication

The network may include this IE to inform to the UE about the authorization status of the UE whether to operate as an MBSR or to operate not as an MBSR but to operate as a UE.

8.2.7.61 On-demand NSSAI

The network may include this IE to provide the on-demand NSSAI to the UE.

8.2.8 Registration complete

8.2.8.1 Message definition

The REGISTRATION COMPLETE message is sent by the UE to the AMF. See table 8.2.8.1.1.

Message type: REGISTRATION COMPLETE

Significance: dual

Direction: UE to network

Table 8.2.8.1.1: REGISTRATION COMPLETE message content

IEI	Information Element	Type/Reference	Presence	Format	Length
	Extended protocol discriminator	Extended protocol discriminator 9.2	M	V	1
	Security header type	Security header type 9.3	M	V	1/2
	Spare half octet	Spare half octet 9.5	M	V	1/2
	Registration complete message identity	Message type 9.7	M	V	1
73	SOR transparent container	SOR transparent container 9.11.3.51	O	TLV-E	20

8.2.8.2 SOR transparent container

This IE may be sent by the UE. If this IE is sent, the contents of this IE indicates the UE acknowledgement of successful reception of the SOR transparent container IE in the REGISTRATION ACCEPT message. This IE shall indicate the ME support of SOR-CMCI.

8.2.9 Registration reject

8.2.9.1 Message definition

The REGISTRATION REJECT message is sent by the AMF to the UE. See table 8.2.9.1.1.

Message type: REGISTRATION REJECT

Significance: dual

Direction: network to UE

Table 8.2.9.1.1: REGISTRATION REJECT message content

IEI	Information Element	Type/Reference	Presence	Format	Length
	Extended protocol discriminator	Extended protocol discriminator 9.2	M	V	1
	Security header type	Security header type 9.3	M	V	1/2
	Spare half octet	Spare half octet 9.5	M	V	1/2
	Registration reject message identity	Message type 9.7	M	V	1
	5GMM cause	5GMM cause 9.11.3.2	M	V	1
5F	T3346 value	GPRS timer 2 9.11.2.4	O	TLV	3
16	T3502 value	GPRS timer 2 9.11.2.4	O	TLV	3
78	EAP message	EAP message 9.11.2.2	O	TLV-E	7-1503
69	Rejected NSSAI	Rejected NSSAI 9.11.3.46	O	TLV	4-42
75	CAG information list	CAG information list 9.11.3.18A	O	TLV-E	3-n
68	Extended rejected NSSAI	Extended rejected NSSAI 9.11.3.75	O	TLV	5-90
2C	Disaster return wait range	Registration wait range 9.11.3.84	O	TLV	4
71	Extended CAG information list	Extended CAG information list 9.11.3.86	O	TLV-E	3-n
3A	Lower bound timer value	GPRS timer 3 9.11.2.5	O	TLV	3
1D	Forbidden TAI(s) for the list of "5GS forbidden tracking areas for roaming"	5GS tracking area identity list 9.11.3.9	O	TLV	9-114
1E	Forbidden TAI(s) for the list of "5GS forbidden tracking areas for regional provision of service"	5GS tracking area identity list 9.11.3.9	O	TLV	9-114
3E	N3IWF identifier	N3IWF identifier 9.11.3.93	O	TLV	7-n
4D	TNAN information	TNAN information 9.11.3.94	O	TLV	3-n
62	Extended 5GMM cause	Extended 5GMM cause 9.11.3.109	O	TLV	3

NOTE: It is possible for AMFs compliant with version 17.7.0 or 17.8.0 of this specification to send the Forbidden TAI(s) for the list of "5GS forbidden tracking areas for roaming" IE with IEI of value "3B" for this message or the Forbidden TAI(s) for the list of "5GS forbidden tracking areas for regional provision of service" IE with IEI of value "3C" for this message.

8.2.9.2 T3346 value

The AMF may include this IE when the general NAS level mobility management congestion control is active

8.2.9.3 T3502 value

This IE may be included to indicate a value for timer T3502 during the initial registration.

8.2.9.4 EAP message

EAP message IE is included if the REGISTRATION REJECT message is used to convey EAP-failure message.

8.2.9.5 Rejected NSSAI

The network may include this IE to inform the UE of one or more S-NSSAIs that were included in the requested NSSAI in the REGISTRATION REQUEST message but were rejected by the network.

8.2.9.6 CAG information list

This IE may be included to assign a new "CAG information list" to the UE or delete the "CAG information list" at the UE side.

8.2.9.7 Extended rejected NSSAI

If the UE supports Extended rejected NSSAI, the network may include this IE to inform the UE of one or more S-NSSAIs that were included in the requested NSSAI in the REGISTRATION REQUEST message but were rejected by the network.

8.2.9.8 Disaster return wait range

This IE may be included to assign a new disaster return wait range to the UE.

8.2.9.9 Extended CAG information list

If the UE supports Extended CAG information list, the network may include this IE to assign a new "CAG information list" to the UE or delete the "CAG information list" at the UE side.

8.2.9.10 Lower bound timer value

The AMF may include this IE when the 5GMM cause is set to #78 "PLMN not allowed to operate at the present UE location", to provide a minimum time value for an entry added to the list of "PLMNs not allowed to operate at the present UE location".

8.2.9.11 Forbidden TAI(s) for the list of "5GS forbidden tracking areas for roaming"

This IE is included to indicate the forbidden TAI(s) to be stored in the list of "5GS forbidden tracking areas for roaming". This IE is included only if the message is sent via satellite NG-RAN access.

8.2.9.12 Forbidden TAI(s) for the list of "5GS forbidden tracking areas for regional provision of service"

This IE is included to indicate the forbidden TAI(s) to be stored in the list of "5GS forbidden tracking areas for regional provision of service". This IE is included only if the message is sent via satellite NG-RAN access.

8.2.9.13 N3IWF identifier

The network may include this IE if the UE supports slice-based N3IWF selection over non-3GPP access network.

8.2.9.14 TNAN information

The network may include this IE if the UE supports slice-based TNGF selection over trusted non-3GPP access network.

8.2.9.15 Extended 5GMM cause

This IE may be included by the network to indicate additional information associated with the 5GMM cause value #15 "no suitable cells in tracking area".

8.2.10 UL NAS transport

8.2.10.1 Message definition

The UL NAS TRANSPORT message transports message payload and associated information to the AMF. See table 8.2.10.1.1.

Message type: UL NAS TRANSPORT

Significance: dual

Direction: UE to network

Table 8.2.10.1.1: UL NAS TRANSPORT message content

IEI	Information Element	Type/Reference	Presence	Format	Length
	Extended protocol discriminator	Extended protocol discriminator 9.2	M	V	1
	Security header type	Security header type 9.3	M	V	1/2
	Spare half octet	Spare half octet 9.5	M	V	1/2
	UL NAS TRANSPORT message identity	Message type 9.7	M	V	1
	Payload container type	Payload container type 9.11.3.40	M	V	1/2
	Spare half octet	Spare half octet 9.5	M	V	1/2
	Payload container	Payload container 9.11.3.39	M	LV-E	3-65537
12	PDU session ID	PDU session identity 2 9.11.3.41	C	TV	2
59	Old PDU session ID	PDU session identity 2 9.11.3.41	O	TV	2
8-	Request type	Request type 9.11.3.47	O	TV	1
22	S-NSSAI	S-NSSAI 9.11.2.8	O	TLV	3-10
25	DNN	DNN 9.11.2.1B	O	TLV	3-102
24	Additional information	Additional information 9.11.2.1	O	TLV	3-n
A-	MA PDU session information	MA PDU session information 9.11.3.31A	O	TV	1
F-	Release assistance indication	Release assistance indication 9.11.3.46A	O	TV	1
4E	Non-3GPP access path switching indication	Non-3GPP access path switching indication 9.11.3.99	O	TLV	3
5A	Alternative S-NSSAI	S-NSSAI 9.11.2.8	O	TLV	3-10
9-	Payload container information	Payload container information 9.11.3.106	O	TV	1

8.2.10.2 PDU session ID

The UE shall include this IE when the Payload container type IE is set to "N1 SM information" or "CIoT user data".

8.2.10.3 Old PDU session ID

The UE shall include this IE if the UL NAS TRANSPORT message transports a PDU SESSION ESTABLISHMENT REQUEST message upon receiving the PDU SESSION MODIFICATION COMMAND message with the 5GSM cause IE set to #39 "reactivation requested" and the Payload container type IE is set to "N1 SM information".

8.2.10.4 Request type

The UE shall include this IE when the PDU session ID IE is included and the Payload container IE contains the PDU SESSION ESTABLISHMENT REQUEST message or the PDU SESSION MODIFICATION REQUEST which is not initiated to indicate a change of 3GPP PS data off UE status associated to a PDU session.

8.2.10.5 S-NSSAI

The UE may include this IE when the Request type IE is set to "initial request", "existing PDU session" or "MA PDU request", the Payload container type IE is set to "N1 SM information" and the UE is not registered for onboarding services in SNPN.

8.2.10.6 DNN

The UE may include this IE when the Request type IE is set to "initial request", "existing PDU session" or "MA PDU request", the Payload container type IE is set to "N1 SM information" and the UE is not registered for onboarding services in SNPN.

8.2.10.7 Additional information

This IE is included when the Payload container type IE is set to "LTE Positioning Protocol (LPP) message container", "UPP-CMI container", "SLPP message container", or "Location services (LCS) message container".

8.2.10.8 MA PDU session information

The UE may include this IE if the Request type IE is included and is not set to "initial emergency request " or "existing emergency PDU session" in the UL NAS TRANSPORT message.

8.2.10.9 Release assistance indication

The UE may include this IE to inform the network whether:

- no further uplink and no further downlink data transmission is expected; or
- only a single downlink data transmission (e.g. acknowledgement or response to uplink data) and no further uplink data transmission subsequent to the uplink data transmission is expected.

8.2.10.10 Non-3GPP access path switching indication

The UE may include this IE when the Payload container type IE is set to "N1 SM information" to indicate whether the UE supports the non-3GPP access path switching for the PDU session.

8.2.10.11 Alternative S-NSSAI

The UE shall include this IE if the UE can provide alternative S-NSSAI associated with the S-NSSAI to be replaced to the network.

8.2.10.12 Payload container information

The UE may include this IE when the Payload container type IE is set to "Location services (LCS) message container".

8.2.11 DL NAS transport

8.2.11.1 Message definition

The DL NAS TRANSPORT message transports message payload and associated information to the UE. See table 8.2.11.1.1.

Message type: DL NAS TRANSPORT

Significance: dual

Direction: network to UE

Table 8.2.11.1.1: DL NAS TRANSPORT message content

IEI	Information Element	Type/Reference	Presence	Format	Length
	Extended protocol discriminator	Extended protocol discriminator 9.2	M	V	1
	Security header type	Security header type 9.3	M	V	1/2
	Spare half octet	Spare half octet 9.5	M	V	1/2
	DL NAS TRANSPORT message identity	Message type 9.7	M	V	1
	Payload container type	Payload container type 9.11.3.40	M	V	1/2
	Spare half octet	Spare half octet 9.5	M	V	1/2
	Payload container	Payload container 9.11.3.39	M	LV-E	3-65537
12	PDU session ID	PDU session identity 2 9.11.3.41	C	TV	2
24	Additional information	Additional information 9.11.2.1	O	TLV	3-n
58	5GMM cause	5GMM cause 9.11.3.2	O	TV	2
37	Back-off timer value	GPRS timer 3 9.11.2.5	O	TLV	3
3A	Lower bound timer value	GPRS timer 3 9.11.2.5	O	TLV	3

8.2.11.2 PDU session ID

The AMF shall include this IE when the Payload container type IE is set to "N1 SM information" or "CIoT user data container".

8.2.11.3 Additional information

This IE is included when the Payload container type IE is set to "LTE Positioning Protocol (LPP) message container", "UPP-CMI container", "SLPP message container", or "Location services (LCS) message container".

8.2.11.4 5GMM cause

The AMF shall include this IE when the Payload container IE contains an uplink payload which was not forwarded and the Payload container type IE is not set to "Multiple payloads".

8.2.11.5 Back-off timer value

The AMF may include this IE to indicate the back-off timer value when the Payload container IE is included and the Payload container type IE is not set to "Multiple payloads".

8.2.11.6 Lower bound timer value

The AMF may include this IE when the 5GMM cause is set to #78 "PLMN not allowed to operate at the present UE location", to provide a minimum time value for an entry added to the list of "PLMNs not allowed to operate at the present UE location".

8.2.12 De-registration request (UE originating de-registration)

8.2.12.1 Message definition

The DEREGISTRATION REQUEST message is sent by the UE to the AMF. See table 8.2.12.1.1.

Message type: DEREGISTRATION REQUEST

Significance: dual

Direction: UE to network

Table 8.2.12.1.1: DEREGISTRATION REQUEST message content

IEI	Information Element	Type/Reference	Presence	Format	Length
	Extended protocol discriminator	Extended protocol discriminator 9.2	M	V	1
	Security header type	Security header type 9.3	M	V	1/2
	Spare half octet	Spare half octet 9.5	M	V	1/2
	De-registration request message identity	Message type 9.7	M	V	1
	De-registration type	De-registration type 9.11.3.20	M	V	1/2
	ngKSI	NAS key set identifier 9.11.3.32	M	V	1/2
	5GS mobile identity	5GS mobile identity 9.11.3.4	M	LV-E	6-n
3C	Unavailability information	Unavailability information 9.11.2.20	O	TLV	3-9
71	NAS message container	NAS message container 9.11.3.33	O	TLV-E	4-n

8.2.12.2 Unavailability information

The UE may include this IE when an event is triggered in the UE that would make the UE unavailable for a certain period and the use of unavailability period is not due to NR satellite access discontinuous coverage.

8.2.12.3 NAS message container

This IE shall be included if the UE is sending a DEREGISTRATION REQUEST message as an initial NAS message and the UE needs to send non-clear-text IEs.

8.2.13 De-registration accept (UE originating de-registration)

8.2.13.1 Message definition

The DEREGISTRATION ACCEPT message is sent by the AMF to the UE. See table 8.2.13.1.1.

Message type: DEREGISTRATION ACCEPT

Significance: dual

Direction: network to UE

Table 8.2.13.1.1: DEREGISTRATION ACCEPT message content

IEI	Information Element	Type/Reference	Presence	Format	Length
	Extended protocol discriminator	Extended protocol discriminator 9.2	M	V	1
	Security header type	Security header type 9.3	M	V	1/2
	Spare half octet	Spare half octet 9.5	M	V	1/2
	De-registration accept message identity	Message type 9.7	M	V	1

8.2.14 De-registration request (UE terminated de-registration)

8.2.14.1 Message definition

The DEREGISTRATION REQUEST message is sent by the AMF to the UE. See table 8.2.14.1.1.

Message type: DEREGISTRATION REQUEST

Significance: dual

Direction: network to UE

Table 8.2.14.1.1: DEREGISTRATION REQUEST message content

IEI	Information Element	Type/Reference	Presence	Format	Length
	Extended protocol discriminator	Extended protocol discriminator 9.2	M	V	1
	Security header type	Security header type 9.3	M	V	1/2
	Spare half octet	Spare half octet 9.5	M	V	1/2
	De-registration request message identity	Message type 9.7	M	V	1
	De-registration type	De-registration type 9.11.3.20	M	V	1/2
	Spare half octet	Spare half octet 9.5	M	V	1/2
58	5GMM cause	5GMM cause 9.11.3.2	O	TV	2
5F	T3346 value	GPRS timer 2 9.11.2.4	O	TLV	3
6D	Rejected NSSAI	Rejected NSSAI 9.11.3.46	O	TLV	4-42
75	CAG information list	CAG information list 9.11.3.18A	O	TLV-E	3-n
68	Extended rejected NSSAI	Extended rejected NSSAI 9.11.3.75	O	TLV	5-90
2C	Disaster return wait range	Registration wait range 9.11.3.84	O	TLV	4
71	Extended CAG information list	Extended CAG information list 9.11.3.86	O	TLV-E	3-n
3A	Lower bound timer value	GPRS timer 3 9.11.2.5	O	TLV	3
1D	Forbidden TAI(s) for the list of "5GS forbidden tracking areas for roaming"	5GS tracking area identity list 9.11.3.9	O	TLV	9-114
1E	Forbidden TAI(s) for the list of "5GS forbidden tracking areas for regional provision of service"	5GS tracking area identity list 9.11.3.9	O	TLV	9-114

NOTE: It is possible for AMFs compliant with version 17.7.0 or 17.8.0 of this specification to send the Forbidden TAI(s) for the list of "5GS forbidden tracking areas for roaming" IE with IEI of value "3B" for this message or the Forbidden TAI(s) for the list of "5GS forbidden tracking areas for regional provision of service" IE with IEI of value "3C" for this message.

8.2.14.2 5GMM cause

This information element is included if a 5GMM cause is provided.

8.2.14.3 T3346 value

The AMF may include this IE when the general NAS level mobility management congestion control is active.

8.2.14.4 Rejected NSSAI

The AMF may include this IE to inform the UE of one or more S-NSSAIs that were rejected by the network.

8.2.14.5 CAG information list

This IE may be included to assign a new "CAG information list" to the UE or delete the "CAG information list" at the UE side.

8.2.14.6 Extended rejected NSSAI

If the UE supports Extended rejected NSSAI, the AMF may include this IE to inform the UE of one or more S-NSSAIs that were rejected by the network.

8.2.14.7 Disaster return wait range

This IE may be included to assign a new disaster return wait range to the UE.

8.2.14.7A Extended CAG information list

If the UE supports Extended CAG information list, the network may include this IE to assign a new "CAG information list" to the UE or delete the "CAG information list" at the UE side.

8.2.14.8 Lower bound timer value

The AMF may include this IE when the 5GMM cause is set to #78 "PLMN not allowed to operate at the present UE location", to provide a minimum time value for an entry added to the list of "PLMNs not allowed to operate at the present UE location".

8.2.14.9 Forbidden TAI(s) for the list of "5GS forbidden tracking areas for roaming"

This IE is included to indicate the forbidden TAI(s) to be stored in the list of "5GS forbidden tracking areas for roaming". This IE is included only if the message is sent via satellite NG-RAN access.

8.2.14.10 Forbidden TAI(s) for the list of "5GS forbidden tracking areas for regional provision of service"

This IE is included to indicate the forbidden TAI(s) to be stored in the list of "5GS forbidden tracking areas for regional provision of service". This IE is included only if the message is sent via satellite NG-RAN access.

8.2.15 De-registration accept (UE terminated de-registration)

8.2.15.1 Message definition

The DEREGISTRATION ACCEPT message is sent by the UE to the AMF. See table 8.2.15.1.1.

Message type: DEREGISTRATION ACCEPT

Significance: dual

Direction: UE to network

Table 8.2.15.1.1.1: DEREGISTRATION ACCEPT message content

IEI	Information Element	Type/Reference	Presence	Format	Length
	Extended protocol discriminator	Extended protocol discriminator 9.2	M	V	1
	Security header type	Security header type 9.3	M	V	1/2
	Spare half octet	Spare half octet 9.5	M	V	1/2
	De-registration accept message identity	Message type 9.7	M	V	1

8.2.16 Service request

8.2.16.1 Message definition

The SERVICE REQUEST message is sent by the UE to the AMF in order to request the establishment of an N1 NAS signalling connection, to request the establishment of user-plane resources for PDU sessions which are established without user-plane resources, or both. See table 8.2.16.1.1.

Message type: SERVICE REQUEST

Significance: dual

Direction: UE to network

Table 8.2.16.1.1: SERVICE REQUEST message content

IEI	Information Element	Type/Reference	Presence	Format	Length
	Extended protocol discriminator	Extended protocol discriminator 9.2	M	V	1
	Security header type	Security header type 9.3	M	V	1/2
	Spare half octet	Spare half octet 9.5	M	V	1/2
	Service request message identity	Message type 9.7	M	V	1
	ngKSI	NAS key set identifier 9.11.3.32	M	V	1/2
	Service type	Service type 9.11.3.50	M	V	1/2
	5G-S-TMSI	5GS mobile identity 9.11.3.4	M	LV-E	9
40	Uplink data status	Uplink data status 9.11.3.57	O	TLV	4-34
50	PDU session status	PDU session status 9.11.3.44	O	TLV	4-34
25	Allowed PDU session status	Allowed PDU session status 9.11.3.13	O	TLV	4-34
71	NAS message container	NAS message container 9.11.3.33	O	TLV-E	4-n
29	UE request type	UE request type 9.11.3.76	O	TLV	3
28	Paging restriction	Paging restriction 9.11.3.77	O	TLV	3-35

8.2.16.2 Uplink data status

This IE shall be included if the UE has uplink user data pending to be sent.

8.2.16.3 PDU session status

This IE shall be included when the UE needs to indicate the PDU sessions that are associated with the access type that the message is sent over, that are active within the UE.

8.2.16.4 Allowed PDU session status

This IE shall be included if the SERVICE REQUEST message is sent as a response to paging with the access type indicating non-3GPP access or notification via 3GPP access for PDU session(s) associated with non-3GPP access.

8.2.16.5 NAS message container

This IE shall be included if the UE is sending a SERVICE REQUEST message as an initial NAS message and the UE needs to send non-clear-text IEs.

8.2.16.6 UE request type

The UE shall include this IE if the MUSIM UE requests the release of the NAS signalling connection or rejects the paging request from the network.

8.2.16.7 Paging restriction

The UE shall include this IE if the Request type is set to "NAS signalling connection release" or to "Rejection of paging" in the UE request type IE and the UE requests the network to restrict paging.

8.2.17 Service accept

8.2.17.1 Message definition

The SERVICE ACCEPT message is sent by the AMF to the UE in order to accept the service request procedure. See table 8.2.17.1.1.

Message type: SERVICE ACCEPT

Significance: dual

Direction: network to UE

Table 8.2.17.1.1: SERVICE ACCEPT message content

IEI	Information Element	Type/Reference	Presence	Format	Length
	Extended protocol discriminator	Extended protocol discriminator 9.2	M	V	1
	Security header type	Security header type 9.3	M	V	1/2
	Spare half octet	Spare half octet 9.5	M	V	1/2
	Service accept message identity	Message type 9.7	M	V	1
50	PDU session status	PDU session status 9.11.3.44	O	TLV	4-34
26	PDU session reactivation result	PDU session reactivation result 9.11.3.42	O	TLV	4-34
72	PDU session reactivation result error cause	PDU session reactivation result error cause 9.11.3.43	O	TLV-E	5-515
78	EAP message	EAP message 9.11.2.2	O	TLV-E	7-1503
6B	T3448 value	GPRS timer 2 9.11.2.4	O	TLV	3
34	5GS additional request result	5GS additional request result 9.11.3.81	O	TLV	3
1D	Forbidden TAI(s) for the list of "5GS forbidden tracking areas for roaming"	5GS tracking area identity list 9.11.3.9	O	TLV	9-114
1E	Forbidden TAI(s) for the list of "5GS forbidden tracking areas for regional provision of service"	5GS tracking area identity list 9.11.3.9	O	TLV	9-114

8.2.17.2 PDU session status

This IE shall be included when the network needs to indicate the PDU sessions that are associated with the access type that the message is sent over that are active within the network.

8.2.17.3 PDU session reactivation result

This IE shall be included:

- if the Uplink data status IE is included in the SERVICE REQUEST message; or
- if the Allowed PDU session status IE is included in the SERVICE REQUEST message and there is at least one PDU session indicated in the Allowed PDU session status IE for which user-plane resources can be re-established over 3GPP access.

8.2.17.4 PDU session reactivation result error cause

This IE may be included if the PDU session reactivation result IE is included and there exist one or more PDU sessions for which the user-plane resources cannot be re-established, to indicate the cause of failure to re-establish the user-plane resources.

8.2.17.5 EAP message

EAP message IE is included if the SERVICE ACCEPT message is sent to a UE registered for emergency services and is used to convey EAP-failure message.

8.2.17.6 T3448 value

The network may include this IE if the congestion control for transport of user data via the control plane is active and the UE supports the control plane CIoT 5GS optimizations.

8.2.17.7 5GS additional request result

The network may include this IE to inform the UE about the result of additional request.

8.2.17.8 Forbidden TAI(s) for the list of "5GS forbidden tracking areas for roaming"

This IE is included to indicate the forbidden TAI(s) to be stored in the list of "5GS forbidden tracking areas for roaming". This IE is included only if the message is sent via satellite NG-RAN access.

8.2.17.9 Forbidden TAI(s) for the list of "5GS forbidden tracking areas for regional provision of service"

This IE is included to indicate the forbidden TAI(s) to be stored in the list of "5GS forbidden tracking areas for regional provision of service". This IE is included only if the message is sent via satellite NG-RAN access.

8.2.18 Service reject

8.2.18.1 Message definition

The SERVICE REJECT message is sent by the AMF to the UE in order to reject the service request procedure. See table 8.2.18.1.1.

Message type: SERVICE REJECT

Significance: dual

Direction: network to UE

Table 8.2.18.1.1: SERVICE REJECT message content

IEI	Information Element	Type/Reference	Presence	Format	Length
	Extended protocol discriminator	Extended protocol discriminator 9.2	M	V	1
	Security header type	Security header type 9.3	M	V	1/2
	Spare half octet	Spare half octet 9.5	M	V	1/2
	Service reject message identity	Message type 9.7	M	V	1
	5GMM cause	5GMM cause 9.11.3.2	M	V	1
50	PDU session status	PDU session status 9.11.3.44	O	TLV	4-34
5F	T3346 value	GPRS timer 2 9.11.2.4	O	TLV	3
78	EAP message	EAP message 9.11.2.2	O	TLV-E	7-1503
6B	T3448 value	GPRS timer 2 9.11.2.4	O	TLV	3
75	CAG information list	CAG information list 9.11.3.18A	O	TLV-E	3-n
2C	Disaster return wait range	Registration wait range 9.11.3.84	O	TLV	4
71	Extended CAG information list	Extended CAG information list 9.11.3.86	O	TLV-E	3-n
3A	Lower bound timer value	GPRS timer 3 9.11.2.5	O	TLV	3
1D	Forbidden TAI(s) for the list of "5GS forbidden tracking areas for roaming"	5GS tracking area identity list 9.11.3.9	O	TLV	9-114
1E	Forbidden TAI(s) for the list of "5GS forbidden tracking areas for regional provision of service"	5GS tracking area identity list 9.11.3.9	O	TLV	9-114

NOTE: It is possible for AMFs compliant with version 17.7.0 or 17.8.0 of this specification to send the Forbidden TAI(s) for the list of "5GS forbidden tracking areas for roaming" IE with IEI of value "3B" for this message or the Forbidden TAI(s) for the list of "5GS forbidden tracking areas for regional provision of service" IE with IEI of value "3C" for this message.

8.2.18.2 PDU session status

This IE shall be included when the network needs to indicate the PDU sessions that are associated with the access type that the message is sent over, that are active within the network.

8.2.18.3 T3346 value

The AMF may include this IE when the general NAS level mobility management congestion control is active.

8.2.18.4 EAP message

EAP message IE is included if the SERVICE REJECT message is used to convey EAP-failure message.

8.2.18.5 T3448 value

The network may include this IE if the congestion control for transport of user data via the control plane is active and the UE supports the control plane CIoT 5GS optimizations.

8.2.18.6 CAG information list

This IE may be included to assign a new "CAG information list" to the UE or delete the "CAG information list" at the UE side.

8.2.18.7 Disaster return wait range

This IE may be included to assign a new disaster return wait range to the UE.

8.2.18.8 Extended CAG information list

If the UE supports Extended CAG information list, the network may include this IE to assign a new "CAG information list" to the UE or delete the "CAG information list" at the UE side.

8.2.18.9 Lower bound timer value

The AMF may include this IE when the 5GMM cause is set to #78 "PLMN not allowed to operate at the present UE location", to provide a minimum time value for an entry added to the list of "PLMNs not allowed to operate at the present UE location".

8.2.18.10 Forbidden TAI(s) for the list of "5GS forbidden tracking areas for roaming"

This IE is included to indicate the forbidden TAI(s) to be stored in the list of "5GS forbidden tracking areas for roaming". This IE is included only if the message is sent via satellite NG-RAN access.

8.2.18.11 Forbidden TAI(s) for the list of "5GS forbidden tracking areas for regional provision of service"

This IE is included to indicate the forbidden TAI(s) to be stored in the list of "5GS forbidden tracking areas for regional provision of service". This IE is included only if the message is sent via satellite NG-RAN access.

8.2.19 Configuration update command

8.2.19.1 Message definition

The CONFIGURATION UPDATE COMMAND message is sent by the AMF to the UE. See table 8.2.19.1.1.

Message type: CONFIGURATION UPDATE COMMAND

Significance: dual

Direction: network to UE

Table 8.2.19.1.1: CONFIGURATION UPDATE COMMAND message content

IEI	Information Element	Type/Reference	Presence	Format	Length
	Extended protocol discriminator	Extended protocol discriminator 9.2	M	V	1
	Security header type	Security header type 9.3	M	V	1/2
	Spare half octet	Spare half octet 9.5	M	V	1/2
	Configuration update command message identity	Message type 9.7	M	V	1
D-	Configuration update indication	Configuration update indication 9.11.3.18	O	TV	1
77	5G-GUTI	5GS mobile identity 9.11.3.4	O	TLV-E	14
54	TAI list	5GS tracking area identity list 9.11.3.9	O	TLV	9-114
15	Allowed NSSAI	NSSAI 9.11.3.37	O	TLV	4-74
27	Service area list	Service area list 9.11.3.49	O	TLV	6-114
43	Full name for network	Network name 9.11.3.35	O	TLV	3-n
45	Short name for network	Network name 9.11.3.35	O	TLV	3-n
46	Local time zone	Time zone 9.11.3.52	O	TV	2
47	Universal time and local time zone	Time zone and time 9.11.3.53	O	TV	8
49	Network daylight saving time	Daylight saving time 9.11.3.19	O	TLV	3
79	LADN information	LADN information 9.11.3.30	O	TLV-E	3-1715
B-	MICO indication	MICO indication 9.11.3.31	O	TV	1
9-	Network slicing indication	Network slicing indication 9.11.3.36	O	TV	1
31	Configured NSSAI	NSSAI 9.11.3.37	O	TLV	4-146
11	Rejected NSSAI	Rejected NSSAI 9.11.3.46	O	TLV	4-42
76	Operator-defined access category definitions	Operator-defined access category definitions 9.11.3.38	O	TLV-E	3-8323
F-	SMS indication	SMS indication 9.11.3.50A	O	TV	1
6C	T3447 value	GPRS timer 3 9.11.2.5	O	TLV	3
75	CAG information list	CAG information list 9.11.3.18A	O	TLV-E	3-n
67	UE radio capability ID	UE radio capability ID 9.11.3.68	O	TLV	3-n
A-	UE radio capability ID deletion indication	UE radio capability ID deletion indication 9.11.3.69	O	TV	1
44	5GS registration result	5GS registration result 9.11.3.6	O	TLV	3
1B	Truncated 5G-S-TMSI configuration	Truncated 5G-S-TMSI configuration 9.11.3.70	O	TLV	3
C-	Additional configuration indication	Additional configuration indication 9.11.3.74	O	TV	1
68	Extended rejected NSSAI	Extended rejected NSSAI 9.11.3.75	O	TLV	5-90
72	Service-level-AA container	Service-level-AA container 9.11.2.10	O	TLV-E	4-65538
70	NSSRG information	NSSRG information 9.11.3.82	O	TLV-E	7-4099

14	Disaster roaming wait range	Registration wait range 9.11.3.84	O	TLV	4
2C	Disaster return wait range	Registration wait range 9.11.3.84	O	TLV	4
13	List of PLMNs to be used in disaster condition	List of PLMNs to be used in disaster condition 9.11.3.83	O	TLV	2-n
71	Extended CAG information list	Extended CAG information list 9.11.3.86	O	TLV-E	3-n
1F	Updated PEIPS assistance information	PEIPS assistance information 9.11.3.80	O	TLV	3-n
73	NSAG information	NSAG information 9.11.3.87	O	TLV-E	9-3143
E-	Priority indicator	Priority indicator 9.11.3.91	O	TV	1
4B	RAN timing synchronization	RAN timing synchronization 9.11.3.95	O	TLV	3
78	Extended LADN information	Extended LADN information 9.11.3.96	O	TLV-E	3-1787
4C	Alternative NSSAI	Alternative NSSAI 9.11.3.97	O	TLV	2-146
7B	S-NSSAI location validity information	S-NSSAI location validity information 9.11.3.100	O	TLV-E	17-38611
5B	S-NSSAI time validity information	S-NSSAI time validity information 9.11.3.101	O	TLV	23-257
4F	Maximum time offset	GPRS timer 3 9.11.2.5	O	TLV	3
74	Partially allowed NSSAI	Partial NSSAI 9.11.3.103	O	TLV-E	3-808
7A	Partially rejected NSSAI	Partial NSSAI 9.11.3.103	O	TLV-E	3-808
5C	Feature authorization indication	Feature authorization indication 9.11.3.105	O	TLV	3-257
61	On-demand NSSAI	On-demand NSSAI 9.11.3.108	O	TLV	5-210

8.2.19.2 Configuration update indication

The AMF shall include this IE if the AMF needs to request an acknowledgement or a registration procedure from the UE.

8.2.19.3 5G-GUTI

This IE may be included to assign a new 5G GUTI to the UE.

8.2.19.4 TAI list

This IE may be included to assign a new TAI list to the UE.

8.2.19.5 Allowed NSSAI

This IE may be included to assign a new allowed NSSAI to the UE not registered for onboarding services in SNPN.

8.2.19.6 Service area list

This IE may be included to assign a new service area list to the UE.

8.2.19.7 Full name for network

This IE may be included to assign a new full name for network to the UE.

8.2.19.8 Short name for network

This IE may be included to assign a new short name for network to the UE.

8.2.19.9 Local time zone

This IE may be included to assign a new local time zone to the UE.

8.2.19.10 Universal time and local time zone

This IE may be included to assign new universal time and local time zone to the UE.

8.2.19.11 Network daylight saving time

This IE may be included to assign new network daylight saving time to the UE.

8.2.19.12 LADN information

This IE may be included to assign new LADN information to the UE or delete the LADN information at the UE side.

8.2.19.13 MICO indication

This IE may be included to request the UE to re-negotiate MICO mode.

8.2.19.14 Network slicing indication

This IE shall be included if the user's network slicing subscription has changed in the UDM of a PLMN or an SNPN.

8.2.19.15 Configured NSSAI

The AMF shall include this IE when the AMF needs to provide the UE with a new configured NSSAI for the current PLMN or SNPN and the UE is neither registering nor registered for onboarding services in SNPN.

8.2.19.16 Rejected NSSAI

The network may include this IE to inform the UE of one or more S-NSSAIs that were previously sent to the UE in the allowed NSSAI or the pending NSSAI, but are now considered rejected by the network.

8.2.19.17 Operator-defined access category definitions

This IE may be included to assign new operator-defined access category definitions to the UE or delete the operator-defined access category definitions at the UE side.

8.2.19.18 SMS indication

This IE may be included to indicate that the ability for the UE to use SMS over NAS has changed.

8.2.19.19 T3447 value

This IE may be included to assign a new T3447 value to the UE.

8.2.19.20 CAG information list

This IE may be included to assign new "CAG information list" to the UE or delete the "CAG information list" at the UE side.

8.2.19.21 UE radio capability ID

This IE may be included if the UE is not in NB-N1 mode, both the UE and the network support RACS and the network needs to assign a network-assigned UE radio capability ID to the UE.

8.2.19.22 UE radio capability ID deletion indication

This IE may be included if the UE is not in NB-N1 mode, both the UE and the network support RACS and the network needs to trigger the UE to delete all network-assigned UE radio capability IDs stored at the UE for the serving PLMN or serving SNPN.

8.2.19.23 5GS registration result

This IE shall be included if the network wants to indicate to the UE that the UE is registered for emergency services.

8.2.19.24 Truncated 5G-S-TMSI configuration

This IE may be included to provide a new truncated 5G-S-TMSI configuration to the UE in NB-N1 mode if the network is configured to provide the truncated 5G-S-TMSI configuration for control plane CIoT 5GS optimizations.

8.2.19.25 Additional configuration indication

The network may include this IE when requesting the UE to register without the release of the N1 NAS signalling connection.

8.2.19.26 Extended rejected NSSAI

If the UE supports Extended rejected NSSAI, the network may include this IE to inform the UE of one or more S-NSSAIs that were previously sent to the UE in the allowed NSSAI or the pending NSSAI, but are now considered rejected by the network.

8.2.19.27 Service-level-AA container

The network shall include this IE when the AMF receives the Service-level-AA payload or the UUAA-MM result from the UAS-NF during the UUAA-MM procedure or the UUAA revocation procedure. The network shall also include this IE if the AMF receives from the UAS-NF, the CAA-Level UAV ID as part of the UUAA-MM procedure.

8.2.19.28 NSSRG information

This IE may be included to provide NSSRG information associated with the configured NSSAI.

8.2.19.29 Disaster roaming wait range

This IE may be included to assign a new disaster roaming wait range to the UE.

8.2.19.30 Disaster return wait range

This IE may be included to assign a new disaster return wait range to the UE.

8.2.19.31 List of PLMNs to be used in disaster condition

This IE may be included by an allowed PLMN to assign a new "list of PLMN(s) to be used in disaster condition" associated with the serving PLMN to the UE.

8.2.19.32 Extended CAG information list

If the UE supports Extended CAG information list, the network may include this IE to assign a new "CAG information list" to the UE or delete the "CAG information list" at the UE side.

8.2.19.33 Updated PEIPS assistance information

The AMF may include this IE if the UE supports NR paging subgrouping, the AMF supports and accepts the use of PEIPIS assistance information for the UE, the UE is not registered for emergency services, the UE does not have an active emergency PDU session, and the network needs to update PEIPS assistance information for the UE.

8.2.19.34 NSAG information

If the UE has set the NSAG bit to "NSAG supported" in the 5GMM capability IE of the REGISTRATION REQUEST message and the CONFIGURATION UPDATE COMMAND message is sent over 3GPP access, the network may include this IE to provide NSAG information to the UE.

8.2.19.35 Priority indicator

The network shall include this IE when it needs to inform the UE that the use of access identity 1 is valid or is no longer valid.

8.2.19.36 RAN timing synchronization

This IE may be included to provide information related to the RAN timing synchronization to a UE which has set the Reconnection to the network due to RAN timing synchronization status change (RANtiming) bit to "Reconnection to the network due to RAN timing synchronization status change supported" in the 5GMM capability IE of the REGISTRATION REQUEST message.

8.2.19.37 Extended LADN information

This IE may be included to assign new extended LADN information to the UE or delete the extended LADN information at the UE side.

8.2.19.38 Alternative NSSAI

The network may include this IE to provide the mapping information between the S-NSSAI to be replaced and the alternative S-NSSAI to the UE.

8.2.19.39 S-NSSAI location validity information

The network may include this IE to update the S-NSSAI location validity information.

8.2.19.40 S-NSSAI time validity information

The network may include this IE to update the S-NSSAI time validity information.

8.2.19.41 Maximum time offset

This IE may be included to provide the UE with a maximum time offset after return from discontinuous coverage.

8.2.19.42 Partially allowed NSSAI

The network may include this IE to assign a partially allowed NSSAI to the UE.

8.2.19.43 Partially rejected NSSAI

The network may include this IE to assign a partially rejected NSSAI to the UE.

8.2.19.44 Feature authorization indication

The network may include this IE to inform to the UE about the authorization status of the UE whether to operate as an MBSR or to operate not as an MBSR but to operate as a UE.

8.2.19.45 On-demand NSSAI

The network may include this IE to provide the on-demand NSSAI to the UE.

8.2.20 Configuration update complete

8.2.20.1 Message definition

The CONFIGURATION UPDATE COMPLETE message is sent by the UE to the AMF. See table 8.2.20.1.1.

Message type: CONFIGURATION UPDATE COMPLETE

Significance: dual

Direction: UE to network

Table 8.2.20.1.1: CONFIGURATION UPDATE COMPLETE message content

IEI	Information Element	Type/Reference	Presence	Format	Length
	Extended protocol discriminator	Extended protocol discriminator 9.2	M	V	1
	Security header type	Security header type 9.3	M	V	1/2
	Spare half octet	Spare half octet 9.5	M	V	1/2
	Configuration update complete message identity	Message type 9.7	M	V	1

8.2.20.2 Void

8.2.21 Identity request

8.2.21.1 Message definition

The IDENTITY REQUEST message is sent by the AMF to the UE to request the UE to provide specified identity. See table 8.2.21.1.1

Message type: IDENTITY REQUEST

Significance: dual

Direction: AMF to UE

Table 8.2.21.1.1: IDENTITY REQUEST message content

IEI	Information Element	Type/Reference	Presence	Format	Length
	Extended protocol discriminator	Extended protocol discriminator 9.2	M	V	1
	Security header type	Security header type 9.3	M	V	1/2
	Spare half octet	Spare half octet 9.5	M	V	1/2
	Identity request message identity	Message type 9.7	M	V	1
	Identity type	5GS identity type 9.11.3.3	M	V	1/2
	Spare half octet	Spare half octet 9.5	M	V	1/2

8.2.22 Identity response

8.2.22.1 Message definition

The IDENTITY RESPONSE message is sent by the UE to the AMF to provide the requested identity. See table 8.2.22.1.

Message type: IDENTITY RESPONSE

Significance: dual

Direction: UE to AMF

Table 8.2.22.1.1: IDENTITY RESPONSE message content

IEI	Information Element	Type/Reference	Presence	Format	Length
	Extended protocol discriminator	Extended protocol discriminator 9.2	M	V	1
	Security header type	Security header type 9.3	M	V	1/2
	Spare half octet	Spare half octet 9.5	M	V	1/2
	Identity response message identity	Message type 9.7	M	V	1
	Mobile identity	5GS mobile identity 9.11.3.4	M	LV-E	3-n

8.2.23 Notification

8.2.23.1 Message definition

The NOTIFICATION message is sent by the AMF to the UE to notify the UE to initiate a service request procedure. See table 8.2.23.1.1.

Message type: NOTIFICATION

Significance: dual

Direction: network to UE

Table 8.2.23.1.1: NOTIFICATION message content

IEI	Information Element	Type/Reference	Presence	Format	Length
	Extended protocol discriminator	Extended protocol discriminator 9.2	M	V	1
	Security header type	Security header type 9.3	M	V	1/2
	Spare half octet	Spare half octet 9.5	M	V	1/2
	Notification message identity	Message type 9.7	M	V	1
	Access type	Access type 9.11.2.1A	M	V	1/2
	Spare half octet	Spare half octet 9.5	M	V	1/2

8.2.24 Notification response

8.2.24.1 Message definition

The NOTIFICATION RESPONSE message is sent by the UE to the AMF to notify the failure to initiate the service request procedure as a response of notification. See table 8.2.24.1.1.

Message type: NOTIFICATION RESPONSE

Significance: dual

Direction: UE to network

Table 8.2.2341.1: NOTIFICATION RESPONSE message content

IEI	Information Element	Type/Reference	Presence	Format	Length
	Extended protocol discriminator	Extended protocol discriminator 9.2	M	V	1
	Security header type	Security header type 9.3	M	V	1/2
	Spare half octet	Spare half octet 9.5	M	V	1/2
	Notification response message identity	Message type 9.7	M	V	1
50	PDU session status	PDU session status 9.11.3.44	O	TLV	4-34

8.2.24.2 PDU session status

This information element shall be included when the UE needs to indicate over non-3GPP access the PDU sessions that are associated with the 3GPP access type that are active within the UE.

8.2.25 Security mode command

8.2.25.1 Message definition

The SECURITY MODE COMMAND message is sent by the AMF to the UE to establish NAS signalling security. See table 8.2.25.1.1.

Message type: SECURITY MODE COMMAND

Significance: dual

Direction: network to UE

Table 8.2.25.1.1: SECURITY MODE COMMAND message content

IEI	Information Element	Type/Reference	Presence	Format	Length
	Extended protocol discriminator	Extended protocol discriminator 9.2	M	V	1
	Security header type	Security header type 9.3	M	V	1/2
	Spare half octet	Spare half octet 9.5	M	V	1/2
	Security mode command message identity	Message type 9.7	M	V	1
	Selected NAS security algorithms	NAS security algorithms 9.11.3.34	M	V	1
	ngKSI	NAS key set identifier 9.11.3.32	M	V	1/2
	Spare half octet	Spare half octet 9.5	M	V	1/2
	Replayed UE security capabilities	UE security capability 9.11.3.54	M	LV	3-9
E-	IMEISV request	IMEISV request 9.11.3.28	O	TV	1
57	Selected EPS NAS security algorithms	EPS NAS security algorithms 9.11.3.25	O	TV	2
36	Additional 5G security information	Additional 5G security information 9.11.3.12	O	TLV	3
78	EAP message	EAP message 9.11.2.2	O	TLV-E	7-1503
38	ABBA	ABBA 9.11.3.10	O	TLV	4-n
19	Replayed S1 UE security capabilities	S1 UE security capability 9.11.3.48A	O	TLV	4-7
55	AUN3 device security key	AUN3 device security key 9.11.3.107	O	TLV	36-257

NOTE: It is possible for AMFs compliant with version 18.3.0 or 18.3.1 of this specification to send the AUN3 device security key IE with a fixed length of 66 octets.

8.2.25.2 IMEISV request

The AMF may include this information element to request the UE to send its IMEISV with the corresponding SECURITY MODE COMPLETE message.

8.2.25.3 Void

8.2.25.4 Selected EPS NAS security algorithms

This IE shall be included if the AMF supports N26 interface, the UE set the S1 mode bit to "S1 mode supported" in the 5GMM capability IE of the REGISTRATION REQUEST message, and the AMF needs to provide the selected EPS NAS security algorithms to the UE.

8.2.25.5 Additional 5G security information

The network shall include this IE if:

- a) the network needs to provide the UE with horizontal derivation parameter; or
- b) the applicable initial NAS message (i.e. REGISTRATION REQUEST, CONTROL PLANE SERVICE REQUEST or SERVICE REQUEST) does not successfully pass the integrity check at the AMF (see subclause 5.4.2.2).

8.2.25.6 EAP message

This IE is included when the EAP Success message is sent as part of the EAP based primary authentication and key agreement procedure, as specified in subclause 5.4.1.2.

8.2.25.7 ABBA

This IE shall be included if the message contains an EAP message IE with an EAP-success message.

8.2.25.8 Replayed S1 UE security capabilities

This IE shall be included if the Selected EPS NAS security algorithms information element is included.

8.2.25.9 AUN3 device security key

This IE shall be included when the SECURITY MODE COMMAND message is provided to a 5G-RG that is acting on behalf of an AUN3 device if the EAP message IE is set to an EAP-success message.

8.2.26 Security mode complete

8.2.26.1 Message definition

The SECURITY MODE COMPLETE message is sent by the UE to the AMF in response to a SECURITY MODE COMMAND message. See table 8.2.26.1.1.

Message type: SECURITY MODE COMPLETE

Significance: dual

Direction: UE to network

Table 8.2.26.1.1: SECURITY MODE COMPLETE message content

IEI	Information Element	Type/Reference	Presence	Format	Length
	Extended protocol discriminator	Extended protocol discriminator 9.2	M	V	1
	Security header type	Security header type 9.3	M	V	1/2
	Spare half octet	Spare half octet 9.5	M	V	1/2
	Security mode complete message identity	Message type 9.6	M	V	1
77	IMEISV	5GS mobile identity 9.11.3.4	O	TLV-E	12
71	NAS message container	NAS message container 9.11.3.33	O	TLV-E	4-n
78	non-IMEISV PEI	5GS mobile identity 9.11.3.4	O	TLV-E	7-n

8.2.26.2 IMEISV

The UE shall include this information element, if the IMEISV was requested within the corresponding SECURITY MODE COMMAND message.

8.2.26.3 NAS message container

The UE shall include this information element:

- a) if during an ongoing registration procedure or service request procedure, the AMF included the Additional 5G security information with the RINMR bit set to "Retransmission of the initial NAS message requested" in the SECURITY MODE COMMAND message as described in 3GPP TS 33.501 [24]; or
- b) if during an ongoing registration procedure, the UE does not have a valid 5G NAS security context.

8.2.26.4 non-IMEISV PEI

The 5G-RG or the W-AGF acting on behalf of the FN-RG (or on behalf of the N5GC device) shall include this information element, if the IMEISV was requested within the corresponding SECURITY MODE COMMAND message, the IMEISV is not available but MAC address is available.

The UE shall include this information element, if the IMEISV was requested within the corresponding SECURITY MODE COMMAND message, the IMEISV is not available but EUI-64 is available.

8.2.27 Security mode reject

8.6.27.1 Message definition

The SECURITY MODE REJECT message is sent by the UE to the AMF to indicate that the corresponding security mode command has been rejected. See table 8.2.27.1.1.

Message type: SECURITY MODE REJECT

Significance: dual

Direction: UE to network

Table 8.2.27.1.1: SECURITY MODE REJECT message content

IEI	Information Element	Type/Reference	Presence	Format	Length
	Extended protocol discriminator	Extended protocol discriminator 9.2	M	V	1
	Security header type	Security header type 9.3	M	V	1/2
	Spare half octet	Spare half octet 9.5	M	V	1/2
	Security mode reject message identity	Message type 9.6	M	V	1
	5GMM cause	5GMM cause 9.11.3.2	M	V	1

8.2.28 Security protected 5GS NAS message

8.2.28.1 Message definition

This message is sent by the UE or the network to transfer a plain 5GS NAS message as specified in subclause 8.2 together with the sequence number and the message authentication code protecting the message. See table 8.2.28.1.1.

Message type: SECURITY PROTECTED 5GS NAS MESSAGE

Significance: dual

Direction: both

Table 8.2.28.1.1: SECURITY PROTECTED 5GS NAS MESSAGE message content

IEI	Information Element	Type/Reference	Presence	Format	Length
	Extended protocol discriminator	Extended protocol discriminator 9.2	M	V	1
	Security header type	Security header type 9.3	M	V	1/2
	Spare half octet	Spare half octet 9.5	M	V	1/2
	Message authentication code	Message authentication code 9.8	M	V	4
	Sequence number	Sequence number 9.10	M	V	1
	Plain 5GS NAS message	Plain 5GS NAS message 9.9	M	V	3-n

NOTE: The minimum length of Plain 5GS NAS message IE can be 2 octets if it includes a Test Mode Control message specified in 3GPP TS 38.509 [31AA].

8.2.29 5GMM status

8.2.29.1 Message definition

The 5GMM STATUS message is sent by the UE or by the AMF at any time to report certain error conditions. See table 8.2.29.1.1.

Message type: 5GMM STATUS

Significance: local

Direction: both

Table 8.2.29.1.1: 5GMM STATUS message content

IEI	Information Element	Type/Reference	Presence	Format	Length
	Extended protocol discriminator	Extended protocol discriminator 9.2	M	V	1
	Security header type	Security header type 9.3	M	V	1/2
	Spare half octet	Spare half octet 9.5	M	V	1/2
	5GMM STATUS message identity	Message type 9.7	M	V	1
	5GMM cause	5GMM cause 9.11.3.2	M	V	1

8.2.30 Control Plane Service request

8.2.30.1 Message definition

The CONTROL PLANE SERVICE REQUEST message is sent by the UE to the AMF when the UE is using 5GS services with control plane CIoT 5GS optimization. See table 8.2.30.1.1.

Message type: CONTROL PLANE SERVICE REQUEST

Significance: dual

Direction: UE to network

Table 8.2.30.1.1: CONTROL PLANE SERVICE REQUEST message content

IEI	Information Element	Type/Reference	Presence	Format	Length
	Extended protocol discriminator	Extended protocol discriminator 9.2	M	V	1
	Security header type	Security header type 9.3	M	V	1/2
	Spare half octet	Spare half octet 9.5	M	V	1/2
	Control plane service request message identity	Message type 9.7	M	V	1
	Control plane service type	Control plane service type 9.11.3.18D	M	V	1/2
	ngKSI	NAS key set identifier 9.11.3.32	M	V	1/2
6F	CloT small data container	CloT small data container 9.11.3.18B	O	TLV	4-257
8-	Payload container type	Payload container type 9.11.3.40	O	TV	1
7B	Payload container	Payload container 9.11.3.39	O	TLV-E	4-65538
12	PDU session ID	PDU session identity 2 9.11.3.41	C	TV	2
50	PDU session status	PDU session status 9.11.3.44	O	TLV	4-34
F-	Release assistance indication	Release assistance indication 9.11.3.46A	O	TV	1
40	Uplink data status	Uplink data status 9.11.3.57	O	TLV	4-34
71	NAS message container	NAS message container 9.11.3.33	O	TLV-E	4-n
24	Additional information	Additional information 9.11.2.1	O	TLV	3-n
25	Allowed PDU session status	Allowed PDU session status 9.11.3.13	O	TLV	4-34
29	UE request type	UE request type 9.11.3.76	O	TLV	3
28	Paging restriction	Paging restriction 9.11.3.77	O	TLV	3-35

8.2.30.2 CloT small data container

This IE shall be included if the UE needs to send uplink small user data, SMS or location services message that is not more than 254 bytes, and there is no other optional IE to be sent.

NOTE: When the UE determines to use the CloT small data container IE to send uplink data in this message, there is no other optional IEs in this message.

8.2.30.3 Payload container type

This IE shall be included if the UE includes the Payload container IE.

8.2.30.4 Payload container

This IE shall be included if the UE needs to send uplink CloT user data, SMS or location services message.

8.2.30.5 PDU session ID

The UE shall include this IE when the Payload container type IE is set to "CloT user data container".

8.2.30.6 PDU session status

This IE shall be included when the UE needs to indicate the PDU sessions that are associated with the access type that the message is sent over, that are active within the UE.

8.2.30.7 Release assistance indication

The UE may include this IE to inform the network whether:

- no further uplink and no further downlink data transmission is expected; or
- only a single downlink data transmission (e.g. acknowledgement or response to uplink data) and no further uplink data transmission subsequent to the uplink data transmission is expected.

8.2.30.8 Uplink data status

This IE shall be included if the UE has uplink user data pending to be sent over the user plane.

8.2.30.9 NAS message container

This IE shall be included if the UE is sending a CONTROL PLANE SERVICE REQUEST message as an initial NAS message and the UE needs to send non-clear-text IEs.

8.2.30.10 Additional information

The UE may include this IE when the Payload container type IE is set to "Location services message container".

8.2.30.11 Allowed PDU session status

This IE shall be included if the CONTROL PLANE SERVICE REQUEST message is sent as a response to paging with the access type indicating non-3GPP access or notification via 3GPP access for PDU session(s) associated with non-3GPP access.

8.2.30.12 UE request type

The UE shall include this IE if the MUSIM UE requests the release of the NAS signalling connection or rejects the paging request from the network.

8.2.30.13 Paging restriction

The UE shall include this IE if the Request type is set to "NAS signalling connection release" or to "Rejection of paging" in the UE request type IE and the UE requests the network to restrict paging.

8.2.31 Network slice-specific authentication command

8.2.31.1 Message definition

The NETWORK SLICE-SPECIFIC AUTHENTICATION COMMAND message is sent by the AMF to the UE for authentication of the upper layers of the UE. See table 8.2.31.1.1.

Message type: NETWORK SLICE-SPECIFIC AUTHENTICATION COMMAND

Significance: dual

Direction: network to UE

Table 8.2.31.1.1: NETWORK SLICE-SPECIFIC AUTHENTICATION COMMAND message content

IEI	Information Element	Type/Reference	Presence	Format	Length
	Extended protocol discriminator	Extended protocol discriminator 9.2	M	V	1
	Security header type	Security header type 9.3	M	V	1/2
	Spare half octet	Spare half octet 9.5	M	V	1/2
	NETWORK SLICE-SPECIFIC AUTHENTICATION COMMAND message identity	Message type 9.7	M	V	1
	S-NSSAI	S-NSSAI 9.11.2.8	M	LV	2-5
	EAP message	EAP message 9.11.2.2	M	LV-E	6-1502

8.2.32 Network slice-specific authentication complete

8.2.32.1 Message definition

The NETWORK SLICE-SPECIFIC AUTHENTICATION COMPLETE message is sent by the UE to the AMF in response to the NETWORK SLICE-SPECIFIC AUTHENTICATION COMMAND message and indicates acceptance of the NETWORK SLICE-SPECIFIC AUTHENTICATION COMMAND message. See table 8.2.32.1.1.

Message type: NETWORK SLICE-SPECIFIC AUTHENTICATION COMPLETE

Significance: dual

Direction: UE to network

Table 8.2.32.1.1: NETWORK SLICE-SPECIFIC AUTHENTICATION COMPLETE message content

IEI	Information Element	Type/Reference	Presence	Format	Length
	Extended protocol discriminator	Extended protocol discriminator 9.2	M	V	1
	Security header type	Security header type 9.3	M	V	1/2
	Spare half octet	Spare half octet 9.5	M	V	1/2
	NETWORK SLICE-SPECIFIC AUTHENTICATION COMPLETE message identity	Message type 9.7	M	V	1
	S-NSSAI	S-NSSAI 9.11.2.8	M	LV	2-5
	EAP message	EAP message 9.11.2.2	M	LV-E	6-1502

8.2.33 Network slice-specific authentication result

8.2.33.1 Message definition

The NETWORK SLICE-SPECIFIC AUTHENTICATION RESULT message is sent by the AMF to the UE for indicating the result of the network slice-specific authentication and authorization procedure. See table 8.2.33.1.1.

Message type: NETWORK SLICE-SPECIFIC AUTHENTICATION RESULT

Significance: dual

Direction: network to UE

Table 8.2.33.1.1: NETWORK SLICE-SPECIFIC AUTHENTICATION RESULT message content

IEI	Information Element	Type/Reference	Presence	Format	Length
	Extended protocol discriminator	Extended protocol discriminator 9.2	M	V	1
	Security header type	Security header type 9.3	M	V	1/2
	Spare half octet	Spare half octet 9.5	M	V	1/2
	NETWORK SLICE-SPECIFIC AUTHENTICATION RESULT message identity	Message type 9.7	M	V	1
	S-NSSAI	S-NSSAI 9.11.2.8	M	LV	2-5
	EAP message	EAP message 9.11.2.2	M	LV-E	6-1502

8.2.34 Relay key request

8.2.34.1 Message definition

The RELAY KEY REQUEST message is sent by the UE to the AMF for initiation of PC5 keys establishment with the 5G ProSe remote UE or the 5G ProSe end UE as specified in 3GPP TS 33.503 [56]. See table 8.2.34.1.

Message type: RELAY KEY REQUEST

Significance: dual

Direction: UE to network

Table 8.2.34.1: RELAY KEY REQUEST message content

IEI	Information Element	Type/Reference	Presence	Format	Length
	Extended protocol discriminator	Extended protocol discriminator 9.2	M	V	1
	Security header type	Security header type 9.3	M	V	1/2
	Spare half octet	Spare half octet 9.5	M	V	1/2
	Relay key request message identity	Message type 9.7	M	V	1
	PRTI	ProSe relay transaction identity 9.11.3.88	M	V	1
	Relay key request parameters	Relay key request parameters 9.11.3.89	M	LV	22-65537

8.2.35 Relay key accept

8.2.35.1 Message definition

The RELAY KEY ACCEPT message is sent by the AMF to the UE as specified in 3GPP TS 33.503 [56]. See table 8.2.35.1.

Message type: RELAY KEY ACCEPT

Significance: dual

Direction: network to UE

Table 8.2.35.1: RELAY KEY ACCEPT message content

IEI	Information Element	Type/Reference	Presence	Format	Length
	Extended protocol discriminator	Extended protocol discriminator 9.2	M	V	1
	Security header type	Security header type 9.3	M	V	1/2
	Spare half octet	Spare half octet 9.5	M	V	1/2
	Relay key accept message identity	Message type 9.7	M	V	1
	PRTI	ProSe relay transaction identity 9.11.3.88	M	V	1
	Relay key response parameters	Relay key response parameters 9.11.3.90	M	LV-E	51-65537
78	EAP message	EAP message 9.11.2.2	O	TLV-E	7-1503

8.2.35.2 EAP message

The AMF shall include the EAP message IE if the AMF has received an EAP-success message from the AUSF.

8.2.36 Relay key reject

8.2.36.1 Message definition

The RELAY KEY REJECT message is sent by the AMF to the UE to indicate the rejection of the relay key request. See table 8.2.36.1.

Message type: RELAY KEY REJECT

Significance: dual

Direction: network to UE

Table 8.2.36.1: RELAY KEY REJECT message content

IEI	Information Element	Type/Reference	Presence	Format	Length
	Extended protocol discriminator	Extended protocol discriminator 9.2	M	V	1
	Security header type	Security header type 9.3	M	V	1/2
	Spare half octet	Spare half octet 9.5	M	V	1/2
	Relay key reject message identity	Message type 9.7	M	V	1
	PRTI	ProSe relay transaction identity 9.11.3.88	M	V	1
78	EAP message	EAP message 9.11.2.2	O	TLV-E	7-1503

8.2.36.2 EAP message

EAP message IE is included if the RELAY KEY REJECT message is used to convey EAP-failure message.

8.2.37 Relay authentication request

8.2.37.1 Message definition

The RELAY AUTHENTICATION REQUEST message is sent by the network to the UE to initiate authentication of the 5G ProSe remote UE or the 5G ProSe end UE as specified in 3GPP TS 33.503 [56]. See table 8.2.37.1.

Message type: RELAY AUTHENTICATION REQUEST

Significance: dual

Direction: Network to UE

Table 8.2.37.1: RELAY AUTHENTICATION REQUEST message content

IEI	Information Element	Type/Reference	Presence	Format	Length
	Extended protocol discriminator	Extended protocol discriminator 9.2	M	V	1
	Security header type	Security header type 9.3	M	V	1/2
	Spare half octet	Spare half octet 9.5	M	V	1/2
	Relay authentication request message identity	Message type 9.7	M	V	1
	PRTI	ProSe relay transaction identity 9.11.3.88	M	V	1
	EAP message	EAP message 9.11.2.2	M	LV-E	7-1503

8.2.38 Relay authentication response

8.2.38.1 Message definition

The RELAY AUTHENTICATION RESPONSE message is sent by the UE to the network to forward the authentication response from the 5G ProSe remote UE or the 5G ProSe end UE as specified in 3GPP TS 33.503 [56]. See table 8.2.38.1.

Message type: RELAY AUTHENTICATION RESPONSE

Significance: dual

Direction: UE to network

Table 8.2.38.1: RELAY AUTHENTICATION RESPONSE message content

IEI	Information Element	Type/Reference	Presence	Format	Length
	Extended protocol discriminator	Extended protocol discriminator 9.2	M	V	1
	Security header type	Security header type 9.3	M	V	1/2
	Spare half octet	Spare half octet 9.5	M	V	1/2
	Relay authentication response message identity	Message type 9.7	M	V	1
	PRTI	ProSe relay transaction identity 9.11.3.88	M	V	1
	EAP message	EAP message 9.11.2.2	M	LV-E	6-1502

8.3 5GS session management messages

8.3.1 PDU session establishment request

8.3.1.1 Message definition

The PDU SESSION ESTABLISHMENT REQUEST message is sent by the UE to the SMF to initiate establishment of a PDU session. See table 8.3.1.1.1.

Message type: PDU SESSION ESTABLISHMENT REQUEST

Significance: dual

Direction: UE to network

Table 8.3.1.1.1: PDU SESSION ESTABLISHMENT REQUEST message content

IEI	Information Element	Type/Reference	Presence	Format	Length
	Extended protocol discriminator	Extended protocol discriminator 9.2	M	V	1
	PDU session ID	PDU session identity 9.4	M	V	1
	PTI	Procedure transaction identity 9.6	M	V	1
	PDU SESSION ESTABLISHMENT REQUEST message identity	Message type 9.7	M	V	1
	Integrity protection maximum data rate	Integrity protection maximum data rate 9.11.4.7	M	V	2
9-	PDU session type	PDU session type 9.11.4.11	O	TV	1
A-	SSC mode	SSC mode 9.11.4.16	O	TV	1
28	5GSM capability	5GSM capability 9.11.4.1	O	TLV	3-15
55	Maximum number of supported packet filters	Maximum number of supported packet filters 9.11.4.9	O	TV	3
B-	Always-on PDU session requested	Always-on PDU session requested 9.11.4.4	O	TV	1
39	SM PDU DN request container	SM PDU DN request container 9.11.4.15	O	TLV	3-255
7B	Extended protocol configuration options	Extended protocol configuration options 9.11.4.6	O	TLV-E	4-65538
66	IP header compression configuration	IP header compression configuration 9.11.4.24	O	TLV	5-257
6E	DS-TT Ethernet port MAC address	DS-TT Ethernet port MAC address 9.11.4.25	O	TLV	8
6F	UE-DS-TT residence time	UE-DS-TT residence time 9.11.4.26	O	TLV	10
74	Port management information container	Port management information container 9.11.4.27	O	TLV-E	8-65538
1F	Ethernet header compression configuration	Ethernet header compression configuration 9.11.4.28	O	TLV	3
29	Suggested interface identifier	PDU address 9.11.4.10	O	TLV	11
72	Service-level-AA container	Service-level-AA container 9.11.2.10	O	TLV-E	4-65538
70	Requested MBS container	Requested MBS container 9.11.4.30	O	TLV-E	8-65538
34	PDU session pair ID	PDU session pair ID 9.11.4.32	O	TLV	3
35	RSN	RSN 9.11.4.33	O	TLV	3
36	URSP rule enforcement reports	URSP rule enforcement reports 9.11.4.38	O	TLV	4-n

8.3.1.2 PDU session type

This IE shall be included in the message when the UE requests to establish a new PDU session.

8.3.1.3 SSC mode

This IE is included in the message when the UE requests to establish a new PDU session with a DN and requests an SSC mode.

8.3.1.4 Maximum number of supported packet filters

This IE shall be included in the message when the selected PDU session type is "IPv4", "IPv6", "IPv4v6" or "Ethernet" and the UE can support more than 16 packet filters for this PDU session.

8.3.1.5 5GSM capability

This IE is included in the message when the UE requests to establish a new PDU session or to transfer an existing PDN connection and any of the 5GSM capabilities supported by the UE is relevant for the PDU session.

8.3.1.6 Void

8.3.1.7 Always-on PDU session requested

The UE shall include this IE if the UE requests to establish a PDU session as an always-on PDU session.

8.3.1.8 SM PDU DN request container

This IE is included in the message when the UE requests to establish a new PDU session with a DN and needs to provide information for the PDU session authentication and authorization by the external DN.

8.3.1.9 Extended protocol configuration options

This IE is included in the message when the UE needs to transmit (protocol) data (e.g. configuration parameters, error codes or messages/events) to the network.

8.3.1.10 IP header compression configuration

The UE shall include the IP header compression configuration IE if:

- the PDU session type value of the PDU session type IE is set to "IPv4", "IPv6" or "IPv4v6";
- the UE indicates "Control Plane CIoT 5GS optimization supported" and "IP header compression for control plane CIoT 5GS optimization supported" in the 5GMM capability IE of the REGISTRATION REQUEST message; and
- the network indicates "Control plane CIoT 5GS optimization supported" and "IP header compression for control plane CIoT 5GS optimization supported" in the 5GS network support feature IE of the REGISTRATION ACCEPT message.

8.3.1.11 DS-TT Ethernet port MAC address

This IE shall be included in the message if the UE supports transfer of port management information containers and the UE requests to establish a new PDU session of "Ethernet" PDU session type.

8.3.1.12 UE-DS-TT residence time

This IE shall be included in the message if:

- a) the UE supports transfer of port management information containers; and
- b) the UE-DS-TT residence time is available at the UE.

8.3.1.13 Port management information container

This IE shall be included in the message if the UE supports transfer of port management information containers.

8.3.1.14 Ethernet header compression configuration

The UE shall include the Ethernet header compression configuration IE if:

- the PDU session type value of the PDU session type IE is set to "Ethernet";
- the UE indicated "Control Plane CIoT 5GS optimization supported" and "Ethernet header compression for control plane CIoT 5GS optimization supported" in the 5GMM capability IE of the REGISTRATION REQUEST message; and
- the network indicated "Control plane CIoT 5GS optimization supported" and "Ethernet header compression for control plane CIoT 5GS optimization supported" in the 5GS network support feature IE of the REGISTRATION ACCEPT message.

8.3.1.15 Suggested interface identifier

This IE may be included by the W-AGF acting on behalf of the FN-RG.

8.3.1.16 Service-level-AA container

This IE shall be included in the message when the UE needs to establish a PDU session for the UAS services.

8.3.1.17 Requested MBS container

This IE is included in the message when the UE requests to join one or more multicast MBS sessions that are associated with the PDU session.

8.3.1.18 PDU session pair ID

This IE shall be included in the message when the UE needs to include a PDU session pair ID.

8.3.1.19 RSN

This IE shall be included in the message when the UE needs to include an RSN.

8.3.1.20 URSP rule enforcement reports

This IE is included in the message when the UE sends one or more URSP rule enforcement reports to the network.

8.3.2 PDU session establishment accept

8.3.2.1 Message definition

The PDU SESSION ESTABLISHMENT ACCEPT message is sent by the SMF to the UE in response to PDU SESSION ESTABLISHMENT REQUEST message and indicates successful establishment of a PDU session. See table 8.3.2.1.1.

Message type: PDU SESSION ESTABLISHMENT ACCEPT

Significance: dual

Direction: network to UE

Table 8.3.2.1.1: PDU SESSION ESTABLISHMENT ACCEPT message content

IEI	Information Element	Type/Reference	Presence	Format	Length
	Extended protocol discriminator	Extended protocol discriminator 9.2	M	V	1
	PDU session ID	PDU session identity 9.4	M	V	1
	PTI	Procedure transaction identity 9.6	M	V	1
	PDU SESSION ESTABLISHMENT ACCEPT message identity	Message type 9.7	M	V	1
	Selected PDU session type	PDU session type 9.11.4.11	M	V	1/2
	Selected SSC mode	SSC mode 9.11.4.16	M	V	1/2
	Authorized QoS rules	QoS rules 9.11.4.13	M	LV-E	6-65538
	Session AMBR	Session-AMBR 9.11.4.14	M	LV	7
59	5GSM cause	5GSM cause 9.11.4.2	O	TV	2
29	PDU address	PDU address 9.11.4.10	O	TLV	7-31
56	RQ timer value	GPRS timer 9.11.2.3	O	TV	2
22	S-NSSAI	S-NSSAI 9.11.2.8	O	TLV	3-10
8-	Always-on PDU session indication	Always-on PDU session indication 9.11.4.3	O	TV	1
75	Mapped EPS bearer contexts	Mapped EPS bearer contexts 9.11.4.8	O	TLV-E	7-65538
78	EAP message	EAP message 9.11.2.2	O	TLV-E	7-1503
79	Authorized QoS flow descriptions	QoS flow descriptions 9.11.4.12	O	TLV-E	6-65538
7B	Extended protocol configuration options	Extended protocol configuration options 9.11.4.6	O	TLV-E	4-65538
25	DNN	DNN 9.11.2.1B	O	TLV	3-102
17	5GSM network feature support	5GSM network feature support 9.11.4.18	O	TLV	3-15
18	Serving PLMN rate control	Serving PLMN rate control 9.11.4.20	O	TLV	4
77	ATSSS container	ATSSS container 9.11.4.22	O	TLV-E	3-65538
C-	Control plane only indication	Control plane only indication 9.11.4.23	O	TV	1
66	IP header compression configuration	IP header compression configuration 9.11.4.24	O	TLV	5-257
1F	Ethernet header compression configuration	Ethernet header compression configuration 9.11.4.28	O	TLV	3
72	Service-level-AA container	Service-level-AA container 9.11.2.10	O	TLV-E	4-65538
71	Received MBS container	Received MBS container 9.11.4.31	O	TLV-E	9-65538
70	N3QAI	N3QAI 9.11.4.36	O	TLV-E	9-n
73	Protocol description	Protocol description 9.11.4.39	O	TLV-E	6-n

8.3.2.2 5GSM cause

This IE is included when the selected PDU session type is different from the PDU session type requested by the UE.

8.3.2.3 PDU address

This IE is included when the selected PDU session type is "IPv4", "IPv6" or "IPv4v6".

8.3.2.4 RQ timer value

This IE is included when the network needs to provide the RQ timer value.

8.3.2.5 S-NSSAI

This IE shall be included in the message when the SMF received from the AMF an S-NSSAI together with the PDU SESSION ESTABLISHMENT REQUEST message, the PDU session is a non-emergency PDU session and the UE is not registered for onboarding services in SNPN.

8.3.2.6 Always-on PDU session indication

The network shall include this IE if the network decides to inform the UE whether the PDU session is established as an always-on PDU session.

8.3.2.7 Mapped EPS bearer contexts

This IE is included when interworking with EPS is supported for the PDU session.

8.3.2.8 EAP message

This IE is included when the external DN successfully performed authentication and authorization of the UE using EAP.

8.3.2.9 Authorized QoS flow descriptions

This IE is included when the network needs to provide authorized QoS flow descriptions.

8.3.2.10 Extended protocol configuration options

This IE is included in the message when the network needs to transmit (protocol) data (e.g. configuration parameters, error codes or messages/events) to the UE.

8.3.2.11 DNN

The IE shall be included in the message when the PDU session is a non-emergency PDU session and the UE is not registered for onboarding services in SNPN.

8.3.2.12 5GSM network feature support

This IE is included when the network needs to indicate support of 5GSM network features.

8.3.2.13 Void

8.3.2.14 Serving PLMN rate control

This IE shall be included when the network needs to indicate the maximum uplink control plane user data the UE is allowed to send per 6 minute interval.

8.3.2.15 ATSSS container

The IE shall be included in the message when the PDU session is an MA PDU session.

8.3.2.16 Control plane only indication

The network shall include the control plane only indication IE if the network determines that the associated PDU session is only for control plane CIoT 5GS optimization.

8.3.2.17 IP header compression configuration

The SMF may include the IP header compression configuration IE if:

- the network accepts an IP PDU session type;
- control plane CIoT 5GS optimization is selected; and
- the UE provided the IP header compression configuration IE in the PDU SESSION ESTABLISHMENT REQUEST message.

8.3.2.18 Ethernet header compression configuration

The SMF may include the Ethernet header compression configuration IE if:

- the network accepts an Ethernet PDU session type;
- control plane CIoT 5GS optimization is selected; and
- the UE provided the Ethernet header compression configuration IE in the PDU SESSION ESTABLISHMENT REQUEST message.

8.3.2.19 Service-level-AA container

The SMF shall include the Service-level-AA container IE if the service-level authentication and authorization procedure is completed successfully by the external DN.

8.3.2.20 Received MBS container

The network shall include this IE if the UE has requested to join one or more multicast MBS sessions.

8.3.2.21 N3QAI

This IE is included when the network needs to provide the N3QAI to the UE.

8.3.2.22 Protocol description

This IE is included when the network needs to indicate the protocol description for UL PDU set handling to the UE.

8.3.3 PDU session establishment reject

8.3.3.1 Message definition

The PDU SESSION ESTABLISHMENT REJECT message is sent by the SMF to the UE in response to PDU SESSION ESTABLISHMENT REQUEST message and indicates unsuccessful establishment of a PDU session. See table 8.3.3.1.1.

Message type: PDU SESSION ESTABLISHMENT REJECT

Significance: dual

Direction: network to UE

Table 8.3.3.1.1: PDU SESSION ESTABLISHMENT REJECT message content

IEI	Information Element	Type/Reference	Presence	Format	Length
	Extended protocol discriminator	Extended protocol discriminator 9.2	M	V	1
	PDU session ID	PDU session identity 9.4	M	V	1
	PTI	Procedure transaction identity 9.6	M	V	1
	PDU SESSION ESTABLISHMENT REJECT message identity	Message type 9.7	M	V	1
	5GSM cause	5GSM cause 9.11.4.2	M	V	1
37	Back-off timer value	GPRS timer 3 9.11.2.5	O	TLV	3
F-	Allowed SSC mode	Allowed SSC mode 9.11.4.5	O	TV	1
78	EAP message	EAP message 9.11.2.2	O	TLV-E	7-1503
61	5GSM congestion re-attempt indicator	5GSM congestion re-attempt indicator 9.11.4.21	O	TLV	3
7B	Extended protocol configuration options	Extended protocol configuration options 9.11.4.6	O	TLV-E	4-65538
1D	Re-attempt indicator	Re-attempt indicator 9.11.4.17	O	TLV	3
72	Service-level-AA container	Service-level-AA container 9.11.2.10	O	TLV-E	4-65538

8.3.3.2 Back-off timer value

The network may include this IE if the 5GSM cause is not #28 "unknown PDU session type", #39 "reactivation requested", #46 "out of LADN service area", #50 "PDU session type IPv4 only allowed", #51 "PDU session type IPv6 only allowed", #54 "PDU session does not exist", #57 "PDU session type IPv4v6 only allowed", #58 "PDU session type Unstructured only allowed", #61 "PDU session type Ethernet only allowed", #68 "not supported SSC mode", or #86 "UAS services not allowed" to request a minimum time interval before procedure retry is allowed.

8.3.3.3 Allowed SSC mode

This IE is included when the network rejects the PDU SESSION ESTABLISHMENT REQUEST with cause #68 "not supported SSC mode".

8.3.3.4 EAP message

This IE is included when the external DN unsuccessfully performed authentication and authorization of the UE using EAP.

8.3.3.4A 5GSM congestion re-attempt indicator

The network may include this IE only if it includes the Back-off timer value IE and the 5GSM cause value is either #67 "insufficient resources for specific slice and DNN" or #69 "insufficient resources for specific slice".

8.3.3.5 Extended protocol configuration options

This IE is included in the message when the network needs to transmit (protocol) data (e.g. configuration parameters, error codes or messages/events) to the UE.

8.3.3.6 Re-attempt indicator

The network may include this IE if the network includes the Back-off timer value IE and the 5GSM cause value is not #26 "insufficient resources", #28 "unknown PDU session type", #39 "reactivation requested", #46 "out of LADN service area", #54 "PDU session does not exist", #67 "insufficient resources for specific slice and DNN", #68 "not supported SSC mode", or #69 "insufficient resources for specific slice".

8.3.3.7 Service-level-AA container

The network shall include this IE if the service-level authentication and authorization procedure has completed unsuccessfully and the 5GSM cause is #29 "user authentication or authorization failed". The network shall include the service-level-AA response if provided by the DN in the service-level-AA container.

8.3.4 PDU session authentication command

8.3.4.1 Message definition

The PDU SESSION AUTHENTICATION COMMAND message is sent by the SMF to the UE for authentication of the UE establishing the PDU session or of the UE participating in the PDU session. See table 8.3.4.1.1.

Message type: PDU SESSION AUTHENTICATION COMMAND

Significance: dual

Direction: network to UE

Table 8.3.4.1.1: PDU SESSION AUTHENTICATION COMMAND message content

IEI	Information Element	Type/Reference	Presence	Format	Length
	Extended protocol discriminator	Extended protocol discriminator 9.2	M	V	1
	PDU session ID	PDU session identity 9.4	M	V	1
	PTI	Procedure transaction identity 9.6	M	V	1
	PDU SESSION AUTHENTICATION COMMAND message identity	Message type 9.7	M	V	1
	EAP message	EAP message 9.11.2.2	M	LV-E	6-1502
7B	Extended protocol configuration options	Extended protocol configuration options 9.11.4.6	O	TLV-E	4-65538

8.3.4.2 Extended protocol configuration options

This IE is included in the message when the network needs to transmit (protocol) data (e.g. configuration parameters, error codes or messages/events) to the UE.

NOTE: How the Extended protocol configuration options IE is used by the network and the UE during the PDU session authentication and authorization procedure is not specified in this release of the specification.

8.3.4.3 Void

8.3.5 PDU session authentication complete

8.3.5.1 Message definition

The PDU SESSION AUTHENTICATION COMPLETE message is sent by the UE to the SMF in response to the PDU SESSION AUTHENTICATION COMMAND message and indicates acceptance of the PDU SESSION AUTHENTICATION COMMAND message. See table 8.3.5.1.1.

Message type: PDU SESSION AUTHENTICATION COMPLETE

Significance: dual

Direction: UE to network

Table 8.3.5.1.1: PDU SESSION AUTHENTICATION COMPLETE message content

IEI	Information Element	Type/Reference	Presence	Format	Length
	Extended protocol discriminator	Extended protocol discriminator 9.2	M	V	1
	PDU session ID	PDU session identity 9.4	M	V	1
	PTI	Procedure transaction identity 9.6	M	V	1
	PDU SESSION AUTHENTICATION COMPLETE message identity	Message type 9.7	M	V	1
	EAP message	EAP message 9.11.2.2	M	LV-E	6-1502
7B	Extended protocol configuration options	Extended protocol configuration options 9.11.4.6	O	TLV-E	4-65538

8.3.5.2 Extended protocol configuration options

This IE is included in the message when the UE needs to transmit (protocol) data (e.g. configuration parameters, error codes or messages/events) to the network.

NOTE: How the Extended protocol configuration options IE is used by the network and the UE during the PDU session authentication and authorization procedure is not specified in this release of the specification.

8.3.5.3 Void

8.3.6 PDU session authentication result

8.3.6.1 Message definition

The PDU SESSION AUTHENTICATION RESULT message is sent by the SMF to the UE for indication of successful result of authentication of the UE participating in the PDU session. See table 8.3.6.1.1.

Message type: PDU SESSION AUTHENTICATION RESULT

Significance: dual

Direction: network to UE

Table 8.3.6.1.1: PDU SESSION AUTHENTICATION RESULT message content

IEI	Information Element	Type/Reference	Presence	Format	Length
	Extended protocol discriminator	Extended protocol discriminator 9.2	M	V	1
	PDU session ID	PDU session identity 9.4	M	V	1
	PTI	Procedure transaction identity 9.6	M	V	1
	PDU SESSION AUTHENTICATION RESULT message identity	Message type 9.7	M	V	1
78	EAP message	EAP message 9.11.2.2	O	TLV-E	7-1503
7B	Extended protocol configuration options	Extended protocol configuration options 9.11.4.6	O	TLV-E	4-65538

8.3.6.2 EAP message

This IE shall be included when the external DN performs authentication and authorization of the UE using EAP and it completes successfully.

8.3.6.3 Extended protocol configuration options

This IE is included in the message when the network needs to transmit (protocol) data (e.g. configuration parameters, error codes or messages/events) to the UE.

NOTE: How the Extended protocol configuration options IE is used by the network and the UE during the PDU session authentication and authorization procedure is not specified in this release of the specification.

8.3.7 PDU session modification request

8.3.7.1 Message definition

The PDU SESSION MODIFICATION REQUEST message is sent by the UE to the SMF to request a modification of a PDU session. See table 8.3.7.1.1.

Message type: PDU SESSION MODIFICATION REQUEST

Significance: dual

Direction: UE to network

Table 8.3.7.1.1: PDU SESSION MODIFICATION REQUEST message content

IEI	Information Element	Type/Reference	Presence	Format	Length
	Extended protocol discriminator	Extended protocol discriminator 9.2	M	V	1
	PDU session ID	PDU session identity 9.4	M	V	1
	PTI	Procedure transaction identity 9.6	M	V	1
	PDU SESSION MODIFICATION REQUEST message identity	Message type 9.7	M	V	1
28	5GSM capability	5GSM capability 9.11.4.1	O	TLV	3-15
59	5GSM cause	5GSM cause 9.11.4.2	O	TV	2
55	Maximum number of supported packet filters	Maximum number of supported packet filters 9.11.4.9	O	TV	3
B-	Always-on PDU session requested	Always-on PDU session requested 9.11.4.4	O	TV	1
13	Integrity protection maximum data rate	Integrity protection maximum data rate 9.11.4.7	O	TV	3
7A	Requested QoS rules	QoS rules 9.11.4.13	O	TLV-E	7-65538
79	Requested QoS flow descriptions	QoS flow descriptions 9.11.4.12	O	TLV-E	6-65538
75	Mapped EPS bearer contexts	Mapped EPS bearer contexts 9.11.4.8	O	TLV-E	7-65538
7B	Extended protocol configuration options	Extended protocol configuration options 9.11.4.6	O	TLV-E	4-65538
74	Port management information container	Port management information container 9.11.4.27	O	TLV-E	4-65538
66	IP header compression configuration	Header compression configuration 9.11.4.24	O	TLV	5-257
1F	Ethernet header compression configuration	Ethernet header compression configuration 9.11.4.28	O	TLV	3
70	Requested MBS container	Requested MBS container 9.11.4.30	O	TLV-E	8-65538
72	Service-level-AA container	Service-level-AA container 9.11.2.10	O	TLV-E	4-65538
73	Non-3GPP delay budget	Non-3GPP delay budget 9.11.4.37	O	TLV-E	6-n
36	URSP rule enforcement reports	URSP rule enforcement reports 9.11.4.38	O	TLV	4-n

NOTE: It is possible for UEs compliant with version 15.2.1 or earlier versions of this specification to send the Mapped EPS bearer contexts IE with IEI of value "7F" for this message.

8.3.7.2 5GSM capability

This IE is included in the message:

- 1) for a PDN connection established when in S1 mode, after an inter-system change from S1 mode to N1 mode, if the UE is a UE operating in single-registration mode in a network supporting N26 interface, the UE has not previously successfully performed the UE-requested PDU session modification to provide this capability, and:
 - a) if the PDU session is of "IPv4", "IPv6", "IPv4v6" or "Ethernet" PDU session type, and the UE supports reflective QoS; or
 - b) if the PDU session is of "IPv6" or "IPv4v6" PDU session type, and the UE supports multi-homed IPv6 PDU session; or

2) if the UE needs to revoke the previously indicated support of reflective QoS.

8.3.7.3 5GSM cause

This IE is included in the message to indicate the reason for the deletion of one or more non-default QoS rules, QoS flow descriptions or mapped EPS bearer contexts.

8.3.7.4 Maximum number of supported packet filters

This IE shall be included in the message for a PDN connection established when in S1 mode, after an inter-system change from S1 mode to N1 mode, if the UE is a UE operating in single-registration mode in a network supporting N26 interface, the UE has not previously successfully performed the UE-requested PDU session modification to provide this capability, the PDU session type is "IPv4", "IPv6", "IPv4v6" or "Ethernet", and the UE can support more than 16 packet filters for this PDU session.

8.3.7.5 Always-on PDU session requested

This IE shall be included in the message for a PDN connection established when in S1 mode, after an inter-system change from S1 mode to N1 mode, if the UE is a UE operating in single-registration mode in a network supporting N26 interface, the UE has not previously successfully performed the UE-requested PDU session modification to provide this capability, and the UE requests the PDU session to be an always-on PDU session in the 5GS.

8.3.7.6 Integrity protection maximum data rate

This IE shall be included in the message for a PDN connection established when in S1 mode, after an inter-system change from S1 mode to N1 mode, if the UE is a UE operating in single-registration mode in a network supporting N26 interface, and the UE has not previously successfully performed the UE-requested PDU session modification to provide this capability.

8.3.7.7 Requested QoS rules

This IE is included in the message when the UE requests a specific QoS handling.

8.3.7.8 Requested QoS flow descriptions

This IE is included in the message when the UE requests a specific QoS flow descriptions.

8.3.7.9 Extended protocol configuration options

This IE is included in the message when the UE needs to transmit (protocol) data (e.g. configuration parameters, error codes or messages/events) to the network.

8.3.7.10 Mapped EPS bearer contexts

This IE is included when the UE requests to delete one or more mapped EPS bearer contexts.

8.3.7.11 Port management information container

This IE shall be included when the UE needs to convey a port management information container.

8.3.7.12 IP header compression configuration

This IE is included in the message:

- a) if the UE wishes to re-negotiate IP header compression configuration associated to a PDU session and both the UE and the network supports Control plane ClIoT 5GS optimization and IP header compression; or
- b) to negotiate IP header compression configuration associated to a PDU session after an inter-system change from S1 mode to N1 mode when both the UE and the network support control plane ClIoT 5GS optimization and IP

header compression, and the UE is operating in single-registration mode in the network supporting N26 interface.

8.3.7.13 Ethernet header compression configuration

This IE is included in the message:

- a) if the UE wishes to re-negotiate Ethernet header compression configuration associated to a PDU session and both the UE and the network support Control plane ClIoT 5GS optimization and Ethernet header compression; or
- b) to negotiate Ethernet header compression configuration associated to a PDU session after an inter-system change from S1 mode to N1 mode.

8.3.7.14 Requested MBS container

This IE is included in the message when the UE requests to join or leave one or more multicast MBS sessions that are associated with the PDU session.

8.3.7.15 Service-level-AA container

This IE shall be included in the message when the UE needs to modify an established PDU session for C2 communication.

8.3.7.16 Non-3GPP delay budget

This IE is included in the message when the UE requests a specific QoS handling for the PDU session established for PIN.

8.3.7.17 URSP rule enforcement reports

This IE is included in the message when the UE sends one or more URSP rule enforcement reports to the network.

8.3.8 PDU session modification reject

8.3.8.1 Message definition

The PDU SESSION MODIFICATION REJECT message is sent by the SMF to the UE to indicate rejection of the PDU SESSION MODIFICATION REQUEST. See table 8.3.8.1.1.

Message type: PDU SESSION MODIFICATION REJECT

Significance: dual

Direction: network to UE

Table 8.3.8.1.1: PDU SESSION MODIFICATION REJECT message content

IEI	Information Element	Type/Reference	Presence	Format	Length
	Extended protocol discriminator	Extended protocol discriminator 9.2	M	V	1
	PDU session ID	PDU session identity 9.4	M	V	1
	PTI	Procedure transaction identity 9.6	M	V	1
	PDU SESSION MODIFICATION REJECT message identity	Message type 9.7	M	V	1
	5GSM cause	5GSM cause 9.11.4.2	M	V	1
37	Back-off timer value	GPRS timer 3 9.11.2.5	O	TLV	3
61	5GSM congestion re-attempt indicator	5GSM congestion re-attempt indicator 9.11.4.21	O	TLV	3
7B	Extended protocol configuration options	Extended protocol configuration options 9.11.4.6	O	TLV-E	4-65538
1D	Re-attempt indicator	Re-attempt indicator 9.11.4.17	O	TLV	3

8.3.8.2 Back-off timer value

The network may include this IE if the 5GSM cause is not #26 "insufficient resources", #37 "5GS QoS not accepted", #44 "Semantic errors in packet filter(s)", #45 "Syntactical error in packet filter(s)", #46 "out of LADN service area", #59 "unsupported 5QI value", #67 "insufficient resources for specific slice and DNN", #69 "insufficient resources for specific slice", #83 "Semantic error in the QoS operation", or #84 "Syntactical error in the QoS operation" to request a minimum time interval before procedure retry is allowed.

8.3.8.2A 5GSM congestion re-attempt indicator

The network may include this IE only if it includes the Back-off timer value IE and the 5GSM cause value is either #67 "insufficient resources for specific slice and DNN" or #69 "insufficient resources for specific slice".

8.3.8.3 Extended protocol configuration options

This IE is included in the message when the network needs to transmit (protocol) data (e.g. configuration parameters, error codes or messages/events) to the UE.

8.3.8.4 Re-attempt indicator

The network may include this IE only if it includes the Back-off timer value IE and the 5GSM cause value is not #26 "insufficient resources", #37 "5GS QoS not accepted", #44 "Semantic errors in packet filter(s)", #45 "Syntactical error in packet filter(s)", #46 "out of LADN service area", #59 "unsupported 5QI value", #67 "insufficient resources for specific slice and DNN", #69 "insufficient resources for specific slice", #83 "Semantic error in the QoS operation", or #84 "Syntactical error in the QoS operation".

8.3.9 PDU session modification command

8.3.9.1 Message definition

The PDU SESSION MODIFICATION COMMAND message is sent by the SMF to the UE to indicate a modification of a PDU session. See table 8.3.9.1.1.

Message type: PDU SESSION MODIFICATION COMMAND

Significance: dual

Direction: network to UE

Table 8.3.9.1.1: PDU SESSION MODIFICATION COMMAND message content

IEI	Information Element	Type/Reference	Presence	Format	Length
	Extended protocol discriminator	Extended protocol discriminator 9.2	M	V	1
	PDU session ID	PDU session identity 9.4	M	V	1
	PTI	Procedure transaction identity 9.6	M	V	1
	PDU SESSION MODIFICATION COMMAND message identity	Message type 9.7	M	V	1
59	5GSM cause	5GSM cause 9.11.4.2	O	TV	2
2A	Session AMBR	Session-AMBR 9.11.4.14	O	TLV	8
56	RQ timer value	GPRS timer 9.11.2.3	O	TV	2
8-	Always-on PDU session indication	Always-on PDU session indication 9.11.4.3	O	TV	1
7A	Authorized QoS rules	QoS rules 9.11.4.13	O	TLV-E	7-65538
75	Mapped EPS bearer contexts	Mapped EPS bearer contexts 9.11.4.8	O	TLV-E	7-65538
79	Authorized QoS flow descriptions	QoS flow descriptions 9.11.4.12	O	TLV-E	6-65538
7B	Extended protocol configuration options	Extended protocol configuration options 9.11.4.6	O	TLV-E	4-65538
77	ATSSS container	ATSSS container 9.11.4.22	O	TLV-E	3-65538
66	IP header compression configuration	IP header compression configuration 9.11.4.24	O	TLV	5-257
74	Port management information container	Port management information container 9.11.4.27	O	TLV-E	4-65538
1E	Serving PLMN rate control	Serving PLMN rate control 9.11.4.20	O	TLV	4
1F	Ethernet header compression configuration	Ethernet header compression configuration 9.11.4.28	O	TLV	3
71	Received MBS container	Received MBS container 9.11.4.31	O	TLV-E	9-65538
72	Service-level-AA container	Service-level-AA container 9.11.2.10	O	TLV-E	4-65538
5A	Alternative S-NSSAI	S-NSSAI 9.11.2.8	O	TLV	3-10
70	N3QAI	N3QAI 9.11.4.36	O	TLV-E	9-n
73	Protocol description	Protocol description 9.11.4.39	O	TLV-E	6-n

NOTE: It is possible for networks compliant with version 15.2.1 or earlier versions of this specification to send the Mapped EPS bearer contexts IE with IEI of value "7F" for this message.

8.3.9.2 5GSM cause

This IE is included when the network performs the PDU session anchor relocation for SSC mode 3.

8.3.9.3 Session-AMBR

This IE is included when the session-AMBR of the PDU session is modified.

8.3.9.4 RQ timer value

This IE is included when the network needs to provide the RQ timer value.

8.3.9.5 Always-on PDU session indication

The network shall include this IE if the network decides to inform the UE whether the PDU session is an always-on PDU session.

8.3.9.6 Authorized QoS rules

This IE is included when the authorized QoS rules of the PDU session are modified.

8.3.9.7 Mapped EPS bearer contexts

This IE is included when interworking with EPS is supported for the PDU session and the mapped EPS bearer contexts is modified.

8.3.9.8 Authorized QoS flow descriptions

This IE is included when the authorized QoS flow descriptions of the PDU session are modified.

8.3.9.9 Extended protocol configuration options

This IE is included in the message when the network needs to transmit (protocol) data (e.g. configuration parameters, error codes or messages/events) to the UE.

8.3.9.10 Void

8.3.9.11 ATSSS container

The IE is included in the message when the network needs to indicate that the ATSSS parameters of the MA PDU session are modified.

8.3.9.12 IP header compression configuration

This IE is included in the message if the network wishes to re-negotiate IP header compression configuration associated to a PDU session and both the UE and the network support Control plane ClIoT 5GS optimization and IP header compression.

8.3.9.13 Port management information container

This IE shall be included when the network needs to convey a port management information container.

8.3.9.14 Serving PLMN rate control

This IE shall be included when the network needs to indicate the maximum uplink control plane user data the UE is allowed to send per 6 minute interval.

8.3.9.15 Ethernet header compression configuration

This IE is included in the message if the network wishes to re-negotiate Ethernet header compression configuration associated to a PDU session and both the UE and the network support Control plane ClIoT 5GS optimization and Ethernet header compression.

8.3.9.16 Received MBS container

The network shall include this IE if:

- the UE has requested to join or leave one or more multicast MBS sessions;
- the network wants to remove joined UE from one or more multicast MBS sessions; or
- the network wants to update the MBS service area of multicast MBS session that the UE has joined; or
- the network wants to update the MBS security information of multicast MBS session that the UE has joined.

8.3.9.17 Service-level-AA container

The SMF shall include the service-level-AA container IE if the service-level authentication and authorization procedure for re-authentication purpose is completed successfully by the external DN.

8.3.9.18 Alternative S-NSSAI

This IE shall be included when the network needs to provide the alternative S-NSSAI to replace the S-NSSAI of the SSC mode 1 or SSC mode 3 PDU session.

8.3.9.19 N3QAI

This IE is included when the network needs to provide the N3QAI to the UE.

8.3.9.20 Protocol description

This IE is included when the network needs to provide the protocol description for UL PDU set handling to the UE.

8.3.10 PDU session modification complete

8.3.10.1 Message definition

The PDU SESSION MODIFICATION COMPLETE message is sent by the UE to the SMF in response to the PDU SESSION MODIFICATION COMMAND message and indicates an acceptance of the PDU SESSION MODIFICATION COMMAND message. See table 8.3.10.1.1.

Message type: PDU SESSION MODIFICATION COMPLETE

Significance: dual

Direction: UE to network

Table 8.3.10.1.1: PDU SESSION MODIFICATION COMPLETE message content

IEI	Information Element	Type/Reference	Presence	Format	Length
	Extended protocol discriminator	Extended protocol discriminator 9.2	M	V	1
	PDU session ID	PDU session identity 9.4	M	V	1
	PTI	Procedure transaction identity 9.6	M	V	1
	PDU SESSION MODIFICATION COMPLETE message identity	Message type 9.7	M	V	1
7B	Extended protocol configuration options	Extended protocol configuration options 9.11.4.6	O	TLV-E	4-65538
74	Port management information container	Port management information container 9.11.4.27	O	TLV-E	4-65538

NOTE: It is possible for UEs compliant with version 15.3.0 of this specification to include the 5GSM cause IE with IEI 59 in the PDU SESSION MODIFICATION COMPLETE message, and therefore the IEI 59 cannot be used for other optional IEs other than the 5GSM cause IE for future extensions of the PDU SESSION MODIFICATION COMPLETE message.

8.3.10.2 Extended protocol configuration options

This IE is included in the message when the UE needs to transmit (protocol) data (e.g. configuration parameters, error codes or messages/events) to the network.

8.3.10.3 Port management information container

This IE shall be included when the UE needs to convey a port management information container.

8.3.11 PDU session modification command reject

8.3.11.1 Message definition

The PDU SESSION MODIFICATION COMMAND REJECT message is sent by the UE to the SMF to indicate rejection of the PDU SESSION MODIFICATION COMMAND message. See table 8.3.11.1.1.

Message type: PDU SESSION MODIFICATION COMMAND REJECT

Significance: dual

Direction: UE to network

Table 8.3.11.1.1: PDU SESSION MODIFICATION COMMAND REJECT message content

IEI	Information Element	Type/Reference	Presence	Format	Length
	Extended protocol discriminator	Extended protocol discriminator 9.2	M	V	1
	PDU session ID	PDU session identity 9.4	M	V	1
	PTI	Procedure transaction identity 9.6	M	V	1
	PDU SESSION MODIFICATION COMMAND REJECT message identity	Message type 9.7	M	V	1
	5GSM cause	5GSM cause 9.11.4.2	M	V	1
7B	Extended protocol configuration options	Extended protocol configuration options 9.11.4.6	O	TLV-E	4-65538

8.3.11.2 Extended protocol configuration options

This IE is included in the message when the UE needs to transmit (protocol) data (e.g. configuration parameters, error codes or messages/events) to the network.

8.3.12 PDU session release request

8.3.12.1 Message definition

The PDU SESSION RELEASE REQUEST message is sent by the UE to the SMF to request a release of a PDU session. See table 8.3.12.1.1.

Message type: PDU SESSION RELEASE REQUEST

Significance: dual

Direction: UE to network

Table 8.3.12.1.1: PDU SESSION RELEASE REQUEST message content

IEI	Information Element	Type/Reference	Presence	Format	Length
	Extended protocol discriminator	Extended protocol discriminator 9.2	M	V	1
	PDU session ID	PDU session identity 9.4	M	V	1
	PTI	Procedure transaction identity 9.6	M	V	1
	PDU SESSION RELEASE REQUEST message identity	Message type 9.7	M	V	1
59	5GSM cause	5GSM cause 9.11.4.2	O	TV	2
7B	Extended protocol configuration options	Extended protocol configuration options 9.11.4.6	O	TLV-E	4-65538

8.3.12.2 5GSM cause

This IE is included in the message to indicate the reason for releasing the PDU session.

8.3.12.3 Extended protocol configuration options

This IE is included in the message when the UE needs to transmit (protocol) data (e.g. configuration parameters, error codes or messages/events) to the network.

8.3.13 PDU session release reject

8.3.13.1 Message definition

The PDU SESSION RELEASE REJECT message is sent by the SMF to the UE to indicate rejection of request a release of a PDU session. See table 8.3.13.1.1.

Message type: PDU SESSION RELEASE REJECT

Significance: dual

Direction: network to UE

Table 8.3.13.1.1: PDU SESSION RELEASE REJECT message content

IEI	Information Element	Type/Reference	Presence	Format	Length
	Extended protocol discriminator	Extended protocol discriminator 9.2	M	V	1
	PDU session ID	PDU session identity 9.4	M	V	1
	PTI	Procedure transaction identity 9.6	M	V	1
	PDU SESSION RELEASE REJECT message identity	Message type 9.7	M	V	1
	5GSM cause	5GSM cause 9.11.4.2	M	V	1
7B	Extended protocol configuration options	Extended protocol configuration options 9.11.4.6	O	TLV-E	4-65538

8.3.13.2 Extended protocol configuration options

This IE is included in the message when the network needs to transmit (protocol) data (e.g. configuration parameters, error codes or messages/events) to the UE.

8.3.14 PDU session release command

8.3.14.1 Message definition

The PDU SESSION RELEASE COMMAND message is sent by the SMF to the UE to indicate a release of a PDU session. See table 8.3.14.1.1.

Message type: PDU SESSION RELEASE COMMAND

Significance: dual

Direction: network to UE

Table 8.3.14.1.1: PDU SESSION RELEASE COMMAND message content

IEI	Information Element	Type/Reference	Presence	Format	Length
	Extended protocol discriminator	Extended protocol discriminator 9.2	M	V	1
	PDU session ID	PDU session identity 9.4	M	V	1
	PTI	Procedure transaction identity 9.6	M	V	1
	PDU SESSION RELEASE COMMAND message identity	Message type 9.7	M	V	1
	5GSM cause	5GSM cause 9.11.4.2	M	V	1
37	Back-off timer value	GPRS timer 3 9.11.2.5	O	TLV	3
78	EAP message	EAP message 9.11.2.2	O	TLV-E	7-1503
61	5GSM congestion re-attempt indicator	5GSM congestion re-attempt indicator 9.11.4.21	O	TLV	3
7B	Extended protocol configuration options	Extended protocol configuration options 9.11.4.6	O	TLV-E	4-65538
D-	Access type	Access type 9.11.2.1A	O	TV	1
72	Service-level-AA container	Service-level-AA container 9.11.2.10	O	TLV-E	4-65538
5A	Alternative S-NSSAI	S-NSSAI 9.11.2.8	O	TLV	3-10

8.3.14.2 Back-off timer value

The network may include this IE to request a minimum time interval before procedure retry is allowed.

8.3.14.3 EAP message

This IE is included when the external DN performs re-authentication and re-authorization of the UE using EAP and it completes unsuccessfully.

8.3.14.4 Extended protocol configuration options

This IE is included in the message when the network wants to transmit (protocol) data (e.g. configuration parameters, error codes or messages/events) to the UE.

8.3.14.5 5GSM congestion re-attempt indicator

The network may include this IE only if it includes the Back-off timer value IE and the 5GSM cause value is either #67 "insufficient resources for specific slice and DNN" or #69 "insufficient resources for specific slice".

8.3.14.6 Access type

This IE is included in the message when the network releases user-plane resources of an MA PDU session specifically over either 3GPP access or non-3GPP access.

8.3.14.7 Service-level-AA container

The SMF shall include the service-level-AA container IE if the service-level authentication and authorization procedure for re-authentication purpose is completed unsuccessfully by the external DN.

8.3.14.8 Alternative S-NSSAI

This IE shall be included when the network needs to trigger the re-establishment of the PDU Session with the alternative S-NSSAI in SSC mode 2 or SSC mode 1.

8.3.15 PDU session release complete

8.3.15.1 Message definition

The PDU SESSION RELEASE COMPLETE message is sent by the UE to the SMF in response to the PDU SESSION RELEASE COMMAND message and indicates an acceptance of a release of the PDU session. See table 8.3.15.1.1.

Message type: PDU SESSION RELEASE COMPLETE

Significance: dual

Direction: UE to network

Table 8.3.15.1.1: PDU SESSION RELEASE COMPLETE message content

IEI	Information Element	Type/Reference	Presence	Format	Length
	Extended protocol discriminator	Extended protocol discriminator 9.2	M	V	1
	PDU session ID	PDU session identity 9.4	M	V	1
	PTI	Procedure transaction identity 9.6	M	V	1
	PDU SESSION RELEASE COMPLETE message identity	Message type 9.7	M	V	1
59	5GSM cause	5GSM cause 9.11.4.2	O	TV	2
7B	Extended protocol configuration options	Extended protocol configuration options 9.11.4.6	O	TLV-E	4-65538

8.3.15.2 5GSM cause

This IE is included in the message when the UE needs to indicate to the network that an error encountered with a mandatory information element in the PDU SESSION RELEASE COMMAND message.

8.3.15.3 Extended protocol configuration options

This IE is included in the message when the UE needs to transmit (protocol) data (e.g. configuration parameters, error codes or messages/events) to the network.

8.3.16 5GSM status

8.3.16.1 Message definition

The 5GSM STATUS message is sent by the SMF or the UE to pass information on the status of the indicated PDU session and report certain error conditions. See table 8.3.16.1.1.

Message type: 5GSM STATUS

Significance: dual

Direction: both

Table 8.3.16.1.1: 5GSM STATUS message content

IEI	Information Element	Type/Reference	Presence	Format	Length
	Extended protocol discriminator	Extended protocol discriminator 9.2	M	V	1
	PDU session ID	PDU session identity 9.4	M	V	1
	PTI	Procedure transaction identity 9.6	M	V	1
	5GSM STATUS message identity	Message type 9.7	M	V	1
	5GSM cause	5GSM cause 9.11.4.2	M	V	1

8.3.17 Service-level authentication command

8.3.17.1 Message definition

The SERVICE-LEVEL AUTHENTICATION COMMAND message is sent by the SMF to the UE for service-level authentication and authorization procedure. See table 8.3.17.1.1.

Message type: SERVICE-LEVEL AUTHENTICATION COMMAND

Significance: dual

Direction: network to UE

Table 8.3.17.1.1: SERVICE-LEVEL AUTHENTICATION COMMAND message content

IEI	Information Element	Type/Reference	Presence	Format	Length
	Extended protocol discriminator	Extended protocol discriminator 9.2	M	V	1
	PDU session ID	PDU session identity 9.4	M	V	1
	PTI	Procedure transaction identity 9.6	M	V	1
	SERVICE-LEVEL AUTHENTICATION COMMAND message identity	Message type 9.7	M	V	1
	Service-level-AA container	Service-level-AA container 9.11.2.10	M	LV-E	5-n

8.3.18 Service-level authentication complete

8.3.18.1 Message definition

The SERVICE-LEVEL AUTHENTICATION COMPLETE message is sent by the UE to the SMF in response to the SERVICE-LEVEL AUTHENTICATION COMMAND message and indicates acceptance of the SERVICE-LEVEL AUTHENTICATION COMMAND message. See table 8.3.18.1.1.

Message type: SERVICE-LEVEL AUTHENTICATION COMPLETE

Significance: dual

Direction: UE to network

Table 8.3.18.1.1: SERVICE-LEVEL AUTHENTICATION COMPLETE message content

IEI	Information Element	Type/Reference	Presence	Format	Length
	Extended protocol discriminator	Extended protocol discriminator 9.2	M	V	1
	PDU session ID	PDU session identity 9.4	M	V	1
	PTI	Procedure transaction identity 9.6	M	V	1
	SERVICE-LEVEL AUTHENTICATION COMPLETE message identity	Message type 9.7	M	V	1
	Service-level-AA container	Service-level-AA container 9.11.2.10	M	LV-E	5-n

8.3.19 Remote UE report

8.3.19.1 Message definition

The REMOTE UE REPORT message is sent by the UE to the network to report connection or disconnection of 5G ProSe remote UE(s). See table 8.3.19.1.

Message type: REMOTE UE REPORT

Significance: dual

Direction: UE to network

Table 8.3.19.1: REMOTE UE REPORT message content

IEI	Information Element	Type/Reference	Presence	Format	Length
	Extended protocol discriminator	Extended protocol discriminator 9.2	M	V	1
	PDU session ID	PDU session identity 9.4	M	V	1
	PTI	Procedure transaction identity 9.6	M	V	1
	Remote UE report message identity	Message type 9.7	M	V	1
76	Remote UE context connected	Remote UE context list 9.11.4.29	O	TLV-E	16-65538
70	Remote UE context disconnected	Remote UE context list 9.11.4.29	O	TLV-E	16-65538

8.3.19.2 Remote UE context connected

This IE is included in the message by the UE acting as a 5G ProSe layer-3 UE-to-network UE relay to provide the network with newly connected 5G ProSe remote UE information as specified in 3GPP TS 23.304 [6E].

8.3.19.3 Remote UE context disconnected

This IE is included in the message by the UE acting as a 5G ProSe layer-3 UE-to-network UE relay to provide the network with disconnected 5G ProSe remote UE information as specified in 3GPP TS 23.304 [6E].

8.3.20 Remote UE report response

8.3.20.1 Message definition

The REMOTE UE REPORT RESPONSE message is sent by the network to the UE to acknowledge receipt of a remote UE report message. See table 8.3.20.1.

Message type: REMOTE UE REPORT RESPONSE

Significance: dual

Direction: network to UE

Table 8.3.20.1: REMOTE UE REPORT RESPONSE message content

IEI	Information Element	Type/Reference	Presence	Format	Length
	Extended protocol discriminator	Extended protocol discriminator 9.2	M	V	1
	PDU session ID	PDU session identity 9.4	M	V	1
	PTI	Procedure transaction identity 9.6	M	V	1
	Remote UE report response message identity	Message type 9.7	M	V	1

8.3.20.2 Void

8.3.20.3 Void

8.3.20.4 Void

9 General message format and information elements coding

9.1 Overview

9.1.1 NAS message format

Within the protocols defined in the present document, every 5GS NAS message is a standard L3 message as defined in 3GPP TS 24.007 [11]. This means that the message consists of the following parts:

- 1) if the message is a plain 5GS NAS message:
 - a) extended protocol discriminator;

- b) security header type associated with a half spare octet or PDU session identity;
 - c) procedure transaction identity;
 - d) message type;
 - e) other information elements, as required.
- 2) if the message is a security protected 5GS NAS message:
- a) extended protocol discriminator;
 - b) security header type associated with a half spare octet;
 - c) message authentication code;
 - d) sequence number;
 - e) plain 5GS NAS message, as defined in item 1

The organization of a plain 5GS NAS message is illustrated in the example shown in figure 9.1.1.1.

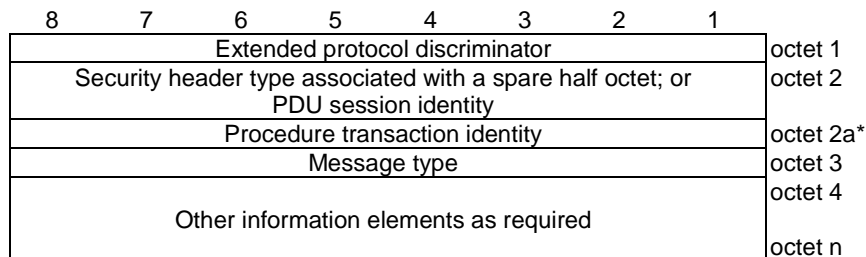

Figure 9.1.1.1: General message organization example for a plain 5GS NAS message

The PDU session identity and the procedure transaction identity are only used in messages with extended protocol discriminator 5GS session management. Octet 2a with the procedure transaction identity shall only be included in these messages.

The organization of a security protected 5GS NAS message is illustrated in the example shown in figure 9.1.1.2.

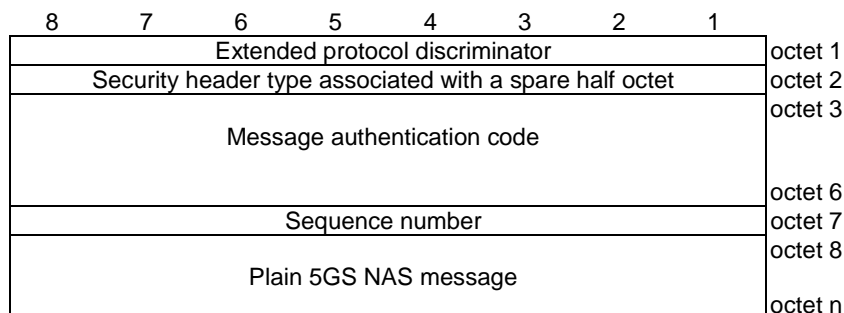

Figure 9.1.1.2: General message organization example for a security protected 5GS NAS message

Unless specified otherwise in the message descriptions of clause 8 and annex D, a particular information element shall not be present more than once in a given message.

9.1.2 Field format and mapping

When a field is contained within a single octet, the lowest numbered bit of the field represents the least significant bit.

When a field extends over more than one octet, the order of bit values progressively decreases as the octet number increases. In that part of the field contained in a given octet, the lowest numbered bit represents the least significant bit.

The most significant bit of the field is represented by the highest numbered bit of the lowest numbered octet of the field. The least significant bit of the field is represented by the lowest numbered bit of the highest numbered octet of the field.

For example, a bit number can be identified as a couple (o, b) where o is the octet number and b is the relative bit number within the octet. Figure 9.1.2.1 illustrates a field that spans from bit (1, 3) to bit (2, 7). The most significant bit of the field is mapped on bit (1, 3) and the least significant bit is mapped on bit (2, 7).

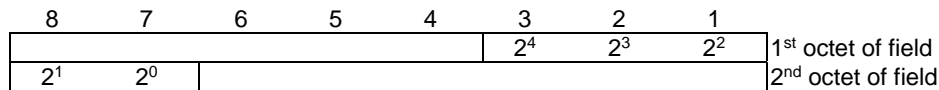

Figure 9.1.2.1: Field mapping convention

9.2 Extended protocol discriminator

Bits 1 to 8 of the first octet of every 5GS NAS message contain the Extended protocol discriminator (EPD) IE. The EPD and its use are defined in 3GPP TS 24.007 [11]. The extended protocol discriminator in the header (see 3GPP TS 24.007 [11]) of a security protected 5GS NAS message is encoded as "5GS mobility management messages".

9.3 Security header type

Bits 1 to 4 of the second octet of every 5GMM message contain the Security header type IE. This IE includes control information related to the security protection of a 5GMM message. The total size of the Security header type IE is 4 bits.

The Security header type IE can take the values shown in table 9.3.1.

Table 9.3.1: Security header type

Security header type (octet 1)			
Bits			
4	3	2	1
0	0	0	0
Plain 5GS NAS message, not security protected			
Security protected 5GS NAS message:			
0	0	0	1
Integrity protected			
0	0	1	0
Integrity protected and ciphered			
0	0	1	1
Integrity protected with new 5G NAS security context (NOTE 1)			
0	1	0	0
Integrity protected and ciphered with new 5G NAS security context (NOTE 2)			
All other values are reserved.			
NOTE 1: This codepoint may be used only for a SECURITY MODE COMMAND message.			
NOTE 2: This codepoint may be used only for a SECURITY MODE COMPLETE message.			

A 5GMM message received with the security header type encoded as 0000 shall be treated as not security protected, plain 5GS NAS message. A protocol entity sending a not security protected 5GMM message shall send the message as plain 5GS NAS message and encode the security header type as 0000.

9.4 PDU session identity

Bits 1 to 8 of the second octet of every 5GSM message contain the PDU session identity IE. The PDU session identity and its use to identify a message flow are defined in 3GPP TS 24.007 [11].

9.5 Spare half octet

This element is used in the description of 5GMM and 5GSM messages when an odd number of half octet type 1 information elements are used. This element is filled with spare bits set to zero and is placed in bits 5 to 8 of the octet unless otherwise specified.

9.6 Procedure transaction identity

Bits 1 to 8 of the third octet of every 5GSM message contain the procedure transaction identity. Bits 1 to 8 of the first octet of every UE policy delivery message contain the procedure transaction identity. The procedure transaction identity and its use are defined in 3GPP TS 24.007 [11].

9.7 Message type

The Message type IE and its use are defined in 3GPP TS 24.007 [11]. Tables 9.7.1 and 9.7.2 define the value part of the message type IE used in the 5GS mobility management protocol and 5GS session management protocol.

Table 9.7.1: Message types for 5GS mobility management

Bits								
8	7	6	5	4	3	2	1	
0	1	-	-	-	-	-	-	5GS mobility management messages
0	1	0	0	0	0	0	1	Registration request
0	1	0	0	0	0	1	0	Registration accept
0	1	0	0	0	0	1	1	Registration complete
0	1	0	0	0	1	0	0	Registration reject
0	1	0	0	0	1	0	1	Deregistration request (UE originating)
0	1	0	0	0	1	1	0	Deregistration accept (UE originating)
0	1	0	0	0	1	1	1	Deregistration request (UE terminated)
0	1	0	0	1	0	0	0	Deregistration accept (UE terminated)
0	1	0	0	1	1	0	0	Service request
0	1	0	0	1	1	0	1	Service reject
0	1	0	0	1	1	1	0	Service accept
0	1	0	0	1	1	1	1	Control plane service request
0	1	0	1	0	0	0	0	Network slice-specific authentication command
0	1	0	1	0	0	0	1	Network slice-specific authentication complete
0	1	0	1	0	0	1	0	Network slice-specific authentication result
0	1	0	1	0	1	0	0	Configuration update command
0	1	0	1	0	1	0	1	Configuration update complete
0	1	0	1	0	1	1	0	Authentication request
0	1	0	1	0	1	1	1	Authentication response
0	1	0	1	1	0	0	0	Authentication reject
0	1	0	1	1	0	0	1	Authentication failure
0	1	0	1	1	0	1	0	Authentication result
0	1	0	1	1	0	1	1	Identity request
0	1	0	1	1	1	0	0	Identity response
0	1	0	1	1	1	0	1	Security mode command
0	1	0	1	1	1	1	0	Security mode complete
0	1	0	1	1	1	1	1	Security mode reject
0	1	1	0	0	1	0	0	5GMM status
0	1	1	0	0	1	0	1	Notification
0	1	1	0	0	1	1	0	Notification response
0	1	1	0	0	1	1	1	UL NAS transport
0	1	1	0	1	0	0	0	DL NAS transport
0	1	1	0	1	0	0	1	Relay key request
0	1	1	0	1	0	1	0	Relay key accept
0	1	1	0	1	0	1	1	Relay key reject
0	1	1	0	1	1	0	0	Relay authentication request
0	1	1	0	1	1	0	1	Relay authentication response

Table 9.7.2: Message types for 5GS session management

Bits								
8	7	6	5	4	3	2	1	
1	1	-	-	-	-	-	-	5GS session management messages
1	1	0	0	0	0	0	1	PDU session establishment request
1	1	0	0	0	0	1	0	PDU session establishment accept
1	1	0	0	0	0	1	1	PDU session establishment reject
1	1	0	0	0	1	0	1	PDU session authentication command
1	1	0	0	0	1	1	0	PDU session authentication complete
1	1	0	0	0	1	1	1	PDU session authentication result
1	1	0	0	1	0	0	1	PDU session modification request
1	1	0	0	1	0	1	0	PDU session modification reject
1	1	0	0	1	0	1	1	PDU session modification command
1	1	0	0	1	1	0	0	PDU session modification complete
1	1	0	0	1	1	0	1	PDU session modification command reject
1	1	0	1	0	0	0	1	PDU session release request
1	1	0	1	0	0	1	0	PDU session release reject
1	1	0	1	0	0	1	1	PDU session release command
1	1	0	1	0	1	0	0	PDU session release complete
1	1	0	1	0	1	1	0	5GSM status
1	1	0	1	1	0	0	0	Service-level authentication command
1	1	0	1	1	0	0	1	Service-level authentication complete
1	1	0	1	1	0	1	0	Remote UE report
1	1	0	1	1	0	1	1	Remote UE report response

9.8 Message authentication code

The message authentication code (MAC) information element contains the integrity protection information for the message. The MAC IE shall be included in the SECURITY PROTECTED 5GS NAS MESSAGE message if a valid 5G NAS security context exists and security functions are started.

The message authentication code (MAC) is also included in the Intra N1 mode NAS transparent container IE and in the S1 mode to N1 mode NAS transparent container IE.

The usage of MAC is specified in subclause 4.4.3.3.

9.9 Plain 5GS NAS message

This IE includes a complete plain 5GS NAS message as specified in subclauses 8.2 and 8.3. The SECURITY PROTECTED 5GS NAS MESSAGE (see subclause 8.2.28) includes a complete plain 5GS NAS message as specified in subclauses 8.2. The SECURITY PROTECTED 5GS NAS MESSAGE message (see subclause 8.2.28) is not plain 5GS NAS messages and shall not be included in this IE.

9.10 Sequence number

This IE includes the NAS message sequence number (SN) which consists of the eight least significant bits of the NAS COUNT for a SECURITY PROTECTED 5GS NAS MESSAGE message.

The NAS message sequence number (SN) with the eight least significant bits of the NAS COUNT is also included in the Intra N1 mode NAS transparent container IE and in the N1 mode to S1 mode NAS transparent container IE.

The usage of SN is specified in subclause 4.4.3.

9.11 Other information elements

9.11.1 General

The different formats (V, LV, T, TV, TLV, LV-E, TLV-E) and the five categories of information elements (type 1, 2, 3, 4 and 6) are defined in 3GPP TS 24.007 [11].

The first octet of an information element in the non-imperative part contains the IEI of the information element. If this octet does not correspond to an IEI known in the message, the receiver shall determine whether this IE is of type 1 or 2 (i.e. it is an information element of one octet length) or an IE of type 4 or 6 (i.e. that the next octet is the length indicator or, for a type 6 IE, the next 2 octets are the length indicator indicating the length of the remaining of the information element) (see 3GPP TS 24.007 [11]).

NOTE: This requirement for the receiver is not applicable for information elements included in a Type 6 IE container information element. Any IE in the Type 6 IE container information element is of type 6 with format TLV-E; therefore, the rules for the IEI value encoding defined in 3GPP TS 24.007 [11], subclause 11.2.4, are not applicable.

This allows the receiver to jump over unknown information elements and to analyse any following information elements of a particular message.

The definitions of information elements which are:

- a) common for the 5GMM and 5GSM protocols;
- b) used by access stratum protocols; or
- c) sent to upper layers

are described in subclause 9.11.2.

The information elements of the 5GMM or 5GSM protocols can be defined by reference to an appropriate specification which provides the definition of the information element, e.g., "see subclause 10.5.6.3A in 3GPP TS 24.008 [12]".

9.11.2 Common information elements

9.11.2.1 Additional information

The purpose of the Additional information information element is to provide additional information to upper layers in relation to the NAS transport mechanism.

The Additional information information element is coded as shown in figure 9.11.2.1.1 and table 9.11.2.1.1.

The Additional information is a type 4 information element with a minimum length of 3 octets.

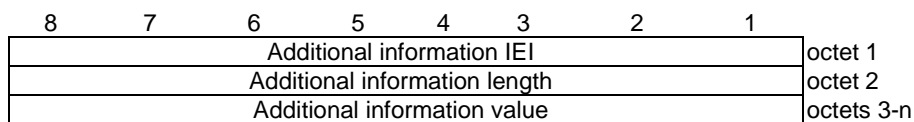

Figure 9.11.2.1.1: Additional information information element

Table 9.11.2.1.1 : Additional information information element

Additional information value (octet 3 to octet n)
The coding of the additional information value is dependent on the LCS application.

9.11.2.1A Access type

The purpose of the access type information element is to indicate the access type over which the signalling or user data is pending to be sent to the UE.

The access type is a type 1 information element.

The access type information element is coded as shown in figure 9.11.2.1A.1 and table 9.11.2.1A.1.

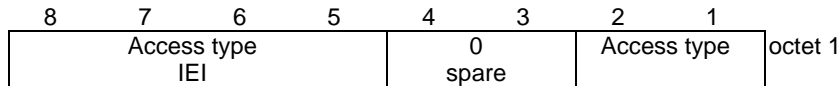

Figure 9.11.2.1A.1: Access type information element

Table 9.11.2.1A.1: Access type information element

Access type value (octet 1, bit 1 to bit 2)	
Bits	
2 1	
0 1	3GPP access
1 0	Non-3GPP access
All other values are reserved.	

9.11.2.1B DNN

The purpose of the DNN information element is to identify the data network.

The DNN information element is coded as shown in figure 9.11.2.1B.1.

The DNN is a type 4 information element with a minimum length of 3 octets and a maximum length of 102 octets.

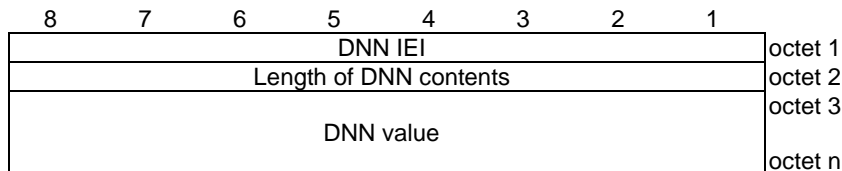

Figure 9.11.2.1B.1: DNN information element

A DNN value field contains an APN as defined in 3GPP TS 23.003 [4].

9.11.2.2 EAP message

The purpose of the EAP message information element is to transport an EAP message as specified in IETF RFC 3748 [34].

The EAP message information element is coded as shown in figure 9.11.2.2.1 and table 9.11.2.2.1.

The EAP message is a type 6 information element with minimum length of 7 octets and maximum length of 1503 octets.

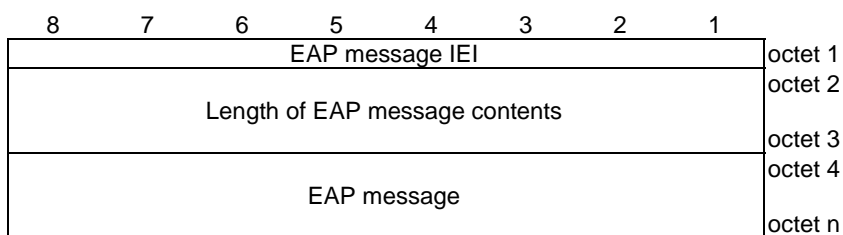

Figure 9.11.2.2.1: EAP message information element

Table 9.11.2.2.1: EAP message information element

EAP message (octet 4 to n) An EAP message as specified in IETF RFC 3748 [34].
--

9.11.2.3 GPRS timer

See subclause 10.5.7.3 in 3GPP TS 24.008 [12].

9.11.2.4 GPRS timer 2

See subclause 10.5.7.4 in 3GPP TS 24.008 [12].

9.11.2.5 GPRS timer 3

See subclause 10.5.7.4a in 3GPP TS 24.008 [12].

9.11.2.6 Intra N1 mode NAS transparent container

The purpose of the Intra N1 mode NAS transparent container information element is to provide the UE with parameters that enable the UE to handle the 5G NAS security context after N1 mode to N1 mode handover.

The Intra N1 mode NAS transparent container information element is coded as shown in figure 9.11.2.6.1 and table 9.11.2.6.1.

The Intra N1 mode NAS transparent container is a type 4 information element with a length of 9 octets.

The value part of the Intra N1 mode NAS transparent container information element is included in specific information elements within some RRC messages sent to the UE.

NOTE: For these cases the coding of the information element identifier and length information of RRC is defined in 3GPP TS 38.331 [30].

8	7	6	5	4	3	2	1	
Intra N1 mode NAS transparent container IEI								octet 1
Length of Intra N1 mode NAS transparent container contents								octet 2
Message authentication code								octet 3
Message authentication code								octet 6
Type of ciphering algorithm				Type of integrity protection algorithm				octet 7
0	0	0	KACF	TSC	Key set identifier in 5G			octet 8
	Spare							octet 9
Sequence number								octet 9

Figure 9.11.2.6.1: Intra N1 mode NAS transparent container information element

Table 9.11.2.6.1: Intra N1 mode NAS transparent container information element

<p>Message authentication code (octet 3 to 6)</p> <p>This field is coded as the Message authentication code information element (see subclause 9.8).</p> <p>Type of integrity protection algorithm (octet 7, bit 1 to 4) and type of ciphering algorithm (octet 7, bit 5 to 8)</p> <p>These fields are coded as the type of integrity protection algorithm and type of ciphering algorithm in the NAS security algorithms information element (see subclause 9.11.3.34).</p> <p>K_{AMF}_change_flag (KACF) (octet 8, bit 5)</p> <p>Bit</p> <p>5</p> <p>0 a new K_{AMF} has not been calculated by the network</p> <p>1 a new K_{AMF} has been calculated by the network</p> <p>Key set identifier in 5G (octet 8, bit 1 to 3) and Type of security context flag (TSC) (octet 8, bit 4)</p> <p>These fields are coded as the NAS key set identifier and type of security context flag in the NAS key set identifier information element (see subclause 9.11.3.32).</p> <p>Sequence number (octet 9)</p> <p>This field is coded as the Sequence number information element (see subclause 9.10)</p>
--

9.11.2.7 N1 mode to S1 mode NAS transparent container

The purpose of the N1 mode to S1 mode NAS transparent container information element is to provide the UE with information that enables the UE to create a mapped EPS security context.

The N1 mode to S1 mode NAS transparent container information element is coded as shown in figure 9.11.2.7.1 and table 9.11.2.7.1.

The N1 mode to S1 mode NAS transparent container is a type 3 information element with a length of 2 octets.

The value part of the N1 mode to S1 mode NAS transparent container information element is included in specific information elements within some RRC messages sent to the UE; see 3GPP TS 38.331 [30]. For these cases the coding of the information element identifier and length information is defined in 3GPP TS 38.331 [30].

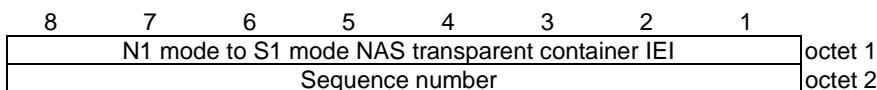

Figure 9.11.2.7.1: N1 mode to S1 mode NAS transparent container information element

Table 9.11.2.7.1: N1 mode to S1 mode NAS transparent container information element

<p>Sequence number (octet 2)</p> <p>This field is coded as the Sequence number information element (see subclause 9.10).</p>
--

9.11.2.8 S-NSSAI

The purpose of the S-NSSAI information element is to identify a network slice.

The S-NSSAI information element is coded as shown in figure 9.11.2.8.1 and table 9.11.2.8.1.

The S-NSSAI is a type 4 information element with a minimum length of 3 octets and a maximum length of 10 octets.

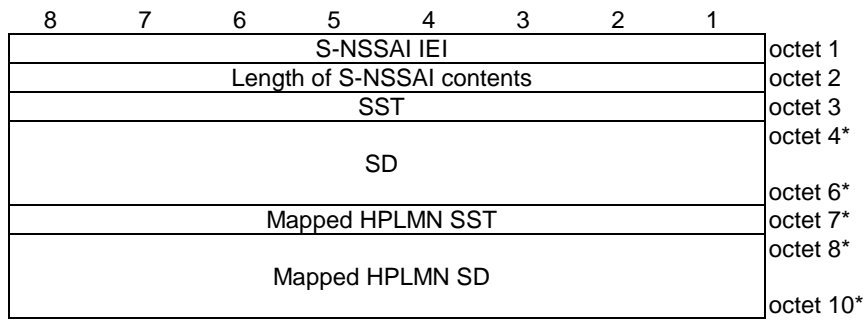

Figure 9.11.2.8.1: S-NSSAI information element

Table 9.11.2.8.1: S-NSSAI information element

Length of S-NSSAI contents (octet 2)	
This field indicates the length of the included S-NSSAI contents, and it can have the following values. Depending on the value of the length field the following S-NSSAI contents are included:	
Bits	
8 7 6 5 4 3 2 1	
0 0 0 0 0 0 0 1	SST
0 0 0 0 0 0 1 0	SST and mapped HPLMN SST
0 0 0 0 0 1 0 0	SST and SD
0 0 0 0 0 1 0 1	SST, SD and mapped HPLMN SST
0 0 0 0 1 0 0 0	SST, SD, mapped HPLMN SST and mapped HPLMN SD
All other values are reserved.	
Slice/service type (SST) (octet 3)	
This field contains the 8 bit SST value. The coding of the SST value part is defined in 3GPP TS 23.003 [4]. If this IE is included during the network slice-specific authentication and authorization procedure, this field contains the 8 bit SST value of an S-NSSAI in the S-NSSAI(s) of the HPLMN or the RSNPN.	
Slice differentiator (SD) (octet 4 to octet 6)	
This field contains the 24 bit SD value. The coding of the SD value part is defined in 3GPP TS 23.003 [4]. If this IE is included during the network slice-specific authentication and authorization procedure, this field contains the 24 bit SD value of an S-NSSAI in the S-NSSAI(s) of the HPLMN or the RSNPN.	
If the SST encoded in octet 3 is not associated with a valid SD value, and the sender needs to include a mapped HPLMN SST (octet 7) and a mapped HPLMN SD (octets 8 to 10), then the sender shall set the SD value (octets 4 to 6) to "no SD value associated with the SST".	
mapped HPLMN Slice/service type (SST) (octet 7)	
This field contains the 8 bit SST value of an S-NSSAI in the S-NSSAI(s) of the HPLMN to which the SST value is mapped. The coding of the SST value part is defined in 3GPP TS 23.003 [4].	
mapped HPLMN Slice differentiator (SD) (octet 8 to octet 10)	
This field contains the 24 bit SD value of an S-NSSAI in the S-NSSAI(s) of the HPLMN to which the SD value is mapped. The coding of the SD value part is defined in 3GPP TS 23.003 [4].	
NOTE 1: Octet 3 shall always be included.	
NOTE 2: If the octet 4 is included, then octet 5 and octet 6 shall be included.	
NOTE 3: If the octet 7 is included, then octets 8, 9, and 10 may be included.	
NOTE 4: If the octet 8 is included, then octet 9 and octet 10 shall be included.	
NOTE 5: If only HPLMN S-NSSAI or subscribed SNPN S-NSSAI is included, then octets 7 to 10 shall not be included.	

9.11.2.9 S1 mode to N1 mode NAS transparent container

The purpose of the S1 mode to N1 mode NAS transparent container information element is to provide the UE with parameters that enable the UE to create a mapped 5G NAS security context and take this context into use after inter-system change to N1 mode in 5GMM-CONNECTED mode.

The S1 mode to N1 mode NAS transparent container information element is coded as shown in figure 9.11.2.9.1 and table 9.11.2.9.1.

The S1 mode to N1 mode NAS transparent container is a type 4 information element with a length of 10 octets.

The value part of the S1 mode to N1 mode NAS transparent container information element is included in specific information elements within some RRC messages sent to the UE.

NOTE: For these cases the coding of the information element identifier and length information of RRC is defined in 3GPP TS 38.331 [30].

8 7 6 5 4 3 2 1								
S1 mode to N1 mode NAS transparent container IEI								octet 1
Length of S1 mode to N1 mode NAS transparent container contents								octet 2
Message authentication code								octet 3
Message authentication code								octet 6
Type of ciphering algorithm				Type of integrity protection algorithm				octet 7
0	NCC			TSC	Key set identifier in 5G			octet 8
Spare	0	0	0	0	0	0	0	octet 9
Spare	Spare	Spare	Spare	Spare	Spare	Spare	Spare	octet 9
0	0	0	0	0	0	0	0	octet 10
Spare	Spare	Spare	Spare	Spare	Spare	Spare	Spare	octet 10

Figure 9.11.2.9.1: S1 mode to N1 mode NAS transparent container information element

Table 9.11.2.9.1: S1 mode to N1 mode NAS transparent container information element

<p>Message authentication code (octet 3 to 6)</p> <p>This field is coded as the Message authentication code information element (see subclause 9.8).</p> <p>Type of integrity protection algorithm (octet 7, bit 1 to 4) and type of ciphering algorithm (octet 7, bit 5 to 8)</p> <p>These fields are coded as the type of integrity protection algorithm and type of ciphering algorithm in the NAS security algorithms information element (see subclause 9.11.3.34).</p> <p>NCC (octet 8, bits 5 to 7)</p> <p>This field contains the 3 bit Next hop chaining counter (see 3GPP TS 33.501 [24])</p> <p>Key set identifier in 5G (octet 8, bit 1 to 3) and type of security context flag (TSC) (octet 8, bit 4)</p> <p>These fields are coded as the NAS key set identifier and type of security context flag in the NAS key set identifier information element (see subclause 9.11.3.32).</p> <p>Octets 9 and 10 are spare and shall be coded as zero.</p> <p>NOTE: In earlier versions of this protocol, octets 9 and 10 can have any value. In this version of the protocol, octets 9 and 10 can always be ignored by the UE.</p>

9.11.2.10 Service-level-AA container

The purpose of the Service-level-AA container information element is to transfer upper layer information for authentication and authorization between the UE and the network.

The Service-level-AA container information element is coded as shown in figure 9.11.2.10.1, figure 9.11.2.10.2, figure 9.11.2.10.3, figure 9.11.2.10.4 and table 9.11.2.10.1.

The Service-level-AA container information element is a type 6 information element with a minimum length of 4 octets and a maximum length of 65538 octets.

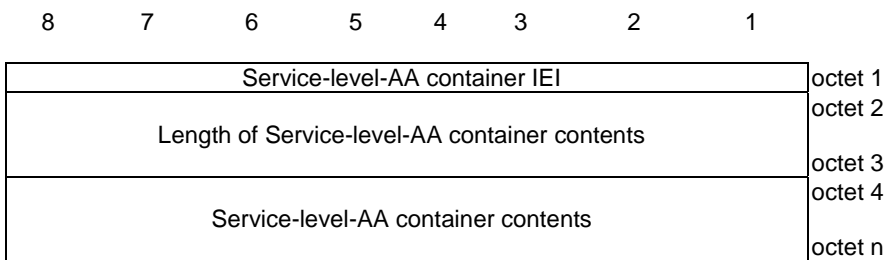

Figure 9.11.2.10.1: Service-level-AA container information element

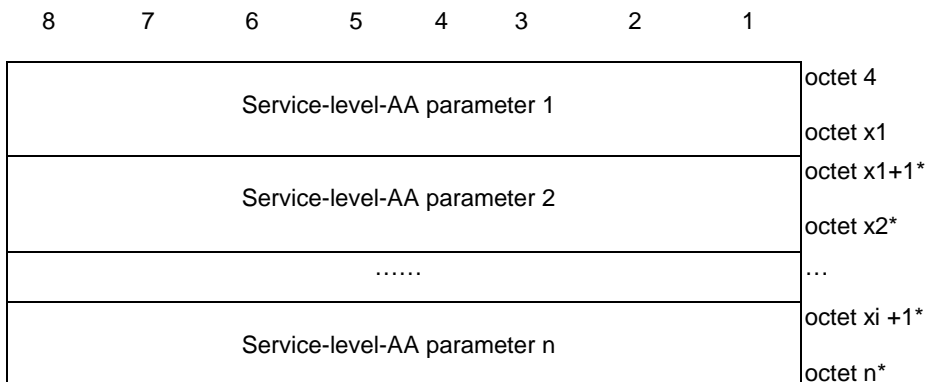

Figure 9.11.2.10.2: Service-level-AA container contents

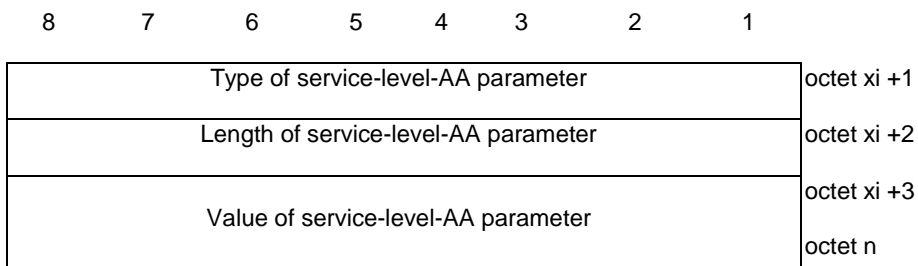

Figure 9.11.2.10.3: Service-level-AA parameter (when the type of service-level-AA parameter field contains an IEI of a type 4 information element as specified in 3GPP TS 24.007 [11])

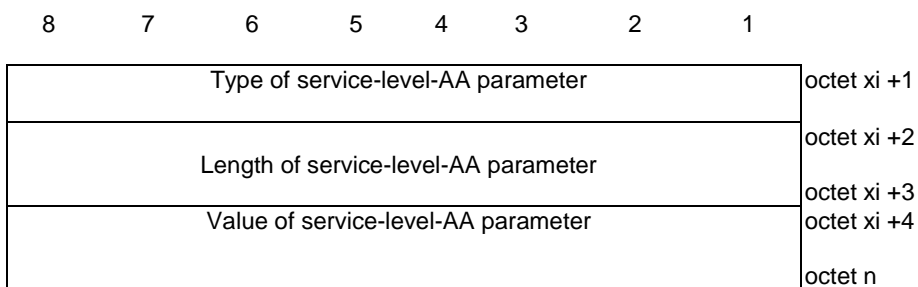

Figure 9.11.2.10.4: Service-level-AA parameter (when the type of service-level-AA parameter field contains an IEI of a type 6 information element as specified in 3GPP TS 24.007 [11])

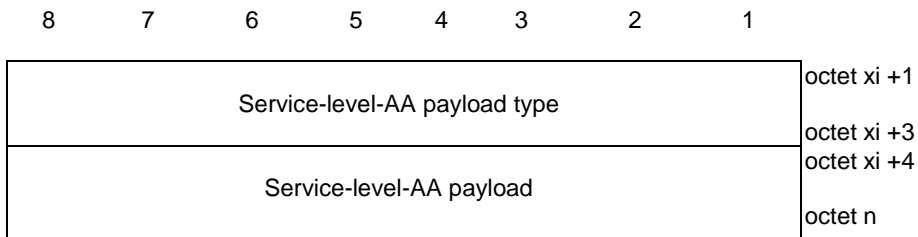

Figure 9.11.2.10.5: Service-level-AA parameter (when Service-level-AA payload type and its associated Service-level-AA payload are included in the Service-level-AA container contents)

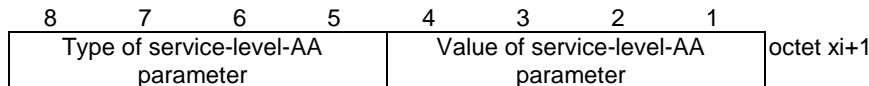

Figure 9.11.2.10.6: Service-level-AA parameter (when the type of service-level-AA parameter field contains an IEI of a type 1 information element as specified in 3GPP TS 24.007 [11])

Table 9.11.2.10.1: Service-level-AA container information element

Service-level-AA container contents (octet 4 to octet n); max value of 65535 octets		
The error handlings for service-level-AA parameters specified in subclauses 7.6.1, 7.6.3 and 7.7.1 shall apply to the service-level-AA parameters included in the service-level-AA container contents.		
Service-level-AA parameters		
Type of service-level-AA parameter (octet xi +1)		
This field contains the IEI of the service-level-AA parameter.		
Length of service-level-AA parameter		
This field indicates binary coded length of the value of the service-level-AA parameter.		
Value of service-level-AA parameter		
This field contains the value of the service-level-AA parameter with the value part of the referred information element based on following service-level-AA parameter reference.		
The receiving entity shall ignore service-level-AA parameter with type of service-level-AA parameter field containing an unknown IEI.		
IEI (hexadecimal)	Service-level-AA parameter name	Service-level-AA parameter reference
10	Service-level device ID	Service-level device ID (see subclause 9.11.2.11)
20	Service-level-AA server address	Service-level-AA server address (see subclause 9.11.2.12)
30	Service-level-AA response	Service-level-AA response (see subclause 9.11.2.14)
40	Service-level-AA payload type	Service-level-AA payload type (see subclause 9.11.2.15) (NOTE)
70	Service-level-AA payload	Service-level-AA payload (see subclause 9.11.2.13)
A-	Service-level-AA pending indication	Service-level-AA pending indication (see subclause 9.11.2.17)
50	Service-level-AA service status indication	Service-level-AA service status indication (see subclause 9.11.2.18)
NOTE: A service-level-AA payload type is always followed by the associated service-level-AA payload as shown in figure 9.11.2.10.5.		

9.11.2.11 Service-level device ID

The purpose of the Service-level device ID information element is to carry the necessary identity for authentication and authorization by the external DN.

The Service-level device ID information element is coded as shown in figure 9.11.2.11.1 and table 9.11.2.11.1.

The Service-level device ID information element is a type 4 information element with minimum length of 3 octets and maximum length of 257 octets.

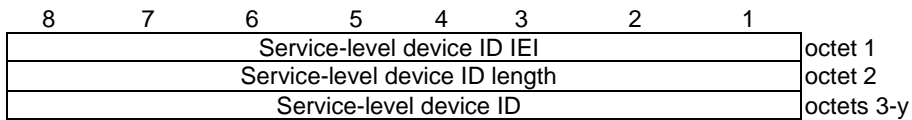

Figure 9.11.2.11.1: Service-level device ID information element

Table 9.11.2.11.1: Service-level device ID information element

Service-level device ID (octet 3 to octet y) A service-level device ID encoded as UTF-8 string.
--

9.11.2.12 Service-level-AA server address

The purpose of the Service-level-AA server address information element is to carry the address of the service level authentication and authorization server.

The Service-level-AA server address information element is coded as shown in figure 9.11.2.12.1 and table 9.11.2.12.1.

The Service-level-AA server address information element is a type 4 information element with minimum length of 4 octets and maximum length of 257 octets.

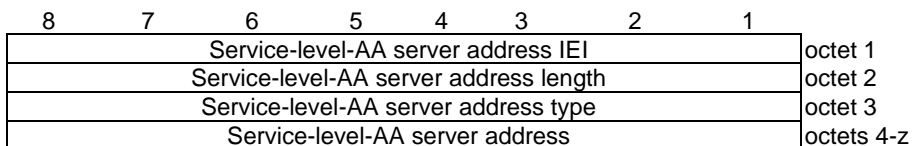

Figure 9.11.2.12.1: Service-level-AA server address information element

Table 9.11.2.12.1: Service-level-AA server address information element

Service-level-AA server address type (octet 3): Bits									
8	7	6	5	4	3	2	1		
0	0	0	0	0	0	0	1		IPv4
0	0	0	0	0	0	1	0		IPv6
0	0	0	0	0	0	1	1		IPv4v6
0	0	0	0	0	1	0	0		FQDN
All other values are spare. If received they shall be ignored.									
If the service-level-AA server address type indicates IPv4, then the service-level-AA server address field contains an IPv4 address in octet 4 to octet 7.									
If the service-level-AA server address type indicates IPv6, then the service-level-AA server address field contains an IPv6 address in octet 4 to octet 19.									
If the service-level-AA server address type indicates IPv4v6, then the service-level-AA server address field contains two IP addresses. The first IP address is an IPv4 address in octet 4 to octet 7. The second IP address is an IPv6 address in octet 8 to octet 23.									
If the service-level-AA server address type indicates FQDN, octet 4 to octet z is encoded as defined in subclause 19.4.2.1 in 3GPP TS 23.003 [4].									

9.11.2.13 Service-level-AA payload

The purpose of the Service-level-AA payload information element is to carry the upper layer payload for authentication and authorization between the UE and the service-level-AA server.

The Service-level-AA payload information element is coded as shown in figure 9.11.2.13.1 and table 9.11.2.13.1.

The Service-level-AA payload information element is a type 6 information element with minimum length of 4 octets and maximum length of 65538 octets.

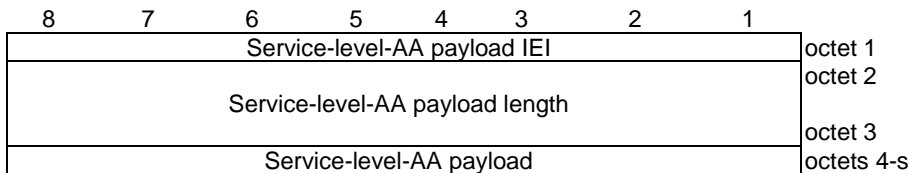

Figure 9.11.2.13.1: Service-level-AA payload information element

Table 9.11.2.13.1: Service-level-AA payload information element

Service-level-AA payload (octet 4 to octet s) A payload for authentication and authorization transparently transported and which is provided from/to the upper layers.

9.11.2.14 Service-level-AA response

The purpose of the Service-level-AA response information element is to provide information regarding the service level authentication and authorization request, e.g. to indicate that the authentication and authorization request to the service level authentication server was successful, or to notify that service level authorization is revoked.

The Service-level-AA response information element is coded as shown in figure 9.11.2.14.1 and table 9.11.2.14.1.

The Service-level-AA response information element is a type 4 information element with length of 3 octets.

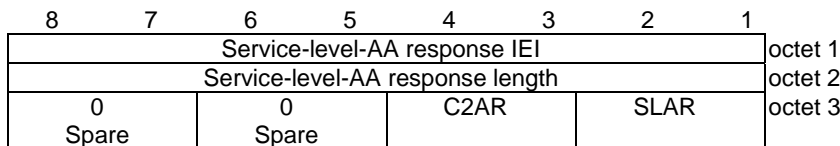

Figure 9.11.2.14.1: Service-level-AA response information element

Table 9.11.2.14.1: Service-level-AA response information element

Service-level-AA result field (SLAR) (octet 3, bits 1 and 2)	
Bits	
1 2	
0 0	No information
0 1	Service level authentication and authorization was successful.
1 0	Service level authentication and authorization was not successful or service level authorization is revoked.
1 1	Reserved
C2 authorization result field (C2AR) (octet 3, bits 3 and 4)	
Bits	
3 4	
0 0	No information
0 1	C2 authorization was successful.
1 0	C2 authorization was not successful or C2 authorization is revoked.
1 1	Reserved
Bits 5 to 8 of octet 3 are spare and shall be coded as zero.	

9.11.2.15 Service-level-AA payload type

The purpose of the Service-level-AA payload type information element is to indicate type of payload included in the Service-level-AA payload information element.

The Service-level-AA payload type information element is coded as shown in figure 9.11.2.15.1 and table 9.11.2.15.1.

The Service-level-AA payload type information element is a type 4 information element with length of 3 octets.

8	7	6	5	4	3	2	1	
Service-level-AA payload type IEI								octet 1
Service-level-AA payload type length								octet 2
Service-level-AA payload type								octet 3

Figure 9.11.2.15.1: Service-level-AA payload type information element

Table 9.11.2.15.1: Service-level-AA payload type information element

Service-level-AA payload type (octet 3):								
Bits								
8	7	6	5	4	3	2	1	
0	0	0	0	0	0	0	1	UUAA payload (see NOTE 1)
0	0	0	0	0	0	1	0	C2 authorization payload (see NOTE 2)
All other values are spare, and the receiving entity shall ignore the service-level-AA payload type value set to a spare value.								
NOTE 1: If the service-level-AA payload type indicates UUAA payload, the field for the service-level-AA payload of the Service-level AA payload information element is an application layer payload for UUAA procedure between the UE supporting UAS services and the USS.								
NOTE 2: If the service-level-AA payload type indicates C2 authorization payload, the field for the service-level-AA payload of the Service-level-AA payload information element is an application layer payload for C2 authorization procedure between the UE supporting UAS services and the USS.								

9.11.2.16 Void

9.11.2.17 Service-level-AA pending indication

The purpose of the Service-level-AA pending indication information element is to provide an indication that the service level authentication and authorization procedure is to be performed.

The Service-level-AA pending indication information element is coded as shown in figure 9.11.2.17.1 and table 9.11.2.17.1.

The Service-level-AA pending indication information element is a type 1 information element.

8	7	6	5	4	3	2	1	
Service-level-AA pending indication IEI				0	0	0	SLAPI	octet 1
				Spare	Spare	Spare		

Figure 9.11.2.17.1: Service-level-AA pending indication

Table 9.11.2.17.1: Service-level-AA pending indication

Service-level-AA pending indication (SLAPI) (octet 1, bit 1)	
Bit	
1	
0	reserved
1	Service-level-AA procedure is to be performed

9.11.2.18 Service-level-AA service status indication

The purpose of the Service-level-AA service status indication information element is to provide an indication of the service availability to the UE.

The Service-level-AA service status indication information element is coded as shown in figure 9.11.2.18.1 and table 9.11.2.18.1.

The Service-level-AA service status indication information element is a type 4 information element with a length of 3 octets.

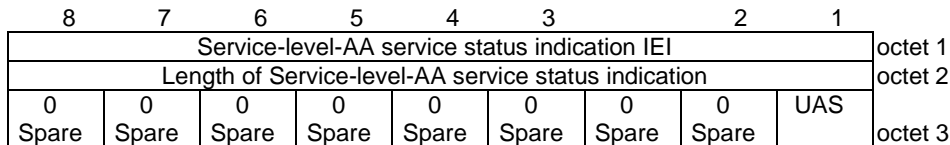

Figure 9.11.2.18.1: Service-level-AA-service-status indication information element

Table 9.11.2.18.1: Service-level-AA-service-status indication information element

UAS (octet 3, bit 1) Bit 1 0 UAS services not enabled 1 UAS services enabled Bits 2 to 8 of octet 3 are spare and shall be encoded as zero.

9.11.2.19 Time duration

See subclause 9.9.3.68 in 3GPP TS 24.301 [15].

9.11.2.20 Unavailability information

See subclause 9.9.3.69 in 3GPP TS 24.301 [15].

9.11.2.21 Unavailability configuration

See subclause 9.9.3.70 in 3GPP TS 24.301 [15].

9.11.3 5GS mobility management (5GMM) information elements

9.11.3.1 5GMM capability

The purpose of the 5GMM capability information element is to provide the network with information concerning aspects of the UE related to the 5GCN or interworking with the EPS. The contents might affect the manner in which the network handles the operation of the UE.

The 5GMM capability information element is coded as shown in figure 9.11.3.1.1 and table 9.11.3.1.1.

The 5GMM capability is a type 4 information element with a minimum length of 3 octets and a maximum length of 15 octets.

8	7	6	5	4	3	2	1	
5GMM capability IEI								octet 1
Length of 5GMM capability contents								octet 2
SGC	5G-IPHC-CP CloT	N3 data	5G-CP CloT	RestrictEC	LPP	HO attach	S1 mode	octet 3
RACS	NSSAA	5G-LCS	V2X NPC5	V2X EPC5	V2X	5G-UP CloT	5GSR VCC	octet 4*
5G ProSe-I2relay	5G ProSe-dc	5G ProSe-dd	ER-NSSAI	5G-EHC-CP CloT	multipl eUP	WUSA	CAG	octet 5*
PR	RPR	PIV	NCR	NR-PSSI	5G ProSe-I3rmt	5G ProSe-I2rmt	5G ProSe-I3relay	octet 6*
MPSIU	UAS	NSAG	Ex-CAG	SSNP NSI	Event Notification	MINT	NSSR G	octet 7*
SBTS	NSR	LADN-DS	RAN timing	ECI	ESI	RCMA N	RCMA P	octet 8*
5G ProSe-I2end	5G ProSe-I3U2U relay	5G ProSe-I2U2U relay	RSLP S	SBNS	UN-PER	A2XN PC5	A2XEP C5	octet 9*
A2X-Uu	SLVI	Temp NS	SUPL	LCS-UPP	PNS	RSLP	5G ProSe-I3end	octet 10*
0 spare	0 spare	0 spare	0 spare	NSUC	RSLPL	NVL-SATN R	MCSIU	octet 11*
0	0	0	0	0	0	0	0	octet 12*-15*
Spare								

Figure 9.11.3.1.1: 5GMM capability information element

Table 9.11.3.1.1: 5GMM capability information element

EPC NAS supported (S1 mode) (octet 3, bit 1)	
Bit	
1	
0	S1 mode not supported
1	S1 mode supported
ATTACH REQUEST message containing PDN CONNECTIVITY REQUEST message for handover support (HO attach) (octet 3, bit 2)	
Bit	
2	
0	ATTACH REQUEST message containing PDN CONNECTIVITY REQUEST message with request type set to "handover" or "handover of emergency bearer services" to transfer PDU session from N1 mode to S1 mode not supported
1	ATTACH REQUEST message containing PDN CONNECTIVITY REQUEST message with request type set to "handover" or "handover of emergency bearer services" to transfer PDU session from N1 mode to S1 mode supported
LTE Positioning Protocol (LPP) capability (octet 3, bit 3)	
This bit indicates the capability to support LTE Positioning Protocol (LPP) (see 3GPP TS 37.355 [26]).	
Bit	
3	
0	LPP in N1 mode not supported
1	LPP in N1 mode supported
Restriction on use of enhanced coverage support (RestrictEC) (octet 3, bit 4)	
This bit indicates the capability to support restriction on use of enhanced coverage.	
Bit	
4	
0	Restriction on use of enhanced coverage not supported
1	Restriction on use of enhanced coverage supported
Control plane Clot 5GS optimization (5G-CP Clot) (octet 3, bit 5)	
This bit indicates the capability for control plane Clot 5GS optimization.	
Bit	
5	
0	Control plane Clot 5GS optimization not supported
1	Control plane Clot 5GS optimization supported
N3 data transfer (N3 data) (octet 3, bit 6)	
This bit indicates the capability for N3 data transfer.	
Bit	
6	
0	N3 data transfer supported
1	N3 data transfer not supported
IP header compression for control plane Clot 5GS optimization (5G-IPHC-CP Clot) (octet 3, bit 7)	
This bit indicates the capability for IP header compression for control plane Clot 5GS optimization.	
Bit	
7	
0	IP header compression for control plane Clot 5GS optimization not supported
1	IP header compression for control plane Clot 5GS optimization supported
Service gap control (SGC) (octet 3, bit 8)	
Bit	
8	
0	service gap control not supported
1	service gap control supported
5G-SRVCC from NG-RAN to UTRAN (5GSRVCC) capability (octet 4, bit 1)	
This bit indicates the capability for 5G-SRVCC from NG-RAN to UTRAN (5GSRVCC) (see 3GPP TS 23.216 [6A]).	
Bit	
1	
0	5G-SRVCC from NG-RAN to UTRAN not supported
1	5G-SRVCC from NG-RAN to UTRAN supported

User plane CloT 5GS optimization (5G-UP CloT) (octet 4, bit 2)	
This bit indicates the capability for user plane CloT 5GS optimization.	
Bit	
2	
0	User plane CloT 5GS optimization not supported
1	User plane CloT 5GS optimization supported
V2X capability (V2X) (octet 4, bit 3)	
This bit indicates the capability for V2X, as specified in 3GPP TS 24.587 [19B].	
Bit	
3	
0	V2X not supported
1	V2X supported
V2X communication over E-UTRA-PC5 capability (V2XCEPC5) (octet 4, bit 4)	
This bit indicates the capability for V2X communication over E-UTRA-PC5, as specified in 3GPP TS 24.587 [19B].	
Bit	
4	
0	V2X communication over E-UTRA-PC5 not supported
1	V2X communication over E-UTRA-PC5 supported
V2X communication over NR-PC5 capability (V2XCNPC5) (octet 4, bit 5)	
This bit indicates the capability for V2X communication over NR-PC5, as specified in 3GPP TS 24.587 [19B].	
Bit	
5	
0	V2X communication over NR-PC5 not supported
1	V2X communication over NR-PC5 supported
Location Services (5G-LCS) notification mechanisms capability (octet 4, bit 6)	
This bit indicates the capability to support Location Services (5G-LCS) notification mechanisms (see 3GPP TS 23.273 [6B]).	
Bit	
6	
0	LCS notification mechanisms not supported
1	LCS notification mechanisms supported
Network slice-specific authentication and authorization (NSSAA) (octet 4, bit 7)	
This bit indicates the capability to support network slice-specific authentication and authorization.	
Bit	
7	
0	Network slice-specific authentication and authorization not supported
1	Network slice-specific authentication and authorization supported
Radio capability signalling optimisation (RACS) capability (octet 4, bit 8)	
Bit	
8	
0	RACS not supported
1	RACS supported
Closed Access Group (CAG) capability (octet 5, bit 1)	
Bit	
1	
0	CAG not supported
1	CAG supported
WUS assistance (WUSA) information reception capability (octet 5, bit 2)	
Bit	
2	
0	WUS assistance information reception not supported
1	WUS assistance information reception supported
Multiple user-plane resources support (multipleUP) (octet 5, bit 3)	
This bit indicates the capability to support multiple user-plane resources in NB-N1 mode.	
Bit	
3	
0	Multiple user-plane resources not supported
1	Multiple user-plane resources supported

Ethernet header compression for control plane CloT 5GS optimization (5G-EHC-CP CloT) (octet 5, bit 4)

Bit

4

0

Ethernet header compression for control plane CloT 5GS optimization not supported

1

Ethernet header compression for control plane CloT 5GS optimization supported

Extended rejected NSSAI support (ER-NSSAI) (octet 5, bit 5)

This bit indicates the capability to support extended rejected NSSAI.

Bit

5

0

Extended rejected NSSAI not supported

1

Extended rejected NSSAI supported

5G ProSe direct discovery (5G ProSe-dd) (octet 5, bit 6)

This bit indicates the capability for 5G ProSe direct discovery.

Bit

6

0

5G ProSe direct discovery not supported

1

5G ProSe direct discovery supported

5G ProSe direct communication (5G ProSe-dc) (octet 5, bit 7)

This bit indicates the capability for 5G ProSe direct communication.

Bit

7

0

5G ProSe direct communication not supported

1

5G ProSe direct communication supported

5G ProSe layer-2 UE-to-network-relay (5G ProSe-l2relay) (octet 5, bit 8)

This bit indicates the capability to act as a 5G ProSe layer-2 UE-to-network relay UE.

Bit

8

0

Acting as a 5G ProSe layer-2 UE-to-network relay UE not supported

1

Acting as a 5G ProSe layer-2 UE-to-network relay UE supported

5G ProSe layer-3 UE-to-network-relay (5G ProSe-l3relay) (octet 6, bit 1)

This bit indicates the capability to act as a 5G ProSe layer-3 UE-to-network relay UE

Bit

1

0

Acting as a 5G ProSe layer-3 UE-to-network relay UE not supported

1

Acting as a 5G ProSe layer-3 UE-to-network relay UE supported

5G ProSe layer-2 UE-to-network-remote (5G ProSe-l2rmt) (octet 6, bit 2)

This bit indicates the capability to act as a 5G ProSe layer-2 UE-to-network remote UE

Bit

2

0

Acting as a 5G ProSe layer-2 UE-to-network remote UE not supported

1

Acting as a 5G ProSe layer-2 UE-to-network remote UE supported

5G ProSe layer-3 UE-to-network-remote (5G ProSe-l3rmt) (octet 6, bit 3)

This bit indicates the capability to act as a 5G ProSe layer-3 UE-to-network remote UE

Bit

3

0

Acting as a 5G ProSe layer-3 UE-to-network remote UE not supported

1

Acting as a 5G ProSe layer-3 UE-to-network remote UE supported

NR paging subgroup support indication (NR-PSSI) (octet 6, bit 4)

This bit indicates the capability to support NR paging subgrouping

Bit

4

0

NR paging subgrouping not supported

1

NR paging subgrouping supported

N1 NAS signalling connection release (NCR) (octet 6, bit 5)

This bit indicates whether N1 NAS signalling connection release is supported.

Bit	
5	
0	N1 NAS signalling connection release not supported
1	N1 NAS signalling connection release supported
Paging indication for voice services (PIV) (octet 6, bit 6)	
This bit indicates whether paging indication for voice services is supported.	
Bit	
6	
0	paging indication for voice services not supported
1	paging indication for voice services supported
Reject paging request (RPR) (octet 6, bit 7)	
This bit indicates whether reject paging request is supported.	
Bit	
7	
0	reject paging request not supported
1	reject paging request supported
Paging restriction (PR) (octet 6, bit 8)	
This bit indicates whether paging restriction is supported.	
Bit	
8	
0	paging restriction not supported
1	paging restriction supported
NSSRG (octet 7, bit 1)	
This bit indicates the capability to support the NSSRG.	
Bit	
1	
0	NSSRG not supported
1	NSSRG supported
Minimization of service interruption (MINT) (octet 7, bit 2)	
This bit indicates the capability to support Minimization of service interruption (MINT)	
Bit	
2	
0	MINT not supported
1	MINT supported
Event notification (EventNotification) (octet 7, bit 3)	
This bit indicates the capability to support event notification for upper layers	
Bit	
3	
0	Event notification not supported
1	Event notification supported
SOR-SNPN-SI (SOR SNPNI) (octet 7, bit 4)	
This bit indicates the capability to support SOR-SNPN-SI.	
Bit	
4	
0	SOR-SNPN-SI not supported
1	SOR-SNPN-SI supported
Extended CAG information list support (Ex-CAG) (octet 7, bit 5)	
This bit indicates the capability to support extended CAG information list.	
Bit	
5	
0	Extended CAG information list not supported
1	Extended CAG information list supported
NSAG (octet 7, bit 6)	
This bit indicates the capability to support NSAG.	
Bit	
76	
0	NSAG not supported
1	NSAG supported
UAS (octet 7, bit 7)	

This bit indicates the capability to support UAS services.	
Bit	
7	
0	UAS services not supported
1	UAS services supported
MPS indicator update (MPSIU) (octet 7, bit 8)	
This bit indicates the capability to support MPS indicator update via the UE configuration update procedure.	
Bit	
8	
0	MPS indicator update not supported
1	MPS indicator update supported
Registration complete message for acknowledging negotiated PEIPS assistance information (RCMAP) (octet 8, bit 1)	
This bit indicates the capability for sending REGISTRATION COMPLETE message when Negotiated PEIPS assistance information IE is included in the REGISTRATION ACCEPT message.	
Bit	
1	
0	Sending of REGISTRATION COMPLETE message for negotiated PEIPS assistance information not supported
1	Sending of REGISTRATION COMPLETE message for negotiated PEIPS assistance information supported
Registration complete message for acknowledging NSAG information (RCMAN) (octet 8, bit 2)	
This bit indicates the capability for sending REGISTRATION COMPLETE message when NSAG information IE is included in the REGISTRATION ACCEPT message.	
Bit	
2	
0	Sending of REGISTRATION COMPLETE message for NSAG information not supported
1	Sending of REGISTRATION COMPLETE message for NSAG information supported
Equivalent SNPNS indicator (ESI) (octet 8, bit 3)	
This bit indicates the capability to support equivalent SNPNS.	
Bit	
3	
0	Equivalent SNPNS not supported
1	Equivalent SNPNS supported
Enhanced CAG information (ECI) (octet 8, bit 4)	
This bit indicates the capability to support enhanced CAG information.	
Bit	
4	
0	Enhanced CAG information not supported
1	Enhanced CAG information supported
Reconnection to the network due to RAN timing synchronization status change (RANtiming) (octet 8, bit 5)	
This bit indicates the capability to support Reconnection to the network due to RAN timing synchronization status change.	
Bit	
5	
0	Reconnection to the network due to RAN timing synchronization status change not supported
1	Reconnection to the network due to RAN timing synchronization status change supported
LADN per DNN and S-NSSAI support (LADN-DS) (octet 8, bit 6)	
This bit indicates the capability to support LADN per DNN and S-NSSAI.	
Bit	
6	
0	LADN per DNN and S-NSSAI not supported
1	LADN per DNN and S-NSSAI supported

Network slice replacement (NSR) (octet 8, bit 7)	
This bit indicates the capability to support network slice replacement.	
Bit	
7	
0	Network slice replacement not supported
1	Network slice replacement supported
Slice-based TNGF selection support (SBTS) (octet 8, bit 8)	
This bit indicates the capability to support slice-based TNGF selection.	
Bit	
8	
0	Slice-based TNGF selection not supported
1	Slice-based TNGF selection supported
A2X over E-UTRA-PC5 (A2XEPC5) (octet 9, bit 1)	
This bit indicates the capability for A2X over E-UTRA-PC5, as specified in 3GPP TS 24.577 [60].	
Bit	
1	
0	A2X over E-UTRA-PC5 not supported
1	A2X over E-UTRA-PC5 supported
A2X over NR-PC5 (A2XNPC5) (octet 9, bit 2)	
This bit indicates the capability for A2X over NR-PC5, as specified in 3GPP TS 24.577 [60].	
Bit	
2	
0	A2X over NR-PC5 not supported
1	A2X over NR-PC5 supported
Unavailability period (UN-PER) (octet 9, bit 3)	
This bit indicates the capability to support unavailability period.	
Bit	
3	
0	Unavailability period not supported
1	Unavailability period supported
Slice-based N3IWFselection support (SBNS) (octet 9, bit 4)	
This bit indicates the capability to support slide-based N3IWF selection	
Bit	
4	
0	Slice-based N3IWF selection not supported
1	Slice-based N3IWF selection supported
SL positioning server UE (RSLPS) (octet 9, bit 5)	
This bit indicates the capability for SL positioning server UE, as specified in 3GPP TS 24.586 [ts23586].	
Bit	
5	
0	Ranging and sidelink positioning for SL positioning server UE not supported
1	Ranging and sidelink positioning for SL positioning server UE supported
5G ProSe layer-2 UE-to-UE relay (5G ProSe-l2U2U relay) (octet 9, bit 6)	
This bit indicates the capability to act as a 5G ProSe layer-2 UE-to-UE relay UE.	
Bit	
6	
0	Acting as a 5G ProSe layer-2 UE-to-UE relay UE not supported
1	Acting as a 5G ProSe layer-2 UE-to-UE relay UE supported
5G ProSe layer-3 UE-to-UE relay (5G ProSe-l3U2U relay) (octet 9, bit 7)	
This bit indicates the capability to act as a 5G ProSe layer-3 UE-to-UE relay UE.	
Bit	
7	
0	Acting as a 5G ProSe layer-3 UE-to-UE relay UE not supported
1	Acting as a 5G ProSe layer-3 UE-to-UE relay UE supported
5G ProSe layer-2 end UE (5G ProSe-l2end) (octet 9, bit 8)	
This bit indicates the capability to act as a 5G ProSe layer-2 end UE.	
Bit	
8	
0	Acting as a 5G ProSe layer-23 UE-to-UE relayend UE not supported

1	Acting as a 5G ProSe layer-23 UE-to-UE relayend UE supported
5G ProSe layer-3 end UE (5G ProSe-I3end) (octet 10, bit 1)	
This bit indicates the capability to act as a 5G ProSe layer-3 end UE.	
Bit	
1	
0	Acting as a 5G ProSe layer-3 end UE not supported
1	Acting as a 5G ProSe layer-3 end UE supported
Ranging and sidelink positioning support (RSLP) (octet 10, bit 2)	
Bit	
2	
0	Ranging and sidelink positioning not supported
1	Ranging and sidelink positioning supported
Partial network slice (PNS) (octet 10, bit 3)	
This bit indicates whether the UE support partial network slice in the registration area.	
Bit	
3	
0	Partial network slice not supported
1	Partial network slice supported
LCS-UPP user plane positioning (LCS-UPP) (octet 10, bit 4)	
This bit indicates the capability to support LCS-UPP user plane positioning (see 3GPP TS 23.273 [6B]).	
Bit	
4	
0	User plane positioning using LCS-UPP not supported
1	User plane positioning using LCS-UPP supported
SUPL user plane positioning (SUPL) (octet 10, bit 5)	
This bit indicates the capability to support SUPL user plane positioning (see 3GPP TS 38.305 [67] and 3GPP TS 23.271 [68]).	
Bit	
5	
0	User plane positioning using SUPL not supported
1	User plane positioning using SUPL supported
S-NSSAI time validity information (TempNS) (octet 10, bit 6)	
This bit indicates the capability to support the S-NSSAI time validity information.	
Bit	
6	
0	S-NSSAI time validity information not supported
1	S-NSSAI time validity information supported
S-NSSAI location validity information (SLVI) (octet 10, bit 7)	
This bit indicates the capability to support S-NSSAI location validity information.	
Bit	
7	
0	S-NSSAI location validity information not supported
1	S-NSSAI location validity information supported
A2X over Uu capability (A2X-Uu) (octet 10, bit 8)	
This bit indicates the capability for A2X over Uu, as specified in 3GPP TS 24.577 [60].	
Bit	
8	
0	A2X over Uu not supported
1	A2X over Uu supported
MCS indicator update (MCSIU) (octet 11, bit 1)	
This bit indicates the capability to support MCS indicator update via the UE configuration update procedure.	
Bit	
1	
0	MCS indicator update not supported
1	MCS indicator update supported
Network verified UE location over satellite NG-RAN (NVL-SATNR) (octet 11, bit 2)	

This bit indicates the capability to support network verified UE location over satellite NG-RAN as specified in 3GPP TS 23.501 [8].	
Bit	
2	
0	Network verified UE location over satellite NG-RAN not supported
1	Network verified UE location over satellite NG-RAN supported
Ranging and sidelink positioning over PC5 for located UE support (RSLPL) (octet 11, bit 3)	
This bit indicates the capability to support ranging and sidelink positioning over PC5 for located UE support.	
Bit	
3	
0	Ranging and sidelink positioning for located UE not supported
1	Ranging and sidelink positioning for located UE supported
Network slice usage control (NSUC) (octet 11, bit 4)	
This bit indicates the capability to support network slice usage control.	
Bit	
4	
0	Network slice usage control not supported
1	Network slice usage control supported
Bits 5 to 8 in octet 11 and bits in octets 12 to 15 are spare and shall be coded as zero, if the respective octet is included in the information element.	

9.11.3.2 5GMM cause

The purpose of the 5GMM cause information element is to indicate the reason why a 5GMM request is rejected.

The 5GMM cause information element is coded as shown in figure 9.11.3.2.1 and table 9.11.3.2.1.

The 5GMM cause is a type 3 information element with length of 2 octets.

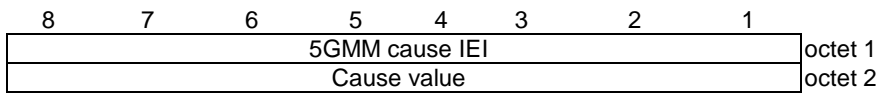

Figure 9.11.3.2.1: 5GMM cause information element

Table 9.11.3.2.1: 5GMM cause information element

Cause value (octet 2)								
Bits								
8	7	6	5	4	3	2	1	
0	0	0	0	0	0	1	1	Illegal UE
0	0	0	0	0	1	0	1	PEI not accepted
0	0	0	0	0	1	1	0	Illegal ME
0	0	0	0	0	1	1	1	5GS services not allowed
0	0	0	0	1	0	0	1	UE identity cannot be derived by the network
0	0	0	0	1	0	1	0	Implicitly de-registered
0	0	0	0	1	0	1	1	PLMN not allowed
0	0	0	0	1	1	0	0	Tracking area not allowed
0	0	0	0	1	1	0	1	Roaming not allowed in this tracking area
0	0	0	0	1	1	1	1	No suitable cells in tracking area
0	0	0	1	0	1	0	0	MAC failure
0	0	0	1	0	1	0	1	Synch failure
0	0	0	1	0	1	1	0	Congestion
0	0	0	1	0	1	1	1	UE security capabilities mismatch
0	0	0	1	1	0	0	0	Security mode rejected, unspecified
0	0	0	1	1	0	1	0	Non-5G authentication unacceptable
0	0	0	1	1	0	1	1	N1 mode not allowed
0	0	0	1	1	1	0	0	Restricted service area
0	0	0	1	1	1	1	1	Redirection to EPC required
0	0	1	0	0	1	0	0	IAB-node operation not authorized
0	0	1	0	1	0	1	1	LADN not available
0	0	1	1	1	1	1	0	No network slices available
0	1	0	0	0	0	0	1	Maximum number of PDU sessions reached
0	1	0	0	0	0	1	1	Insufficient resources for specific slice and DNN
0	1	0	0	0	1	0	1	Insufficient resources for specific slice
0	1	0	0	0	1	1	1	ngKSI already in use
0	1	0	0	1	0	0	0	Non-3GPP access to 5GCN not allowed
0	1	0	0	1	0	0	1	Serving network not authorized
0	1	0	0	1	0	1	0	Temporarily not authorized for this SNPN
0	1	0	0	1	0	1	1	Permanently not authorized for this SNPN
0	1	0	0	1	1	0	0	Not authorized for this CAG or authorized for CAG cells only
0	1	0	0	1	1	0	1	Wireline access area not allowed
0	1	0	0	1	1	1	0	PLMN not allowed to operate at the present UE location
0	1	0	0	1	1	1	1	UAS services not allowed
0	1	0	1	0	0	0	0	Disaster roaming for the determined PLMN with disaster condition not allowed
0	1	0	1	0	0	0	1	Selected N3IWF is not compatible with the allowed NSSAI
0	1	0	1	0	0	1	0	Selected TNGF is not compatible with the allowed NSSAI
0	1	0	1	1	0	1	0	Payload was not forwarded
0	1	0	1	1	0	1	1	DNN not supported or not subscribed in the slice
0	1	0	1	1	1	0	0	Insufficient user-plane resources for the PDU session
0	1	0	1	1	1	0	1	Onboarding services terminated
0	1	0	1	1	1	1	0	User plane positioning not authorized
0	1	0	1	1	1	1	1	Semantically incorrect message
0	1	1	0	0	0	0	0	Invalid mandatory information
0	1	1	0	0	0	0	1	Message type non-existent or not implemented
0	1	1	0	0	0	1	0	Message type not compatible with the protocol state
0	1	1	0	0	0	1	1	Information element non-existent or not implemented
0	1	1	0	0	1	0	0	Conditional IE error
0	1	1	0	0	1	0	1	Message not compatible with the protocol state
0	1	1	0	1	1	1	1	Protocol error, unspecified

Any other value received by the mobile station shall be treated as 0110 1111, "protocol error, unspecified". Any other value received by the network shall be treated as 0110 1111, "protocol error, unspecified".

9.11.3.2A 5GS DRX parameters

The purpose of the 5GS DRX parameters information element is to indicate that the UE wants to use DRX and for the network to indicate the DRX cycle value to be used at paging.

The 5GS DRX parameters is a type 4 information element with a length of 3 octets.

The 5GS DRX parameters information element is coded as shown in figure 9.11.3.2A.1 and table 9.11.3.2A.1.

The value part of a DRX parameter information element is coded as shown in table 9.11.3.2A.1.

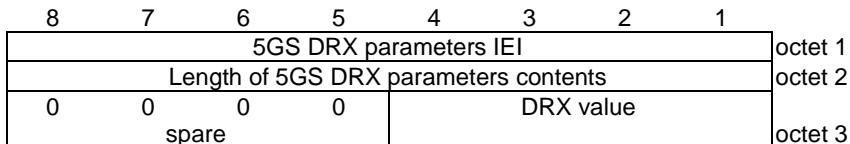

Figure 9.11.3.2A.1: 5GS DRX parameters information element

Table 9.11.3.2A.1: 5GS DRX parameters information element

<p>DRX value (bits 4 to 1 of octet 3)</p> <p>This field represents the DRX cycle parameter 'T' as defined in 3GPP TS 38.304 [28] or 3GPP TS 36.304 [25C].</p> <p>Bits</p> <table style="width: 100%; border-collapse: collapse;"> <tr> <td style="width: 12.5%;">4</td> <td style="width: 12.5%;">3</td> <td style="width: 12.5%;">2</td> <td style="width: 12.5%;">1</td> <td></td> </tr> <tr> <td>0</td> <td>0</td> <td>0</td> <td>0</td> <td>DRX value not specified</td> </tr> <tr> <td>0</td> <td>0</td> <td>0</td> <td>1</td> <td>DRX cycle parameter T = 32</td> </tr> <tr> <td>0</td> <td>0</td> <td>1</td> <td>0</td> <td>DRX cycle parameter T = 64</td> </tr> <tr> <td>0</td> <td>0</td> <td>1</td> <td>1</td> <td>DRX cycle parameter T = 128</td> </tr> <tr> <td>0</td> <td>1</td> <td>0</td> <td>0</td> <td>DRX cycle parameter T = 256</td> </tr> </table> <p>All other values shall be interpreted as "DRX value not specified" by this version of the protocol.</p> <p>Bits 5 to 8 of octet 3 are spare and shall be coded as zero.</p>	4	3	2	1		0	0	0	0	DRX value not specified	0	0	0	1	DRX cycle parameter T = 32	0	0	1	0	DRX cycle parameter T = 64	0	0	1	1	DRX cycle parameter T = 128	0	1	0	0	DRX cycle parameter T = 256
4	3	2	1																											
0	0	0	0	DRX value not specified																										
0	0	0	1	DRX cycle parameter T = 32																										
0	0	1	0	DRX cycle parameter T = 64																										
0	0	1	1	DRX cycle parameter T = 128																										
0	1	0	0	DRX cycle parameter T = 256																										

9.11.3.3 5GS identity type

The purpose of the 5GS identity type information element is to specify which identity is requested.

The 5GS identity type is a type 1 information element.

The 5GS identity type information element is coded as shown in figure 9.11.3.3.1 and table 9.11.3.3.1.

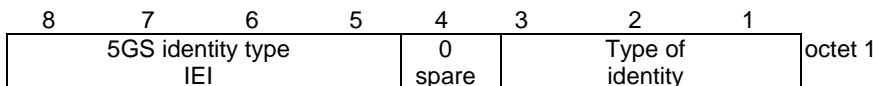

Figure 9.11.3.3.1: 5GS identity type information element

Table 9.11.3.3.1: 5GS identity type information element

Type of identity (octet 1)		
Bits		
3	2	1
0	0	1
0	1	0
0	1	1
1	0	0
1	0	1
1	1	0
1	1	1

SUCI
5G-GUTI
IMEI
5G-S-TMSI
IMEISV
MAC address
EUI-64

All other values are unused and shall be interpreted as "SUCI", if received by the UE.

9.11.3.4 5GS mobile identity

The purpose of the 5GS mobile identity information element is to provide either the SUCI, the 5G-GUTI, the IMEI, the IMEISV, the 5G-S-TMSI, the MAC address or the EUI-64.

The 5GS mobile identity information element is coded as shown in figures 9.11.3.4.1, 9.11.3.4.2, 9.11.3.4.3, 9.11.3.4.4, 9.11.3.4.5, 9.11.3.4.6, 9.11.3.4.8 and 9.11.3.4.7, and table 9.11.3.4.1.

The 5GS mobile identity is a type 6 information element with a minimum length of 4.

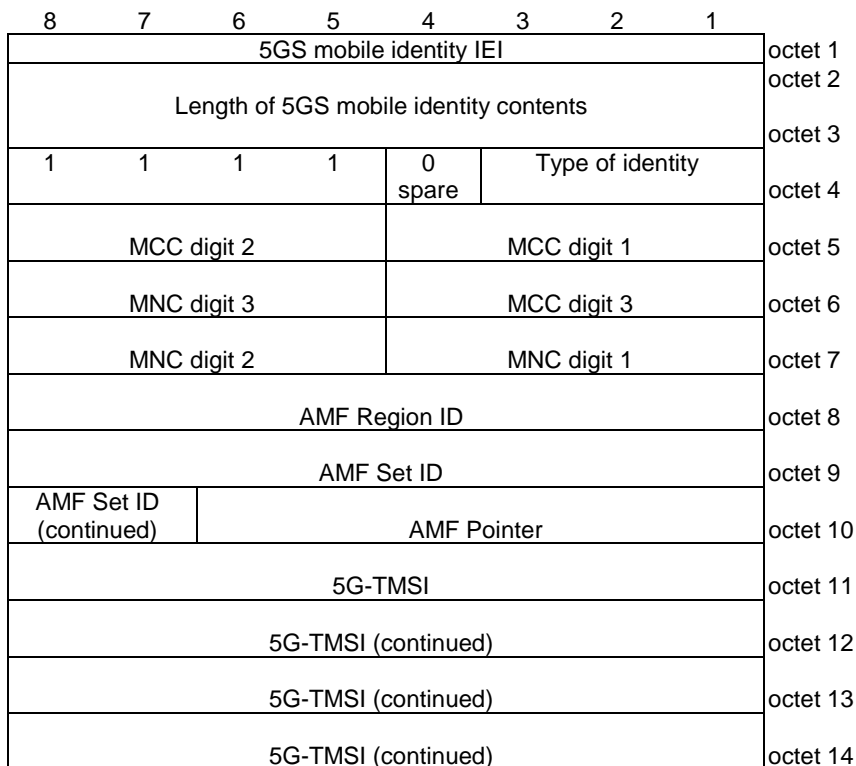

Figure 9.11.3.4.1: 5GS mobile identity information element for type of identity "5G-GUTI"

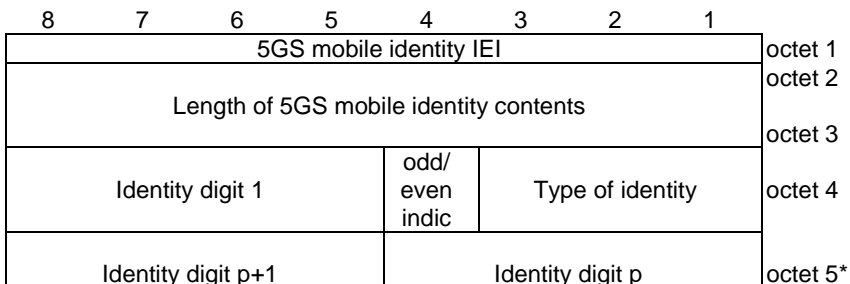

Figure 9.11.3.4.2: 5GS mobile identity information element for type of identity "IMEI" or "IMEISV"

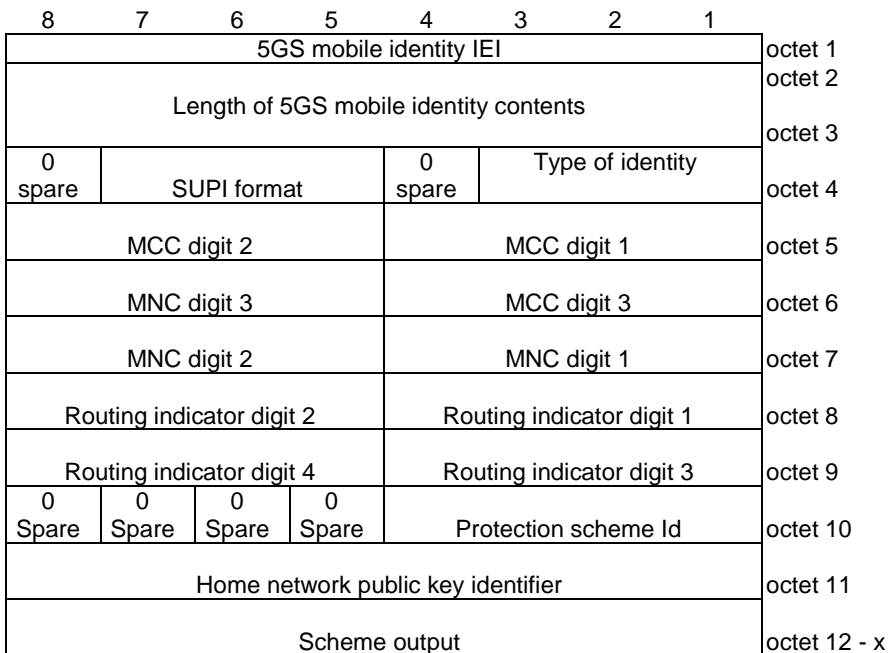

Figure 9.11.3.4.3: 5GS mobile identity information element for type of identity "SUCI" and SUPI format "IMSI"

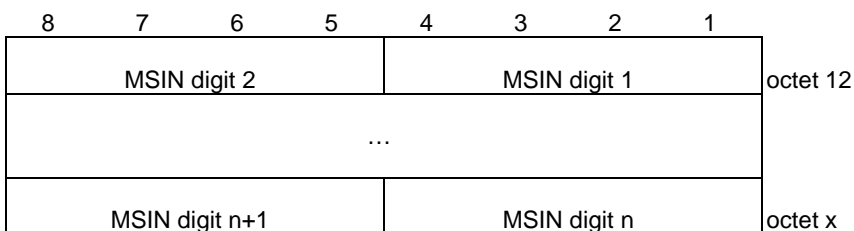

Figure 9.11.3.4.3a: Scheme output for type of identity "SUCI", SUPI format "IMSI" and Protection scheme Id "Null scheme"

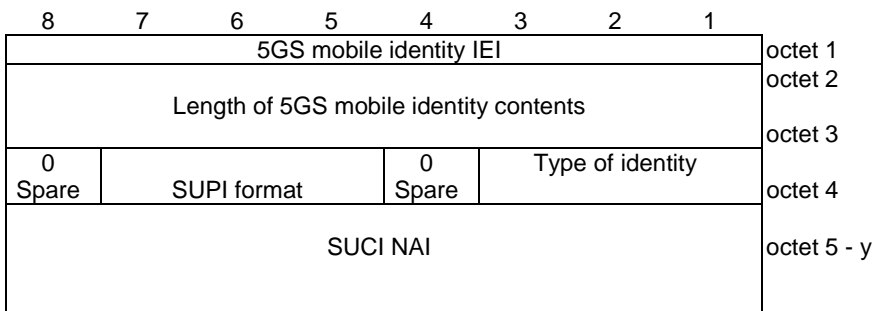

Figure 9.11.3.4.4: 5GS mobile identity information element for type of identity "SUCI" and SUPI format "Network specific identifier", "GCI" or "GLI"

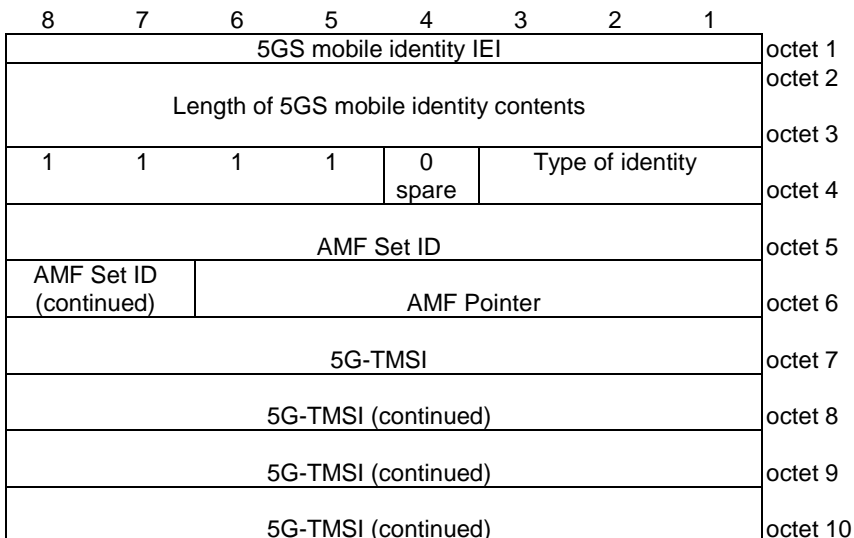

Figure 9.11.3.4.5: 5GS mobile identity information element for type of identity "5G-S-TMSI"

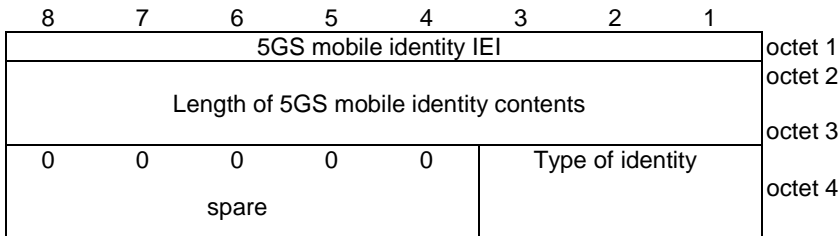

Figure 9.11.3.4.6: 5GS mobile identity information element for type of identity "No identity"

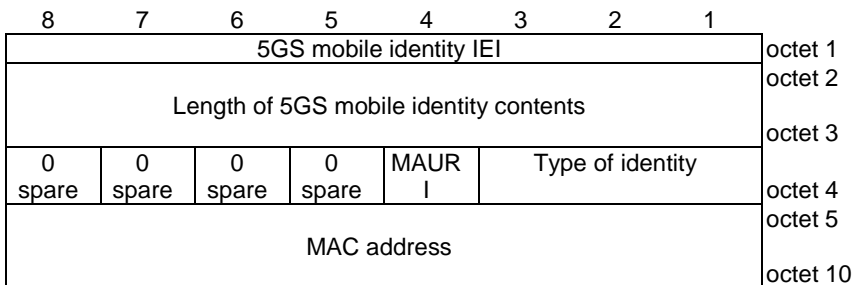

Figure 9.11.3.4.7: 5GS mobile identity information element for type of identity "MAC address"

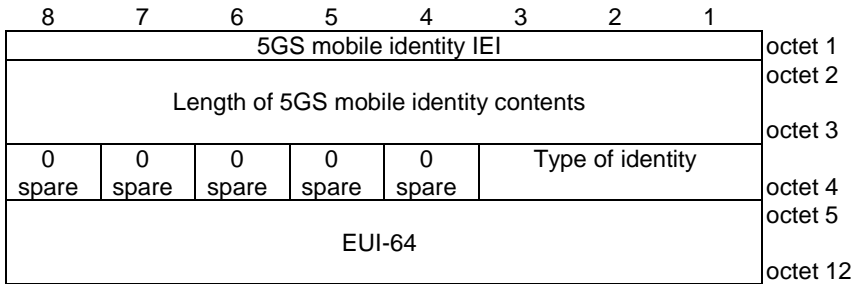

Figure 9.11.3.4.8: 5GS mobile identity information element for type of identity "EUI-64"

Table 9.11.3.4.1: 5GS mobile identity information element

Type of identity (octet 4)

Bits

3 2 1

0	0	0	No identity (see NOTE 1)
0	0	1	SUCI
0	1	0	5G-GUTI
0	1	1	IMEI
1	0	0	5G-S-TMSI
1	0	1	IMEISV
1	1	0	MAC address
1	1	1	EUI-64

All other values are reserved.

Odd/even indication (octet 4)

Bit

4

0	even number of identity digits
1	odd number of identity digits

For the 5G-GUTI, then bits 5 to 8 of octet 4 are coded as "1111", octet 5 through 7 contain the MCC and MNC values as specified below, octet 8 through 10 contain the AMF Region ID, the AMF Set ID and the AMF Pointer values and octet 11 through 14 contain the 5G-TMSI as defined in 3GPP TS 23.003 [4].

MCC, Mobile country code (octet 5, octet 6 bits 1 to 4)

The MCC field is coded as in ITU-T Recommendation E.212 [42], annex A.

MNC, Mobile network code (octet 6 bits 5 to 8, octet 7)

The coding of this field is the responsibility of each administration but BCD coding shall be used. The MNC shall consist of 2 or 3 digits. If a network operator decides to use only two digits in the MNC, bits 5 to 8 of octet 6 shall be coded as "1111".

The MCC and MNC digits are coded as octets 6 to 8 of the Temporary mobile group identity IE in figure 10.5.154 of 3GPP TS 24.008 [12].

AMF Region ID (octet 8)

This field contains the binary encoding of the AMF Region ID. Bit 8 of octet 7 is the most significant bit and bit 1 of octet 7 is the least significant bit.

AMF Set ID (octet 9, octet 10 bits 7 to 8)

This field contains the binary encoding of the AMF Set ID. Bit 8 of octet 9 is the most significant bit and bit 7 of octet 10 is the least significant bit.

AMF Pointer (octet 10 bits 1 to 6)

This field contains the binary encoding of the AMF Pointer. Bit 6 of octet 9 is the most significant bit and bit 1 of octet 9 is the least significant bit.

5G-TMSI (octet 11 to 14)

Bit 8 of octet 11 is the most significant bit and bit 1 of octet 14 is the least significant bit.

Identity digit (octet 4 bits 5 to 8, octet 5 etc.)

For the IMEI, Identity digit field is coded using BCD coding. If the number of identity digits is even then bits 5 to 8 of the last octet shall be filled with an end mark coded as "1111". The format of the IMEI is described in 3GPP TS 23.003 [4].

For the IMEISV, Identity digit field is coded using BCD coding. Bits 5 to 8 of the last octet shall be filled with an end mark coded as "1111". The format of the IMEISV is described in 3GPP TS 23.003 [4].

For the SUCI, bit 8 of octet 4 is spare and shall be coded as zero. Bits 5-7 of octet 4 contain the SUPI format and are coded as shown below.

SUPI format (octet 4, bits 5-7)

Bits

7	6	5	
0	0	0	IMSI
0	0	1	Network specific identifier
0	1	0	GCI
0	1	1	GLI

All other values are interpreted as IMSI by this version of the protocol.

For the SUCI with SUPI format "IMSI", octets 5 through 7 contain the MCC and MNC values as specified below. For subsequent fields, bit 8 of octet 8 is the most significant bit and bit 1 of the last octet the least significant bit. The required fields for the SUCI are as defined in 3GPP TS 23.003 [4].

MCC, Mobile country code (octet 5, octet 6 bits 1 to 4)

The MCC field is coded as in ITU-T Recommendation E.212 [42], annex A.

MNC, Mobile network code (octet 6 bits 5 to 8, octet 7)

The coding of this field is the responsibility of each administration but BCD coding shall be used. The MNC shall consist of 2 or 3 digits. If a network operator decides to use only two digits in the MNC, bits 5 to 8 of octet 6 shall be coded as "1111".

The MCC and MNC digits are coded as octets 6 to 8 of the Temporary mobile group identity IE in figure 10.5.154 of 3GPP TS 24.008 [12].

Routing indicator (octets 8-9)

Routing Indicator shall consist of 1 to 4 digits. The coding of this field is the responsibility of home network operator but BCD coding shall be used. If a network operator decides to assign less than 4 digits to Routing Indicator, the remaining digits shall be coded as "1111" to fill the 4 digits coding of Routing Indicator (see NOTE 2). If no Routing Indicator is configured in the USIM or the ME, the UE shall code bits 1 to 4 of octet 8 of the Routing Indicator as "0000" and the remaining digits as "1111".

Protection scheme identifier (octet 10 bits 1 to 4)

Bits

4	3	2	1	
0	0	0	0	Null scheme
0	0	0	1	ECIES scheme profile A
0	0	1	0	ECIES scheme profile B
0	0	1	1	
				to
1	0	1	1	Reserved
1	1	0	0	
				to
1	1	1	1	Operator-specific protection scheme

Bits 5-8 of octet 10 are spare and shall be coded as zero.

Home network public key identifier (octet 11)

The Home network public key identifier (PKI) field is coded as defined in 3GPP TS 23.003 [4]. Home network public key identifier shall be coded as "00000000" when Protection scheme identifier is set to "0000" (i.e. Null scheme).

Bits

8	7	6	5	4	3	2	1	
0	0	0	0	0	0	0	0	Home network PKI value 0
0	0	0	0	0	0	0	1	
								to
1	1	1	1	1	1	1	0	Home network PKI value (1-254)
1	1	1	1	1	1	1	1	Reserved

Scheme output (octets 12 to x)

The Scheme output field consists of a string of characters with a variable length or hexadecimal digits as specified in 3GPP TS 23.003 [4]. If Protection scheme identifier is set to "0000" (i.e. Null scheme), then the Scheme output consists of the MSIN and is coded using BCD coding with each digit of the MSIN coded over 4 bits. If the MSIN includes an odd number of digits, bits 5 to 8 of octet x shall be coded as "1111". If Protection scheme identifier is not "0000" (i.e. ECIES scheme profile A, ECIES scheme profile B or Operator-specific protection scheme), then Scheme output is coded as hexadecimal digits.

For the SUCI with SUPI format set to "Network specific identifier", the SUCI NAI field contains an NAI constructed as specified in subclause 28.7.3 of 3GPP TS 23.003 [4] and encoded as UTF-8 string.

For the SUCI with SUPI format set to "GCI", the SUCI NAI field contains an NAI constructed as specified in subclause 28.15.5 of 3GPP TS 23.003 [4] and encoded as UTF-8 string.

For the SUCI with SUPI format set to "GLI", the SUCI NAI field contains an NAI constructed as specified in subclause 28.16.5 of 3GPP TS 23.003 [4] and encoded as UTF-8 string.

For the 5G-S-TMSI, bits 5 to 8 of octet 4 are coded as "1111". The coding of the 5G-S-TMSI is left open for each administration.

AMF Set ID (octet 5, octet 6 bits 7 to 8)

This field contains the binary encoding of the AMF Set ID. Bit 8 of octet 5 is the most significant bit and bit 7 of octet 6 is the least significant bit.

AMF Pointer (octet 6 bits 1 to 6)

This field contains the binary encoding of the AMF Pointer. Bit 6 of octet 6 is the most significant bit and bit 1 of octet 6 is the least significant bit.

5G-TMSI (octet 7 to 10)

Bit 8 of octet 7 is the most significant bit and bit 1 of octet 10 is the least significant bit.

For Type of identity "No identity", the length of mobile identity contents parameter shall be set to 1 and the bits 4-8 of octet 4 are spare and shall be coded as zero.

MAC address usage restriction indication (MAURI) (octet 4 bit 4)

Bit

4

0 No restrictions

1 MAC address is not usable as an equipment identifier

MAC address (octets 5 to 10)

This field contains the MAC address as defined in subclause 8 of IEEE Std 802 [43]. Bit 8 of octet 5 is the most significant bit and bit 1 of octet 10 is the least significant bit.

EUI-64 (octets 5 to 12)

This field contains an EUI-64 as defined in [48].

Bit 8 of octet 5 is the most significant bit and bit 1 of octet 12 is the least significant bit.

NOTE 1: This can be used when the requested identity is not available at the UE during the identification procedure.

NOTE 2: For a 3-digit Routing Indicator, e.g "567", bits 1 to 4 of octet 8 are coded as "0101", bits 5 to 8 of octet 8 are coded as "0110", bits 1 to 4 of octet 9 are coded as "0111", bits 5 to 8 of octet 9 are coded as "1111".

9.11.3.5 5GS network feature support

The purpose of the 5GS network feature support information element is to indicate whether certain features are supported by the network.

The 5GS network feature support information element is coded as shown in figure 9.11.3.5.1 and table 9.11.3.5.1.

The 5GS network feature support is a type 4 information element with a minimum length of 3 octets and a maximum length of 6 octets.

If:

- the length of 5GS network feature support contents field is set to one, then the UE shall interpret this as a receipt of an information element with all bits of octet 4, octet 5 and octet 6 coded as zero.
- the length of 5GS network feature support contents field is set to two, the UE shall interpret this as a receipt of an information element with all bits of octet 5 and octet 6 coded as zero.
- the length of 5GS network feature support contents field is set to three, the UE shall interpret this as a receipt of an information element with all bits of octet 6 coded as zero.

8 7 6 5 4 3 2 1								
5GS network feature support IEI								octet 1
Length of 5GS network feature support contents								octet 2
MPSI	IWK N26	EMF		EMC		IMS- VoPS- N3GP P	IMS- VoPS- 3GPP	octet 3
5G-UP CloT	5G- IPHC- CP CloT	N3 data	5G-CP CloT	RestrictEC		MCSI	EMCN 3	octet 4*
UN- PER	PR	RPR	PIV	NCR	5G- EHC- CP CloT	ATS- IND	5G- LCS	octet 5*
0 spare	0 spare	0 spare	0 spare	RSLP	SUPL	LCS- UPP	NAPS	octet 6*

Figure 9.11.3.5.1: 5GS network feature support information element

Table 9.11.3.5.1: 5GS network feature support information element

IMS voice over PS session over 3GPP access indicator (IMS-VoPS-3GPP) (octet 3, bit 1)	
This bit indicates the support of IMS voice over PS session over 3GPP access (see NOTE 1).	
Bit	
1	
0	IMS voice over PS session not supported over 3GPP access
1	IMS voice over PS session supported over 3GPP access
IMS voice over PS session over non-3GPP access indicator (IMS-VoPS-N3GPP) (octet 3, bit 2)	
This bit indicates the support of IMS voice over PS session over non-3GPP access.	
Bit	
2	
0	IMS voice over PS session not supported over non-3GPP access
1	IMS voice over PS session supported over non-3GPP access
Emergency service support indicator for 3GPP access (EMC) (octet 3, bit 3 and bit 4)	
These bits indicate the support of emergency services in 5GS for 3GPP access (see NOTE 1).	
Bits	
4 3	
0 0	Emergency services not supported
0 1	Emergency services supported in NR connected to 5GCN only
1 0	Emergency services supported in E-UTRA connected to 5GCN only
1 1	Emergency services supported in NR connected to 5GCN and E-UTRA connected to 5GCN
Emergency services fallback indicator for 3GPP access (EMF) (octet 3, bit 5 and bit 6)	
These bits indicate the support of emergency services fallback for 3GPP access (see NOTE 1).	
Bits	
6 5	
0 0	Emergency services fallback not supported
0 1	Emergency services fallback supported in NR connected to 5GCN only
1 0	Emergency services fallback supported in E-UTRA connected to 5GCN only
1 1	Emergency services fallback supported in NR connected to 5GCN and E-UTRA connected to 5GCN
Interworking without N26 interface indicator (IWK N26) (octet 3, bit 7)	
This bit indicates whether interworking without N26 interface is supported.	
Bit	
7	
0	Interworking without N26 interface not supported
1	Interworking without N26 interface supported
MPS indicator (MPSI) (octet 3, bit 8)	
This bit indicates the validity of MPS.	
Bit	
8	
0	Access identity 1 not valid
1	Access identity 1 valid
Emergency service support for non-3GPP access indicator (EMCN3) (octet 4, bit 1)	
This bit indicates the support of emergency services in 5GS for non-3GPP access.	
Bit (see NOTE 2)	
1	
0	Emergency services not supported over non-3GPP access
1	Emergency services supported over non-3GPP access
MCS indicator (MCSI) (octet 4, bit 2)	
This bit indicates the validity of MCS.	
Bit	
2	
0	Access identity 2 not valid
1	Access identity 2 valid

Restriction on enhanced coverage (RestrictEC) (octet 4, bit 3 and bit 4)

These bits indicate enhanced coverage restricted information.

In WB-N1 mode these bits are set as follows:

Bits

4 3

0	0	Both CE mode A and CE mode B are not restricted
0	1	Both CE mode A and CE mode B are restricted
1	0	CE mode B is restricted
1	1	Reserved

In NB-N1 mode these bits are set as follows

Bits

4 3

0	0	Use of enhanced coverage is not restricted
0	1	Use of enhanced coverage is restricted
1	0	Reserved
1	1	Reserved

Control plane CloT 5GS optimization (5G-CP CloT) (octet 4, bit 5)

This bit indicates the capability for control plane CloT 5GS optimization.

Bit

5

0	Control plane CloT 5GS optimization not supported
1	Control plane CloT 5GS optimization supported

N3 data transfer (N3 data) (octet 4, bit 6)

This bit indicates the capability for N3 data transfer.

Bit

6

0	N3 data transfer supported
1	N3 data transfer not supported

IP header compression for control plane CloT 5GS optimization (5G-IPHC-CP CloT) (octet 4, bit 7)

This bit indicates the capability for IP header compression for control plane CloT 5GS optimization.

Bit

7

0	IP header compression for control plane CloT 5GS optimization not supported
1	IP header compression for control plane CloT 5GS optimization supported

User plane CloT 5GS optimization (5G-UP CloT) (octet 4, bit 8)

This bit indicates the capability for user plane CloT 5GS optimization.

Bit

8

0	User plane CloT 5GS optimization not supported
1	User plane CloT 5GS optimization supported

Location Services indicator in 5GC (5G-LCS) (octet 5, bit 1)

Bit

1

0	Location services via 5GC not supported
1	Location services via 5GC supported

ATSSS support indicator (ATS-IND) (octet 5, bit 2)

This bit indicates the network support for ATSSS.

Bit

2

0	ATSSS not supported
1	ATSSS supported

Ethernet header compression for control plane CloT 5GS optimization (5G-EHC-CP CloT) (octet 5, bit 3)

This bit indicates the capability for Ethernet header compression for control plane CloT 5GS optimization

Bit

3

0	Ethernet header compression for control plane Clot 5GS optimization not supported
1	Ethernet header compression for control plane Clot 5GS optimization supported
N1 NAS signalling connection release (NCR) (octet 5, bit 4) This bit indicates whether N1 NAS signalling connection release is supported.	
Bit	
4	
0	N1-NAS signalling connection release not supported
1	N1-NAS signalling connection release supported
Paging indication for voice services (PIV) (octet 5, bit 5) This bit indicates whether paging indication for voice services is supported.	
Bit	
5	
0	paging indication for voice services not supported
1	paging indication for voice services supported
Reject paging request (RPR) (octet 5, bit 6) This bit indicates whether reject paging request is supported.	
Bit	
6	
0	reject paging request not supported
1	reject paging request supported
Paging restriction (PR) (octet 5, bit 7) This bit indicates whether paging restriction is supported.	
Bit	
7	
0	paging restriction not supported
1	paging restriction supported
UN-PER (octet 5, bit 8) This bit indicates the capability to support Unavailability period	
Bit	
8	
0	unavailability period not supported
1	unavailability period supported
Non-3GPP access path switching (NAPS) (octet 6, bit 1) This bit indicates whether non-3GPP access path switching is supported.	
Bit	
1	
0	non-3GPP access path switching not supported
1	non-3GPP access path switching supported
LCS-UPP user plane positioning (LCS-UPP) (octet 6, bit 2) This bit indicates the capability to support LCS-UPP user plane positioning (see 3GPP TS 23.273 [6B]).	
Bit	
2	
0	User plane positioning using LCS-UPP not supported
1	User plane positioning using LCS-UPP supported
SUPL user plane positioning (SUPL) (octet 6, bit 3) This bit indicates the capability to support SUPL user plane positioning (see 3GPP TS 38.305 [67] and 3GPP TS 23.271 [68]).	
Bit	
3	
0	User plane positioning using SUPL not supported
1	User plane positioning using SUPL supported
Ranging and sidelink positioning support (RSLP) (octet 6, bit 4)	

This bit indicates the capability to support ranging and sidelink positioning.
 Bit
4
 0 Ranging and sidelink positioning not supported
 1 Ranging and sidelink positioning supported

Bits 5 to 8 of octet 6 are spare and shall be coded as zero.

NOTE 1: For a registration procedure over non-3GPP access, bit 1 of octet 3 and bits 3 to 7 of octet 3 are ignored.
 NOTE 2: For a registration procedure over 3GPP access, bit 2 of octet 3 and bit 1 of octet 4 are ignored.

9.11.3.6 5GS registration result

The purpose of the 5GS registration result information element is to specify the result of a registration procedure.

The 5GS registration result information element is coded as shown in figure 9.11.3.6.1 and table 9.11.3.6.1.

The 5GS registration result is a type 4 information element with a length of 3 octets.

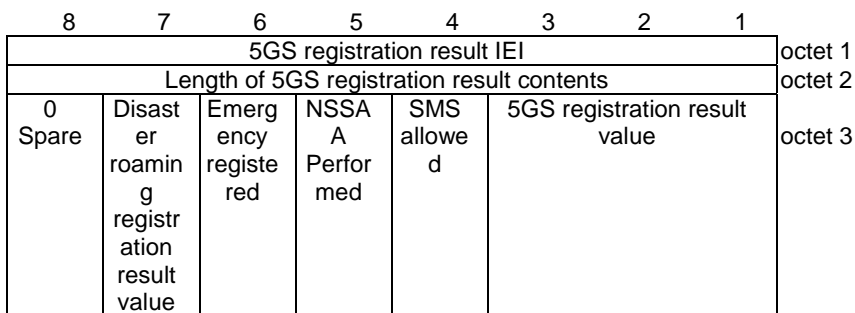

Figure 9.11.3.6.1: 5GS registration result information element

Table 9.11.3.6.1: 5GS registration result information element

5GS registration result value (octet 3, bits 1 to 3) (NOTE)	
Bits	
3	2 1
0	0 1 3GPP access
0	1 0 Non-3GPP access
0	1 1 3GPP access and non-3GPP access
1	1 1 reserved
All other values are unused and shall be treated as "3GPP access", if received by the UE.	
SMS over NAS transport allowed (SMS allowed) (octet 3, bit 4) (NOTE)	
Bit	
4	
0	SMS over NAS not allowed
1	SMS over NAS allowed
Network slice-specific authentication and authorization is to be performed (NSSAA to be performed) (octet 3, bit 5) (NOTE)	
Bit	
5	
0	Network slice-specific authentication and authorization is not to be performed
1	Network slice-specific authentication and authorization is to be performed
Emergency registered (octet 3, bit 6)	
Bit	
6	
0	Not registered for emergency services
1	Registered for emergency services
Disaster roaming registration result value (octet 3, bit 7) (NOTE)	
Bit	
7	
0	No additional information
1	Request for registration for disaster roaming service accepted as registration not for disaster roaming service
Bit 8 of octet 3 is spare and shall be coded as zero.	
NOTE: All bits other than bit 6 in octet 3 shall be ignored by the UE when the 5GS registration result IE is received in the CONFIGURATION UPDATE COMMAND message	

9.11.3.7 5GS registration type

The purpose of the 5GS registration type information element is to indicate the type of the requested registration.

The 5GS registration type information element is coded as shown in figure 9.11.3.7.1 and table 9.11.3.7.1.

The 5GS registration type is a type 1 information element with a length of 1 octet.

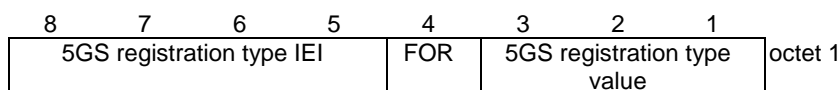

Figure 9.11.3.7.1: 5GS registration type information element

Table 9.11.3.7.1: 5GS registration type information element

5GS registration type value (octet 1, bits 1 to 3)			
Bits			
3	2	1	
0	0	1	initial registration
0	1	0	mobility registration updating
0	1	1	periodic registration updating
1	0	0	emergency registration
1	0	1	SNPN onboarding registration
1	1	0	disaster roaming mobility registration updating
1	1	1	disaster roaming initial registration
All other values are unused and shall be interpreted as "initial registration", if received by the network.			
Follow-on request bit (FOR) (octet 1, bit 4)			
Bit			
4			
0	No follow-on request pending		
1	Follow-on request pending		

9.11.3.8 5GS tracking area identity

The purpose of the 5GS tracking area identity information element is to provide an unambiguous identification of tracking areas within the area covered by the 5GS.

The 5GS tracking area identity information element is coded as shown in figure 9.11.3.8.1 and table 9.11.3.8.1.

The 5GS tracking area identity is a type 3 information element with a length of 7 octets.

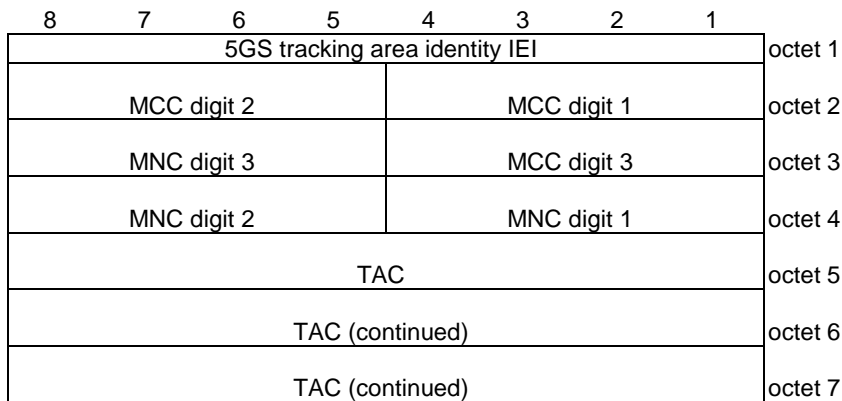

Figure 9.11.3.8.1: 5GS tracking area identity information element

Table 9.11.3.8.1: 5GS tracking area identity information element

<p>MCC, Mobile country code (octets 2 and 3) The MCC field is coded as in ITU-T Recommendation E212 [42], annex A.</p> <p>If the TAI is deleted the MCC and MNC shall take the value from the deleted TAI.</p> <p>In abnormal cases, the MCC stored in the UE can contain elements not in the set {0, 1 ... 9}. In such cases the UE should transmit the stored values using full hexadecimal encoding. When receiving such an MCC, the network shall treat the TAI as deleted.</p> <p>MNC, Mobile network code (octet 3 bits 5 to 8, octet 4) The coding of this field is the responsibility of each administration, but BCD coding shall be used. The MNC shall consist of 2 or 3 digits. For PCS 1900 for NA, Federal regulation mandates that a 3-digit MNC shall be used. However, a network operator may decide to use only two digits in the MNC in the TAI over the radio interface. In this case, bits 5 to 8 of octet 3 shall be coded as "1111". Mobile equipment shall accept a TAI coded in such a way.</p> <p>In abnormal cases, the MNC stored in the UE can have:</p> <ul style="list-style-type: none"> - digit 1 or 2 not in the set {0, 1 ... 9}, or - digit 3 not in the set {0, 1 ... 9, F} hex. <p>In such cases the UE shall transmit the stored values using full hexadecimal encoding. When receiving such an MNC, the network shall treat the TAI as deleted.</p> <p>The same handling shall apply for the network, if a 3-digit MNC is sent by the UE to a network using only a 2-digit MNC.</p> <p>TAC, Tracking area code (octets 5 to 7) In the TAC field bit 8 of octet 5 is the most significant bit and bit 1 of octet 7 the least significant bit.</p> <p>The coding of the tracking area code is the responsibility of each administration except that two values are used to mark the TAC, and hence the TAI, as deleted. Coding using full hexadecimal representation may be used. The tracking area code consists of 3 octets.</p> <p>If a TAI has to be deleted, then all bits of the tracking area code shall be set to one with the exception of the least significant bit which shall be set to zero. If a USIM is inserted in a mobile equipment with the tracking area code containing all zeros, then the mobile equipment shall recognise this TAC as part of a deleted TAI.</p>
--

9.11.3.9 5GS tracking area identity list

The purpose of the 5GS tracking area identity list information element is to transfer a list of tracking areas from the network to the UE.

The coding of the information element allows combining different types of lists. The lists of type "00" and "01" allow a more compact encoding, when the different TAIs are sharing the PLMN identity.

The 5GS tracking area identity list information element is coded as shown in figure 9.11.3.8.1, figure 9.11.3.8.2, figure 9.11.3.9.3, figure 9.11.3.9.4 and table 9.11.3.9.1.

The 5GS tracking area identity list is a type 4 information element, with a minimum length of 9 octets and a maximum length of 114 octets. The list can contain a maximum of 16 different tracking area identities.

8	7	6	5	4	3	2	1	
5GS tracking area identity list IEI								octet 1
Length of 5GS tracking area identity list contents								octet 2
Partial tracking area identity list 1								octet 3
Partial tracking area identity list 2								octet i octet i+1*
...								octet l* octet l+1*
Partial tracking area identity list p								octet m* octet m+1* octet n*

Figure 9.11.3.9.1: 5GS tracking area identity list information element

8	7	6	5	4	3	2	1	
0 Spare	Type of list		Number of elements					octet 1
MCC digit 2			MCC digit 1					octet 2
MNC digit 3			MCC digit 3					octet 3
MNC digit 2			MNC digit 1					octet 4
TAC 1								octet 5
TAC 1 (continued)								octet 6
TAC 1 (continued)								octet 7
...								...
...								...
TAC k								octet 3k+2*
TAC k (continued)								octet 3k+3*
TAC k (continued)								octet 3k+4*

Figure 9.11.3.9.2: Partial tracking area identity list – type of list = "00"

8 0 Spare	7 Type of list	6	5	4	3	2	1	
		Number of elements						octet 1
MCC digit 2			MCC digit 1				octet 2	
MNC digit 3			MCC digit 3				octet 3	
MNC digit 2			MNC digit 1				octet 4	
TAC 1								octet 5
TAC 1 (continued)								octet 6
TAC 1 (continued)								octet 7

Figure 9.11.3.9.3: Partial tracking area identity list – type of list = "01"

8 0 Spare	7 Type of list	6	5	4	3	2	1	
		Number of elements						octet 1
MCC digit 2			MCC digit 1				octet 2	
MNC digit 3			MCC digit 3				octet 3	
MNC digit 2			MNC digit 1				octet 4	
TAC 1								octet 5
TAC 1 (continued)								octet 6
TAC 1 (continued)								octet 7
MCC digit 2			MCC digit 1				octet 8*	
MNC digit 3			MCC digit 3				octet 9*	
MNC digit 2			MNC digit 1				octet 10*	
TAC 2								octet 11*
TAC 2 (continued)								octet 12*
TAC 2 (continued)								octet 13*
...								
...								
MCC digit 2			MCC digit 1				octet 6k-4*	
MNC digit 3			MCC digit 3				octet 6k-3*	
MNC digit 2			MNC digit 1				octet 6k-2*	
TAC k								octet 6k-1*
TAC k (continued)								octet 6k*
TAC k (continued)								octet 6k+1*

Figure 9.11.3.9.4: Partial tracking area identity list – type of list = "10"

Table 9.11.3.9.1: Tracking area identity list information element

Value part of the Tracking area identity list information element (octets 3 to n)

The value part of the Tracking area identity list information element consists of one or several partial tracking area identity lists. The length of each partial tracking area identity list can be determined from the 'type of list' field and the 'number of elements' field in the first octet of the partial tracking area identity list.

The UE shall store the complete list received. If more than 16 TAIs are included in this information element, the UE shall store the first 16 TAIs and ignore the remaining octets of the information element.

Partial tracking area identity list:

Type of list (octet 1)

Bits

7 6

0 0 list of TACs belonging to one PLMN or SNPN, with non-consecutive TAC values
 0 1 list of TACs belonging to one PLMN or SNPN, with consecutive TAC values
 1 0 list of TAIs belonging to different PLMNs (see NOTE)

All other values are reserved.

Number of elements (octet 1)

Bits

5 4 3 2 1

0 0 0 0 0 1 element
 0 0 0 0 1 2 elements
 0 0 0 1 0 3 elements

...

0 1 1 0 1 14 elements
 0 1 1 1 0 15 elements
 0 1 1 1 1 16 elements

All other values are unused and shall be interpreted as 16, if received by the UE.

Bit 8 of octet 1 is spare and shall be coded as zero.

For type of list = "00" and number of elements = k:

octet 2 to 4 contain the MCC+MNC, and

for $j = 1, \dots, k$:

octets $3j+2$ to $3j+4$ contain the TAC of the j -th TAI belonging to the partial list,

For type of list = "01" and number of elements = k:

octet 2 to 4 contain the MCC+MNC, and

octets 5 to 7 contain the TAC of the first TAI belonging to the partial list.

The TAC values of the other $k-1$ TAIs are TAC+1, TAC+2, ..., TAC+k-1.

For type of list = "10" and number of elements = k:

for $j = 1, \dots, k$.

octets $6j-4$ to $6j-2$ contain the MCC+MNC, and

octets $6j-1$ to $6j+1$ contain the TAC of the j -th TAI belonging to the partial list.

MCC, Mobile country code

The MCC field is coded as in ITU-T Recommendation E.212 [42], annex A.

MNC, Mobile network code

The coding of this field is the responsibility of each administration but BCD coding shall be used. The MNC shall consist of 2 or 3 digits. If a network operator decides to use only two digits in the MNC, MNC digit 3 shall be coded as "1111".

TAC, Tracking area code

In the TAC field bit 8 of the first octet is the most significant bit and bit 1 of third octet the least significant bit.
 The coding of the tracking area code is the responsibility of each administration.
 Coding using full hexadecimal representation may be used. The tracking area code consists of 3 octets.

NOTE: If the "list of TALs belonging to different PLMNs" is used, the PLMNs included in the list need to be present in the list of "equivalent PLMNs". This type of list is not applicable in an SNPN.

9.11.3.9A 5GS update type

The purpose of the 5GS update type IE is to allow the UE to provide additional information to the network when performing a registration procedure.

The 5GS update type information element is coded as shown in figure 9.11.3.9A.1 and table 9.11.3.9A.1.

The 5GS update type is a type 4 information element with a length of 3 octets.

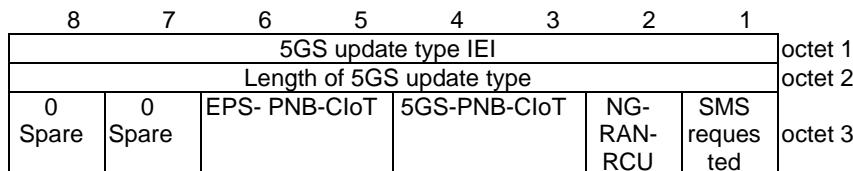

Figure 9.11.3.9A.1: 5GS update type information element

Table 9.11.3.9A.1: 5GS update type information element

SMS over NAS transport requested (SMS requested) (octet 3, bit 1)	
Bit	
1	
0	SMS over NAS not supported
1	SMS over NAS supported
NG-RAN Radio Capability Update (NG-RAN-RCU) (octet 3, bit 2)	
Bit	
2	
0	UE radio capability update not needed
1	UE radio capability update needed
For a list of RATs for which a radio capability update can be triggered by means of this indication see subclause 5.5.1.3.2, case n).	
5GS Preferred CloT network behaviour (5GS PNB-CIoT) (octet 3, bits 3 and 4)	
Bits	
4 3	
0 0	no additional information
0 1	control plane CloT 5GS optimization
1 0	user plane CloT 5GS optimization
1 1	reserved
EPS Preferred CloT network behaviour (EPS-PNB-CIoT) (octet 3, bits 5 and 6)	
Bits	
6 5	
0 0	no additional information
0 1	control plane CloT EPS optimization
1 0	user plane CloT EPS optimization
1 1	reserved
Bits 7 to 8 of octet 3 are spare and shall be coded as zero.	

9.11.3.10 ABBA

The purpose of the ABBA information element is to enable the bidding down protection of security features.

The ABBA information element is coded as shown in figure 9.11.3.10.1 and table 9.11.3.10.1.

The ABBA is a type 4 information element with a minimum length of 4 octets and maximum length of 257 octets.

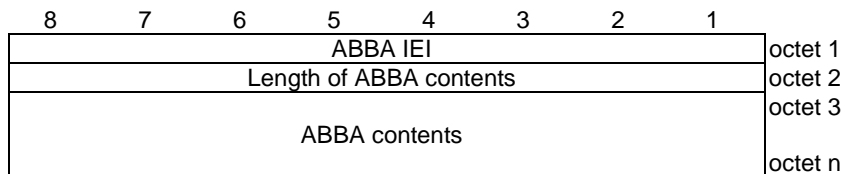

Figure 9.11.3.10.1: ABBA information element

Table 9.11.3.10.1: ABBA information element

ABBA contents (octet 3-n): indicate set of security features defined for 5GS as described in 3GPP TS 33.501 [24].
NOTE 1: If the UE receives the ABBA IE with a length that is set to a value of 2 and with a value of 0000H, the UE shall use the length and the contents of the ABBA IE as received from the network.
NOTE 2: If the UE receives the ABBA IE with a length that is set to a value larger than 2 or with a value that is different from 0000H, the UE shall use the length and the contents of the ABBA IE as received from the network.

9.11.3.11 Void

9.11.3.12 Additional 5G security information

The purpose of the Additional 5G security information information element is to provide the UE with additional security parameters (e.g. horizontal derivation parameter) or to request the UE to retransmit an initial NAS message during a security mode control procedure as defined in 3GPP TS 33.501 [24]. The UE uses these parameters for completion of security mode control procedure.

The Additional 5G security information information element is coded as shown in figure 9.11.3.12.1 and table 9.11.3.12.1.

The Additional 5G security information is a type 4 information element with a length of 3 octets.

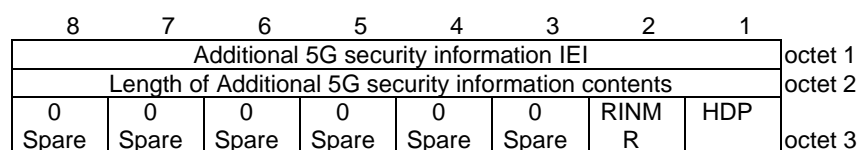

Figure 9.11.3.12.1: Additional 5G security information information element

Table 9.11.3.12.1: Additional 5G security information information element

Horizontal derivation parameter (HDP) (octet 3, bit 1) 0 K _{AMF} derivation is not required 1 K _{AMF} derivation is required	
Retransmission of initial NAS message request (octet 3, bit 2) 0 Retransmission of the initial NAS message not requested 1 Retransmission of the initial NAS message requested	
Bits 3 to 8 of octet 3 are spare and shall be coded as zero.	

9.11.3.12A Additional information requested

The purpose of the Additional information requested information element is to enable the UE to request ciphering keys for deciphering of ciphered broadcast assistance data.

The Additional information requested information element is coded as shown in figure 9.11.3.12A.1 and table 9.11.3.12A.1.

The Additional information requested is a type 4 information element with a length of 3 octets.

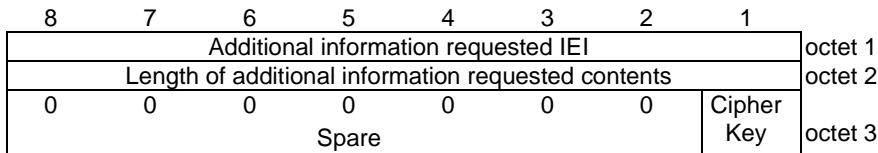

Figure 9.11.3.12A.1: Additional information requested information element

Table 9.11.3.12A.1: Additional information requested information element

Ciphering keys for ciphered broadcast assistance data (CipherKey) (octet 3, bit 1)	
Bit	
1	
0	ciphering keys for ciphered broadcast assistance data not requested
1	ciphering keys for ciphered broadcast assistance data requested
Bits 8 to 2 of octet 3 are spare and shall be coded as zero.	

9.11.3.13 Allowed PDU session status

The purpose of the Allowed PDU session status information element is to indicate to the network user-plane resources of PDU sessions associated with non-3GPP access that are allowed to be re-established over 3GPP access or if there is no PDU session(s) for which the UE allows the user-plane resources to be re-established over 3GPP access.

NOTE: Allowed PDU session status IE is not applicable for MA PDU session(s) in this release of specification.

The Allowed PDU session status information element is coded as shown in figure 9.11.3.13.1 and table 9.11.3.13.1.

The Allowed PDU session status is a type 4 information element with minimum length of 4 octets and maximum length of 34 octets.

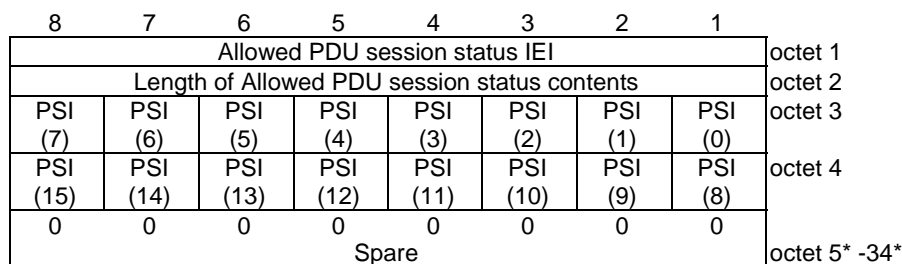

Figure 9.11.3.13.1: Allowed PDU session status information element

Table 9.11.3.13.1: Allowed PDU session status information element

<p>PSI(x) shall be coded as follows:</p> <p>PSI(0): Bit 1 octet 3 is spare and shall be coded as zero.</p> <p>PSI(1) – PSI(15): 0 indicates that the user-plane resources of corresponding PDU session is not allowed to be re-established over 3GPP access. 1 indicates that the user-plane resources of corresponding PDU session can be re-established over 3GPP access.</p> <p>If there is no PDU session for which the user-plane resources can be re-established over 3GPP access, all bits in PSI(1) – PSI(15) shall be coded as zero.</p> <p>All bits in octet 5 to 34 are spare and shall be coded as zero, if the respective octet is included in the information element.</p>
--

9.11.3.14 Authentication failure parameter

See subclause 10.5.3.2.2 in 3GPP TS 24.008 [12].

9.11.3.15 Authentication parameter AUTN

See subclause 10.5.3.1.1 in 3GPP TS 24.008 [12].

9.11.3.16 Authentication parameter RAND

See subclause 10.5.3.1 in 3GPP TS 24.008 [12].

9.11.3.17 Authentication response parameter

See subclause 9.9.3.4 in 3GPP TS 24.301 [15].

9.11.3.18 Configuration update indication

The purpose of the Configuration update indication information element is to indicate the additional information associated with the generic UE configuration update procedure.

The Configuration update indication information element is coded as shown in figure 9.11.3.18.1 and table 9.11.3.18.1.

The Configuration update indication is a type 1 information element.

8	7	6	5	4	3	2	1	
Configuration update indication IEI				0	0	RED	ACK	octet 1
				Spare	Spare			

Figure 9.11.3.18.1: Configuration update indication

Table 9.11.3.18.1: Configuration update indication

Acknowledgement (ACK) (octet 1, bit 1)	
Bit	
1	
0	acknowledgement not requested
1	acknowledgement requested
Registration requested (RED) (octet 1, bit 2)	
Bit	
2	
0	registration not requested
1	registration requested
Bits 3 and 4 are spare and shall be coded as zero,	

9.11.3.18A CAG information list

The purpose of the CAG information list information element is to provide "CAG information list" or to delete the "CAG information list" at the UE.

The CAG information list information element is coded as shown in figures 9.11.3.18A.1 and 9.11.3.18A.2 and table 9.11.3.18A.1.

The CAG information list is a type 6 information element, with a minimum length of 3 octets.

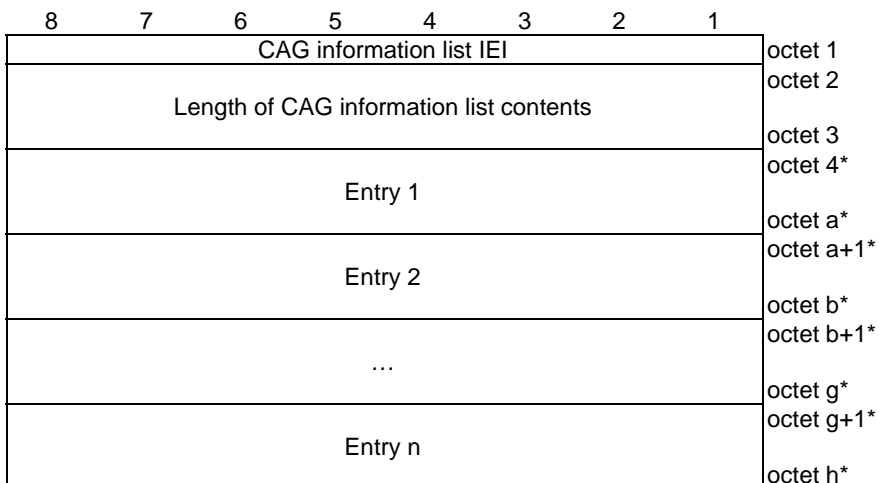

Figure 9.11.3.18A.1: CAG information list information element

8	7	6	5	4	3	2	1	
Length of entry contents								octet q
MCC digit 2				MCC digit 1				octet q+1
MNC digit 3				MNC digit 3				octet q+2
MNC digit 2				MNC digit 1				octet q+3
0	0	0	0	0	0	0	CAG	octet q+4
Spare	Spare	Spare	Spare	Spare	Spare	Spare	only	
CAG-ID 1								octet q+5*
CAG-ID 2								octet q+8*
...								octet q+9*
CAG-ID m								octet q+12*
CAG-ID m								octet q+13*
CAG-ID m								octet q+4m*
CAG-ID m								octet q+4m+1*
CAG-ID m								octet q+4m+4*

Figure 9.11.3.18A.2: Entry n

Table 9.11.3.18A.1: CAG information list information element

<p>MCC, Mobile country code (octet q+1 and bits 1 to 4 octet q+2) The MCC field is coded as in ITU-T Recommendation E.212 [42], annex A.</p> <p>MNC, Mobile network code (bits 5 to 8 of octet q+2 and octet q+3) The coding of this field is the responsibility of each administration, but BCD coding shall be used. The MNC shall consist of 2 or 3 digits. If a network operator decides to use only two digits in the MNC, bits 5 to 8 of octet q+2 shall be coded as "1111".</p> <p>The MCC and MNC digits are coded as octets 6 to 8 of the Temporary mobile group identity IE in figure 10.5.154 of 3GPP TS 24.008 [12].</p> <p>Indication that the UE is only allowed to access 5GS via CAG cells (CAGOnly) (bit 1 of octet q+4) Bit 1 0 "Indication that the UE is only allowed to access 5GS via CAG cells" is not set (i.e., the UE is allowed to access 5GS via non-CAG cells) 1 "Indication that the UE is only allowed to access 5GS via CAG cells" is set (i.e., the UE is not allowed to access 5GS via non-CAG cells)</p> <p>CAG-ID m (octet q+4m+1 to octet q+4m+4) This field contains the 32 bit CAG-ID. The coding of the CAG-ID is defined as the CAG-Identifier in 3GPP TS 23.003 [4].</p> <p>NOTE 1: The Length of CAG information list contents shall be 0 if no subscription data for CAG information list exists. NOTE 2: The Length of entry contents shall be 4 if there is no allowed CAG-ID for the PLMN. NOTE 3: Bit 2 in octet q+4 may be set to 1 in the USIM (see 3GPP TS 31.102 [22]). NOTE 4: For a given PLMN ID, there shall be up to one Entry containing the MCC value and the MNC value of the PLMN ID.</p>

9.11.3.18B CIoT small data container

This information element is used to encapsulate the CIoT user data, SMS, or location services message with a size that is not more than 254 octets between the UE and the AMF when the UE is using control plane CIoT 5GS optimization. The CIoT small data container information element is coded as shown in figure 9.11.3.18B.1, figure 9.11.3.18B.2, figure 9.11.3.18B.3, figure 9.11.3.18B.4 and table 9.11.3.18B.1.

The CIoT small data container is a type 4 information element with a minimum length of 4 octets and a maximum length of 257 octets.

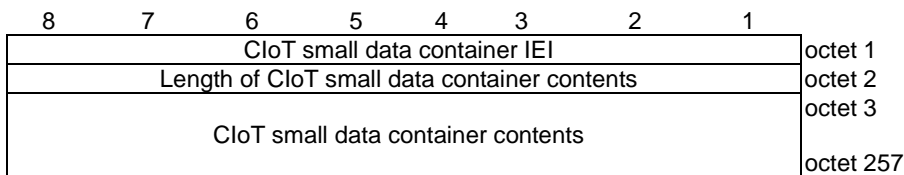

Figure 9.11.3.18B.1: CIoT small data container information element

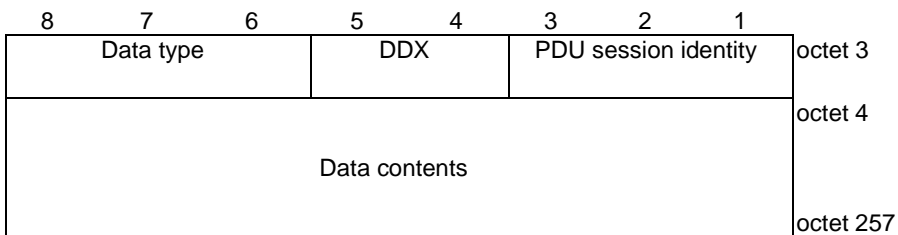

Figure 9.11.3.18B.2: CIoT small data container contents for Data type "Control plane user data"

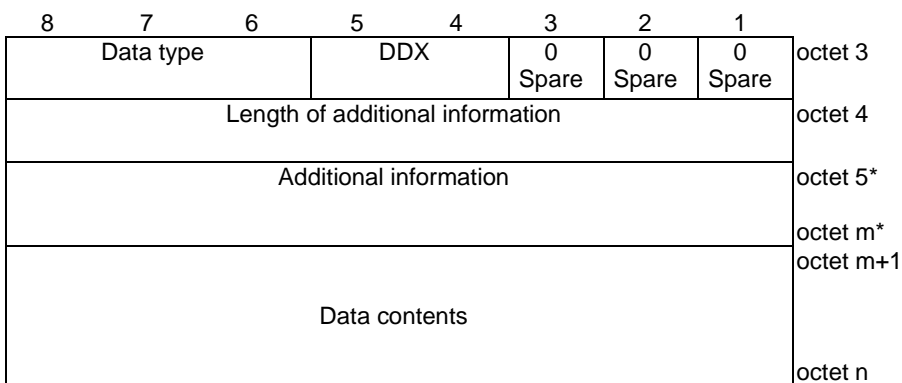

Figure 9.11.3.18B.3: CIoT small data container contents for Data type "Location services message container"

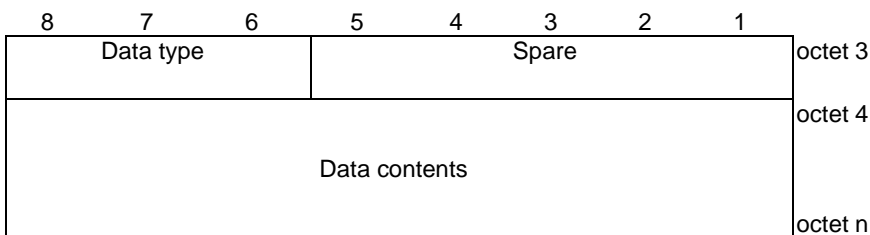

Figure 9.11.3.18B.4: CIoT small data container contents for Data type "SMS"

Table 9.11.3.18B.1: Clot small data container information element

CloT small data container contents (octet 3 to octet 257)

These octets include user data to be delivered between UE and AMF.

Data type (octet 3, bits 6 to 8)

Bits

8	7	6	
0	0	0	Control plane user data
0	0	1	SMS
0	1	0	Location services message container

All other values are spare. If received they shall be ignored.

When the Data type is "Control plane user data ", the PDU session identity and Downlink data expected (DDX) fields are encoded as follows:

PDU session identity (octet 3, bits 1 to 4)

Bit

3	2	1	
0	0	0	No PDU session identity assigned
0	0	1	PDU session identity value 1
0	1	0	PDU session identity value 2
0	1	1	PDU session identity value 3
1	0	0	PDU session identity value 4
1	0	1	PDU session identity value 5
1	1	0	PDU session identity value 6
1	1	1	PDU session identity value 7

Downlink data expected (DDX) (octet 3, bits 5 to 6)

Bits

5	4	
0	0	No information available
0	1	No further uplink and no further downlink data transmission subsequent to the uplink data transmission is expected
1	0	Only a single downlink data transmission and no further uplink data transmission subsequent to the uplink data transmission is expected
1	1	reserved

NOTE: The DDX field is only used in the UE to network direction.

Data contents (octet 4 to octet 257)

This field contains the control plane user data.

When the Data type is "SMS", Bits 1 to 5 of octet 3 are spare and shall be coded as zero.

Data contents (octet 4 to octet 257)

This field contains an SMS message.

When the Data type is "Location services message container":

Downlink data expected (DDX) (octet 3, bits 5 to 4)

This field is encoded as described above for the case when the Data type is "Control plane user data".

Bits 3 to 1 of octet 3 are spare and shall be encoded as zero.

Length of Additional information (octet 4) (see NOTE)

Indicates the length, in octets, of the Additional information field.

Additional information (octets 5 to m)

Contains additional information if provided by the upper layer location services application.

Data contents (octets m+1 to n)

Contains the location services message payload.

NOTE: The Length of Additional information shall be set to zero if the upper layer location service application does not provide routing information.

9.11.3.18C Cipherring key data

The purpose of the Cipherring key data information element is to transfer a list of cipherring data sets from the network to the UE for deciphering of cipherrered assistance data.

The Cipherring key data information element is coded as shown in figure 9.11.3.18C.1, figure 9.11.3.18C.2 and table 9.11.3.18C.1.

The Cipherring key data is a type 6 information element, with a minimum length of 34 octets and a maximum length of 2675 octets. The list can contain a maximum of 16 cipherring data sets.

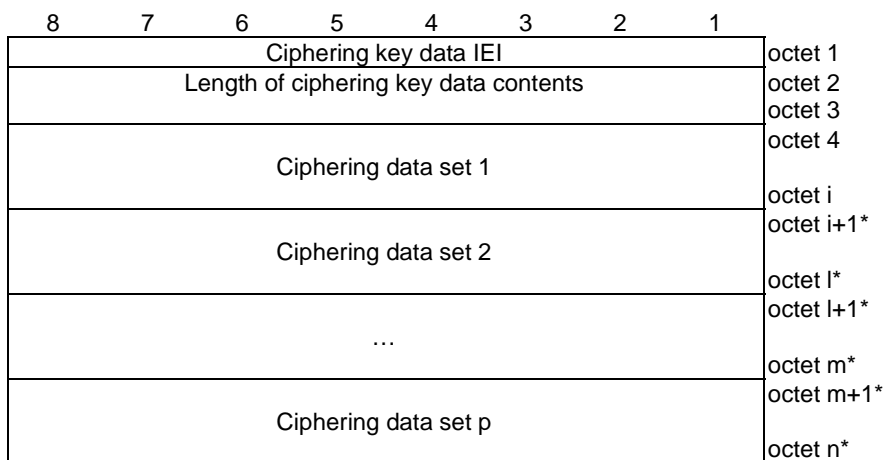

Figure 9.11.3.18C.1: Cipherring key data information element

8	7	6	5	4	3	2	1		
Ciphering set ID								octet 1	
Ciphering key								octet 2	
Ciphering key								octet 3	
Ciphering key								octet 18	
0 0 0 Spare			c0 length						octet 19
c0								octet 20	
c0								octet k	
0 0 0 0 Spare				E-UTRA posSIB length					octet k+1
PosSIB Type1- 1	PosSIB Type1- 2	PosSIB Type1- 3	PosSIB Type1- 4	PosSIB Type1- 5	PosSIB Type1- 6	PosSIB Type1- 7	PosSIB Type1- 8	octet (k+2)*	
PosSIB Type2- 1	PosSIB Type2- 2	PosSIB Type2- 3	PosSIB Type2- 4	PosSIB Type2- 5	PosSIB Type2- 6	PosSIB Type2- 7	PosSIB Type2- 8	octet (k+3)*	
PosSIB Type2- 9	PosSIB Type2- 10	PosSIB Type2- 11	PosSIB Type2- 12	PosSIB Type2- 13	PosSIB Type2- 14	PosSIB Type2- 15	PosSIB Type2- 16	octet (k+4)*	
PosSIB Type2- 17	PosSIB Type2- 18	PosSIB Type2- 19	PosSIB Type2- 20	PosSIB Type2- 21	PosSIB Type2- 22	PosSIB Type2- 23	PosSIB Type2- 24	octet (k+5)*	
PosSIB Type2- 25	PosSIB Type3- 1	PosSIB Type4- 1	PosSIB Type5- 1	PosSIB Type1- 9	PosSIB Type1- 10	PosSIB Type2- 17a	PosSIB Type2- 18a	octet (k+6)*	
PosSIB Type2- 20a	PosSIB Type2- 26	PosSIB Type2- 27	PosSIB Type1- 11	PosSIB Type1- 12	0 Spare	0 Spare	0 Spare	octet p*	
0 0 0 0 Spare				NR posSIB length					octet p+1
PosSIB Type1- 1	PosSIB Type1- 2	PosSIB Type1- 3	PosSIB Type1- 4	PosSIB Type1- 5	PosSIB Type1- 6	PosSIB Type1- 7	PosSIB Type1- 8	octet (p+2)*	
PosSIB Type2- 1	PosSIB Type2- 2	PosSIB Type2- 3	PosSIB Type2- 4	PosSIB Type2- 5	PosSIB Type2- 6	PosSIB Type2- 7	PosSIB Type2- 8	octet (p+3)*	
PosSIB Type2- 9	PosSIB Type2- 10	PosSIB Type2- 11	PosSIB Type2- 12	PosSIB Type2- 13	PosSIB Type2- 14	PosSIB Type2- 15	PosSIB Type2- 16	octet (p+4)*	
PosSIB Type2- 17	PosSIB Type2- 18	PosSIB Type2- 19	PosSIB Type2- 20	PosSIB Type2- 21	PosSIB Type2- 22	PosSIB Type2- 23	PosSIB Type3- 1	octet (p+5)*	
PosSIB Type4- 1	PosSIB Type5- 1	PosSIB Type6- 1	PosSIB Type6- 2	PosSIB Type6- 3	PosSIB Type6- 4	PosSIB Type6- 5	PosSIB Type6- 6	octet (p+6)*	
PosSIB Type1- 9	PosSIB Type1- 10	PosSIB Type2- 24	PosSIB Type2- 25	PosSIB Type2- 17a	PosSIB Type2- 18a	PosSIB Type2- 20a	PosSIB Type2- 26	octet (p+7)*	
PosSIB Type2- 27	PosSIB Type1- 11	PosSIB Type1- 12	PosSIB Type6- 7	PosSIB Type7- 1	PosSIB Type7- 2	PosSIB Type7- 3	PosSIB Type7- 4	octet q*	
Validity start time								octet q+1	
Validity duration								octet q+5	
Validity duration								octet q+6	
Validity duration								octet q+7	
TAIs list								octet q+8	
TAIs list								octet r	

Figure 9.11.3.18C.2: Ciphering data set

Table 9.11.3.18C.1: Ciphering key data information element

Value part of the Ciphering key data information element (octets 4 to n)

The value part of the Ciphering key data information element consists of one or several ciphering data sets.

The UE shall store the complete list received. If more than 16 ciphering data sets are included in this information element, the UE shall store the first 16 ciphering data sets and ignore the remaining octets of the information element.

Ciphering data set:

Ciphering set ID (octets 1 to 2)

This field contains the binary encoding of the ID identifying the ciphering set.

Ciphering key (octets 3 to octet 18)

This field contains the 128 bit ciphering key.

c0 length (octet 19, bits 5 to 1)

This field contains the binary encoding of the length, in octets, of the c0 counter. The maximum value for the length of the c0 counter is 16 octets.

Bits 8 to 6 of octet 19 are spare and shall be coded as zero.

c0 (octets 20 to k)

This field contains the binary encoding of the c0 counter.

E-UTRA posSIB length (octet k+1, bits 4 to 1)

This field contains the length in octets of the E -UTRA Positioning SIB types. A length of zero means E -UTRA Positioning SIB types are not included (see NOTE).

E-UTRA Positioning SIB types for which the ciphering data set is applicable (octets k+2 to p). Unassigned bits shall be ignored by a UE. Non-included bits shall be assumed to be zero by a UE.

Ciphering data set applicable for positioning SIB type 1-1 (octet k+2, bit 8)

0	Ciphering data set not applicable to positioning SIB type 1-1
1	Ciphering data set applicable to positioning SIB type 1-1

Ciphering data set applicable for positioning SIB type 1-2 (octet k+2, bit 7)

0	Ciphering data set not applicable to positioning SIB type 1-2
1	Ciphering data set applicable to positioning SIB type 1-2

Ciphering data set applicable for positioning SIB type 1-3 (octet k+2, bit 6)

0	Ciphering data set not applicable to positioning SIB type 1-3
1	Ciphering data set applicable to positioning SIB type 1-3

Ciphering data set applicable for positioning SIB type 1-4 (octet k+2, bit 5)

0	Ciphering data set not applicable to positioning SIB type 1-4
1	Ciphering data set applicable to positioning SIB type 1-4

Ciphering data set applicable for positioning SIB type 1-5 (octet k+2, bit 4)

0	Ciphering data set not applicable to positioning SIB type 1-5
1	Ciphering data set applicable to positioning SIB type 1-5

Ciphering data set applicable for positioning SIB type 1-6 (octet k+2, bit 3)

0	Ciphering data set not applicable to positioning SIB type 1-6
1	Ciphering data set applicable to positioning SIB type 1-6

Ciphering data set applicable for positioning SIB type 1-7 (octet k+2, bit 2)

0	Ciphering data set not applicable to positioning SIB type 1-7
1	Ciphering data set applicable to positioning SIB type 1-7

Ciphering data set applicable for positioning SIB type 1-8 (octet k+2, bit 1)
0 Ciphering data set not applicable to positioning SIB type 1-8
1 Ciphering data set applicable to positioning SIB type 1-8
Ciphering data set applicable for positioning SIB type 2-1 (octet k+3, bit 8)
0 Ciphering data set not applicable to positioning SIB type 2-1
1 Ciphering data set applicable to positioning SIB type 2-1
Ciphering data set applicable for positioning SIB type 2-2 (octet k+3, bit 7)
0 Ciphering data set not applicable to positioning SIB type 2-2
1 Ciphering data set applicable to positioning SIB type 2-2
Ciphering data set applicable for positioning SIB type 2-3 (octet k+3, bit 6)
0 Ciphering data set not applicable to positioning SIB type 2-3
1 Ciphering data set applicable to positioning SIB type 2-3
Ciphering data set applicable for positioning SIB type 2-4 (octet k+3, bit 5)
0 Ciphering data set not applicable to positioning SIB type 2-4
1 Ciphering data set applicable to positioning SIB type 2-4
Ciphering data set applicable for positioning SIB type 2-5 (octet k+3, bit 4)
0 Ciphering data set not applicable to positioning SIB type 2-5
1 Ciphering data set applicable to positioning SIB type 2-5
Ciphering data set applicable for positioning SIB type 2-6 (octet k+3, bit 3)
0 Ciphering data set not applicable to positioning SIB type 2-6
1 Ciphering data set applicable to positioning SIB type 2-6
Ciphering data set applicable for positioning SIB type 2-7 (octet k+3, bit 2)
0 Ciphering data set not applicable to positioning SIB type 2-7
1 Ciphering data set applicable to positioning SIB type 2-7
Ciphering data set applicable for positioning SIB type 2-8 (octet k+3, bit 1)
0 Ciphering data set not applicable to positioning SIB type 2-8
1 Ciphering data set applicable to positioning SIB type 2-8
Ciphering data set applicable for positioning SIB type 2-9 (octet k+4, bit 8)
0 Ciphering data set not applicable to positioning SIB type 2-9
1 Ciphering data set applicable to positioning SIB type 2-9
Ciphering data set applicable for positioning SIB type 2-10 (octet k+4, bit 7)
0 Ciphering data set not applicable to positioning SIB type 2-10
1 Ciphering data set applicable to positioning SIB type 2-10
Ciphering data set applicable for positioning SIB type 2-11 (octet k+4, bit 6)
0 Ciphering data set not applicable to positioning SIB type 2-11
1 Ciphering data set applicable to positioning SIB type 2-11
Ciphering data set applicable for positioning SIB type 2-12 (octet k+4, bit 5)
0 Ciphering data set not applicable to positioning SIB type 2-12
1 Ciphering data set applicable to positioning SIB type 2-12
Ciphering data set applicable for positioning SIB type 2-13 (octet k+4, bit 4)
0 Ciphering data set not applicable to positioning SIB type 2-13
1 Ciphering data set applicable to positioning SIB type 2-13
Ciphering data set applicable for positioning SIB type 2-14 (octet k+4, bit 3)
0 Ciphering data set not applicable to positioning SIB type 2-14
1 Ciphering data set applicable to positioning SIB type 2-14
Ciphering data set applicable for positioning SIB type 2-15 (octet k+4, bit 2)
0 Ciphering data set not applicable to positioning SIB type 2-15
1 Ciphering data set applicable to positioning SIB type 2-15
Ciphering data set applicable for positioning SIB type 2-16 (octet k+4, bit 1)
0 Ciphering data set not applicable to positioning SIB type 2-16

1	Ciphering data set applicable to positioning SIB type 2-16
Ciphering data set applicable for positioning SIB type 2-17 (octet k+5, bit 8)	
0	Ciphering data set not applicable to positioning SIB type 2-17
1	Ciphering data set applicable to positioning SIB type 2-17
Ciphering data set applicable for positioning SIB type 2-18 (octet k+5, bit 7)	
0	Ciphering data set not applicable to positioning SIB type 2-18
1	Ciphering data set applicable to positioning SIB type 2-18
Ciphering data set applicable for positioning SIB type 2-19 (octet k+5, bit 6)	
0	Ciphering data set not applicable to positioning SIB type 2-19
1	Ciphering data set applicable to positioning SIB type 2-19
Ciphering data set applicable for positioning SIB type 2-20 (octet k+5, bit 5)	
0	Ciphering data set not applicable to positioning SIB type 2-20
1	Ciphering data set applicable to positioning SIB type 2-20
Ciphering data set applicable for positioning SIB type 2-21 (octet k+5, bit 4)	
0	Ciphering data set not applicable to positioning SIB type 2-21
1	Ciphering data set applicable to positioning SIB type 2-21
Ciphering data set applicable for positioning SIB type 2-22 (octet k+5, bit 3)	
0	Ciphering data set not applicable to positioning SIB type 2-22
1	Ciphering data set applicable to positioning SIB type 2-22
Ciphering data set applicable for positioning SIB type 2-23 (octet k+5, bit 2)	
0	Ciphering data set not applicable to positioning SIB type 2-23
1	Ciphering data set applicable to positioning SIB type 2-23
Ciphering data set applicable for positioning SIB type 2-24 (octet k+5, bit 1)	
0	Ciphering data set not applicable to positioning SIB type 2-24
1	Ciphering data set applicable to positioning SIB type 2-24
Ciphering data set applicable for positioning SIB type 2-25 (octet k+6, bit 8)	
0	Ciphering data set not applicable to positioning SIB type 2-25
1	Ciphering data set applicable to positioning SIB type 2-25
Ciphering data set applicable for positioning SIB type 3-1 (octet k+6, bit 7)	
0	Ciphering data set not applicable to positioning SIB type 3-1
1	Ciphering data set applicable to positioning SIB type 3-1
Ciphering data set applicable for positioning SIB type 4-1 (octet k+6, bit 6)	
0	Ciphering data set not applicable to positioning SIB type 4-1
1	Ciphering data set applicable to positioning SIB type 4-1
Ciphering data set applicable for positioning SIB type 5-1 (octet k+6, bit 5)	
0	Ciphering data set not applicable to positioning SIB type 5-1
1	Ciphering data set applicable to positioning SIB type 5-1
Ciphering data set applicable for positioning SIB type 1-9 (octet k+6, bit 4)	
0	Ciphering data set not applicable to positioning SIB type 1-9
1	Ciphering data set applicable to positioning SIB type 1-9
Ciphering data set applicable for positioning SIB type 1-10 (octet k+6, bit 3)>	
0	Ciphering data set not applicable to positioning SIB type 1-10
1	Ciphering data set applicable to positioning SIB type 1-10
Ciphering data set applicable for positioning SIB type 2-17a (octet k+6, bit 2)	
0	Ciphering data set not applicable to positioning SIB type 2-17a
1	Ciphering data set applicable to positioning SIB type 2-17a
Ciphering data set applicable for positioning SIB type 2-18a (octet k+6, bit 1)	
0	Ciphering data set not applicable to positioning SIB type 2-18a
1	Ciphering data set applicable to positioning SIB type 2-18a
Ciphering data set applicable for positioning SIB type 2-20a (octet k+7, bit 8)	
0	Ciphering data set not applicable to positioning SIB type 2-20a

1	Ciphering data set applicable to positioning SIB type 2-20a
Ciphering data set applicable for positioning SIB type 2-26 (octet k+7, bit 7)	
0	Ciphering data set not applicable to positioning SIB type 2-26
1	Ciphering data set applicable to positioning SIB type 2-26
Ciphering data set applicable for positioning SIB type 2-27 (octet k+7, bit 6)	
0	Ciphering data set not applicable to positioning SIB type 2-27
1	Ciphering data set applicable to positioning SIB type 2-27
Ciphering data set applicable for positioning SIB type 1-11 (octet k+7, bit 5)	
0	Ciphering data set not applicable to positioning SIB type 1-11
1	Ciphering data set applicable to positioning SIB type 1-11
Ciphering data set applicable for positioning SIB type 1-12 (octet k+7, bit 4)	
0	Ciphering data set not applicable to positioning SIB type 1-12
1	Ciphering data set applicable to positioning SIB type 1-12
Any unassigned bits shall be coded as zero.	
NR posSIB length (octet p+1, bits 4 to 1)	
This field contains the length in octets of the NR Positioning SIB types. A length of zero means NR Positioning SIB types are not included (see NOTE).	
NR Positioning SIB types for which the ciphering data set is applicable (octets p+2 to q).	
Unassigned bits shall be ignored. Non-included bits shall be assumed to be zero.	
Ciphering data set applicable for positioning SIB type 1-1 (octet p+2, bit 8)	
0	Ciphering data set not applicable to positioning SIB type 1-1
1	Ciphering data set applicable to positioning SIB type 1-1
Ciphering data set applicable for positioning SIB type 1-2 (octet p+2, bit 7)	
0	Ciphering data set not applicable to positioning SIB type 1-2
1	Ciphering data set applicable to positioning SIB type 1-2
Ciphering data set applicable for positioning SIB type 1-3 (octet p+2, bit 6)	
0	Ciphering data set not applicable to positioning SIB type 1-3
1	Ciphering data set applicable to positioning SIB type 1-3
Ciphering data set applicable for positioning SIB type 1-4 (octet p+2, bit 5)	
0	Ciphering data set not applicable to positioning SIB type 1-4
1	Ciphering data set applicable to positioning SIB type 1-4
Ciphering data set applicable for positioning SIB type 1-5 (octet p+2, bit 4)	
0	Ciphering data set not applicable to positioning SIB type 1-5
1	Ciphering data set applicable to positioning SIB type 1-5
Ciphering data set applicable for positioning SIB type 1-6 (octet p+2, bit 3)	
0	Ciphering data set not applicable to positioning SIB type 1-6
1	Ciphering data set applicable to positioning SIB type 1-6
Ciphering data set applicable for positioning SIB type 1-7 (octet p+2, bit 2)	
0	Ciphering data set not applicable to positioning SIB type 1-7
1	Ciphering data set applicable to positioning SIB type 1-7
Ciphering data set applicable for positioning SIB type 1-8 (octet p+2, bit 1)	
0	Ciphering data set not applicable to positioning SIB type 1-8
1	Ciphering data set applicable to positioning SIB type 1-8
Ciphering data set applicable for positioning SIB type 2-1 (octet p+3, bit 8)	
0	Ciphering data set not applicable to positioning SIB type 2-1
1	Ciphering data set applicable to positioning SIB type 2-1
Ciphering data set applicable for positioning SIB type 2-2 (octet p+3, bit 7)	
0	Ciphering data set not applicable to positioning SIB type 2-2
1	Ciphering data set applicable to positioning SIB type 2-2

Ciphering data set applicable for positioning SIB type 2-3 (octet p+3, bit 6)	
0	Ciphering data set not applicable to positioning SIB type 2-3
1	Ciphering data set applicable to positioning SIB type 2-3
Ciphering data set applicable for positioning SIB type 2-4 (octet p+3, bit 5)	
0	Ciphering data set not applicable to positioning SIB type 2-4
1	Ciphering data set applicable to positioning SIB type 2-4
Ciphering data set applicable for positioning SIB type 2-5 (octet p+3, bit 4)	
0	Ciphering data set not applicable to positioning SIB type 2-5
1	Ciphering data set applicable to positioning SIB type 2-5
Ciphering data set applicable for positioning SIB type 2-6 (octet p+3, bit 3)	
0	Ciphering data set not applicable to positioning SIB type 2-6
1	Ciphering data set applicable to positioning SIB type 2-6
Ciphering data set applicable for positioning SIB type 2-7 (octet p+3, bit 2)	
0	Ciphering data set not applicable to positioning SIB type 2-7
1	Ciphering data set applicable to positioning SIB type 2-7
Ciphering data set applicable for positioning SIB type 2-8 (octet p+3, bit 1)	
0	Ciphering data set not applicable to positioning SIB type 2-8
1	Ciphering data set applicable to positioning SIB type 2-8
Ciphering data set applicable for positioning SIB type 2-9 (octet p+4, bit 8)	
0	Ciphering data set not applicable to positioning SIB type 2-9
1	Ciphering data set applicable to positioning SIB type 2-9
Ciphering data set applicable for positioning SIB type 2-10 (octet p+4, bit 7)	
0	Ciphering data set not applicable to positioning SIB type 2-10
1	Ciphering data set applicable to positioning SIB type 2-10
Ciphering data set applicable for positioning SIB type 2-11 (octet p+4, bit 6)	
0	Ciphering data set not applicable to positioning SIB type 2-11
1	Ciphering data set applicable to positioning SIB type 2-11
Ciphering data set applicable for positioning SIB type 2-12 (octet p+4, bit 5)	
0	Ciphering data set not applicable to positioning SIB type 2-12
1	Ciphering data set applicable to positioning SIB type 2-12
Ciphering data set applicable for positioning SIB type 2-13 (octet p+4, bit 4)	
0	Ciphering data set not applicable to positioning SIB type 2-13
1	Ciphering data set applicable to positioning SIB type 2-13
Ciphering data set applicable for positioning SIB type 2-14 (octet p+4, bit 3)	
0	Ciphering data set not applicable to positioning SIB type 2-14
1	Ciphering data set applicable to positioning SIB type 2-14
Ciphering data set applicable for positioning SIB type 2-15 (octet p+4, bit 2)	
0	Ciphering data set not applicable to positioning SIB type 2-15
1	Ciphering data set applicable to positioning SIB type 2-15
Ciphering data set applicable for positioning SIB type 2-16 (octet p+4, bit 1)	
0	Ciphering data set not applicable to positioning SIB type 2-16
1	Ciphering data set applicable to positioning SIB type 2-16
Ciphering data set applicable for positioning SIB type 2-17 (octet p+5, bit 8)	
0	Ciphering data set not applicable to positioning SIB type 2-17
1	Ciphering data set applicable to positioning SIB type 2-17
Ciphering data set applicable for positioning SIB type 2-18 (octet p+5, bit 7)	
0	Ciphering data set not applicable to positioning SIB type 2-18
1	Ciphering data set applicable to positioning SIB type 2-18
Ciphering data set applicable for positioning SIB type 2-19 (octet p+5, bit 6)	
0	Ciphering data set not applicable to positioning SIB type 2-19
1	Ciphering data set applicable to positioning SIB type 2-19

Cipherring data set applicable for positioning SIB type 2-20 (octet p+5, bit 5)	
0	Cipherring data set not applicable to positioning SIB type 2-20
1	Cipherring data set applicable to positioning SIB type 2-20
Cipherring data set applicable for positioning SIB type 2-21 (octet p+5, bit 4)	
0	Cipherring data set not applicable to positioning SIB type 2-21
1	Cipherring data set applicable to positioning SIB type 2-21
Cipherring data set applicable for positioning SIB type 2-22 (octet p+5, bit 3)	
0	Cipherring data set not applicable to positioning SIB type 2-22
1	Cipherring data set applicable to positioning SIB type 2-22
Cipherring data set applicable for positioning SIB type 2-23 (octet p+5, bit 2)	
0	Cipherring data set not applicable to positioning SIB type 2-23
1	Cipherring data set applicable to positioning SIB type 2-23
Cipherring data set applicable for positioning SIB type 3-1 (octet p+5, bit 1)	
0	Cipherring data set not applicable to positioning SIB type 3-1
1	Cipherring data set applicable to positioning SIB type 3-1
Cipherring data set applicable for positioning SIB type 4-1 (octet p+6, bit 8)	
0	Cipherring data set not applicable to positioning SIB type 4-1
1	Cipherring data set applicable to positioning SIB type 4-1
Cipherring data set applicable for positioning SIB type 5-1 (octet p+6, bit 7)	
0	Cipherring data set not applicable to positioning SIB type 5-1
1	Cipherring data set applicable to positioning SIB type 5-1
Cipherring data set applicable for positioning SIB type 6-1 (octet p+6, bit 6)	
0	Cipherring data set not applicable to positioning SIB type 6-1
1	Cipherring data set applicable to positioning SIB type 6-1
Cipherring data set applicable for positioning SIB type 6-2 (octet p+6, bit 5)	
0	Cipherring data set not applicable to positioning SIB type 6-2
1	Cipherring data set applicable to positioning SIB type 6-2
Cipherring data set applicable for positioning SIB type 6-3 (octet p+6, bit 4)	
0	Cipherring data set not applicable to positioning SIB type 6-3
1	Cipherring data set applicable to positioning SIB type 6-3
Cipherring data set applicable for positioning SIB type 6-4 (octet p+6, bit 3)	
0	Cipherring data set not applicable to positioning SIB type 6-4
1	Cipherring data set applicable to positioning SIB type 6-4
Cipherring data set applicable for positioning SIB type 6-5 (octet p+6, bit 2)	
0	Cipherring data set not applicable to positioning SIB type 6-5
1	Cipherring data set applicable to positioning SIB type 6-5
Cipherring data set applicable for positioning SIB type 6-6 (octet p+6, bit 1)	
0	Cipherring data set not applicable to positioning SIB type 6-6
1	Cipherring data set applicable to positioning SIB type 6-6
Cipherring data set applicable for positioning SIB type 1-9 (octet p+7, bit 8)	
0	Cipherring data set not applicable to positioning SIB type 1-9
1	Cipherring data set applicable to positioning SIB type 1-9
Cipherring data set applicable for positioning SIB type 1-10 (octet p+7, bit 7)	
0	Cipherring data set not applicable to positioning SIB type 1-10
1	Cipherring data set applicable to positioning SIB type 1-10
Cipherring data set applicable for positioning SIB type 2-24 (octet p+7, bit 6)	
0	Cipherring data set not applicable to positioning SIB type 2-24
1	Cipherring data set applicable to positioning SIB type 2-24
Cipherring data set applicable for positioning SIB type 2-25 (octet p+7, bit 5)	
0	Cipherring data set not applicable to positioning SIB type 2-25
1	Cipherring data set applicable to positioning SIB type 2-25

Ciphering data set applicable for positioning SIB type 2-17a (octet p+7, bit 4)
 0 Ciphering data set not applicable to positioning SIB type 2-17a
 1 Ciphering data set applicable to positioning SIB type 2-17a

Ciphering data set applicable for positioning SIB type 2-18a (octet p+7, bit 3)
 0 Ciphering data set not applicable to positioning SIB type 2-18a
 1 Ciphering data set applicable to positioning SIB type 2-18a

Ciphering data set applicable for positioning SIB type 2-20a (octet p+7, bit 2)
 0 Ciphering data set not applicable to positioning SIB type 2-20a
 1 Ciphering data set applicable to positioning SIB type 2-20a

Ciphering data set applicable for positioning SIB type 2-26 (octet p+7, bit 1)
 0 Ciphering data set not applicable to positioning SIB type 2-26
 1 Ciphering data set applicable to positioning SIB type 2-26

Ciphering data set applicable for positioning SIB type 2-27 (octet p+8, bit 8)
 0 Ciphering data set not applicable to positioning SIB type 2-27
 1 Ciphering data set applicable to positioning SIB type 2-27

Ciphering data set applicable for positioning SIB type 1-11 (octet p+8, bit 7)
 0 Ciphering data set not applicable to positioning SIB type 1-11
 1 Ciphering data set applicable to positioning SIB type 1-11

Ciphering data set applicable for positioning SIB type 1-12 (octet p+8, bit 6)
 0 Ciphering data set not applicable to positioning SIB type 1-12
 1 Ciphering data set applicable to positioning SIB type 1-12

Ciphering data set applicable for positioning SIB type 6-7 (octet p+8, bit 5)
 0 Ciphering data set not applicable to positioning SIB type 6-7
 1 Ciphering data set applicable to positioning SIB type 6-7

Ciphering data set applicable for positioning SIB type 7-1 (octet p+8, bit 4)
 0 Ciphering data set not applicable to positioning SIB type 7-1
 1 Ciphering data set applicable to positioning SIB type 7-1

Ciphering data set applicable for positioning SIB type 7-2 (octet p+8, bit 3)
 0 Ciphering data set not applicable to positioning SIB type 7-2
 1 Ciphering data set applicable to positioning SIB type 7-2

Ciphering data set applicable for positioning SIB type 7-3 (octet p+8, bit 2)
 0 Ciphering data set not applicable to positioning SIB type 7-3
 1 Ciphering data set applicable to positioning SIB type 7-3

Ciphering data set applicable for positioning SIB type 7-4 (octet p+8, bit 1)
 0 Ciphering data set not applicable to positioning SIB type 7-4
 1 Ciphering data set applicable to positioning SIB type 7-4

Any unassigned bits shall be coded as zero.

Validity start time (octets q+1 to q+5)

This field contains the UTC time when the ciphering data set becomes valid, encoded as octets 2 to 6 of the Time zone and time IE specified in 3GPP TS 24.008 [12].

Validity duration (octets q+6 to q+7)

This field contains the duration for which the ciphering data set is valid after the validity start time, in units of minutes.

TAs list (octets q+8 to r)

This field contains the list of tracking areas for which the ciphering data set is applicable, encoded as octets 2 to n of the Tracking area identity list IE as specified in subclause 9.11.3.9. If the TAs list is empty (as indicated by a zero length), the ciphering data set is applicable to the entire serving PLMN.

NOTE: The ciphering data set is always applicable to at least one of the E -UTRA Positioning SIB types or the NR Positioning SIB types.

9.11.3.18D Control plane service type

The purpose of the Control plane service type information element is to specify the purpose of the CONTROL PLANE SERVICE REQUEST message.

The Control plane service type information element is coded as shown in figure 9.11.3.18D.1 and table 9.11.3.18D.1.

The Control plane service type is a type 1 information element.

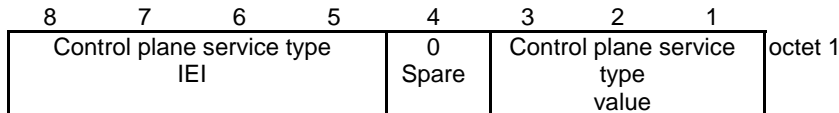

Figure 9.9.3.18D.1: Control plane service type information element

Table 9.9.3.18D.1: Control plane service type information element

Control plane service type value (octet 1, bit 1 to 3)			
Bits			
3	2	1	
0	0	0	mobile originating request
0	0	1	mobile terminating request
0	1	0	emergency services
0	1	1	emergency services fallback
1	0	0	
			to unused; shall be interpreted as "mobile originating request", if received by the network.
1	1	1	

9.11.3.19 Daylight saving time

See subclause 10.5.3.12 in 3GPP TS 24.008 [12].

9.11.3.20 De-registration type

The purpose of the De-registration type information element is to indicate the type of de-registration.

The De-registration type information element is coded as shown in figure 9.11.3.20.1 and table 9.11.3.20.1.

The De-registration type is a type 1 information element.

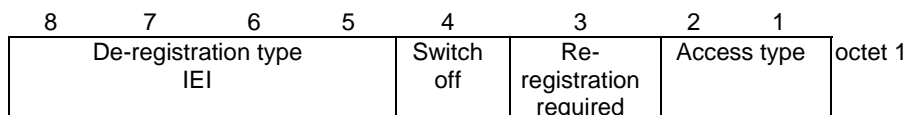

Figure 9.11.3.20.1: Deregistration type information element

Table 9.11.3.20.1: Deregistration type information element

Switch off (octet 1, bit 4)	
In the UE to network direction:	
Bit	
4	
0	Normal de-registration
1	Switch off
In the network to UE direction bit 4 is spare. The network shall set this bit to zero.	
Re-registration required (octet 1, bit 3)	
In the network to UE direction:	
Bit	
3	
0	re-registration not required
1	re-registration required
In the UE to network direction bit 3 is spare. The UE shall set this bit to zero.	
Access type (octet 1, bit 2, bit 1)	
Bit	
2 1	
0 1	3GPP access
1 0	Non-3GPP access
1 1	3GPP access and non-3GPP access
All other values are reserved.	

9.11.3.21 Void

9.11.3.22 Void

9.11.3.23 Emergency number list

See subclause 10.5.3.13 in 3GPP TS 24.008 [12].

9.11.3.23A EPS bearer context status

See subclause 9.9.2.1 in 3GPP TS 24.301 [15].

9.11.3.24 EPS NAS message container

The purpose of the EPS NAS message container information element is to transport an EPS NAS message as specified in 3GPP TS 24.301 [15].

The EPS NAS message container information element is coded as shown in figure 9.11.3.24.1 and table 9.11.3.24.1.

The EPS NAS message container is a type 6 information element.

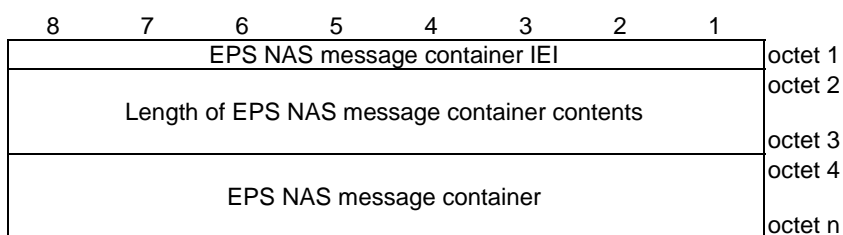

Figure 9.11.3.24.1: EPS NAS message container information element

Table 9.11.3.24.1: EPS NAS message container information element

EPS NAS message container (octet 4 to n) An EPS NAS message as specified in 3GPP TS 24.301 [15].

9.11.3.25 EPS NAS security algorithms

See subclause 9.9.3.23 in 3GPP TS 24.301 [15].

9.11.3.26 Extended emergency number list

See subclause 9.9.3.37A in 3GPP TS 24.301 [15].

9.11.3.26A Extended DRX parameters

See subclause 10.5.5.32 in 3GPP TS 24.008 [12].

9.11.3.27 Void

9.11.3.28 IMEISV request

See subclause 10.5.5.10 in 3GPP TS 24.008 [12].

9.11.3.29 LADN indication

The purpose of the LADN indication information element is to request the network for LADN information for specific LADN DNN(s) or to indicate a request for LADN information.

The LADN indication information element is coded as shown in figure 9.11.3.29.1 and table 9.11.3.29.1.

The LADN indication is a type 6 information element with a minimum length of 3 octets and a maximum length of 811 octets.

The LADN indication information element can contain a minimum of 0 and a maximum of 8 different LADN DNN values.

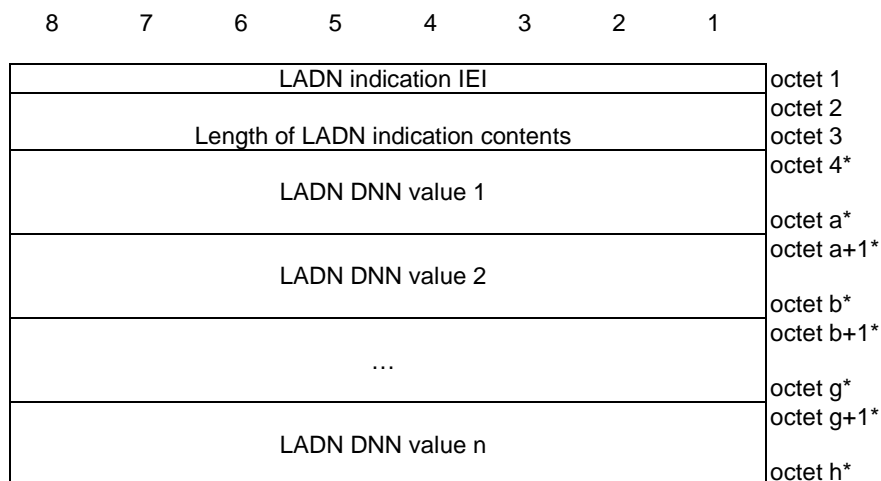

Figure 9.11.3.29.1: LADN indication information element

Table 9.11.3.29.1: LADN indication information element

Value part of the LADN indication information element (octet 4 to h):
The value part of the LADN indication information element consists of zero or more LADN DNN values. If the LADN indication information element conveys more than 8 LADN DNN values in this information element, the network shall consider the first 8 LADN DNN values and ignore the remaining octets of the information element.
LADN DNN value:
LADN DNN value is coded as the length and value part of DNN information element as specified in subclause 9.11.2.1B starting with the second octet.

9.11.3.30 LADN information

The purpose of the LADN information information element is to provide the UE with the LADN service area for each available LADN in the current registration area or to delete the LADN information at the UE.

The LADN information information element is coded as shown in figure 9.11.3.30.1, figure 9.11.3.30.2 and table 9.11.3.30.1.

The LADN information is a type 6 information element with a minimum length of 3 octets and a maximum length of 1715 octets.

The LADN information information element can contain a minimum of 0 and a maximum of 8 different LADNs each including a DNN and a 5GS tracking area identity list.

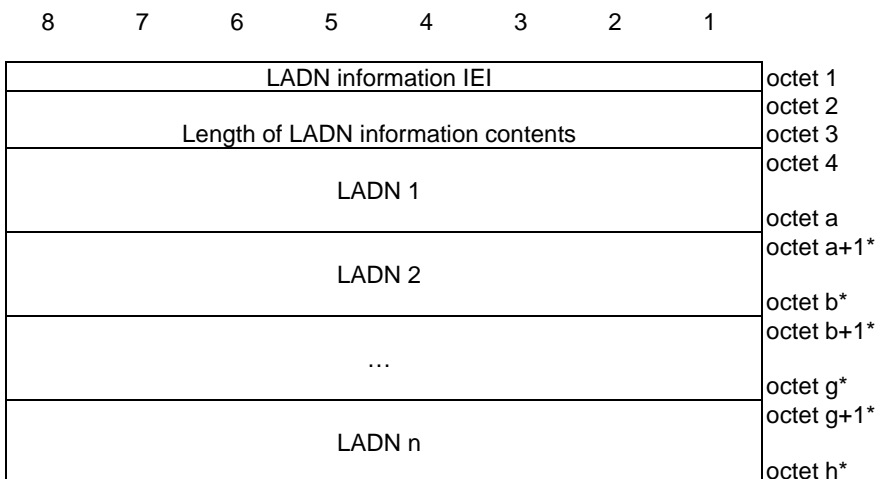

Figure 9.11.3.30.1: LADN information information element

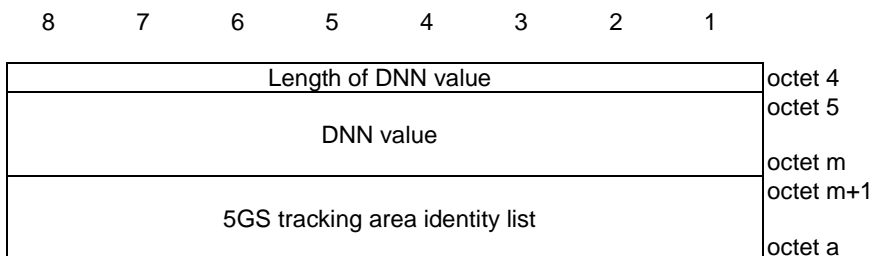

Figure 9.11.3.30.2: LADN

Table 9.11.3.30.1: LADN information information element

<p>Value part of the LADN information information element (octet 4 to octet h) The value part of the LADN information information element consists of one or several LADNs. Each LADN (e.g. octet 4 to octet a) consists one DNN value and one 5GS tracking area identity list. The length of each LADN is determined by the length of DNN value field and the length of 5GS tracking area identity list field. The UE shall store the complete list as received. If more than 8 LADNs are included in this information element, the UE shall store the first 8 LADNs and ignore the remaining octets of the information element.</p> <p>DNN value (octet 5 to octet m):</p> <p>DNN value field is coded as DNN value part of DNN information element as specified in subclause 9.11.2.1B starting with the third octet.</p> <p>5GS tracking area identity list (octet m+1 to octet a):</p> <p>5GS tracking area identity list field is coded as the length and the value part of the 5GS Tracking area identity list information element as specified in subclause 9.11.3.9 starting with the second octet.</p>
--

9.11.3.31 MICO indication

The purpose of the MICO indication information element is to indicate the use of MICO mode or the re-negotiation of MICO mode.

The MICO indication information element is coded as shown in figure 9.11.3.31.1 and table 9.11.3.31.1.

The MICO indication is a type 1 information element.

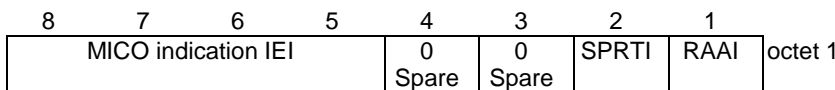

Figure 9.11.3.31.1: MICO indication

Table 9.11.3.31.1: MICO indication

<p>Registration Area Allocation Indication (RAAI) (octet 1, bit 1)</p> <p>In the network to UE direction: Bit 1 0 all PLMN registration area not allocated 1 all PLMN registration area allocated</p> <p>In the UE to network direction bit 1 is spare. The UE shall set this bit to zero.</p> <p>Strictly Periodic Registration Timer Indication (SPRTI) (octet 1, bit 2)</p> <p>In the network to UE and the UE to network direction: Bit 2 0 strictly periodic registration timer not supported 1 strictly periodic registration timer supported</p> <p>Bits 3 and 4 are spare and shall be coded as zero.</p> <p>NOTE: In the network to UE direction in the CONFIGURATION UPDATE COMMAND message, bits 1 and 2 shall be coded as zero.</p>

9.11.3.31A MA PDU session information

The purpose of the MA PDU session information information element is to convey the MA-related information for the PDU session.

The MA PDU session information information element is coded as shown in figure 9.11.3.31A.1 and table 9.11.3.31A.1.

The MA PDU session information is a type 1 information element.

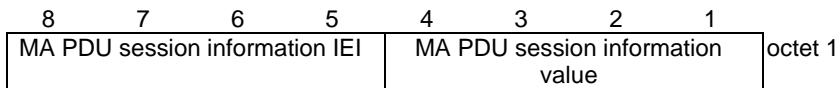

Figure 9.11.3.31A.1: MA PDU session information information element

Table 9.11.3.31A.1: MA PDU session information information element

MA PDU session information value (octet 1, bit 1 to bit 4)	
Bits	
4 3 2 1	
0 0 0 0	No additional information
0 0 0 1	MA PDU session network upgrade is allowed
All other values are spare. If received they shall be ignored.	

9.11.3.31B Mapped NSSAI

The purpose of the Mapped NSSAI information element is to transfer S-NSSAI(s) applicable in the HPLMN to the visited PLMN.

The Mapped NSSAI information element is coded as shown in figure 9.11.3.31B.1, figure 9.11.3.31B.2 and table 9.11.3.31B.1.

The Mapped NSSAI is a type 4 information element with a minimum length of 4 octets and a maximum length of 42 octets.

NOTE 1: The total number of S-NSSAI values in a requested mapped NSSAI cannot exceed eight.

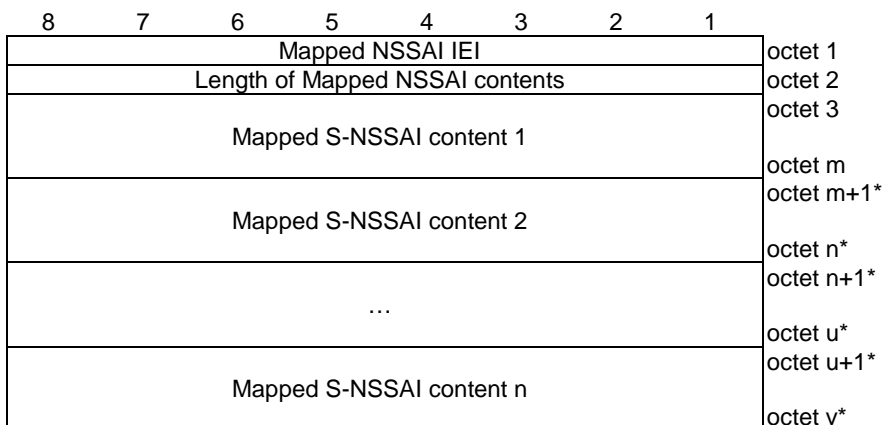

Figure 9.11.3.31B.1: Mapped NSSAI information element

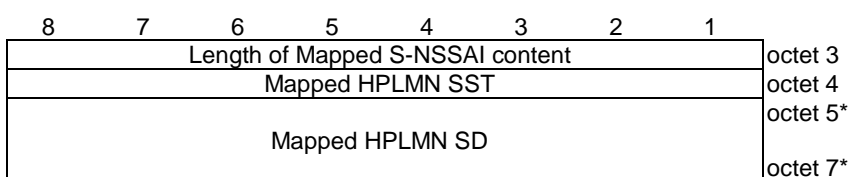

Figure 9.11.3.31B.2: Mapped S-NSSAI content

Table 9.11.3.31B.1: Mapped NSSAI information element

<p>Value part of the Mapped NSSAI information element (octet 3 to v) The value part of the Mapped NSSAI information element consists of one or more mapped S-NSSAI contents.</p> <p>Mapped S-NSSAI content:</p> <p>Length of S-NSSAI contents (octet 3)</p> <p>Mapped HPLMN Slice/service type (SST) (octet 4) This field contains the 8 bit SST value of an S-NSSAI in the S-NSSAI(s) of the HPLMN to which the SST value is mapped. The coding of the SST value part is defined in 3GPP TS 23.003 [4].</p> <p>NOTE 1: Octet 4 (i.e. mapped HPLMN SST) shall always be included.</p> <p>Mapped HPLMN Slice differentiator (SD) (octet 5 to octet 7)</p> <p>This field contains a 24-bit SD value of an S-NSSAI in the S-NSSAI(s) of the HPLMN to which the SD value is mapped. The coding of the SD value part is defined in 3GPP TS 23.003 [4].</p> <p>NOTE 2: If the octet 5 is included, then octet 6 and octet 7 shall be included.</p>
--

9.11.3.31C Mobile station classmark 2

See subclause 10.5.1.6 in 3GPP TS 24.008 [12].

9.11.3.32 NAS key set identifier

The NAS key set identifier is allocated by the network.

The NAS key set identifier information element is coded as shown in figure 9.11.3.32.1 and table 9.11.3.32.1.

The NAS key set identifier is a type 1 information element.

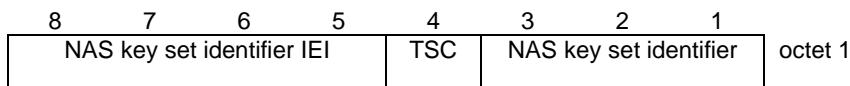

Figure 9.11.3.32.1: NAS key set identifier information element

Table 9.11.3.32.1: NAS key set identifier information element

Type of security context flag (TSC) (octet 1)	
Bit	
4	
0	native security context (for KSI _{AMF})
1	mapped security context (for KSI _{ASME})
TSC does not apply for NAS key set identifier value "111".	
NAS key set identifier (octet 1)	
Bits	
3 2 1	
0 0 0	
through possible values for the NAS key set identifier	
1 1 0	
1 1 1	no key is available (UE to network); reserved (network to UE)

9.11.3.33 NAS message container

The purpose of the NAS message container IE is to encapsulate a plain 5GS NAS REGISTRATION REQUEST, DEREGISTRATION REQUEST, or SERVICE REQUEST message, or to encapsulate non-clear-text IEs of a CONTROL PLANE SERVICE REQUEST message.

The NAS message container information element is coded as shown in figure 9.11.3.33.1 and table 9.11.3.33.1.

The NAS message container is a type 6 information element.

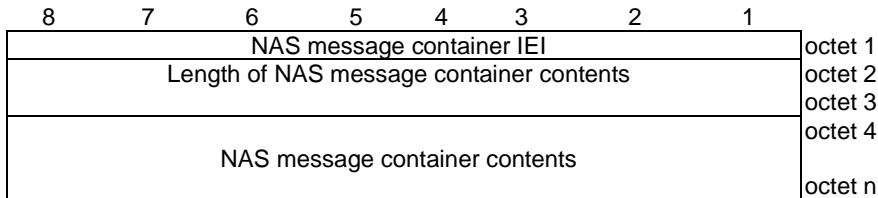

Figure 9.11.3.33.1: NAS message container information element

Table 9.11.3.33.1: NAS message container information element

<p>NAS message container contents (octet 4 to octet n); Max value of 65535 octets</p> <p>This IE can contain a REGISTRATION REQUEST message as defined in subclause 5.5.1, DEREGISTRATION REQUEST message as defined in subclause 5.5.2.2.1, or a SERVICE REQUEST message as defined in subclause 5.6.1, or non-clear-text IEs of a CONTROL PLANE SERVICE REQUEST message as defined in subclause 5.6.1.</p>
--

9.11.3.34 NAS security algorithms

The purpose of the NAS security algorithms information element is to indicate the 5G algorithms to be used for ciphering and integrity protection.

The NAS security algorithms information element is coded as shown in figure 9.11.3.34.1 and table 9.11.3.34.1.

The NAS security algorithms is a type 3 information element with a length of 2 octets.

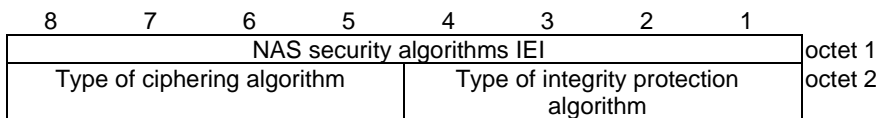

Figure 9.11.3.34.1: NAS security algorithms information element

Table 9.11.3.34.1: NAS security algorithms information element

Type of integrity protection algorithm (octet 2, bit 1 to 3)				
Bits				
4	3	2	1	
0	0	0	0	5G integrity algorithm 5G-IA0 (null integrity protection algorithm)
0	0	0	1	5G integrity algorithm 128-5G-IA1
0	0	1	0	5G integrity algorithm 128-5G-IA2
0	0	1	1	5G integrity algorithm 128-5G-IA3
0	1	0	0	5G integrity algorithm 5G-IA4
0	1	0	1	5G integrity algorithm 5G-IA5
0	1	1	0	5G integrity algorithm 5G-IA6
0	1	1	1	5G integrity algorithm 5G-IA7
All other values are reserved.				
Type of ciphering algorithm (octet 2, bit 5 to 7)				
Bits				
8	7	6	5	
0	0	0	0	5G encryption algorithm 5G-EA0 (null ciphering algorithm)
0	0	0	1	5G encryption algorithm 128-5G-EA1
0	0	1	0	5G encryption algorithm 128-5G-EA2
0	0	1	1	5G encryption algorithm 128-5G-EA3
0	1	0	0	5G encryption algorithm 5G-EA4
0	1	0	1	5G encryption algorithm 5G-EA5
0	1	1	0	5G encryption algorithm 5G-EA6
0	1	1	1	5G encryption algorithm 5G-EA7
All other values are reserved.				

9.11.3.35 Network name

See subclause 10.5.3.5a in 3GPP TS 24.008 [12].

9.11.3.36 Network slicing indication

The purpose of the Network slicing indication information element is to indicate additional information associated with network slicing in the generic UE configuration update procedure and the registration procedure, other than the user's configured NSSAI, allowed NSSAI, pending NSSAI and rejected NSSAI information.

The Network slicing indication information element is coded as shown in figure 9.11.3.36.1 and table 9.11.3.36.1.

The Network slicing indication is a type 1 information element.

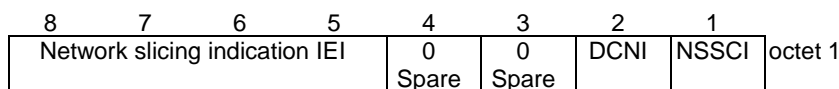

Figure 9.11.3.36.1: Network slicing indication

Table 9.11.3.36.1: Network slicing indication

Network slicing subscription change indication (NSSCI) (octet 1, bit 1)	
Bit	
1	
0	Network slicing subscription not changed
1	Network slicing subscription changed
Default configured NSSAI indication (DCNI) (octet 1, bit 2)	
Bit	
2	
0	Requested NSSAI not created from default configured NSSAI
1	Requested NSSAI created from default configured NSSAI
In the UE to network direction bit 1 is spare. The UE shall set this bit to zero.	
In the network to UE direction bit 2 is spare. The network shall set this bit to zero.	
Bits 3 and 4 are spare and shall be coded as zero.	

9.11.3.36A Non-3GPP NW provided policies

See subclause 10.5.5.37 in 3GPP TS 24.008 [12].

9.11.3.37 NSSAI

The purpose of the NSSAI information element is to identify a collection of S-NSSAIs

The NSSAI information element is coded as shown in figure 9.11.3.37.1 and table 9.11.3.37.1.

The NSSAI is a type 4 information element with a minimum length of 4 octets and a maximum length of 146 octets.

NOTE: More than one S-NSSAIs in an NSSAI can have the same SST values, and optionally same SD values, which are associated with different mapped HPLMN SST values and optionally mapped HPLMN SD values.

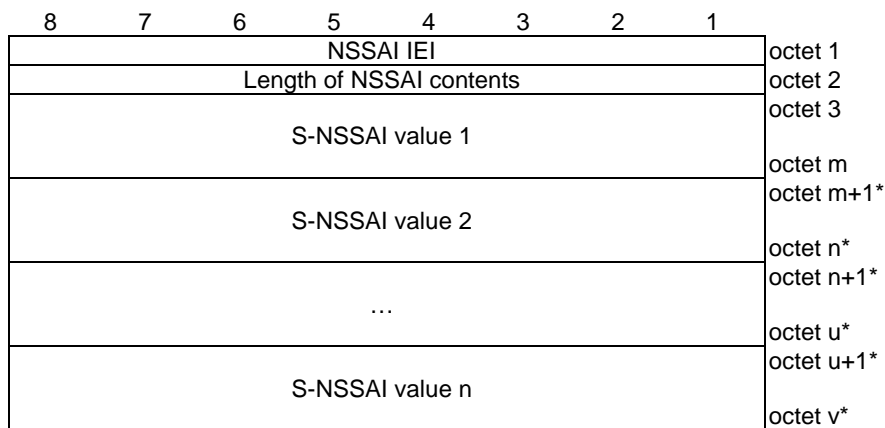

Figure 9.11.3.37.1: NSSAI information element

Table 9.11.3.37.1: NSSAI information element

<p>Value part of the NSSAI information element (octet 3 to v) The value part of the NSSAI information element consists of one or more S-NSSAI values. Each S-NSSAI value consists of one S-NSSAI and optionally one mapped S-NSSAI. The recipient of this information element shall store the complete list received (NOTE 1, NOTE 2, NOTE 3). If the NSSAI information element conveys an allowed NSSAI and more than 8 S-NSSAI values are included in this information element, the UE shall store the first 8 S-NSSAI values and ignore the remaining octets of the information element. If the NSSAI information element conveys a configured NSSAI (including the default configured NSSAI) or pending NSSAI and more than 16 S-NSSAI values are included in this information element, the UE shall store the first 16 S-NSSAI values and ignore the remaining octets of the information element.</p> <p>S-NSSAI value: S-NSSAI value is coded as the length and value part of S-NSSAI information element as specified in subclause 9.11.2.8 starting with the second octet.</p> <p>NOTE 1: The total number of S-NSSAI values in a requested NSSAI shall not exceed eight. NOTE 2: The number of S-NSSAI values in an allowed NSSAI shall not exceed eight. NOTE 3: The number of S-NSSAI values in a configured NSSAI (including the default configured NSSAI) or pending NSSAI shall not exceed sixteen.</p>
--

9.11.3.37A NSSAI inclusion mode

The purpose of the NSSAI inclusion mode information element is to indicate the NSSAI inclusion mode in which the UE shall operate.

The NSSAI inclusion mode is a type 1 information element.

The NSSAI inclusion mode information element is coded as shown in figure 9.11.3.37A.1 and table 9.11.3.37A.1.

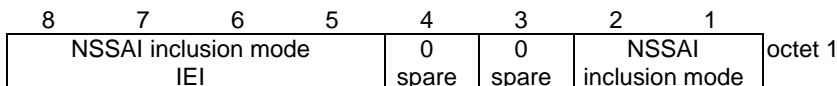

Figure 9.11.3.37A.1: NSSAI inclusion mode information element

Table 9.11.3.37A.1: NSSAI inclusion mode information element

NSSAI inclusion mode (octet 1, bit 1 to bit 2)		
Bits		
2	1	
0	0	NSSAI inclusion mode A
0	1	NSSAI inclusion mode B
1	0	NSSAI inclusion mode C
1	1	NSSAI inclusion mode D

9.11.3.38 Operator-defined access category definitions

The purpose of the Operator-defined access category definitions information element is to provide the UE with the operator-defined access category definitions or to delete the operator-defined access category definitions at the UE.

The Operator-defined access category definitions information element is coded as shown in figure 9.11.3.38.1, figure 9.11.3.38.2 and table 9.11.3.38.1.

The Operator-defined access category definitions is a type 6 information element with a minimum length of 3 octets, and maximum length of 8323 octets.

8	7	6	5	4	3	2	1	
Operator-defined access category definitions IEI								octet 1
Length of operator-defined access category definitions contents								octet 2
Operator-defined access category definition 1								octet 3
Operator-defined access category definition 2								octet 4*
Operator-defined access category definition 1								octet a*
Operator-defined access category definition 2								octet a+1*
Operator-defined access category definition 2								octet b*
...								octet b+1*
Operator-defined access category definition n								octet g*
Operator-defined access category definition n								octet g+1*
Operator-defined access category definition n								octet h*

Figure 9.11.3.38.1: Operator-defined access category definitions information element

8	7	6	5	4	3	2	1	
Length of operator-defined access category definition contents								octet 4
Precedence value								octet 5
PSAC	0	0	Operator-defined access category number					octet 6
	Spare	Spare						
Length of criteria								octet 7
Criteria								octet 8
Criteria								octet a-1
0	0	0	Standardized access category					octet a*
Spare	Spare	Spare						

Figure 9.11.3.38.2: Operator-defined access category definition

Table 9.11.3.38.1: Operator-defined access category definitions information element

Value part of the Operator-defined access category definitions information element (octet 4 to h)

The value part of the Operator-defined access category definitions information element consists of zero or no more than 32 operator-defined access category definition fields. Each operator-defined access category definition field is coded as described in figure 9.11.3.38.2. The length of each operator-defined access category definition field is determined by the length of operator-defined access category definition contents field.

Operator-defined access category definition (octet 4 to octet a):

Length of operator-defined access category definition contents (octet 4)
Length of operator-defined access category definition contents indicates binary coded length of the operator-defined access category definition value field (octet 5 to octet a).

Precedence value (octet 5)

Bits

8	7	6	5	4	3	2	1	
0	0	0	0	0	0	0	0	Precedence value 0
								to
1	1	1	1	1	1	1	1	Precedence value 255

Operator-defined access category number (bits 5 to 1 of octet 6)

Bits

5	4	3	2	1	
0	0	0	0	0	Access category number 32
					to
1	1	1	1	1	Access category number 63

Presence of standardized access category (PSAC) (bit 8 of octet 6)

PSAC field indicates whether the standardized access category field is present or absent.

Bit

8	
0	Standardized access category field is not included
1	Standardized access category field is included

Length of criteria (octet 7)

Length of criteria field indicates binary coded length of the criteria field.

Criteria (octets 8 to octet a-1)

The criteria field contains one or more criteria components fields. Each criteria component field shall be encoded as a sequence of a one octet criteria type field and zero or more octets criteria value field. The criteria type field shall be transmitted first.

Criteria type

Bits

8	7	6	5	4	3	2	1	
0	0	0	0	0	0	0	0	DNN type
0	0	0	0	0	0	0	1	OS id + OS App Id type
0	0	0	0	0	0	1	0	S-NSSAI type

All other values are reserved.

For "DNN type", the criteria value field shall be encoded as a sequence of one octet DNN length-value pair count field and one or more DNN length-value pair fields.

The DNN length-value pair count field indicates the number of included DNN length-value pair fields. Each DNN length-value pair field is coded as a sequence of one octet DNN value length field and a DNN value field. The DNN value length field indicates the length in octets of the DNN value field. The DNN value field contains an APN as specified in 3GPP TS 23.003 [4].

For "OS Id + OS App Id type", the criteria value field shall be encoded as a sequence of one octet app id value count field and one or more app id value fields. The app id value count field indicates the number of included app id value fields. Each app id value field is coded as a sequence of a sixteen octet OS id value field, one octet OS app id value length field and an OS app id value field. The OS app id value length field indicates the length in octets of the OS app id value field. The OS id value field contains a Universally Unique Identifier (UUID) as specified in IETF RFC 4122 [35A]. The OS app id value field contains an OS specific application identifier. Coding of the OS app id value field is outside the scope of the present document.

For "S-NSSAI type", the criteria value field shall be encoded as a sequence of one octet S-NSSAI length-value pair count field and one or more S-NSSAI length-value value fields. The S-NSSAI length-value pair count field indicates the number of included S-NSSAI length-value pair fields. Each S-NSSAI length-value pair field is coded as a sequence of one octet S-NSSAI value length field and an S-NSSAI value field. The S-NSSAI value length field indicates the length in octets of the S-NSSAI value field. The S-NSSAI value field contains one octet SST field optionally followed by three octets SD field. The SST field contains a SST. The SD field contains an SD. SST and SD are specified in 3GPP TS 23.003 [4].

Standardized access category (bits 5 to 1 of octet a)
 Standardized access category field indicates the access category number of the standardized access category that is used in combination with the access identities to determine the establishment cause.

Bits

5	4	3	2	1	
0	0	0	0	0	Access category number 0
		to			
0	0	1	1	1	Access category number 7
0	1	0	0	1	Access category number 9
0	1	0	1	0	Access category number 10

All other values are reserved.

9.11.3.39 Payload container

The purpose of the Payload container information element is to transport one or multiple payloads. If multiple payloads are transported, the associated information of each payload are also transported together with the payload.

The Payload container information element is coded as shown in figure 9.11.3.39.1, figure 9.11.3.39.1A, figure 9.11.3.39.1B, figure 9.11.3.39.2, figure 9.11.3.39.3, figure 9.11.3.39.4 and table 9.11.3.39.1.

The Payload container information element is a type 6 information element with a minimum length of 4 octets and a maximum length of 65538 octets.

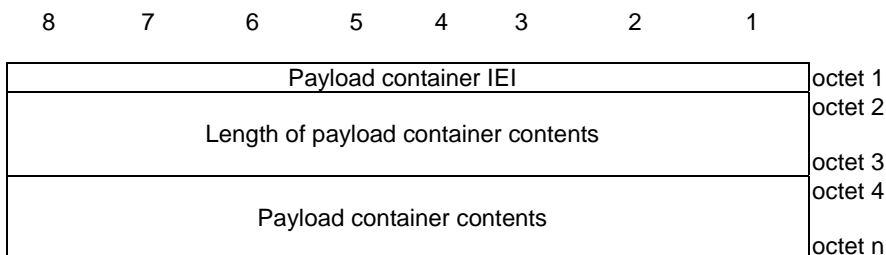

Figure 9.11.3.39.1: Payload container information element

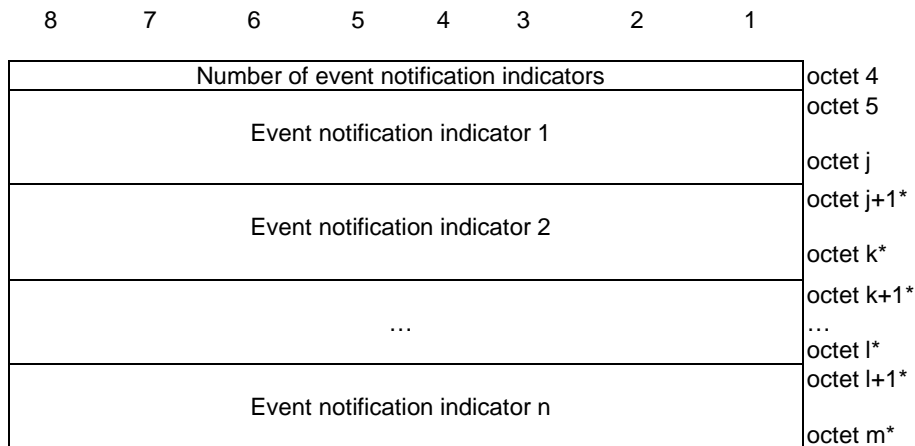

Figure 9.11.3.39.1A: Payload container contents with Payload container type "Event notification"

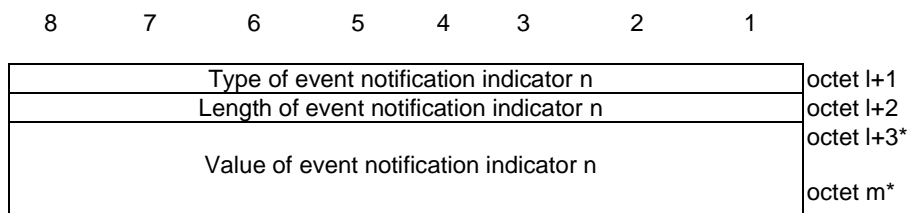

Figure 9.11.3.39.1B: Even notification indicator n

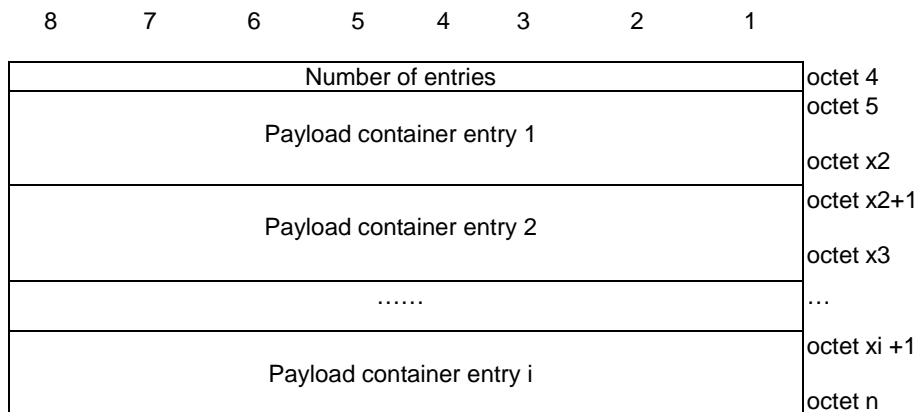

Figure 9.11.3.39.2: Payload container contents with Payload container type "Multiple payloads"

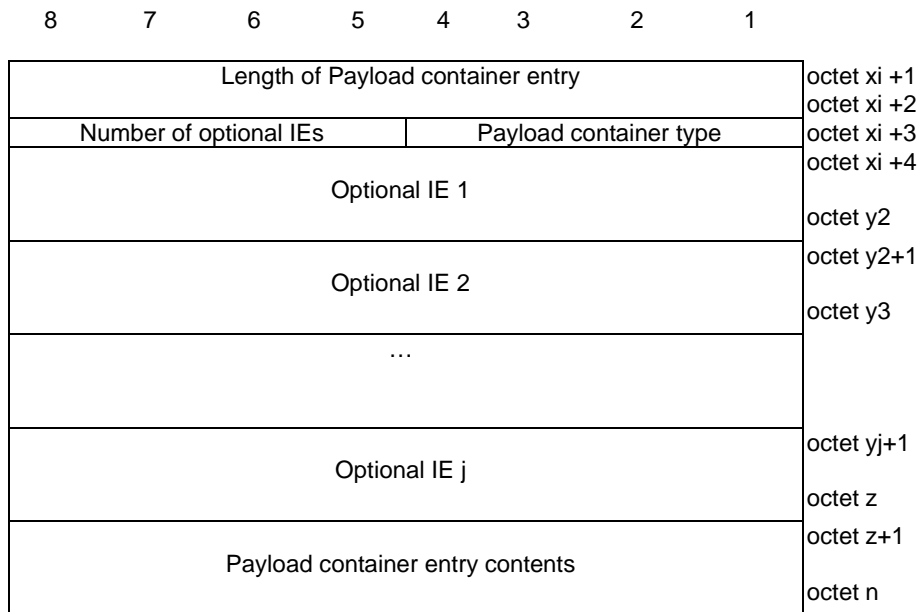

Figure 9.11.3.39.3: Payload container entry

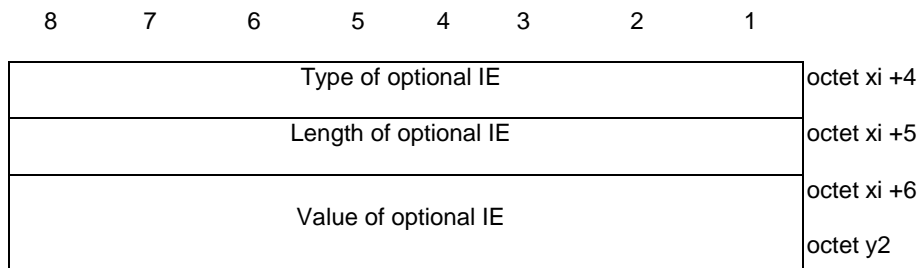

Figure 9.11.3.39.4: Optional IE

Table 9.11.3.39.1: Payload container information element

Payload container contents (octet 4 to octet n); max value of 65535 octets

If the payload container type is set to "N1 SM information" and is included in the UL NAS TRANSPORT or DL NAS TRANSPORT message, the payload container contents contain a 5GSM message as defined in subclause 8.3.

If the payload container type is set to "SOR transparent container" and is included in the DL NAS TRANSPORT message, the payload container contents are coded the same way as the contents of the SOR transparent container IE (see subclause 9.11.3.51) for SOR data type is set to value "0" except that the first three octets are not included.

If the payload container type is set to "SOR transparent container" and is included in the UL NAS TRANSPORT message, the payload container contents are coded the same way as the contents of the SOR transparent container IE (see subclause 9.11.3.51) for SOR data type is set to value "1" except that the first three octets are not included.

If the payload container type is set to "UE policy container" and is included in the DL NAS TRANSPORT, UL NAS TRANSPORT or REGISTRATION REQUEST message, the payload container contents are coded as defined in subclause Annex D.

If the payload container type is set to "UE parameters update transparent container" and is included in the DL NAS TRANSPORT message, the payload container contents are coded the same way as the contents of the UE parameters update transparent container IE (see subclause 9.11.3.53A) for UE parameters update data type is set to value "0" except that the first three octets are not included.

If the payload container type is set to "UE parameters update transparent container" and is included in the UL NAS TRANSPORT message, the payload container contents are coded the same way as the contents of the UE parameters update transparent container IE (see subclause 9.11.3.53A) for UE parameters update data type is set to value "1" except that the first three octets are not included.

If the payload container type is set to "SMS" and is included in the UL NAS TRANSPORT or DL NAS TRANSPORT message, the payload container contents contain an SMS message (i.e. CP-DATA, CP-ACK or CP-ERROR) as defined in subclause 7.2 in 3GPP TS 24.011 [13].

If the payload container type is set to "IoT user data container" and is included in the UL NAS TRANSPORT, DL NAS TRANSPORT or CONTROL PLANE SERVICE REQUEST message, the payload container contents are coded the same way as the contents of the user data container IE (see subclause 9.9.4.24 in 3GPP TS 24.301 [15]) except that the first three octets are not included.

If the payload container type is set to "SMS" and is included in the CONTROL PLANE SERVICE REQUEST message, the payload container contents are coded the same way as the contents of the NAS message container IE (see subclause 9.9.3.22 in 3GPP TS 24.301 [15]) except that the first two octets are not included.

If the payload container type is set to "Location services message container" and is included in the UL NAS TRANSPORT, DL NAS TRANSPORT or CONTROL PLANE SERVICE REQUEST message, the payload container contents include location services message payload.

If the payload container type is set to "LTE Positioning Protocol (LPP) message container" and is included in the UL NAS TRANSPORT or DL NAS TRANSPORT message, the payload container contents include LPP message payload.

If the payload container type is set to "SLPP message container" and is included in the UL NAS TRANSPORT or DL NAS TRANSPORT message, the payload container contents include SLPP message payload.

If the payload container type is set to "Service-level-AA container" and is included in the UL NAS TRANSPORT or DL NAS TRANSPORT message, the payload container contents are coded the same way as the contents of service-level-AA container (see subclause 9.11.2.10).

If the payload container type is set to "Event notification", the payload container contents include one or more event notification indicators.

Type of event notification indicator n (octet l+1)		
Bits		
8	7	6 5 4 3 2 1
0	0	0 0 0 0 0 0 0
		"SRVCC handover cancelled, IMS session re-establishment required" indicator
0	0	0 0 0 0 0 0 1
		Unused, shall be ignored if received by the UE
1	1	1 1 1 1 1 1 1
<p>If the type of an event notification indicator is set to "SRVCC handover cancelled, IMS session re-establishment required" indicator, the value of the event notification indicator shall not be included.</p> <p>If the payload container type is set to "UPP-CMI container" and is included in the UL NAS TRANSPORT or DL NAS TRANSPORT message, the payload container contents include UPP-CMI messages as specified in 3GPP TS 24.572 [64].</p> <p>If the payload container type is set to "Multiple payloads", the number of entries field represents the total number of payload container entries, and the payload container entry contents field is coded as a list of payload container entry according to figure 9.11.3.39.2, with each payload container entry is coded according to figure 9.11.3.39.3 and figure 9.11.3.39.4.</p> <p>The coding of Payload container contents is dependent on the particular application.</p>		
Payload container entry		
<p>For each payload container entry, the payload container type field represents the payload container type value as described in subclause 9.11.3.40, the coding of payload container contents field is dependent on the particular application, and the number of optional IEs field represents the total number of optional IEs associated with the payload container entry contents field in the payload container entry. The error handlings for optional IEs specified in subclauses 7.6.3 and 7.7.1 shall apply to the optional IEs included in the payload container entry.</p> <p>The receiving entity shall ignore Optional IEs with type of optional IE parameter field containing an unknown IEI.</p>		
Optional IEs		
Type of optional IE (octet xi +4)		
This field contains the IEI of the optional IE.		
Length of optional IE (octet xi+5)		
This field indicates binary coded length of the value of the optional IE entry.		
Value of optional IE (octet xi+6 to octet y2)		
This field contains the value of the optional IE entry with the value part of the referred information element based on following optional IE reference. If the Request type is included, the value part of the Request type shall be encoded in the bits 1 to 4 and bits 5 to 8 shall be coded as zero. If the Release assistance indication is included, the value part of the Release assistance indication shall be encoded in the bits 1 to 4 and bits 5 to 8 shall be coded as zero. If the MA PDU session information is included, the value part of the MA PDU session information shall be encoded in the bits 1 to 4 and bits 5 to 8 shall be coded as zero.		
IEI	Optional IE name	Optional IE reference
12	PDU session ID	PDU session identity 2 (see subclause 9.11.3.41)
24	Additional information	Additional information (see subclause 9.11.2.1)
58	5GMM cause	5GMM cause (see subclause 9.11.3.2)
37	Back-off timer value	GPRS timer 3 (see subclause 9.11.2.5)
59	Old PDU session ID	PDU session identity 2 (see subclause 9.11.3.41)
80	Request type	Request type (see subclause 9.11.3.47)
22	S-NSSAI	S-NSSAI (see subclause 9.11.2.8)
25	DNN	DNN (see subclause 9.11.2.1B)
F0	Release assistance indication	Release assistance indication (see subclause 9.11.3.46A)

A0	MA PDU session information	MA PDU session information (see subclause 9.11.3.31A)
----	----------------------------	---

9.11.3.40 Payload container type

The purpose of the Payload container type information element indicates type of payload included in the payload container information element.

The Payload container type information element is coded as shown in figure 9.11.3.40.1 and table 9.11.3.40.1.

The Payload container type information element is a type 1 information element.

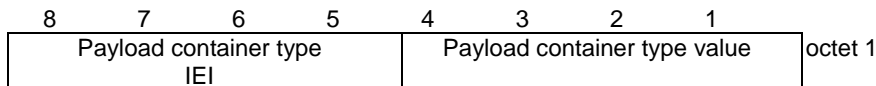

Figure 9.11.3.40.1: Payload container type information element

Table 9.11.3.40.1: Payload container type information element

Payload container type value (octet 1)				
Bits				
4	3	2	1	
0	0	0	1	N1 SM information
0	0	1	0	SMS
0	0	1	1	LTE Positioning Protocol (LPP) message container
0	1	0	0	SOR transparent container
0	1	0	1	UE policy container
0	1	1	0	UE parameters update transparent container
0	1	1	1	Location services message container (see 3GPP TS 23.273 [6B])
1	0	0	0	CloT user data container
1	0	0	1	Service-level-AA container
1	0	1	0	Event notification
1	0	1	1	UPP-CMI container
1	1	0	0	SLPP message container
1	1	1	1	Multiple payloads
All other values are reserved.				
NOTE: The value "Multiple payloads" is only used when the Payload container contents in figure 9.11.3.39.1 contains multiple payloads as shown in figure 9.11.3.39.2.				

9.11.3.41 PDU session identity 2

The purpose of the PDU session identity 2 information element is to indicate the identity of a PDU session in a 5GMM message.

The PDU session identity 2 information element is coded as shown in figure 9.11.3.41.1 and table 9.11.3.41.1.

The PDU session identity 2 is a type 3 information element with a length of 2 octets .

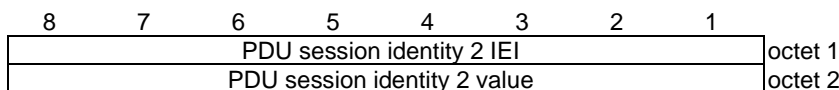

Figure 9.11.3.41.1: PDU session identity 2 information element

Table 9.11.3.41.1: PDU session identity 2 information element

PDU session identity 2 value (octet 2)
The coding of the PDU session identity 2 value is identical to the coding of the PDU session identity value as defined in 3GPP TS 24.007 [11] .

9.11.3.42 PDU session reactivation result

The purpose of the PDU session reactivation result information element is to indicate the result of establishments of user-plane resources of PDU sessions.

The PDU session reactivation result information element is coded as shown in figure 9.11.3.42.1 and table 9.11.3.42.1.

The PDU session reactivation result is a type 4 information element with minimum length of 4 octets and maximum length of 34 octets.

8	7	6	5	4	3	2	1	
PDU session reactivation result IEI								octet 1
Length of PDU session reactivation result								octet 2
PSI (7)	PSI (6)	PSI (5)	PSI (4)	PSI (3)	PSI (2)	PSI (1)	PSI (0)	octet 3
PSI (15)	PSI (14)	PSI (13)	PSI (12)	PSI (11)	PSI (10)	PSI (9)	PSI (8)	octet 4
0	0	0	0	0	0	0	0	octet 5* -34*
Spare								

Figure 9.11.3.42.1: PDU session reactivation result information element

Table 9.11.3.42.1: PDU session reactivation result information element

<p>PSI(x) shall be coded as follows:</p> <p>PSI(0): Bit 1 of octet 3 is spare and shall be coded as zero.</p> <p>PSI(1) – PSI(15): 0 indicates establishment of user-plane resources of the PDU session was not requested in the Uplink data status IE or establishment of user-plane resources of the PDU session was not allowed in the Allowed PDU session status IE or establishment of user-plane resource of the PDU session is successful. 1 indicates either establishment of user-plane resources of the PDU session was requested in the Uplink data status IE but establishment of user-plane resource of the PDU session is not successful or indicates establishment of user-plane resources of the PDU session was allowed in the Allowed PDU session status IE but establishment of user-plane resource of the PDU session is either not performed or not successful.</p> <p>All bits in octet 5 to 34 are spare and shall be coded as zero, if the respective octet is included in the information element.</p>

9.11.3.43 PDU session reactivation result error cause

The purpose of the PDU session reactivation result error cause information element is to indicate error causes for PDU session ID(s) where there was a failure to establish the user-plane resources.

The PDU session reactivation result error cause information element is coded as shown in figure 9.11.3.43.1 and table 9.11.3.43.1.

The PDU session reactivation result error cause is a type 6 information element with a minimum length of 5 octets and a maximum length of 515 octets.

8	7	6	5	4	3	2	1	
PDU session reactivation result error cause IEI								octet 1
Length of PDU session reactivation result error cause								octet 2
PDU session ID								octet 3
cause value								octet 4
....								octet 5
PDU session ID								octet 514*
cause value								octet 515*

Figure 9.11.3.43.1: PDU session reactivation result error cause information element

Table 9.11.3.43.1: PDU session reactivation result error cause information element

PDU session ID is coded same as PDU session ID IE (see subclause 9.4).
The cause value is coded same as second octet of 5GMM cause information element (see subclause 9.11.3.2).

9.11.3.44 PDU session status

The purpose of the PDU session status information element is to indicate the state of each PDU session that can be identified by a PDU session identity.

The PDU session status information element is coded as shown in figure 9.11.3.44.1 and table 9.11.3.44.1.

The PDU session status information element is a type 4 information element with minimum length of 4 octets and a maximum length of 34 octets.

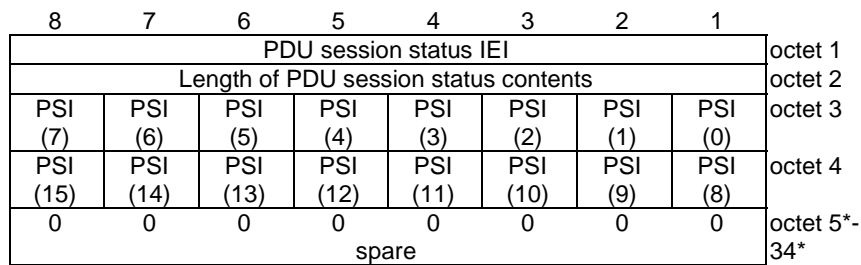

Figure 9.11.3.44.1: PDU session status information element

Table 9.11.3.44.1: PDU session status information element

PSI(x) shall be coded as follows:
PSI(0): Bit 1 of octet 3 is spare and shall be coded as zero.
PSI(1) – PSI(15): 0 indicates that the 5GSM state of the corresponding PDU session is PDU SESSION INACTIVE. 1 indicates that the 5GSM state of the corresponding PDU session is not PDU SESSION INACTIVE
All bits in octet 5 to 34 are spare and shall be coded as zero, if the respective octet is included in the information element.

9.11.3.45 PLMN list

See subclause 10.5.1.13 in 3GPP TS 24.008 [12].

9.11.3.46 Rejected NSSAI

The purpose of the Rejected NSSAI information element is to identify a collection of rejected S-NSSAIs.

The Rejected NSSAI information element is coded as shown in figure 9.11.3.46.1, figure 9.11.3.46.2 and table 9.11.3.46.1.

The Rejected NSSAI is a type 4 information element with a minimum length of 4 octets and a maximum length of 42 octets.

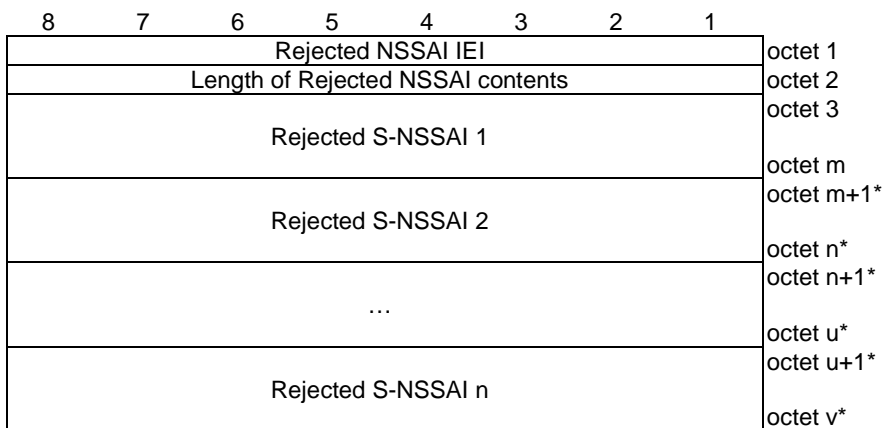

Figure 9.11.3.46.1: Rejected NSSAI information element

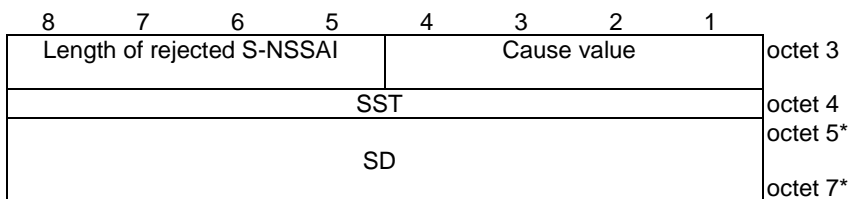

Figure 9.11.3.46.2: Rejected S-NSSAI

Table 9.11.3.46.1: Rejected NSSAI information element

<p>Value part of the Rejected NSSAI information element (octet 3 to v)</p> <p>The value part of the Rejected NSSAI information element consists of one or more rejected S-NSSAIs. Each rejected S-NSSAI consists of one S-NSSAI and an associated cause value. The length of each rejected S-NSSAI can be determined by the 'length of rejected S-NSSAI' field in the first octet of the rejected S-NSSAI. The UE shall store the complete list received (NOTE 0). If more than 8 rejected S-NSSAIs are included in this information element, the UE shall store the first 8 rejected S-NSSAIs and ignore the remaining octets of the information element.</p> <p>Rejected S-NSSAI:</p> <p>Cause value (octet 3)</p> <p>Bits</p> <table border="0"> <tr> <td style="text-align: right;">4</td> <td style="text-align: right;">3</td> <td style="text-align: right;">2</td> <td style="text-align: right;">1</td> <td></td> </tr> <tr> <td>0</td> <td>0</td> <td>0</td> <td>0</td> <td>S-NSSAI not available in the current PLMN or SNPN</td> </tr> <tr> <td>0</td> <td>0</td> <td>0</td> <td>1</td> <td>S-NSSAI not available in the current registration area</td> </tr> <tr> <td>0</td> <td>0</td> <td>1</td> <td>0</td> <td>S-NSSAI not available due to the failed or revoked network slice-specific authentication and authorization</td> </tr> </table> <p>All other values are reserved.</p> <p>Slice/service type (SST) (octet 4)</p> <p>This field contains the 8 bit SST value. The coding of the SST value part is defined in 3GPP TS 23.003 [4]. (NOTE 2)</p> <p>Slice differentiator (SD) (octet 5 to octet 7)</p> <p>This field contains the 24 bit SD value. The coding of the SD value part is defined in 3GPP TS 23.003 [4]. (NOTE 3)</p> <p>NOTE 0: The number of rejected S-NSSAI(s) shall not exceed eight.</p> <p>NOTE 1: If octet 5 is included, then octet 6 and octet 7 shall be included.</p> <p>NOTE 2: If the Cause value is "S-NSSAI not available due to the failed or revoked network slice-specific authentication and authorization", this field shall contain the 8 bit SST value of an S-NSSAI in the S-NSSAI(s) of the HPLMN.</p> <p>NOTE 3: If the Cause value is "S-NSSAI not available due to the failed or revoked network slice-specific authentication and authorization", this field, if included, shall contain the 24 bit SD value of an S-NSSAI in the S-NSSAI(s) of the HPLMN.</p>	4	3	2	1		0	0	0	0	S-NSSAI not available in the current PLMN or SNPN	0	0	0	1	S-NSSAI not available in the current registration area	0	0	1	0	S-NSSAI not available due to the failed or revoked network slice-specific authentication and authorization
4	3	2	1																	
0	0	0	0	S-NSSAI not available in the current PLMN or SNPN																
0	0	0	1	S-NSSAI not available in the current registration area																
0	0	1	0	S-NSSAI not available due to the failed or revoked network slice-specific authentication and authorization																

9.11.3.46A Release assistance indication

See subclause 9.9.4.25 in 3GPP TS 24.301 [15].

9.11.3.47 Request type

The purpose of the Request type information element is to indicate the type of the 5GSM message.

The Request type information element is coded as shown in figure 9.11.3.47.1 and table 9.11.3.47.1.

The Request type is a type 1 information element.

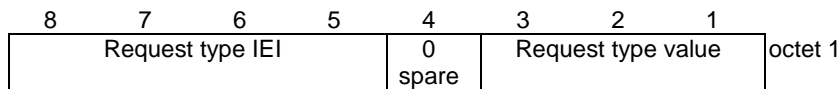

Figure 9.11.3.47.1: Request type information element

Table 9.11.3.47.1: Request type information element

Request type value (octet 1, bit 1 to bit 4)			
Bits			
3	2	1	
0	0	1	initial request
0	1	0	existing PDU session
0	1	1	initial emergency request
1	0	0	existing emergency PDU session
1	0	1	modification request
1	1	0	MA PDU request (NOTE)
1	1	1	reserved
All other values are unused and shall be interpreted as "initial request", if received by the network.			
NOTE: This value shall be interpreted as "initial request", if received by a network not supporting MA PDU sessions.			

9.11.3.48 S1 UE network capability

See subclause 9.9.3.34 in 3GPP TS 24.301 [15].

9.11.3.48A S1 UE security capability

See subclause 9.9.3.36 in 3GPP TS 24.301 [15].

9.11.3.49 Service area list

The purpose of the Service area list information element is to transfer a list of allowed tracking areas for an allowed area or a list of non-allowed tracking areas for a non-allowed area from the network to the UE.

The coding of the information element allows combining different types of lists. The lists of type "00" and "01" allow a more compact encoding, when the different TAIs are sharing the PLMN identity. The lists of type "11" indicate all TAIs of the PLMNs in the registration area are allowed area.

The Service area list information element is coded as shown in figure 9.11.3.49.1, figure 9.11.3.49.2, figure 9.11.3.49.3, figure 9.11.3.49.4, figure 9.11.3.49.5 and table 9.11.3.49.1.

The Service area list is a type 4 information element with a minimum length of 6 octets and a maximum length of 114 octets. The list can contain a maximum of 16 different tracking area identities.

8	7	6	5	4	3	2	1	
Service area list IEI								octet 1
Length of service area list contents								octet 2
Partial service area list 1								octet 3
Partial service area list 2								octet i octet i+1*
...								octet l* octet l+1*
Partial service area list p								octet m* octet m+1*
								octet n*

Figure 9.11.3.49.1: Service area list information element

8	7	6	5	4	3	2	1	
Allowed type	Type of list		Number of elements					octet 1
	MCC digit 2			MCC digit 1				octet 2
	MNC digit 3			MCC digit 3				octet 3
	MNC digit 2			MNC digit 1				octet 4
TAC 1								octet 5
TAC 1 (continued)								octet 6
TAC 1 (continued)								octet 7
...								...
TAC k								octet 3k+2*
TAC k (continued)								octet 3k+3*
TAC k (continued)								octet 3k+4*

Figure 9.11.3.49.2: Partial service area list – type of list = "00"

8	7	6	5	4	3	2	1	
Allowed type	Type of list		Number of elements					octet 1
	MCC digit 2			MCC digit 1				octet 2
	MNC digit 3			MCC digit 3				octet 3
	MNC digit 2			MNC digit 1				octet 4
TAC 1								octet 5
TAC 1 (continued)								octet 6
TAC 1 (continued)								octet 7

Figure 9.11.3.49.3: Partial service area list – type of list = "01"

8	7	6	5	4	3	2	1	
Allowed type	Type of list		Number of elements				octet 1	
	MCC digit 2		MCC digit 1				octet 2	
	MNC digit 3		MCC digit 3				octet 3	
	MNC digit 2		MNC digit 1				octet 4	
TAC 1								octet 5
TAC 1 (continued)								octet 6
TAC 1 (continued)								octet 7
	MCC digit 2		MCC digit 1				octet 8*	
	MNC digit 3		MCC digit 3				octet 9*	
	MNC digit 2		MNC digit 1				octet 10*	
TAC 2								octet 11*
TAC 2 (continued)								octet 12*
TAC 2 (continued)								octet 13*
...								
	MCC digit 2		MCC digit 1				octet 6k-4*	
	MNC digit 3		MCC digit 3				octet 6k-3*	
	MNC digit 2		MNC digit 1				octet 6k-2*	
TAC k								octet 6k*-1
TAC k (continued)								octet 6k*
TAC k (continued)								octet 6k+1*

Figure 9.11.3.49.4: Partial service area list – type of list = "10"

8	7	6	5	4	3	2	1	
Allowed type	Type of list		Number of elements				octet 1	
	MCC digit 2		MCC digit 1				octet 2	
	MNC digit 3		MCC digit 3				octet 3	
	MNC digit 2		MNC digit 1				octet 4	

Figure 9.11.3.49.5: Partial service area list – type of list = "11"

Table 9.11.3.49.1: Service area list information element

Value part of the Service area list information element (octets 3 to n)

The value part of the Service area list information element consists of one or several partial service area lists. The length of each partial service area list can be determined from the 'type of list' field and the 'number of elements' field in the first octet of the partial service area list.

The "Allowed type" fields in all the partial service area lists shall have the same value. For allowed type "0", TAIs contained in all partial service area lists are in the allowed area. For allowed type "1", TAIs contained in all partial service area lists are in the non-allowed area.

The UE shall store the complete list received. If more than 16 TAIs are included in this information element, the UE shall store the first 16 TAIs and ignore the remaining octets of the information element.

Partial service area list:

Allowed type (octet 1)

Bit

8

0 TAIs in the list are in the allowed area
1 TAIs in the list are in the non-allowed area

Type of list (octet 1)

Bits

7 6

0 0 list of TACs belonging to one PLMN, with non-consecutive TAC values
0 1 list of TACs belonging to one PLMN, with consecutive TAC values
1 0 list of TAIs belonging to different PLMNs (see NOTE)
1 1 All TAIs belonging to the PLMNs in the registration area are in the allowed area

Number of elements (octet 1)

Bits

5 4 3 2 1

0 0 0 0 0 1 element
0 0 0 0 1 2 elements
0 0 0 1 0 3 elements
to
0 1 1 0 1 14 elements
0 1 1 1 0 15 elements
0 1 1 1 1 16 elements

All other values are unused and shall be interpreted as 16, if received by the UE.

For type of list = "00" and number of elements = k:

octets 2 to 4 contain the MCC+MNC, and

for $j = 1, \dots, k$:

octets $3j+2$ to $3j+4$ contain the TAC of the j -th TAI belonging to the partial list,

For type of list = "01" and number of elements = k:

octets 2 to 4 contain the MCC+MNC, and

octets 5 to 7 contain the TAC of the first TAI belonging to the partial list.

The TAC values of the other $k-1$ TAIs are TAC+1, TAC+2, ..., TAC+k-1.

For type of list = "10" and number of elements = k:

for $j = 1, \dots, k$.

octets $6j-4$ to $6j-2$ contain the MCC+MNC, and

octets $6j-1$ to $6j+1$ contain the TAC of the j -th TAI belonging to the partial list.

For type of list = "11":

Allowed type shall be coded as "0" and number of elements shall be ignored, and octets 2 to 4 containing the MCC+MNC can be ignored.

If allowed type is coded as "1", it shall be interpreted as "0".

<p>MCC, Mobile country code</p> <p>The MCC field is coded as in ITU-T Recommendation E.212 [42], annex A.</p> <p>MNC, Mobile network code</p> <p>The coding of this field is the responsibility of each administration but BCD coding shall be used. The MNC shall consist of 2 or 3 digits. If a network operator decides to use only two digits in the MNC, MNC digit 3 shall be coded as "1111".</p> <p>TAC, Tracking area code</p> <p>In the TAC field bit 8 of the first octet is the most significant bit and bit 1 of the third octet the least significant bit.</p> <p>The coding of the tracking area code is the responsibility of each administration. Coding using full hexadecimal representation may be used. The tracking area code consists of 3 octets.</p> <p>NOTE: If the "list of TAs belonging to different PLMNs" is used, the PLMNs included in the list need to be present in the list of equivalent PLMNs. This type is not applicable in an SNPN.</p>

9.11.3.50 Service type

The purpose of the service type information element is to specify the purpose of the service request procedure.

The service type is a type 1 information element.

The service type information element is coded as shown in figure 9.11.3.50.1 and table 9.11.3.50.1.

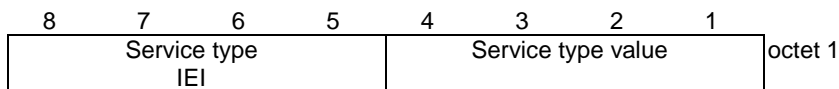

Figure 9.11.3.50.1: Service type information element

Table 9.11.3.50.1: Service type information element

Service type value (octet 1)				
Service type value				
Bits				
4	3	2	1	
0	0	0	0	signalling
0	0	0	1	data
0	0	1	0	mobile terminated services
0	0	1	1	emergency services
0	1	0	0	emergency services fallback
0	1	0	1	high priority access
0	1	1	0	elevated signalling
0	1	1	1	unused; shall be interpreted as "signalling", if received by the network
1	0	0	0	unused; shall be interpreted as "signalling", if received by the network
1	0	0	1	unused; shall be interpreted as "data", if received by the network
1	0	1	0	unused; shall be interpreted as "data", if received by the network
1	0	1	1	unused; shall be interpreted as "data", if received by the network
All other values are reserved.				

9.11.3.50A SMS indication

The purpose of the SMS indication information element is to indicate that the ability for the UE to use SMS over NAS has changed.

The SMS indication information element is coded as shown in figure 9.11.3.50A.1 and table 9.11.3.50A.1.

The SMS indication is a type 1 information element.

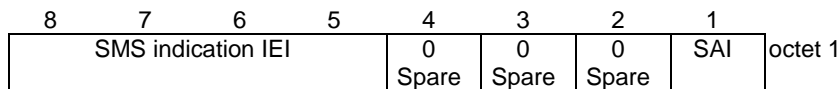

Figure 9.11.3.50A.1: SMS indication

Table 9.11.3.50A.1: SMS indication

SMS availability indication (SAI) (octet 1)	
Bit	
1	
0	SMS over NAS not available
1	SMS over NAS available
Bits 2, 3 and 4 are spare and shall be coded as zero,	

9.11.3.51 SOR transparent container

The purpose of the SOR transparent container information element in the REGISTRATION ACCEPT message is to provide the list of preferred PLMN/access technology combinations (or HPLMN indication that 'no change of the "Operator Controlled PLMN Selector with Access Technology" list stored in the UE is needed and thus no list of preferred PLMN/access technology combinations is provided'), or a secured packet (see 3GPP TS 23.122 [5] annex C) and optional indication of an acknowledgement request, SOR-CMCI, request the storage of the received SOR-CMCI in the ME, SOR-SNPN-SI (or subscribed SNPN or HPLMN indication that 'no change of the SOR-SNPN-SI stored in the UE is needed and thus no SOR-SNPN-SI is provided'), and SOR-SNPN-SI-LS. The purpose of the SOR transparent container information element in the REGISTRATION COMPLETE message is to indicate the UE acknowledgement of successful reception of the SOR transparent container IE in the REGISTRATION ACCEPT message as well as to indicate the ME support of SOR-CMCI, the ME support of SOR-SNPN-SI and the ME support of SOR-SNPN-SI-LS.

NOTE 1: When used in NAS transport procedure, the contents of the SOR transparent container information element in the Payload container IE of the DL NAS TRANSPORT message are used to provide the list of preferred PLMN/access technology combinations and optional indication of an acknowledgement request, SOR-CMCI, request the storage of the received SOR-CMCI in the ME, SOR-SNPN-SI, and SOR-SNPN-SI-LS. The contents of the SOR transparent container information element in the Payload container IE of the UL NAS TRANSPORT message are used to indicate the UE acknowledgement of successful reception of the SOR transparent container IE in the DL NAS TRANSPORT message as well as to indicate the ME support of SOR-CMCI, the ME support of SOR-SNPN-SI and the ME support of SOR-SNPN-SI-LS.

NOTE 2: The "Operator controlled signal threshold per access technology" content to update the USIM file EF_{OCST} (see 3GPP TS 31.102 [22]) can be included in the secured packet of the SOR transparent container.

The SOR transparent container information element is coded as shown in figure 9.11.3.51.1, figure 9.11.3.51.2, figure 9.11.3.51.3, figure 9.11.3.51.4, figure 9.11.3.51.5, figure 9.11.3.51.6, figure 9.11.3.51.7, figure 9.11.3.51.8, figure 9.11.3.51.9, figure 9.11.3.51.9A, figure 9.11.3.51.10, figure 9.11.3.51.11, figure 9.11.3.51.11A, figure 9.11.3.51.11B, figure 9.11.3.51.11C, figure 9.11.3.51.11D, figure 9.11.3.51.11E, figure 9.11.3.51.11F, figure 9.11.3.51.11G, figure 9.11.3.51.11H, figure 9.11.3.51.11I, figure 9.11.3.51.12, figure 9.11.3.51.13, table 9.11.3.51.1, table 9.11.3.51.2, table 9.11.3.51.3, table 9.11.3.51.4, table 9.11.3.51.4A, table 9.11.3.51.5 and table 9.11.3.51.6.

The SOR transparent container is a type 6 information element with a minimum length of 20 octets.

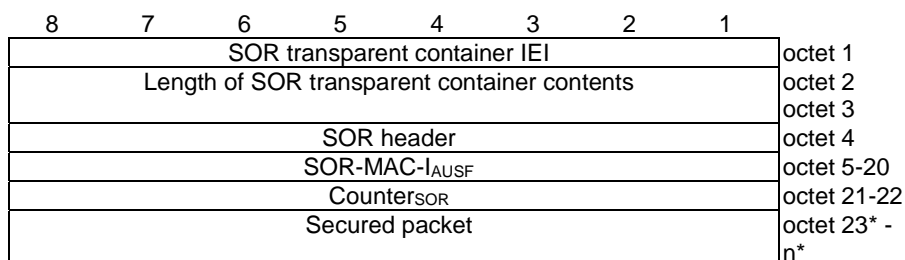

Figure 9.11.3.51.1: SOR transparent container information element for list type with value "0" and SOR data type with value "0"

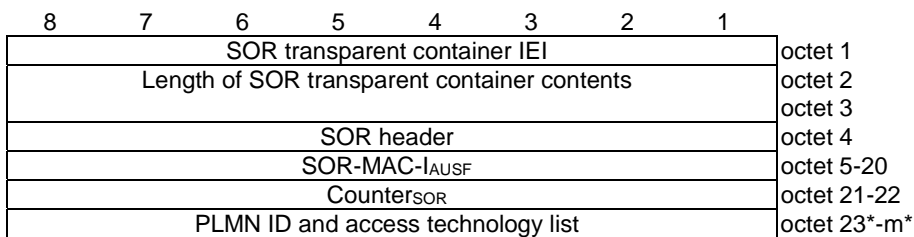

Figure 9.11.3.51.2: SOR transparent container information element for list type with value "1", SOR data type with value "0", and additional parameters with value "0"

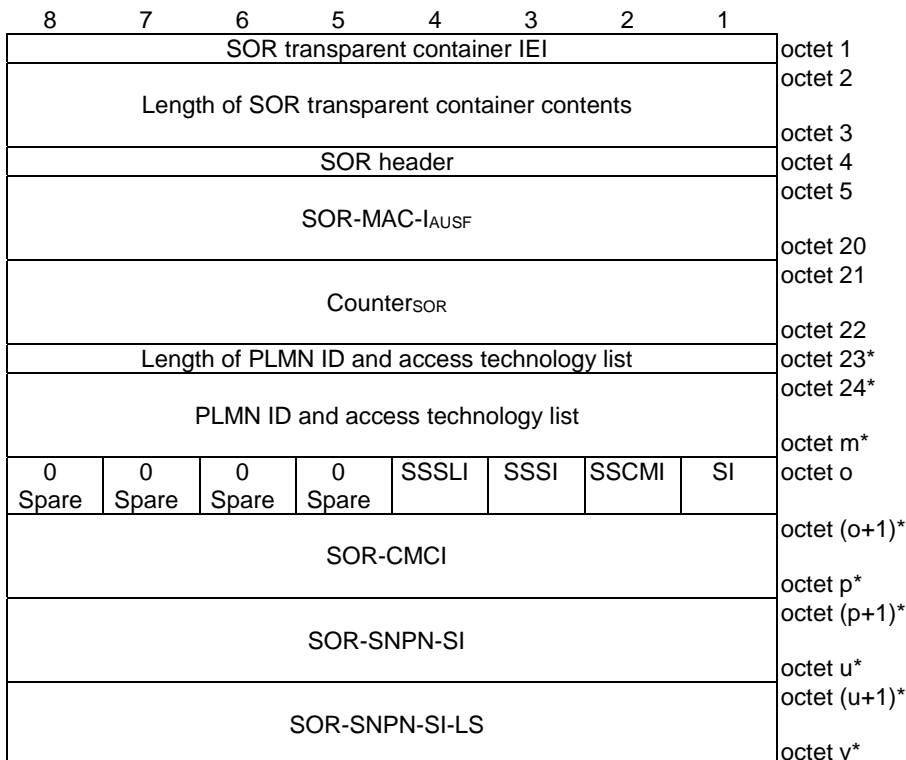

Figure 9.11.3.51.2A: SOR transparent container information element for list type with value "1", SOR data type with value "0", additional parameters with value "1"

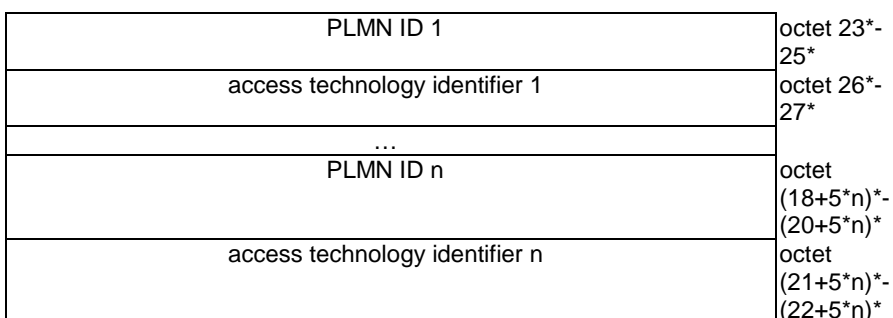

Figure 9.11.3.51.3: PLMN ID and access technology list (m=22+5*n)

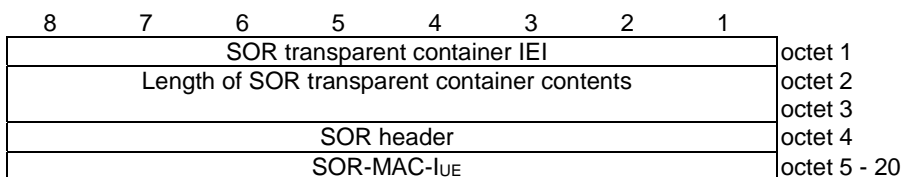

Figure 9.11.3.51.4: SOR transparent container information element for SOR data type with value "1"

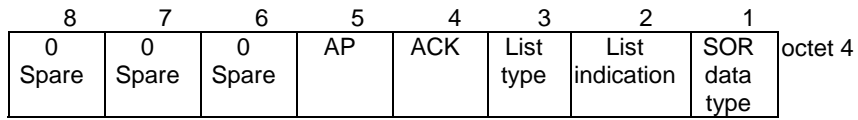

Figure 9.11.3.51.5: SOR header for SOR data type with value "0"

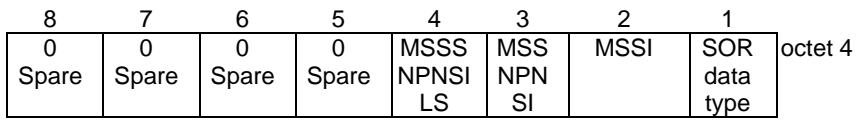

Figure 9.11.3.51.6: SOR header for SOR data type with value "1"

Table 9.11.3.51.1: SOR transparent container information element

SOR-MAC-I_{AUSF} (see NOTE 1), SOR-MAC-I_{UE} (see NOTE 2) and Counter_{SOR} (see NOTE 1) are coded as specified in 3GPP TS 33.501 [24].

SOR data type (octet 4, bit 1)

- 0 The SOR transparent container carries steering of roaming information.
- 1 The SOR transparent container carries acknowledgement of successful reception of the steering of roaming information.

List indication (octet 4, bit 2) (see NOTE 1 and NOTE 5)

- 0 HPLMN indication that 'no change of the "Operator Controlled PLMN Selector with Access Technology" list stored in the UE is needed and thus no list of preferred PLMN/access technology combinations is provided'
- 1 list of preferred PLMN/access technology combinations is provided

List type (octet 4, bit 3) (see NOTE 1)

- 0 The list type is a secured packet.
- 1 The list type is a "PLMN ID and access technology list".

Acknowledgement (ACK) value (octet 4, bit 4) (see NOTE 1)

- 0 acknowledgement not requested
- 1 acknowledgement requested

Additional parameters (AP) value (octet 4, bit 5)

Bit

5

- 0 Additional parameters not included
- 1 Additional parameters included (see NOTE 3)

If the SOR data type is set to value "0", the list type bit is set to value "1", and the additional parameters bit is set to value "1" then:

- the octet o is present.
- if the list indication bit is set to "0" then the PLMN ID and access technology list field and the length of PLMN ID and access technology list field are absent.
- if the list indication bit is set to "1" then the PLMN ID and access technology list field and the length of PLMN ID and access technology list field are present.

The secure packet is coded as specified in 3GPP TS 31.115 [22B]. (see NOTE 1)

The PLMN ID and access technology list consists of PLMN ID and access technology identifier and are coded as specified in 3GPP TS 31.102 [22] subclause 4.2.5. The PLMN ID and access technology identifier are provided in decreasing order of priority, i.e. PLMN ID 1 indicates highest priority and PLMN ID n indicates lowest priority. The PLMN ID and access technology list contains at minimum zero and at maximum 16 (decimal) PLMN IDs and access technology identifiers. (see NOTE 1)

ME support of SOR-CMCI indicator (MSSI) value (octet 4, bit 2) (see NOTE 2, NOTE 4)

- 0 SOR-CMCI not supported by the ME
- 1 SOR-CMCI supported by the ME

ME support of SOR-SNPN-SI indicator (MSSNPNSI) value (octet 4, bit 3) (see NOTE 2, NOTE 6)

- 0 SOR-SNPN-SI not supported by the ME
- 1 SOR-SNPN-SI supported by the ME

MS support of SOR-SNPN-SI-LS indicator (MSSNPNSILS) value (octet 4, bit 4) (see NOTE 2)

Bit

4

- 0 SOR-SNPN-SI-LS not supported by the ME
- 1 SOR-SNPN-SI-LS supported by the ME

SOR-CMCI indicator (SI) value (octet o, bit 1)

Bit

1

- 0 SOR-CMCI absent
- 1 SOR-CMCI present

If the SOR-CMCI indicator bit is set to "SOR-CMCI present", the SOR-CMCI field is present. If the SI bit is set to "SOR-CMCI absent", the SOR-CMCI field is absent.

Store SOR-CMCI in ME indicator (SSCMI) value (octet o, bit 2)
 Bit
2
 0 Do not store SOR-CMCI in ME
 1 Store SOR-CMCI in ME

SOR-CMCI (octet o+1 to octet p)
 The SOR-CMCI field is coded according to figure 9.11.3.51.7 and table 9.11.3.51.2.

SOR-SNPN-SI indicator (SSSI) value (octet o, bit 3)
 Bit
3
 0 subscribed SNPN or HPLMN indication that 'no change of the SOR-SNPN-SI stored in the UE is needed and thus no SOR-SNPN-SI is provided'
 1 SOR-SNPN-SI present

If the SSSI bit is set to "SOR-SNPN-SI present", the SOR-SNPN-SI field is present. If the SSSI bit is set to "subscribed SNPN or HPLMN indication that 'no change of the SOR-SNPN-SI stored in the UE is needed and thus no SOR-SNPN-SI is provided'", the SOR-SNPN-SI is absent.

SOR-SNPN-SI-LS indicator (SSSLI) value (octet o, bit 4)
 Bit
4
 0 SOR-SNPN-SI-LS absent
 1 SOR-SNPN-SI-LS present

If the SSSLI bit is set to "SOR-SNPN-SI-LS present", the SOR-SNPN-SI-LS field is present. If the SSSLI bit is set to "SOR-SNPN-SI-LS absent", the SOR-SNPN-SI-LS is absent.

NOTE 1: This bit or field applies for SOR header with SOR data type with value "0".
 NOTE 2: This bit or field applies for SOR header with SOR data type with value "1".
 NOTE 3: Additional parameters can be set to value "1" only when the ME supports SOR-CMCI, SOR-SNPN-SI or SOR-SNPN-SI-LS, and the list type bit is set to value "1". The ME supporting SOR-SNPN-SI-LS supports SOR-SNPN-SI as specified in 3GPP TS 23.122 [5].
 NOTE 4: The "SOR-CMCI supported by the ME" is not set by a UE compliant to an earlier release of the specification.
 NOTE 5: This bit or field applies for SOR header with list type with value "1".
 NOTE 6: The "SOR-SNPN-SI supported by the ME" may only be set by a UE which supports access to an SNPN using credentials from a credentials holder and which is not operating in SNPN access operation mode.

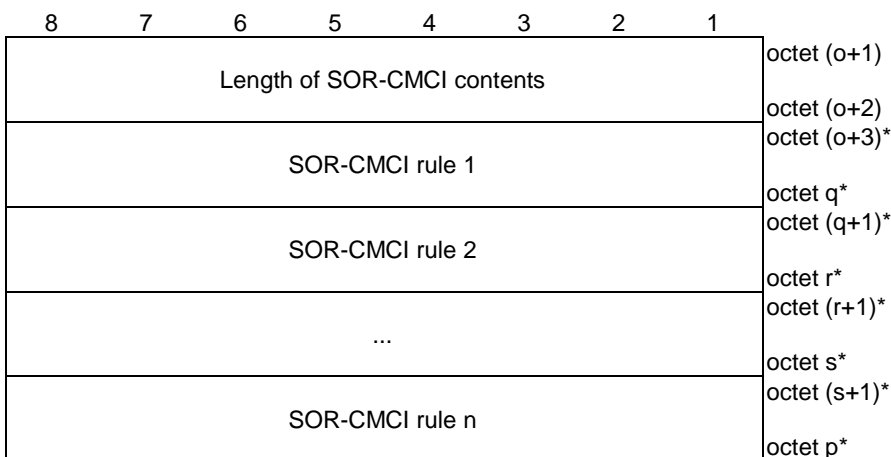

Figure 9.11.3.51.7: SOR-CMCI

Table 9.11.3.51.2: SOR-CMCI

SOR-CMCI rule:
 The SOR-CMCI rule is coded according to figure 9.11.3.51.8 and table 9.11.3.51.3.
 If the length of SOR-CMCI contents field indicates a length bigger than indicated in figure 9.11.3.51.7, receiving entity shall ignore any superfluous octets located at the end of the SOR-CMCI.

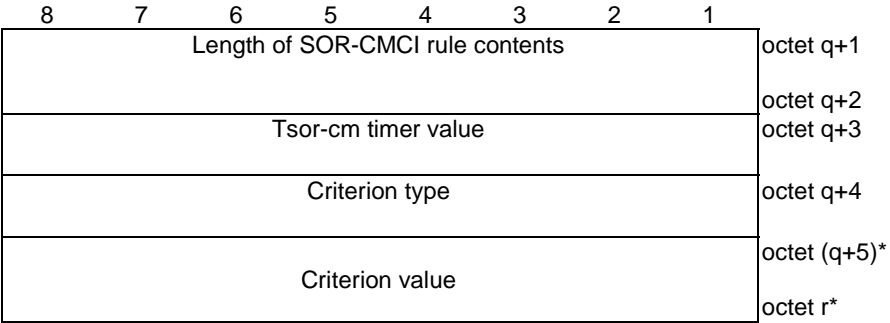

Figure 9.11.3.51.8: SOR-CMCI rule

Table 9.11.3.51.3: SOR-CMCI rule

Tsor-cm timer value
 The Tsor-cm timer value field is coded according to octet 2 of the GPRS timer information element as specified in 3GPP TS 24.008 [12] subclause 10.5.7.3 and indicates the Tsor-cm timer value. When the unit field of the Tsor-cm timer value field indicates that the timer is deactivated, the receiving entity shall consider that Tsor-cm timer value is set to the infinity value.

Criterion type
 Bits

8 7 6 5 4 3 2 1	
0 0 0 0 0 0 0 1	DNN
0 0 0 0 0 0 1 0	S-NSSAI SST
0 0 0 0 0 0 1 1	S-NSSAI SST and SD
0 0 0 0 0 1 0 0	IMS registration related signalling
0 0 0 0 0 1 0 1	MMTEL voice call
0 0 0 0 0 1 1 0	MMTEL video call
0 0 0 0 0 1 1 1	SMS over NAS or SMSoIP
0 0 0 0 1 0 0 0	SOR security check not successful
1 1 1 1 1 1 1 1	match all

All other values are spare.

The receiving entity shall ignore SOR-CMCI rule with criterion of criterion type set to a spare value.

For "DNN", the criterion value field shall be encoded as a DNN length-value pair field.

For "S-NSSAI SST", the criterion value field shall be encoded as one octet SST field.

For "S-NSSAI SST and SD", the criterion value field shall be encoded as a sequence of one octet SST field and three octets SD field. The SST field shall be transmitted first.

The DNN length-value pair field shall be encoded as a sequence of one octet DNN value length field and a DNN value field. The DNN value length field shall be transmitted first. The DNN value length field indicates the length in octets of the DNN value field. The DNN value field contains an APN as specified in 3GPP TS 23.003 [4].

The SST field contains SST of HPLMN's S-NSSAI.

The SD field contains SD of HPLMN's S-NSSAI.

For "match all", "SOR security check not successful", "IMS registration related signalling", "MMTEL voice call", "MMTEL video call", and "SMS over NAS or SMSoIP", the criterion value field is zero octets long.

If the length of SOR-CMCI rule contents field indicates a length bigger than indicated in figure 9.11.3.51.8, receiving entity shall ignore any superfluous octets located at the end of the SOR-CMCI rule.

The UE applies SOR-CMCI rules as described in 3GPP TS 23.122 [5] annex C.

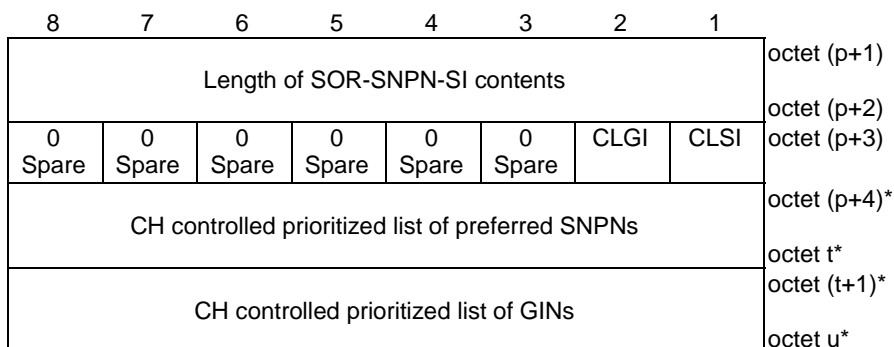

Figure 9.11.3.51.9: SOR-SNPNI-SI

Table 9.11.3.51.4: SOR-SNPNI-SI

CH controlled prioritized list of preferred SNPNS indicator (CLSI) value (octet p+3, bit 1)
 Bit
1
 0 CH controlled prioritized list of preferred SNPNS absent
 1 CH controlled prioritized list of preferred SNPNS present

If the CLSI bit is set to "CH controlled prioritized list of preferred SNPNS present", the CH controlled prioritized list of preferred SNPNS field is present. If the CLSI bit is set to "CH controlled prioritized list of preferred SNPNS absent", the CH controlled prioritized list of preferred SNPNS field is absent.

CH controlled prioritized list of GINs indicator (CLGI) value (octet p+3, bit 2)
 Bit
2
 0 CH controlled prioritized list of GINs absent
 1 CH controlled prioritized list of GINs present

If the CLGI bit is set to "CH controlled prioritized list of GINs present", the CH controlled prioritized list of GINs field is present. If the CLGI bit is set to "CH controlled prioritized list of GINs absent", the CH controlled prioritized list of GINs field is absent.

If the length of SOR-SNPNS-SI contents field indicates a length bigger than indicated in figure 9.11.3.51.9, receiving entity shall ignore any superfluous octets located at the end of the SOR-SNPNS-SI.

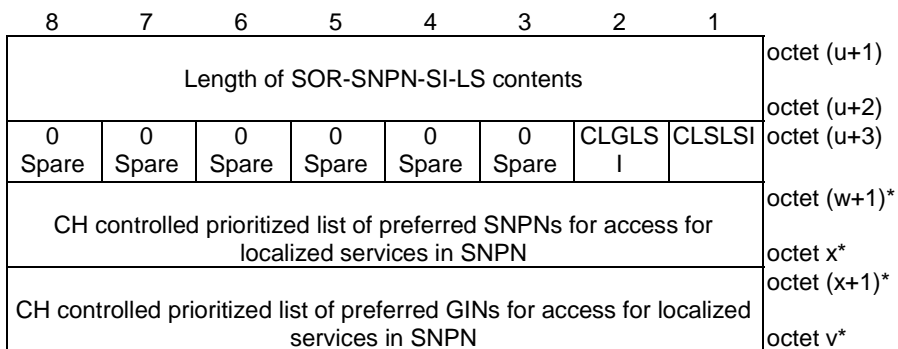

Figure 9.11.3.51.9A: SOR-SNPNS-SI-LS

Table 9.11.3.51.4A: SOR-SNPNS-SI-LS

CH controlled prioritized list of preferred SNPNs for access for localized services in SNPN indicator (CLSLSI) value (octet u+3, bit 1)
 Bit
1
 0 CH controlled prioritized list of preferred SNPNs for access for localized services in SNPN absent
 1 CH controlled prioritized list of preferred SNPNs for access for localized services in SNPN present

If the CLSLSI bit is set to " CH controlled prioritized list of preferred SNPNs for access for localized services in SNPN present", the CH controlled prioritized list of preferred SNPNs for access for localized services in SNPN field is present. If the CLSLSI bit is set to " CH controlled prioritized list of preferred SNPNs for access for localized services in SNPN absent", the CH controlled prioritized list of preferred SNPNs for access for localized services in SNPN field is absent.

CH controlled prioritized list of preferred GINs for access for localized services in SNPN indicator (CLGLSI) value (octet u+3, bit 2)
 Bit
2
 0 CH controlled prioritized list of preferred GINs for access for localized services in SNPN absent
 1 CH controlled prioritized list of preferred GINs for access for localized services in SNPN present

If the CLGLSI bit is set to " CH controlled prioritized list of preferred GINs for access for localized services in SNPN present", the CH controlled prioritized list of preferred GINs for access for localized services in SNPN field is present. If the CLGLSI bit is set to " CH controlled prioritized list of preferred GINs for access for localized services in SNPN absent", the CH controlled prioritized list of preferred GINs for access for localized services in SNPN field is absent.

If the length of SOR-SNPN-SI-LS contents field indicates a length bigger than indicated in figure 9.11.3.51.9A, receiving entity shall ignore any superfluous octets located at the end of the SOR-SNPN-SI.

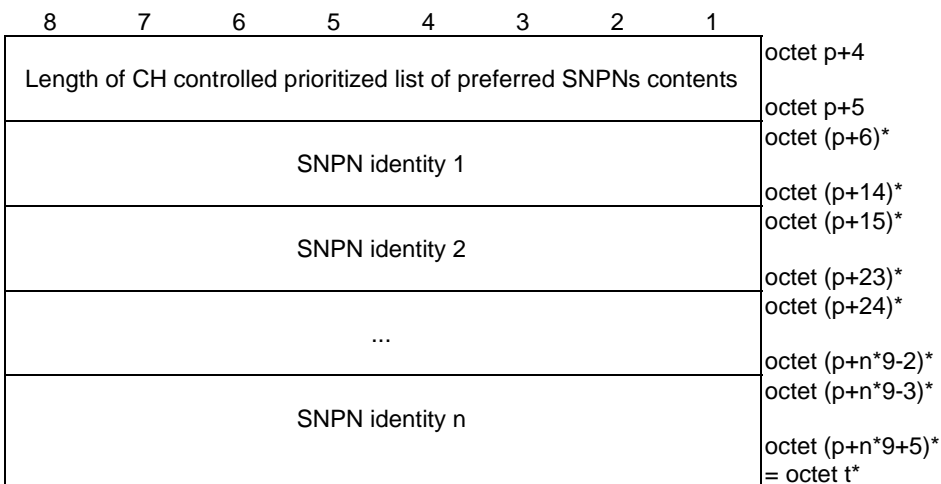

Figure 9.11.3.51.10: CH controlled prioritized list of preferred SNPNs

8	7	6	5	4	3	2	1	
Length of CH controlled prioritized list of preferred SNPNs for access for localized services in SNPN contents								octet u+1
								octet u+2
SNPN info 1								octet (u+3)*
SNPN info 2								octet u1*
...								octet (u1+1)*
SNPN info n								octet u2*
								octet (u2+1)*
								octet u3*
								octet (u3+1)*
								octet v*

Figure 9.11.3.51.10A: CH controlled prioritized list of preferred SNPNs for access for localized services in SNPN

8	7	6	5	4	3	2	1	
Length of SNPN info								octet u+3
								octet u+4
0	0	0	0	0	LVII	LAI	Time Ind	octet u+5
SNPN identity								octet (u+6)*
Time validity information								octet (u+14)*
								octet (u+15)*
Location assistance information								octet s*
								octet (s+1)*
Location validity information								octet q*
								octet (q+1)*
								octet u1*

Figure 9.11.3.51.10B: SNPN info

8	7	6	5	4	3	2	1	
MCC digit 2				MCC digit 1				octet p+15
MNC digit 3				MCC digit 3				octet p+16
MNC digit 2				MNC digit 1				octet p+17
0	0	0	0	NID assignment mode				octet p+18
Spare				Spare				
NID value digit 2				NID value digit 1				octet p+19
NID value digit 4				NID value digit 3				octet p+20
NID value digit 6				NID value digit 5				octet p+21
NID value digit 8				NID value digit 7				octet p+22
NID value digit 10				NID value digit 9				octet p+23

Figure 9.11.3.51.11: SNPN identity

8	7	6	5	4	3	2	1	
Number of time periods								octet (p+18) or (t+15)
Time period 1								octet (p+19) or (t+16)
Time period 2								octet (p+34) or (t+31)
Time period 2								octet (p+35)* or (t+32)*
Time period 2								octet (p+50)* or (t+47)*
...								octet (p+51)* or (t+48)*
Time period o								octet (p+2+o*16)* or (t-1+o*16)*
Time period o								octet (p+3+o*16)* or (t+o*16)
Time period o								octet (p+18+o*16)* or (t+15+o*16) = octet s*

Figure 9.11.3.51.11A: Time validity information

8	7	6	5	4	3	2	1	
0	0	0	0	0	TAISI	TAIPI	GADI	octet (s+1)
Spare	Spare	Spare	Spare	Spare				octet (s+2)*
Geographical area descriptions								octet s3*
Tracking area information of PLMNs								octet (s3+1)*
Tracking area information of SNPNs								octet s4*
Tracking area information of SNPNs								octet (s4+1)*
Tracking area information of SNPNs								octet s5* = octet q*

Figure 9.11.3.51.11B: Location assistance information

8	7	6	5	4	3	2	1	
Number of geographical area descriptions								octet (s+2)
Type of shape 1								octet (s+3)
Shape description 1								octet (s+4)
...								octet s1
Type of shape n								octet (s1+1)*
Shape description n								octet s2*
Shape description n								octet (s2+1)*
Shape description n								octet (s2+2)*
Shape description n								octet s3*

Figure 9.11.3.51.11C: Geographical area descriptions

8	7	6	5	4	3	2	1	
Number of tracking area information of PLMNs								octet s3+1
Tracking area information of PLMN 1								octet (s3+2)
Tracking area information of PLMN 2								octet s8 octet (s8+1)*
...								octet s9* octet (s9+1)*
Tracking area information of PLMN n								octet s10* octet (s10+1)* octet s4*

Figure 9.11.3.51.11D: Tracking area information of PLMNs

8	7	6	5	4	3	2	1	
MCC digit 2				MCC digit 1				octet s8+1
MNC digit 3				MCC digit 3				octet s8+2
MNC digit 2				MNC digit 1				octet s8+3
TAC list								octet s8+4 octet s9

Figure 9.11.3.51.11E: Tracking area information of PLMN

8	7	6	5	4	3	2	1	
Number of TACs								octet s14 = octet s8+4 or octet s11+10
TAC 1								octet s14+1 octet s14+3
TAC 2								octet (s14+4)*
...								octet (s14+6)*
TAC m								octet (s14+m*3-2)* octet (s14+m*3)* = octet s9 or octet s12

Figure 9.11.3.51.11F: TAC list

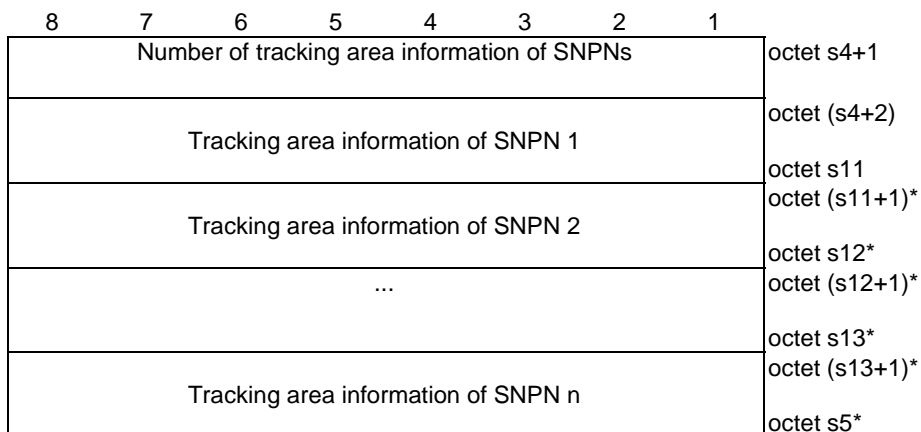

Figure 9.11.3.51.11G: Tracking area information of SNPNs

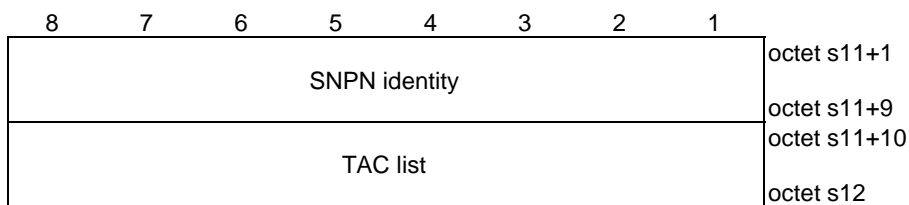

Figure 9.11.3.51.11H: Tracking area information of SNPN

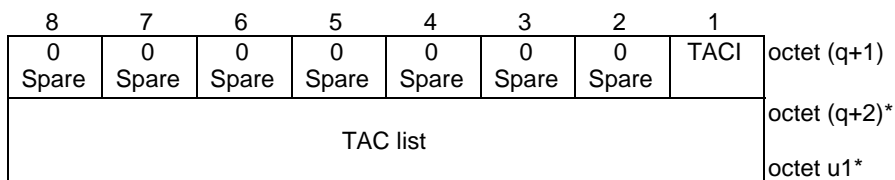

Figure 9.11.3.51.11I: Location validity information

Table 9.11.3.51.5: CH controlled prioritized list of preferred SNPNs and CH controlled prioritized list of preferred SNPNs for access for localized services in SNPN

Mobile country code (MCC):	
The MCC field is coded as in ITU-T Recommendation E.212 [42], annex A.	
Mobile network code (MNC):	
The coding of MNC field is the responsibility of each administration but BCD coding shall be used. The MNC shall consist of 2 or 3 digits. If a network operator decides to use only two digits in the MNC, MNC digit 3 shall be coded as "1111".	
NID assignment mode (see NOTE 1)	
NID assignment mode is coded as specified in 3GPP TS 23.003 [4].	
NID value (see NOTE 1)	
NID value is coded as specified in 3GPP TS 23.003 [4].	
Time indication (bit1 of octet u+5)	
Bit	
1	
0	Time validity information not included
1	Time validity information is included
Location assistance information indicator (LAI) (bit 2 of octet u+5)	
Bit	
2	
0	Location assistance information not included
1	Location assistance information included
Location validity information indicator (LVII) (bit 3 of octet u+5)	
Bit	
3	
0	Location validity information not included
1	Location validity information included
Tracking area code list indicator (TACI) (bit 1 of octet q+1) (see NOTE 2)	
Bit	
2	
0	TAC list not included
1	TAC list included
Geographical area descriptions indicator (GADI) (bit 1 of octet s+1)	
Bit	
1	
0	Geographical area descriptions not included
1	Geographical area descriptions included
Tracking area information of PLMNs (TAIPI) (bit 2 of octet s+1)	
Bit	
2	
0	Tracking area information of PLMNs not included
1	Tracking area information of PLMNs included
Tracking area information of SNPNs (TAISI) (bit 3 of octet s+1)	
Bit	
3	
0	Tracking area information of SNPNs not included
1	Tracking area information of SNPNs included
Location assistance information	
Location assistance information field contains the geographical area descriptions field, the tracking area information of PLMNs field, the tracking area information of SNPNs field. or any combination of them.	
Time period	
The time period field is coded as the route selection descriptor component value field for "time window type" specified in 3GPP TS 24.526 [19] table 5.2.1.	
Type of shape	
Type of shape is coded as specified in Table 2a in 3GPP TS 23.032 [4B].	

<p>Shape description Shape description is coded as specified in subclause 7.3 in 3GPP TS 23.032 [4B].</p> <p>Tracking area information of PLMNs Tracking area information of PLMNs field contains one or more tracking area information of PLMN fields.</p> <p>Tracking area information of PLMN Tracking area information of PLMN field contains an MCC and MNC of a PLMN identity and a TAC list field containing one or more tracking area code fields, each indicating a TAC of a PLMN identified by the PLMN identity.</p> <p>Tracking area information of SNPNs Tracking area information of SNPNs field contains one or more tracking area information of SNPN fields. If the tracking area information of SNPNs field is included in a location assistance information field of an SNPN info field, the SNPN identity field in each tracking area information of SNPN field of the tracking area information of SNPNs field is different from the SNPN identity field in the SNPN info field.</p> <p>Tracking area information of SNPN Tracking area information of SNPN field contains SNPN identity and a TAC list containing one or more tracking area code fields, each indicating a TAC of an SNPN identified by the SNPN identity.</p> <p>Tracking area code (TAC) In the TAC field bit 8 of the first octet is the most significant bit and bit 1 of third octet the least significant bit. The coding of the tracking area code is the responsibility of each administration. Coding using full hexadecimal representation may be used. The tracking area code consists of 3 octets.</p>
<p>NOTE 1: NID coding deviates from coding of value part of NID IE as specified in subclause 9.2.7 of 3GPP TS 24.502 [18], coding of the NID field of the SNPN list IE as specified in subclause 9.11.3.92, and coding of the NID field of the SNPN list with trusted 5G connectivity IE as specified in subclause H.2.4.7 of 3GPP TS 24.302 [16].</p> <p>NOTE 2: If the location validity information indicator is set to 'Location validity information included' but TAC list indicator is set to 'TAC list not included', the UE shall ignore the location validity information.</p>

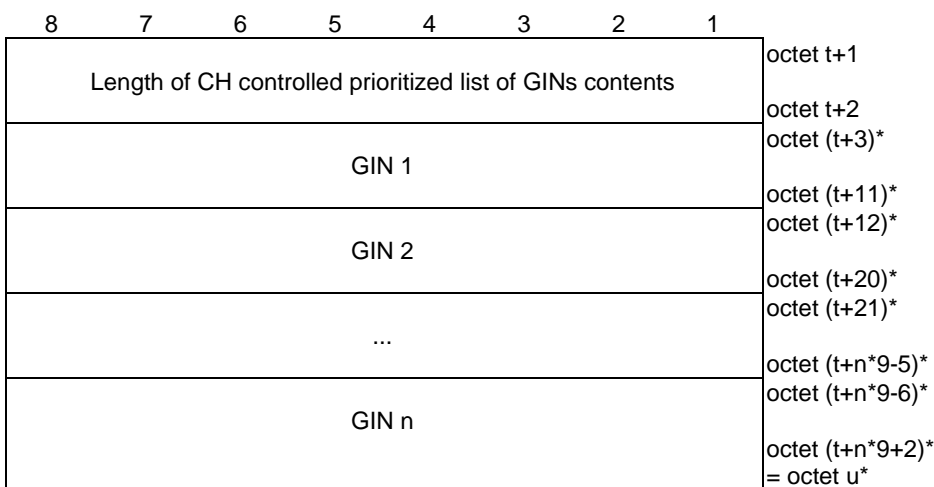

Figure 9.11.3.51.12: CH controlled prioritized list of GINs

8	7	6	5	4	3	2	1	
Length of CH controlled prioritized list of preferred GINs for access for localized services in SNPN contents								octet v+1
								octet v+2
GIN info 1								octet (v+3)*
GIN info 2								octet v1*
GIN info 2								octet (v1+1)*
...								octet v2*
GIN info n								octet (v2+1)*
GIN info n								octet v3*
GIN info n								octet (v3+1)*
GIN info n								octet w*

Figure 9.11.3.51.12A: CH controlled prioritized list of preferred GINs for access for localized services in SNPN

8	7	6	5	4	3	2	1	
Length of GIN info								octet v+3
								octet v+4
0	0	0	0	0	LVII	LAI	Time Ind	octet v+5
GIN								octet (v+6)*
GIN								octet (v+14)*
Time validity information								octet (v+15)*
Time validity information								octet s*
Location assistance information								octet (s+1)*
Location assistance information								octet q*
Location validity information								octet (q+1)*
Location validity information								octet v1*

Figure 9.11.3.51.12B: GIN info

8	7	6	5	4	3	2	1	
MCC digit 2				MCC digit 1				octet t+12
MNC digit 3				MCC digit 3				octet t+13
MNC digit 2				MNC digit 1				octet t+14
0	0	0	0	NID assignment mode				octet t+15
Spare	Spare	Spare	Spare	NID assignment mode				octet t+15
NID value digit 2				NID value digit 1				octet t+16
NID value digit 4				NID value digit 3				octet t+17
NID value digit 6				NID value digit 5				octet t+18
NID value digit 8				NID value digit 7				octet t+19
NID value digit 10				NID value digit 9				octet t+20

Figure 9.11.3.51.13: GIN

Table 9.11.3.51.6: CH controlled prioritized list of GINs and CH controlled prioritized list of preferred GINs for access for localized services in SNPN

<p>Mobile country code (MCC): The MCC field is coded as in ITU-T Recommendation E.212 [42], annex A.</p> <p>Mobile network code (MNC): The coding of MNC field is the responsibility of each administration but BCD coding shall be used. The MNC shall consist of 2 or 3 digits. If a network operator decides to use only two digits in the MNC, MNC digit 3 shall be coded as "1111".</p> <p>NID assignment mode (see NOTE) NID assignment mode is coded as specified in 3GPP TS 23.003 [4].</p> <p>NID value (see NOTE) NID value is coded as specified in 3GPP TS 23.003 [4].</p> <p>Time indication (bit1 of octet v+5) Bit 1 0 Time validity information not included 1 Time validity information included</p> <p>Location assistance information indicator (LAI) (bit 2 of octet v+5) Bit 2 0 Location assistance information not included 1 Location assistance information included</p> <p>Location validity information indicator (LVII) (bit 3 of octet v+5) Bit 3 0 Location validity information not included 1 Location validity information included</p> <p>Time period The time period field is coded as the route selection descriptor component value field for "time window type" specified in 3GPP TS 24.526 [19] table 5.2.1.</p> <p>Location assistance information (oct(s+1)* to (q)*) The Location assistance information is coded according to Figure 9.11.3.51.11B and Table 9.11.3.51.5.</p> <p>NOTE: NID coding deviates from coding of value part of NID IE as specified in subclause 9.2.7 of 3GPP TS 24.502 [18], coding of the NID field of the SNPN list IE as specified in subclause 9.11.3.92, and coding of the NID field of the SNPN list with trusted 5G connectivity IE as specified in subclause H.2.4.7 of 3GPP TS 24.302 [16].</p>
--

9.11.3.51A Supported codec list

See subclause 10.5.4.32 in 3GPP TS 24.008 [12].

9.11.3.52 Time zone

See subclause 10.5.3.8 in 3GPP TS 24.008 [12].

9.11.3.53 Time zone and time

See subclause 10.5.3.9 in 3GPP TS 24.008 [12].

9.11.3.53A UE parameters update transparent container

The purpose of the UE parameters update transparent container when sent from the network to the UE is to provide UE parameters update data, optional acknowledgement request and optional re-registration request. The purpose of the UE parameters update transparent container when sent from the UE to the network is to indicate the UE acknowledgement of successful reception of the UE parameters update transparent container.

The UE parameters update transparent container information element is coded as shown in figure 9.11.3.53A.1, figure 9.11.3.53A.2, figure 9.11.3.53A.3, figure 9.11.3.53A.4, figure 9.11.3.53A.4B, figure 9.11.3.53A.5, figure 9.11.3.53A.6, figure 9.11.3.53A.7 and table 9.11.3.53A.1.

The UE parameters update transparent container is a type 6 information element with a minimum length of 20 octets.

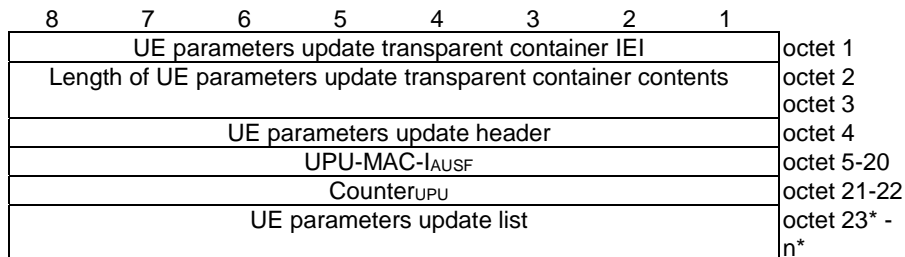

Figure 9.11.3.53A.1: UE parameters update transparent container information element for UE parameters update data type with value "0"

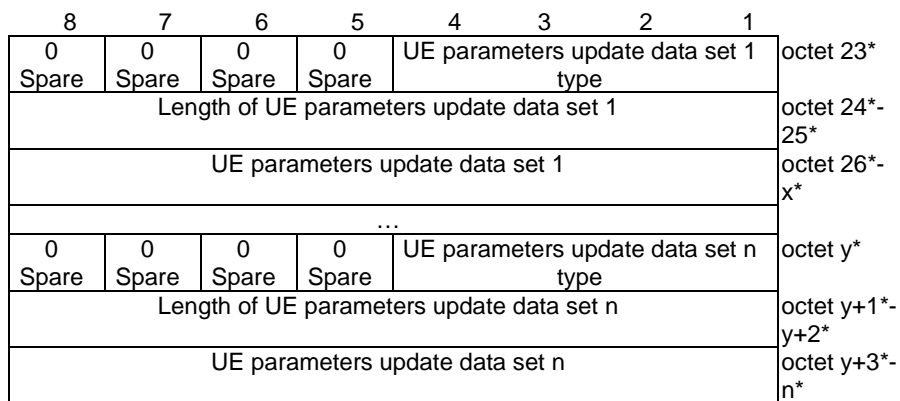

Figure 9.11.3.53A.2: UE parameters update list

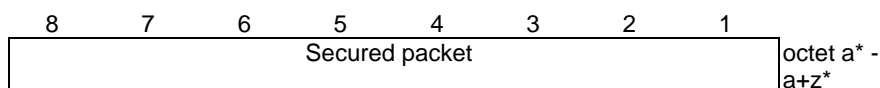

Figure 9.11.3.53A.3: UE parameters update data set for UE parameters update data set type with value "0001"

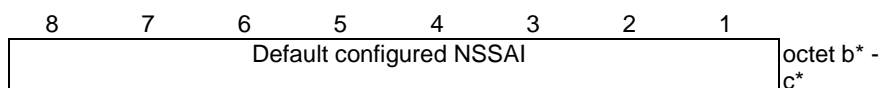

Figure 9.11.3.53A.4: UE parameters update data set for UE parameters update data set type with value "0010"

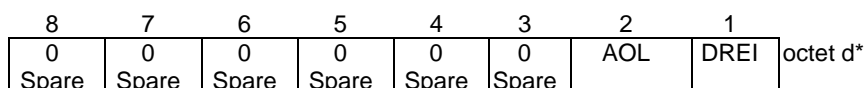

Figure 9.11.3.53A.4A: UE parameters update data set for UE parameters update data set type with value "0011"

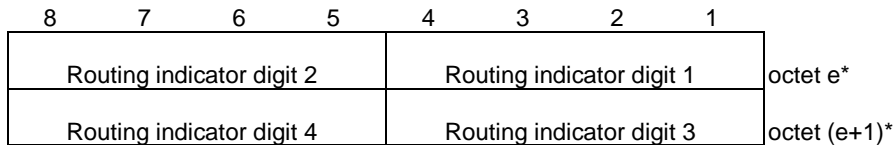

Figure 9.11.3.53A.4B: UE parameters update data set for UE parameters update data set type with value "0100"

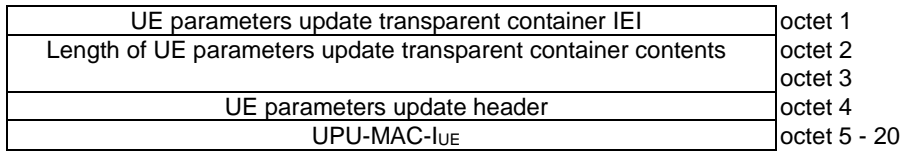

Figure 9.11.3.53A.5: UE parameters update transparent container information element for UE parameters update data type with value "1"

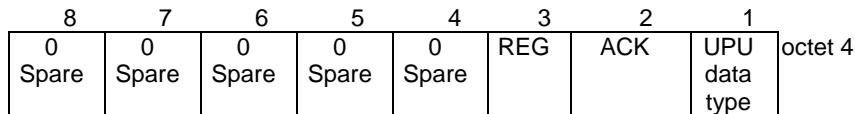

Figure 9.11.3.53A.6: UE parameters update header for UE parameters update data type with value "0"

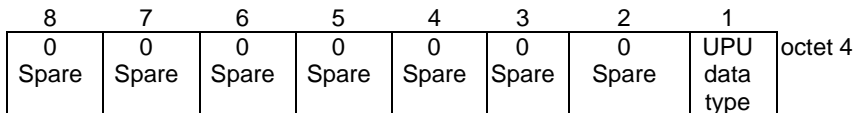

Figure 9.11.3.53A.7: UE parameters update header for UE parameters update data type with value "1"

Table 9.11.3.53A.1: UE parameters update transparent container information element

<p>UPU-MAC-I_{AUSF}, UPU-MAC-I_{UE} and Counter_{UPU} are coded as specified in 3GPP TS 33.501 [24]</p> <p>UPU data type (octet 4, bit 1)</p> <p>0 The UE parameters update transparent container carries a UE parameters update list</p> <p>1 The UE parameters update transparent container carries an acknowledgement of successful reception of a UE parameters update list</p> <p>Acknowledgement (ACK) value (octet 4, bit 2)</p> <p>0 acknowledgement not requested</p> <p>1 acknowledgement requested</p> <p>Re-registration (REG) value (octet 4, bit 3)</p> <p>0 re-registration not requested</p> <p>1 re-registration requested</p> <p>UE parameters update data set type</p> <p>Bits</p> <p>4 3 2 1</p> <p>0 0 0 1 Routing indicator update data</p> <p>0 0 1 0 Default configured NSSAI update data</p> <p>0 0 1 1 Disaster roaming information update data</p> <p>0 1 0 0 ME routing indicator update data</p> <p>All other values are reserved</p> <p>Disaster Roaming Enabled Indication (DREI) value (octet d*, bit 1)</p> <p>0 Disaster roaming is disabled in the UE</p> <p>1 Disaster roaming is enabled in the UE</p> <p>Indication of 'applicability of "lists of PLMN(s) to be used in disaster condition" provided by a VPLMN' (AOL) value (octet d*, bit 2)</p> <p>0 false</p> <p>1 true</p> <p>The secured packet is coded as specified in 3GPP TS 31.115 [22B].</p> <p>The default configured NSSAI is encoded as the value part of the NSSAI IE (see subclause 9.11.3.37).</p> <p>Routing indicator</p> <p>Routing indicator is encoded as the routing indicator field of the 5GS mobile identity IE (see subclause 9.11.3.4).</p> <p>NOTE: When the routing indicator is updated, if the SNPN uses the EAP based primary authentication and key agreement procedure using the EAP-AKA' or the 5G AKA based primary authentication and key agreement procedure, then UE parameter update data set type is set to "routing indicator update data", otherwise, UE parameter update data set type is set to "ME routing indicator update data".</p>

9.11.3.54 UE security capability

The UE security capability information element is used by the UE and by the network to indicate which security algorithms are supported by the UE in N1 mode for NAS security as well as which security algorithms are supported over NR and E-UTRA connected to 5GCN for AS security.

The UE security capability information element is coded as shown in figure 9.11.3.54.1 and table 9.11.3.54.1.

The UE security capability is a type 4 information element with a minimum length of 4 octets and a maximum length of 10 octets.

Octets 5 to 10 are optional. If octet 5 is included, then also octet 6 shall be included.

If the UE does not support any security algorithm for AS security over E-UTRA connected to 5GCN, it shall not include octets 5 and 6. The UE shall not include octets 7 to 10.

If the UE does not support any security algorithm for AS security over E-UTRA connected to 5GCN, and if the network includes octets 7 to 10, then the network shall also include octets 5 to 6.

If the network includes octet 7, then it shall include also octet 8. If the network includes octet 9, then it shall include also octet 10.

8 7 6 5 4 3 2 1								
UE security capability IEI								octet 1
Length of UE security capability contents								octet 2
5G- EA0	128- 5G- EA1	128- 5G- EA2	128- 5G- EA3	5G- EA4	5G- EA5	5G- EA6	5G- EA7	octet 3
5G-IA0	128- 5G-IA1	128- 5G-IA2	128- 5G-IA3	5G-IA4	5G-IA5	5G-IA6	5G-IA7	octet 4
EEA0	128- EEA1	128- EEA2	128- EEA3	EEA4	EEA5	EEA6	EEA7	octet 5*
EIA0	128- EIA1	128- EIA2	128- EIA3	EIA4	EIA5	EIA6	EIA7	octet 6*
0	0	0	0	0	0	0	0	octet 7* -10*
Spare								

Figure 9.11.3.54.1: UE security capability information element

Table 9.11.3.54.1: UE security capability information element

5GS encryption algorithms supported (see NOTE 1) (octet 3)	
5GS encryption algorithm 5G-EA0 supported (octet 3, bit 8)	
0	5GS encryption algorithm 5G-EA0 not supported
1	5GS encryption algorithm 5G-EA0 supported
5GS encryption algorithm 128-5G-EA1 supported (octet 3, bit 7)	
0	5GS encryption algorithm 128-5G-EA1 not supported
1	5GS encryption algorithm 128-5G-EA1 supported
5GS encryption algorithm 128-5G-EA2 supported (octet 3, bit 6)	
0	5GS encryption algorithm 128-5G-EA2 not supported
1	5GS encryption algorithm 128-5G-EA2 supported
5GS encryption algorithm 128-5G-EA3 supported (octet 3, bit 5)	
0	5GS encryption algorithm 128-5G-EA3 not supported
1	5GS encryption algorithm 128-5G-EA3 supported
5GS encryption algorithm 5G-EA4 supported (octet 3, bit 4)	
0	5GS encryption algorithm 5G-EA4 not supported
1	5GS encryption algorithm 5G-EA4 supported
5GS encryption algorithm 5G-EA5 supported (octet 3, bit 3)	
0	5GS encryption algorithm 5G-EA5 not supported
1	5GS encryption algorithm 5G-EA5 supported
5GS encryption algorithm 5G-EA6 supported (octet 3, bit 2)	
0	5GS encryption algorithm 5G-EA6 not supported
1	5GS encryption algorithm 5G-EA6 supported
5GS encryption algorithm 5G-EA7 supported (octet 3, bit 1)	
0	5GS encryption algorithm 5G-EA7 not supported
1	5GS encryption algorithm 5G-EA7 supported
5GS integrity algorithms supported (see NOTE 2) (octet 4)	
5GS integrity algorithm 5G-IA0 supported (octet 4, bit 8)	
0	5GS integrity algorithm 5G-IA0 not supported
1	5GS integrity algorithm 5G-IA0 supported
5GS integrity algorithm 128-5G-IA1 supported (octet 4, bit 7)	
0	5GS integrity algorithm 128-5G-IA1 not supported
1	5GS integrity algorithm 128-5G-IA1 supported
5GS integrity algorithm 128-5G-IA2 supported (octet 4, bit 6)	
0	5GS integrity algorithm 128-5G-IA2 not supported
1	5GS integrity algorithm 128-5G-IA2 supported
5GS integrity algorithm 128-5G-IA3 supported (octet 4, bit 5)	
0	5GS integrity algorithm 128-5G-IA3 not supported
1	5GS integrity algorithm 128-5G-IA3 supported
5GS integrity algorithm 5G-IA4 supported (octet 4, bit 4)	
0	5GS integrity algorithm 5G-IA4 not supported
1	5GS integrity algorithm 5G-IA4 supported
5GS integrity algorithm 5G-IA5 supported (octet 4, bit 3)	
0	5GS integrity algorithm 5G-IA5 not supported
1	5GS integrity algorithm 5G-IA5 supported
5GS integrity algorithm 5G-IA6 supported (octet 4, bit 2)	
0	5GS integrity algorithm 5G-IA6 not supported
1	5GS integrity algorithm 5G-IA6 supported
5GS integrity algorithm 5G-IA7 supported (octet 4, bit 1)	
0	5GS integrity algorithm 5G-IA7 not supported
1	5GS integrity algorithm 5G-IA7 supported

EPS encryption algorithms supported (see NOTE 3) (octet 5)

EPS encryption algorithm EEA0 supported (octet 5, bit 8)

0 EPS encryption algorithm EEA0 not supported
1 EPS encryption algorithm EEA0 supported

EPS encryption algorithm 128-EEA1 supported (octet 5, bit 7)

0 EPS encryption algorithm 128-EEA1 not supported
1 EPS encryption algorithm 128-EEA1 supported

EPS encryption algorithm 128-EEA2 supported (octet 5, bit 6)

0 EPS encryption algorithm 128-EEA2 not supported
1 EPS encryption algorithm 128-EEA2 supported

EPS encryption algorithm 128-EEA3 supported (octet 5, bit 5)

0 EPS encryption algorithm 128-EEA3 not supported
1 EPS encryption algorithm 128-EEA3 supported

EPS encryption algorithm EEA4 supported (octet 5, bit 4)

0 EPS encryption algorithm EEA4 not supported
1 EPS encryption algorithm EEA4 supported

EPS encryption algorithm EEA5 supported (octet 5, bit 3)

0 EPS encryption algorithm EEA5 not supported
1 EPS encryption algorithm EEA5 supported

EPS encryption algorithm EEA6 supported (octet 5, bit 2)

0 EPS encryption algorithm EEA6 not supported
1 EPS encryption algorithm EEA6 supported

EPS encryption algorithm EEA7 supported (octet 5, bit 1)

0 EPS encryption algorithm EEA7 not supported
1 EPS encryption algorithm EEA7 supported

EPS integrity algorithms supported (see NOTE 4) (octet 6)

EPS integrity algorithm EIA0 supported (octet 6, bit 8)

0 EPS integrity algorithm EIA0 not supported
1 EPS integrity algorithm EIA0 supported

EPS integrity algorithm 128-EIA1 supported (octet 6, bit 7)

0 EPS integrity algorithm 128-EIA1 not supported
1 EPS integrity algorithm 128-EIA1 supported

EPS integrity algorithm 128-EIA2 supported (octet 6, bit 6)

0 EPS integrity algorithm 128-EIA2 not supported
1 EPS integrity algorithm 128-EIA2 supported

EPS integrity algorithm 128-EIA3 supported (octet 6, bit 5)

0 EPS integrity algorithm 128-EIA3 not supported
1 EPS integrity algorithm 128-EIA3 supported

EPS integrity algorithm EIA4 supported (octet 6, bit 4)

0 EPS integrity algorithm EIA4 not supported
1 EPS integrity algorithm EIA4 supported

EPS integrity algorithm EIA5 supported (octet 6, bit 3)

0 EPS integrity algorithm EIA5 not supported
1 EPS integrity algorithm EIA5 supported

EPS integrity algorithm EIA6 supported (octet 6, bit 2)

0 EPS integrity algorithm EIA6 not supported
1 EPS integrity algorithm EIA6 supported

EPS integrity algorithm EIA7 supported (octet 6, bit 1)

0 EPS integrity algorithm EIA7 not supported
1 EPS integrity algorithm EIA7 supported

For the UE not supporting any security algorithm for AS security over E-UTRA connected to 5GCN, all bits in octets 5 to 10 are spare and shall be ignored, if the respective octet is received with the information element.
 For the UE supporting at least one security algorithm for AS security over E-UTRA connected to 5GCN all bits in octets 7 to 10 are spare and shall be ignored, if the respective octet is received with the information element.
 If the AMF receives any of the octets 7 to 10 (NOTE 5), it shall store the octets as received and include them when sending the UE security capability information element to the UE.

NOTE 1: The code points in octet 3 are used to indicate support for 5GS encryption algorithms for NAS security in N1 mode and support for 5GS encryption algorithms for AS security over NR.
 NOTE 2: The code points in octet 4 are used to indicate support for 5GS integrity algorithms for NAS security in N1 mode and support for 5GS integrity algorithms for AS security over NR.
 NOTE 3: The code points in octet 5 are used to indicate support for EPS encryption algorithms for AS security over E-UTRA connected to 5GCN.
 NOTE 4: The code points in octet 6 are used to indicate support for EPS integrity algorithms for AS security over E-UTRA connected to 5GCN.
 NOTE 5: The AMF can receive this information element also from another AMF or MME during N1 mode to N1 mode or S1 mode to N1 mode handover preparation.

9.11.3.55 UE's usage setting

The purpose of the UE's usage setting information element is to provide the network with the UE's usage setting as defined in 3GPP TS 24.301 [15]. The network uses the UE's usage setting to select the RFSP index.

The UE's usage setting information element is coded as shown in figure 9.11.3.55.1 and table 9.11.3.55.1.

The UE's usage setting is a type 4 information element with a length of 3 octets.

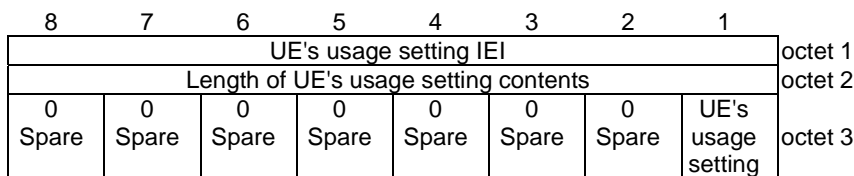

Figure 9.11.3.55.1: UE's usage setting information element

Table 9.11.3.55.1: UE's usage setting information element

UE's usage setting (octet 3, bit 1)	
0	voice centric
1	data centric
All other bits in the octet 3 are spare and shall be coded as zero,	

9.11.3.56 UE status

The purpose of the UE status information element is to provide the network with information concerning aspects of the current UE registration status which is used for interworking with EPS.

The UE status information element is coded as shown in figure 9.11.3.56.1 and table 9.11.3.56.1.

The UE status is a type 4 information element with a length of 3 octets.

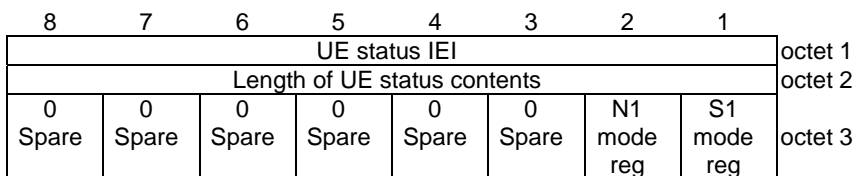

Figure 9.11.3.56.1: UE status information element

Table 9.11.3.56.1: UE status information element

EMM registration status (S1 mode reg) (octet 3, bit 1)	
0	UE is not in EMM-REGISTERED state
1	UE is in EMM-REGISTERED state
5GMM registration status (N1 mode reg) (octet 3, bit 2)	
0	UE is not in 5GMM-REGISTERED state
1	UE is in 5GMM-REGISTERED state
All other bits in the octet 3 are spare and shall be coded as zero.	

9.11.3.57 Uplink data status

The purpose of the Uplink data status information element is to indicate to the network which preserved PDU session(s) have uplink data pending or which preserved PDU session(s) are associated with active multicast MBS session(s).

The Uplink data status information element is coded as shown in figure 9.11.3.57.1 and table 9.11.3.57.1.

The Uplink data status information element is a type 4 information element with minimum length of 4 octets a maximum length of 34 octets.

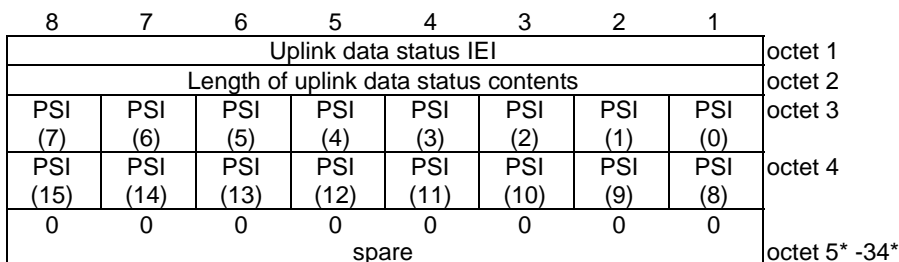

Figure 9.11.3.57.1: Uplink data status information element

Table 9.11.3.57.1: Uplink data status information element

<p>PSI(x) shall be coded as follows:</p> <p>PSI(0): Bit 1 of octet 3 is spare and shall be coded as zero.</p> <p>PSI(1) – PSI(15): 0 indicates that no uplink data are pending for the corresponding PDU session identity or the PDU session is in PDU SESSION INACTIVE state or is in PDU SESSION ACTIVE state with user-plane resources already established. 1 indicates that uplink data are pending for the corresponding PDU session identity and the user-plane resources for the corresponding PDU session are not established, or the UE has active multicast MBS session(s) associated with the corresponding PDU session.</p> <p>All bits in octet 5 to 34 are spare and shall be coded as zero, if the respective octet is included in the information element.</p>
--

- 9.11.3.58 Void
- 9.11.3.59 Void
- 9.11.3.60 Void
- 9.11.3.61 Void
- 9.11.3.62 Void
- 9.11.3.63 Void
- 9.11.3.64 Void
- 9.11.3.65 Void
- 9.11.3.66 Void
- 9.11.3.67 Void

9.11.3.68 UE radio capability ID

The purpose of the UE radio capability ID information element is to carry a UE radio capability ID.

The UE radio capability ID information element is coded as shown in figure 9.11.3.68.1 and table 9.11.3.68.1.

The UE radio capability ID is a type 4 information element with a length of n octets.

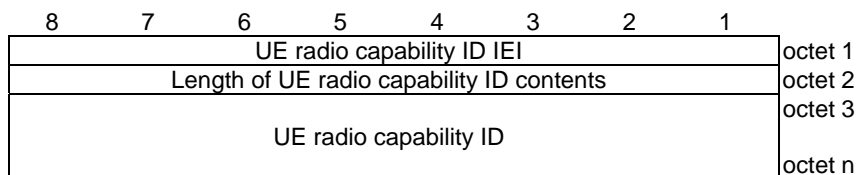

Figure 9.11.3.68.1: UE radio capability ID information element

Table 9.11.3.68.1: UE radio capability ID information element

<p>UE radio capability ID (octets 3 to n)</p> <p>The UE radio capability ID contents contain the UE radio capability ID as specified in 3GPP TS 23.003 [4], with each hexadecimal digit coded over 4 bits, starting with the first hexadecimal digit coded in bits 4 to 1 of octet 3, the second hexadecimal digit coded in bits 8 to 5 of octet 3, and so on. If the UE radio capability ID contains an odd number of hexadecimal digits, bits 8 to 5 of the last octet (octet n) shall be coded as "1111".</p>
--

9.11.3.69 UE radio capability ID deletion indication

The purpose of the UE radio capability ID deletion indication information element is to indicate to the UE that deletion of UE radio capability IDs is requested.

The UE radio capability ID deletion indication is a type 1 information element.

The UE radio capability ID deletion indication information element is coded as shown in figure 9.11.3.69.1 and table 9.11.3.69.1.

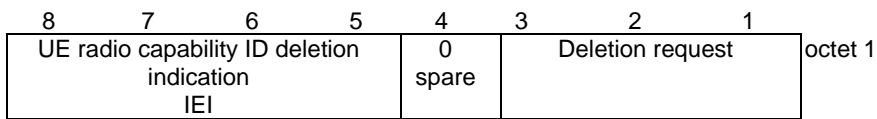

Figure 9.11.3.69.1: UE radio capability ID deletion indication information element

Table 9.11.3.69.1: UE radio capability ID deletion indication information element

Deletion requested (octet 1)		
Bits		
3	2	1
0 0 0	UE radio capability ID deletion not requested	
0 0 1	Network-assigned UE radio capability IDs deletion requested	
All other values are unused and shall be interpreted as "UE radio capability ID deletion not requested", if received by the UE.		

9.11.3.70 Truncated 5G-S-TMSI configuration

The purpose of the Truncated 5G-S-TMSI configuration information element is to provide the size of the components of the truncated 5G-S-TMSI to the UE in NB-N1 mode to create the truncated 5G-S-TMSI.

The Truncated 5G-S-TMSI configuration information element is coded as shown in figure 9.11.3.70.1 and table 9.11.3.70.1.

The Truncated 5G-S-TMSI configuration is a type 4 information element with 3 octets length.

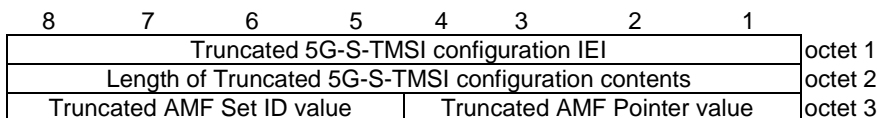

Figure 9.11.3.70.1: Truncated 5G-S-TMSI configuration information element

Table 9.11.3.70.1: Truncated 5G-S-TMSI configuration information element

Truncated AMF Pointer value (bits 4 to 1 of octet 3)			
This field represents the size of the least significant bits of the AMF Pointer.			
Bits			
4	3	2	1
0	0	0	0
reserved			
0	0	0	1
1 least significant bit of the AMF Pointer			
0	0	1	0
2 least significant bits of the AMF Pointer			
0	0	1	1
3 least significant bits of the AMF Pointer			
0	1	0	0
4 least significant bits of the AMF Pointer			
0	1	0	1
5 least significant bits of the AMF Pointer			
0	1	1	0
6 least significant bits of the AMF Pointer			
All other values shall be interpreted as "6 least significant bits of the AMF Pointer" by this version of the protocol.			
Truncated AMF Set ID value (bits 8 to 5 of octet 3)			
This field represents the size of the least significant bits of the AMF Set ID.			
Bits			
4	3	2	1
0	0	0	0
reserved			
0	0	0	1
1 least significant bit of the AMF Set ID			
0	0	1	0
2 least significant bits of the AMF Set ID			
0	0	1	1
3 least significant bits of the AMF Set ID			
0	1	0	0
4 least significant bits of the AMF Set ID			
0	1	0	1
5 least significant bits of the AMF Set ID			
0	1	1	0
6 least significant bits of the AMF Set ID			
0	1	1	1
7 least significant bits of the AMF Set ID			
1	0	0	0
8 least significant bits of the AMF Set ID			
1	0	0	1
9 least significant bits of the AMF Set ID			
1	0	1	0
10 least significant bits of the AMF Set ID			
All other values shall be interpreted as "10 least significant bits of the AMF Set ID" by this version of the protocol.			
NOTE: Total sum of the "Truncated AMF Set ID value" and the "Truncated AMF Pointer value" in the Truncated 5G-S-TMSI configuration IE is specified in 3GPP TS 23.003 [4] and 3GPP TS 36.300 [25B].			

9.11.3.71 WUS assistance information

See subclause 9.9.3.62 in 3GPP TS 24.301 [15].

9.11.3.72 N5GC indication

The purpose of the N5GC indication information element is to indicate to the network that the registration request by the W-AGF is on behalf of an N5GC device.

The N5GC indication information element is coded as shown in figure 9.11.3.72.1.

The N5GC indication is a type 1 information element.

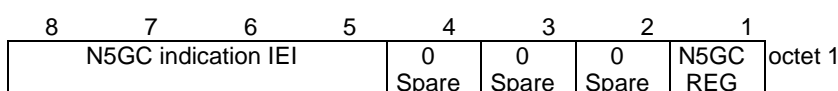

Figure 9.11.3.72.1: N5GC indication

Table 9.11.3.72.1: N5GC indication

N5GC device indication bit (N5GCREG) (octet 1, bit 1)	
Bit	
1	
0	N5GC device registration is not requested
1	N5GC device registration is requested
Bits 2 to 4 are spare and shall be coded as zero.	

9.11.3.73 NB-N1 mode DRX parameters

The purpose of the NB-N1 mode DRX parameters information element is to indicate that the UE wants to use DRX in NB-N1 mode and for the network to indicate the DRX cycle value to be used at paging in NB-N1 mode.

The NB-N1 mode DRX parameters is a type 4 information element with a length of 3 octets.

The NB-N1 mode DRX parameters information element is coded as shown in figure 9.11.3.73.1 and table 9.11.3.73.1.

The value part of a DRX parameter information element is coded as shown in table 9.11.3.73.1.

8	7	6	5	4	3	2	1	
NB-N1 mode DRX parameters IEI								octet 1
Length of NB-N1 mode DRX parameters contents								octet 2
0	0	0	0	NB-N1 mode DRX value				
Spare								octet 3

Figure 9.11.3.73.1: NB-N1 mode DRX parameters information element

Table 9.11.3.73.1: NB-N1 mode DRX parameters information element

NB-N1 mode DRX value (octet 3, bits 1 to 4)	
This field represents the DRX cycle parameter 'T', for NB-N1 mode, as defined in 3GPP TS 36.304 [25C].	
Bits	
4	3 2 1
0 0 0 0	DRX value not specified
0 0 0 1	DRX cycle parameter T = 32
0 0 1 0	DRX cycle parameter T = 64
0 0 1 1	DRX cycle parameter T = 128
0 1 0 0	DRX cycle parameter T = 256
0 1 0 1	DRX cycle parameter T = 512
0 1 1 1	DRX cycle parameter T = 1024
All other values shall be interpreted as "DRX value not specified" by this version of the protocol.	
Bits 5 to 8 of octet 3 are spare and shall be coded as zero.	

9.11.3.74 Additional configuration indication

The purpose of the Additional configuration indication information element is to indicate additional information associated with the generic UE configuration update procedure.

The Additional configuration indication information element is coded as shown in figure 9.11.3.74.1 and table 9.11.3.74.1.

The Additional configuration indication is a type 1 information element.

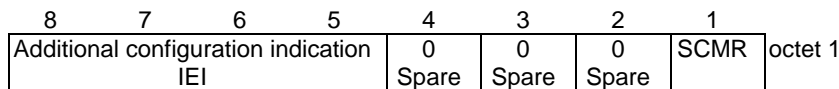

Figure 9.11.3.74.1: Additional configuration indication

Table 9.11.3.74.1: Additional configuration indication

Signalling connection maintain request (SCMR) (octet 1, bit 1) Bit 1 0 no additional information 1 release of N1 NAS signalling connection not required Bits 2 to 4 are spare and shall be coded as zero,

9.11.3.75 Extended rejected NSSAI

The purpose of the Extended rejected NSSAI information element is to identify a collection of rejected S-NSSAIs if UE supports extended rejected NSSAI.

The Extended rejected NSSAI information element is coded as shown in figure 9.11.3.75.1, figure 9.11.3.75.2 and table 9.11.3.75.1.

The Extended rejected NSSAI is a type 4 information element with a minimum length of 5 octets and a maximum length of 90 octets.

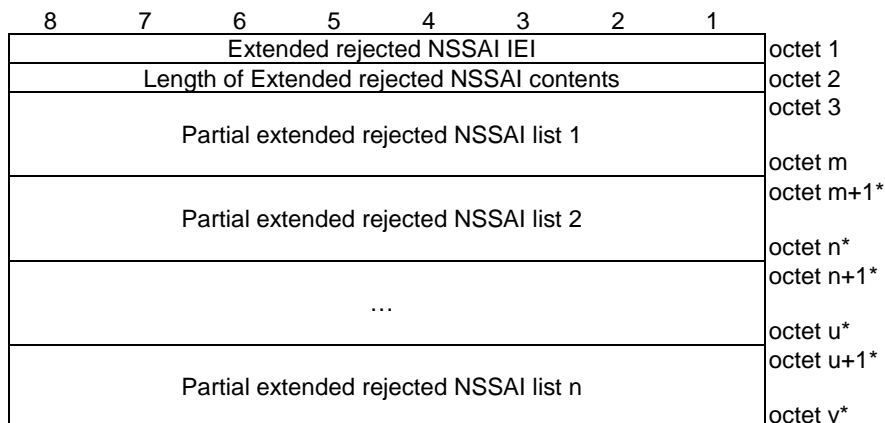

Figure 9.11.3.75.1: Extended rejected NSSAI information element

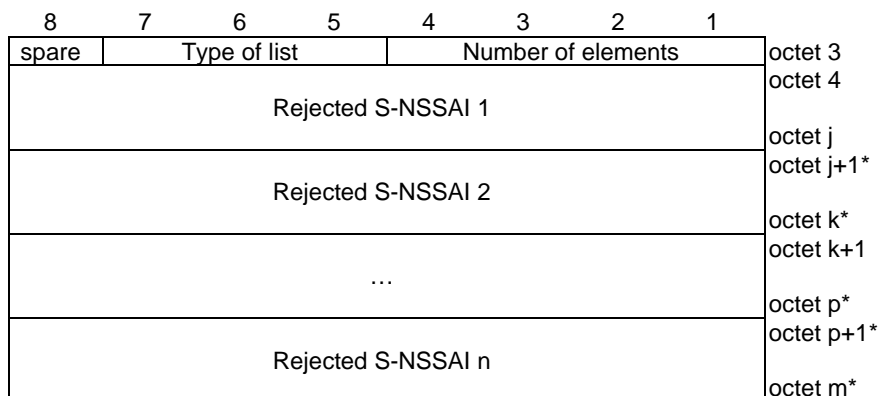

Figure 9.11.3.75.2: Partial extended rejected NSSAI list – type of list = 000

8	7	6	5	4	3	2	1	
spare		Type of list			Number of elements			octet 3
Back-off timer value								octet 4
Rejected S-NSSAI 1								octet 5
Rejected S-NSSAI 2								octet j octet j+1*
...								octet k* octet k+1*
Rejected S-NSSAI n								octet p* octet p+1*
								octet m*

Figure 9.11.3.75.3: Partial extended rejected NSSAI list – type of list = 001

8	7	6	5	4	3	2	1	
Length of rejected S-NSSAI				Cause value				octet 4
SST								octet 5
SD								octet 6*
Mapped HPLMN SST								octet 8* octet 9*
Mapped HPLMN SD								octet 10* octet 12*

Figure 9.11.3.75.4: Rejected S-NSSAI

Table 9.11.3.75.1: Extended rejected NSSAI information element

Value part of the Extended rejected NSSAI information element (octet 3 to v)

The value part of the Extended rejected NSSAI information element consists of one or more partial extended rejected NSSAI lists. The length of each partial extended rejected NSSAI list can be determined from the 'type of list' field and the 'number of elements' field in the first octet of the partial extended rejected NSSAI list.

Each rejected S-NSSAI consists of one S-NSSAI and an associated cause value. Each rejected S-NSSAI also includes the mapped HPLMN S-NSSAI if available. The length of each rejected S-NSSAI can be determined by the 'length of rejected S-NSSAI' field in the first octet of the rejected S-NSSAI.

The UE shall store the complete list received (NOTE 0). If more than 8 rejected S-NSSAIs are included in this information element, the UE shall store the first 8 rejected S-NSSAIs and ignore the remaining octets of the information element.

Partial extended rejected NSSAI list:

Number of elements (octet 3, bits 1 to 4)

Bits

4	3	2	1	
0	0	0	0	1 element
0	0	0	1	2 element
			...	
0	1	1	0	7 element
0	1	1	1	8 element

All other values are unused and shall be interpreted as 8, if received by the UE.

Type of list (octet 3, bits 5 to 7) (NOTE 7)

Bits

7	6	5	
0	0	0	list of S-NSSAIs without any associated back-off timer value
0	0	1	list of S-NSSAIs with one associated back-off timer value that applies to all S-NSSAIs in the list

All other values are reserved.

Bit 8 of octet 3 is spare and shall be coded as zero.

Back-off timer value (octet 4):

Back-off timer value is coded as the value part of GPRS timer 3 in subclause 10.5.7.4a in 3GPP TS 24.008 [12].

Rejected S-NSSAI:

Cause value (octet x) (NOTE 8)

Bits

4	3	2	1	
0	0	0	0	S-NSSAI not available in the current PLMN or SNPN
0	0	0	1	S-NSSAI not available in the current registration area
0	0	1	0	S-NSSAI not available due to the failed or revoked network slice-specific authentication and authorization
0	0	1	1	S-NSSAI not available due to maximum number of UEs reached

All other values are reserved.

Slice/service type (SST) (octet x+1)

This field contains the 8 bit SST value. The coding of the SST value part is defined in 3GPP TS 23.003 [4]. (NOTE 5)

Slice differentiator (SD) (octet x+2 to octet x+4)

This field contains the 24 bit SD value. The coding of the SD value part is defined in 3GPP TS 23.003 [4]. (NOTE 6)

If the SST encoded in octet x+1 is not associated with a valid SD value, and the sender needs to include a mapped HPLMN SST (octet x+5) and a mapped HPLMN SD (octets x+6 to x+8), then the sender shall set the SD value (octets x+2 to x+4) to "no SD value associated with the SST".

mapped HPLMN Slice/service type (SST) (octet x+5)

This field contains the 8 bit SST value of an S-NSSAI in the S-NSSAI(s) of the HPLMN to which the SST value is mapped. The coding of the SST value part is defined in 3GPP TS 23.003 [4].

mapped HPLMN Slice differentiator (SD) (octet x+6 to octet x+8)

This field contains the 24 bit SD value of an S-NSSAI in the S-NSSAI(s) of the HPLMN to which the SD value is mapped. The coding of the SD value part is defined in 3GPP TS 23.003 [4].

NOTE 0: The number of rejected S-NSSAI(s) shall not exceed eight.
 NOTE 1: Octet x and octet x+1 shall always be included.
 NOTE 2: If the octet x+2 is included, then octet x+3 and octet x+4 shall be included.
 NOTE 3: If the octet x+5 is included, then octets x+6, x+7, and x+8 may be included.
 NOTE 4: If the octet x+6 is included, then octet x+7 and octet x+8 shall be included.
 NOTE 5: If the Cause value is "S-NSSAI not available due to the failed or revoked network slice-specific authentication and authorization", this field shall contain the 8 bit SST value of an S-NSSAI in the S-NSSAI(s) of the HPLMN and octets x+5, x+6, x+7, and x+8 shall not be included.
 NOTE 6: If the Cause value is "S-NSSAI not available due to the failed or revoked network slice-specific authentication and authorization", this field shall contain the 24 bit SD value of an S-NSSAI in the S-NSSAI(s) of the HPLMN and octets x+5, x+6, x+7, and x+8 shall not be included.
 NOTE 7: The partial extended rejected NSSAI with type of list = 001 shall only be used for rejected S-NSSAI(s) with the rejection cause "S-NSSAI not available due to maximum number of UEs reached".
 NOTE 8: Octet x can be 4 or 5.

9.11.3.76 UE request type

See subclause 9.9.3.65 in 3GPP TS 24.301 [15].

9.11.3.77 Paging restriction

The purpose of the Paging restriction information element is to request the network to restrict paging.

The Paging restriction information element is coded as shown in figure 9.11.3.77.1, figure 9.11.3.77.2 and table 9.11.3.77.1.

The Paging restriction is a type 4 information element with a minimum length of 3 octets and a maximum length of 35 octets.

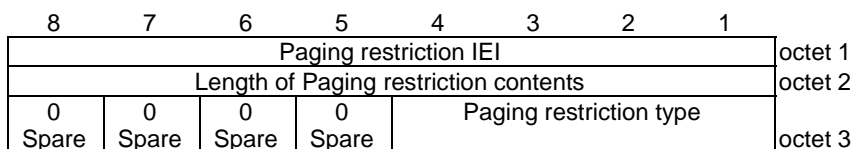

Figure 9.11.3.77.1: Paging restriction information element for Paging restriction type = "All paging is restricted" and for Paging restriction type = "All paging is restricted except voice"

8	7	6	5	4	3	2	1	
Paging restriction IEI								octet 1
Length of Paging restriction contents								octet 2
0 Spare	0 Spare	0 Spare	0 Spare	Paging restriction type				octet 3
PSI (7)	PSI (6)	PSI (5)	PSI (4)	PSI (3)	PSI (2)	PSI (1)	PSI (0)	octet 4
PSI (15)	PSI (14)	PSI (13)	PSI (12)	PSI (11)	PSI (10)	PSI (9)	PSI (8)	octet 5
0	0	0	0	0	0	0	0	octet 6*-35*
spare								

Figure 9.11.3.77.2: Paging restriction information element for Paging restriction type = "All paging is restricted except for specified PDU session(s)" and for Paging restriction type = "All paging is restricted except for voice service and specified PDU session(s)"

Table 9.11.3.77.1: Paging restriction information element

Paging restriction type (bits 4 to 1 of octet 3)			
Bits			
4	3	2	1
0	0	0	0
reserved			
0	0	0	1
All paging is restricted			
0	0	1	0
All paging is restricted except for voice service			
0	0	1	1
All paging is restricted except for specified PDU session(s)			
0	1	0	0
All paging is restricted except for voice service and specified PDU session(s)			
All other values are reserved.			
Bits 5 to 8 of octet 3 are spare and shall be coded as zero.			
PSI(x) (bits 8 to 1 of octet 4 and octet 5): This field indicates the PDU session identity of the PDU session for which paging is restricted.			
PSI(0): (bit 1 of octet 4) Spare and shall be coded as zero.			
PSI(1) – PSI(15): 0 indicates that paging is restricted for the PDU session associated with the PDU session identity. 1 indicates that paging is not restricted for the PDU session associated with the PDU session identity. All bits in octet 6 to 35 are spare and shall be coded as zero, if the respective octet is included in the information element.			

9.11.3.78 Void

9.11.3.79 NID

See subclause 9.2.7 in 3GPP TS 24.502 [18].

9.11.3.80 PEIPS assistance information

The purpose of the PEIPS assistance information, information element is to transfer the required assistance information to indicate the paging subgroup used when paging the UE.

The coding of the information element allows combining different types of PEIPS assistance information.

The PEIPS assistance information, information element is coded as shown in figure 9.11.3.80.1, figure 9.11.3.80.2, figure 9.11.3.80.3 and table 9.11.3.80.1.

The PEIPS assistance information is a type 4 information element, with a minimum length of 3 octets.

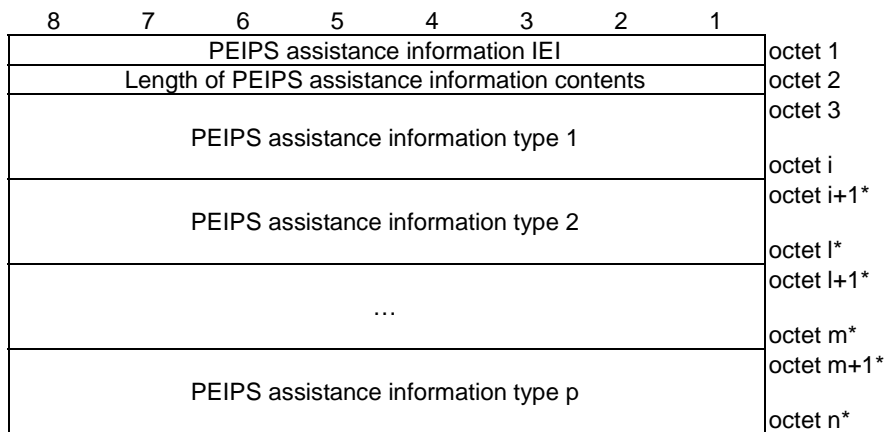

Figure 9.11.3.80.1: PEIPS assistance information information element

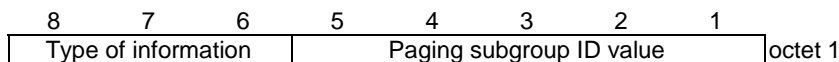

Figure 9.11.3.80.2: PEIPS assistance information type –type of information= "000"

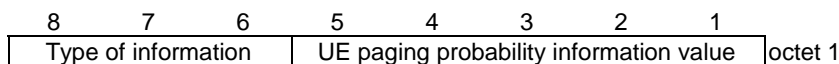

Figure 9.11.3.80.3: PEIPS assistance information type –type of information= "001"

Table 9.11.3.80.1: PEIPS assistance information information element

Value part of the PEIPS assistance information information element (octets 3 to n)	
The value part of the PEIPS assistance information information element consists of one or several types of PEIPS assistance information.	
PEIPS assistance information type:	
Type of information (octet 1)	
Bits	
8	7 6
0 0 0	Paging subgroup ID
0 0 1	UE paging probability information
All other values are reserved.	
Paging subgroup ID value: (octet 1, bits 1-5)	
This field contains the value (in decimal) of paging subgroup ID that is assigned by the AMF for paging the UE. This field has a valid range of values from (0-7). All other values are unused and shall be interpreted as 0 by this version of the protocol.	
UE paging probability information value: (octet 1, bits 1-5)	
This field contains the value of UE paging probability information provided by the UE to the AMF. It represents the probability of the UE receiving the paging.	
Bit	
5	4 3 2 1
0 0 0 0 0	p00 (UE calculated paging probability is 0%)
0 0 0 0 1	p05 (UE calculated paging probability > 0% and <= 5%)
0 0 0 1 0	p10 (UE calculated paging probability > 5% and <= 10%)
0 0 0 1 1	p15 (UE calculated paging probability > 10% and <= 15%)
0 0 1 0 0	p20 (UE calculated paging probability > 15% and <= 20%)
0 0 1 0 1	p25 (UE calculated paging probability > 20% and <= 25%)
0 0 1 1 0	p30 (UE calculated paging probability > 25% and <= 30%)
0 0 1 1 1	p35 (UE calculated paging probability > 30% and <= 35%)
0 1 0 0 0	p40 (UE calculated paging probability > 35% and <= 40%)
0 1 0 0 1	p45 (UE calculated paging probability > 40% and <= 45%)
0 1 0 1 0	p50 (UE calculated paging probability > 45% and <= 50%)
0 1 0 1 1	p55 (UE calculated paging probability > 50% and <= 55%)
0 1 1 0 0	p60 (UE calculated paging probability > 55% and <= 60%)
0 1 1 0 1	p65 (UE calculated paging probability > 60% and <= 65%)
0 1 1 1 0	p70 (UE calculated paging probability > 65% and <= 70%)
0 1 1 1 1	p75 (UE calculated paging probability > 70% and <= 75%)
1 0 0 0 0	p80 (UE calculated paging probability > 75% and <= 80%)
1 0 0 0 1	p85 (UE calculated paging probability > 80% and <= 85%)
1 0 0 1 0	p90 (UE calculated paging probability > 85% and <= 90%)
1 0 0 1 1	p95 (UE calculated paging probability > 90% and <= 95%)
1 0 1 0 0	p100 (UE calculated paging probability > 95% and <= 100%)
All other values shall be interpreted as 10100 by this version of the protocol.	

9.11.3.81 5GS additional request result

The purpose of the 5GS additional request result information element is to inform the UE about the result of additional request.

The 5GS additional request result information element is coded as shown in figure 9.11.3.81.1 and table 9.11.3.81.1.

The 5GS additional request result is a type 4 information element with a length of 3 octets.

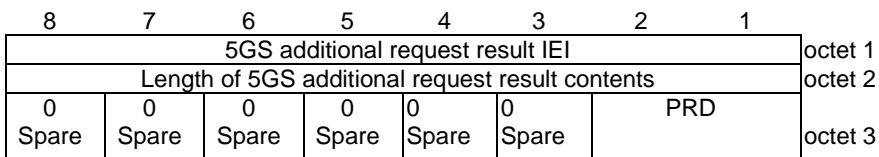

Figure 9.11.3.81.1: 5GS additional request result information element

Table 9.11.3.81.1: 5GS additional request result information element

Paging restriction decision (PRD) (bits 2 to 1 of octet 3)		
Bits		
2	1	
0	0	no additional information
0	1	paging restriction is accepted
1	0	paging restriction is rejected
All other values are reserved.		
Bits 3 to 8 of octet 3 are spare and shall be coded as zero.		

9.11.3.82 NSSRG information

The purpose of the NSSRG information information element is to identify one or more NSSRG values associated with each of the HPLMN S-NSSAIs in a configured NSSAI.

The NSSRG information information element is coded as shown in figure 9.11.3.82.1, figure 9.11.3.82.2 and table 9.11.3.82.1.

The NSSRG information is a type 6 information element with minimum length of 7 octets and maximum length of 4099 octets.

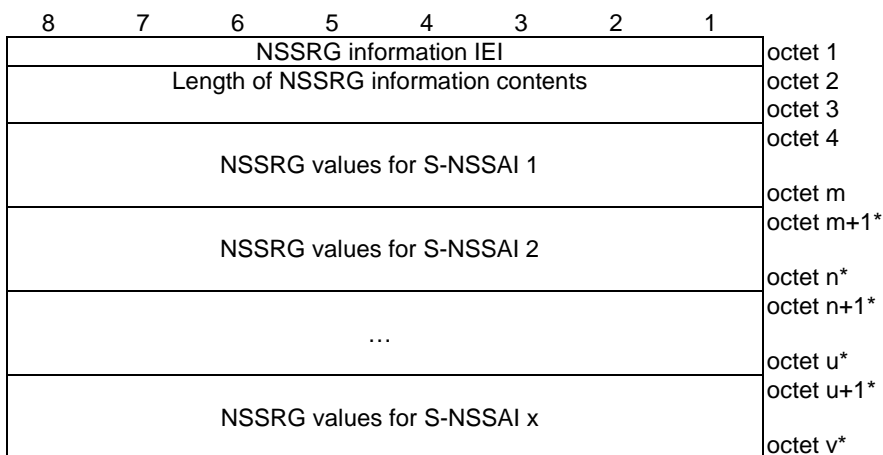

Figure 9.11.3.82.1: NSSRG information information element

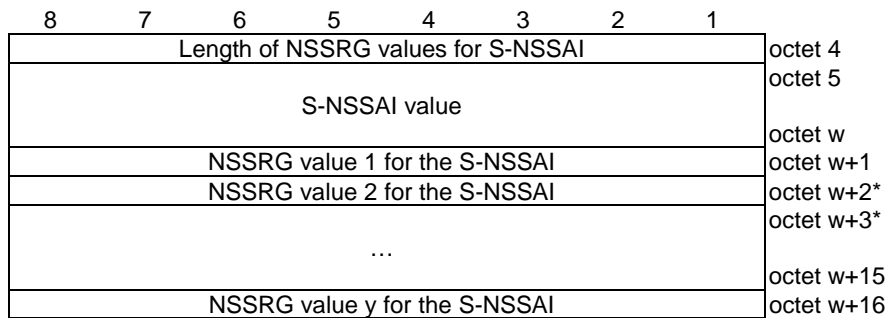

Figure 9.11.3.82.2: NSSRG values for S-NSSAI

Table 9.11.3.82.1: NSSRG information information element

Value part of the NSSRG information information element (octet 4 to v)
The value part of the NSSRG information information element consists of one or more NSSRG values for each S-NSSAI in the Configured NSSAI IE.
S-NSSAI value (octet 5 to w) (see NOTE 2)
S-NSSAI value is coded as the length and value part of S-NSSAI information element as specified in subclause 9.11.2.8 starting with the second octet. See NOTE 1.
NSSRG value for the S-NSSAI (octet w+1)
This field contains the 8 bit NSSRG value.
NOTE 1: If a mapped HPLMN SST is included in a S-NSSAI value, then the NSSRG value(s) are associated with the Mapped HPLMN SST, and the Mapped HPLMN SD, if included.
NOTE 2: The NSSRG information IE shall contain the complete set of S-NSSAI(s) included in the configured NSSAI.
NOTE 3: The number of NSSRG values associated with an S-NSSAI cannot exceed 16. If there are more than 16 NSSRG values for an S-NSSAI in the NSSRG information, then the UE shall retain only the first 16 NSSRG values and ignore the rest.

9.11.3.83 List of PLMNs to be used in disaster condition

The purpose of the list of PLMNs to be used in disaster condition information element is to provide the "list of PLMN(s) to be used in disaster condition" associated with the serving PLMN to the UE.

The list of PLMNs to be used in disaster condition information element is coded as shown in figures 9.11.3.83.1 and 9.11.3.83.2 and table 9.11.3.83.1.

The list of PLMNs to be used in disaster condition is a type 4 information element, with a minimum length of 2 octets.

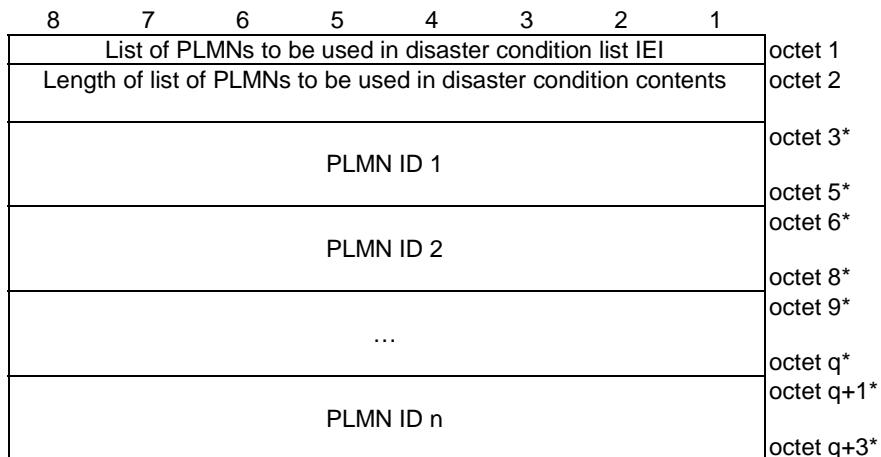

Figure 9.11.3.83.1: List of PLMNs to be used in disaster condition information element

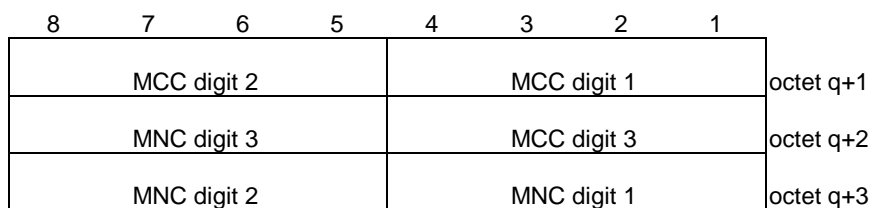

Figure 9.11.3.83.2: PLMN ID n

Table 9.11.3.83.1: List of PLMNs to be used in disaster condition information element

<p>MCC, Mobile country code (octet q+1 and bits 1 to 4 octet q+2) The MCC field is coded as in ITU-T Recommendation E.212 [42], annex A.</p> <p>MNC, Mobile network code (bits 5 to 8 of octet q+2 and octet q+3) The coding of this field is the responsibility of each administration but BCD coding shall be used. The MNC shall consist of 2 or 3 digits. If a network operator decides to use only two digits in the MNC, bits 5 to 8 of octet q+2 shall be coded as "1111".</p> <p>The MCC and MNC digits are coded as octets 6 to 8 of the Temporary mobile group identity IE in figure 10.5.154 of 3GPP TS 24.008 [12].</p> <p>NOTE: The PLMN IDs are provided in decreasing order of priority, i.e. PLMN ID 1 indicates highest priority and PLMN ID n indicates lowest priority.</p>
--

9.11.3.84 Registration wait range

The purpose of the registration wait range information element is to provide the disaster roaming wait range or the disaster return wait range to the UE.

The registration wait range information element is coded as shown in figure 9.11.3.84.1 and table 9.11.3.84.1.

The registration wait range is a type 4 information element, with a length of 4 octets.

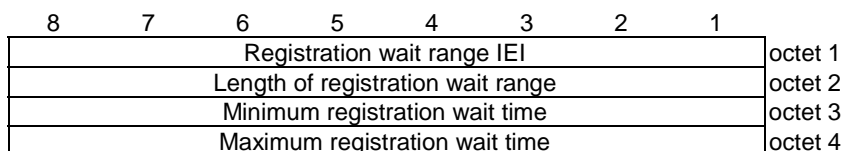

Figure 9.11.3.84.1: Registration wait range information element

Table 9.11.3.84.1: Registration wait range information element

<p>Minimum registration wait time (octet 3) The minimum registration wait time contains the minimum duration of the registration wait time, encoded as octet 2 of the GPRS timer information element (see 3GPP TS 24.008 [12] subclause 10.5.7.3).</p> <p>Maximum registration wait time (octet 4) The maximum registration wait time contains the maximum duration of the registration wait time, encoded as octet 2 of the GPRS timer information element (see 3GPP TS 24.008 [12] subclause 10.5.7.3).</p>

9.11.3.85 PLMN identity

The purpose of the PLMN identity information element is to provide a PLMN identity.

The PLMN identity information element is coded as shown in figure 9.11.3.85.1, and table 9.11.3.85.1.

The PLMN identity is a type 4 information element.

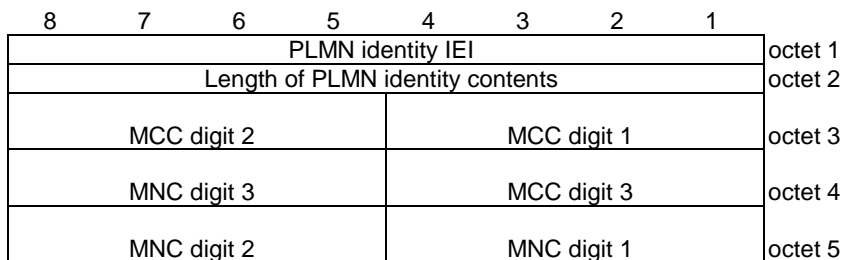

Figure 9.11.3.85.1: PLMN identity information element

Table 9.11.3.85.1: PLMN identity information element

<p>MCC, Mobile country code (octet 3, octet 4 bits 1 to 4) The MCC field is coded as in ITU-T Recommendation E.212 [42], annex A.</p> <p>MNC, Mobile network code (octet 4 bits 5 to 8, octet 5) The coding of this field is the responsibility of each administration but BCD coding shall be used. The MNC shall consist of 2 or 3 digits. If a network operator decides to use only two digits in the MNC, bits 5 to 8 of octet 4 shall be coded as "1111".</p> <p>The MCC and MNC digits are coded as octets 6 to 8 of the Temporary mobile group identity IE in figure 10.5.154 of 3GPP TS 24.008 [12].</p>
--

9.11.3.86 Extended CAG information list

The purpose of the Extended CAG information list information element is to provide "CAG information list" or to delete the "CAG information list" at the UE.

The Extended CAG information list information element is coded as shown in figures 9.11.3.86.1, figure 9.11.3.86.2, figure 9.11.3.86.3, figure 9.11.3.86.4, figure 9.11.3.86.5 and table 9.11.3.86.1.

The Extended CAG information list is a type 6 information element, with a minimum length of 3 octets.

8	7	6	5	4	3	2	1	
Extended CAG information list IEI								octet 1
Length of Extended CAG information list contents								octet 2
Entry 1								octet 3 octet 4*
Entry 2								octet a* octet a+1*
...								octet b* octet b+1*
Entry n								octet g* octet g+1* octet h*

Figure 9.11.3.86.1: Extended CAG information list information element

8	7	6	5	4	3	2	1	
Length of entry contents								octet q octet q+1
MCC digit 2				MCC digit 1				octet q+2
MNC digit 3				MCC digit 3				octet q+3
MNC digit 2				MNC digit 1				octet q+4
0 Spare	0 Spare	0 Spare	0 Spare	CAILI	LCI	0 Spare	CAG only	octet q+5
Length of CAG-ID without additional information list								octet (q+6)*
CAG-ID 1								octet (q+7)* octet r* (see NOTE)
CAG-ID 2								octet (r+3)* octet (r+4)*
...								octet (r+7)* octet (r+8)*
CAG-ID m								octet (r+4*m-5)* octet (r+4*m-4)*
CAG-ID with additional information list								octet (r+4*m-1)* octet t* (see NOTE) octet u*

NOTE: The field is placed immediately after the last present preceding field.

Figure 9.11.3.86.2: Entry n

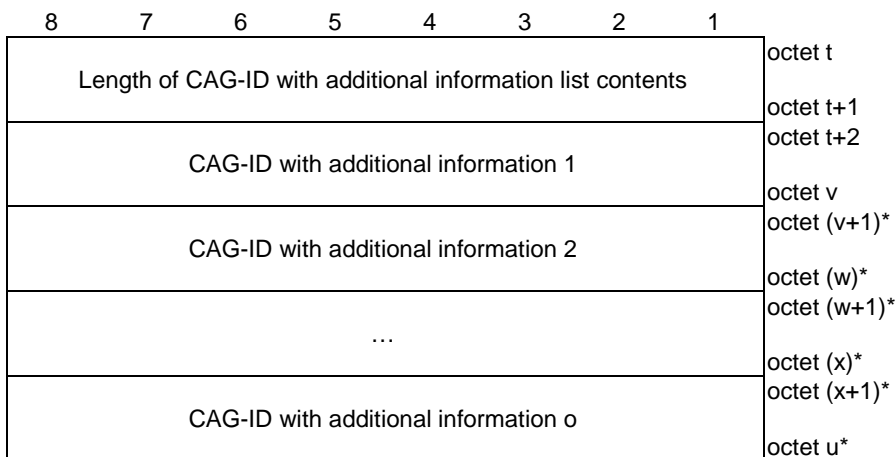
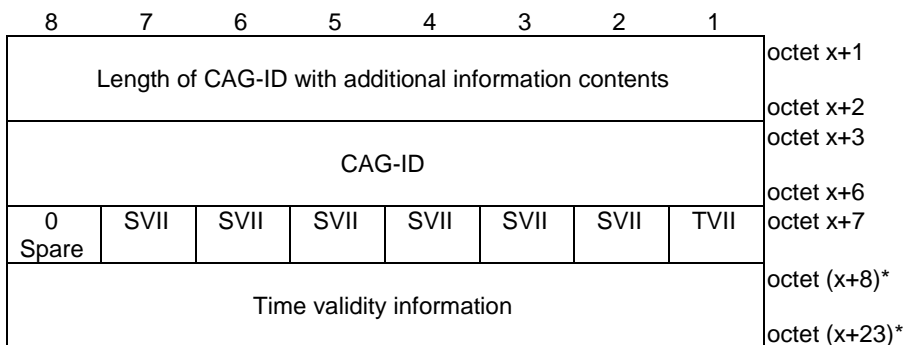

Figure 9.11.3.86.3: CAG-ID with additional information list



NOTE: The field is placed immediately after the last present preceding field.

Figure 9.11.3.86.4: CAG-ID with additional information

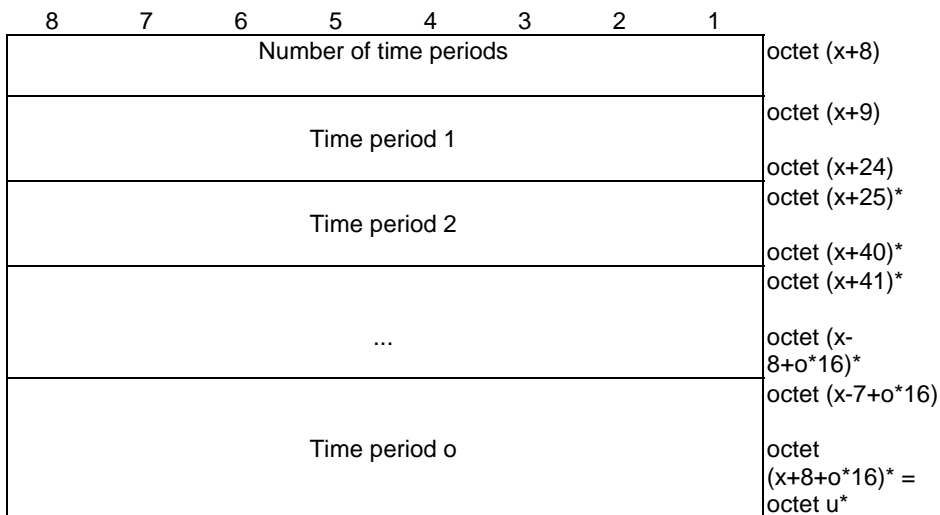

Figure 9.11.3.86.5: Time validity information

Table 9.11.3.86.1: Extended CAG information list information element

<p>Value part of the Extended CAG information list information element (octet 4 to h) The value part of the Extended CAG information list information element consists of one or more entries.</p> <p>Entry n:</p> <p>Length of entry contents (octet q and q+1)</p> <p>MCC, Mobile country code (octet q+2 and bits 1 to 4 octet q+3) The MCC field is coded as in ITU-T Recommendation E.212 [42], annex A.</p> <p>MNC, Mobile network code (bits 5 to 8 of octet q+3 and octet q+4) The coding of this field is the responsibility of each administration, but BCD coding shall be used. The MNC shall consist of 2 or 3 digits. If a network operator decides to use only two digits in the MNC, bits 5 to 8 of octet q+2 shall be coded as "1111".</p> <p>The MCC and MNC digits are coded as octets 6 to 8 of the Temporary mobile group identity IE in figure 10.5.154 of 3GPP TS 24.008 [12].</p> <p>Indication that the UE is only allowed to access 5GS via CAG cells (CAGonly) (bit 1 of octet q+5)</p> <p>Bit 1 0 "Indication that the UE is only allowed to access 5GS via CAG cells" is not set (i.e., the UE is allowed to access 5GS via non-CAG cells) 1 "Indication that the UE is only allowed to access 5GS via CAG cells" is set (i.e., the UE is not allowed to access 5GS via non-CAG cells)</p> <p>Length of CAG-ID without additional information list indicator (LCI) (bit 3 of octet q+5)</p> <p>Bit 3 0 Length of CAG-ID without additional information list field is absent 1 Length of CAG-ID without additional information list field is present If the UE does not support enhanced CAG information, the LCI bit shall be set to "Length of CAG-ID without additional information list field is absent".</p> <p>CAG-ID with additional information list indicator (CAILI) (bit 4 of octet q+5)</p> <p>Bit 4 0 CAG-ID with additional information list field is absent 1 CAG-ID with additional information list field is present If the UE does not support enhanced CAG information or the LCI bit is set to "Length of CAG-ID without additional information list field is absent", the CAILI bit shall be set to "CAG-ID with additional information list field is absent".</p> <p>Length of CAG-ID without additional information list (octet q+6 to octet q+7) This field indicates length of CAG-ID fields in octet r to octet (r+4*m-1).</p> <p>CAG-ID m (octet r+4*m-4 to octet r+4*m-1) This field contains the 32 bit CAG-ID which is not associated with additional information. The coding of the CAG-ID is defined as the CAG-Identifier in 3GPP TS 23.003 [4]. See NOTE 4.</p> <p>If the length of entry contents field indicates a length bigger than indicated in figure 9.11.3.86.1, receiving entity shall ignore any superfluous octets located at the end of the entry contents.</p> <p>CAG-ID (octet x+3 to octet x+6) This field contains the 32 bit CAG-ID which is associated with additional information. The additional information is indicated in remaining fields of figure 9.11.3.86.4. The coding of the CAG-ID is defined as the CAG-Identifier in 3GPP TS 23.003 [4].</p> <p>Time validity information indicator (TVII) (bit 1 of octet x+7)</p> <p>Bit 1 0 Time validity information field is absent 1 Time validity information field is present</p>
--

<p>Spare validity information indicator (SVII) 0 Spare validity information is absent 1 Spare validity information is present The SVII bit indicates presence of a validity information not specified in the present version of the present document. See NOTE 5. If the SVII bit is set to "Spare validity information is present", the receiving entity shall ignore the CAG-ID with additional information field.</p> <p>Time period (octet x+25 to octet x+40) The time period field is coded as the route selection descriptor component value field for "time window type" specified in 3GPP TS 24.526 [19] table 5.2.1.</p> <p>If the length of CAG-ID with additional information contents field indicates a length bigger than indicated in figure 9.11.3.86.4, receiving entity shall ignore any superfluous octets located at the end of the CAG-ID with additional information contents.</p>
<p>NOTE 1: The length of extended CAG information list contents field shall be 0 if no subscription data for CAG information list exists. NOTE 2: The length of entry contents field shall be 4 if there is no allowed CAG-ID for the PLMN. NOTE 3: For a given PLMN ID, there shall be up to one entry field containing the MCC value and the MNC value of the PLMN ID. NOTE 4: CAG-ID field containing a CAG-ID which is not associated with additional information, can be provided regardless whether the LCI bit is set to "Length of CAG-ID without additional information list field is absent" or "Length of CAG-ID without additional information list field is present". NOTE 5: In a future version of the present document, semantic of this bit can be changed to indicate presence or absence of an additional validity information.</p>

9.11.3.87 NSAG information

The purpose of the NSAG information information element is to provide the NSAG information to the UE.

The NSAG information information element is coded as shown in figures 9.11.3.87.1, 9.11.3.87.2 and 9.11.3.87.3, and table 9.11.3.87.1.

The NSAG information information element can contain a maximum of 32 NSAG entries.

In the NSAG information information element, at most 4 NSAG entries can contain a TAI list.

The NSAG information is a type 6 information element, with a minimum length of 9 octets and a maximum length of 3143 octets.

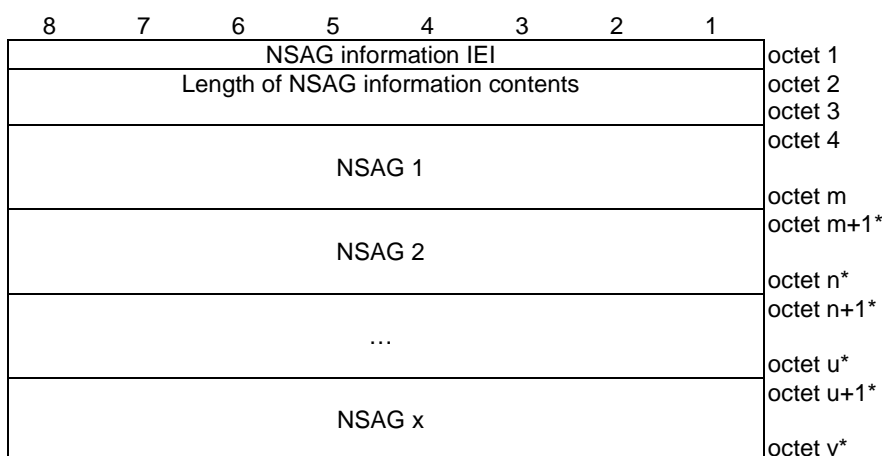

Figure 9.11.3.87.1: NSAG information information element

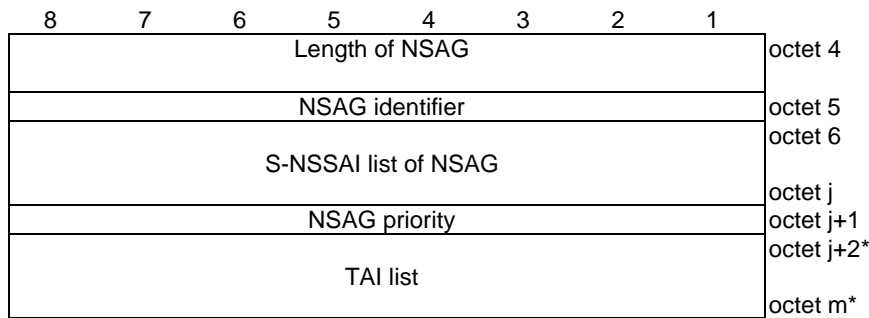

Figure 9.11.3.87.2: NSAG

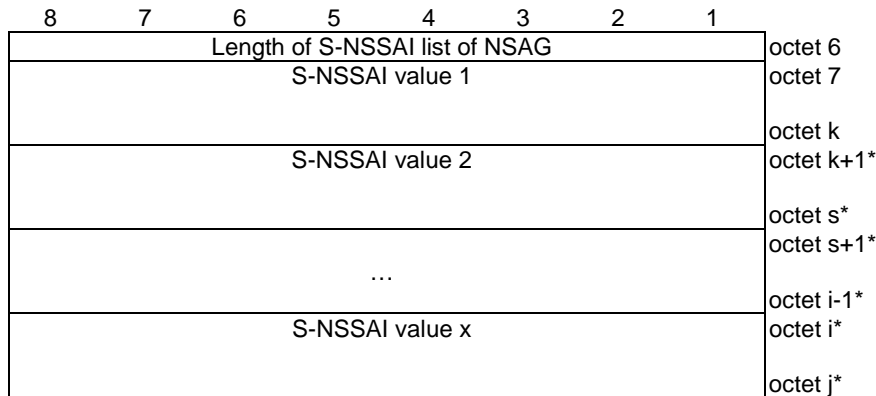

Figure 9.11.3.87.3: S-NSSAI list of NSAG

Table 9.11.3.87.1: NSAG information information element

<p>NSAG part of the NSAG information information element (octet 4 to m)</p> <p>Each entry of the NSAG information information element consists of one NSAG in the NSAG information IE.</p> <p>NSAG identifier(octet 5) NSAG identifier field contains an 8 bits NSAG ID value.</p> <p>S-NSSAI list of NSAG (octet 6 to j) S-NSSAI list of NSAG field consists of one or more S-NSSAIs in the configured NSSAI. Each S-NSSAI in S-NSSAI list of NSAG field is coded as the length and value part of S-NSSAI information element as specified in subclause 9.11.2.8 starting with the second octet, without the mapped HPLMN SST field and without the mapped HPLMN SD field.</p> <p>NSAG priority (octet j+1) The NSAG priority field represents the binary coded value of NSAG priority for cell reselection (see 3GPP TS 38.304 [28]) and random access (see 3GPP TS 38.321 [58]). The range of the NSAG priority is 0 to 255. A lower value indicates a higher priority, with 0 as the highest priority.</p> <p>TAI list (octet j+2 to m) The TAI list field is coded as the length and value part of the 5GS tracking area identity list IE defined in subclause 9.11.3.9 starting with the second octet.</p>
--

9.11.3.88 ProSe relay transaction identity

The purpose of the ProSe relay transaction identity (PRTI) information element is to uniquely identify an authentication and key agreement procedure for 5G ProSe UE-to-network relay or 5G ProSe UE-to-UE relay. The PRTI allows distinguishing up to 254 different bi-directional messages.

The ProSe relay transaction identity information element is coded as shown in figure 9.11.3.88.1 and table 9.11.3.88.1.

The ProSe relay transaction identity is a type 3 information element with a length of 2 octets.

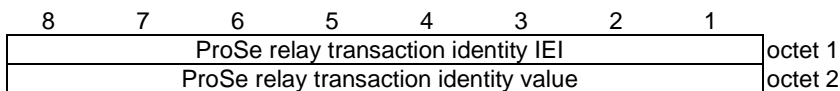

Figure 9.11.3.88.1: ProSe relay transaction identity information element

Table 9.11.3.88.1: ProSe relay transaction identity information element

ProSe relay transaction identity value (octet 2)								
Bits								
8	7	6	5	4	3	2	1	
0	0	0	0	0	0	0	0	No ProSe relay transaction identity assigned
0	0	0	0	0	0	0	1	\
1	1	1	1	1	1	1	0	/
1	1	1	1	1	1	1	1	Reserved

9.11.3.89 Relay key request parameters

The purpose of the relay key request parameters information element is to transport the parameters of the key request for 5G ProSe UE-to-network relay or 5G ProSe UE-to-UE relay as specified in 3GPP TS 33.503 [56].

The relay key request parameters information element is coded as shown in figure 9.11.3.89.1, figure 9.11.3.89.2 and table 9.11.3.89.1.

The relay key request parameters is a type 6 information element.

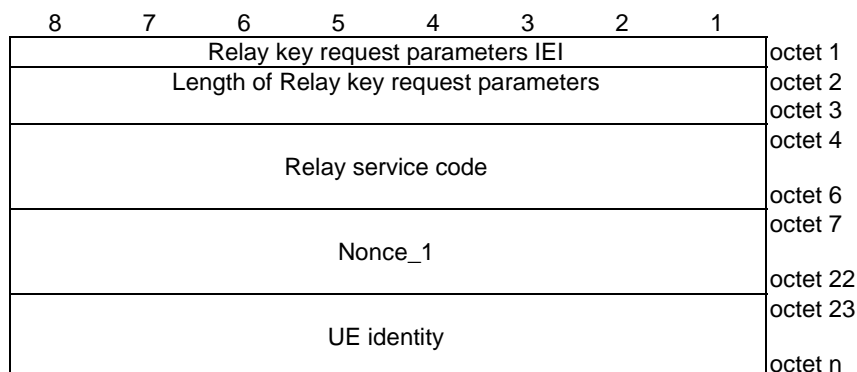

Figure 9.11.3.89.1: Relay key request parameters information element

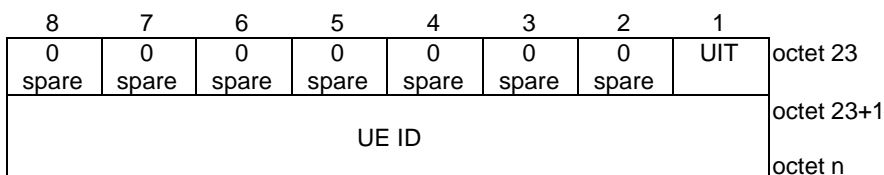

Figure 9.11.3.89.2: UE identity

Table 9.11.3.89.1: Relay key request parameters information element

Relay service code (octet 4 to 6) The relay service code contains 24-bit relay service code as defined in 3GPP TS 24.554 [19E].
Nonce_1 (octet 7 to 22) Nonce_1 is the 128-bit nonce value as defined in 3GPP TS 24.554 [19E].
UE ID type (UIT) (octet 23, bit 1) Bit 1 0 SUCI 1 CP-PRUK ID
UE ID (octet 23+1 to n) UE ID indicates the value of the 5G ProSe remote UE identity or the 5G ProSe end UE identity. If the UE ID type is set to SUCI, the UE ID is coded as 5GS mobile identity IE starting from octet 2 with the Type of identity set to "SUCI" (see subclause 9.11.3.4). If the UE ID type is set to CP-PRUK ID, the UE ID is coded as the CP-PRUK ID as defined in 3GPP TS 33.503 [56].

9.11.3.90 Relay key response parameters

The purpose of the relay key response parameters information element is to transport the parameters of the key response for 5G ProSe UE-to-network relay or 5G ProSe UE-to-UE relay as specified in 3GPP TS 33.503 [56].

The relay key response parameters information element is coded as shown in figure 9.11.3.90.1 and table 9.11.3.90.1.

The relay key response parameters is a type 6 information element.

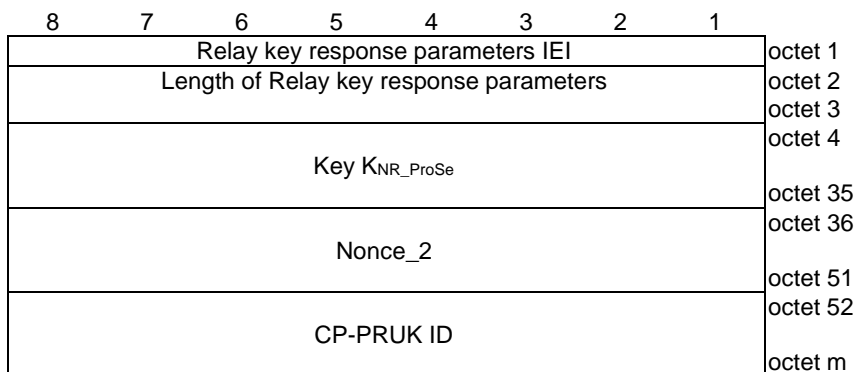

Figure 9.11.3.90.1: Relay key response parameters information element

Table 9.11.3.90.1: Relay key response parameters information element

Key K_{NR_ProSe} (Octet 5 to 35) Key K_{NR_ProSe} contains a 256-bit root key that is established between the two entities that communicating using NR PC5 unicast link as defined in 3GPP TS 33.503 [56].
Nonce_2 (octet 36 to 51) Nonce_2 is the 128-bit nonce value as defined in 3GPP TS 24.554 [19E].
CP-PRUK ID (octet 52 to m) The CP-PRUK ID is defined in 3GPP TS 33.503 [56].

9.11.3.91 Priority indicator

The purpose of the Priority indicator information element is to convey a priority indication to the UE.

The Priority indicator information element is coded as shown in figure 9.11.3.91.1 and table 9.11.3.91.1.

The Priority indicator is a type 1 information element.

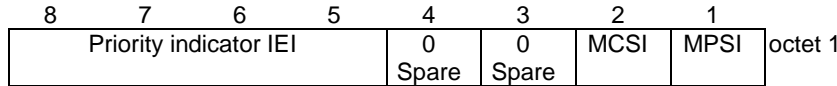

Figure 9.11.3.91.1: Priority indicator

Table 9.11.3.91.1: Priority indicator

MPS indicator (MPSI) (octet 1, bit 1)	
Bit	
1	
0	Access identity 1 not valid
1	Access identity 1 valid
MCS indicator (MCSI) (octet 1, bit 2)	
Bit	
2	
0	Access identity 2 not valid
1	Access identity 2 valid
Bits 3, 4 are spare and shall be coded as zero.	

9.11.3.92 SNPN list

The purpose of the SNPN list information element is to provide a list of SNPN identities.

The SNPN list information element is coded as shown in figure 9.11.3.92.1, table 9.11.3.92.1, figure 9.11.3.92.2 and table 9.11.3.92.2.

The SNPN list is a type 4 information element with a minimum length of 11 octets and a maximum length of 137 octets.

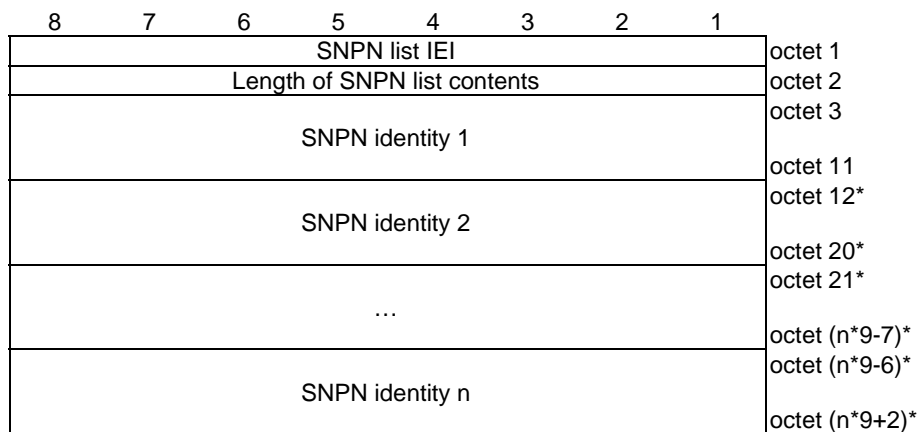

Figure 9.11.3.92.1: SNPN list information element

Table 9.11.3.92.1: SNPN list information element

Each SNPN identity field is coded according to figure 9.11.3.92.2 and table 9.11.3.92.2.
--

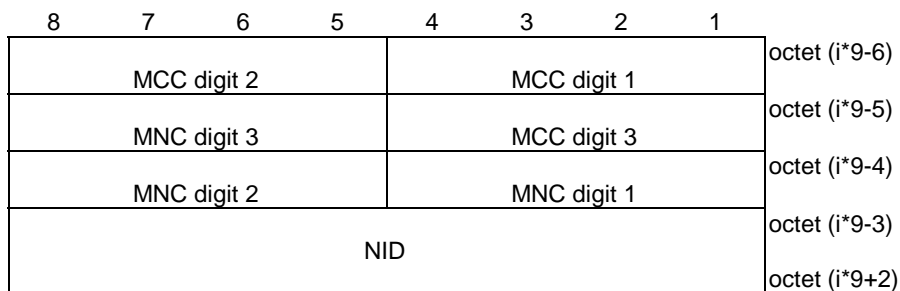

Figure 9.11.3.92.2: SNPN identity i

Table 9.11.3.92.2: SNPN identity i

<p>MCC, Mobile country code (octet (i*9-6), octet (i*9-5) bits 1 to 4) The MCC field is coded as in ITU-T Recommendation E.212 [42], annex A.</p> <p>MNC, Mobile network code (octet (i*9-5) bits 5 to 8, octet (i*9-4)) The coding of this field is the responsibility of each administration but BCD coding shall be used. The MNC shall consist of 2 or 3 digits. If a network operator decides to use only two digits in the MNC, bits 5 to 8 of octet 6 shall be coded as "1111"</p> <p>The MCC and MNC digits are coded as octets 6 to 8 of the Temporary mobile group identity IE in figure 10.5.154 of 3GPP TS 24.008 [12].</p> <p>NID (octet (i*9-3) to octet (i*9+2)) NID field is coded as the NID field of NID IE as specified in figure 9.2.7-2 and table 9.2.7-2 of 3GPP TS 24.502 [18] starting with the octet 3 and ending with the octet 8.</p>
--

9.11.3.93 N3IWF identifier

The purpose of the N3IWF identifier information element is to enable the network to assign the UE, a suitable N3IWF for the requested NSSAI.

The N3IWF identifier information element is coded as shown in figure 9.11.3.93.1, figure 9.11.3.93.2, figure 9.11.3.93.3 and table 9.11.3.93.1.

The N3IWF identifier information element is a type 4 information element with a minimum length of 7 octets.

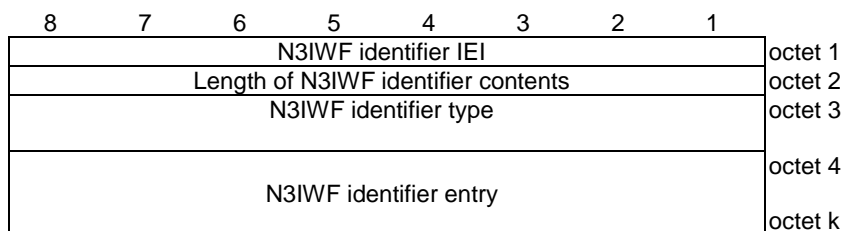

Figure 9.11.3.93.1: N3IWF identifier information element

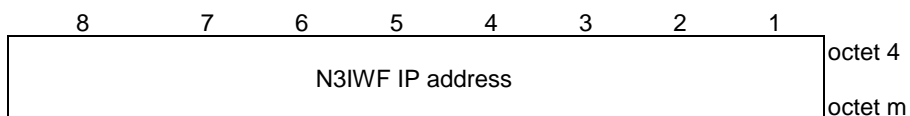

Figure 9.11.3.93.2: N3IWF address entry (N3IWF identifier type = "IPv4", "IPv6" or "IPv4v6")

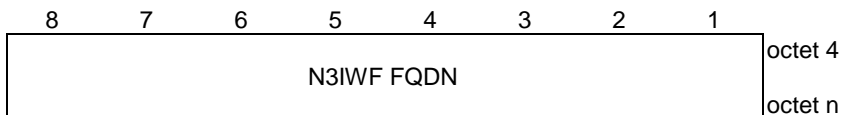

Figure 9.11.3.93.3: N3IWF identifier entry (N3IWF identifier type = "FQDN")

Table 9.11.3.93.1: N3IWF address entry

N3IWF identifier type (octet 3) is set as follows:

8	7	6	5	4	3	2	1	
0	0	0	0	0	0	0	1	IPv4
0	0	0	0	0	0	1	0	IPv6
0	0	0	0	0	0	1	1	IPv4v6
0	0	0	0	0	1	0	0	FQDN

All other values are reserved.

If the N3IWF identifier type indicates IPv4, then the N3IWF IP address field contains an IPv4 address in octet 4 to octet 7.

If the N3IWF identifier type indicates IPv6, then the N3IWF IP address field contains an IPv6 address in octet 4 to octet 19.

If the N3IWF identifier type indicates IPv4v6, then the N3IWF IP address field contains two IP addresses. The first IP address is an IPv4 address in octet 4 to octet 7. The second IP address is an IPv6 address in octet 8 to octet 23.

If the N3IWF identifier type indicates FQDN, the N3IWF FQDN field in octet 4 to octet n is encoded as defined in subclauses 28.3.2.2.2, 28.3.2.2.3, 28.3.2.2.8 or 28.3.2.2.9 in 3GPP TS 23.003 [4].

9.11.3.94 TNAN information

The purpose of the TNAN information information element is to enable the network to assign the UE, a suitable TNAN information (SSID and TNGF ID) for the requested NSSAI.

The TNAN information information element is coded as shown in figure 9.11.3.94.1 and table 9.11.3.94.1.

The TNAN information information element is a type 4 information element with a minimum length of 3 octets.

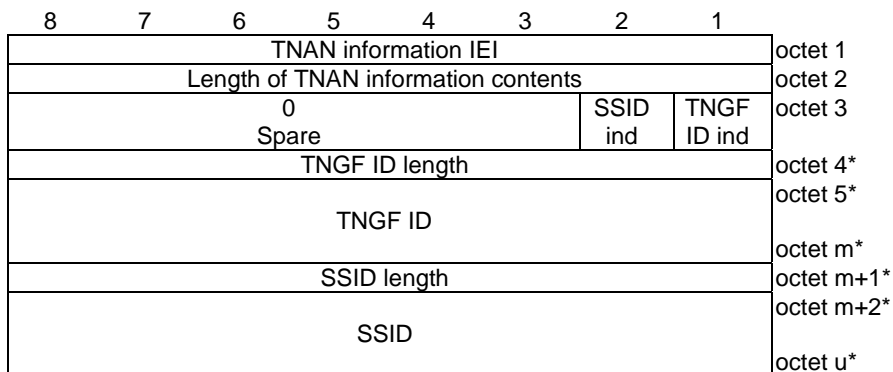

Figure 9.11.3.94.1: TNAN information information element

Table 9.11.3.94.1: TNAN information information element

<p>TNGF ID indication (TNGF ID ind) (bit 1 of octet 3) The TNGF ID ind indicates whether the TNGF ID length field and the TNGF ID field are included in the TNAN information or not.</p>	
<p>Bit</p>	
1	
0	TNGF ID length and TNGF ID not included
1	TNGF ID length and TNGF ID included
<p>SSID indication (SSID ind) (bit 2 of octet 3) The SSID ind indicates whether the SSID length field and the SSID field are included in the TNAN information or not.</p>	
<p>Bit</p>	
2	
0	SSID length and SSID not included
1	SSID length and SSID included
<p>Bits 3 to 8 of octet 3 are spare and shall be coded as zero</p>	
<p>TNGF ID length (octet 4) indicates the length of the TNGF ID field. TNGF ID (octets 5 to m) The TNGF ID field is an octet string that indicates the TNGF ID.</p>	
<p>SSID length (octet m+1) indicates the length of the SSID field. SSID (octets m+2 to u) The SSID field is an octet string which shall have a maximum length of 32 octets (see IEEE Std 802.11 [59]).</p>	

9.11.3.95 RAN timing synchronization

The purpose of the RAN timing synchronization IE is to provide information related to the RAN timing synchronization.

The RAN timing synchronization information element is coded as shown in figure 9.11.3.95.1 and table 9.11.3.95.1.

The RAN timing synchronization is a type 4 information element with a length of 3 octets.

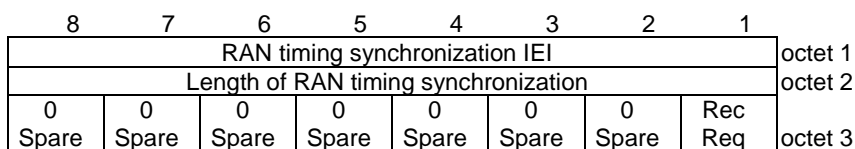

Figure 9.11.3.95.1: RAN timing synchronization information element

Table 9.11.3.95.1: RAN timing synchronization information element

<p>Request to reconnect to the network upon receiving an indication of a change in the RAN timing synchronization status (RecReq) (octet 3, bit 1)</p>	
<p>Bit</p>	
1	
0	Reconnection not requested
1	Reconnection requested
<p>Bits 2 to 8 of octet 3 are spare and shall be coded as zero.</p>	

9.11.3.96 Extended LADN information

The purpose of the Extended LADN information information element is to provide the UE with the LADN service area for each available LADN associated for an LADN DNN and an S-NSSAI in the current registration area or to delete the Extended LADN information at the UE.

The Extended LADN information information element is coded as shown in figure 9.11.3.96.1, figure 9.11.3.96.2 and table 9.11.3.96.1.

The Extended LADN information is a type 6 information element with a minimum length of 3 octets and a maximum length of 1787 octets.

The Extended LADN information information element can contain a minimum of 0 and a maximum of 8 different LADNs each including a DNN, an S-NSSAI and a 5GS tracking area identity list.

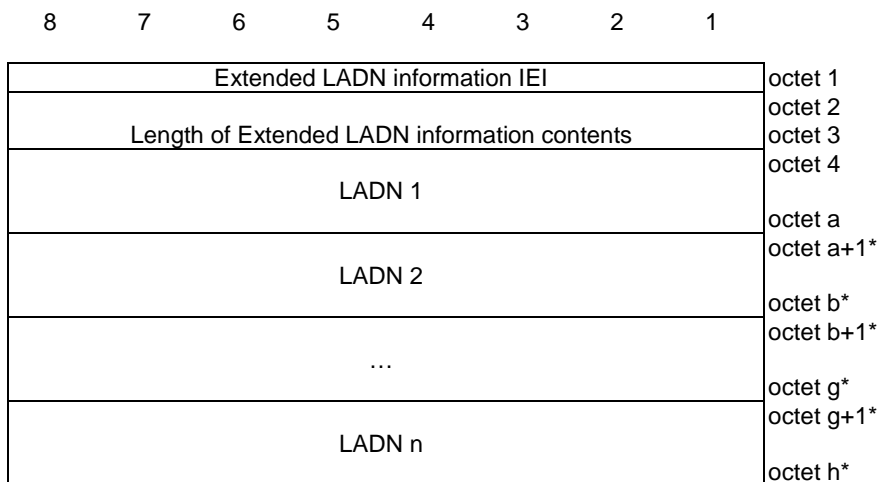

Figure 9.11.3.96.1: Extended LADN information information element

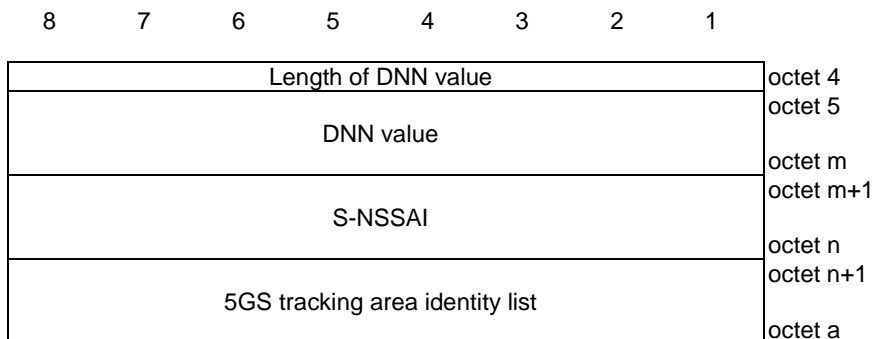

Figure 9.11.3.96.2: LADN

Table 9.11.3.96.1: Extended LADN information information element

<p>Value part of the Extended LADN information information element (octet 4 to octet h)</p> <p>The value part of the Extended LADN information information element consists of one or several LADNs. Each LADN (e.g. octet 4 to octet a) consists of one DNN value, one S-NSSAI and one 5GS tracking area identity list. The length of each LADN is determined by the length of DNN value field, the length of S-NSSAI field and the length of 5GS tracking area identity list field.</p> <p>The UE shall store the complete list as received. If more than 8 LADNs are included in this information element, the UE shall store the first 8 LADNs and ignore the remaining octets of the information element.</p> <p>DNN value (octet 5 to octet m):</p> <p>DNN value field is coded as DNN value part of DNN information element as specified in subclause 9.11.2.1B starting with the third octet.</p> <p>S-NSSAI (octet m+1 to n) (see NOTE 1)</p> <p>S-NSSAI is coded as the length and value part of S-NSSAI information element as specified in subclause 9.11.2.8 starting with the second octet.</p> <p>5GS tracking area identity list (octet m+1 to octet a):</p> <p>5GS tracking area identity list field is coded as the length and the value part of the 5GS Tracking area identity list information element as specified in subclause 9.11.3.9 starting with the second octet.</p> <p>NOTE 1: The S-NSSAI included in the Extended LADN information information element shall be an S-NSSAI from, an allowed NSSAI or an partially allowed NSSAI provided to the UE.</p>

9.11.3.97 Alternative NSSAI

The purpose of the Alternative NSSAI information element is to identify a list of mapping information between the S-NSSAI to be replaced and the alternative S-NSSAI.

The Alternative NSSAI information element is coded as shown in figure 9.11.3.97.1, figure 9.11.3.97.2 and table 9.11.3.97.1.

The Alternative NSSAI is a type 4 information element with minimum length of 2 octets and maximum length of 146 octets.

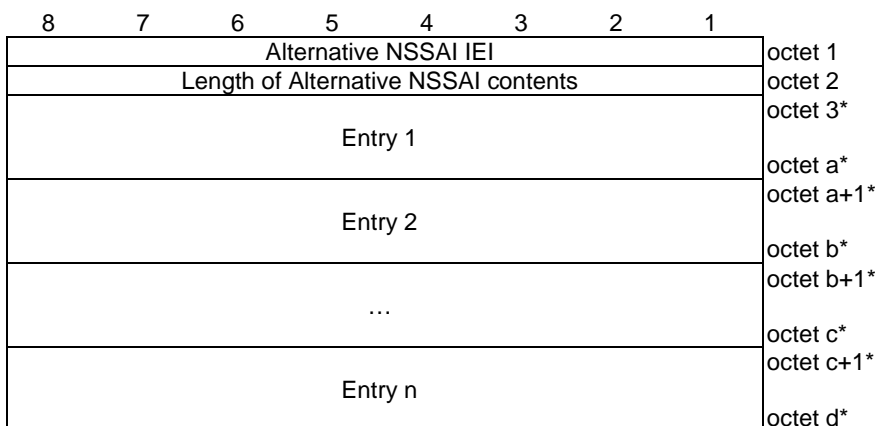

Figure 9.11.3.97.1: Alternative NSSAI information element

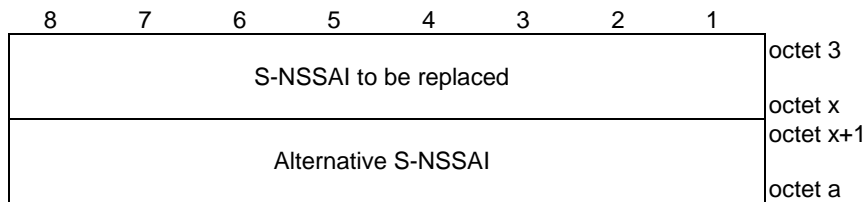

Figure 9.11.3.97.2: Entry

Table 9.11.3.97.1: Alternative NSSAI information element

<p>Value part of the Alternative NSSAI information element (octet 3 to d)</p> <p>The value part of the Alternative NSSAI information element consists of one or more entries, each entry consists of one S-NSSAI to be replaced and one alternative S-NSSAI. The number of entries shall not exceed eight.</p> <p>S-NSSAI to be replaced (octet 3 to x) (see NOTE)</p> <p>S-NSSAI to be replaced is coded as the length and value part of S-NSSAI information element as specified in subclause 9.11.2.8 starting with the second octet.</p> <p>Alternative S-NSSAI (octet x+1 to a)</p> <p>Alternative S-NSSAI is coded as the length and value part of S-NSSAI information element as specified in subclause 9.11.2.8 starting with the second octet.</p> <p>NOTE: The S-NSSAI to be replaced shall be one S-NSSAI included in the allowed NSSAI or partially allowed NSSAI.</p>

9.11.3.98 Type 6 IE container

The purpose of the Type 6 IE container information element is to transfer type 6 IEs of format TLV-E explicitly specified for inclusion in this information element for the respective message.

NOTE: Use of this information element is intended only for type 6 IEs added to a message in Rel-18 or later.

The rules for the IEI value encoding specified in 3GPP TS 24.007 [11], subclause 11.2.4, are not applicable for the IEIs of the type 6 IEs within the Type 6 IE container information element. These IEIs can take any value in the range 00 to FF (hexadecimal).

The type 6 IE container information element is coded as shown in figure 9.11.3.98.1, figure 9.11.3.98.2 and table 9.11.3.98.1.

The type 6 IE container is a type 6 information element with a minimum length of 6 octets.

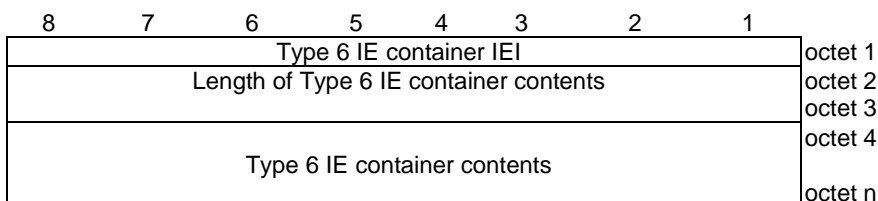

Figure 9.11.3.98.1: Type 6 IE container information element

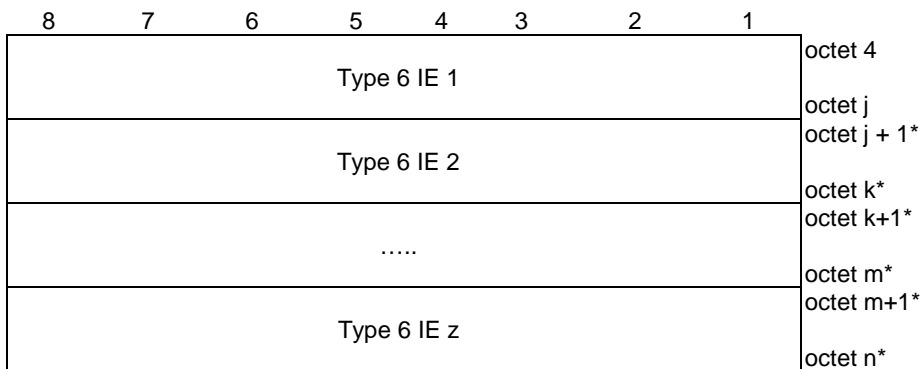

Figure 9.11.3.98.2: Type 6 IE container contents

Table 9.11.3.98.1: Type 6 IE container contents

<p>Type 6 IE container contents (octets 4 to n) The Type 6 IE container is coded according to figure 9.11.3.98.2.</p> <p>The sender of this information element shall encode each type 6 IE included in the contents in format TLV-E.</p> <p>For the coding of each of the type 6 IEs in the type 6 IE container, see the definition of the respective type 6 IE in subclause 9.11</p>

9.11.3.99 Non-3GPP access path switching indication

The purpose of the Non-3GPP access path switching indication information element is to indicate whether the UE supports the non-3GPP access path switching for the PDU session.

The Non-3GPP access path switching indication information element is coded as shown in figure 9.11.3.99.1 and table 9.11.3.99.1.

The Non-3GPP access path switching indication is a type 4 information element with a length of 3 octets.

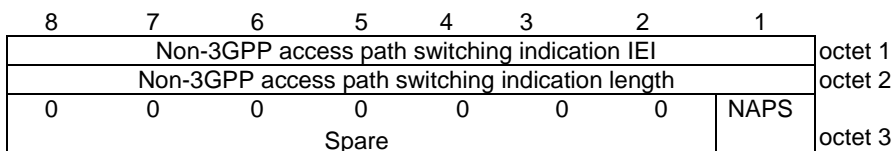

Figure 9.11.3.99.1: Non-3GPP access path switching indication information element

Table 9.11.3.99.1 : Non-3GPP access path switching indication information element

<p>Non-3GPP access path switching (NAPS) (octet 3, bit 1) This bit indicates whether non-3GPP access path switching is supported.</p> <p>Bit</p> <p>1</p> <p>0 non-3GPP access path switching not supported</p> <p>1 non-3GPP access path switching supported</p> <p>Bits 2 to 8 of octet 3 are spare and shall be coded as zero.</p>

9.11.3.100 S-NSSAI location validity information

The purpose of the S-NSSAI location validity information information element is to provide the S-NSSAI location validity information to the UE.

The S-NSSAI location validity information information element is coded as shown in figures 9.11.3.100.1, 9.11.3.100.2, 9.11.3.100.3, and 9.11.3.100.4 and table 9.11.3.100.1.

The S-NSSAI location validity information information element can contain per-S-NSSAI location validity information for maximum 16 S-NSSAIs.

The S-NSSAI location validity information information is a type 6 information element with a minimum length of 17 octets and a maximum length of 38611 octets.

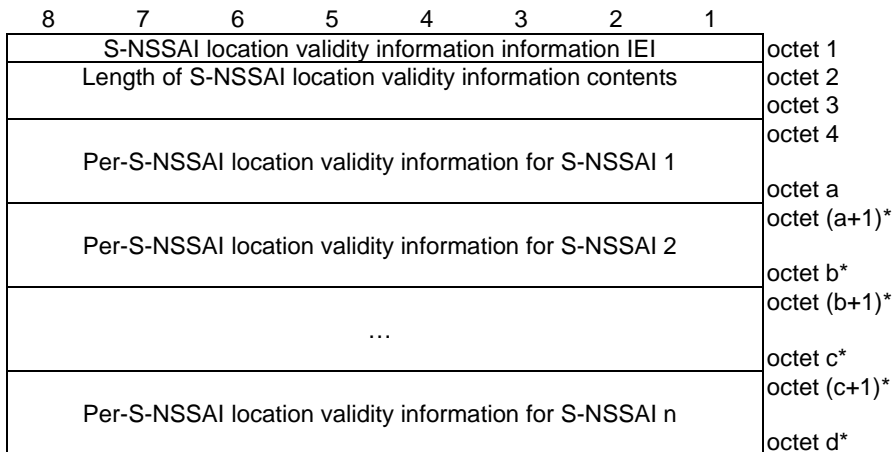

Figure 9.11.3.100.1: S-NSSAI location validity information information element

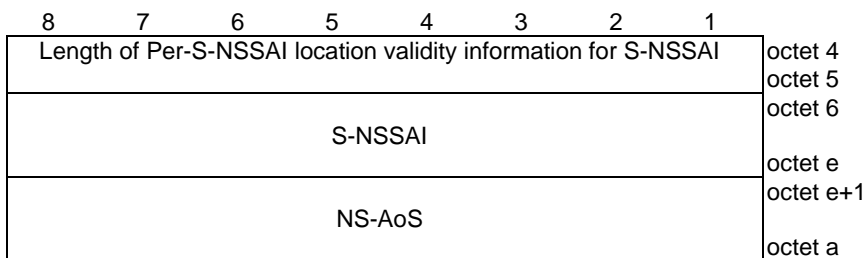

Figure 9.11.3.100.2: Per-S-NSSAI location validity information for S-NSSAI

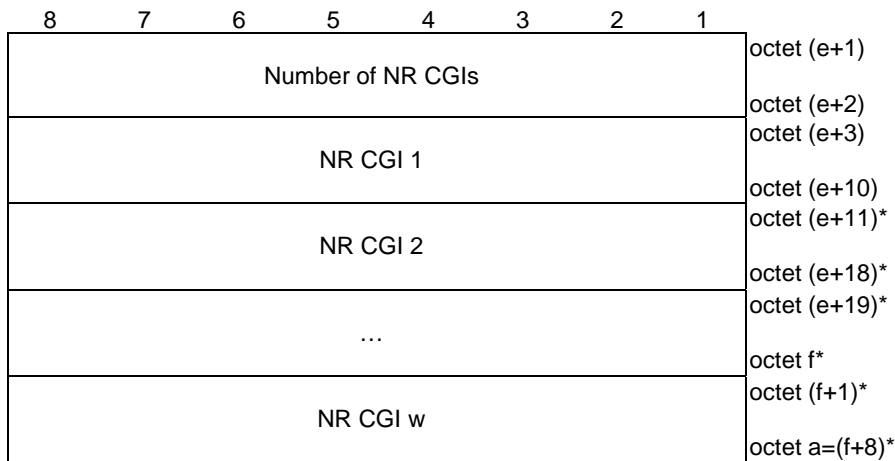

Figure 9.11.3.100.3: NS-AoS

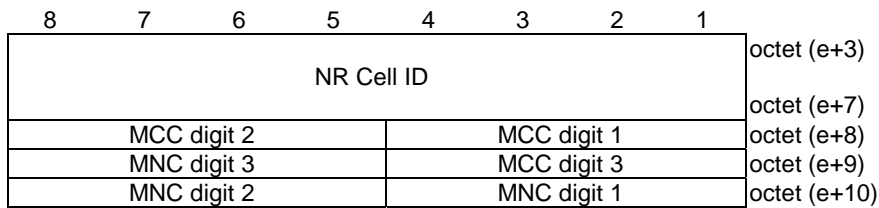

Figure 9.11.3.100.4: NR CGI

Table 9.11.3.100.1: S-NSSAI location validity information information element

<p>S-NSSAI (octet 6 to e) S-NSSAI value is coded as the length and value part of S-NSSAI information element as specified in subclause 9.11.2.8 starting with the second octet.</p> <p>NS-AoS (octet e+1 to octet a) NS-AoS field consists of the Number of NR cell IDs field and at least two NR CGIs.</p> <p>Number of NR CGIs (octet e+1 to octet e+2) The field indicates the number of NR CGIs included in octets e+3 to octet a. (NOTE).</p> <p>NR CGI (octet e+3 to e+10) The NR CGI globally identifies an NR cell. It contains the NR Cell ID and the PLMN ID of that cell.</p> <p>NR Cell ID (octet e+3 to e+7) The NR Cell ID consists of 36 bits identifying an NR Cell ID as specified in subclause 9.3.1.7 of 3GPP TS 38.413 [31], in hexadecimal representation. Bit 8 of octet e+3 is the most significant bit and bit 5 of octet e+7 is the least significant bit. Bits 1 to 4 of octet e+7 are spare and shall be coded as zero.</p> <p>MCC, Mobile country code (octet e+8 and bits 1 to 4 octet e+9) The MCC field is coded as in ITU-T Recommendation E.212 [42], annex A.</p> <p>MNC, Mobile network code (bits 5 to 8 of octet e+9 and octet e+10) The coding of this field is the responsibility of each administration but BCD coding shall be used. The MNC shall consist of 2 or 3 digits. If a network operator decides to use only two digits in the MNC, bits 5 to 8 of octet e+9 shall be coded as "1111".</p> <p>The MCC and MNC digits are coded as octets 6 to 8 of the Temporary mobile group identity IE in figure 10.5.154 of 3GPP TS 24.008 [12].</p> <p>NOTE: In this version the specification, the maximum number of NR cell IDs is 300.</p>
--

9.11.3.101 S-NSSAI time validity information

The purpose of the S-NSSAI time validity information information element is to provide S-NSSAI time validity information of one or more S-NSSAIs to the UE.

The S-NSSAI time validity information information element is coded as shown in figures 9.11.3.101.1 and 9.11.3.101.2 and table 9.11.3.101.1.

The S-NSSAI time validity information information element can contain per-S-NSSAI time validity information for maximum 16 S-NSSAIs.

The S-NSSAI time validity information information is a type 4 information element with a minimum length of 23 octets and a maximum length of 257 octets.

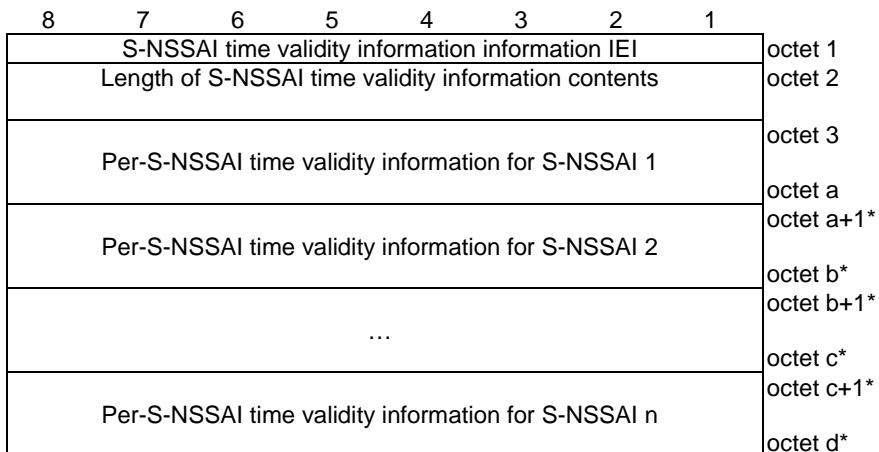

Figure 9.11.3.101.1: S-NSSAI time validity information information element

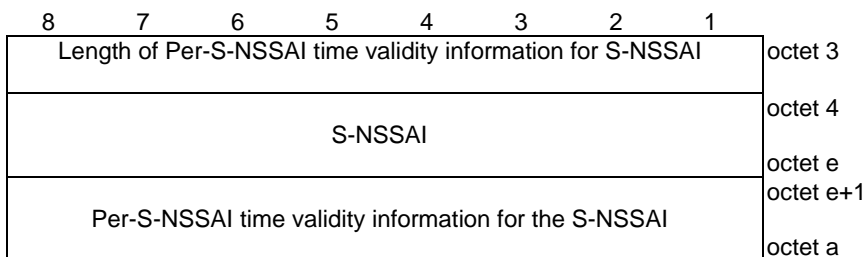

Figure 9.11.3.101.2: Per-S-NSSAI time validity information for S-NSSAI 1

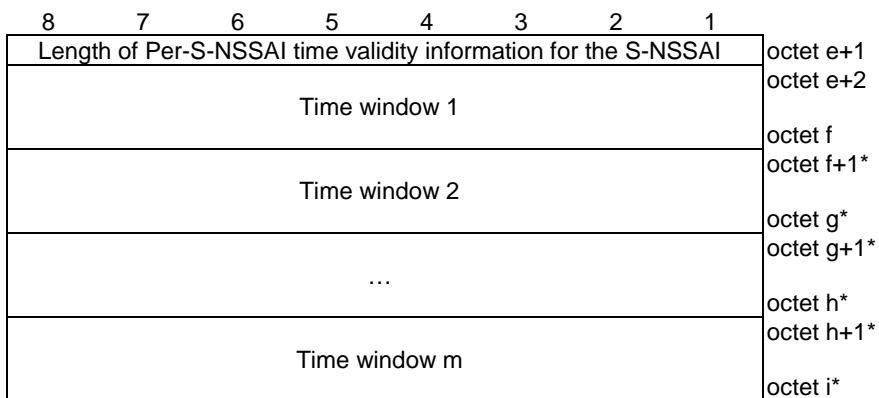

Figure 9.11.3.101.3: Per-S-NSSAI time validity information for the S-NSSAI

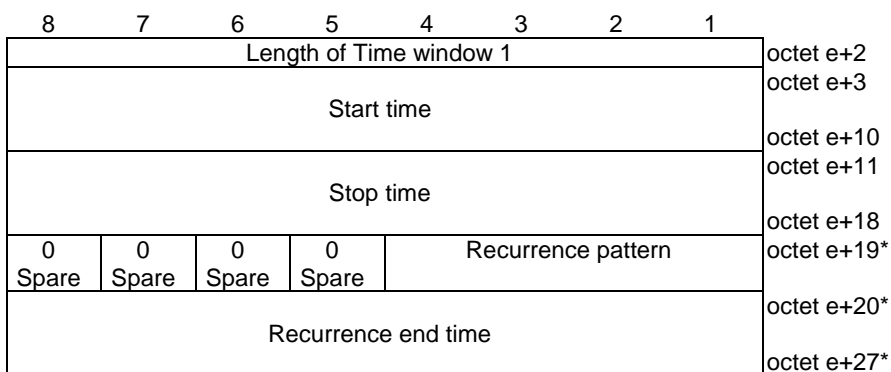

Figure 9.11.3.101.4: Time window 1

Table 9.11.3.101.1: S-NSSAI time validity information information element

S-NSSAI (octet 6 to octet e)	
S-NSSAI value is coded as the length and value part of S-NSSAI information element as specified in subclause 9.11.2.8 starting with the second octet.	
Start time (octet e+3 to octet e+10)	
The field indicates the time when the network slice identified by the S-NSSAI becomes available (for the first time if octet e+20 is included) and is represented by the number of seconds since 00:00:00 on 1 January 1970 UTC and is encoded as the 64-bit NTP timestamp format defined in IETF RFC 5905 [36A], where binary encoding of the integer part is in the first 32 bits and binary encoding of the fraction part in the last 32 bits.	
Stop time (octet e+11 to octet e+18)	
The field indicates the time when the network slice identified by the S-NSSAI becomes unavailable (for the first time if octet e+20 is included) and is represented by the number of seconds since 00:00:00 on 1 January 1970 UTC and is encoded as the 64-bit NTP timestamp format defined in IETF RFC 5905 [36A], where binary encoding of the integer part is in the first 32 bits and binary encoding of the fraction part in the last 32 bits.	
Recurrence pattern (bit 1 to bit 4 of octet e+19)	
Bits	
4	3 2 1
0 0 0 0	Everyday
0 0 0 1	Every weekday
0 0 1 0	Every week
0 0 1 1	Every 2 weeks
0 1 0 0	Every month (absolute)
0 1 0 1	Every month (relative)
0 1 1 0	Every quarter (absolute)
0 1 1 1	Every quarter (relative)
1 0 0 0	Every 6 months (absolute)
1 0 0 1	Every 6 months (relative)
All other values are reserved.	
The recurrence pattern indicates how often the time window is repeated. For example, if the time window starts at 13:00 on Wednesday January 1 st 2020 and stops at 13:30 on Wednesday January 1 st 2020 and the recurrent pattern is set to:	
<ul style="list-style-type: none"> - "Everyday", the time window repeats everyday from 13:00 to 13:30; - "Every week", the time window repeats every Wednesday from 13:00 to 13:30; - "Every month (absolute)", the time window repeats every 1st day of the month from 13:00 to 13:30; and - "Every month (relative)", the time window repeats every month on the first Wednesday from 13:00 to 13:30. 	
Recurrence end time (octet e+20 to octet e+27)	
The field indicates the time when the repetition of the time window ends. If the field is not included and octet e+19 is included in the IE, the time window is repeated indefinitely. The field is represented by the number of seconds since 00:00:00 on 1 January 1970 UTC and is encoded as the 64-bit NTP timestamp format defined in IETF RFC 5905 [36A], where binary encoding of the integer part is in the first 32 bits and binary encoding of the fraction part in the last 32 bits.	

9.11.3.102 Non-3GPP path switching information

The purpose of the Non-3GPP path switching information information element is to request from the network to keep using the user plane resources of the old non-3GPP access during path switching to the new non-3GPP access.

The Non-3GPP path switching information information element is coded as shown in figure 9.11.3.102.1 and table 9.11.3.102.1.

The Non-3GPP path switching information is a type 4 information element with a length of 3 octets.

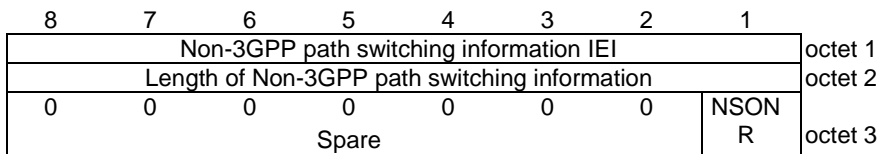

Figure 9.11.3.102.1: Non-3GPP path switching information information element

Table 9.11.3.102.1: Non-3GPP path switching information information element

Non-3GPP path switching while using old non-3GPP resources (NSONR) (octet 3, bit 1)	
Bit	
1	
0	non-3GPP path switching while using old non-3GPP resources not requested
1	non-3GPP path switching while using old non-3GPP resources requested
Bits 8 to 2 of octet 3 are spare and shall be coded as zero.	

9.11.3.103 Partial NSSAI

The purpose of the Partial NSSAI information element is to deliver one or more S-NSSAIs in a set of tracking areas of a registration area from the network to the UE.

The Partial NSSAI information element is coded as shown in figure 9.11.3.103.1, and table 9.11.3.103.1.

The Partial NSSAI information element is a type 6 information element, with a minimum length of 3 octets and a maximum length of 808 octets.

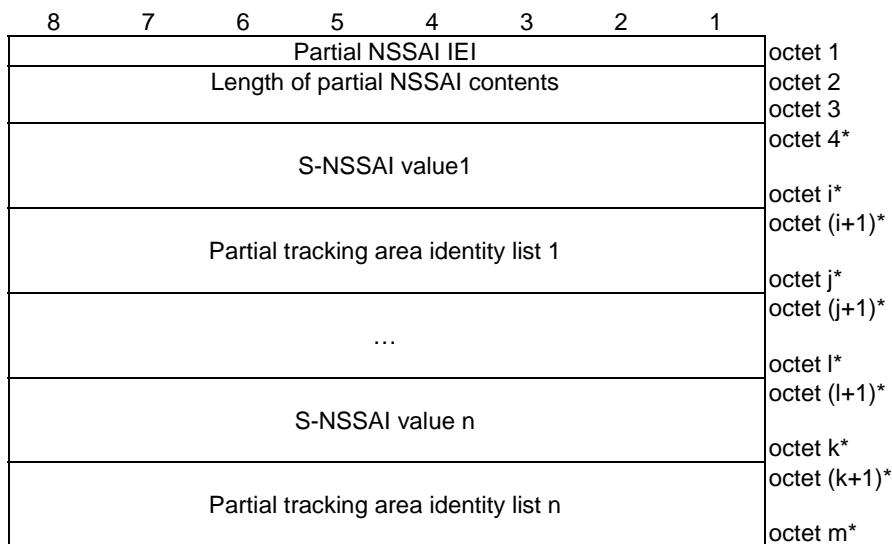

Figure 9.11.3.103.1: Partial NSSAI information element

Table 9.11.3.103.1: Partial NSSAI information element

<p>S-NSSAI value (octet 4 to i) (NOTE 1) S-NSSAI value is coded as the length and value part of S-NSSAI information element as specified in subclause 9.11.2.8 starting with the second octet.</p> <p>Partial tracking area identity list (octet i+1 to j) The partial tracking area identity list field is coded as the length and value part of the 5GS tracking area identity list IE defined in subclause 9.11.3.9 starting with the second octet (NOTE 2).</p>
<p>NOTE 1: The maximum number of S-NSSAIs included in this information element is 7.</p> <p>NOTE 2: A registration area contains maximum 16 different tracking areas, therefore the partial tracking area identity list can contain at the most 15 tracking area identities.</p> <p>NOTE 3: The AMF shall set the Length of partial NSSAI contents to 0 if there are no S-NSSAIs to deliver in a set of tracking areas of a registration area and, the UE shall delete any existing stored partially allowed NSSAI for the current registration area or partially rejected NSSAI for the current registration area.</p>

9.11.3.104 AUN3 indication

The purpose of the AUN3 indication information element is to indicate to the network that the registration request by the 5G-RG is on behalf of an AUN3 device.

The AUN3 indication information element is coded as shown in figure 9.11.3.104.1 and table 9.11.3.104.1.

The AUN3 indication is a type 4 information element with a length of 3 octets.

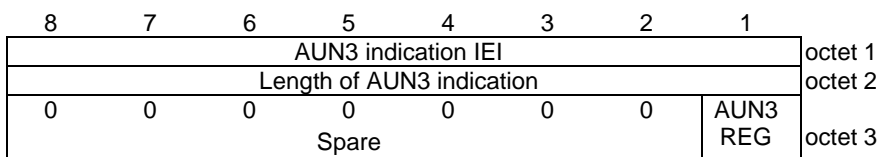

Figure 9.11.3.104.1: AUN3 indication information element

Table 9.11.3.104.1: AUN3 indication information element

AUN3 device indication bit (AUN3REG) (octet 3, bit 1)	
Bit	
1	
0	AUN3 device registration is not requested
1	AUN3 device registration is requested
Bits 8 to 2 of octet 3 are spare and shall be coded as zero.	

9.11.3.105 Feature authorization indication

The purpose of the Feature authorization indication information element is to indicate whether the UE that is authorized to operate certain feature.

The Feature authorization indication is a type 4 information element with a minimum length of 3 octets and maximum length of 257 octets.

The Feature authorization indication information element is coded as shown in Figure 9.11.3.105.1 and Table 9.11.3.105.1.

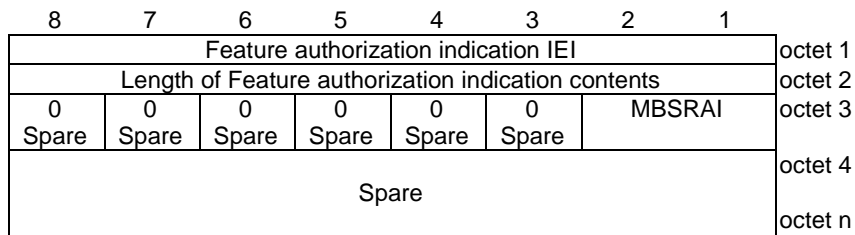

Figure 9.11.3.105.1: Feature authorization indication information element

Table 9.11.3.105.1: Feature authorization indication information element

MBSR authorization indication (MBSRAI) (octet 3, bit 1 to bit 2)	
This field indicates whether UE is authorized or not to operate as an MBSR node	
Bits	
2	1
0 0	no information
0 1	not authorized to operate as MBSR but allowed to operate as a UE
1 0	authorized to operate as MBSR
1 1	spare
Bits 3 to 8 of octet 3 are spare and shall be coded as zero.	

9.11.3.106 Payload container information

The purpose of the Payload container information information element is to provide information related to a payload container.

The Payload container information is a type 1 information element.

The Payload container information information element is coded as shown in figure 9.11.3.106.1 and table 9.11.3.106.1.

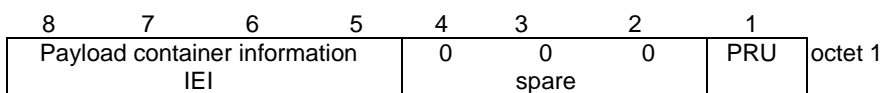

Figure 9.11.3.106.1: Payload container information information element

Table 9.11.3.106.1: Payload container information information element

PRU related content (PRU) (octet 1, bit 1)	
Bit	
1	
0	Payload container not related to PRU
1	Payload container related to PRU
Bits 2 to 4 are spare and shall be coded as zero.	

9.11.3.107 AUN3 device security key

The purpose of the AUN3 device security key information element is to provide the security keys to the 5G-RG that is acting on behalf of an AUN3 device.

The AUN3 device security key information element is coded as shown in figure 9.11.3.107.1 and table 9.11.3.107.1.

The AUN3 device security key is a type 4 information element with a minimum length of 36 octets.

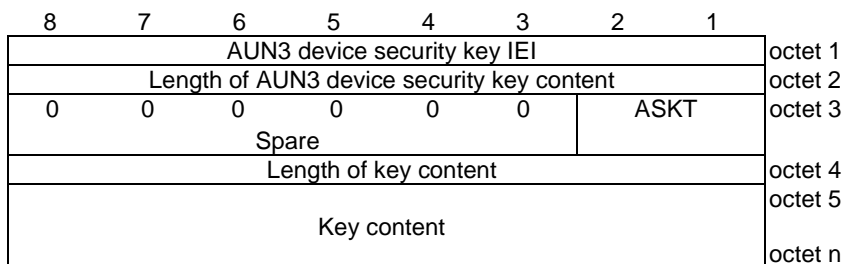

Figure 9.11.3.107.1: AUN3 device security key information element

Table 9.11.3.107.1: AUN3 device security key information element

<p>AUN3 device security key type (ASKT) (bits 1 and 2 of octet 3) The ASKT indicates which AUN3 device security key is included in the IE. Bits</p> <table border="0"> <tr> <td style="text-align: right;">2</td> <td style="text-align: right;">1</td> <td></td> </tr> <tr> <td style="text-align: right;">0</td> <td style="text-align: right;">0</td> <td>Master session key is included</td> </tr> <tr> <td style="text-align: right;">0</td> <td style="text-align: right;">1</td> <td>K_{WAGF} key is included</td> </tr> </table> <p>All other values are unused and shall be interpreted as "Master session key is included", if received by the UE.</p> <p>Key content (octets 5 to n) If ASKT is set to "Master session key included", the Key content contains the value of the Master session key as defined in 3GPP TS 33.501 [24]. If ASKT is set to "K_{WAGF} key included", the Key content contains the value of the K_{WAGF} key as defined in 3GPP TS 33.501 [24].</p>	2	1		0	0	Master session key is included	0	1	K _{WAGF} key is included
2	1								
0	0	Master session key is included							
0	1	K _{WAGF} key is included							

9.11.3.108 On-demand NSSAI

The purpose of the On-demand NSSAI information element is to provide a list of one or more on-demand S-NSSAIs and the associated slice deregistration inactivity timer value per the on-demand S-NSSAI to the UE.

The On-demand NSSAI information element is coded as shown in figure 9.11.3.108.1, figure 9.11.3.108.2, and table 9.11.3.108.1.

The On-demand NSSAI is a type 4 information element with a minimum length of 5 octets and a maximum length of 210 octets.

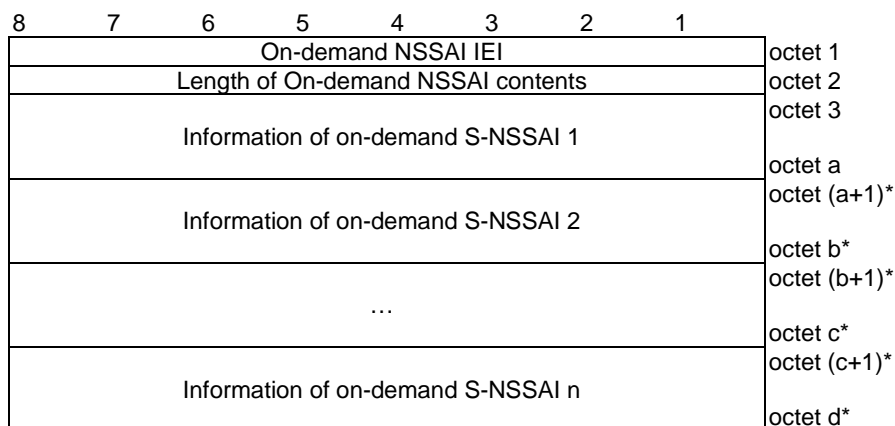

Figure 9.11.3.108.1: On-demand NSSAI information element

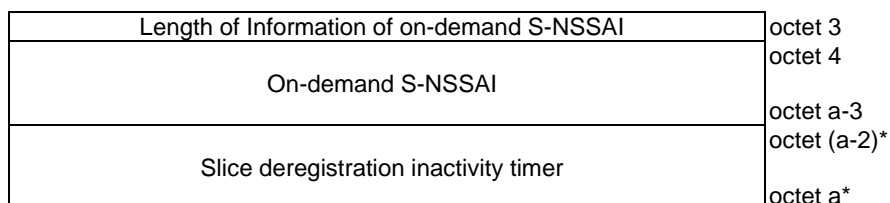

Figure 9.11.3.108.2: Information of on-demand S-NSSAI

Table 9.11.3.108.1: On-demand NSSAI information element

<p>Value part of the On-demand NSSAI information element (octet 3 to d)</p> <p>The value part of the On-demand NSSAI information element consists of one or more Information of on-demand S-NSSAIs. Each Information of on-demand S-NSSAI consists of one on-demand S-NSSAI and optionally the slice deregistration inactivity timer of the on-demand S-NSSAI. The number of information of on-demand S-NSSAIs shall not exceed 16.</p> <p>On-demand S-NSSAI (octet 4 to a-3)</p> <p>On-demand S-NSSAI is coded as the length and value part of S-NSSAI information element as specified in subclause 9.11.2.8 starting with the second octet.</p> <p>Slice deregistration inactivity timer (octet (a-2)* to a*)</p> <p>Slice deregistration inactivity timer is coded as the value part of Time duration information element as specified in subclause 9.9.3.68 of 3GPP TS 24.301 [15] starting with the third octet.</p>
--

9.11.3.109 Extended 5GMM cause

The purpose of the Extended 5GMM cause information element is to indicate additional information associated with a 5GMM cause.

The Extended 5GMM cause information element is coded as shown in figure 9.11.3.109.1 and table 9.11.3.109.1.

The Extended 5GMM cause is a type 4 information element with a length of 3 octets.

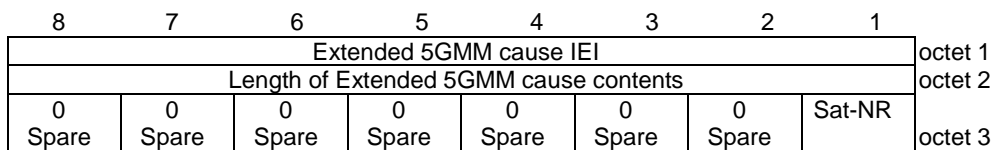

Figure 9.11.3.109.1: Extended 5GMM cause information element

Table 9.11.3.109.1: Extended 5GMM cause information element

Sat-NR value (octet 3, bit 1)	
Bit	
1	
0	Satellite NG-RAN allowed in PLMN
1	Satellite NG-RAN not allowed in PLMN
Bit 2 to 8 of octet 3 are spare and shall be coded as zero.	

9.11.4 5GS session management (5GSM) information elements

9.11.4.1 5GSM capability

The purpose of the 5GSM capability information element is to indicate UE capability related to the PDU session management.

The 5GSM capability information element is coded as shown in figure 9.11.4.1.1 and table 9.11.4.1.1.

The 5GSM capability is a type 4 information element with a minimum length of 3 octets and a maximum length of 15 octets.

8	7	6	5	4	3	2	1	
5GSM capability IEI								octet 1
Length of 5GSM capability contents								octet 2
TPMIC	ATSSS-ST				EPT-S1	MH6-PDU	RqoS	octet 3
0 Spare	MPQU IC- UDP	MPTC P	ATSSS-LL		0 Spare	SDNA EPC	APMQ F	octet 4
0	0	0	0	0	0	0	0	octet 5* -15*
Spare								

Figure 9.11.4.1.1: 5GSM capability information element

Table 9.11.4.1.1: 5GSM capability information element

5GSM capability value	
RqoS (octet 3, bit 1)	
This bit indicates the 5GSM capability to support reflective QoS.	
0	Reflective QoS not supported
1	Reflective QoS supported
Multi-homed IPv6 PDU session (MH6-PDU) (octet 3, bit 2)	
This bit indicates the 5GSM capability for Multi-homed IPv6 PDU session.	
0	Multi-homed IPv6 PDU session not supported
1	Multi-homed IPv6 PDU session supported
Ethernet PDN type in S1 mode (EPT-S1) (octet 3, bit 3)	
This bit indicates UE's 5GSM capability for Ethernet PDN type in S1 mode.	
0	Ethernet PDN type in S1 mode not supported
1	Ethernet PDN type in S1 mode supported
Supported ATSSS steering functionalities and steering modes (ATSSS-ST) (octet 3, bits 4 to 7) (NOTE 1)	
These bits indicate the 5GSM capability of ATSSS steering functionalities and steering modes	
0 0 0 0	ATSSS not supported (NOTE 2)
0 0 0 1	ATSSS Low-Layer functionality with any steering mode allowed for ATSSS-LL supported
0 0 1 0	MPTCP functionality with any steering mode and ATSSS-LL functionality with only active-standby steering mode supported
0 0 1 1	MPTCP functionality with any steering mode and ATSSS-LL functionality with any steering mode allowed for ATSSS-LL supported
All other values are reserved.	
Transfer of port management information containers (TPMIC) (octet 3, bit 8)	
This bit indicates the 5GSM capability to support transfer of port management information containers	
0	Transfer of port management information containers not supported
1	Transfer of port management information containers supported
Access performance measurements per QoS flow rule (APMQF) (octet 4, bit1)	
This bit indicates the 5GSM capability to support access performance measurements using the QoS flow of the non default QoS rule, that is used by the service data flow (SDF) traffic.	
0	Access performance measurements per QoS flow not supported.
1	Access performance measurements per QoS flow supported.
Secondary DN authentication and authorization over EPC (SDNAEPC) (octet 4, bit 2)	
This bit indicates the 5GSM capability to support secondary DN authentication and authorization over EPC	
0	Secondary DN authentication and authorization over EPC not supported
1	Secondary DN authentication and authorization over EPC supported
ATSSS-LL functionality support (ATSSS-LL) (octet 4 bits 4 and 5)	
This capability indicates the support for ATSSS-LL functionality.	
Bit	
5 4	
0 0	ATSSS-LL functionality not supported (NOTE 2)
0 1	ATSSS-LL functionality with only active-standby steering mode supported
1 0	ATSSS-LL functionality with any steering mode allowed for ATSSS-LL supported
1 1	spare
Supporting MPTCP functionality with any steering mode (MPTCP) (octet 4, bit 6)	
This bit indicates whether the MPTCP functionality with any steering mode is supported (NOTE 3).	
0	MPTCP functionality with any steering mode not supported (NOTE 2)
1	MPTCP functionality with any steering mode supported
Supporting MPQUIC functionality with any steering mode (MPQUIC-UDP) (octet 4, bit 7)	
This bit indicates whether the MPQUIC functionality with any steering mode is supported (NOTE 3).	

0	MPQUIC functionality with any steering mode not supported (NOTE 2)
1	MPQUIC functionality with any steering mode supported
All other bits in octet 4 to 15 are spare and shall be coded as zero, if the respective octet is included in the information element.	
NOTE 1: The UE shall populate these bits in the same way as a UE of a previous release..	
NOTE 2: For MA PDU session, at least one of the following fields: ATSSS-ST, ATSSS-LL, MPTCP, and MPQUIC-UDP shall be set to a non-zero value.	
NOTE 3: If ATSSS-LL is set to 00 then this bit shall be set to 0.	

9.11.4.2 5GSM cause

The purpose of the 5GSM cause information element is to indicate the reason why a 5GSM request is rejected.

The 5GSM cause information element is coded as shown in figure 9.11.4.2.1 and table 9.11.4.2.1.

The 5GSM cause is a type 3 information element with a length of 2 octets.

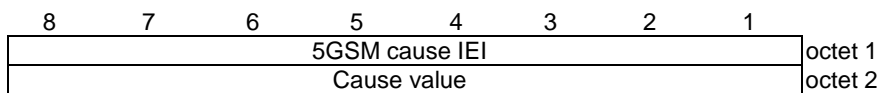

Figure 9.11.4.2.1: 5GSM cause information element

Table 9.11.4.2.1: 5GSM cause information element

Cause value (octet 2)								
Bits								
8	7	6	5	4	3	2	1	
0	0	0	0	1	0	0	0	Operator determined barring
0	0	0	1	1	0	1	0	Insufficient resources
0	0	0	1	1	0	1	1	Missing or unknown DNN
0	0	0	1	1	1	0	0	Unknown PDU session type
0	0	0	1	1	1	0	1	User authentication or authorization failed
0	0	0	1	1	1	1	1	Request rejected, unspecified
0	0	1	0	0	0	0	0	Service option not supported
0	0	1	0	0	0	0	1	Requested service option not subscribed
0	0	1	0	0	0	1	1	PTI already in use
0	0	1	0	0	1	0	0	Regular deactivation
0	0	1	0	0	1	0	1	5GS QoS not accepted
0	0	1	0	0	1	1	0	Network failure
0	0	1	0	0	1	1	1	Reactivation requested
0	0	1	0	1	0	0	1	Semantic error in the TFT operation
0	0	1	0	1	0	1	0	Syntactical error in the TFT operation
0	0	1	0	1	0	1	1	Invalid PDU session identity
0	0	1	0	1	1	0	0	Semantic errors in packet filter(s)
0	0	1	0	1	1	0	1	Syntactical error in packet filter(s)
0	0	1	0	1	1	1	0	Out of LADN service area
0	0	1	0	1	1	1	1	PTI mismatch
0	0	1	1	0	0	1	0	PDU session type IPv4 only allowed
0	0	1	1	0	0	1	1	PDU session type IPv6 only allowed
0	0	1	1	0	1	1	0	PDU session does not exist
0	0	1	1	1	0	0	1	PDU session type IPv4v6 only allowed
0	0	1	1	1	0	1	0	PDU session type Unstructured only allowed
0	0	1	1	1	0	1	1	Unsupported 5QI value
0	0	1	1	1	1	0	1	PDU session type Ethernet only allowed
0	1	0	0	0	0	1	1	Insufficient resources for specific slice and DNN
0	1	0	0	0	1	0	0	Not supported SSC mode
0	1	0	0	0	1	0	1	Insufficient resources for specific slice
0	1	0	0	0	1	1	0	Missing or unknown DNN in a slice
0	1	0	1	0	0	0	1	Invalid PTI value
0	1	0	1	0	0	1	0	Maximum data rate per UE for user-plane integrity protection is too low
0	1	0	1	0	0	1	1	Semantic error in the QoS operation
0	1	0	1	0	1	0	0	Syntactical error in the QoS operation
0	1	0	1	0	1	0	1	Invalid mapped EPS bearer identity
0	1	0	1	0	1	1	0	UAS services not allowed
0	1	0	1	1	1	1	1	Semantically incorrect message
0	1	1	0	0	0	0	0	Invalid mandatory information
0	1	1	0	0	0	0	1	Message type non-existent or not implemented
0	1	1	0	0	0	1	0	Message type not compatible with the protocol state
0	1	1	0	0	0	1	1	Information element non-existent or not implemented
0	1	1	0	0	1	0	0	Conditional IE error
0	1	1	0	0	1	0	1	Message not compatible with the protocol state
0	1	1	0	1	1	1	1	Protocol error, unspecified

Any other value received by the UE shall be treated as 0001 1111, "Request rejected, unspecified". Any other value received by the network shall be treated as 0110 1111, "protocol error, unspecified".

9.11.4.3 Always-on PDU session indication

The purpose of the Always-on PDU session indication information element is to indicate whether a PDU session is established as an always-on PDU session.

The Always-on PDU session indication information element is coded as shown in figure 9.11.4.3.1 and table 9.11.4.3.1.

The Always-on PDU session indication is a type 1 information element.

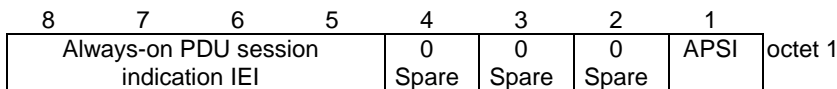

Figure 9.11.4.3.1: Always-on PDU session indication

Table 9.11.4.3.1: Always-on PDU session indication

Always-on PDU session indication (APSI) (octet 1)	
Bit	
1	
0	Always-on PDU session not allowed
1	Always-on PDU session required
Bits 2, 3 and 4 are spare and shall be coded as zero,	

9.11.4.4 Always-on PDU session requested

The purpose of the Always-on PDU session requested information element is to indicate whether a PDU session is requested to be established as an always-on PDU session.

The Always-on PDU session requested information element is coded as shown in figure 9.11.4.4.1 and table 9.11.4.4.1.

The Always-on PDU session requested is a type 1 information element.

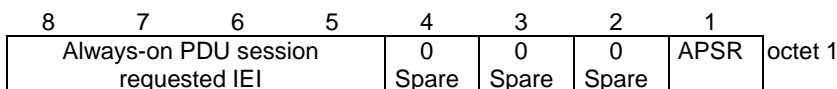

Figure 9.11.4.4.1: Always-on PDU session requested

Table 9.11.4.4.1: Always-on PDU session requested

Always-on PDU session requested (APSR) (octet 1)	
Bit	
1	
0	Always-on PDU session not requested
1	Always-on PDU session requested
Bits 2, 3 and 4 are spare and shall be coded as zero,	

9.11.4.5 Allowed SSC mode

The purpose of the Allowed SSC mode information element is to indicate the SSC modes allowed to be used by the UE for the PDU session.

The Allowed SSC mode information element is coded as shown in figure 9.11.4.5.1 and table 9.11.4.5.1.

The Allowed SSC mode is a type 1 information element.

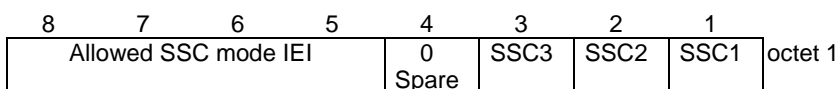

Figure 9.11.4.5.1: Allowed SSC mode information element

Table 9.11.4.5.1: Allowed SSC mode information element

SSC1 (octet 1, bit 1)	
Bit	
1	
0	SSC mode 1 not allowed
1	SSC mode 1 allowed
SSC2 (octet 1, bit 2)	
Bit	
2	
0	SSC mode 2 not allowed
1	SSC mode 2 allowed
SSC3 (octet 1, bit 3)	
Bit	
3	
0	SSC mode 3 not allowed
1	SSC mode 3 allowed
Bit 4 is spare and shall be encoded as zero.	

9.11.4.6 Extended protocol configuration options

See subclause 10.5.6.3A in 3GPP TS 24.008 [12].

9.11.4.7 Integrity protection maximum data rate

The purpose of the integrity protection maximum data rate information element is for the UE to indicate to the network the maximum data rate per UE for user-plane integrity protection for uplink and the maximum data rate per UE for user-plane integrity protection for downlink that are supported by the UE.

The integrity protection maximum data rate is coded as shown in figure 9.11.4.7.1 and table 9.11.4.7.2.

The integrity protection maximum data rate is a type 3 information element with a length of 3 octets.

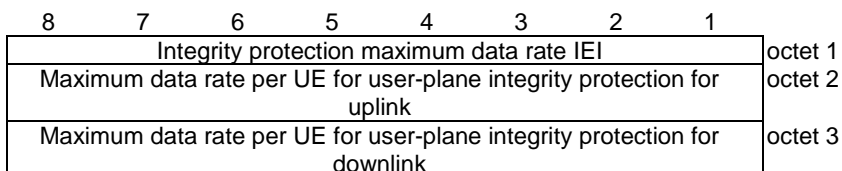

Figure 9.11.4.7.1: Integrity protection maximum data rate information element

Table 9.11.4.7.2: Integrity protection maximum data rate information element

Maximum data rate per UE for user-plane integrity protection for uplink (octet 2)								
Bits								
8	7	6	5	4	3	2	1	
0	0	0	0	0	0	0	0	64 kbps (NOTE 3)
0	0	0	0	0	0	0	1	NULL (NOTE 1)
1	1	1	1	1	1	1	1	Full data rate (NOTE 2)
All other values are spare and shall not be used by a UE compliant to the present version of this specification. If received they shall be interpreted as "64 kbps".								
Maximum data rate per UE for user-plane integrity protection for downlink (octet 3)								
Bits								
8	7	6	5	4	3	2	1	
0	0	0	0	0	0	0	0	64 kbps (NOTE 3)
0	0	0	0	0	0	0	1	NULL (NOTE 1)
1	1	1	1	1	1	1	1	Full data rate (NOTE 2)
All other values are spare and shall not be used by a UE compliant to the present version of this specification. If received they shall be interpreted as "64 kbps".								
NOTE 1: This value shall be used when N3 data transfer is not supported by the UE or when the UE does not support standalone NR connected to 5GCN.								
NOTE 2: If the UE supports N3 data transfer and supports standalone NR connected to 5GCN (this includes UEs supporting NR-NR dual connectivity, NR-E-UTRA dual connectivity with MN terminated bearers or both of them as described in 3GPP TS 37.340 [51]), then the UE shall use this value.								
NOTE 3: The network can receive this value from a UE compliant to an earlier version of this specification.								

9.11.4.8 Mapped EPS bearer contexts

The purpose of the mapped EPS bearer contexts information element is to indicate a set of EPS bearer contexts for a PDU session, as described in subclause 6.1.4.1.

The mapped EPS bearer contexts information element is a type 6 information element with a minimum length of 7 octet and a maximum length of 65538 octets.

The mapped EPS bearer contexts information element is coded as shown in figure 9.11.4.8.1, figure 9.11.4.8.2, figure 9.11.4.8.3 and table 9.11.4.8.1.

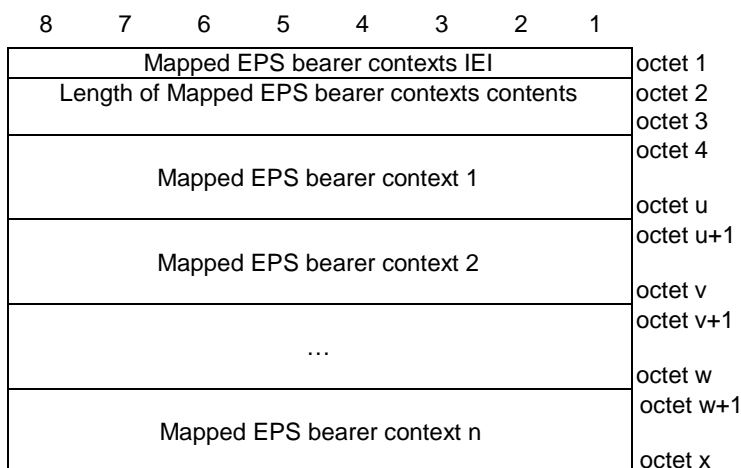

Figure 9.11.4.8.1: Mapped EPS bearer contexts

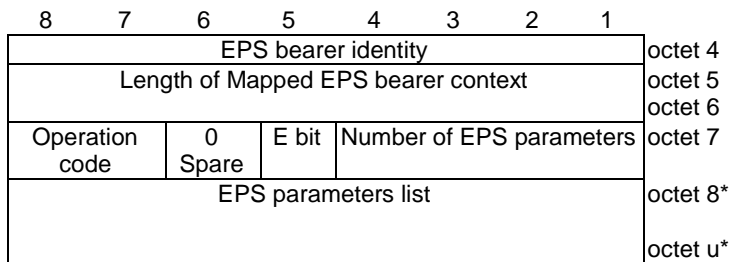

Figure 9.11.4.8.2: Mapped EPS bearer context

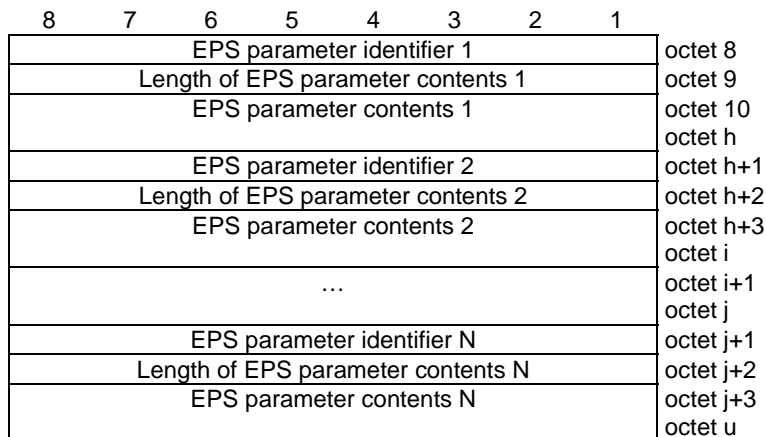

Figure 9.11.4.8.3: EPS parameters list

Table 9.11.4.8.1: Mapped EPS bearer contexts information element

EPS bearer identity (octet 4)

Bits 5 to 8 contain the EPS bearer identity, and are coded as specified in subclause 9.3.2 of 3GPP TS 24.301 [15]. Bits 1 to 4 are spare and shall be coded as zero.

Operation code (bits 8 to 7 of octet 7)

Bits

8 7

0 0 Reserved

0 1 Create new EPS bearer

1 0 Delete existing EPS bearer

1 1 Modify existing EPS bearer

Bit 6 of octet 7 is spare and shall be coded as zero.

E bit (bit 5 of octet 7)

For the "create new EPS bearer" operation, the E bit is encoded as follows:

Bit

5

0 parameters list is not included (NOTE)

1 parameters list is included

For the "modify existing EPS bearer" operation, the E bit is encoded as follows:

Bit

5

0 extension of previously provided parameters list

1 replacement of all previously provided parameters list

If the E bit is set to "parameters list is included", the number of EPS parameters field has non-zero value. If the E bit is set to "extension of previously provided parameters list" or "replacement of previously provided parameters list", the number of parameters field has non-zero value. If the E bit is set to "extension of previously provided parameters" and one of the parameters in the new parameters list already exists in the previously provided parameters, the parameter shall be set to the new value. If the E bit is set to "replacement of all previously provided parameters list" and a parameter in the previously provided parameters is not provided in the new parameters list, the parameter shall be deleted.

For the "create new EPS bearer" operation and "delete existing EPS bearer" operation, bit 5 of octet 7 is ignored.

Number of EPS parameters (bits 4 to 1 of octet 7)

The number of EPS parameters contains the binary coding for the number of EPS parameters in the EPS parameters list field. The number of EPS parameters field is encoded in bits 4 through 1 of octet 7 where bit 4 is the most significant and bit 1 is the least significant bit.

EPS parameters list (octets 8 to u)

The EPS parameters list contains a variable number of EPS parameters.

Each EPS parameter included in the EPS parameters list is of variable length and consists of:

- an EPS parameter identifier (1 octet);
- the length of the EPS parameter contents (1 octet); and
- the EPS parameter contents itself (variable amount of octets).

The EPS parameter identifier field is used to identify each EPS parameter included in the EPS parameters list and it contains the hexadecimal coding of the EPS parameter identifier. Bit 8 of the EPS parameter identifier field contains the most significant bit and bit 1 contains the least significant bit. In this version of the protocol, the following EPS parameter identifiers are specified:

- 01H (Mapped EPS QoS parameters);
- 02H (Mapped extended EPS QoS parameters); and
- 03H (Traffic flow template).
- 04H (APN-AMBR).
- 05H (extended APN-AMBR).

If the EPS parameters list contains an EPS parameter identifier that is not supported by the receiving entity the corresponding EPS parameter shall be discarded.

The length of EPS parameter contents field contains the binary coded representation of the length of the EPS parameter contents field. The first bit in transmission order is the most significant bit.

When the parameter identifier indicates mapped EPS QoS parameters, the length and parameter contents field are coded as specified in subclause 9.9.4.3 of 3GPP TS 24.301 [15].

When the parameter identifier indicates mapped extended EPS QoS parameters, the length and parameter contents field are coded as specified in subclause 9.9.4.30 of 3GPP TS 24.301 [15].

When the parameter identifier indicates traffic flow template, the length and parameter contents field are coded from octet 2 as shown figure 10.5.144 and table 10.5.162 of 3GPP TS 24.008 [12].

When the parameter identifier indicates APN-AMBR, the length and parameter contents field are coded as specified in subclause 9.9.4.2 of 3GPP TS 24.301 [15].

When the parameter identifier indicates Extended APN-AMBR, the length and parameter contents field are coded as specified in subclause 9.9.4.29 of 3GPP TS 24.301 [15].

NOTE: This value shall not be used in this version of the specification.

9.11.4.9 Maximum number of supported packet filters

The purpose of the Maximum number of supported packet filters information element is for the UE to indicate to the network the maximum number of packet filters, associated with signaled QoS rules, that can be supported by the UE for the PDU session that is being established, when the PDU session type "IPv4", "IPv6", "IPv4v6" or "Ethernet".

The Maximum number of supported packet filters is coded as shown in figure 9.11.4.9.1 and table 9.11.4.9.1.

The Maximum number of supported packet filters is a type 3 information element with a length of 3 octets.

	8	7	6	5	4	3	2	1	
Maximum number of supported packet filters IEI									octet 1
Maximum number of supported packet filters									octet 2
Maximum number of supported packet filters (continued)	0	0	0	0	0	0	0	0	octet 3
	Spare	Spare	Spare	Spare	Spare	Spare	Spare	Spare	

Figure 9.11.4.9.1: Maximum number of supported packet filters information element

Table 9.11.4.9.1: Maximum number of supported packet filters information element

Maximum number of supported packet filters (octet 2 to 3)

In the Maximum number of supported packet filters field bit 8 of the first octet is the most significant bit and bit 6 of second octet is the least significant bit. Bit 5 to bit 1 of the second octet are spare bits and shall be coded as zero.

The number of supported packet filters shall be in the range of 17 to 1024.

9.11.4.10 PDU address

The purpose of the PDU address information element is to assign to the UE:

- an IPv4 address associated with a PDU session;
- an interface identifier for the IPv6 link local address associated with the PDU session; or
- an IPv4 address and an interface identifier for the IPv6 link local address, associated with the PDU session.

This purpose of the PDU address information element is also to enable the W-AGF acting on behalf of the FN-RG to provide an interface identifier for the IPv6 link local address associated with the PDU session suggested to be allocated to the FN-RG, and to enable the SMF to provide SMF's IPv6 link local address to the W-AGF acting on behalf of the FN-RG.

The PDU address information element is coded as shown in figure 9.11.4.10.1 and table 9.11.4.10.1.

The PDU address is a type 4 information element with minimum length of 7 octets and a maximum length of 31 octets.

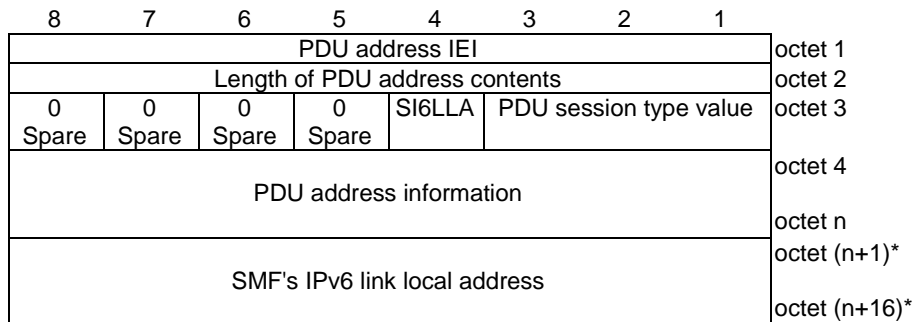

Figure 9.11.4.10.1: PDU address information element

Table 9.11.4.10.1: PDU address information element

PDU session type value (octet 3, bits 1 to 3)	
Bits	
3	2 1
0	0 1 IPv4
0	1 0 IPv6
0	1 1 IPv4v6
All other values are reserved.	
SI6LLA (SMF's IPv6 link local address) bit (octet 3, bit 4) (see NOTE)	
Bit	
4	
0	SMF's IPv6 link local address field is absent
1	SMF's IPv6 link local address field is present
Bits 5 to 8 of octet 3 are spare and shall be coded as zero.	
PDU address information (octet 4 to n)	
If the PDU session type value indicates IPv4, the PDU address information in octet 4 to octet 7 contains an IPv4 address.	
If the PDU session type value indicates IPv6, the PDU address information in octet 4 to octet 11 contains an interface identifier for the IPv6 link local address.	
If the PDU session type value indicates IPv4v6, the PDU address information in octet 4 to octet 11 contains an interface identifier for the IPv6 link local address and in octet 12 to octet 15 contains an IPv4 address.	
SMF's IPv6 link local address (octet n+1 to n+16)	
SMF's IPv6 link local address field contains SMF's IPv6 link local address.	
NOTE: In the UE to network direction, the SI6LLA bit shall be set to "SMF's IPv6 link local address field is absent".	

9.11.4.11 PDU session type

The purpose of the PDU session type information element is to indicate type of the PDU session.

The PDU session type information element is coded as shown in figure 9.11.4.11.1 and table 9.11.4.11.1.

The PDU session type is a type 1 information element.

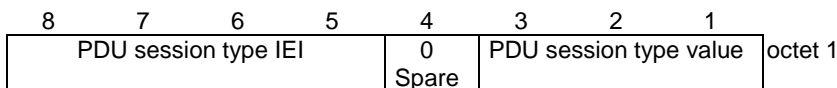

Figure 9.11.4.11.1: PDU session type information element

Table 9.11.4.11.1: PDU session type information element

PDU session type value (octet 1, bit 1 to bit 3)			
Bits			
3	2	1	
0	0	1	IPv4
0	1	0	IPv6
0	1	1	IPv4v6
1	0	0	Unstructured
1	0	1	Ethernet
1	1	1	reserved
All other values are unused and shall be interpreted as "IPv4v6", if received by the UE or the network.			

9.11.4.12 QoS flow descriptions

The purpose of the QoS flow descriptions information element is to indicate a set of QoS flow descriptions to be used by the UE, where each QoS flow description is a set of parameters as described in subclause 6.2.5.1.1.4.

The QoS flow descriptions information element is a type 6 information element with a minimum length of 6 octets. The maximum length for the information element is 65538 octets.

The QoS flow descriptions information element is coded as shown in figure 9.11.4.12.1, figure 9.11.4.12.2, figure 9.11.4.12.3, figure 9.11.4.12.4, and table 9.11.4.12.1.

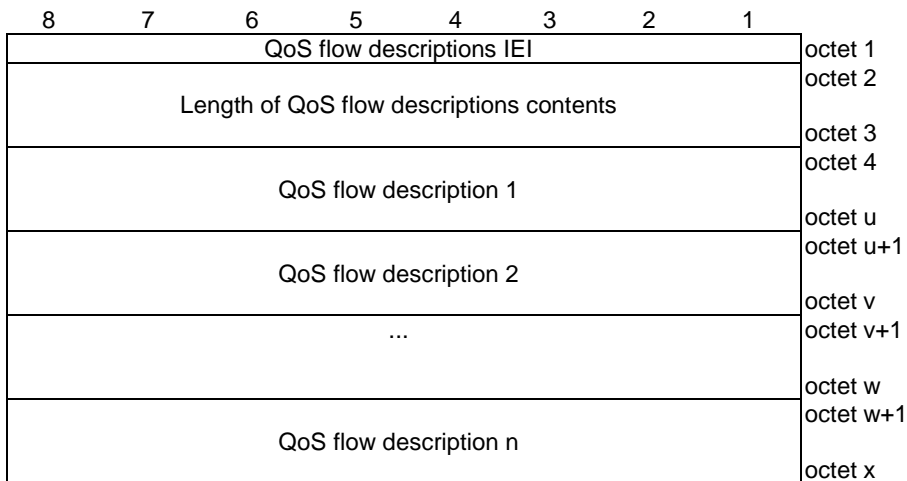

Figure 9.11.4.12.1: QoS flow descriptions information element

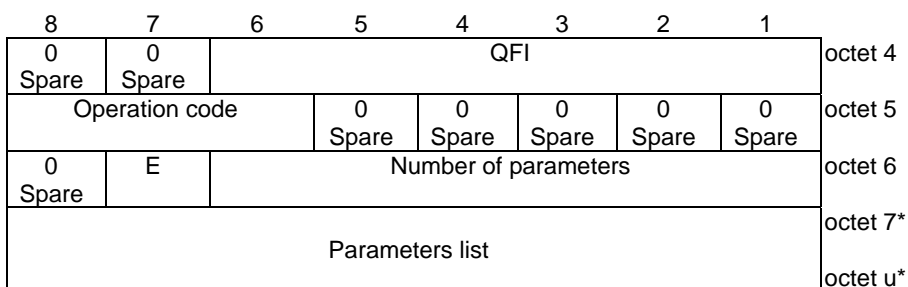

Figure 9.11.4.12.2: QoS flow description

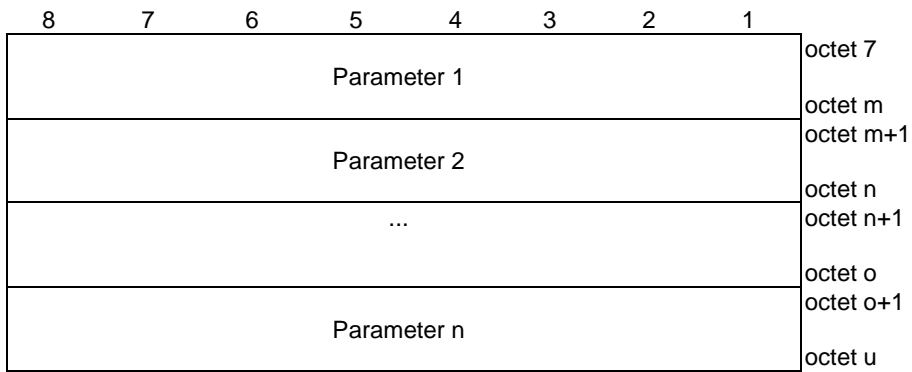

Figure 9.11.4.12.3: Parameters list

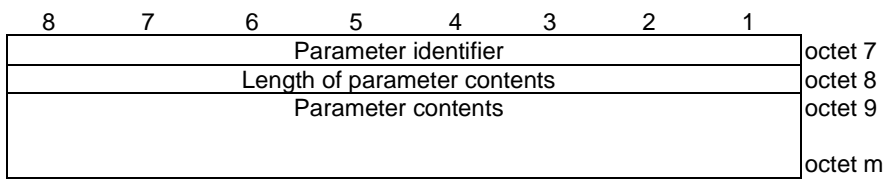

Figure 9.11.4.12.4: Parameter

Table 9.11.4.12.1: QoS flow descriptions information element

QoS flow identifier (QFI) (bits 6 to 1 of octet 4)

QFI field contains the QoS flow identifier.

Bits

6 5 4 3 2 1

0 0 0 0 0 0 no QoS flow identifier assigned

0 0 0 0 0 1 QFI 1

to

1 1 1 1 1 1 QFI 63

The network shall not set the QFI value to 0.

Operation code (bits 8 to 6 of octet 5)

Bits

8 7 6

0 0 1 Create new QoS flow description

0 1 0 Delete existing QoS flow description

0 1 1 Modify existing QoS flow description

All other values are reserved.

E bit (bit 7 of octet 6)

For the "create new QoS flow description" operation, the E bit is encoded as follows:

Bit

7

0 reserved

1 parameters list is included

For the "Delete existing QoS flow description" operation, the E bit is encoded as follows:

Bit

7

0 parameters list is not included

1 reserved

For the "modify existing QoS flow description" operation, the E bit is encoded as follows:

Bit

7

0 extension of previously provided parameters

1 replacement of all previously provided parameters

If the E bit is set to "parameters list is not included", the number of parameters field has zero value. If the E bit is set to "parameters list is included", the number of parameters field has non-zero value. If the E bit is set to "extension of previously provided parameters" or "replacement of all previously provided parameters", the number of parameters field has non-zero value. If the E bit is set to "extension of previously provided parameters" and one of the parameters in the new parameters list already exists in the previously provided parameters, the parameter shall be set to the new value. If the E bit is set to "replacement of all previously provided parameters list" and a parameter in the previously provided parameters is not provided in the new parameters list, the parameter shall be deleted.

Number of parameters (bits 6 to 1 of octet 6)

The number of parameters field contains the binary coding for the number of parameters in the parameters list field. The number of parameters field is encoded in bits 6 through 1 of octet 6 where bit 6 is the most significant and bit 1 is the least significant bit.

Parameters list (octets 7 to u)

The parameters list contains a variable number of parameters.

Each parameter included in the parameters list is of variable length and consists of:

- a parameter identifier (1 octet);
- the length of the parameter contents (1 octet); and
- the parameter contents itself (variable amount of octets).

The parameter identifier field is used to identify each parameter included in the parameters list and it contains the hexadecimal coding of the parameter identifier. Bit 8 of the parameter identifier field contains the most significant bit and bit 1 contains the least significant bit. In this version of the protocol, the following parameter identifiers are specified:

- 01H (5QI);
- 02H (GFBR uplink);
- 03H (GFBR downlink);
- 04H (MFBR uplink);
- 05H (MFBR downlink);
- 06H (Averaging window); and
- 07H (EPS bearer identity).

If the parameters list contains a parameter identifier that is not supported by the receiving entity the corresponding parameter shall be discarded.

The length of parameter contents field contains the binary coded representation of the length of the parameter contents field. The first bit in transmission order is the most significant bit.

When the parameter identifier indicates 5QI, the parameter contents field contains the binary representation of 5G QoS identifier (5QI) that is one octet in length.

5QI:

Bits

8 7 6 5 4 3 2 1	
0 0 0 0 0 0 0 0	Reserved
0 0 0 0 0 0 0 1	5QI 1
0 0 0 0 0 0 1 0	5QI 2
0 0 0 0 0 0 1 1	5QI 3
0 0 0 0 0 1 0 0	5QI 4
0 0 0 0 0 1 0 1	5QI 5
0 0 0 0 0 1 1 0	5QI 6
0 0 0 0 0 1 1 1	5QI 7
0 0 0 0 1 0 0 0	5QI 8
0 0 0 0 1 0 0 1	5QI 9
0 0 0 0 1 0 1 0	5QI 10
0 0 0 0 1 0 1 1	
	to Spare
0 1 0 0 0 0 0 0	
0 1 0 0 0 0 0 1	5QI 65
0 1 0 0 0 0 1 0	5QI 66
0 1 0 0 0 0 1 1	5QI 67
0 1 0 0 0 1 0 0	Spare
0 1 0 0 0 1 0 1	5QI 69
0 1 0 0 0 1 1 0	5QI 70
0 1 0 0 0 1 1 1	5QI 71
0 1 0 0 1 0 0 0	5QI 72
0 1 0 0 1 0 0 1	5QI 73
0 1 0 0 1 0 1 0	5QI 74
0 1 0 0 1 0 1 1	5QI 75
0 1 0 0 1 1 0 0	5QI 76
0 1 0 0 1 1 0 1	
	to Spare
0 1 0 0 1 1 1 0	
0 1 0 0 1 1 1 1	5QI 79
0 1 0 1 0 0 0 0	5QI 80
0 1 0 1 0 0 0 1	Spare
0 1 0 1 0 0 1 0	5QI 82
0 1 0 1 0 0 1 1	5QI 83
0 1 0 1 0 1 0 0	5QI 84
0 1 0 1 0 1 0 1	5QI 85
0 1 0 1 0 1 1 0	5QI 86
0 1 0 1 0 1 1 1	5QI 87
0 1 0 1 1 0 0 0	5QI 88
0 1 0 1 1 0 0 1	5QI 89
0 1 0 1 1 0 1 0	5QI 90
0 1 0 1 1 0 1 1	
	to Spare
0 1 1 1 1 1 1 1	
1 0 0 0 0 0 0 0	
	to Operator-specific 5QIs
1 1 1 1 1 1 1 0	
1 1 1 1 1 1 1 1	Reserved

The network shall consider all other values not explicitly defined in this version of the protocol as unsupported.

If the UE receives a 5QI value (excluding the reserved 5QI values) that it does not understand, the UE shall choose a 5QI value from the set of 5QI values defined in this version of the protocol (see 3GPP TS 23.501 [8]) and associated with:

- GBR QoS flows, if the QoS flow includes a GFBR uplink parameter, a GFBR downlink parameter, a MFBR uplink parameter and a MFBR downlink parameter; and
- non-GBR QoS flows, if the QoS flow does not include any one of a GFBR uplink parameter, a GFBR downlink parameter, a MFBR uplink parameter or a MFBR downlink parameter.

The UE shall use this chosen 5QI value for internal operations only. The UE shall use the received 5QI value in subsequent NAS signalling procedures.

When the parameter identifier indicates "GFBR uplink", the parameter contents field contains one octet indicating the unit of the guaranteed flow bit rate for uplink followed by two octets containing the value of the guaranteed flow bit rate for uplink.

Unit of the guaranteed flow bit rate for uplink (octet 1)	
Bits	
8 7 6 5 4 3 2 1	
0 0 0 0 0 0 0 0	value is not used (see NOTE 2)
0 0 0 0 0 0 0 1	value is incremented in multiples of 1 Kbps
0 0 0 0 0 0 1 0	value is incremented in multiples of 4 Kbps
0 0 0 0 0 0 1 1	value is incremented in multiples of 16 Kbps
0 0 0 0 0 1 0 0	value is incremented in multiples of 64 Kbps
0 0 0 0 0 1 0 1	value is incremented in multiples of 256 Kbps
0 0 0 0 0 1 1 0	value is incremented in multiples of 1 Mbps
0 0 0 0 0 1 1 1	value is incremented in multiples of 4 Mbps
0 0 0 0 1 0 0 0	value is incremented in multiples of 16 Mbps
0 0 0 0 1 0 0 1	value is incremented in multiples of 64 Mbps
0 0 0 0 1 0 1 0	value is incremented in multiples of 256 Mbps
0 0 0 0 1 0 1 1	value is incremented in multiples of 1 Gbps
0 0 0 0 1 1 0 0	value is incremented in multiples of 4 Gbps
0 0 0 0 1 1 0 1	value is incremented in multiples of 16 Gbps
0 0 0 0 1 1 1 0	value is incremented in multiples of 64 Gbps
0 0 0 0 1 1 1 1	value is incremented in multiples of 256 Gbps
0 0 0 1 0 0 0 0	value is incremented in multiples of 1 Tbps
0 0 0 1 0 0 0 1	value is incremented in multiples of 4 Tbps
0 0 0 1 0 0 1 0	value is incremented in multiples of 16 Tbps
0 0 0 1 0 0 1 1	value is incremented in multiples of 64 Tbps
0 0 0 1 0 1 0 0	value is incremented in multiples of 256 Tbps
0 0 0 1 0 1 0 1	value is incremented in multiples of 1 Pbps
0 0 0 1 0 1 1 0	value is incremented in multiples of 4 Pbps
0 0 0 1 0 1 1 1	value is incremented in multiples of 16 Pbps
0 0 0 1 1 0 0 0	value is incremented in multiples of 64 Pbps
0 0 0 1 1 0 0 1	value is incremented in multiples of 256 Pbps
Other values shall be interpreted as multiples of 256 Pbps in this version of the protocol.	
Value of the guaranteed flow bit rate for uplink (octets 2 and 3)	
Octets 2 and 3 represent the binary coded value of the guaranteed flow bit rate for uplink in units defined by the unit of the guaranteed flow bit rate for uplink.	
When the UE indicates subscribed GFBR for uplink, the "GFBR uplink" parameter is not included in the "Parameters list".	
When the parameter identifier indicates "GFBR downlink", the parameter contents field contains one octet indicating the unit of the guaranteed flow bit rate for downlink followed by two octets containing the value of the guaranteed flow bit rate for downlink.	
Unit of the guaranteed flow bit rate for downlink (octet 1)	
The coding is identical to that of the unit of the guaranteed flow bit rate for uplink.	
Value of the guaranteed flow bit rate for downlink (octets 2 and 3)	
Octets 2 and 3 represent the binary coded value of the guaranteed flow bit rate for downlink in units defined by the unit of the guaranteed flow bit rate for downlink.	
When the UE indicates subscribed GFBR for downlink, the "GFBR downlink" parameter is not included in the "Parameters list".	
When the parameter identifier indicates "MFBR uplink", the parameter contents field contains the one octet indicating the unit of the maximum flow bit rate for uplink followed by two octets containing the value of maximum flow bit rate for uplink.	
Unit of the maximum flow bit rate for uplink (octet 1)	
The coding is identical to that of the unit of the guaranteed flow bit rate for uplink.	
Value of the maximum flow bit rate for uplink (octets 2 and 3)	
Octets 2 and 3 represent the binary coded value of the maximum flow bit rate for uplink in units defined by the unit of the maximum flow bit rate for uplink.	
When the UE indicates subscribed MFBR for uplink, the "MFBR uplink" parameter is not included in the "Parameters list".	

<p>When the parameter identifier indicates "MFBR downlink", the parameter contents field contains one octet indicating the unit of the maximum flow bit rate for downlink followed by two octets containing the value of the maximum flow bit rate for downlink.</p> <p>Unit of the maximum flow bit rate for downlink (octet 1) The coding is identical to that of the unit of the guaranteed flow bit rate for uplink.</p> <p>Value of the maximum flow bit rate for downlink (octets 2 and 3) Octets 2 and 3 represent the binary coded value of the maximum flow bit rate for downlink in units defined by the unit of the maximum flow bit rate for downlink.</p> <p>When the UE indicates subscribed MFBR for downlink, the "MFBR downlink" parameter is not included in the "Parameters list".</p> <p>In this version of the protocol, for messages specified in the present document, the sending entity shall not request 0 kbps for both the maximum flow bit rate for downlink and the maximum flow bit rate for uplink at the same time. Any entity receiving a request for 0 kbps in both the maximum flow bit rate for downlink and the maximum flow bit rate for uplink shall consider that as a syntactical error (see clause 7).</p> <p>When the parameter identifier indicates "averaging window", the parameter contents field contains the binary representation of the averaging window for both uplink and downlink in milliseconds and the parameter contents field is two octets in length.</p> <p>When the parameter identifier indicates EPS bearer identity, the length of EPS bearer identity is one octet, bits 5 to 8 of the parameter contents contain the EPS bearer identity as specified in subclause 9.3.2 of 3GPP TS 24.301 [15] and bits 1 to 4 of the parameter contents are spare and shall be coded as zero. The UE shall not include the EPS bearer identity parameter in any mobile originated 5GSM messages (see NOTE 1).</p> <p>NOTE 1: The total number of EPS bearer identities included in all QoS flow descriptions of a UE cannot exceed fifteen.</p> <p>NOTE 2: In this release of the specifications if received it shall be interpreted as value is incremented in multiples of 1 Kbps. In earlier releases of specifications, the interpretation of this value is up to implementation.</p>
--

9.11.4.13 QoS rules

The purpose of the QoS rules information element is to indicate a set of QoS rules to be used by the UE, where each QoS rule is a set of parameters as described in subclause 6.2.5.1.1.2:

- a) for classification and marking of uplink user traffic; and
- b) for identification of a QoS flow which the network is to use for a particular downlink user traffic.

NOTE: The UE needs to be aware of a QoS flow which the network is to use for a particular downlink user traffic e.g. to determine whether a resource is available for downlink media of a media stream of an SDP media description provided by the UE in an IMS session.

The QoS rules may contain a set of packet filters consisting of zero or more packet filters for UL direction, zero or more packet filters for DL direction, zero or more packet filters for both UL and DL directions or any combinations of these. The set of packet filters determine the traffic mapping to QoS flows.

The QoS rules information element is a type 6 information element with a minimum length of 7 octets. The maximum length for the information element is 65538 octets.

The QoS rules information element is coded as shown in figure 9.11.4.13.1, figure 9.11.4.13.2, figure 9.11.4.13.3, figure 9.11.4.13.4 and table 9.11.4.13.1.

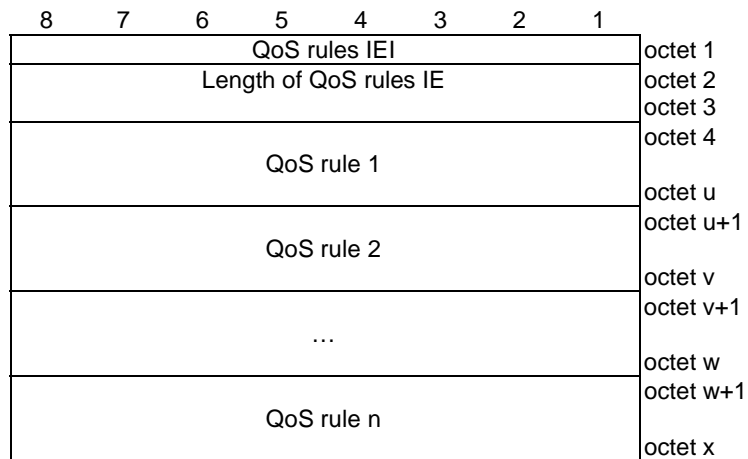

Figure 9.11.4.13.1: QoS rules information element

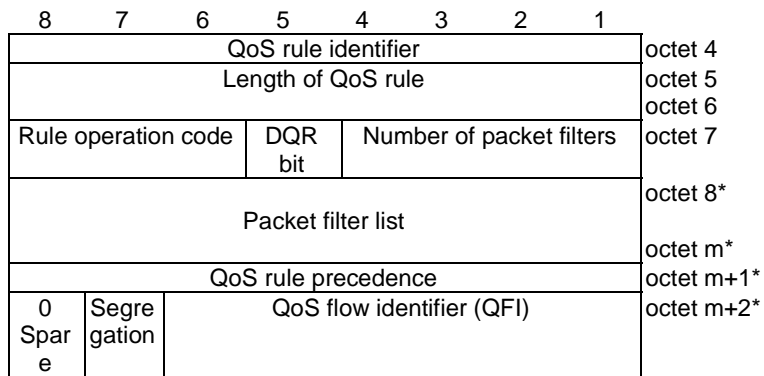

Figure 9.11.4.13.2: QoS rule (u=m+2)

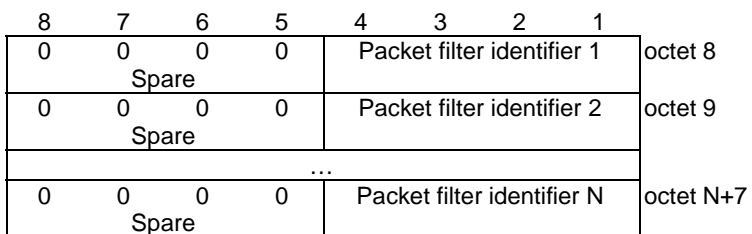

Figure 9.11.4.13.3: Packet filter list when the rule operation is "modify existing QoS rule and delete packet filters" (m=N+7)

8	7	6	5	4	3	2	1	
0	0	Packet filter direction 1		Packet filter identifier 1				octet 8
Spare		Length of packet filter contents 1						octet 9
Packet filter contents 1								octet 10
Packet filter contents 1								octet m
0	0	Packet filter direction 2		Packet filter identifier 2				octet k+1
Spare		Length of packet filter contents 2						octet k+2
Packet filter contents 2								octet k+3
Packet filter contents 2								octet n
...								octet n+1
...								octet y
0	0	Packet filter direction N		Packet filter identifier N				octet y+1
Spare		Length of packet filter contents N						octet y+2
Packet filter contents N								octet y+3
Packet filter contents N								octet m

Figure 9.11.4.13.4: Packet filter list when the rule operation is "create new QoS rule", or "modify existing QoS rule and add packet filters" or "modify existing QoS rule and replace all packet filters"

Table 9.11.4.13.1: QoS rules information element

<p>QoS rule identifier (octet 4) The QoS rule identifier field is used to identify the QoS rule.</p> <p>Bits</p> <p>8 7 6 5 4 3 2 1</p> <p>0 0 0 0 0 0 0 0 no QoS rule identifier assigned</p> <p>0 0 0 0 0 0 0 1 QRI 1</p> <p>to</p> <p>1 1 1 1 1 1 1 1 QRI 255</p> <p>The network shall not set the QRI value to 0.</p> <p>QoS rule precedence (octet m+1) The QoS rule precedence field is used to specify the precedence of the QoS rule among all QoS rules (both the signalled QoS rules as described in subclause 6.2.5.1.1.2 and the derived QoS rules as described in subclause 6.2.5.1.1.3) associated with the PDU session of the QoS flow. This field includes the binary coded value of the QoS rule precedence in the range from 0 to 255 (decimal). The higher the value of the QoS rule precedence field, the lower the precedence of that QoS rule is. For the "delete existing QoS rule" operation, the QoS rule precedence value field shall not be included. For the "create new QoS rule" operation, the QoS rule precedence value field shall be included. The value 80 (decimal) is reserved.</p> <p>Segregation bit (bit 7 of octet m+2) (see NOTE 1) In the UE to network direction the segregation bit indicates whether the UE is requesting the network to bind service data flows described by the QoS rule to a dedicated QoS Flow and it is encoded as follows. In the network to UE direction this bit is spare.</p> <p>Bit</p> <p>7</p> <p>0 Segregation not requested</p> <p>1 Segregation requested</p> <p>QoS flow identifier (QFI) (bits 6 to 1 of octet m+2) (see NOTE 1) The QoS flow identifier (QFI) field contains the QoS flow identifier.</p> <p>Bits</p> <p>6 5 4 3 2 1</p> <p>0 0 0 0 0 0 no QoS flow identifier assigned</p> <p>0 0 0 0 0 1 QFI 1</p> <p>to</p> <p>1 1 1 1 1 1 QFI 63</p> <p>The network shall not set the QFI value to 0. For the "delete existing QoS rule" operation, the QoS flow identifier value field shall not be included. For the "create new QoS rule" operation, the QoS flow identifier value field shall be included.</p> <p>DQR bit (bit 5 of octet 7) The DQR bit indicates whether the QoS rule is the default QoS rule and it is encoded as follows:</p> <p>Bit</p> <p>5</p> <p>0 the QoS rule is not the default QoS rule.</p> <p>1 the QoS rule is the default QoS rule.</p> <p>Rule operation code (bits 8 to 6 of octet 7)</p> <p>Bits</p> <p>8 7 6</p> <p>0 0 0 Reserved</p> <p>0 0 1 Create new QoS rule</p> <p>0 1 0 Delete existing QoS rule</p> <p>0 1 1 Modify existing QoS rule and add packet filters</p> <p>1 0 0 Modify existing QoS rule and replace all packet filters</p> <p>1 0 1 Modify existing QoS rule and delete packet filters</p> <p>1 1 0 Modify existing QoS rule without modifying packet filters</p> <p>1 1 1 Reserved</p> <p>Number of packet filters (bits 4 to 1 of octet 7)</p>

The number of packet filters contains the binary coding for the number of packet filters in the packet filter list. The number of packet filters field is encoded in bits 4 through 1 of octet 7 where bit 4 is the most significant and bit 1 is the least significant bit. For the "delete existing QoS rule" operation and for the "modify existing QoS rule without modifying packet filters" operation, the number of packet filters shall be coded as 0. For the "create new QoS rule" operation and the "modify existing QoS rule and replace all packet filters" operation, the number of packet filters shall be greater than or equal to 0 and less than or equal to 15. For all other operations, the number of packet filters shall be greater than 0 and less than or equal to 15.

Packet filter list (octets 8 to m)

The packet filter list contains a variable number of packet filters.

For the "delete existing QoS rule" operation, the length of QoS rule field is set to one.

For the "delete existing QoS rule" operation and the "modify existing QoS rule without modifying packet filters" operation, the packet filter list shall be empty.

For the "modify existing QoS rule and delete packet filters" operation, the packet filter list shall contain a variable number of packet filter identifiers. This number shall be derived from the coding of the number of packet filters field in octet 7.

For the "create new QoS rule" operation and for the "modify existing QoS rule and replace all packet filters" operation, the packet filter list shall contain 0 or a variable number of packet filters. This number shall be derived from the coding of the number of packet filters field in octet 7.

For the "modify existing QoS rule and add packet filters" operation, the packet filter list shall contain a variable number of packet filters. This number shall be derived from the coding of the number of packet filters field in octet 7.

Each packet filter is of variable length and consists of

- a packet filter direction (2 bits);
- a packet filter identifier (4 bits);
- the length of the packet filter contents (1 octet); and
- the packet filter contents itself (variable amount of octets).

The packet filter direction field is used to indicate for what traffic direction the filter applies.

Bits

6 5

0 0 reserved

0 1 downlink only (see NOTE 2)

1 0 uplink only

1 1 bidirectional

The packet filter identifier field is used to identify each packet filter in a QoS rule. The least significant 4 bits are used. When the UE requests to "create new QoS rule", "modify existing QoS rule and replace all packet filters" or "modify existing QoS rule and add packet filters", the packet filter identifier values shall be set to 0.

The length of the packet filter contents field contains the binary coded representation of the length of the packet filter contents field of a packet filter. The first bit in transmission order is the most significant bit.

The packet filter contents field is of variable size and contains a variable number (at least one) of packet filter components. Each packet filter component shall be encoded as a sequence of a one octet packet filter component type identifier and a fixed length packet filter component value field. The packet filter component type identifier shall be transmitted first.

In each packet filter, there shall not be more than one occurrence of each packet filter component type. Among the "IPv4 remote address type" and "IPv6 remote address/prefix length type" packet filter components, only one shall be present in one packet filter. Among the "IPv4 local address type" and "IPv6 local address/prefix length type" packet filter components, only one shall be present in one packet filter.

Among the "single local port type" and "local port range type" packet filter components, only one shall be present in one packet filter. Among the "single remote port type" and "remote port range type" packet filter components, only one shall be present in one packet filter. Among the "destination MAC address type" and "destination MAC address range type" packet filter components, only one shall be present in one packet filter. Among the "source MAC address type" and "source MAC address range type" packet filter components, only one shall be present in one packet filter. If the "match-all type" packet filter component is present in the packet filter, no other packet filter component shall be present in the packet filter and the length of the packet filter contents field shall be set to one. If the "Ethernet type" packet filter component is present in the packet filter and the "Ethernet type" packet filter component value is neither "0800H" (for IPv4) nor "86DDH" (for IPv6), no IP packet filter component shall be present in the packet filter.

The term "IP packet filter component" refers to "IPv4 remote address type", "IPv4 local address type", "IPv6 remote address/prefix length type", "IPv6 local address/prefix length type", "Protocol identifier/Next header type", "Single local port type", "Local port range type", "Single remote port type", "Remote port range type", "Security parameter index type", "Type of service/Traffic class type" and "Flow label type".

The term local refers to the UE and the term remote refers to an external network entity.

Packet filter component type identifier

Bits

8 7 6 5 4 3 2 1

0 0 0 0 0 0 1	Match-all type (see NOTE 2)
0 0 0 1 0 0 0 0	IPv4 remote address type
0 0 0 1 0 0 0 1	IPv4 local address type
0 0 1 0 0 0 0 1	IPv6 remote address/prefix length type
0 0 1 0 0 0 1 1	IPv6 local address/prefix length type
0 0 1 1 0 0 0 0	Protocol identifier/Next header type
0 1 0 0 0 0 0 0	Single local port type
0 1 0 0 0 0 0 1	Local port range type
0 1 0 1 0 0 0 0	Single remote port type
0 1 0 1 0 0 0 1	Remote port range type
0 1 1 0 0 0 0 0	Security parameter index type
0 1 1 1 0 0 0 0	Type of service/Traffic class type
1 0 0 0 0 0 0 0	Flow label type
1 0 0 0 0 0 0 1	Destination MAC address type
1 0 0 0 0 0 1 0	Source MAC address type
1 0 0 0 0 0 1 1	802.1Q C-TAG VID type
1 0 0 0 0 1 0 0	802.1Q S-TAG VID type
1 0 0 0 0 1 0 1	802.1Q C-TAG PCP/DEI type
1 0 0 0 0 1 1 0	802.1Q S-TAG PCP/DEI type
1 0 0 0 0 1 1 1	Ethertype type
1 0 0 0 1 0 0 0	Destination MAC address range type
1 0 0 0 1 0 0 1	Source MAC address range type

All other values are reserved.

The description and valid combinations of packet filter component type identifiers in a packet filter are defined in 3GPP TS 23.501 [8].

For "match-all type", the packet filter component shall not include the packet filter component value field.

For "IPv4 remote address type", the packet filter component value field shall be encoded as a sequence of a four octet IPv4 address field and a four octet IPv4 address mask field. The IPv4 address field shall be transmitted first.

For "IPv4 local address type", the packet filter component value field shall be encoded as defined for "IPv4 remote address type".

For "IPv6 remote address/prefix length type", the packet filter component value field shall be encoded as a sequence of a sixteen octet IPv6 address field and one octet prefix length field. The IPv6 address field shall be transmitted first.

For "IPv6 local address/prefix length type", the packet filter component value field shall be encoded as defined for "IPv6 remote address /prefix length".

For "protocol identifier/Next header type", the packet filter component value field shall be encoded as one octet which specifies the IPv4 protocol identifier or Ipv6 next header.

For "single local port type" and "single remote port type", the packet filter component value field shall be encoded as two octets which specify a port number.

For "local port range type" and "remote port range type", the packet filter component value field shall be encoded as a sequence of a two octet port range low limit field and a two octet port range high limit field. The port range low limit field shall be transmitted first.

For "security parameter index", the packet filter component value field shall be encoded as four octets which specify the IPSec security parameter index.

For "type of service/traffic class type", the packet filter component value field shall be encoded as a sequence of a one octet type-of-service/traffic class field and a one octet type-of-service/traffic class mask field. The type-of-service/traffic class field shall be transmitted first.

For "flow label type", the packet filter component value field shall be encoded as three octets which specify the IPv6 flow label. The bits 8 through 5 of the first octet shall be spare whereas the remaining 20 bits shall contain the IPv6 flow label.

For "destination MAC address type" and "source MAC address type", the packet filter component value field shall be encoded as 6 octets which specify a MAC address. When the packet filter direction field indicates "bidirectional", the destination MAC address is the remote MAC address and the source MAC address is the local MAC address.

For "802.1Q C-TAG VID type", the packet filter component value field shall be encoded as two octets which specify the VID of the customer-VLAN tag (C-TAG). The bits 8 through 5 of the first octet shall be spare whereas the remaining 12 bits shall contain the VID. If there are more than one C-TAG in the Ethernet frame header, the outermost C-TAG is evaluated.

For "802.1Q S-TAG VID type", the packet filter component value field shall be encoded as two octets which specify the VID of the service-VLAN tag (S-TAG). The bits 8 through 5 of the first octet shall be spare whereas the remaining 12 bits shall contain the VID. If there are more than one S-TAG in the Ethernet frame header, the outermost S-TAG is evaluated.

For "802.1Q C-TAG PCP/DEI type", the packet filter component value field shall be encoded as one octet which specifies the 802.1Q C-TAG PCP and DEI. The bits 8 through 5 of the octet shall be spare, the bits 4 through 2 contain the PCP and bit 1 contains the DEI. If there are more than one C-TAG in the Ethernet frame header, the outermost C-TAG is evaluated.

For "802.1Q S-TAG PCP/DEI type", the packet filter component value field shall be encoded as one octet which specifies the 802.1Q S-TAG PCP. The bits 8 through 5 of the octet shall be spare, the bits 4 through 2 contain the PCP and bit 1 contains the DEI. If there are more than one S-TAG in the Ethernet frame header, the outermost S-TAG is evaluated.

For "ethertype type", the packet filter component value field shall be encoded as two octets which specify an ethertype.

For "destination MAC address range type", the packet filter component value field shall be encoded as a sequence of a 6 octet destination MAC address range low limit field and a 6 octet destination MAC address range high limit field. The destination MAC address range low limit field shall be transmitted first. When the packet filter direction field indicates "bidirectional", the destination MAC address range is the remote MAC address range.

For "source MAC address range type", the packet filter component value field shall be encoded as a sequence of a 6 octet source MAC address range low limit field and a 6 octet source MAC address range high limit field. The source MAC address range low limit field shall be transmitted first. When the packet filter direction field indicates "bidirectional", the source MAC address is the local MAC address range.

NOTE 1: Octet m+2 shall not be included without octet m+1.

NOTE 2: The "Match-all type" packet filter component type identifier shall not be used with packet filter direction "downlink only".

9.11.4.14 Session-AMBR

The purpose of the Session-AMBR information element is to indicate the initial subscribed PDU session aggregate maximum bit rate when the UE establishes a PDU session or to indicate the new subscribed PDU session aggregate maximum bit rate if it is changed by the network.

The Session-AMBR information element is coded as shown in figure 9.11.4.14.1 and table 9.11.4.14.1.

The Session-AMBR is a type 4 information element with a length of 8 octets.

	8	7	6	5	4	3	2	1	
	Session-AMBR IEI								octet 1
	Length of Session-AMBR contents								octet 2
	Unit for Session-AMBR for downlink								octet 3
	Session-AMBR for downlink								octet 4-5
	Unit for Session-AMBR for uplink								octet 6
	Session-AMBR for uplink								octet 7-8

Figure 9.11.4.14.1: Session-AMBR information element

Table 9.11.4.14.1: Session-AMBR information element

Unit for Session-AMBR for downlink (octet 3)	
0 0 0 0 0 0 0 0	value is not used (see NOTE)
0 0 0 0 0 0 0 1	value is incremented in multiples of 1 Kbps
0 0 0 0 0 0 1 0	value is incremented in multiples of 4 Kbps
0 0 0 0 0 0 1 1	value is incremented in multiples of 16 Kbps
0 0 0 0 0 1 0 0	value is incremented in multiples of 64 Kbps
0 0 0 0 0 1 0 1	value is incremented in multiples of 256 kbps
0 0 0 0 0 1 1 0	value is incremented in multiples of 1 Mbps
0 0 0 0 0 1 1 1	value is incremented in multiples of 4 Mbps
0 0 0 0 1 0 0 0	value is incremented in multiples of 16 Mbps
0 0 0 0 1 0 0 1	value is incremented in multiples of 64 Mbps
0 0 0 0 1 0 1 0	value is incremented in multiples of 256 Mbps
0 0 0 0 1 0 1 1	value is incremented in multiples of 1 Gbps
0 0 0 0 1 1 0 0	value is incremented in multiples of 4 Gbps
0 0 0 0 1 1 0 1	value is incremented in multiples of 16 Gbps
0 0 0 0 1 1 1 0	value is incremented in multiples of 64 Gbps
0 0 0 0 1 1 1 1	value is incremented in multiples of 256 Gbps
0 0 0 1 0 0 0 0	value is incremented in multiples of 1 Tbps
0 0 0 1 0 0 0 1	value is incremented in multiples of 4 Tbps
0 0 0 1 0 0 1 0	value is incremented in multiples of 16 Tbps
0 0 0 1 0 0 1 1	value is incremented in multiples of 64 Tbps
0 0 0 1 0 1 0 0	value is incremented in multiples of 256 Tbps
0 0 0 1 0 1 0 1	value is incremented in multiples of 1 Pbps
0 0 0 1 0 1 1 0	value is incremented in multiples of 4 Pbps
0 0 0 1 0 1 1 1	value is incremented in multiples of 16 Pbps
0 0 0 1 1 0 0 0	value is incremented in multiples of 64 Pbps
0 0 0 1 1 0 0 1	value is incremented in multiples of 256 Pbps
Other values shall be interpreted as multiples of 256 Pbps in this version of the protocol.	
Session-AMBR for downlink (octets 4 and 5)	
Octets 4 and 5 represent the binary coded value of PDU session aggregated maximum bit rate for downlink in units defined by octet 3.	
Unit for Session-AMBR for uplink (octet 6)	
The coding is identical to the unit coding defined for Session-AMBR for downlink (octet 3)	
Session-AMBR for uplink (octets 7 and 8)	
Octets 7 and 8 represent the binary coded value of PDU session aggregated maximum bit rate for uplink in units defined by octet 6.	
NOTE:	In this release of the specifications if received it shall be interpreted as value is incremented in multiples of 1 Kbps. In earlier releases of specifications, the interpretation of this value is up to implementation.

9.11.4.15 SM PDU DN request container

The purpose of the SM PDU DN request container information element is to carry a DN-specific identity of the UE in the network access identifier (NAI) format.

The SM PDU DN request container information element is coded as shown in figure 9.11.4.15.1 and table 9.11.4.15.1.

The SM PDU DN request container is a type 4 information element with minimal length of 3 octets and maximum length of 255 octets.

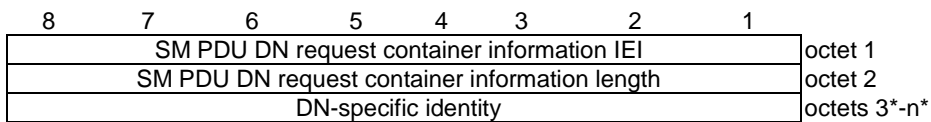

Figure 9.11.4.15.1: SM PDU DN request container information element

Table 9.11.4.15.1: SM PDU DN request container information element

DN-specific identity (octet 3 to octet n) A DN-specific identity of the UE in the network access identifier (NAI) format according to IETF RFC 7542 [37], encoded as UTF-8 string.

9.11.4.16 SSC mode

The purpose of the SSC mode information element is to indicate SSC mode.

The SSC mode information element is coded as shown in figure 9.11.4.16.1 and table 9.11.4.16.1.

The SSC mode is a type 1 information element.

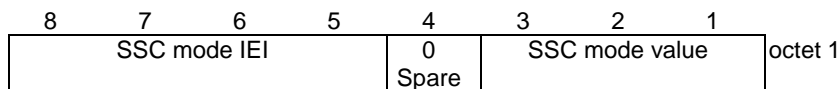

Figure 9.11.4.16.1: SSC mode information element

Table 9.11.4.16.1: SSC mode information element

SSC mode value (octet 1, bit 1 to bit 4)	
Bits	
3 2 1	
0 0 1	SSC mode 1
0 1 0	SSC mode 2
0 1 1	SSC mode 3
1 0 0	unused; shall be interpreted as "SSC mode 1", if received by the network
1 0 1	unused; shall be interpreted as "SSC mode 2", if received by the network
1 1 0	unused; shall be interpreted as "SSC mode 3", if received by the network
All other values are reserved.	

9.11.4.17 Re-attempt indicator

The purpose of the Re-attempt indicator information element is to indicate a condition under which the UE is allowed in the current PLMN or its equivalent PLMN(s) or the current SNPN or its equivalent SNPNs for the same DNN, to re-attempt a session management procedure (see 3GPP TS 24.301 [15]) corresponding to the 5GS session management procedure which was rejected by the network.

The Re-attempt indicator information element is coded as shown in figure 9.11.4.17.1 and table 9.11.4.17.1.

The Re-attempt indicator is a type 4 information element with a length of 3 octets.

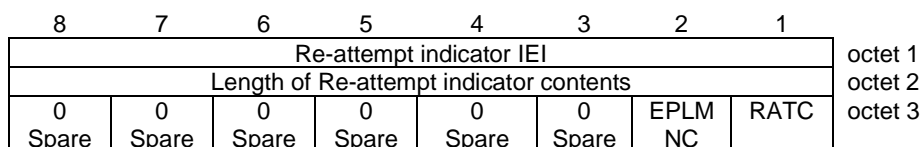

Figure 9.11.4.17.1: Re-attempt indicator

Table 9.11.4.17.1: Re-attempt indicator

RATC (octet 3, bit 1)	
Bit	1
0	UE is allowed to re-attempt the procedure in S1 mode
1	UE is not allowed to re-attempt the procedure in S1 mode
EPLMNC (octet 3, bit 2)	
Bit	2
0	UE is allowed to re-attempt the procedure in an equivalent PLMN or equivalent SNPN
1	UE is not allowed to re-attempt the procedure in an equivalent PLMN or equivalent SNPN
Bits 3 to 8 of octet 3 are spare and shall be encoded as zero.	

9.11.4.18 5GSM network feature support

The purpose of the 5GSM network feature support information element is to indicate whether certain session management related features are supported by the network.

The 5GSM network feature support information element is coded as shown in figure 9.11.4.18.1 and table 9.11.4.18.1.

The 5GSM network feature support is a type 4 information element with a minimum length of 3 octets and a maximum length of 15 octets.

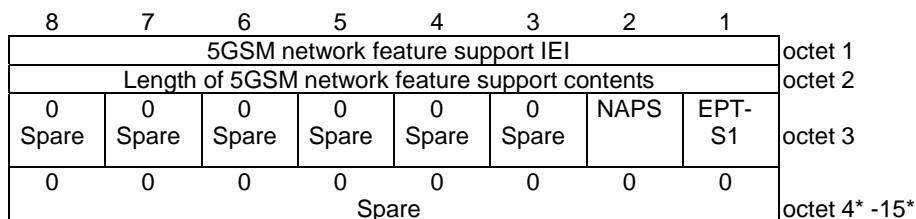

Figure 9.11.4.18.1: 5GSM network feature support information element

Table 9.11.4.18.1: 5GSM network feature support information element

5GSM network feature support contents	
Ethernet PDN type in S1 mode (IEPT-S1) (octet 3, bit 1)	
This bit indicates network's capability for Ethernet PDN type in S1 mode.	
0	Ethernet PDN type in S1 mode not supported
1	Ethernet PDN type in S1 mode supported
Non-3GPP access path switching (NAPS) (octet 3, bit 2)	
This bit indicates whether non-3GPP access path switching is supported.	
Bit	2
0	non-3GPP access path switching not supported
1	non-3GPP access path switching supported
All other bits in octet 3 to 15 are spare and shall be coded as zero, if the respective octet is included in the information element.	

9.11.4.19 Void

9.11.4.20 Serving PLMN rate control

See subclause 9.9.4.28 in 3GPP TS 24.301 [15].

9.11.4.21 5GSM congestion re-attempt indicator

The purpose of the 5GSM congestion re-attempt indicator information element is to indicate whether the back-off timer is applied in the registered PLMN or all PLMNs or in the registered SNPN or all equivalent SNPNS, and additionally to indicate whether the back-off timer is applied in the current access type or both 3GPP access type and non-3GPP access type.

The 5GSM congestion re-attempt indicator information element is coded as shown in figure 9.11.4.21.1 and table 9.11.4.21.1.

The 5GSM congestion re-attempt indicator is a type 4 information element with a length of 3 octets.

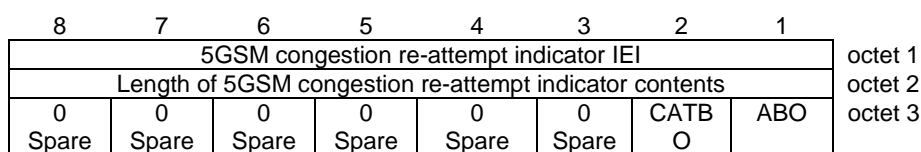

Figure 9.11.4.21.1: 5GSM congestion re-attempt indicator

Table 9.11.4.21.1: 5GSM congestion re-attempt indicator

ABO (All PLMNs Back-off timer) (octet 3, bit 1) Bit 1 0 The back-off timer is applied in the registered PLMN or registered SNPN. 1 The back-off timer is applied in all PLMNs or all equivalent SNPNS.
CATBO (Current Access Type Back-off Timer) (octet 3, bit 2) Bit 2 0 The back-off timer is applied in both 3GPP access type and non-3GPP access type 1 The back-off timer is applied in the current access type
Bits 3 to 8 of octet 3 are spare and shall be encoded as zero.

9.11.4.22 ATSSS container

The purpose of the ATSSS container information element is to transfer parameters associated with ATSSS.

The ATSSS container information element is coded as shown in figure 9.11.4.22.1 and table 9.11.4.22.1.

The ATSSS container is a type 6 information element with a minimum length of 3 octets and a maximum length of 65538 octets.

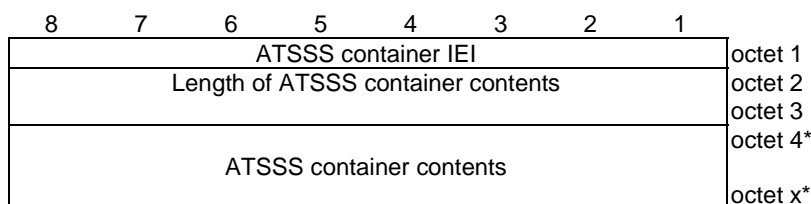

Figure 9.11.4.22.1: ATSSS container information element

Table 9.11.4.22.1: ATSSS container information element

ATSSS container contents are defined in 3GPP TS 24.193 [13B].

9.11.4.23 Control plane only indication

The purpose of the control plane only indication information element is to indicate that a PDU session is only for control plane Clot 5GS optimization.

The control plane only indication information element is coded as shown in figure 9.11.4.23.1.

The control plane only indication is a type 1 information element.

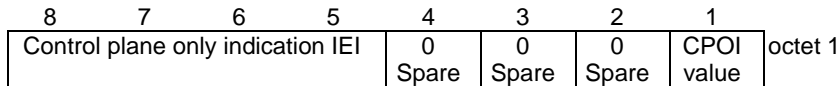

Figure 9.11.4.23.1: Control plane only indication information element

Table 9.11.4.23.1: Control plane only indication information element

Control plane only indication value (CPOI) (octet 1)
Bit
1
0 reserved
1 PDU session can be used for control plane Clot 5GS optimization only
The value 0 is reserved. If received, it shall be interpreted as if the control plane only indication IE was not included in the message.
Bits 4 to 2 of octet 1 are spare and shall be all encoded as zero.

9.11.4.24 IP header compression configuration

The purpose of the IP header compression configuration information element is to negotiate ROHC channel setup parameters specified in IETF RFC 5795 [39B] and, optionally, provide additional header compression context setup parameters.

The IP header compression configuration information element is coded as shown in figure 9.11.4.24.1 and table 9.11.4.24.1.

The IP header compression configuration is a type 4 information element with a minimum length of 5 octets and a maximum length of 257 octets.

The optional Additional IP header compression parameters container field conveys the additional header compression context setup parameters as specified in 3GPP TS 23.501 [8] in a generic container. This field corresponds to the profile-specific information in the header of the ROHC IR packet type in IETF RFC 5795 [39B].

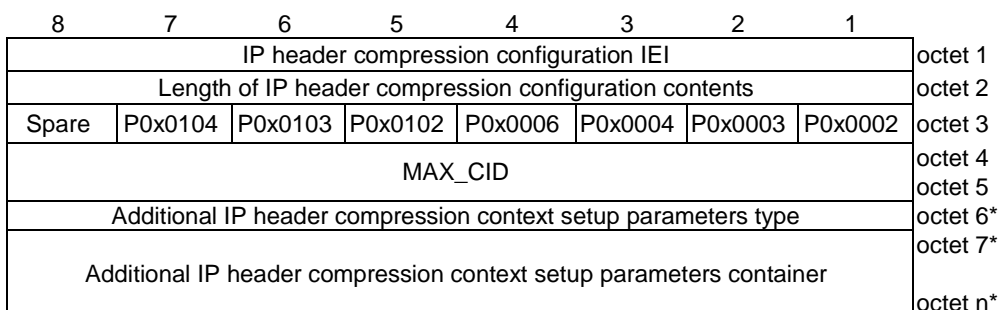

Figure 9.11.4.24.1: IP header compression configuration information element

Table 9.11.4.24.1: IP header compression configuration information element

ROHC Profiles (octet 3)

The ROHC Profiles shall indicate which of the ROHC profiles is supported. When a particular bit is set to 1, this indicates that the corresponding profile is supported. The No Compression profile 0x0000 (see IETF RFC 5795 [39B]) shall always be supported. When all the bits are set to 0, this indicates that only the No Compression profile 0x0000 is supported.

Profile 0x0002 support indicator (see IETF RFC 3095 [33A] and IETF RFC 4815 [38A]) (octet 3 bit 1)

- 0 RoHC profile 0x0002 (UDP/IP) is not supported
- 1 RoHC profile 0x0002 (UDP/IP) is supported

Profile 0x0003 support indicator (see IETF RFC 3095 [33A] and IETF RFC 4815 [38A]) (octet 3 bit 2)

- 0 RoHC profile 0x0003 (ESP/IP) is not supported
- 1 RoHC profile 0x0003 (ESP/IP) is supported

Profile 0x0004 support indicator (see IETF RFC 3843 [34A] and IETF RFC 4815 [38A]) (octet 3 bit 3)

- 0 RoHC profile 0x0004 (IP) is not supported
- 1 RoHC profile 0x0004 (IP) is supported

Profile 0x0006 support indicator (see IETF RFC 6846 [40B]) (octet 3 bit 4)

- 0 RoHC profile 0x0006 (TCP/IP) is not supported
- 1 RoHC profile 0x0006 (TCP/IP) is supported

Profile 0x0102 support indicator (see IETF RFC 5225 [39A]) (octet 3 bit 5)

- 0 RoHC profile 0x0102 (UDP/IP) is not supported
- 1 RoHC profile 0x0102 (UDP/IP) is supported

Profile 0x0103 support indicator (see IETF RFC 5225 [39A]) (octet 3 bit 6)

- 0 RoHC profile 0x0103 (ESP/IP) is not supported
- 1 RoHC profile 0x0103 (ESP/IP) is supported

Profile 0x0104 support indicator (see IETF RFC 5225 [39A]) (octet 3 bit 7)

- 0 RoHC profile 0x0104 (IP) is not supported
- 1 RoHC profile 0x0104 (IP) is supported

Bits 8 is spare and shall be set to 0.

MAX_CID (octet 4 and octet 5)

This is the MAX_CID value as specified in 3GPP TS 36.323 [25]. It is encoded in binary coding with a value in the range from 1 to 16383.

Additional IP header compression context parameters type (octet 6).

The Additional IP header compression context parameters type octet indicates the profile associated with the profile-specific information in the Additional IP header compression context parameters container.

Bits

8 7 6 5 4 3 2 1Type

0 0 0 0 0 0 0 0	0x0000 (No Compression)
0 0 0 0 0 0 0 1	0x0002 (UDP/IP)
0 0 0 0 0 0 1 0	0x0003 (ESP/IP)
0 0 0 0 0 0 1 1	0x0004 (IP)
0 0 0 0 0 1 0 0	0x0006 (TCP/IP)
0 0 0 0 0 1 0 1	0x0102 (UDP/IP)
0 0 0 0 0 1 1 0	0x0103 (ESP/IP)
0 0 0 0 0 1 1 1	0x0104 (IP)
0 0 0 0 1 0 0 0	Other

0 0 0 0 1 0 0 1
 to
 1 1 1 1 1 1 1 1 Spare

Additional IP header compression context parameters container (octets 7 to n).

Additional IP header compression context parameters container carries the profile-specific information (see IETF RFC 5795 [39B]). The maximum size is 251 octets.

NOTE: If the Additional IP header compression context setup parameters container is included, then the Additional IP header compression context parameters type shall be included in the octet 6.

9.11.4.25 DS-TT Ethernet port MAC address

The purpose of the DS-TT Ethernet port MAC address information element is to signal the MAC address of the DS-TT Ethernet port used for a PDU session of "Ethernet" PDU session type.

The DS-TT Ethernet port MAC address information element is coded as shown in figure 9.11.4.25.1 and table 9.11.4.25.1.

The DS-TT Ethernet port MAC address is a type 4 information element with a length of 8 octets.

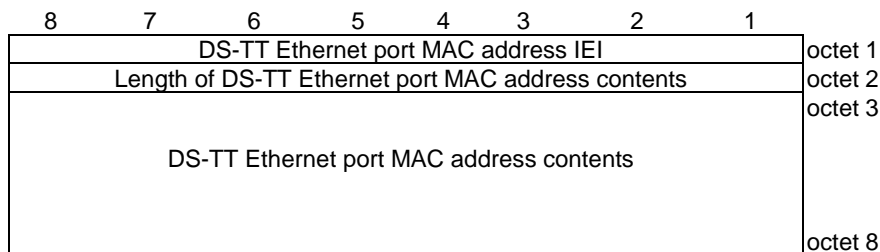

Figure 9.11.4.25.1: DS-TT Ethernet port MAC address information element

Table 9.11.4.25.1: DS-TT Ethernet port MAC address information element

DS-TT Ethernet port MAC address contents (octets 3 to 8)
The DS-TT Ethernet port MAC address contents consist of the binary representation of the MAC address of the DS-TT Ethernet port used for the PDU session, starting with the LSB bit of the first octet of the MAC address included in bit 1 of octet 3.

9.11.4.26 UE-DS-TT residence time

The purpose of the UE-DS-TT residence time information element is to signal the time taken within the UE and the DS-TT to forward a packet i.e. between the ingress of the UE and the DS-TT port in the DL direction, or between the DS-TT port and the egress of the UE in the UL direction.

The UE- DS-TT residence time information element is coded as shown in figure 9.11.4.26.1 and table 9.11.4.26.1.

The UE-DS-TT residence time is a type 4 information element with a length of 10 octets.

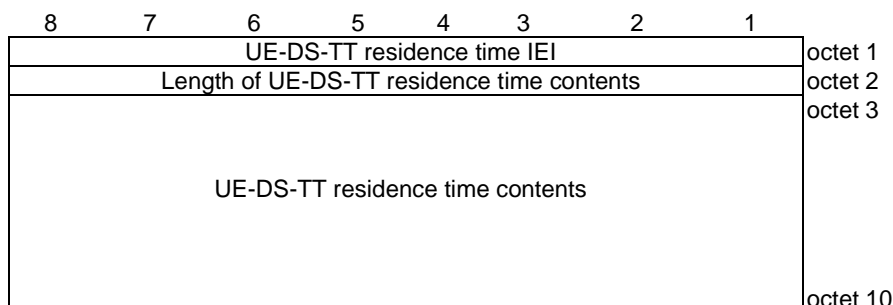

Figure 9.11.4.26.1: UE-DS-TT residence time information element

Table 9.11.4.26.1: UE-DS-TT residence time information element

UE-DS-TT residence time contents (octets 3 to 10) The UE-DS-TT residence time contents contain the UE-DS-TT residence time encoded as specified for the correctionField in IEEE Std 1588-2019 [43B], with the LSB bit of the first octet of the UE-DS-TT residence time included in bit 1 of octet 3. If the UE-DS-TT residence time is too big to be represented, all bits of octets 3 to 10 shall be coded as "1" except the MSB bit of octet 10.
--

9.11.4.27 Port management information container

The purpose of the Port management information container information element is to transport a port management service message as specified in clause 8 of 3GPP TS 24.539 [19BA].

The Port management information container information element is coded as shown in figure 9.11.4.27.1 and table 9.11.4.27.1.

The Port management information container is a type 6 information element with a minimum length of 4 octets and a maximum length of 65538 octets.

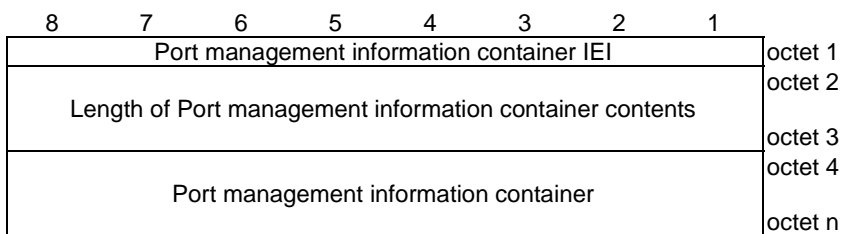

Figure 9.11.4.27.1: Port management information container information element

Table 9.11.4.27.1: Port management information container information element

Port management information container (octet 4 to n) A port management service message as specified in clause 8 of 3GPP TS 24.539 [19BA].
--

9.11.4.28 Ethernet header compression configuration

The purpose of the Ethernet header compression configuration information element is to negotiate the use of EHC and the length of the CID field in the EHC packet (see 3GPP TS 38.323 [29]).

The Ethernet header compression configuration information element is coded as shown in figure 9.11.4.28.1 and table 9.11.4.28.1.

The Ethernet header compression configuration is a type 4 information element with the length of 3 octets.

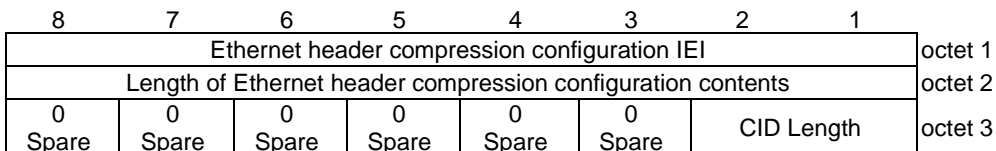

Figure 9.11.4.28.1: Ethernet header compression configuration information element

Table 9.11.4.28.1: Ethernet header compression configuration information element

Length of CID field value (CID Length) (octet 3 bits 1 and 2)		
Bit		
2	1	
0	0	Ethernet header compression not used
0	1	7 bits
1	0	15 bits
All other values shall be interpreted as "7 bits".		
Bits 3 to 8 of octet 3 are spare and shall be coded as zero.		

9.11.4.29 Remote UE context list

The purpose of the Remote UE context list information element is to provide identity and optionally IP address of a 5G ProSe remote UE connected to, or disconnected from, a UE acting as a 5G ProSe layer-3 UE-to-network relay.

The Remote UE context list information element is coded as shown in figure 9.11.4.29.1, figure 9.11.4.29.2, table 9.11.4.29.1 and table 9.11.4.29.2.

The Remote UE context list is a type 6 information element with a minimum length of 16 octets and a maximum length of 65538 octets.

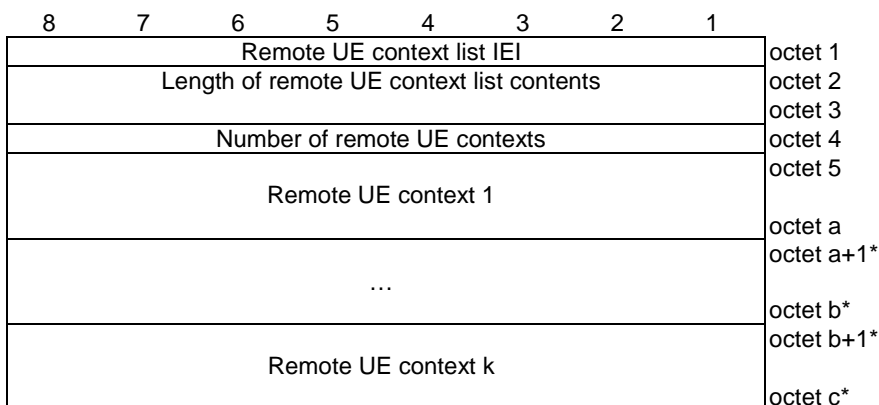

Figure 9.11.4.29.1: Remote UE context list

Table 9.11.4.29.1: Remote UE context list

Remote UE context (octet 5 etc)

The contents of remote UE context are applicable for one individual UE and are coded as shown in figure 9.11.4.29.2 and table 9.11.4.29.2.

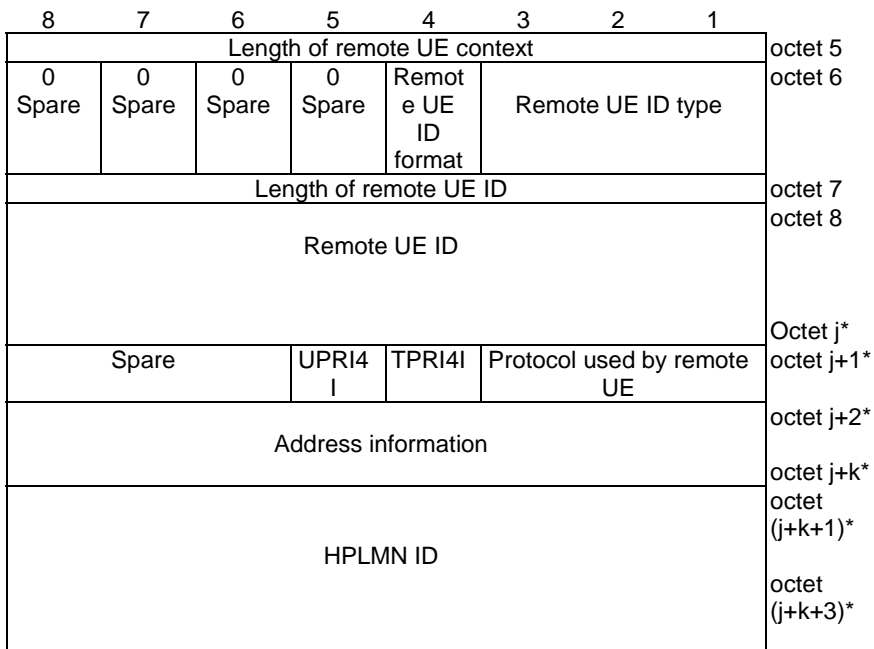

Figure 9.11.4.29.2: Remote UE context

Table 9.11.4.29.2: Remote UE context

Remote UE ID type (bits 1 to 3 of octet 6)

Bits

3 2 1

0 0 1 UP-PRUK ID

0 1 0 CP-PRUK ID

0 1 1 IMEI

1 0 0 IMEISV

All other values are reserved.

Remote UE ID format (bit 4 of octet 6) (NOTE)

Bit

4

0 Network access identifier (NAI)

1 64-bit string

Bits 5 to 8 of octet 6 are spare and shall be coded as zero.

Remote UE ID (octet 8 to octet j)

The UP-PRUK ID as specified in 3GPP TS 33.503 [56], the CP-PRUK ID as specified in 3GPP TS 33.503 [56], the IMEI or the IMEISV of the 5G ProSe Remote UE. If the remote UE ID type field indicates "UP-PRUK ID" or "CP-PRUK ID", and the remote UE ID format field indicates "NAI", the remote UE ID field contains the UP-PRUK ID or the CP-PRUK ID in the NAI format as defined in 3GPP TS 23.003 [4], encoded as UTF-8 string. If the remote UE ID type field indicates "UP-PRUK ID", and the remote UE ID format field indicates "64-bit string", the remote UE ID field contains the UP-PRUK ID as a 64-bit string, encoded using binary encoding. If the remote UE ID type field indicates "IMEI" or "IMEISV", the remote UE ID field contains the IMEI or the IMEISV encoded as 5GS mobile identity information element for type of identity "IMEI" or "IMEISV" as specified in subclause 9.11.3.4, starting with the fourth octet.

Protocol used by remote UE (octet j+1, bits 1 to 3)

Bits

3 2 1

0 0 0 No IP info

0 0 1 IPv4

0 1 0 IPv6

1 0 0 Unstructured

1 0 1 Ethernet

All other values are reserved.

TCP port range for IPv4 indicator (TPRI4I) (octet j+1, bits 4)

Bit

4

0 TCP port range for IPv4 absent

1 TCP port range for IPv4 present

UDP port range for IPv4 indicator (UPRI4I) (octet j+1, bits 5)

Bit

5

0 UDP port range for IPv4 absent

1 UDP port range for IPv4 present

Bits 4 to 8 of octet j+1 are spare and shall be coded as zero.

The length of remote UE ID field contains the binary coded representation of the length of the remote UE ID field. The first bit in transmission order is the most significant bit.

If the Protocol used by remote UE indicates IPv4 and:

- TPRI4I bit indicates "TCP port range for IPv4 absent" and UPRI4I bit indicates "UDP port range for IPv4 absent", the Address information in octet j+2 to octet j+5 contains the IPv4 address.
- TPRI4I bit indicates "TCP port range for IPv4 present" and UPRI4I bit indicates "UDP port range for IPv4 absent", the Address information in octet j+2 to octet j+9 contains the IPv4 address followed by the TCP port range field.
- TPRI4I bit indicates "TCP port range for IPv4 absent" and UPRI4I bit indicates "UDP port range for IPv4 present", the Address information in octet j+2 to octet j+9 contains the IPv4 address followed by the UDP port range field.
- TPRI4I bit indicates "TCP port range for IPv4 present" and UPRI4I bit indicates "UDP port range for IPv4 present", the Address information in octet j+2 to octet j+13 contains the IPv4 address followed by the UDP port range field followed by the TCP port range field.

See NOTE.

The UDP port range field consists of the lowest UDP port number field followed by the highest UDP port number field, of the UDP port range assigned to the remote UE in the NAT function of 5G ProSe layer-3 UE-to-network relay.

The TCP port range field consists of the lowest TCP port number field followed by highest TCP port number field, of the TCP port range assigned to the remote UE in the NAT function of 5G ProSe layer-3 UE-to-network relay.

Each port number field is two octets long and bit 8 of first octet of the port number field represents the most significant bit of the port number and bit 1 of second octet of the port number field the least significant bit.

If the Protocol used by remote UE indicates IPv6, the Address information in octet j+2 to octet j+9 contains the /64 IPv6 prefix of a remote UE. Bit 8 of octet j+2 represents the most significant bit of the /64 IPv6 prefix and bit 1 of octet j+9 the least significant bit.

If the Protocol used by remote UE indicates Ethernet, the Address information in octet j+2 to octet j+7 contains the remote UE MAC address. Bit 8 of octet j+2 represents the most significant bit of the MAC address and bit 1 of octet j+7 the least significant bit.

If the Protocol used by remote UE indicates Unstructured, the Address information octets are not included.

If the Protocol used by remote UE indicates No IP info, the Address information octets are not included

If the Remote UE ID type field indicates "PRUK ID" and the Remote UE ID format field indicates "64-bit string", then the HPLMN ID field is present otherwise the HPLMN ID field is absent. The HPLMN ID field indicates HPLMN ID of the 5G ProSe remote UE and is coded as value part of the PLMN ID information element as specified in 3GPP TS 24.554 [19E] subclause 11.3.33 starting with the second octet.

NOTE: In the present release of the specification, providing information for IP protocols other than UDP or TCP is not specified

9.11.4.30 Requested MBS container

The purpose of the Requested MBS container information element is for UE to request to join or leave one or more multicast MBS sessions.

The Requested MBS container information element is coded as shown in figure 9.11.4.30.1, figure 9.11.4.30.2, figure 9.11.4.30.3, figure 9.11.4.30.4 and table 9.11.4.30.1.

The Requested MBS container is a type 6 information element with a minimum length of 8 octets and a maximum length of 65538 octets.

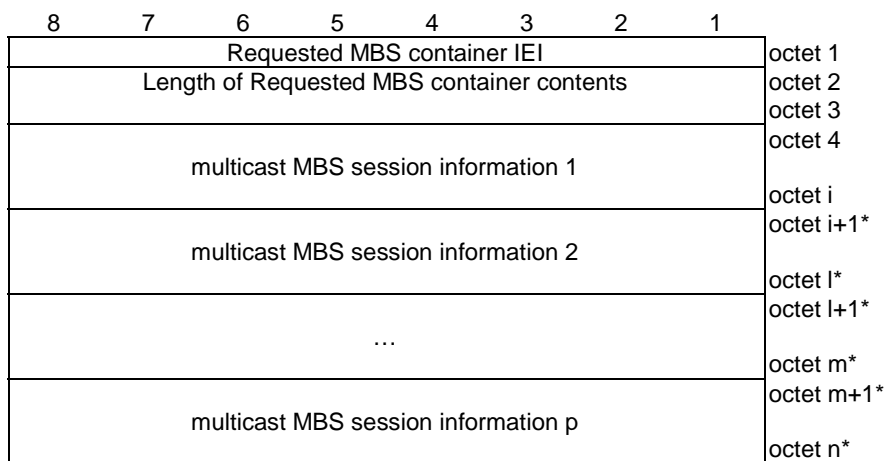

Figure 9.11.4.30.1: Requested MBS container information element

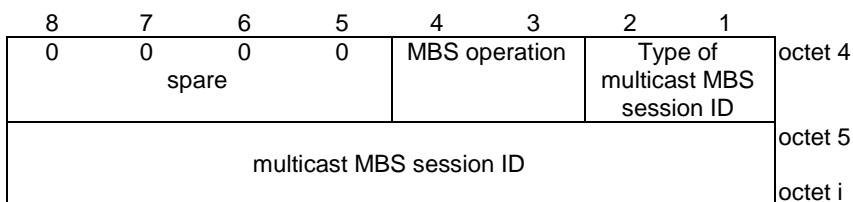

Figure 9.11.4.30.2: multicast MBS session information

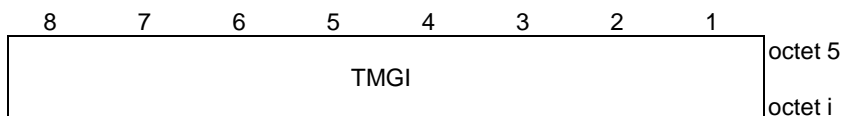

Figure 9.11.4.30.3: multicast MBS session ID for Type of multicast MBS session ID = "Temporary Mobile Group Identity (TMGI)"

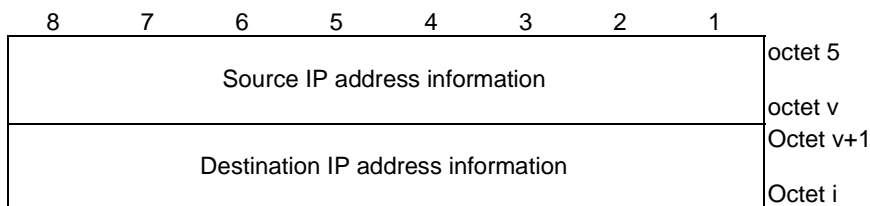

Figure 9.11.4.30.4: multicast MBS session ID for Type of multicast MBS session ID = "Source specific IP multicast address for IPv4" or "Source specific IP multicast address for IPv6"

Table 9.11.4.30.1: Requested MBS container information element

Type of multicast MBS session ID (bits 1 to 2 of octet 4)	
Bits	
2	1
0	1
1	0
1	1
Temporary Mobile Group Identity (TMGI)	
Source specific IP multicast address for IPv4	
Source specific IP multicast address for IPv6	
All other values are reserved.	
MBS operation (bits 3 to 4 of octet 4)	
Bits	
4	3
0	1
1	0
Join multicast MBS session	
Leave multicast MBS session	
All other values are reserved.	
Bits 5 to 8 of octet 4 are spare and shall be coded as zero.	
If Type of multicast MBS session ID is set to "Temporary Mobile Group Identity (TMGI)", the multicast MBS session ID contains the TMGI (octet 5 to i) and is coded as described in subclause 10.5.6.13 in 3GPP TS 24.008 [12] starting from octet 2. The structure of the TMGI is defined in 3GPP TS 23.003 [4].	
If Type of multicast MBS session ID is set to "Source specific IP multicast address for IPv4" or "Source specific IP multicast address for IPv6", the multicast MBS session ID contains the Source IP address information and the Destination IP address information.	
Source IP address information (octet 5 to v)	
This field contains the IP unicast address used as source address in IP packets for identifying the source of the multicast service.	
If the type of multicast MBS session ID indicates "Source specific IP multicast address for IPv4", the Source IP address information in octet 5 to octet 8 contains an IPv4 address. If the type of multicast MBS session ID indicates "Source specific IP multicast address for IPv6", the Source IP address information in octet 5 to octet 20 contains an IPv6 address.	
Destination IP address information (octet v+1 to i)	
This field contains the IP multicast address used as destination address in related IP packets for identifying a multicast service associated with the source.	
If the type of multicast MBS session ID indicates "Source specific IP multicast address for IPv4", the Destination IP address information in octet v+1 to octet v+4 contains an IPv4 address. If the type of multicast MBS session ID indicates "Source specific IP multicast address for IPv6", the Destination IP address information in octet v+1 to octet v+16 contains an IPv6 address.	

9.11.4.31 Received MBS container

The purpose of the Received MBS container information element is to indicate to the UE the information of the multicast MBS sessions that the network accepts or rejects the UE to join, the information of the multicast MBS sessions that the UE is removed from, or the information of the updated MBS service area.

The Received MBS container information element is coded as shown in figure 9.11.4.31.1, figure 9.11.4.31.2, figure 9.11.4.31.3, figure 9.11.4.31.4, figure 9.11.4.31.5, figure 9.11.4.31.6, figure 9.11.4.31.7, figure 9.11.4.31.8, figure 9.11.4.31.9, figure 9.11.4.31.10, figure 9.11.4.31.11 and table 9.11.4.31.1.

The Received MBS container is a type 6 information element with a minimum length of 9 octets and a maximum length of 65538 octets.

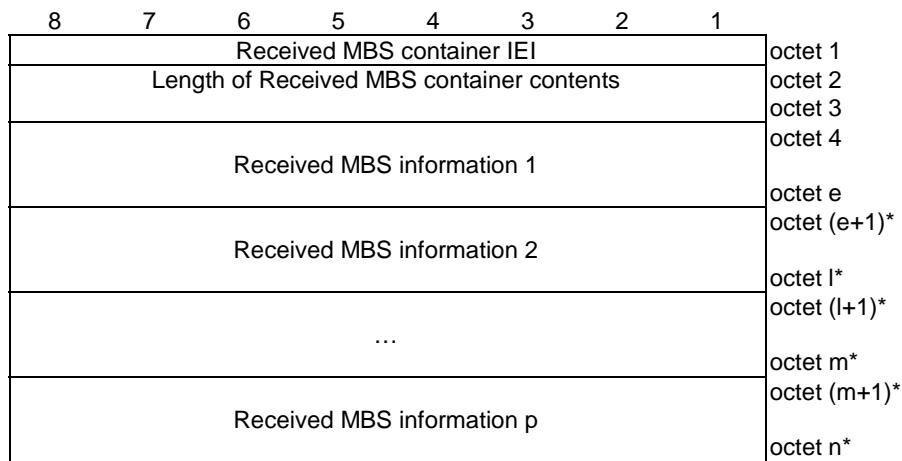

Figure 9.11.4.31.1: Received MBS container information element

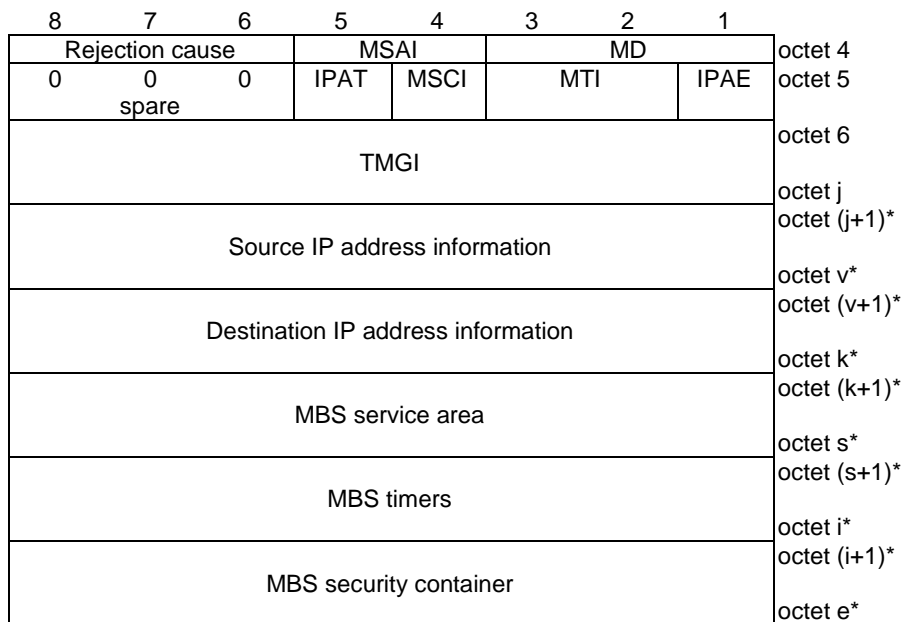

Figure 9.11.4.31.2: Received MBS information

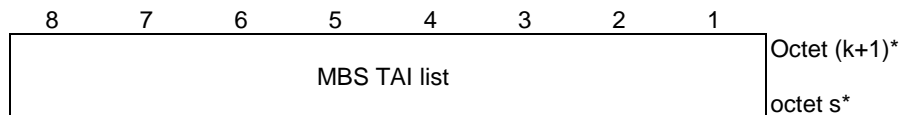

Figure 9.11.4.31.3: MBS service area for MBS service area indication = "MBS service area included as MBS TAI list"

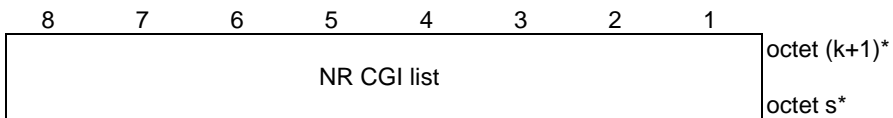

Figure 9.11.4.31.4: MBS service area for MBS service area indication = "MBS service area included as NR CGI list"

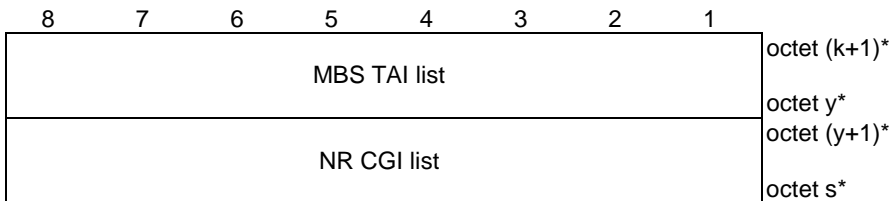

Figure 9.11.4.31.5: MBS service area for MBS service area indication = "MBS service area included as MBS TAI list and NR CGI list"

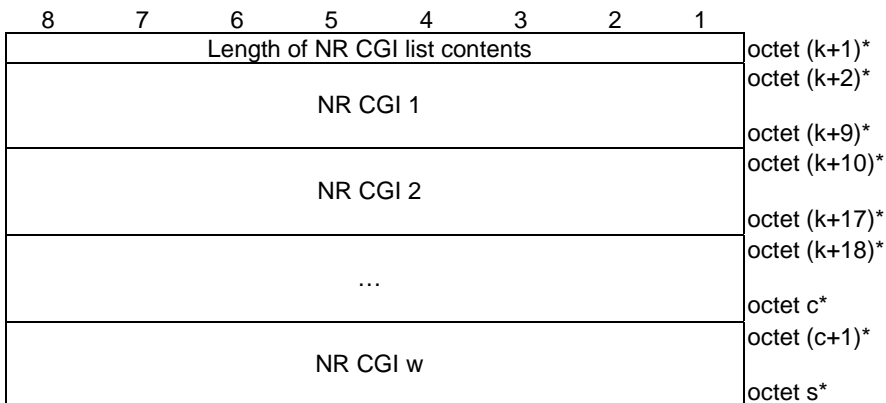

Figure 9.11.4.31.6: NR CGI list

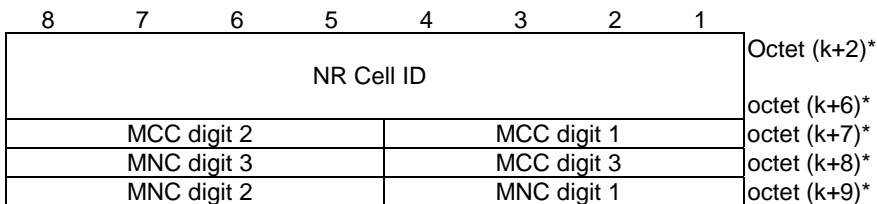

Figure 9.11.4.31.7: NR CGI

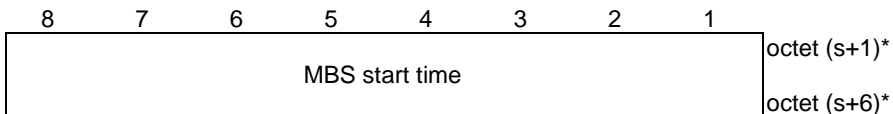

Figure 9.11.4.31.8: MBS timers for MBS timer indication = "MBS start time"

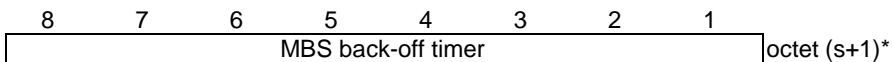

Figure 9.11.4.31.9: MBS timers for MBS timer indication = "MBS back-off timer"

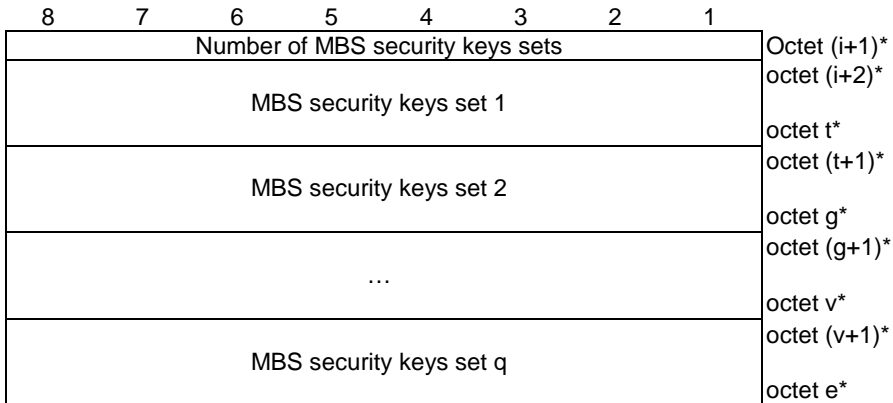

Figure 9.11.4.31.10: MBS security container

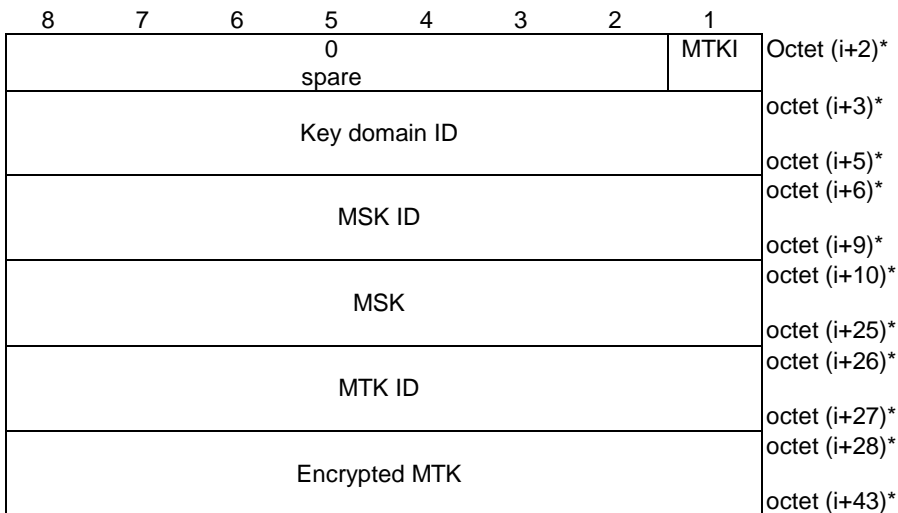

Figure 9.11.4.31.11: MBS security keys set

Table 9.11.4.31.1: Received MBS container information element

MBS decision (MD) (bits 1 to 3 of octet 4)

The MD indicates the network decision of the join requested by the UE, the network requests to remove the UE from the multicast MBS session or the network request to update the MBS service area or the security information of multicast MBS session.

Bits

3	2	1	
0	0	1	MBS service area update
0	1	0	MBS join is accepted
0	1	1	MBS join is rejected
1	0	0	Remove UE from multicast MBS session
1	0	1	MBS security information update

All other values are unused in this version of the specification and interpreted as 000 if received.

If MD is set to "MBS join is rejected" or "Remove UE from multicast MBS session", bits 6 to 8 of octet 4 shall contain the Rejection cause which indicates the reason of rejecting the MBS join request or the reason of removing the UE from multicast MBS session, respectively, otherwise bits 6 to 8 of octet 4 are spare and shall be coded as zero.

MBS service area indication (MSAI) (bits 4 and 5 of octet 4)

The MSAI indicates whether and how the MBS service area is included in the IE.

Bits

5	4	
0	0	MBS service area not included
0	1	MBS service area included as MBS TAI list
1	0	MBS service area included as NR CGI list
1	1	MBS service area included as MBS TAI list and NR CGI list

Rejection cause (bits 6 to 8 of octet 4)

The Rejection cause indicates the reason of rejecting the join request or the reason of removing the UE from the MBS session.

Bits

8	7	6	
0	0	0	No additional information provided
0	0	1	Insufficient resources
0	1	0	User is not authorized to use MBS service
0	1	1	multicast MBS session has not started or will not start soon
1	0	0	User is outside of local MBS service area
1	0	1	Session context not found
1	1	0	multicast MBS session is released

All other values are unused in this version of the specification and interpreted as 000 if received.

IP address existence (IPAE) (bit1 of octet 5)

The IPAE indicates whether the Source IP address information and Destination IP address information are included in the IE or not.

Bit

1	
0	Source and destination IP address information not included
1	Source and destination IP address information included

If IPAE is set to "Source and destination IP address information included", Source IP address information and Destination IP address information shall be included in the IE, otherwise Source IP address information and Destination IP address information shall not be included in the IE (NOTE 1).

MBS timer indication (MTI) (bits 2 and 3 of octet 5)

The MTI indicates whether there is MBS timer included in the IE or not.

Bit

3	2	
0	0	No MBS timers included
0	1	MBS start time included
1	0	MBS back-off timer included

All other values are unused in this version of the specification and interpreted as 00 if received

MBS security container indication (MSCI) (bit 4 of octet 5)

The MSCI indicates whether the MBS security container is included in the IE or not

Bit

4

- 0 MBS security container not included
- 1 MBS security container included

IP address type (IPAT) (bit 5 of octet 5)

The IPAT indicates the type of the source IP address information and destination IP address information. This field is ignored when IPAE is set to "Source and destination IP address information not included".

Bit

5

- 0 Source IP address information and destination IP address information are IPv4
- 1 Source IP address information and destination IP address information are IPv6

Bits 6 to 8 of octet 5 are spare and shall be coded as zero.

TMGI (octets 6 to j)

The TMGI is coded as described in subclause 10.5.6.13 in 3GPP TS 24.008 [12] starting from octet 2. The structure of the TMGI is defined in 3GPP TS 23.003 [4].

Source IP address information (octet j+1 to v)

This field contains the IP unicast address used as source address in IP packets for identifying the source of the multicast service. The value of this field is copied from the corresponding source IP address information in the requested MBS container. If the IPAT indicates "Source and destination IP address information are IPv4", the Source IP address information in octet j+1 to octet j+4 contains an IPv4 address. If the IPAT indicates "Source and destination IP address information are IPv6", the Source IP address information in octet j+1 to octet j+16 contains an IPv6 address

Destination IP address information (octet v+1 to k)

This field contains the IP multicast address used as destination address in related IP packets for identifying a multicast service associated with the source. The value of this field is copied from the corresponding destination IP address information in the requested MBS container. If the IPAT indicates "Source and destination IP address information are IPv4", the Destination IP address information in octet v+1 to octet v+4 contains an IPv4 address. If the IPAT indicates "Source and destination IP address information are IPv6", the Destination IP address information in octet v+1 to octet v+16 contains an IPv6 address.

MBS service area (octet k+1 to s)

The MBS service area contains the MBS TAI list, the NR CGI list or both, that identifies the service area(s) for a local MBS service.

MBS TAI list (octet k+1 to s)

The MBS TAI list is coded as octet 2 and above of the 5GS tracking area identity list IE defined in subclause 9.11.3.9.

NR CGI (octet k+2 to k+9)

The NR CGI globally identifies an NR cell. It contains the NR Cell ID and the PLMN ID of that cell.

NR Cell ID (octet k+2 to k+6)

The NR Cell ID consists of 36 bits identifying an NR Cell ID as specified in subclause 9.3.1.7 of 3GPP TS 38.413 [31], in hexadecimal representation. Bit 8 of octet k+2 is the most significant bit and bit 5 of octet k+6 is the least significant bit. Bits 1 to 4 of octet k+6 are spare and shall be coded as zero.

MCC, Mobile country code (octet k+7 and bits 1 to 4 octet k+8)

The MCC field is coded as in ITU-T Recommendation E.212 [42], annex A.

MNC, Mobile network code (bits 5 to 8 of octet k+8 and octet k+9)

The coding of this field is the responsibility of each administration but BCD coding shall be used. The MNC shall consist of 2 or 3 digits. If a network operator decides to use only two digits in the MNC, bits 5 to 8 of octet k+8 shall be coded as "1111".

The MCC and MNC digits are coded as octets 6 to 8 of the Temporary mobile group identity IE in figure 10.5.154 of 3GPP TS 24.008 [12].

<p>MBS start time (octets s+1 to s+6) The MBS start time is coded as described in subclause 10.5.3.9 in 3GPP TS 24.008 [12] starting from octet 2 till octet 7.</p> <p>MBS back-off timer (octet s+1) The MBS back-off timer is coded as octet 3 described in subclause 10.5.7.4a in 3GPP TS 24.008 [12].</p> <p>MTK indication (MTKI) (bit1 of octet i+2) The MTKI indicates whether the MTK ID and Encrypted MTK are included in the MBS security keys set or not. Bit 1 0 MTK ID and Encrypted MTK not included 1 MTK ID and Encrypted MTK included</p> <p>Bits 2 to 8 of octet i+2 are spare and shall be coded as zero</p> <p>Key domain ID (octet i+3 to i+5) The key domain ID is 3 bytes long and is defined in 3GPP TS 33.246 [57] (NOTE 2).</p> <p>MBS Service Key Identifier (MSK ID) (octets i+6 to i+9) The MSK ID is 4 bytes long and is defined in 3GPP TS 33.246 [57].</p> <p>MBS Service Key (MSK) (octets i+10 to i+25) The MSK is 16 bytes long and is defined in 3GPP TS 33.246 [57].</p> <p>MBS Traffic Key Identifier (MTK ID) (octets i+26 to i+27) The MTK ID is 2 bytes long and is defined in 3GPP TS 33.246 [57].</p> <p>Encrypted MBS Traffic Key (Encrypted MTK) (octets i+28 to i+43) The Encrypted MTK is 16 bytes long and contains the encrypted version of MTK using MSK as defined in 3GPP TS 33.246 [57].</p> <p>NOTE 1: The IPAE bit is not expected to be set to "Source and destination IP address information included" when the MBS decision (MD) indicates "Remove UE from multicast MBS session".</p> <p>NOTE 2: As specified in annex W in 3GPP TS 33.501 [24], the UE should not try to use the MCC and MNC constructing the key domain ID in another context, e.g., the UE should not compare those MCC and MNC to parameters received from lower layers.</p>

9.11.4.32 PDU session pair ID

The purpose of the PDU session pair ID information element is to indicate a PDU session pair ID.

The PDU session pair ID information element is coded as shown in figure 9.11.4.32.1 and table 9.11.4.32.1.

The PDU session pair ID is a type 4 information element with a length of 3 octets.

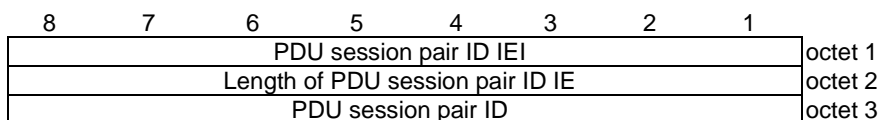

Figure 9.11.4.32.1: PDU session pair ID information element

Table 9.11.4.32.1: PDU session pair ID information element

PDU session pair ID (octet 3)							
Bits							
8	7	6	5	4	3	2	1
0	0	0	0	0	0	0	0
				to			
0	0	0	0	0	1	1	0
				to			
						PDU session pair ID 6	
All other values are reserved.							

9.11.4.33 RSN

The purpose of the RSN information element is to indicate an RSN.

The RSN information element is coded as shown in figure 9.11.4.33.1 and table 9.11.4.33.1.

The RSN is a type 4 information element with a length of 3 octets.

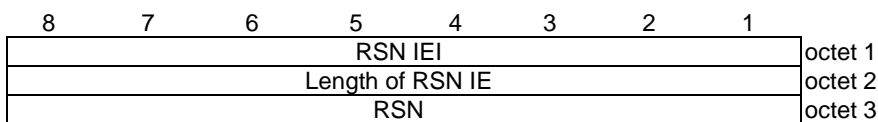

Figure 9.11.4.33.1: RSN information element

Table 9.11.4.33.1: RSN information element

RSN (octet 3)							
Bits							
8	7	6	5	4	3	2	1
0	0	0	0	0	0	0	0
						v1	
0	0	0	0	0	0	0	1
						v2	
All other values are spare and shall not be used by a UE compliant to the present version of this specification.							

9.11.4.34 ECS address

The purpose of the ECS address information element is to indicate the ECS address (either IPv4 address, IPv6 address, or FQDN) and the associated spatial validity condition.

The ECS address information element is coded as shown in figure 9.11.4.34.1, figure 9.11.4.34.2, figure 9.11.4.34.3, figure 9.11.4.34.4, figure 9.11.4.34.5, figure 9.11.4.34.6, table 9.11.4.34.1, table 9.11.4.34.2, table 9.11.4.34.4 and table 9.11.4.34.5.

The ECS address information element is a type 6 information element with minimum length of 8 octets and a maximum length of 65538 octets.

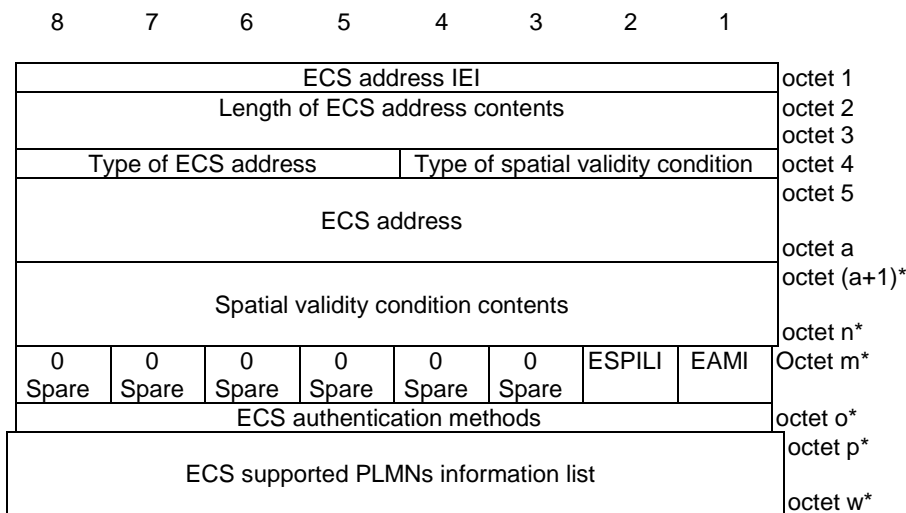

Figure 9.11.4.34.1: ECS address information element

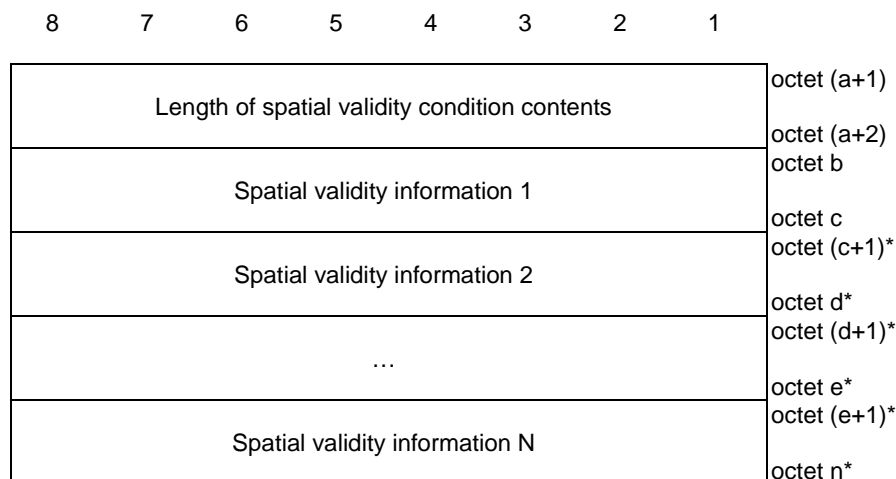

Figure 9.11.4.34.2: Spatial validity condition contents

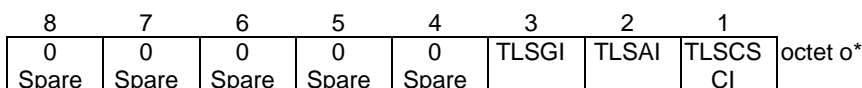

Figure 9.11.4.34.3: ECS authentication methods

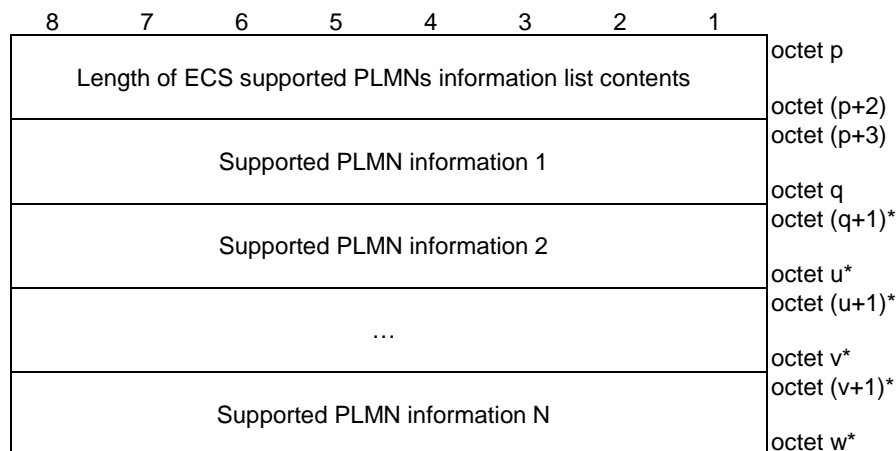

Figure 9.11.4.34.4: ECS supported PLMNs information list contents

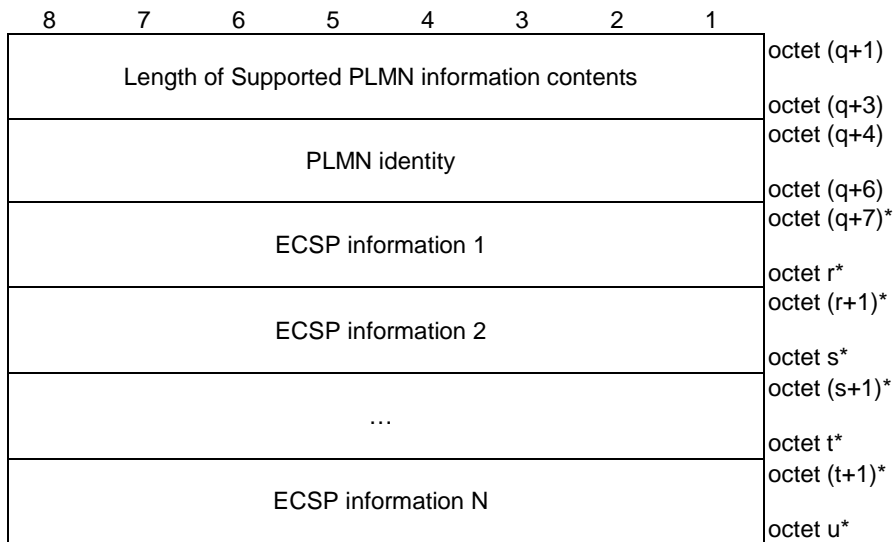

Figure 9.11.4.34.5: Supported PLMN information contents

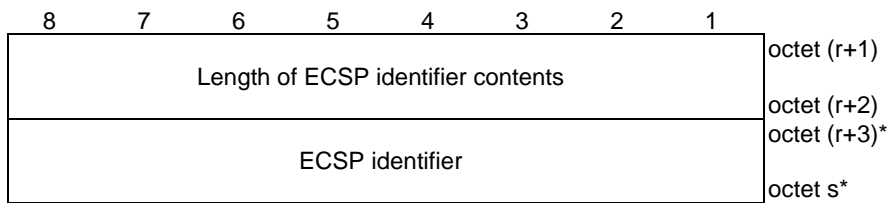

Figure 9.11.4.34.6: ECSP information contents

Table 9.11.4.34.1: ECS address information element

Type of ECS address (octet 4, bit 1 to 4)	
Bits	
4	3 2 1
0	0 0 0 IPv4
0	0 0 1 IPv6
0	0 1 0 FQDN
1	1 1 1 Unspecified
All other values are spare. The receiving entity shall ignore an ECS address IE with type of ECS address containing a spare value.	
Type of spatial validity condition (octet 4, bit 5 to 8)	
Bits	
8	7 6 5
0	0 0 0 No spatial validity condition
0	0 0 1 Geographical service area
0	0 1 0 Tracking area
0	0 1 1 Country-wide
All other values are spare. The receiving entity shall ignore a spatial validity condition with type of spatial validity condition containing an unknown value.	
If the type of ECS address indicates IPv4, then the ECS address field contains an IPv4 address in octet 5 to octet 8.	
If the type of ECS address indicates IPv6, then the ECS address field contains an IPv6 address in octet 5 to octet 20 and is encoded according to IETF RFC 4291 [66].	
If the type of ECS address indicates FQDN, then the ECS address field contains in octet 5 the length of FQDN value and in octet 6 to octet a an FQDN value encoded as defined in subclause 19.4.2 in 3GPP TS 23.003 [4].	
If the type of ECS address indicates unspecified, then the remaining fields of ECS address information element shall be passed to the upper layers.	
Spatial validity condition contents (octet (a+1)* to n*)	
The spatial validity condition contents contain a variable number of spatial validity condition information.	
ECS authentication methods indicator (EAMI) (octet m*, bit 1)	
Bits	
1	
0	ECS authentication methods field is not included
1	ECS authentication methods field is included
If the EAMI bit is set to "ECS authentication methods field is included" then the ECS authentication methods field is included otherwise the ECS authentication methods field is not included. ECS authentication methods is an optional field and is included based on operator requirements.	
ECS supported PLMNs information list indication (ESPILI) (octet m*, bit 2)	
Bits	
2	
0	ECS supported PLMNs information list field is not included
1	ECS supported PLMNs information list field is included
If the ESPILI bit is set to "ECS supported PLMNs information list field is included" then the ECS supported PLMNs information list field is included otherwise the ECS supported PLMNS information list field is not included.	
ECS supported PLMNs information list (octet p* to w*)	
The ECS supported PLMNs information list contains a variable number of supported PLMN information field. The supported PLMN information field is coded according to figure 9.11.4.34.5.	

Table 9.11.4.34.2: Spatial validity condition contents

<p>If the type of spatial validity condition of the ECS address indicates No spatial validity condition, then the spatial validity condition information field is empty.</p> <p>If the type of spatial validity condition of the ECS address indicates geographical service area, then the spatial validity condition information field contains a geographical service area which is specified by geographical descriptions as defined in 3GPP TS 23.032 [4B].</p> <p>If the type of spatial validity condition of the ECS address indicates tracking area, then the spatial validity condition information field contains a TAI as defined in subclause 9.11.3.8 starting from octet 2.</p> <p>If the type of spatial validity condition of the ECS address indicates country-wide, then the spatial validity condition information field contains an MCC as defined in ITU-T Recommendation E.212 [42], annex A. The first MCC digit is coded in bit 1 to 4 of the octet b, the second MCC digit is coded in bit 5 to 8 of the octet b, and the third MCC digit is coded in bit 1 to 4 of the octet b+1. Bit 5 to bit 8 of the octet b+1 shall be padded with 1. If only two digits are used for MCC, octet b+1 shall be padded with 1.</p>
--

Table 9.11.4.34.3: ECS authentication methods contents

ECS authentication methods (octet o*)	
TLS client server certificate indicator (TLSCSCI) (octet o*, bit 1)	
0	TLS client server certificate not supported
1	TLS client server certificate supported
TLS with AKMA indicator (TLSAI) (octet o*, bit 2)	
0	TLS with AKMA not supported
1	TLS with AKMA supported
TLS with GBA indicator (TLSGI) (octet o*, bit 3)	
0	TLS with GBA not supported
1	TLS with GBA supported

Table 9.11.4.34.4: Supported PLMN information contents

<p>PLMN identity: The PLMN identity for which the EDN configuration information can be provided by the ECS. This is encoded as octet 3 to octet 5 in figure 9.11.3.85.1.</p> <p>ECSP information: The identifier of the ECSP(s) associated with the PLMN and whose information is available at the ECS. The ECSP information is coded according to figure 9.11.4.34.z.</p>
--

Table 9.11.4.34.5: ECSP information contents

<p>ECSP identifier This field contains one ECSP identifier. The ECSP identifier is encoded as a UTF-8 string.</p>

9.11.4.35 Void

9.11.4.36 N3QAI

The purpose of the N3QAI information element is to indicate a set of QoS parameters to be used by the UE for non-3GPP access network resource management behind the UE.

The N3QAI information element is a type 6 information element with a minimum length of 9 octets. The maximum length for the information element is 65538 octets.

The N3QAI information element is coded as shown in figure 9.11.4.36.1, figure 9.11.4.36.2, figure 9.11.4.36.3, figure 9.11.4.36.4, and table 9.11.4.36.1.

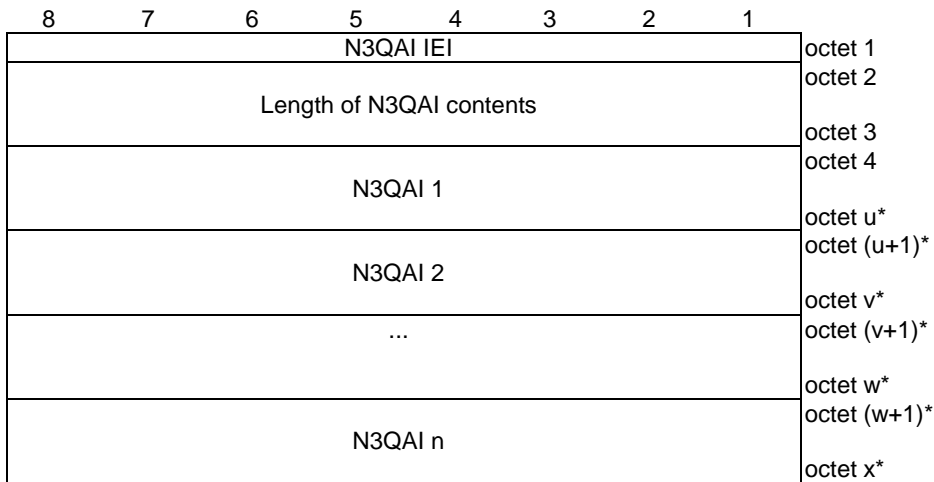

Figure 9.11.4.36.1: N3QAI information element

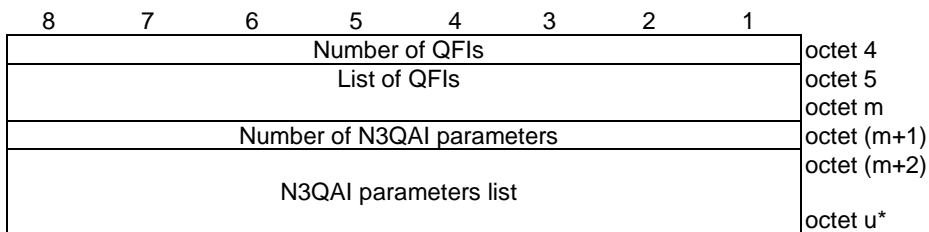

Figure 9.11.4.36.2: N3QAI

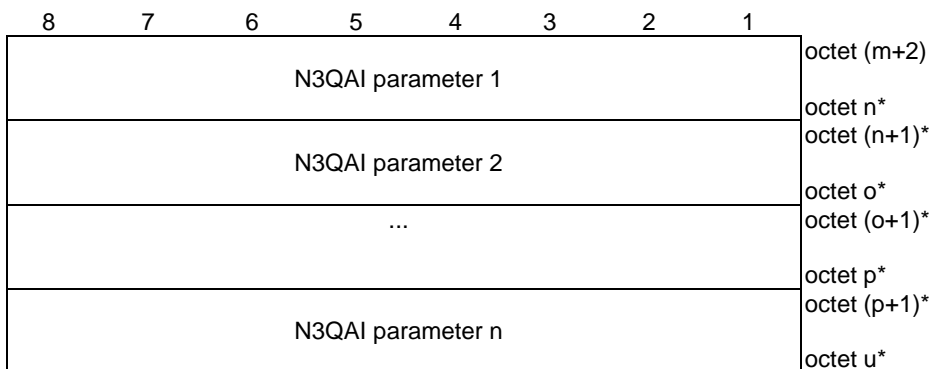

Figure 9.11.4.36.3: N3QAI parameters list

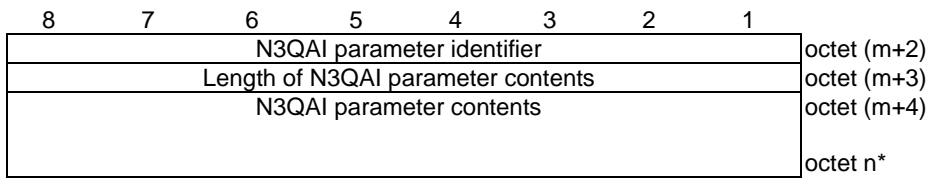

Figure 9.11.4.36.4: N3QAI parameter

Table 9.11.4.36.1: N3QAI information element

Number of QFIs (octet 4)

The number of QFIs field contains the binary coding for the number of QFIs associated with the same N3QAI parameters. This field is encoded in bits 8 through 1 of octet 4 where bit 8 is the most significant and bit 1 is the least significant bit.

List of QFIs (octet 5 to octet m)

This field indicates QoS flow(s) associated with the same N3QAI parameters. This field contains QFI values encoded as below:

Bits

8 7 6 5 4 3 2 1

0 0 0 0 0 0 0 0 Reserved

0 0 0 0 0 0 0 1 QFI 1

to

0 0 1 1 1 1 1 1 QFI 63

The other values are spare. If spare value is used, the UE shall ignore the value.

Number of N3QAI parameters (bits 8 to 1 of octet (m+1))

The number of N3QAI parameters field contains the binary coding for the number of N3QAI parameters in the N3QAI parameters list field. The number of N3QAI parameters field is encoded in bits 8 through 1 of octet (m+1) where bit 8 is the most significant and bit 1 is the least significant bit.

<p>N3QAI parameters list (octets (m+2) to q*) The N3QAI parameters list field contains a variable number of N3QAI parameters.</p> <p>Each N3QAI parameter included in the N3QAI parameters list is of variable length and consists of:</p> <ul style="list-style-type: none"> - a N3QAI parameter identifier (1 octet); - the length of the N3QAI parameter contents (1 octet); and - the N3QAI parameter contents itself (variable number of octets). <p>The N3QAI parameter identifier field is used to identify each parameter included in the N3QAI parameters list and it contains the hexadecimal coding of the parameter identifier. Bit 8 of the parameter identifier field contains the most significant bit and bit 1 contains the least significant bit. In this version of the protocol, the following parameter identifiers are specified:</p> <ul style="list-style-type: none"> - 01H (5QI); - 02H (GFBR uplink); - 03H (GFBR downlink); - 04H (MFBR uplink); - 05H (MFBR downlink); - 06H (Averaging window); - 07H (Resource type); - 08H (Priority level); - 09H (Packet delay budget); - 0AH (Packet error rate); - 0BH (Maximum data burst volume); - 0CH (Maximum packet loss rate downlink); - 0DH (Maximum packet loss rate uplink); - 0EH (ARP); and - 0FH (Periodicity). <p>If the N3QAI parameters list contains a N3QAI parameter identifier that is not supported by the receiving entity, the corresponding parameter shall be discarded. The length of N3QAI parameter contents field contains the binary coded representation of the length of the parameter contents field. The first bit in transmission order is the most significant bit.</p> <p>For the N3QAI parameter identifiers indicating "5QI", "GFBR uplink", "GFBR downlink", "MFBR uplink", "MFBR downlink", and "Averaging window", the format of the N3QAI parameter contents follows the table 9.11.4.12.1 of subclause 9.11.4.12 of this specification.</p> <p>For the N3QAI parameter identifiers indicating "Resource type", "Priority level", "Packet delay budget", "Packet error rate", "Maximum data burst volume", "Maximum packet loss rate downlink", and "Maximum packet loss rate uplink", the format of the N3QAI parameter contents follows the table 9.3.1.1-2 of subclause 9.3.1.1 of 3GPP TS 24.502 [18].</p> <p>When the N3QAI parameter identifier indicates "ARP", the N3QAI parameter contents field contains the binary representation of ARP that is one octet in length. The range of the ARP priority level is 1 to 15 with 1 as the highest priority as specified in subclause 5.7.2.2 of 3GPP TS.23.501 [8].</p> <p>When the N3QAI parameter identifier indicates "Periodicity", the N3QAI parameter contents field contains the binary representation of the periodicity for the traffic with a unit of microsecond. (NOTE 1)</p> <p>NOTE 1: The periodicity refers to the time interval between start of two data bursts for supporting consumer real time applications e.g., XR.</p>
--

9.11.4.37 Non-3GPP delay budget

The purpose of the Non-3GPP delay budget information element is to indicate the non-3GPP delay budget for the non-3GPP network behind the UE to the network.

The Non-3GPP delay budget information element is a type 6 information element with a minimum length of 8 octets. The maximum length for the information element is 65538 octets.

The Non-3GPP delay budget information element is coded as shown in figure 9.11.4.37.1.

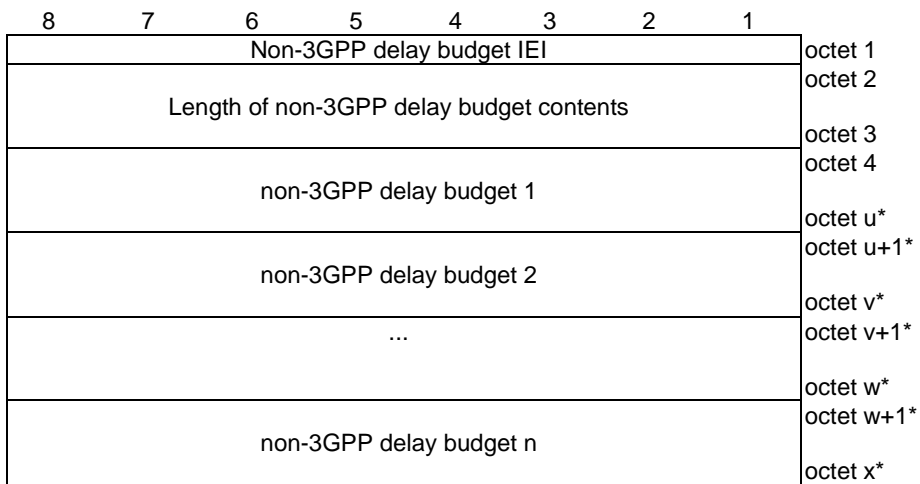

Figure 9.11.4.37.1: Non-3GPP delay budget information element

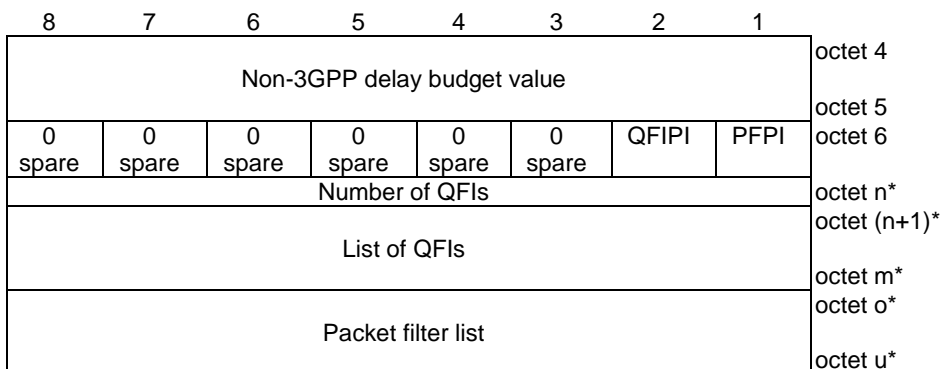

Figure 9.11.4.37.2: Non-3GPP delay budget

Table 9.11.4.37.1: Non-3GPP delay budget information element

<p>The Non-3GPP delay budget value field contains the binary representation of the Non-3gpp delay budget in units of 0.5ms.</p> <p>Bits</p> <p>8 7 6 5 4 3 2 1 8 7 6 5 4 3 2 1</p> <p>0 0 0 0 0 0 0 0 0 0 0 0 0 0 0 0</p> <p>thru</p> <p>1 1 1 1 1 1 1 1 1 1 1 1 1 1 1 1</p> <p>Packet filter presence indicator (PFPI) (bit 1 of octet 6)</p> <p>Bit</p> <p>1</p> <p>0 Packet filter list associated with the Non-3GPP delay budget value is not present</p> <p>1 Packet filter list associated with the Non-3GPP delay budget value is present</p> <p>QoS flow identifier presence indicator (QFIPI) (bit 2 of octet 6)</p> <p>Bit</p> <p>2</p> <p>0 QoS flow identifier associated with the Non-3GPP delay budget value is not present</p> <p>1 QoS flow identifier associated with the Non-3GPP delay budget value is present</p> <p>Number of QFIs (octet n*)</p> <p>The number of QFIs field is present if QFIPI is set to 1. If QFIPI is not set to 1, this field shall not be included in the non-3GPP delay budget. The number of QFIs field contains the binary coding for the number of QFIs associated with the same non-3GPP delay budget value. This field is encoded in bits 8 through 1 of octet 4 where bit 8 is the most significant and bit 1 is the least significant bit.</p> <p>List of QFIs (octet (n+1)* to octet m*)</p> <p>The list of QFIs field is present if QFIPI is set to 1. If QFIPI is not set to 1, this field shall not be included in the non-3GPP delay budget. This field indicates QoS flow(s) associated with the same non-3GPP delay budget value. This field contains QFI values encoded as below</p> <p>Bits</p> <p>8 7 6 5 4 3 2 1</p> <p>0 0 0 0 0 0 0 0 Reserved</p> <p>0 0 0 0 0 0 0 1 QFI 1</p> <p>to</p> <p>0 0 1 1 1 1 1 1 QFI 63</p> <p>The other values are spare. If spare value is used, the UE shall ignore the value.</p> <p>Packet filter list (octet 7 to u)</p> <p>The packet filter list is present if PFPI is set to 1. If not present, this field shall not be included in the non-3GPP delay budget. The encoding of the packet filter list follows the figure 9.11.4.13.4 and the table 9.11.4.13.1.</p>

9.11.4.38 URSP rule enforcement reports

The purpose of the URSP rule enforcement reports information element is to provide one or more URSP rule enforcement reports to the network. Each URSP rule enforcement report includes all the connection capabilities contained in the traffic descriptor of each URSP rule associated to the PDU session.

The URSP rule enforcement reports information element is coded as shown in figure 9.11.4.38.1, figure 9.11.4.38.2, and table 9.11.4.38.1.

The URSP rule enforcement reports is a type 4 information element with a minimum length of 4 octets.

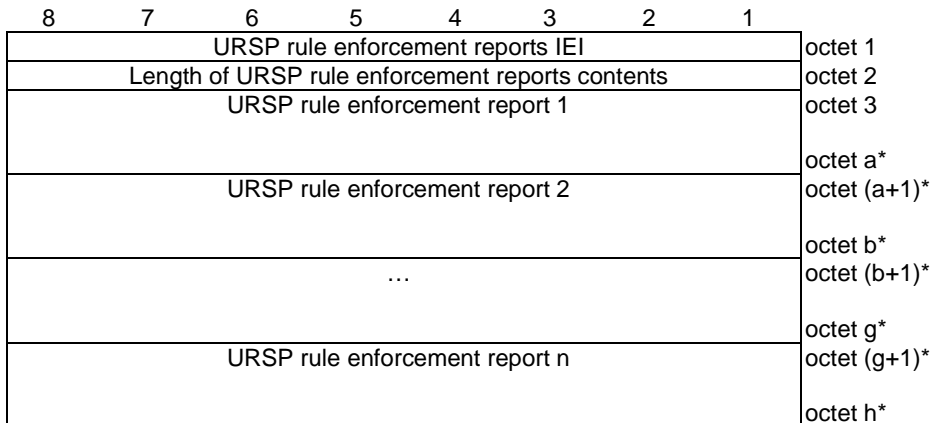

Figure 9.11.4.38.1: URSP rule enforcement reports information element

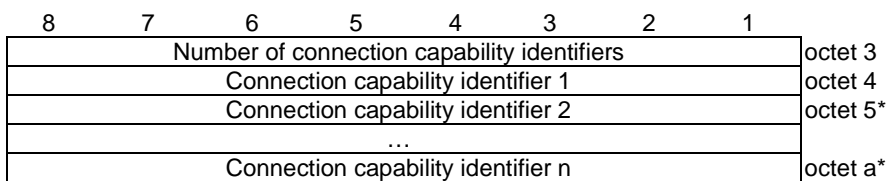

Figure 9.11.4.38.2: URSP rule enforcement report

Table 9.11.4.38.1: URSP rule enforcement reports information element

<p>URSP rule enforcement report (octet 3 to octet a) The URSP rule enforcement report field contains all the connection capabilities contained in the traffic descriptor of one reported URSP rule.</p> <p>Number of connection capability identifiers (octet 3) The number of connection capability identifiers field indicates number of indicated connection capability identifiers in binary representation. The value of this field shall be set to at least one, and the receiving entity shall ignore the URSP rule enforcement reports IE with "Number of connection capability identifiers" field set to zero.</p> <p>Connection capability identifier Connection capability identifier is encoded as defined in 3GPP TS 24.526 [19] table 5.2.1.</p>
--

9.11.4.39 Protocol description

The purpose of the Protocol description information element is to provide protocol description for UL PDU set handling to the UE.

The Protocol description information element is a type 6 information element with a minimum length of 6 octets.

The Protocol description information element is coded as shown in figure 9.11.4.39.1, figure 9.11.4.39.2, figure 9.11.4.39.3, figure 9.11.4.39.4, and table 9.11.4.39.1.

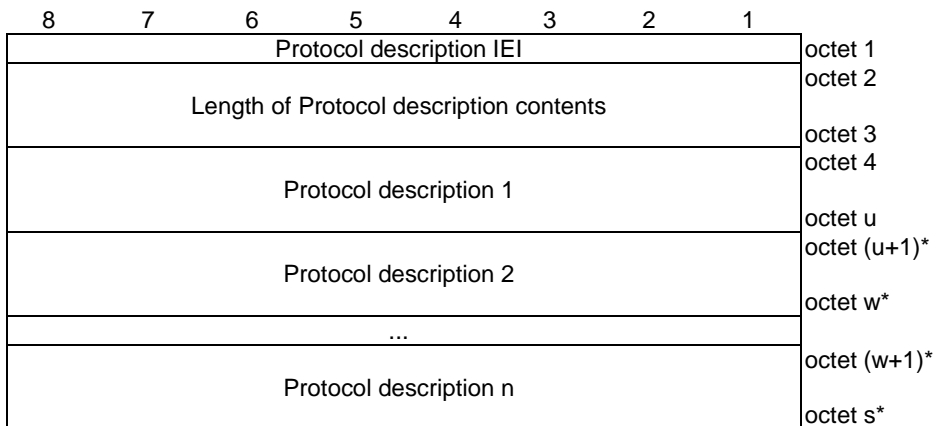

Figure 9.11.4.39.1: Protocol description information element

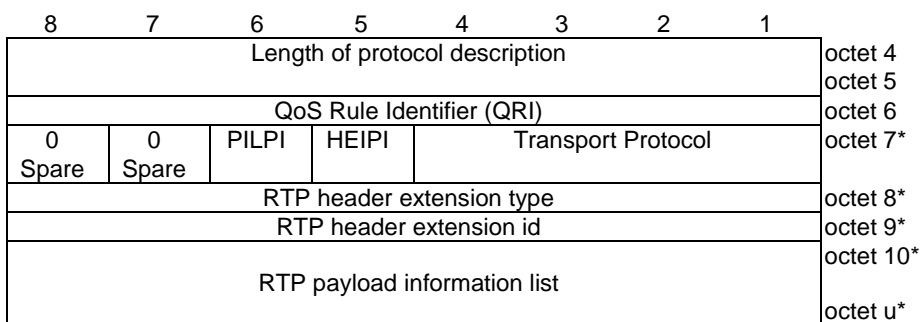

Figure 9.11.4.39.2: Protocol description

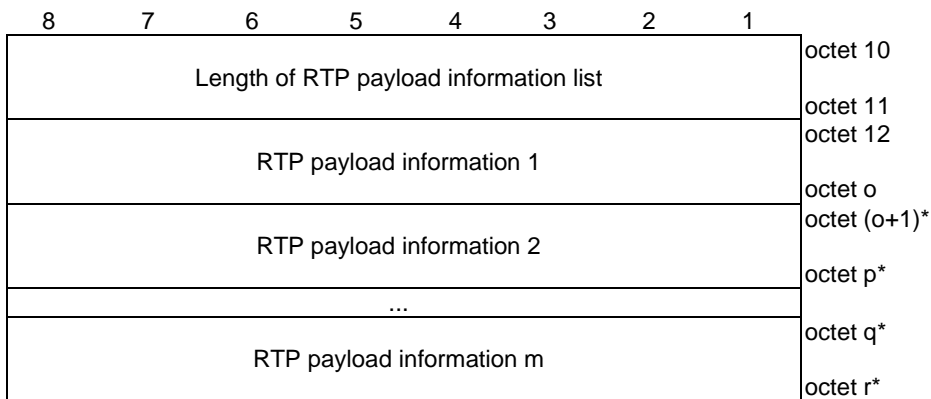

Figure 9.11.4.39.3: RTP payload information list

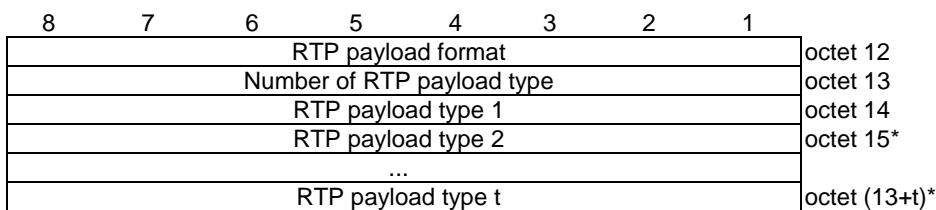

Figure 9.11.4.39.4: RTP payload information

Table 9.11.4.39.1: Protocol description information element

Length of protocol description (octet 4 and octet 5) (see NOTE 1)	
The length of protocol description field indicates the length of the protocol description entry.	
QoS Rule Identifier (QRI) (octet 6)	
The QoS Rule Identifier (QRI) field contains the QoS rule identifier as specified in subclause 9.11.4.13. Each protocol description entry is associated with the QoS rule identified by the QRI field.	
Transport Protocol (octet 7, bits 1 to 4)	
The Transport Protocol field indicates the transport protocol used by the media flow, e.g., RTP or SRTP as specified in 3GPP TS 26.522 [69].	
Bits	
4 3 2 1	
0 0 0 1	RTP
0 0 1 0	SRTP
All other values are spare.	
If Transport Protocol field indicates a spare value, the corresponding entry for the protocol description shall be ignored.	
RTP header extension information presence indicator (HEIPI) (bit 5 of octet 7)	
The HEIPI field indicates whether the RTP header extension information (RTP header extension type field and RTP header extension id field) is included in the IE or not.	
Bit	
5	
0	RTP header extension information not included
1	RTP header extension information included
RTP payload information list presence indicator (PILPI) (bit 6 of octet 7)	
The PILPI field indicates whether the RTP payload information list is included in the IE or not.	
Bit	
6	
0	RTP payload information list not included
1	RTP payload information list included
RTP header extension type (octet 8)	
The RTP header extension type field contains the RTP header extension type, i.e the RTP Header Extension for PDU Set Marking as specified in subclause 4.2 of 3GPP TS 26.522 [69].	
Bits	
8 7 6 5 4 3 2 1	
0 0 0 0 0 0 0 1	RTP Header Extension for PDU Set Marking
All other values are spare.	
RTP header extension id (octet 9)	
If RTP header extension type has a value other than spare values, the RTP header extension id field contains the RTP header extension id which is coded as binary representation of an integer between 1 (inclusive) and 255 (inclusive) as defined in IETF RFC 8285 [70].	
RTP payload information list (octets 10 to u) (see NOTE 2)	
The RTP payload information list contains the RTP payload information for the RTP stream, which can be used to derive the PDU set information.	
RTP payload format (octet 12)	
Bits	
8 7 6 5 4 3 2 1	
0 0 0 0 0 0 0 1	RTP payload format for H.264/AVC codec as specified in subclause A.2.2 of 3GPP TS 26.522 [69]
0 0 0 0 0 0 1 0	RTP payload format for H.265/HEVC codec as specified in subclause A.2.2 of 3GPP TS 26.522 [69]
All other values are spare.	

If the RTP payload format indicates a spare value, the corresponding entry for the RTP payload information shall be ignored.

RTP payload type (octet 14)

The RTP payload type field indicates the RTP or SRTP payload type, it contains the binary representation of an integer between 0(inclusive) and 127(inclusive). The other values are spare. If spare value is used, the UE shall ignore the value.

NOTE 1: If the value of the length of protocol description field is set to 1, the corresponding entry for the protocol description shall be deleted for the associated QoS rule. If the value of the length of protocol description field is greater than 1, the corresponding entry for the protocol description shall be added or replaced for the associated QoS rule.

NOTE 2: In this release of the specification, the RTP payload information list contains only one RTP payload information entry.

9.12 3GPP specific coding information defined within present document

9.12.1 Serving network name (SNN)

The serving network name (SNN) is used:

- in the Network name field of the AT_KDF_INPUT attribute defined in IETF RFC 5448 [40];
- in K_{AUSF} derivation function as specified in 3GPP TS 33.501 [24] annex A; and
- in RES* and XRES* derivation function as specified in 3GPP TS 33.501 [24] annex A.

SNN shall contain a UTF-8 string without terminating null characters.

SNN is of maximum length of 1020 octets.

SNN consists of SNN-service-code and SNN-network-identifier, delimited by a colon.

SNN-network-identifier identifies the serving PLMN or the serving SNPN.

MCC and MNC in the SNN-PLMN-ID are MCC and MNC of the serving PLMN. If the MNC of the serving PLMN has two digits, then a zero is added at the beginning.

MCC and MNC in the SNN-SNPN-ID are MCC and MNC of the serving SNPN. If the MNC of the serving SNPN has two digits, then a zero is added at the beginning.

SNN-NID contains an NID in hexadecimal digits.

ABNF syntax of SNN is specified in table 9.12.1.1

Table 9.12.1.1: ABNF syntax of SNN

```

SNN = SNN-service-code ":" SNN-network-identifier

SNN-service-code = %x35.47 ; "5G"

SNN-network-identifier = SNN-PLMN-ID / SNN-SNPN-ID

SNN-PLMN-ID = SNN-mnc-string SNN-mnc-digits "." SNN-mcc-string SNN-mcc-digits "." SNN-3gppnetwork-
string "." SNN-org-string ; applicable when not operating in SNPN access operation mode.

SNN-SNPN-ID = SNN-mnc-string SNN-mnc-digits "." SNN-mcc-string SNN-mcc-digits "." SNN-3gppnetwork-
string "." SNN-org-string ":" SNN-NID ; applicable when operating in SNPN access operation mode.

SNN-mnc-digits = DIGIT DIGIT DIGIT ; MNC of the PLMN ID

SNN-mcc-digits = DIGIT DIGIT DIGIT ; MCC of the PLMN ID

```

```
SNN-mnc-string = %x6d.6e.63 ; "mnc" in lower case
SNN-mcc-string = %x6d.63.63 ; "mcc" in lower case
SNN-3gppnetwork-string = %x33.67.70.70.6e.65.74.77.6f.72.6b ; "3gppnetwork" in lower case
SNN-org-string = %x6f.72.67 ; "org" in lower case
SNN-NID = 11SNN-hexadecimal-digit ; NID in hexadecimal digits
SNN-hexadecimal-digit = DIGIT / %x41 / %x42 / %x43 / %x44 / %x45 / %x46
```

NOTE: SNN-service-code allows for distinguishing of ANID specified in 3GPP TS 24.302 [16] and SNN as either of SNN or ANID can be carried in the AT_KDF_INPUT attribute.

EXAMPLE 1: In case of a PLMN, if PLMN ID contains MCC = 234 and MNC = 15, SNN is 5G:mnc015.mcc234.3gppnetwork.org.

EXAMPLE 2: In case of an SNPN, if SNPN ID contains a PLMN ID of MCC = 234 and MNC = 15 and an NID of 123456ABCDEH, SNN is 5G:mnc015.mcc234.3gppnetwork.org:123456ABCDE.

10 List of system parameters

10.1 General

The description of timers in the following tables should be considered a brief summary. The precise details are found in clauses 4 to 6, which should be considered the definitive descriptions.

10.2 Timers of 5GS mobility management

Timers of 5GS mobility management are shown in table 10.2.1 and table 10.2.2.

NOTE: Timers T3324, T3346, T3245 and T3247 are defined in 3GPP TS 24.008 [12]. Timers T3444, T3445, T3447 and T3448 are defined in 3GPP TS 24.301 [15].

Table 10.2.1: Timers of 5GS mobility management – UE side

TIMER NUM.	TIMER VALUE	STATE	CAUSE OF START	NORMAL STOP	ON EXPIRY
T3502	Default 12 min. NOTE 1	5GMM-DEREGISTERED 5GMM-REGISTERED	At registration failure and the attempt counter is equal to 5	Transmission of REGISTRATION REQUEST message	Initiation of the registration procedure, if still required
T3510	15s NOTE 7 NOTE 8 In WB-N1/CE mode, 85s For access via a satellite NG-RAN cell, 27s NOTE 12	5GMM-REGISTERED-INITIATED	Transmission of REGISTRATION REQUEST message	REGISTRATION ACCEPT message received or REGISTRATION REJECT message received	Start T3511 or T3502 as specified in subclause 5.5.1.2.7 if T3510 expired during registration procedure for initial registration. Start T3511 or T3502 as specified in subclause 5.5.1.3.7 if T3510 expired during the registration procedure for mobility and periodic registration update
T3511	10s	5GMM-DEREGISTERED.ATTEMPTING-REGISTRATION 5GMM-REGISTERED.ATTEMPTING-REGISTRATION-UPDATE 5GMM-REGISTERED.NORMAL-SERVICE or 5GMM-REGISTERED.NORMAL-ALLOWED-SERVICE	At registration failure due to lower layer failure, T3510 timeout or registration rejected with other 5GMM cause values than those treated in subclause 5.5.1.2.5 for initial registration or subclause 5.5.1.3.5 for mobility and periodic registration	Transmission of REGISTRATION REQUEST message 5GMM-CONNECTED mode entered (NOTE 5)	Retransmission of the REGISTRATION REQUEST message, if still required
T3512	Default 54 min NOTE 1 NOTE 2	5GMM-REGISTERED	In 5GMM-REGISTERED, when 5GMM-CONNECTED mode is left and if the NW does not indicate support for strictly periodic registration timer as specified in subclause 5.3.7. If the network indicates support for strictly periodic registration timer, T3512 is started after the successful completion of registration update procedure. T3512 is restarted if it expires in 5GMM-CONNECTED mode as specified in subclause 5.3.7.	When entering state 5GMM-DEREGISTERED When entering 5GMM-CONNECTED mode if the NW does not indicate support for strictly periodic registration timer as specified in subclause 5.3.7.	In 5GMM-IDLE mode, Initiation of the periodic registration procedure if the UE is not registered for emergency services. In 5GMM-CONNECTED mode, restart the timer T3512. Locally deregister if the UE is registered for emergency services

TIMER NUM.	TIMER VALUE	STATE	CAUSE OF START	NORMAL STOP	ON EXPIRY
T3516	30s NOTE 7 NOTE 8 In WB-N1/CE mode, 48s For access via a satellite NG-RAN cell, 35s NOTE 12	5GMM-REGISTERED-INITIATED 5GMM-REGISTERED 5GMM-DEREGISTERED-INITIATED 5GMM-SERVICE-REQUEST-INITIATED	RAND and RES* stored as a result of an 5G authentication challenge	SECURITY MODE COMMAND message received SERVICE REJECT message received REGISTRATION ACCEPT message received AUTHENTICATION REJECT message received AUTHENTICATION FAILURE message sent 5GMM-DEREGISTERED, 5GMM-NULL or 5GMM-IDLE mode entered	Delete the stored RAND and RES*
T3517	(a) 5s for case h) in subclause 5.6.1.1; or (b) 15s for cases other than h) in subclause 5.6.1.1 NOTE 7 NOTE 8 NOTE 10 In WB-N1/CE mode, 61s For access via a satellite NG-RAN cell, 27s NOTE 12	5GMM-SERVICE-REQUEST-INITIATED	Transmission of SERVICE REQUEST message, or CONTROL PLANE SERVICE REQUEST message	(a) Indication from the lower layers that the UE has changed to S1 mode or E-UTRA connected to 5GCN for case h) in subclause 5.6.1.1; or (b) SERVICE ACCEPT message received, or SERVICE REJECT message received for cases other than h) in subclause 5.6.1.1 see subclause 5.6.1.4.2	Abort the procedure
T3519	60s NOTE 7 NOTE 8 In WB-N1/CE mode, 90s For access via a satellite NG-RAN cell, 65s	5GMM-REGISTERED-INITIATED 5GMM-REGISTERED 5GMM-DEREGISTERED-INITIATED 5GMM-SERVICE-REQUEST-INITIATED (NOTE 6)	Transmission of IDENTITY RESPONSE message, REGISTRATION REQUEST message, or DEREGISTRATION REQUEST message with freshly generated SUCI	REGISTRATION ACCEPT message with new 5G-GUTI received CONFIGURATION UPDATE COMMAND message with new 5G-GUTI received DEREGISTRATION ACCEPT message	Delete stored SUCI

TIMER NUM.	TIMER VALUE	STATE	CAUSE OF START	NORMAL STOP	ON EXPIRY
T3520	15s NOTE 7 NOTE 8 In WB-N1/CE mode, 33s For access via a satellite NG-RAN cell, 20s NOTE 12	5GMM-REGISTERED-INITIATED 5GMM-REGISTERED 5GMM-DEREGISTERED-INITIATED 5GMM-SERVICE-REQUEST-INITIATED	Transmission of AUTHENTICATION FAILURE message with any of the 5GMM cause #20, #21, #26 or #71 Transmission of AUTHENTICATION RESPONSE message with an EAP-response message after detection of an error as described in subclause 5.4.1.2.2.4	AUTHENTICATION REQUEST message received or AUTHENTICATION REJECT message received or SECURITY MODE COMMAND message received when entering 5GMM-IDLE mode indication of transmission failure of AUTHENTICATION FAILURE message from lower layers	On first expiry during a 5G AKA based primary authentication and key agreement procedure, the UE should consider the network as false and follow item g of subclause 5.4.1.3.7, if the UE is not registered for emergency services. On first expiry during a 5G AKA based primary authentication and key agreement procedure, the UE will follow subclause 5.4.1.3.7 under "For items c, d, e and f:", if the UE is registered for emergency services. On first expiry during an EAP based primary authentication and key agreement procedure, the UE should consider the network as false and follow item e of subclause 5.4.1.2.4.5, if the UE is not registered for emergency services. On first expiry during an EAP based primary authentication and key agreement procedure, the UE will follow subclause 5.4.1.2.4.5 under "For item e:", if the UE is registered for emergency services

TIMER NUM.	TIMER VALUE	STATE	CAUSE OF START	NORMAL STOP	ON EXPIRY
T3521	15s NOTE 7 NOTE 8 In WB-N1/CE mode, 45s For access via a satellite NG-RAN cell, 27s NOTE 12	5GMM-DEREGISTERED-INITIATED	Transmission of DEREGISTRATION REQUEST message when de-registration procedure is not due to a "switch off"	DEREGISTRATION ACCEPT message received	Retransmission of DEREGISTRATION REQUEST message
T3525	Default 60s NOTE 3 NOTE 7 NOTE 8 In WB-N1/CE mode, default 120s For access via a satellite NG-RAN cell, default 72s NOTE 12	5GMM-REGISTERED.NORMAL-SERVICE or 5GMM-REGISTERED.NON-ALLOWED-SERVICE	T3517 expires and service request attempt counter is greater than or equal to 5	When entering state other than 5GMM-REGISTERED.NORMAL-SERVICE state or 5GMM-REGISTERED.NON-ALLOWED-SERVICE, or UE camped on a new PLMN other than the PLMN on which timer started, or User-plane resources established with the network	The UE may initiate service request procedure
T3540		5GMM-DEREGISTERED 5GMM-REGISTERED	REGISTRATION REJECT message or DEREGISTRATION REQUEST message received with any of the 5GMM cause #3, #6, #7, #11, #12, #13, #15, #27, #31, #36, #62, #72, #73, #74, #75, #76 or #78 SERVICE REJECT message received with any of the 5GMM cause #3, #6, #7, #11, #12, #13, #15, #27, #36, #72, #73, #74, #75, #76 or #78. REGISTRATION ACCEPT message received as described in subclause 5.3.1.3 case b) and case h) SERVICE ACCEPT message received as described in subclause 5.3.1.3 case f) AUTHENTICATION REJECT message received DEREGISTRATION ACCEPT message received as described in subclause 5.3.1.3 case k)	N1 NAS signalling connection released PDU sessions have been set up except for the case the UE has set Request type to "NAS signalling connection release" in the UE request type IE in the REGISTRATION REQUEST message as described in subclause 5.3.1.3 case b) Other use cases see subclause 5.3.1.3	Release the NAS signalling connection for the cases a), a1), b), c), d), e), f), g), h), i), j), k), l) as described in subclause 5.3.1.3

TIMER NUM.	TIMER VALUE	STATE	CAUSE OF START	NORMAL STOP	ON EXPIRY
	10s NOTE 7 (applicable to case f) in subclause 5.3.1.3) NOTE 8 In WB-N1/CE mode, 34s (applicable to case f) in subclause 5.3.1.3) NOTE 11 For access via a satellite NG-RAN cell, default 22s (applicable to case f) in subclause 5.3.1.3) NOTE 12	5GMM-REGISTERED	CONFIGURATION UPDATE COMMAND message received as described in subclause 5.3.1.3 case e) and h) SERVICE ACCEPT message received as described in subclause 5.3.1.3 case i)	N1 NAS signalling connection released Other use cases see subclause 5.3.1.3	Release the NAS signalling connection for the case e) as described in subclause 5.3.1.3 and perform a new registration procedure as described in subclause 5.5.1.3.2 Release the NAS signalling connection for the case h) and i) as described in subclause 5.3.1.3 Release the NAS signalling connection for the cases c) and d) as described in subclause 5.3.1.3 and initiation of the registration procedure as specified in subclause 5.5.1.2.2 or 5.5.1.3.2
		5GMM-DEREGISTERED 5GMM-DEREGISTERED. NORMAL-SERVICE 5GMM-REGISTERED.N ON-ALLOWED-SERVICE	REGISTRATION REJECT message received with the 5GMM cause #9 or #10 SERVICE REJECT message received with the 5GMM cause #9, #10 or #28		
Non-3GPP de-registration timer	Default 54 min. NOTE 1 NOTE 2 NOTE 4	All 5GMM state over non-3GPP access except 5GMM-DEREGISTERED over non-3GPP access	Entering 5GMM-IDLE mode over non-3GPP access	N1 NAS signalling connection over non-3GPP access established or when entering state 5GMM-DEREGISTERED over non-3GPP access	Implicitly de-register the UE for non-3GPP access on 1st expiry
T3526	NOTE 9	5GMM-DEREGISTERED 5GMM-REGISTERED	Rejected S-NSSAI with rejection cause "S-NSSAI not available due to maximum number of UEs reached" received.	Associated S-NSSAI in the rejected NSSAI for the maximum number of UEs reached as specified in subclause 4.6.2.2 deleted.	Remove the S-NSSAI in the rejected NSSAI for the maximum number of UEs reached associated with the T3526 timer.
T3527	15s	5GMM-REGISTERED.N ORMAL-SERVICE	Transmission of RELAY KEY REQUEST message Transmission of RELAY AUTHENTICATION RESPONSE message	RELAY KEY REJECT message received or RELAY AUTHENTICATION REQUEST message received or RELAY KEY ACCEPT message received	Retransmission of RELAY KEY REQUEST message

TIMER NUM.	TIMER VALUE	STATE	CAUSE OF START	NORMAL STOP	ON EXPIRY
NOTE 1:	The value of this timer is provided by the network operator during the registration procedure.				
NOTE 2:	The default value of this timer is used if the network does not indicate a value in the REGISTRATION ACCEPT message and the UE does not have a stored value for this timer.				
NOTE 3:	The value of this timer is UE implementation specific, with a minimum value of 60 seconds if not in NB-N1 mode and if not in WB-N1/CE mode.				
NOTE 4:	If the T3346 value received in the mobility management messages is greater than the value of the non-3GPP de-registration timer, the UE sets the non-3GPP de-registration timer value to be 4 minutes greater than the value of timer T3346.				
NOTE 5:	The conditions for which this applies are described in subclause 5.5.1.3.7.				
NOTE 6:	The conditions for which this applies to the 5GMM-SERVICE-REQUEST-INITIATED state are described in subclause 5.4.1.3.7 case c) and case d).				
NOTE 7:	In NB-N1 mode, the timer value shall be calculated as described in subclause 4.17.				
NOTE 8:	In WB-N1 mode, if the UE supports CE mode B and operates in either CE mode A or CE mode B, then the timer value is as described in this table for the case of WB-N1/CE mode (see subclause 4.19).				
NOTE 9:	The value of this timer is provided by the network operator during the registration procedure or the generic UE configuration update procedure along with the rejected S-NSSAI with rejection cause "S-NSSAI not available due to maximum number of UEs reached". The default value of this timer is implementation specific with a minimum value of 12 minutes and used if the network does not provide a value in the REGISTRATION ACCEPT message, the REGISTRATION REJECT message, or the CONFIGURATION UPDATE COMMAND message along with the rejected S-NSSAI with rejection cause "S-NSSAI not available due to maximum number of UEs reached".				
NOTE 10:	Based on implementation, the timer may be set to a value between 250ms and 15s when the MUSIM UE indicates "NAS signalling connection release" in the UE request type IE of the SERVICE REQUEST message or CONTROL PLANE SERVICE REQUEST message.				
NOTE 11:	Based on implementation, the timer may be set to a value between 250ms and 10s when the MUSIM UE not in NB-N1 mode or WB-N1 mode indicated "NAS signalling connection release" or "Rejection of paging" in the UE request type IE of the SERVICE REQUEST message or CONTROL PLANE SERVICE REQUEST message; or indicated "NAS signalling connection release" in the UE request type IE of the REGISTRATION REQUEST message.				
NOTE 12:	In satellite NG-RAN access, this value shall be selected when satellite NG-RAN RAT type is NR(MEO) or NR(GEO).				

Table 10.2.2: Timers of 5GS mobility management – AMF side

TIMER NUM.	TIMER VALUE	STATE	CAUSE OF START	NORMAL STOP	ON EXPIRY
T3513 NOTE 7 NOTE 9	NOTE 4	5GMM-REGISTERED	Paging procedure initiated	Paging procedure completed as specified in subclause 5.6.2.2.1	Network dependent
T3522 NOTE 6 NOTE 8	6s In WB-N1/CE mode, 24s For access via a satellite NG-RAN cell, 11s NOTE 12	5GMM-DEREGISTERED-INITIATED	Transmission of DEREGISTRATION REQUEST message	DEREGISTRATION ACCEPT message received	Retransmission of DEREGISTRATION REQUEST message
T3550 NOTE 6 NOTE 8	6s In WB-N1/CE mode, 18s For access via a satellite NG-RAN cell, 11s NOTE 12	5GMM-COMMON-PROCEDURE-INITIATED	Transmission of REGISTRATION ACCEPT message as specified in subclause 5.5.1.2.4 and 5.5.1.3.4	REGISTRATION COMPLETE message received	Retransmission of REGISTRATION ACCEPT message
T3555 NOTE 6 NOTE 8	6s In WB-N1/CE mode, 24s For access via a satellite NG-RAN cell, 11s NOTE 12	5GMM-REGISTERED	Transmission of CONFIGURATION UPDATE COMMAND message with "acknowledgement requested" set in the Acknowledgement bit of the Configuration update indication IE	CONFIGURATION UPDATE COMPLETE message received	Retransmission of CONFIGURATION UPDATE COMMAND message
T3560 NOTE 6 NOTE 8	6s In WB-N1/CE mode, 24s For access via a satellite NG-RAN cell, 11s	5GMM-COMMON-PROCEDURE-INITIATED	Transmission of AUTHENTICATION REQUEST message Transmission of SECURITY MODE COMMAND message	AUTHENTICATION RESPONSE message received AUTHENTICATION FAILURE message received SECURITY MODE COMPLETE message received SECURITY MODE REJECT message received	Retransmission of AUTHENTICATION REQUEST message or SECURITY MODE COMMAND message

TIMER NUM.	TIMER VALUE	STATE	CAUSE OF START	NORMAL STOP	ON EXPIRY
T3565 NOTE 6 NOTE 8	6s In WB-N1/CE mode, 24s For access via a satellite NG-RAN cell, 11s NOTE 12	5GMM-REGISTERED	Transmission of NOTIFICATION message	SERVICE REQUEST message received CONTROL PLANE SERVICE REQUEST message received NOTIFICATION RESPONSE message received REGISTRATION REQUEST Message received DEREGISTRATION REQUEST message received NGAP UE context resume request message as specified in 3GPP TS 38.413 [31] received	Retransmission of NOTIFICATION message
T3570 NOTE 6 NOTE 8	6s In WB-N1/CE mode, 24s For access via a satellite NG-RAN cell, 11s NOTE 12	5GMM-COMMON-PROCEDURE-INITIATED	Transmission of IDENTITY REQUEST message	IDENTITY RESPONSE message received	Retransmission of IDENTITY REQUEST message
T3575 NOTE 6 NOTE 8	15s In WB-N1/CE mode, 60s For access via a satellite NG-RAN cell, 27s NOTE 12	5GMM-REGISTERED	Transmission of NETWORK SLICE-SPECIFIC AUTHENTICATION COMMAND message	NETWORK SLICE-SPECIFIC AUTHENTICATION COMPLETE message received	Retransmission of NETWORK SLICE-SPECIFIC AUTHENTICATION COMMAND message
Active timer	NOTE 10	All except 5GMM-DEREGISTERED	Entering 5GMM-IDLE mode after indicating MICO mode activation to the UE with an active timer value.	N1 NAS signalling connection established	Activate MICO mode for the UE.
Implicit de-registration timer	NOTE 2	All except 5GMM-DEREGISTERED	The mobile reachable timer expires while the network is in 5GMM-IDLE mode Entering 5GMM-IDLE mode over 3GPP access if the MICO mode is activated and strictly periodic monitoring timer is not running The strictly periodic monitoring timer expires while the network is in 5GMM-IDLE mode	N1 NAS signalling connection established	Implicitly de-register the UE on 1 st expiry

TIMER NUM.	TIMER VALUE	STATE	CAUSE OF START	NORMAL STOP	ON EXPIRY
Mobile reachable timer	NOTE 1	All except 5GMM-DEREGISTERED	Entering 5GMM-IDLE mode	N1 NAS signalling connection established	Network dependent, but typically paging is halted on 1 st expiry, and start implicit de-registration timer, if the UE is not registered for emergency services. Implicitly de-register the UE which is registered for emergency services
Non-3GPP implicit de-registration timer	NOTE 3	All except 5GMM-DEREGISTERED	Entering 5GMM-IDLE mode over non-3GPP access	N1 NAS signalling connection over non-3GPP access established	Implicitly de-register the UE for non-3GPP access on 1 ^s expiry
Strictly periodic monitoring timer	NOTE 5	All except 5GMM-DEREGISTERED	At the successful completion of registration update procedure if strictly periodic registration timer indication is supported as specified in subclause 5.3.7.	Entering 5GMM-DEREGISTERED.	In 5GMM-IDLE mode, start implicit de-registration timer as specified in subclause 5.3.7. In 5GMM-CONNECTED mode, Strictly periodic monitoring timer is started again as specified in subclause 5.3.7.
Implementation specific timer for onboarding services	NOTE 11	5GMM-REGISTERED	At the successful completion of initial registration for onboarding services in SNPN or initial registration for the UE which the subscription is only for configuration of SNPN subscription parameters in PLMN via the user plane or successful completion of registration procedure for mobility and periodic registration update if the implementation specific timer for onboarding services is not running and: - the UE is registered for onboarding services in SNPN; or - the UE's subscription only allows for configuration of SNPN subscription parameters in PLMN via the user plane.	DEREGISTRATION REQUEST message received.	Network-initiated de-registration procedure performed

TIMER NUM.	TIMER VALUE	STATE	CAUSE OF START	NORMAL STOP	ON EXPIRY
NOTE 1:	The default value of this timer is 4 minutes greater than the value of timer T3512. If the UE is registered for emergency services, the value of this timer is set equal to the value of timer T3512. If the T3346 value provided in the mobility management messages is greater than the value of the timer T3512, the AMF sets the mobile reachable timer and the implicit de-registration timer such that the sum of the timer values is greater than the value of timer T3346.				
NOTE 2:	The value of this timer is network dependent. If MICO is activated, the default value of this timer is 4 minutes greater than the value of timer T3512.				
NOTE 3:	The value of this timer is network dependent. The default value of this timer is 4 minutes greater than the non-3GPP de-registration timer. If the T3346 value provided in the mobility management messages is greater than the value of the non-3GPP de-registration timer, the AMF sets the non-3GPP implicit de-registration timer value to be 8 minutes greater than the value of timer T3346.				
NOTE 4:	The value of this timer is network dependent.				
NOTE 5:	The value of this timer is the same as the value of timer T3512.				
NOTE 6:	In NB-N1 mode, the timer value shall be calculated as described in subclause 4.17.				
NOTE 7:	In NB-N1 mode, the timer value shall be calculated by using an NAS timer value which is network dependent.				
NOTE 8:	In WB-N1 mode, if the UE supports CE mode B and operates in either CE mode A or CE mode B, then the timer value is as described in this table for the case of WB-N1/CE mode (see subclause 4.19).				
NOTE 9:	In WB-N1 mode, if the UE supports CE mode B, then the timer value shall be calculated by using an NAS timer value which value is network dependent.				
NOTE 10:	If the AMF includes timer T3324 in the REGISTRATION ACCEPT message and if the UE is not registered for emergency services, the value of this timer is equal to the value of timer T3324.				
NOTE 11:	The value of this timer needs to be large enough to allow a UE to complete the configuration of one or more entries of the "list of subscriber data" and considering that configuration of SNPN subscription parameters in PLMN via the user plane or onboarding services in SNPN involves third party entities outside of the operator's network.				
NOTE 12:	In satellite NG-RAN access, this value shall be selected when satellite NG-RAN RAT type is NR(MEO) or NR(GEO).				

10.3 Timers of 5GS session management

Timers of 5GS session management are shown in table 10.3.1 and table 10.3.2.

NOTE: Timer T3396 is defined in 3GPP TS 24.008 [12].

Table 10.3.1: Timers of 5GS session management – UE side

TIMER NUM.	TIMER VALUE	STATE	CAUSE OF START	NORMAL STOP	ON THE 1 st , 2 nd , 3 rd , 4 th EXPIRY (NOTE 1)
T3580 NOTE 4 NOTE 5	16s In WB-N1/CE mode, 24s For access via a satellite NG-RAN cell, 21s NOTE 7	PDU SESSION ACTIVE PENDING	Transmission of PDU SESSION ESTABLISHMENT REQUEST message	PDU SESSION ESTABLISHMENT ACCEPT message received or PDU SESSION ESTABLISHMENT REJECT message received or PDU SESSION ESTABLISHMENT REQUEST message received in a DL NAS TRANSPORT message with 5GMM cause #22, #28, #65, #67, #69, #90, #91 or #92	Retransmission of PDU SESSION ESTABLISHMENT REQUEST message
T3581 NOTE 4 NOTE 5	16s In WB-N1/CE mode, 24s For access via a satellite NG-RAN cell, 21s NOTE 7	PDU SESSION MODIFICATION PENDING	Transmission of PDU SESSION MODIFICATION REQUEST message	PDU SESSION MODIFICATION COMMAND message with the same PTI is received or PDU SESSION MODIFICATION REJECT message received or PDU SESSION MODIFICATION REQUEST message received in a DL NAS TRANSPORT message with 5GMM cause #22, #28, #67, #69, or #90	Retransmission of PDU SESSION MODIFICATION REQUEST message
T3582 NOTE 4 NOTE 5	16s In WB-N1/CE mode, 24s For access via a satellite NG-RAN cell, 21s NOTE 7	PDU SESSION INACTIVE PENDING	Transmission of PDU SESSION RELEASE REQUEST message	PDU SESSION RELEASE COMMAND message with the same PTI is received or PDU SESSION RELEASE REJECT message received	Retransmission of PDU SESSION RELEASE REQUEST message
T3583	Default 1 min. NOTE 2	PDU SESSION ACTIVE	UE creates or updates a derived QoS rule	UE deletes the derived QoS rule (see subclause 6.2.5.1.4.5)	On 1 st expiry: Deletion of the derived QoS rule

TIMER NUM.	TIMER VALUE	STATE	CAUSE OF START	NORMAL STOP	ON THE 1 st , 2 nd , 3 rd , 4 th EXPIRY (NOTE 1)
T3584	NOTE 3	<p>PDU SESSION ACTIVE PENDING</p> <p>PDU SESSION MODIFICATION PENDING</p> <p>PDU SESSION ACTIVE or PDU SESSION INACTIVE PENDING</p>	<p>PDU SESSION ESTABLISHMENT REJECT, PDU SESSION MODIFICATION REJECT, or PDU SESSION RELEASE COMMAND received with 5GSM cause #67 and with a timer value for T3584</p> <p>PDU SESSION ESTABLISHMENT REQUEST, or PDU SESSION MODIFICATION REQUEST received in a DL NAS TRANSPORT message with 5GMM cause #67 and with a timer value for T3584 (see subclause 5.4.5.3.3)</p>	<p>PDU SESSION RELEASE COMMAND message (see NOTE 6) or PDU SESSION MODIFICATION COMMAND message or PDU SESSION AUTHENTICATION COMMAND message or DEREGISTRATION REQUEST message with the de-registration type "re-registration required"</p>	None
T3585	NOTE 3	<p>PDU SESSION ACTIVE PENDING</p> <p>PDU SESSION MODIFICATION PENDING</p> <p>PDU SESSION ACTIVE or PDU SESSION INACTIVE PENDING</p>	<p>PDU SESSION ESTABLISHMENT REJECT, PDU SESSION MODIFICATION REJECT, or PDU SESSION RELEASE COMMAND received with 5GSM cause #69 and with a timer value for T3585</p> <p>PDU SESSION ESTABLISHMENT REQUEST, or PDU SESSION MODIFICATION REQUEST received in a DL NAS TRANSPORT message with 5GMM cause #69 and with a timer value for T3585(see subclause 5.4.5.3.3)</p>	<p>DU SESSION RELEASE COMMAND message (see NOTE 6) or PDU SESSION MODIFICATION COMMAND message or PDU SESSION AUTHENTICATION COMMAND message or DEREGISTRATION REQUEST message with the de-registration type "re-registration required"</p>	None
Back-off timer			defined in 3GPP TS 24.008 [12]		
T3586 NOTE 4 NOTE 5	8s In WB-N1/CE mode, 16s For access via a satellite NG-RAN cell, 13s NOTE 7	PDU SESSION ACTIVE	REMOTE UE REPORT message sent	REMOTE UE REPORT RESPONSE message received	On the 1 st and 2 nd expiry, retransmission of REMOTE UE REPORT message On the 3 rd expiry, the procedure is aborted (see subclause 6.6.2.4).
T3587	NOTE 8	PDU SESSION ACTIVE	PDU SESSION MODIFICATION COMMAND message or PDU SESSION ESTABLISHMENT ACCEPT message received with Received MBS information that includes MBS decision set to "MBS join is rejected" and Rejection cause set to "multicast MBS session has not started or will not start soon" and an MBS back-off timer value	None	Initiating a request to join the multicast MBS session associated with the PDU session if still needed

TIMER NUM.	TIMER VALUE	STATE	CAUSE OF START	NORMAL STOP	ON THE 1 st , 2 nd , 3 rd , 4 th EXPIRY (NOTE 1)
NOTE 1:	Typically, the procedures are aborted on the fifth expiry of the relevant timer. Exceptions are described in the corresponding procedure description.				
NOTE 2:	The network may provide the value of this timer applicable to the derived QoS rules of a specific PDU session as RQ timer value in the PDU SESSION ESTABLISHMENT ACCEPT message and PDU SESSION MODIFICATION COMMAND message. The maximum value of the timer is 30 min. If the network indicates a value greater than the maximum value, then the UE shall use the maximum value.				
NOTE 3:	The value of this timer is provided by the network.				
NOTE 4:	In NB-N1 mode, then the timer value shall be calculated as described in subclause 4.18.				
NOTE 5:	In WB-N1 mode, if the UE supports CE mode B and operates in either CE mode A or CE mode B, then the timer value is as described in this table for the case of WB-N1/CE mode (see subclause 4.20).				
NOTE 6:	If the PDU SESSION RELEASE COMMAND message includes the Back-off timer value IE where the timer value indicates neither zero nor deactivated and the 5GSM cause is not #39, the UE then starts the timer with the value provided in the Back-off timer value IE after stopping the existing timer (see subclause 6.3.3.3).				
NOTE 7:	In satellite NG-RAN access, this value shall be selected when satellite NG-RAN RAT type is NR(MEO) or NR(GEO).				
NOTE 8:	The value of this timer is provided by the network in the Received MBS container IE (see subclause 6.3.2.3, subclause 6.4.1.3 and subclause 9.11.4.31).				

NOTE 1: The back-off timer is used to describe a logical model of the required UE behaviour. This model does not imply any specific implementation, e.g. as a timer of timestamp.

NOTE 2: Reference to back-off timer in this section can either refer to use of timer T3396 or to use of a different packet system specific timer within the UE. Whether the UE uses T3396 as a back-off timer or it uses different packet system specific timers as back-off timers is left up to UE implementation.

Table 10.3.2: Timers of 5GS session management – SMF side

TIMER NUM.	TIMER VALUE	STATE	CAUSE OF START	NORMAL STOP	ON THE 1 st , 2 nd , 3 rd , 4 th EXPIRY (NOTE 1)
T3590 NOTE 3 NOTE 4	15s In WB-N1/CE mode, 23s For access via a satellite NG-RAN cell, 21s NOTE 5	PROCEDURE TRANSACTION PENDING	Transmission of PDU SESSION AUTHENTICATION COMMAND message	PDU SESSION AUTHENTICATION COMPLETE message received	Retransmission of PDU SESSION AUTHENTICATION COMMAND message
T3591 NOTE 3 NOTE 4	16s In WB-N1/CE mode, 24s For access via a satellite NG-RAN cell, 22s NOTE 5	PDU SESSION MODIFICATION PENDING	Transmission of PDU SESSION MODIFICATION COMMAND message	PDU SESSION MODIFICATION COMPLETE message received or PDU SESSION MODIFICATION COMMAND REJECT message received	Retransmission of PDU SESSION MODIFICATION COMMAND message
T3592 NOTE 3 NOTE 4	16s In WB-N1/CE mode, 24s For access via a satellite NG-RAN cell, 22s NOTE 5	PDU SESSION INACTIVE PENDING	Transmission of PDU SESSION RELEASE COMMAND message	PDU SESSION RELEASE COMPLETE message received or N1 SM delivery skipped indication received	Retransmission of PDU SESSION RELEASE COMMAND message
T3593 NOTE 3 NOTE 4	Default 60s (NOTE 2)	PDU SESSION MODIFICATION PENDING	Reception of PDU SESSION MODIFICATION COMPLETE message for transmitted PDU SESSION MODIFICATION COMMAND message where the PDU SESSION MODIFICATION COMMAND message included 5GSM cause #39	PDU SESSION RELEASE REQUEST message received	Network-requested PDU session release procedure performed
T3594 NOTE 3 NOTE 4	15s In WB-N1/CE mode, 23s For access via a satellite NG-RAN cell, 21s NOTE 5	PROCEDURE TRANSACTION PENDING	Transmission of SERVICE-LEVEL AUTHENTICATION COMMAND message	SERVICE-LEVEL AUTHENTICATION COMPLETE message received	Retransmission of SERVICE-LEVEL AUTHENTICATION COMMAND message
<p>NOTE 1: Typically, the procedures are aborted on the fifth expiry of the relevant timer. Exceptions are described in the corresponding procedure description.</p> <p>NOTE 2: If the PDU Session Address Lifetime value is sent to the UE in the PDU SESSION MODIFICATION COMMAND message then timer T3593 shall be started with the same value, otherwise it shall use a default value.</p> <p>NOTE 3: In NB-N1 mode, the timer value shall be calculated as described in subclause 4.18.</p> <p>NOTE 4: In WB-N1 mode, if the UE supports CE mode B and operates in either CE mode A or CE mode B, then the timer value is as described in this table for the case of WB-N1/CE mode (see subclause 4.20).</p> <p>NOTE 5: In satellite NG-RAN access, this value shall be selected when satellite NG-RAN RAT type is NR(MEO) or NR(GEO).</p>					

10.4 Void

Annex A (informative): Cause values for 5GS mobility management

A.1 Causes related to UE identification

Cause #3 – Illegal UE

This 5GMM cause is sent to the UE when the network refuses service to the UE either because an identity of the UE is not acceptable to the network or because the UE does not pass the authentication check.

Cause #6 – Illegal ME

This 5GMM cause is sent to the UE if the ME used is not acceptable to the network, e.g. on the prohibited list.

Cause #9 – UE identity cannot be derived by the network.

This 5GMM cause is sent to the UE when the network cannot derive the UE's identity from the 5G-GUTI or 5G-S-TMSI because of e.g. no matching identity/context in the network, failure to validate the UE's identity due to integrity check failure of the received message.

Cause #10 – Implicitly de-registered

This 5GMM cause is sent to the UE either if the network has implicitly de-registered the UE, e.g. after the implicit de-registration timer has expired, or if the 5GMM context data related to the subscription does not exist in the AMF e.g. because of a AMF restart, or because of a registration request for mobility or registration update is routed to a new AMF.

A.2 Cause related to subscription options

Cause #5 – PEI not accepted

This cause is sent to the UE if the network does not accept an initial registration procedure for emergency services using a PEI.

Cause #7 – 5GS services not allowed

This 5GMM cause is sent to the UE when it is not allowed to operate 5GS services.

Cause #11 – PLMN not allowed

This 5GMM cause is sent to the UE if it requests service, or if the network initiates a de-registration request, in a PLMN where the UE, by subscription or due to operator determined barring, is not allowed to operate.

This 5GMM cause can also be sent to the UE when the disaster condition is no longer being applicable in the current location of the UE.

Cause #12 – Tracking area not allowed

This 5GMM cause is sent to the UE if it requests service, or if the network initiates a de-registration request, in a tracking area where the HPLMN or SNPN determines that the UE, by subscription, is not allowed to operate.

NOTE 1: If 5GMM cause #12 is sent to a roaming subscriber the subscriber is denied service even if other PLMNs are available on which registration was possible.

Cause #13 – Roaming not allowed in this tracking area

This 5GMM cause is sent to a UE which requests service, or if the network initiates a de-registration request, in a tracking area of a PLMN or SNPN which by subscription offers roaming to that UE but not in that tracking area.

This 5GMM cause can also be sent to the UE when the disaster condition is no longer being applicable in the current location of the UE.

Cause #15 – No suitable cells in tracking area

This 5GMM cause is sent to the UE if it requests service, or if the network initiates a de-registration request, in a tracking area where the UE, by subscription, is not allowed to operate, but when it should find another allowed tracking area in the same PLMN or an equivalent PLMN or the same SNPN or an equivalent SNPN.

NOTE 2: Cause #15 and cause #12 differ in the fact that cause #12 does not trigger the UE to search for another allowed tracking area on the same PLMN or SNPN.

Cause #27 – N1 mode not allowed

This 5GMM cause is sent to the UE if it requests service, or if the network initiates a de-registration request, in a PLMN or SNPN where the UE by subscription or operator policy, is not allowed to operate in N1 mode.

Cause #31 – Redirection to EPC required

This 5GMM cause is sent to the UE if it requests service in a PLMN where the UE by operator policy, is not allowed in 5GCN and redirection to EPC is required.

Cause #36 – IAB-node operation not authorized

This 5GMM cause is sent to the UE if a UE operating as an IAB-node requests service, or if the network initiates a de-registration procedure, in a PLMN or SNPN where the UE by subscription is not authorized for IAB operation.

Cause #72 – Non-3GPP access to 5GCN not allowed

This 5GMM cause is sent to the UE if it requests accessing 5GCN over non-3GPP access in a PLMN or SNPN, where the UE by subscription, is not allowed to access 5GCN over non-3GPP access.

Cause #74 – Temporarily not authorized for this SNPN

This 5GMM cause is sent to the UE if it requests access, or if the network initiates a de-registration procedure, in a cell belonging to an SNPN for which the UE has no subscription to operate or for which the UE is not allowed to operate onboarding services.

Cause #75 – Permanently not authorized for this SNPN

This 5GMM cause is sent to the UE if it requests access, or if the network initiates a de-registration procedure, in a cell belonging to an SNPN with a globally-unique SNPN identity for which the UE either has no subscription to operate, the UE's subscription has expired or the UE is not allowed to operate onboarding services.

Cause #76 – Not authorized for this CAG or authorized for CAG cells only

This 5GMM cause is sent to the UE if the UE requests access or de-registration:

- i) in a CAG cell with a CAG-ID which is not authorized based on the UE's "allowed CAG list" for the PLMN; or
- ii) in a non-CAG cell, wherein the UE is only allowed to access 5GS via CAG cells

Cause #77 – Wireline access area not allowed

This 5GMM cause is sent to the 5G-RG or the W-AGF acting on behalf of the FN-CRG (or on behalf of the N5GC device) if the 5G-RG or the W-AGF acting on behalf of the FN-CRG (or on behalf of the N5GC device) request accessing 5GCN over a wireline access network belonging to a wireline access area, where the 5G-RG or the W-AGF acting on behalf of the FN-CRG (or on behalf of the N5GC device) are not allowed by subscription to access the 5GCN over the wireline access.

Cause #79 – UAS services not allowed

This 5GMM cause is sent to the UE to indicate that the request of UAS services is not allowed.

Cause #80 – Disaster roaming for the determined PLMN with disaster condition not allowed

This 5GMM cause is sent by the network in a PLMN where the UE has requested registration for disaster roaming service for the determined PLMN with disaster condition, but the AMF determines that it does not support providing disaster roaming services to the UE for the determined PLMN with disaster condition as roaming agreement for disaster roaming services with HPLMN of the UE does not exist, or the determined PLMN with disaster condition is a forbidden PLMN of the UE.

Cause #94 – User plane positioning not authorized

This 5GMM cause is sent to the UE if it requests the user plane positioning, where the UE by subscription is not authorized for user plane positioning.

A.3 Causes related to PLMN or SNPN specific network failures and congestion/authentication failures

Cause #20 – MAC failure

This 5GMM cause is sent to the network if the USIM detects that the MAC in the AUTHENTICATION REQUEST message is not fresh.

Cause #21 – Synch failure

This 5GMM cause is sent to the network if the USIM detects that the SQN in the AUTHENTICATION REQUEST message is out of range.

Cause #22 – Congestion

This 5GMM cause is sent to the UE because of congestion in the network (e.g. no channel, facility busy/congested etc.).

Cause #23 – UE security capabilities mismatch

This 5GMM cause is sent to the network if the UE detects that the UE security capability does not match the one sent back by the network.

Cause #24 – Security mode rejected, unspecified

This 5GMM cause is sent to the network if the security mode command is rejected by the UE for unspecified reasons.

Cause #26 – Non-5G authentication unacceptable

This 5GMM cause is sent to the network in N1 mode if the "separation bit" in the AMF field of AUTN is set to 0 in the AUTHENTICATION REQUEST message (see 3GPP TS 33.501 [24]).

Cause #28 – Restricted service area

This 5GMM cause is sent to the UE if it requests service in a tracking area of the 3GPP access or in an area of the wireline access, which is a part of the UE's non-allowed area or is not a part of the UE's allowed area.

Cause #43 – LADN not available

This 5GMM cause is sent to the UE if the user-plane resources of the PDU session are not established when the UE is located outside the LADN service area.

Cause #62 – No network slices available

This 5GMM cause is sent by the network if there are no available network slices allowed for use by the UE.

NOTE: Network does not send this cause in REGISTRATION REJECT message if the UE does not include a requested NSSAI in the REGISTRATION REQUEST message. In that case, if the UE is not registered for onboarding services in SNPN, the network uses other causes (e.g. #13, #15, etc.) based on the subscription.

Cause #65 – Maximum number of PDU sessions reached

This 5GMM cause is used by the network to indicate that the procedure requested by the UE was rejected as the network has reached the maximum number of simultaneously active PDU sessions for the UE.

Cause #67 – Insufficient resources for specific slice and DNN

This 5GMM cause is sent by the network to indicate that the requested service cannot be provided due to insufficient resources for specific slice and DNN.

Cause #69 – Insufficient resources for specific slice

This 5GMM cause is sent by the network to indicate that the requested service cannot be provided due to insufficient resources for specific slice.

Cause #71 – ngKSI already in use

This 5GMM cause is sent to the network in N1 mode if the ngKSI value received in the AUTHENTICATION REQUEST message is already associated with one of the 5G security contexts stored in the UE.

Cause #73 – Serving network not authorized

This 5GMM cause is sent to the UE if the UE initiates registration towards a serving network and the serving network fails to be authorized by the UE's home network.

Cause #78 – PLMN not allowed to operate at the present UE location

This 5GMM cause is sent to the UE to indicate that the PLMN is not allowed to operate at the present UE location.

NOTE: This cause is only applicable for satellite NG-RAN access.

Cause #81 – Selected N3IWF is not compatible with the allowed NSSAI

This 5GMM cause is sent by the network to indicate that the requested service cannot be provided due to the selected N3IWF is not compatible with the allowed NSSAI.

Cause #82 – Selected TNGF is not compatible with the allowed NSSAI

This 5GMM cause is sent by the network to indicate that the requested service cannot be provided due to the selected TNGF is not compatible with the allowed NSSAI.

Cause #90 – Payload was not forwarded

This 5GMM cause is sent by the network to indicate that the requested service cannot be provided because payload could not be forwarded by AMF.

Cause #91 – DNN not supported or not subscribed in the slice

This 5GMM cause is sent by the network to indicate that the requested service cannot be provided because payload could not be forwarded by AMF because the DNN is not supported or not subscribed in the slice selected by the network if the UE did not indicate a slice, or the DNN is not supported or not subscribed in the slice indicated by the UE.

Cause #92 – Insufficient user-plane resources for the PDU session

This 5GMM cause is sent by the network to indicate that the requested service cannot be provided due to insufficient user-plane resources for the PDU session.

Cause #93 – Onboarding services terminated

This 5GMM cause is sent by the network if the network initiates a de-registration procedure because the onboarding services are terminated.

A.4 Causes related to invalid messages

Cause #95 – Semantically incorrect message

This 5GMM cause is used to report receipt of a message with semantically incorrect contents.

Cause #96 – Invalid mandatory information

This cause 5GMM indicates that the equipment sending this 5GMM cause has received a message with a non-semantic mandatory IE error.

Cause #97 – Message type non-existent or not implemented

This 5GMM cause indicates that the equipment sending this 5GMM cause has received a message with a message type it does not recognize either because this is a message not defined, or defined but not implemented by the equipment sending this 5GMM cause.

Cause #98 – Message type not compatible with protocol state

This 5GMM cause indicates that the equipment sending this 5GMM cause has received a message not compatible with the protocol state.

Cause #99 – Information element non-existent or not implemented

This 5GMM cause indicates that the equipment sending this 5GMM cause has received a message which includes information elements not recognized because the information element identifier is not defined or it is defined but not implemented by the equipment sending the 5GMM cause. However, the information element is not required to be present in the message in order for the equipment sending the 5GMM cause to process the message.

Cause #100 – Conditional IE error

This 5GMM cause indicates that the equipment sending this cause has received a message with conditional IE errors.

Cause #101 – Message not compatible with protocol state

This 5GMM cause indicates that a message has been received which is incompatible with the protocol state.

Cause #111 – Protocol error, unspecified

This 5GMM cause is used to report a protocol error event only when no other 5GMM cause in the protocol error class applies.

Annex B (informative): Cause values for 5GS session management

B.1 Causes related to nature of request

Cause #8 – Operator Determined Barring

This 5GSM cause is used by the network to indicate that the requested service was rejected by the SMF due to Operator Determined Barring.

Cause #26 – Insufficient resources

This 5GSM cause is used by the UE or by the network to indicate that the requested service cannot be provided due to insufficient resources.

Cause #27 – Missing or unknown DNN

This 5GSM cause is used by the network to indicate that the requested service was rejected by the external DN because the DNN was not included although required or if the DNN could not be resolved.

Cause #28 – Unknown PDU session type

This 5GSM cause is used by the network to indicate that the requested service was rejected by the external DN because the requested PDU session type could not be recognised or is not allowed.

Cause #29 – User authentication or authorization failed

This 5GSM cause is used by the network to indicate that the requested service was rejected by the external DN due to a failed user authentication, revoked by the external DN, or rejected by 5GCN due to a failed user authentication or authorization.

Cause #31 – Request rejected, unspecified

This 5GSM cause is used by the network or by the UE to indicate that the requested service or operation or the request for a resource was rejected due to unspecified reasons.

Cause #32 – Service option not supported

This 5GSM cause is used by the network when the UE requests a service which is not supported by the PLMN.

Cause #33 – Requested service option not subscribed

This 5GSM cause is sent when the UE requests a service option for which it has no subscription.

Cause #35 – PTI already in use

This 5GSM cause is used by the network to indicate that the PTI included by the UE is already in use by another active UE requested procedure for this UE.

Cause #36 – Regular deactivation

This 5GSM cause is used to indicate a regular UE or network initiated release of PDU session resources.

Cause #37 – 5GS QoS not accepted

This 5GSM cause is used by the network if the new 5GS QoS that was indicated in the UE request cannot be accepted.

Cause #38 – Network failure

This 5GSM cause is used by the network to indicate that the requested service was rejected due to an error situation in the network.

Cause #39 – Reactivation requested

This 5GSM cause is used by the network to request a PDU session reactivation.

Cause #41 – Semantic error in the TFT operation

This 5GSM cause is used by the UE to indicate a semantic error in the TFT operation included in the request.

Cause #42 – Syntactical error in the TFT operation

This 5GSM cause is used by the UE to indicate a syntactical error in the TFT operation included in the request.

Cause #43 – Invalid PDU session identity

This 5GSM cause is used by the network or the UE to indicate that the PDU session identity value provided to it is not a valid value or the PDU session identified by the PDU session identity IE in the request or the command is not active.

Cause #44 – Semantic errors in packet filter(s)

This 5GSM cause is used by the network or the UE to indicate that the requested service was rejected due to one or more semantic errors in packet filter(s) of the QoS rule included in the request.

Cause #45 – Syntactical error in packet filter(s)

This 5GSM cause is used by the network or the UE to indicate that the requested service was rejected due to one or more syntactical errors in packet filter(s) of the QoS rule included in the request.

Cause #46 – Out of LADN service area

This 5GSM cause is used by the network to indicate the UE is out of the LADN service area.

Cause #47 – PTI mismatch

This 5GSM cause is used by the network or UE to indicate that the PTI provided to it does not match any PTI in use.

Cause #50 – PDU session type IPv4 only allowed

This 5GSM cause is used by the network to indicate that only PDU session type IPv4 is allowed for the requested IP connectivity.

Cause #51 – PDU session type IPv6 only allowed

This 5GSM cause is used by the network to indicate that only PDU session type IPv6 is allowed for the requested IP connectivity.

Cause #54 – PDU session does not exist

This 5GSM cause is used by the network at handover of a PDU session between non-3GPP access and 3GPP access, or at interworking of a PDN connection from non-3GPP access network connected to EPC or from E-UTRAN connected to EPC to a PDU session, to indicate that the network does not have any information about the requested PDU session.

Cause #57 – PDU session type IPv4v6 only allowed

This 5GSM cause is used by the network to indicate that only PDU session types IPv4, IPv6 or IPv4v6 are allowed for the requested IP connectivity.

Cause #58 – PDU session type Unstructured only allowed

This 5GSM cause is used by the network to indicate that only PDU session type Unstructured is allowed for the requested DN connectivity.

Cause #59 – Unsupported 5QI value

This 5GSM cause is used by the network if the 5QI indicated in the UE request cannot be supported.

Cause #61 – PDU session type Ethernet only allowed

This 5GSM cause is used by the network to indicate that only PDU session type Ethernet is allowed for the requested DN connectivity.

Cause #67 – Insufficient resources for specific slice and DNN

This 5GSM cause is by the network to indicate that the requested service cannot be provided due to insufficient resources for specific slice and DNN or maximum group data rate on a 5G VN group identified by a specific slice and DNN has been exceeded.

Cause #68 – Not supported SSC mode

This 5GSM cause is used by the network to indicate that the requested SSC mode is not supported.

Cause #69 – Insufficient resources for specific slice

This 5GSM cause is used by the network to indicate that the requested service cannot be provided due to insufficient resources for specific slice, maximum number of PDU sessions on a specific slice has been already reached, data rate on a specific slice has been exceeded, or UE-Slice-MBR has been exceeded.

Cause #70 – Missing or unknown DNN in a slice

This 5GSM cause is used by the network to indicate that the requested service was rejected by the external DN because the DNN was not included although required or if the DNN could not be resolved, in the slice.

Cause #81 – Invalid PTI value

This 5GSM cause is used by the network or UE to indicate that the PTI provided to it is invalid for the specific 5GSM message.

Cause #82 – Maximum data rate per UE for user-plane integrity protection is too low

This 5GSM cause is used by the network to indicate that the requested service cannot be provided because the maximum data rate per UE for user-plane integrity protection is too low.

Cause #83 – Semantic error in the QoS operation

This 5GSM cause is used by the network or the UE to indicate that the requested service was rejected due to a semantic error in the QoS operation included in the request.

Cause #84 – Syntactical error in the QoS operation

This 5GSM cause is used by the network or the UE to indicate that the requested service was rejected due to a syntactical error in the QoS operation included in the request.

Cause #85 – Invalid mapped EPS bearer identity

This 5GSM cause is used by the network or the UE to indicate that the mapped EPS bearer identity value provided to it is not a valid value or the mapped EPS bearer identified by the mapped EPS bearer identity does not exist.

Cause #86 – UAS services not allowed

This 5GSM cause is used by the network to indicate that the requested UAS services are not allowed.

B.2 Protocol errors (e.g., unknown message)

Cause #95 – Semantically incorrect message

This 5GSM cause is used to report receipt of a message with semantically incorrect contents.

Cause #96 – Invalid mandatory information

This 5GSM cause indicates that the equipment sending this 5GSM cause has received a message with a non-semantic mandatory IE error.

Cause #97 – Message type non-existent or not implemented

This 5GSM cause indicates that the equipment sending this 5GSM cause has received a message with a message type it does not recognize either because this is a message not defined, or defined but not implemented by the equipment sending this 5GSM cause.

Cause #98 – Message type not compatible with protocol state

This 5GSM cause indicates that the equipment sending this 5GSM cause has received a message not compatible with the protocol state.

Cause #99 – Information element non-existent or not implemented

This 5GSM cause indicates that the equipment sending this 5GSM cause has received a message which includes information elements not recognized because the information element identifier is not defined or it is defined but not implemented by the equipment sending the 5GSM cause. However, the information element is not required to be present in the message in order for the equipment sending the 5GSM cause to process the message.

Cause #100 – Conditional IE error

This 5GSM cause indicates that the equipment sending this cause has received a message with conditional IE errors.

Cause #101 – Message not compatible with protocol state

This 5GSM cause indicates that a message has been received which is incompatible with the protocol state.

Cause #111 – Protocol error, unspecified

This 5GSM cause is used to report a protocol error event only when no other 5GSM cause in the protocol error class applies.

Annex C (normative): Storage of 5GMM information

C.1 Storage of 5GMM information for UEs not operating in SNPN access operation mode

The following 5GMM parameters shall be stored on the USIM if the corresponding file or file extension is present:

- a) 5G-GUTI;
- b) last visited registered TAI;
- c) 5GS update status;
- d) 5G NAS security context parameters from a full native 5G NAS security context (see 3GPP TS 33.501 [24]);
- e) K_{AUSF} and K_{SEAF} (see 3GPP TS 33.501 [24]);
- f) SOR counter (see subclause 9.11.3.51); and
- g) UE parameter update counter (see subclause 9.11.3.53A);

The UE may support multiple records of NAS security context storage for multiple registration (see 3GPP TS 31.102 [22]). If the UE supports multiple records of NAS security context storage for multiple registration, the first 5G security context of one access shall be stored in record 1 of the 5G NAS Security Context USIM file for that access and the second 5G security context of that access shall be stored in record 2 of the same file. The presence and format of corresponding files on the USIM is specified in 3GPP TS 31.102 [22].

If the corresponding file or file extension is not present on the USIM, these 5GMM parameters are stored in a non-volatile memory in the ME together with the SUPI from the USIM. These 5GMM parameters can only be used if the SUPI from the USIM matches the SUPI stored in the non-volatile memory; else the UE shall delete the 5GMM parameters.

Upon power up or when a USIM is inserted if K_{AUSF} is stored on the USIM but the SOR counter and the UE parameter update counter are not present on the USIM the UE may delete the K_{AUSF} and associated 5G security context that are stored at the USIM and set the KSI value of ngKSI to '111' (see 3GPP TS 33.501 [24]).

NOTE: The above handling can be used to prevent a stored CounterSoR and CounterUPU being associated with the wrong K_{AUSF} . Further criteria for deleting the security information are left to the UE implementation.

The following 5GMM parameters shall be stored in a non-volatile memory in the ME together with the SUPI from the USIM:

- configured NSSAI(s);
- NSSRG information;
- S-NSSAI time validity information;
- S-NSSAI location validity information;
- on-demand NSSAI;
- NSSAI inclusion mode(s);
- MPS indicator;
- MCS indicator;
- operator-defined access category definitions;

- network-assigned UE radio capability IDs;
- "CAG information list", if the UE supports CAG;
- signalled URSP (see 3GPP TS 24.526 [19]);
- SOR-CMCI;
- one or more lists of type "list of PLMN(s) to be used in disaster condition", if the UE supports MINT;
- disaster roaming wait range, if the UE supports MINT;
- disaster return wait range, if the UE supports MINT;
- indication of whether disaster roaming is enabled in the UE;
- indication of 'applicability of "lists of PLMN(s) to be used in disaster condition" provided by a VPLMN';
- VPS URSP configuration; and
- indication of whether interworking without N26 interface is supported.

The following 5GMM parameters should be stored in a non-volatile memory in the ME together with the SUPI from the USIM:

- allowed NSSAI(s); and
- partially allowed NSSAI(s).

Each configured NSSAI consists of S-NSSAI(s) stored together with a PLMN identity, if it is associated with a PLMN. The UE shall store the S-NSSAI(s) of the HPLMN. If the UE is in the VPLMN, the UE shall also store the configured NSSAI for the current PLMN and any necessary mapped S-NSSAI(s). The configured NSSAI(s) can only be used if the SUPI from the USIM matches the SUPI stored in the non-volatile memory of the ME; else the UE shall delete the configured NSSAI(s). A configured NSSAI may be associated with NSSRG information, S-NSSAI location validity information, S-NSSAI time validity information, NSAG information and on-demand NSSAI.

Each NSSAI inclusion mode is associated with a PLMN identity and access type. The NSSAI inclusion mode(s) can only be used if the SUPI from the USIM matches the SUPI stored in the non-volatile memory of the ME; else the UE shall delete the NSSAI inclusion mode(s).

The MPS indicator is stored together with a PLMN identity of the PLMN that provided it, and is valid in that RPLMN or equivalent PLMN. The MPS indicator can only be used if the SUPI from the USIM matches the SUPI stored in the non-volatile memory of the ME, else the UE shall delete the MPS indicator.

The MCS indicator is stored together with a PLMN identity of the PLMN that provided it, and is valid in that RPLMN or equivalent PLMN. The MCS indicator can only be used if the SUPI from the USIM matches the SUPI stored in the non-volatile memory of the ME, else the UE shall delete the MCS indicator.

Operator-defined access category definitions are stored together with a PLMN identity of the PLMN that provided them, and is valid in that PLMN or equivalent PLMN. The operator-defined access category definitions can only be used if the SUPI from the USIM matches the SUPI stored in the non-volatile memory of the ME, else the UE shall delete the operator-defined access category definitions. The maximum number of stored operator-defined access category definitions is UE implementation dependent.

Each network-assigned UE radio capability ID is stored together with a PLMN identity of the PLMN that provided it as well as a mapping to the corresponding UE radio configuration, and is valid in that PLMN. A network-assigned UE radio capability ID can only be used if the SUPI from the USIM matches the SUPI stored in the non-volatile memory of the ME, else the UE shall delete the network-assigned UE radio capability ID. The UE shall be able to store at least the last 16 received network-assigned UE radio capability IDs. There shall be only one network-assigned UE radio capability ID stored for a given combination of PLMN identity and UE radio configuration and any existing UE radio capability ID shall be deleted when a new UE radio capability ID is added for the same combination of PLMN identity and UE radio configuration. If the UE receives a network-assigned UE radio capability ID with a Version ID value different from the value included in the network-assigned UE radio capability ID(s) stored at the UE for the serving PLMN, the UE may delete these stored network-assigned UE radio capability ID(s).

The allowed NSSAI(s) can be stored in a non-volatile memory in the ME together with the SUPI from the USIM. Allowed NSSAI consists of S-NSSAI(s) stored together with a PLMN identity, if it is associated with a PLMN. If the allowed NSSAI is stored, then the UE shall store the S-NSSAI(s) of the HPLMN. If the UE is in the VPLMN, the UE shall also store the allowed NSSAI for the serving PLMN and any necessary mapping of the allowed NSSAI for the serving PLMN to the S-NSSAI(s) of the HPLMN. The allowed NSSAI(s) can only be used if the SUPI from the USIM matches the SUPI stored in the non-volatile memory of the ME; else the UE shall delete the allowed NSSAI(s).

The partially allowed NSSAI(s) can be stored as allowed NSSAI(s) in a non-volatile memory in the ME together with the SUPI from the USIM. Partially allowed NSSAI consists of allowed S-NSSAI(s) and for each S-NSSAI a list of TAs for which the S-NSSAI is allowed, together with a PLMN identity.

If the UE is registered for emergency services, the UE shall not store the 5GMM parameters described in this annex on the USIM or in non-volatile memory. Instead the UE shall temporarily store these parameters locally in the ME and the UE shall delete these parameters when the UE is deregistered from emergency services (e.g. before registering for normal service).

If the UE is configured for eCall only mode as specified in 3GPP TS 31.102 [22], the UE shall not store the 5GMM parameters described in this annex on the USIM or in non-volatile memory. Instead the UE shall temporarily store these parameters locally in the ME and the UE shall delete these parameters when the UE enters 5GMM-DEREGISTERED.eCALL-INACTIVE state, the UE is switched-off or the USIM is removed.

The "CAG information list" can only be used if the SUPI from the USIM matches the SUPI stored in the non-volatile memory of the ME; else the UE shall delete the "CAG information list".

The handling of the SOR-CMCI stored in the non-volatile memory in the ME is specified in 3GPP TS 23.122 [5].

Each "list of PLMN(s) to be used in disaster condition" is stored together with the PLMN identity of the PLMN that provided it. The stored lists of type "list of PLMN(s) to be used in disaster condition" can only be used if the SUPI from the USIM matches the SUPI stored in the non-volatile memory of the ME; else the UE shall delete the lists of type "list of PLMN(s) to be used in disaster condition". The UE shall store at least the "list of PLMN(s) to be used in disaster condition" provided by the HPLMN or EHPLMN. If the 'applicability of "lists of PLMN(s) to be used in disaster condition" provided by a VPLMN' is set to "true", the UE should also store the "list of PLMN(s) to be used in disaster condition" provided by the VPLMN. The maximum number of stored lists of type "list of PLMN(s) to be used in disaster condition" provided by a PLMN other than the HPLMN or EHPLMN is UE implementation dependent.

The disaster roaming wait range can only be used if the SUPI from the USIM matches the SUPI stored in the non-volatile memory of the ME; else the UE shall delete the disaster roaming wait range.

The disaster return wait range can only be used if the SUPI from the USIM matches the SUPI stored in the non-volatile memory of the ME; else the UE shall delete the disaster return wait range.

The indication of whether disaster roaming is enabled in the UE can only be used if the SUPI from the USIM matches the SUPI stored in the non-volatile memory of the ME; else the UE shall delete the indication of whether disaster roaming is enabled in the UE.

The indication of 'applicability of "lists of PLMN(s) to be used in disaster condition" provided by a VPLMN' can only be used if the SUPI from the USIM matches the SUPI stored in the non-volatile memory of the ME; else the UE shall delete the indication of 'applicability of "lists of PLMN(s) to be used in disaster condition" provided by a VPLMN'.

C.2 Storage of 5GMM information for UEs operating in SNPN access operation mode

The 5GMM information for UEs operating in SNPN access operation mode and not registering or registered for the onboarding service in SNPN are stored according to the following conditions:

- if the UE does not support access to an SNPN using credentials from a credentials holder and equivalent SNPNs, the following 5GMM parameters shall be stored per subscribed SNPN in a non-volatile memory in the ME together with the subscriber identifier associated with the SNPN identity of the SNPN in the "list of subscriber data" configured in the ME (see 3GPP TS 23.122 [5]) or with the SUPI from the USIM if no subscriber identifier is configured in the entry of the "list of subscriber data" associated with the SNPN identity and the UE has a valid USIM;and

- if the UE supports access to an SNPN using credentials from a credentials holder, equivalent SNPNS or both, the following 5GMM parameters shall be stored in a non-volatile memory in the ME per:
 - i) the subscribed SNPN together with the subscriber identifier associated with the selected entry in the "list of subscriber data" configured in the ME (see 3GPP TS 23.122 [5]) or with the SUPI from the USIM if no subscriber identifier is configured in the selected entry of the "list of subscriber data" configured in the ME and the UE has a valid USIM; or
 - ii) if the UE supports access to an SNPN using credentials from a credentials holder, the PLMN subscription together with the SUPI from the USIM which is associated with the PLMN subscription:
 - a) 5G-GUTI;a1) NID of the registered SNPN;
 - b) last visited registered TAI;
 - c) 5GS update status;
 - d) 5G NAS security context parameters from a full native 5G NAS security context (see 3GPP TS 33.501 [24]);
 - e) K_{AUSF} and K_{SEAF} (see 3GPP TS 33.501 [24]);
 - f) UE parameter update counter (see subclause 9.11.3.53A);
 - g) configured NSSAI(s);
 - g1)NSSRG information;
 - g2)S-NSSAI time validity information;
 - g3) S-NSSAI location validity information;
 - g4)on-demand NSSAI;
 - h) NSSAI inclusion mode(s);
 - i) MPS indicator;
 - j) MCS indicator;
 - k) operator-defined access category definitions;
 - l) network-assigned UE radio capability IDs;
 - m) zero or more instances of signalled URSP (see 3GPP TS 24.526 [19]), each associated with a non-subscribed SNPN, the subscribed SNPN or the HPLMN, which provided the URSP;
 - m1) zero or more instances of pre-configured URSP rules (see 3GPP TS 24.526 [19]), each associated with the subscribed SNPN or the HPLMN, which provided the URSP;
 - n) optionally a non-subscribed SNPN signalled URSP handling indication indicating whether the UE is allowed to accept URSP signalled by non-subscribed SNPNS;
 - o) "permanently forbidden SNPNS" list;
 - o1)"permanently forbidden SNPNS for access for localized services in SNPN" list;
 - p) "temporarily forbidden SNPNS" list;
 - p1)"temporarily forbidden SNPNS for access for localized services in SNPN" list;
 - q) SOR counter (see subclause 9.11.3.51);
 - r) SOR-CMCI; and
 - s) optionally, the SNPN selection parameters associated with the PLMN subscription (see 3GPP TS 23.122 [5] subclause 4.9.3.0).

The 5GMM information for UEs operating in SNPN access operation mode and registering or registered for the onboarding service in SNPN are stored as follows:

- a) 5G-GUTI;
- b) last visited registered TAI;
- c) 5GS update status;
- d) 5G NAS security context parameters from a full native 5G NAS security context (see 3GPP TS 33.501 [24]);
- e) K_{AUSF} and K_{SEAF} (see 3GPP TS 33.501 [24]);
- f) UE parameter update counter (see subclause 9.11.3.53A);
- g) network-assigned UE radio capability IDs;
- h) "permanently forbidden SNPNs for onboarding services in SNPN" list; and
- i) "temporarily forbidden SNPNs for onboarding services in SNPN" list.

The 5GMM information for UEs operating in SNPN access operation mode are stored according to the following conditions:

- if the UE does not support access to an SNPN using credentials from a credentials holder, equivalent SNPNs or both, the following 5GMM parameters should be stored per subscribed SNPN in a non-volatile memory in the ME together with the subscriber identifier associated with the SNPN identity of the SNPN in the "list of subscriber data" configured in the ME (see 3GPP TS 23.122 [5]) or with the SUPI from the USIM if no subscriber identifier is configured in the entry of the "list of subscriber data" associated with the SNPN identity and the UE has a valid USIM; and
- if the UE supports access to an SNPN using credentials from a credentials holder, equivalent SNPNs or both, the following 5GMM parameters should be stored in a non-volatile memory in the ME per:
 - i) the subscribed SNPN together with the subscriber identifier associated with the selected entry in the "list of subscriber data" configured in the ME (see 3GPP TS 23.122 [5]) or with the SUPI from the USIM if no subscriber identifier is configured in the selected entry of the "list of subscriber data" configured in the ME and the UE has a valid USIM; or
 - ii) if the UE supports access to an SNPN using credentials from a credentials holder, the PLMN subscription together with the SUPI from the USIM which is associated with the PLMN subscription:
 - a) allowed NSSAI(s).

If the 5GMM parameters are associated with the PLMN subscription, then the 5GMM parameters can only be used if the SUPI from the USIM which is associated with the selected PLMN subscription matches the SUPI stored in the non-volatile memory; else the UE shall delete the 5GMM parameters.

If the 5GMM parameters are associated with the subscribed SNPN of the entry in the "list of subscriber data", then the 5GMM parameters can only be used if the subscriber identifier of the selected entry of the "list of subscriber data" matches the subscriber identifier stored in the non-volatile memory or if the subscriber identifier from the USIM matches the subscriber identifier stored in the non-volatile memory, no subscriber identifier is configured in the selected entry of the "list of subscriber data" configured in the ME and the UE has a valid USIM.

Each configured NSSAI consists of S-NSSAI(s) stored together with an SNPN identity, if it is associated with an SNPN. A configured NSSAI may be associated with NSSRG information, S-NSSAI time validity information, S-NSSAI location validity information, NSAG information and on-demand NSSAI.

Each NSSAI inclusion mode is associated with an SNPN identity and access type.

The MPS indicator is stored together with an SNPN identity of the SNPN that provided it, and is valid in that registered SNPN or equivalent SNPN.

The MCS indicator is stored together with an SNPN identity of the SNPN that provided it, and is valid in that registered SNPN or equivalent SNPN.

Operator-defined access category definitions are stored together with an SNPN identity of the SNPN that provided them, and are valid in that SNPN or equivalent SNPN. The maximum number of stored operator-defined access category definitions is UE implementation dependent.

Each network-assigned UE radio capability ID is stored together with an SNPN identity of the SNPN that provided it as well as a mapping to the corresponding UE radio configuration, and is valid in that SNPN. The UE shall be able to store at least the last 16 received network-assigned UE radio capability IDs. There shall be only one network-assigned UE radio capability ID stored for a given combination of SNPN identity and UE radio configuration and any existing UE radio capability ID shall be deleted when a new UE radio capability ID is added for the same combination of SNPN identity and UE radio configuration. If the UE receives a network-assigned UE radio capability ID with a Version ID value different from the value included in the network-assigned UE radio capability ID(s) stored at the UE for the serving SNPN, the UE may delete these stored network-assigned UE radio capability ID(s).

The handling of the SOR-CMCI stored in the non-volatile memory in the ME is specified in 3GPP TS 23.122 [5].

The allowed NSSAI(s) can be stored in a non-volatile memory in the ME. Allowed NSSAI consists of S-NSSAI(s) stored together with an SNPN identity, if it is associated with an SNPN.

The partially allowed NSSAI(s) can be stored as allowed NSSAI(s) in a non-volatile memory in the ME. Partially allowed NSSAI consists of S-NSSAI(s) and a list of TAs for which the S-NSSAI is allowed, stored together with an SNPN identity, if it is associated with an SNPN.

Annex D (normative): UE policy delivery service

D.1 General

D.1.1 Overview

The UE provides the PCF with a list of one or more stored UE policy section identifiers (UPSIs) during the UE-initiated UE state indication procedure. The UPSI is composed of two parts:

- a) a PLMN ID part containing:
 - 1) the PLMN ID for the PLMN; or
 - 2) the PLMN ID part of the SNPN identity for the SNPN;of the PCF which provides the UE policies; and
- b) a UE policy section code (UPSC) containing a value assigned by the PCF.

During the UE-initiated UE state indication procedure, the UE also provides the PCF with the UE policy related capabilities such as the UE's support for ANDSP, the UE's support for URSP provisioning in EPS, and the UE's OS Id.

During the network-requested UE policy management procedure, the PCF provides the UE with one or more UE policy sections containing UE policies. The UE processes the received UE policy sections, each identified by the UPSI, received from the PCF and informs the PCF of the result.

In the present annex, the condition that the PLMN ID part of the UPSI is referring to the HPLMN shall be considered as fulfilled only if the PLMN ID is equal to the HPLMN code derived from the IMSI.

NOTE: This is also applicable if the UE has a non-empty EHPLMN list, even if the EHPLMN list does not include the PLMN ID derived from the IMSI.

The UE can also request the PCF to provide V2XP as specified in 3GPP TS 24.587 [19B].

The UE can also request the PCF to provide ProSeP as specified in 3GPP TS 24.554 [19E].

The UE can also request the PCF to provide A2XP as specified in 3GPP TS 24.577 [60].

The UE can also request the PCF to provide RSLPP as specified in 3GPP TS 24.514 [62].

D.1.2 Principles of PTI handling for UE policy delivery service procedures

When the PCF or the UE initiates a procedure, it shall include a valid PTI value in the message header of the command message or the request message. When the UE initiates a procedure, the UE shall use a PTI value in range between 01H and 77H. When the PCF initiates a procedure, the PCF shall use a PTI value in range between 80H and FEH.

When the PCF initiates a transaction related procedure (i.e. a procedure consisting of more than one message and the messages are related), it shall include a valid PTI value in the message header of the command message.

If a response message is sent as result of a received command or request message, the UE or the PCF shall include in the response message the PTI value received within the received command or request message (see examples in figure D.1.2.1, figure D.1.2.2 and figure D.1.2.3).

If a command message is sent as result of a received request message, the PCF shall include in the command message the PTI value received with the request message (see examples in figure D.1.2.3).

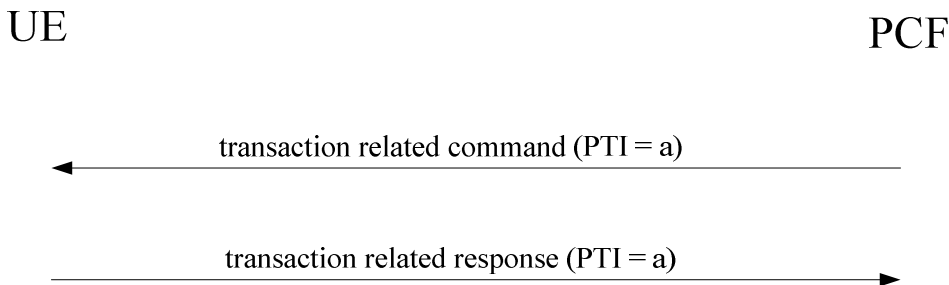

Figure D.1.2.1: Network-requested transaction related procedure

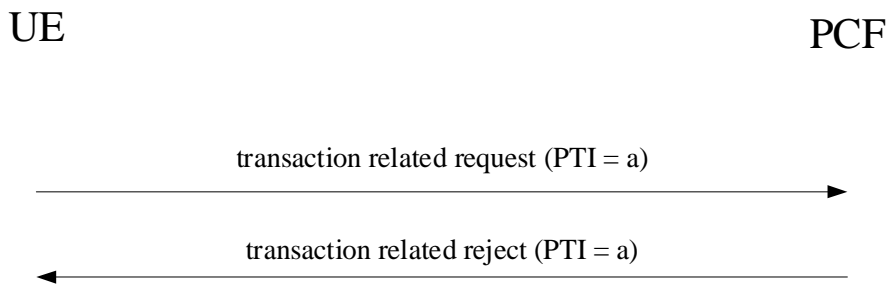

Figure D.1.2.2: UE-requested transaction related procedure rejected by the network

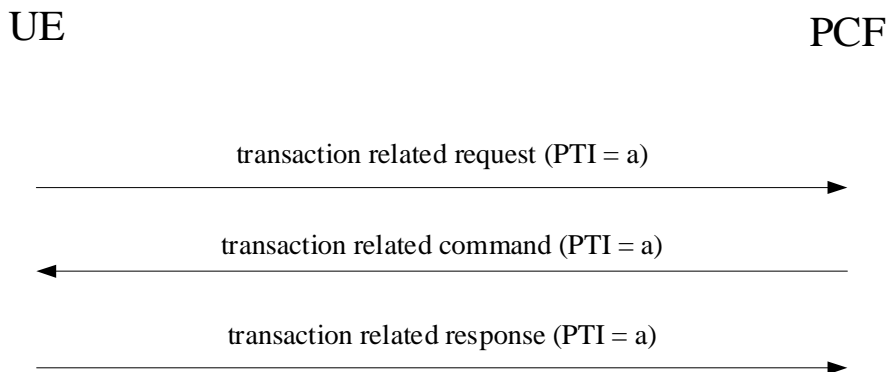

Figure D.1.2.3: UE-requested transaction related procedure triggering a network-requested transaction related procedure

NOTE: In earlier versions of this protocol, the UE can include in the response message a PTI value which is not the same as the one received within the command message, and therefore the PCF could not associate the response message from the UE to the command message sent.

D.2 Procedures

D.2.1 Network-requested UE policy management procedure

D.2.1.1 General

The purpose of the network-requested UE policy management procedure is to enable the network to:

- a) add one or more new UE policy sections to the UE;
- b) modify one or more UE policy sections stored at the UE; or
- c) delete one or more UE policy sections stored at the UE;

and optionally to enable the HPLMN or the subscribed SNPN to provide a UE accessing the subscribed SNPN or the HPLMN with a non-subscribed SNPN signalled URSP handling indication indicating whether the UE is allowed to accept URSP signalled by non-subscribed SNPNs.

D.2.1.2 Network-requested UE policy management procedure initiation

In order to initiate the network-requested UE policy management procedure, the PCF shall:

- a) if the network-requested UE policy management procedure is triggered by the UE-requested V2X policy provisioning procedure as specified in 3GPP TS 24.587 [19B], the UE-requested ProSe policy provisioning procedure as specified in 3GPP TS 24.554 [19E] or the UE-requested A2X policy provisioning procedure as specified in 3GPP TS 24.577 [60], then set the PTI IE to the PTI value of the received UE POLICY PROVISIONING REQUEST message of the UE-requested V2X policy provisioning procedure, the UE-requested ProSe policy provisioning procedure or the UE-requested A2X policy provisioning procedure, otherwise allocate a PTI value currently not used and set the PTI IE to the allocated PTI value;
- b) encode the information about the UE policy sections to be added, modified or deleted in a UE policy section management list IE as specified in subclause D.6.2 and include it in a MANAGE UE POLICY COMMAND message;
- c) if the PCF is a PCF of the HPLMN or the subscribed SNPN, optionally include the UE policy network classmark IE in a MANAGE UE POLICY COMMAND message and set the non-subscribed SNPN signalled URSP handling indication of the UE policy network classmark IE to "UE is not allowed to accept URSP signalled by non-subscribed SNPNs", or "UE is allowed to accept URSP signalled by non-subscribed SNPNs";
- c1) if the UE supports VPS URSP, optionally encode the information about entries of VPS URSP configuration to be added, modified or deleted in the VPS URSP configuration IE as specified in subclause D.6.8 and include it in a MANAGE UE POLICY COMMAND message;
- d) send the MANAGE UE POLICY COMMAND message to the UE via the AMF as specified in 3GPP TS 23.502 [9]; and
- e) start timer T3501 (see example in figure D.2.1.2.1).

NOTE: The PCF starts a different timer T3501 for each PTI value.

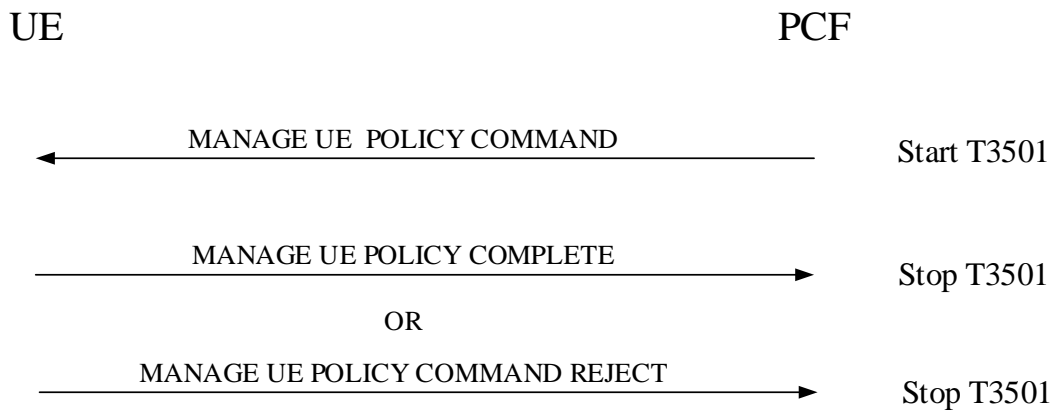

Figure D.2.1.2.1: Network-requested UE policy management procedure

Upon receipt of the MANAGE UE POLICY COMMAND message with a PTI value currently not used by a network-requested UE policy management procedure, for each instruction included in the UE policy section management list IE, the UE shall:

- store the received UE policy section of the instruction, if the UE has no stored UE policy section associated with the same UPSI as the UPSI associated with the instruction;
- replace the stored UE policy section with the received UE policy section of the instruction, if the UE has a stored UE policy section associated with the same UPSI as the UPSI associated with the instruction; or
- delete the stored UE policy section, if the UE has a stored UE policy section associated with the same UPSI as the UPSI associated with the instruction and the UE policy section of the instruction is empty;

additionally, if the UE policy network classmark IE is included in the MANAGE UE POLICY COMMAND message, and

- the UE has an empty EHPLMN list or the EHPLMN list is not present, and the UE's RPLMN is the HPLMN;
- the UE has a non-empty EHPLMN list, and the UE's RPLMN is an EHPLMN; or
- the UE's RSNPN is the subscribed SNPN,

the UE shall delete the non-subscribed SNPN signalled URSP handling indication stored for the selected entry of "list of subscriber data" or the selected PLMN subscription, if any, and store the non-subscribed SNPN signalled URSP handling indication received in the UE policy network classmark IE, for the selected entry of "list of subscriber data" or the selected PLMN subscription.

If the UE supports the VPS URSP, and the VPS URSP configuration is included in the MANAGE UE POLICY COMMAND message:

- if the replacement type field of the received VPS URSP configuration indicates "full list of tuples", the UE shall delete the stored VPS URSP configuration, if any; and
- if the received VPS URSP configuration contains one or more tuples:
 - if the UE does not have the stored VPS URSP configuration, the UE shall store the received VPS URSP configuration except zero or more tuples with no UPSCs; or
 - otherwise:
 - for each tuple with a tuple ID in the stored VPS URSP configuration:
 - if a tuple with the tuple ID is in the received VPS URSP configuration and contains:

- no UPSCs, the UE shall delete the tuple with the tuple ID from the stored VPS URSP configuration; or
 - one or more UPSCs, the UE shall replace the tuple with the tuple ID in the stored VPS URSP configuration with the tuple with the tuple ID from the received VPS URSP configuration; or
- B) if no tuple with the tuple ID is in the received VPS URSP configuration, the UE shall keep the tuple with the tuple ID in the stored VPS URSP configuration; and
- ii) for each tuple with a tuple ID in the received VPS URSP configuration, if no tuple with the tuple ID is in the stored VPS URSP configuration and:
- A) the tuple with the tuple ID in the received VPS URSP configuration contains no UPSCs, the UE shall ignore the tuple with the tuple ID in the received VPS URSP configuration; or
 - B) the tuple with the tuple ID in the received VPS URSP configuration contains one or more UPSCs, the UE shall add the tuple with the tuple ID from the received VPS URSP configuration to the stored VPS URSP configuration.

The UE may continue storing a received UE policy section for a PLMN or SNPN when the UE registers in another PLMN or SNPN. If necessary, the UE may delete UE policy sections stored for a PLMN other than the RPLMN and the HPLMN or for an SNPN other than the registered SNPN and the subscribed SNPN, before storing the new received UE policy sections.

When storing a UE policy section received from an SNPN, the UE shall associate the NID of that SNPN with the UPSI of the stored UE policy section.

NOTE: The maximum number of UE policy sections for PLMNs or SNPNs other than the HPLMN and the RPLMN or the registered SNPN and the subscribed SNPN that the UE can store and how the UE selects the UE policy sections to be deleted are up to the UE implementation.

D.2.1.3 Network-requested UE policy management procedure accepted by the UE

If all instructions included in the UE policy section management list IE were executed successfully by the UE, the UE shall:

- a) create a MANAGE UE POLICY COMPLETE message including the PTI value received within the MANAGE UE POLICY COMMAND message; and
- b) transport the MANAGE UE POLICY COMPLETE message using the NAS transport procedure as specified in subclause 5.4.5.

Upon receipt of the MANAGE UE POLICY COMPLETE message, the PCF shall stop timer T3501. The PCF should ensure that the PTI value assigned to this procedure is not released immediately.

NOTE: The way to achieve this is implementation dependent. For example, the PCF can ensure that the PTI value assigned to this procedure is not released during the time equal to or greater than the default value of timer T3501.

D.2.1.4 Network-requested UE policy management procedure not accepted by the UE

If the UE could not execute all instructions included in the UE policy section management list IE successfully, the UE shall:

- a) set the PTI IE to the PTI value received within the MANAGE UE POLICY COMMAND message and encode the results by including:
 - 1) the UPSI associated with the instructions which could not be executed successfully;
 - 2) the failed instruction order set to order of the instruction in the UE policy section management sublist of the received UE policy section management list IE which could not be executed successfully; and

3) the cause of the failure,

in the UE policy section management result IE as specified in subclause D.5.3 and include it in a MANAGE UE POLICY COMMAND REJECT message, and

- b) transport the MANAGE UE POLICY COMMAND REJECT message using the NAS transport procedure as specified in subclause 5.4.5.

Upon receipt of the MANAGE UE POLICY COMMAND REJECT message, the PCF shall stop timer T3501. Any instruction that was included in the UE policy section management list IE but not indicated in the UE policy section management result IE of the received MANAGE UE POLICY COMMAND REJECT message, shall be considered as successfully executed.

The PCF should ensure that the PTI value assigned to this procedure is not released immediately.

NOTE: The way to achieve this is implementation dependent. For example, the PCF can ensure that the PTI value assigned to this procedure is not released during the time equal to or greater than the default value of timer T3501.

Upon receipt of the notification from the AMF that the UE is not reachable, the PCF shall stop the T3501.

D.2.1.5 Abnormal cases on the network side

The following abnormal cases can be identified:

- a) T3501 expired.

The PCF shall, on the first expiry of the timer T3501, retransmit the MANAGE UE POLICY COMMAND message and shall reset and start timer T3501. This retransmission is repeated four times, i.e. on the fifth expiry of timer T3501, the PCF shall abort the procedure and release the allocated PTI.

D.2.1.6 Abnormal cases in the UE

The following abnormal cases can be identified:

- a) Receipt of an instruction associated with a UPSI which has a PLMN ID part that is not equal to the PLMN ID of the UE's HPLMN and the instruction contains a UE policy part with a UE policy part type set to "URSP" for a UE not operating in SNPN access operation mode, or receipt of an instruction associated with a UPSI which has a PLMN ID part that is not equal to the PLMN ID part of the selected SNPN and the instruction contains a UE policy part with a UE policy part type set to "URSP" for a UE operating in SNPN access operation mode.

The UE shall set the UE policy delivery service cause to #111 "Protocol error, unspecified" for the instruction in the UE policy section management result IE of the MANAGE UE POLICY COMMAND REJECT message.

- b) Receipt of an instruction associated with a UPSI which has a PLMN ID part that is not equal to the PLMN ID of the UE's HPLMN or the UE's RPLMN and the instruction contains a UE policy part with a UE policy part type set to "ANDSP" for a UE not operating in SNPN access operation mode or receipt of an instruction associated with a UPSI which has a PLMN ID part that is not equal to the PLMN ID part of the subscribed SNPN or the UE's RSNPN and the instruction contains a UE policy part with a UE policy part type set to "ANDSP" for a UE operating in SNPN access operation mode.

The UE shall set the UE policy delivery service cause to #111 "Protocol error, unspecified" for the instruction in the UE policy section management result IE of the MANAGE UE POLICY COMMAND REJECT message.

- c) Transmission failure of the MANAGE UE POLICY COMPLETE message indication from lower layers.

The UE shall not diagnose an error and consider the network-requested UE policy management procedure is complete.

NOTE 1: Considering the network-requested UE policy management procedure is complete as the result of this abnormal case, does not cause the UE to revert the execution of the successfully executed instructions included in the MANAGE UE POLICY COMMAND message.

- d) Transmission failure of the MANAGE UE POLICY COMMAND REJECT message indication from lower layers.

The UE shall not diagnose an error and consider the network-requested UE policy management procedure is complete.

NOTE 2: Considering the network-requested UE policy management procedure is complete as the result of this abnormal case, does not cause the UE to revert the execution of the successfully executed instructions included in the MANAGE UE POLICY COMMAND message.

- e) Receipt of a MANAGE UE POLICY COMMAND message with a PTI set to the same value as the PTI of a previously received MANAGE UE POLICY COMMAND message.

The UE shall discard the message and retransmit the MANAGE UE POLICY COMMAND COMPLETE or MANAGE UE POLICY COMMAND REJECT message transmitted in response to the previously received MANAGE UE POLICY COMMAND message.

NOTE 3: The way to achieve this is UE implementation dependent. For example, the UE can assume that on the fifth expiry of timer T3501, the PCF will abort the procedure and that the PTI value assigned to the procedure will be released.

- f) Receipt of an instruction associated with a UPSI which has a PLMN ID part that is equal to the PLMN ID part of the selected SNPN, the instruction contains a UE policy part with a UE policy part type set to "URSP", UE's RSNPN is a non-subscribed SNPN and:

- 1) the UE has a stored non-subscribed SNPN signalled URSP handling indication for the selected entry of "list of subscriber data" or the selected PLMN subscription indicating that the UE is not allowed to accept URSP signalled by non-subscribed SNPNs; or
- 2) the UE does not have a stored non-subscribed SNPN signalled URSP handling indication for the selected entry of "list of subscriber data" or the selected PLMN subscription, and the non-subscribed SNPN signalled URSP handling indication preconfigured in the selected entry of "list of subscriber data" or the selected PLMN subscription indicates that the UE is not allowed to accept URSP signalled by non-subscribed SNPNs;

for a UE operating in SNPN access operation mode.

The UE shall set the UE policy delivery service cause to #111 "Protocol error, unspecified" for the instruction in the UE policy section management result IE of the MANAGE UE POLICY COMMAND REJECT message.

D.2.2 UE-initiated UE state indication procedure

D.2.2.1 General

The purpose of the UE-initiated UE state indication procedure is:

- a) to deliver the UPSI(s) of the UE policy section(s) which are:
 - identified by a UPSI with the PLMN ID part indicating the HPLMN or the selected PLMN, and stored in the UE, if any; or
 - identified by a UPSI with the PLMN ID part indicating the PLMN ID part of the SNPN identity of the selected SNPN and associated with the NID of the selected SNPN, and stored in the UE, if any;
- b) to indicate whether UE supports ANDSP;
- c) to indicate whether UE supports URSP provisioning in EPS;
- c1) to indicate whether UE supports VPS URSP;
- d) to indicate whether UE supports reporting URSP rule enforcement; and
- e) to deliver the UE's one or more OS IDs;

to the PCF.

D.2.2.2 UE-initiated UE state indication procedure initiation

In order to initiate the UE-initiated UE state indication procedure, the UE shall create a UE STATE INDICATION message. The UE:

- a) shall allocate a PTI value currently not used and set the PTI IE to the allocated PTI value;
- b) if not operating in SNPN access operation mode, shall include the UPSI(s) of the UE policy section(s) which are identified by a UPSI with the PLMN ID part indicating the HPLMN or the selected PLMN available in the UE in the UPSI list IE, if any;

NOTE 1: If the UE does not have any UE policy section which is identified by a UPSI with the PLMN ID part indicating the HPLMN or the selected PLMN, the UE sets the Length of UPSI list contents field in the UPSI list IE to zero.

- c) if operating in SNPN access operation mode, shall include UPSI(s) of the UE policy section(s) which are identified by a UPSI:

- with the PLMN ID part indicating the MCC and MNC of the selected SNPN; and
- associated with the NID of the selected SNPN;

available in the UE in the UPSI list IE, if any;

NOTE 2: If the UE does not have any UE policy section which is identified by a UPSI with the PLMN ID part indicating the MCC and MNC of the selected SNPN and associated with the NID of the selected SNPN, the UE sets the Length of UPSI list contents field in the UPSI list IE to zero.

- d) shall specify whether the UE supports ANDSP in the UE policy classmark IE;
- e) shall specify whether the UE supports URSP provisioning in EPS in the UE policy classmark IE;

NOTE 3: ANDSP and URSP are specified in 3GPP TS 24.526 [19].

- e1) if the UE supports VPS URSP, shall set the SVPSU bit to "VPS URSP supported by the UE" in the UE policy classmark IE;
- f) if the UE supports reporting URSP rule enforcement, shall set the SupportRURE bit to "Reporting URSP rule enforcement supported by the UE"; and
- g) may include the UE's one or more OS IDs in the UE OS Id IE.

The UE shall send the UE STATE INDICATION message (see example in figure D.2.2.2.1). The UE shall transport the created UE STATE INDICATION message using the registration procedure (see subclause 5.5.1).



Figure D.2.2.2.1: UE-initiated UE state indication procedure

D.2.2.3 UE-initiated UE state indication procedure accepted by the network

Upon receipt of the UE STATE INDICATION message, the PCF shall operate as described in 3GPP TS 23.502 [9] and 3GPP TS 29.525 [21].

D.2.2.4 Abnormal cases on the network side

Apart from the case described in subclause D.2.2.3, no abnormal cases have been identified.

D.3 UE policy re-assembly at the UE

When the UE needs to apply ANDSP as specified in 3GPP TS 24.502 [18], the UE shall consider all UE policy parts with ANDSP contents currently stored at the UE.

When the UE needs to apply URSP as specified in 3GPP TS 24.526 [19], the UE shall consider all UE policy parts with URSP contents currently stored at the UE.

a) if the UE supports VPS URSP then:

- 1) the UE shall consider as VPS URSP of the RPLMN all UE policy parts with URSP contents currently stored at the UE, which are a part of one or more UE policy sections identified by a UPSI:
 - i) with the PLMN ID part indicating the HPLMN; and
 - ii) with UPSC indicated in a tuple of the stored VPS URSP configuration, such that the tuple contains the network descriptor with a network descriptor entry containing:
 - A) the network descriptor entry type field set to "one or more VPLMNs" and the network descriptor entry value field containing PLMN ID of the RPLMN of an access, if the UE is registered via one or both accesses and the RPLMN of each access is a VPLMN;
 - B) the network descriptor entry type field set to "one or more MCCs" and the network descriptor entry value field containing MCC of the PLMN ID of the RPLMN of an access, if the UE is registered via one or both accesses and the RPLMN of each access is a VPLMN; or
 - C) the network descriptor entry type field set to "any VPLMN", if the UE is registered via one or both accesses and the RPLMN of each access is a VPLMN;
- 2) the UE shall consider as VPS URSP of the equivalent PLMN of the RPLMN all UE policy parts with URSP contents currently stored at the UE, which are a part of one or more UE policy sections identified by a UPSI:
 - i) with the PLMN ID part indicating the HPLMN; and
 - ii) with UPSC indicated in a tuple of the stored VPS URSP configuration, such that the tuple contains the network descriptor with a network descriptor entry containing:
 - A) the network descriptor entry type field set to "one or more VPLMNs" and the network descriptor entry value field containing PLMN ID of an equivalent PLMN, if the UE is registered via one or both accesses, the RPLMN of each access is a VPLMN and the equivalent PLMN is a VPLMN;
 - B) the network descriptor entry type field set to "one or more MCCs" and the network descriptor entry value field containing MCC of the PLMN ID of an equivalent PLMN, if the UE is registered via one or both accesses, the RPLMN of each access is a VPLMN and the equivalent PLMN is a VPLMN; or
 - C) the network descriptor entry type field set to "any VPLMN", if the UE is registered via one or both accesses, the RPLMN of each access is a VPLMN and an equivalent PLMN is a VPLMN; and
- 3) the UE shall consider as PG URSP all UE policy parts with URSP contents currently stored at the UE except zero or more UE policy parts, if any, which are a part of one or more UE policy sections identified by a UPSI:
 - i) with the PLMN ID part indicating the HPLMN; and
 - ii) with UPSC indicated in any tuple of the stored VPS URSP configuration; and

b) the UE shall consider all UE policy parts with URSP contents currently stored at the UE as the signalled URSP.

When the UE needs to apply V2XP as specified in 3GPP TS 24.588 [19C], the UE shall consider all UE policy parts with V2XP contents currently stored at the UE.

When the UE needs to apply ProSeP as specified in 3GPP TS 24.555 [19F], the UE shall consider all UE policy parts with ProSeP contents currently stored at the UE.

When the UE needs to apply A2XP as specified in 3GPP TS 24.578 [61], the UE shall consider all UE policy parts with A2XP contents currently stored at the UE.

When the UE needs to apply RSLPP as specified in 3GPP TS 24.514 [62], the UE shall consider all UE policy parts with RSLPP contents currently stored at the UE.

D.4 Void

D.5 Message functional definition and contents

D.5.1 Manage UE policy command

D.5.1.1 Message definition

The MANAGE UE POLICY COMMAND message is sent by the PCF to the UE to request the UE to manage UE policy sections, see table D.5.1.1.1

Message type: MANAGE UE POLICY COMMAND

Significance: dual

Direction: network to UE

Table D.5.1.1.1: MANAGE UE POLICY COMMAND message content

IEI	Information Element	Type/Reference	Presence	Format	Length
	PTI	Procedure transaction identity 9.6	M	V	1
	MANAGE UE POLICY COMMAND message identity	UE policy delivery service message type D.6.1	M	V	1
	UE policy section management list	UE policy section management list D.6.2	M	LV-E	11-65533
42	UE policy network classmark	UE policy network classmark D.6.7	O	TLV	3-5
70	VPS URSP configuration	VPS URSP configuration D.6.8	O	TLV-E	3-65533
NOTE: The total length of the MANAGE UE POLICY COMMAND message content cannot exceed 65535 octets (see Payload container contents maximum length as specified in subclause 9.11.3.39.1).					

D.5.1.2 UE policy network classmark

The UE policy network classmark is included when the PCF of a PLMN or an SNPN intends to provide the UE with information about the policy aspects of the network.

D.5.1.3 VPS URSP configuration

The VPS URSP configuration IE is included when the PCF of a PLMN intends to provide the UE with the VPS URSP configuration.

D.5.2 Manage UE policy complete

D.5.2.1 Message definition

The MANAGE UE POLICY COMPLETE message is sent by the UE to the PCF to report that all received instructions have been successfully executed at the UE, see table D.5.2.1.1

Message type: MANAGE UE POLICY COMPLETE

Significance: dual

Direction: UE to network

Table D.5.2.1.1: MANAGE UE POLICY COMPLETE message content

IEI	Information Element	Type/Reference	Presence	Format	Length
	PTI	Procedure transaction identity 9.6	M	V	1
	MANAGE UE POLICY COMPLETE message identity	UE policy delivery service message type D.6.1	M	V	1

D.5.3 Manage UE policy command reject

D.5.3.1 Message definition

The MANAGE UE POLICY COMMAND REJECT message is sent by the UE to the PCF to report that one or more instructions could not be successfully executed at the UE, see table D.5.3.1.1

Message type: MANAGE UE POLICY COMMAND REJECT

Significance: dual

Direction: UE to network

Table D.5.3.1.1: MANAGE UE POLICY COMMAND REJECT message content

IEI	Information Element	Type/Reference	Presence	Format	Length
	PTI	Procedure transaction identity 9.6	M	V	1
	MANAGE UE POLICY COMMAND REJECT message identity	UE policy delivery service message type D.6.1.	M	V	1
	UE policy section management result	UE policy section management result D.6.3	M	LV-E	11-65533
NOTE: The total length of the MANAGE UE POLICY COMMAND REJECT message content cannot exceed 65535 octets (see Payload container contents maximum length as specified in subclause 9.11.3.39.1).					

D.5.4 UE state indication

D.5.4.1 Message definition

The UE STATE INDICATION message is sent by the UE to the PCF:

- a) to deliver the UPSI(s) of the UE policy section(s) stored in the UE;
- b) to indicate whether the UE supports ANDSP;

- c) to indicate whether the UE supports URSP provisioning in EPS in the UE policy classmark IE;
- c1) to indicate whether the UE supports VPS URSP;
- c2) to indicate whether the UE supports reporting URSP rule enforcement; and
- d) to deliver the UE's one or more OS IDs;

see table D.5.4.1.1.

Message type: UE STATE INDICATION

Significance: dual

Direction: UE to network

Table D.5.4.1.1: UE STATE INDICATION message content

IEI	Information Element	Type/Reference	Presence	Format	Length
	PTI	Procedure transaction identity 9.6	M	V	1
	UE STATE INDICATION message identity	UE policy delivery service message type D.6.1	M	V	1
	UPSI list	UPSI list D.6.4	M	LV-E	2-65531
	UE policy classmark	UE policy classmark D.6.5	M	LV	2-4
41	UE OS Id	OS Id D.6.6	O	TLV	18-242
NOTE: The total length of the UE STATE INDICATION message content cannot exceed 65535 octets (see Payload container contents maximum length as specified in subclause 9.11.3.39.1).					

D.6 Information elements coding

D.6.1 UE policy delivery service message type

Table D.6.1.1: UE policy delivery service message type

Bits								
8	7	6	5	4	3	2	1	
0	0	0	0	0	0	0	0	Reserved
0	0	0	0	0	0	0	1	MANAGE UE POLICY COMMAND message
0	0	0	0	0	0	1	0	MANAGE UE POLICY COMPLETE message
0	0	0	0	0	0	1	1	MANAGE UE POLICY COMMAND REJECT message
0	0	0	0	0	1	0	0	UE STATE INDICATION message
0	0	0	0	0	1	0	1	UE POLICY PROVISIONING REQUEST message (see NOTE)
0	0	0	0	0	1	1	0	UE POLICY PROVISIONING REJECT message (see NOTE)
All other values are reserved								
NOTE: Coding of UE POLICY PROVISIONING REQUEST message and UE POLICY PROVISIONING REJECT message are specified in 3GPP TS 24.587 [19B]. Usage of UE POLICY PROVISIONING REQUEST message and UE POLICY PROVISIONING REJECT message for V2X policy is specified in 3GPP TS 24.587 [19B]. Usage of UE POLICY PROVISIONING REQUEST message and UE POLICY PROVISIONING REJECT message for ProSeP policy is specified in 3GPP TS 24.554 [19E]. Usage of UE POLICY PROVISIONING REQUEST message and UE POLICY PROVISIONING REJECT message for A2X policy is specified in 3GPP TS 24.577 [60]. Usage of UE POLICY PROVISIONING REQUEST message and UE POLICY PROVISIONING REJECT message for RSLPP policy is specified in 3GPP TS 24.514 [62].								

D.6.2 UE policy section management list

The purpose of the UE policy section management list information element is to transfer from the PCF to the UE a list of instructions to be performed at the UE for management of UE policy section stored at the UE.

The UE policy section management list information element is coded as shown in figure D.6.2.1, figure D.6.2.2, figure D.6.2.3, figure D.6.2.4, figure D.6.2.5, figure D.6.2.6, figure D.6.2.7 and table D.6.2.1.

The UE policy section management list information element has a minimum length of 12 octets and a maximum length of 65534 octets.

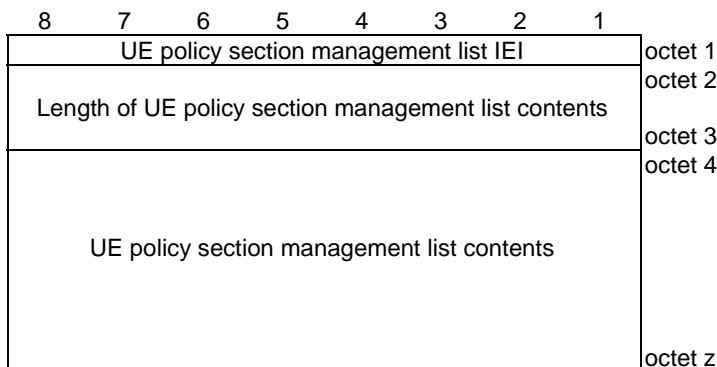

Figure D.6.2.1: UE policy section management list information element

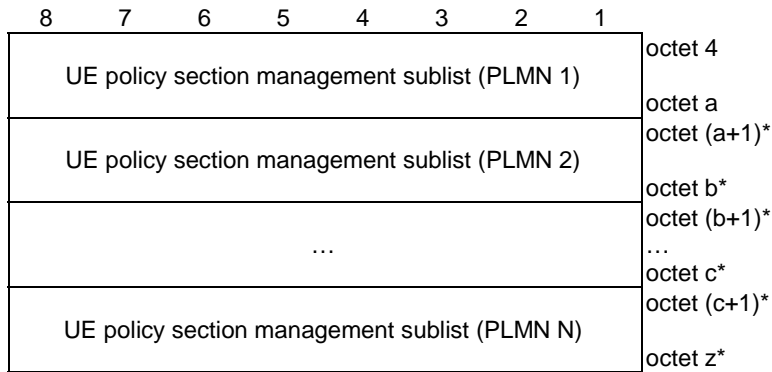

Figure D.6.2.2: UE policy section management list contents

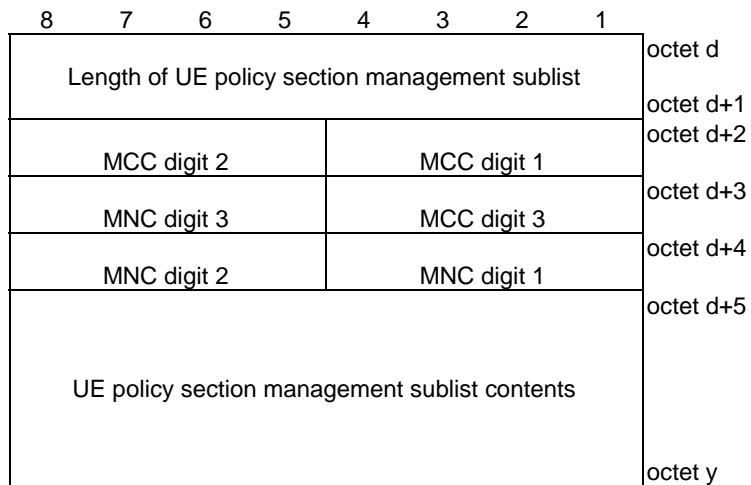

Figure D.6.2.3: UE policy section management sublist

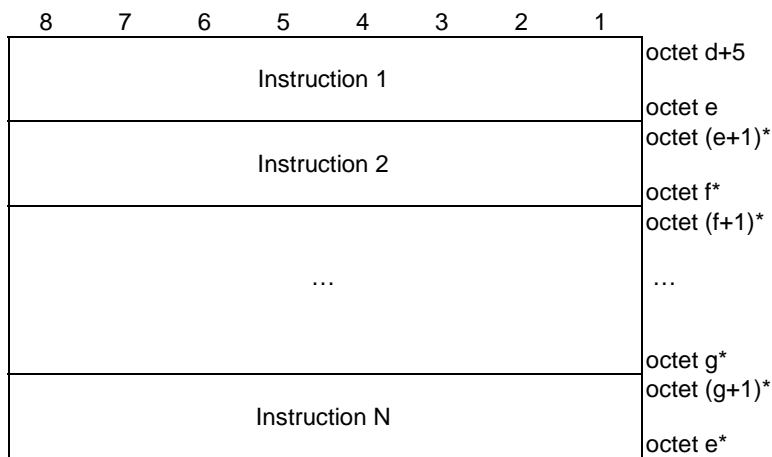

Figure D.6.2.4: UE policy section management sublist contents

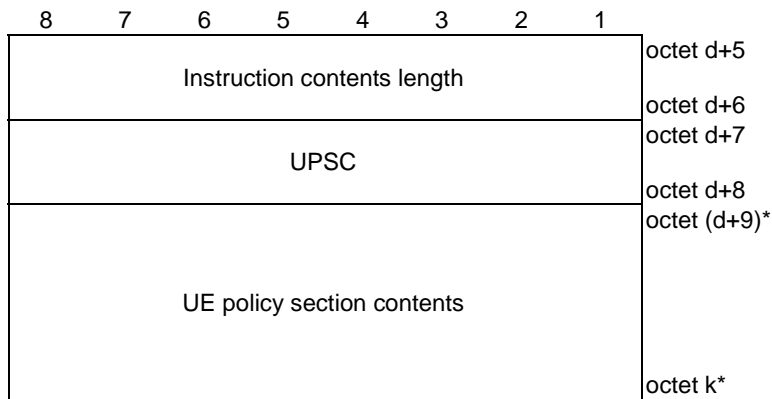

Figure D.6.2.5: Instruction

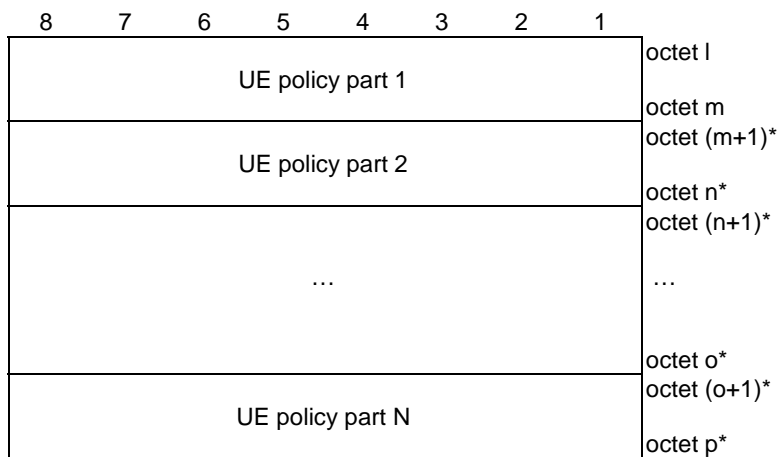

Figure D.6.2.6: UE policy section contents

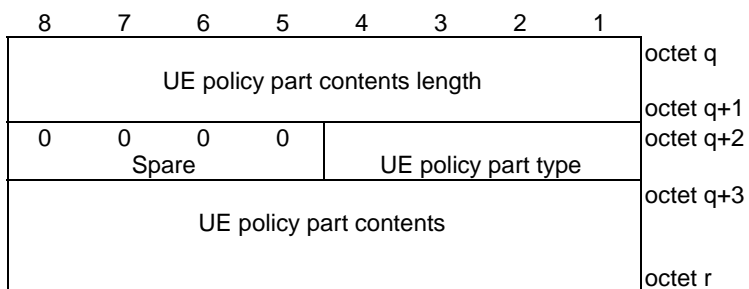

Figure D.6.2.7: UE policy part

Table D.6.2.1: UE policy section management list information element

Value part of the UE policy section management list information element (octets 4 to z)

The value part of the UE policy section management list information element consists of one or several UE policy section management sublists.

UE policy section management sublist:

Length of UE policy section management sublist (octets d to d+1)

This field contains the binary encoding of the length of the UE policy section management sublist in units of octets.

MCC, Mobile country code (octet d+2, and bits 4 to 1 of octet d+3)

The MCC field is coded as in ITU-T Recommendation E.212 [42], annex A.

MNC, Mobile network code (bits 8 to 5 of octet d+3, and octet d+4)

The coding of this field is the responsibility of each administration but BCD coding shall be used. The MNC shall consist of 2 or 3 digits. If a network operator decides to use only two digits in the MNC, MNC digit 3 shall be coded as "1111". (NOTE 1)

UE policy section management sublist contents (octets d+5 to y)

The UE policy section management sublist contents consist of one or several instructions.

Instruction:

Instruction contents length (octets d+5 to d+6)

This field contains the binary encoding of the instruction contents length in units of octets.

UPSC (octets d+7 to d+8)

This field contains the binary encoding of the UPSC. The value of the UPSC is set by the PCF.

UE policy section contents (octets d+9 to k)

The UE policy section contents consist of one or several UE policy parts.

UE policy part:

UE policy part contents length (octets q to q+1)

This field contains the binary encoding of the UE policy part contents length in units of octets (NOTE 2).

UE policy part type (bits 4 to 1 of octet q+2)

Bits

4	3	2	1	
0	0	0	0	Reserved
0	0	0	1	URSP
0	0	1	0	ANDSP
0	0	1	1	V2XP
0	1	0	0	ProSeP
0	1	0	1	A2XP
0	1	1	0	RSLPP

All other values are reserved.

Bits 8 to 5 of octet q+2 are spare and shall be coded as zero.

UE policy part contents (octets q+3 to r)

This field contains a UE policy part encoded as specified in 3GPP TS 24.526 [19] for the UE policy part type field set to "URSP" or "ANDSP", in 3GPP TS 24.588 [19C] for the UE policy part type field set to "V2XP", in 3GPP TS 24.555 [19F] for the UE policy part type field set to "ProSeP" and in 3GPP TS 24.514 [62] for the UE policy part type field set to "RSLPP" and in 3GPP TS 24.578 [61] for the UE policy part type field set to "A2XP" respectively.

NOTE 1: When the PCF is in an SNPN, the PCF shall include the PLMN ID part of the SNPN identity in the UE policy section management sublist.

NOTE 2: The UE policy part contents length indicates the length of the value part of the UE policy part field (i.e. octet q+2 to octet r).

D.6.3 UE policy section management result

The purpose of the UE policy section management result information element is to transfer from the UE to the PCF information about instructions for UE policy section management which the UE could not execute successfully.

The UE policy section management result information element is coded as shown in figure D.6.3.1, figure D.6.3.2, figure D.6.3.3, figure D.6.3.4, figure D.6.3.5 and table D.6.3.1.

The UE policy section management result information element has a minimum length of 12 octets and a maximum length of 65534 octets.

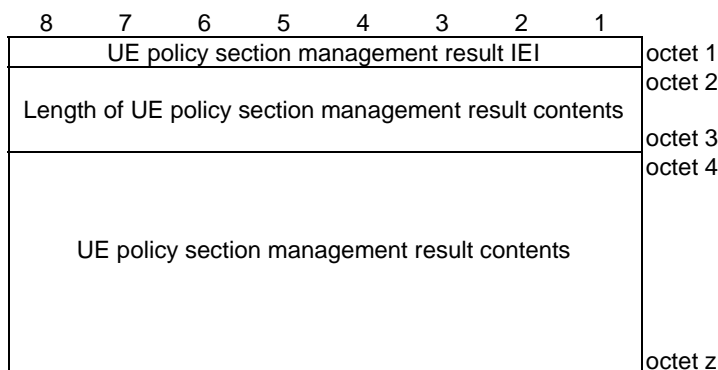

Figure D.6.3.1: UE policy section management result information element

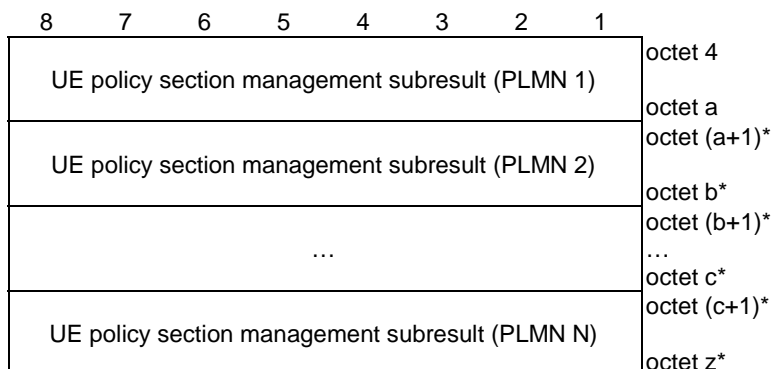

Figure D.6.3.2: UE policy section management result contents

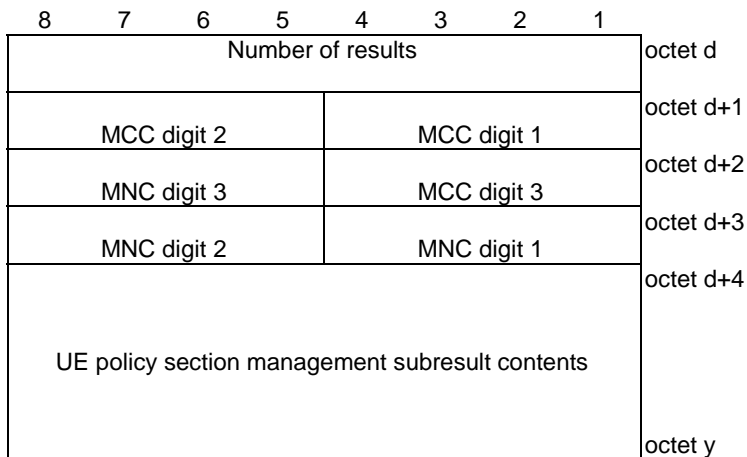

Figure D.6.3.3: UE policy section management subresult

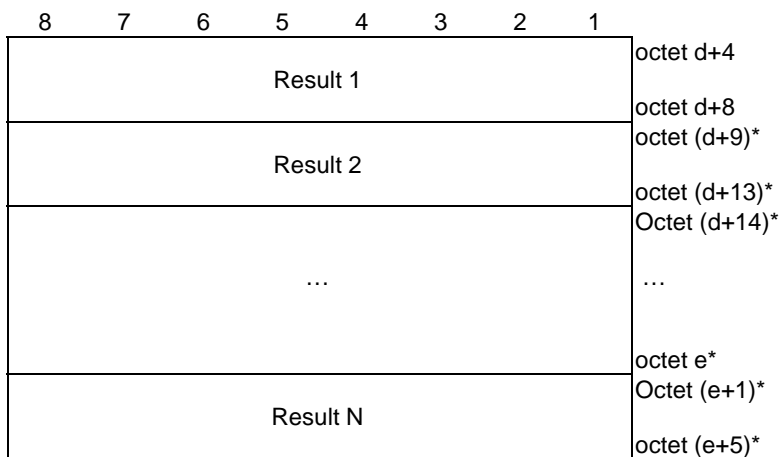

Figure D.6.3.4: UE policy section management subresult contents

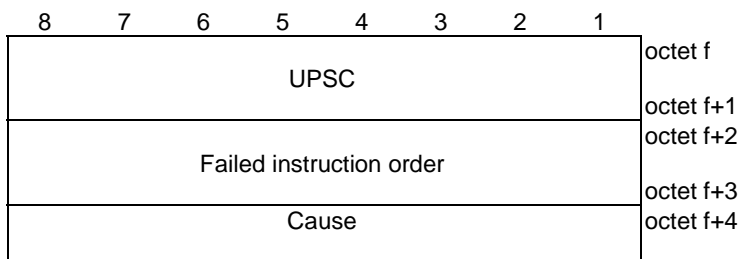

Figure D.6.3.5: Result

Table D.6.3.1: UE policy section management result information element

<p>Value part of the UE policy section management result information element (octets 4 to z)</p> <p>The value part of the UE policy section management result information element consists of one or several UE policy section management subresults.</p> <p>UE policy section management subresult:</p> <p>Number of results (octet d)</p> <p>This field contains the binary encoding of number of results included in the UE policy section management subresult.</p> <p>MCC, Mobile country code (octet d+1, and bits 4 to 1 of octet d+2)</p> <p>The MCC field is coded as in ITU-T Recommendation E.212 [42], annex A.</p> <p>MNC, Mobile network code (bits 8 to 5 of octet d+2, and octet d+3)</p> <p>The coding of this field is the responsibility of each administration but BCD coding shall be used. The MNC shall consist of 2 or 3 digits. If a network operator decides to use only two digits in the MNC, MNC digit 3 shall be coded as "1111". (NOTE)</p> <p>UE policy section management subresult contents (octets d+4 to y)</p> <p>The UE policy section management subresult contents consist of one or several results.</p> <p>Result (octet f to f+4)</p> <p>UPSC (octet f to f+1)</p> <p>This field contains the binary encoding of the UPSC. The value of the UPSC is set by the PCF</p> <p>Failed instruction order (octets f+2 to f+3)</p> <p>This field contains the binary encoding of the order of the instruction in the UE policy section management sublist contents as specified in Figure D.6.2.4, which could not be executed successfully. The value of failed instruction order set to one indicates that the first instruction in the UE policy section management sublist contents could not be executed successfully.</p> <p>Cause (octet f+4)</p> <p>Bits</p> <table style="border: none;"> <tr> <td style="padding-right: 10px;">8</td> <td style="padding-right: 10px;">7</td> <td style="padding-right: 10px;">6</td> <td style="padding-right: 10px;">5</td> <td style="padding-right: 10px;">4</td> <td style="padding-right: 10px;">3</td> <td style="padding-right: 10px;">2</td> <td style="padding-right: 10px;">1</td> <td></td> </tr> <tr> <td style="padding-right: 10px;">0</td> <td style="padding-right: 10px;">1</td> <td style="padding-right: 10px;">1</td> <td style="padding-right: 10px;">0</td> <td style="padding-right: 10px;">1</td> <td style="padding-right: 10px;">1</td> <td style="padding-right: 10px;">1</td> <td style="padding-right: 10px;">1</td> <td style="padding-left: 20px;">Protocol error, unspecified</td> </tr> </table> <p>The receiving entity shall treat any other value as 0110 1111, "Protocol error, unspecified".</p>	8	7	6	5	4	3	2	1		0	1	1	0	1	1	1	1	Protocol error, unspecified
8	7	6	5	4	3	2	1											
0	1	1	0	1	1	1	1	Protocol error, unspecified										
<p>NOTE: The UE operating in the SNPN access operation mode shall include the PLMN ID part of the SNPN identity of the SNPN in the UE policy section management subresult.</p>																		

D.6.4 UPSI list

The purpose of the UPSI list information element is to transfer from the UE to the PCF a list of UPSIs.

The UPSI list information element is coded as shown in figure D.6.4.1, figure D.6.4.2, and table D.6.4.1.

The UPSI list information element has a minimum length of 3 octets and a maximum length of 65532 octets.

NOTE: A PCF implementing a previous version of the present specification will expect the UPSI list information element to have a minimum length of 10 octets and could be unable to decode a UPSI list information element with a length of 3 octets i.e. a UPSI list information element not containing any UPSI.

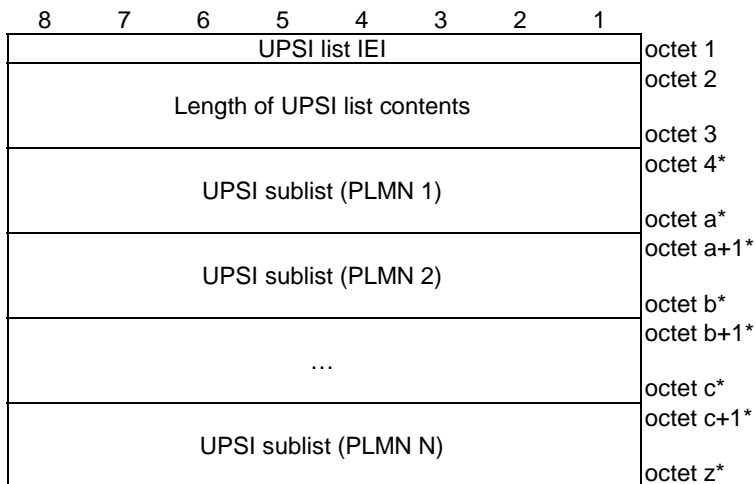

Figure D.6.4.1: UPSI list information element

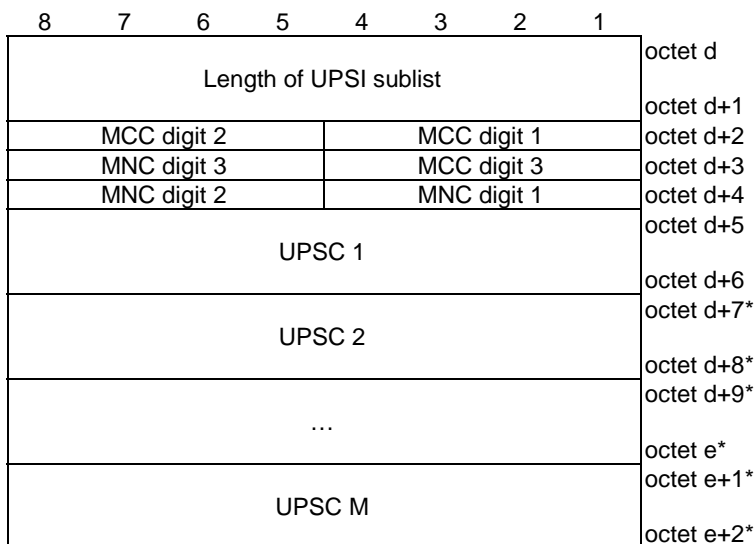

Figure D.6.4.2: UPSI sublist

Table D.6.4.1: UPSI list information element

Length of UPSI list contents (octets 2 to 3)	
This field indicates the length of the UPSI list contents. If no UPSIs are included in the UPSI list, the UE shall set the length of UPSI list contents to zero.	
MCC, Mobile country code (octet d+2, and bits 4 to 1 of octet d+3)	
The MCC field is coded as in ITU-T Recommendation E.212 [42], annex A.	
MNC, Mobile network code (bits 8 to 5 of octet d+3, and octet d+4)	
The coding of this field is the responsibility of each administration but BCD coding shall be used. The MNC shall consist of 2 or 3 digits. If a network operator decides to use only two digits in the MNC, MNC digit 3 shall be coded as "1111". (NOTE)	
UPSC (octets d+5 to d+6)	
This field contains the binary encoding of the UPSC. The value of the UPSC is set by the PCF.	
NOTE:	The UE operating in the SNPN access operation mode shall include the PLMN ID part of the SNPN identity in the UPSI sublist.

D.6.5 UE policy classmark

The purpose of the UE policy classmark information element is to provide the network with information about the policy aspects of the UE.

The UE policy classmark information element is coded as shown in figure D.6.5.1 and table D.6.5.1.

The UE policy classmark is a type 4 information element with a minimum length of 3 octets and a maximum length of 5 octets.

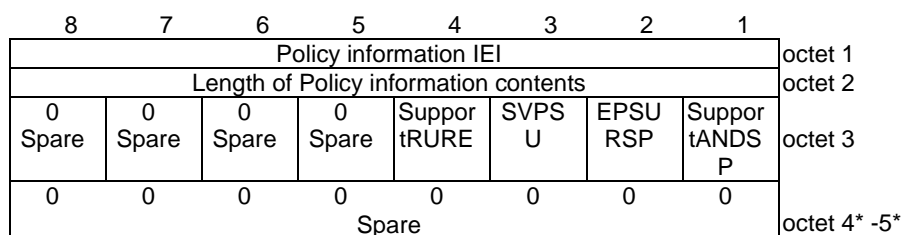

Figure D.6.5.1: UE policy classmark information element

Table D.6.5.1: UE policy classmark information element

Support of ANDSP by the UE (SupportANDSP) (octet 3, bit 1) Bit 1 0 ANDSP not supported by the UE 1 ANDSP supported by the UE
Support of URSP provisioning in EPS by the UE (EPSURSP) (octet 3, bit 2) (see NOTE) Bit 2 0 URSP provisioning in EPS not supported by the UE 1 URSP provisioning in EPS supported by the UE
Support of VPS URSP (SVPSU) (octet 3, bit 3) Bit 3 0 VPS URSP not supported by the UE 1 VPS URSP supported by the UE
Support of Reporting URSP Rule Enforcement by the UE (SupportRURE) (octet 3, bit 4) Bit 4 0 Reporting URSP rule enforcement not supported by the UE 1 Reporting URSP rule enforcement supported by the UE
All other bits in octet 3 to 5 are spare and shall be coded as zero, if the respective octet is included in the information element.
NOTE: This indicator shall be ignored by an EPS receiving entity as the UE in EPS providing UE STATE INDICATION message, supports URSP provisioning in EPS.

D.6.6 UE OS Id

The purpose of the UE OS Id information element is to provide the network with information about the OS of the UE.

The UE OS Id information element is coded as shown in figure D.6.6.1 and table D.6.6.1.

The UE OS Id is a type 4 information element with a minimum length of 18 octet and a maximum length of 242 octets.

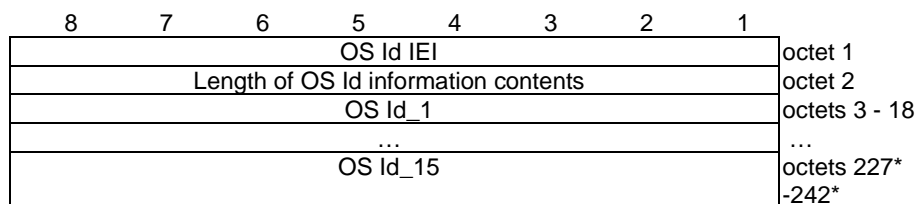

Figure D.6.6.1: UE OS Id information element

Table D.6.6.1: UE OS Id information element

OS Id: The OS Id is coded as a sequence of a sixteen octet OS Id value field. The OS Id value field is defined as Universally Unique IDentifier (UUID) as specified in IETF RFC 4122 [35A].
--

D.6.7 UE policy network classmark

The purpose of the UE policy network classmark information element is to provide the UE with information about the policy aspects of the network.

The UE policy network classmark information element is coded as shown in figure D.6.7.1 and table D.6.7.1.

The UE policy network classmark is a type 4 information element with a minimum length of 3 octets and a maximum length of 5 octets.

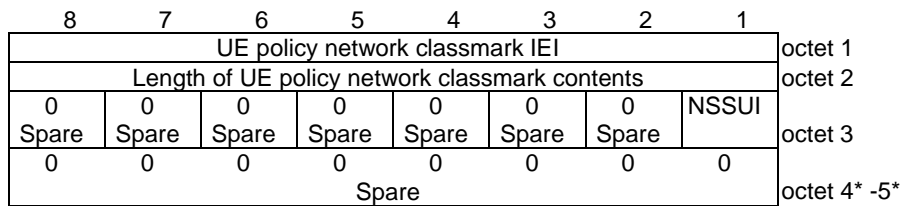

Figure D.6.7.1: UE policy network classmark information element

Table D.6.7.1: UE policy network classmark information element

Non-subscribed SNPN signalled URSP handling indication (NSSUI) (octet 3, bit 1) (see NOTE)	
Bits	
1	
0	UE is allowed to accept URSP signalled by non-subscribed SNPNs
1	UE is not allowed to accept URSP signalled by non-subscribed SNPNs
All other bits in octet 3 to 5 are spare and shall be coded as zero, if the respective octet is included in the information element.	
NOTE: Receiving UE shall ignore this bit, if i) UE has an empty or non-present EHPLMN list and the bit is received from the RPLMN which is not the HPLMN, ii) UE has non-empty EHPLMN list and the bit is received from the RPLMN which is not an EHPLMN or iii) the bit is received from the RSNPN which is not the subscribed SNPN.	

D.6.8 VPS URSP configuration

The purpose of the VPS URSP configuration information element is to transfer the VPS URSP configuration from the PCF to the UE. The VPS URSP configuration contains zero or more tuples. Each tuple contains the tuple ID identifying the tuple, the network descriptor identifying one or more VPLMNs, and zero or more UPSCs of HPLMN's UE policy sections which contain solely one or more UE policy parts with the UE policy part type set to "URSP", such that the URSP rules in those one or more UE policy parts are applicable to the VPLMN and its equivalent PLMN.

The VPS URSP configuration information element is coded as shown in figure D.6.8.1, figure D.6.8.2, figure D.6.8.3, figure D.6.8.4, figure D.6.8.5, figure D.6.8.6, figure D.6.8.7, figure D.6.8.8, figure D.6.8.9, and table D.6.8.1.

The VPS URSP configuration is type 6 information element with a minimum length of 3 octets and a maximum length of 65533 octets.

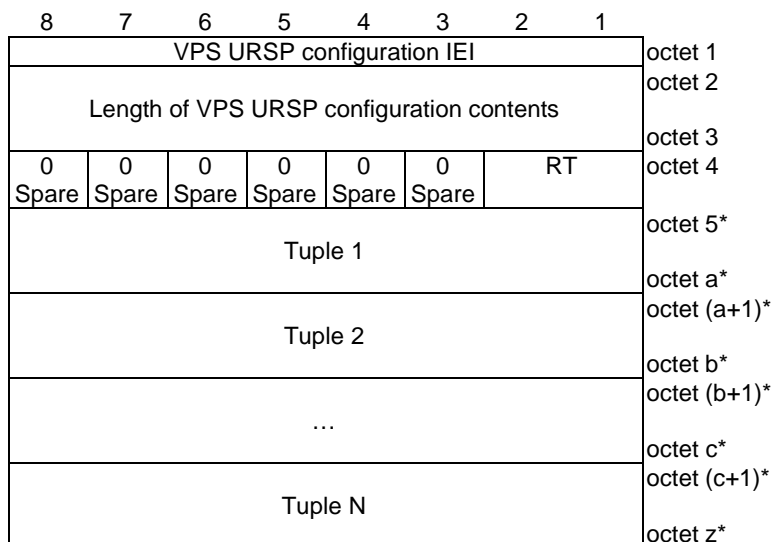

Figure D.6.8.1: VPS URSP configuration information element

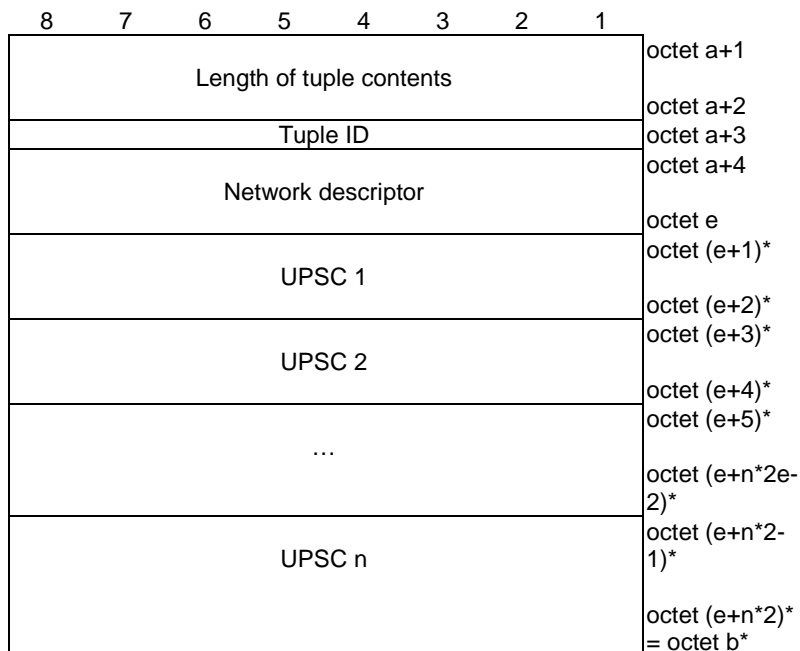

Figure D.6.8.2: Tuple

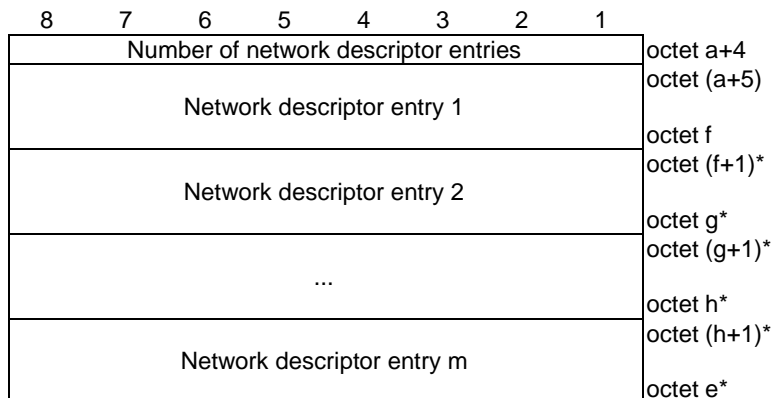

Figure D.6.8.3: Network descriptor

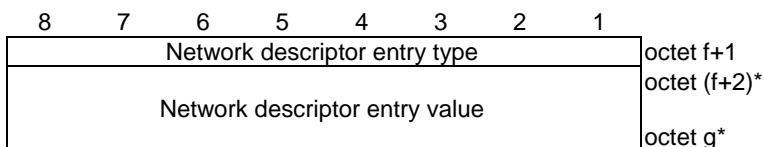

Figure D.6.8.4: Network descriptor entry

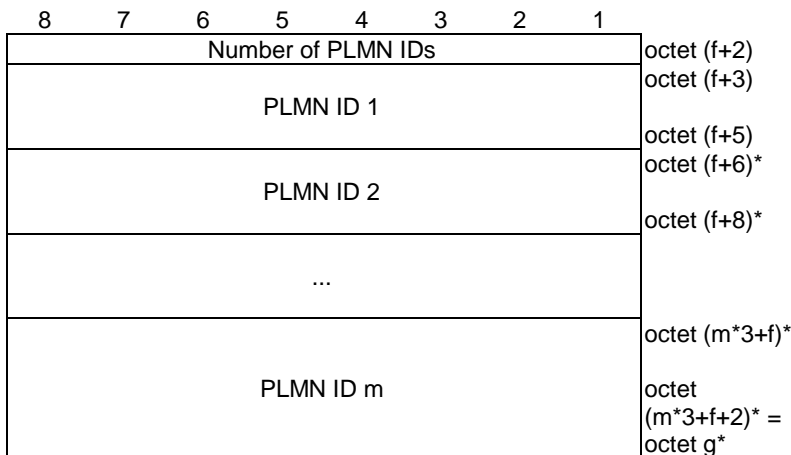

Figure D.6.8.5: Network descriptor entry value for network descriptor entry type set to "one or more VPLMNs"

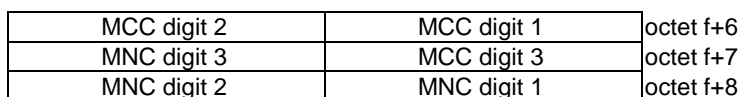

Figure D.6.8.6: PLMN ID

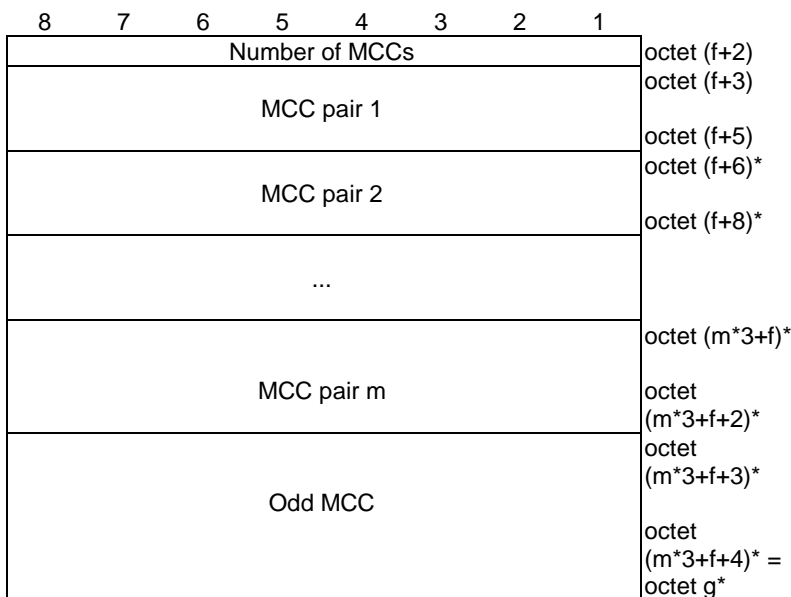

Figure D.6.8.7: Network descriptor entry value for network descriptor entry type set to "one or more MCCs"

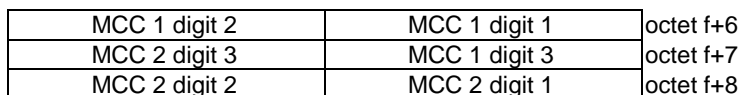

Figure D.6.8.8: MCC pair

MCC digit 2				MCC digit 1	octet (m*3+f+3)
0 Spare	0 Spare	0 Spare	0 Spare	MCC digit 3	octet (m*3+f+4) = octet g

Figure D.6.8.9: Odd MCC

Table D.6.8.1: VPS URSP configuration information element

<p>Replacement type (octet 4, bits 1 and 2)</p> <p>Bits</p> <p>2 1</p> <p>0 1 per-tuple replacement</p> <p>1 0 full list of tuples</p> <p>All other values are reserved.</p> <p>Tuple ID (octet a+3)</p> <p>This field contains the binary encoding of the tuple ID. The value of the tuple ID is set by the PCF.</p> <p>Network descriptor entry type (octet f+1)</p> <p>Bits</p> <p>8 7 6 5 4 3 2 1</p> <p>0 0 0 0 0 0 0 1 one or more VPLMNs</p> <p>0 0 0 0 0 0 1 0 one or more MCCs</p> <p>0 0 0 0 0 0 1 1 any VPLMN</p> <p>All other values are reserved.</p> <p>If the network descriptor entry type field is set to "one or more VPLMNs" or "one or more MCCs", then the network descriptor entry value field is present. If the network descriptor entry type field is set to "any VPLMN", then the network descriptor entry value field is absent.</p> <p>Number of PLMN IDs (octet (f+2) of the network descriptor entry value for network descriptor entry type set to "one or more VPLMNs")</p> <p>The number of PLMN IDs field indicates the number of the PLMN IDs in the network descriptor entry value field.</p> <p>MCC, Mobile country code (octet f+6 and bits 4 to 1 of octet f+7 of the PLMN ID, octet f+6 and bits 4 to 1 of octet f+7 of the MCC pair, and octet f+8 and bits 8 to 5 of octet f+7 of the MCC pair, octet m*3+f+3 and bits 4 to 1 of m*3+f+4 of the odd MCC)</p> <p>The MCC field is coded as in ITU-T Recommendation E.212 [42], annex A.</p> <p>MNC, Mobile network code (bits 8 to 5 of octet f+7, and octet f+8)</p> <p>The coding of this field is the responsibility of each administration but BCD coding shall be used. The MNC shall consist of 2 or 3 digits. If a network operator decides to use only two digits in the MNC, MNC digit 3 shall be coded as "1111".</p> <p>Number of MCCs (octet (f+2) of the network descriptor entry value for network descriptor entry type set to "one or more MCCs")</p> <p>The number of MCCs field indicates the number of the MCCs in the network descriptor entry value field. If the number of MCCs field is an odd value, then the odd MCC field is present otherwise the odd MCC field is absent.</p> <p>UPSC (octets e+3 to e+4)</p> <p>This field contains the binary encoding of the UPSC of an UPSI of a UE policy section of the HPLMN (see NOTE), which contains solely one or more UE policy parts with the UE policy part type set to "URSP", such that the URSP rules in those one or more UE policy parts are applicable to the VPLMN and its equivalent PLMN.</p> <p>NOTE: PLMN ID of the UPSI is not indicated.</p>
--

D.7 Timers of UE policy delivery service

Timers of UE policy delivery service are shown in table D.7.1.

Table D.7.1: Timers of UE policy delivery service – PCF side

TIMER NUM.	TIMER VALUE	CAUSE OF START	NORMAL STOP	ON THE 1 st , 2 nd , 3 rd , 4 th EXPIRY
T3501	NOTE 1	Transmission of MANAGE UE POLICY COMMAND	MANAGE UE POLICY COMMAND COMPLETE or MANAGE UE POLICY COMMAND REJECT message received	Retransmission of MANAGE UE POLICY COMMAND message
NOTE 1: The value of this timer is network dependent.				

D.8 Handling of unknown, unforeseen, and erroneous UPDS data

D.8.1 General

The procedures specified in the subclause apply to those messages which pass the checks described in this subclause.

This subclause also specifies procedures for the handling of unknown, unforeseen, and erroneous UPDS data by the receiving entity. These procedures are called "error handling procedures", but in addition to providing recovery mechanisms for error situations they define a compatibility mechanism for future extensions of the UPDS.

Subclauses D.8.1 to D.8.8 shall be applied in order of precedence.

Detailed error handling procedures in the network are implementation dependent and may vary from PLMN to PLMN. However, when extensions of UPDS are developed, networks are assumed to have the error handling which is indicated in this subclause as mandatory ("shall") and that is indicated as strongly recommended ("should").

Also, the error handling of the network is only considered as mandatory or strongly recommended when certain thresholds for errors are not reached during a dedicated connection.

For definition of semantical and syntactical errors see 3GPP TS 24.007 [11], subclause 11.4.2.

D.8.2 Message too short or too long

D.8.2.1 Message too short

When a message is received that is too short to contain a complete message type information element, that message shall be ignored, c.f. 3GPP TS 24.007 [11].

D.8.2.2 Message too long

The maximum size of a UE policy delivery service message is 65535 octets.

D.8.3 Unknown or unforeseen procedure transaction identity

D.8.3.1 Procedure transaction identity

The following network procedures shall apply for handling an unknown, erroneous, or unforeseen PTI received in a UPDS message:

- a) In case the network receives a MANAGE UE POLICY COMPLETE message or MANAGE UE POLICY COMMAND REJECT message in which the PTI value is an assigned or unassigned value that does not match any PTI in use, the network shall ignore the UPDS message.
- b) In case the network receives a UPDS message in which the PTI value is a reserved value, the network shall ignore the UPDS message.

The following UE procedures shall apply for handling an unknown, erroneous, or unforeseen PTI received in a UPDS message:

- a) In case the UE receives a UPDS message in which the PTI value is a reserved value, the UE shall ignore the UPDS message.

D.8.4 Unknown or unforeseen message type

If the UE or the network receives a UPDS message with message type not defined for the UPDS or not implemented by the receiver, it shall ignore the UPDS message.

NOTE: A message type not defined for the UPDS in the given direction is regarded by the receiver as a message type not defined for the UPDS, see 3GPP TS 24.007 [11].

If the UE receives a message not compatible with the UPDS state, the UE shall ignore the UPDS message.

If the network receives a message not compatible with the UPDS state, the network actions are implementation dependent.

D.8.5 Non-semantical mandatory information element errors

D.8.5.1 Common procedures

When on receipt of a message,

- a) an "imperative message part" error; or
- b) a "missing mandatory IE" error

is diagnosed or when a message containing:

- a) a syntactically incorrect mandatory IE;
- b) an IE with an IEI unknown in the message, but encoded as "comprehension required" (see 3GPP TS 24.007 [11]); or
- c) an out of sequence IE encoded as "comprehension required" (see 3GPP TS 24.007 [11]) is received,

the UE shall ignore the UPDS message;

the network shall proceed as follows:

the network shall:

- 1) try to treat the message (the exact further actions are implementation dependent); or
- 2) ignore the message.

D.8.6 Unknown and unforeseen IEs in the non-imperative message part

D.8.6.1 IEs unknown in the message

The UE shall ignore all IEs unknown in a message which are not encoded as "comprehension required" (see 3GPP TS 24.007 [11]).

The network shall take the same approach.

D.8.6.2 Out of sequence IEs

The UE shall ignore all out of sequence IEs in a message which are not encoded as "comprehension required" (see 3GPP TS 24.007 [11]).

The network should take the same approach.

D.8.6.3 Repeated IEs

If an information element with format T, TV, TLV, or TLV-E is repeated in a message in which repetition of the information element is not specified in subclause D.5, the UE shall handle only the contents of the information element appearing first and shall ignore all subsequent repetitions of the information element. When repetition of information elements is specified, the UE shall handle only the contents of specified repeated information elements. If the limit on repetition of information elements is exceeded, the UE shall handle the contents of information elements appearing first up to the limit of repetitions and shall ignore all subsequent repetitions of the information element.

The network should follow the same procedures.

D.8.7 Non-imperative message part errors

This category includes:

- a) syntactically incorrect optional IEs; and
- b) conditional IE errors.

D.8.7.1 Syntactically incorrect optional IEs

The UE shall treat all optional IEs that are syntactically incorrect in a message as not present in the message.

The network shall take the same approach.

D.8.7.2 Conditional IE errors

When upon receipt of a UPDS message the UE diagnoses a "missing conditional IE" error or an "unexpected conditional IE" error, or when it receives a UPDS message containing at least one syntactically incorrect conditional IE, the UE shall ignore the message.

When the network receives a message and diagnoses a "missing conditional IE" error or an "unexpected conditional IE" error or when it receives a message containing at least one syntactically incorrect conditional IE, the network shall either:

- a) try to treat the message (the exact further actions are implementation dependent); or
- b) ignore the message.

D.8.8 Messages with semantically incorrect contents

When a message with semantically incorrect contents is received, the UE shall perform the foreseen reactions of the procedural part of subclauses D.2. If, however no such reactions are specified, the UE shall ignore the message.

The network should follow the same procedure.

Annex E (informative):
Void

Annex F (informative): Change history

Change history							
Date	Meeting	Tdoc	CR	Rev	Cat	Subject/Comment	New version
2017-10	CT1#106	C1-174182				Draft skeleton provided by the rapporteur.	0.0.0
2017-11	CT1#106					Implementing the following p-CRs agreed by CT1: C1-174183, C1-174184, C1-174185.	0.1.0
2017-12	CT1#107					Implementing the following p-CRs agreed by CT1: C1-175098, C1-175313. Corrections done by the rapporteur.	0.2.0
2017-12	CT1 e-mail review					Editorial corrections.	0.2.1
2017-12	CT1 e-mail review					Re-introduction of table in subclause 8.2.23.1	0.2.2
2018-02	CT1#108					Implementing the following p-CRs agreed by CT1: C1-180663, C1-180224, C1-180046, C1-180437, C1-180438, C1-180448, C1-180307, C1-180211, C1-180316, C1-180221, C1-180281, C1-180339, C1-180361, C1-180148, C1-180415, C1-180451, C1-180453, C1-180455, C1-180459, C1-180482, C1-180483, C1-180484, C1-180619, C1-180620, C1-180623, C1-180624, C1-180627, C1-180628, C1-180664, C1-180665, C1-180668, C1-180672, C1-180673, C1-180679, C1-180680, C1-180684, C1-180707, C1-180721, C1-180725, C1-180736, C1-180737, C1-180738, C1-180739, C1-180740, C1-180741, C1-180750, C1-180751, C1-180013, C1-180311, C1-180312, C1-180197, C1-180313, C1-180283, C1-180037, C1-180041, C1-180464, C1-180465, C1-180466, C1-180469, C1-180645, C1-180646, C1-180648, C1-180688, C1-180689, C1-180690, C1-180473, C1-180720, C1-180226, C1-180632, C1-180633, C1-180635, C1-180640, C1-180669, C1-180731, C1-180732, C1-180734, C1-180735, C1-180746, C1-180209, C1-180040, C1-180015, C1-180035, C1-180198, C1-180421, C1-180487, C1-180488, C1-180490, C1-180621, C1-180622, C1-180701, C1-180162, C1-180190, C1-180604, C1-180605, C1-180606, C1-180611, C1-180614, C1-180616, C1-180704, C1-180719, C1-180722, C1-180747, C1-180755, C1-180756 Corrections done by the rapporteur.	0.3.0
2018-02	CT1 e-mail review					Resolution of collision among C1-180679, C1-180721 and C1-180740. Resolution of collision among C1-180605, C1-180616 and C1-180704. Re-implementation of parts of C1-180035, C1-180488, C1-180605, C1-180606, C1-180729 and C1-180734 as some of the proposed changes were not implemented correctly in the previous version. Implementation of C1-180646 which was missed. Editorial corrections. Corrections done by the rapporteur.	0.3.1
2018-03	CT1#109					Implementing the following p-CRs agreed by CT1: C1-181362, C1-181377, C1-181456, C1-181457, C1-181703, C1-181748, C1-181462, C1-181786, C1-181168, C1-181269, C1-181278, C1-181307, C1-181180, C1-181279, C1-181280, C1-181281, C1-181354, C1-181283, C1-181284, C1-181287, C1-181305, C1-181352, C1-181364, C1-181365, C1-181366, C1-181399, C1-181466, C1-181467, C1-181468, C1-181470, C1-181471, C1-181473, C1-181474, C1-181477, C1-181628, C1-181629, C1-181633, C1-181661, C1-181663, C1-181666, C1-181668, C1-181670, C1-181681, C1-181682, C1-181683, C1-181684, C1-181695, C1-181696, C1-181707, C1-181713, C1-181715, C1-181716, C1-181717, C1-181718, C1-181733, C1-181734, C1-181735, C1-181736, C1-181737, C1-181738, C1-181739, C1-181740, C1-181741, C1-181747, C1-181752, C1-181764, C1-181770, C1-181771, C1-181781, C1-181782, C1-181785, C1-181182, C1-181120, C1-181121, C1-181395, C1-181480, C1-181482, C1-181484, C1-181485, C1-181486, C1-181487, C1-181488, C1-181650, C1-181651, C1-181652, C1-181678, C1-181726, C1-181751, C1-181273, C1-181274, C1-181276, C1-181277, C1-181496, C1-181784, C1-181312, C1-181357, C1-181605, C1-181606, C1-181609, C1-181645, C1-181674, C1-181675, C1-181677, C1-181679, C1-181708, C1-181710, C1-181728, C1-181613, C1-181615, C1-181680, C1-181750, C1-181618, C1-181619, C1-181779, C1-181360, C1-181636, C1-181640, C1-181643, C1-181729, C1-181730, C1-181731, C1-181732 Corrections done by the rapporteur.	0.4.0

2018-03	CT1 e-mail review				Re-implementation of C1-181168 and C1-181307. Re-implementation of C1-181656 and C1-181606 so that C1-181656 is implemented first. Reverting to the old title. Editorial corrections of some of the implemented p-CRs as well as adding some missing parts. Corrections done by the rapporteur.	0.4.1
2018-03	CT#79	CP-180101			Version 1.0.0 created for presentation to TSG CT#79 for information.	1.0.0
2018-05	CT1#110				Implementing the following p-CRs agreed by CT1: C1-182219, C1-182493, C1-182496, C1-182202, C1-182497, C1-182053, C1-182311, C1-182019, C1-182359, C1-182360, C1-182361, C1-182358, C1-182305, C1-182306, C1-182354, C1-182117, C1-182182, C1-182455, C1-182459, C1-182491, C1-182600, C1-182601, C1-182605, C1-182606, C1-182607, C1-182608, C1-182609, C1-182610, C1-182614, C1-182615, C1-182621, C1-182662, C1-182664, C1-182665, C1-182708, C1-182728, C1-182730, C1-182733, C1-182724, C1-182757, C1-182759, C1-182760, C1-182768, C1-182772, C1-182775, C1-182786, C1-182787, C1-182791, C1-182831, C1-182832, C1-182833, C1-182834, C1-182835, C1-183836, C1-182838, C1-182840, C1-182844, C1-182067, C1-182073, C1-182303, C1-182321, C1-182352, C1-182385, C1-182645, C1-182646, C1-182647, C1-182648, C1-182650, C1-182651, C1-182657, C1-182659, C1-182660, C1-182741, C1-182742, C1-182761, C1-182762, C1-182763, C1-182764, C1-182765, C1-182774, C1-182789, C1-182789, C1-182815, C1-182845, C1-182797, C1-182232, C1-182230, C1-182666, C1-182667, C1-182671, C1-182673, C1-182677, C1-182800, C1-182824, C1-182710, C1-182072, C1-182078, C1-182174, C1-182190, C1-182456, C1-182636, C1-182637, C1-182638, C1-182639, C1-182726, C1-182729, C1-182747, C1-182749, C1-182766, C1-182767, C1-182841, C1-182847, C1-182043, C1-182057, C1-182260, C1-182044, C1-182617, C1-182618, C1-182619, C1-182620, C1-182622, C1-182623, C1-182624, C1-182627, C1-182628, C1-182629, C1-182802, C1-182808, C1-182345, C1-182461, C1-182630 Corrections done by the rapporteur.	1.1.0
2018-05	CT1 e-mail review				Re-implementation of C1-182768, C1-182841, C1-182841, C1-182619, C1-182665, C1-182497, C1-182067 and C1-182078 to correct some editorials as well as adding some missing parts. Corrections done by the rapporteur.	1.1.1
2018-06	CT1#111				Implementing the following p-CRs agreed by CT1: C1-183268, C1-183109, C1-183281, C1-183517, C1-183518, C1-183519, C1-183791, C1-183115, C1-183527, C1-183812, C1-183813, C1-183141, C1-183148, C1-183406, C1-183070, C1-183207, C1-183273, C1-183276, C1-183277, C1-183415, C1-183143, C1-183146, C1-183197, C1-183260, C1-183142, C1-183151, C1-183154, C1-183225, C1-183205, C1-183223, C1-183314, C1-183278, C1-183367, C1-183279, C1-183381, C1-183399, C1-183413, C1-183467, C1-183530, C1-183532, C1-183533, C1-183534, C1-183535, C1-183538, C1-183539, C1-183715, C1-183716, C1-183717, C1-183718, C1-183720, C1-183721, C1-183737, C1-183739, C1-183741, C1-183744, C1-183745, C1-183748, C1-183749, C1-183750, C1-183751, C1-183774, C1-183775, C1-183779, C1-183780, C1-183781, C1-183809, C1-183822, C1-183824, C1-183825, C1-183826, C1-183845, C1-183858, C1-183761, C1-183147, C1-183237, C1-183329, C1-183353, C1-183378, C1-183387, C1-183401, C1-183408, C1-183499, C1-183541, C1-183542, C1-183543, C1-183545, C1-183726, C1-183756, C1-183757, C1-183758, C1-183759, C1-183762, C1-183795, C1-183796, C1-183802, C1-183827, C1-183846, C1-183847, C1-183848, C1-183211, C1-183731, C1-183784, C1-183578, C1-183585, C1-183831, C1-183861, C1-183247, C1-183562, C1-183563, C1-183798, C1-183194, C1-183238, C1-183256, C1-183528, C1-183427, C1-183706, C1-183707, C1-183709, C1-183763, C1-183766, C1-183767, C1-183768, C1-183769, C1-183770, C1-183771, C1-183772, C1-183773, C1-183785, C1-183787, C1-183788, C1-183789, C1-183799, C1-183805, C1-183816, C1-183832, C1-183834, C1-183849, C1-183850, C1-183114, C1-183457, C1-183458, C1-183510, C1-183511, C1-183512, C1-183513, C1-183515, C1-183800, C1-183806, C1-183470 Corrections done by the rapporteur.	1.2.0

2018-06	CT1 e-mail review					Re-implementation of C1-183535, C1-183813, C1-183408, C1-183766 and C1-183831. Implementation of C1-183816 which was missed. Editorial corrections of some of the implemented p-CRs. Corrections done by the rapporteur.	1.2.1
2018-06	CT#80	CP-181094				Version 2.0.0 created for presentation to TSG CT#80 for approval.	2.0.0
2018-06	CT#80					Version 15.0.0 created after approval	15.0.0
2018-09	CT#81	CP-182139	0001		F	Replace unknown "registration update accept"	15.1.0
2018-09	CT#81	CP-182142	0003	2	F	Pass (Extended) Emergency Number List to upper layers	15.1.0
2018-09	CT#81	CP-182132	0004		F	Correcting access selection for SMS over NAS	15.1.0
2018-09	CT#81	CP-182138	0006	1	F	Referring to the correct bits for SMS over NAS during the registration procedure	15.1.0
2018-09	CT#81	CP-182140	0007	1	F	Setting and checking 5GS update status	15.1.0
2018-09	CT#81	CP-182132	0008	1	F	Clarifications on MICO indication	15.1.0
2018-09	CT#81	CP-182141	0009	1	F	Timer T3540 clarifications	15.1.0
2018-09	CT#81	CP-182137	0010	3	F	Network Slicing Subscription Change Indication	15.1.0
2018-09	CT#81	CP-182133	0012		F	Correction for PDU session context	15.1.0
2018-09	CT#81	CP-182133	0013	1	F	Correction for establishment of user-plane resources	15.1.0
2018-09	CT#81	CP-182133	0014	1	F	Correction for establishment cause	15.1.0
2018-09	CT#81	CP-182133	0016	4	F	Correction for maximum data rate per UE for integrity protection for DRBs	15.1.0
2018-09	CT#81	CP-182137	0018	3	F	Invalid DNN	15.1.0
2018-09	CT#81	CP-182132	0020	1	F	Correction for 5GMM cause #90 in subclause A.3	15.1.0
2018-09	CT#81	CP-182135	0021		F	Editor's notes in UPDP	15.1.0
2018-09	CT#81	CP-182136	0023	2	F	Exchange of extended protocol configuration options	15.1.0
2018-09	CT#81	CP-182130	0024	1	F	5G QoS - restructuring QoS rules IE	15.1.0
2018-09	CT#81	CP-182133	0025	1	F	Correction for editor's note on further 5GSM causes and further minor issues	15.1.0
2018-09	CT#81	CP-182132	0026		F	Correction and alignment of cause code values	15.1.0
2018-09	CT#81	CP-182141	0027	2	F	UAC information and establishment cause when uplink user data packet is to be sent for a PDU session with suspended user-plane resources	15.1.0
2018-09	CT#81	CP-182134	0028	2	F	Corrections for operator-defined access categories	15.1.0
2018-09	CT#81	CP-182131	0030	1	F	AMF Region ID (8 bits), AMF Set ID (10 bits), and AMF Pointer (6 bits)	15.1.0
2018-09	CT#81	CP-182132	0031	1	F	Correcting message definition of message including EENL	15.1.0
2018-09	CT#81	CP-182141	0032	2	F	SMF knowledge that a UE is configured for high priority access	15.1.0
2018-09	CT#81	CP-182131	0035	2	F	Authentication for normal services not accepted by network	15.1.0
2018-09	CT#81	CP-182130	0036	4	C	Addition of ABBA in 5G based primary authentication procedure	15.1.0
2018-09	CT#81	CP-182131	0037	2	C	Alignment and correction of mapped security context creation at S1 to N1 mode HO	15.1.0
2018-09	CT#81	CP-182130	0038	1	C	Addition of NAS container IE for N1 mode HO	15.1.0
2018-09	CT#81	CP-182132	0039	1	F	Correction and update of S1 mode to N1 mode NAS transparent container	15.1.0
2018-09	CT#81	CP-182139	0040	1	C	Removal of MAC editor's note	15.1.0
2018-09	CT#81	CP-182139	0041	1	F	Removal of transparent container at N1 mode to S1 mode HO	15.1.0
2018-09	CT#81	CP-182133	0042		F	Correction of 5GS TAC LSB	15.1.0
2018-09	CT#81	CP-182136	0043	1	B	Handling of Emergency PDU sessions and null algorithms	15.1.0
2018-09	CT#81	CP-182139	0044	2	B	Request for Kamf re-derivation	15.1.0
2018-09	CT#81	CP-182137	0045	1	F	Mobility Registration when T3346 running	15.1.0
2018-09	CT#81	CP-182135	0046		F	DL NAS Transport message	15.1.0
2018-09	CT#81	CP-182140	0047	1	F	Single-registration mode	15.1.0
2018-09	CT#81	CP-182131	0048		F	Authentication Response	15.1.0
2018-09	CT#81	CP-182138	0049	2	F	Parameters for PDU session establishment due to change of SSC mode 3 or 2 PSA	15.1.0
2018-09	CT#81	CP-182136	0054	2	F	Equivalent PLMNs	15.1.0
2018-09	CT#81	CP-182139	0055	2	F	Remove the remaining instance of SUPI paging	15.1.0
2018-09	CT#81	CP-182138	0056	2	F	PDU session status	15.1.0
2018-09	CT#81	CP-182131	0058	1	F	Clarification on NAS level MM congestion Control	15.1.0
2018-09	CT#81	CP-182141	0060	3	B	SM cause for out of LADN service area	15.1.0
2018-09	CT#81	CP-182139	0064	1	F	Removal of redundant MICO statement	15.1.0
2018-09	CT#81	CP-182137	0065	4	C	LADN indication from UE at registration	15.1.0
2018-09	CT#81	CP-182137	0066		F	Mapping to configured NSSAI for HPLM shall be included if available	15.1.0
2018-09	CT#81	CP-182130	0069	2	F	Abnormal Cases in the UE for mobility and periodic Registration Update Procedures	15.1.0
2018-09	CT#81	CP-182134	0070	1	D	Correction to 5GMM Substate	15.1.0
2018-09	CT#81	CP-182135	0071	1	F	Definition of emergency and non-emergency PDU sessions	15.1.0
2018-09	CT#81	CP-182138	0074	2	F	PDU session establish criteria for emergency PDU sessions	15.1.0
2018-09	CT#81	CP-182140	0075	3	F	Service request allowed for PDU release outside LADN	15.1.0
2018-09	CT#81	CP-182136	0076	2	F	Handling of Transmission failure for Service request message.	15.1.0

2018-09	CT#81	CP-182136	0077	4	B	How to determine the maximum number of established PDU sessions	15.1.0
2018-09	CT#81	CP-182141	0079	2	F	UAC and setting of the Uplink data status IE	15.1.0
2018-09	CT#81	CP-182137	0080	1	C	Non-3GPP access to 5GCN not allowed	15.1.0
2018-09	CT#81	CP-182136	0082	2	B	Including S-NSSAI received in EPS in Requested NSSAI and in PDU session establishment request upon inter-system change from S1 mode to N1 mode	15.1.0
2018-09	CT#81	CP-182141	0083		B	UE configuration for AC 11-15 and MCS (access identity 2)	15.1.0
2018-09	CT#81	CP-182142	0084		B	UE configuration for NAS signalling low priority via OMA-DM or USIM not applicable in 5GS	15.1.0
2018-09	CT#81	CP-182137	0085	2	F	Miscellaneous corrections	15.1.0
2018-09	CT#81	CP-182132	0086	2	F	Clarifications on ATTEMPTING-REGISTRATION-UPDATE	15.1.0
2018-09	CT#81	CP-182141	0087	2	F	UE behaviour in substate ATTEMPTING-REGISTRATION-UPDATE	15.1.0
2018-09	CT#81	CP-182140	0090		F	Service area list IE	15.1.0
2018-09	CT#81	CP-182136	0091	1	F	Handling of forbidden tracking area list	15.1.0
2018-09	CT#81	CP-182134	0092	2	F	Corrections for authentication	15.1.0
2018-09	CT#81	CP-182141	0094	4	F	Trigger for mobility and periodic registration update	15.1.0
2018-09	CT#81	CP-182130	0095		F	Abnormal cases in the UE for network-initiated de-registration procedure	15.1.0
2018-09	CT#81	CP-182130	0096	4	F	Add attempt counter to Service Request procedure	15.1.0
2018-09	CT#81	CP-182131	0097	1	F	Authentication procedure during registration procedure for mobility and periodic registration update	15.1.0
2018-09	CT#81	CP-182138	0098	4	F	Registration procedure for mobility and periodic registration update	15.1.0
2018-09	CT#81	CP-182138	0099	3	F	Release of the N1 NAS signalling connection	15.1.0
2018-09	CT#81	CP-182139	0100	2	F	Resetting of registration attempt counter	15.1.0
2018-09	CT#81	CP-182138	0101	4	F	On #27 N1 mode not allowed	15.1.0
2018-09	CT#81	CP-182130	0102	3	F	Adding EPLMN list related descriptions	15.1.0
2018-09	CT#81	CP-182138	0104	2	F	Provision of IWK N26 indication in registration update procedure	15.1.0
2018-09	CT#81	CP-182134	0105		F	Corrections for interworking with EPS	15.1.0
2018-09	CT#81	CP-182135	0106	4	F	Emergency Services Support indicator for non-3GPP access	15.1.0
2018-09	CT#81	CP-182219	0107	7	C	Network control for always-on PDU sessions	15.1.0
2018-09	CT#81	CP-182135	0108		F	Corrections on inconsistent descriptions for 5GSM and 5GMM	15.1.0
2018-09	CT#81	CP-182135	0110		F	Corrections on the timers of 5GMM	15.1.0
2018-09	CT#81	CP-182137	0112	1	F	No operation code for UE policy management	15.1.0
2018-09	CT#81	CP-182134	0113	1	F	Correction on UE behaviour for 5GSM congestion control	15.1.0
2018-09	CT#81	CP-182134	0114		F	Correction on UE security capability IE	15.1.0
2018-09	CT#81	CP-182136	0115	5	F	Including SD when Mapped configured SD is included in S-NSSAI	15.1.0
2018-09	CT#81	CP-182142	0116	3	F	Updates to deleting a derived QoS rule in the UE	15.1.0
2018-09	CT#81	CP-182138	0117		F	Provisioning of ANDSP for non-3GPP access	15.1.0
2018-09	CT#81	CP-182136	0118		D	Fix incorrect references	15.1.0
2018-09	CT#81	CP-182130	0120	2	F	Addition of ngKSI in DEREGISTRATION REQUEST	15.1.0
2018-09	CT#81	CP-182141	0123	2	F	Storing of MPS indicator in non-volatile memory of mobile	15.1.0
2018-09	CT#81	CP-182138	0124	4	C	NW slicing and delayed re-registration due to emergency services	15.1.0
2018-09	CT#81	CP-182131	0125	1	F	Addition of cause values for service request reject	15.1.0
2018-09	CT#81	CP-182141	0126	3	F	UE actions when other causes received at SERVICE REJECT	15.1.0
2018-09	CT#81	CP-182137	0128		F	Missing general description on sub-clause 9.10	15.1.0
2018-09	CT#81	CP-182134	0130		F	Correction to general message format	15.1.0
2018-09	CT#81	CP-182138	0131		F	Plain 5GS NAS message	15.1.0
2018-09	CT#81	CP-182134	0134	1	F	Correction to the 5GMM capability IE	15.1.0
2018-09	CT#81	CP-182134	0135		F	Correction to the 5GS identity type IE	15.1.0
2018-09	CT#81	CP-182134	0136	1	F	Correction to the 5GS network feature support IE	15.1.0
2018-09	CT#81	CP-182135	0137	1	F	Editorials and minor corrections	15.1.0
2018-09	CT#81	CP-182140	0138		F	Security procedures and handling after inter-system change	15.1.0
2018-09	CT#81	CP-182130	0140		F	5GMM aspects of NAS over non-3GPP access	15.1.0
2018-09	CT#81	CP-182139	0141	2	F	Resolution of editor's note on equivalent PLMN list	15.1.0
2018-09	CT#81	CP-182140	0142		F	Resolution of editor's notes on 5GMM sub-layer design	15.1.0
2018-09	CT#81	CP-182139	0143		F	Resolution of editor's note on UE behaviour in substate 5GMM-DEREGISTERED.ATTEMPTING-REGISTRATION	15.1.0
2018-09	CT#81	CP-182139	0144		F	Resolution of editor's note on other sub-states of state 5GMM-DEREGISTERED	15.1.0
2018-09	CT#81	CP-182139	0145	3	F	Resolution of editor's note on sub-states of state 5GMM-REGISTERED	15.1.0
2018-09	CT#81	CP-182139	0146	1	F	Resolution of editor's note on the key derivation function field	15.1.0
2018-09	CT#81	CP-182139	0147		F	Resolution of editor's note on security context coordination	15.1.0
2018-09	CT#81	CP-182139	0148		F	Removal of unnecessary editor's notes FFS	15.1.0
2018-09	CT#81	CP-182139	0151		F	Resolution of editor's note on handling of unknown, unforeseen, and erroneous protocol data	15.1.0

2018-09	CT#81	CP-182131	0153	2	C	AMF taking both EMC and EMC BS availability into account in setting EMF	15.1.0
2018-09	CT#81	CP-182131	0154	1	F	Clarification on SM congestion control specific to PLMN	15.1.0
2018-09	CT#81	CP-182131	0155	1	F	Aligning T35cd handling upon NW initiated SM request with T3396 and T35ef	15.1.0
2018-09	CT#81	CP-182132	0156	2	F	Clarification on stopping back-off timers upon reception of NW initiated SM request	15.1.0
2018-09	CT#81	CP-182131	0157	1	F	Clarification for registration attempt counter handling and introduction of lower layer failure	15.1.0
2018-09	CT#81	CP-182137	0158	2	B	Introduction of 5GMM cause #15	15.1.0
2018-09	CT#81	CP-182141	0159	1	F	Timer for re-enabling N1 mode capability	15.1.0
2018-09	CT#81	CP-182137	0160		F	Lists of 5GS forbidden tracking areas	15.1.0
2018-09	CT#81	CP-182137	0162	1	F	Local release of a persistent PDU session	15.1.0
2018-09	CT#81	CP-182134	0163	1	F	Correction on retry of PDU session establishment procedure	15.1.0
2018-09	CT#81	CP-182134	0164		F	Correction to 5GSM/ESM coordination	15.1.0
2018-09	CT#81	CP-182133	0165		F	Correction on PDU address IE	15.1.0
2018-09	CT#81	CP-182130	0166	1	F	5GSM congestion control over AMF on PDU session modification procedure	15.1.0
2018-09	CT#81	CP-182136	0167	3	F	Exception handling in QoS operation	15.1.0
2018-09	CT#81	CP-182134	0168	1	F	Correction on PTI mismatch	15.1.0
2018-09	CT#81	CP-182136	0169	1	B	Establishment of N1 NAS signalling connection due to change in the network slicing information	15.1.0
2018-09	CT#81	CP-182138	0170	2	F	Release of N1 NAS signalling connection due to change in the network slicing information	15.1.0
2018-09	CT#81	CP-182137	0171	3	F	Multiple S-NSSAIs in PDU session establishment	15.1.0
2018-09	CT#81	CP-182132	0173	3	F	Clarifications on UE 5GSM capabilities and procedures during inter-working with EPS	15.1.0
2018-09	CT#81	CP-182136	0174	1	B	Interworking between ePDG/EPC and NG-RAN/5GCN	15.1.0
2018-09	CT#81	CP-182136	0176	1	B	Interworking between E-UTRAN/EPC and N3IWF/5GCN	15.1.0
2018-09	CT#81	CP-182142	0178	2	F	UE re-registration when the AMF cannot determine an Allowed NSSAI	15.1.0
2018-09	CT#81	CP-182137	0180	2	F	Local release of a PDU session due to 5GSM cause #43: Invalid PDU session identity	15.1.0
2018-09	CT#81	CP-182132	0182	2	C	Common NAS security transparent container IE for intra-5G HO and S1 to N1 inter-system HO	15.1.0
2018-09	CT#81	CP-182136	0184	1	F	Handling of PDU session type after intersystem change from N1 mode to S1 mode	15.1.0
2018-09	CT#81	CP-182131	0185	2	F	Allowed NSSAI of a single-registration mode UE within a network with N26	15.1.0
2018-09	CT#81	CP-182141	0187	1	F	SMF selection based on DNN for transfer a PDN connection from EPS to 5GS	15.1.0
2018-09	CT#81	CP-182141	0188	1	F	UE behaviour for determination of the UE presence in LADN service area	15.1.0
2018-09	CT#81	CP-182133	0189	3	F	Correction on emergency PDU session handling	15.1.0
2018-09	CT#81	CP-182137	0190	1	F	No EMM parameters handling for DR mode UEs due to rejected service request	15.1.0
2018-09	CT#81	CP-182131	0192	3	F	Clarification on activation of UP resources of PDU session	15.1.0
2018-09	CT#81	CP-182130	0194	1	B	Access attempt barred for the UE-initiated NAS transport procedure	15.1.0
2018-09	CT#81	CP-182142	0195	5	F	UE configured for EAB and access category 1	15.1.0
2018-09	CT#81	CP-182137	0197	1	F	No bearer for N1 NAS	15.1.0
2018-09	CT#81	CP-182133	0198	4	F	Correction of S-NSSAI based congestion control	15.1.0
2018-09	CT#81	CP-182132	0199	1	F	Clean-up in definitions	15.1.0
2018-09	CT#81	CP-182132	0200	4	F	Clarify abnormal cases in the UE for independency of 5GMM procedures between accesses	15.1.0
2018-09	CT#81	CP-182141	0203	2	B	Storing Configured NSSAI when the PLMN is changed	15.1.0
2018-09	CT#81	CP-182136	0206		F	Incorrect statement for handling of security context at IWK	15.1.0
2018-09	CT#81	CP-182134	0207	2	F	Correction to SSC mode selection	15.1.0
2018-09	CT#81	CP-182135	0208	2	F	Corrections to terms and references	15.1.0
2018-09	CT#81	CP-182140	0209	1	C	Revision on AMF transport behaviour of 5GSM message	15.1.0
2018-09	CT#81	CP-182135	0210	2	F	Differences between NAS over 3GPP access and NAS over non-3GPP access	15.1.0
2018-09	CT#81	CP-182138	0212	6	B	Preferred list terminating at ME or USIM	15.1.0
2018-09	CT#81	CP-182131	0213	4	F	Clarification on network-initiated de-registration procedure	15.1.0
2018-09	CT#81	CP-182133	0214		F	Correction of detach terminology	15.1.0
2018-09	CT#81	CP-182132	0215		F	Clarification on S-NSSAI based congestion control for PDU session modification procedure	15.1.0
2018-09	CT#81	CP-182141	0216	4	B	SOR acknowledge message coding	15.1.0
2018-09	CT#81	CP-182141	0232	1	F	SMS over NAS re-transmission upon delivery failure on one Access Type	15.1.0
2018-09	CT#81	CP-182134	0233	2	F	Corrections in EAP based primary authentication procedure (alternative 2)	15.1.0
2018-09	CT#81	CP-182133	0234		F	Correction for multi-homed IPv6 PDU session	15.1.0

2018-09	CT#81	CP-182133	0235	1	F	Correction for transfer of a PDN connection from untrusted non-3GPP access connected to EPC	15.1.0
2018-09	CT#81	CP-182133	0237	1	F	Correction for generation of QoS rules	15.1.0
2018-09	CT#81	CP-182137	0239		F	Interworking for multi-homed IPv6 PDU session	15.1.0
2018-09	CT#81	CP-182131	0241	1	F	Clarification of N1 NAS signalling connection release in AMF on generic UE configuration update completion	15.1.0
2018-09	CT#81	CP-182139	0242	1	F	Requests for emergency services fallback from upper layers	15.1.0
2018-09	CT#81	CP-182135	0245		F	Corrections to the Identification and Registration procedures	15.1.0
2018-09	CT#81	CP-182132	0246		F	Correct abnormal procedures reference when handling CC #22 (Congestion)	15.1.0
2018-09	CT#81	CP-182137	0247	1	F	Non-IP PDN connection type for S1 to N1 interworking	15.1.0
2018-09	CT#81	CP-182137	0248	1	F	Non-3GPP de-registration timer	15.1.0
2018-09	CT#81	CP-182141	0250	3	F	Substates for registration result	15.1.0
2018-09	CT#81	CP-182142	0251	1	F	Updating NS Configuration via registration procedure	15.1.0
2018-09	CT#81	CP-182141	0254	4	B	SUCI encoding format and protection scheme	15.1.0
2018-09	CT#81	CP-182132	0255	1	C	Clarify the method of configuring the UE to use Access Identity 1	15.1.0
2018-09	CT#81	CP-182136	0256	1	B	Handling of error case when UE gets URSP from VPLMN	15.1.0
2018-09	CT#81	CP-182132	0258	2	F	Correction for abnormal cases in the UE of service request procedure	15.1.0
2018-09	CT#81	CP-182140	0259	1	F	Setting of RRC establishment cause for operator-defined access categories	15.1.0
2018-09	CT#81	CP-182131	0262		F	Alignment with terminology "emergency PDU session" throughout TS 24.501	15.1.0
2018-09	CT#81	CP-182141	0263	1	F	TAI removed from list of Service area lists after reject from network	15.1.0
2018-09	CT#81	CP-182135	0264	1	F	EAP message IE mandatory in PDU SESSION AUTHENTICATION messages	15.1.0
2018-09	CT#81	CP-182135	0269	1	F	Corrections related to the authentication procedure	15.1.0
2018-09	CT#81	CP-182140	0271	2	F	Security parameter carrying DL NAS COUNT during N1 to S1 mode HO	15.1.0
2018-09	CT#81	CP-182130	0272	2	F	Adding procedures for updating local emergency numbers in other modes	15.1.0
2018-09	CT#81	CP-182131	0275		F	Authentication response parameter IE to be of fixed length (24.501)	15.1.0
2018-09	CT#81	CP-182134	0276		F	Correction to the PDU Session ID value in Allowed PDU session status IE	15.1.0
2018-09	CT#81	CP-182138	0277	2	F	Reactivation result indicating insufficient resources during service request procedure	15.1.0
2018-09	CT#81	CP-182138	0278	1	C	Registration procedure triggered by a change of UE Radio Capability	15.1.0
2018-09	CT#81	CP-182142	0280	2	F	Updates to RRC fallback indication while in 5GMM-CONNECTED mode, or while in 5GMM-CONNECTED mode with RRC inactive indication	15.1.0
2018-09	CT#81	CP-182138	0281	2	C	PDU Session Release due to Semantic or Syntactical Errors	15.1.0
2018-09	CT#81	CP-182138	0282	3	F	Removal of 5GSM cause from ePCO for PDU Session Release Complete	15.1.0
2018-09	CT#81	CP-182134	0283		F	Correction on PTI definition	15.1.0
2018-09	CT#81	CP-182140	0284	1	F	Resolving EN on fatal causes in 5GMM/5GSM state machine	15.1.0
2018-09	CT#81	CP-182130	0285	1	F	Uplink data handling for MT notification	15.1.0
2018-09	CT#81	CP-182136	0286	1	F	Fallback handling for RRC inactive	15.1.0
2018-09	CT#81	CP-182134	0287	1	F	Correction on PDU session modification procedure	15.1.0
2018-09	CT#81	CP-182140	0289	1	F	RRC establishment cause for EAB	15.1.0
2018-09	CT#81	CP-182138	0290	2	C	NW slicing and delayed registration due to emergency services, reject PDU session request	15.1.0
2018-09	CT#81	CP-182134	0291	1	F	Correction to the UE security capability IE encoding	15.1.0
2018-09	CT#81	CP-182130	0292	3	F	Additions to UE configuration update completion clause	15.1.0
2018-09	CT#81	CP-182139	0293	2	F	Removal of local PDU session release statement in UCU procedure	15.1.0
2018-09	CT#81	CP-182140	0294		F	Resolution of editor's notes in D.3 and D.6.2	15.1.0
2018-09	CT#81	CP-182140	0295		F	Resolution of the editor's note on value of the non-3GPP de-registration timer value	15.1.0
2018-09	CT#81	CP-182139	0296		F	Resolution of editor's note on the format of the authentication parameters	15.1.0
2018-09	CT#81	CP-182140	0297	2	F	Resolution of editor's note on unknown or unforeseen PDU session identity	15.1.0
2018-09	CT#81	CP-182139	0298		F	Resolution of editor's note on other types of payload for the NAS transport procedure(s)	15.1.0
2018-09	CT#81	CP-182140	0300	2	F	Serving network name format for primary authentication	15.1.0
2018-09	CT#81	CP-182136	0301	1	B	Initial registration not accepted due to serving network not authorized	15.1.0
2018-09	CT#81	CP-182130	0303	1	F	5GSM cause #xx –out of LADN service area	15.1.0
2018-09	CT#81	CP-182142	0304	1	F	UE policy delivery protocol in the scope	15.1.0
2018-09	CT#81	CP-182131	0305	1	F	AMF pointer pointing one or more AMFs	15.1.0
2018-09	CT#81	CP-182135	0306		F	Corrections in the conditions for SMS via non-3GPP access	15.1.0

2018-09	CT#81	CP-182130	0308		F	5GMM STATUS message sent by the AMF when certain error conditions are detected upon receipt of 5GMM protocol data in the AMF	15.1.0
2018-09	CT#81	CP-182137	0311	1	F	Interworking with E-UTRAN connected to EPC of a UE registered to 5GC via non-3GPP access	15.1.0
2018-09	CT#81	CP-182142	0313	2	F	Use of S-NSSAI and session-AMBR provided during the EPS bearer context modification procedure	15.1.0
2018-09	CT#81	CP-182136	0314	1	F	Handling of inter-access handover of a PDU session whose S-NSSAI is not allowed for the target access	15.1.0
2018-09	CT#81	CP-182130	0319	1	F	5GSM sublayer states for PDU session inactive	15.1.0
2018-09	CT#81	CP-182139	0321	1	F	Rename of T3584 and T3585	15.1.0
2018-09	CT#81	CP-182133	0322		F	Correction on acknowledgement handling of UE configuration update	15.1.0
2018-09	CT#81	CP-182133	0323	1	F	Correction on NW initiated de-registration procedure	15.1.0
2018-09	CT#81	CP-182140	0326	1	F	Service area restrictions	15.1.0
2018-09	CT#81	CP-182135	0327	3	F	Disabling and re-enabling N1 mode capability	15.1.0
2018-09	CT#81	CP-182131	0328	1	F	Clarification on packet filters	15.1.0
2018-09	CT#81	CP-182133	0329	1	F	Correction on 5G-GUTI type encoding	15.1.0
2018-09	CT#81	CP-182133	0330	1	F	Correction on EAP-AKA' based primary authentication	15.1.0
2018-09	CT#81	CP-182133	0331		F	Correction on 5GSM state mapping when interworking	15.1.0
2018-09	CT#81	CP-182138	0333	1	F	Removal of Default EPS Bearer (DEB) indication	15.1.0
2018-09	CT#81	CP-182133	0334	1	F	Correction on interaction with upper layers	15.1.0
2018-09	CT#81	CP-182140	0337	2	F	Security Context	15.1.0
2018-09	CT#81	CP-182135	0339	3	B	Emergency call in limited service state	15.1.0
2018-09	CT#81	CP-182201	0340	3	C	Emergency call error handling	15.1.0
2018-09	CT#81	CP-182138	0341	2	F	PDU session status in notification response message	15.1.0
2018-09	CT#81	CP-182132	0342	1	F	Clarifications on inclusion of S-NSSAI in 5GSM request	15.1.0
2018-09	CT#81	CP-182133	0344		F	Correction for LADN	15.1.0
2018-09	CT#81	CP-182135	0345	1	F	Definition of user-plane resources	15.1.0
2018-09	CT#81	CP-182136	0346	1	F	Handling of PDU session(s) not supporting interworking with EPS	15.1.0
2018-09	CT#81	CP-182141	0350		D	Terminology correction	15.1.0
2018-09	CT#81	CP-182131	0351	3	F	Clarification on MICO indication and LADN information via generic UE configuration update procedure	15.1.0
2018-09	CT#81	CP-182132	0352	1	F	Clarification on the temporary identity in the service request procedure	15.1.0
2018-09	CT#81	CP-182130	0353		F	Abbreviation update for NITZ	15.1.0
2018-09	CT#81	CP-182135	0355		D	Duplicated subclause for registration request message	15.1.0
2018-09	CT#81	CP-182135	0356	1	D	Editorial corrections	15.1.0
2018-09	CT#81	CP-182135	0357	2	B	DL and UL NAS Transport procedure updates for SOR	15.1.0
2018-09	CT#81	CP-182132	0358	1	F	Conditions to send registration complete message.	15.1.0
2018-09	CT#81	CP-182132	0359	1	F	Condition for starting timer T3540	15.1.0
2018-09	CT#81	CP-182140	0361	2	F	Security context mapping at 5GS to EPS HO	15.1.0
2018-09	CT#81	CP-182134	0363	2	F	Correction to reset registration attempt counter	15.1.0
2018-09	CT#81	CP-182130	0365	3	F	Adding the reference to T3346	15.1.0
2018-09	CT#81	CP-182130	0367	1	F	Access attempt due to delivery of LPP message/transparent container/UE policy container	15.1.0
2018-12	CT#82	CP-183032	0103	6	F	Clarification on coordination between 5GMM and 5GSM	15.2.0
2018-12	CT#82	CP-183032	0121	10	F	Clarification to VoPS indicator	15.2.0
2018-12	CT#82	CP-183032	0274	4	F	Correct Extended Local Emergency Numbers List deletion upon PLMN change	15.2.0
2018-12	CT#82	CP-183032	0315	4	F	Operator-controlled inclusion of NSSAI in access stratum connection establishment	15.2.0
2018-12	CT#82	CP-183032	0371	2	F	Correction for maximum data rate per UE for integrity protection for DRBs for PDU sessions in non-3GPP access which are transferable to 3GPP access	15.2.0
2018-12	CT#82	CP-183032	0372	1	F	Correction for 3GPP PS data off and non-IP user data packets	15.2.0
2018-12	CT#82	CP-183032	0373	2	F	Corrections for determination of RRC establishment cause and establishment cause for non-3GPP access	15.2.0
2018-12	CT#82	CP-183032	0374		F	Corrections for MTU PCO parameters handling	15.2.0
2018-12	CT#82	CP-183032	0376	2	F	Correction for SM PDU DN request container coding	15.2.0
2018-12	CT#82	CP-183032	0379	1	F	UAC: Correction for SMSoIP sent over DNN other than "IMS"	15.2.0
2018-12	CT#82	CP-183032	0380	2	F	UAC: Correction for operator-defined access categories	15.2.0
2018-12	CT#82	CP-183032	0381	1	F	DRX parameters IE definition	15.2.0
2018-12	CT#82	CP-183032	0383	1	F	Removal of UE security capability from Intra N1 mode NAS container	15.2.0
2018-12	CT#82	CP-183032	0385		F	Correct procedure for determining registered PLMN	15.2.0
2018-12	CT#82	CP-183032	0392	1	F	Definition of emergency registration	15.2.0
2018-12	CT#82	CP-183032	0393	1	F	Correction for EAP based primary authentication and AUTHENTICATION REJECT	15.2.0
2018-12	CT#82	CP-183032	0394		F	Correction for LADN information encoding	15.2.0
2018-12	CT#82	CP-183032	0395	3	B	Dynamic Routing indicator update description	15.2.0
2018-12	CT#82	CP-183032	0398	1	F	ABBA handling for 5G-AKA based authentication procedure	15.2.0

2018-12	CT#82	CP-183032	0399	2	F	ABBA handling when initiating EAP procedures	15.2.0
2018-12	CT#82	CP-183032	0401	3	F	Clarification on NAS message field format and mapping	15.2.0
2018-12	CT#82	CP-183032	0402	1	F	Correction to home country definition	15.2.0
2018-12	CT#82	CP-183032	0403	1	F	Signalling Default Configured NSSAI indication in the registration procedure	15.2.0
2018-12	CT#82	CP-183032	0404	1	F	Rename "configured NSSAI not associated with a PLMN" to align to new stage 2 terminology	15.2.0
2018-12	CT#82	CP-183032	0405	1	F	"SMS subscribed indication" in CONFIGURATION UPDATE COMMAND	15.2.0
2018-12	CT#82	CP-183033	0406	1	F	S-NSSAI not allowed by AMF	15.2.0
2018-12	CT#82	CP-183033	0407		F	Continued need to align with terminology "emergency PDU session" throughout TS 24.501	15.2.0
2018-12	CT#82	CP-183033	0408	1	F	Ambiguity in the use of the terms "no other parameter" and "no parameters"	15.2.0
2018-12	CT#82	CP-183033	0409		F	Change EMCW to EMCN3	15.2.0
2018-12	CT#82	CP-183033	0410	2	F	Miscellaneous wording, terminology and reference corrections	15.2.0
2018-12	CT#82	CP-183033	0411		F	Rejected NSSAI clarifications	15.2.0
2018-12	CT#82	CP-183033	0413	1	F	Rejected NSSAI sent in CONFIGURATION UPDATE COMMAND – Alt 2	15.2.0
2018-12	CT#82	CP-183033	0415		F	UAC – meaning of "the broadcast of categories a, b or c"	15.2.0
2018-12	CT#82	CP-183033	0416	2	F	Clarification of "registration requested" in CONFIGURATION UPDATE COMMAND	15.2.0
2018-12	CT#82	CP-183033	0417	5	F	Updates on steering of roaming handling and information coding	15.2.0
2018-12	CT#82	CP-183033	0419	3	F	Security context usage during NAS security mode control procedure	15.2.0
2018-12	CT#82	CP-183033	0420	1	F	Corrections on GFBR parameter for QoS flow	15.2.0
2018-12	CT#82	CP-183033	0421	1	F	Correction to UE behavior when disabling N1 mode for non-3GPP access	15.2.0
2018-12	CT#82	CP-183033	0423	1	F	Mapped QoS information validation (Solution 1)	15.2.0
2018-12	CT#82	CP-183033	0424	4	B	Protection of initial NAS messages – overall description	15.2.0
2018-12	CT#82	CP-183033	0425	4	B	Support for protection of initial NAS messages	15.2.0
2018-12	CT#82	CP-183033	0426	2	B	Update to 5GS registration type IE and introduction of a new 5GS update type IE	15.2.0
2018-12	CT#82	CP-183033	0427	1	F	S-NSSAI received in Notify payload during PDN connection establishment over ePDG/EPC	15.2.0
2018-12	CT#82	CP-183033	0428		F	No interworking to ePDG/EPC for Ethernet and unstructured PDU sessions	15.2.0
2018-12	CT#82	CP-183033	0429		F	Addition of UE capability for LPP in 5GMM capability IE	15.2.0
2018-12	CT#82	CP-183033	0430	1	F	Correct superfluous test for N1 mode and S1 mode capability	15.2.0
2018-12	CT#82	CP-183033	0431	1	F	Change UE policy classmark as mandatory IE	15.2.0
2018-12	CT#82	CP-183033	0432	2	F	Forward compatibility for UE security capability IE and a few other IEs	15.2.0
2018-12	CT#82	CP-183033	0433	1	F	Introduction of Replayed S1 UE security capabilities	15.2.0
2018-12	CT#82	CP-183033	0434	1	F	Applicability of UAC for other cases of NAS message transport	15.2.0
2018-12	CT#82	CP-183034	0435	5	F	Emergency registered	15.2.0
2018-12	CT#82	CP-183034	0436	3	F	Correction to domain selection rules for EPS/RAT Fallback	15.2.0
2018-12	CT#82	CP-183034	0438		F	UL data status upon fallback indication from lower layers	15.2.0
2018-12	CT#82	CP-183034	0440	1	F	Misc. corrections to 24.501	15.2.0
2018-12	CT#82	CP-183034	0441	2	F	Clarification on handling of PDU session for LADN	15.2.0
2018-12	CT#82	CP-183034	0442	2	F	Correction to determination method of LADN DNN	15.2.0
2018-12	CT#82	CP-183034	0443	1	F	Correction to trigger of the mobility and periodic registration update procedure	15.2.0
2018-12	CT#82	CP-183034	0444	1	F	Abnormal cases in the network side for Configuration update procedure.	15.2.0
2018-12	CT#82	CP-183034	0445	1	F	Correction in emergency reg cause name	15.2.0
2018-12	CT#82	CP-183034	0446		F	UE behavior on NW initiated deregistration procedure with #22	15.2.0
2018-12	CT#82	CP-183034	0447	1	F	Miscellaneous corrections	15.2.0
2018-12	CT#82	CP-183034	0448	3	F	Resetting service request attempt counter upon receipt of the REGISTRATION ACCEPT message	15.2.0
2018-12	CT#82	CP-183034	0450		F	Correction in determining syntactic errors for PDU session establishment accept	15.2.0
2018-12	CT#82	CP-183034	0451		F	T3540 started by the UE on getting 5GMM cause #27 – N1 mode not allowed	15.2.0
2018-12	CT#82	CP-183034	0452	2	F	Clarification on UE identities used for registration	15.2.0
2018-12	CT#82	CP-183034	0454	1	F	Transition from 5GMM-CONNECTED mode with RRC inactive indication to 5GMM-IDLE mode triggered by radio capability update	15.2.0
2018-12	CT#82	CP-183034	0455	1	F	Finalizing 5GSM timers on the UE and SMF side	15.2.0
2018-12	CT#82	CP-183034	0458	1	F	Local PDU session release upon receipt of PDU Session Release Reject with 5GSM cause #34 (service option temporarily out of order) or #35 (PTI already in use)	15.2.0
2018-12	CT#82	CP-183034	0460	3	F	Clarifications on the EAP based AKA procedure	15.2.0

2018-12	CT#82	CP-183034	0461	1	F	Applicability of the Service area list IE indicating all TAIs to equivalent PLMNs	15.2.0
2018-12	CT#82	CP-183034	0464	1	F	Clarification on PDU session transfer from non-3GPP to 3GPP access when 3GPP PS data off UE status is activated	15.2.0
2018-12	CT#82	CP-183034	0465	1	F	EAP-Identification in EAP-AKA' primary authentication and key agreement procedure	15.2.0
2018-12	CT#82	CP-183034	0467	1	F	Excluding mobility procedures from ODAC access control checks	15.2.0
2018-12	CT#82	CP-183034	0470	3	F	Alignment of 5G-GUTI assignment with SA3	15.2.0
2018-12	CT#82	CP-183034	0471	1	F	Network initiated de-registration in case of emergency PDU session	15.2.0
2018-12	CT#82	CP-183035	0472		F	Resolution of editor's note on always-on PDU session	15.2.0
2018-12	CT#82	CP-183035	0473		F	Addition of 5GSM cause values	15.2.0
2018-12	CT#82	CP-183035	0474		F	Resolution of editor's note on operator-defined access category	15.2.0
2018-12	CT#82	CP-183035	0476	6	C	Support for Traffic Segregation	15.2.0
2018-12	CT#82	CP-183035	0479		F	Correct reference to Mapped EPS bearer contexts	15.2.0
2018-12	CT#82	CP-183035	0480		F	Aborted UE-initiated NAS transport procedure for delivery of SMS/LPP message/UE policy container	15.2.0
2018-12	CT#82	CP-183035	0484	3	F	Clarification on back-off timer upon PLMN change	15.2.0
2018-12	CT#82	CP-183035	0485	2	F	Emergency call in limited service state	15.2.0
2018-12	CT#82	CP-183035	0490	2	F	Correction on Network slicing indication	15.2.0
2018-12	CT#82	CP-183035	0491		F	Correction on De-registration procedure	15.2.0
2018-12	CT#82	CP-183035	0492	1	F	Correction on dual-registration mode	15.2.0
2018-12	CT#82	CP-183035	0494	1	F	Correction to Configured NSSAI for the HPLMN	15.2.0
2018-12	CT#82	CP-183035	0499		F	Updates to 5GS mobility management aspects subclause	15.2.0
2018-12	CT#82	CP-183035	0500	5	F	Editorials and minor corrections	15.2.0
2018-12	CT#82	CP-183035	0501	3	F	Adding necessary term definitions	15.2.0
2018-12	CT#82	CP-183035	0502	1	F	Resolution of editor's notes on abnormal case handling when rejection with "Extended wait time" received from lower layers	15.2.0
2018-12	CT#82	CP-183035	0503	1	F	Resolution of editor's note on maximum length of the 5GS mobile identity IE	15.2.0
2018-12	CT#82	CP-183035	0505	1	F	Resolution of editor's note in sub-clause 4.8.3	15.2.0
2018-12	CT#82	CP-183035	0506	1	F	Correct unified access control applicability in 5GMM-REGISTERED.UPDATE-NEEDED	15.2.0
2018-12	CT#82	CP-183035	0507	3	F	Correct non-3GPP registration accept procedure when local emergency numbers are received from a different country	15.2.0
2018-12	CT#82	CP-183035	0509	1	F	Remove editor's note for MT LCS	15.2.0
2018-12	CT#82	CP-183035	0510	1	F	Reusing T3519 for Initial Registration procedure	15.2.0
2018-12	CT#82	CP-183035	0511	2	F	Abnormal cases for Registration procedure for mobility and periodic registration update	15.2.0
2018-12	CT#82	CP-183035	0516	1	F	Correction on handling of mandatory IE errors	15.2.0
2018-12	CT#82	CP-183035	0517	1	F	Correction on handling of invalid PSI	15.2.0
2018-12	CT#82	CP-183036	0518	2	F	Clarification on PLMN's maximum number of PDU sessions	15.2.0
2018-12	CT#82	CP-183036	0519	1	F	Handling on collision of PDU session establishment and release procedures	15.2.0
2018-12	CT#82	CP-183036	0521		F	Correction on QoS rules IE	15.2.0
2018-12	CT#82	CP-183036	0522	2	F	Correction on QoS flow description IE	15.2.0
2018-12	CT#82	CP-183036	0523	1	F	Correction of storage of operator-defined access categories	15.2.0
2018-12	CT#82	CP-183036	0525	2	F	Clarification on coordination between 5GMM and EMM for a UE in DRM	15.2.0
2018-12	CT#82	CP-183036	0526		F	The UE behavior in non-3GPP access and in state ATTEMPTING-REGISTRATION	15.2.0
2018-12	CT#82	CP-183036	0528	1	F	Enabling use of and disabling use of MICO mode	15.2.0
2018-12	CT#82	CP-183036	0529	2	F	Apply service area restrictions in NAS procedures	15.2.0
2018-12	CT#82	CP-183036	0530	1	F	Abnormal cases in 5GSM procedures	15.2.0
2018-12	CT#82	CP-183036	0532		F	Clarifications on UE behaviour upon receiving RRC fallback indication	15.2.0
2018-12	CT#82	CP-183036	0533	2	F	Corrections for interworking with EPS	15.2.0
2018-12	CT#82	CP-183036	0534	1	F	Release of the N1 NAS signalling connection upon Service Accept message	15.2.0
2018-12	CT#82	CP-183036	0535	1	F	QoS rules verification during PDU session establishment procedure	15.2.0
2018-12	CT#82	CP-183036	0536	1	F	Clarifications on UE and network state	15.2.0
2018-12	CT#82	CP-183036	0537	1	F	T3517 handling and emergency services fallback	15.2.0
2018-12	CT#82	CP-183036	0540	2	F	Revisions on N1 NAS signaling connection establishment and release	15.2.0
2018-12	CT#82	CP-183036	0541	1	F	Disabling N1 mode capability for 3GPP access and impacts to PLMN selection	15.2.0
2018-12	CT#82	CP-183036	0543	1	F	UE's homogeneous support of emergency services fallback per RAT	15.2.0
2018-12	CT#82	CP-183036	0544		F	Context management for 3GPP access and non-3GPP access due to SR rejection	15.2.0
2018-12	CT#82	CP-183036	0545	2	F	Clarification on setting a service type of a SERVICE REQUEST message	15.2.0

2018-12	CT#82	CP-183036	0546	1	F	UL NAS TRNAPORT message pending due to network slicing information update	15.2.0
2018-12	CT#82	CP-183036	0547		F	Distinction in AMF-side abnormal cases for generic UE configuration update procedure with respect to 5G-GUTI update	15.2.0
2018-12	CT#82	CP-183036	0548	1	F	Handling of security contexts by a UE operating in dual-registration mode	15.2.0
2018-12	CT#82	CP-183036	0549	2	F	Establishment of secure exchange of NAS messages during inter-system change between N1 mode and S1 mode	15.2.0
2018-12	CT#82	CP-183037	0550	2	D	Terminology alignment regarding support for interworking without N26	15.2.0
2018-12	CT#82	CP-183037	0551	3	F	Correction on reporting change of 3GPP PS data off UE status	15.2.0
2018-12	CT#82	CP-183037	0553	1	F	Correction on Uplink data status handling	15.2.0
2018-12	CT#82	CP-183037	0557	2	F	Correction of LADN information for generic UE configuration update procedure	15.2.0
2018-12	CT#82	CP-183037	0559		F	Management of the registration attempt counter and the attach attempt counter during inter-system change	15.2.0
2018-12	CT#82	CP-183037	0560	1	F	No direct security protection to 5GSM	15.2.0
2018-12	CT#82	CP-183037	0562	1	F	No S-NSSAI for emergency PDU sessions	15.2.0
2018-12	CT#82	CP-183037	0563	1	F	S-NSSAI selection for S-NSSAI based congestion control	15.2.0
2018-12	CT#82	CP-183037	0565	2	F	UE in registered state without registration complete	15.2.0
2018-12	CT#82	CP-183037	0569	1	F	Abnormal Cases in the UE for initial registration	15.2.0
2018-12	CT#82	CP-183037	0571	2	F	Addition of 24.501 overview	15.2.0
2018-12	CT#82	CP-183037	0572	2	F	Service area restrictions applicable for PLMNs in registration area	15.2.0
2018-12	CT#82	CP-183037	0573	1	F	Periodically erase of service area restriction list	15.2.0
2018-12	CT#82	CP-183037	0574	1	F	Completion of mobile identity IE definition in messages	15.2.0
2018-12	CT#82	CP-183037	0575		F	Correction of erroneously encoded IE	15.2.0
2018-12	CT#82	CP-183037	0576	2	F	Correction for local release	15.2.0
2018-12	CT#82	CP-183037	0577	3	F	UAC - providing access identities for barring checks of AS triggered access attempts	15.2.0
2018-12	CT#82	CP-183037	0578	2	F	Correction for indicating 3GPP PS data off status	15.2.0
2018-12	CT#82	CP-183037	0580	1	F	UPSIs in UE STATE INDICATION	15.2.0
2018-12	CT#82	CP-183037	0582	1	F	Initial registration for emergency PDU session	15.2.0
2018-12	CT#82	CP-183037	0583	2	F	Multiple 5G-GUTIs	15.2.0
2018-12	CT#82	CP-183037	0584		F	Correction on Maximum number of supported packet filters	15.2.0
2018-12	CT#82	CP-183037	0585		F	T3584 and T3585 update in Timer table	15.2.0
2018-12	CT#82	CP-183037	0586	1	F	Abnormal case for T3550	15.2.0
2018-12	CT#82	CP-183038	0590	1	F	No UPF Resources at PDU Session Establishment	15.2.0
2018-12	CT#82	CP-183038	0591	2	F	Clarifications on NAS level mobility management congestion control	15.2.0
2018-12	CT#82	CP-183038	0592	1	F	SOR over control plane in non-3GPP access	15.2.0
2018-12	CT#82	CP-183038	0593	1	F	Handling of target CN type by NAS upon redirection to E-UTRA cell	15.2.0
2018-12	CT#82	CP-183038	0594	3	C	Procedure for UDM-triggered UE parameters update	15.2.0
2018-12	CT#82	CP-183038	0595	1	F	Sending of 5GSM capability IE and Maximum number of supported packet filters IE in in PDU SESSION ESTABLISHMENT REQUEST with request type "existing PDU session"	15.2.0
2018-12	CT#82	CP-183038	0597	3	F	Correction of reference	15.2.0
2018-12	CT#82	CP-183038	0598	2	C	Clarification on 5GSM cause_#46 out of LADN service area	15.2.0
2018-12	CT#82	CP-183038	0604	2	C	Clarification on congestion control upon intersystem change	15.2.0
2018-12	CT#82	CP-183038	0605		F	Editorial correction related to LADN	15.2.0
2018-12	CT#82	CP-183038	0606	1	F	Correcting the structure of LADN related description	15.2.0
2018-12	CT#82	CP-183038	0607	2	F	N3GPP de-registration timers handling at long MM back-off time	15.2.0
2018-12	CT#82	CP-183038	0608	1	F	Abnormal cases in the network side for Configuration update procedure.	15.2.0
2018-12	CT#82	CP-183038	0609	1	F	Abnormal cases in the UE side for Configuration update procedure.	15.2.0
2018-12	CT#82	CP-183038	0610	1	F	Handling of 5GSM reject causes #50 and #51 for PDU types IPv4v6.	15.2.0
2018-12	CT#82	CP-183038	0611	1	F	Correction to QoS rules verification during PDU session establishment.	15.2.0
2018-12	CT#82	CP-183038	0612	1	F	QoS rules verification during PDU session modification.	15.2.0
2018-12	CT#82	CP-183038	0613	1	F	QoS flow descriptions IE to be set by SMF mandatory in PDU establishment accept for initial request.	15.2.0
2018-12	CT#82	CP-183038	0614	1	B	MCS Indicator and Access Identity 2	15.2.0
2018-12	CT#82	CP-183038	0615	3	F	SUCI encoding and support of NAI format	15.2.0
2018-12	CT#82	CP-183038	0617	1	F	UAC for simultaneous access attempt triggers	15.2.0
2018-12	CT#82	CP-183038	0618	1	F	Reset of registration attempt counter	15.2.0
2018-12	CT#82	CP-183038	0619		F	Reset of service request attempt counter	15.2.0
2018-12	CT#82	CP-183038	0622		F	CN paging handling in RRC inactive	15.2.0
2018-12	CT#82	CP-183038	0623	2	F	Procedure collision handling in paging and notification procedure	15.2.0
2018-12	CT#82	CP-183039	0624		F	Resolution of editor's note on different TAI for 4G and for 5G	15.2.0
2018-12	CT#82	CP-183039	0625		F	Correction on 'E' bit for deleting QoS flow description	15.2.0

2018-12	CT#82	CP-183039	0626		F	EMM parameters handling for EPC interworking	15.2.0
2018-12	CT#82	CP-183039	0627	1	F	Registration rejected because of non-3GPP access to 5GCN is not allowed	15.2.0
2018-12	CT#82	CP-183039	0628	2	F	Correction to SUPI definition due to NAI format	15.2.0
2018-12	CT#82	CP-183039	0629		F	Correct secured packet procedures	15.2.0
2018-12	CT#82	CP-183039	0630	2	F	Abnormal cases for EAP-based AKA	15.2.0
2018-12	CT#82	CP-183039	0631	1	F	CONFIGURATION UPDATE COMMAND with no parameters other than registraion requested.	15.2.0
2018-12	CT#82	CP-183039	0633	1	F	Correction of the UE-initiated de-registration procedure	15.2.0
2018-12	CT#82	CP-183039t	0634	1	F	Definition of a 5GMM cause for DNN subscription check failure	15.2.0
2018-12	CT#82	CP-183039	0635	1	F	Stopping T3511 after transitioning to 5GMM-CONNECTED mode	15.2.0
2018-12	CT#82	CP-183039	0636	2	F	Clarification on storage of UE policy sections of multiple PLMNs	15.2.0
2018-12	CT#82	CP-183039	0637	1	F	Corrections to UE handling of reject with cause #13	15.2.0
2018-12	CT#82	CP-183039	0639	1	F	Clarification on the Selected EPS NAS security algorithms	15.2.0
2018-12	CT#82	CP-183039	0641	3	F	Handling errors due to missing QoS flow descriptions parameters for GBR QoS flows	15.2.0
2018-12	CT#82	CP-183039	0642	2	F	Clarification on inclusion of Requested NSSAI during periodic registration updating	15.2.0
2018-12	CT#82	CP-183039	0643	1	F	The release of the existing N1 NAS signalling connection after UCU	15.2.0
2018-12	CT#82	CP-183039	0646	1	F	Always-on PDU sessions and associated access	15.2.0
2018-12	CT#82	CP-183039	0647	1	F	Clarification on the applicability of NSSAI to the EPLMNs	15.2.0
2018-12	CT#82	CP-183039	0648	1	F	Clarification on the applicability of service area restrictions to the EPLMNs	15.2.0
2018-12	CT#82	CP-183039	0649	1	F	QFI and QRI values in 5GSM messages	15.2.0
2018-12	CT#82	CP-183039	0650	2	F	Corrections on operation mode selection	15.2.0
2018-12	CT#82	CP-183039	0651	1	F	Clarification on handling of PDU sessions associated with 3GPP access and non-3GPP access for interworking	15.2.0
2018-12	CT#82	CP-183039	0652		F	Clarifications on Configuration Update procedure	15.2.0
2018-12	CT#82	CP-183039	0653		F	Correction on timer T3511	15.2.0
2018-12	CT#82	CP-183040	0654	2	F	Clarification on Notification procedure	15.2.0
2018-12	CT#82	CP-183040	0655	1	F	Clarification on handling of invalid LADN DNN in registration procedure – Alt 1	15.2.0
2018-12	CT#82	CP-183040	0657	1	F	Correction for LADN information IE	15.2.0
2018-12	CT#82	CP-183040	0659		F	Editorial correction for the generic UE configuration update procedure	15.2.0
2018-12	CT#82	CP-183040	0660	1	F	UE behavior in ATTEMPTING-REGISTRATION state	15.2.0
2018-12	CT#82	CP-183040	0661	1	F	UE-AMF selected PLMN ID mismatch in INACTIVE state	15.2.0
2018-12	CT#82	CP-183040	0662		F	UL NAS Transport behavior due to transmission failure	15.2.0
2018-12	CT#82	CP-183029	0663	1	F	UAC: Correction for operator-defined access categories of acknowledgement	15.2.0
2018-12	CT#82	CP-183040	0664	2	F	Lower layer indication on the establishment/release of user plane resources	15.2.0
2018-12	CT#82	CP-183040	0665	3	F	Setting the Uplink data status and Service type IEs after receiving a fallback indication from the lower layers	15.2.0
2018-12	CT#82	CP-183040	0666	2	F	Indication of a reason for failure in reactivating a PDU session	15.2.0
2018-12	CT#82	CP-183040	0667	1	F	Adding the case that UE initiates the registration procedure for mobility and periodic registration	15.2.0
2018-12	CT#82	CP-183040	0668	1	F	Handling of network rejection with 5GSM cause values #50, #51, and #54	15.2.0
2018-12	CT#82	CP-183040	0669	2	F	Mobility and periodic registration update triggered by indications from lower layers	15.2.0
2018-12	CT#82	CP-183040	0673	1	F	UE STATE INDICATION message delivered in a REGISTRATION REQUEST message	15.2.0
2018-12	CT#82	CP-183040	0674	1	F	Correction to operator-defined access category criteria type values	15.2.0
2018-12	CT#82	CP-183040	0677	1	F	Exceptions for UEs configured for high priority access in handling T3396, T3584, and T3585	15.2.0
2018-12	CT#82	CP-183040	0678		D	Removal of non-seamless non-3GPP offload from definitions	15.2.0
2018-12	CT#82	CP-183040	0679	4	F	UE identifier provided during an initial registration procedure	15.2.0
2018-12	CT#82	CP-183040	0680	1	F	Revisions on PDU Session Establishment procedure	15.2.0
2018-12	CT#82	CP-183040	0682	1	F	UE registered for emergency services upon authentication failure	15.2.0
2018-12	CT#82	CP-183040	0683		F	Update the trigger of mobility registration update initiation	15.2.0
2018-12	CT#82	CP-183040	0684	2	F	Clarification on T3346 for registration procedure	15.2.0
2018-12	CT#82	CP-183040	0686	2	F	Support sending multiple payloads via Payload container	15.2.0
2018-12	CT#82	CP-183040	0687	1	F	Correction on LADN information handling	15.2.0
2018-12	CT#82	CP-183040	0688	2	F	Mapping of a NOTIFICATION message to an access category	15.2.0
2018-12	CT#82	CP-183041	0690	2	F	Transmission of SUCI in DEREGISTRATION REQUEST	15.2.0
2018-12	CT#82	CP-183041	0691		F	Clarification on missing subclause	15.2.0
2018-12	CT#82	CP-183041	0692		F	Stop T3516 when authentication reject received	15.2.0
2018-12	CT#82	CP-183041	0693	1	F	Limited service and no SUPI states in 5GMM instance for non-3GPP accesst	15.2.0
2018-12	CT#82	CP-183041	0695	1	F	QoS flow and mapped EPS bearer context	15.2.0

2018-12	CT#82	CP-183041	0696	1	F	Corrections on 5GSM IEs	15.2.0
2018-12	CT#82	CP-183041	0697	1	F	Correction on 5GSM congestion control	15.2.0
2018-12	CT#82	CP-183041	0698		F	Correction on PTI value release	15.2.0
2018-12	CT#82	CP-183041	0699	1	F	Corrections on QoS rules IE	15.2.0
2018-12	CT#82	CP-183041	0700	1	F	UE handling for semantic error in the QoS operation	15.2.0
2018-12	CT#82	CP-183041	0701		F	Resolution of editor's note on abnormal case handling for the UE-initiated UE state indication procedure	15.2.0
2018-12	CT#82	CP-183041	0702	1	F	Resolution of editor's note on abnormal case handling for the network-requested UE policy management procedure	15.2.0
2018-12	CT#82	CP-183041	0703		F	Resolution of editor's note on the information the N3IWF maintains for a registered UE	15.2.0
2018-12	CT#82	CP-183041	0709	2	F	Congestion control	15.2.0
2018-12	CT#82	CP-183041	0711	1	F	Correction to authentication abnormal cases	15.2.0
2018-12	CT#82	CP-183041	0712	1	F	Corrections for non-3GPP access idle mode	15.2.0
2018-12	CT#82	CP-183041	0715	1	F	Integrity protection maximum data rate for UL and DL	15.2.0
2018-12	CT#82	CP-183041	0717	1	F	General section for limited service state over non-3GPP access	15.2.0
2018-12	CT#82	CP-183041	0718		F	T35xx in Annex D	15.2.0
2019-01	CT#82					Change of IEI values from 7E to 74 and from 7F to 75	15.2.1
2019-03	CT#83	CP-190084	0382	9	F	Correct Extended Local Emergency Numbers List use involving WLAN	15.3.0
2019-03	CT#83	CP-190084	0638	3	F	Clarification for abnormal case handling of registration procedure after inter-system change from S1 mode to N1 mode	15.3.0
2019-03	CT#83	CP-190084	0706	6	F	Resolution on the editor's note on abnormal cases in the UE for the PDU EAP message reliable transport procedure	15.3.0
2019-03	CT#83	CP-190084	0721	2	F	Clarification on inclusion of the Uplink data status IE in the SERVICE REQUEST message after an RRC fallback indication	15.3.0
2019-03	CT#83	CP-190084	0724	4	F	Corrections to Annex D	15.3.0
2019-03	CT#83	CP-190084	0725	2	F	Update reference for UE policy control service	15.3.0
2019-03	CT#83	CP-190084	0728	1	F	Completion of correction for local release	15.3.0
2019-03	CT#83	CP-190084	0729	2	F	UAC - access attempt matching criteria of operator-defined access category	15.3.0
2019-03	CT#83	CP-190084	0731	2	F	Correcting the name of ITU-T Recommendation E.212	15.3.0
2019-03	CT#83	CP-190084	0732	2	F	5GSM - request type not included in PDU SESSION ESTABLISHMENT REQUEST	15.3.0
2019-03	CT#83	CP-190084	0734	2	F	AMF rejecting PDU session establishment when the DNN is not subscribed	15.3.0
2019-03	CT#83	CP-190084	0735	1	F	Correction for acknowledgement of extended emergency number list	15.3.0
2019-03	CT#83	CP-190084	0741	3	F	Mobility between 5GS over non-3GPP access and EPS over 3GPP access	15.3.0
2019-03	CT#83	CP-190084	0743	1	F	PDU session status for IWK without N26	15.3.0
2019-03	CT#83	CP-190084	0744	2	F	EPS GUTI provided to lower layer	15.3.0
2019-03	CT#83	CP-190084	0745	1	F	Length of 5G-S-TMSI	15.3.0
2019-03	CT#83	CP-190084	0746	3	F	S1 UE security capability	15.3.0
2019-03	CT#83	CP-190084	0747	2	F	Clarification on creating new QoS flowst	15.3.0
2019-03	CT#83	CP-190084	0750	1	F	Correction to handling of #50 and #51t	15.3.0
2019-03	CT#83	CP-190085	0752	1	F	PDU session modification for emergency PDU sessions.	15.3.0
2019-03	CT#83	CP-190085	0753	1	F	Removal of unnecessary text.	15.3.0
2019-03	CT#83	CP-190085	0754	1	F	QoS flow description to be added in PDU session modification command	15.3.0
2019-03	CT#83	CP-190100	0758		F	Correction of the erroneous length of EAP messageIE	15.3.0
2019-03	CT#83	CP-190085	0759	2	F	Update of SUCI encoding	15.3.0
2019-03	CT#83	CP-190085	0762		F	Minor corrections to TS 24.501	15.3.0
2019-03	CT#83	CP-190085	0763	2	F	Cleanup on support of multiple payloads for NAS transport	15.3.0
2019-03	CT#83	CP-190085	0765	1	F	Correction on initial NAS message protection	15.3.0
2019-03	CT#83	CP-190085	0766	2	F	Correction on 5GS mobile identity IE name	15.3.0
2019-03	CT#83	CP-190085	0767	1	F	Addition of the 5GSM cause IE in the PDU SESSION MODIFICATION COMPLETE message	15.3.0
2019-03	CT#83	CP-190085	0768	2	D	Minor corrections for interworking	15.3.0
2019-03	CT#83	CP-190085	0769	1	F	Change of "a wildcard DNN" to "the wildcard DNN"	15.3.0
2019-03	CT#83	CP-190085	0771	2	F	Adding missing abnormal cases for initial registration (UE side)	15.3.0
2019-03	CT#83	CP-190085	0772	2	F	Clarification for the use of the default value for T3512	15.3.0
2019-03	CT#83	CP-190085	0773	3	F	Removal of UE security capabilities from the S1 mode to N1 mode NAS transparent container	15.3.0
2019-03	CT#83	CP-190085	0774	2	F	Clarification on NSSAI inclusion mode after an inter-system change from S1 mode to N1 mode	15.3.0
2019-03	CT#83	CP-190085	0780	1	F	Corrections to UE policy section management result	15.3.0
2019-03	CT#83	CP-190085	0785	1	F	Removal of abnormal case handling for collision between initial registration and paging or notification	15.3.0
2019-03	CT#83	CP-190085	0788		D	DNN as a common IE	15.3.0
2019-03	CT#83	CP-190085	0791	2	F	Generic UE configuration update procedure during registration procedure	15.3.0

2019-03	CT#83	CP-190085	0792		D	References for NAS signalling connection recovery and a fallback indication from the lower layers	15.3.0
2019-03	CT#83	CP-190086	0796	1	F	Corrections on fallback indication from lower layers	15.3.0
2019-03	CT#83	CP-190086	0798	2	F	Correction to the notification procedure	15.3.0
2019-03	CT#83	CP-190086	0801	1	D	Correction on sub-clause numbering	15.3.0
2019-03	CT#83	CP-190086	0802	3	F	Handling of QoS flow description without valid EPS bearer contextt	15.3.0
2019-03	CT#83	CP-190086	0803		F	Correction on the lengths of 5GSM procedures	15.3.0
2019-03	CT#83	CP-190086	0804	2	F	Corrections on Mapped EPS bearer context IE	15.3.0
2019-03	CT#83	CP-190086	0805	2	F	Handling of missing QoS flow description and QoS rule	15.3.0
2019-03	CT#83	CP-190086	0806	3	F	UE re-registration following UE parameters update	15.3.0
2019-03	CT#83	CP-190086	0807	1	F	Clarification on providing NSSAI to the lower layer	15.3.0
2019-03	CT#83	CP-190086	0808	1	F	Adjustment of relevant timers when T3346 is included in the 5GMM message	15.3.0
2019-03	CT#83	CP-190086	0809	1	F	Clarification on PDU Session Modification procedure	15.3.0
2019-03	CT#83	CP-190086	0810	1	F	Clarification on the behaviors of UE and SMF during the inter-system change	15.3.0
2019-03	CT#83	CP-190086	0812	2	F	Several corrections to messages and IEs	15.3.0
2019-03	CT#83	CP-190086	0814	2	F	Correction to IEI values	15.3.0
2019-03	CT#83	CP-190086	0815	2	F	Resolution on editor's notes on whether explicit start and stop indications for SMS over NAS is needed	15.3.0
2019-03	CT#83	CP-190086	0817		F	Correction to the definition of UE STATE INDICATION message content	15.3.0
2019-03	CT#83	CP-190086	0819	1	F	Reference corrections on UE's state change due to congestion control	15.3.0
2019-03	CT#83	CP-190086	0820	3	F	Correction to behaviour upon receipt of 5GMM reject cause for a UE in single-registration mode	15.3.0
2019-03	CT#83	CP-190086	0821	1	F	Informing the UE about the integrity protection failure at S1 to N1 mode change	15.3.0
2019-03	CT#83	CP-190086	0823	1	F	Handling of abnormal case when UE gets UE policies with incorrect PLMN ID	15.3.0
2019-03	CT#83	CP-190087	0824		F	Abnormal case handling for cause#72	15.3.0
2019-03	CT#83	CP-190087	0829	3	F	Correction on handling of invalid PSI	15.3.0
2019-03	CT#83	CP-190087	0831		F	Correction for missing 5QIs	15.3.0
2019-03	CT#83	CP-190174	0833	4	F	Possible criterion for the selection of the requested NSSAI	15.3.0
2019-03	CT#83	CP-190087	0834	2	F	Skip barring checks during fallback handling	15.3.0
2019-03	CT#83	CP-190087	0835	1	F	Correct missing Non-3GPP NW policies IE	15.3.0
2019-03	CT#83	CP-190087	0836	1	F	5G-GUTI provided to lower layer	15.3.0
2019-03	CT#83	CP-190087	0838	1	F	Handling of abnormal authentication errors	15.3.0
2019-03	CT#83	CP-190087	0839	1	F	Update the conditions on the AMF to provide the configured NSSAI to the UE	15.3.0
2019-03	CT#83	CP-190087	0844	1	F	Rejected NSSAI for current registration area	15.3.0
2019-03	CT#83	CP-190087	0845	1	F	Removal of Editor's note on home network public key and home network public key identifier update and removal of protection scheme identifier	15.3.0
2019-03	CT#83	CP-190087	0846	1	F	Update of PDU session authentication and authorization messages	15.3.0
2019-03	CT#83	CP-190087	0847	2	F	Update of error handling for Mapped EPS bearer contexts IE	15.3.0
2019-03	CT#83	CP-190087	0849	1	F	Correction for Cause code #7	15.3.0
2019-03	CT#83	CP-190087	0854	1	F	3GPP PS Data Off UE status change and congestion control in AMF - alternative 2	15.3.0
2019-03	CT#83	CP-190087	0855	1	F	Retransmission of PDU SESSION ESTABLISHMENT REQUEST	15.3.0
2019-03	CT#83	CP-190087	0856	1	F	Retransmission of PDU SESSION MODIFICATION REQUEST	15.3.0
2019-03	CT#83	CP-190087	0857	1	F	Retransmission of PDU SESSION RELEASE REQUEST	15.3.0
2019-03	CT#83	CP-190087	0859	1	F	Correction in EAP handling	15.3.0
2019-03	CT#83	CP-190087	0860		F	Issue in SNN	15.3.0
2019-03	CT#83	CP-190087	0862	2	F	Temporary identity allocation	15.3.0
2019-03	CT#83	CP-190088	0863		F	Initial maximum number of packet filters for associated PDU session	15.3.0
2019-03	CT#83	CP-190088	0864	1	F	SUCI to be used for the registration for emergency services	15.3.0
2019-03	CT#83	CP-190088	0867		F	Correction to the inclusion of requested QoS rule and requested QoS flow description in PDU session modification request.	15.3.0
2019-03	CT#83	CP-190088	0868	1	F	Wrong message name	15.3.0
2019-03	CT#83	CP-190088	0870	2	F	SUCI applicability	15.3.0
2019-03	CT#83	CP-190088	0873	1	F	Transmission failure at UE side for UE policy delivery procedure	15.3.0
2019-03	CT#83	CP-190088	0875	2	F	Upper layer request while T3540 is running	15.3.0
2019-03	CT#83	CP-190088	0876	1	F	Encoding of Routing indicator set to default value 0	15.3.0
2019-03	CT#83	CP-190088	0877	2	F	OS Id information element	15.3.0
2019-03	CT#83	CP-190088	0878	1	F	Clarification on deregistration procedure.	15.3.0
2019-03	CT#83	CP-190088	0880	1	D	Correction of the use of word "wants"	15.3.0
2019-03	CT#83	CP-190088	0883	1	F	Handling on errors of QoS flow description operations	15.3.0
2019-03	CT#83	CP-190088	0885	1	F	Addressing missing scenarios and providing other clarifications related to fallback indication	15.3.0

2019-03	CT#83	CP-190088	0888	2	F	Handling when the UE indicated security capabilities are invalid or unacceptable	15.3.0
2019-03	CT#83	CP-190088	0889	1	F	Correction in UE-initiated de-registration procedure initiation	15.3.0
2019-03	CT#83	CP-190088	0891	1	F	Reporting QoS error when a delete or modify operation is received for a non-existent QoS rule	15.3.0
2019-03	CT#83	CP-190088	0892	1	F	Presence of the precedence and QFI fields in QoS rules	15.3.0
2019-03	CT#83	CP-190088	0894	2	F	Mandating UE sending registration complete for SOR	15.3.0
2019-03	CT#83	CP-190088	0895	1	F	Improvement on 5G-GUTI allocation after network triggered service request	15.3.0
2019-03	CT#83	CP-190088	0899	2	F	Clarification on the authorized QoS rule modification	15.3.0
2019-03	CT#83	CP-190089	0901	1	F	Clarification on congestion control upon intersystem change	15.3.0
2019-03	CT#83	CP-190089	0902	4	F	Default EPS bearer associates with the default QoS rule	15.3.0
2019-03	CT#83	CP-190089	0907	2	F	NSSAI inclusion mode, EPLMNs, and registration area	15.3.0
2019-03	CT#83	CP-190089	0910	2	F	5GSM messages for a PDU session associated with non-3GPP access exchanged via 3GPP access	15.3.0
2019-03	CT#83	CP-190089	0911	1	F	Mobility and periodic registration update initiation by a UE in inactive mode reselecting an EPLMN cell	15.3.0
2019-03	CT#83	CP-190089	0912	1	F	Change of N1 mode capability on UE mode change or on IMS availability change	15.3.0
2019-03	CT#83	CP-190089	0914	1	F	Inclusion of a 5G-GUTI mapped from the valid 4G-GUTI in the REGISTRATION REQUEST message during an initial registration is not available in Rel-15	15.3.0
2019-03	CT#83	CP-190209	0915	3	F	Correction to the REGISTRATION REQUEST msg when the Payload container IE is included	15.3.0
2019-03	CT#83	CP-190089	0917	1	F	Correction to the length of the IMEISV	15.3.0
2019-03	CT#83	CP-190089	0918	1	F	Correcton on handing of downlink signalling and data for non-3GPP PDU session	15.3.0
2019-03	CT#83	CP-190089	0919		F	Correction to the Payload container IE	15.3.0
2019-03	CT#83	CP-190089	0920		F	Correction to several 5GMM IEs	15.3.0
2019-03	CT#83	CP-190089	0921	1	F	Mapped configured S-NSSAI from the S-NSSAI(s) of the HPLMN	15.3.0
2019-03	CT#83	CP-190089	0922		F	Use of stored NSSAI inclusion mode during initial registration	15.3.0
2019-03	CT#83	CP-190089	0923		F	Correction to the Operator-defined access category definitions IE t	15.3.0
2019-03	CT#83	CP-190089	0925	1	F	Non-delivery of PDU SESSION ESTABLISHMENT ACCEPT	15.3.0
2019-03	CT#83	CP-190089	0926	1	F	Correction to Service area list IE Type of list "11"	15.3.0
2019-03	CT#83	CP-190089	0927	1	F	Setting of 5GSM cause value #36 regular deactivation	15.3.0
2019-03	CT#83	CP-190092	0929	3	F	Local release	15.3.0
2019-03	CT#83	CP-190089	0930	1	F	Adding the UE local configuration option in 24.501	15.3.0
2019-03	CT#83	CP-190089	0933		F	Handling of Replayed S1 UE security capabilities IE in Security Mode Command message	15.3.0
2019-03	CT#83	CP-190089	0934	2	F	Clarifications on use of PCF-provided PTI for UE policies delivery	15.3.0
2019-03	CT#83	CP-190101	0720	1	F	Initiation of Service Request after reception of Notification over non-3GPP while the UE is in 5GMM-CONNECTED mode with RRC inactive indication in the 3GPP access	16.0.0
2019-03	CT#83	CP-190106	0730	4	B	SINE_5G: Back-off control and retry restriction mechanisms in 5GS	16.0.0
2019-03	CT#83	CP-190101	0733	1	F	Transfer of a PDU session among 5G-ANs and DNN	16.0.0
2019-03	CT#83	CP-190101	0739	5	F	Handling for QoS Flow status synchronization failure	16.0.0
2019-03	CT#83	CP-190101	0775	5	F	Clarification on rejected NSSAI for the PLMN	16.0.0
2019-03	CT#83	CP-190101	0782	1	F	5G-GUTI as additional guti in initial registration and UE holds 4G-GUTI	16.0.0
2019-03	CT#83	CP-190101	0786	1	D	Consistent description on release of N1 NAS signalling connection	16.0.0
2019-03	CT#83	CP-190101	0787	1	F	Correction to TFT check	16.0.0
2019-03	CT#83	CP-190101	0789	4	F	Handling of indication to the 5GSM sublayer in case of 5GSM message not forwarded to SMF due to service area restrictions	16.0.0
2019-03	CT#83	CP-190101	0797	3	F	Alignment for the notification procedure	16.0.0
2019-03	CT#83	CP-190108	0830		B	New 5QIs for Enhanced Framework for Uplink Streaming	16.0.0
2019-03	CT#83	CP-190101	0840		F	Update the conditions on the AMF to provide an allowed NSSAI based upon the default S-NSSAI(s)	16.0.0
2019-03	CT#83	CP-190101	0841	1	F	Alignment of terms of configured NSSAI and allowed NSSAI	16.0.0
2019-03	CT#83	CP-190101	0842	1	F	Provision of NSSAI information to the lower layers	16.0.0
2019-03	CT#83	CP-190101	0843	1	F	Correction for the UE configuration update procedure	16.0.0
2019-03	CT#83	CP-190101	0848	1	F	Clarification to definition of "ongoing service"	16.0.0
2019-03	CT#83	CP-190101	0851	1	F	Update of validity conditions for access identities 1 and 2	16.0.0
2019-03	CT#83	CP-190101	0852		F	SR procedure for emergency services fallback when T3525 timer running	16.0.0
2019-03	CT#83	CP-190101	0865	2	F	Clarification on allowed NSSAI storage in Non Volatile Memory	16.0.0
2019-03	CT#83	CP-190101	0866	1	F	UE state at lower layer failure on the NW side at initial registration	16.0.0
2019-03	CT#83	CP-190101	0869		F	Content of SMS payload container	16.0.0
2019-03	CT#83	CP-190101	0872	1	F	Correct mistake in case (i) in service request procedure	16.0.0
2019-03	CT#83	CP-190101	0881		D	Correction of wrong reference	16.0.0

2019-03	CT#83	CP-190101	0886	2	F	Clarifications related to fallback indication	16.0.0
2019-03	CT#83	CP-190101	0896		F	Correction on deriving mapped EPS security context for EPC interworking in connected mode	16.0.0
2019-03	CT#83	CP-190101	0897	1	F	Correction on abnormal case handling at AMF for registration	16.0.0
2019-03	CT#83	CP-190101	0904	2	F	Clarification on MICO mode	16.0.0
2019-03	CT#83	CP-190101	0905		F	Correction on 5GMM cause #65	16.0.0
2019-03	CT#83	CP-190101	0924		F	Correction to N1 NAS signalling connection establishment	16.0.0
2019-03	CT#83					De-implementation of CR468	16.0.1
2019-03	CT#83					Completion of de-implementation of CR468	16.0.2
2019-06	CT#84	CP-191147	0936		B	Interworking of Ethernet PDU session to Ethernet PDN connection	16.1.0
2019-06	CT#84	CP-191137	0937	2	B	PEI for 5G-CRG and FN-CRG	16.1.0
2019-06	CT#84	CP-191137	0938		B	Usage of ACS information PCO parameter	16.1.0
2019-06	CT#84	CP-191137	0939		B	Session-TMBR for PDU session in W-5GAN	16.1.0
2019-06	CT#84	CP-191132	0944	5	F	Handling of 5G NAS security contexts	16.1.0
2019-06	CT#84	CP-191132	0946	1	F	Handling of PDU session type	16.1.0
2019-06	CT#84	CP-191124	0948	2	A	Precedence between access identities for derivation of RRC establishment cause and for derivation of establishment cause for non-3GPP access	16.1.0
2019-06	CT#84	CP-191132	0949		F	Clarifications on the validity of access identities	16.1.0
2019-06	CT#84	CP-191132	0950		F	Corrections to the length of the SOR transparent container and UE parameters update transparent container	16.1.0
2019-06	CT#84	CP-191122	0953	1	A	Correction on T3396	16.1.0
2019-06	CT#84	CP-191132	0955	1	F	Correction on the descriptions of 5GSM parameters and capabilities	16.1.0
2019-06	CT#84	CP-191123	0957	2	A	Handling of PS Data Off status update	16.1.0
2019-06	CT#84	CP-191124	0959	1	A	SR procedure for emergency services fallback when T3346 timer running	16.1.0
2019-06	CT#84	CP-191148	0963	3	B	Adding support for SNPNs (Stand-alone Non-Public Networks)	16.1.0
2019-06	CT#84	CP-191132	0964		F	Clarification on LADN information for the registered and equivalent PLMNs	16.1.0
2019-06	CT#84	CP-191132	0965	3	F	Clarification on the stop of T3540	16.1.0
2019-06	CT#84	CP-191132	0966	1	F	Clarification on the creation of a single QoS flow during a PDU session modification procedure	16.1.0
2019-06	CT#84	CP-191132	0968	2	F	Correction to the checks on QoS rule operations - R16	16.1.0
2019-06	CT#84	CP-191129	0969	1	B	Introduction of extended DRX for 5G CIoT	16.1.0
2019-06	CT#84	CP-191129	0970	1	B	Small data rate control, general description	16.1.0
2019-06	CT#84	CP-191129	0971	1	B	Small data rate control, activation	16.1.0
2019-06	CT#84	CP-191129	0972	4	B	Serving PLMN rate control, general description	16.1.0
2019-06	CT#84	CP-191129	0973	4	B	Serving PLMN rate control, activation	16.1.0
2019-06	CT#84	CP-191129	0974	1	B	Service Gap control in 5GS, general description	16.1.0
2019-06	CT#84	CP-191129	0975	3	B	Service Gap control in 5GS, activation with IE and indication flag	16.1.0
2019-06	CT#84	CP-191129	0977	3	B	Service Gap control in 5GS, enforcement in UE	16.1.0
2019-06	CT#84	CP-191129	0978	3	B	Service Gap control in 5GS, enforcement in AMF	16.1.0
2019-06	CT#84	CP-191129	0979	1	B	Service Gap control in 5GS, new time value via UCU procedure	16.1.0
2019-06	CT#84	CP-191129	0980	1	B	General Description for Restriction on use of enhanced coverage	16.1.0
2019-06	CT#84	CP-191129	0981	1	B	Updates to Registration procedure for Restriction on use of enhanced coverage	16.1.0
2019-06	CT#84	CP-191129	0982	2	B	Support for Reliable Data Service in 5GS	16.1.0
2019-06	CT#84	CP-191132	0983	1	F	Handling 5GMM cause #5 "PEI not accepted"	16.1.0
2019-06	CT#84	CP-191132	0984		F	Correcting UE state when disabling and re-enabling N1 mode	16.1.0
2019-06	CT#84	CP-191129	0985	2	F	Terminology definition for 5G_CIoT	16.1.0
2019-06	CT#84	CP-191129	0986	3	B	General introduction on CIoT 5GS optimizations	16.1.0
2019-06	CT#84	CP-191129	0987	5	B	CIoT capability negotiation between UE and network	16.1.0
2019-06	CT#84	CP-191129	0988	3	B	CIoT optimisations redirection between EPC and 5GC	16.1.0
2019-06	CT#84	CP-191129	0989	2	B	Inter-RAT mobility to and from NB-IoT in 5GS	16.1.0
2019-06	CT#84	CP-191129	0990	3	B	Congestion control for CP data transport in 5GS	16.1.0
2019-06	CT#84	CP-191122	0992	2	A	Correction on the 5GSM S-NSSAI congestion control	16.1.0
2019-06	CT#84	CP-191132	0993	2	F	Network slicing indication	16.1.0
2019-06	CT#84	CP-191122	0995	1	A	Correction on the SMS over NAS	16.1.0
2019-06	CT#84	CP-191148	0997	2	B	Providing CAG ID to the lower layer	16.1.0
2019-06	CT#84	CP-191132	0998	5	B	UE behaviour upon receiving non-integrity protected NAS reject messages in 5GS	16.1.0
2019-06	CT#84	CP-191217	1000	5	A	Multiple NAS connections and 5G NAS security context change handling	16.1.0
2019-06	CT#84	CP-191123	1002	1	A	EPS bearer synchronization when moving from EPC to 5GC	16.1.0
2019-06	CT#84	CP-191132	1018	6	F	UE-requested PDU session modification procedure and exemption indication	16.1.0
2019-06	CT#84	CP-191129	1019	1	B	Active Time for MICO mode	16.1.0
2019-06	CT#84	CP-191138	1020	5	B	MA PDU request in UL NAS TRANSPORT message	16.1.0
2019-06	CT#84	CP-191138	1021	4	B	Update PDU session establishment procedure to support MA PDU session	16.1.0

2019-06	CT#84	CP-191132	1022		F	Correction to Mico mode activation in the UE	16.1.0
2019-06	CT#84	CP-191132	1023	4	F	Correction to rejected NSSAI deletion.	16.1.0
2019-06	CT#84	CP-191122	1025		A	Correction of timer table	16.1.0
2019-06	CT#84	CP-191132	1027	2	F	Coordination between GMM and 5GMM	16.1.0
2019-06	CT#84	CP-191132	1029	2	F	Correction of requirements for the handling of access barring	16.1.0
2019-06	CT#84	CP-191129	1030	2	B	Strictly periodic registration timer indication for MICO mode	16.1.0
2019-06	CT#84	CP-191124	1037	2	A	Network initiated deregistration update for cause #3 and #6	16.1.0
2019-06	CT#84	CP-191132	1038		F	Correction of typos in octet numbering for AMF Set ID	16.1.0
2019-06	CT#84	CP-191132	1039		F	Stopping T3519 and deleting SUCI when receiving authentication reject	16.1.0
2019-06	CT#84	CP-191122	1041	1	A	Correct UE parameters update data type	16.1.0
2019-06	CT#84	CP-191132	1043	2	F	Clarifications to the Routing indicator encoding	16.1.0
2019-06	CT#84	CP-191132	1045	1	F	Correction on Payload container type information element	16.1.0
2019-06	CT#84	CP-191129	1046	2	B	Introduction to UE selection of CN for 5G IoT (for 24.501)	16.1.0
2019-06	CT#84	CP-191133	1047		F	Exception in suspension of 5GSM procedures in case of ongoing 5GMM procedures: Service request procedure initiated during connected mode	16.1.0
2019-06	CT#84	CP-191124	1050	1	A	PDU SESSION ESTABLISHMENT message sent via target access in case of handover of an existing PDU session between 3GPP access and non-3GPP access	16.1.0
2019-06	CT#84	CP-191133	1052	2	F	Retrieval of an SMF ID during transfer of a PDN connection in EPS to 5GS	16.1.0
2019-06	CT#84	CP-191146	1053	3	F	Clarification of 5GSM cause values for which network may include a back-off timer or a re-attempt indicator	16.1.0
2019-06	CT#84	CP-191148	1054	4	B	Introduction of non-public network	16.1.0
2019-06	CT#84	CP-191148	1055	1	B	PLMN ID and NID provided to the lower layers	16.1.0
2019-06	CT#84	CP-191133	1058		F	Extensible Authentication Protocol specified in IETF RFC 3748	16.1.0
2019-06	CT#84	CP-191133	1059		F	Corrections on security context terminologies	16.1.0
2019-06	CT#84	CP-191133	1060	2	F	Correction on UE handling for network initiated de-registration with #22	16.1.0
2019-06	CT#84	CP-191133	1061	1	F	T3540 handling for re-registration triggered by UCU	16.1.0
2019-06	CT#84	CP-191133	1062	2	F	Correction on coding of "all other values are spare"	16.1.0
2019-06	CT#84	CP-191124	1064	2	A	Indication of resume failure from the lower layer	16.1.0
2019-06	CT#84	CP-191133	1066	1	F	Integrity protection failure	16.1.0
2019-06	CT#84	CP-191133	1067	1	F	Clarification related to dual registration mode	16.1.0
2019-06	CT#84	CP-191133	1070		F	Including the other cases in [S-NSSAI, DNN] combination back-off timer	16.1.0
2019-06	CT#84	CP-191123	1071	4	A	Correction to the Payload container IE	16.1.0
2019-06	CT#84	CP-191122	1073	3	A	Correction because of wrong implementation of CR0763 and CR0919	16.1.0
2019-06	CT#84	CP-191124	1075	2	A	Resolution of editor's notes on handling at emergency registration and emergency PDU sessions	16.1.0
2019-06	CT#84	CP-191124	1077	2	A	Resolution of editor's notes on handling at non-existing 5G NAS security context indicated by the UE when an emergency PDU session exists	16.1.0
2019-06	CT#84	CP-191137	1078	3	B	Introduction of general aspects of wireline access	16.1.0
2019-06	CT#84	CP-191137	1082	1	B	Introduction of references, definitions and abbreviations for 5WWC	16.1.0
2019-06	CT#84	CP-191133	1088	1	F	Correction on PTI error handling of the UE	16.1.0
2019-06	CT#84	CP-191133	1090	1	F	Correction on PTI error handling of the network	16.1.0
2019-06	CT#84	CP-191133	1092	1	F	Correction on QoS rule operation	16.1.0
2019-06	CT#84	CP-191122	1094	1	A	Correction on handling of mapped EPS bearer contexts IE	16.1.0
2019-06	CT#84	CP-191133	1096	2	F	Correction on associating default EPS bearer with the default QoS rule	16.1.0
2019-06	CT#84	CP-191133	1098	1	F	Feature support after inter-system change from 5GS to EPS	16.1.0
2019-06	CT#84	CP-191133	1100	3	F	Correction on 5GSM IE handling when an error is detected	16.1.0
2019-06	CT#84	CP-191133	1105	1	F	Security Mode Command procedure when S1 mode supported	16.1.0
2019-06	CT#84	CP-191133	1107	1	F	Correction of term "user preference" to "UE local configuration" for inter-system change without N26	16.1.0
2019-06	CT#84	CP-191122	1109	1	A	Addition of missing codepoints for 5GSM causes	16.1.0
2019-06	CT#84	CP-191133	1114	2	F	Modification of the maximum number of supported packet filters	16.1.0
2019-06	CT#84	CP-191133	1115	1	F	5GS-EPS interworking for Multi-homed IPv6 PDU Session not supported without N26	16.1.0
2019-06	CT#84	CP-191133	1118	3	F	UE-requested PDU session modification for emergency PDU session	16.1.0
2019-06	CT#84	CP-191133	1119		F	Clarification of emergency support indications	16.1.0
2019-06	CT#84	CP-191122	1121	3	A	Access control and indication that access barring is applicable for all access categories except categories '0' and '2'	16.1.0
2019-06	CT#84	CP-191138	1122	2	B	Multiple Access PDU Session	16.1.0
2019-06	CT#84	CP-191122	1124	1	A	5GSM cause value #29 semantic extension	16.1.0
2019-06	CT#84	CP-191124	1128	4	A	NSSAI inclusion mode in ePLMN	16.1.0
2019-06	CT#84	CP-191129	1129	1	F	Interaction between active time for MICO mode and eDRX	16.1.0
2019-06	CT#84	CP-191224	1130	4	B	User plane IoT 5GS optimization	16.1.0

2019-06	CT#84	CP-191129	1131	3	B	CP only indication	16.1.0
2019-06	CT#84	CP-191123	1133	1	A	Handling of PDU session modification while a back-off timer is running	16.1.0
2019-06	CT#84	CP-191148	1134	1	B	Adding support for unified access control in SNPNs (Stand-alone Non-Public Networks)	16.1.0
2019-06	CT#84	CP-191134	1135	1	D	The phrase "outside the scope of the present document" is not used consistently	16.1.0
2019-06	CT#84	CP-191134	1137	3	F	Clarification regarding replayed UE security capabilities	16.1.0
2019-06	CT#84	CP-191124	1140	1	A	UE policy length mismatch	16.1.0
2019-06	CT#84	CP-191134	1142	2	F	Conditions for congestion control in AMF	16.1.0
2019-06	CT#84	CP-191134	1146	3	F	Correction of inconsistent requirements for the use of SUCI	16.1.0
2019-06	CT#84	CP-191134	1147	1	F	Disabling of N1 mode capability after emergency services fallback	16.1.0
2019-06	CT#84	CP-191134	1149	1	F	Clarification on disabling N1 mode capability when there is persistent PDU session	16.1.0
2019-06	CT#84	CP-191123	1151	1	A	Indicating PS data off status report for the UE in the Non-allowed Area	16.1.0
2019-06	CT#84	CP-191134	1156	1	F	Clarification of "registration requested" with no other parameters	16.1.0
2019-06	CT#84	CP-191134	1157		F	Updates to Network slicing indication	16.1.0
2019-06	CT#84	CP-191134	1160		F	Clarification on the length of the key stream for initial NAS message protection	16.1.0
2019-06	CT#84	CP-191207	1162	4	F	Applicability of the allowed NSSAI in an equivalent PLMN outside the UE's registration area	16.1.0
2019-06	CT#84	CP-191123	1164	3	A	Handling of the ABBA parameter with a non-zero value and a length of more than 2 octets	16.1.0
2019-06	CT#84	CP-191134	1165	1	F	Clarifications to service area restrictions	16.1.0
2019-06	CT#84	CP-191123	1168	1	A	IEI for the Non-3GPP NW provided policies IE	16.1.0
2019-06	CT#84	CP-191136	1169		F	Reference to IEEE 802.3	16.1.0
2019-06	CT#84	CP-191123	1171	2	A	Correction to serving network name (SNN) reference	16.1.0
2019-06	CT#84	CP-191123	1173	1	A	IEI for the UE OS Id IE	16.1.0
2019-06	CT#84	CP-191134	1174	2	F	Correction for PDU session modification with QFI change.	16.1.0
2019-06	CT#84	CP-191134	1175	2	F	Correction to PDU session release reject handling	16.1.0
2019-06	CT#84	CP-191134	1176	1	F	Correction to PDU session authentication result transport procedure.	16.1.0
2019-06	CT#84	CP-191134	1177	1	F	Clarification for transfer of PDU session for LADN to EPS.	16.1.0
2019-06	CT#84	CP-191134	1178	1	F	Correction to De-registration and registration procedure collision	16.1.0
2019-06	CT#84	CP-191134	1179		F	Clarification for 5GMM cause #3 and #6 in the SERVICE REJECT message	16.1.0
2019-06	CT#84	CP-191134	1180	2	F	Added detailed description for substates INITIAL-REGISTRATION-NEEDED and UPDATE-NEEDED	16.1.0
2019-06	CT#84	CP-191134	1182		D	Minor editorial corrections	16.1.0
2019-06	CT#84	CP-191122	1185	1	A	Always-on PDU session	16.1.0
2019-06	CT#84	CP-191134	1186	1	F	S-NSSAI association for PDU session established in S1 mode	16.1.0
2019-06	CT#84	CP-191130	1187	1	B	5GMM capability for SRVCC from NG-RAN to UTRAN	16.1.0
2019-06	CT#84	CP-191130	1188	1	B	MS classmark 2 and supported codec	16.1.0
2019-06	CT#84	CP-191134	1191	2	F	Handling of 5GSM parameters	16.1.0
2019-06	CT#84	CP-191134	1193	2	F	Handling of SM back-off timer	16.1.0
2019-06	CT#84	CP-191123	1195	1	A	DNN based congestion control for PDU session for LADN	16.1.0
2019-06	CT#84	CP-191135	1197		F	Terminology correction about PDU session type	16.1.0
2019-06	CT#84	CP-191135	1199	1	F	Definition of EMM-IDLE mode in TS 24.501	16.1.0
2019-06	CT#84	CP-191129	1200		F	No CIoT 5GS optimizations for non-3GPP access	16.1.0
2019-06	CT#84	CP-191124	1203	2	A	Network initiated EPS bearer synchronization when moving from EPC to 5GC	16.1.0
2019-06	CT#84	CP-191135	1204	1	F	Correction on follow-on request indicator	16.1.0
2019-06	CT#84	CP-191135	1205		F	Correction on UE behaviour in 5GMM-REGISTERED.PLMN-SEARCH	16.1.0
2019-06	CT#84	CP-191123	1206	1	A	Deletion of the 5GSM cause IE in the PDU SESSION MODIFICATION COMPLETE message	16.1.0
2019-06	CT#84	CP-191135	1207	1	F	Correction on the abnormal cases for registration procedure	16.1.0
2019-06	CT#84	CP-191129	1210		F	Alignment of the Abnormal cases for eDRX between 5GS and EPS	16.1.0
2019-06	CT#84	CP-191135	1211	1	F	Collision handling	16.1.0
2019-06	CT#84	CP-191135	1212	2	F	Authenticate before deleting UE context	16.1.0
2019-06	CT#84	CP-191129	1213	3	B	Uplink NAS message transmission and CIoT data transfer	16.1.0
2019-06	CT#84	CP-191135	1214	1	F	Correction on T3346 and EPLMN handling	16.1.0
2019-06	CT#84	CP-191122	1219	2	A	Alignment of the 5G ciphering and integrity algorithm identifiers	16.1.0
2019-06	CT#84	CP-191135	1220	2	F	Conditions to apply the "null-scheme" to generate the SUCI	16.1.0
2019-06	CT#84	CP-191135	1221		F	Correction on the description of code point for 128-5G-EA3	16.1.0
2019-06	CT#84	CP-191129	1222	1	B	Service Gap control in 5GS, reject of UL NAS Transport message	16.1.0
2019-06	CT#84	CP-191135	1227	2	F	Transmission failure of Registration Request during Initial Reg proc	16.1.0
2019-06	CT#84	CP-191135	1228	3	F	Handling of Radio Link failure during service Req proc	16.1.0

2019-06	CT#84	CP-191148	1229	1	B	Abnormal case handling for receipt of 5GMM cause value #11 from a PLMN	16.1.0
2019-06	CT#84	CP-191148	1231	2	B	Packet filters based on N3IWF IP address and SPI for IPsec SA	16.1.0
2019-06	CT#84	CP-191124	1238	1	A	QoS flow for SIP signalling after inter-system change	16.1.0
2019-06	CT#84	CP-191135	1239	1	F	Handling of multiple QoS rule/flow parameters included in one PCO/ePCO	16.1.0
2019-06	CT#84	CP-191135	1240	1	F	Error handling of optional IEs in a payload container entry of the Payload container IE	16.1.0
2019-06	CT#84	CP-191135	1241		F	Add codings of 5GSM causes #41 and #42	16.1.0
2019-06	CT#84	CP-191124	1245	1	A	Indication of syntactical or semantic errors related to SM policy association to UE	16.1.0
2019-06	CT#84	CP-191135	1246	3	F	Clean-up of general section for 5GMM aspects of network slicing	16.1.0
2019-06	CT#84	CP-191135	1247		F	Request from the upper layers to perform emergency service fallback	16.1.0
2019-06	CT#84	CP-191135	1248		F	Non-overlapping tracking areas	16.1.0
2019-06	CT#84	CP-191146	1249	1	C	5GSM cause values #27, #50, #51 and #70 for SINE_5G	16.1.0
2019-06	CT#84	CP-191123	1251	1	A	Correction to handling of cause #72	16.1.0
2019-06	CT#84	CP-191135	1254	2	F	Originating MMTEL voice due to upper layers request while T3346 is running	16.1.0
2019-06	CT#84	CP-191135	1257		F	Shared or valid 5G NAS security context	16.1.0
2019-06	CT#84	CP-191135	1264	1	F	EAP-success of EAP-TLS received in SECURITY MODE COMMAND	16.1.0
2019-09	CT#85	CP-192073	1056	5	B	Provisioning of an allowed CAG list and a CAG access only indication	16.2.0
2019-09	CT#85	CP-192073	1057	8	B	5GMM cause value for CAG	16.2.0
2019-09	CT#85	CP-192056	1189	3	F	PDU session modification command not forwarded to 5G AN	16.2.0
2019-09	CT#85	CP-192073	1236	3	B	Storage for CAG information	16.2.0
2019-09	CT#85	CP-192060	1269	2	B	Procedure for Multiple Access upgrade of PDU Session	16.2.0
2019-09	CT#85	CP-192056	1270	1	F	Handling the non-current 5G NAS security context after inter-system change from N1 mode to S1 mode	16.2.0
2019-09	CT#85	CP-192060	1271	2	B	NSSAI not allowed for MA PDU session establishment	16.2.0
2019-09	CT#85	CP-192073	1273		F	Updates to new stage-2 requirements of CAG information structure	16.2.0
2019-09	CT#85	CP-192059	1274	2	F	Wireline access is a type of non-3GPP access	16.2.0
2019-09	CT#85	CP-192059	1276	2	F	Management of service area restrictions in wireline access	16.2.0
2019-09	CT#85	CP-192059	1277	2	F	IP address allocation for 5G-RG	16.2.0
2019-09	CT#85	CP-192059	1278	2	B	Security for W-AGF acting on behalf of an FN-RGt	16.2.0
2019-09	CT#85	CP-192059	1279	1	C	Alignment with stage-2 on PEI for 5G-RG and FN-RG	16.2.0
2019-09	CT#85	CP-192063	1280	2	B	V2X capability and V2X PC5 capability	16.2.0
2019-09	CT#85	CP-192063	1281	1	B	USPS extension for V2X policy	16.2.0
2019-09	CT#85	CP-192056	1282		F	Incorrect security algorithm	16.2.0
2019-09	CT#85	CP-192056	1283		F	Registration attempt counter correction	16.2.0
2019-09	CT#85	CP-192073	1286	2	C	5GMM cause values applicable in an SNPN	16.2.0
2019-09	CT#85	CP-192052	1287	1	F	Clarification for UE selecting a suitable cell that supports CIoT optimisation	16.2.0
2019-09	CT#85	CP-192056	1288	1	F	Core network type restriction determined by operator policy	16.2.0
2019-09	CT#85	CP-192056	1290	1	F	Disabling the N1 mode capability for 3GPP access in Idle mode	16.2.0
2019-09	CT#85	CP-192060	1293	1	C	PDU Session release for MA PDU Session	16.2.0
2019-09	CT#85	CP-192056	1295	1	F	Clarification on error check for QoS rules	16.2.0
2019-09	CT#85	CP-192060	1297	1	B	MA PDU session establishment reject due to unstructured PDU Session type	16.2.0
2019-09	CT#85	CP-192056	1298		F	Clarification for T3580 Stop condition	16.2.0
2019-09	CT#85	CP-192060	1300	1	B	MA PDU session modification for ATSSS parameters	16.2.0
2019-09	CT#85	CP-192056	1302	3	F	Staying in inactive upon resume failure with RRC staying in RRC_INACTIVE	16.2.0
2019-09	CT#85	CP-192045	1306	1	A	Maintaining the UL and DL NAS COUNTs after a handover from 5GS to EPS	16.2.0
2019-09	CT#85	CP-192052	1308	2	BV	PDU sessions and QoS flows for NB-IoT UEs	16.2.0
2019-09	CT#85	CP-192052	1311	3	B	Idle mode optimizations for 5G Control plane CIoT small data transfer t	16.2.0
2019-09	CT#85	CP-192056	1315	1	F	Performing registration update upon resume failure for reasons other than barring	16.2.0
2019-09	CT#85	CP-192062	1316	2	B	5GMM capability update for eNS	16.2.0
2019-09	CT#85	CP-192052	1318	1	B	Header compression for control plane user data	16.2.0
2019-09	CT#85	CP-192052	1322	1	B	UE behavior when RRC connection resume failst	16.2.0
2019-09	CT#85	CP-192052	1323	1	F	Correction on service gap timer	16.2.0
2019-09	CT#85	CP-192052	1324	1	F	Correction on T3448 value IE	16.2.0
2019-09	CT#85	CP-192052	1325	1	F	Alleviation of SM congestion	16.2.0
2019-09	CT#85	CP-192056	1326		F	Correction wrt EPS attempt counter to be used for Single Registration Failure use cases	16.2.0
2019-09	CT#85	CP-192056	1328		F	Correction on terminology regarding EPS bearer contextst	16.2.0
2019-09	CT#85	CP-192056	1330	1	F	Correction to SM procedures for back off timer not forwarded from 5GMM case.	16.2.0

2019-09	CT#85	CP-192056	1332		F	Deletion of RAND and RES on receiving Service Accept message	16.2.0
2019-09	CT#85	CP-192056	1333		F	Clarification for emergency call when T3396 or T3585 is running	16.2.0
2019-09	CT#85	CP-192052	1334	1	F	Removal of Editors Note for active timers in the NW	16.2.0
2019-09	CT#85	CP-192083	1335	1	B	Addition of LCS indication in 5GMM capability and 5GS NW capability	16.2.0
2019-09	CT#85	CP-192083	1336	1	B	Addition of location service message condition to Additional informaton IE	16.2.0
2019-09	CT#85	CP-192056	1337		F	Minor miscellaneous corrections	16.2.0
2019-09	CT#85	CP-192056	1340		F	Clarify encoding of EPS bearer identity	16.2.0
2019-09	CT#85	CP-192071	1341		F	Keep equivalent PLMNs list for Deregistration Request message with 5GMM cause #7	16.2.0
2019-09	CT#85	CP-192056	1344		F	Correction to handling of operator-defined access category missing a standardized access category	16.2.0
2019-09	CT#85	CP-192056	1345	1	F	ODAC IEI correction	16.2.0
2019-09	CT#85	CP-192052	1346		F	Removal of eDRX support with RRC_INACTIVE for NB-IoT	16.2.0
2019-09	CT#85	CP-192057	1348	1	F	IMEI not required for non-3GPP only UEs	16.2.0
2019-09	CT#85	CP-192057	1351	1	F	Emergency services fallback from non-3GPP access or ePDG/EPC	16.2.0
2019-09	CT#85	CP-192057	1353	1	F	Re-ordering of text on the applicability of access identities	16.2.0
2019-09	CT#85	CP-192057	1354	1	F	Trigger for NAS procedure retry in case NAS is put back in RRC inactivet	16.2.0
2019-09	CT#85	CP-192069	1355		B	Adding general description of RACS	16.2.0
2019-09	CT#85	CP-192069	1356	1	B	Signalling of UE support for RACS and of UE radio capability ID	16.2.0
2019-09	CT#85	CP-192069	1357	2	B	UE radio capability ID assignment by the network	16.2.0
2019-09	CT#85	CP-192073	1358	1	B	Signalling of UE support for transfer of port management information containers, MAC address and DS-TT residence time	16.2.0
2019-09	CT#85	CP-192073	1359	2	B	Adding support for transfer of Ethernet port management information containers	16.2.0
2019-09	CT#85	CP-192073	1360	1	F	Removal of Editor's note on adding unified access control configuration to "list of subscriber data" for access to SNPNs	16.2.0
2019-09	CT#85	CP-192073	1361	2	F	Resolution of Editor's notes on abnormal case handling for UE-initiated de-registration procedure in an SNPN	16.2.0
2019-09	CT#85	CP-192073	1363	1	F	Resolution of Editor's notes on the applicability of MPS, MCS and delay tolerant in SNPNs	16.2.0
2019-09	CT#85	CP-192073	1364	1	F	Update of requirements on UE to construct packet filters based on the N3IWF destination IP address and the SPI for the IPsec SA	16.2.0
2019-09	CT#85	CP-192083	1365	2	B	NAS transport of supplementary services messages for a deferred 5GC-MT-LR	16.2.0
2019-09	CT#85	CP-192052	1366		F	Resolve Editor's note on support indication for Small Data Rate Control	16.2.0
2019-09	CT#85	CP-192052	1367	1	B	Small data rate control parameters received in EPS	16.2.0
2019-09	CT#85	CP-192052	1369	1	F	Including EPS Preferred Network Behaviour to 5GCN	16.2.0
2019-09	CT#85	CP-192052	1370	1	F	General description on redirection of the UE by the core network	16.2.0
2019-09	CT#85	CP-192052	1371		F	No RRC inactive for NB-IoT	16.2.0
2019-09	CT#85	CP-192052	1372		F	Removal of Editor's Note for the T3348	16.2.0
2019-09	CT#85	CP-192057	1380		F	T3540 for 5GMM cause #31 or #73	16.2.0
2019-09	CT#85	CP-192052	1384	1	F	Service gap control timer and MICO mode	16.2.0
2019-09	CT#85	CP-192052	1385	2	F	Service gap control, stop of timer via configuration update command	16.2.0
2019-09	CT#85	CP-192052	1386		F	Service gap control, MO service request when connected and timer running	16.2.0
2019-09	CT#85	CP-192052	1387	2	C	Service gap control, follow-on request indicator at mobility update registration	16.2.0
2019-09	CT#85	CP-192052	1388	2	2	Service gap control, follow-on request indicator at initial registration	16.2.0
2019-09	CT#85	CP-192052	1391		F	MICO mode and stop of active timer in AMF when UE enters 5GMM-CONNECTED	16.2.0
2019-09	CT#85	CP-192062	1395	3	C	Registration reject due to no available allowed S-NSSAI(s)	16.2.0
2019-09	CT#85	CP-192052	1396	1	F	Service gap control, MO SMS or LPP payload not allowed when connected	16.2.0
2019-09	CT#85	CP-192057	1398	1	F	Consistent use of PLMN ID for AKA	16.2.0
2019-09	CT#85	CP-192057	1399		F	Service reject without integrity protection	16.2.0
2019-09	CT#85	CP-192052	1405		F	Strictly periodic handling due to emergency service.	16.2.0
2019-09	CT#85	CP-192073	1406	2	F	Emergency call handling for a CAG only UE	16.2.0
2019-09	CT#85	CP-192057	1408		F	Collision of deregistration and other NAS procedure	16.2.0
2019-09	CT#85	CP-192057	1410		D	Missing inactive term.	16.2.0
2019-09	CT#85	CP-192073	1411	1	F	Handling of an emergency call in SNPN access mode.	16.2.0
2019-09	CT#85	CP-192057	1412	1	F	Initial NAS message protection	16.2.0
2019-09	CT#85	CP-192057	1413	1	F	Stopping conditions for Timer T3565.	16.2.0
2019-09	CT#85	CP-192062	1421	4	BV	Update of existing subclause for network slice specific authentication and authorization	16.2.0

2019-09	CT#85	CP-192060	1425	1	F	Updates to UE-requested PDU session procedures for converting to MA PDU session	16.2.0
2019-09	CT#85	CP-192059	1427	2	F	Applicability of unified access control for wireline 5G access network	16.2.0
2019-09	CT#85	CP-192070	1434	2	F	Correction of handling of 5GSM causes #27 and #70 for SINE_5G	16.2.0
2019-09	CT#85	CP-192057	1435	1	F	Corrections to the disabling and re-enabling of N1 mode	16.2.0
2019-09	CT#85	CP-192057	1436	1	F	FPLMN list for 3GPP and non-3GPP access types	16.2.0
2019-09	CT#85	CP-192057	1438	1	F	Resolve ENs in clause 5.3.20	16.2.0
2019-09	CT#85	CP-192083	1440	1	B	Access control on MO-LR	16.2.0
2019-09	CT#85	CP-192057	1442		F	Barred MO SMSoNAS	16.2.0
2019-09	CT#85	CP-192057	1448		F	Correction of the QoS rule operation name	16.2.0
2019-09	CT#85	CP-192073	1453	2	B	Handling of non-integrity protected messages in an SNPN	16.2.0
2019-09	CT#85	CP-192073	1454	1	C	Support of network slicing in an SNPN	16.2.0
2019-09	CT#85	CP-192073	1456	1	F	Lists of forbidden networks in an SNPN	16.2.0
2019-09	CT#85	CP-192073	1457	1	F	Lists of forbidden TAs in an SNPN	16.2.0
2019-09	CT#85	CP-192073	1458	1	F	5G-GUTI not globally unique in an SNPN	16.2.0
2019-09	CT#85	CP-192073	1460	2	C	Shared network broadcasting PLMN identity(ies) or SNPN identity(ies)	16.2.0
2019-09	CT#85	CP-192057	1461	2	F	Alignment on the implication description of type of list = "11" in service area list IE	16.2.0
2019-09	CT#85	CP-192073	1466	1	B	Support of time sensitive communication	16.2.0
2019-09	CT#85	CP-192073	1470	2	B	Port management information container: Delivery via the NAS protocol and coding	16.2.0
2019-09	CT#85	CP-192054	1474	2	F	Update the UE-requested PDU session establishment procedure regarding always-on PDU session for URLLC service	16.2.0
2019-09	CT#85	CP-192054	1476	2	F	Update the network-requested PDU session modification procedure regarding always-on PDU session for URLLC service	16.2.0
2019-09	CT#85	CP-192057	1482	1	F	Periodic update is allowed also in non-allowed area	16.2.0
2019-12	CT#86	CP-193094	1233	4	F	QoS operation upon activation of dedicated EPS bearer	16.3.0
2019-12	CT#86	CP-193100	1275	3	F	Management of forbidden area in wireline access	16.3.0
2019-12	CT#86	CP-193094	1284	2	F	Handling of unknown, unforeseen, and erroneous UPDS data in UE policy delivery service	16.3.0
2019-12	CT#86	CP-193094	1327	4	F	Handling of 5GMM parameters during certain mobility registration failures	16.3.0
2019-12	CT#86	CP-193094	1339	2	F	Consistent back off timer handling for EPC interworking	16.3.0
2019-12	CT#86	CP-193094	1342	2	F	Local release when receiving REFRESH command for routing indicator in RRC inactive	16.3.0
2019-12	CT#86	CP-193094	1349	3	F	UAC check for services started in WLAN and being transferred to 3GPP access	16.3.0
2019-12	CT#86	CP-193094	1352	2	F	Addition of abnormal case handling for T3346 running in NAS transport procedure	16.3.0
2019-12	CT#86	CP-193094	1373	4	F	Maintenance of forbidden TA lists for non-integrity protected NAS reject	16.3.0
2019-12	CT#86	CP-193094	1374	2	F	EMM parameters handling for 5G only causes	16.3.0
2019-12	CT#86	CP-193094	1375	5	F	Covering 5GMM cause #31 for DoS attack	16.3.0
2019-12	CT#86	CP-193094	1376	3	F	UE checking the active EPS bearer ID for mapped QoS flows	16.3.0
2019-12	CT#86	CP-193094	1378	3	F	5G NAS security context for interworking	16.3.0
2019-12	CT#86	CP-193094	1397	2	F	Clarification on handling of MP-REG	16.3.0
2019-12	CT#86	CP-193094	1400	3	F	Correction on handling and coding of Mapped EPS bearer contexts	16.3.0
2019-12	CT#86	CP-193094	1401	4	F	QoS rule and QoS flow error handling	16.3.0
2019-12	CT#86	CP-193094	1402	2	F	QoS error operation during interworking	16.3.0
2019-12	CT#86	CP-193115	1403	1	F	Correction on the condition for handling reattempt for PDU session type related rejection	16.3.0
2019-12	CT#86	CP-193094	1404	1	F	Additional 5GS PDU session rejection cause values	16.3.0
2019-12	CT#86	CP-193094	1409	4	F	Emergency registered state handling.	16.3.0
2019-12	CT#86	CP-193094	1416	2	F	Correction for N1 signalling connection release	16.3.0
2019-12	CT#86	CP-193094	1418	3	F	Emergency PDU session establishment upon expiry of timer T3580	16.3.0
2019-12	CT#86	CP-193095	1426	1	F	Correction to the storage of 5GMM information; SOR counter and a UE parameter update counter	16.3.0
2019-12	CT#86	CP-193118	1431	8	B	Transmission of the UE CAG capability to the network	16.3.0
2019-12	CT#86	CP-193095	1432	3	F	Correction of 5GMM state for cause #27 "N1 mode not allowed"	16.3.0
2019-12	CT#86	CP-193095	1433	3	F	Correction and clarification of interworking with ePDG connected to EPC	16.3.0
2019-12	CT#86	CP-193095	1449	1	F	No requirement for network to store a back-off timer per UE and other criteria	16.3.0
2019-12	CT#86	CP-193104	1450	5	B	Slice-specific authentication and authorization procedure	16.3.0
2019-12	CT#86	CP-193115	1452	3	B	Back-off control in case of routing failure	16.3.0
2019-12	CT#86	CP-193118	1469	3	C	PDU session used for TSC established as an always-on PDU session	16.3.0
2019-12	CT#86	CP-193095	1480	7	F	Correction to delivery of mapped S-NSSAI(s)	16.3.0

2019-12	CT#86	CP-193095	1489		F	Correction of statement related to K'AMF derivation during S1 to N1 handover	16.3.0
2019-12	CT#86	CP-193095	1490	1	C	Condition to avoid redundant registration procedures during inter system change from S1 to N1 mode	16.3.0
2019-12	CT#86	CP-193095	1493	1	F	Removal of update status dependency for sub-state selection	16.3.0
2019-12	CT#86	CP-193089	1494	2	F	Handling of pending NAS messages during resume of the N1 NAS signalling connection	16.3.0
2019-12	CT#86	CP-193088	1495	1	F	Apply UAC during resume of the N1 NAS signalling connection	16.3.0
2019-12	CT#86	CP-193095	1496	2	F	Receiving deregistration with cause #72 when registered for both 3GPP and Non-3GPP accesst	16.3.0
2019-12	CT#86	CP-193088	1497	2	F	Correcting DDX description	16.3.0
2019-12	CT#86	CP-193113	1499		F	Correct UE radio capability ID reference	16.3.0
2019-12	CT#86	CP-193101	1500	2	B	MA PDU session release	16.3.0
2019-12	CT#86	CP-193101	1501		F	Add the missing MA PDU request	16.3.0
2019-12	CT#86	CP-193101	1504	2	F	MA PDU session rejection due to operator policy and subscription policy	16.3.0
2019-12	CT#86	CP-193104	1505	6	C	Introduction of pending NSSAI for network slice-specific authentication and authorization	16.3.0
2019-12	CT#86	CP-193089	1506	1	F	Resolving Editor's Note for need of new EPD in CPSR message	16.3.0
2019-12	CT#86	CP-193089	1507	1	F	Resolving Editor's Note on whether CloT small data container IE can be TV format in CPSR message	16.3.0
2019-12	CT#86	CP-193088	1509	2	F	Corrections of service gap control	16.3.0
2019-12	CT#86	CP-193118	1510	3	B	Primary authentication using EAP methods other than EAP-AKA' and EAP-TLS	16.3.0
2019-12	CT#86	CP-193118	1511	1	B	Serving network name in SNPN	16.3.0
2019-12	CT#86	CP-193118	1512	2	B	Extensions of EAP-TLS usage in primary authentication	16.3.0
2019-12	CT#86	CP-193118	1513		B	Extensions of EAP-AKA' usage in primary authentication	16.3.0
2019-12	CT#86	CP-193100	1514	1	F	Further alignment with stage-2 on PEI for 5G-RG and FN-RG	16.3.0
2019-12	CT#86	CP-193100	1515	1	F	Corrections for wireline access service area restrictions	16.3.0
2019-12	CT#86	CP-193088	1516	2	F	Corrections related to Service Gap timer	16.3.0
2019-12	CT#86	CP-193088	1517	1	F	5GS Control plane CloT data transfer for UE in connected mode	16.3.0
2019-12	CT#86	CP-193089	1518	2	F	NAS message container for Control plane service request	16.3.0
2019-12	CT#86	CP-193088	1519	4	F	Abnormal case handling for uplink NAS transport for non-supporting UEs	16.3.0
2019-12	CT#86	CP-193088	1520	2	F	Applicability of existing emergency PDU session request type	16.3.0
2019-12	CT#86	CP-193118	1523		F	Corrections on the Port management information container IE	16.3.0
2019-12	CT#86	CP-193104	1526	6	F	Deregistration due to the failed network Slice-Specific Authentication and Authorization	16.3.0
2019-12	CT#86	CP-193088	1527	1	F	Correction of the misuse of T3525	16.3.0
2019-12	CT#86	CP-193089	1529		F	Inclusion of the T3324 IE in REGISTRATION ACCEPT	16.3.0
2019-12	CT#86	CP-193088	1532	1	C	Control plane service request message and abnormal cases on the network side	16.3.0
2019-12	CT#86	CP-193113	1535	1	B	RACS support at EPS to 5GS IWK	16.3.0
2019-12	CT#86	CP-193113	1539	1	F	UE storage of RACS parameters in non-volatile memory	16.3.0
2019-12	CT#86	CP-193089	1541	1	B	Initial Small Data rate control parameters	16.3.0
2019-12	CT#86	CP-193104	1542		F	Reset of registration attempt counter at registration reject with cause #62	16.3.0
2019-12	CT#86	CP-193095	1543		F	Incorrect reference in Authentication subclause	16.3.0
2019-12	CT#86	CP-193095	1544		F	IE inclusion criteria style alignment	16.3.0
2019-12	CT#86	CP-193088	1545	1	C	CP CloT header compression, UE initiated re-configuration	16.3.0
2019-12	CT#86	CP-193095	1546	1	F	Correction to the notification procedure and collision with UE initiated de-registration	16.3.0
2019-12	CT#86	CP-193095	1547	1	F	Request of IMEISV via the security mode control procedure	16.3.0
2019-12	CT#86	CP-193089	1548	1	F	Service gap control, simultaneous registration over N3GPP access in same PLMN	16.3.0
2019-12	CT#86	CP-193104	1549	3	F	Registration reject due to no allowed slices and NW slice specific authentication and authorization	16.3.0
2019-12	CT#86	CP-193118	1551	2	F	Clarification to forbidden TAI lists for SNPN	16.3.0
2019-12	CT#86	CP-193118	1552	1	F	Clarification to PLMN-SEARCH substate.	16.3.0
2019-12	CT#86	CP-193118	1553	1	F	Correction to SNPN enabled terminology.	16.3.0
2019-12	CT#86	CP-193118	1555	2	F	5GMM cause value #74 and requirements for non-integrity protected reject messages	16.3.0
2019-12	CT#86	CP-193118	1556	1	F	Discarding the REGISTRATION REJECT message with 5GMM cause #76 received without integrity protection	16.3.0
2019-12	CT#86	CP-193118	1558		F	Handling of the DEREGISTRATION REQUEST message with 5GMM cause value #74 or #75 in a PLMN	16.3.0
2019-12	CT#86	CP-193118	1559		F	Reset of the registration attempt counter upon receipt of NPN-based cause values	16.3.0
2019-12	CT#86	CP-193118	1560		F	Handling of T3510, T3517, and the service request attempt counter in an SNPN	16.3.0
2019-12	CT#86	CP-193118	1561	4	F	Missing requirement on UE policies for SNPN	16.3.0
2019-12	CT#86	CP-193088	1562	1	F	Corrections of RRC requirements specified in NAS specs	16.3.0
2019-12	CT#86	CP-193088	1563	5	F	Handling of maximum number of allowed active DRBs	16.3.0

2019-12	CT#86	CP-193118	1565		F	Correction to name of IE carrying residence time for TSN	16.3.0
2019-12	CT#86	CP-193095	1569		F	Stop conditions for timers T3580 and T3581	16.3.0
2019-12	CT#86	CP-193115	1570	1	F	Correction to re-attempt indicator IE description	16.3.0
2019-12	CT#86	CP-193104	1571	2	F	5GMM Cause #62	16.3.0
2019-12	CT#86	CP-193095	1574		F	SMC message trigger	16.3.0
2019-12	CT#86	CP-193095	1575	1	F	Congestion control for UL NAS TRANSPORT message	16.3.0
2019-12	CT#86	CP-193088	1577	1	F	Applying small data rate control at inter-system change	16.3.0
2019-12	CT#86	CP-193118	1578	1	F	Counter events handling for SNPN	16.3.0
2019-12	CT#86	CP-193118	1579	1	F	5GMM cause handling for SNPN	16.3.0
2019-12	CT#86	CP-193101	1580	1	F	Provision of MA PDU session information during the UE-initiated NAS transport procedure initiation	16.3.0
2019-12	CT#86	CP-193095	1583		F	Octet alignment for 5G-GUTI in 5GS mobile identity IE	16.3.0
2019-12	CT#86	CP-193095	1584	1	F	Clarification on handling of 5G NAS security context	16.3.0
2019-12	CT#86	CP-193089	1585	1	C	Resolving Editor's notes on the Data Type field for the Control Plane Service Request message	16.3.0
2019-12	CT#86	CP-193095	1586	1	F	Registration upon change of UE radio capability during 5GMM-CONNECTED mode	16.3.0
2019-12	CT#86	CP-193095	1589		F	Handling of 5GSM cause #54 PDU session does not exist	16.3.0
2019-12	CT#86	CP-193096	1590	1	F	Correction to the indication upon receipt of 5GMM cause #91	16.3.0
2019-12	CT#86	CP-193096	1592	2	F	Handling of errors in mapped EPS bearer contexts	16.3.0
2019-12	CT#86	CP-193096	1593	1	F	Cleanups and editorials	16.3.0
2019-12	CT#86	CP-193104	1598	4	B	"S-NSSAI not available in the current PLMN" when non NSSAA supported UE requesting the S-NSSAI subjects to NSSAA	16.3.0
2019-12	CT#86	CP-193104	1602	6	B	NSSAI storage impact with NSSAA	16.3.0
2019-12	CT#86	CP-193096	1603		F	EHPLMN and Dual registration	16.3.0
2019-12	CT#86	CP-193119	1604	7	F	CAG only UE and emergency procedure.	16.3.0
2019-12	CT#86	CP-193089	1605	3	F	SGC timer and handling during intersystem change	16.3.0
2019-12	CT#86	CP-193096	1608		F	Abbreviation of AUSF and UDM	16.3.0
2019-12	CT#86	CP-193106	1619	1	B	Release of NAS signalling connection for the UE authorized for V2X communication over PC5	16.3.0
2019-12	CT#86	CP-193113	1622	3	F	Identification procedure for RACS	16.3.0
2019-12	CT#86	CP-193088	1623	2	F	Control plane service request, correction regarding service accept message applicability	16.3.0
2019-12	CT#86	CP-193096	1625	2	F	Precedence for segregation flow	16.3.0
2019-12	CT#86	CP-193096	1628	4	F	Unified Access Control for IMS registration related signalling	16.3.0
2019-12	CT#86	CP-193096	1633	1	B	Handling of non-integrity protected rejects when registered	16.3.0
2019-12	CT#86	CP-193101	1636		D	Editorial on PDU session establishment request upgraded to MA PDU session	16.3.0
2019-12	CT#86	CP-193089	1640	1	C	Handling of MT paging for CP-CIoT	16.3.0
2019-12	CT#86	CP-193088	1647	2	B	5GS NAS extended timers for NB-N1 mode and WB-N1/CE mode devices	16.3.0
2019-12	CT#86	CP-193089	1648	1	C	Serving PLMN rate control at PDU session modification	16.3.0
2019-12	CT#86	CP-193096	1649	1	F	Clarification on the Mapped EPS bearer context	16.3.0
2019-12	CT#86	CP-193096	1650		D	Editorial corrections to text related to the status of PDU sessions during SR procedure	16.3.0
2019-12	CT#86	CP-193089	1651	1	F	Short MAC and ngKSI in Control plane service request NAS message	16.3.0
2019-12	CT#86	CP-193089	1657	2	B	Introduction of NSSAI efficient signalling for IoT devices	16.3.0
2019-12	CT#86	CP-193104	1658	1	C	Removal of Editor's note on conditions of accepting registration	16.3.0
2019-12	CT#86	CP-193089	1660	2	F	UE behaviour when T3448 timer running	16.3.0
2019-12	CT#86	CP-193088	1661		F	AMF behaviour for mobility registration when SGC timer running	16.3.0
2019-12	CT#86	CP-193096	1662		F	Clarification on the UE policy container	16.3.0
2019-12	CT#86	CP-193096	1663	1	F	DNN Replacement	16.3.0
2019-12	CT#86	CP-193096	1664	1	F	Faulty and missing reference	16.3.0
2019-12	CT#86	CP-193096	1665	1	F	Correction of handling of de-registration procedure in ATTEMPTING-REGISTRATION-UPDATE	16.3.0
2019-12	CT#86	CP-193096	1666	1	F	Corrections and enhancements for T3540	16.3.0
2019-12	CT#86	CP-193084	1668	2	A	Handling of UE NAS Count during handover from N1 mode to S1 mode	16.3.0
2019-12	CT#86	CP-193096	1669	2	F	Handling multiple QoS errors during a PDU session modification procedure – Option 1	16.3.0
2019-12	CT#86	CP-193104	1674	1	F	No info on S-NSSAI subject to NSSAA in UE	16.3.0
2019-12	CT#86	CP-193169	1676	2	F	Equivalent SNPNs not supported for stand-alone non-public networks	16.3.0
2019-12	CT#86	CP-193096	1680		F	5GMM state in non-3GPP access not impacting EMM state of single-registered UE	16.3.0
2019-12	CT#86	CP-193096	1681	1	F	Registration attempt counter reset by single-registered UE	16.3.0
2019-12	CT#86	CP-193096	1682		F	Correction for 5GMM and inter-system change	16.3.0
2019-12	CT#86	CP-193096	1683		F	Correction for 5GSM and inter-system change with N26	16.3.0
2019-12	CT#86	CP-193097	1684	1	F	Clarification to forbidden PLMN list	16.3.0
2019-12	CT#86	CP-193100	1685		C	Access stratum connection and user-plane resources for trusted non-3GPP access and wireline access	16.3.0

2019-12	CT#86	CP-193100	1686	1	B	Usage of PDU session identity for the PDU sessions requested by the TWIF	16.3.0
2019-12	CT#86	CP-193100	1687		C	Removal of Session-TMBRt	16.3.0
2019-12	CT#86	CP-193100	1688		C	5G-RG and W-AGF acting on behalf of FN-RG performing UE requirements	16.3.0
2019-12	CT#86	CP-193097	1690		F	Correction for 5GS network feature support IE	16.3.0
2019-12	CT#86	CP-193106	1692	1	B	UPDS updates enabling UE-requested V2X policy provisioning procedure	16.3.0
2019-12	CT#86	CP-193119	1693	1	B	Exchange of port management capabilities during PDU session establishment	16.3.0
2019-12	CT#86	CP-193119	1694	1	C	Additional abnormal cases in SNPN	16.3.0
2019-12	CT#86	CP-193106	1697	1	B	5QI 86 introduction	16.3.0
2019-12	CT#86	CP-193097	1698	1	F	Deletion of UE radio capability in the network	16.3.0
2019-12	CT#86	CP-193115	1699	1	C	Retry restriction on non-3GPP access	16.3.0
2019-12	CT#86	CP-193115	1700	1	F	No retry restriction for 5GSM cause value #39	16.3.0
2019-12	CT#86	CP-193089	1702	3	C	Support of UE specific DRX for NB-IoT	16.3.0
2019-12	CT#86	CP-193090	1705	1	B	Transfer of Ciphering Key Information for Broadcast Location Assistance Data	16.3.0
2019-12	CT#86	CP-193089	1707		F	Timer T3448	16.3.0
2019-12	CT#86	CP-193097	1709	1	F	Rejected NSSAI	16.3.0
2019-12	CT#86	CP-193090	1710	1	F	Sending location services data from 5GMM-IDLE mode using the Control Plane Service Request message	16.3.0
2019-12	CT#86	CP-193088	1711	1	F	Correction of the format of CIoT small data container	16.3.0
2019-12	CT#86	CP-193089	1712	3	F	Removal of a Code-Point in Control Plane Service Type	16.3.0
2019-12	CT#86	CP-193097	1715	1	F	Correction to EPLMN list deletion for 5GMM cause #7	16.3.0
2019-12	CT#86	CP-193097	1716		F	Correction to UE OS ID encoding	16.3.0
2019-12	CT#86	CP-193119	1717	3	F	Removal of CAG suscription while emergency PDU session is established.	16.3.0
2019-12	CT#86	CP-193119	1718	1	F	Defenition of CAG cell, CAG ID and CAG selection	16.3.0
2019-12	CT#86	CP-193119	1719	2	F	Handling of Service request message in a non-subscribed CAG cell	16.3.0
2019-12	CT#86	CP-193119	1720	1	F	Updation of LIMITED SERVICE state for CAG	16.3.0
2019-12	CT#86	CP-193116	1722	2	F	Handling of parameters stored in the ME memory	16.3.0
2019-12	CT#86	CP-193104	1723	2	F	Network slice authentication and emergency procedure	16.3.0
2019-12	CT#86	CP-193115	1728		F	Excluding 5GSM causes for congestion control from SINE	16.3.0
2019-12	CT#86	CP-193089	1730	1	F	ngKSI for CONTROL PLANE SERVICE REQUEST message	16.3.0
2019-12	CT#86	CP-193097	1731		F	Inclusion of PDU session reactivation result error cause IE	16.3.0
2019-12	CT#86	CP-193097	1732	1	F	IMEI and IMEISV formats support	16.3.0
2019-12	CT#86	CP-193097	1733	1	F	PEI format for non-3GPP access only UE	16.3.0
2019-12	CT#86	CP-193097	1737	1	F	Correction to the coding of EPS bearer identity	16.3.0
2019-12	CT#86	CP-193097	1740	1	F	UE handling upon receipt of 5GSM #46 out of LADN service area	16.3.0
2019-12	CT#86	CP-193088	1742	1	C	CIoT user data container in UL NAS transport message not routable	16.3.0
2019-12	CT#86	CP-193089	1744	1	C	Service gap control, supporting UE sends MO user data when connected when timer running	16.3.0
2019-12	CT#86	CP-193088	1749	2	F	Correction on the condition for including CP only indication	16.3.0
2019-12	CT#86	CP-193097	1752		F	T3540 in Service Accept Case	16.3.0
2019-12	CT#86	CP-193106	1753	1	C	Access control for UE triggered V2X policy provisioning procedure	16.3.0
2019-12	CT#86	CP-193119	1754	2	F	Abnormal cases for 5GMM cause values #74 and #75	16.3.0
2019-12	CT#86	CP-193119	1755	1	C	Rejected NSSAI in SNPNs	16.3.0
2019-12	CT#86	CP-193119	1756	2	C	Introduction of SNPN-specific attempt counter for non-3GPP access and counter for "the entry for the current SNPN considered invalid for non-3GPP access" events	16.3.0
2019-12	CT#86	CP-193119	1758	1	F	Maintenance of forbidden TA lists for non-integrity protected NAS reject in an SNPN	16.3.0
2019-12	CT#86	CP-193097	1759	1	F	Handling of UAC for an MO IMS registration related signalling	16.3.0
2019-12	CT#86	CP-193097	1760		D	Correction of the definition of Network slicing information	16.3.0
2019-12	CT#86	CP-193119	1766	2	F	Moving Annex E to TS 24.5xy	16.3.0
2019-12	CT#86	CP-193097	1767	1	F	Follow on request codepoint value	16.3.0
2019-12	CT#86	CP-193119	1770	1	F	No CAG access control for emergency services	16.3.0
2019-12	CT#86	CP-193119	1772	2	F	Coding of the CAG-ID	16.3.0
2019-12	CT#86	CP-193097	1773	1	D	Timer order in timer tables	16.3.0
2019-12	CT#86	CP-193097	1774	1	F	Mobility registration accept with NSSAIs	16.3.0
2019-12	CT#86	CP-193097	1775	2	F	Correction to PLMN change with 5G-EA0	16.3.0
2019-12	CT#86	CP-193101	1778	1	D	Editorial on PDU session establishment request upgraded to MA PDU session	16.3.0
2020-03	CT#87e	CP-200117	1533	6	C	NW slice specific authentication and authorization failure and revocation	16.4.0
2020-03	CT#87e	CP-200130	1567	2	B	CAG information towards the lower layers for paging	16.4.0
2020-03	CT#87e	CP-200113	1641	5	B	PDU session handling for N5CW device	16.4.0
2020-03	CT#87e	CP-200107	1672	4	C	Handling of user-plane resources for NB-IoT UEs having at least two PDU sessions	16.4.0

2020-03	CT#87e	CP-200113	1689	2	C	Secondary authentication and W-AGF acting on behalf of FN-RG	16.4.0
2020-03	CT#87e	CP-200111	1781	3	F	Correcting unimplementable condition regarding N26 interworking support detection	16.4.0
2020-03	CT#87e	CP-200111	1784	2	F	Maintain Selected EPS NAS security algorithms during N1 mode to N1 mode handover	16.4.0
2020-03	CT#87e	CP-200111	1785		F	Correction for AUTHENTICATION REJECT handling	16.4.0
2020-03	CT#87e	CP-200111	1786	1	D	Editorial correction of an input parameter for 5G NAS message integrity protection	16.4.0
2020-03	CT#87e	CP-200111	1789	1	F	Correction to sending of EPS NAS message container in Registration Request message	16.4.0
2020-03	CT#87e	CP-200111	1793		D	Correct "ANSDP"	16.4.0
2020-03	CT#87e	CP-200111	1794	2	F	Handling of unsupported SSC mode	16.4.0
2020-03	CT#87e	CP-200111	1797	1	F	Abnormal case for service request procedure	16.4.0
2020-03	CT#87e	CP-200111	1798	2	F	Mapped EPS bearer contexts deletion	16.4.0
2020-03	CT#87e	CP-200111	1799	1	F	Service Request for PS Data Off	16.4.0
2020-03	CT#87e	CP-200111	1800	1	F	Abnormal case for UL NAS TRANSPORT	16.4.0
2020-03	CT#87e	CP-200111	1804		F	Declare syntactical error when both MFBR uplink and MFBR downlink equal zero	16.4.0
2020-03	CT#87e	CP-200111	1805	1	D	Editorial correction to T3447 timer behavior	16.4.0
2020-03	CT#87e	CP-200111	1807	1	F	Handling multiple QoS errors during a PDU session establishment procedure	16.4.0
2020-03	CT#87e	CP-200111	1810	1	F	Inclusion of PDU session reactivation result error cause IE	16.4.0
2020-03	CT#87e	CP-200111	1811		F	Correction on NAS transparent container for 5G-4G interworking	16.4.0
2020-03	CT#87e	CP-200111	1812	2	F	Deletion of the rejected NSSAI for the current registration area	16.4.0
2020-03	CT#87e	CP-200111	1813		F	Trigger for stopping timer T3511	16.4.0
2020-03	CT#87e	CP-200111	1814		F	Correction on T3502 for deactivated value	16.4.0
2020-03	CT#87e	CP-200111	1815	1	F	5GMM cause #22 for resetting registration attempt counter	16.4.0
2020-03	CT#87e	CP-200111	1816		F	Consistent use of additional 5G security information IE	16.4.0
2020-03	CT#87e	CP-200111	1817		F	Correction on N26 interface indicator	16.4.0
2020-03	CT#87e	CP-200111	1818		F	Correction on reference of TS 36.304	16.4.0
2020-03	CT#87e	CP-200111	1819	1	F	Inclusion of 5GSM cause in PDU session modification request	16.4.0
2020-03	CT#87e	CP-200111	1820		F	Inclusion of 5GSM cause in PDU session release request	16.4.0
2020-03	CT#87e	CP-200112	1821		F	PDU session establishment reject with 5GSM #29	16.4.0
2020-03	CT#87e	CP-200112	1822	1	F	Correction on QoS rule/QoS flow synchronization	16.4.0
2020-03	CT#87e	CP-200112	1824	1	F	Correction on NAS COUNT handling for intra-N1 handover	16.4.0
2020-03	CT#87e	CP-200112	1825	1	F	Correction on Uplink data status IE coding	16.4.0
2020-03	CT#87e	CP-200112	1826		F	Acknowledgement of UCU procedure	16.4.0
2020-03	CT#87e	CP-200112	1827	1	F	Update bullet index to include all NAS transport cases	16.4.0
2020-03	CT#87e	CP-200112	1828	1	D	Editorial correction on payload container	16.4.0
2020-03	CT#87e	CP-200112	1829	2	F	Corrections on UE-initiated NAS transport procedure initiation	16.4.0
2020-03	CT#87e	CP-200112	1834	2	D	Corrections in specifying reasons for errors	16.4.0
2020-03	CT#87e	CP-200112	1835	1	F	UE handling of invalid QoS flow description	16.4.0
2020-03	CT#87e	CP-200112	1836	2	F	S-NSSAI as a mandatory parameter to support interworking with 5GS	16.4.0
2020-03	CT#87e	CP-200112	1837	1	F	Optional IE description for release assistance indication IE	16.4.0
2020-03	CT#87e	CP-200112	1838	1	F	UE handling of multiple QoS errors in EPS	16.4.0
2020-03	CT#87e	CP-200112	1839	1	F	S-NSSAI value associated with the BO timer applied for all PLMNs	16.4.0
2020-03	CT#87e	CP-200112	1840	1	F	Abnormal case handling for 5GMM cause value #90 along with a PDU SESSION MODIFICATION REQUEST message	16.4.0
2020-03	CT#87e	CP-200112	1842		F	Correction in handling of persistent PDU session during the mobility registration update	16.4.0
2020-03	CT#87e	CP-200112	1843		D	NAS signalling spelling correction	16.4.0
2020-03	CT#87e	CP-200112	1845	2	F	Reject non-emergency PDU session request attempt while UE registered for emergency services in the network	16.4.0
2020-03	CT#87e	CP-200112	1846		F	Correction to IEI values	16.4.0
2020-03	CT#87e	CP-200112	1847	1	F	Correction to 5GMM cause IE	16.4.0
2020-03	CT#87e	CP-200112	1848		F	Correction to UCU procedure abnormal cases on NW side for a new TAI list	16.4.0
2020-03	CT#87e	CP-200112	1853	3	F	Service area restrictions, case missing for when UE is out of allowed tracking area list and RA	16.4.0
2020-03	CT#87e	CP-200112	1854		F	Correction to the Mapped NSSAI IE	16.4.0
2020-03	CT#87e	CP-200112	1858		D	Correcting reference to 5GSM procedures	16.4.0
2020-03	CT#87e	CP-200114	1860	2	F	5GSM capabilities for MA PDU session	16.4.0
2020-03	CT#87e	CP-200114	1862	4	B	MA PDU session is not supported	16.4.0
2020-03	CT#87e	CP-200117	1869	2	F	Cleanups on introduction of pending NSSAI	16.4.0
2020-03	CT#87e	CP-200113	1870		F	SUCI used by W-AGF acting on behalf of FN-RG	16.4.0
2020-03	CT#87e	CP-200113	1871		F	Resolving editor's note on W-AGF acting on behalf of FN-RG not using the "null integrity protection algorithm" 5G-IAO	16.4.0
2020-03	CT#87e	CP-200113	1872		F	Resolving editor's note on service area restrictions in case of FN-BRG	16.4.0
2020-03	CT#87e	CP-200113	1873		F	Resolving editor's note in forbidden wireline access area	16.4.0

2020-03	CT#87e	CP-200113	1874		F	Wireline 5G access network and wireline 5G access clean up	16.4.0
2020-03	CT#87e	CP-200113	1875	1	F	PEI clean up	16.4.0
2020-03	CT#87e	CP-200113	1876		F	Alignment for stop of enforcement of mobility restrictions in 5G-RG and W-AGF acting on behalf of FN-CRG	16.4.0
2020-03	CT#87e	CP-200113	1877	1	F	Introduction of GCI and GLI	16.4.0
2020-03	CT#87e	CP-200109	1878	1	F	Always-On PDU session and URLLC	16.4.0
2020-03	CT#87e	CP-200130	1879	1	F	CAG information list storage	16.4.0
2020-03	CT#87e	CP-200107	1881	2	F	Abnormal case for cause #31	16.4.0
2020-03	CT#87e	CP-200130	1882		F	Removal of Editor's note on the use of the NOTIFICATION message in SNPNs	16.4.0
2020-03	CT#87e	CP-200135	1884	3	B	Including CAG information list in REGISTRATION ACCEPT message	16.4.0
2020-03	CT#87e	CP-200130	1885		F	Update of text on time synchronization	16.4.0
2020-03	CT#87e	CP-200125	1886		F	Removal of Editor's note on applicability of RACS to SNPNs	16.4.0
2020-03	CT#87e	CP-200125	1887		C	Finalizing the encoding of the UE radio capability ID	16.4.0
2020-03	CT#87e	CP-200125	1888	1	B	UE radio capability ID deletion upon Version ID change	16.4.0
2020-03	CT#87e	CP-200117	1889	2	B	Handling of S-NSSAIs in the pending NSSAI	16.4.0
2020-03	CT#87e	CP-200107	1891		F	Resolve Editor's Notes on NB-N1 mode extended NAS timers for CE	16.4.0
2020-03	CT#87e	CP-200107	1892		F	Resolve Editor's Notes on WB-N1 mode extended NAS timers for CE	16.4.0
2020-03	CT#87e	CP-200117	1893	1	F	Clarification on HPLMN S-NSSAI	16.4.0
2020-03	CT#87e	CP-200114	1896	1	F	MA PDU session and one set of QoS parameters	16.4.0
2020-03	CT#87e	CP-200117	1899	1	F	Update to registration procedure due to eNS	16.4.0
2020-03	CT#87e	CP-200107	1900	1	F	Stop T3565 upon connection resumption	16.4.0
2020-03	CT#87e	CP-200125	1902	1	F	RACS not apply for non-3GPP access	16.4.0
2020-03	CT#87e	CP-200114	1903		F	Minor Correction to ATSSS container IE description	16.4.0
2020-03	CT#87e	CP-200107	1907	3	B	Support for the signalling of the capability for receiving WUS assistance information	16.4.0
2020-03	CT#87e	CP-200113	1910	3	F	Enabling mobility with (emergency) sessions/connections between the (trusted) non-3GPP access network connected to the 5GCN and the E-UTRANt	16.4.0
2020-03	CT#87e	CP-200117	1913	1	F	UE behaviour for other causes in the rejected NSSAI during deregistration procedure	16.4.0
2020-03	CT#87e	CP-200117	1914	1	F	Pending NSSAI update for the configured NSSAI in the CUC message	16.4.0
2020-03	CT#87e	CP-200139	1915	2	F	Cleanup for NSSAA message and coding	16.4.0
2020-03	CT#87e	CP-200117	1916	1	F	Rejected NSSAI during the initial registration procedure	16.4.0
2020-03	CT#87e	CP-200107	1917	1	F	UE behaviour when T3447 running	16.4.0
2020-03	CT#87e	CP-200108	1918	1	C	PDU session release	16.4.0
2020-03	CT#87e	CP-200113	1919		B	ACS information via DHCP	16.4.0
2020-03	CT#87e	CP-200117	1921	1	D	Name of the rejected NSSAI cause values	16.4.0
2020-03	CT#87e	CP-200125	1922		F	Clarification of the cause of start of T3550	16.4.0
2020-03	CT#87e	CP-200130	1923	1	F	Clarification of forbidden TAI lists for SNPN	16.4.0
2020-03	CT#87e	CP-200130	1924		F	Deletion of all CAG-IDs of a CAG cell 5GMM cause for #76	16.4.0
2020-03	CT#87e	CP-200130	1926		F	Clarification of the rejected NSSAI cause value	16.4.0
2020-03	CT#87e	CP-200130	1927		F	Removal of term CAG access control	16.4.0
2020-03	CT#87e	CP-200130	1928		F	Definition alignment for UE-DS-TT residence time	16.4.0
2020-03	CT#87e	CP-200107	1930		F	Ciphering and deciphering handling of CPSR message	16.4.0
2020-03	CT#87e	CP-200107	1932	1	C	Truncated 5G-S-TMSI over NAS	16.4.0
2020-03	CT#87e	CP-200107	1933		F	AMF behavior on stop T3448	16.4.0
2020-03	CT#87e	CP-200107	1934	1	F	Correction on SMS in payload container IE in CPSR message	16.4.0
2020-03	CT#87e	CP-200130	1935	1	F	Correction on 5GMM cause #74/#75 for no touching non-3GPP access	16.4.0
2020-03	CT#87e	CP-200130	1937		F	Correction on term "non-3GPP access" used in SNPN	16.4.0
2020-03	CT#87e	CP-200130	1938		F	Reset the registration attempt counter for #76 in service reject	16.4.0
2020-03	CT#87e	CP-200117	1941	1	F	ENs resolution for revoked or failed NSSAA	16.4.0
2020-03	CT#87e	CP-200117	1942		D	Consistent name for NSSAA	16.4.0
2020-03	CT#87e	CP-200127	1943		F	No retry in 4G for PDU session type related 5GSM causes	16.4.0
2020-03	CT#87e	CP-200127	1944		F	Correction on UE retry restriction on EPLMN	16.4.0
2020-03	CT#87e	CP-200130	1945	1	F	Clarification on Public Network Integrated NPN in TS 24.501	16.4.0
2020-03	CT#87e	CP-200130	1946	1	F	UE receives CAG information in SNPN access mode	16.4.0
2020-03	CT#87e	CP-200130	1947	2	F	Establish PDU session to transfer port management information containers	16.4.0
2020-03	CT#87e	CP-200114	1948	2	F	ATSSS Non-MPTCP traffic support	16.4.0
2020-03	CT#87e	CP-200130	1949	1	F	Correction for the wrongly implemented CR1693r1	16.4.0
2020-03	CT#87e	CP-200117	1953		F	NSSAA revocation function	16.4.0
2020-03	CT#87e	CP-200107	1956	1	F	Stopping of T3513 after connection resume for user plane CloT 5GS optimization	16.4.0
2020-03	CT#87e	CP-200117	1958		F	Correction UE behaviour when the UE recives the pending NSSAI	16.4.0

2020-03	CT#87e	CP-200107	1961	1	F	Adding an editor's note for suspend indication due to user plane ClIoT 5GS optimization	16.4.0
2020-03	CT#87e	CP-200107	1966	1	C	Recovery from fallback for UEs using CP ClIoT optimization	16.4.0
2020-03	CT#87e	CP-200119	1968		B	Triggering service request procedure for V2X communication over PC5 interface	16.4.0
2020-03	CT#87e	CP-200117	1971	1	C	Removal of the use of Service area list IE during NSSAA	16.4.0
2020-03	CT#87e	CP-200117	1973		F	Additional triggers for deletion of pending S-NSSAI	16.4.0
2020-03	CT#87e	CP-200114	1976	1	B	Considering allowed NSSAI when establishing MA PDU session	16.4.0
2020-03	CT#87e	CP-200114	1977	1	B	UE Handling upon receipt of PDU session release command	16.4.0
2020-03	CT#87e	CP-200107	1978	1	F	Correction to UL ClIoT user data container not routable or not allowed to be routed	16.4.0
2020-03	CT#87e	CP-200107	1979	1	F	Single downlink data only indication and release of N1 NAS signalling connection	16.4.0
2020-03	CT#87e	CP-200107	1980	2	F	PDU session status with control plane service request message	16.4.0
2020-03	CT#87e	CP-200107	1981	1	F	Service gap control, correction when to start service gap control timer in UE and NW	16.4.0
2020-03	CT#87e	CP-200107	1982	1	F	Clarification of control plane service request message options	16.4.0
2020-03	CT#87e	CP-200107	1983	1	C	UAC updates for NB-IoT to include "MO exception data"	16.4.0
2020-03	CT#87e	CP-200107	1984	1	B	Clarification on the use of exception data reporting	16.4.0
2020-03	CT#87e	CP-200286	1985	5	F	Update SNPN key differences	16.4.0
2020-03	CT#87e	CP-200109	1987	1	F	Setting the Always-on PDU session indication IE in the PDU SESSION ESTABLISHMENT ACCEPT message	16.4.0
2020-03	CT#87e	CP-200117	1991		F	AMF updates the UE NSSAI storage after network slice-specific authentication and authorization is completed	16.4.0
2020-03	CT#87e	CP-200117	1995		F	Clarification on the S-NSSAI not subject to NSSAA included in allowed NSSAI	16.4.0
2020-03	CT#87e	CP-200117	1996	2	F	Subscribed S-NSSAI marked as default and NSSAA	16.4.0
2020-03	CT#87e	CP-200117	1997		F	Additional conditions to the presence in the subscribed S-NSSAIs	16.4.0
2020-03	CT#87e	CP-200130	1998	1	F	Triggering mobility registration update due to manual CAG selection	16.4.0
2020-03	CT#87e	CP-200117	2000	1	F	Emergency PDU session handling after NSSAA failure	16.4.0
2020-03	CT#87e	CP-200125	2002		F	UE behaviour upon receipt of a UE radio capability ID deletion indication	16.4.0
2020-03	CT#87e	CP-200125	2005	1	F	Additional condition to change UE radio capability ID during mobility registration update	16.4.0
2020-03	CT#87e	CP-200125	2006	1	F	UE radio capability information storage not needed for RACS	16.4.0
2020-03	CT#87e	CP-200097	2008	3	F	Handling of a UE with an emergency PDU session in terms of CAG	16.4.0
2020-03	CT#87e	CP-200130	2012	2	F	N1 mode capability disabling and re-enabling for SNPN	16.4.0
2020-03	CT#87e	CP-200130	2013	1	F	#31 not applicable in an SNPN	16.4.0
2020-03	CT#87e	CP-200130	2015	1	F	Validity of the USIM for an SNPN and for a specific access type	16.4.0
2020-03	CT#87e	CP-200130	2016		F	Handling of 5GMM cause values #62 in an SNPN	16.4.0
2020-03	CT#87e	CP-200130	2017	1	F	No mandate to support default configured NSSAI or network slicing indication	16.4.0
2020-03	CT#87e	CP-200130	2018	2	F	SNN coding	16.4.0
2020-03	CT#87e	CP-200130	2019	1	F	5GMM cause value #74 in an SNPN with a globally-unique SNPN identity	16.4.0
2020-03	CT#87e	CP-200113	2020	1	B	Registration of N5GC devices via wireline access	16.4.0
2020-03	CT#87e	CP-200113	2021	1	F	Correction on EUI-64 as PEI	16.4.0
2020-03	CT#87e	CP-200113	2022		F	Corrections on N5CW support	16.4.0
2020-03	CT#87e					Addition of IEI values, editorial corrections, implementation of missing CR1985	16.4.1
2020-06	CT#88e	CP-201102	0793	9	F	Inclusion of ATTACH REQUEST message in REGISTRATION REQUEST message during initial registration when 5G-GUTI mapped from 4G-GUTI is used	16.5.0
2020-06	CT#88e	CP-201102	1379	6	F	Corrections on the abnormal cases of registration procedure for initial registration	16.5.0
2020-06	CT#88e	CP-201102	1415	12	F	Handling of MCS data in various 5GMM states.	16.5.0
2020-06	CT#88e	CP-201096	1701	5	C	Enhancement on CPSR for ClIoT CP data transport	16.5.0
2020-06	CT#88e	CP-201113	1734	2	F	S-NSSAI in rejected NSSAI for the failed or revoked NSSAA not to be requested	16.5.0
2020-06	CT#88e	CP-201102	1782	5	F	Correcting transfer of connections/sessions if there is an emergency call	16.5.0
2020-06	CT#88e	CP-201102	1792	2	F	Restricting handling of cause #9 to the access on which it was received	16.5.0
2020-06	CT#88e	CP-201102	1795	3	F	Clarification on use of operator-defined access categories	16.5.0
2020-06	CT#88e	CP-201102	1803	3	F	Add handling for UE configured to use timer T3245 in 5GS via 3GPP access	16.5.0
2020-06	CT#88e	CP-201102	1823	4	F	Correction on UE behaviour for service area restriction	16.5.0
2020-06	CT#88e	CP-201102	1841	4	F	Paging with two valid 5G-GUTIs	16.5.0
2020-06	CT#88e	CP-201136	1880	2	C	CAG-ID not provided to lower layers during NAS signalling connection establishment	16.5.0

2020-06	CT#88e	CP-201113	1912	5	C	Deleting Editors note regarding indefinite wait at the UE for NSSAA completion	16.5.0
2020-06	CT#88e	CP-201102	1974	1	F	Dual-registration requirements for EHPLMNs	16.5.0
2020-06	CT#88e						16.5.0
2020-06	CT#88e	CP-201136	2010	2	C	Correction in UE behavior upon receipt of 5GMM cause value #74 or #75 via a non-integrity protected NAS message	16.5.0
2020-06	CT#88e	CP-201109	2027		B	EPS interworking of MA PDU session of 5G-RG when N26 is not supported	16.5.0
2020-06	CT#88e	CP-201108	2028	1	F	Secondary authentication and W-AGF acting on behalf of N5GC device	16.5.0
2020-06	CT#88e	CP-201109	2029	2	B	EPS interworking of MA PDU session of 5G-RG when N26 is supported	16.5.0
2020-06	CT#88e	CP-201096	2030	2	F	Indication of change in the use of enhanced coverage	16.5.0
2020-06	CT#88e	CP-201096	2031		F	Integrity protection data rate for UEs that don't support N3 data transfer	16.5.0
2020-06	CT#88e	CP-201096	2032		F	Addition of Control Plane Service Request in the abnormal cases for service request procedure	16.5.0
2020-06	CT#88e	CP-201132	2033		F	Correction of certain erroneous Information Element Identifiers	16.5.0
2020-06	CT#88e	CP-201096	2034	5	F	DRX parameters for NB-IoT	16.5.0
2020-06	CT#88e	CP-201096	2035		F	Correcting a wrong reference	16.5.0
2020-06	CT#88e	CP-201102	2037		F	Clarification on DL only match-all packet filter	16.5.0
2020-06	CT#88e	CP-201113	2038	1	F	Clarification S-NSSAI status in AMF for NSSAA	16.5.0
2020-06	CT#88e	CP-201113	2039	2	F	Update description on UE indicate supporting NSSAA	16.5.0
2020-06	CT#88e	CP-201113	2040	1	F	Pending NSSAI update for the configured NSSAI in the UCU message	16.5.0
2020-06	CT#88e	CP-201109	2042	1	F	Applicability of PS data off to MA PDU session	16.5.0
2020-06	CT#88e	CP-201113	2043	1	F	Missing condition for inclusion of "NSSAA to be performed" indicator	16.5.0
2020-06	CT#88e	CP-201113	2044	1	F	AMF triggers PDU session release	16.5.0
2020-06	CT#88e	CP-201102	2047		F	Correction of the handling of 5GMM cause #27	16.5.0
2020-06	CT#88e	CP-201113	2049		F	Stopping of T3346 after receiving the NSSA Command message	16.5.0
2020-06	CT#88e	CP-201102	2050	2	F	Additional condition to start T3540	16.5.0
2020-06	CT#88e	CP-201102	2051	1	F	Specify UE behaviour for NOTIFICATION message for additional state/sub-states	16.5.0
2020-06	CT#88e	CP-201113	2053	1	F	Clarification on the rejected S-NSSAI included in requested NSSAI in registration procedure.	16.5.0
2020-06	CT#88e	CP-201108	2055		F	ANDSP is not supported by 5G-RG and W-AGF	16.5.0
2020-06	CT#88e	CP-201096	2056	3	C	Adding a new abnormal case on the network side for CPSR	16.5.0
2020-06	CT#88e	CP-201113	2058	3	F	Clarifying the description for Network Slice-Specific Authorization Revocation	16.5.0
2020-06	CT#88e	CP-201113	2059	3	C	Updating requirements of NSSAA for roaming scenarios	16.5.0
2020-06	CT#88e	CP-201136	2060	1	F	Definition of registered SNPN	16.5.0
2020-06	CT#88e	CP-201096	2062		F	Correction of SGC	16.5.0
2020-06	CT#88e	CP-201096	2063	1	F	Emergency PDU session established after WUS negotiation	16.5.0
2020-06	CT#88e	CP-201136	2064		F	update of the counter for SNPN	16.5.0
2020-06	CT#88e	CP-201136	2065		F	temporarily and permanently forbidden SNPNs lists per access type	16.5.0
2020-06	CT#88e	CP-201136	2066	3	F	storage of counters for UE in SNPN	16.5.0
2020-06	CT#88e	CP-201136	2067	1	F	5G GUTI of SNPN	16.5.0
2020-06	CT#88e	CP-201136	2068		F	5GMM cause value #74 in an SNPN with a globally-unique SNPN identity	16.5.0
2020-06	CT#88e	CP-201136	2069	2	F	5GMM cause value #13 not supporting roaming for SNPN	16.5.0
2020-06	CT#88e	CP-201136	2070		F	Clarification of the cause of start of T3550	16.5.0
2020-06	CT#88e	CP-201102	2071	2	F	storage of counters for UE in PLMN	16.5.0
2020-06	CT#88e	CP-201102	2072		F	Clarification of the figure of registration procedure	16.5.0
2020-06	CT#88e	CP-201102	2074	1	D	Editorial corrections	16.5.0
2020-06	CT#88e	CP-201113	2075		F	T3540 is not started if the Registration Accept includes a pending NSSAI	16.5.0
2020-06	CT#88e	CP-201096	2077	1	C	Generic UE configuration update trigger for registration and EC Restriction change	16.5.0
2020-06	CT#88e	CP-201127	2078	1	F	RACS parameters in generic UE configuration procedure	16.5.0
2020-06	CT#88e	CP-201113	2079	1	F	Clarify that NSSAA can occur during periodic registration or mobility updating for NB-N1 mode UEs	16.5.0
2020-06	CT#88e	CP-201113	2080		F	Fixing typo related to eNS	16.5.0
2020-06	CT#88e	CP-201113	2084	1	F	Alignment of UE actions of rejected NSSAI for the failed or revoked NSSAA	16.5.0
2020-06	CT#88e	CP-201136	2087	1	C	Addition of CAG information list in registration reject message.	16.5.0
2020-06	CT#88e	CP-201113	2089	1	F	Exception to initiate the service request procedure during NSSAA when there is no allowed NSSAI	16.5.0

2020-06	CT#88e	CP-201113	2091	1	F	Missing condition at registration reject due to no available slices	16.5.0
2020-06	CT#88e	CP-201102	2093	1	F	Add handling for parameter set to "value is not used" in 5GS	16.5.0
2020-06	CT#88e	CP-201096	2094	1	F	Correct UE behavior for receiving 5GMM cause #31 in 5GS	16.5.0
2020-06	CT#88e	CP-201102	2095		F	Correct parameters included by AMF during inter-system change from S1 mode to N1 mode in 5GMM-CONNECTED mode	16.5.0
2020-06	CT#88e	CP-201102	2096		F	Remove invalid cases in error handling for QoS rule operation and TFT operation	16.5.0
2020-06	CT#88e	CP-201102	2098	2	F	Applicable URSP is not optional for a UE	16.5.0
2020-06	CT#88e	CP-201144	2100	2	F	Inclusion of NSSAI in AN Parameters for non-3GPP access	16.5.0
2020-06	CT#88e	CP-201102	2101	1	F	Additional QoS error handling related to mapped EBI	16.5.0
2020-06	CT#88e	CP-201102	2102	1	F	PS Data Off status report for non-3GPP access	16.5.0
2020-06	CT#88e	CP-201102	2103	1	D	Unify terms network-initiated and network-requested	16.5.0
2020-06	CT#88e	CP-201102	2104	1	F	Network triggered service request procedure over non-3GPP access	16.5.0
2020-06	CT#88e	CP-201096	2106	3	F	Avoid repeated redirection for CIoT	16.5.0
2020-06	CT#88e	CP-201096	2107	2	F	PDU session release due to CP only revocation	16.5.0
2020-06	CT#88e	CP-201113	2108	3	C	Updating Rejected NSSAI IE for failed NSSAA case in roaming scenarios	16.5.0
2020-06	CT#88e	CP-201102	2110		F	Consider PDU session type IE set by UE in IP address allocation	16.5.0
2020-06	CT#88e	CP-201116	2111	1	F	T3540 for service request for V2X communications	16.5.0
2020-06	CT#88e	CP-201096	2112	1	F	Clarification on the UE behaviour when receiving T3448	16.5.0
2020-06	CT#88e	CP-201096	2113	2	F	Connection Resumption for Notification	16.5.0
2020-06	CT#88e	CP-201096	2114	1	F	CIoT user or small data container in CPSR message not forwarded	16.5.0
2020-06	CT#88e	CP-201099	2115	2	F	Initial Registration after 5G-SRVCC	16.5.0
2020-06	CT#88e	CP-201103	2118		F	Fixing a reference in the service request procedure	16.5.0
2020-06	CT#88e	CP-201103	2120	1	F	Add MFBR as mandatory parameter in GBR QoS flow	16.5.0
2020-06	CT#88e	CP-201103	2121	2	F	Initial registration for initiating emergency PDU session	16.5.0
2020-06	CT#88e	CP-201103	2122	3	F	Missing QoS flow description parameters for GBR QoS flows in 5GSM and ESM coordination	16.5.0
2020-06	CT#88e	CP-201196	2128	4	F	Sending CAG information list	16.5.0
2020-06	CT#88e	CP-201096	2130	1	F	Correction on terminology for the Control plane CIoT 5GS optimization	16.5.0
2020-06	CT#88e	CP-201096	2132	1	F	Handling of PDU session and PDN connection associated with Control plane only indication in case of N26 based interworking procedures	16.5.0
2020-06	CT#88e	CP-201136	2134	1	F	Non-integrity protected REGISTRATION REJECT message including 5GMM cause #76	16.5.0
2020-06	CT#88e	CP-201114	2135	2	F	NSSAA in an SNPN	16.5.0
2020-06	CT#88e	CP-201139	2140	3	F	Correction in the UE behaviour upon failure of the procedures initiated for ESFB	16.5.0
2020-06	CT#88e	CP-201103	2141		F	No emergency session transfer after ESFB	16.5.0
2020-06	CT#88e	CP-201103	2142	2	F	Indication that the emergency services fallback attempt failed	16.5.0
2020-06	CT#88e	CP-201113	2144	1	F	Handling of Pending S-NSSAI	16.5.0
2020-06	CT#88e	CP-201096	2145	1	F	QoS error checks for UEs in NB-N1 mode	16.5.0
2020-06	CT#88e	CP-201136	2149	2	F	NB-IoT not applicable for SNPN	16.5.0
2020-06	CT#88e	CP-201096	2150	1	F	Retransmission of a CPSR message after integrity check failure at the AMF	16.5.0
2020-06	CT#88e	CP-201136	2152	1	F	Miscellaneous clean-up for SNPN	16.5.0
2020-06	CT#88e	CP-201136	2153	2	F	Service area restrictions in an SNPN	16.5.0
2020-06	CT#88e	CP-201103	2154	1	D	Corrections on MICO	16.5.0
2020-06	CT#88e	CP-201136	2156	3	F	5GSM back-off mechanisms in an SNPN	16.5.0
2020-06	CT#88e	CP-201136	2157	1	F	UE in the 5GMM-REGISTERED.ATTEMPTING-REGISTRATION-UPDATE substate operating in SNPN access mode	16.5.0
2020-06	CT#88e	CP-201136	2158	2	F	Routing indicator update in an SNPN	16.5.0
2020-06	CT#88e	CP-201136	2159	1	F	3GPP PS data off in an SNPN	16.5.0
2020-06	CT#88e	CP-201103	2161	1	F	Correction to conditions for including the S-NSSAI(s) from default NSSAI in the requested NSSAI	16.5.0
2020-06	CT#88e	CP-201096	2162		F	Corrections to CR#1907	16.5.0
2020-06	CT#88e	CP-201096	2164	1	B	Signalling of EPS APN rate control parameters during PDU session establishment	16.5.0
2020-06	CT#88e	CP-201283	2165	3	B	Ethernet header compression for CP CIoT – 5GMM aspects	16.5.0
2020-06	CT#88e	CP-201109	2169	1	F	Editorial fix in 9.11.4	16.5.0
2020-06	CT#88e	CP-201096	2173		F	Acknowledgement of truncated 5G-S-TMSI configuration	16.5.0
2020-06	CT#88e	CP-201096	2174		F	NAS-MAC calculation for RRC connection reestablishment for NB-IoT CP optimisation	16.5.0
2020-06	CT#88e	CP-201097	2175		F	Removal of Editor's Note for CP congestion control	16.5.0

2020-06	CT#88e	CP-201097	2176	1	F	Correction on WUS assistance	16.5.0
2020-06	CT#88e	CP-201136	2177	1	F	Non-3GPP access for PLMN and SNPN	16.5.0
2020-06	CT#88e	CP-201136	2178		F	No CAG in non-3GPP access	16.5.0
2020-06	CT#88e	CP-201136	2179		F	Correction on 5GMM #27 for CAG	16.5.0
2020-06	CT#88e	CP-201114	2180	2	F	Clarification on handling of pending NSSAI	16.5.0
2020-06	CT#88e	CP-201114	2181		F	Term on rejected NSSAI for the failed or revoked NSSAA	16.5.0
2020-06	CT#88e	CP-201103	2182	1	F	Single-registration mode without N26	16.5.0
2020-06	CT#88e	CP-201103	2183	1	F	Handling of unallowed SSC mode	16.5.0
2020-06	CT#88e	CP-201103	2184	1	F	UAC exception for emergency	16.5.0
2020-06	CT#88e	CP-201103	2185	3	F	MRU after SR for ESFB aborted	16.5.0
2020-06	CT#88e	CP-201103	2187	1	F	Correction to criteria to enter 5GMM-REGISTERED.UPDATE-NEEDED substate after resumption failure	16.5.0
2020-06	CT#88e	CP-201103	2192		F	Correcting that 5G NAS integrity key is one of the input parameters for integrity protection algorithm	16.5.0
2020-06	CT#88e	CP-201103	2193	2	F	Correction to Handling of T3521 timer	16.5.0
2020-06	CT#88e	CP-201103	2194		F	Correction to Handling of #31	16.5.0
2020-06	CT#88e	CP-201097	2195	1	F	Correction to handling of T3447 timer	16.5.0
2020-06	CT#88e	CP-201137	2196		D	Correct "theregistration"	16.5.0
2020-06	CT#88e	CP-201103	2197		F	De-registration before initial registration for Emergency Services	16.5.0
2020-06	CT#88e	CP-201103	2198	2	F	Handling of allowed NSSAI when the RA includes the TAI belonging to EPLMN	16.5.0
2020-06	CT#88e	CP-201103	2200		F	Corrections on NSSAI storage	16.5.0
2020-06	CT#88e	CP-201103	2202	1	F	UE behaviour when the UE receives the rejected NSSAI for the current RA and does not have a valid RA	16.5.0
2020-06	CT#88e	CP-201109	2203	1	B	Handlings of MA PDU session when deregistration from an access	16.5.0
2020-06	CT#88e	CP-201103	2204		F	Indicate support of ePCO length of two octets parameter when establishing the PDU session – Alt#2	16.5.0
2020-06	CT#88e	CP-201103	2205	2	F	Addition of 5GSM cause #59	16.5.0
2020-06	CT#88e	CP-201103	2214	1	F	Handling of mapped EPS bearer contexts	16.5.0
2020-06	CT#88e	CP-201103	2215	1	F	Integrity check interworking in 5GMM-CONNECTED mode	16.5.0
2020-06	CT#88e	CP-201103	2216	1	F	Correction on LADN DNN based congestion control	16.5.0
2020-06	CT#88e	CP-201108	2218	1	B	Primary authentication of an N5GC device	16.5.0
2020-06	CT#88e	CP-201108	2219		F	Stop of enforcement of wireline access service area restrictions and forbidden wireline access area	16.5.0
2020-06	CT#88e						16.5.0
2020-06	CT#88e	CP-201104	2221		F	Incorrect set up of PDN type in inter-system change from S1 mode to N1 mode	16.5.0
2020-06	CT#88e	CP-201109	2222		F	Session-AMBR and MA PDU session	16.5.0
2020-06	CT#88e	CP-201109	2223	1	F	Introduction of ATSSS	16.5.0
2020-06	CT#88e	CP-201109	2224		F	"MA PDU request" when the UE has an MA PDU session established over one access and requests establishment of user plane resources over the other access	16.5.0
2020-06	CT#88e	CP-201104	2227	1	F	Mobile Terminated Voice Gap for MPS	16.5.0
2020-06	CT#88e	CP-201114	2228	1	F	Adding AAA-S via NSSAAF to support NSSAA	16.5.0
2020-06	CT#88e	CP-201311	2229	2	F	Resolve EN for Ciphering Key data IE regarding positioning SIBs	16.5.0
2020-06	CT#88e	CP-201104	2230	1	F	MICO indication needs to be included without Network Slicing Subscription Change Indication in UCU.	16.5.0
2020-06	CT#88e	CP-201104	2231	2	F	Conditions for use of S-NSSAIs after receiving Rejected NSSAI Conditions for use of S-NSSAIs after receiving Rejected NSSAI	16.5.0
2020-06	CT#88e	CP-201114	2232	2	F	Default S-NSSAI not subject to network slice-specific authentication and authorization	16.5.0
2020-06	CT#88e	CP-201114	2233	3	F	Performing network slice-specific re-authentication and re-authorization	16.5.0
2020-06	CT#88e	CP-201114	2234	2	F	Storage of pending NSSAI	16.5.0
2020-06	CT#88e	CP-201104	2235	1	F	UE stopping back-off timer when receiving PDU SESSION AUTHENTICATION COMMAND	16.5.0
2020-06	CT#88e	CP-201114	2236	4	F	Pending NSSAI and equivalent PLMNs	16.5.0
2020-06	CT#88e	CP-201132	2237		F	Correcting the incorrect mode of the UE	16.5.0
2020-06	CT#88e	CP-201127	2241	1	F	Avoiding too frequent registration procedures due to signalling of UE radio capability ID	16.5.0
2020-06	CT#88e	CP-201119	2242	1	F	Unified access control is not applicable to a UE operating as IAB-node	16.5.0
2020-06	CT#88e	CP-201104	2247	1	F	Revert CR 0820t	16.5.0
2020-06	CT#88e	CP-201104	2249	1	F	Change of E-UTRAN UE Capability	16.5.0
2020-06	CT#88e	CP-201106	2250		F	Store the received S-NSSAI via ePDG in the configured NSSAI	16.5.0
2020-06	CT#88e	CP-201114	2254		F	Re-initiation of NSSAA – Reactive solution	16.5.0
2020-06	CT#88e	CP-201104	2255	1	F	Clarification of the forbidden PLMN list used for non-3GPP access	16.5.0

2020-06	CT#88e	CP-201104	2256		F	Re-enabling the N1 mode capability upon request from the upper layers	16.5.0
2020-06	CT#88e	CP-201104	2257		F	Correction of re-enabling E-UTRA capability	16.5.0
2020-06	CT#88e	CP-201104	2258	1	F	Native 5G-GUTI in Additional GUTI IE	16.5.0
2020-06	CT#88e	CP-201104	2259	1	F	Correction of IE1	16.5.0
2020-06	CT#88e	CP-201097	2260		F	Maintenance of T3517	16.5.0
2020-06	CT#88e	CP-201137	2261		F	Operation of UE in SNPN access mode when timer T3247 expires	16.5.0
2020-06	CT#88e	CP-201137	2262		F	Reference correction for SNPN	16.5.0
2020-06	CT#88e	CP-201104	2264	1	D	Stop T3346 before sending NAS message	16.5.0
2020-06	CT#88e	CP-201097	2265	1	F	Condition under which the UE shall enter 5GMM-IDLE mode when user plane ClOT 5GS optimization is used	16.5.0
2020-06	CT#88e	CP-201104	2267	1	F	Correction to handling of 5GSM timers in abnormal cases	16.5.0
2020-06	CT#88e	CP-201104	2269	1	F	Clarification for de-registration procedure initiation	16.5.0
2020-06	CT#88e	CP-201104	2270		F	Clarification in state transition of 5GMM-DEREGISTERED from another 5GMM state	16.5.0
2020-06	CT#88e	CP-201104	2271		F	Clarification of SMS over NAS supported bit in initial registration	16.5.0
2020-06	CT#88e	CP-201104	2272		F	Clarification on missing subclause in 5GMM-DEREGISTERED.ATTEMPTING-REGISTRATION	16.5.0
2020-06	CT#88e	CP-201104	2273		F	Clarification on missing subclause in 5GMM-REGISTERED.ATTEMPTING-REGISTRATION-UPDATE	16.5.0
2020-06	CT#88e	CP-201104	2274		F	Clarification regarding update status in NR RAT	16.5.0
2020-06	CT#88e	CP-201104	2275	1	F	Correction to paging timer stop in case of integrity check failure	16.5.0
2020-06	CT#88e	CP-201104	2277	1	D	Correction to spelling mistakes	16.5.0
2020-06	CT#88e	CP-201137	2278	2	F	UE shall use the GUTI assigned by the same SNPN during registration	16.5.0
2020-06	CT#88e	CP-201137	2279		F	Correct PLMN to SNPN	16.5.0
2020-06	CT#88e	CP-201114	2281	1	F	Clarification on S-NSSAI deletion based on the rejected NSSAI due to NSSAA in the roaming case	16.5.0
2020-06	CT#88e	CP-201114	2282	1	F	Correction on allowed NSSAI for UE not supporting NSSAA	16.5.0
2020-06	CT#88e	CP-201104	2283		B	Indicate 5GSM cause when initiating 5GSM procedure for error handling	16.5.0
2020-06	CT#88e	CP-201104	2284	1	F	PDU session release upon receipt of PDU session status IE	16.5.0
2020-06	CT#88e	CP-201130	2286	1	F	Correction to the handling for 5GSM #27	16.5.0
2020-06	CT#88e	CP-201104	2287		F	Stop back-off timer upon receipt of 5GSM #39	16.5.0
2020-06	CT#88e	CP-201104	2289		D	Removal of duplicate words	16.5.0
2020-06	CT#88e	CP-201105	2290	1	F	Correction to 5GMM-REGISTERED.NORMAL-SERVICE	16.5.0
2020-06	CT#88e	CP-201105	2292		F	Correction to handling of #3/#6/#7	16.5.0
2020-06	CT#88e	CP-201105	2294	1	F	Correction to 5GMM-DEREGISTERED.NORMAL-SERVICE	16.5.0
2020-06	CT#88e	CP-201105	2296		F	Correction to subclause in Requested NSSAI	16.5.0
2020-06	CT#88e	CP-201105	2297		F	Clarification in usage of SIM terminology in 5GS services	16.5.0
2020-06	CT#88e	CP-201105	2299	2	F	Support for continuity of emergency session upon registration failure	16.5.0
2020-06	CT#88e	CP-201137	2303		F	Updating Port management information container IE	16.5.0
2020-06	CT#88e	CP-201097	2304		F	De-registration request and CPSR collision case in the NW	16.5.0
2020-06	CT#88e	CP-201097	2305		F	Additional stop condition for timer T3580	16.5.0
2020-06	CT#88e	CP-201097	2306	1	F	Abnormal cases on UE side and the CPSR message	16.5.0
2020-06	CT#88e	CP-201097	2307	1	F	Service gap control: Alignment of NW and UE behaviour for timer T3447	16.5.0
2020-06	CT#88e	CP-201097	2308	1	F	Service gap control: Exceptions to start of timer T3447	16.5.0
2020-06	CT#88e	CP-201114	2309	1	F	UE behaviour when more than 16 S-NSSAIs received in pending NSSAI IE	16.5.0
2020-06	CT#88e	CP-201137	2313	1	F	Handling of CAG information list in REGISTRATION ACCEPT messages	16.5.0
2020-06	CT#88e	CP-201137	2314		F	Provision of CAG information list in SERVICE REJECT message.	16.5.0
2020-06	CT#88e	CP-201114	2315	1	F	Size of pending NSSAI in REGISTRATION ACCEPT message	16.5.0
2020-06	CT#88e	CP-201097	2316		F	Corrections for Enhanced Coverage in 5GS for ClOT	16.5.0
2020-06	CT#88e	CP-201105	2317		F	Not including NSSAI for emergency session for interworking without N26 interface	16.5.0
2020-06	CT#88e	CP-201105	2318		F	AMF not using 5GMM registration status in UE status IE	16.5.0
2020-06	CT#88e	CP-201097	2319	1	F	CPBO timer handling when AMF is congested for CP data.	16.5.0
2020-06	CT#88e	CP-201108	2321		D	Removal of TMBR	16.5.0
2020-06	CT#88e	CP-201284	2323	2	B	Ethernet header compression for CP ClOT – 5GSM aspects	16.5.0
2020-06	CT#88e	CP-201105	2326	1	C	Associating S-NSSAI-based congestion backoff timers with S-NSSAI when S-NSSAI is provided during PDU session establishment	16.5.0
2020-06	CT#88e	CP-201097	2327	2	C	Updates to non-allowed area restrictions	16.5.0
2020-06	CT#88e	CP-201127	2328	1	F	Correction of RACS ID deletion via UCU	16.5.0

2020-06	CT#88e	CP-201114	2330	1	F	Correction related the pending NSSAI	16.5.0
2020-06	CT#88e	CP-201105	2332	1	F	Clarification on handling of rejected NSSAI for the current registration area	16.5.0
2020-06	CT#88e	CP-201114	2333	1	F	Clarification on S-NSSAI(s) in URSP(NSSP) be added into the request NSSAI	16.5.0
2020-06	CT#88e	CP-201097	2336	1	F	Multiple DRB support for UEs in NB-N1 mode	16.5.0
2020-06	CT#88e	CP-201097	2337	1	F	Establishment of UP resources for NB-IoT based on number of supported DRBs	16.5.0
2020-06	CT#88e	CP-201114	2339	1	F	A default S-NSSAI not subject to NSSAA	16.5.0
2020-06	CT#88e	CP-201137	2340	1	F	Clarification on the non-supported functions and procedures for SNPN	16.5.0
2020-06	CT#88e	CP-201105	2341		D	Correction on unclear texts regarding the CONFIGURATION UPDATE COMMAND message	16.5.0
2020-06	CT#88e	CP-201097	2342	1	F	IP header compression after inter-system change from S1 mode to N1 mode	16.5.0
2020-06	CT#88e	CP-201105	2344	1	F	Trigger SR over non-3GPP access after T3346 expiry.	16.5.0
2020-06	CT#88e	CP-201322	2345	2	B	Provisioning of DNS server security information to the UE	16.5.0
2020-06	CT#88e	CP-201097	2346	1	F	Adding a missing case on the UE side for CPSR	16.5.0
2020-06	CT#88e	CP-201105	2347		F	Condition for setting the Selected EPS NAS algorithm IE to NULL	16.5.0
2020-06	CT#88e	CP-201105	2348	2	F	Connected mode mobility from N1 mode to S1 mode and DL NAS COUNT handling	16.5.0
2020-06	CT#88e	CP-201105	2350	1	F	Correction in the AMF behaviour upon LADN information update	16.5.0
2020-06	CT#88e	CP-201105	2352	1	F	Unify terminology for default S-NSSAIs and subscribed S-NSSAIs marked as default	16.5.0
2020-06	CT#88e	CP-201105	2356		F	Correction to Service Reject with cause #28	16.5.0
2020-06	CT#88e	CP-201105	2357	1	F	UE behaviour when receiving allowed NSSAI in CUC	16.5.0
2020-06	CT#88e	CP-201105	2358		F	Ciphering initial registration message with NULL algorithm	16.5.0
2020-06	CT#88e	CP-201105	2362		F	Clean up description of Cause #34 in TS 24.501	16.5.0
2020-06	CT#88e	CP-201105	2364	1	F	Semantic error check for duplicate QRI or QFI	16.5.0
2020-06	CT#88e	CP-201137	2366		D	Editorial change to SNPN	16.5.0
2020-06	CT#88e	CP-201137	2368	1	F	No CAG ID in de-registration request	16.5.0
2020-06	CT#88e	CP-201097	2369	1	F	No dedicated EPS bearer for interworking from WB-N1 to NB-S1 mode	16.5.0
2020-06	CT#88e	CP-201137	2371	1	F	Management for SNPN access mode per access type	16.5.0
2020-06	CT#88e	CP-201097	2372	2	F	Redirection of UE from N1 mode to S1 mode	16.5.0
2020-06	CT#88e	CP-201105	2375	1	F	NAS message transmission failure indication with delayed TAI change	16.5.0
2020-06	CT#88e	CP-201097	2376	1	F	PDU session transfer between 3GPP and non-3GPP when CP Clot 5GS optimization is being used	16.5.0
2020-06	CT#88e	CP-201097	2377	1	F	PDU session transfer between 3GPP and non-3GPP when UP Clot 5GS optimization is being used	16.5.0
2020-06	CT#88e	CP-201097	2379		F	Correction on Clot small data container IE	16.5.0
2020-06	CT#88e	CP-201097	2380		F	Maximum length of Unstructured data via the control plane	16.5.0
2020-06	CT#88e	CP-201097	2381		F	Missing LCS/LPP container content in Payload container IE	16.5.0
2020-06	CT#88e	CP-201105	2382		F	Handling of multiple QoS flow descriptions	16.5.0
2020-06	CT#88e	CP-201105	2384	1	F	Clarification of NAS COUNT handling in 5G	16.5.0
2020-06	CT#88e	CP-201114	2386	1	F	Providing complete pending NSSAI for NSSAA	16.5.0
2020-06	CT#88e	CP-201137	2388	1	F	SNPN services via a PLMN over 3GPP access	16.5.0
2020-06	CT#88e	CP-201108	2390	1	B	N5GC NAS aspects	16.5.0
2020-06	CT#88e	CP-201108	2391	1	B	N5GC service area restrictions	16.5.0
2020-06	CT#88e	CP-201137	2394	2	F	Prevention of loop for 5GMM cause #62	16.5.0
2020-06	CT#88e	CP-201108	2398		F	N5CW device registration and IP assignment	16.5.0
2020-07	CT#88e					Editorial corrections by rapporteur and MCC. Addition of IEI values	16.5.1
2020-09	CT#89e	CP-202171	1970	2	F	Handling of LADN information when the UE is operating in SNPN access mode	16.6.0
2020-09	CT#89e	CP-202156	2086	5	F	S-NSSAIs always selected by AMF from allowed NSSAI	16.6.0
2020-09	CT#89e	CP-202166	2092	5	F	TA change during Authentication procedure in 5GMM-CONNECTED mode	16.6.0
2020-09	CT#89e	CP-202152	2220	2	F	IPv6 configuration for W-AGF acting on behalf of FN-RG	16.6.0
2020-09	CT#89e	CP-202156	2244	4	F	Disabling of N1 capabilities when all requested S-NSSAIs subjected to NSSAA are rejected due to failure of NSSAA or when no slice is available for UE	16.6.0
2020-09	CT#89e	CP-202171	2251	2	F	Alternative 2: UE behaviour regarding N1 mode capability upon T3247 expiry	16.6.0
2020-09	CT#89e	CP-202171	2252	1	B	Alternative 2: Handling of a UE not allowed to access SNPN services via a PLMN by subscription with 5GMM cause value #72	16.6.0
2020-09	CT#89e	CP-202150	2397	4	F	Transfer of PDN connection from untrusted non-3GPP access connected to EPC to 5GS	16.6.0

2020-09	CT#89e	CP-202146	2401		F	Correction to PDU session ID inclusion in UL and DL NAS transport	16.6.0
2020-09	CT#89e	CP-202156	2403	1	F	Clarification on the condition when the allowed NSSAI IE shall be included in the REGISTRATION ACCEPT message	16.6.0
2020-09	CT#89e	CP-202156	2405	1	F	Consistency of the term on rejected NSSAI for the failed or revoked NSSAA	16.6.0
2020-09	CT#89e	CP-202156	2409	1	F	Correction to clarify S-NSSAI(s) in allowed NSSAI doesn't require NSSAA	16.6.0
2020-09	CT#89e	CP-202156	2410	1	F	Clarification on the "NSSAA to be performed" indicator	16.6.0
2020-09	CT#89e	CP-202166	2411	1	F	Support of User Plane Integrity Protection for any data rates	16.6.0
2020-09	CT#89e	CP-202150	2418	1	F	URSP evaluation after rejection with the same URSP rule	16.6.0
2020-09	CT#89e	CP-202150	2419	1	F	Remove #43 in PDU session modification command not accepted by UE	16.6.0
2020-09	CT#89e	CP-202156	2420	1	F	NSSAA Slice handling for 1-to-many mapping in roaming scenario	16.6.0
2020-09	CT#89e	CP-202153	2422	1	F	Correcting partial implementation of CR#2029	16.6.0
2020-09	CT#89e	CP-202150	2423		F	Correcting partial implementation of CR#2221	16.6.0
2020-09	CT#89e	CP-202153	2424	1	F	"MA PDU request" when the 5G-RG performs inter-system change from S1 mode to N1 mode with an MA PDU session with a PDN connection as a user-plane resource	16.6.0
2020-09	CT#89e	CP-202152	2430		F	W-CP connection	16.6.0
2020-09	CT#89e	CP-202150	2433		F	SIM not applicable for 5GS cases	16.6.0
2020-09	CT#89e	CP-202150	2434	1	F	NAS MAC terminology	16.6.0
2020-09	CT#89e	CP-202150	2436	1	F	Congestion handling of initial registration for emergency	16.6.0
2020-09	CT#89e	CP-202150	2437	1	F	Corrections to the QoS parameter checks for "unstructured" data and for QoS flow deletion	16.6.0
2020-09	CT#89e	CP-202168	2441		F	Removal of Editor's note on inter PLMN mobility under same AMF	16.6.0
2020-09	CT#89e	CP-202159	2442		F	Removal of Editor's note on UAC for IAB	16.6.0
2020-09	CT#89e	CP-202146	2443		F	Avoiding double barring for CPSR following NAS connection recovery from fallback	16.6.0
2020-09	CT#89e	CP-202146	2445		F	Correction to the 5GS network feature support IE	16.6.0
2020-09	CT#89e	CP-202171	2459		F	Correction of counters in an SNPN	16.6.0
2020-09	CT#89e	CP-202171	2460		F	Provisioning of a CAG information list in Service Request procedure	16.6.0
2020-09	CT#89e	CP-202156	2462	1	F	NSSAA during PDU session modification procedure	16.6.0
2020-09	CT#89e	CP-202153	2464	1	F	Clarification on the applicability of Allowed PDU session status IE to MA PDU	16.6.0
2020-09	CT#89e	CP-202153	2465	1	F	Correction on unnecessary restriction for modifying/upgrading a PDU session to an MA PDU session	16.6.0
2020-09	CT#89e	CP-202153	2466	1	F	Correction on PDU session status IE handling for MA PDU sessions	16.6.0
2020-09	CT#89e	CP-202153	2467	1	F	local release of an MA PDU session having user plane resources established on both 3GPP access and non-3GPP access	16.6.0
2020-09	CT#89e	CP-202150	2468	1	F	Clarification for SR attempt count reset	16.6.0
2020-09	CT#89e	CP-202150	2469	1	F	Handling for SR in 5U2 state	16.6.0
2020-09	CT#89e	CP-202156	2470	1	F	Clairification of Rejected NSSAI	16.6.0
2020-09	CT#89e	CP-202146	2473		F	CP data allowed in connected mode in Non-allowed area	16.6.0
2020-09	CT#89e	CP-202156	2474	1	F	Deleting Editors note regarding to network slice-specific re-authorization and re-authorization	16.6.0
2020-09	CT#89e	CP-202152	2476		F	IPv6 prefix not allocated	16.6.0
2020-09	CT#89e	CP-202171	2480		F	Minimum length of port management information container in SM messages	16.6.0
2020-09	CT#89e	CP-202150	2481	1	F	Mapped dedicated EPS bearer without default EPS bearer	16.6.0
2020-09	CT#89e	CP-202150	2482		F	Calculation of MAC in NAS transparent containers	16.6.0
2020-09	CT#89e	CP-202150	2483	1	F	Provisioning of DNS server security information to the UE-25.401	16.6.0
2020-09	CT#89e	CP-202168	2484	1	F	Use existing NAS signalling connection to send mobility reg due to receipt of URC delete indication IE.	16.6.0
2020-09	CT#89e	CP-202156	2488	1	F	Clarification of Rejected NSSAI associated with 5GMM cause #62	16.6.0
2020-09	CT#89e	CP-202171	2491		F	CAG information list in Registration reject message.	16.6.0
2020-09	CT#89e	CP-202150	2492	1	F	CR#2299 clean up: continuity of emergency session upon registration failure	16.6.0
2020-09	CT#89e	CP-202156	2497	2	F	Correction on UE behavior for the rejected NSSAI for the failed or revoked NSSAA and the pending NSSAI when the Allowed NSSAI is received	16.6.0
2020-09	CT#89e	CP-202146	2499	1	F	Adding the handling of AMF for case k in the service request procedure	16.6.0
2020-09	CT#89e	CP-202146	2502	1	F	UE behavior when the timer T3447 is stopped	16.6.0

2020-09	CT#89e	CP-202171	2503		F	UE behavior on SNPN access mode when accessing to PLMN services via a SNPN	16.6.0
2020-09	CT#89e	CP-202150	2506	2	F	Mobility Registration for Inter-RAT movement	16.6.0
2020-09	CT#89e	CP-202171	2507	1	F	#76 cause handling in case of reception of Registration Reject in roaming scenarios	16.6.0
2020-09	CT#89e	CP-202150	2509	1	F	Corrections on the error check of QoS rules	16.6.0
2020-09	CT#89e	CP-202171	2512	1	F	Add definition of "allowed CAG list"	16.6.0
2020-09	CT#89e	CP-202032	2514	1	F	Paging not initiated for PDU session transfer from non-3GPP access when CP ClOT 5GS optimization is being used	16.6.0
2020-09	CT#89e	CP-202146	2515		F	UE specific DRX value for NB-IoT	16.6.0
2020-09	CT#89e	CP-202156	2521	1	F	Rejection of PDU session establishment associated with an S-NSSAI for which NSSAA is re-initiated	16.6.0
2020-09	CT#89e	CP-202156	2525	1	F	Removal of the "failed or revoked NSSAA" definition	16.6.0
2020-09	CT#89e	CP-202171	2526		F	Finding a suitable cell in a PLMN where a UE is allowed to access a non-CAG cell	16.6.0
2020-09	CT#89e	CP-202171	2527	1	F	5GMM cause value #76 mapped to a different 5GMM cause value	16.6.0
2020-09	CT#89e	CP-202171	2528	1	F	EAB not applicable for a UE operating in SNPN access mode	16.6.0
2020-09	CT#89e	CP-202171	2530	1	F	T3245 for a UE operating in SNPN access mode	16.6.0
2020-09	CT#89e	CP-202171	2531	1	F	Handling of back-off due to 5GSM cause value #27 "missing or unknown DNN" by a UE operating in SNPN access mode	16.6.0
2020-09	CT#89e	CP-202151	2534	1	F	Handling of QoS errors in ESM procedures	16.6.0
2020-09	CT#89e	CP-202151	2535		F	Delete unimplementable QoS operations in ESM procedure	16.6.0
2020-09	CT#89e	CP-202151	2536		F	Packet filter identifier setting when requesting new packet filters	16.6.0
2020-09	CT#89e	CP-202151	2537	1	F	Update of the timers table for 5GS session management	16.6.0
2020-09	CT#89e	CP-202151	2539	1	F	Infinite De-registration attempt	16.6.0
2020-09	CT#89e	CP-202146	2540	1	F	Define "emergency services" for Control plane service type in CPSR	16.6.0
2020-09	CT#89e	CP-202122	2552	4	F	Type of the N5GC indication information element	16.6.0
2020-09	CT#89e	CP-202156	2555		F	Clarification of conditions which the rejected NSSAI for the failed or revoked NSSAA is deleted	16.6.0
2020-09	CT#89e	CP-202151	2561	1	F	T3525 clarification for UE configured with high priority access	16.6.0
2020-09	CT#89e	CP-202171	2562	1	F	Clarification to the usage of last visited registered TAI in SNPN registration	16.6.0
2020-09	CT#89e	CP-202151	2564	1	F	Minimum length of "Plain 5GS NAS message"	16.6.0
2020-09	CT#89e	CP-202203	2568	2	F	Resolution of editor's notes on the handling of timers T3484 and T3585 when the UE provided no S-NSSAI during PDU session establishment.	16.6.0
2020-09	CT#89e	CP-202151	2570	1	F	Handling of timers T3484 and T3585 received with 5GSM cause value #39	16.6.0
2020-09	CT#89e	CP-202151	2572	1	C	Allowed NSSAI assignment based on default subscribed NSSAI	16.6.0
2020-09	CT#89e	CP-202146	2575		F	Retry restriction for NB-IoT UEs due to out of tariff package	16.6.0
2020-09	CT#89e	CP-202156	2577	1	F	Default subscribed S-NSSAIs for re-NSSAA or revoked NSSAA	16.6.0
2020-09	CT#89e	CP-202156	2578	1	F	Deleting pending NSSAI when moving to 4G	16.6.0
2020-09	CT#89e	CP-202151	2582	1	F	Correction on QoS parameter "value is not used" in 5GS	16.6.0
2020-09	CT#89e	CP-202151	2587		F	Handling of T3520 in AUTH REJ	16.6.0
2020-09	CT#89e	CP-202151	2589	1	F	Correction that service reject is received not service request	16.6.0
2020-09	CT#89e	CP-202151	2590		F	Correction to implementation of CR2297	16.6.0
2020-09	CT#89e	CP-202151	2591		F	Correction to the implementation of CR0988	16.6.0
2020-09	CT#89e	CP-202146	2598	1	F	Fix of Timer T3448 encoding	16.6.0
2020-09	CT#89e	CP-202152	2602		F	Clarification on TWIF acting on behalf of N5CW device	16.6.0
2020-09	CT#89e	CP-202141	2606		F	AMF including CAG information list in rejection messages	16.6.0
2020-09	CT#89e	CP-202228	2608		F	Correction of the IEI of UE radio capability ID deletion indication	16.6.0
2020-09	CT#89e	CP-202173	2248	3	F	Update of emergency number list using Configuration Update Command	17.0.0
2020-09	CT#89e	CP-202173	2383	3	F	Single-registration mode without N26 for EPS NAS message container IE	17.0.0
2020-09	CT#89e	CP-202173	2404	1	F	Clarification on the applicable access type for persistent PDU session	17.0.0
2020-09	CT#89e	CP-202173	2406	1	D	Clarification on protection of initial NAS messages	17.0.0
2020-09	CT#89e	CP-202173	2408	1	F	Fixing several typos and adding full form of abbreviation W-AGF	17.0.0
2020-09	CT#89e	CP-202184	2416	1	D	Editorial changes – red text corrected to black text	17.0.0
2020-09	CT#89e	CP-202173	2425		D	Not capitalized 5GSM IE names	17.0.0
2020-09	CT#89e	CP-202173	2426		F	Incorrect IE names	17.0.0
2020-09	CT#89e	CP-202173	2427		F	Selected PDU session type	17.0.0
2020-09	CT#89e	CP-202173	2429		F	Overlapping requirements in 5.3.23	17.0.0
2020-09	CT#89e	CP-202173	2432		F	Minor corrections	17.0.0
2020-09	CT#89e	CP-202173	2435		F	Dual-registration mode list correction	17.0.0

2020-09	CT#89e	CP-202173	2448	2	F	QoS error checks for unstructured PDU session type	17.0.0
2020-09	CT#89e	CP-202024	2452	2	F	The requirement of AMF to provide CAG information list for the current PLMN	17.0.0
2020-09	CT#89e	CP-202173	2454	1	D	Abbreviations correction	17.0.0
2020-09	CT#89e	CP-202173	2456	1	F	Definition of Routing Indicator	17.0.0
2020-09	CT#89e	CP-202173	2457		F	Service Request procedure over non-3GPP access	17.0.0
2020-09	CT#89e	CP-202173	2458		D	Several editorial changes	17.0.0
2020-09	CT#89e	CP-202174	2471	1	F	Clarification of paging response	17.0.0
2020-09	CT#89e	CP-202174	2477		F	Misleading definition of 5G-IA and 5G-EA	17.0.0
2020-09	CT#89e	CP-202174	2479		D	Restructure the statement on establishment cause for non-3GPP access	17.0.0
2020-09	CT#89e	CP-202174	2489	1	F	Correction to the octet number in 5GS network feature support	17.0.0
2020-09	CT#89e	CP-202174	2490	1	F	Correction to Configured NSSAI updation based on Rejected NSSAI.	17.0.0
2020-09	CT#89e	CP-202174	2505	1	F	Handling of 5GSM procedures when fallback is triggered	17.0.0
2020-09	CT#89e	CP-202174	2511		F	Include NAS message container in security mode complete message	17.0.0
2020-09	CT#89e	CP-202113	2513	1	F	High priority access before pass the NSSAA	17.0.0
2020-09	CT#89e	CP-202174	2516	1	F	Exceptions in providing NSSAI to lower layers	17.0.0
2020-09	CT#89e	CP-202033	2517	1	F	No VPLMN S-NSSAI change via the generic UE configuration update	17.0.0
2020-09	CT#89e	CP-202174	2519	1	F	Correction in the session transfer	17.0.0
2020-09	CT#89e	CP-202174	2532		F	UE behaviour for service reject with #15	17.0.0
2020-09	CT#89e	CP-202174	2541		F	Mapped 5G security context deletion upon IDLE mode mobility from 5GS to EPS over N26 interface	17.0.0
2020-09	CT#89e	CP-202227	2547	2	F	Clarification to emergency registration procedure	17.0.0
2020-09	CT#89e	CP-202174	2573	2	C	Rejected NSSAI due to subscription	17.0.0
2020-09	CT#89e	CP-202174	2579	1	D	Deleting 5G NAS security context when 5G-EA0 used and PLMN changed	17.0.0
2020-09	CT#89e	CP-202184	2580	1	F	De-registration in ATTEMPTING-REGISTRATION-UPDATE	17.0.0
2020-09	CT#89e	CP-202174	2581	1	F	Correction on Payload container IE	17.0.0
2020-09	CT#89e	CP-202174	2583	1	F	EMM parameters handling for 5G only causes	17.0.0
2020-09	CT#89e	CP-202174	2584	2	F	Clarification on Operator-defined access category definitions IE	17.0.0
2020-09	CT#89e	CP-202174	2585	1	F	The suggestion on back-off timer for 5GSM #29	17.0.0
2020-09	CT#89e	CP-202174	2597	1	F	Fix of encoding errors in 5GS mobile identity IE	17.0.0
2020-09	CT#89e	CP-202249	2609		F	Avoid unnecessary signalling for CP only PDU sessions after inter-system change from S1 mode to N1 mode	17.0.0
2020-12	CT#90e	CP-203169	2524	2	F	Clarification on HPLMN S-NSSAI	17.1.0
2020-12	CT#90e	CP-203169	2610	1	F	Clarification for CP only PDU session	17.1.0
2020-12	CT#90e	CP-203169	2611	1	F	Clarification for reflective QoS	17.1.0
2020-12	CT#90e	CP-203213	2615	1	A	Alignment of User Plane Integrity Protection description	17.1.0
2020-12	CT#90e	CP-203169	2617		F	Consistency of the term on rejection cause "S-NSSAI not available due to the failed or revoked network slice-specific authentication and authorization"	17.1.0
2020-12	CT#90e	CP-203169	2618	1	F	Clarification on the condition when registration request is rejected for no network slices available	17.1.0
2020-12	CT#90e	CP-203169	2619		F	Correction on UE behaviour after receiving "Network slicing subscription changed" indication	17.1.0
2020-12	CT#90e	CP-203169	2620	1	F	Clarification on the S-NSSAI(s) included in the pending NSSAI	17.1.0
2020-12	CT#90e	CP-203169	2621	1	F	Consistency of NETWORK SLICE-SPECIFIC AUTHENTICATION COMPLETE message	17.1.0
2020-12	CT#90e	CP-203169	2623	1	F	AMF behavior upon receipt of NETWORK SLICE-SPECIFIC AUTHENTICATION COMPLETE message	17.1.0
2020-12	CT#90e	CP-203169	2624		F	Addition of used definitions and abbreviations	17.1.0
2020-12	CT#90e	CP-203169	2625		D	Editorial corrections in 24.501	17.1.0
2020-12	CT#90e	CP-203169	2626		F	Clarification on the 5GMM procedures which can be initiated by the UE in substate 5GMM-REGISTERED.ATTEMPTING-REGISTRATION-UPDATE	17.1.0
2020-12	CT#90e	CP-203169	2627		F	Removal of bullet irrelevant to tracking area concept	17.1.0
2020-12	CT#90e	CP-203169	2628	1	F	Merge of two bullets with the same handling for different Request type IE	17.1.0
2020-12	CT#90e	CP-203169	2631	1	D	Phrase that the abbreviation PCO represents	17.1.0
2020-12	CT#90e	CP-203169	2632	1	F	Protection of NAS IEs	17.1.0
2020-12	CT#90e	CP-203167	2635	2	A	QoS parameter handling for the PDU session transfer between 3GPP and non-3GPP access	17.1.0
2020-12	CT#90e	CP-203169	2637	1	F	Handling of QoS flow description without associated QoS rule	17.1.0
2020-12	CT#90e	CP-203169	2640		F	RFCs related to DHCPv6 are obsoleted by RFC 8415	17.1.0
2020-12	CT#90e	CP-203169	2642		F	Inclusion of requested NSSAI in the REGISTRATION REQUEST message	17.1.0

2020-12	CT#90e	CP-203169	2643		F	Clarification on the SPRTI bit of the MICO indication IE	17.1.0
2020-12	CT#90e	CP-203170	2644		F	UE behavior after receiving the rejected NSSAI with rejection cause "S-NSSAI not available in the current PLMN or SNPN"	17.1.0
2020-12	CT#90e	CP-203166	2645	1	A	5G-GUTI reallocation after resume from 5GMM-IDLE mode with suspend indication due to paging	17.1.0
2020-12	CT#90e	CP-203186	2647	1	A	Adding a missing "modification request" for the Request type IE during NSSAA	17.1.0
2020-12	CT#90e	CP-203218	2657	1	A	NAS signalling connection release upon CAG information update via UCU	17.1.0
2020-12	CT#90e	CP-203170	2659		F	Missing lower layer indications of barring and alleviation of barring	17.1.0
2020-12	CT#90e	CP-203170	2662	2	F	Uplink data status IE in CPSR after integrity check failure	17.1.0
2020-12	CT#90e	CP-203170	2664	1	F	Missing Allowed PDU Session Status IE in CPSR	17.1.0
2020-12	CT#90e	CP-203179	2667	2	A	Clarification on 2nd Leg PDU SESSION ESTABLISHMENT ACCEPT handling for MA PDU Sessions	17.1.0
2020-12	CT#90e	CP-203179	2669	2	A	Clarifications on Necessity of ATSSS Container IE	17.1.0
2020-12	CT#90e	CP-203170	2670	1	F	Prohibit UE from setting "Follow-on request pending" in the REGISTRATION REQUEST when UE is in non-allowed area	17.1.0
2020-12	CT#90e	CP-203170	2675		F	Clarifications on indicating subscribed MFBR/GFBR uplink/downlink	17.1.0
2020-12	CT#90e	CP-203170	2676	1	F	Update cases where whether ER-NSSAI IE is used	17.1.0
2020-12	CT#90e	CP-203170	2677	1	F	Extended rejected NSSAI storage	17.1.0
2020-12	CT#90e	CP-203170	2679	1	F	Update definition of Network slicing information	17.1.0
2020-12	CT#90e	CP-203186	2681	2	A	Excluding the S-NSSAI(s) in the pending NSSAI from the requested NSSAI	17.1.0
2020-12	CT#90e	CP-203186	2683	1	A	Update the allowed/rejected NSSAI based on the result of NSSAA over 3GPP access and N3GPP access separately	17.1.0
2020-12	CT#90e	CP-203170	2687	2	F	Add some missing ESM causes on the network side	17.1.0
2020-12	CT#90e	CP-203166	2688	1	A	Timer value of active timer	17.1.0
2020-12	CT#90e	CP-203170	2689	1	F	Paging collision with 5GMM specific procedure or service request procedure	17.1.0
2020-12	CT#90e	CP-203211	2690	1	A	Correction to S-NSSAI based retry restriction	17.1.0
2020-12	CT#90e	CP-203167	2692	1	A	EN resolution on 5QI as criteria type for ODAC	17.1.0
2020-12	CT#90e	CP-203170	2694		F	Correction on slice based congestion control	17.1.0
2020-12	CT#90e	CP-203170	2696	1	F	Rejected NSSAI handling for 1-to-many mapping in roaming scenario	17.1.0
2020-12	CT#90e	CP-203170	2697		F	Set T3517 to smaller value for emergency services fallback	17.1.0
2020-12	CT#90e	CP-203170	2700	1	F	Service request procedure and abnormal cases in the UE for CPSR and emergency fallback	17.1.0
2020-12	CT#90e	CP-203170	2701	1	F	IEEE Std reference updates	17.1.0
2020-12	CT#90e	CP-203186	2703	1	A	Correct pending NSSAI handling	17.1.0
2020-12	CT#90e	CP-203170	2707	1	F	Correction to NAS transport procedure	17.1.0
2020-12	CT#90e	CP-203170	2708	1	F	Correction to 5GMM cause #62 and allowed NSSAI	17.1.0
2020-12	CT#90e	CP-203170	2712	1	D	Improve "Emergency PDU session" definition	17.1.0
2020-12	CT#90e	CP-203186	2717	1	A	Correction in allowed NSSAI and pending NSSAI handling upon receipt of rejected NSSAI	17.1.0
2020-12	CT#90e	CP-203170	2719		F	Clarification the condition that the Extended NSSAI IE is included in the CONFIGURATION UPDATE COMMAND message	17.1.0
2020-12	CT#90e	CP-203171	2722	1	F	Correction on inclusion criteria for IP header compression configuration IE	17.1.0
2020-12	CT#90e	CP-203171	2724	1	F	Correction on inclusion criteria for Ethernet header compression configuration IE	17.1.0
2020-12	CT#90e	CP-203171	2725	1	F	Correction on the rejected NSSAI in the registration reject message	17.1.0
2020-12	CT#90e	CP-203171	2727	1	F	SNPN access mode over 3GPP access when accessing SNPN services via a PLMN	17.1.0
2020-12	CT#90e	CP-203171	2729	3	F	Handling of pending NSSAI and allowed NSSAI during periodic registration update	17.1.0
2020-12	CT#90e	CP-203171	2730		F	Cell search in NG-RAN	17.1.0
2020-12	CT#90e	CP-203171	2731		F	Correction in the N1 mode capability handling	17.1.0
2020-12	CT#90e	CP-203171	2733	4	F	UE operation in case of routing failure	17.1.0
2020-12	CT#90e	CP-203171	2734		F	Paging a UE using eDRX	17.1.0
2020-12	CT#90e	CP-203171	2735	1	F	Correction in the AUSF operation in terms of checking the presence of the AT_RESULT_IND attribute in the EAP-response/AKA'-challenge message	17.1.0
2020-12	CT#90e	CP-203218	2739	2	A	CAG information list in SR reject message	17.1.0
2020-12	CT#90e	CP-203171	2742	1	F	Provision CAG information list through de-registration procedure	17.1.0
2020-12	CT#90e	CP-203171	2742	3	F	Mobility Registration after back to coverage	17.1.0
2020-12	CT#90e	CP-203171	2744		F	Delete 5G NAS security context due to invalid key	17.1.0
2020-12	CT#90e	CP-203171	2745		F	Lack of ID for inter-system change from S1 mode to N1 mode	17.1.0

2020-12	CT#90e	CP-203166	2748	1	A	PDU session release in CP-SR	17.1.0
2020-12	CT#90e	CP-203218	2750	2	A	Update IEI of Port management information container	17.1.0
2020-12	CT#90e	CP-203171	2751		F	Correct location of ABO field	17.1.0
2020-12	CT#90e	CP-203171	2752		F	Correct reference of SM timer	17.1.0
2020-12	CT#90e	CP-203171	2754		F	Only CAG supported UE process CAG information list	17.1.0
2020-12	CT#90e	CP-203171	2757	1	F	Correction of EPS bearer context being activated	17.1.0
2020-12	CT#90e	CP-203171	2758	3	F	Clarification on LADN Information update	17.1.0
2020-12	CT#90e	CP-203171	2759	1	F	Absence of timer T3448	17.1.0
2020-12	CT#90e	CP-203186	2761	1	A	NSSAA for roaming UEs	17.1.0
2020-12	CT#90e	CP-203172	2764	1	D	IE length style in message definition	17.1.0
2020-12	CT#90e	CP-203172	2765		D	Minor corrections	17.1.0
2020-12	CT#90e	CP-203218	2771	1	A	Reception of CAG information list without serving PLMN's entry in roaming	17.1.0
2020-12	CT#90e	CP-203172	2772		F	N5CW device clean up	17.1.0
2020-12	CT#90e	CP-203172	2773		F	Correction in paging procedure	17.1.0
2020-12	CT#90e	CP-203172	2774	3	B	Usage of initial CAG information list	17.1.0
2020-12	CT#90e	CP-203218	2776		A	5GMM cause value #76 mapped to a different 5GMM cause value in network-initiated de-registration procedure	17.1.0
2020-12	CT#90e	CP-203172	2779	4	F	Handling of radio link failure during NSSAA procedure	17.1.0
2020-12	CT#90e	CP-203172	2780	4	F	AMF behavior in case of NSSAA failure due to temporal network failure	17.1.0
2020-12	CT#90e	CP-203172	2782	1	F	Addition of 5GSM cause #37	17.1.0
2020-12	CT#90e	CP-203172	2783	2	F	Handling of QoS flow description errors	17.1.0
2020-12	CT#90e	CP-203172	2785	1	F	Clarification on stopping back-off timers	17.1.0
2020-12	CT#90e	CP-203172	2786		F	Delete EBI in the QoS flow description when the corresponding mapped EPS bearer context is deleted	17.1.0
2020-12	CT#90e	CP-203172	2787		F	Update of the timers table for PDU session authentication command	17.1.0
2020-12	CT#90e	CP-203178	2794	2	B	The impact on UE due to the introduction of Authentication and Key Management for Applications (AKMA)	17.1.0
2020-12	CT#90e	CP-203186	2796	2	A	PLMN selection condition upon reception Registration Reject with cause #62	17.1.0
2020-12	CT#90e	CP-203172	2807	1	F	Avoiding repeated inter-system re-directions	17.1.0
2020-12	CT#90e	CP-203172	2809	3	F	UE procedures when a request for emergency services fallback not accepted	17.1.0
2020-12	CT#90e	CP-203215	2811	2	B	Notification to upper layer upper layer for MMTEL video call when T3346 or T3525 running	17.1.0
2020-12	CT#90e	CP-203172	2812		F	Correct UE behaviour for cause #31 in SR	17.1.0
2020-12	CT#90e	CP-203172	2813	1	F	Correction to T3502 for MRU	17.1.0
2020-12	CT#90e	CP-203172	2814	1	F	Deregistration before initial registration in SNPN selection	17.1.0
2020-12	CT#90e	CP-203172	2815	1	F	Clarification on description of triggering UE to enter 5GMM-DEREGISTERED state	17.1.0
2020-12	CT#90e	CP-203218	2817	2	A	Correction in 5GMM cause value #72	17.1.0
2020-12	CT#90e	CP-203166	2818		A	Rapporteur cleanup of editor's notes for 5G_CIoT	17.1.0
2020-12	CT#90e	CP-203172	2819	2	F	MO-SMS in non-3GPP access	17.1.0
2020-12	CT#90e	CP-203172	2824	1	F	Clarification on default configured NSSAI update will initiate a registration procedure by UE when "re-registration requested" indicated	17.1.0
2020-12	CT#90e	CP-203173	2826		F	Addition of used abbreviations	17.1.0
2020-12	CT#90e	CP-203173	2827	1	D	Editorial corrections in 24.501	17.1.0
2020-12	CT#90e	CP-203173	2828	1	F	Consistency of terms "5GMM-IDLE mode over non-3GPP access" and "5GMM-CONNECTED mode over non-3GPP access"	17.1.0
2020-12	CT#90e	CP-203173	2829	1	D	Consistent usage of acronym UE	17.1.0
2020-12	CT#90e	CP-203173	2832	1	F	Set the Follow-on request indicator to "Follow-on request pending"	17.1.0
2020-12	CT#90e	CP-203173	2833		F	requested NSSAI is Requested NSSAI IE or Requested mapped NSSAI IE	17.1.0
2020-12	CT#90e	CP-203173	2834		F	Mobility and periodic registration update when the UE receives "RRC Connection failure" indication	17.1.0
2020-12	CT#90e	CP-203173	2835		F	Condition when the UE shall include or not include the NAS message container IE	17.1.0
2020-12	CT#90e	CP-203173	2836		F	S-NSSAI(s) contained in the pending NSSAI	17.1.0
2020-12	CT#90e	CP-203173	2839	1	F	Default configured NSSAI storage after update by UE Parameters Update via UDM Control Plane Procedure	17.1.0
2020-12	CT#90e	CP-203173	2841	1	F	Correcting the SERVICE ACCEPT message into SERVICE REQUEST message.	17.1.0
2020-12	CT#90e	CP-203173	2842		D	REGISTRATION ACCEPT message	17.1.0

2020-12	CT#90e	CP-203173	2845	1	F	Correction on the condition of filling allowed NSSAI in registration accept message	17.1.0
2020-12	CT#90e	CP-203186	2847	2	A	Add a missing case for registration reject	17.1.0
2020-12	CT#90e	CP-203173	2848		F	Limit the guidance only for UE not supporting ER-NSSAI	17.1.0
2020-12	CT#90e	CP-203173	2851	1	F	The handling of a CAG information list with no entry	17.1.0
2020-12	CT#90e	CP-203173	2853		F	Correction to incrementing the registration attempt counter during abnormal cases for Mobility and periodic registration update for initiating an emergency PDU session	17.1.0
2020-12	CT#90e	CP-203173	2854		F	Correction to the reference to service request abnormal cases	17.1.0
2020-12	CT#90e	CP-203173	2855		F	Clarify PDU session modification command reject due to QoS-related errors	17.1.0
2020-12	CT#90e	CP-203173	2858	1	F	Addition of missing requirements for storing KAUSF, KSEAF, SOR counter and UE parameter update counter	17.1.0
2020-12	CT#90e	CP-203173	2859	1	F	Correction of UE-requested PDU session modification	17.1.0
2020-12	CT#90e	CP-203205	2860	2	B	DNN setting in the 5GSM sublayer	17.1.0
2020-12	CT#90e	CP-203174	2861	1	F	Buffered T3512 handling in non allowed service area	17.1.0
2020-12	CT#90e	CP-203174	2863	1	F	Handling of Emergency Service Fallback procedure in NON-ALLOWED area	17.1.0
2020-12	CT#90e	CP-203174	2866	1	F	NAS signalling connection release when SAR list is received	17.1.0
2020-12	CT#90e	CP-203166	2868		A	5G-GUTI reallocation after MT service request but before connection suspend	17.1.0
2020-12	CT#90e	CP-203174	2869	1	F	Completion of service request procedure following CPSR for emergency fallback	17.1.0
2020-12	CT#90e	CP-203174	2870	1	F	Clarification on Selected EPS NAS security algorithms IE	17.1.0
2020-12	CT#90e	CP-203174	2872		F	SNPN access mode over 3GPP access when accessing PLMN services via a SNPN	17.1.0
2020-12	CT#90e	CP-203174	2876	1	F	Adding the definition of non-CAG cell	17.1.0
2020-12	CT#90e	CP-203174	2877	1	F	Protection of 5GSM message	17.1.0
2020-12	CT#90e	CP-203167	2879		A	Shared 5G NAS security context	17.1.0
2020-12	CT#90e	CP-203205	2882	1	F	Adding the abbreviations of PAP/CHAP in TS 24.501 and fixing a minor grammatical error in the NOTE on PAP/CHAP	17.1.0
2020-12	CT#90e	CP-203218	2884	1	A	AN Release triggered by CAG information Update	17.1.0
2020-12	CT#90e	CP-203174	2885	1	F	Miss local de-registration procedure before entering DEREGISTERED state	17.1.0
2020-12	CT#90e	CP-203270	2889	5	F	N1 mode disable when neither emergency services nor emergency services fallback works	17.1.0
2020-12	CT#90e	CP-203174	2890	1	F	Provide different UE IDs for trusted and untrusted non-3GPP access	17.1.0
2020-12	CT#90e	CP-203174	2895	1	F	Delay enabling N1 mode until NAS signalling connection or RR connection is released	17.1.0
2020-12	CT#90e	CP-203179	2900	1	A	Release MA PDU session when connecting to an ATSSS unsupported AMF	17.1.0
2020-12	CT#90e	CP-203174	2901		F	Correction of UE handlings on 5GSM cause #50 and #51	17.1.0
2020-12	CT#90e	CP-203174	2905	1	F	UE behavior when the UE receives the rejected NSSAI	17.1.0
2020-12	CT#90e	CP-203174	2907	1	F	S-NSSAI not available due to the failed or revoked NSSAA	17.1.0
2020-12	CT#90e	CP-203174	2908	1	F	PDU session ID in CPSR message	17.1.0
2020-12	CT#90e	CP-203174	2910	1	F	No available S-NSSAIs and emergency PDU session	17.1.0
2020-12	CT#90e	CP-203174	2917		F	Correction on handling for 5GMM #73 for DoS attack	17.1.0
2020-12	CT#90e	CP-203174	2918		F	Correction on MICO indication IE	17.1.0
2020-12	CT#90e	CP-203174	2922		F	Collision of error handling on QoS operations	17.1.0
2020-12	CT#90e	CP-203186	2924	1	A	Default S-NSSAI for which NSSAA has been successful, is included in allowed NSSAI in case of no eligible requested NSSAI	17.1.0
2020-12	CT#90e	CP-203179	2931	1	A	SM/MM coordination for MAPDUs	17.1.0
2020-12	CT#90e	CP-203179	2935	1	A	Clarification on release of MA PDU session over both accesses	17.1.0
2020-12	CT#90e	CP-203268	2921	3	F	UE reachability after NOTIFICATION RESPONSE	17.1.0
2020-12	CT#90e	CO-203253	2926	4	F	Checking ACK bit of the SOR container in the DL NAS TRANSPORT	17.1.0
2020-12	CT#90e	CP-203179	2937	1	A	MA PDU session modification rejection during change from S1 mode to N1 mode	17.1.0
2020-12	CT#90e	CP-203177	2939		A	Emergency registration not applicable for FN-RG	17.1.0
2020-12	CT#90e	CP-203174	2940	1	F	The selected PLMN for emergency services via trusted non-3GPP access	17.1.0
2020-12	CT#90e	CP-203205	2941	1	F	Avoid including both PAP/CHAP and EAP identifiers in PDU session establishment request	17.1.0
2020-12	CT#90e	CP-203177	2945		A	Addition to the non 5G capable over WLAN (N5CW) device term	17.1.0
2020-12	CT#90e	CP-203274	2947	2	F	Delete previously allowed NSSAI upon receipt of "NSSAA to be performed"	17.1.0
2021-03	CT#91e	CP-210117	2549	2	F	UE behaviour in case of no allowed NSSAI is available	17.2.0
2021-03	CT#91e	CP-210117	2705	5	F	PDU session establishment request attempt during ongoing re-NSSAA procedure	17.2.0

2021-03	CT#91e	CP-210117	2864	4	F	Local release of PDU session due to Service Area Restriction	17.2.0
2021-03	CT#91e	CP-210117	2865	3	F	Conflict of sub-state NON-ALLOWED-SERVICE with other 5GMM-REGISTERED sub-states	17.2.0
2021-03	CT#91e	CP-210117	2898	7	F	Condition to stop timer T3540	17.2.0
2021-03	CT#91e	CP-210121	2948	3	F	Kausf change	17.2.0
2021-03	CT#91e	CP-210121	2949	1	F	Clarification on AKMA	17.2.0
2021-03	CT#91e	CP-210121	2952	3	F	Obtaining KAKMA and A-KID from NAS	17.2.0
2021-03	CT#91e	CP-210121	2953	1	F	Collision of AKMA and NAS AKA procedure handling	17.2.0
2021-03	CT#91e	CP-210121	2954	2	F	UE handling in case of no KAUSF available for AKMA	17.2.0
2021-03	CT#91e	CP-210117	2956	1	F	Suspension of 5GSM messages during SOR	17.2.0
2021-03	CT#91e	CP-210117	2958	1	F	Correction of Requested NSSAI handling	17.2.0
2021-03	CT#91e	CP-210114	2960		A	Correction of handling of CAG information from a "PLMN equivalent to the HPLMN"	17.2.0
2021-03	CT#91e	CP-210117	2962		D	Minor corrections	17.2.0
2021-03	CT#91e	CP-210114	2964	1	A	Correction for SNPN access mode in non-3GPP access	17.2.0
2021-03	CT#91e	CP-210117	2965	1	F	NAS signalling connection release triggered by CAG information list without entry of current PLMN	17.2.0
2021-03	CT#91e	CP-210117	2967		F	Abnormal cases in the UE for PDU EAP result message transport procedure	17.2.0
2021-03	CT#91e	CP-210095	2968	2	F	Handling of Kausf and Kseaf created before EAP-success	17.2.0
2021-03	CT#91e	CP-210117	2969	1	F	PDU SESSION ESTABLISHMENT message	17.2.0
2021-03	CT#91e	CP-210249	2970	3	F	SOR transparent container coding	17.2.0
2021-03	CT#91e	CP-210107	2972	1	A	Fixing mis-implementation of CR2140	17.2.0
2021-03	CT#91e	CP-210117	2973	2	F	NB-N1 mode and max number of user planes resources established for MT case	17.2.0
2021-03	CT#91e	CP-210117	2974		F	The handling of a CAG information list with no entry	17.2.0
2021-03	CT#91e	CP-210117	2976	1	F	Correction for NB-N1 mode and maximum number of PDU sessions with active user plane resources	17.2.0
2021-03	CT#91e	CP-210117	2978	1	F	PEI for UE not supporting any 3GPP access technologies	17.2.0
2021-03	CT#91e	CP-210117	2979		F	Reference to UCU procedure is missing for a 5G-GUTI reallocation variant	17.2.0
2021-03	CT#91e	CP-210117	2980	1	F	Re-initiation of NSSAA when S-NSSAI rejected for the failed or revoked NSSAA	17.2.0
2021-03	CT#91e	CP-210169	2982	3	F	Update of CPSR procedure for low power location event reporting	17.2.0
2021-03	CT#91e	CP-210117	2983		F	UE-requested PDU session release with 5GSM cause #26	17.2.0
2021-03	CT#91e	CP-210117	2984	1	F	Clarify UE handling of receiving DL NAS TRANSPORT message with 5GMM cause #28	17.2.0
2021-03	CT#91e	CP-210117	2985		F	Clarify association of back-off timer for 5GSM cause #27	17.2.0
2021-03	CT#91e	CP-210118	2986	1	F	Clarify 5GSM non-congestion back-off timer handling for re-registration required	17.2.0
2021-03	CT#91e	CP-210107	2989		A	Fix location of 5GSM congestion re-attempt indicator IE in PDU session establishment reject message and PDU session modification reject message	17.2.0
2021-03	CT#91e	CP-210118	2993	1	F	Correct description of #54 by taking into account its applicability in interworking scenarios	17.2.0
2021-03	CT#91e	CP-210118	2995		F	Correction of Notification procedure	17.2.0
2021-03	CT#91e	CP-210133	2996	1	F	Actions on T3247 expiry for other supported RATs	17.2.0
2021-03	CT#91e	CP-210118	2997	2	F	Timer related actions upon reception of AUTHENTICATION REJECT	17.2.0
2021-03	CT#91e	CP-210118	2998	1	F	State transition from 5GMM-CONNECTED mode with RRC inactive indication to LIMITED-SERVICE	17.2.0
2021-03	CT#91e	CP-210118	3002	1	F	Clarifications to the handling of the stored pending NSSAI	17.2.0
2021-03	CT#91e	CP-210118	3004		F	Corrections for 5GS network feature support IE	17.2.0
2021-03	CT#91e	CP-210118	3005		F	UE behavior when received cause #62 in the REGISTRATION REJECT message	17.2.0
2021-03	CT#91e	CP-210118	3006		F	Consistency of the term on rejection cause "S-NSSAI not available due to the failed or revoked network slice-specific authentication and authorization"	17.2.0
2021-03	CT#91e	CP-210118	3007	1	F	Inclusion of Extended rejected NSSAI IE	17.2.0
2021-03	CT#91e	CP-210118	3008	1	D	Editorial corrections on the first letter to be lowercase or uppercase	17.2.0
2021-03	CT#91e	CP-210118	3009	1	F	Correction of storage of operator-defined access categories	17.2.0
2021-03	CT#91e	CP-210118	3010		D	Fix several typos	17.2.0
2021-03	CT#91e	CP-210118	3011	3	F	Complement when and how the configured NSSAI, rejected NSSAI and pending NSSAI may be changed	17.2.0
2021-03	CT#91e	CP-210118	3012		F	Deletion of the duplicated content about new allowed NSSAI storage	17.2.0

2021-03	CT#91e	CP-210118	3013		F	Missing pending NSSAI and rejected NSSAI(s) for the failed or revoked NSSAA for no duplicated PLMN identities or SNPN identities	17.2.0
2021-03	CT#91e	CP-210118	3014		F	Add the native security context after changing to N1 mode in connected mode	17.2.0
2021-03	CT#91e	CP-210118	3016	1	F	Clarification of maintaining 5G-GUTI in an abnormal case	17.2.0
2021-03	CT#91e	CP-210118	3019		F	Delete previously allowed NSSAI upon receipt of "NSSAA to be performed" during initial registration	17.2.0
2021-03	CT#91e	CP-210118	3020		F	Cleanup of "NSSAA to be performed set to 1"	17.2.0
2021-03	CT#91e	CP-210119	3022		F	Remove the error case for mandatory IE of PDU SESSION MODIFICATION COMMAND message	17.2.0
2021-03	CT#91e	CP-210119	3024	1	F	T3540	17.2.0
2021-03	CT#91e	CP-210119	3025	2	F	Exception data in restricted service area for a UE in connected mode	17.2.0
2021-03	CT#91e	CP-210106	3027		A	T3575	17.2.0
2021-03	CT#91e	CP-210135	3028		D	Inclusive language review	17.2.0
2021-03	CT#91e	CP-210119	3029		F	Alignment of protection of NAS IEs	17.2.0
2021-03	CT#91e	CP-210119	3030	1	F	S-NSSAI association for 5GSM non-congestion control	17.2.0
2021-03	CT#91e	CP-210107	3033		A	Corrections to congestion control procedure	17.2.0
2021-03	CT#91e	CP-210114	3035	1	A	5GSM back-off mechanisms in PDU session release procedure for SNPN	17.2.0
2021-03	CT#91e	CP-210119	3036	1	F	Correction to the QoS operation error handlings in PDU session establishment procedure	17.2.0
2021-03	CT#91e	CP-210119	3037	1	F	Handling for collision of PDU session handover procedures	17.2.0
2021-03	CT#91e	CP-210119	3038		F	Mapped dedicated EPS bearer without default EPS bearer in the establishment procedure	17.2.0
2021-03	CT#91e	CP-210119	3041	1	F	AN Release triggered by CAG information set list in Registration Accept message	17.2.0
2021-03	CT#91e	CP-210119	3042		F	Clarification on CAG-only UE behaviour for emergency PDU session	17.2.0
2021-03	CT#91e	CP-210119	3043	2	F	Clarification on EPS bearer identity handling	17.2.0
2021-03	CT#91e	CP-210119	3044	1	F	Clarification on the handling of QoS flow description without associated QoS rule	17.2.0
2021-03	CT#91e	CP-210119	3045	1	F	Correct a copy error	17.2.0
2021-03	CT#91e	CP-210133	3046		F	Correct the length of IE	17.2.0
2021-03	CT#91e	CP-210119	3048	3	F	Error check and handling for match-all packet filter	17.2.0
2021-03	CT#91e	CP-210119	3049	1	F	Handling of Rejected NSSAI in registration reject message without integrity protection	17.2.0
2021-03	CT#91e	CP-210119	3052		F	Unify terminology about the Authorized QoS rules IE	17.2.0
2021-03	CT#91e	CP-210119	3053		F	PLMN Search at Registered State	17.2.0
2021-03	CT#91e	CP-210119	3054		F	UE behaviour when rejected with #76 via a non-CAG cell	17.2.0
2021-03	CT#91e	CP-210119	3055	1	F	Deregister from emergency registered state as indicated	17.2.0
2021-03	CT#91e	CP-210119	3056		F	Disable N1 mode after change to S1 mode for emergency services	17.2.0
2021-03	CT#91e	CP-210120	3057		F	Clarification on NSSAI inclusion mode	17.2.0
2021-03	CT#91e	CP-210120	3058	1	F	Initiate SMC to provide Selected EPS NAS security algorithms	17.2.0
2021-03	CT#91e	CP-210120	3059	1	F	5GSM cause handling in UE-requested PDU session modification procedure	17.2.0
2021-03	CT#91e	CP-210107	3063	1	A	Local IP address in TFT negotiation in 5GS for 5G-4G interworking	17.2.0
2021-03	CT#91e	CP-210120	3066	1	F	Consistent ngKSI IE name	17.2.0
2021-03	CT#91e	CP-210120	3067	1	F	Correction on semantic errors in QoS operations	17.2.0
2021-03	CT#91e	CP-210120	3068		F	Semantic errors in QoS operations on EPS bearers vs. QoS rules	17.2.0
2021-03	CT#91e	CP-210120	3069		F	Syntactical errors on lack of mandatory parameters	17.2.0
2021-03	CT#91e	CP-210120	3070	1	F	Correction on UE retry restriction for 5GSM causes #50/#51/#57/#58/#61	17.2.0
2021-03	CT#91e	CP-210120	3071		F	Correction on UE retry restriction for 5GSM cause #68	17.2.0
2021-03	CT#91e	CP-210120	3073		F	Rejected NSSAI in registration accept for NSSAA	17.2.0
2021-03	CT#91e	CP-210120	3076	1	F	Prevention of loop scenario for 5GMM cause #62	17.2.0
2021-03	CT#91e	CP-210120	3080	2	F	Clarifications on PLMN and SNPN URSP storage - 24.501 part	17.2.0
2021-03	CT#91e	CP-210120	3082	3	F	Clarification on SNPN UE policy management procedure abnormal handling	17.2.0
2021-03	CT#91e	CP-210120	3087		D	Incorrect reference for NAS security algorithms	17.2.0
2021-03	CT#91e	CP-210120	3088		F	Clarification on NAS security context alignment on 3GPP access and non-3GPP access	17.2.0
2021-03	CT#91e	CP-210120	3089	1	F	Default configured NSSAI for PLMN	17.2.0
2021-03	CT#91e	CP-210120	3090		F	"No suitable cells in tracking area" not applicable to non-3GPP access	17.2.0
2021-03	CT#91e	CP-210120	3091	1	F	The UE behavior when the UE receives the allowed NSSAI	17.2.0

2021-03	CT#91e	CP-210120	3093	1	F	Correction on service area list IEs	17.2.0
2021-03	CT#91e	CP-210114	3097		A	T3245 of a UE operating in SNPN access operation mode	17.2.0
2021-04	CT#91e					Correction of misimplementation of CR 3091	17.2.1
2021-06	CT#92e	CP-211131	3196	1	A	Clarification on MA PDU session for LADN	17.3.0
2021-06	CT#92e	CP-211136				Clarification on a PDU session for time synchronization: SSC mode, always-on-ness	17.3.0
			3140		F		
2021-06	CT#92e	CP-211136				DS-TT Ethernet port MAC address only sent when the PDU session type is Ethernet	17.3.0
			3141		F		
2021-06	CT#92e	CP-211136	3142	1	F	UE-DS-TT residence time used for UE-UE TSC	17.3.0
2021-06	CT#92e	CP-211136	3139	4	B	Introduction of NAS enablers for IIoT	17.3.0
2021-06	CT#92e	CP-211136	3188	1	F	Clarification on port management information container	17.3.0
2021-06	CT#92e	CP-211136				Clarification on EPS interworking of a PDU session for time synchronization or TSC	17.3.0
			3190	1	F		
2021-06	CT#92e	CP-211137	3144	1	C	Emergency services in an SNPN	17.3.0
2021-06	CT#92e	CP-211137				SNN verification for SNPN supporting AAA-Server for primary authentication and authorization	17.3.0
			3137	1	B		
2021-06	CT#92e	CP-211137	3128	1	B	Lists of 5GS forbidden tracking areas	17.3.0
2021-06	CT#92e	CP-211137	3129	1	B	Forbidden SNPNs	17.3.0
2021-06	CT#92e	CP-211137	3130	1	B	Enabling selection of an SNPN other than the subscribed SNPN	17.3.0
2021-06	CT#92e	CP-211137	3205		F	Emergency service fallback and SNPN	17.3.0
2021-06	CT#92e	CP-211137	3206		B	Inter-network mobility	17.3.0
2021-06	CT#92e	CP-211137				"List of subscriber data" handling for SNPN supporting AAA-Server for primary authentication and authorization	17.3.0
			3133	3	B		
2021-06	CT#92e	CP-211137				Storage of 5GMM information for UEs in SNPN access operation mode	17.3.0
			3262	1	C		
2021-06	CT#92e	CP-211137	3259	1	C	The usage of the last visited registered TAI	17.3.0
2021-06	CT#92e	CP-211137	3260	1	B	Support of the default configured NSSAI in the SNPN	17.3.0
2021-06	CT#92e	CP-211137	3204	1	B	Onboarding in SNPN - slicing in initial registration	17.3.0
2021-06	CT#92e	CP-211137	3319	1	B	Reject handling of registration for SNPN onboarding	17.3.0
2021-06	CT#92e	CP-211137	3320	1	B	Slice handling in registration for SNPN onboarding	17.3.0
2021-06	CT#92e	CP-211137	3321	1	B	De-registration for SNPN onboarding registered UE	17.3.0
2021-06	CT#92e	CP-211137				DNN/S-NSSAI providing in PDU session establishment for SNPN onboarding	17.3.0
			3322	1	B		
2021-06	CT#92e	CP-211137				PVS information providing in PDU session establishment for onboarding	17.3.0
			3323	1	B		
2021-06	CT#92e	CP-211137	3211	1	B	Onboarding in SNPN - mobility registration update	17.3.0
2021-06	CT#92e	CP-211138	3208	1	B	Support for MA PDU Session with 3GPP access in EPC	17.3.0
2021-06	CT#92e	CP-211138				Indication of UE supporting 3GPP access leg in EPC during MA PDU session establishment procedure	17.3.0
			3194	1	F		
2021-06	CT#92e	CP-211138				Add target QoS flow capability for access performance measurement	17.3.0
			3248	1	B		
2021-06	CT#92e	CP-211139				Handling the paging cause in the UE and the network for MUSIM in 5GS	17.3.0
			3124	1	B		
2021-06	CT#92e	CP-211139	3119	5	B	Definitions and abbreviations for Multi-USIM in 5GS	17.3.0
2021-06	CT#92e	CP-211139	3166	1	B	Remove paging restriction via Registration	17.3.0
2021-06	CT#92e	CP-211139				Considering paging restrictions while paging the UE that is MUSIM capable in 5GS	17.3.0
			3224	1	B		
2021-06	CT#92e	CP-211139				The MUSIM capable UE shall not initiate Service Request procedure for Leaving the network if Emergency service is ongoing in 5GS	17.3.0
			3225	1	B		
2021-06	CT#92e	CP-211139				Using Service Request procedure for removing paging restrictions in 5GS for a Multi-USIM UE	17.3.0
			3226	1	B		
2021-06	CT#92e	CP-211139	3267	3	B	Updates to Registration procedure for MUSIM Leaving in 5GS	17.3.0
2021-06	CT#92e	CP-211139				Handling of service request when responding to paging with voice service indication	17.3.0
			3170	2	C		
2021-06	CT#92e	CP-211139	3121	3	B	Multi-USIM UE support indications in 5GS	17.3.0
2021-06	CT#92e	CP-211140	3106	1	B	New cause value for rejected NSSAI	17.3.0
2021-06	CT#92e	CP-211140	3249	1	F	Correction of the definition of the Rejected NSSAI	17.3.0
2021-06	CT#92e	CP-211140	3111	3	B	Introduction of Network Slice Admission Control	17.3.0
2021-06	CT#92e	CP-211140				Clarification on behaviors of the UE and the network supporting Network Slice Admission Control	17.3.0
			3112	3	B		
2021-06	CT#92e	CP-211140				S-NSSAI rejected due to maximum number of UEs reached and BO timer value	17.3.0
			3123	4	B		
2021-06	CT#92e	CP-211140				Maximum number of established PDU sessions already reached for a NW slice	17.3.0
			3213	2	B		
2021-06	CT#92e	CP-211141	3135	1	B	General section for ID_UAS	17.3.0
2021-06	CT#92e	CP-211141	3218	1	B	Definition of UAV for purpose of UE NAS	17.3.0
2021-06	CT#92e	CP-211141	3244	1	B	UE configuration update procedure update for UUAA	17.3.0
2021-06	CT#92e	CP-211141	3138	3	B	Update on Registration procedure for UUAA-MM	17.3.0
2021-06	CT#92e	CP-211142	3125	1	B	ProSe as a trigger for Service Request procedure	17.3.0
2021-06	CT#92e	CP-211142	3126	1	B	Network shall not release the RRC connection for ProSe services	17.3.0
2021-06	CT#92e	CP-211142	3127	1	B	ProSe policy provisioning start and stop indications	17.3.0

2021-06	CT#92e	CP-211142	3159	2	B	UE ProSe capability negotiation with 5GC	17.3.0
2021-06	CT#92e	CP-211142	3110	3	B	UE ProSe policy transmission	17.3.0
2021-06	CT#92e	CP-211144	3160		F	Correction of a message name	17.3.0
2021-06	CT#92e	CP-211144	3174		F	Revisions on the description of IEs in Service Request message	17.3.0
2021-06	CT#92e	CP-211144	3181		F	Clarification on handling maximum number of established PDU sessions for MA PDU session	17.3.0
2021-06	CT#92e	CP-211144	3182		F	Clarification of MA PDU session handling after network initiated deregistration	17.3.0
2021-06	CT#92e	CP-211144	3197		D	Correction on "security control mode procedure"	17.3.0
2021-06	CT#92e	CP-211144	3198		F	Update cause of start T3540	17.3.0
2021-06	CT#92e	CP-211144	3212		F	Removal of editor's note on CAG information list in USIM	17.3.0
2021-06	CT#92e	CP-211144	3220		D	Minor corrections	17.3.0
2021-06	CT#92e	CP-211144	3234		F	Conditions for applying 5G-EA0 for the initial NAS message	17.3.0
2021-06	CT#92e	CP-211144	3238		F	The UE enters the state 5GMM-SERVICE-REQUEST-INITIATED after sending the SERVICE REQUEST message	17.3.0
2021-06	CT#92e	CP-211144	3253		D	Editorial corrections in TS 24.501	17.3.0
2021-06	CT#92e	CP-211144	3263		F	Abnormal cases in the PDU session authentication and authorization procedure	17.3.0
2021-06	CT#92e	CP-211144	3296		F	Use the latest UE security capability when selecting 5G security algorithms	17.3.0
2021-06	CT#92e	CP-211144	3297		F	null integrity protection algorithm used when UE has an emergency PDU session	17.3.0
2021-06	CT#92e	CP-211144	3300		F	Clarification on the setting of packet filter identifier value	17.3.0
2021-06	CT#92e	CP-211144	3051	2	F	Perform slice-independent services when no allowed NSSAI available	17.3.0
2021-06	CT#92e	CP-211144	3327		F	UL DRB setup collided with DL 5GSM message	17.3.0
2021-06	CT#92e	CP-211145	3325		F	Alignment on UE retry restriction for 5GSM causes #50/#51/#57/#58/#61	17.3.0
2021-06	CT#92e	CP-211145	3345		F	MNC digit 3 in the CAG information list IE	17.3.0
2021-06	CT#92e	CP-211145	3192	1	F	T3447 value parameter in gUCU procedure	17.3.0
2021-06	CT#92e	CP-211145	3193	1	F	Clot, nw initiated re-negotiation of any header compression configuration	17.3.0
2021-06	CT#92e	CP-211145	3294	1	F	NSSAA and de-registration procedures collision	17.3.0
2021-06	CT#92e	CP-211145	3039	2	F	Handling of multiple SM Retry Timer values configured in a UE	17.3.0
2021-06	CT#92e	CP-211145	3344	1	F	Correction in the CAG only UE	17.3.0
2021-06	CT#92e	CP-211145	3278	1	F	Correction to resetting of the registration update counter	17.3.0
2021-06	CT#92e	CP-211145	3246	2	F	UE behavior when the UE receives the Allowed NSSAI	17.3.0
2021-06	CT#92e	CP-211145	3279	1	F	Correction to T3540 handling	17.3.0
2021-06	CT#92e	CP-211145	3280	1	F	Update of stored pending NSSA for equivalent PLMN(s)	17.3.0
2021-06	CT#92e	CP-211145	3072	3	F	Excluding re-NSSAA for creating pending NSSAI	17.3.0
2021-06	CT#92e	CP-211145	2961	2	F	Handling of collisions between UE-requested 5GSM procedures and N1 NAS signalling connection release	17.3.0
2021-06	CT#92e	CP-211145	3329	1	F	Transmission failure handling for NETWORK SLICE-SPECIFIC AUTHENTICATION COMPLETE	17.3.0
2021-06	CT#92e	CP-211145	3233	1	F	LADN T3396 handling	17.3.0
2021-06	CT#92e	CP-211145	3272	2	F	Forbidding registration area when no slice available	17.3.0
2021-06	CT#92e	CP-211145	3236	2	F	Access barring for access categories '0' and '2' while timer RRC T302 is active	17.3.0
2021-06	CT#92e	CP-211146	3328		F	Correction on UE radio capability update	17.3.0
2021-06	CT#92e	CP-211146	3335		F	Relaxing requirement for NSSAA timing	17.3.0
2021-06	CT#92e	CP-211146	3346		F	AMF decision on the use of a 5G NAS security context	17.3.0
2021-06	CT#92e	CP-211146	3172	1	F	Retransmission timer starting for T3520 with emergency PDU session	17.3.0
2021-06	CT#92e	CP-211146	3175	1	F	Add EMM SR procedure for non-integrity protected reject message	17.3.0
2021-06	CT#92e	CP-211146	2913	3	F	Clarification of access control checks for specific procedures initiated in 5GMM-CONNECTED mode with RRC Inactive	17.3.0
2021-06	CT#92e	CP-211146	3185	1	F	Clarification of Collision of PDU session establishment procedure and network-requested PDU session release procedure for MA PDU sessions	17.3.0
2021-06	CT#92e	CP-211146	3230	1	F	Disabling of N1 mode capability after failure in service request procedure triggered due to Emergency Service Fallback	17.3.0
2021-06	CT#92e	CP-211146	3240	1	F	Correcting the NOTES related to changes in some IEI values across releases	17.3.0
2021-06	CT#92e	CP-211146	3291	1	F	Handling of abnormal cases of PDU session establishment procedure	17.3.0
2021-06	CT#92e	CP-211146	3292	1	F	UE handling of S-NSSAI when interworking with ePDG and EPC	17.3.0
2021-06	CT#92e	CP-211146	3031	3	F	Handling of 5GMM cause #91	17.3.0
2021-06	CT#92e	CP-211146	3318	1	F	DNN as an optional parameter when interworking with EPS	17.3.0
2021-06	CT#92e	CP-211146	3232	1	F	AMF handling when none of the DNN's in LADN Indication IE are part of subscribed DNN list	17.3.0
2021-06	CT#92e	CP-211146	3239	1	F	ESFB handling in case of network authentication failure	17.3.0
2021-06	CT#92e	CP-211147	3270	1	F	RAT disable when re-attempts are not allowed	17.3.0

2021-06	CT#92e	CP-211147	3305	1	D	Remove duplicated text about semantic error handling	17.3.0
2021-06	CT#92e	CP-211147	3293	1	F	Correction to description of #54	17.3.0
2021-06	CT#92e	CP-211147	3295	1	F	Add a note to reference 24.173	17.3.0
2021-06	CT#92e	CP-211147	3299	1	F	Storage on counters and keys in 5G AKA	17.3.0
2021-06	CT#92e	CP-211147	3301	1	F	UE does not delete 5G NAS security context in connected mode	17.3.0
2021-06	CT#92e	CP-211147	3302	1	F	Clarification on CAG information list handling received in HPLMN	17.3.0
2021-06	CT#92e	CP-211147				Send REGISTRATION COMPLETE message only if the SOR information is received	17.3.0
2021-06	CT#92e	CP-211147	3303	1	F		
2021-06	CT#92e	CP-211147	3187	1	F	Clarification on UE initiated MA PDU deactivation	17.3.0
2021-06	CT#92e	CP-211147	3347	1	F	5GMM procedure updating the default configured NSSAI	17.3.0
2021-06	CT#92e	CP-211147	3330	1	F	Correction to Ciphering key data IE	17.3.0
2021-06	CT#92e	CP-211147	3331	1	F	Registration attempt counter reset when in SNPN	17.3.0
2021-06	CT#92e	CP-211147	3264	1	F	Updating timer table for stopping timer T3540	17.3.0
2021-06	CT#92e	CP-211147				Updating timer table for stopping timer T3565 when receiving CONTROL PLANE SERVICE REQUEST message	17.3.0
2021-06	CT#92e	CP-211147	3261	1	F		
2021-06	CT#92e	CP-211147	3265	1	F	The list of NSSAI(s)	17.3.0
2021-06	CT#92e	CP-211147	3221	1	F	Second SMC procedure after RINMR	17.3.0
2021-06	CT#92e	CP-211147	3247	2	F	Correction of Requested NSSAI handling	17.3.0
2021-06	CT#92e	CP-211148	3178		F	Non-3GPP access T3540 timer after service procedure	17.3.0
2021-06	CT#92e	CP-211148	3191	1	F	Non-3GPP access cannot use PLMN-SEARCH state	17.3.0
2021-06	CT#92e	CP-211148	3179	1	F	Non-3GPP access and 5GMM cause 76	17.3.0
2021-06	CT#92e	CP-211148	3050	5	F	MMTEL Voice and MMTEL Video in non-3GPP	17.3.0
2021-06	CT#92e	CP-211149	3145	3	B	Introduction of handling of Edge computing for 5GS	17.3.0
2021-06	CT#92e	CP-211149	2977	7	B	ECS address support indication and provisioning in ePCO	17.3.0
2021-06	CT#92e	CP-211150	3237		D	Various editorial corrections	17.3.0
2021-06	CT#92e	CP-211150	3243	1	F	Incorrect reference in subclause 4.5.4.2	17.3.0
2021-06	CT#92e	CP-211150	3336	1	B	Update Non-3GPP TAI to support N3SLICE	17.3.0
2021-06	CT#92e	CP-211151	3105	1	F	Support of SOR-CMCI	17.3.0
2021-06	CT#92e	CP-211151	3131	1	F	"ME support of SOR-CMCI" indicator	17.3.0
2021-06	CT#92e	CP-211151	3207	1	B	SOR-CMCI transport and usage	17.3.0
2021-06	CT#92e	CP-211152	3143	1	B	5QI for satellite access	17.3.0
2021-06	CT#92e	CP-211152	3101	2	B	New 5GMM cause for satellite access	17.3.0
2021-06	CT#92e	CP-211152	3219	2	B	UE's handling of the indication of country of UE location	17.3.0
2021-06	CT#92e	CP-211152	3348	1	B	PDU session establishment for NR satellite access	17.3.0
2021-06	CT#92e	CP-211152	3100	3	B	MCC list for 5GMM message	17.3.0
2021-06	CT#92e	CP-211153	3115		F	UE handling in case of no valid KAUSF for AKMA	17.3.0
2021-06	CT#92e	CP-211165	3103	4	B	Encoding of API-based DN-AA	17.3.0
2021-06	CT#92e	CP-211311	3258	2	B	Update of registration procedure for SNPN case	17.3.0
2021-06	CT#92e	CP-211312				S-NSSAI providing in UE-requested PDU session establishment procedure with "existing PDU session" request type	17.3.0
2021-06	CT#92e	CP-211312	2843	10	F		
2021-06	CT#92e	CP-211316	3202	3	B	Onboarding in SNPN - initial registration	17.3.0
2021-06	CT#92e	CP-211322				Updates to Service Request for MUSIM Leaving and Reject Paging in 5GS	17.3.0
2021-06	CT#92e	CP-211322	3268	4	B		
2021-06	CT#92e	CP-211325	3215	3	F	Providing wildcard CAG-ID in the USIM	17.3.0
2021-06	CT#92e					Editorial correction in clause 5.3.19a	17.3.1
2021-09	CT#93e	CP-212120	3425	1	A	Enabling storing two 5G NAS security contexts	17.4.0
2021-09	CT#93e	CP-212239	3546	2	A	5G NAS Security Context handling for multiple registrations	17.4.0
2021-09	CT#93e	CP-212160	3521	2	B	Multiple round-trips of AA messages during UAAA-MM	17.4.0
2021-09	CT#93e	CP-212240	3581	-	F	Correction for incorrect CR implementation	17.4.0
2021-09	CT#93e	CP-212263	3250	6	B	C2 pairing authorization at PDU session establishment	17.4.0
2021-09	CT#93e	CP-212264	3251	6	B	C2 pairing authorization at PDU session modification	17.4.0
2021-09	CT#93e	CP-212125	3567	1	F	MINT: Added new registration type for disaster roaming.	17.4.0
2021-09	CT#93e	CP-212125	3512	1	B	Deregister for disaster inbound roaming services	17.4.0
2021-09	CT#93e	CP-212128	3463	-	F	UE-DS-TT residence time defined in 3GPP TS 23.501	17.4.0
2021-09	CT#93e	CP-212128	3464	-	F	Replacement of TS 24.519 with TS 24.539	17.4.0
2021-09	CT#93e	CP-212128				Cleanup limitation about Ethernet DS-TT port and Ethernet type PDU session	17.4.0
2021-09	CT#93e	CP-212128	3538	1	F		
2021-09	CT#93e	CP-212128	3539	1	F	Supporting of TSCTSFS	17.4.0
2021-09	CT#93e	CP-212128	3569	1	F	IEEE Std 1588-2019 reference update	17.4.0
2021-09	CT#93e	CP-212129	3558	-	F	Consistent terms on SNPN onboarding	17.4.0
2021-09	CT#93e	CP-212129	3557	1	B	Slice handling for SNPN onboarding	17.4.0
2021-09	CT#93e	CP-212129				NSSAAF : Network slice-specific and SNPN authentication and authorization function	17.4.0
2021-09	CT#93e	CP-212129	3519	1	F		
2021-09	CT#93e	CP-212129	3507	1	F	Handling of AUTHENTICATION REJECT message in ON-SNPN	17.4.0
2021-09	CT#93e	CP-212129				Association of NSSAI, UE radio capability ID and back-off timers for UE supporting access to an SNPN using credentials from a credentials holder	17.4.0
2021-09	CT#93e	CP-212129	3448	1	C		
2021-09	CT#93e	CP-212129	3446	1	C	No support for eCall over IMS in SNPNs	17.4.0
2021-09	CT#93e	CP-212129				UE identity when onboarding in SNPN for which the UE has 5G-GUTI	17.4.0
2021-09	CT#93e	CP-212129	3392	1	F		
2021-09	CT#93e	CP-212129	3391	1	F	Editor's note on onboarding SUCI derivation	17.4.0

2021-09	CT#93e	CP-212129	3390	1	F	S-NSSAI not provided when registered for onboarding services in SNPN	17.4.0
2021-09	CT#93e	CP-212129	3389	-	F	Network identifier is not specified	17.4.0
2021-09	CT#93e	CP-212129	3387	1	B	Authentication handling	17.4.0
2021-09	CT#93e	CP-212129	3384	1	F	NID of SNPN which assigned 5G-GUTI in mobility registration update	17.4.0
2021-09	CT#93e	CP-212129	3383	-	F	NID as cleartext IE	17.4.0
2021-09	CT#93e	CP-212129	3382	1	F	PVS PCO parameter providing	17.4.0
2021-09	CT#93e	CP-212129	3377	1	B	Clarification of UE status during registration procedure for onboarding	17.4.0
2021-09	CT#93e	CP-212129	3368	1	B	Service request not accepted by an ON-SNPN	17.4.0
2021-09	CT#93e	CP-212130	3410	1	F	Rename the 5GSM capability of supporting access performance measurements per QoS flow	17.4.0
2021-09	CT#93e	CP-212131	3489	2	F	Corrections in Service Request procedure	17.4.0
2021-09	CT#93e	CP-212131	3488	3	B	Reject RAN Paging using Service Request in RRC Inactive	17.4.0
2021-09	CT#93e	CP-212131	3487	-	F	Corrections to Paging restriction IE	17.4.0
2021-09	CT#93e	CP-212131	3476	1	B	NAS leaving to reject RAN paging	17.4.0
2021-09	CT#93e	CP-212131	3439	-	B	Using Service Request procedure for removing paging restrictions in 5GS for MUSIM UE that uses the control plane Clot 5GS optimization	17.4.0
2021-09	CT#93e	CP-212131	3438	1	B	Resolving the Editor's note related to Paging Rejection for MUSIM UE in 5GS	17.4.0
2021-09	CT#93e	CP-212131	3421	2	F	Timer handling for MUSIM UEs (for 24.501)	17.4.0
2021-09	CT#93e	CP-212131	3372	-	D	Editorial corrections to CR#3170	17.4.0
2021-09	CT#93e	CP-212131	3360	1	B	MUSIM features are not applicable for non-3GPP access	17.4.0
2021-09	CT#93e	CP-212131	3354	1	B	T3540 for MUSIM	17.4.0
2021-09	CT#93e	CP-212131	3352	1	B	MUSIM and PEIs	17.4.0
2021-09	CT#93e	CP-212131	3350	1	B	NOTIFICATION RESPONSE message indicating failure	17.4.0
2021-09	CT#93e	CP-212132	3570	1	B	Clarification of the UCU procedure upon completion of NSSAA	17.4.0
2021-09	CT#93e	CP-212132	3561	1	F	Correction on AMF actions on NSAC	17.4.0
2021-09	CT#93e	CP-212132	3560	1	B	NSAC in de-registration procedure	17.4.0
2021-09	CT#93e	CP-212132	3559	1	B	AMF handling on NSAC based on EAC mode	17.4.0
2021-09	CT#93e	CP-212132	3535	1	F	Clarification on rejected NSSAI term	17.4.0
2021-09	CT#93e	CP-212132	3534	-	F	Stop associated back-off timer when remove S-NSSAI from rejected NSSAI for the maximum number of UEs reached	17.4.0
2021-09	CT#93e	CP-212132	3517	1	F	Removal of unnecessary ENs	17.4.0
2021-09	CT#93e	CP-212132	3516	1	B	Clarify mobility management based on NSAC per access type independently	17.4.0
2021-09	CT#93e	CP-212142	3361	-	F	Removal of CR3100r3 (C1-213895) (MCC list for 5GMM message)	17.4.0
2021-09	CT#93e	CP-212132	3515	1	B	Clarification of mobility management based NSAC for roaming case	17.4.0
2021-09	CT#93e	CP-212132	3468	1	B	Update to session management based NSAC	17.4.0
2021-09	CT#93e	CP-212132	3467	1	F	Clarification on network behavior when all S-NSSAIs included in the requested NSSAI are rejected	17.4.0
2021-09	CT#93e	CP-212132	3417	1	F	Update the description of NSAC about SNPN	17.4.0
2021-09	CT#93e	CP-212132	3416	1	C	Resolution of an EN about pre-Rel-17 UE on NSAC	17.4.0
2021-09	CT#93e	CP-212132	3415	1	C	The exception in Network Slice Admission Control for Emergency and Priority Services	17.4.0
2021-09	CT#93e	CP-212142	3510	1	F	Handling of a reject message including 5GMM cause value #78 without integrity protection	17.4.0
2021-09	CT#93e	CP-212142	3414	1	F	Update the description for satellite access	17.4.0
2021-09	CT#93e	CP-212142	3217	3	B	5GMM procedures for satellite access for reject cause on UE location - alternative handling	17.4.0
2021-09	CT#93e	CP-212133	3566	-	F	Consistent term on USS communication	17.4.0
2021-09	CT#93e	CP-212133	3565	1	F	EN resolution on delivering UUAA-MM result via UCU	17.4.0
2021-09	CT#93e	CP-212133	3564	1	B	PDU session establishment reject for UUAA-SM	17.4.0
2021-09	CT#93e	CP-212133	3563	1	B	UAV registered as normal UE	17.4.0
2021-09	CT#93e	CP-212133	3523	1	F	Update of general section for ID_UAS	17.4.0
2021-09	CT#93e	CP-212133	3522	1	B	Multiple round-trip of AA messages during UUAA-SM	17.4.0
2021-09	CT#93e	CP-212133	3520	1	F	Clarification on UE behavior after Registration reject with UAV service is not allowed	17.4.0
2021-09	CT#93e	CP-212133	3418	1	B	PDU session establishment request for UAS services	17.4.0
2021-09	CT#93e	CP-212133	3406	2	B	NW initiated de-registration upon failure of ongoing UUAA-MM	17.4.0
2021-09	CT#93e	CP-212134	3486	-	F	Add the missing description on ProSe under avoiding double barring	17.4.0
2021-09	CT#93e	CP-212134	3430	1	F	Requesting ProSe resources as a trigger for Service Request procedure	17.4.0
2021-09	CT#93e	CP-212134	3426	1	B	Introducing the Remote UE report procedure	17.4.0
2021-09	CT#93e	CP-212134	3420	1	F	Resuming a connection due to ProSe discovery/communication over PC5	17.4.0
2021-09	CT#93e	CP-212136	3386	1	B	EAS rediscovery	17.4.0
2021-09	CT#93e	CP-212136	3385	1	B	(Re)configuring DNS server addresses	17.4.0

2021-09	CT#93e	CP-212139	3399	1	B	Network-requested PDU session modification procedure to be used for removing joined UE from MBS session(s)	17.4.0
2021-09	CT#93e	CP-212139	3395	1	B	Introducing the MBS join and leave procedures	17.4.0
2021-09	CT#93e	CP-212139	3394	1	B	Adding MBS join and Leave as purposes of the UE-requested PDU session modification procedure	17.4.0
2021-09	CT#93e	CP-212139	3370	2	B	Multicast join procedure - Alt.1	17.4.0
2021-09	CT#93e	CP-212139	3369	1	C	Paging with TMGI for multicast services	17.4.0
2021-09	CT#93e	CP-212140	3529	1	F	Correction on value of UE radio capability ID deletion indication IE	17.4.0
2021-09	CT#93e	CP-212140	3527	1	F	Sending P-CSCF address(es)	17.4.0
2021-09	CT#93e	CP-212140	3457	-	F	Incorrect reference in subclause 6.2.16	17.4.0
2021-09	CT#93e	CP-212140	3453	-	D	Editorial corrections	17.4.0
2021-09	CT#93e	CP-212140	3423	-	F	Add handling of 5GMM cause #76 when UE does not have any stored CAG information list	17.4.0
2021-09	CT#93e	CP-212141	3525	-	D	Corrected S-NSSAI SST for SOR-CMCI	17.4.0
2021-09	CT#93e	CP-212141	3365	1	B	Alignments for the introduction of SOR-CMCI	17.4.0
2021-09	CT#93e	CP-212143	3452	-	F	Resolving the Editor's note in AKMA procedure related to K_AUSF change after 5G AKA based primary authentication	17.4.0
2021-09	CT#93e	CP-212152	3483	-	D	Superfluous description	17.4.0
2021-09	CT#93e	CP-212152	3482	-	F	Non-IP MTU request in the PDU session establishment procedure	17.4.0
2021-09	CT#93e	CP-212152	3478	-	F	Handling of multiple S-TAGs in the Ethernet header	17.4.0
2021-09	CT#93e	CP-212152	3477	-	F	Clarification of destination and source MAC addresses	17.4.0
2021-09	CT#93e	CP-212152	3475	-	F	Add a missing message to relax SM congestion control	17.4.0
2021-09	CT#93e	CP-212152	3470	-	D	Editorial corrections	17.4.0
2021-09	CT#93e	CP-212152	3460	-	F	Clarification of NSAAA abnormal failure handling	17.4.0
2021-09	CT#93e	CP-212152	3458	-	F	Correction to CPSR handling in AMF	17.4.0
2021-09	CT#93e	CP-212152	3455	-	F	Correction to #62 handling	17.4.0
2021-09	CT#93e	CP-212152	3454	-	F	Clarification to collision of PDU sessions release procedures.	17.4.0
2021-09	CT#93e	CP-212152	3432	-	D	Editorial corrections	17.4.0
2021-09	CT#93e	CP-212152	3422	-	F	Fix inconsistent QoS handling for network-requested PDU session modification procedure	17.4.0
2021-09	CT#93e	CP-212152	3411	-	F	AMF provides the CAG information list	17.4.0
2021-09	CT#93e	CP-212152	3409	-	F	The incorrectly placed NOTE in QoS rule	17.4.0
2021-09	CT#93e	CP-212153	3542	-	F	5GSM state transition of MA PDU session	17.4.0
2021-09	CT#93e	CP-212153	3514	-	F	Assignment of IEI values	17.4.0
2021-09	CT#93e	CP-212153	3505	-	F	ANDSP not specified for a UE operating in SNPN access operation mode	17.4.0
2021-09	CT#93e	CP-212153	3502	1	F	Processing Authentication Reject only if timer T3516 or T3520 is running	17.4.0
2021-09	CT#93e	CP-212153	3495	1	F	UE changing from N1 mode to S1 mode	17.4.0
2021-09	CT#93e	CP-212153	3494	-	F	Deleting forbidden PLMNs list when UE is switched off	17.4.0
2021-09	CT#93e	CP-212153	3474	1	F	Align deregistration #62 with initial registration reject	17.4.0
2021-09	CT#93e	CP-212153	3473	1	F	Clarification on NSSAI storage	17.4.0
2021-09	CT#93e	CP-212153	3472	1	F	Clarify on T3245 in each specific procedure	17.4.0
2021-09	CT#93e	CP-212153	3471	1	D	Remove duplicated MCC	17.4.0
2021-09	CT#93e	CP-212154	3568	1	F	Handling redirection cause #31 for UE does not support S1 mode	17.4.0
2021-09	CT#93e	CP-212154	3550	1	F	Rejected S-NSSAI update	17.4.0
2021-09	CT#93e	CP-212154	3549	1	F	Correction on N5GC indication IE Format	17.4.0
2021-09	CT#93e	CP-212154	3544	1	F	Not start T3540 if 5GMM cause is considered as abnormal cases	17.4.0
2021-09	CT#93e	CP-212154	3531	1	F	Include UE radio capability ID deletion indication IE and UE radio capability ID IE simultaneously	17.4.0
2021-09	CT#93e	CP-212154	3506	1	F	Handling two available native 5G-GUTIs during the registration procedure	17.4.0
2021-09	CT#93e	CP-212154	3504	1	F	Maximum number of S-NSSAIs in an NSSAI	17.4.0
2021-09	CT#93e	CP-212154	3481	1	F	Clarification of PF for Ethernet PDU session	17.4.0
2021-09	CT#93e	CP-212154	3427	1	F	Trigger PDU SESSION MODIFICATION for deletion of mapped EPS to ensure sync with network	17.4.0
2021-09	CT#93e	CP-212154	3408	1	F	Support MAC address range in packet filter	17.4.0
2021-09	CT#93e	CP-212154	3168	2	F	24.501 Redirect with MPS	17.4.0
2021-09	CT#93e	CP-212155	3555	1	F	Correction on UE parameters update data set type	17.4.0
2021-09	CT#93e	CP-212155	3554	1	F	Correction on indication of support of local address in TFT in S1 mode	17.4.0
2021-09	CT#93e	CP-212155	3553	1	F	Correction on UE error handling on QoS operations	17.4.0
2021-09	CT#93e	CP-212155	3503	2	F	SMC after Primary Authentication	17.4.0
2021-09	CT#93e	CP-212155	3493	1	F	Discarding the content of the container for SOR when the security check about the container is failed.	17.4.0
2021-09	CT#93e	CP-212155	3469	1	F	Simplification of description about rejected NSSAI and correction of requested NSSAI handling	17.4.0
2021-09	CT#93e	CP-212155	3461	1	F	Starting T3540 for 5GMM cause #22 with T3346 value	17.4.0
2021-09	CT#93e	CP-212155	3449	1	F	Resuming the RRC connection upon requesting resources for V2X communication over PC5	17.4.0

2021-09	CT#93e	CP-212155	3443	1	F	Clarification that IP and Ethernet packets can be delivered over Control Plane	17.4.0
2021-09	CT#93e	CP-212155	3435	1	F	Uplink data status IE inclusion criteria clarification	17.4.0
2021-09	CT#93e	CP-212155	3434	1	F	Correction of PCO related terminology	17.4.0
2021-09	CT#93e	CP-212155	3433	1	F	Correction on providing Selected EPS NAS security algorithms in SMC	17.4.0
2021-09	CT#93e	CP-212155	3359	1	D	Correction of MA PDU session network upgrade is allowed	17.4.0
2021-09	CT#93e	CP-212155	3326	3	F	Registered for emergency services due to CAG restrictions	17.4.0
2021-09	CT#93e	CP-212155	3183	3	F	Clarification of reactivation requested in PDU SESSION MODIFICATION COMMAND for an MA PDU session	17.4.0
2021-09	CT#93e	CP-212156	3480	-	F	Correction on handling of the IMS VoPS over non-3GPP access indicator	17.4.0
2021-09	CT#93e	CP-212156	3279	1	F	Handling of N1 mode capability for non-3GPP access for voice domain selection	17.4.0
2021-09	CT#93e	CP-212156	3401	-	F	UE identity in NAS signalling connection establishment over wireline access	17.4.0
2021-09	CT#93e	CP-21215	3400	1	F	SMSolP triggering mo-SMS establishment cause for non-3GPP access	17.4.0
2021-09	CT#93e					Editorial corrections and IEIs values added in tables 8.3.1.1.1, 8.3.2.1.1, 8.3.7.1.1 and 8.3.9.1.1	17.4.1
2021-12	CT#94e	CP-213211	3803	2	B	Paging Early Indication with Paging Subgrouping Assistance	17.5.0
2021-12	CT#94e	CP-213252	3786	2	B	Paging Subgrouping	17.5.0
2021-12	CT#94e	CP-213255	3780	2	F	Access attempt of 5GMM CM management procedure without ongoing 5G-MO-LR	17.5.0
2021-12	CT#94e	CP-213027	3445	1	A	Signalling support for UPIP for UEs not supporting standalone NR connected to 5GCN	17.5.0
2021-12	CT#94e	CP-213030	3701	1	B	Introduction of EPS-UIP support indication in 5GC	17.5.0
2021-12	CT#94e	CP-213030	3796	1	F	PTI assignment in MANAGE UE POLICY COMMAND triggered by UE POLICY PROVISIONING REQUEST	17.5.0
2021-12	CT#94e	CP-213030	3800	-	D	Miscellaneous corrections	17.5.0
2021-12	CT#94e	CP-213030	3811	-	F	Remove PLMN from the extension of the forbidden PLMNs list upon T3247 expiry	17.5.0
2021-12	CT#94e	CP-213032	3688	1	B	Add requirements to support NR RedCap devices	17.5.0
2021-12	CT#94e	CP-213032	3699	1	C	Paging using eDRX for NR RedCap UE	17.5.0
2021-12	CT#94e	CP-213034	3695	-	F	Error handling for QRI and QFI set to zero by the network	17.5.0
2021-12	CT#94e	CP-213034	3696	-	F	DNS server security information UE capability	17.5.0
2021-12	CT#94e	CP-213034	3700	-	F	Correction for the protection of initial NAS messages in case of CPSR message	17.5.0
2021-12	CT#94e	CP-213034	3707	2	F	Abort deregistration for emergency	17.5.0
2021-12	CT#94e	CP-213034	3715	-	D	Minor corrections	17.5.0
2021-12	CT#94e	CP-213034	3731	-	D	Add abbreviations of MPS and MCS	17.5.0
2021-12	CT#94e	CP-213034	3735	-	F	Clarification of N1 mode capability	17.5.0
2021-12	CT#94e	CP-213034	3738	-	F	UE handling upon receipt of 5GSM cause #33	17.5.0
2021-12	CT#94e	CP-213034	3739	-	F	Access type of the PDU session when re-activation failure	17.5.0
2021-12	CT#94e	CP-213034	3753	-	F	Correction to item code	17.5.0
2021-12	CT#94e	CP-213034	3755	-	F	UE re-initiate initial registration procedure if authentication procedure is failed	17.5.0
2021-12	CT#94e	CP-213034	3761	-	F	Correction to 5GSM cause value list	17.5.0
2021-12	CT#94e	CP-213034	3768	-	F	Resolution of an EN about CAG-ID range-24.501	17.5.0
2021-12	CT#94e	CP-213034	3774	-	F	Clarification on destination and source MAC address range	17.5.0
2021-12	CT#94e	CP-213034	3806	-	F	Correction of PDU sessions release procedures	17.5.0
2021-12	CT#94e	CP-213034	3814	-	F	Align mapping of SMS over IP & SMS over NAS during double barring	17.5.0
2021-12	CT#94e	CP-213037	3584	3	B	CP SoR in SNPN - procedures and coding	17.5.0
2021-12	CT#94e	CP-213037	3393	2	F	Forbidden lists when an entry of the list of subscriber data is updated or UICC containing USIM is removed	17.5.0
2021-12	CT#94e	CP-213037	3586	2	F	NSSAI when registered for onboarding services in SNPN	17.5.0
2021-12	CT#94e	CP-213037	3625	-	F	SMF selection for SNPN onboarding	17.5.0
2021-12	CT#94e	CP-213037	3632	4	B	De-registration for onboarding registered UE	17.5.0
2021-12	CT#94e	CP-213037	3633	1	F	AMF Onboarding Configuration Data	17.5.0
2021-12	CT#94e	CP-213037	3634	1	F	an indication registered for SNPN onboarding	17.5.0
2021-12	CT#94e	CP-213037	3668	4	F	Handling of emergency numbers in SNPN	17.5.0
2021-12	CT#94e	CP-213037	3674	-	F	T3510 expiry for the UE registered for onboarding services in SNPN	17.5.0
2021-12	CT#94e	CP-213037	3675	4	F	Kausf generation when AAA server of CH is EAP server of EAP based primary authentication and key agreement procedure	17.5.0
2021-12	CT#94e	CP-213037	3748	1	F	DNN and S-NSSAI used for onboarding in PLMN	17.5.0
2021-12	CT#94e	CP-213037	3750	1	F	SMF configuring to UE with PVS address	17.5.0
2021-12	CT#94e	CP-213037	3751	1	F	Secondary authentication/authorization by a DN-AAA server	17.5.0
2021-12	CT#94e	CP-213038	3778	1	F	Updating ATSSS parameter update with network-requested PDU session modification	17.5.0
2021-12	CT#94e	CP-213039	3589	1	B	Paging timing collision control support in 5GS	17.5.0
2021-12	CT#94e	CP-213039	3590	-	B	Reject RAN paging with optional paging restrictions	17.5.0

2021-12	CT#94e	CP-213039	3591	1	F	Clarification on removal of paging restrictions	17.5.0
2021-12	CT#94e	CP-213039	3601	1	C	Always-on PDU sessions for MUSIM UE	17.5.0
2021-12	CT#94e	CP-213039	3619	1	F	Service request procedure due to MUSIM when no allowed NSSAI is available	17.5.0
2021-12	CT#94e	CP-213039	3622	1	F	Service request procedure for NAS connection release when T3346 is running (for 24.501)	17.5.0
2021-12	CT#94e	CP-213039	3623	1	F	NAS connection release from 5GMM-CONNECTED mode with RRC inactive indication	17.5.0
2021-12	CT#94e	CP-213039	3665	-	B	5GS MUSIM SR transmission failure	17.5.0
2021-12	CT#94e	CP-213039	3667	-	D	5GS MUSIM Editorial Correction	17.5.0
2021-12	CT#94e	CP-213040	3402	4	B	MUSIM capability negotiation in 5GCN	17.5.0
2021-12	CT#94e	CP-213040	3722	1	F	T3447 handling for MUSIM capable UE	17.5.0
2021-12	CT#94e	CP-213040	3727	1	F	MRU procedure for allocation of 5G-GUTI when T3346 is running	17.5.0
2021-12	CT#94e	CP-213040	3766	1	F	Remove duplicated MUSIM definition	17.5.0
2021-12	CT#94e	CP-213040	3767	1	F	Resolve EN on SR for rejecting RAN paging in 5GMM-CONNECTED mode with RRC inactive	17.5.0
2021-12	CT#94e	CP-213040	3773	1	C	Remove paging restrictions in case of service area restrictions	17.5.0
2021-12	CT#94e	CP-213040	3794	-	F	Only Paging for voice service	17.5.0
2021-12	CT#94e	CP-213040	3807	1	F	Corrections for paging restriction preferences terminology in 5GS	17.5.0
2021-12	CT#94e	CP-213040	3808	1	F	Releasing NAS signalling connection and Paging restriction during mobility registration in a TA outside the current Registration Area for MUSIM UE in 5GS	17.5.0
2021-12	CT#94e	CP-213040	3809	1	B	Network to accept or reject the paging restriction requested by MUSIM capable UE in 5GS	17.5.0
2021-12	CT#94e	CP-213041	3349	4	B	Network slice simultaneous registration group	17.5.0
2021-12	CT#94e	CP-213041	3599	1	F	Add rejected nssai for max UE reached for #62	17.5.0
2021-12	CT#94e	CP-213041	3617	1	F	Clarification of the timer T3526	17.5.0
2021-12	CT#94e	CP-213041	3618	1	F	Removing the rejected S-NSSAI for the maximum number of UEs reached in case of IWK with EPC	17.5.0
2021-12	CT#94e	CP-213041	3620	1	F	Support of NSAC and interworking with EPC	17.5.0
2021-12	CT#94e	CP-213041	3621	1	F	Skip NSAC for existing PDU session request type	17.5.0
2021-12	CT#94e	CP-213041	3626	1	F	NSAC for legacy UEs	17.5.0
2021-12	CT#94e	CP-213041	3627	1	F	Removal of S-NSSAI from rejected NSSAI for the maximum number of UEs reached	17.5.0
2021-12	CT#94e	CP-213041	3640	2	F	AMF handling of NSAC function for legacy UE.	17.5.0
2021-12	CT#94e	CP-213041	3655	1	F	Clarification on rejected NSSAI for the maximum number of UEs reached with value 0 back-off timer	17.5.0
2021-12	CT#94e	CP-213041	3673	1	F	5GSM procedure when EAC is disabled	17.5.0
2021-12	CT#94e	CP-213041	3692	1	F	Correction of the rejected NSSAI for the maximum number of UEs reached handling	17.5.0
2021-12	CT#94e	CP-213041	3698	-	F	Correction on SM based NSAC	17.5.0
2021-12	CT#94e	CP-213041	3724	-	F	Clarification of registration procedure in which NSAC is performed	17.5.0
2021-12	CT#94e	CP-213041	3744	1	F	Clarification on SMF performing NSAC for an MA PDU session	17.5.0
2021-12	CT#94e	CP-213041	3763	1	F	Local timer for AMF to update rejected NSSAI	17.5.0
2021-12	CT#94e	CP-213042	3689	-	F	Change the reference to LPP protocol	17.5.0
2021-12	CT#94e	CP-213043	3628	2	B	Common IE for C2 authorization	17.5.0
2021-12	CT#94e	CP-213043	3629	3	B	5GSM cause value of PDU session establishment reject for UAS services	17.5.0
2021-12	CT#94e	CP-213043	3630	1	F	Missed CAA-Level UAV ID for C2 authorization	17.5.0
2021-12	CT#94e	CP-213043	3631	1	F	Miscellaneous corrections on Service-level-AA container IE	17.5.0
2021-12	CT#94e	CP-213043	3637	1	C	Update the general part for Authentication and authorization of UAV	17.5.0
2021-12	CT#94e	CP-213043	3638	1	B	UUAA revocation for the case of UUAA-MM	17.5.0
2021-12	CT#94e	CP-213043	3641	3	B	C2 aviation payload	17.5.0
2021-12	CT#94e	CP-213043	3645	3	F	Using Service-level AA container for C2 authorization	17.5.0
2021-12	CT#94e	CP-213043	3648	1	F	Service-level-AA pending indication	17.5.0
2021-12	CT#94e	CP-213043	3649	1	F	Restriction to non3gpp access	17.5.0
2021-12	CT#94e	CP-213043	3651	1	C	UUAA-SM procedure for re-authorization or re-authentication	17.5.0
2021-12	CT#94e	CP-213043	3653	1	F	Remove EN on payload differentiation of Service-level-AA container	17.5.0
2021-12	CT#94e	CP-213043	3658	3	B	SM request while UUAA-SM is ongoing	17.5.0
2021-12	CT#94e	CP-213043	3770	1	B	Requirements related to UAS subscription change	17.5.0
2021-12	CT#94e	CP-213043	3789	1	B	Collision between UUAA-MM and UE initiated deregistration	17.5.0
2021-12	CT#94e	CP-213043	3790	1	B	Collision between UUAA-SM and UE requested PDU session release	17.5.0
2021-12	CT#94e	CP-213043	3791	1	B	UUAA abnormal case	17.5.0
2021-12	CT#94e	CP-213045	3595	1	B	Add the SMF shall provide the QoS flow description(s) for the PDU sessions used for relaying	17.5.0
2021-12	CT#94e	CP-213045	3616	1	F	NAS signalling recovery from fallback when the UE was only performing ProSe PC5 procedures	17.5.0
2021-12	CT#94e	CP-213045	3644	-	D	Editorial corrections for the ProSe relay terminologies and capabilities	17.5.0

2021-12	CT#94e	CP-213045	3683	1	B	Triggering Service Request procedure due to lower layers request for ProSe layer-2 UE-to-network relay	17.5.0
2021-12	CT#94e	CP-213045	3775	1	B	IPv6 prefix delegation via DHCPv6 for 5G ProSe layer-3 UE-to-network relay	17.5.0
2021-12	CT#94e	CP-213045	3776	1	F	The type of the port number in Remote UE context list information element	17.5.0
2021-12	CT#94e	CP-213045	3782	1	F	Merging UE triggered V2X and ProSe policy provision procedure in UAC	17.5.0
2021-12	CT#94e	CP-213045	3812	-	F	Correcting the reference of the spec in which the UE requests the PCF to provide ProSeP	17.5.0
2021-12	CT#94e	CP-213047	3690	1	F	SNPN for NSSAI inclusion mode	17.5.0
2021-12	CT#94e	CP-213047	3725	1	F	Correction in mobility registration reject	17.5.0
2021-12	CT#94e	CP-213047	3729	1	F	Clarification on when a 5GSM procedure can be initiated for LADN	17.5.0
2021-12	CT#94e	CP-213047	3732	1	F	PDU session modification after inter-system change into a non-allowed area	17.5.0
2021-12	CT#94e	CP-213047	3733	1	F	The order of PDU sessions to be transferred to EPS	17.5.0
2021-12	CT#94e	CP-213047	3734	1	F	Collision handling of UE-requested PDU session establishment procedure and network-requested PDU session modification procedure	17.5.0
2021-12	CT#94e	CP-213047	3736	1	F	PDU session type required in PDU session establishment request	17.5.0
2021-12	CT#94e	CP-213047	3741	1	F	Issues with the condition of FIRST inter-system change for PDU session modification	17.5.0
2021-12	CT#94e	CP-213047	3756	1	F	Reattempting LADN DNN rejected with #46	17.5.0
2021-12	CT#94e	CP-213047	3757	1	F	UE behaviour on #29 related back-off timer	17.5.0
2021-12	CT#94e	CP-213047	3760	1	F	Add missing 5GSM cause values	17.5.0
2021-12	CT#94e	CP-213047	3762	1	F	Correction on unidentifiable example for syntactical error	17.5.0
2021-12	CT#94e	CP-213047	3772	1	F	Reservation of a bit in an entry of the CAG information list IE	17.5.0
2021-12	CT#94e	CP-213047	3805	1	F	Clarification for UE parameters update data handling	17.5.0
2021-12	CT#94e	CP-213047	3813	1	D	Reference correction - Editorial	17.5.0
2021-12	CT#94e	CP-213047	3823	-	D	Editorial corrections in TS 24.501	17.5.0
2021-12	CT#94e	CP-213047	3831	-	F	Correction to condition to include the 5GS registration result IE in the REGISTRATION ACCEPT message	17.5.0
2021-12	CT#94e	CP-213047	3706	1	F	Handling of the non-current 5G NAS security context at inter-system change from N1 mode to S1 mode	17.5.0
2021-12	CT#94e	CP-213048	3412	3	F	The solution to the case the allowed CAG IDs of a PLMN beyond the limit of one Entry-1	17.5.0
2021-12	CT#94e	CP-213048	3447	2	F	Authentication failure when emergency service is ongoing	17.5.0
2021-12	CT#94e	CP-213048	3716	1	F	MA PDU session information IE update	17.5.0
2021-12	CT#94e	CP-213048	3737	1	F	Delete the PCO parameters after handover between 3GPP and non-3GPP access	17.5.0
2021-12	CT#94e	CP-213048	3752	1	F	Acknowledgment for the security packet of SOR information	17.5.0
2021-12	CT#94e	CP-213048	3754	3	F	Clarification on semantic error about match-all packet filter	17.5.0
2021-12	CT#94e	CP-213048	3795	1	B	Derived QoS for UDP encapsulated IPsec packets	17.5.0
2021-12	CT#94e	CP-213048	3713	1	F	Storing Allowed NSSAI for EPLMNs	17.5.0
2021-12	CT#94e	CP-213048	3714	1	F	Deleting rejected S-NSSAI	17.5.0
2021-12	CT#94e	CP-213048	3712	2	F	S-NSSAI with non-standard values	17.5.0
2021-12	CT#94e	CP-213049	3804	1	F	Clarification for parameters associated with non-3GPP access	17.5.0
2021-12	CT#94e	CP-213050	3654	1	B	Update on ECS configuration information	17.5.0
2021-12	CT#94e	CP-213050	3681	1	F	ECS configuration information provisioning corrections	17.5.0
2021-12	CT#94e	CP-213053	3660	1	B	Updating MBS service area for the MBS session that the UE has joined	17.5.0
2021-12	CT#94e	CP-213053	3661	-	F	The MBS service area received in PDU SESSION ESTABLISHMENT ACCEPT message can include both of MBS TAI list and NR CGI list	17.5.0
2021-12	CT#94e	CP-213053	3662	1	B	Introducing MBS back-off timer for MBS join rejection	17.5.0
2021-12	CT#94e	CP-213053	3663	1	F	Aligning the MBS procedures across different clauses	17.5.0
2021-12	CT#94e	CP-213053	3709	1	B	MBS operation in Requested MBS container IE	17.5.0
2021-12	CT#94e	CP-213053	3777	1	F	Correction to type of MBS session ID source specific IP multicast address	17.5.0
2021-12	CT#94e	CP-213053	3815	-	B	The impact of the De-registration procedure on the MBS sessions	17.5.0
2021-12	CT#94e	CP-213053	3816	-	B	SMF to consider the UE as removed from the associated MBS sessions due to the PDU session release procedure	17.5.0
2021-12	CT#94e	CP-213053	3817	1	B	Removing the joined UE from MBS session due to becoming outside an updated MBS service area	17.5.0
2021-12	CT#94e	CP-213053	3818	-	B	Removing joined UE from MBS sessions at inter-system change from N1 mode to S1 mode	17.5.0
2021-12	CT#94e	CP-213054	3670	1	B	Introduction of redundant PDU sessions	17.5.0
2021-12	CT#94e	CP-213054	3671	3	B	5GSM protocol update for redundant PDU sessions	17.5.0
2021-12	CT#94e	CP-213055	3437	6	B	Provisioning of parameters for disaster roaming in the UE	17.5.0
2021-12	CT#94e	CP-213055	3585	4	B	PLMN with disaster condition	17.5.0
2021-12	CT#94e	CP-213055	3614	3	B	Addition of 5GS registration type for initial registration disaster roaming.	17.5.0

2021-12	CT#94e	CP-213055	3642	-	F	Correction of implementation errors of CR3512 (C1-215139)	17.5.0
2021-12	CT#94e	CP-213055	3656	4	F	Registration result IE indicate UE is registered for disaster roaming service	17.5.0
2021-12	CT#94e	CP-213055	3679	1	B	Introducing access identity 3 for disaster roamer	17.5.0
2021-12	CT#94e	CP-213055	3742	-	B	Unnecessary signalling for providing selected EPS NAS security algorithms to disaster roaming UEs	17.5.0
2021-12	CT#94e	CP-213055	3820	1	B	Updating initial registration for disaster roaming services	17.5.0
2021-12	CT#94e	CP-213055	3825	1	B	Adding definition for registered for disaster roaming services	17.5.0
2021-12	CT#94e	CP-213056	3669	1	F	SOR-CMCI storage	17.5.0
2021-12	CT#94e	CP-213056	3702	-	B	Adding the SOR security check criterion to the SOR-CMCI	17.5.0
2021-12	CT#94e	CP-213056	3797	1	F	UE performing deregistration procedure in 5GMM-CONNECTED mode	17.5.0
2021-12	CT#94e	CP-213057	3431	4	B	Validity of cause code #78	17.5.0
2021-12	CT#94e	CP-213057	3606	1	B	Alignment to KI#2 conclusions on EPLMN list	17.5.0
2021-12	CT#94e	CP-213057	3636	-	F	Access Technology Identifier satellite NG-RAN	17.5.0
2021-12	CT#94e	CP-213057	3833	1	C	Clarification of UE location verification in registration procedure	17.5.0
2022-03	CT#95e	CP-220022	3981	2	B	Failure case for 5G SRVCC	17.6.0
2022-03	CT#95e	CP-220147	4131	-	B	Handling of forbidden TAI(s) within broadcast TACs in registration procedure	17.6.0
2022-03	CT#95e	CP-220213	3711	4	F	Paging restrictions with Connection Release in 5GS	17.6.0
2022-03	CT#95e	CP-220233	3948	2	F	MUSIM capabilities exchange while Emergency service is ongoing in 5GS	17.6.0
2022-03	CT#95e	CP-220234	4077	2	F	Adding the paging timing collision control in the definition of the MUSIM UE in 5GS	17.6.0
2022-03	CT#95e	CP-220250	3850	2	B	MUSIM support for SNPN access mode	17.6.0
2022-03	CT#95e	CP-220317	3868	2	B	UUAA-MM completion alignment	17.6.0
2022-03	CT#95e	CP-220318	3867	2	B	UUAA revocation alignment	17.6.0
2022-03	CT#95e	CP-220319	3765	5	B	UAS security information obtained during UUAA	17.6.0
2022-03	CT#95e	CP-220337	3916	2	F	General description on Multi-USIM UE in 5GS	17.6.0
2022-03	CT#95e	CP-220229	3984	1	A	RID for SNPN UEs	17.6.0
2022-03	CT#95e	CP-220229	3985	2	A	RID update for SNPN UEs	17.6.0
2022-03	CT#95e	CP-220229	4002	1	A	NSSAA applicable for SNPN in Rel-17	17.6.0
2022-03	CT#95e	CP-220236	3849	-	F	SUPI type of onboarding SUPI	17.6.0
2022-03	CT#95e	CP-220236	3871	1	F	Clarification on lists of forbidden SNPNs in an ON-SNPN	17.6.0
2022-03	CT#95e	CP-220236	3872	1	F	Handling of 5GMM cause values #3 and #6 in an ON-SNPN	17.6.0
2022-03	CT#95e	CP-220236	3873	1	F	Handling of 5GMM cause value #7 in an ON-SNPN	17.6.0
2022-03	CT#95e	CP-220236	3874	-	F	Handling of non-integrity protected reject messages with 5GMM cause value #3, #6, or #7 in an ON-SNPN	17.6.0
2022-03	CT#95e	CP-220236	3917	1	F	UE operation after adding the ID of an ON-SNPN in the permanently forbidden SNPNs list	17.6.0
2022-03	CT#95e	CP-220236	3918	1	F	Handling of a non-integrity protected AUTHENTICATION REJECT message received from an ON-SNPN	17.6.0
2022-03	CT#95e	CP-220236	3925	-	F	Correction in 5GMM cause value #93 handling	17.6.0
2022-03	CT#95e	CP-220236	3933	1	F	Onboarding indication	17.6.0
2022-03	CT#95e	CP-220237	3844	1	F	Two available native 5G-GUTIs during the registration procedure not applicable in SNPN	17.6.0
2022-03	CT#95e	CP-220237	3845	1	F	NID IE inclusion condition	17.6.0
2022-03	CT#95e	CP-220237	3846	1	F	3GPP PS data off and UE in non-subscribed SNPN	17.6.0
2022-03	CT#95e	CP-220237	3847	1	B	Anonymous SUCI	17.6.0
2022-03	CT#95e	CP-220237	3905	1	F	NSAC for S-NSSAI used for onboarding services in SNPN	17.6.0
2022-03	CT#95e	CP-220237	3923	1	B	Onboarding indication over N11 in an ON-SNPN	17.6.0
2022-03	CT#95e	CP-220237	3966	1	F	Onboarding DNN/S-NSSAI	17.6.0
2022-03	CT#95e	CP-220237	3986	-	F	Providing PVS information for obtaining credentials for NSSAA or PDU session authentication and authorization procedure in SNPN	17.6.0
2022-03	CT#95e	CP-220237	3924	1	F	Correction in the UE behavior upon receipt of a Deregistration Request message with 5GMM cause value #75 from an ON-SNPN	17.6.0
2022-03	CT#95e	CP-220238	3839	4	B	Enabling update of SOR-SNPN-SI in a PLMN	17.6.0
2022-03	CT#95e	CP-220238	3843	2	B	Usage of indication to use MSK for derivation of KAUSF after success of primary authentication and key agreement procedure	17.6.0
2022-03	CT#95e	CP-220238	3934	3	F	NSAC for SNPN onboarding	17.6.0
2022-03	CT#95e	CP-220238	3987	1	F	UE requesting PVS information	17.6.0
2022-03	CT#95e	CP-220238	3988	1	B	Providing PVS addresses for obtaining SO-SNPN credentials when registered for non-onboarding services in SNPN	17.6.0
2022-03	CT#95e	CP-220238	3990	1	B	EAP-TTLS with two phases of authentication	17.6.0
2022-03	CT#95e	CP-220238	4019	1	F	Congestion control for onboarding in SNPN	17.6.0
2022-03	CT#95e	CP-220238	4048	1	F	Clarification of the UE behavior for the pending NSSAI for the current SNPN	17.6.0
2022-03	CT#95e	CP-220238	4049	1	F	Clarification of the UE behavior for the rejected NSSAI for the failed or revoked NSSAA for the current SNPN	17.6.0
2022-03	CT#95e	CP-220238	4064	1	F	Missing cause value number for Onboarding services terminated	17.6.0

2022-03	CT#95e	CP-220239	3860	1	B	Local deactivation of UP resource for an MA PDU session with PDN leg - 24501 Part	17.6.0
2022-03	CT#95e	CP-220239	3861	1	F	Clarification on maximum number of PDU sessions has been reached	17.6.0
2022-03	CT#95e	CP-220239	3862	1	F	UE receives ATSSS not supported	17.6.0
2022-03	CT#95e	CP-220239	3863	1	F	Abnormal handling for adding non-3GPP leg to an MA PDU session already with PDN leg	17.6.0
2022-03	CT#95e	CP-220239	3864	1	F	Clarification on QoS rules merge for MA PDU session	17.6.0
2022-03	CT#95e	CP-220240	3666	2	B	5GS MUSIM Paging restriction	17.6.0
2022-03	CT#95e	CP-220240	3851	-	F	Condition for removing the paging restriction	17.6.0
2022-03	CT#95e	CP-220240	3853	-	F	N1 NAS signalling connection release reformulation	17.6.0
2022-03	CT#95e	CP-220240	3854	-	F	Paging restriction in N1 NAS signalling connection release upon RAN paging rejection	17.6.0
2022-03	CT#95e	CP-220240	3857	1	F	Correction of T3540 start scenarios for MRU procedure	17.6.0
2022-03	CT#95e	CP-220240	3913	1	F	The interaction of AS-NAS layer on RAN paging	17.6.0
2022-03	CT#95e	CP-220240	3914	1	F	Connection release for emergency service in 5GS	17.6.0
2022-03	CT#95e	CP-220240	3949	-	F	UE to release NAS signalling connection and indicate Paging restriction during mobility Registration only if no emergency service is ongoing in 5GS	17.6.0
2022-03	CT#95e	CP-220240	3960	1	C	PTCC handling during emergency registration	17.6.0
2022-03	CT#95e	CP-220241	3912	2	F	The handling of paging cause support indicator in 5GS	17.6.0
2022-03	CT#95e	CP-220241	3937	1	F	Collision between UCU and SR	17.6.0
2022-03	CT#95e	CP-220241	3939	2	F	Clarification on Paging cause	17.6.0
2022-03	CT#95e	CP-220241	3982	-	F	Terminology clean up in 5GS	17.6.0
2022-03	CT#95e	CP-220241	4038	1	F	Paging restriction with connection release in non-allowed area	17.6.0
2022-03	CT#95e	CP-220241	4039	1	F	Correction of T3447 handling for Multi-USIM UE	17.6.0
2022-03	CT#95e	CP-220241	4040	-	F	Correction of T3346 handling for Multi-USIM UE	17.6.0
2022-03	CT#95e	CP-220241	4078	-	F	Harmonization of the paging restriction terminology for MUSIM in 5GS	17.6.0
2022-03	CT#95e	CP-220241	4081	1	F	Uplink data status IE not included when requesting release	17.6.0
2022-03	CT#95e	CP-220241	4051	1	F	Clearing paging restrictions when no Allowed NSSAI is available	17.6.0
2022-03	CT#95e	CP-220241	4050	2	F	Clearing paging restrictions during lower layer failure in 5GS	17.6.0
2022-03	CT#95e	CP-220242	3536	2	F	Rejected NSSAI for the maximum number of UE reached with different PLMNs in RA	17.6.0
2022-03	CT#95e	CP-220242	3855	3	B	PDU session establishment reject for network slice data rate control	17.6.0
2022-03	CT#95e	CP-220242	3875	1	F	NSAC for number of PDU sessions taking access type into account	17.6.0
2022-03	CT#95e	CP-220242	3876	1	F	Clarification on NSAC for emergency and priority services	17.6.0
2022-03	CT#95e	CP-220242	3877	1	F	NSAC for existing PDU session with inter access handover	17.6.0
2022-03	CT#95e	CP-220242	3878	1	F	S-NSSAIs in allowed NSSAI share common NSSRG value	17.6.0
2022-03	CT#95e	CP-220242	3879	2	F	Provide all subscribed S-NSSAIs in configured NSSAI	17.6.0
2022-03	CT#95e	CP-220242	3881	1	F	NSAC during PDU session transfer with the Allowed PDU session status IE	17.6.0
2022-03	CT#95e	CP-220242	3886	1	F	5GSM message not forwarded in case of NSAC reject	17.6.0
2022-03	CT#95e	CP-220242	3906	1	F	Access type for rejected NSSAI for the maximum number of UEs reached	17.6.0
2022-03	CT#95e	CP-220242	3907	-	F	NSSAA result not impacted by NSAC	17.6.0
2022-03	CT#95e	CP-220242	3926	2	F	Clarification on an S-NSSAI not allowed solely due to NSSRG restriction	17.6.0
2022-03	CT#95e	CP-220242	3929	1	F	NSAC applicable for SNPN	17.6.0
2022-03	CT#95e	CP-220242	3999	1	F	Removal of several Editor's notes related to NSAC and NSSRG	17.6.0
2022-03	CT#95e	CP-220242	4015	1	F	Coding of NSSRG information IE	17.6.0
2022-03	CT#95e	CP-220242	4016	1	F	NSSRG feature applicable to SNPN	17.6.0
2022-03	CT#95e	CP-220242	4111	1	F	5GSM message not forwarded in case of NSAC reject: AMF operation	17.6.0
2022-03	CT#95e	CP-220242	4112	-	F	Correction on EAC mode to per slice level	17.6.0
2022-03	CT#95e	CP-220244	3792	5	B	PDU session establishment with the DNN/S-NSSAI for UAS service from the UE which has valid aerial subscription but UUA-MM is failed abnormally	17.6.0
2022-03	CT#95e	CP-220244	3841	1	F	Clarification of including Service-level-AA container in PDU SESSION MODIFICATION REQUEST message	17.6.0
2022-03	CT#95e	CP-220244	3865	3	F	Adding missing UUA-SM text	17.6.0
2022-03	CT#95e	CP-220244	3889	1	F	Clarification on PDU session establishment for valid subscription of DNN/S-NSSAI	17.6.0
2022-03	CT#95e	CP-220244	3890	1	F	Generalizing 5GMM cause for UAS service not allowed.	17.6.0
2022-03	CT#95e	CP-220244	3891	1	F	Clarification when valid UUA result is available in the UE MM context	17.6.0
2022-03	CT#95e	CP-220244	3892	-	F	Remove resolved ENs	17.6.0
2022-03	CT#95e	CP-220244	3893	1	F	SA3 requirement for security protected UAS parameters.	17.6.0
2022-03	CT#95e	CP-220244	3945	1	F	Correction to the general part for UUA	17.6.0
2022-03	CT#95e	CP-220244	3947	2	C	The handling of 5GMM#79	17.6.0
2022-03	CT#95e	CP-220244	4010	1	F	Modify service-level-AA parameters	17.6.0

2022-03	CT#95e	CP-220244	4011	1	F	Correction of procedure and text for UAS services	17.6.0
2022-03	CT#95e	CP-220244	4054	1	F	Clarification for revocation of C2 authorization	17.6.0
2022-03	CT#95e	CP-220244	4089	-	F	Update IEI of Service-level-AA container	17.6.0
2022-03	CT#95e	CP-220244	4113	1	F	Correction on description of C2 authorization parameters	17.6.0
2022-03	CT#95e	CP-220244	4114	-	F	Correction on service-level-AA response bit name	17.6.0
2022-03	CT#95e	CP-220245	3882	1	F	Remote UE report not allowed when 5GSM BO timer is running	17.6.0
2022-03	CT#95e	CP-220245	3884	1	F	Collision of network initiated PDU session release and remote UE report procedures	17.6.0
2022-03	CT#95e	CP-220245	3956	-	F	Corrections for Service Request procedure when requesting 5G ProSe resources is the trigger for the procedure	17.6.0
2022-03	CT#95e	CP-220245	3995	1	B	Update to NAS security mode command during PC5 link establishment	17.6.0
2022-03	CT#95e	CP-220245	4065	1	F	Correction of IEI values for the REMOTE UE REPORT message	17.6.0
2022-03	CT#95e	CP-220247	3967	-	F	DNN as an optional parameter for emergency PDU session when interworking with EPS	17.6.0
2022-03	CT#95e	CP-220247	3968	-	F	Applicability of NULL integrity protection algorithm in case of a established emergency PDU session	17.6.0
2022-03	CT#95e	CP-220247	3969	-	F	Disabling of N1 mode in case of #10 while Emergency call pending	17.6.0
2022-03	CT#95e	CP-220247	3989	-	F	Lost text in 6.4.1.2	17.6.0
2022-03	CT#95e	CP-220247	4000	-	D	Two editorial corrections	17.6.0
2022-03	CT#95e	CP-220247	4004	-	F	Clarification to payload container IE	17.6.0
2022-03	CT#95e	CP-220247	4006	-	F	Correction to 5GSM capability IE	17.6.0
2022-03	CT#95e	CP-220247	4021	-	F	Correct Re-attempt indicator IE for #39 in PDU session release	17.6.0
2022-03	CT#95e	CP-220247	4024	-	F	Adding the missing implementation of C1-215154	17.6.0
2022-03	CT#95e	CP-220247	4026	-	D	Editorial correction of 5GS network support	17.6.0
2022-03	CT#95e	CP-220247	4027	-	F	UE is allowed to use PCO IE after inter-system change from N1 mode to S1 mode	17.6.0
2022-03	CT#95e	CP-220247	4037	-	F	CIoT user data container not forwarded due to congestion control	17.6.0
2022-03	CT#95e	CP-220247	4041	-	F	Correction for enabling use of MICO mode	17.6.0
2022-03	CT#95e	CP-220247	4042	-	F	Correction of eDRX handling in 5GS	17.6.0
2022-03	CT#95e	CP-220247	4053	-	F	Clarification of Notification response message	17.6.0
2022-03	CT#95e	CP-220247	4061	-	F	Correction on UAC exception handling	17.6.0
2022-03	CT#95e	CP-220247	4063	-	F	Correction to the MBS back-off timer	17.6.0
2022-03	CT#95e	CP-220247	4079	-	F	Correcting the terminology of the signalling between the UE and the SMF	17.6.0
2022-03	CT#95e	CP-220247	3997	1	F	Alignment of 5GSM state machine to procedural descriptions	17.6.0
2022-03	CT#95e	CP-220248	4023	1	F	Correction on #62	17.6.0
2022-03	CT#95e	CP-220248	4031	1	F	Handling of ESM non-congestion back-off timer	17.6.0
2022-03	CT#95e	CP-220248	4032	1	F	Correction to the PDU session release procedure	17.6.0
2022-03	CT#95e	CP-220248	4034	1	F	Starting T3540 only considers Service Request message but not the CPSR Message	17.6.0
2022-03	CT#95e	CP-220248	4085	-	F	Correction on creating QoS rule in an ACTIVATE DEDICATED EPS BEARER CONTEXT REQUEST message	17.6.0
2022-03	CT#95e	CP-220248	4087	-	F	Correction on number of standardized access category	17.6.0
2022-03	CT#95e	CP-220248	4093	-	F	No modification operation permitted in ACTIVATE BEARER CONTEXT REQUEST message	17.6.0
2022-03	CT#95e	CP-220248	4102	-	F	5GMM cause #31 not used instead of #76	17.6.0
2022-03	CT#95e	CP-220248	4106	-	F	Counter management in a UE	17.6.0
2022-03	CT#95e	CP-220248	4107	-	F	Clarification on SM_RetryAtRATChange values configured in both ME and USIM	17.6.0
2022-03	CT#95e	CP-220248	4116	-	F	Correction on establishment of NAS signalling connection over non-3GPP access	17.6.0
2022-03	CT#95e	CP-220248	4118	-	F	Correction on UE handling on semantic errors in QoS operations	17.6.0
2022-03	CT#95e	CP-220249	4007	1	F	Duplicate 5GMM message type values	17.6.0
2022-03	CT#95e	CP-220249	4008	1	F	Indication of pending PDU session for NAS recovery	17.6.0
2022-03	CT#95e	CP-220249	4017	1	F	Correct Coding of PEIPS assistance information IE	17.6.0
2022-03	CT#95e	CP-220249	4036	1	F	Clarification on Allowed PDU session status IE included in registration request message and service request message	17.6.0
2022-03	CT#95e	CP-220249	4043	1	F	The handling of eDRX in the AMF	17.6.0
2022-03	CT#95e	CP-220249	4069	1	F	Change in CIoT optimizations preferred network behavior	17.6.0
2022-03	CT#95e	CP-220249	4080	1	F	Clarifications on the mapped 5G-GUTI terminology	17.6.0
2022-03	CT#95e	CP-220249	4083	1	D	Service request for redirecting CIoT UEs to EPC	17.6.0
2022-03	CT#95e	CP-220249	4086	1	F	Correction on syntactical error in QoS operation	17.6.0
2022-03	CT#95e	CP-220249	4090	1	F	Initiate PDU session modification procedure for emergency PDU session	17.6.0
2022-03	CT#95e	CP-220249	4091	2	F	Indicate change of PS data off UE status outside of LADN service area	17.6.0
2022-03	CT#95e	CP-220249	4092	1	F	Error handling about QoS rule without corresponding QoS flow description	17.6.0
2022-03	CT#95e	CP-220249	4094	1	F	Clarification on QoS flow handling	17.6.0
2022-03	CT#95e	CP-220249	4096	1	F	Protect emergency PDU session when receiving #28 in the service reject message	17.6.0

2022-03	CT#95e	CP-220249	4104	1	F	Correction in the AMF operation upon initiating a UCU for CAG information update	17.6.0
2022-03	CT#95e	CP-220249	4105	1	F	Correction in the UE operation upon receipt of a CAG information list during the initial registration	17.6.0
2022-03	CT#95e	CP-220249	4117	1	F	Authorized QoS flow provided by network	17.6.0
2022-03	CT#95e	CP-220249	4119	1	F	Correction on UE handling on syntactical errors in packet filters	17.6.0
2022-03	CT#95e	CP-220249	4120	1	F	Correction on attempt counter reset	17.6.0
2022-03	CT#95e	CP-220249	4124	1	C	The solution to CAG IDs of a PLMN beyond the limit of one Entry-IE part	17.6.0
2022-03	CT#95e	CP-220249	4125	1	C	The solution to CAG IDs of a PLMN beyond the limit of one Entry-Procedure part	17.6.0
2022-03	CT#95e	CP-220251	3996	1	F	Updates to 5GS session management aspects over non-3GPP access	17.6.0
2022-03	CT#95e	CP-220252	3848	1	B	EDC related PCO parameters usage	17.6.0
2022-03	CT#95e	CP-220252	3895	3	B	Spatial validity condition coding	17.6.0
2022-03	CT#95e	CP-220252	3957	3	B	Support of updating ECS configuration info	17.6.0
2022-03	CT#95e	CP-220256	3856	2	B	Update for multicast session release	17.6.0
2022-03	CT#95e	CP-220256	3900	2	B	UE MBS session local release at PDU session release	17.6.0
2022-03	CT#95e	CP-220256	3903	1	F	Correction of the length field of the requested MBS container IE	17.6.0
2022-03	CT#95e	CP-220256	3920	1	B	UE handling of MBS back-off timer	17.6.0
2022-03	CT#95e	CP-220256	3921	-	B	UE Locally leaves the MBS session when the PDU session is released	17.6.0
2022-03	CT#95e	CP-220256	3922	1	F	Associate the MBS service area with the TMGI	17.6.0
2022-03	CT#95e	CP-220256	3950	-	B	Using separate QoS flows dedicated for multicast	17.6.0
2022-03	CT#95e	CP-220256	3951	1	B	Introducing the security aspects for MBS	17.6.0
2022-03	CT#95e	CP-220256	3952	-	F	Removing UE from MBS session when the UE moves outside all the MBS service area(s) of that MBS session	17.6.0
2022-03	CT#95e	CP-220256	3953	2	F	Including the reason of removing a joined UE from an MBS session by the network	17.6.0
2022-03	CT#95e	CP-220256	3954	1	F	Correction to MBS service area	17.6.0
2022-03	CT#95e	CP-220256	3955	1	F	Correction for NR CGI list in the MBS service area	17.6.0
2022-03	CT#95e	CP-220256	3992	1	F	MCC and MNC coding in Received MBS container IE	17.6.0
2022-03	CT#95e	CP-220256	4028	1	B	Remove UE from MBS session when the PDU session is released implicitly	17.6.0
2022-03	CT#95e	CP-220256	4029	-	B	UE MBS session local leave when the 3GPP access UP resources are released	17.6.0
2022-03	CT#95e	CP-220256	4035	1	F	UE locally leaves the MBS sessions locally when the PDU session is released locally	17.6.0
2022-03	CT#95e	CP-220256	4072	-	D	Moving the impact of inter-system change from N1 mode to S1 mode on MBS to the correct clauses	17.6.0
2022-03	CT#95e	CP-220256	4073	1	F	Correcting the type of the Requested MBS container IE and the Received MBS container IE to be type 6	17.6.0
2022-03	CT#95e	CP-220256	4075	-	F	MBS inapplicability over non-3GPP access	17.6.0
2022-03	CT#95e	CP-220256	4076	-	F	The impact of PDU session hand-over from 3GPP access to non-3GPP access on MBS sessions	17.6.0
2022-03	CT#95e	CP-220257	3870	3	F	TAI configuration for non-3GPP access	17.6.0
2022-03	CT#95e	CP-220258	3919	1	B	PDU session associating with PDU session pair ID and RSN	17.6.0
2022-03	CT#95e	CP-220258	3928	1	F	Clarification in the NSAC for redundant PDU sessions	17.6.0
2022-03	CT#95e	CP-220258	3888	1	F	End of disaster condition during an emergency PDU session	17.6.0
2022-03	CT#95e	CP-220258	3940	1	B	AMF behaviors during the registration for disaster roaming	17.6.0
2022-03	CT#95e	CP-220260	4097	-	F	Correction to usage of disaster return wait range	17.6.0
2022-03	CT#95e	CP-220260	4098	-	F	Correction on disaster roaming information updating data	17.6.0
2022-03	CT#95e	CP-220260	4101	-	F	Correction to disaster return wait range in Service reject message.	17.6.0
2022-03	CT#95e	CP-220260	4062	1	F	Correction of IEI value of the Disaster return wait range IE	17.6.0
2022-03	CT#95e	CP-220260	3970	1	B	PLMN with disaster condition IE as cleartext	17.6.0
2022-03	CT#95e	CP-220260	4067	1	F	Clarifications on wait timer	17.6.0
2022-03	CT#95e	CP-220260	4066	1	F	HPLMN control in roaming area	17.6.0
2022-03	CT#95e	CP-220260	3887	2	F	Non supporting PLMN for disaster service	17.6.0
2022-03	CT#95e	CP-220261	3909	1	F	Mismatch for MO SMS over NAS or MO SMS over IP service type criterion between TS23.122 and TS24.501	17.6.0
2022-03	CT#95e	CP-220261	3941	1	F	List indication not apply for secured packet	17.6.0
2022-03	CT#95e	CP-220261	3904	2	F	High Priority PLMN search due to SOR	17.6.0
2022-03	CT#95e	CP-220261	3908	1	F	De-registration handling due to Tso-cm timer expiry	17.6.0
2022-03	CT#95e	CP-220261	4088	1	F	Clarification on list indication with secured packet	17.6.0
2022-03	CT#95e	CP-220262	3944	-	C	About the decision on eDRX parameters IE in AMF	17.6.0
2022-03	CT#95e	CP-220264	3974	-	F	Remove Editor's Note in TS24.501 about RAN work on UPIP support for EPC	17.6.0
2022-03	CT#95e	CP-220265	3902	-	F	Addition of NAS over Non-Terrestrial Network general clause text	17.6.0
2022-03	CT#95e	CP-220265	3975	1	F	Applicability condition of the list of PLMNs not allowed to operate at the present UE location	17.6.0
2022-03	CT#95e	CP-220265	3998	1	F	Storage and deletion of PLMNs not allowed to operate at the present UE location list	17.6.0

2022-03	CT#95e	CP-220265	4129	1	C	Taking GNSS fix time into account in UE NAS layer	17.6.0
2022-03	CT#95e	CP-220265	3901	3	B	Addition of extended NAS timers via a satellite NG-RAN cell - Alternative A	17.6.0
2022-03	CT#95e	CP-220265	4057	1	F	Update the contents of an entry in the PLMN List for #78	17.6.0
2022-03	CT#95e	CP-220265	4009	1	F	Handling of PDU session modification not forwarded due to #78	17.6.0
2022-03	CT#95e	CP-220282	4123	1	B	Extension of SNN description for NSWO	17.6.0
2022-03	CT#95e	CP-220283	3896	3	C	Paging Subgrouping updates in Registration and UE Configuration Update procedure	17.6.0
2022-03	CT#95e	CP-220283	4055	1	F	Paging subgroup during emergency call	17.6.0
2022-03	CT#95e					Editorial correction in clause 5.3.25	17.6.1
2022-06	CT#96	CP-221195	4275	1	A	SSC mode corrections	17.7.0
2022-06	CT#96	CP-221189	4139	4	F	Anonymous SUCI usage	17.7.0
2022-06	CT#96	CP-221226	4255	2	A	Indicating Supported SSC Mode(s) by the UE	17.7.0
2022-06	CT#96	CP-221280	4190	4	F	Correction on terminology and description for ID_UAS	17.7.0
2022-06	CT#96	CP-221343	4327	3	F	UE enter in substate NO-SUPI	17.7.0
2022-06	CT#96	CP-221202	4199	5	B	Network slice AS group - General aspects	17.7.0
2022-06	CT#96	CP-221202	4292	1	B	Support NSAG - Procedure Message and NSAG information IE coding	17.7.0
2022-06	CT#96	CP-221202	4295	1	B	Support NSAG in 5GMM capability	17.7.0
2022-06	CT#96	CP-221202	4308	2	B	NSAG information storage	17.7.0
2022-06	CT#96	CP-221203	4166	2	B	Onboarding SNPN and secondary authentication support	17.7.0
2022-06	CT#96	CP-221203	4261	1	F	list of configuration data	17.7.0
2022-06	CT#96	CP-221203	4264	-	F	PVS address providing correction	17.7.0
2022-06	CT#96	CP-221203	4266	1	F	Editor's note in subclause 9.11.3.51	17.7.0
2022-06	CT#96	CP-221203	4267	1	F	AMF onboarding configuration data clean up	17.7.0
2022-06	CT#96	CP-221203	4268	1	F	S-NSSAI when URSP rule triggering establishment of PDU session was signalled by non-subscribed SNPN	17.7.0
2022-06	CT#96	CP-221203	4285	1	F	UE parameter update data set for ME routing indicator update data	17.7.0
2022-06	CT#96	CP-221203	4286	1	D	Editorial change : onboarding indicator	17.7.0
2022-06	CT#96	CP-221203	4337	1	F	No NSSAI provided to lower layer for onboarding service	17.7.0
2022-06	CT#96	CP-221203	4368	1	F	Usage of the onboarding SUCI	17.7.0
2022-06	CT#96	CP-221203	4369	-	F	Correction for the note about the UE policy sections stored for PLMNs or SNPNS	17.7.0
2022-06	CT#96	CP-221203	4375	2	F	Mapped S-NSSAI applicable for SNPN	17.7.0
2022-06	CT#96	CP-221203	4421	1	F	SUPI handling in case of CH using AAA server	17.7.0
2022-06	CT#96	CP-221203	4422	1	F	Storage of SNPN Forbidden List Across Power Cycle	17.7.0
2022-06	CT#96	CP-221203	4257	1	F	Correction of non-3GPP access in SNPN	17.7.0
2022-06	CT#96	CP-221203	4424	2	F	Storage of 5GMM parameters mapping with SUPI from USIM for AKA based SNPN	17.7.0
2022-06	CT#96	CP-221204	4162	-	F	Correction on session-AMBR for MA PDU session	17.7.0
2022-06	CT#96	CP-221204	4234	3	F	DEREGISTRATION handling for MA PDU session with PDN leg	17.7.0
2022-06	CT#96	CP-221204	4354	-	F	Clarification on PDU session establishment for MA PDU session	17.7.0
2022-06	CT#96	CP-221205	4140	-	F	Completing terminology clean up in 5GS	17.7.0
2022-06	CT#96	CP-221205	4156	1	F	Uplink data status handling for removing paging restriction in 5GS	17.7.0
2022-06	CT#96	CP-221205	4157	-	F	Uplink data status handling for NAS connection release	17.7.0
2022-06	CT#96	CP-221205	4159	1	F	The handling of paging cause in 5GS	17.7.0
2022-06	CT#96	CP-221205	4160	1	F	PEI handling for the MUSIM UE	17.7.0
2022-06	CT#96	CP-221205	4229	1	F	Correction for setting the Follow-on request indicator in abnormal cases for MUSIM UE in 5GS	17.7.0
2022-06	CT#96	CP-221205	4230	-	F	Referring to the correct terminology for the paging indication for voice services for MUSIM handling in 5GS	17.7.0
2022-06	CT#96	CP-221205	4374	2	F	UE no longer a MUSIM UE	17.7.0
2022-06	CT#96	CP-221205	4427	1	F	Clarification to MUSIM UEs operating in NB-N1 mode and WB-N1 CE mode B	17.7.0
2022-06	CT#96	CP-221206	4144	1	F	Alignment for NSAC for emergency and priority services	17.7.0
2022-06	CT#96	CP-221206	4182	1	F	Clarification on NSAC for SNPN onboarding	17.7.0
2022-06	CT#96	CP-221206	4183	1	F	Default subscribed S-NSSAI not subject to NSAC	17.7.0
2022-06	CT#96	CP-221206	4184	1	F	Clarification on condition of registration rejection	17.7.0
2022-06	CT#96	CP-221206	4185	-	F	Clarification on update of pending NSSAI if UE receives rejected NSSAI	17.7.0
2022-06	CT#96	CP-221206	4187	1	F	Addition of the NSSRG information in the Network slicing information	17.7.0
2022-06	CT#96	CP-221206	4200	2	F	Trigger to update configured NSSAI and NSSRG information	17.7.0
2022-06	CT#96	CP-221206	4204	-	F	The S-NSSAIs in an NSSAI associated with one or more common NSSRG values	17.7.0
2022-06	CT#96	CP-221206	4238	3	F	Clarification on the conflict between the NSSRG information IE and the Configured NSSAI IE	17.7.0
2022-06	CT#96	CP-221206	4240	1	F	Exemptions for the network slice data rate limitation control	17.7.0
2022-06	CT#96	CP-221206	4241	1	F	EAC mode is activated when the number of UEs associated with S-NSSAI reaches a certain threshold	17.7.0
2022-06	CT#96	CP-221206	4242	1	F	PDU sessions reactivation failure due to NSAC	17.7.0

2022-06	CT#96	CP-221206	4334	-	F	Manage NSSRG information over 3GPP access and non-3GPP access type	17.7.0
2022-06	CT#96	CP-221206	4335	1	F	Correction on NSSRG information	17.7.0
2022-06	CT#96	CP-221206	4363	-	F	Differential backoff timer in NSAC	17.7.0
2022-06	CT#96	CP-221206	4381	-	F	NSSRG information value	17.7.0
2022-06	CT#96	CP-221206	4382	-	F	Incorrect statement subscribed S-NSSAI(s) marked as default subject to NSAC	17.7.0
2022-06	CT#96	CP-221206	4383	1	F	Extended rejected NSSAI IE mandatory support	17.7.0
2022-06	CT#96	CP-221208	3866	5	F	Correction of procedures providing UUAA authorization payload	17.7.0
2022-06	CT#96	CP-221208	4168	-	F	Correction to the Service-level-AA container IEI value	17.7.0
2022-06	CT#96	CP-221208	4173	-	F	Correction on DL NAS TRANSFER for UUAA procedure	17.7.0
2022-06	CT#96	CP-221208	4174	4	F	Completion of service-level-AA procedure	17.7.0
2022-06	CT#96	CP-221208	4175	1	F	USS FQDN as service-level-AA server address	17.7.0
2022-06	CT#96	CP-221208	4177	-	F	Correction on UUAA-MM handling at AMF	17.7.0
2022-06	CT#96	CP-221208	4178	1	F	UUAA-MM failure delivery	17.7.0
2022-06	CT#96	CP-221208	4179	-	F	Retry restriction for 5GSM cause #86	17.7.0
2022-06	CT#96	CP-221208	4180	-	F	Parameters in Service-level-AA container IE are not standalone IE	17.7.0
2022-06	CT#96	CP-221208	4191	2	F	Resolving editor's note for ID_UAS	17.7.0
2022-06	CT#96	CP-221208	4192	1	F	Correction of the condition when the network initiates de-registration	17.7.0
2022-06	CT#96	CP-221208	4252	-	F	Correction of the definition of UE supporting UAS services	17.7.0
2022-06	CT#96	CP-221208	4367	1	F	Editorial correction	17.7.0
2022-06	CT#96	CP-221208	4387	1	F	Clarification on service level AA procedure for NI PDU modification	17.7.0
2022-06	CT#96	CP-221208	4405	-	F	Handling of EMM parameters on getting #79 in SRM	17.7.0
2022-06	CT#96	CP-221209	4262	-	F	IE coded as 'comprehension required'	17.7.0
2022-06	CT#96	CP-221209	4316	1	F	Interaction between 5GSM entity and upper layers with respect to the ProSeP	17.7.0
2022-06	CT#96	CP-221209	4317	-	F	A few cleanups on 5G ProSe	17.7.0
2022-06	CT#96	CP-221209	4318	1	B	The timer for authentication and key agreement for 5G ProSe UE-to-network relay	17.7.0
2022-06	CT#96	CP-221209	4360	-	F	Invalid PDU session identity in Remote UE Report message	17.7.0
2022-06	CT#96	CP-221209	4365	1	B	Secondary authentication via L3 relay	17.7.0
2022-06	CT#96	CP-221210	4219	3	B	Authentication and key agreement for 5G ProSe UE-to-network relay	17.7.0
2022-06	CT#96	CP-221211	4280	-	F	Correction on UE 5GMM state for 5GMM cause #76	17.7.0
2022-06	CT#96	CP-221211	4281	-	F	Correction on AMF handling on PDU session release	17.7.0
2022-06	CT#96	CP-221211	4282	-	F	Correction on RRC resume indication at AMF	17.7.0
2022-06	CT#96	CP-221211	4289	-	F	Correction to PDU session type	17.7.0
2022-06	CT#96	CP-221211	4299	-	F	Taking into account information from the NG-RAN when determining the Paging subgroup ID	17.7.0
2022-06	CT#96	CP-221211	4301	1	F	Conditions for an inactive UE to request the lower layers to transition to the connected mode	17.7.0
2022-06	CT#96	CP-221211	4269	-	F	Skipping access control checking for NAS signalling connection recovery after IRAT change from LTE to NR	17.7.0
2022-06	CT#96	CP-221211	4311	-	F	Condition of including new configured NSSAI in Registration Accept message	17.7.0
2022-06	CT#96	CP-221211	4312	-	F	Simplify enumeration of all kinds of rejected NSSAI	17.7.0
2022-06	CT#96	CP-221211	4325	-	F	Removing the obsolete description of C1-211443	17.7.0
2022-06	CT#96	CP-221211	4330	-	F	Correction on 5GMM deregistration state for CC #62 and #79	17.7.0
2022-06	CT#96	CP-221211	4338	-	F	Correction on Extended rejected NSSAI IE	17.7.0
2022-06	CT#96	CP-221211	4341	-	F	Coordination between 5GMM and EMM state	17.7.0
2022-06	CT#96	CP-221211	4343	-	F	Perform deregistration procedure in 5GMM- REGISTERED state	17.7.0
2022-06	CT#96	CP-221211	4352	-	F	Clarification on CPSR procedure and minor correction	17.7.0
2022-06	CT#96	CP-221211	4353	-	F	Correction on session-AMBR during the PDU session establishment	17.7.0
2022-06	CT#96	CP-221211	4356	-	F	Storing Allowed NSSAIs for EPLMNs during registration	17.7.0
2022-06	CT#96	CP-221211	4371	-	D	Wording correction for the UE policy classmark	17.7.0
2022-06	CT#96	CP-221211	4377	-	F	N1 NAS signalling Connection maintenance for abnormal cases and PLMN selection	17.7.0
2022-06	CT#96	CP-221211	4378	-	F	Start T3540 when non-switch-off de-registration procedure complete	17.7.0
2022-06	CT#96	CP-221211	4379	-	F	Clarification for Semantic error in the mapped EPS bearer	17.7.0
2022-06	CT#96	CP-221211	4390	-	F	Clarification of UE initiated PDU procedure and NAS signalling connection release	17.7.0
2022-06	CT#96	CP-221211	4259	1	F	Correction of duplicated info in the Generic UE Configuration Update procedure	17.7.0
2022-06	CT#96	CP-221212	4251	1	F	Correction of the condition that the UE removes the pending NSSAI	17.7.0
2022-06	CT#96	CP-221212	4294	1	F	Clarification on the update of allowed NSSAI	17.7.0
2022-06	CT#96	CP-221212	4300	1	F	Note on the default configured NSSAI	17.7.0
2022-06	CT#96	CP-221212	4302	1	F	Emergency registration without allowed NSSAI	17.7.0

2022-06	CT#96	CP-221212	4320	1	D	Delete repeat description	17.7.0
2022-06	CT#96	CP-221212	4321	1	F	Scenarios to stop T3526	17.7.0
2022-06	CT#96	CP-221212	4322	1	F	QoS error checks for unstructured PDU session type in PCO	17.7.0
2022-06	CT#96	CP-221212	4324	1	F	Missing state when disabling N1 mode for 3GPP access	17.7.0
2022-06	CT#96	CP-221212	4329	1	F	Perform eCall inactivity procedure in 5GMM-REGISTERED.NON-ALLOWED-SERVICE substate	17.7.0
2022-06	CT#96	CP-221212	4331	1	F	No need to include Uplink data status IE in periodic registration message	17.7.0
2022-06	CT#96	CP-221212	4344	1	F	Correction on trigger to initiate registration procedure	17.7.0
2022-06	CT#96	CP-221212	4347	1	F	Correction on the IE coding	17.7.0
2022-06	CT#96	CP-221212	4366	2	F	UE delete NAS security context only when not be used	17.7.0
2022-06	CT#96	CP-221212	4385	1	F	Use of definition default S-NSSAI	17.7.0
2022-06	CT#96	CP-221212	4414	1	F	Length information correction of 5GS update type IE	17.7.0
2022-06	CT#96	CP-221212	4357	1	F	Abnormal cases in Registration procedure for handling Paging subgroup ID	17.7.0
2022-06	CT#96	CP-221212	4358	1	F	Abnormal cases in Generic UE configuration update procedure for handling Paging subgroup ID	17.7.0
2022-06	CT#96	CP-221212	4359	1	F	Deleting PEIPS assistance information on Registration procedure failure	17.7.0
2022-06	CT#96	CP-221212	4256	1	F	Mismatch of the Legth Indicators between two similar IEs	17.7.0
2022-06	CT#96	CP-221213	4284	1	F	Correction on UE handling on extended local emergency numbers list via non-3GPP access	17.7.0
2022-06	CT#96	CP-221213	4309	1	F	Network slicing features applicable in SNPN	17.7.0
2022-06	CT#96	CP-221213	4313	1	D	Editorial corrections	17.7.0
2022-06	CT#96	CP-221213	4323	1	F	Correction on using T3540	17.7.0
2022-06	CT#96	CP-221213	4326	1	F	Clarification on UE action for not forwarded 5GSM message	17.7.0
2022-06	CT#96	CP-221213	4345	1	F	Correction on access category about MO IMS registration related signalling	17.7.0
2022-06	CT#96	CP-221213	4348	2	F	Support MAC address range in packet filter	17.7.0
2022-06	CT#96	CP-221213	4350	1	F	The handling of establishing an emergency PDU session after WUS negotiation in 5GS	17.7.0
2022-06	CT#96	CP-221213	4351	1	F	Correction on the WUS assistance information	17.7.0
2022-06	CT#96	CP-221213	4376	1	F	Indication for no 5GMM or 5GSM messages to the lower layers	17.7.0
2022-06	CT#96	CP-221213	4380	1	F	Handling of multiple TAGs in the Ethernet header for signalled and derived QoS rules	17.7.0
2022-06	CT#96	CP-221213	4388	1	F	Correction to TFT check for PDU session establishment procedure	17.7.0
2022-06	CT#96	CP-221213	4389	1	F	Correction to TFT check for PDU session modification procedure	17.7.0
2022-06	CT#96	CP-221213	4391	2	F	Clarification of Release of non-emergency PDU sessions	17.7.0
2022-06	CT#96	CP-221213	4392	1	F	Clarification of UE configuration parameter updates	17.7.0
2022-06	CT#96	CP-221213	4393	1	F	Clarification of handlings of 5GMM cause #65 maximum number of PDU sessions reached for SNPN	17.7.0
2022-06	CT#96	CP-221213	4394	1	F	Storage of NSSAI	17.7.0
2022-06	CT#96	CP-221213	4395	1	D	Editorial corrections	17.7.0
2022-06	CT#96	CP-221213	4399	1	D	Editorial correction to operation codes	17.7.0
2022-06	CT#96	CP-221213	3497	6	F	NSSAI mapping during transfer of PDU session from HPLMN to VPLMN & VPLMN to HPLMN	17.7.0
2022-06	CT#96	CP-221214	4431	1	B	Support of provisioning ECS configuration info per ECSP	17.7.0
2022-06	CT#96	CP-221218	4163	1	F	Correction on MBS service area indication	17.7.0
2022-06	CT#96	CP-221218	4167	-	F	Correction to the Requested MBS container and the Received MBS container IEI values	17.7.0
2022-06	CT#96	CP-221218	4225	1	F	Updating the MBS service area of MBS multicast session using MBS Service Announcement	17.7.0
2022-06	CT#96	CP-221218	4226	1	F	Corrections related to MBS multicast sessions	17.7.0
2022-06	CT#96	CP-221218	4227	-	F	Delivering multiple MBS service areas to the UE for Location dependent MBS service	17.7.0
2022-06	CT#96	CP-221218	4228	1	F	Applicability of security protection for MBS session	17.7.0
2022-06	CT#96	CP-221218	4235	1	F	Deregistration procedure impacts for MBS session	17.7.0
2022-06	CT#96	CP-221218	4236	1	B	MBS backoff timer in PDU SESSION ESTABLISHMENT ACCEPT message	17.7.0
2022-06	CT#96	CP-221218	4270	1	F	Maximum number of associated MBS sessions	17.7.0
2022-06	CT#96	CP-221218	4396	1	F	Correction to MBS service area indication	17.7.0
2022-06	CT#96	CP-221218	4397	1	D	Minor editorial	17.7.0
2022-06	CT#96	CP-221218	4406	1	F	Removing the EN related to the maximum lengths of the Received MBS container IE	17.7.0
2022-06	CT#96	CP-221218	4407	1	F	Correcting the implementation of MBS containers IEs lengths in the spec	17.7.0
2022-06	CT#96	CP-221219	4141	1	F	MS determined PLMN with disaster condition and broadcasting disaster related indication	17.7.0
2022-06	CT#96	CP-221219	4149	1	F	Cause code for MINT	17.7.0

2022-06	CT#96	CP-221219				Resolution of Editor's note on handling of the indication of whether disaster roaming is enabled in the UE and the indication of 'applicability of lists of PLMN(s) to be used in disaster condition provided by a VPLMN'	17.7.0
			4170	3	F		
2022-06	CT#96	CP-221219	4209	1	F	Trigger of UE-initiated de-registration procedure	17.7.0
2022-06	CT#96	CP-221219	4223	1	F	Clarification on DREI.	17.7.0
2022-06	CT#96	CP-221219	4233	2	F	Clarify that S1 mode is not supported for MINT	17.7.0
2022-06	CT#96	CP-221219	4243	-	F	Correct on List of PLMNs to be used in disaster condition list IEI	17.7.0
2022-06	CT#96	CP-221219	4265	1	F	Editor's notes in subclause 5.4.4.1 and subclause 5.4.4.2	17.7.0
2022-06	CT#96	CP-221219	4349	2	F	Emergency PDU session while the timer for disaster roaming wait range is running	17.7.0
2022-06	CT#96	CP-221219	4361	-	F	Non-emergency PDU sessions are not transferable to EPS during disaster roaming	17.7.0
2022-06	CT#96	CP-221219	4384	1	F	Storage of List of PLMNs to be used in disaster condition to NVM	17.7.0
2022-06	CT#96	CP-221219	4411	-	F	Resolution of editors note for registration type	17.7.0
2022-06	CT#96	CP-221219	4413	1	F	Handling of EMM parameters on getting #80	17.7.0
2022-06	CT#96	CP-221223	4340	1	D	Correction on CAG information list format	17.7.0
2022-06	CT#96	CP-221223	4362	1	B	SDT support	17.7.0
2022-06	CT#96	CP-221223	4409	-	D	Aligning the terminologies of signalling messages	17.7.0
2022-06	CT#96	CP-221223	4410	1	F	Clarification for the encoding of MCC and MNC parameters in TS 24.501	17.7.0
2022-06	CT#96	CP-221224	3588	11	B	Multiple TACs from the lower layers	17.7.0
2022-06	CT#96	CP-221224	4148	-	C	Removal of the indication of the country of UE location	17.7.0
2022-06	CT#96	CP-221224	4152	3	C	Update the description on the lists of 5GS forbidden tracking areas	17.7.0
2022-06	CT#96	CP-221224	4165	1	B	Definition of last visited registered TAI for 5GSat	17.7.0
2022-06	CT#96	CP-221224	4194	-	F	Correction in the applicability of 5GMM cause value #78	17.7.0
2022-06	CT#96	CP-221224	4195	1	F	Correction on the note on GNSS fix time	17.7.0
2022-06	CT#96	CP-221224	4272	-	B	Addition of lower bound IEs for #78, alt 2	17.7.0
2022-06	CT#96	CP-221224	4305	-	F	Correction in the AMF operation to determine forbidden TAIs	17.7.0
2022-06	CT#96	CP-221224	4306	1	F	Forbidden TAIs delivered to a UE during a successful MRU and SR procedures	17.7.0
2022-06	CT#96	CP-221224	4372	1	F	Clarification on emergency service initiation via the PLMN which is not allowed to operate at the present UE location	17.7.0
2022-06	CT#96	CP-221224	4401	1	F	Handling of EMM parameters on getting #78	17.7.0
2022-06	CT#96	CP-221224	4404	-	F	Handling of PDU session release request not forwarded due to #78	17.7.0
2022-06	CT#96	CP-221224	3976	7	C	Forbidden TAI handling in case of multiple TACs	17.7.0
2022-06	CT#96	CP-221227	4433	1	B	Support of MC slicing configuration as part of UE local configuration	17.7.0
2022-06	CT#96	CP-221241	4231	-	F	The remote UE report procedure is initiated by a 5G ProSe layer-3 UE-to-network relay UE	17.7.0
2022-06	CT#96	CP-221242	4221	1	F	UE-requested PDU session establishment procedure based on ProSeP	17.7.0
2022-06	CT#96	CP-221245	4150	1	C	Considering eDRX parameter in the USIM	17.7.0
2022-06	CT#96	CP-221249	4135	1	B	UE required to not accept URSP signalled by non-subscribed SNPNs	17.7.0
2022-06	CT#96	CP-221249	4137	1	F	Editor's note in subclause 5.5.1.3.4	17.7.0
2022-06	CT#96	CP-221249	4138	-	F	Access identities when UE accesses SNPN using PLMN subscription	17.7.0
2022-06	CT#96	CP-221249	4171	1	F	Signalling UE support for SOR-SNPN-SI in SOR ACK	17.7.0
2022-06	CT#96	CP-221249	4186	1	F	Support of mapped S-NSSAI in SNPN	17.7.0
2022-06	CT#96	CP-221249	4196	-	F	ON-SNPN: Correction in the operation of a UE entering the 5GMM-DEREGISTERED.PLMN-SEARCH state	17.7.0
2022-06	CT#96	CP-221249	4202	-1	F	NSSAA performed for a UE operating in SNPN access operation mode	17.7.0
2022-06	CT#96	CP-221249	4203	2	F	Clarification of ProSe support in NPN	17.7.0
2022-06	CT#96	CP-221249	4208	1	F	URSP rules for SNPN	17.7.0
2022-06	CT#96	CP-221249	4213	-	F	Correction of definition given in TS 23.501 about GIN	17.7.0
2022-06	CT#96	CP-221256	4145	1	F	UCU for MPS	17.7.0
2022-06	CT#96	CP-221257	3927	4	B	Access category assignment for an access attempt occurred due to call pull	17.7.0
2022-06	CT#96	CP-221258	4218	1	F	Clarification on lists of 5GS forbidden tracking areas over non-3GPP access	17.7.0
2022-06	CT#96					Some IEI values assigned by the rapporteur of the TS	17.7.1
2022-09	CT#97e	CP-222137	4442	1	F	Correction for default UE credentials	17.8.0
2022-09	CT#97e	CP-222137	4444	-	F	PVS addresses for NSSAA not associated with DNN	17.8.0
2022-09	CT#97e	CP-222137	4445	1	F	Precedence between PVS addresses or PVS names	17.8.0
2022-09	CT#97e	CP-222137	4446	1	F	Alignment with SA3 on 5G AKA and EAP-AKA' based primary authentication and key agreement procedure used for onboarding services in SNPN	17.8.0
2022-09	CT#97e	CP-222137	4548	1	F	Put the NOTE about network slice used for onboarding under corresponding bullet	17.8.0

2022-09	CT#97e	CP-222137	4549	1	F	PVS information in SMF	17.8.0
2022-09	CT#97e	CP-222137	4557	-	F	HPLMN S-NSSAI in case of SNPN	17.8.0
2022-09	CT#97e	CP-222137	4620	1	F	Resolving EN on KSEAF derivation indicator in USIM	17.8.0
2022-09	CT#97e	CP-222137	4636	1	F	Storage and access of 5GMM parameters mapping with SUPI from USIM for AKA based SNPN	17.8.0
2022-09	CT#97e	CP-222139	4538	1	F	The RAN paging handling for MUSIM UE in 5GS	17.8.0
2022-09	CT#97e	CP-222139	4613	-	F	Harmonization for the paging restriction terminology for MUSIM UE	17.8.0
2022-09	CT#97e	CP-222139	4619	1	F	Rejection of paging correction	17.8.0
2022-09	CT#97e	CP-222140	4495	1	F	Additional parameter with generic UE configuration update procedure	17.8.0
2022-09	CT#97e	CP-222140	4499	1	F	NSSRG and allowed NSSAI for the other access	17.8.0
2022-09	CT#97e	CP-222140	4525	1	F	Provide new NSSRG information to UE	17.8.0
2022-09	CT#97e	CP-222140	4566	2	F	Associate NSSRG values with HPLMN S-NSSAI	17.8.0
2022-09	CT#97e	CP-222140	4596	1	F	Correction on the rejected NSSAI due to maximum number of UEs reached	17.8.0
2022-09	CT#97e	CP-222143	4591	-	F	Service-level-AA timer name correction	17.8.0
2022-09	CT#97e	CP-222143	4598	1	F	Correction on Service-level-AA container IEI	17.8.0
2022-09	CT#97e	CP-222144	4456	-	F	Add ProSeP request in UAC	17.8.0
2022-09	CT#97e	CP-222144	4458	-	F	Use the term 5G ProSe	17.8.0
2022-09	CT#97e	CP-222145	4448	1	F	Remote UE IP info of REMOTE UE REPORT for IPv4	17.8.0
2022-09	CT#97e	CP-222145	4455	1	F	UAC not applied to L2 relay	17.8.0
2022-09	CT#97e	CP-222145	4457	1	C	Remove secondary authentication for U2N relay	17.8.0
2022-09	CT#97e	CP-222145	4487	1	F	Clarification on the expiry of T3586 timer	17.8.0
2022-09	CT#97e	CP-222145	4514	1	F	Correction to timer T35xx	17.8.0
2022-09	CT#97e	CP-222146	4553	1	F	Providing HPLMN ID together with PRUK ID in 64-bit string format	17.8.0
2022-09	CT#97e	CP-222146	4614	1	F	Resolving the ENs related to the UE Identities used in the Remote UE report procedure	17.8.0
2022-09	CT#97e	CP-222146	4615	1	F	Some corrections related to the Relay Key Request procedure	17.8.0
2022-09	CT#97e	CP-222146	4616	1	B	Introducing the 5GPRUK ID in the Relay key Request procedure	17.8.0
2022-09	CT#97e	CP-222146	4617	1	F	ProSe relay transaction identity as a type 3 IE	17.8.0
2022-09	CT#97e	CP-222146	4639	2	F	Setting RRC establishment cause value when relay UE has its own service	17.8.0
2022-09	CT#97e	CP-222147	4501	1	C	New 5QI values to support Advance Interactive Services (AIS) in 5G	17.8.0
2022-09	CT#97e	CP-222147	4542	1	F	Correction on serving PLMN rate control	17.8.0
2022-09	CT#97e	CP-222148	4482	2	F	Correction to ECS Address Provisioning	17.8.0
2022-09	CT#97e	CP-222148	4492	-	F	Clarification on indicating the EDC support to network	17.8.0
2022-09	CT#97e	CP-222151	4491	1	F	Handling of the MBS multicast session on local release of PDU session	17.8.0
2022-09	CT#97e	CP-222151	4568	1	F	Providing TMGI to lower layer for paging	17.8.0
2022-09	CT#97e	CP-222151	4582	1	F	MBS session maintenance when releasing user-plane resources of a MA PDU session	17.8.0
2022-09	CT#97e	CP-222151	4583	1	F	MBS back-off timer for IP address	17.8.0
2022-09	CT#97e	CP-222151	4584	1	F	Clarification on the determination of outside the MBS service area	17.8.0
2022-09	CT#97e	CP-222151	4585	1	F	PDU session status IE handling for MBS session	17.8.0
2022-09	CT#97e	CP-222151	4586	-	F	MBS session maintenance after handover	17.8.0
2022-09	CT#97e	CP-222151	4587	1	F	Request to join MBS session during establishment procedure	17.8.0
2022-09	CT#97e	CP-222151	4607	-	F	Delivering list of keys in MBS Security container	17.8.0
2022-09	CT#97e	CP-222151	4609	-	F	Correction for the condition of including the Security container in the Received MBS container IE	17.8.0
2022-09	CT#97e	CP-222151	4610	1	F	MBS Security keys update to the UE	17.8.0
2022-09	CT#97e	CP-222151	4621	1	F	Correction to timers of multicast/broadcast services	17.8.0
2022-09	CT#97e	CP-222152	4440	-	F	Errors in PLMN ID IE	17.8.0
2022-09	CT#97e	CP-222155	4641	-	F	Addition of the length value of the Negotiated eDRX parameters IE	17.8.0
2022-09	CT#97e	CP-222156	4534	1	F	Add satellite E-UTRAN as an UE supported access technology	17.8.0
2022-09	CT#97e	CP-222158	4450	1	F	Clarification that the NSAG information can not be sent with a request to perform the registration procedure	17.8.0
2022-09	CT#97e	CP-222158	4452	1	F	Clarification that the NSAG information is sent over 3GPP access only	17.8.0
2022-09	CT#97e	CP-222158	4471	1	F	Indicating the deletion or invalidation of the NSAG information to lower layers	17.8.0
2022-09	CT#97e	CP-222158	4483	1	F	Support NSAG for SNPN	17.8.0
2022-09	CT#97e	CP-222158	4484	1	F	NSAG priority	17.8.0
2022-09	CT#97e	CP-222158	4560	1	F	IEI assignment for the NSAG information IE	17.8.0
2022-09	CT#97e	CP-222159	4469	1	F	The consideration of avoiding unnecessary TAI change	17.8.0
2022-09	CT#97e	CP-222159	4475	1	F	Extended NAS timers based on satellite NG-RAN RAT type	17.8.0
2022-09	CT#97e	CP-222159	4476	1	F	Alignment of terminology in current TAI definition	17.8.0
2022-09	CT#97e	CP-222159	4533	-	F	Suggest simplifying the selection for the current TAI	17.8.0
2022-09	CT#97e	CP-222159	4535	1	F	Update of conditions for deleting entries in # 78 list	17.8.0

2022-09	CT#97e	CP-222159	4556	1	F	Current TAI	17.8.0
2022-09	CT#97e	CP-222159	4624	2	F	Clarification on handling related to #78	17.8.0
2022-09	CT#97e	CP-222159	4625	2	F	Clarification on timer instance associated with the entry	17.8.0
2022-09	CT#97e	CP-222163	4498	1	F	MPS exemption in Attempting to reRegister	17.8.0
2022-09	CT#97e	CP-222163	4518	1	F	MPS exemption in Attempting to Register	17.8.0
2022-09	CT#97e	CP-222168	4526	1	F	Condition of returning REGISTRATION COMPLETE by UE	17.8.0
2022-09	CT#97e	CP-222147	4447	1	F	Correcting minor issues in TS 24.501	18.0.0
2022-09	CT#97e	CP-222167	4460	1	F	Check the match-all packet filter in QoS rule	18.0.0
2022-09	CT#97e	CP-222167				Missing EPS-UIPI bit in the S1 UE network capability IE of the mobility and periodic REGISTRATION REQUEST	18.0.0
2022-09	CT#97e	CP-222167	4461	1	F		
2022-09	CT#97e	CP-222167	4462	1	F	QoS error checks for unstructured PDU session type in PCO	18.0.0
2022-09	CT#97e	CP-222167				Add back off timer handling for rejected nssai for max UE reached for MT Deregistration procedure with cause #62.	18.0.0
2022-09	CT#97e	CP-222167	4463	1	F		
2022-09	CT#97e	CP-222167	4478	-	F	Clarification of UE paging probability information value	18.0.0
2022-09	CT#97e	CP-222167	4481	-	F	Clarification of IWK N26 bit when received in non-3GPP access	18.0.0
2022-09	CT#97e	CP-222167	4489	-	F	Correction to QoS rule error checking operation.	18.0.0
2022-09	CT#97e	CP-222167	4497	1	F	Service gap control correction	18.0.0
2022-09	CT#97e	CP-222167	4510	1	F	Correcting a NOTE	18.0.0
2022-09	CT#97e	CP-222167				Clarification of interworking between N1 mode over non-3GPP access and ePDG	18.0.0
2022-09	CT#97e	CP-222167	4551	1	F		
2022-09	CT#97e	CP-222167	4552	1	F	T3540 handling upon receipt of 5GMM common procedure	18.0.0
2022-09	CT#97e	CP-222167				ODAC decision for a UE is in state 5GMM-REGISTERED.ATTEMPTING-REGISTRATION-UPDATE	18.0.0
2022-09	CT#97e	CP-222167	4554	-	F		
2022-09	CT#97e	CP-222167	4571	-	F	Registration attempt counter reset for successful TAU	18.0.0
2022-09	CT#97e	CP-222167	4572	-	F	Correction to 5GMM-Deregistration attempting registration state	18.0.0
2022-09	CT#97e	CP-222167	4589	1	F	Clarification when authentication fails	18.0.0
2022-09	CT#97e	CP-222167	4605	-	F	Handling the DRX parameter on the AMF side	18.0.0
2022-09	CT#97e	CP-222167	4611	-	F	Adding missing abbreviation and other corrections	18.0.0
2022-09	CT#97e	CP-222167	4626	1	F	At least one default subscribed S-NSSAI in user subscription	18.0.0
2022-09	CT#97e	CP-222167	4628	1	F	Handling when FPLMN is declared allowable PLMN by network	18.0.0
2022-09	CT#97e	CP-222167				Abnormal cases in Registration procedure for handling WUS assistance information	18.0.0
2022-09	CT#97e	CP-222167	4523	1	F		
2022-09	CT#97e	CP-222167				Deleting WUS assistance information on Registration procedure failure	18.0.0
2022-09	CT#97e	CP-222167	4524	1	F		
2022-09	CT#97e	CP-222168	4451	1	D	Editorial corrections to TS 24.501	18.0.0
2022-09	CT#97e	CP-222168				Precluding inclusion of both a destination (resp. source) MAC address type and a destination (resp. source) MAC address range type packet filter components in a packet filter	18.0.0
2022-09	CT#97e	CP-222168	4468	1	F		
2022-09	CT#97e	CP-222168	4473	2	F	Correction to the 5GMM capability IE	18.0.0
2022-09	CT#97e	CP-222168	4479	1	F	Clarification of 5GS registration result value handling	18.0.0
2022-09	CT#97e	CP-222168	4480	1	F	MPS and MCS indicators for 3GPP and non-3GPP accesses	18.0.0
2022-09	CT#97e	CP-222168				5GSM coordination: UE behaviour in case of missing EPS bearer parameters	18.0.0
2022-09	CT#97e	CP-222168	4500	2	F		
2022-09	CT#97e	CP-222168	4527	1	F	Storage of NSSAI for EPLMNs in updated registration area	18.0.0
2022-09	CT#97e	CP-222168				Handling of re-NSSAA or network slice-specific authorization revocation result	18.0.0
2022-09	CT#97e	CP-222168	4528	1	F		
2022-09	CT#97e	CP-222168	4529	1	F	Alignment of term re-NSSAA	18.0.0
2022-09	CT#97e	CP-222168				UE behavior after receiving registration requested in CUC message	18.0.0
2022-09	CT#97e	CP-222168	4531	1	F		
2022-09	CT#97e	CP-222168	4532	1	D	Editorial corrections	18.0.0
2022-09	CT#97e	CP-222168				No NSSAI provided to lower layer for SERVICE REQUEST message	18.0.0
2022-09	CT#97e	CP-222168	4564	3	F		
2022-09	CT#97e	CP-222168				Corrections related to cause value #78 PLMN not allowed to operate at the present UE location	18.0.0
2022-09	CT#97e	CP-222168	4574	1	F		
2022-09	CT#97e	CP-222168	4580	1	F	Access handling when stopping T3585	18.0.0
2022-09	CT#97e	CP-222168				Correction on UE handling on syntactical errors in QoS operations	18.0.0
2022-09	CT#97e	CP-222168	4593	1	F		
2022-09	CT#97e	CP-222168	4594	1	F	Covering a missing semantic errors in QoS operations	18.0.0
2022-09	CT#97e	CP-222168	4595	1	F	UE handling on local emergency numbers	18.0.0
2022-09	CT#97e	CP-222168				Correction on disabling the N1 mode capability when all S-NSSAI was rejected	18.0.0
2022-09	CT#97e	CP-222168	4604	1	F		
2022-09	CT#97e	CP-222168				Corrections for UE behaviour upon receiving CONFIGURATION UPDATE COMMAND message that indicates registration requested	18.0.0
2022-09	CT#97e	CP-222168	4612	1	F		
2022-09	CT#97e	CP-222168	4519	1	F	Registering slices removed from rejected NSSAI list	18.0.0
2022-09	CT#97e	CP-222168	4520	2	F	Including S-NSSAIs received in S1 mode in configured NSSAI	18.0.0
2022-09	CT#97e	CP-222168				Editorial correction done by MCC	18.0.1
2022-12	CT#98e	CP-223158				Abnormal cases for the SMC initiated for context synchronization between 3GPP access and non-3GPP access	18.1.0
2022-12	CT#98e	CP-223158	4304	2	F		
2022-12	CT#98e	CP-223158				Cause #62 handling in case of "S-NSSAI not available in the current registration area"	18.1.0
2022-12	CT#98e	CP-223158	4502	4	F		
2022-12	CT#98e	CP-223158	4506	3	F	Using UE local configuration for default DNN and S-NSSAI	18.1.0
2022-12	CT#98e	CP-223158	4579	2	F	Clarification on the SD value in Rejected NSSAI	18.1.0

2022-12	CT#98e	CP-223122	4642	2	A	Editor's note in 6.4.1.2	18.1.0
2022-12	CT#98e	CP-223122	4643	2	A	Editor's note in subclause 5.3.2	18.1.0
2022-12	CT#98e	CP-223158	4644	3	D	Re-use of S-NSSAI after removal of S-NSSAI from rejected NSSAI.	18.1.0
2022-12	CT#98e	CP-223136	4652	1	A	Correction to the NSAG priority field reference	18.1.0
2022-12	CT#98e	CP-223116	4654	1	A	Correction to PDU session types	18.1.0
2022-12	CT#98e	CP-223158	4656	1	F	Added further clarification in handling of T3502, T3346 in SNPN.	18.1.0
2022-12	CT#98e	CP-223116	4658	2	A	Correction to the CONFIGURATION UPDATE COMMAND message	18.1.0
2022-12	CT#98e	CP-223158	4660	1	F	Clarification on packet filter in signalled QoS rule	18.1.0
2022-12	CT#98e	CP-223158	4661		F	Correction to the PDU session modification for LADN	18.1.0
2022-12	CT#98e	CP-223158	4662		F	Correction to QoS rules IE	18.1.0
2022-12	CT#98e	CP-223158	4663	1	F	Correction to default NSSAI inclusion mode	18.1.0
2022-12	CT#98e	CP-223127	4664	2	F	Error handling to PTI	18.1.0
2022-12	CT#98e	CP-223136	4666		A	Correction to NSAG default area	18.1.0
2022-12	CT#98e	CP-223158	4669	1	F	Abnormal case handling	18.1.0
2022-12	CT#98e	CP-223133	4671	1	A	Correction to name of List of PLMNs offering disaster roaming services	18.1.0
2022-12	CT#98e	CP-223158	4672	1	F	Max limit for NSSRG values per S-NSSAI	18.1.0
2022-12	CT#98e	CP-223144	4673	1	D	Editorial Corrections	18.1.0
2022-12	CT#98e	CP-223136	4679	1	A	Maximum and minimum length of NSAG information IE	18.1.0
2022-12	CT#98e	CP-223136	4681	1	A	Maximum number of TAI list restriction for NSAG	18.1.0
2022-12	CT#98e	CP-223136	4683	1	A	NSAG priority handling at the AMF	18.1.0
2022-12	CT#98e	CP-223136	4685	1	A	Correction on NSAG information handling	18.1.0
2022-12	CT#98e	CP-223158	4686		F	Correction on identical QFIs semantic errors in QoS operations	18.1.0
2022-12	CT#98e	CP-223158	4687		F	Correction on identical QRIs semantic errors in QoS operations	18.1.0
2022-12	CT#98e	CP-223158	4688	1	F	Exemption of 5GS update status removal for causes #3, #6 and #7	18.1.0
2022-12	CT#98e	CP-223158	4689		F	Mapped dedicated EPS bearer without default EPS bearer in the establishment procedure	18.1.0
2022-12	CT#98e	CP-223158	4692		F	Update the description on the subscribed SNPN	18.1.0
2022-12	CT#98e	CP-223158	4694		D	Remove duplicated context	18.1.0
2022-12	CT#98e	CP-223158	4695		F	Correct the message for joining multicast session	18.1.0
2022-12	CT#98e	CP-223158	4696	1	F	Correction on semantic error about UL PF of TFT	18.1.0
2022-12	CT#98e	CP-223136	4702	5	A	NAS operation for network slice-based random access	18.1.0
2022-12	CT#98e	CP-223148	4704	1	A	Corrections on UE-initiated authentication and key agreement procedure	18.1.0
2022-12	CT#98e	CP-223121	4706	1	A	Registration update triggered by NSSRG update in UCU procedure	18.1.0
2022-12	CT#98e	CP-223158	4708	1	F	NSSRG restriction applicability for the other access type	18.1.0
2022-12	CT#98e	CP-223121	4710	2	F	UE behaviour when receiving cause #62 with rejected NSSAI for maximum number of UEs reached	18.1.0
2022-12	CT#98e	CP-223136	4712	1	A	NSAG information provision over 3GPP access only	18.1.0
2022-12	CT#98e	CP-223101	4713	2	F	Clarification on equivalent PLMN applicability	18.1.0
2022-12	CT#98e	CP-223158	4714		Fa	Clarification on condition of sending 5GMM cause #62	18.1.0
2022-12	CT#98e	CP-223158	4715	1	F	Condition of including equivalent PLMNs in Registration Accept message	18.1.0
2022-12	CT#98e	CP-223160	4717	1	F	EAP-TTLS used between the UE and the DCS	18.1.0
2022-12	CT#98e	CP-223148	4719	1	A	Initiation of authentication and key agreement procedure for 5G ProSe U2N relay UE in NORMAL-SERVICE state	18.1.0
2022-12	CT#98e	CP-223127	4721		A	Correction on USS FQDN	18.1.0
2022-12	CT#98e	CP-223127	4723	1	A	Clarification on authorization of UAV flight	18.1.0
2022-12	CT#98e	CP-223158	4724	3	F	Correction for IoT data not forwarded from a CPSR message	18.1.0
2022-12	CT#98e	CP-223159	4726	1	F	Clarification on initiating registration procedure when timer T3512 expires	18.1.0
2022-12	CT#98e	CP-223116	4728		A	Correction on single-registration subclause	18.1.0
2022-12	CT#98e	CP-223159	4729	1	F	Alignment for the emergency registered bit of the 5GS registration result IE	18.1.0
2022-12	CT#98e	CP-223159	4730		F	Alignment of the abbreviation NITZ	18.1.0
2022-12	CT#98e	CP-223159	4731		F	Clarification on UE supporting S1 mode	18.1.0
2022-12	CT#98e	CP-223117	4734	1	A	Alignment of terminology on multicast MBS session	18.1.0
2022-12	CT#98e	CP-223117	4736		A	Correction on handling of the MBS multicast session	18.1.0
2022-12	CT#98e	CP-223117	4738		A	Handling of the MBS multicast sessions when the PDU session is locally released	18.1.0
2022-12	CT#98e	CP-223159	4739		F	Correction on S1 UE network capability IE	18.1.0
2022-12	CT#98e	CP-223144	4740	1	F	Correction on WUS handling in 5GS	18.1.0
2022-12	CT#98e	CP-223159	4741	2	F	MUSIM features considered not used when the UE's normal registration changes to registered for emergency services	18.1.0
2022-12	CT#98e	CP-223148	4744	1	A	Rename 5GPRUK ID and 5GPRUK in CP based solution and rename PRUK and PRUK ID in UP based solution	18.1.0
2022-12	CT#98e	CP-223159	4747	1	F	NSSAA and SR procedure collision handling	18.1.0
2022-12	CT#98e	CP-223159	4749		F	Providing NSSRG information to the lower layers	18.1.0

2022-12	CT#98e	CP-223127	4751	1	A	Correction on unused value of payload type	18.1.0
2022-12	CT#98e	CP-223116	4757	3	A	Mapped S-NSSAI when UE is roaming	18.1.0
2022-12	CT#98e	CP-223116	4759	2	A	Addition of UE requested T3512 value at MICO	18.1.0
2022-12	CT#98e	CP-223159	4760	1	F	Treating an MRU as an initial registration when UE identity cannot be derived	18.1.0
2022-12	CT#98e	CP-223159	4761		F	Clarification on the S-NSSAIs included in the rejected NSSAI of the REGISTRATION REJECT message	18.1.0
2022-12	CT#98e	CP-223159	4765	1	B	Access Category and establishment cause for the MT call and the MT SMSolP	18.1.0
2022-12	CT#98e	CP-223117	4766	1	A	MBS address information type in the received MBS information	18.1.0
2022-12	CT#98e	CP-223148	4776	2	A	Including TCP/UDP port ranges in REMOTE UE REPORT	18.1.0
2022-12	CT#98e	CP-223135	4778	2	F	MUSIM UE and PEI	18.1.0
2022-12	CT#98e	CP-223135	4779	1	F	MUSIM and notification message over non-3GPP access	18.1.0
2022-12	CT#98e	CP-223159	4783		F	Addition of missing maximum size for Default configured NSSAI	18.1.0
2022-12	CT#98e	CP-223148	4788	1	A	Mandatory inclusion of 5GPRUK ID in the RELAY KEY ACCEPT message	18.1.0
2022-12	CT#98e	CP-223148	4790	1	A	Correcting the reference for the PRTI	18.1.0
2022-12	CT#98e	CP-223144	4791		F	Adding ANDSP to abbreviations	18.1.0
2022-12	CT#98e	CP-223159	4796	1	F	CAG restrictions is not applied to emergency services fallback	18.1.0
2022-12	CT#98e	CP-223159	4798	1	F	Correction on UE behavior about rejected NSSAI	18.1.0
2022-12	CT#98e	CP-223135	4804	1	A	Paging rejection in RRC inactive	18.1.0
2022-12	CT#98e	CP-223159	4806	1	F	Correction on Emergency PDU Sessions	18.1.0
2022-12	CT#98e	CP-223121	4807	1	A	Remove redundant content about NSSRG information R18	18.1.0
2022-12	CT#98e	CP-223117	4810	1	A	Indicate to lower layer to delete stored TMGI R18	18.1.0
2022-12	CT#98e	CP-223122	4813	2	A	Clarification on providing SOR-CMCI in SNPN access operation mode R18	18.1.0
2022-12	CT#98e	CP-223159	4816		F	UE DS-TT Residence time	18.1.0
2022-12	CT#98e	CP-223144	4827		F	5GC MPS exemption for non-congestion back-off	18.1.0
2022-12	CT#98e	CP-223116	4829	1	A	Correction of implementation error of CR4124	18.1.0
2022-12	CT#98e	CP-223148	4831	1	A	Correction of implementation error of CR4615	18.1.0
2022-12	CT#98e	CP-223133	4833		A	Allowed access attempts while timer precluding registration is running in 24.501	18.1.0
2022-12	CT#98e	CP-223120	4834	2	B	Providing Equivalent SNPNS	18.1.0
2022-12	CT#98e	CP-223120	4835	2	B	Providing registered SNPNS	18.1.0
2022-12	CT#98e	CP-223120	4836		B	Equivalent SNPNS usage for mobility	18.1.0
2022-12	CT#98e	CP-223120	4837		B	Equivalent SNPNS usage for NSAG information storage	18.1.0
2022-12	CT#98e	CP-223120	4838		B	Equivalent SNPNS usage for congestion control	18.1.0
2022-12	CT#98e	CP-223120	4839	2	B	Equivalent SNPNS usage in 5GMM-CONNECTED mode with RRC inactive indication	18.1.0
2022-12	CT#98e	CP-223120	4840	2	B	Equivalent SNPN usage for mobile identity selection	18.1.0
2022-12	CT#98e	CP-223120	4841	1	B	Equivalent SNPN usage in UAC	18.1.0
2022-12	CT#98e	CP-223100	4842	2	F	Issues in slicing and SNPN	18.1.0
2022-12	CT#98e	CP-223116	4844	1	A	Lost scope of AMF requirements for allowed NSSAI in NB-N1 mode	18.1.0
2022-12	CT#98e	CP-223115	4848	1	F	Handling of current TAI in case of reception of Forbidden TAI IEs	18.1.0
2022-12	CT#98e	CP-223159	4849		F	Removal of duplicated info in CiOT small data container	18.1.0
2022-12	CT#98e	CP-223159	4850	1	F	Corrections and clarifications for the case when T3502 is "Zero"	18.1.0
2022-12	CT#98e	CP-223159	4852	3	F	Add the invalid RA case to multiple TACs handling	18.1.0
2022-12	CT#98e	CP-223115	4854	3	A	AMF behaviour on Forbidden TAIs list IEs	18.1.0
2022-12	CT#98e	CP-223115	4856	1	A	UE behaviour on Forbidden TAIs list IEs	18.1.0
2022-12	CT#98e	CP-223159	4859		F	Terminology alignment on SNPN-enabled UE	18.1.0
2022-12	CT#98e	CP-223159	4860	2	F	Alignment on procedure name	18.1.0
2022-12	CT#98e	CP-223159	4861		F	Correction on session-AMBR handling	18.1.0
2022-12	CT#98e	CP-223159	4862	1	F	Clarification on SNPN access operation mode	18.1.0
2022-12	CT#98e	CP-223116	4864	1	A	Registration procedure triggered by a change of UE Requested T3512	18.1.0
2022-12	CT#98e	CP-223159	4865	3	F	The handling on high priority access in SNPN	18.1.0
2022-12	CT#98e	CP-223160	4866	1	F	Correction on the length of IE	18.1.0
2022-12	CT#98e	CP-223160	4868		F	Correction to the emergency service	18.1.0
2022-12	CT#98e	CP-223160	4870	1	F	QoS flow description correction	18.1.0
2022-12	CT#98e	CP-223116	4872	1	A	Correction on conditions for using SPI for UE derived QoS rules	18.1.0
2022-12	CT#98e	CP-223160	4874	1	F	Correction of terminology related to the rejected NSSAI due to maximum number of UEs reached	18.1.0
2022-12	CT#98e	CP-223142	4875	2	B	Support for Unavailability Period	18.1.0
2022-12	CT#98e	CP-223160	4876	1	F	Correction to other syntactical errors in TFT	18.1.0
2022-12	CT#98e	CP-223118	4877	2	B	N3IWF with slice capability	18.1.0
2022-12	CT#98e	CP-223160	4878		F	Missing registration updates for emergency service fallback in 5GMM-REGISTERED.ATTEMPTING-REGISTRATION-UPDATE.	18.1.0
2022-12	CT#98e	CP-223160	4879		F	UE handling on PCO or EPCO syntactical errors in QoS operations	18.1.0
2022-12	CT#98e	CP-223136	4882	1	A	Maximum length of NSAG information IE	18.1.0
2022-12	CT#98e	CP-223136	4884	2	A	TAI lists restriction for NSAG information	18.1.0

2022-12	CT#98e	CP-223127	4886		A	Procedure type for service-level authentication and authorization procedure	18.1.0
2022-12	CT#98e	CP-223115	4887	1	F	Forbidden TAI lists update via satellite access	18.1.0
2022-12	CT#98e	CP-223143	4889	1	A	Modify network handling of PDU sessions for emergency request in abnormal case	18.1.0
2022-12	CT#98e	CP-223160	4890		F	Correction to references	18.1.0
2022-12	CT#98e	CP-223156	4891	1	F	Multiple DHCP requests with different IA_NA options by RG	18.1.0
2022-12	CT#98e	CP-223160	4894	1	F	Correction to MA PDU session status when user plane resources are establishing	18.1.0
2022-12	CT#98e	CP-223160	4895		F	Mapped S-NSSAI for rejected NSSAI for the maximum number of UEs reached	18.1.0
2022-12	CT#98e	CP-223160	4896		F	Consistency on rejection cause "S-NSSAI not available due to maximum number of UEs reached"	18.1.0
2022-12	CT#98e	CP-223160	4899	1	F	Deleting NSSRG Information	18.1.0
2022-12	CT#98e	CP-223127	4905	2	A	Clarification on payload and payload type for UUA and C2 authorization	18.1.0
2022-12	CT#98e	CP-223160	4908		F	Clarification of UE behaviour when the UE receives the "Network slicing subscription changed".	18.1.0
2022-12	CT#98e	CP-223121	4910	3	A	Handling of pending NSSAI in NSSRG procedure Rel18 - option 1	18.1.0
2022-12	CT#98e	CP-223160	4914	1	F	Octets 7 to 10 in the S-NSSAI IE	18.1.0
2022-12	CT#98e	CP-223115	4920	3	A	Correction in the forbidden TAI lists in NAS messages over satellite access	18.1.0
2022-12	CT#98e	CP-223160	4923		F	S-NSSAI added to configured NSSAI only if there is less than 16 entries	18.1.0
2022-12	CT#98e	CP-223160	4929	1	F	Remove S-NSSAI from NSAG if S-NNSAI is not in configured NSSAI (Rel-18)	18.1.0
2022-12	CT#98e	CP-223160	4933		F	Considering the access type in the de-registration type IE when handling the 5GMM cause	18.1.0
2022-12	CT#98e	CP-223160	4934		F	Clarification on derived QoS Rules for an IPv6 UDP encapsulated ESP packet	18.1.0
2022-12	CT#98e	CP-223120	4936		B	WLANS provisioning in SNPN	18.1.0
2022-12	CT#98e	CP-223160	4937	1	F	No specific DRX parameter negotiation in periodic registration procedure	18.1.0
2022-12	CT#98e	CP-223160	4938	1	F	Correction on format of Extended rejected NSSAI	18.1.0
2022-12	CT#98e	CP-223160	4939		F	Semantic error in QoS operations about unstructure PDU session type	18.1.0
2022-12	CT#98e	CP-223160	4940		F	Perform eCall inactivity procedure in RRC inactive state	18.1.0
2022-12	CT#98e	CP-223117	4943	2	A	Multicast MBS session join or leave for local multicast service	18.1.0
2022-12	CT#98e	CP-223160	4945	1	F	Cause 80 handling	18.1.0
2022-12	CT#98e	CP-223115	4946	1	F	Correction to #78 timer handling	18.1.0
2022-12	CT#98e	CP-223121	4951	1	A	Maximum length of NSSRG information IE	18.1.0
2022-12	CT#98e	CP-223118	4961	1	B	UE to indicate its support for Slice-based N3IWF selection to the network	18.1.0
2022-12	CT#98e	CP-223118	4963	1	B	Rejecting the UE Registration due to the selected N3IWF by the UE is not compatible with the used slices	18.1.0
2022-12	CT#98e	CP-223145	4964	1	B	Indicating the capability of supporting SDNAEPC during the PDU session establishment procedure	18.1.0
2022-12	CT#98e	CP-223144	4965	1	F	Adding missing Abbreviations and other miscellaneous corrections in TS 24.501	18.1.0
2022-12	CT#98e	CP-223160	4968	1	F	UE behavior when an always-on PDU session is subject to ODAC	18.1.0
2022-12	CT#98e	CP-223115	4971		A	Correction of IEI values	18.1.0
2022-12	CT#98e	CP-223279	4973	3	A	Notification of change of aerial service availability to the UE	18.1.0
2023-03	CT#99	CP-230265	4977	-	B	Enhanced CAG selection - enforcement in successful cases	18.2.0
2023-03	CT#99	CP-230265	4978	-	B	Enhanced CAG selection - enforcement in unsuccessful cases	18.2.0
2023-03	CT#99	CP-230220	4995	-	D	Editorial corrections	18.2.0
2023-03	CT#99	CP-230260	5011	-	B	General updates for LADN per DNN & S-NSSAI	18.2.0
2023-03	CT#99	CP-230217	5021	-	F	Correction to the coding of N3IWF address IE	18.2.0
2023-03	CT#99	CP-230252	5024	-	B	IPv6 prefix delegation in 5GS	18.2.0
2023-03	CT#99	CP-230231	5025	-	B	Equivalent SNPNs: 5GS forbidden tracking areas in TS 24.501	18.2.0
2023-03	CT#99	CP-230219	5027	-	B	Equivalent SNPNs: NSSAIs, network-assigned UE radio capability ID, maximum number of established PDU sessions and 5GMM parameters in annex C stored per selected entry	18.2.0
2023-03	CT#99	CP-230219	5028	-	B	Equivalent SNPNs: entry of list of subscriber data becoming invalid	18.2.0
2023-03	CT#99	CP-230214	5033	-	A	Fix encoding of 5QI 87	18.2.0
2023-03	CT#99	CP-230215	5041	-	F	Clarification on PDU session type in PDU session establishment request	18.2.0
2023-03	CT#99	CP-230215	5052	-	F	Corrections to TAI list handling in deregistration and FTAI storing	18.2.0
2023-03	CT#99	CP-230224	5055	-	A	Correction of implementation error of CR4615	18.2.0

2023-03	CT#99	CP-230250	5074	-	F	Clarification on determination of T3512 value based on unavailability period duration	18.2.0
2023-03	CT#99	CP-230285	5075	-	F	NSAC applicability in SNPN	18.2.0
2023-03	CT#99	CP-230285	5076	-	F	Correction on reference of S-NSSAI inclusion in ACTIVATE DEFAULT EPS BEARER CONTEXT REQUEST message	18.2.0
2023-03	CT#99	CP-230219	5082	-	F	Correction on the equivalent SNPNs	18.2.0
2023-03	CT#99	CP-230219	5085	-	F	Correction on the equivalent SNPNs usage for congestion control	18.2.0
2023-03	CT#99	CP-230214	5090	-	A	Correction of incomplete implementation of CR4380 (C1-224129)	18.2.0
2023-03	CT#99	CP-230250	5103	-	F	Abnormal case handling for registration procedure due to Unavailability period duration	18.2.0
2023-03	CT#99	CP-230217	5119	-	B	Aborting registration procedure when the selected N3IWF is not compatible with the allowed NSSAI	18.2.0
2023-03	CT#99	CP-230217	5120	-	F	Correction for N3IWF identifier IE	18.2.0
2023-03	CT#99	CP-230285	5152		F	Store the rejected NSSAI for failed or revoked NSSAI associated with EPLMN	18.2.0
2023-03	CT#99	CP-230285	5153		F	Handling pending paging message if access attempt for registration procedure is barred	18.2.0
2023-03	CT#99	CP-230278	4983	1	B	Equivalent SNPNs: error cases and abnormal cases	18.2.0
2023-03	CT#99	CP-230219	5026	1	B	Equivalent SNPNs: forbidden SNPNs in TS 24.501	18.2.0
2023-03	CT#99	CP-230232	5078	1	A	UE and AMF comply with NSSRG restriction across different access types over the same PLMN and different PLMNs	18.2.0
2023-03	CT#99	CP-230271	5125	1	A	Correction for SNN related to 5G NSWO	18.2.0
2023-03	CT#99	CP-230307	5073	1	A	Clarification on NSAG information validity when TAI list is absent	18.2.0
2023-03	CT#99	CP-230214	4993	1	A	5GMM IEI Duplicated in Registration Accept	18.2.0
2023-03	CT#99	CP-230312	5128	1	A	Impact on network and relay UE behaviour when CP-PRUK is not found	18.2.0
2023-03	CT#99	CP-230236	5037	1	F	Added DNN and S-NSSAI as indication for UUA-SM and C2 authorization	18.2.0
2023-03	CT#99	CP-230307	5164	2	A	Correction of misimplementation of CR 4883, 4665, and 4678 (Rel 18)	18.2.0
2023-03	CT#99	CP-230311	5112	4	F	Forbidden lists handling due to SNPN mode switch.	18.2.0
2023-03	CT#99	CP-230215	5016	2	F	Correction on NAS signalling connection	18.2.0
2023-03	CT#99	CP-230215	4991	2	F	Clarification on UE policy part contents	18.2.0
2023-03	CT#99	CP-230215	5017	1	F	Correction on Back-off timer value IE conditions in network-initiated NAS transport procedure	18.2.0
2023-03	CT#99	CP-230219	5084	1	F	The equivalent SNPNs usage for access identities	18.2.0
2023-03	CT#99	CP-230214	5010	2	F	No PDU session release for non-current access	18.2.0
2023-03	CT#99	CP-230217	5002	1	F	Correction N3IWF address information element	18.2.0
2023-03	CT#99	CP-230210	5015	1	B	User plane positioning capability indication	18.2.0
2023-03	CT#99	CP-230278	4985	1	B	Equivalent SNPNs: MPS and MCS indicators	18.2.0
2023-03	CT#99	CP-230219	5063	1	F	The AMF shall not provide equivalent SNPN/PLMN list when the UE is registered in PLMN/SNPN	18.2.0
2023-03	CT#99	CP-230310	4982	1	B	Equivalent SNPNs: LADN service area	18.2.0
2023-03	CT#99	CP-230278	4981	1	B	Equivalent SNPNs: service area restrictions	18.2.0
2023-03	CT#99	CP-230278	4984	1	B	Equivalent SNPNs: applicability of network-assigned UE radio capability ID, NSSAI inclusion mode IE and operator-defined access category definitions	18.2.0
2023-03	CT#99	CP-230278	5014	1	F	Term definition for SNPN access mode	18.2.0
2023-03	CT#99	CP-230218	4944	3	B	Support for UE accessing SNPN services using non-3GPP access	18.2.0
2023-03	CT#99	CP-230217	5121	1	B	UE to indicate its support for Slice-based TNGF selection to the network	18.2.0
2023-03	CT#99	CP-230217	5122	1	B	Aborting registration procedure when the selected TNGF is not compatible with the allowed NSSAI	18.2.0
2023-03	CT#99	CP-230217	5123	1	B	Introducing the TNAN information IE	18.2.0
2023-03	CT#99	CP-230217	5020	1	F	Correction to the IP address type and minor fixes on N3IWF address IE	18.2.0
2023-03	CT#99	CP-230250	4999	-	B	UE initiated de-registration procedure for Unavailability Period	18.2.0
2023-03	CT#99	CP-230250	5053	1	B	Handling UE NAS timers in duration of unavailability period	18.2.0
2023-03	CT#99	CP-230254	5061	1	B	Instructing a UE to reconnect to the network upon receiving an indication of a change in the RAN timing synchronization status	18.2.0
2023-03	CT#99	CP-230260	5012	1	B	5GMM procedure updates for LADN per DNN & S-NSSAI	18.2.0
2023-03	CT#99	CP-230262	5081	1	B	Introduction of general aspects of PIN	18.2.0
2023-03	CT#99	CP-230220	4989	2	F	Missing message in the inclusion criteria of Additional 5G security information	18.2.0
2023-03	CT#99	CP-230265	4976	1	B	Enhanced CAG selection - providing additional information	18.2.0
2023-03	CT#99	CP-230257	5003	1	B	Update UE handling of the MA PDU session	18.2.0
2023-03	CT#99	CP-230257	5138	1	B	Redundant steering mode is not applicable for ATSSS-LL functionality (impact on TS 24.501)	18.2.0
2023-03	CT#99	CP-230264	5008	1	B	UE capability indication to the network for A2X	18.2.0
2023-03	CT#99	CP-230260	5013	1	B	5GSM procedure updates for LADN per DNN & S-NSSAI	18.2.0
2023-03	CT#99	CP-230215	5004	1	F	Use default configured NSSAI because of no configured NSSAI	18.2.0
2023-03	CT#99	CP-230215	4867	3	F	Clarification to the Mapped EPS bearer contexts	18.2.0

2023-03	CT#99	CP-230215	5031	1	B	Protocol error handling enhancements for Type 6 IE container IEs	18.2.0
2023-03	CT#99	CP-230215	5047	1	F	Extended CAG information list in CONFIGURATION UPDATE COMMAND	18.2.0
2023-03	CT#99	CP-230285	5091	1	F	UE handling for cause78 in DL NAS TRANSPORT and connection management	18.2.0
2023-03	CT#99	CP-230236	5135	1	A	Rejecting PDU session for C2 communication when UAS service is not allowed	18.2.0
2023-03	CT#99	CP-230285	5093	1	F	Clarification on remote UE ID	18.2.0
2023-03	CT#99	CP-230215	4998	1	F	UE-requested PDU session modification after inter-system change from S1 mode to N1 mode	18.2.0
2023-03	CT#99	CP-230215	5044	1	F	Support for S-NSSAI(s) added in S1 mode without NSSRG Information	18.2.0
2023-03	CT#99	CP-230220	5049	1	F	MBS handling in abnormal and PDU session rejection cases	18.2.0
2023-03	CT#99	CP-230258	5069	1	B	General introduction of network slice replacement	18.2.0
2023-03	CT#99		5070	1	B	Support of network slice replacement during registration procedure	18.2.0
2023-03	CT#99	CP-230258	5071	1	B	Support of network slice replacement during UCU procedure	18.2.0
2023-03	CT#99	CP-230278	4996	1	F	Equivalent SNPNs: identification	18.2.0
2023-03	CT#99	CP-230278	4997	1	F	Equivalent SNPNs: 5G-GUTI selection	18.2.0
2023-03	CT#99	CP-230219	5029	1	B	Equivalent SNPNs: last visited TAI	18.2.0
2023-03	CT#99	CP-230215	5007	1	F	NSSAI applicable to equivalent PLMNs in registration area	18.2.0
2023-03	CT#99	CP-230285	5154	1	F	Start T3540 upon receiving #22 along with a T3346 value	18.2.0
2023-03	CT#99	CP-230285	5019	1	F	Correction to NSAG	18.2.0
2023-03	CT#99	CP-230215	5045	1	F	NSAG and lower layer failure	18.2.0
2023-03	CT#99	CP-230215	5060	2	F	No transfer of LADN PDU session to S1 mode	18.2.0
2023-03	CT#99	CP-230232	4910	6	F	Handling of pending NSSAI in NSSRG procedure-option 1	18.2.0
2023-03	CT#99	CP-230219	5087	2	B	The enhancement on onboarding services in SNPN supporting localized services	18.2.0
2023-03	CT#99	CP-230219	5113	2	F	Extending Re-attempt indicator IE & 5GSM congestion re-attempt indicator IE for equivalent SNPN	18.2.0
2023-03	CT#99	CP-230219	5118	4	F	Save NID value of registered SNPN in NV memory.	18.2.0
2023-03	CT#99	CP-230219	5116	3	F	Mobility registration update for SNPNs.	18.2.0
2023-03	CT#99	CP-230285	5114	2	F	Deletion of 5GS forbidden tracking areas for roaming added due to rejected S-NSSAI	18.2.0
2023-03	CT#99	CP-230254	5056	2	B	Indication of support for reconnection to the network due to RAN timing synchronization status change via the 5GMM capability IE	18.2.0
2023-03	CT#99	CP-230214	5107	3	A	Update MPS indicator in CUC message R18	18.2.0
2023-03	CT#99	CP-230234	5117	2	B	Add new indication on the UE support of URSP Provisioning in EPS	18.2.0
2023-03	CT#99	CP-230219	5097	3	B	Equivalent SNPN information provided to lower layers for cell reselection	18.2.0
2023-03	CT#99	CP-230215	4994	2	B	Type 6 IE container	18.2.0
2023-03	CT#99	CP-230307	5058	2	A	Slices provided to the lower layers for NSAG	18.2.0
2023-03	CT#99	CP-230219	5036	3	B	CH controlled prioritized list of preferred SNPNs and GINs for access for localized services in SNPN	18.2.0
2023-03	CT#99	CP-230257	5165	2	B	Capability for MPQUIC Steering Functionality	18.2.0
2023-03	CT#99					Correction of Formatting errors and mis implementation	18.2.1
2023-06	CT#100	CP-231216	5167	-	F	Inconsistent description of UE policy section management list IE	18.3.0
2023-06	CT#100	CP-231240	5181	-	F	Use defined term Alternative NSSAI	18.3.0
2023-06	CT#100	CP-231216	5182	-	F	UE behaviour after receiving rejected NSSAI	18.3.0
2023-06	CT#100	CP-231277	5050	1	B	Transmission of A2X Policy	18.3.0
2023-06	CT#100	CP-231216	5198	-	F	Remove the NOTE not applicable to SNPN scenario	18.3.0
2023-06	CT#100	CP-231219	5199	-	F	Remove NSW0 from abbreviation list	18.3.0
2023-06	CT#100	CP-231216	5202	-	F	Correcting few errors in UE handing of QoS rules	18.3.0
2023-06	CT#100	CP-231232	5218	-	F	NF name correction for UUAA-MM	18.3.0
2023-06	CT#100	CP-231232	5219	-	F	Correction on referred table No. to 24.008	18.3.0
2023-06	CT#100	CP-231216	5233	-	F	Correction of Paging Subgroup ID value	18.3.0
2023-06	CT#100	CP-231216	5224	1	F	Clarification on UE policy part contents length	18.3.0
2023-06	CT#100	CP-231216	5295	-	F	NW handling when treating an MRU as an initial registration	18.3.0
2023-06	CT#100	CP-231216	5298	-	F	Correction to handling of FTAI list on receiving #62	18.3.0
2023-06	CT#100	CP-231238	5303	-	F	Clarification on Emergency PDU session release	18.3.0
2023-06	CT#100	CP-231228	5312	-	B	AMF to indicate the capability of supporting non-3GPP access path switching	18.3.0
2023-06	CT#100	CP-231228	5313	-	B	UE to indicate the capability of supporting non-3GPP access path switching	18.3.0
2023-06	CT#100	CP-231221	5320	-	B	Indicating Uplink data status IE in REGISTRATION REQUEST message after failure of resumption of the RRC connection for UE that has joined Multicast session	18.3.0
2023-06	CT#100	CP-231304	5225	2	B	Ranging capability over NAS	18.3.0
2023-06	CT#100	CP-231277	5250	1	B	AMF should not release NAS signalling after Registration procedure if the UE is authorized A2X	18.3.0

2023-06	CT#100	CP-231216	5272	1	F	Not include uplink data status IE in mobility registration procedure	18.3.0
2023-06	CT#100	CP-231216	5279	1	F	Clearing maximum number of PDU sessions	18.3.0
2023-06	CT#100	CP-231216				TAs belonging to different PLMNs which are equivalent PLMNs in forbidden tracking areas for regional provision of service or forbidden tracking areas for roaming	18.3.0
			5332	1	F		
2023-06	CT#100	CP-231240				Mobility management for the support of optimised handling of temporarily available network slices	18.3.0
			5176	1	B		
2023-06	CT#100	CP-231216				No need to include rejected NSSAI for 5GMM causes other than #62	18.3.0
			5274	1	F		
2023-06	CT#100	CP-231223	5309	1	F	Adding reject cause values #81 and #82 under the Annex A	18.3.0
2023-06	CT#100	CP-231207	5323	1	F	Support of PRUs in NAS transport procedure	18.3.0
2023-06	CT#100	CP-231240				Indication of partial network slice support in a registration area when registering	18.3.0
			5205	2	B		
2023-06	CT#100	CP-231216				Enabling UE to send UE STATE INDICATION message even when UE does not have stored UE policy sections - Option B	18.3.0
			5186	2	F		
2023-06	CT#100	CP-231240	5329	1	B	Capability indication to support of network slice usage control	18.3.0
2023-06	CT#100	CP-231216				Correction of handling of the PDU session reactivation result error cause	18.3.0
			5171	1	F		
2023-06	CT#100	CP-231276	5192	1	F	MRU for RAN timing synchronization status change	18.3.0
2023-06	CT#100	CP-231245	5188	1	F	Correction to LADN restriction for UE to create PDU session	18.3.0
2023-06	CT#100	CP-231245				Clarify the behavior of Service area restriction and the LADN per DNN/S-NSSAI	18.3.0
			5189	1	F		
2023-06	CT#100	CP-231240	5204	2	F	Network Slice replacement	18.3.0
2023-06	CT#100	CP-231277	5193	1	B	Authorization of A2X Direct C2 Communications in 5GS	18.3.0
2023-06	CT#100	CP-231265	5197	1	B	Transmission of Ranging/SL Positioning Policy	18.3.0
2023-06	CT#100	CP-231216				Correction on a missing parameter in the UE-initiated NAS transport procedure	18.3.0
			5327	1	F		
2023-06	CT#100	CP-231216				Add the definition of satellite NG-RAN cell and non-satellite NG-RAN cell	18.3.0
			5149	3	F		
2023-06	CT#100	CP-231265	5226	1	B	Service request for ranging	18.3.0
2023-06	CT#100	CP-231240	5178	1	F	Define maximum length of Alternative NSSAI IE	18.3.0
2023-06	CT#100	CP-231240	5180	1	F	Clarify AMF behaviour when S-NSSAI to be replaced is available	18.3.0
2023-06	CT#100	CP-231216				Send 5GMM cause #62 during NW-initiated de-registration procedure	18.3.0
			5183	1	F		
2023-06	CT#100	CP-231216				Correction to the conditions for inclusion of the PDU session reactivation result IE	18.3.0
			5184	1	F		
2023-06	CT#100	CP-231216				5G AKA based primary authentication and key agreement procedure initiation	18.3.0
			5185	1	D		
2023-06	CT#100	CP-231238	5263	1	F	Condition for mobility registration update in SNPN	18.3.0
2023-06	CT#100	CP-231282	5220	1	B	General section for MBSR	18.3.0
2023-06	CT#100	CP-231216	5266	1	F	Minor correction on the T3540	18.3.0
2023-06	CT#100	CP-231238	5299	1	F	Correction in references of non-3GPP access for SNPNs	18.3.0
2023-06	CT#100	CP-231264				Resolution of editor's note on the request frequency of non-3GPP delay	18.3.0
			5261	1	F		
2023-06	CT#100	CP-231240	5328	2	B	General introduction on support of network slice usage control	18.3.0
2023-06	CT#100	CP-231218				Clarification on handling of received T3502 in registration accept message	18.3.0
			5288	2	F		
2023-06	CT#100	CP-231240	5283	1	B	The partially allowed NSSAI - UE storage	18.3.0
2023-06	CT#100	CP-231207	5285	1	B	User plane positioning capability	18.3.0
2023-06	CT#100	CP-231217				Emergency service handling when low layer failure and NW initiated deregistration	18.3.0
			5172	1	F		
2023-06	CT#100	CP-231276				UAC for RAN timing synchronization status change - RRC inactive UE	18.3.0
			5191	1	B		
2023-06	CT#100	CP-231238	5265	2	F	Resolution of editor's note on NID assignment	18.3.0
2023-06	CT#100	CP-231245	5187	2	F	Correction to Extended LADN information	18.3.0
2023-06	CT#100	CP-231232	5245	1	F	Updation to REGISTERED LIMITED service state.	18.3.0
2023-06	CT#100	CP-231219				Creation of access stratum connection for wireline access used by 5G-RG	18.3.0
			5168	1	F		
2023-06	CT#100	CP-231238	5166	1	F	Removal of redundant description of NID coding in SNPN list IE	18.3.0
2023-06	CT#100	CP-231221	5318	1	B	Supporting multicast MBS session for UE in MICO mode	18.3.0
2023-06	CT#100	CP-231217	5246	2	F	Deregistration procedure and access type	18.3.0
2023-06	CT#100	CP-231223				Correction related to receiving N3IWF identifier IE in the REGISTRATION REJECT	18.3.0
			5322	1	F		
2023-06	CT#100	CP-231211				RRC Establishment cause when RSC is dedicated for Emergency for layer-2 relay	18.3.0
			5326	1	B		
2023-06	CT#100	CP-231217	5276	3	F	Paging to re-establish user-plane resources over 3GPP access	18.3.0
2023-06	CT#100	CP-231240				Support of network slice replacement during PDU session modification procedure	18.3.0
			5248	2	B		
2023-06	CT#100	CP-231217				Correction in the 5GSM sublayer state transition in terms of the PDU SESSION MODIFICATION REJECT message including 5GSM cause value #43	18.3.0
			5241	1	F		
2023-06	CT#100	CP-231240				Support of network slice replacement during PDU session release procedure	18.3.0
			5255	2	B		

2023-06	CT#100	CP-231240	5310	1	F	Restriction in the requested NSSAI creation if an S-NSSAI is temporarily unavailable	18.3.0
2023-06	CT#100	CP-231240	5307	1	B	UE capability indication for the support of optimized handling of temporarily available network slices	18.3.0
2023-06	CT#100	CP-231240	5308	2	B	AMF operation upon being requested an S-NSSAI which is unavailable according to the validity time	18.3.0
2023-06	CT#100	CP-231240	5316	1	B	Storing validity time	18.3.0
2023-06	CT#100	CP-231240	5304	1	B	S-NSSAI location availability information in the registration procedure	18.3.0
2023-06	CT#100	CP-231240	5305	1	B	Storing S-NSSAI location availability information	18.3.0
2023-06	CT#100	CP-231240	5306	1	B	S-NSSAI location availability information via UCU	18.3.0
2023-06	CT#100	CP-231282	5301	2	B	UE handling upon CAG validity state change	18.3.0
2023-06	CT#100	CP-231217	5349	-	F	Clarification on MRU/PRU initiation	18.3.0
2023-06	CT#100	CP-231233	5330	1	D	Editorial corrections to the ECS address clause	18.3.0
2023-06	CT#100	CP-231277	5357	-	B	Request resources for A2X communication over PC5	18.3.0
2023-06	CT#100	CP-231245	5213	2	B	AMF enforcement for LADN per DNN & S-NSSAI	18.3.0
2023-06	CT#100	CP-231245	5370	-	B	LADN per DNN & S-NSSAI handling for legacy UE	18.3.0
2023-06	CT#100	CP-231238	5371	-	F	Correction on SOR-SNPN-SI-LS IE coding	18.3.0
2023-06	CT#100	CP-231240	5377	-	F	Partially allowed NSSAI for slice based cell re-selection and random access	18.3.0
2023-06	CT#100	CP-231240	5378	-	F	Partially allowed NSSAI for RFSP derivation	18.3.0
2023-06	CT#100	CP-231217	5379	-	D	Editorial corrections	18.3.0
2023-06	CT#100	CP-231228	5381	-	F	Correction in mapping supported ATSSS steering functionalities and modes	18.3.0
2023-06	CT#100	CP-231238	5262	1	F	Correction on onboarding in SNPN supporting localized services	18.3.0
2023-06	CT#100	CP-231243	5424		B	Resolve EN on URSP provisioning in EPS support indication when the UE does not have UPSIs	18.3.0
2023-06	CT#100	CP-231232	5270	1	F	Update of DEREGISTERED LIMITED service state for CAG	18.3.0
2023-06	CT#100	CP-231232	5445	-	F	UE-ID based Paging Early Indication	18.3.0
2023-06	CT#100	CP-231228	5314	1	B	SMF to indicate the capability of supporting non-3GPP access path switching	18.3.0
2023-06	CT#100	CP-231236	5412	1	A	Coding of NID of SNPN identity and GIN of SOR transparent container - alternative 2	18.3.0
2023-06	CT#100	CP-231218	5355	1	F	Interaction between a 5GSM entity and upper layers for URSP handling	18.3.0
2023-06	CT#100	CP-231206	5404	1	A	Correction to the IoT small data container IE	18.3.0
2023-06	CT#100	CP-231246	5364	1	A	Correction to the Service-level-AA server address IE	18.3.0
2023-06	CT#100	CP-231207	5215	3	B	UL/DL NAS transport updates for user plane positioning	18.3.0
2023-06	CT#100	CP-231226	5407	1	A	Correction to the MA PDU session information IE	18.3.0
2023-06	CT#100	CP-231239	5414	1	F	Equivalent SNPNs: re-attempt control not due to congestion - enforcement	18.3.0
2023-06	CT#100	CP-231243	5362	1	B	UE reporting of URSP rule enforcement in TS 24.501	18.3.0
2023-06	CT#100	CP-231243	5339	3	B	Indicating the support of URSP rule enforcement in the UE policy classmark	18.3.0
2023-06	CT#100	CP-231243	5169	3	B	Providing VPLMN specific URSP	18.3.0
2023-06	CT#100	CP-231239	5415	1	B	Handling of forbidden SNPN lists for localized services	18.3.0
2023-06	CT#100	CP-231239	5438	1	F	Deletion of 5GS forbidden tracking area per entry of list of subscriber data.	18.3.0
2023-06	CT#100	CP-231239	5413	1	F	SOR transparent container clean up	18.3.0
2023-06	CT#100	CP-231239	5203	3	B	CH controlled prioritized list of preferred SNPNs and GINs for access for localized services in SNPN	18.3.0
2023-06	CT#100	CP-231239	5444	1	F	Clarification for SOR-SNPN-SI-LS in SOR ACK	18.3.0
2023-06	CT#100	CP-231211	5466	1	B	Introducing the capabilities related to supporting UE-to-UE relay	18.3.0
2023-06	CT#100	CP-231277	5430	1	B	Clarification about the condition of the PCF initiating the Network-requested UE policy management procedure	18.3.0
2023-06	CT#100	CP-231282	5408	1	F	Location validity information for enhanced CAG list in TS 24.501	18.3.0
2023-06	CT#100	CP-231223	5356	2	F	Slice-based N3IWF or TNGF selection	18.3.0
2023-06	CT#100	CP-231223	5421	1	B	Support of AUN3/NAUN3 device behind 5G-RG	18.3.0
2023-06	CT#100	CP-231241	5177	2	B	UE storage of alternative NSSAI	18.3.0
2023-06	CT#100	CP-231241	5179	3	B	Provision alternative NSSAI during registration procedure	18.3.0
2023-06	CT#100	CP-231241	5375	1	F	Clarification on alternative S-NSSAI being part of the subscribed S-NSSAIs	18.3.0
2023-06	CT#100	CP-231241	5376	1	F	Clarification on when to provide alternative NSSAI to UE	18.3.0
2023-06	CT#100	CP-231241	5400	1	F	Handling Alternative NSSAI when SM backoff timer is running	18.3.0
2023-06	CT#100	CP-231241	5401	1	F	Deleting Alternative NSSAI	18.3.0
2023-06	CT#100	CP-231241	5247	7	B	Support of network slice replacement during PDU session establishment procedure	18.3.0
2023-06	CT#100	CP-231241	5297	2	B	Network slices with NS-AoS not matching deployed tracking areas	18.3.0
2023-06	CT#100	CP-231241	5425	1	B	The condition that the UE does not trigger a service request procedure	18.3.0
2023-06	CT#100	CP-231241	5344	1	B	Session management for optimized handling of temporarily available network slices	18.3.0

2023-06	CT#100	CP-231241	5317	3	B	Provisioning validity time	18.3.0
2023-06	CT#100	CP-231241	5372	1	B	Enhancement on partial network slice storage	18.3.0
2023-06	CT#100	CP-231241	5383	1	B	UE storage - partially rejected NSSAI	18.3.0
2023-06	CT#100	CP-231241	5462	1	B	Allowed PDU session status	18.3.0
2023-06	CT#100	CP-231271	5346	1	F	Adding inclusion criteria for newly added IE	18.3.0
2023-06	CT#100	CP-231271	5374	1	F	Unavailability period duration IE as a non-clear-text IE	18.3.0
2023-06	CT#100	CP-231271	5388	1	F	The AMF behaviour on the unavailability period duration	18.3.0
2023-06	CT#100	CP-231271	5458	1	B	5GMM state for unavailability period	18.3.0
2023-06	CT#100	CP-231271	5459	1	B	Coming out of unavailability period when deregistered	18.3.0
2023-06	CT#100	CP-231220	5238	3	B	New trigger for registration procedure to indicate loss of coverage	18.3.0
2023-06	CT#100	CP-231220	5240	3	B	New Maximum signalling waiting time due to discontinuous coverage	18.3.0
2023-06	CT#100	CP-231241	5281	3	B	The partially allowed NSSAI - registration procedures	18.3.0
2023-06	CT#100	CP-231241	5423	1	B	Adding mapped S-NSSAI for partially allowed NSSAI to the definition	18.3.0
2023-06	CT#100	CP-231241	5433	1	B	The AMF sends the partially allowed NSSAI to the UE after NSSAA	18.3.0
2023-06	CT#100	CP-231241	5228	4	B	Partial rejected NSSAI to registration procedure	18.3.0
2023-06	CT#100	CP-231265	5437	1	B	Capability of SL Positioning Server UE over PC5	18.3.0
2023-06	CT#100	CP-231277	5427	2	F	Removing ENS	18.3.0
2023-06	CT#100	CP-231245	5214	3	B	Inclusion of Extended LADN information IE in REGISTRATION ACCEPT message	18.3.0
2023-06	CT#100	CP-231223	5222	3	B	PDU session modification procedure for supporting N3QAI and non-3gpp delay budget	18.3.0
2023-06	CT#100	CP-231228	5315	2	B	Introducing the non-3GPP access path switching procedure	18.3.0
2023-06	CT#100	CP-231228	5449	1	B	PDU session IDs not included in Uplink data status IE during non-3GPP access path switching	18.3.0
2023-06	CT#100	CP-231218	5450	1	F	Abort registration procedure for initiating an emergency PDU session because of lower layer failure	18.3.0
2023-06	CT#100	CP-231218	5467	1	F	Start timer T3540 upon receiving #78	18.3.0
2023-06	CT#100	CP-231218	5244	3	F	Correction on UE handling of NAS security context	18.3.0
2023-06	CT#100	CP-231218	5348	1	F	Clarification on disabling and enabling N1 mode and SNPN selection for onboarding services	18.3.0
2023-06	CT#100	CP-231218	5234	2	F	Storing the indication of interworking without N26 interface in NVM	18.3.0
2023-06	CT#100	CP-231218	5428	1	F	Clarification of T3540 and CAG cell	18.3.0
2023-06	CT#100	CP-231218	4772	9	F	Clarification to handling of multiple 5G NAS security contexts	18.3.0
2023-06	CT#100	CP-231218	5440	1	F	Emergency call not allowed while registered for onboarding services	18.3.0
2023-06	CT#100	CP-231218	5420	1	F	QoS rule handling for a GBR QoS flow during modification procedure	18.3.0
2023-06	CT#100	CP-231218	5447	1	F	Additional handling on T3245 expiry.	18.3.0
2023-06	CT#100	CP-231218	5399	1	F	Rejected NSSAI with cause #62	18.3.0
2023-06	CT#100	CP-231277	5358	3	B	Authorization of A2X direct C2 communication during registration in 5GS	18.3.0
2023-06	CT#100	CP-231223	5453	1	F	Including last visited registered TAI for registration procedure over non-3gpp access	18.3.0
2023-06	CT#100	CP-231243	5208	3	F	URSP support in EPS	18.3.0
2023-06	CT#100	CP-231218	5345	1	F	Correction of the deletion of mapped S-NSSAIs for the rejected NSSAI	18.3.0
2023-06	CT#100	CP-231239	5387	2	F	Clarification on the UE mobility for SNPN	18.3.0
2023-06	CT#100	CP-231241	5336	3	B	SSC mode 2/3 PDU session relocation for network slice instance change	18.3.0
2023-06	CT#100	CP-231241	5280	4	B	The partial network slice feature - general introduction	18.3.0
2023-06	CT#100	CP-231241	5431	2	B	Partial network slice applicable on 3GPP access only	18.3.0
2023-06	CT#100	CP-231233	5373	2	F	Correction on S-NSSAI provision to lower layers for NSAG	18.3.0
2023-06	CT#100	CP-231218	5451	1	F	Additional NAS handling for SNPN related to timers T3584 T3585 & SM level rejection causes #50 and #51.	18.3.0
2023-06	CT#100	CP-231218	5456	1	F	SR for emergency services failing due to LLF or NW initiated deregistration	18.3.0
2023-06	CT#100	CP-231271	5368	3	B	Unavailability period duration for MUSIM UE	18.3.0
2023-06	CT#100	CP-231241	5207	6	B	UE configuration update when supporting the partial network slice support	18.3.0
2023-06	CT#100	CP-231264	5259	4	B	Update of general aspects of PIN	18.3.0
2023-06	CT#100	CP-231227	5380	2	A	ATSSS capabilities of MA PDU session	18.3.0
2023-06	CT#100	CP-231215	5448	2	A	Sending registration complete message for PEIPS information acknowledgment.	18.3.0
2023-06	CT#100	CP-231221	5321	4	B	Indicating Uplink data status IE considering multicast MBS session reception in 5GMM-CONNECTED mode with RRC inactive indication	18.3.0
2023-06	CT#100	CP-231218	5398	2	F	Coordination between 5GMM and EMM states in single registration mode	18.3.0
2023-06	CT#100	CP-231232	5441	2	F	NSSAI in Requested mapped NSSAI IE Share NSSRG value	18.3.0

2023-06	CT#100	CP-231215	5436	4	A	Sending the registration complete message after receiving the NSAG information	18.3.0
2023-06	CT#100	CP-231292	5351	5	F	AMF including configured NSSAI for IWK scenarios	18.3.0
2023-06	CT#100					Clashes and other editorials addressed	18.3.1
2023-09	CT#101	CP-232223	5510	-	F	Missing references for pre-configuration	18.4.0
2023-09	CT#101	CP-232233	5512	-	F	Alignment on MBS start time for multicast MBS sessions	18.4.0
2023-09	CT#101	CP-232201	5522	-	B	Handling on UE requested UPP not authorized by network	18.4.0
2023-09	CT#101	CP-232220	5528	-	F	Resolve EN about access category for RAN timing synchronization status change	18.4.0
2023-09	CT#101	CP-232201	5538	-	F	Correction to wrong reference	18.4.0
2023-09	CT#101	CP-232204	5542	-	F	Correction to clause reference to the Non-3GPP delay budget IE	18.4.0
2023-09	CT#101	CP-232187	5554	-	F	Missing parts of agreed C1-232764 and C1-233959 for network slice replacement	18.4.0
2023-09	CT#101	CP-232187	5557	-	F	General cleanup regarding S-NSSAI location validity information and S-NSSAI time validity information	18.4.0
2023-09	CT#101	CP-232187	5561	-	F	Condition on providing S-NSSAI time validity information to supporting UE	18.4.0
2023-09	CT#101	CP-232187	5562	-	F	S-NSSAI rejection for UE not supporting S-NSSAI time validity information	18.4.0
2023-09	CT#101	CP-232231	5541	-	A	Correction to the Service-level-AA service status indication IE	18.4.0
2023-09	CT#101	CP-232187	5563	-	F	General cleanup regarding partial network slice	18.4.0
2023-09	CT#101	CP-232187	5567	-	F	Registration update triggered by update of partially allowed NSSAI	18.4.0
2023-09	CT#101	CP-232189	5569	-	D	Editorial corrections	18.4.0
2023-09	CT#101	CP-232189	5581	-	F	Clarification on the usage of WUS	18.4.0
2023-09	CT#101	CP-232191	5587	-	F	Handling of forbidden SNPN list for localized services on T3245 expiry	18.4.0
2023-09	CT#101	CP-232191	5588	-	F	Saving forbidden list of SNPNs for localized services in NV	18.4.0
2023-09	CT#101	CP-232189	5591	-	F	Clarification in the Delete existing EPS bearer operation	18.4.0
2023-09	CT#101	CP-232198	5620	-	F	Correction to the trigger for deregistration procedure in the UE.	18.4.0
2023-09	CT#101	CP-232233	5637	-	F	Correction for including the Uplink data status IE in REGISTRATION REQUEST message after failure of resumption of the RRC connection for UE that has joined Multicast session	18.4.0
2023-09	CT#101	CP-232191	5658	-	F	Forbidden SNPN list for localized services for 3GPP access only	18.4.0
2023-09	CT#101	CP-232210	5660	-	B	Path switching for PDU sessions is still establishing	18.4.0
2023-09	CT#101	CP-232187	5665	-	F	Network control of the slice usage in roaming aspects	18.4.0
2023-09	CT#101	CP-232189	5669	-	F	Default NSSAI inclusion mode pre-configuration	18.4.0
2023-09	CT#101	CP-232187	5694	-	B	Resolve the EN for the partial network slice feature	18.4.0
2023-09	CT#101	CP-232189	5667	1	F	Addition of SNPNs with GINs in forbidden lists	18.4.0
2023-09	CT#101	CP-232191	5492	1	F	Clarification of the use of counters regarding SNPN	18.4.0
2023-09	CT#101	CP-232191	5544	1	F	TWIF handling of decorated NAI for N5CW device	18.4.0
2023-09	CT#101	CP-232200	5539	1	F	Correction to reference to the VPS URSP configuration IE	18.4.0
2023-09	CT#101	CP-232232	5498	1	B	MBSR authorization update	18.4.0
2023-09	CT#101	CP-232266	5551	1	C	Updates to allow N3IWF and TNGF relocation	18.4.0
2023-09	CT#101	CP-232266	5642	1	B	N3QAI inclusion in NAS SM signalling for 5G-RG	18.4.0
2023-09	CT#101	CP-232266	5643	1	B	Requirements for supporting AUN3 devices connected to 5G-RG	18.4.0
2023-09	CT#101	CP-232266	5645	1	B	Impact on registration procedure for authenticating AUN3 device behind 5G-RG	18.4.0
2023-09	CT#101	CP-232187	5504	1	F	Correction of style and wording	18.4.0
2023-09	CT#101	CP-232187	5532	1	F	Correction to the Registration accept type 6 IE container IE	18.4.0
2023-09	CT#101	CP-232187	5533	1	F	Correction to the CONFIGURATION UPDATE COMMAND message content	18.4.0
2023-09	CT#101	CP-232230	5536	1	A	Correction to the clause on the ECS address IE	18.4.0
2023-09	CT#101	CP-232204	5575	1	F	Correction on the PIN communication	18.4.0
2023-09	CT#101	CP-232204	5530	1	F	Include N3QAI in PDU session establishment procedure	18.4.0
2023-09	CT#101	CP-232204	5531	1	F	Correction to N3QAI coding	18.4.0
2023-09	CT#101	CP-232187	5553	1	F	Update the definition of network slicing information	18.4.0
2023-09	CT#101	CP-232187	5555	1	F	PDU session re-establishment on the alternative S-NSSAI	18.4.0
2023-09	CT#101	CP-232187	5556	1	F	Minimum length of Alternative NSSAI IE	18.4.0
2023-09	CT#101	CP-232187	5505	1	F	Correction of 5GMM aspects of NS-AoS	18.4.0
2023-09	CT#101	CP-232187	5506	1	C	PDU session establishment from non-supporting UE outside AoS	18.4.0
2023-09	CT#101	CP-232187	5519	1	F	Correction on S-NSSAI location validity information	18.4.0
2023-09	CT#101	CP-232187	5559	1	F	Service request as per S-NSSAI location validity information	18.4.0
2023-09	CT#101	CP-232187	5593	1	B	5GMM operation of a UE with S-NSSAI location validity information	18.4.0
2023-09	CT#101	CP-232188	5594	1	B	5GSM operation for a UE with S-NSSAI location validity information	18.4.0
2023-09	CT#101	CP-232188	5596	1	F	KI#3-2 - No new AMF/UE operation when an S-NSSAI becomes available again	18.4.0
2023-09	CT#101	CP-232188	5597	1	B	Coding of the Per-S-NSSAI time validity information for the S-NSSAI field	18.4.0
2023-09	CT#101	CP-232188	5520	1	F	Correction on Partial NSSAI IE coding	18.4.0

2023-09	CT#101	CP-232188	5534	1	F	Correction to clause reference to Mobility management for partial network slice	18.4.0
2023-09	CT#101	CP-232188	5564	1	F	Further clarification on partially allowed NSSAI and NSSAA	18.4.0
2023-09	CT#101	CP-232188	5565	1	F	Clarification on partially allowed NSSAI and NSAC	18.4.0
2023-09	CT#101	CP-232188	5612	1	B	control plane user data associated with S-NSSAI not allowed in current TA	18.4.0
2023-09	CT#101	CP-232188	5571	1	F	NSSAI inclusion to AS layer considering partially allowed NSSAI	18.4.0
2023-09	CT#101	CP-232220	5529	1	F	Correction to the condition of RAN timing synchronization status change	18.4.0
2023-09	CT#101	CP-232220	5680	1	F	RAN timing synchronization and T3502 and T3525 timer	18.4.0
2023-09	CT#101	CP-232198	5604	1	B	Handling emergency services during discontinuous waiting time	18.4.0
2023-09	CT#101	CP-232198	5617	1	B	Clarification to storage of NAS context	18.4.0
2023-09	CT#101	CP-232263	5632	3	F	Signalling of the unavailability period duration from the AMF to the UE	18.4.0
2023-09	CT#101	CP-232198	5618	1	B	Update to the periodic timer determination at AMF	18.4.0
2023-09	CT#101	CP-232198	5623	1	B	Clarification to the trigger of mobility registration due to unavailability	18.4.0
2023-09	CT#101	CP-232198	5690	1	F	Correction of the IE name for discontinuous coverage overload control	18.4.0
2023-09	CT#101	CP-232195	5524	1	F	Correction on network handling in DL NAS transport for CIoT user data transfer	18.4.0
2023-09	CT#101	CP-232195	5647	1	F	Correction on the Received MBS container IE	18.4.0
2023-09	CT#101	CP-232189	5673	1	F	equivalent PLMN list when UE registers to two PLMNs	18.4.0
2023-09	CT#101	CP-232188	5657	2	F	Slice Usage Policy for on-demand NSSAI	18.4.0
2023-09	CT#101	CP-232201	5696	1	F	Update the terminology of user plane positioning connection management information	18.4.0
2023-09	CT#101	CP-232190	5609	2	F	Clarifications on UE behavior for several reject causes for no CH support case	18.4.0
2023-09	CT#101	CP-232232	5473	1	B	Support for MBSR authorization signaling during registration	18.4.0
2023-09	CT#101	CP-232210	5659	2	F	Path switching while using old n3 for at least one PDU session supporting path switching	18.4.0
2023-09	CT#101	CP-232266	5640	2	F	Resolving the EN related to preventing the legacy UEs from loop of registration requests due to incompatible N3IWF/TNGF with the allowed NSSAI	18.4.0
2023-09	CT#101	CP-232200	5472	2	F	VPLMN specific URSP changes	18.4.0
2023-09	CT#101	CP-232205	5627	2	A	Handling of un-authorized IAB UEs	18.4.0
2023-09	CT#101	CP-232190	5491	2	F	Condition for inclusion of Allowed PDU session status IE	18.4.0
2023-09	CT#101	CP-232190	4785	6	F	Condition for inclusion of Uplink data status IE in non-allowed service area	18.4.0
2023-09	CT#101	CP-232192	5475	2	F	Equivalent SNPNs: congestion control corrections	18.4.0
2023-09	CT#101	CP-232192	5579	2	F	Resolution of EN on equivalent SNPNs assignment during onboarding registration	18.4.0
2023-09	CT#101	CP-232201	5501	2	B	Support indications for user plane positioning	18.4.0
2023-09	CT#101	CP-232201	5503	2	B	Identification of PRU related to forwarded LCS messages	18.4.0
2023-09	CT#101	CP-232188	5668	3	B	Network Slice Replacement in roaming	18.4.0
2023-09	CT#101	CP-232188	5624	2	B	How to determine if the UE is in the NS-AoS	18.4.0
2023-09	CT#101	CP-232198	5549	3	B	UE unavailability period reporting overrides mobility management congestion control	18.4.0
2023-09	CT#101	CP-232198	5616	2	B	Update of general section for unavailability period	18.4.0
2023-09	CT#101	CP-232198	5630	2	B	Updates to conditions for the support of unavailability period	18.4.0
2023-09	CT#101	CP-232196	5572	3	F	Release PDU session to share NSSRG value	18.4.0
2023-09	CT#101	CP-232192	5471	2	F	SOR-SNPN-SI-LS separate from SOR-SNPN-SI	18.4.0
2023-09	CT#101	CP-232196	5525	3	F	Handling of PDU session modification command when there are semantic errors in packet filters or QoS operations	18.4.0
2023-09	CT#101	CP-232190	5543	2	F	Cleanup on N5CW device supporting 3GPP access	18.4.0
2023-09	CT#101	CP-232200	5608	2	B	Resolve Editor's Note about URSP rule enforcement report indication	18.4.0
2023-09	CT#101	CP-232188	5548	4	F	Reestablishment of NAS connection with UP resource request	18.4.0
2023-09	CT#101	CP-232241	5682	3	B	Time validity information and location assistance information in SOR transport container	18.4.0
2023-09	CT#101	CP-232189	5545	1	F	LADN PDU session and data over NAS	18.4.0
2023-09	CT#101	CP-232189	5654	1	F	Correction on 5GMM capability IE encoding	18.4.0
2023-09	CT#101	CP-232189	5663	1	F	Use the null scheme if USIM is valid	18.4.0
2023-09	CT#101	CP-232189	5600	1	F	Correction to reject cause #62	18.4.0
2023-09	CT#101	CP-232204	5497	2	F	Encoding of non-3gpp delay budget	18.4.0
2023-09	CT#101	CP-232189	5568	1	F	Optional support of network slice related features	18.4.0
2023-09	CT#101	CP-232189	5671	1	F	Ignore 5GSM congestion re-attempt indicator IE if receiving #39	18.4.0
2023-09	CT#101	CP-232190	5686	1	F	Clarification on Back-off timer value IE conditions in network-initiated NAS transport procedure	18.4.0
2023-09	CT#101	CP-232190	5672	1	F	Clarification on abnormal case handling when PEIPS information is negotiated	18.4.0
2023-09	CT#101	CP-232190	5547	1	F	Avoid UAC for UE acting as NCR-MT node	18.4.0
2023-09	CT#101	CP-232190	5488	1	F	Registration procedure handling for RACS	18.4.0

2023-09	CT#101	CP-232190	5537	1	F	Correction to the Payload container IE	18.4.0
2023-09	CT#101	CP-232191	5470	1	F	Time validity information format	18.4.0
2023-09	CT#101	CP-232190	5516	1	F	Not using mapped S-NSSAI when roaming in pre-Rel-17 network	18.4.0
2023-09	CT#101	CP-232266	5646	1	B	EAP methods for authenticating AUN3 devices behind 5G-RG	18.4.0
2023-09	CT#101	CP-232191	5676	1	F	NAS procedure collision with Validity information becomes not met	18.4.0
2023-09	CT#101	CP-232188				NAS message handling in case of transmission failure for UE supporting partial network slice	18.4.0
			5443	4	F		
2023-09	CT#101	CP-232188				Correction on the maximum number of S-NSSAIs in partial NSSAI IE	18.4.0
			5692	1	F		
2023-09	CT#101	CP-232188				The partial network slice usage during the PDU session establishment procedure	18.4.0
			5693	1	B		
2023-09	CT#101	CP-232188				Clarification of handling of the slice deregistration inactivity timer in a case of MA PDU session	18.4.0
			5493	1	F		
2023-12	CT#102	CP-233162				Editorial corrections of SOR transparent container	18.5.0
			5703	-	D		
2023-12	CT#102	CP-233189				Correction to DNS over (D)TLS	18.5.0
			5726	-	F		
2023-12	CT#102	CP-233141				Correction to starting T3540 timer	18.5.0
			5517	1	F		
2023-12	CT#102	CP-233141				Correction to QoS handling for empty packet filter list	18.5.0
			5518	1	F		
2023-12	CT#102	CP-233195				Resolution of editor's note for UAS_Ph2	18.5.0
			5733	-	F		
2023-12	CT#102	CP-233182				Correction to ranging and sidelink positioning capability	18.5.0
			5738	-	F		
2023-12	CT#102	CP-233164				Correction to support for partial network slice	18.5.0
			5751	-	F		
2023-12	CT#102	CP-233164				Missing consideration of the allowed NSSAI and partially allowed NSSAI when using the Allowed PDU session status IE in the CPSR message	18.5.0
			5757	-	F		
2023-12	CT#102	CP-233164				Alternative NSSAI update during UCU and registration procedure	18.5.0
			5762	-	F		
2023-12	CT#102	CP-233166				URSP rule enforcement indication corrections	18.5.0
			5809		F		
2023-12	CT#102	CP-233151				Clarification on maintaining the user plane resources of the old non-3GPP access during the non-3GPP access path switching	18.5.0
			5813	-	F		
2023-12	CT#102	CP-233149				Clarification on the Key domain ID	18.5.0
			5815	-	F		
2023-12	CT#102	CP-233141				Correction on starting timer T3540 if indicate re-registration required	18.5.0
			5666	1	F		
2023-12	CT#102	CP-233140				Allowed NSSAI includes S-NSSAI(s) not contained in requested NSSAI	18.5.0
			5768	1	A		
2023-12	CT#102	CP-233148				Encoding of unavailability information and related corrections	18.5.0
			5707	1	B		
2023-12	CT#102	CP-233145				Clarify on Discontinuous Coverage Support negotiation	18.5.0
			5783	1	F		
2023-12	CT#102	CP-233145				Addition of the parameters of the Unavailability Period due to DC	18.5.0
			5691	4	B		
2023-12	CT#102	CP-233148				Encoding of unavailability configuration	18.5.0
			5752	1	B		
2023-12	CT#102	CP-233145				Update for the timer handling for unavailability period activation.	18.5.0
			5791	1	B		
2023-12	CT#102	CP-233145				Solve EN about the unavailability period	18.5.0
			5801	1	F		
2023-12	CT#102	CP-233145				Updating the name for maximum time offset for unavailability period	18.5.0
			5810	1	B		
2023-12	CT#102	CP-233148				AS deactivation/activation during unavailability period	18.5.0
			5606	3	B		
2023-12	CT#102	CP-233128				Corrections on PRU	18.5.0
			5712	1	F		
2023-12	CT#102	CP-233128				Correction on term name of UPP information container	18.5.0
			5740	1	F		
2023-12	CT#102	CP-233128				Editor's note resolution on UPP-CMI container	18.5.0
			5739	1	F		
2023-12	CT#102	CP-233166				VPS URSP terminology alignment in 24.501	18.5.0
			5705	1	F		
2023-12	CT#102	CP-233166				Received VPS URSP configuration when UE has no stored VPS URSP configuration	18.5.0
			5706	1	F		
2023-12	CT#102	CP-233141				UE policy sections and associated UPSCs	18.5.0
			5480	2	F		
2023-12	CT#102	CP-233141				Added UE policy section management list IE for SNPN operation mode	18.5.0
			5485	2	F		
2023-12	CT#102	CP-233150				Forbidden Area for AUN3 device behind 5G-RG	18.5.0
			5724	1	C		
2023-12	CT#102	CP-233150				Authentication for AUN3 devices supporting 5G key hierarchy	18.5.0
			5811	1	B		
2023-12	CT#102	CP-233164				NSAG information for alternative S-NSSAI	18.5.0
			5760	1	F		
2023-12	CT#102	CP-233164				NS-AoS of alternative S-NSSAI	18.5.0
			5761	1	F		
2023-12	CT#102	CP-233164				Updating the S-NSSAI location validity information IE coding	18.5.0
			5710	1	B		
2023-12	CT#102	CP-233164				Request lower layer to enter connected state for data over UP based on NS-AoS	18.5.0
			5758	1	F		
2023-12	CT#102	CP-233164				Control plane user data when the UE is outside NS-AoS	18.5.0
			5763	1	F		
2023-12	CT#102	CP-233164				Acknowledge the reception of S-NSSAI location or time validity information	18.5.0
			5764	1	F		
2023-12	CT#102	CP-233164				Reject cause for UE not supporting S-NSSAI time validity information	18.5.0
			5728	1	F		
2023-12	CT#102	CP-233164				Correction to the CONFIGURATION UPDATE COMMAND message	18.5.0
			5749	1	F		
2023-12	CT#102	CP-233164				Applicability of validity time information across access type	18.5.0
			5839	1	B		
2023-12	CT#102	CP-233164				Performing MRU for partially rejected NSSAI	18.5.0
			5721	1	F		

2023-12	CT#102	CP-233164	5756	1	F	Missing consideration of partially allowed NSSAI for handover of a session from non-3gpp to 3gpp	18.5.0
2023-12	CT#102	CP-233166	5526	2	C	Update the handling on collision of PDU session modification procedures	18.5.0
2023-12	CT#102	CP-233164	5804	-	B	UE storage of network slice usage control information	18.5.0
2023-12	CT#102	CP-233162	5779	1	F	Addition of SNPNs for localized service in SNPN along with GINs in forbidden lists	18.5.0
2023-12	CT#102	CP-233162	5795	1	B	Handling of equivalent SNPN for localized services	18.5.0
2023-12	CT#102	CP-233151	5773	1	F	Clarification on the non-3GPP path switching capability when a UE is registered to different PLMNs over 3GPP and non-3GPP accesses	18.5.0
2023-12	CT#102	CP-233167	5828	1	F	Extended LADN information deletion when enter deregistered	18.5.0
2023-12	CT#102	CP-233189	5741	1	F	UE act upon receiving 5GMM cause #76	18.5.0
2023-12	CT#102	CP-233190	5817	1	F	Correction related to N5GC device supporting acting as EAP peer	18.5.0
2023-12	CT#102	CP-233189	5711	1	F	Correction on the Received MBS container IE coding	18.5.0
2023-12	CT#102	CP-233141	5800	1	F	Clarification of the UE behavior disabling N1 mode capability	18.5.0
2023-12	CT#102	CP-233141	5800	1	F	Clarification of the UE behavior disabling N1 mode capability	18.5.0
2023-12	CT#102	CP-233141	5825	1	F	Clarification related to Exception Data Reporting	18.5.0
2023-12	CT#102	CP-233141	5489	2	F	Access check of IMS registration during an ongoing IMS voice or video call	18.5.0
2023-12	CT#102	CP-233141	5716	1	F	Correction to PEIPS information in abnormal case	18.5.0
2023-12	CT#102	CP-233141	5826	1	F	The PLMN for pending and rejected NSSAI	18.5.0
2023-12	CT#102	CP-233149	5814	1	B	Deactivate MICO mode at the broadcast start time/activation times of a broadcast MBS session	18.5.0
2023-12	CT#102	CP-233141	5743	1	F	UE Behavior on expiry of timer	18.5.0
2023-12	CT#102	CP-233141	5823	1	F	Clarification on 5GMM status and Notification for T3540 handling	18.5.0
2023-12	CT#102	CP-233141	5670	2	F	Correction on use of and/or term	18.5.0
2023-12	CT#102	CP-233141	5487	1	F	5GMM context storage when emergency attached	18.5.0
2023-12	CT#102	CP-233140	5770	2	A	Update configured NSSAI if slice subscription changed	18.5.0
2023-12	CT#102	CP-233145	5717	2	F	Remove coverage loss indication	18.5.0
2023-12	CT#102	CP-233145	5639	4	B	Update to discontinuous coverage overload control for mobility registration update	18.5.0
2023-12	CT#102	CP-233141	5235	5	F	UAC for Multiple Events	18.5.0
2023-12	CT#102	CP-233141	5486	3	F	Release of the NAS signalling connection established from 5GMM-IDLE mode	18.5.0
2023-12	CT#102	CP-233150	5812	2	B	Impact on NAS signalling for supporting authentication of AUN3 devices supporting and not supporting 5G key hierarchy	18.5.0
2023-12	CT#102	CP-233199	5735	2	F	Removing ENs for VMR	18.5.0
2023-12	CT#102	CP-233164	5729	2	F	Clarification of slice deregistration inactivity timer handling for MA PDU sessions	18.5.0
2023-12	CT#102	CP-233151	5774	2	F	Correction on handling of PDU sessions that are not requested to be moved to the new non-3GPP access	18.5.0
2023-12	CT#102	CP-233145	5792	2	F	Update to Note to align with stage-2	18.5.0
2023-12	CT#102	CP-233162	5746	3	F	Removal of SNPN(s) from the equivalent SNPN list	18.5.0
2023-12	CT#102	CP-233141	5834	2	F	PDU session release collision	18.5.0
2023-12	CT#102	CP-233141	5782	3	F	Saving SNPN selection parameters for USIM in NV	18.5.0
2023-12	CT#102	CP-233150	5725	2	C	Service area restriction for AUN3 device behind 5G-RG	18.5.0
2023-12	CT#102	CP-233164	5772	3	B	Support of network slice usage control during the registration procedure	18.5.0
2023-12	CT#102	CP-233189	5742	2	F	Clarification on remove S-NSSAI from NSAG information	18.5.0
2023-12	CT#102	CP-233162	5794	3	B	T3247 for localized service	18.5.0
2023-12	CT#102	CP-233130	5704	1	B	Remote UE identified by PEI	18.5.0
2023-12	CT#102	CP-233130	5820	1	B	Authentication and key agreement procedure for 5G ProSe UE-to-UE relay	18.5.0
2023-12	CT#102	CP-233195	5732	1	F	Security and privacy for Direct C2 communications for UUA-SM procedure	18.5.0
2023-12	CT#102	CP-233182	5754	1	F	Clarification on service request for ranging	18.5.0
2023-12	CT#102	CP-233180	5713	1	F	Correction to general clause for PIN service	18.5.0
2023-12	CT#102	CP-233180	5714	1	F	The PDU session handling related to PIN service	18.5.0
2023-12	CT#102	CP-233195	5821	1	B	Adding the A2X capability	18.5.0
2023-12	CT#102	CP-233195	5731	2	F	Security and privacy for Direct C2 communications for UUA-MM procedure	18.5.0
2023-12	CT#102	CP-233145	5736	3	F	Corrections to conditions for unavailability period reporting to override mobility management congestion control	18.5.0
2023-12	CT#102	CP-233142	5831	2	F	Handling of emergency services request when auth rejected	18.5.0
2023-12	CT#102	CP-233142	5490	2	F	E bit description in Mapped EPS bearer contexts IE and QoS flow descriptions IE	18.5.0
2023-12	CT#102	CP-233142	5734	2	F	URSP handling for UE configured with EHPLMN list	18.5.0
2023-12	CT#102	CP-233142	5844	1	F	Correction to the condition for stopping timer T3584 and T3585	18.5.0
2023-12	CT#102	CP-233142	5871	-	F	Adding the Deregistration Request message	18.5.0
2023-12	CT#102	CP-233164	5872	-	B	Including alternative S-NSSAI in allowed and configured NSSAI	18.5.0

2023-12	CT#102	CP-233142	5837	1	F	Clarification for the PDU session status IE in NOTIFICATION RESPONSE message	18.5.0
2023-12	CT#102	CP-233164	5883	-	F	Applicability of partially allowed NSSAI and partially rejected NSSAI	18.5.0
2023-12	CT#102	CP-233165	5886	-	F	Applicable access type of S-NSSAI location or time validity information	18.5.0
2023-12	CT#102	CP-233142	5892	-	F	Corrections in storage of Extended Rejected NSSAI	18.5.0
2023-12	CT#102	CP-233142	5527	2	F	PEIPS: Indicating Paging subgroup ID to Access Stratum layer	18.5.0
2023-12	CT#102	CP-233140	5915	-	A	Add missing posSibType to ciphering key data Rel-18	18.5.0
2023-12	CT#102	CP-233162	5918	-	B	WLANSF from RSNPN	18.5.0
2023-12	CT#102	CP-233182	5919	-	B	SLPP transport	18.5.0
2023-12	CT#102	CP-233195	5922	-	F	Correction to service request trigger bullet numbering	18.5.0
2023-12	CT#102	CP-233167	5923	-	F	Clarification of LADN service area	18.5.0
2023-12	CT#102	CP-233145	5929	-	F	Remove the redundant case for unavailability during registration	18.5.0
2023-12	CT#102	CP-233166	5931	-	F	EN resolution on the UE to inform the stored tuples to the network	18.5.0
2023-12	CT#102	CP-233150	5932	-	B	Protecting the N3IWF/TNGF identifier information in the REGISTRATION REJECT message	18.5.0
2023-12	CT#102	CP-233165	5944	-	F	partially allowed NSSAI storage	18.5.0
2023-12	CT#102	CP-233142	5953	-	D	Clarification of abnormal case handling in service request procedure	18.5.0
2023-12	CT#102	CP-233165	5958	-	F	Selection of an S-NSSAI by the AMF	18.5.0
2023-12	CT#102	CP-233189	5868	1	F	MPS NSAC note fix	18.5.0
2023-12	CT#102	CP-233189	5866	1	F	Redirection with MPS corrections	18.5.0
2023-12	CT#102	CP-233184	5840	1	F	Correction to SOR for Signal level enhanced network selection	18.5.0
2023-12	CT#102	CP-233185	5911	1	F	Correction on periodic update timer	18.5.0
2023-12	CT#102	CP-233185	5913	1	F	Clarification on UE behavior upon registration fails	18.5.0
2023-12	CT#102	CP-233185	5959	1	F	Clarification on support for unavailability period in non-3GPP accss	18.5.0
2023-12	CT#102	CP-233162	5879	1	F	Covering user reselection for localized service	18.5.0
2023-12	CT#102	CP-233162	5847	1	F	Congestion handling for UE accessing SNPN for localized services	18.5.0
2023-12	CT#102	CP-233162	5698	6	F	5GMM sub-state handling for localized services in SNPN	18.5.0
2023-12	CT#102	CP-233150	5723	2	B	AUN3 device de-registration	18.5.0
2023-12	CT#102	CP-233150	5644	5	C	Rejecting the registration request of AUN3 device due to no existing 5G-RG connected to the same line	18.5.0
2023-12	CT#102	CP-233150	5934	1	F	Clarification for NAUN3 device connecting to 5GC via 5G-RG that is connected to NG-RAN	18.5.0
2023-12	CT#102	CP-233128	5850	1	F	Clarification on UE capability supporting the user plane connection between UE and LCS client or AF	18.5.0
2023-12	CT#102	CP-233142	5924	1	F	Correction on the UE state indication procedure initiation	18.5.0
2023-12	CT#102	CP-233165	5775	3	B	General introduction on support of network slice usage control	18.5.0
2023-12	CT#102	CP-233165	5772	5	B	Support of network slice usage control during the registration procedure	18.5.0
2023-12	CT#102	CP-233165	5771	4	B	Support of network slice usage control during the UE configuration update procedure	18.5.0
2023-12	CT#102	CP-233165	5882	1	F	Partially rejected NSSAI for RFSP derivation	18.5.0
2023-12	CT#102	CP-233165	5884	1	F	PDU session establishment associated to partially allowed S-NSSAI	18.5.0
2023-12	CT#102	CP-233165	5885	1	F	Clarification on TA list associated with partial NSSAI	18.5.0
2023-12	CT#102	CP-233165	5908	1	F	Releasing PDU sessions for temporarily available network slices	18.5.0
2023-12	CT#102	CP-233165	5909	1	F	Splitting of location and time validity information for S-NSSAI	18.5.0
2023-12	CT#102	CP-233145	5846	1	F	Correction to the AMF handling for unavailability period	18.5.0
2023-12	CT#102	CP-233148	5859	1	B	The end of unavailability period report handling	18.5.0
2023-12	CT#102	CP-233148	5861	1	B	Handling T3448 timer during unavailability period	18.5.0
2023-12	CT#102	CP-233145	5755	2	F	Timer for NAS release when the start of unavailability period is not sent	18.5.0
2023-12	CT#102	CP-233151	5935	2	F	Corrections related to ATSSS steering functionalities and their usage (TS 24.501)	18.5.0
2023-12	CT#102	CP-233167	5877	1	B	PDU session establishment rejection for Maximum Group Data Rate control	18.5.0
2023-12	CT#102	CP-233142	5949	1	F	Updating MCS indicator via configuration update command procedure	18.5.0
2023-12	CT#102	CP-233142	5955	1	D	Editorial corrections for NOTES	18.5.0
2023-12	CT#102	CP-233142	5887	1	F	Abnormal case handling for T3550 time out	18.5.0
2023-12	CT#102	CP-233142	5888	1	F	Clarification on NSSAI storage	18.5.0
2023-12	CT#102	CP-233142	5952	1	F	Clarification of MPS validity	18.5.0
2023-12	CT#102	CP-233142	5894	1	F	Registration Reject in shared networks	18.5.0
2023-12	CT#102	CP-233143	5954	1	F	Consideration of satellite cell after disabling N1 mode	18.5.0
2023-12	CT#102	CP-233143	5906	1	F	List of networks where the N1 mode capability was disabled upon receipt of 5GMM cause #62	18.5.0
2023-12	CT#102	CP-233143	5956	1	F	Missing DEREGISTRATION REQUEST message as content of a NAS message container IE	18.5.0

2023-12	CT#102	CP-233143	5857	1	F	Equivalent PLMN or SNPN list handling of rejecting message and network no response cases	18.5.0
2023-12	CT#102	CP-233144	5856	1	F	Correction due to PLMN Search state is not applicable to non-3GPP access	18.5.0
2023-12	CT#102	CP-233190	5880	1	F	Correction on additional information IE inclusion for LPP message transfer	18.5.0
2023-12	CT#102	CP-233143	5479	5	F	Correction of UE policy sections management	18.5.0
2023-12	CT#102	CP-233140	5870	2	A	Correction of definition and handling of HPLMN S-NSSAIs	18.5.0
2023-12	CT#102	CP-233179	5875	2	A	Correction on NSAG priority	18.5.0
2023-12	CT#102	CP-233162	5702	4	F	TAI based location assistance information	18.5.0
2023-12	CT#102	CP-233185	5912	2	F	Clarification on 5GMM context	18.5.0
2023-12	CT#102	CP-233143	5893	1	F	Locally setting mapped NSSAI for the Extended rejected NSSAI	18.5.0
2023-12	CT#102	CP-233150	5933	2	B	5GMM context for the AUN3 device	18.5.0
2023-12	CT#102	CP-233165	5930	2	B	On-demand NSSAI storage	18.5.0
2023-12	CT#102	CP-233165	5896	2	F	Update slice deregistration inactivity timer value	18.5.0
2023-12	CT#102	CP-233165	5873	1	B	Alternative S-NSSAI not part of subscribed S-NSSAIs	18.5.0
2023-12	CT#102	CP-233185	5957	2	F	Minor corrections of ambiguous texts in clause related to unavailability period	18.5.0
2023-12	CT#102	CP-233132	5950	1	F	Clarification on determining the RRC establishment cause value for 5G ProSe L2 U2N relay UE	18.5.0
2023-12	CT#102	CP-233182	5881	1	F	Network capability to UE	18.5.0
2023-12	CT#102	CP-233143	5863	2	F	UE behaviour in case of RRC Connection failure and fallback indication from lower layers	18.5.0
2023-12	CT#102	CP-233165	5898	2	B	Clarification of the UE storage of network slice usage control information.	18.5.0
2023-12	CT#102	CP-233128	5903	2	F	PRU enhancement of UE-initiated NAS transport of messages accepted by the network	18.5.0
2023-12	CT#102	CP-233165	5895	3	F	Clarification on UE stored slice usage control information	18.5.0
2023-12	CT#102	CP-233148	5860	2	B	Receiving unavailability period duration from the network	18.5.0
2023-12	CT#102	CP-233149	5937	2	B	Supporting multicast MBS session and Broadcast MBS session for UE that uses eDRX	18.5.0
2023-12	CT#102	CP-233143	5832	3	F	Correction to forbidden TAI handling for reject cause #62	18.5.0
2023-12	CT#102	CP-233165	5940	2	B	UE behaviour of slice deregistration inactivity timer regarding MA PDU session in PDU session release procedure	18.5.0
2023-12	CT#102	CP-233165	5948	2	F	Network behavior for on-demand NSSAI in the Generic UE configuration update procedure	18.5.0
2023-12	CT#102	CP-233165	5942	2	B	UE behaviour of slice deregistration inactivity timer regarding MA PDU session in PDU session establishment procedure	18.5.0
2023-12	CT#102	CP-233167	5926	5	F	UE behavior in overlapping areas between LADN service area and partial network slice support area	18.5.0
2023-12	CT#102	CP-233143	5864	2	D	Miscellaneous corrections	18.5.0
2023-12	CT#102	CP-233189	5917	2	F	Clarification on storage of NSAG information	18.5.0
2023-12	CT#102	CP-233121	5921	3	B	UPP-CMI container transport	18.5.0
2023-12	CT#102	CP-233204	5878	6	B	Location validity information for localized services	18.5.0
2023-12	CT#102	CP-233317	5927	3	F	Clarification on the unavailability period in deregistration procedure	18.5.0
2023-12	CT#102	CP-233141	5653	5	F	Clarification on the network behavior when sending CC #76 via non-CAG cell	18.5.0
2024-03	CT#103	CP-240087	5963	1	F	Minor corrections for Payload container information IE	18.6.0
2024-03	CT#103	CP-240087	5965	1	F	Correction on the definition of UPP-CMI	18.6.0
2024-03	CT#103	CP-240087	5966	1	F	Correction on network indication of supported user plane location solution(s)	18.6.0
2024-03	CT#103	CP-240125	5977	-	D	Minor corrections	18.6.0
2024-03	CT#103	CP-240125	5993	-	F	UE capability indication to the network for network verified UE location support	18.6.0
2024-03	CT#103	CP-240089	6014	-	F	Correction on capability indication for 5G ProSe layer-2 end UE	18.6.0
2024-03	CT#103	CP-240106	6016	-	F	Clarification on the access type of on-demand NSSAI	18.6.0
2024-03	CT#103	CP-240093	6017	-	F	Corrections on coding description of the Service-level-AA container	18.6.0
2024-03	CT#103	CP-240097	6020	-	F	Correction to the TNAN information IE	18.6.0
2024-03	CT#103	CP-240125	6021	-	F	Correction to IEEE standards references	18.6.0
2024-03	CT#103	CP-240106	6023	-	F	Correction to an unnecessary sentence	18.6.0
2024-03	CT#103	CP-240106	6029	-	F	AMF behavior when non-supporting UE is outside NS-AoS	18.6.0
2024-03	CT#103	CP-240119	6035	-	F	Correction on the N3QAI and non-3GPP delay budget	18.6.0
2024-03	CT#103	CP-240093	6036	-	F	Correction on the PLMN code	18.6.0
2024-03	CT#103	CP-240093	6037	-	F	Correction on the PEIPS assistance information	18.6.0
2024-03	CT#103	CP-240093	6051	-	F	Service-level AA and congestion	18.6.0
2024-03	CT#103	CP-240093	6072	-	F	Performing both UUA-MM and UUA-SM	18.6.0
2024-03	CT#103	CP-240093	6086	-	F	Correction to 5GMM cause and table number for 5GMM STATUS	18.6.0
2024-03	CT#103	CP-240099	6088	-	F	Corrections for the UE capabilities related to the ATSSS steering functionalities	18.6.0
2024-03	CT#103	CP-240125	6091	-	F	Corrections for setting the TPMIC bit in the 5GSM capability IE	18.6.0
2024-03	CT#103	CP-240095	6114	-	F	Correction to encoding of unavailability configuration	18.6.0

2024-03	CT#103	CP-240109	6061	1	A	Correction on the minimum length of the SLAC	18.6.0
2024-03	CT#103	CP-240106	6028	1	F	Network slice replacement considering NS-AoS	18.6.0
2024-03	CT#103	CP-240106	6079	1	B	Removal of replaced slice from allowed NSSAI due to being out of NS-AoS	18.6.0
2024-03	CT#103	CP-240106	6075	1	F	Addition of Alternative slice in Allowed and/or Configured NSSAI for network slice replacement	18.6.0
2024-03	CT#103	CP-240106	5987	1	F	Registration accept type 6 IE container corrections	18.6.0
2024-03	CT#103	CP-240106	6030	1	F	Downlink data handling when UE location is unknown	18.6.0
2024-03	CT#103	CP-240106	6031	1	F	Session management when the UE is in a cell not within NS-AoS of S-NSSAI	18.6.0
2024-03	CT#103	CP-240106	6085	1	F	Correction regarding S-NSSAI location validity information	18.6.0
2024-03	CT#103	CP-240106	6044	1	F	Condition for inclusion of partially allowed NSSAI	18.6.0
2024-03	CT#103	CP-240106	6012	1	F	Correction on On-demand NSSAI IE coding	18.6.0
2024-03	CT#103	CP-240106	6033	1	F	Network slice usage control not applicable for emergency services	18.6.0
2024-03	CT#103	CP-240106	6056	1	F	Clarifies when the slice deregistration inactivity timer starts when it is updated.	18.6.0
2024-03	CT#103	CP-240106	6125	1	F	Terminology align of the Network slice usage control information	18.6.0
2024-03	CT#103	CP-240093	6129	-	F	Correction to timers handling in MICO mode	18.6.0
2024-03	CT#103	CP-240095	6024	1	F	Correction to the term unavailability duration	18.6.0
2024-03	CT#103	CP-240097	6068	1	F	Registration rejection due to AUN3 device connectivity not allowed	18.6.0
2024-03	CT#103	CP-240097	6084	1	B	USRP rule enforcement reporting is not supported by 5G-RG and FN-RG	18.6.0
2024-03	CT#103	CP-240105	6010	1	F	UE handling of SOR-SNP-SI-LS	18.6.0
2024-03	CT#103	CP-240105	6011	1	F	Reference on SNP selected for localized services in SNP	18.6.0
2024-03	CT#103	CP-240087	6019	1	B	Add Additional information IE for UPP-CMI container in UE initiated NAS transport procedure	18.6.0
2024-03	CT#103	CP-240108	5360	8	B	Connection Capabilities in N1 SM container	18.6.0
2024-03	CT#103	CP-240108	6069	1	F	URSP provisioning in EPS and PDU session / PDN connection transferred between 5GS and EPS	18.6.0
2024-03	CT#103	CP-240095	6001	1	B	Handling NOTIFICATION when UE unavailable	18.6.0
2024-03	CT#103	CP-240095	6098	1	F	Clarification on the periodic registration update timer	18.6.0
2024-03	CT#103	CP-240095	6104	1	F	Clarification on NAS timer value handling for satellite NG-RAN access	18.6.0
2024-03	CT#103	CP-240093	6047	1	F	Correction in clause for AUTH failure in SNP with no CH support	18.6.0
2024-03	CT#103	CP-240093	6009	1	F	Storing NAS security context due to registering to different PLMN in the same access	18.6.0
2024-03	CT#103	CP-240093	5938	3	F	Correction for PDU session type selection in the RSD	18.6.0
2024-03	CT#103	CP-240093	6046	1	F	Clarification of USIM validity for 5GS services	18.6.0
2024-03	CT#103	CP-240093	6048	1	F	Missing clause for KAMF derivation for SNP	18.6.0
2024-03	CT#103	CP-240131	6063	1	F	Clarification of MBSR authorization indication during registration procedure	18.6.0
2024-03	CT#103	CP-240093	5985	1	F	5GSM message transfer in a TA with service area restrictions in 5GMM-CONNECTED mode	18.6.0
2024-03	CT#103	CP-240093	6050	1	F	DL NAS TRANSPORT message with N1 SM information and undefined cause value	18.6.0
2024-03	CT#103	CP-240093	5043	3	F	Handling of SOR counter and the UE parameter update counter if stored in NVM	18.6.0
2024-03	CT#103	CP-240093	6096	1	F	Minor Correction for AMF supporting interworking with EPS	18.6.0
2024-03	CT#103	CP-240093	6101	1	F	Provision of NSAG information to lower layers for SR for UL signalling	18.6.0
2024-03	CT#103	CP-240093	6078	1	F	Correction to referred SM NAS timer table for satellite	18.6.0
2024-03	CT#103	CP-240120	5992	1	F	Corrections to the network indication to the UE for ranging and sidelink positioning support	18.6.0
2024-03	CT#103	CP-240120	6015	1	F	Modification on naming of ranging and sidelink capability	18.6.0
2024-03	CT#103	CP-240120	6100	3	C	Update UE ranging and sidelink positioning capability per role	18.6.0
2024-03	CT#103	CP-240088	6053	1	F	Remote UE report collision with connection release	18.6.0
2024-03	CT#103	CP-240106	6022	1	F	Clarification on the MRU procedure for on-demand S-NSSAI(s) registration	18.6.0
2024-03	CT#103	CP-240125	5939	3	F	Clarification on NSSAI provide to lower layers	18.6.0
2024-03	CT#103	CP-240106	6107	1	F	Clarification on requested NSSAI on alternative NSSAI	18.6.0
2024-03	CT#103	CP-240094	6105	1	F	Clarification on maximum number of S-NSSAI in requested NSSAI	18.6.0
2024-03	CT#103	CP-240097	6083	2	F	The handling of 5GMM parameters upon receiving Registration Reject with cause #81 or #82	18.6.0
2024-03	CT#103	CP-240106	6027	2	F	Alternative S-NSSAI or S-NSSAI to be replaced subject to NSSAA	18.6.0
2024-03	CT#103	CP-240106	6043	2	F	Deleting Partially Allowed and Partially Rejected NSSAI	18.6.0
2024-03	CT#103	CP-240106	6128	2	F	Clarification on UE, AMF and SMF behaviour regarding network slice replacement	18.6.0

2024-03	CT#103	CP-240095	5981	2	C	Handling of unavailability period in the initial registration procedure	18.6.0
2024-03	CT#103	CP-240094	6049	2	F	5GMM handling when receiving cause 80	18.6.0
2024-03	CT#103	CP-240095	6054	2	F	Stop discontinuous coverage maximum time offset timer on receiving NOTIFICATION message.	18.6.0
2024-03	CT#103	CP-240094	6109	1	F	Delete QoS rule when rejected with CC #31	18.6.0
2024-03	CT#103	CP-240094	6073	1	F	UAC and network-requested PDU session modification procedure	18.6.0
2024-03	CT#103	CP-240106	6034	2	F	Correction on NSUC bit in the 5GMM capability IE	18.6.0
2024-03	CT#103	CP-240096	6102	3	F	Support of MBS data reception for UEs using power saving functions	18.6.0
2024-03	CT#103	CP-240105	5920	4	B	CP-SOR corrections in 24.501	18.6.0
2024-03	CT#103	CP-240106	6123	3	F	Further clarification on the handle of changed TAI case	18.6.0
2024-03	CT#103	CP-240106	6124	3	F	Network slice usage control applicability in roaming scenarios	18.6.0
2024-03	CT#103	CP-240095	6099	2	F	Clarification on the unavailability period duration	18.6.0
2024-03	CT#103	CP-240106	5978	3	F	S-NSSAI time validity expiry for last allowed S-NSSAI, alternative 1	18.6.0
2024-03	CT#103	CP-240132	6013	2	B	Clarification on PDU set handling	18.6.0
2024-03	CT#103	CP-240132	5649	11	B	General description of PDU set handling	18.6.0
2024-03	CT#103	CP-240094	6108	3	F	Clarification on inter-system change for UE registered for emergency services	18.6.0
2024-03	CT#103	CP-240094	6110	3	F	Clarification on failed instruction order	18.6.0
2024-03	CT#103	CP-240094	6040	3	F	MRU to register additional slices available from Configured NSSAI.	18.6.0
2024-03	CT#103	CP-240105	6055	3	F	Re-enable N1 mode for SNPN on validity condition met	18.6.0
2024-03	CT#103	CP-240131	6059	2	F	Release the PDU session to support of the MBSR	18.6.0
2024-03	CT#103	CP-240106	6062	2	F	PDU session associated with replaced S-NSSAI	18.6.0
2024-03	CT#103	CP-240106	6092	3	B	Slice replacement back to the replaced S-NSSAI	18.6.0
2024-03	CT#103	CP-240095	6066	2	B	Addition of start of unavailability configuration from the NW to the UE	18.6.0
2024-03	CT#103	CP-240095	5928	6	F	Clarification on the unavailability period	18.6.0
2024-03	CT#103	CP-240095	6115	4	F	Correction on support for unavailability period	18.6.0
2024-03	CT#103	CP-240128	6065	3	F	LADN Provisioning when there is existing PDU session	18.6.0
2024-03	CT#103	CP-240094	6103	3	F	Clarification on common NSSRG value for pending NSSAI	18.6.0
2024-03	CT#103	CP-240125	6018	2	F	Correction of the conditions for initiating a de-registration in 5GMM-REGISTERED.ATTEMPTING-TO-UPDATE and 5GMM-REGISTERED.UPDATE-NEEDED	18.6.0
2024-03	CT#103	CP-240094	5983	3	F	Corrections to the access identity 1 & 2 handling	18.6.0
2024-03	CT#103	CP-240106	5989	3	F	PDU Session management when the UE is outside the area of slice support or availability	18.6.0
2024-03	CT#103	CP-240219	5988	6	F	Clarifications on Network slice replacement	18.6.0
2024-03	CT#103	CP-240248	5973	6	B	Protocol description support	18.6.0
2024-03	CT#103	CP-240250	5976	1	F	Unavailability information IE inclusion	18.6.0
2024-03	CT#103	CP-240286	6106	3	F	Reset counter when activating unavailability period	18.6.0
2024-03	CT#103	CP-240291	5986	4	F	Inclusion of SSC mode IE in case of inter-system change to N1 mode	18.6.0
2024-03	CT#103	CP-240293	6007	4	F	Change in unavailability information	18.6.0
2024-03	CT#103	CP-240294	6008	3	F	Correction to timers handling in unavailability period	18.6.0
2024-03	CT#103	CP-240295	5996	2	F	5GMM state when disaster wait timer is running	18.6.0
2024-06	CT#104	CP-241178	6141	-	F	Correction to abnormal cases on the network side	18.7.0
2024-06	CT#104	CP-241161	6142	-	F	Corrections to incorrect agreed CR5983 not noticed till CR implementation	18.7.0
2024-06	CT#104	CP-241164	6143	-	F	Handling of T3444 and T3445 during UA activation	18.7.0
2024-06	CT#104	CP-241178	6146	-	F	Correction to the PDU SESSION ESTABLISHMENT REQUEST message	18.7.0
2024-06	CT#104	CP-241176	6158	-	F	Congestion handling for SNPN providing access for localized services in SNPN	18.7.0
2024-06	CT#104	CP-241177	6167	-	D	Removal of duplicated paragraph for on-demand NSSAI in initial registration	18.7.0
2024-06	CT#104	CP-241177	6171	-	F	SMF performs NSAC for replaced S-NSSAI and alternative S-NSSAI	18.7.0
2024-06	CT#104	CP-241177	6172	-	F	Term consistency for replaced S-NSSAI	18.7.0
2024-06	CT#104	CP-241161	6181	-	F	Corrections to subject of subclause 5.4.5.3.3	18.7.0
2024-06	CT#104	CP-241161	6203	-	F	Correction on N1 mode capability handling during SoR procedure in connected mode	18.7.0
2024-06	CT#104	CP-241163	6212	-	F	Correction for the Start of the unavailability period	18.7.0
2024-06	CT#104	CP-241161	6216	-	F	Clarification for AMF behaviour on UE location verification for satellite access	18.7.0
2024-06	CT#104	CP-241203	6223	-	D	Editorial correction for MBSR	18.7.0
2024-06	CT#104	CP-241177	6147	1	F	Correction to the CONFIGURATION UPDATE COMMAND message	18.7.0
2024-06	CT#104	CP-241177	6173	1	F	Correction on IoT user data transmission for network slice with NS-AoS and partial network slice	18.7.0

2024-06	CT#104	CP-241177	6175	1	F	Inclusion of Allowed PDU session status IE considering S-NSSAI location validity information	18.7.0
2024-06	CT#104	CP-241177	6217	1	F	Correction on the parameter name in the S-NSSAI time validity information IE	18.7.0
2024-06	CT#104	CP-241177	6150	1	F	Correcting requirements for emergency services and the network slice usage control for the S-NSSAI	18.7.0
2024-06	CT#104	CP-241177	6177	1	F	Term definition for on-demand S-NSSAI and on-demand NSSAI	18.7.0
2024-06	CT#104	CP-241175	6153	1	F	SOR-SNPNI-SI and SOR-SNPNI-SI-SL indicators set in UL NAS transport	18.7.0
2024-06	CT#104	CP-241176	6221	1	F	Reference corrections in SNPNI clause	18.7.0
2024-06	CT#104	CP-241165	6136	1	F	Handling of abnormal cases of cause 81 and 82	18.7.0
2024-06	CT#104	CP-241165	6192	1	F	Definitions and abbreviations for NAUN3 device and AUN3 device	18.7.0
2024-06	CT#104	CP-241178	6206	1	F	URSP rule enforcement reporting after an inter-system change from S1 mode to N1 mode	18.7.0
2024-06	CT#104	CP-241163	6164	1	F	Consideration of discontinuous coverage maximum time offset for determination of periodic T3512 timer.	18.7.0
2024-06	CT#104	CP-241161	6166	1	F	Tsense timer handling for MICO mode	18.7.0
2024-06	CT#104	CP-241163	6201	1	F	Update of the initial registration accept handling for the start of unavailability period time.	18.7.0
2024-06	CT#104	CP-241163	6215	1	F	Clarification on the unavailability case in registration procedure	18.7.0
2024-06	CT#104	CP-241167	6185	1	F	Corrections to NAS transport for Non-3GPP access path switching	18.7.0
2024-06	CT#104	CP-241204	6200	1	F	Abbreviations for PDU set handling	18.7.0
2024-06	CT#104	CP-241179	6154	1	F	AMF handling on LADN provisioning for an existing PDU session	18.7.0
2024-06	CT#104	CP-241179	6191	1	F	Correction to the area restriction for LADN	18.7.0
2024-06	CT#104	CP-241179	6193	1	F	Correction to the inclusion condition of extended LADN information	18.7.0
2024-06	CT#104	CP-241179	6194	1	F	Correction to the wrong message name for LADN information	18.7.0
2024-06	CT#104	CP-241179	6219	1	F	Clarification of ambiguous statement for LADN	18.7.0
2024-06	CT#104	CP-241165	6182	1	F	Clarification of ANDSP and URSP coding	18.7.0
2024-06	CT#104	CP-241199	6195	1	F	Add abbreviation for ABBAf	18.7.0
2024-06	CT#104	CP-241199	6197	1	D	Minor corrections	18.7.0
2024-06	CT#104	CP-241161	6052	2	F	Clarification on disabling and enabling N1 mode for deregistration abnormal	18.7.0
2024-06	CT#104	CP-241161	6160	1	F	The UE handling on the MICO mode	18.7.0
2024-06	CT#104	CP-241161	6186	1	F	Correction to PDU session reactivation result IE	18.7.0
2024-06	CT#104	CP-241161	6202	1	F	Handling of congestion control for transport of user data via the control plane timer for emergency services	18.7.0
2024-06	CT#104	CP-241164	6130	2	F	Clarification on the negotiation of the unavailability period duration during initial registration procedure	18.7.0
2024-06	CT#104	CP-241177	6170	2	F	Remove alternative S-NSSAI from allowed NSSAI and configured NSSAI	18.7.0
2024-06	CT#104	CP-241161	6071	4	F	Inter-system change for SSC mode 2 or SSC mode 3 PDU session	18.7.0
2024-06	CT#104	CP-241159	6152	3	F	Handling of regulatory prioritized services in non-allowed area	18.7.0
2024-06	CT#104	CP-241179	6188	2	F	Clarification to the S-NSSAI in extended LADN information	18.7.0
2024-06	CT#104	CP-241161	6207	2	F	Handling of collision between 5GMM common procedure and deregistration procedure.	18.7.0
2024-06	CT#104	CP-241163	6199	2	F	Update on the condition for AMF to determine periodic timer	18.7.0
2024-06	CT#104	CP-241192	6139	1	F	Minor corrections	18.7.0
2024-06	CT#104	CP-241161	6135	2	F	Handling of Restricted service area cause in non-restricting cases	18.7.0
2024-06	CT#104	CP-241180	6137	2	F	Handling of UAS services not allowed cause for a UE not supporting UAS services	18.7.0
2024-06	CT#104	CP-241164	6178	2	F	Corrected that the deregistration procedure is used only for non satellite cases.	18.7.0
2024-06	CT#104	CP-241160	6237	-	F	Applicability of DefaultNSSAIInclusionMode	18.7.0
2024-06	CT#104	CP-241160	6251	-	F	Missing occurrence of the CPSR message for existing abnormal cases	18.7.0
2024-06	CT#104	CP-241153	6253	-	F	Removal of UPP-CM	18.7.0
2024-06	CT#104	CP-241204	6228	5	F	Corrections for aligning statements for UL PDU set handling	18.7.0
2024-06	CT#104	CP-241177	6257	-	F	Network slice replacement during PDU session establishment procedure	18.7.0
2024-06	CT#104	CP-241177	6262	-	F	Remove redundant paragraph for network slice usage control	18.7.0
2024-06	CT#104	CP-241177	6263	-	F	Network slice usage control for non-supporting UE	18.7.0
2024-06	CT#104	CP-241177	6264	-	F	Slice deregistration inactivity timer per access type	18.7.0
2024-06	CT#104	CP-241153	6265	-	F	DL NAS transport of UPP-CMI container	18.7.0
2024-06	CT#104	CP-241204	6198	2	F	Correction to RTP header extension in Protocol description IE	18.7.0
2024-06	CT#104	CP-241204	6270	-	F	Delete protocol description associated with a QoS rule	18.7.0
2024-06	CT#104	CP-241164	6294	-	F	Correction to handling of Follow-on request indicator in MRU for UA	18.7.0
2024-06	CT#104	CP-241164	6298	-	F	Clarification of T3324 in UA	18.7.0
2024-06	CT#104	CP-241164	6299	-	F	NR disable timers and unavailability period	18.7.0

2024-06	CT#104	CP-241160	6305		F	Clarification on initial registration for emergency services	18.7.0
2024-06	CT#104	CP-241175	6306	-	D	Minor correction of wrong NOTE numbering	18.7.0
2024-06	CT#104	CP-241163	6309	-	F	Add reference to the satellite coverage availability information	18.7.0
2024-06	CT#104	CP-241160	6321	-	F	Correction on missing abbreviations	18.7.0
2024-06	CT#104	CP-241204	6180	2	F	Clarification on UL PDU set handling	18.7.0
2024-06	CT#104	CP-241177	6248	1	F	Correction on coding of S-NSSAI location validity information	18.7.0
2024-06	CT#104	CP-241177	6259	1	F	Transition to RRC_CONNECTED state considering partially allowed NSSAI and S-NSSAI location validity information	18.7.0
2024-06	CT#104	CP-241177	6260	1	F	Maximum number of S-NSSAIs in allowed NSSAI and partially allowed NSSAI	18.7.0
2024-06	CT#104	CP-241177	6250	1	F	Slice deregistration timer during MICO	18.7.0
2024-06	CT#104	CP-241177	6300	1	F	Clarification of slice deregistration timer in deregistered state	18.7.0
2024-06	CT#104	CP-241177	6313	1	F	Slice deregistration inactivity timer for PDU session release	18.7.0
2024-06	CT#104	CP-241164	6268	1	D	Editorial corrections on unavailability configuration and unavailability information	18.7.0
2024-06	CT#104	CP-241175	6240	1	F	Corrections for forbidden SNPNs in 24.501	18.7.0
2024-06	CT#104	CP-241176	6266	1	D	Correction on 5GMM capability indication for equivalent SNPNs support	18.7.0
2024-06	CT#104	CP-241177	6174	1	F	Maximum number of S-NSSAIs in S-NSSAI location validity information IE	18.7.0
2024-06	CT#104	CP-241163	6307	1	F	Correction about terminology regarding 5GSAT	18.7.0
2024-06	CT#104	CP-241163	6279	1	F	Clarification on the unavailability due to UE reasons	18.7.0
2024-06	CT#104	CP-241163	6277	1	F	Clarification on the end of unavailability period report	18.7.0
2024-06	CT#104	CP-241204	6229	4	F	Update UL PDU Set handling when inter-system change	18.7.0
2024-06	CT#104	CP-241165	6274	1	F	Correction for the TNGF ID	18.7.0
2024-06	CT#104	CP-241184	6242	1	D	Replacement of MS with UE for the term MS determined PLMN with disaster condition	18.7.0
2024-06	CT#104	CP-241198	6273	1	F	Clarifications related to QoS flow descriptions	18.7.0
2024-06	CT#104	CP-241177	6261	1	F	Registration complete message to acknowledge the reception of on-demand NSSAI	18.7.0
2024-06	CT#104	CP-241160	6140	2	F	UE identity handling in case of a USIM removal during a registration procedure	18.7.0
2024-06	CT#104	CP-241160	6267	1	F	Clarification on purpose of service request procedure	18.7.0
2024-06	CT#104	CP-241160	6280	1	F	Clarification on some causes received in cell belonging to SNPN	18.7.0
2024-06	CT#104	CP-241160	6281	1	F	Correction on Extended CAG information list IE	18.7.0
2024-06	CT#104	CP-241160	6196	3	F	Correction to the checking of allowed TAI list in attempting to update state.	18.7.0
2024-06	CT#104	CP-241160	6304	1	D	Minor corrections in cause#36 and #62	18.7.0
2024-06	CT#104	CP-241160	6317	1	F	Revise confusing statement in HPLMN S-NSSAI(s) handling	18.7.0
2024-06	CT#104	CP-241164	6289	2	D	Clarification of ambiguity in clause 5.3.26	18.7.0
2024-06	CT#104	CP-241177	6258	2	F	Clarification when the only allowed S-NSSAI expires	18.7.0
2024-06	CT#104	CP-241167	6275	2	F	Corrections on supporting steering modes for the MA PDU session	18.7.0
2024-06	CT#104	CP-241204	6224	2	F	Clarification for QoS rule associated with UL Protocol description	18.7.0
2024-06	CT#104	CP-241177	6156	7	F	Re-enable N1 Mode based on timer validity information	18.7.0
2024-06	CT#104	CP-241177	6190	4	F	Handling of PDU session reactivation when the UE is not located in NS-AoS	18.7.0
2024-06	CT#104	CP-241163	6278	2	F	Clarification on the unavailability configuration during initial registration	18.7.0
2024-06	CT#104	CP-241198	6234	2	F	T3448 exemption for MPS	18.7.0
2024-06	CT#104	CP-241160	6074	5	F	MINT corrections in 24.501	18.7.0
2024-06	CT#104	CP-241160	5997	5	F	Disaster timers handling	18.7.0
2024-06	CT#104	CP-241203	6272	2	F	Clarification on AMF behavior during the deregistration procedure	18.7.0
2024-06	CT#104	CP-241160	5995	5	F	MM parameter handling when receiving DL NAS transport message with cause 78	18.7.0
2024-06	CT#104	CP-241177	6288	2	F	Update of partially allowed NSSAI for network slice replacement operation in the configuration update procedure and registration procedure	18.7.0
2024-06	CT#104	CP-241177	6314	2	F	Slice deregistration inactivity timer at unavailability activation	18.7.0
2024-06	CT#104	CP-241177	6252	4	F	Start of the slice inactivity timer based on the PDU session status IE	18.7.0
2024-06	CT#104	CP-241198	6247	2	F	Corrections to satellite access technologies in disabling and re-enabling of UE's N1 mode capability for 3GPP access	18.7.0
2024-06	CT#104	CP-241177	6311	3	F	NSSAI List Clarification	18.7.0
2024-06	CT#104	CP-241198	6245	2	A	Custom throttling to temporary failed 5GSM procedure	18.7.0
2024-06	CT#104	CP-241170	6244	2	F	Remove NOTE on DNS over (D)TLS	18.7.0
2024-06	CT#104	CP-241170	5968	6	B	Update to add security parameter to ECS address IE	18.7.0
2024-06	CT#104	CP-241163	6249	4	C	5GMM cause code #15 indicating Satellite NG-RAN not allowed in PLMN	18.7.0
2024-06	CT#104	CP-241227	6149	3	F	Correction of the procedure's name	18.7.0
2024-06	CT#104	CP-241231	6162	4	F	Disaster return wait range timer	18.7.0
2024-09	CT#105	CP-242165	6330	-	A	Adding inclusion criteria and correcting information element	18.8.0

2024-09	CT#105	CP-242167	6398	-	F	Collision handling for NSSAA procedure and MRU for release connection	18.8.0
2024-09	CT#105	CP-242205	6334	1	F	Correction of IEI for Protocol description IE	18.8.0
2024-09	CT#105	CP-242184	6365	1	F	Handling of PDU session reactivation in the Mobility registration update procedure	18.8.0
2024-09	CT#105	CP-242184	6410	1	F	Network slice replacement including an on-demand S-NSSAI	18.8.0
2024-09	CT#105	CP-242167	6338	1	F	5GMM capability IE definition errors	18.8.0
2024-09	CT#105	CP-242184	6347	1	F	Correction to the 5GMM capability IE because of implementation error of CR6034	18.8.0
2024-09	CT#105	CP-242201	6427	1	F	Clarification to triggering registration procedure after unavailability period when UE needs to report unavailability	18.8.0
2024-09	CT#105	CP-242167	6352	1	F	Clarification for coding and usage of UE POLICY PROVISIONING REQUEST message	18.8.0
2024-09	CT#105	CP-242167	6387	1	F	Correction of incomplete timer table for T3540	18.8.0
2024-09	CT#105	CP-242190	6391	1	F	Correction to requirements upon determining that a disaster condition has ended for MINT because of implementation collision of CR6074 and CR6162	18.8.0
2024-09	CT#105	CP-242167	6405	1	F	Update description on requirements to be met for MT SMSoIP	18.8.0
2024-09	CT#105	CP-242171	6434	1	F	Resolution of editor's notes on Maximum time offset	18.8.0
2024-09	CT#105	CP-242193	6341	1	F	Correction for undefined names	18.8.0
2024-09	CT#105	CP-242177	6345	2	F	Add list of supported PLMNs with ECSP information to the ECS address information	18.8.0
2024-09	CT#105	CP-242205	6348	2	F	Correction to the uplink PDU set handling at the UE side	18.8.0
2024-09	CT#105	CP-242171	6002	8	F	No T3540 entering unavailability period	18.8.0
2024-09	CT#105	CP-242183	6424	2	F	FSNPN in shared network	18.8.0
2024-09	CT#105	CP-242199	6301	4	F	Handling of ecall timers during intersystem between 2G/3G and 5G	18.8.0
2024-09	CT#105	CP-242171	6342	2	F	Corrections for Cause value 15, satellite disabling	18.8.0
2024-09	CT#105	CP-242230	6429	4	F	Correction to the Note for UEs supporting MUSIM	18.8.0
2024-12	CT#106	CP-243206	6526	1	F	Correction to #62 handling in Initial registration	18.9.0
2024-12	CT#106	CP-243187	6446	1	F	Conditions when to remove alternative S-NSSAI from configured NSSAI	18.9.0
2024-12	CT#106	CP-243182	6479	1	F	AMF provision of unavailability information at DC only	18.9.0
2024-12	CT#106	CP-243209	6494	1	F	Correction to the 5G-RG de-registration	18.9.0
2024-12	CT#106	CP-243182	6551	3	F	AMF indication for unavailability	18.9.0
2024-12	CT#106	CP-243187	6620	-	F	Correction on handling of the slice deregistration inactivity timer	18.9.0
2024-12	CT#106	CP-243187	6580	1	F	Paging procedure for PDU session associated with partially allowed S-NSSAI	18.9.0
2025-03	CT#107	CP-250183	6650	6	F	ATSSS capability IE	18.10.0
2025-03	CT#107	CP-250170	6660		A	Lost text on REGISTRATION COMPLETE upon received 5G-GUTI in initial registration	18.10.0
2025-03	CT#107	CP-250182	6662	1	F	Extended CAG information list coding correction	18.10.0
2025-03	CT#107	CP-250178	6742	2	F	Starting Slice deregistration inactivity timer when the on-demand S-NSSAI is added to allowed NSSAI	18.10.0
2025-06	CT#108	CP-251198	6844	1	F	Add missing posSibType to ciphering key data	18.11.0
2025-06	CT#108	CP-251198	6841	1	F	Access category correction for MT call and MT SMSoIP	18.11.0
2025-06	CT#108	CP-251202	6802	1	F	Correction to payload type and spare value handling for PD-Rel18	18.11.0
2025-06	CT#108	CP-251200	6812	2	A	Addition of abnormal case handling for UE requested MA PDU session with invalid capabilities	18.11.0
2025-06	CT#108	CP-251153	6504	7	F	User plane resource request PDU associated with S-NSSAI not in the allowed S-NSSAI for the current TA	18.11.0
2025-06	CT#108	CP-251154	6868	1	F	Correction related to the depreciation of the ATSSS-ST field	18.11.0
2025-06	CT#108	CP-251154				Editorial Corrections	18.11.1
2025-09	CT#109	CP-252138	7007	1	F	Correction to capability IE and table reference	18.12.0
2025-09	CT#109	CP-252137	6972	1	F	User plane reactivation for always-on PDU session	18.12.0
2025-09	CT#109	CP-252137	6944	2	F	User plane resource request is prohibited for an always-on PDU session associated with an S-NSSAI not allowed by S-NSSAI location validity information	18.12.0
2025-09	CT#109	CP-252132	6962	1	F	Correction on the additional info IE handling for UPP-CMI container type	18.12.0
2025-12	CT#110	CP-253089	7019	1	F	Temporarily unavailable slice handling for non-supporting UE	18.13.0
2025-12	CT#110	CP-253089	7073	1	F	AMF initiation of UCU procedure for network slice replacement	18.13.0
2025-12	CT#110	CP-253089	7075	1	F	Network slice replacement for partially allowed NSSAI	18.13.0

History

Version	Date	Status
V18.6.0	May 2024	Publication
V18.7.0	July 2024	Publication
V18.8.0	October 2024	Publication
V18.9.0	January 2025	Publication
V18.10.0	March 2025	Publication
V18.11.1	August 2025	Publication
V18.12.0	October 2025	Publication
V18.13.0	February 2026	Publication