

ETSI TS 126 531 V17.3.0 (2024-07)



**5G;**  
**Data Collection and Reporting;**  
**General Description and Architecture**  
**(3GPP TS 26.531 version 17.3.0 Release 17)**



---

**Reference**

RTS/TSGS-0426531vh30

---

**Keywords**

5G

**ETSI**

650 Route des Lucioles  
F-06921 Sophia Antipolis Cedex - FRANCE

---

Tel.: +33 4 92 94 42 00 Fax: +33 4 93 65 47 16

Siret N° 348 623 562 00017 - APE 7112B  
Association à but non lucratif enregistrée à la  
Sous-Préfecture de Grasse (06) N° w061004871

---

**Important notice**

The present document can be downloaded from the  
ETSI [Search & Browse Standards application](#).

The present document may be made available in electronic versions and/or in print. The content of any electronic and/or print versions of the present document shall not be modified without the prior written authorization of ETSI. In case of any existing or perceived difference in contents between such versions and/or in print, the prevailing version of an ETSI deliverable is the one made publicly available in PDF format on [ETSI deliver](#).

Users should be aware that the present document may be revised or have its status changed,  
this information is available in the [Milestones listing](#).

If you find errors in the present document, please send your comments to  
the relevant service listed under [Committee Support Staff](#).

If you find a security vulnerability in the present document, please report it through our  
[Coordinated Vulnerability Disclosure \(CVD\)](#) program.

---

**Notice of disclaimer & limitation of liability**

The information provided in the present deliverable is directed solely to professionals who have the appropriate degree of experience to understand and interpret its content in accordance with generally accepted engineering or other professional standard and applicable regulations.

No recommendation as to products and services or vendors is made or should be implied.

No representation or warranty is made that this deliverable is technically accurate or sufficient or conforms to any law and/or governmental rule and/or regulation and further, no representation or warranty is made of merchantability or fitness for any particular purpose or against infringement of intellectual property rights.

In no event shall ETSI be held liable for loss of profits or any other incidental or consequential damages.

Any software contained in this deliverable is provided "AS IS" with no warranties, express or implied, including but not limited to, the warranties of merchantability, fitness for a particular purpose and non-infringement of intellectual property rights and ETSI shall not be held liable in any event for any damages whatsoever (including, without limitation, damages for loss of profits, business interruption, loss of information, or any other pecuniary loss) arising out of or related to the use of or inability to use the software.

---

**Copyright Notification**

No part may be reproduced or utilized in any form or by any means, electronic or mechanical, including photocopying and microfilm except as authorized by written permission of ETSI.

The content of the PDF version shall not be modified without the written authorization of ETSI.

The copyright and the foregoing restriction extend to reproduction in all media.

© ETSI 2024.  
All rights reserved.

---

# Intellectual Property Rights

## Essential patents

IPRs essential or potentially essential to normative deliverables may have been declared to ETSI. The declarations pertaining to these essential IPRs, if any, are publicly available for **ETSI members and non-members**, and can be found in ETSI SR 000 314: "*Intellectual Property Rights (IPRs); Essential, or potentially Essential, IPRs notified to ETSI in respect of ETSI standards*", which is available from the ETSI Secretariat. Latest updates are available on the ETSI Web server (<https://ipr.etsi.org/>).

Pursuant to the ETSI Directives including the ETSI IPR Policy, no investigation regarding the essentiality of IPRs, including IPR searches, has been carried out by ETSI. No guarantee can be given as to the existence of other IPRs not referenced in ETSI SR 000 314 (or the updates on the ETSI Web server) which are, or may be, or may become, essential to the present document.

## Trademarks

The present document may include trademarks and/or tradenames which are asserted and/or registered by their owners. ETSI claims no ownership of these except for any which are indicated as being the property of ETSI, and conveys no right to use or reproduce any trademark and/or tradename. Mention of those trademarks in the present document does not constitute an endorsement by ETSI of products, services or organizations associated with those trademarks.

**DECT™**, **PLUGTESTS™**, **UMTS™** and the ETSI logo are trademarks of ETSI registered for the benefit of its Members. **3GPP™** and **LTE™** are trademarks of ETSI registered for the benefit of its Members and of the 3GPP Organizational Partners. **oneM2M™** logo is a trademark of ETSI registered for the benefit of its Members and of the oneM2M Partners. **GSM®** and the GSM logo are trademarks registered and owned by the GSM Association.

---

# Legal Notice

This Technical Specification (TS) has been produced by ETSI 3rd Generation Partnership Project (3GPP).

The present document may refer to technical specifications or reports using their 3GPP identities. These shall be interpreted as being references to the corresponding ETSI deliverables.

The cross reference between 3GPP and ETSI identities can be found under <https://webapp.etsi.org/key/queryform.asp>.

---

# Modal verbs terminology

In the present document "**shall**", "**shall not**", "**should**", "**should not**", "**may**", "**need not**", "**will**", "**will not**", "**can**" and "**cannot**" are to be interpreted as described in clause 3.2 of the [ETSI Drafting Rules](#) (Verbal forms for the expression of provisions).

"**must**" and "**must not**" are **NOT** allowed in ETSI deliverables except when used in direct citation.

# Contents

Intellectual Property Rights .....	2
Legal Notice .....	2
Modal verbs terminology.....	2
Foreword.....	5
1 Scope .....	7
2 References .....	7
3 Definitions of terms, symbols and abbreviations .....	7
3.1 Terms.....	7
3.2 Symbols.....	8
3.3 Abbreviations .....	8
4 Reference architecture for data collection and reporting.....	8
4.1 General .....	8
4.2 Functional entities for data collection and reporting .....	9
4.3 Reference points for data collection and reporting.....	12
4.4 Service-based architecture for data collection and reporting.....	14
4.5 Information security model .....	16
4.5.1 Transport security .....	16
4.5.2 Data exposure restriction model .....	16
4.5.3 Authentication of data collection clients by the Data Collection AF.....	17
4.5.4 Precedence rules .....	17
4.5.4.1 General .....	17
4.5.4.2 UE data domains owned by the 5G System (MNO) .....	18
4.5.4.3 UE data domains owned by the ASP .....	18
4.6 Domain model .....	19
4.6.1 General.....	19
4.6.2 Provisioning information for data collection and reporting .....	20
4.6.3 Configuration information for data collection clients .....	21
4.6.4 Information included in data reports to the Data Collection AF.....	21
4.7 Service exposure .....	22
4.7.1 Service exposure via Network Exposure Function (NEF).....	22
4.7.2 Service exposure via Common API Framework (CAPIF) for Northbound APIs .....	22
4.7.3 Service exposure via Service Enabler Architecture Layer (SEAL) for Verticals .....	22
5 Procedures for data collection and reporting.....	23
5.1 General .....	23
5.2 Procedures for data collection and reporting provisioning .....	24
5.3 Procedures for Data Collection AF subscription .....	25
5.4 Procedures for configuring data collection client .....	26
5.5 Procedures for reporting to the Data Collection AF.....	27
5.6 Procedures for Data Collection AF data exposure .....	28
5.7 Procedures for Data Collection AF unsubscription .....	28
5.8 Procedures for event consumer authorization.....	29
<b>Annex A (informative): Collaboration scenarios for data collection and reporting.....</b>	<b>31</b>
A.1 General .....	31
A.2 Collaboration A .....	32
A.3 Collaboration B .....	33
A.4 Collaboration C .....	34
A.5 Collaboration D .....	35
A.6 Collaboration E .....	36

**Annex B (normative):**      **UE data domain ownership**.....37  
B.1 General .....37  
B.2 Baseline UE data domains.....37  
**Annex C (informative):**      **Change history** .....38  
History .....39

---

# Foreword

This Technical Specification has been produced by the 3rd Generation Partnership Project (3GPP).

The contents of the present document are subject to continuing work within the TSG and may change following formal TSG approval. Should the TSG modify the contents of the present document, it will be re-released by the TSG with an identifying change of release date and an increase in version number as follows:

Version x.y.z

where:

- x the first digit:
  - 1 presented to TSG for information;
  - 2 presented to TSG for approval;
  - 3 or greater indicates TSG approved document under change control.
- y the second digit is incremented for all changes of substance, i.e. technical enhancements, corrections, updates, etc.
- z the third digit is incremented when editorial only changes have been incorporated in the document.

In the present document, modal verbs have the following meanings:

- shall** indicates a mandatory requirement to do something
- shall not** indicates an interdiction (prohibition) to do something

The constructions "shall" and "shall not" are confined to the context of normative provisions, and do not appear in Technical Reports.

The constructions "must" and "must not" are not used as substitutes for "shall" and "shall not". Their use is avoided insofar as possible, and they are not used in a normative context except in a direct citation from an external, referenced, non-3GPP document, or so as to maintain continuity of style when extending or modifying the provisions of such a referenced document.

- should** indicates a recommendation to do something
- should not** indicates a recommendation not to do something
- may** indicates permission to do something
- need not** indicates permission not to do something

The construction "may not" is ambiguous and is not used in normative elements. The unambiguous constructions "might not" or "shall not" are used instead, depending upon the meaning intended.

- can** indicates that something is possible
- cannot** indicates that something is impossible

The constructions "can" and "cannot" are not substitutes for "may" and "need not".

- will** indicates that something is certain or expected to happen as a result of action taken by an agency the behaviour of which is outside the scope of the present document
- will not** indicates that something is certain or expected not to happen as a result of action taken by an agency the behaviour of which is outside the scope of the present document
- might** indicates a likelihood that something will happen as a result of action taken by some agency the behaviour of which is outside the scope of the present document

**might not** indicates a likelihood that something will not happen as a result of action taken by some agency the behaviour of which is outside the scope of the present document

In addition:

**is** (or any other verb in the indicative mood) indicates a statement of fact

**is not** (or any other negative verb in the indicative mood) indicates a statement of fact

The constructions "is" and "is not" do not indicate requirements.

---

# 1 Scope

The present document defines a generic architecture for collecting and reporting data in the 5G System as defined in TS 23.501 [2], TS 23.502 [3], TS 23.288 [4] and TS 29.517 [5].

---

## 2 References

The following documents contain provisions which, through reference in this text, constitute provisions of the present document.

- References are either specific (identified by date of publication, edition number, version number, etc.) or non-specific.
- For a specific reference, subsequent revisions do not apply.
- For a non-specific reference, the latest version applies. In the case of a reference to a 3GPP document (including a GSM document), a non-specific reference implicitly refers to the latest version of that document *in the same Release as the present document*.

- [1] 3GPP TR 21.905: "Vocabulary for 3GPP Specifications".
- [2] 3GPP TS 23.501: "System architecture for the 5G System (5GS)".
- [3] 3GPP TS 23.502: "Procedures for the 5G System (5GS)".
- [4] 3GPP TS 23.288: "Architecture enhancements for 5G System (5GS) to support network data analytics services".
- [5] 3GPP TS 29.517: "5G System; Application Function Event Exposure Service; Stage 3".
- [6] 3GPP TS 29.510: "Network function repository services; Stage 3".
- [7] 3GPP TS 29.532: "Data Collection and Reporting; Protocols and Formats".
- [8] 3GPP TS 23.222: "Common API Framework for 3GPP Northbound APIs".
- [9] 3GPP TS 33.501: "Security architecture and procedures for 5G System".
- [10] 3GPP TS 29.522: "5G System; Network Exposure Function Northbound APIs; Stage 3".
- [11] 3GPP TS 29.591: "5G System; Network Exposure Function Southbound Services; Stage 3".

---

## 3 Definitions of terms, symbols and abbreviations

### 3.1 Terms

For the purposes of the present document, the terms given in 3GPP TR 21.905 [1], TS 23.501 [2], TS 23.502 [3], TS 23.288 [4], TS 29.517 [5] and the following apply. A term defined in the present document takes precedence over the definition of the same term, if any, in 3GPP TR 21.905 [1].

**data collection client:** functional entity that collects data and reports it to the Data Collection AF, *viz.* Direct Data Collection Client, Indirect Data Collection Client or AS

**direct reporting:** method of sending a data report from the Direct Data Collection Client to the Data Collection AF

**event consumer:** a subscriber to event data at the Data Collection AF, used synonymously with the terms NF consumer in TS 23.502 [3] and NF service consumer in TS 29.517 [5]

**event data:** data exposed by the Data Collection AF to event consumers, used synonymously with the term event reporting information in TS 23.502 [3] and TS 29.517 [5]



**indirect reporting:** method of sending a data report from a UE Application to the Data Collection AF via an Indirect Data Collection Client function of an Application Service Provider

**MNO-managed event consumer:** An event consumer instance that is managed by the MNO

## 3.2 Symbols

Void.

## 3.3 Abbreviations

For the purposes of the present document, the abbreviations given in 3GPP TR 21.905 [1], TS 23.501 [2], TS 23.502 [3], TS 23.288 [4], TS 29.517 [5] and the following apply. An abbreviation defined in the present document takes precedence over the definition of the same abbreviation, if any, in 3GPP TR 21.905 [1].

AF	Application Function
AS	Application Server
CAPIF	Common API Framework for 3GPP Northbound APIs
DN	Data Network
NEF	Network Exposure Function
NF	Network Function
NWDAF	Network Data Analytics Function
SEAL	Service Enabler Architecture Layer for Verticals
UE	User Equipment

---

# 4 Reference architecture for data collection and reporting

## 4.1 General

Clause 6.2.8 of TS 23.288 [4] envisages a set of high-level procedures by which data is collected by a Network Data Analytics Function (NWDAF) from UE Application(s) via an intermediary Application Function that provides an Event Exposure Service to *event consumers*. This clause defines a generic reference architecture for data collection, reporting and subsequent exposure of UE data that satisfies those procedures, including the logical functions involved and the logical reference points between them. The intermediary Application Function envisaged in [4] is here named the *Data Collection AF*.

NOTE 1: It is presumed that the user has granted consent for its UE data to be collected, reported and subsequently exposed by means outside the scope of the present document (e.g. through interactions with the MNO or the Application Service Provider, and via any applicable SLA between the MNO and Application Service Provider). See also the *setUserConsent* client API method specified in table 8.3.1-1 of TS 26.532 [7].

NOTE 2: The collection, reporting and exposure of location-based UE data is expected to comply with regional regulatory requirements and may be further limited by MNO policy.

It is intended that this reference architecture be instantiated in domain-specific ways to suit the needs of different features of the 5G System. The reference architecture may be instantiated separately in different slices of a network.

Each type of UE data subject to collection, reporting and subsequent event exposure in the 5G System is associated with a logical *UE data domain*. Each such UE data domain is associated with a *domain owner* – either the 5G System itself (embodied in a particular deployment by an MNO) or the Application Service Provider (ASP). Ownership of particular UE data domains is specified in annex B.

The Data Collection AF is responsible for receiving *data reports* from UEs pertaining to a particular UE data domain, for processing the UE data contained in those reports, and for exposing them to subscribed event consumers in the form of *events*. Typically, one type of exposed event is based on UE data pertaining to a single UE data domain, but more complex relationships where events are synthesised from several UE data domains are not precluded.

Precedence rules on the exposure (and consequent collection and reporting) of UE data vis-à-vis conflicts between ASP provisioning information and system preconfiguration by the MNO or subscription by MNO-managed event consumers are defined in clause 4.5.4.

The services defined in the present document may be exposed to parties outside the trusted domain via the NEF, as defined in clause 4.7.1.

The Data Collection AF may support CAPIF [8] to provide APIs to other applications (i.e. API invokers), as defined in clause 4.7.2.

## 4.2 Functional entities for data collection and reporting

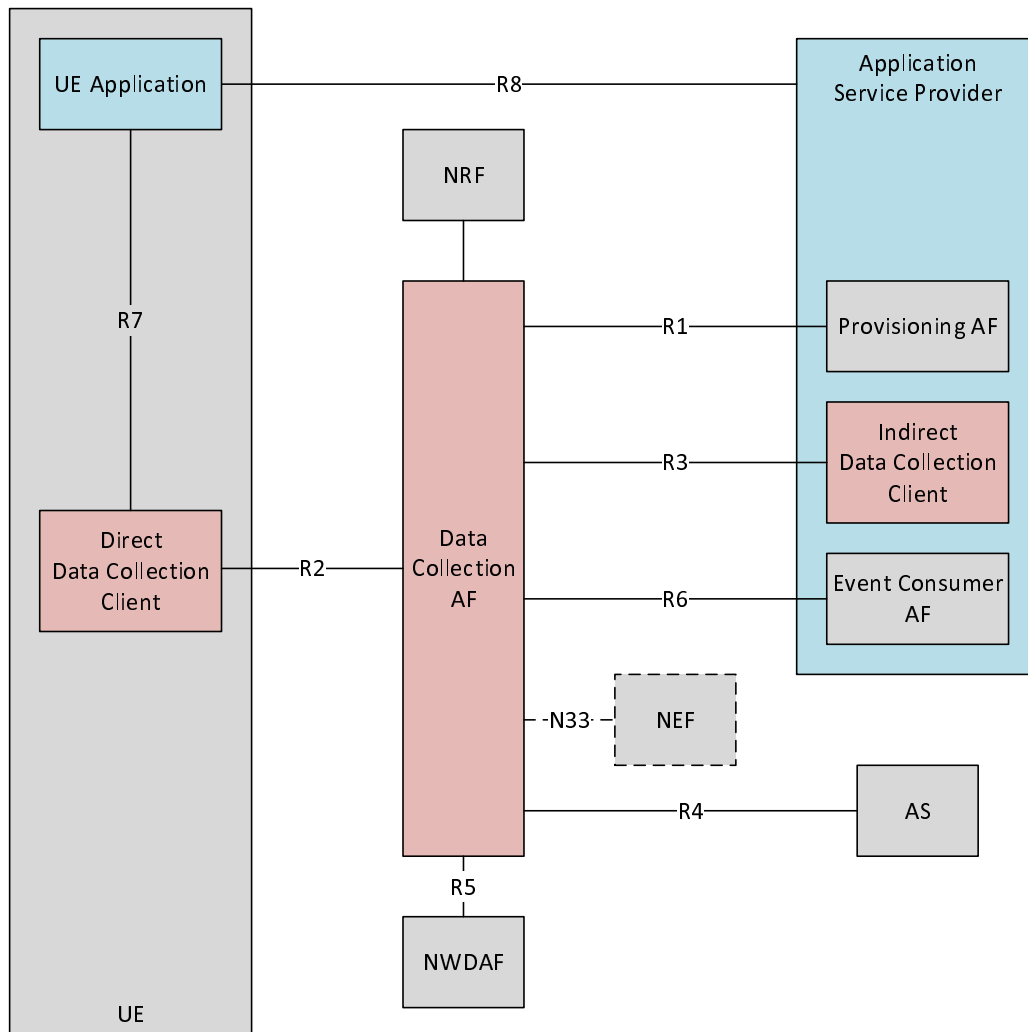

NOTE: The Data Collection AF may be deployed outside the trusted domain, in which case the services it exposes to API invokers are mediated by the NEF. The logical relationships denoted by the reference points are unaffected by such deployment choices.

**Figure 4.2-1: Reference architecture for data collection and reporting in reference point notation**

The functional entities illustrated in the figure are described as follows:

1. Data collection and reporting functionality is provisioned at reference point R1 by a *Provisioning AF* of the *Application Service Provider* that may be deployed either inside or outside the trusted domain. The *Ndcap\_DataReportingProvisioning* service is provided by the Data Collection AF for this purpose.

NOTE 1: When provisioning is initiated from outside the trusted domain via the NEF, the Provisioning AF instead invokes the *Nnef\_DataReportingProvisioning* service.

2. The *Data Collection AF* may be deployed inside or outside the trusted domain. It is responsible for managing the provisioning state for data collection and reporting. When its provisioning state changes, the Data Collection AF updates the set of available NF profile(s) in the NRF by invoking the *Nnrf\_NFManagement* service defined in clause 5.2.7.2 of TS 23.502 [3] according to the usage defined in clause 6.2.8.2.2 of TS 23.288 [4] and specified in clause 6.1 of TS 29.510 [6].

NOTE 2: If the Data Collection AF is deployed outside the trusted domain, this registration occurs via the NEF, as described in clause 6.2.2.3 of TS 23.288 [4].

Depending on the provisioning information provided by the Application Service Provider (see clause 4.6.2), the Data Collection AF provides a data collection and reporting configuration to the *Direct Data Collection Client* at reference point R2, to the *Indirect Data Collection Client* at reference point R3 or to the Application Server (AS) instances at reference point R4, and receives data reports from them respectively at those same reference points.

The Data Collection AF processes received data reports according to processing instructions in its provisioning state. The processing activities include, but are not limited to, reporting format conversion, data normalisation, reporting domain-specific anonymisation of data and (dis)aggregation of data into reports to be exposed as events.

Finally, the Data Collection AF is responsible for exposing processed UE data to event notification subscribers both inside the trusted domain (such as the NWDAF) and outside it (such as the *Event Consumer AF* in the Application Service Provider). In this role, the Data Collection AF realises the Event Exposure Service as defined in clause 6.2.2.1 of TS 23.288 [4] and as specified in TS 29.517 [5]. Subscribers fulfil the role of NF consumers of this service in the service-based architecture [2, 3].

The set of UE data to be collected and exposed by the Data Collection AF is determined by the intersection<sup>1</sup> between its provisioning state provided at R1 and the current set of subscriptions. This is reflected in the data collection and reporting configuration exposed at reference points R2, R3 and R4, and the subscription-driven event notifications sent to consumer entities such as the NWDAF or Event Consumer AF of an Application Service Provider over reference points R5 and R6. The Data Collection AF is responsible for ensuring that access to UE data is controlled according to the rules indicated in its provisioning state, as specified in clause 4.5.2. Where these data exposure restrictions conflict with system preconfiguration by the MNO or event subscriptions by MNO-managed event consumers, the precedence rules defined in clause 4.5.4 shall apply.

NOTE 3: When the Data Collection AF is deployed outside the trusted domain, the NWDAF uses the procedure defined in clause 5.2.6.2 of TS 23.502 [3] and further elaborated by clause 6.2.2.3 of TS 23.288 [4] to collect data from the externally deployed Data Collection AF via the NEF.

NOTE 4: The Data Collection AF is intended to be instantiated inside another Application Function in order to satisfy the domain-specific data collection and reporting requirements corresponding to particular features in the 5G System. As such, there may be several reporting domain-specific Data Collection AF instances operating simultaneously in a particular 5G System, each one performing a different role. The definitions of these instantiations are beyond the scope of the present document.

3. The *Direct Data Collection Client* is responsible for collecting relevant data in the UE and for sending data reports to the Data Collection AF via reference point R2 using the *Ndcaf\_DataReporting* service according to a data collection and reporting configuration that it has previously obtained from the Data Collection AF by invoking the same service at reference point R2.

NOTE 5: This method of reporting corresponds to the direct data collection procedure defined in clause 6.2.8 of TS 23.288 [4].

NOTE 6: In the case where the Data Collection AF is deployed in a different trust domain than the UE, the Direct Data Collection Client instead invokes the equivalent *Nnef\_DataReporting* API via the NEF.

---

<sup>1</sup> In the event that provisioning data and subscription data contain similar rules, the permissible information to be exposed by the Data Collection Function shall be governed by the rule with more restrictive semantics.

NOTE 7: The Direct Data Collection Client function is intended to be instantiated inside other UE functions in order to satisfy the domain-specific data collection and reporting requirements corresponding to particular features of the 5G System. As such, there may be several reporting domain-specific data collection client instances operating simultaneously on a given UE, each one performing a different role. One valid deployment option is to combine these instances in a common middleware component. Another option is to provide the Direct Data Collection Client as an integral part of each relevant UE Application. The definitions of these instantiations are beyond the scope of the present document. The realisation of these logical functions is implementation-dependent.

4. The *UE Application* is responsible for sharing relevant data with the Direct Data Collection Client via reference point R7. This may be achieved as a combination of application design, application configuration via R8 and/or application configuration via R7.
5. An Application Service Provider may also collect data from UE Applications via reference point R8 and employ an *Indirect Data Collection Client* subfunction to then send data reports to the Data Collection AF via reference point R3 by invoking the *Ndcap\_DataReporting* service according to a data collection and reporting configuration that it has previously obtained from the Data Collection AF by invoking the same service at reference point R3.

NOTE 8: This method of reporting corresponds to the indirect data collection procedure defined in clause 6.2.8 of TS 23.288 [4].

NOTE 9: In the case where the Application Service Provider server is deployed in a different trust domain than the Data Collection AF, the Indirect Data Collection Client instead invokes the equivalent *Nnef\_DataReporting* API via the NEF at reference point R3.

NOTE 10: Collection of UE data via reference point R8 and processing by the Application Server Provider are outside 3GPP scope. The Indirect Data Collection Client may modify the collected UE data to satisfy the requirements of its data collection and reporting configuration.

6. Application Server instances (labelled *AS*) inside or outside the trusted domain may also collect data and report it to the Data Collection AF via reference point R4 by invoking the *Ndcap\_DataReporting* service, according to a data collection and reporting configuration previously obtained from the Data Collection AF by invoking the same service at reference point R4.

NOTE 11: In the case where the Application Server is deployed in a different trust domain than the Data Collection AF, the *AS* instead invokes the equivalent *Nnef\_DataReporting* service via the NEF.

NOTE 12: The data collection and reporting requirements for such Application Servers are reporting domain-specific and therefore beyond the scope of the present document.

7. The NWDAF is the primary consumer of processed UE data. This is exposed to the NWDAF by the Data Collection AF in the form of data reporting event notifications via reference point R5 using the *Naf\_EventExposure* service (as specified in TS 29.517 [5]) after any processing by the Data Collection AF has been performed according to its provisioned processing instructions.

NOTE 13: If the Data Collection AF is deployed outside the trusted domain, this interaction occurs instead by invoking the *Nnef\_EventExposure* service via the NEF, as defined in clause 5.2.6.2 of TS 23.502 [3] and as further elaborated by clause 6.2.2.3 of TS 23.288 [4].

NOTE 14: The UE data of interest to the NWDAF at reference point R5, for example Observed Service Experience and Collective Behaviour, is governed by clause 6 of TS 23.288 [4].

8. By means of appropriate data collection and reporting provisioning, certain UE data may also be exposed in the form of data reporting events by the Data Collection AF to an *Event Consumer AF* residing in the Application Service Provider via reference point R6 using the *Naf\_EventExposure* service defined in clause 5.2.19 of TS 23.502 [4] and specified in TS 29.517 [5].

NOTE 15: In the case where the Application Service Provider server is deployed outside the trusted domain, the *Nnef\_EventExposure* service, as defined in clause 5.2.6.2 of TS 23.502 [3], is invoked instead.

## 4.3 Reference points for data collection and reporting

The purposes of the reference points in the functional architecture defined in clause 4.2 above are as follows:

- **R1** supports the following interactions between a Provisioning AF in the Application Service Provider and the Data Collection AF:
  - Used by the Application Service Provider to provision data collection and reporting in a Data Collection AF instance by means of the *Ndcaf\_DataReportingProvisioning* service defined in clause 4.4 of the present document (or else the equivalent service exposed by the NEF if the two functions are deployed in different trust domains). The provisioning information specifies what data is to be collected, and additionally may specify how that data is to be sampled by data collection clients (e.g., sampling frequency, location filter) and/or how the collected data is to be reported by them (e.g., reporting probability, reporting frequency, reporting format, data packaging strategy), how it is to be processed by the Data Collection AF and how it is to be exposed to event notification subscribers. A generic provisioning envelope for data collection and reporting is defined in clause 4.6 of the present document, but this is expected to be extended by individual reporting domains.

NOTE 0: Provisioning of sampling frequency and/or location filters may be limited by MNO policy, for example to limit resource impacts on the 5G System, and the Data Collection AF is expected to reject provisioning information containing out-of-policy values.

- **R2** supports the following interactions between the Direct Data Collection Client in the UE and the Data Collection AF:
  - Used by a Direct Data Collection Client instance to obtain its data collection and reporting configuration from the corresponding Data Collection AF instance by means of the *Ndcaf\_DataReporting* service defined in clause 4.4 of the present document. The client configuration specifies what data is to be collected, and additionally specifies how that data is to be sampled (e.g., sampling frequency, location filter) and/or how the collected data is to be reported (e.g., reporting probability, reporting frequency, reporting format, data packaging strategy). A generic data collection and reporting configuration envelope is defined in clause 4.6.3 of the present document, but details of the configuration are specific to individual reporting domains and are specified elsewhere.
  - Subsequently used by the Direct Data Collection Client to send reports to its Data Collection AF instance by means of the *Ndcaf\_DataReporting* service defined in clause 4.4 of the present document. A generic data reporting envelope is defined in clause 4.6.4 of the present document, but details of the reporting format are specific to individual reporting domains and are specified elsewhere.

NOTE 1: This method of reporting corresponds to the direct data collection procedure defined in clause 6.2.8 of TS 23.288 [4].

- **R3** supports the following interactions between the Indirect Data Collection Client in the Application Service Provider Server and the Data Collection AF:
  - Used by an Indirect Data Collection Client instance to obtain its data collection and reporting configuration from the corresponding Data Collection AF instance by means of the *Ndcaf\_DataReporting* service defined in clause 4.4 of the present document (or else the equivalent service exposed by the NEF if the two functions are deployed in different trust domains). A generic data collection and reporting configuration envelope is defined in clause 4.6.3 of the present document, but details of the configuration are specific to individual reporting domains and are specified elsewhere.
  - Subsequently used by the Indirect Data Collection Client in the Application Service Provider server to send data reports to its Data Collection AF instance by means of the *Ndcaf\_DataReporting* service defined in clause 4.4 of the present document (or else the equivalent service exposed by the NEF if the two functions are deployed in different trust domains). A generic data reporting envelope is defined in clause 4.6.4 of the present document, but details of the reporting format are specific to individual reporting domains and are specified elsewhere.

NOTE 2: This method of reporting corresponds to the indirect data collection procedure defined in clause 6.2.8 of TS 23.288 [4].

- **R4** supports the following interactions between the Application Server (AS) and the Data Collection AF:
  - Used by an AS instance to obtain its data collection and reporting configuration from the corresponding Data Collection AF instance by means of the *Ndcaf\_DataReporting* service defined in clause 4.4 of the present document (or else the equivalent service exposed by the NEF if the two functions are deployed in different trust domains). A generic data collection and reporting configuration envelope is defined in clause 4.6.3 of the present document, but details of the configuration are specific to individual reporting domains and are specified elsewhere.
  - Subsequently used by the AS instance to send data reports to its Data Collection AF instance by means of the *Ndcaf\_DataReporting* service defined in clause 4.4 of the present document (or else the equivalent service exposed by the NEF if the two functions are deployed in different trust domains). A generic data reporting envelope is defined in clause 4.6.4 of the present document, but details of the reporting format are specific to individual reporting domains and are specified elsewhere.

NOTE 3: The AS plays the role of a Network Function when it invokes the *Ndcaf\_DataReporting* service at reference point R4.

- **R5** supports the following interactions between the NWDAF and the Data Collection AF:
  - Used by an NWDAF instance to subscribe to data reporting events exposed by a Data Collection AF instance, according to the *Naf\_EventExposure\_Subscribe* procedure defined in clause 5.2.19.2.2 of TS 23.502 [3], as further elaborated in step 3a of clause 6.2.8.2.3 in TS 23.288 [4], and as specified in TS 29.517 [5] (or else the equivalent *Nnef\_EventExposure\_Subscribe* service exposed by the NEF if the two functions are deployed in different trust domains).
  - Subsequently used by the Data Collection AF to expose data reporting events to the NWDAF, according to the *Naf\_EventExposure\_Notify* procedure defined in clause 5.2.19.2.4 of TS 23.502 [3], as further elaborated in step 5a of clause 6.2.8.2.3 in TS 23.288 [4], and as specified in TS 29.517 [5] (or else the equivalent *Nnef\_EventExposure\_Notify* service exposed by the NEF if the two functions are deployed in different trust domains).
- **R6** supports the following interactions between the Event Consumer AF in the Application Service Provider and the Data Collection AF:
  - Used by an Event Consumer AF instance to subscribe to data reporting events exposed by the Data Collection AF, according to the *Naf\_EventExposure\_Subscribe* procedure defined in clause 5.2.19.2.2 of TS 23.502 [3] and specified in TS 29.517 [5] (or else the equivalent *Nnef\_EventExposure\_Subscribe* service exposed by the NEF if the two functions are deployed in different trust domains).
  - Subsequently used by the Data Collection AF to expose data reporting events to the Event Consumer AF according to the *Naf\_EventExposure\_Notify* procedure defined in clause 5.2.19.2.4 of TS 23.502 [3] and specified in TS 29.517 [5] (or else the equivalent *Nnef\_EventExposure\_Notify* service exposed by the NEF if the two functions are deployed in different trust domains).
- **R7** is a client API offered by the Direct Data Collection Client to the UE Application.

NOTE 4: When the Direct Data Collection Client is embedded in the UE Application, reference point R7 is not used.

- **R8** supports data collection and reporting interactions between the UE Application and the Application Service Provider server.

NOTE 5: Interactions at reference point R8 are beyond the scope of 3GPP standardisation.

## 4.4 Service-based architecture for data collection and reporting

Figure 4.4-1 below shows the reference architecture for data collection and reporting in service-based architecture notation. It depicts the case where the Data Collection AF is deployed inside the trusted domain, while the Application Service Provider and the AS may be deployed independently either inside or outside the trusted domain.

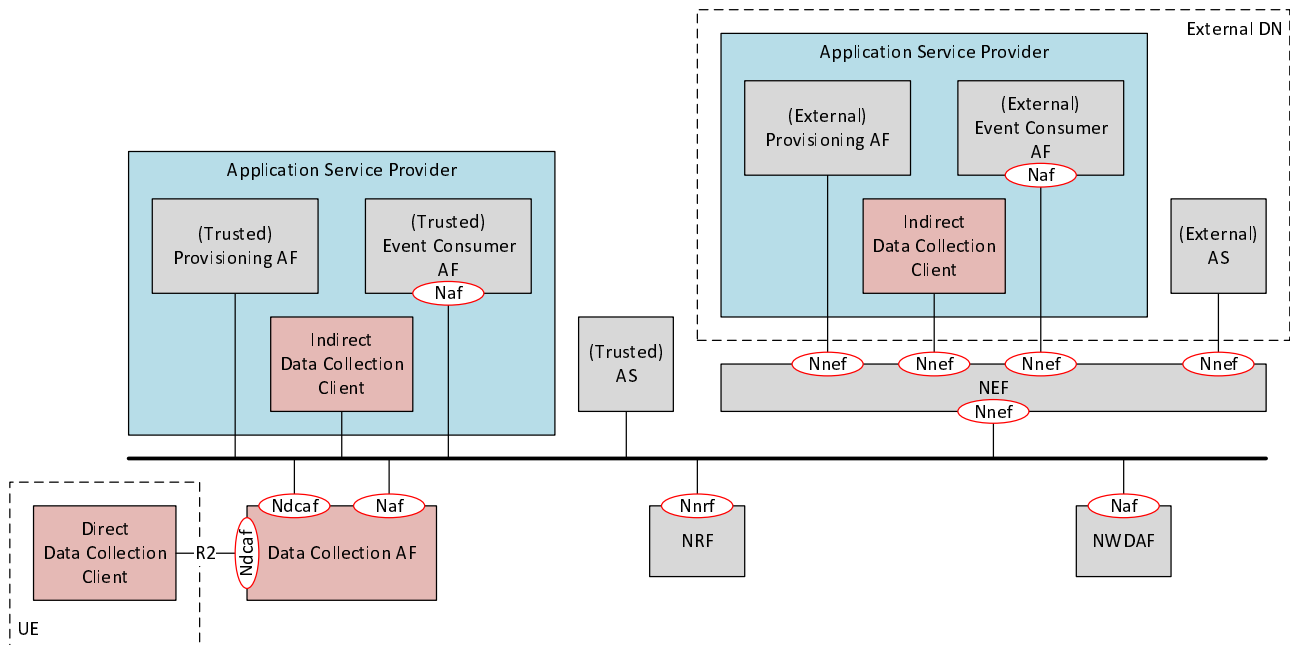

NOTE 1: In its role as an event exposure service provider Application Function, the Data Collection AF provides the (un)subscription operations of the *Naf\_EventExposure* (or *Nnef\_EventExposure*) service for use by Network Function service consumers. As Network Function service consumers, the NWDAF and the Event Consumer AF provide the event notification operation of the *Naf\_EventExposure* (or *Nnef\_EventExposure*) service for use by the Data Collection AF.

NOTE 2: The UE-based Direct Data Collection Client interacts with the Data Collection AF in the user plane, and so the interaction at reference point R2 does not traverse the service bus.

**Figure 4.4-1: Reference architecture for data collection and reporting in service-based architecture notation when the Data Collection AF is deployed in the trusted domain**

The following service-based APIs are used in connection with data collection and reporting:

1. The *Ndcf\_DataReportingProvisioning* service is provided by the Data Collection AF. It is defined by the present document and is specified in TS 26.532 [7]. This service is used by Provisioning AF instances to provision data collection and reporting in the Data Collection AF.
2. The *Nnrf\_NFManagement* service is provided by the NRF. It is defined in clause 5.2.7.2 of TS 23.502 [3] and specified in clause 6.1 of TS 29.510 [6]. This service is used by the Data Collection AF to register an available NF profile with the NRF for each set of data collection and reporting provisioning information held by the former.

NOTE 1: As described in clause 6.2.8.2.2 of TS 23.288 [4] the NF profile in this case includes the External Application Identifier (used by clients when reporting data to the Data Collection AF), the Internal Application Identifier (used for event exposure to the NWDAF) and the Event ID. These NF profile parameters are in addition to those specified in clause 5.2.7.2 of TS 23.502 [3].

3. The *Ndcnf\_DataReporting* service is provided by the Data Collection AF. It is defined by the present document and is specified in TS 26.532 [7].
  - a. This service is used by the Direct Data Collection Client, by the Indirect Data Collection Client in the Application Service Provider server and by AS instances to obtain their data collection and reporting configuration from the Data Collection AF.
  - b. Subsequently, this service is used by the Direct Data Collection Client, by the Indirect Data Collection Client and by AS instances to send data reports to the Data Collection AF.

NOTE 2: Trusted AS instances play the role of a Network Function when invoking the *Ndcnf\_DataReporting* service (or equivalent) and are therefore depicted in figure 4.4-1 as being directly attached to the service bus.

4. The *Naf\_EventExposure* service is provided by the Data Collection AF. It is defined in clause 5.2.19.2 of TS 23.502 [3] and TS 23.288 [4], and is specified in TS 29.517 [5].
  - a. Used by the NWDAF to subscribe to data reporting events exposed by the Data Collection AF and subsequently used by the Data Collection AF to notify these events to the NWDAF, as described in clause 6.2.2.2 or 6.2.2.3 (as appropriate) of TS 23.288 [4].
  - b. Used by an Event Consumer AF in the Application Service Provider server to subscribe to data reporting events exposed by the Data Collection AF and subsequently used by the Data Collection AF to notify these events to the Application Service Provider server, as described in clause 6.2.2.2 or clause 6.2.2.3 (as appropriate) of TS 23.288 [4].

Figure 4.4-2 depicts the case where the Data Collection AF is instead deployed outside the trusted domain, along with the Application Service Provider and the (external) AS. In this case, the subfunctions of the Application Service Provider and the (external) AS do not interact with the Data Collection AF via the 5G System service bus. The *Ndcnf* service is therefore not required in such deployments. The interactions at the relevant reference points are outside the scope of 3GPP and are depicted as R1', R3', R4' and R6' to reflect this.

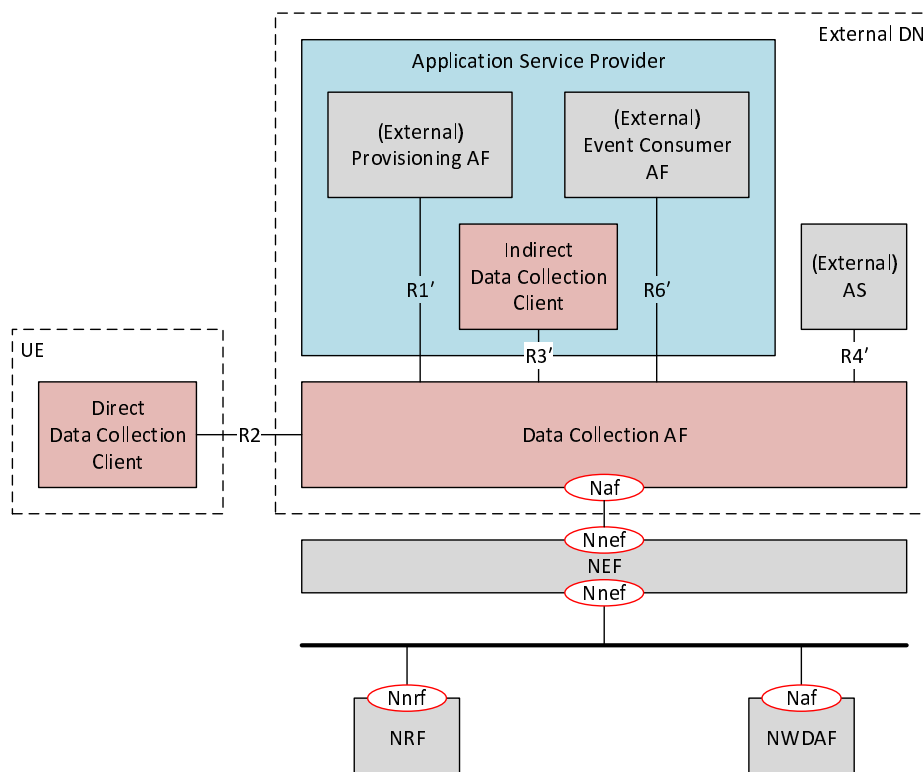

**Figure 4.4-2: Reference architecture for data collection and reporting in service-based architecture notation when the Data Collection AF is deployed outside the trusted domain**



## 4.5 Information security model

### 4.5.1 Transport security

An encrypted data transfer protocol shall be employed at reference point R2 to protect the secrecy and integrity of collected UE data in transit between the Direct Data Collection Client and the Data Collection AF.

### 4.5.2 Data exposure restriction model

The Provisioning AF restricts the exposure of UE data over reference points R5 and R6 by configuring a set of Data Access Profiles for each Event ID to be exposed. A Data Access Profile specifies a set of data processing operations that need to be performed by the Data Collection AF on the collected UE data in order to synthesize the event data that will be exposed to the NWDAF and/or Event Consumer AF.

When subscribing to event exposure notifications for a particular Event ID, an NWDAF or Event Consumer AF goes through an authorisation procedure (see clause 5.8) with an Authorisation AS that determines the level of access the event subscriber is allowed to have by selecting one of the provisioned Data Access Profiles for the Event ID in question. If successful, the Authorisation AS supplies an access token to the subscriber which is presented to and validated by the Data Collection AF as part of the event subscription procedure.

NOTE: The procedure for selecting an appropriate Data Access Profile is not specified in the present document.

Figure 4.5.2-1 depicts the static data model for the data collection provisioning with Data Access Profiles to restrict data exposure access.

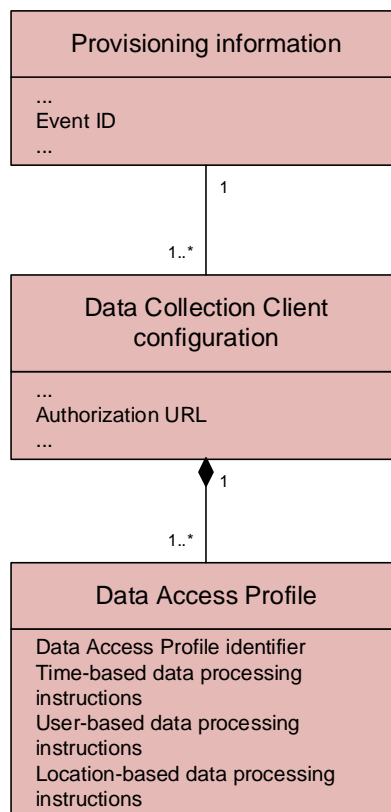

Figure 4.5.2-1: Data exposure restriction domain model

The Data Access Profile defines restrictions along the time, user, and location dimensions:

- Restrictions along the time dimension determine the granularity of access to UE data along the time axis. The finest granularity allows access to events as they take place in time. The coarsest level of access aggregates all event data along the time axis to produce a single aggregated value.
- Restrictions along the user dimension allow the Provisioning AF to restrict access to UE data related events based on groups. The finest granularity allows the event consumer to access events related to single users. Coarse granularity access exposes aggregated collected event data based on user groups. The coarsest granularity access exposes the data being aggregated for all users.
- Restrictions along the location dimension allow the Provisioning AF to restrict access to UE data related events based on the geographical location of the data collection client during the event. The finest granularity allows the event consumer to access events individually, irrespective of the location. Coarse granularity access exposes aggregated collected event data based on a geographical area. The coarsest level of access aggregates all event data along the location axis to produce a single aggregated value for all locations.

The baseline set of aggregation functions is listed in table 4.5.2-1:

**Table 4.5.2-1: Baseline aggregation functions**

Aggregation function	Description
None	No aggregation is applied, and all reported data records are exposed as individual events.
Count	The number of reported data records is exposed to event consumers.
Mean	The mean average of the values in reported data records is exposed to event consumers.
Maximum	The maximal observed value in reported data records is exposed to event consumers.
Minimum	The minimal observed value in reported data records is exposed to event consumers.
Sum	The sum of the values in reported data records is exposed to event consumers.

The authorization URL, if present in the data exposure restrictions, is used to redirect subscription requests without a valid access token to an authorization server, which will perform the authorization for the requested Data Access Profile.

Upon successful authorization, the consumer entity obtains an access token, which contains an identifier of the Data Access Profile that is allowed for the event consumer. Upon successful subscription, the Data Collection AF shall apply the indicated aggregation functions of the corresponding Data Access Profile along the time and user dimensions on the collected data prior to exposing it to the event consumer.

### 4.5.3 Authentication of data collection clients by the Data Collection AF

To satisfy the requirements in clause 6.2.8.1 of TS 23.288 [4], a data collection client shall supply authentication information to the Data Collection AF:

1. When the data collection client requests its data collection and reporting configuration from the Data Collection AF; and
2. When the data collection client reports UE data to the Data Collection AF.

For reasons of efficiency, the authentication information may be provided once at the start of a long-lived UE data reporting session.

**NOTE:** In the case of direct reporting, the requirement to supply authentication information may require the UE Application to first obtain this from the Application Service Provider via reference point R8 and then pass it to the Direct Data Collection Client via R7 (or, in the case of Collaboration E depicted in clause A.6, via an internal interface) before it can be presented to the Data Collection AF at reference point R2.

### 4.5.4 Precedence rules

#### 4.5.4.1 General

Where there is a conflict between data exposure restrictions provisioned by the ASP at reference point R1 and preconfiguration of the Data Collection AF and/or data collection clients by the MNO, or event subscriptions by MNO-

managed event consumers (as defined in clause 3.1) such as the NWDAF, precedence is based on ownership of the UE data domain of concern, with specific rules as described in clauses 4.5.4.2 and 4.5.4.3.

In this context, ownership of specific UE data domains is as specified in annex B.

#### 4.5.4.2 UE data domains owned by the 5G System (MNO)

The following rules shall apply to UE data domains that are owned by the 5G System (MNO):

1. For determining data collection and reporting behaviour, any preconfiguration of the Data Collection AF and/or data collection clients by the 5G System operator shall take precedence over similar ASP-defined provisioning information.
  - a) Any attempt by the ASP to provision data collection and reporting rules that are either more lax or more restrictive than allowed by the preconfiguration may be rejected by the Data Collection AF, subject to MNO policy.
2. For determining permissible access to event data exposed by the Data Collection AF to MNO-managed event consumers such as the NWDAF, MNO policies on event exposure (for example, regarding anonymization and aggregation) shall take precedence over any data exposure restrictions provisioned by the ASP as part of a Data Access Profile.
  - a) Any attempt by the ASP to provision data exposure rules affecting an MNO-managed event consumer that are either more lax or more restrictive than allowed by MNO policy shall be rejected by the Data Collection AF.
  - b) Any event subscription request by the ASP's Event Consumer AF to the Data Collection AF that would relax the data exposure restrictions provisioned on the Data Collection AF by the 5G System operator for that event consumer shall be rejected by the Data Collection AF.

#### 4.5.4.3 UE data domains owned by the ASP

The following rules shall apply to UE data domains that are owned by the ASP:

1. For determining data collection and reporting behaviour, ASP-defined provisioning information shall take precedence over any similar preconfiguration of the Data Collection AF and/or data collection clients by the 5G System operator.
  - a) Any preconfiguration by the 5G System operator of UE data collection and reporting behaviour that is either more lax or more restrictive than similar ASP-defined provisioning information should be ignored by the Data Collection AF and/or data collection clients.
2. For determining permissible access to event data exposed by the Data Collection AF to MNO-managed event consumers such as the NWDAF, data exposure restrictions provisioned by the ASP as part of a Data Access Profile shall take precedence over MNO policies on event exposure (for example, regarding anonymization and aggregation).
  - a) Any event subscription request by an MNO-managed event consumer to the Data Collection AF that would relax the data exposure restrictions provisioned on the Data Collection AF by the ASP for that event consumer shall be rejected by the Data Collection AF.

## 4.6 Domain model

### 4.6.1 General

Figure 4.6.1-1 depicts the static data model for the data collection and reporting domain. It is further described below.

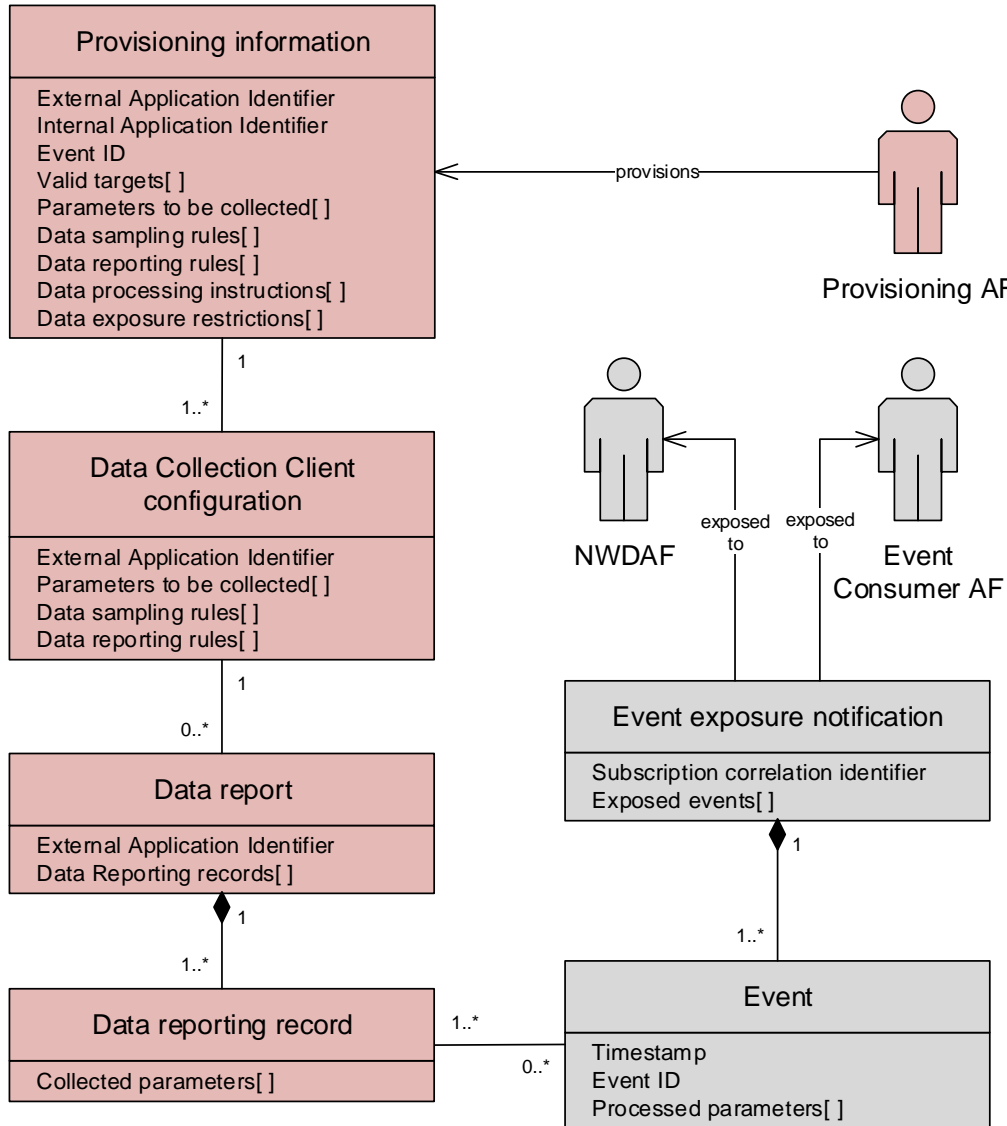

**Figure 4.6.1-1: Static domain model**

The *Provisioning AF* provisions zero or more sets of *provisioning information* in the Data Collection AF at reference point R1. The baseline set of information provisioned is described in clause 4.6.2. Each set of provisioning information pertains to one application, identified by its *external application identifier*, and one type of exposed *event*, uniquely identified in the 5G System by its *Event ID*, as defined in clause 4.15.1 of TS 23.502 [3]. There may be more than one set of provisioning information for a particular external application identifier, but the combination of the external application identifier and Event ID shall be unique for a given Data Collection AF instance.

The types of data collection client that are permitted to collect UE data are indicated in *Valid targets*. *Parameters to be collected* specifies which subset of parameters associated with the UE data domain for the provisioned Event ID are to be collected by these types of data collection clients.

*Data sampling rules* specify how the domain-specific parameters associated with the Event ID are to be collected by the data collection client (e.g., sampling frequency, location filter). *Data reporting rules* specify how the data collection client is to report its collected data parameters to the Data Collection AF (e.g., reporting probability, reporting frequency, reporting format, data packaging strategy).

The *data processing instructions* and *data exposure restrictions* are expressed as a set of Data Access Profiles (see clause 4.5.2). The data exposure restrictions limit the types of event consumer that are authorised to subscribe to the Event ID provisioned for the application and the data processing instructions specify aggregation functions that are applied to UE data prior to exposure to those event consumers.

Each set of provisioning information is manifested as a *data collection client configuration* that the Data Collection AF makes available to Direct Data Collection Client instances at reference point R2, to Indirect Data Collection Client instances at R3 and to AS instances at R4.

Once configured, these data collection clients then send *data reports* to the Data Collection AF associated with the data collection client configuration. Each data report provides the external application identifier associated with the UE Application and also includes a non-empty list of *data reporting records* containing the parameters collected by the data collection client. These parameters typically include a sampling timestamp.

NOTE 1: It is the responsibility of the data collection client to discover its external application identifier by means outside the scope of the present document.

An event consumer (the NWDAF and/or Event Consumer AF) subscribes to a type of event exposed by the Data Collection AF using the procedures defined in clause 6.2.8.2.3 of TS 23.288 [4]. The event consumer may additionally specify user-, location- and/or application-based filters in its subscription request in order to further limit the events exposed to a subset of those permitted by the relevant provisioned data exposure restriction(s). Attempts by an event consumer to subscribe to event types that are not provisioned at the Data Collection AF instance are permitted, but will yield no event notifications until such event types have been successfully provisioned.

NOTE 2: It is the responsibility of the event consumer to discover the relevant application identifier of interest by means outside the scope of the present document.

Depending on the *data processing instructions* provisioned in the Data Collection AF, a data reporting record contributes to zero or more events exposed to subscribers at reference points R5 and/or R6. Conversely, an exposed event arises from one or more data reporting records. In the case of events synthesised by the Data Collection AF from multiple data reporting records, the timestamp of the event shall indicate when it was synthesised. Otherwise, the timestamp of the event shall be identical to the timestamp of the data reporting record from which it arose.

The Data Collection AF exposes a batch of recent events to consumers (the NWDAF and/or Event Consumer AF) as an *event exposure notification*.

## 4.6.2 Provisioning information for data collection and reporting

A separate set of provisioning information shall be provided to the Data Collection AF at reference point R1 for each Event ID it is to expose. This provisioning information embodies the Service Level Agreement between the network operator and the Application Service Provider envisaged in clause 6.2.8.1 of TS 23.288 [4]. The provisioning information shall include at least the parameters defined in table 4.6.2-1 below:

**Table 4.6.2-1: Baseline provisioning information for data collection and reporting**

Parameter	Cardinality	Description
External Application Identifier	1..1	The identifier to be used in reports sent to the Data Collection AF by data collection clients. (This needs to be mapped to the Internal Application Identifier when exposing events to the NWDAF.)
Internal Application Identifier	1..1	The identifier to be used by event consumers (including the NWDAF and the Event Consumer AF) when subscribing to events in the Data Collection AF.
Event ID	1..1	The identifier of an AF event that will be exposed to event consumers as a result of the provisioning.
Data collection client type	1..1	The type of data collection client that will submit data reports to the Data Collection AF.
Valid targets	1..1	A parameter to control whether event consumers are permitted to filter events by External UE identifier or External Group Identifier when subscribing, instead of receiving events relating to all UEs.
Parameters to be reported	1..*	The subset of domain-specific parameters associated with the specified Event ID to be reported to the Data Collection AF (subject to user consent).

Data sampling rules	0..*	Information to be forwarded by the Data Collection AF to the data collection client, representing instructions on how the subset of domain-specific parameters associated with the Event ID are to be sampled by the data collection client (e.g., sampling frequency, location filter).  Default values (which may be agreed between the ASP and the MNO) shall be assumed by the Data Collection AF for any rules that are omitted.
Data reporting rules	0..*	Information to be forwarded by the Data Collection AF to the data collection client, representing instructions on how the data collection client is to report data to the Data Collection AF (e.g., reporting probability, reporting frequency, reporting format, data packaging strategy).  Default values (which may be agreed between the ASP and the MNO) shall be assumed by the Data Collection AF for any rules that are omitted.
Data processing instructions	1..*	A set of operations to be performed by the Data Collection AF on the parameters reported according to clause 4.6.4 prior to exposure as an event at a particular access level.  The set of supported operations shall include at least those listed in table 4.5.2-1.
Data exposure restrictions	1..*	A set of restrictions on the exposure of the collected data after any data processing, each corresponding to a different access level.

### 4.6.3 Configuration information for data collection clients

All clients of the Data Collection AF wishing to report data shall first obtain a data collection and reporting configuration from the Data Collection AF at reference point R2, R3 or R4 (as appropriate). For each Event ID, the data collection and reporting configuration shall include at least the parameters defined in table 4.6.3-1 below:

**Table 4.6.3-1: Baseline information for data collection and reporting configuration**

Parameter	Cardinality	Description
External Application Identifier	1..1	Identifies the UE Application to which this data collection and reporting configuration pertains.  Quoted in reports sent to the Data Collection AF.
Parameters to be collected	1..*	The subset of domain-specific parameters associated with the specified Event ID to be collected by the Data Collection AF (subject to user consent).
Data sampling rules	1..*	Instructions on how the subset of domain-specific parameters associated with the Event ID are to be sampled by the data collection client (e.g., sampling frequency, location filter).
Data reporting rules	1..*	Instructions on how the data collection client is to report data to the Data Collection AF (e.g., reporting probability, reporting frequency, reporting format, data packaging strategy).

### 4.6.4 Information included in data reports to the Data Collection AF

For each Event ID, the data report shall include at least the parameters as defined in table 4.6.4-1 below:

**Table 4.6.4-1: Baseline information for data reporting**

Parameter	Cardinality	Description
External Application Identifier	1..1	Identifies the UE Application to which this data report pertains.
Collected parameters	1..*	The set of parameters collected by the data collection and reporting client.

## 4.7 Service exposure

### 4.7.1 Service exposure via Network Exposure Function (NEF)

The following services provided by a Data Collection AF deployed inside the trusted domain shall be exposed northbound by the NEF to an Application Service Provider outside the trusted domain, as depicted in clauses A.3 and A.4:

- The *Ndcap\_DataReportingProvisioning* service shall be exposed to Provisioning AF instances deployed outside the trusted domain as *Nnef\_DataReportingProvisioning*. See clause 6 of TS 26.532 [7] and clause 5.24 of TS 29.522 [10].
- The *Ndcap\_DataReporting* service shall be exposed to Indirect Data Collection Clients and Application Servers deployed outside the trusted domain as *Nnef\_DataReporting*. See clause 7 of TS 26.532 [7] and clause 5.23 of TS 29.522 [10].
- The *Naf\_EventExposure* service shall be exposed to Event Consumer AF instances deployed outside the trusted domain as *Nnef\_EventExposure*. See TS 29.517 [5] and TS 29.522 [10].

The following services provided by an externally deployed Data Collection AF shall be exposed southbound by the NEF to Network Functions deployed inside the trusted domain, as depicted in clauses A.5:

- The *Naf\_EventExposure* service shall be exposed to Event Consumer AF instances deployed inside the trusted domain as *Nnef\_EventExposure*. See TS 29.517 [5] and TS 29.591 [11].

### 4.7.2 Service exposure via Common API Framework (CAPIF) for Northbound APIs

When CAPIF is supported, then:

- the Data Collection AF shall support the CAPIF API provider domain functions as part of a distributed CAPIF deployment, i.e. *Ndcap* and *Naf* via CAPIF-2/2e; and CAPIF-3, CAPIF-4 and CAPIF-5, as specified in clause 7.3 of TS 23.222 [8];
- the Data Collection AF shall support the CAPIF Core Function and API provider domain functions as part of a centralised CAPIF deployment, i.e. *Ndcap* and *Naf* via CAPIF-2/2e, as specified in clause 7.2 of TS 23.222 [8].

The CAPIF and associated API provider domain functions are specified in TS 23.222 [8].

### 4.7.3 Service exposure via Service Enabler Architecture Layer (SEAL) for Verticals

The use of the SEAL framework for exposure of the *Ndcap\_DataReportingProvisioning*, *Ndcap\_DataReporting* and *Naf\_EventExposure* services is for future study.

# 5 Procedures for data collection and reporting

## 5.1 General

This clause defines the high-level procedures for data collection and reporting.

Figure 5.1-1 below depicts the case where all functional entities lie inside the trusted domain. The detailed steps for each phase are further elaborated in the following clauses.

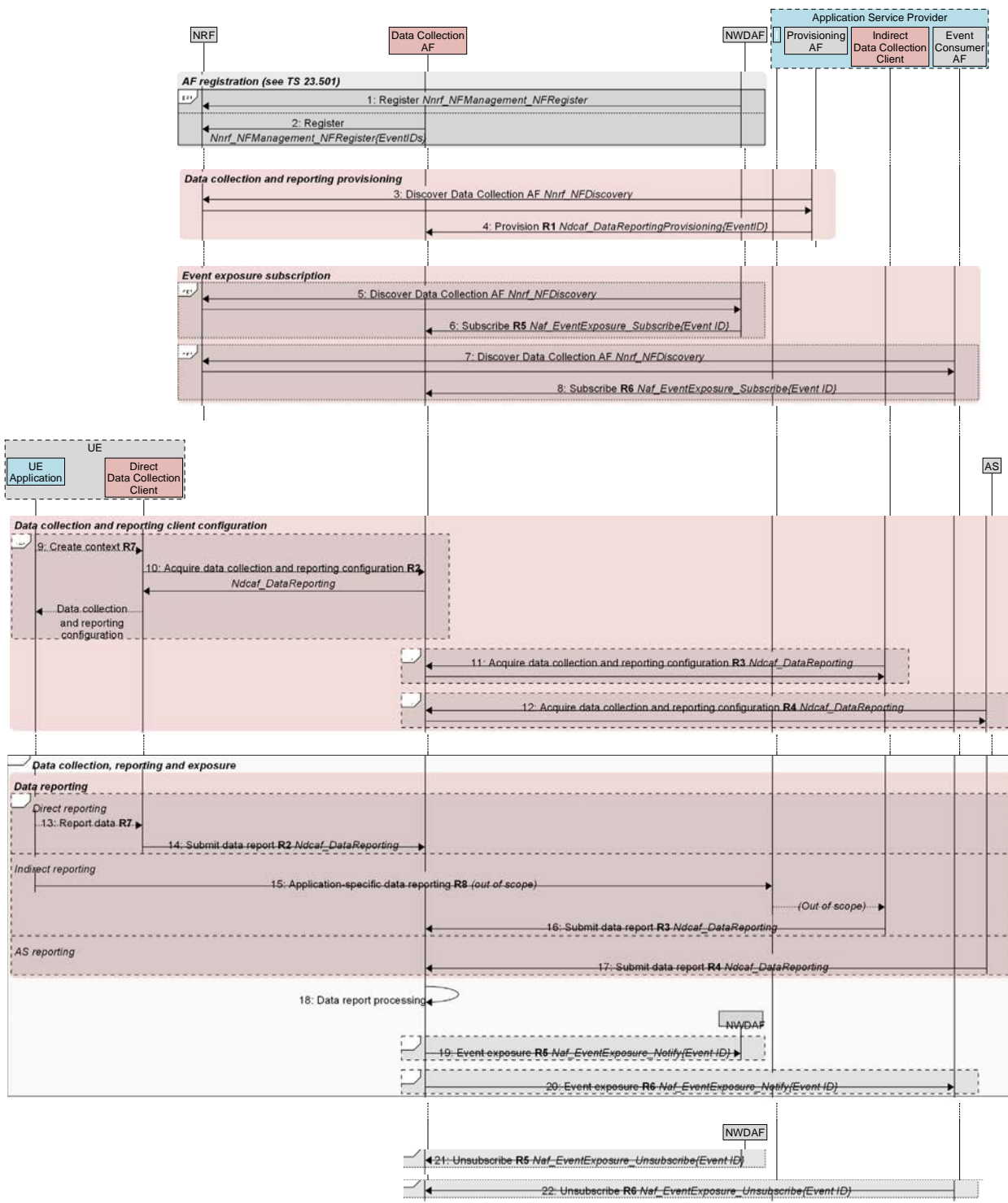
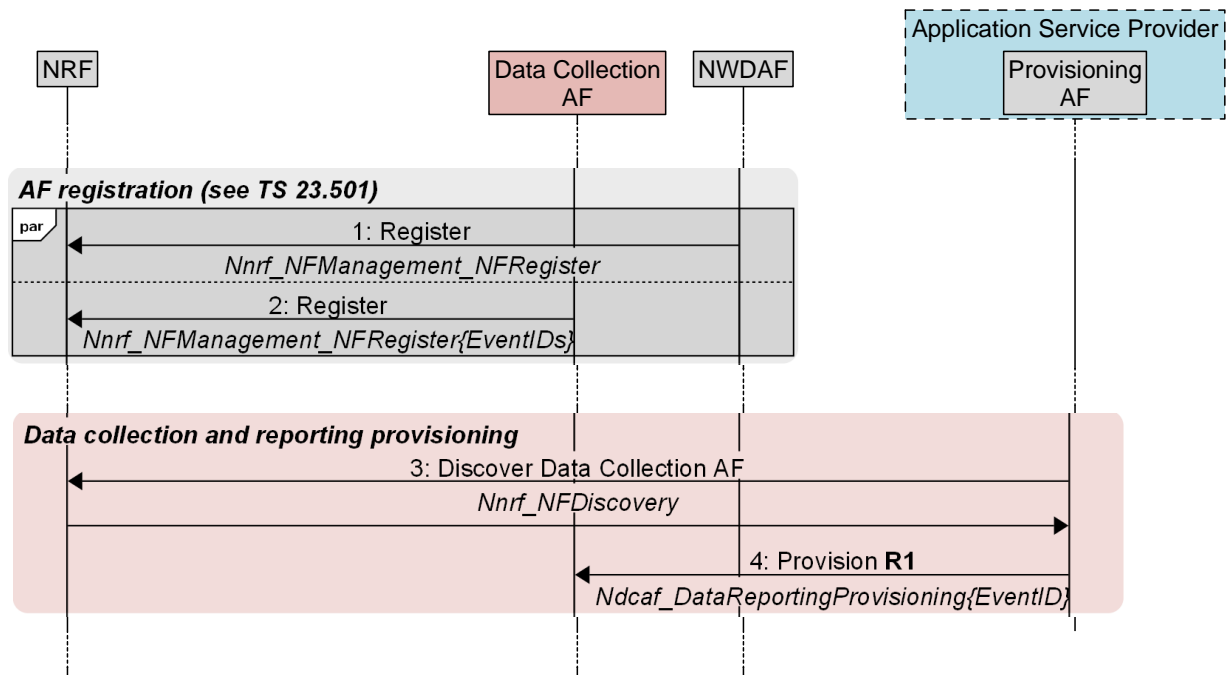

Figure 5.1-1: High-level procedures for data collection and reporting



## 5.2 Procedures for data collection and reporting provisioning



<http://msc-generator.sourceforge.net v6.4.7>

**Figure 5.2-1: High-level procedures for AF registration and provisioning phases**

Initially, the different types of AF register themselves with the NRF using the *Nnrf\_NFManagement\_NFRegister* service operation defined in clause 5.2.7.2.2 of TS 23.502 [3]:

1. The NWDAF registers itself with the NRF.
2. The Data Collection AF registers itself with the NRF. This registration includes a list of Event IDs that it is capable of exposing to event consumers.

At some later point, Data Collection and Reporting features are provisioned by the Application Service Provider's Provisioning AF:

3. The Provisioning AF discovers the Data Collection AF by following the *Nnrf\_NFDiscovery* procedure defined in clause 5.2.7.3 of TS 23.502 [3].
4. The Provisioning AF provisions data collection and reporting in the Data Collection AF for a specific Event ID, using the *Ndcaf\_DataReportingProvisioning* procedures defined in the present document. The provisioning information may vary depending on the data reporting method, i.e. direct reporting or indirect reporting.

### 5.3 Procedures for Data Collection AF subscription

Subsequently, one or more of the two types of event consumer discover the Data Collection AF and subscribe to events from it.

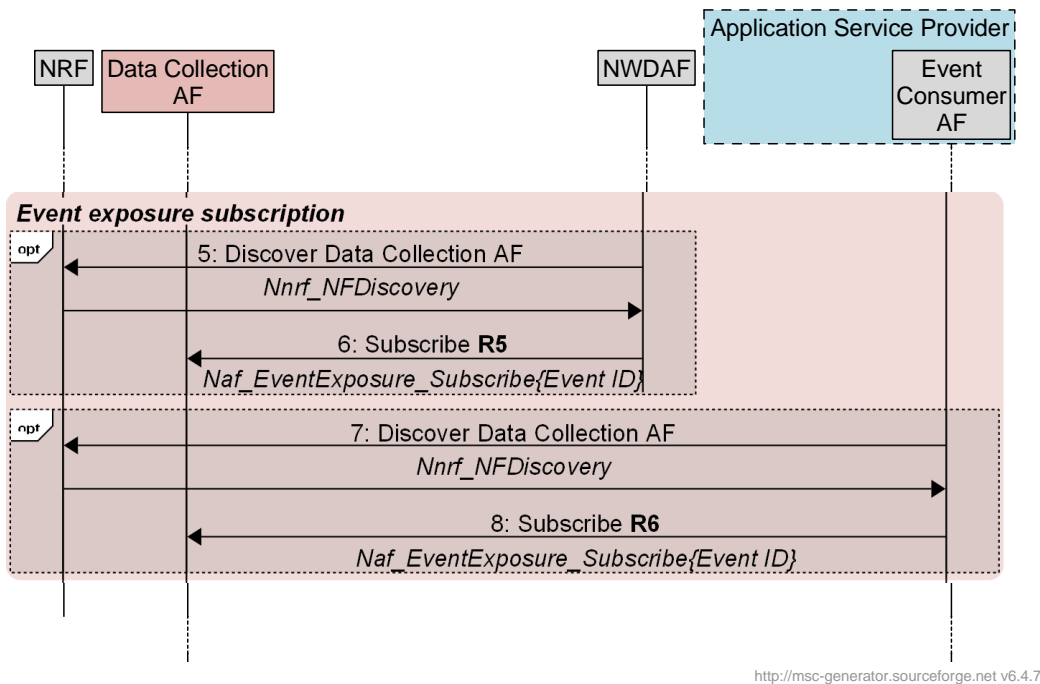

**Figure 5.3-1: High-level procedures for subscription phase**

The steps are as follows:

5. The NWDAF discovers the Data Collection AF by following the *Nnrf\_NFDiscovery* procedure defined in clause 5.2.7.3 of TS 23.502 [3]...
6. ...and then subscribes to event(s) of interest by invoking the *Naf\_EventExposure\_Subscribe* service operation defined in clause 5.2.19.2.2 of TS 23.502 [3] on the discovered Data Collection AF. As described in clause 4.6.1, user-, location- and/or application-based filters may be specified as additional input parameters to the operation.
7. The Event Consumer AF discovers the Data Collection AF by following the *Nnrf\_NFDiscovery* procedure defined in clause 5.2.7.3 of TS 23.502 [3]...
8. ...and then subscribes to event(s) of interest by invoking the *Naf\_EventExposure\_Subscribe* service operation defined in clause 5.2.19.2.2 of TS 23.502 [3] on the discovered Data Collection AF.

## 5.4 Procedures for configuring data collection client

At some later point, one or more of the three types of data collection client obtain their configuration from the Data Collection AF by invoking the *Ndcaf\_DataReporting* service defined in the present document and specified in TS 26.532 [7]. The intersection between the above provisioning information and current event consumer subscriptions determines the contents of this configuration.

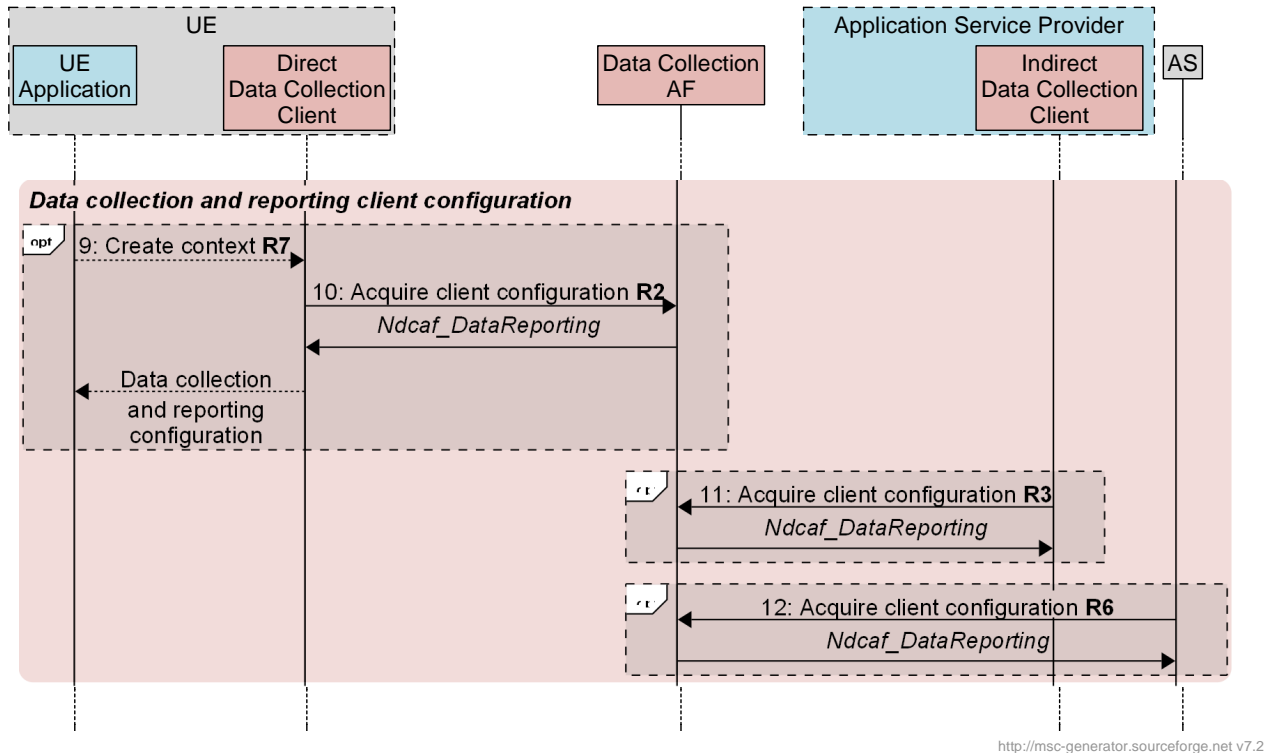

<http://msc-generator.sourceforge.net v7.2>

**Figure 5.4-1: High-level procedures for data collection client configuration phase**

The steps are as follows:

9. If present in the instantiation, the UE Application creates a data collection and reporting context with the Direct Data Collection Client. As part of this context, the UE Application may indicate consent for a UE identifier to be included in data reports submitted on its behalf by the Direct Data Collection Client.
10. As a consequence of step 9 or (if the UE Application is not present) during its own initialisation, the Direct Data Collection Client acquires its data collection and reporting configuration from the Data Collection AF, if relevant.  
  
If the UE Application is instantiated, the Direct Data Collection Client provides it with a data collection and reporting configuration derived from that just obtained from the Data Collection AF.
11. The Indirect Data Collection Client acquires its data collection and reporting configuration from the Data Collection AF, if relevant.
12. The AS acquires its data collection and reporting configuration from the Data Collection AF, if relevant.

Whenever the provisioning information changes, or the set of event exposure subscriptions changes, a new set of data collection and reporting configuration shall be made available to data collection clients by the Data Collection AF.

## 5.5 Procedures for reporting to the Data Collection AF

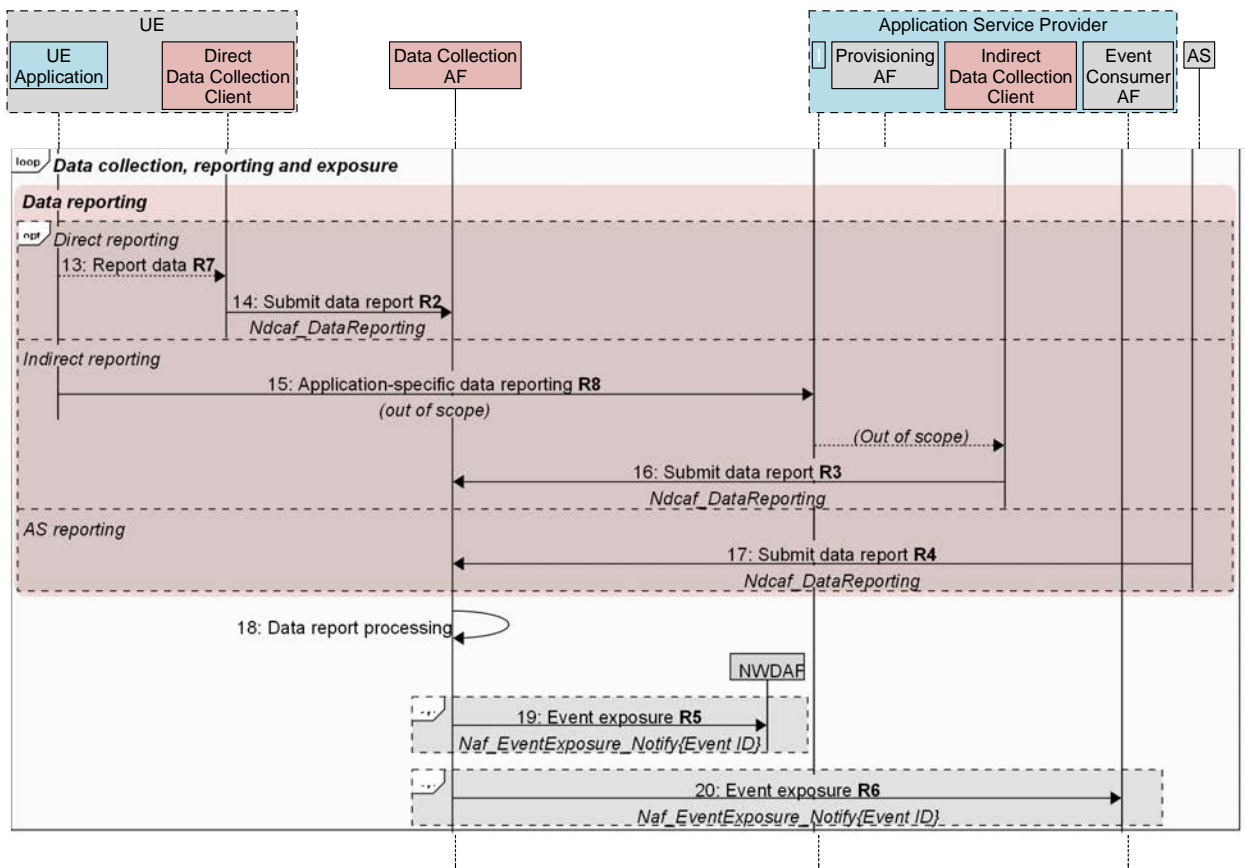

<http://msc-generator.sourceforge.net v7.2>

**Figure 5.5-1: High-level procedures for data reporting and exposure phase**

The different data collection clients proceed as follows:

13. If present in the instantiation, the UE Application reports data to the Direct Data Collection Client according to the configuration provided in step 10 for inclusion in a data report.
14. The Direct Data Collection Client may submit a data report to the Data Collection AF via reference point R2 by invoking the *Ndcaf\_DataReporting* service defined in the present document and specified in TS 26.532 [7].
15. The UE Application may send application-specific data reporting to the Application Service Provider...
16. ...and the Indirect Data Collection Client may, as a result, submit a data report to the Data Collection AF by invoking the *Ndcaf\_DataReporting* service defined in the present document and specified in TS 26.532 [7].
17. The AS may submit a data report to the Data Collection AF by invoking the *Ndcaf\_DataReporting* service defined in the present document and specified in TS 26.532 [7].

## 5.6 Procedures for Data Collection AF data exposure

In response to receiving a data report:

18. The Data Reporting AF processes the data report.

Reception of a data report by the Data Collection AF may result in an event being exposed to subscribed event consumers:

19. The Data Collection AF may expose an event to the NWDAF by invoking the *Naf\_EventExposure\_Notify* service operation on the latter, as defined in clause 5.2.19.2.4 of TS 23.502 [3].
20. The Data Collection AF may expose an event to the Event Consumer AF by invoking the *Naf\_EventExposure\_Notify* service operation on the latter, as defined in clause 5.2.19.2.4 of TS 23.502 [3].

## 5.7 Procedures for Data Collection AF unsubscription

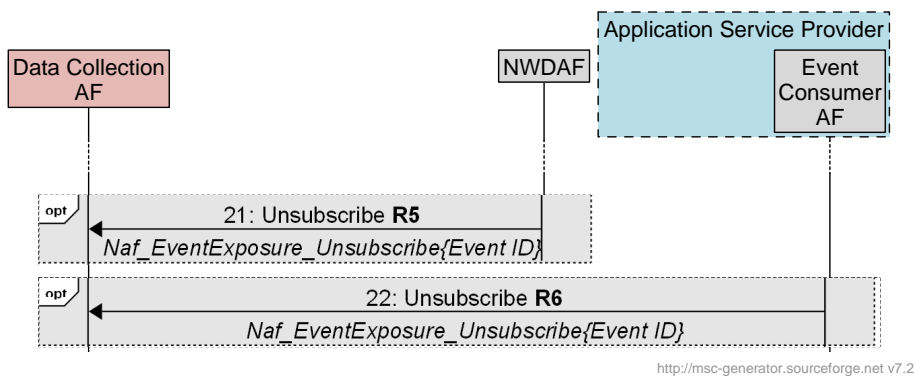

**Figure 5.7-1: High-level procedures for unsubscription phase**

Finally:

21. The NWDAF unsubscribes to events from the Data Collection AF by invoking the *Naf\_EventExposure\_Unsubscribe* service operation, as defined in clause 5.2.19.2.3 of TS 23.502 [3].
22. The Event Consumer AF unsubscribes to events from the Data Collection AF by invoking the *Naf\_EventExposure\_Unsubscribe* service operation, as defined in clause 5.2.19.2.3 of TS 23.502 [3].

## 5.8 Procedures for event consumer authorization

The procedure for authorising access to the events exposed by the Data Collection AF is depicted by the following call flow:

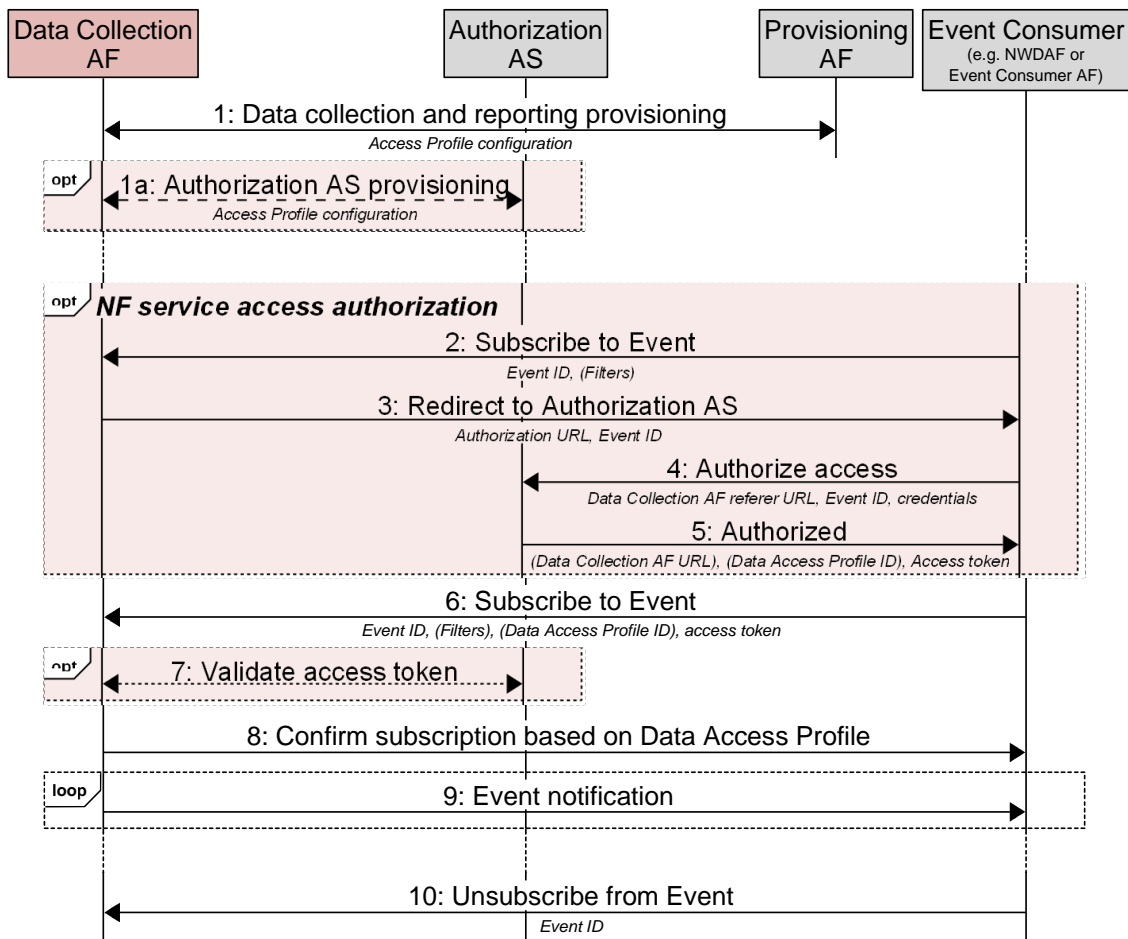

<https://gitlab.com/msc-generator/v8.0>

**Figure 5.8-1: High-level procedures for event consumer authorization**

The steps are:

1. The Provisioning AF provisions the data collection and the report exposure functionality at reference point R1, per the procedures in clause 5.2, including a set of Data Access Profiles.
- 1a. The Data Collection AF may provision the Authorization AS with a Data Access Profile configuration corresponding to step 1, including the Data Access Profile ID. The procedures used in this step are outside the scope of standardisation.
2. An event consumer sends a subscription request to the Data Collection AF to receive events via reference point R5 or R6, per the procedures in clause 5.3, indicating the Event ID of interest and any desired user-, location- and/or application-based filters (see clause 4.6.1).
3. In return, the Data Collection AF redirects the event consumer to the Authorization AS in order to obtain access.
4. The event consumer contacts the Authorization AS (according to the procedures for authorization of NF service access defined in clause 13.4 of TS 33.501 [9]) with a set of valid credentials.
5. If access is granted, the Authorization AS responds with an access token that is valid for a specific period of time. The access token may encode a Data Access Profile ID if the authorization applies narrowly. The response may redirect the event consumer to the Data Collection AF using the initial subscription request URL, enhanced with the access token and optionally with the Data Access Profile ID passed in the clear.

6. The event consumer resends the subscription request (including the Event ID and desired filters, if any) to the Data Collection AF, this time with the access token and, optionally, with the Data Access Profile ID.
7. The Data Collection AF may verify the access token with the Authorization AS, or it may verify it locally.
8. If verification is successful, the Data Collection AF approves the subscription request for the requested Access Profile
9. The Data Collection AF sends event notifications to the event consumer, per the procedures in clause 5.6.
10. The event consumer cancels its event subscription using the procedures in clause 5.7.

---

# Annex A (informative): Collaboration scenarios for data collection and reporting

## A.1 General

This annex documents a set of collaboration scenarios that illustrate potential deployments of the data collection and reporting architecture as defined in the present document.

In deployment, it is possible that some UE data is provided to the Data Collection AF using the direct data reporting method at reference point R2, while other (application-private) UE data is collected via reference R8 and provided to the Data Collection AF via the indirect data reporting method at reference point R3 (R3' in Collaboration D). In certain domains, UE data is collected in the first instance by an AS and therefore needs to be provided to the Data Collection AF at reference point R4 (R4' in Collaboration D). Hence, all three data reporting reference points are potentially in scope for all of the documented collaboration scenarios.

NOTE 1: In all of the documented collaboration scenarios, reference point R2 traverses the data plane between the Direct Data Collection Client and the Data Collection AF regardless of whether the latter is deployed inside or outside the trusted domain.

NOTE 2: In all of the documented collaboration scenarios, reference point R8 traverses the data plane between the UE Application the Application Service Provider. The traffic carried at this reference point is tunneled transparently through the trusted domain without interacting with any control plane entities.



## A.2 Collaboration A

In this collaboration scenario all of the functions are deployed inside the trusted domain. This corresponds to the case where the functional entities of the Application Service Provider as well as the Application Server (AS) are internal to the 5G System.

**NOTE:** Although deployed within the trusted domain, and granted privileged access to certain Network Functions in the 5G System, the Application Service Provider and/or the AS may or may not be under direct control of the MNO in this collaboration scenario. For example, management of one or more of the functional entities may be delegated to a trusted third-party service provider.

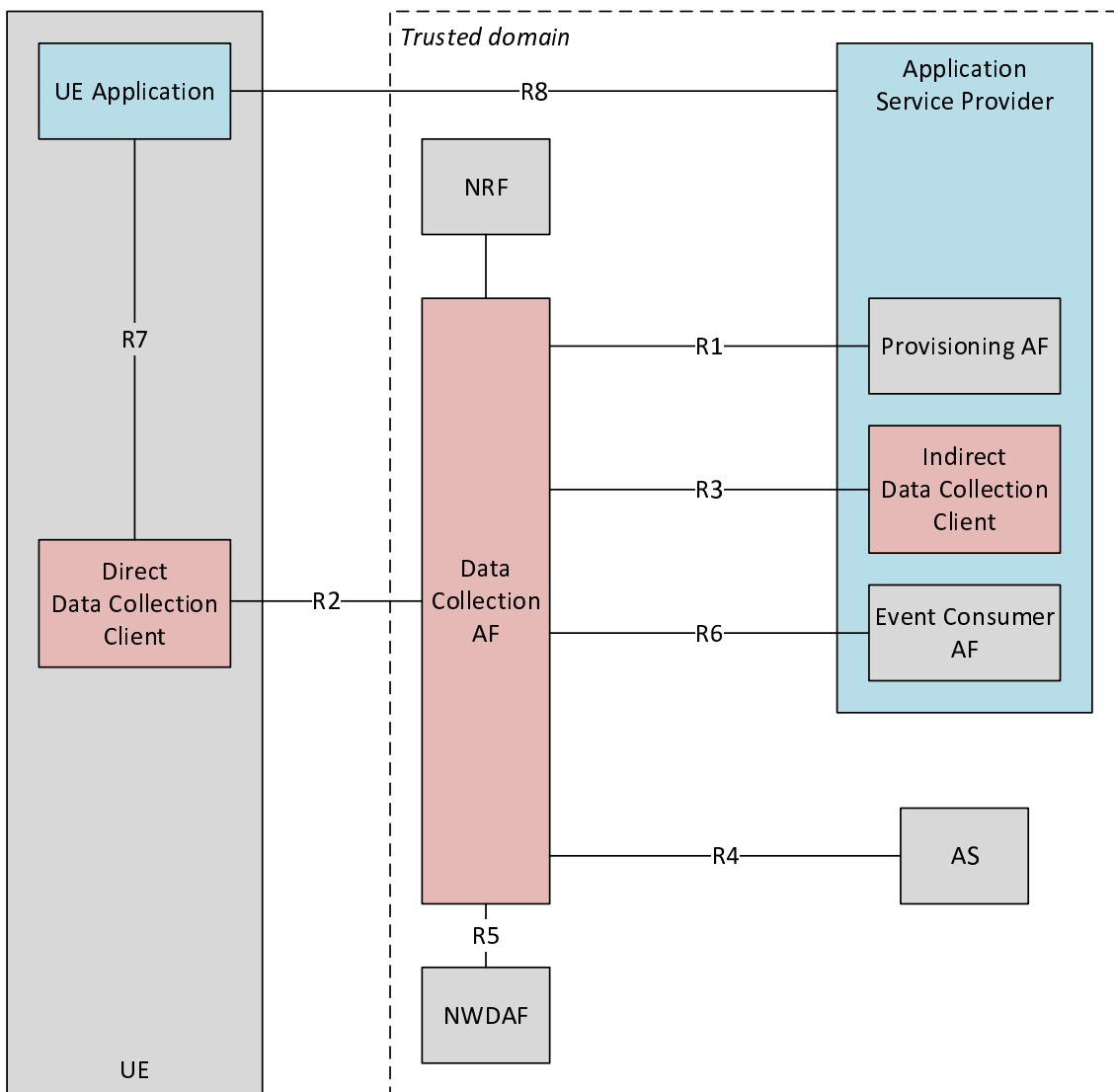
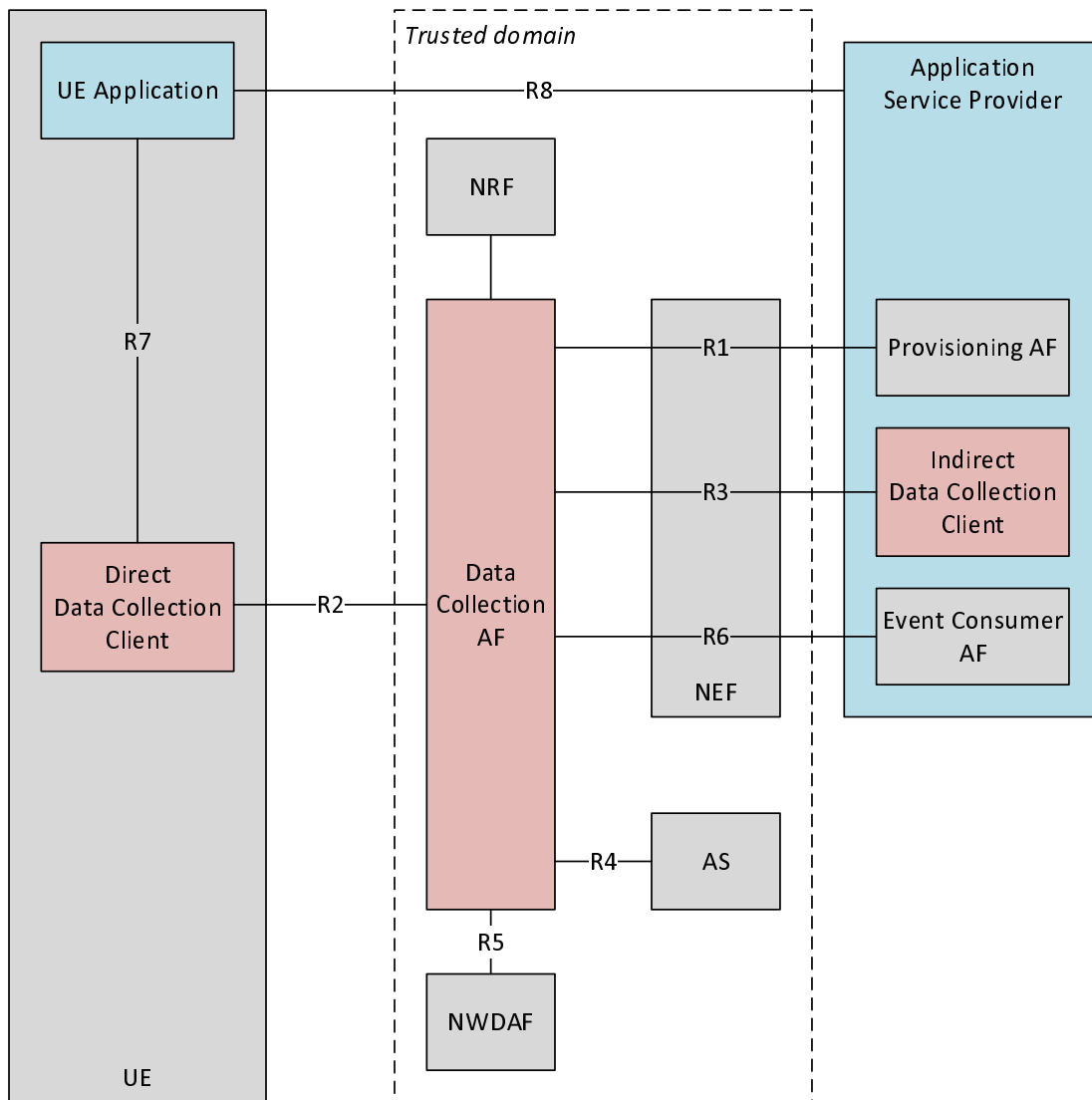

Figure A.2-1: Collaboration A with all functions deployed inside the trusted domain

### A.3 Collaboration B

In this collaboration scenario the functional entities of the Application Service Provider are deployed outside the trusted domain. Interactions between these functions and the Data Collection AF must therefore be mediated by the NEF.



**Figure A.3-1: Collaboration B with all functions of Application Service Provider deployed outside the trusted domain**

## A.4 Collaboration C

This collaboration scenario illustrates the case where the Application Server (AS) is also deployed outside the trusted domain (in addition to the functional entities of the Application Service Provider per Collaboration B). In this case, the AS must therefore additionally interact with the Data Collection AF via the NEF.

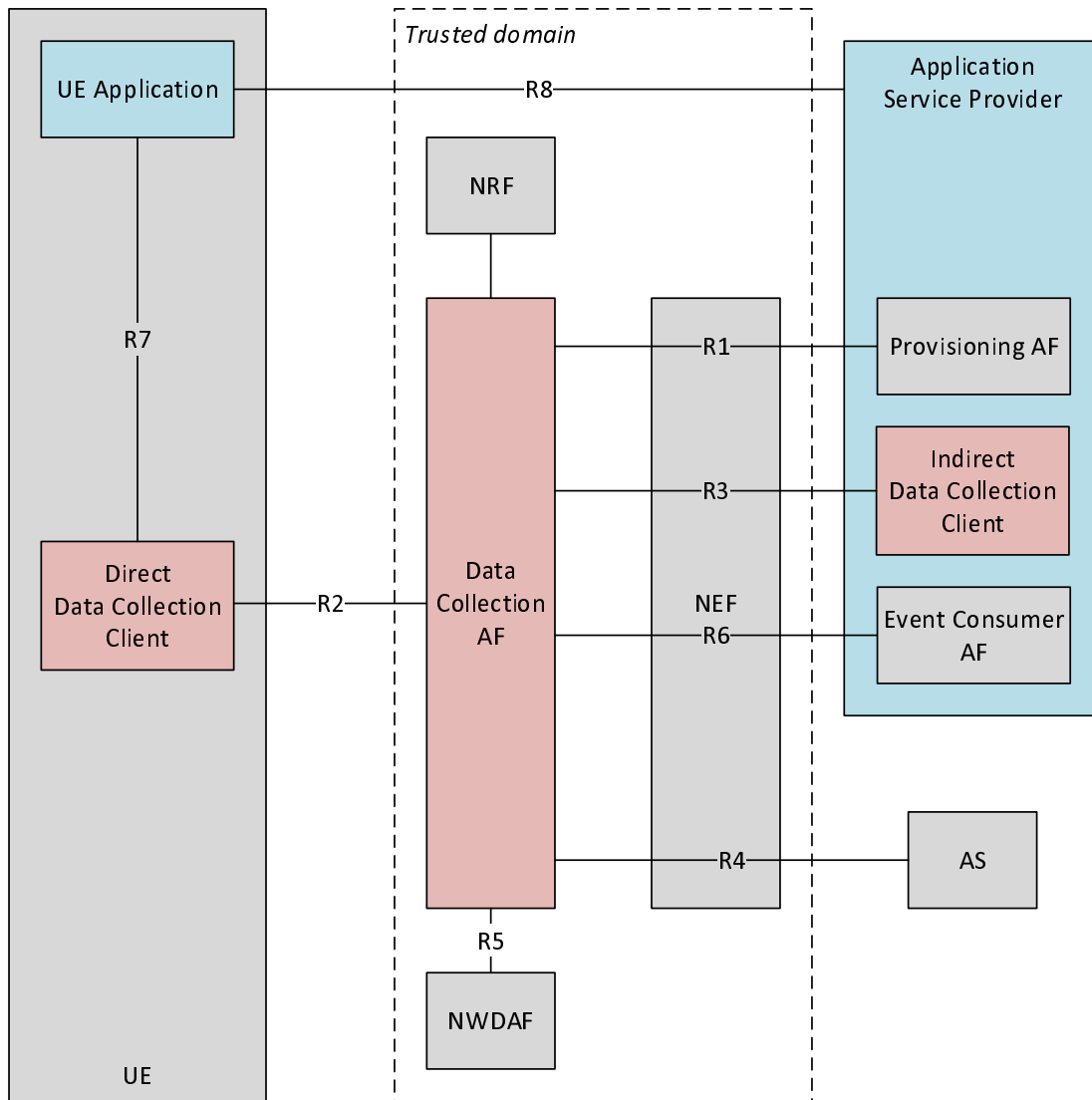

**Figure A.4-1: Collaboration C with all functions of Application Service Provider and Application Server deployed outside the trusted domain**

## A.5 Collaboration D

In this collaboration scenario, the Data Collection AF itself is deployed outside the trusted domain and interactions with functions inside the trusted domain occur via the NEF. This scenario corresponds to the "Procedure for Data Collection from AF via NEF" defined in clause 6.2.2.3 of TS 23.288 [4]. Specifically:

- The externally deployed Data Collection AF registers with the NRF inside the trusted domain using the *Nnef\_NFManagement* service via the NEF.

NOTE: In practice, the Data Collection AF is instantiated as a subfunction of a domain-specific Application Function. The enclosing Application Function should include data collection and reporting capabilities in its own registration with the NRF on behalf of the enclosed Data Collection AF rather than making a separate registration for the subfunction.

- The NWDAF inside the trusted domain uses the *Nnef\_EventExposure* service (as specified in clause 5.2.6.2 of TS 23.502 [3]) to subscribe to and receive events exposed by the externally deployed Data Collection AF.

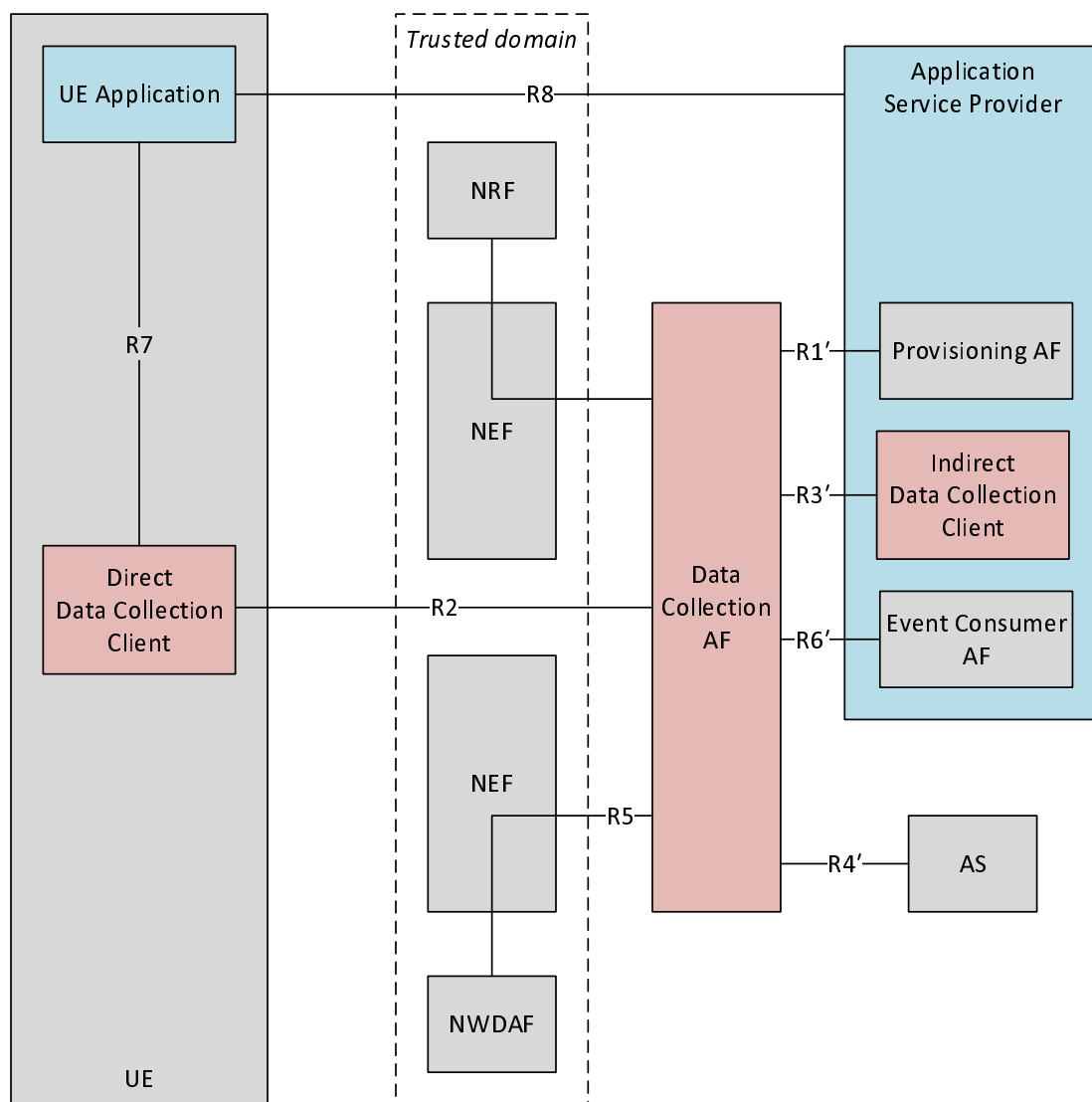

Figure A.5-1: Collaboration D with Data Collection AF deployed outside the trusted domain

The functional entities of the Application Service Provider, as well as the Application Server (AS), interact with the externally deployed Data Collection AF using interfaces that are outside the scope of 3GPP specification. However, the interactions at reference points R1', R3', R4' and R6' are expected to be functionally equivalent to those at R1, R3, R4 and R6 respectively.

## A.6 Collaboration E

In this collaboration scenario, the Data Collection Client is deployed as a subfunction of the UE Application. As a consequence of this arrangement, reference point R7 is subsumed into the UE Application.

This collaboration may be combined with any of the preceding collaboration scenarios. Hence, only reference points R2 and R8 are depicted in the figure in the interests of brevity.

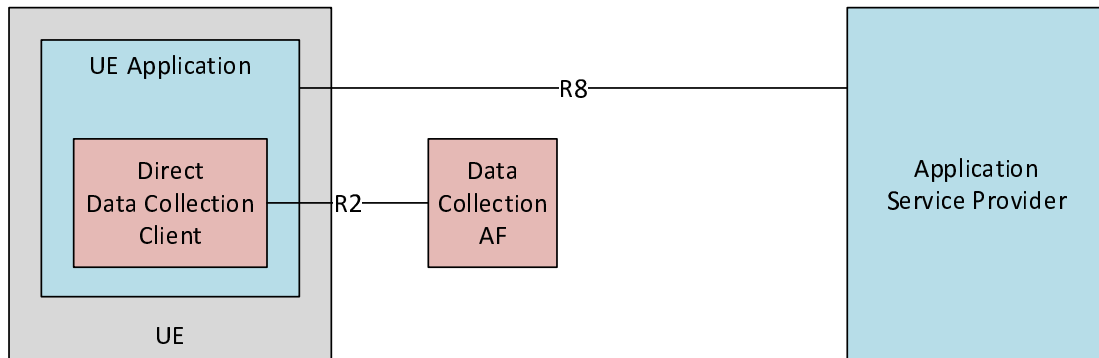

**Figure A.6-1: Collaboration E with Data Collection Client deployed as part of the UE Application**

The Direct Data Collection Client could, for example, be realised as a software library that implements the appropriate protocol at reference point R2. In such a realisation, the procedures defined in the present document at reference point R7 would likely form the API of the Data Collection Client library.

---

## Annex B (normative): UE data domain ownership

### B.1 General

Ownership of any UE data domain not listed in this annex shall be specified in the document defining that domain.

---

### B.2 Baseline UE data domains

Table B.1-1 specifies ownership of the baseline UE data domains defined in TS 23.288 [4].

**Table B.2-1: Ownership of baseline UE data domains**

<b>UE data domain</b>	<b>Owner</b>
<i>Service Experience</i>	5G System (MNO)
<i>UE Location</i>	5G System (MNO)
<i>Communication</i>	5G System (MNO)
<i>Performance</i>	5G System (MNO)
<i>Planned Trips</i>	5G System (MNO)

Application-specific UE data domains shall be owned by the ASP.

## Annex C (informative): Change history

Change history							
Date	Meeting	TDoc	CR	Rev	Cat	Subject/Comment	New version
2021-06	Post-SA4#115-e ad hoc					Initial skeleton document.	0.0.1
2021-08	SA4#115-e	S4-211037 S4-211218 S4-211232				Addition of reference architecture and collaboration scenarios. References to CAPIF as an implementation option.	0.1.0
2021-10	Post SA4#115-e ad hoc	S4al211226 S4al211227 S4al211233				Additional collaboration scenario. Additional service-based reference architecture figure. Informative note declaring R7 for future study.	0.1.1
		S4al211236 S4al211242 S4al211244				Domain model. High-level procedures. Corrections and updates to editor's notes.	0.1.2
2021-11	SA4#116-e	S4-211590 S4-211591				Clarification of direct and indirect reporting. Miscellaneous clarifications and corrections.	0.2.0
2021-12	SA#94-e	SP-211342				Presentation to SA plenary for information	1.0.0
2021-12	Post-SA4#116-e ad hoc	S4-al211254				Domain model revisited.	1.0.1
2022-02	SA4#117-e	S4-200243				S4-220240: Data exposure restriction model.	1.1.0
2022-03	Post-SA4#117-e ad hoc	S4al221307				S4-220240: Added missing subheadings in clause 4.5.	1.1.1
		S4al221317				Replacement figure 4.5.2-1 showing Data Access Profile identifier.	1.1.2
2022-04	SA4#118-e	S4-220349				Resolution of Editor's Notes.	1.2.0
2022-05	SA4#119-e	S4-220637				Draft presentation to TSG.	2.0.0
		S4-220807				Revised presentation to TSG	2.1.0
2022-06	SA#96	SP-220603				Under Change Control	17.0.0
2022-09	SA#97-e	SP-220757	0001	1	F	[EVEX] Miscellaneous corrections and clarifications	17.1.0
2023-06	SA#100	SP-230550	0005	1	F	[EVEX] Provisioning of Data Collection and Reporting Configuration	17.2.0
2023-06	SA#100	SP-230550	0006	1	F	[EVEX] Precedence Rules on Data Collection, Reporting and Event Exposure	17.2.0
2024-06	SA#104	SP-240683	0009	1	F	[EVEX] Data reporting domains and events	17.3.0

---

# History

<b>Document history</b>		
V17.0.0	July 2022	Publication
V17.1.0	October 2022	Publication
V17.2.0	July 2023	Publication
V17.3.0	July 2024	Publication