

# ETSI TS 128 531 V18.8.0 (2025-01)



**5G;  
Management and orchestration;  
Provisioning  
(3GPP TS 28.531 version 18.8.0 Release 18)**



---

**Reference**

RTS/TSGS-0528531v180

---

**Keywords**

5G

**ETSI**

650 Route des Lucioles  
F-06921 Sophia Antipolis Cedex - FRANCE

---

Tel.: +33 4 92 94 42 00 Fax: +33 4 93 65 47 16

Siret N° 348 623 562 00017 - APE 7112B  
Association à but non lucratif enregistrée à la  
Sous-Préfecture de Grasse (06) N° w061004871

---

**Important notice**

The present document can be downloaded from the  
[ETSI Search & Browse Standards application](#).

The present document may be made available in electronic versions and/or in print. The content of any electronic and/or print versions of the present document shall not be modified without the prior written authorization of ETSI. In case of any existing or perceived difference in contents between such versions and/or in print, the prevailing version of an ETSI deliverable is the one made publicly available in PDF format on [ETSI deliver repository](#).

Users should be aware that the present document may be revised or have its status changed, this information is available in the [Milestones listing](#).

If you find errors in the present document, please send your comments to the relevant service listed under [Committee Support Staff](#).

If you find a security vulnerability in the present document, please report it through our [Coordinated Vulnerability Disclosure \(CVD\)](#) program.

---

**Notice of disclaimer & limitation of liability**

The information provided in the present deliverable is directed solely to professionals who have the appropriate degree of experience to understand and interpret its content in accordance with generally accepted engineering or other professional standard and applicable regulations.

No recommendation as to products and services or vendors is made or should be implied.

No representation or warranty is made that this deliverable is technically accurate or sufficient or conforms to any law and/or governmental rule and/or regulation and further, no representation or warranty is made of merchantability or fitness for any particular purpose or against infringement of intellectual property rights.

In no event shall ETSI be held liable for loss of profits or any other incidental or consequential damages.

Any software contained in this deliverable is provided "AS IS" with no warranties, express or implied, including but not limited to, the warranties of merchantability, fitness for a particular purpose and non-infringement of intellectual property rights and ETSI shall not be held liable in any event for any damages whatsoever (including, without limitation, damages for loss of profits, business interruption, loss of information, or any other pecuniary loss) arising out of or related to the use of or inability to use the software.

---

**Copyright Notification**

No part may be reproduced or utilized in any form or by any means, electronic or mechanical, including photocopying and microfilm except as authorized by written permission of ETSI.

The content of the PDF version shall not be modified without the written authorization of ETSI.

The copyright and the foregoing restriction extend to reproduction in all media.

© ETSI 2025.  
All rights reserved.

---

# Intellectual Property Rights

## Essential patents

IPRs essential or potentially essential to normative deliverables may have been declared to ETSI. The declarations pertaining to these essential IPRs, if any, are publicly available for **ETSI members and non-members**, and can be found in ETSI SR 000 314: "*Intellectual Property Rights (IPRs); Essential, or potentially Essential, IPRs notified to ETSI in respect of ETSI standards*", which is available from the ETSI Secretariat. Latest updates are available on the [ETSI IPR online database](#).

Pursuant to the ETSI Directives including the ETSI IPR Policy, no investigation regarding the essentiality of IPRs, including IPR searches, has been carried out by ETSI. No guarantee can be given as to the existence of other IPRs not referenced in ETSI SR 000 314 (or the updates on the ETSI Web server) which are, or may be, or may become, essential to the present document.

## Trademarks

The present document may include trademarks and/or tradenames which are asserted and/or registered by their owners. ETSI claims no ownership of these except for any which are indicated as being the property of ETSI, and conveys no right to use or reproduce any trademark and/or tradename. Mention of those trademarks in the present document does not constitute an endorsement by ETSI of products, services or organizations associated with those trademarks.

**DECT™**, **PLUGTESTS™**, **UMTS™** and the ETSI logo are trademarks of ETSI registered for the benefit of its Members. **3GPP™**, **LTE™** and **5G™** logo are trademarks of ETSI registered for the benefit of its Members and of the 3GPP Organizational Partners. **oneM2M™** logo is a trademark of ETSI registered for the benefit of its Members and of the oneM2M Partners. **GSM®** and the GSM logo are trademarks registered and owned by the GSM Association.

---

# Legal Notice

This Technical Specification (TS) has been produced by the ETSI 3rd Generation Partnership Project (3GPP).

The present document may refer to technical specifications or reports using their 3GPP identities. These shall be interpreted as being references to the corresponding ETSI deliverables.

The cross reference between 3GPP and ETSI identities can be found at [3GPP to ETSI numbering cross-referencing](#).

---

# Modal verbs terminology

In the present document "**shall**", "**shall not**", "**should**", "**should not**", "**may**", "**need not**", "**will**", "**will not**", "**can**" and "**cannot**" are to be interpreted as described in clause 3.2 of the [ETSI Drafting Rules](#) (Verbal forms for the expression of provisions).

"**must**" and "**must not**" are **NOT** allowed in ETSI deliverables except when used in direct citation.

# Contents

Intellectual Property Rights .....	2
Legal Notice .....	2
Modal verbs terminology.....	2
Foreword.....	6
1 Scope .....	7
2 References .....	7
3 Definitions and abbreviations.....	8
3.1 Definitions.....	8
3.2 Abbreviations .....	8
4 General .....	8
4.1 Overview .....	8
4.2 Configuration information for the constituents of an NSI.....	10
4.3 General information for network slice instance.....	10
4.4 General information for network slice subnet instance .....	10
4.5 Void.....	11
4.6 Void.....	11
5 Specification level requirements .....	12
5.1 Use cases .....	12
5.1.1 Network slice instance allocation .....	12
5.1.2 Network slice subnet instance allocation .....	15
5.1.3 Network slice instance deallocation.....	17
5.1.4 Network slice subnet instance deallocation .....	18
5.1.5 Obtaining network slice subnet instance information.....	19
5.1.6 Network slice feasibility check.....	20
5.1.7 Network slice instance activation .....	21
5.1.8 Network slice instance deactivation.....	22
5.1.9 Network slice instance modification.....	23
5.1.10 Network slice subnet instance activation .....	24
5.1.11 Network slice subnet instance deactivation .....	25
5.1.12 Network slice subnet instance modification .....	26
5.1.13 Network slice subnet configuration .....	27
5.1.14 Obtaining network slice management data .....	28
5.1.15 Void .....	29
5.1.16 Void.....	29
5.1.17 Creation of a 3GPP NF.....	29
5.1.18 Configuration of a 3GPP NF instance.....	30
5.1.19 Creation of a 3GPP sub-network .....	31
5.1.20 Configuration of a 3GPP sub-network.....	32
5.1.21 Network slice subnet feasibility check.....	33
5.1.22 Void .....	34
5.1.23 Network slice subnet management with assigned priority.....	34
5.1.24 Management interaction with NFV MANO for network service priority.....	34
5.1.25 Void .....	35
5.1.26 Obtaining network slice subnet provider capability information.....	35
5.2 Requirements.....	35
5.2.1 Requirements for network slice provisioning service .....	35
5.2.2 Requirements for network slice subnet provisioning service.....	36
5.2.3 Requirements for NF provisioning service .....	37
5.2.4 Requirements for sub-network provisioning service .....	37
6 Management services for provisioning of networks and network slicing .....	37
6.1 Management services for network slice provisioning .....	37
6.2 Management services for network slice subnet provisioning.....	38
6.3 Management services for network function provisioning .....	39

6.4	Void.....	40
6.5.	Operations of provisioning.....	40
6.5.1	AllocateNsi operation.....	40
6.5.1.1	Description.....	40
6.5.1.2	Input parameters.....	41
6.5.1.3	Output parameters.....	41
6.5.2	AllocateNssi operation.....	41
6.5.2.1	Description.....	41
6.5.2.2	Input parameters.....	41
6.5.2.3	Output parameters.....	41
6.5.3	DeallocateNsi operation.....	41
6.5.3.1	Description.....	41
6.5.3.2	Input parameters.....	42
6.5.3.3	Output parameters.....	42
6.5.4	DeallocateNssi operation.....	42
6.5.4.1	Description.....	42
6.5.4.2	Input parameters.....	42
6.5.4.3	Output parameters.....	42
6.5.5	Void.....	43
7	Provisioning procedures of networks and network slicing.....	43
7.1	General.....	43
7.2	Procedure of Network Slice Instance Allocation.....	43
7.3	Procedure of Network Slice Subnet Instance Allocation.....	46
7.4	Procedure of Network Slice Instance Deallocation.....	50
7.5	Procedure of network slice subnet instance deallocation.....	51
7.6	Procedure of Network Slice Instance Modification.....	54
7.7	Procedure of Network Slice Subnet Instance Modification.....	55
7.8	Procedure of Obtaining Network Slice Subnet Management Service Producer Capability.....	58
7.8.1	Introduction.....	58
7.8.2	Querying Network Slice Subnet Capability Information.....	58
7.8.3	Void.....	58
7.9	Procedure of TN coordination supporting network slicing.....	58
7.9.1	Introduction.....	58
7.9.2	Interaction with NFVO as TN Manager.....	58
7.10	Procedure of NF instance creation.....	59
7.11	Procedure of NF instance modification.....	61
7.12	Procedure of NF instance deletion.....	61
7.13	Procedure of feasibility check and reservation of NSI.....	63
7.14	Procedure of feasibility check and reservation of network slice subnet.....	65
7.15	Void.....	66
7.16	Void.....	66
7.17	Procedure of management interaction with NFV MANO for network service priority.....	66
7.18	Procedure for Network slice instance activation.....	67
7.19	Procedure for Network slice instance deactivation.....	68
7.20	Procedure for Network slice subnet instance activation.....	68
7.21	Procedure for Network slice subnet instance deactivation.....	69
8	Void.....	71
9	RESTful HTTP-based solution set of provisioning.....	71
9.1	Network slice provisioning management service.....	71
9.1.1	Mapping of operations.....	71
9.1.1.1	Introduction.....	71
9.1.1.2	Operation allocateNsi.....	71
9.1.1.3	Operation deallocateNsi.....	72
9.1.2	Resources.....	72
9.1.2.0	Resource structure.....	72
9.1.2.1	Resource definitions.....	73
9.1.2.1.1	Resource “../ServiceProfiles.....”.....	73
9.1.2.1.2	Resource “../ServiceProfiles/{ServiceProfileId}.....”.....	74
9.2	Network slice subnet provisioning management service.....	75

9.2.1	Mapping of operations .....	75
9.2.1.1	Introduction .....	75
9.2.1.2	Operation allocateNssi .....	75
9.2.1.3	Operation deallocateNssi .....	76
9.2.2	Resources .....	76
9.2.2.0	Resource structure .....	76
9.2.2.1	Resource definitions .....	77
9.2.2.1.1	Resource “.../SliceProfiles .....	77
9.2.2.1.2	Resource “.../SliceProfiles/{SliceProfileId} .....	78
10	OpenAPI specification .....	79
10.1	OpenAPI document for network slice provisioning MnS .....	79
10.2	OpenAPI document for network slice subnet provisioning MnS .....	79
<b>Annex A (informative):</b>	<b>A network slice journey example.....</b>	<b>80</b>
<b>Annex B (informative):</b>	<b>General information for network slice related identifiers .....</b>	<b>83</b>
<b>Annex C (informative):</b>	<b>Plant UML source code .....</b>	<b>84</b>
C.1	General .....	84
C.2	Procedure of network slice instance allocation .....	84
C.3	Procedure of Network Slice Subnet Instance Allocation .....	85
C.4	Procedure of Network Slice Instance Deallocation.....	86
C.5	Procedure of network slice subnet instance deallocation .....	87
C.6	Procedure of Network Slice Instance Modification .....	88
C.7	Procedure of Network Slice Subnet Instance Modification .....	89
<b>Annex D (informative):</b>	<b>Change history .....</b>	<b>92</b>
History .....		95

---

# Foreword

This Technical Specification has been produced by the 3<sup>rd</sup> Generation Partnership Project (3GPP).

The contents of the present document are subject to continuing work within the TSG and may change following formal TSG approval. Should the TSG modify the contents of the present document, it will be re-released by the TSG with an identifying change of release date and an increase in version number as follows:

Version x.y.z

where:

- x the first digit:
  - 1 presented to TSG for information;
  - 2 presented to TSG for approval;
  - 3 or greater indicates TSG approved document under change control.
- y the second digit is incremented for all changes of substance, i.e. technical enhancements, corrections, updates, etc.
- z the third digit is incremented when editorial only changes have been incorporated in the document.

---

# 1 Scope

The present document specifies use cases, requirements, management services and procedures for provisioning of 5G networks. For the cases when a NF taking part in these networks contains virtualized parts, interactions with ETSI NFV MANO system are described.

---

# 2 References

The following documents contain provisions which, through reference in this text, constitute provisions of the present document.

- References are either specific (identified by date of publication, edition number, version number, etc.) or non-specific.
- For a specific reference, subsequent revisions do not apply.
- For a non-specific reference, the latest version applies. In the case of a reference to a 3GPP document (including a GSM document), a non-specific reference implicitly refers to the latest version of that document *in the same Release as the present document*.

- [1] 3GPP TR 21.905: "Vocabulary for 3GPP Specifications".
- [2] 3GPP TS 28.525: "Telecommunication management; Life Cycle Management (LCM) for mobile networks that include virtualized network functions; Requirements".
- [3] ETSI GS NFV-IFA 013 (V4.5.1) (2023-09): "Network Function Virtualisation (NFV); Release 4; Management and Orchestration; Os-Ma-nfvo reference point - Interface and Information Model Specification".
- [4] 3GPP TS 28.530: "Management and orchestration; Concepts, use cases and requirements".
- [5] 3GPP TS 22.261 "Service requirements for next generation new services and markets".
- [6] 3GPP TS 28.541: "Management and orchestration; 5G Network Resource Model (NRM); Stage 2 and stage 3".
- [7] Void.
- [8] 3GPP TS 28.532: "Management and orchestration; Generic management services".
- [9] GSMA NG.116 Generic Network Slice Template v9.0 (2023-04-27) - NG.116-v9.0.pdf (gsma.com).
- [10] 3GPP TS 23.501: "Technical Specification Group Services and System Aspects;System Architecture for the 5G System;Stage 2".
- [11] 3GPP TS 38.300: "Technical Specification Group Radio Access Network;NR; NR and NG-RAN Overall Description;Stage 2".
- [12] ETSI GS NFV-IFA 014 (V4.2.1) (2021-05): "Network Function Virtualisation (NFV); Release 4; Management and Orchestration; Network Service Templates Specification".
- [13] 3GPP TS 28.622: "Telecommunication management; Generic Network Resource Model (NRM) Integration Reference Point (IRP); Information Service (IS)".
- [14] ETSI GS NFV-IFA 011 (V4.3.1) (2022-06): "Network Function Virtualisation (NFV); Release 4; Management and Orchestration; VNF Descriptor and Packaging Specification".
- [15] ETSI GS NFV-IFA 008 (V4.3.1) (2022-05): "Network Function Virtualisation (NFV); Release 4; Management and Orchestration; Ve-Vnfm reference point - Interface and Information Model Specification".



- [16] 3GPP TS 28.623: "Telecommunication management; Generic Network Resource Model (NRM) Integration Reference Point (IRP); Solution Set (SS) definitions".
- [17] 3GPP TS 32.158: "Management and orchestration; Design rules for REpresentational State Transfer (REST) Solution Sets (SS)".

## 3 Definitions and abbreviations

### 3.1 Definitions

For the purposes of the present document, the terms and definitions given in TR 21.905 [1], TS 28.530 [4] and the following apply. A term defined in the present document takes precedence over the definition of the same term, if any, in TR 21.905 [1] and TS 28.530 [4].

### 3.2 Abbreviations

For the purposes of the present document, the abbreviations given in TR 21.905 [1], TS 28.530 [4] and the following apply. An abbreviation defined in the present document takes precedence over the definition of the same abbreviation, if any, in TR 21.905 [1].

5GAA	5G Automotive Association
5G-ACIA	5G Association for Connected Industries and Automation
5GC	5G Core Network
AMF	Access and Mobility Management Function
CSC	Communication Service Customer
CSP	Communication Service Provider
CP	Control Plane
GST	Generic Slice Template
IOC	Information Object Class
MANO	Management and Orchestration
MnS	Management Service
NEST	Network Slice Type
NF	Network Function
NFV	Network Functions Virtualisation
NRM	Network Resource Model
NSaaS	Network Slice as a Service
NSC	Network Slice Customer
NSI	Network Slice Instance
NSP	Network Slice Provider
NSSI	Network Slice Subnet Instance
P-NEST	Private NEST
S-NEST	Standardized NEST
TN	Transport Network
VNF	Virtualized Network Function
UP	User Plane

## 4 General

### 4.1 Overview

A 5G system consists of a 5G Access Network (AN), and a 5G Core Network (5GC). Network slicing is one of the key 5G features.

The management aspects of a Network Slice Instance (NSI) are described by the four phases shown in Figure 4.3.1.1 of TS 28.530 [4].

The provisioning of network slicing includes the four phases which are preparation, commissioning, operation and decommissioning:

- In the preparation phase the NSI does not exist. The preparation phase includes network slice design, onboarding, evaluation of the network slice requirements, preparing the network environment and other necessary preparations required to be done before the creation of an NSI.
- During the NSI lifecycle stage which include commissioning phase, operation phase and decommissioning phase, the NSI provisioning operations include:
  - Create an NSI;
  - Activate an NSI;
  - Deactivate an NSI;
  - Modify an NSI;
  - Terminate an NSI.

The operations of the provisioning of an NSI occurs during different phases of a NSI:

a) During the commissioning phase:

- Create an NSI.

During NSI creation all resources to the NSI have been created and configured to satisfy the network slice requirements. NSI creation may trigger NSSI(s) creation or using existing NSSI(s) and setting up the corresponding associations.

b) During the operation phase:

- Activate an NSI;
- Modify an NSI;
- Deactivate an NSI.

NSI activation includes any actions that make the NSI active to provide communication services. NSI activation may trigger NSSI activation.

NSI modification in operation phase could map to several workflows, e.g. changes of NSI capacity, changes of NSI topology, NSI reconfiguration. NSI modification can be triggered by receiving new network slice related requirements, new communication service requirements, or the result of NSI supervision automatically. NSI modification may trigger NSSI modification.

The NSI deactivation operation may be needed before NSI modification operation and the NSI activation operation may be needed after the NSI modification operation. NSI deactivation includes any actions that make the NSI inactive and not providing any communication services. NSI deactivation trigger NSSI deactivation to deactivate constituent NSSI(s) which is not used by other NSI(s). Operator may decide to keep the NSI without termination after deactivation and reactivate it when receives new communication service request.

c) During the decommissioning phase:

- Terminate an NSI.

NSI termination step includes any action that make the NSI does not exist anymore and release resources that are not used by other NSI(s). NSI termination may trigger NSSI termination to terminate constituent NSSI(s) which is not used by other NSI(s).

Similarly, provisioning for network slice subnet instance includes the following operations:

- Create an NSSI;
- Activate an NSSI and associate it with certain NSI to be used by the NSI;
- Disassociate the NSSI with certain NSI and deactivate the NSSI if it's not associated with any NSI;

- Modify an NSSI;
- Terminate an NSSI.

## 4.2 Configuration information for the constituents of an NSI

To use network slice to support communication service or deliver a network slice as a service, the 3GPP defined constituents of the NSI should be configured by 3GPP management system according to the types and requirements of the network slice so that the NSI can be operated and maintained.

The configuration information of these components may include:

- *Information on the requirements to be applied to every NSI constituent to satisfy the requirements of multiple NSIs* if the constituent is shared by multiple NSIs;
- *Network function selection information*: Information on the selection of the NFs (e.g., AMF) according to the requirements of this NSI;
- *Connection information*: The information of the logical links to carry the NSI's CP and UP data between the component and other NFs and NSSIs belonging to the NSI.

NOTE 1: The list of information above is not exhaustive.

NOTE 2: The list of information above is not all necessary for an NSI.

## 4.3 General information for network slice instance

The general information used to describe a network slice instance may include:

- Resource model information, which describes the static parameters and functional components of network slice, includes service profile, network slice type (e.g. eMBB), additional system feature (e.g. multicast, Edge Computing), priority.
- Management model information, which describes the information model that is used for network slice lifecycle management, includes configuration profile (e.g. application configuration parameters).
- Capability model information, which describes the capability including supported communication service characteristic information (e.g. service type, UE mobility level, density of users, traffic density), QoS attributes (e.g. bandwidth, latency, throughput and so on) and capacity (e.g. maximum number of UEs), can be exposed to CSC .

## 4.4 General information for network slice subnet instance

The general information used to describe a network slice subnet instance may include:

- Resource model information, which describes the static parameters and functional component of network slice subnet, includes slice profile, network slice subnet type (e.g. RAN eMBB, CN eMBB), additional system feature (e.g. multicast, Edge Computing), priority, QoS attributes (e.g. bandwidth, latency, number of subscribers and so on), NSD ID.
- Management model information, which describes the information model that is used for network slice subnet lifecycle management, includes configuration profile (e.g. application configuration parameters).
- Capability model information, which describes the capability including supported communication service characteristic information (e.g. service type, UE mobility level, density of users, traffic density), QoS attributes (e.g. bandwidth, latency, throughput and so on) and capacity (e.g. maximum number of UEs).

4.5 Void

4.6 Void

---

## 5 Specification level requirements

### 5.1 Use cases

#### 5.1.1 Network slice instance allocation

Use case stage	Evolution/Specification	<<Uses>> Related use
<b>Goal</b>	To satisfy request for allocation of a network slice instance with certain characteristics, by creating a new or using an existing network slice instance.	
<b>Actors and Roles</b>	A network slice provisioning management service consumer.	
<b>Telecom resources</b>	Network slice instance Network slice subnet instance Transport network A network slice provisioning management service provider. A network slice subnet provisioning management service provider.	
<b>Assumptions</b>	N/A	
<b>Pre-conditions</b>	N/A	
<b>Begins when</b>	The network slice provisioning management service provider receives the request for allocation of the network slice instance with network slice related requirements. The network slice provisioning management service provider has the capability to process the network slice related requirements (e.g., SLA information from GSMA GST) which are represented by service profile parameters [6]. The service profile can be translated to the corresponding requirements for dedicated domains and NSSIs.	
<b>Step 1 (M)</b>	If the requested NSI can be shared and if an existing NSI can be used, the network slice provisioning management service provider decides to use the existing NSI. Modification of the existing NSI may be needed to satisfy the network slice instance related requirements. Use case is completed go to "Step 8". Otherwise, the network slice provisioning management service provider triggers to create a new NSI, for which the following steps 2 – 8 are needed.	
<b>Step 2 (M)</b>	The network slice provisioning management service provider decides on the constituent NSSIs and the topology of the NSI to be created using the information from service profile [6] and if applicable isolation profiles are selected. For the constituent NSSIs, the network slice provisioning management service provider derives network slice subnet related requirements from the network slice related requirements. If reconfiguration of the transport network is needed, the network slice provisioning management service provider derives transport network related requirements (e.g., latency, bandwidth) from the network slice related requirements.	
<b>Step 3 (M)</b>	For the required NSSI(s), the network slice provisioning management service provider sends network slice subnet related requirements to the network slice subnet provisioning management service provider to request allocation of the required NSSI(s).	Network slice subnet instance allocation use case
<b>Step 4 (M)</b>	The network slice provisioning management service provider receives the information of the allocated NSSI(s) (e.g., the management identifier of NSSI, service access point information of NSSI, external connection point information of NSSI) from NSSMF.	
<b>Step 5 (M)</b>	The network slice provisioning management service provider, via the network slice subnet provisioning management service provider, sends the transport network related requirements (e.g., external connection point, latency and bandwidth) to the TN Manager. The TN manager reconfigures the TN accordingly and responds to the network slice provisioning management service provider via the network slice subnet provisioning management service provider.	
<b>Step 6 (M)</b>	The network slice provisioning management service provider receives the response from TN Manager via the network slice subnet provisioning management service provider.	
<b>Step 7 (M)</b>	The network slice provisioning management service provider associates the NSSI(s) with the corresponding NSI (e.g., allocation of the management identifier of NSI and mapping the management identifier of NSI with the received management Identifier of NSSI(s)), if applicable with the isolation profiles are associated with the NSI and NSSI(s), and triggers to establish the links between the service access points of the NSSI(s).	
<b>Step 8 (M)</b>	The network slice provisioning management service provider notifies the network slice instance information of NSI (e.g., the management identifier of NSI).	
<b>Ends when</b>	All the steps identified above are successfully completed.	
<b>Exceptions</b>	One of the steps identified above fails.	
<b>Post-conditions</b>	An NSI is ready to satisfy the network slice related requirements.	
<b>Traceability</b>	REQ-PRO_NSSI-FUN-1, REQ-PRO_NSI-FUN-3, REQ-PRO_NSI-FUN-9.	



## 5.1.2 Network slice subnet instance allocation



Use case stage	Evolution/Specification	<<Uses>> Related use
<b>Goal</b>	Create a new network slice subnet instance or use an existing network slice subnet instance to satisfy the network slice subnet related requirements; provide the provisioning service consumer with identity of the NFVO which the consumer can use for further access to the information of the involved VNFs, PNFs and NSs.	
<b>Actors and Roles</b>	A network slice subnet provisioning management service consumer.	
<b>Telecom resources</b>	Network Slice Subnet instance Network Service instance A network slice subnet provisioning management service provider. The operator deployed NFVO to manage the lifecycle of VNFs and interconnection between the VNFs and PNFs in terms of the NS instances.	
<b>Assumptions</b>	Network slice subnet instance may include network functions which are virtualized.	
<b>Pre-conditions</b>	VNF Packages for virtualized network functions to be included in the network slice subnet instance have been already on-boarded.	
<b>Begins when</b>	The network slice subnet provisioning management service consumer sends to the network slice subnet provisioning management service provider a request for an NSSI to be associated with the NSI; the request contains network slice subnet related in TS 28.541 [6]. The network slice subnet provisioning management service provider receives request for a network slice subnet instance. The request contains network slice subnet related requirements. The request may also include query of the identity of the NFVO to be used.	
<b>Step 1 (M)</b>	Based on the network slice subnet related requirements received and if applicable the isolation profile is selected, the network slice subnet provisioning management service provider decides to create a new NSSI or use an existing NSSI.	
<b>Step 2 (M)</b>	If an existing network slice subnet instance is decided to be used, the network slice subnet provisioning management service provider may trigger to modify the existing network slice subnet instance to satisfy the network slice subnet related requirements. Go to "Step 8". Otherwise, the network slice subnet provisioning management service provider triggers to create a new NSSI, the following steps are needed.	
<b>Step 3 (O)</b>	If the required NSSI contains constituent NSSI(s) managed by other network slice subnet provisioning management service provider (s), the first network slice subnet provisioning management service provider derives the requirements for the constituent NSSI(s) and sends those requirements to the corresponding network slice subnet provisioning management service provider (s) which manages the constituent NSSI(s). The first network slice subnet provisioning management service provider receives the constituent NSSI information from the other network slice subnet provisioning management service provider (s) and associates the constituent NSSI(s) with the required NSSI.	
<b>Step 4 (M)</b>	Based on the network slice subnet related requirements received and SliceProfile [6], the network slice subnet provisioning management service provider decides that to satisfy the NSSI requirements, the part of the network controlled by certain NFVO should be involved. The network slice subnet provisioning management service provider determines the NS related requirements (i.e., information about the target NSD and additional parameterization for the specific NS to instantiate, see clause 7.3.3 in ETSI GS NFV-IFA013 [3]), and if applicable the associated isolation rules.	
<b>Step 5 (M)</b>	Based on the NS related requirements, the network slice subnet provisioning management service provider triggers corresponding NS instantiation request to NFVO via Os-Ma-nfvo interface as described in clause 6.4.3 in TS 28.525 [2], and the NFVO performs NS instantiation. (see note)	TS 28.525 [2] Clause 6.4.3 NS instance use cases
<b>Step 6 (M)</b>	The network slice subnet provisioning management service provider associates the NS instance with corresponding network slice subnet instance (e.g., allocation of the management identifier of NSSI and mapping with the corresponding identifiers).	
<b>Step 7 (M)</b>	The network slice subnet provisioning management service provider is using the NF provisioning service to configure the NSSI constituents. In case of RAN NSSI, the configuration contains RRM policy information for individual Radio cells. In the cells shared by multiple NSSIs such policy includes guidance for split of Radio resources between the NSSIs.	NF provisioning service

Use case stage	Evolution/Specification	<<Uses>> Related use
<b>Step 8 (M)</b>	The network slice subnet provisioning management service provider notifies the provisioning service consumer with the NSSI information (e.g., the management identifier of NSSI). The network slice provisioning management service provider associates the NSSI with the NSI and if applicable the isolation profile.	
<b>Ends when</b>	All the steps identified above are successfully completed.	
<b>Exceptions</b>	One of the steps identified above fails.	
<b>Post-conditions</b>	A NSSI is ready to satisfy the network slice subnet related requirements.	
<b>Traceability</b>	REQ-PRO_NSSI-FUN-2, REQ-PRO_NSSI-FUN-3, REQ-PRO_NSSI-FUN-4, REQ-PRO_NSSI-FUN-5, REQ-PRO_NSSI-FUN-6, REQ-PRO_NSSI-FUN-14, REQ-PRO_NSSI-FUN-19.	
NOTE: According to the TS 28.525 [2], for the PNFs, NS instantiation includes only establishment of interconnection with other NFs.		

### 5.1.3 Network slice instance deallocation

Use case stage	Evolution/Specification	<<Uses>> Related use
<b>Goal</b>	To deallocate a network slice instance..	
<b>Actors and Roles</b>	A network slice provisioning management service consumer.	
<b>Telecom resources</b>	Network slice instance Network slice subnet instances A network slice provisioning management service provider. A network slice subnet provisioning management service provider.	
<b>Assumptions</b>	N/A	
<b>Pre-conditions</b>	N/A	
<b>Begins when</b>	The network slice provisioning management service provider receives the request indicating that an existing NSI is no longer needed to support a particular service. (identified by service profile Id) The NSI identification is included in the request.	
<b>Step 1 (M)</b>	Based on the request, the network slice provisioning management service provider deletes the corresponding slice profile and checks if there are other services to be supported by the NSI. If there are none the network slice provisioning management service provider may decide to terminate the NSI; then proceed to Step 2. Otherwise, the network slice provisioning management service provider may decide to trigger to modify the NSI or to do nothing. The use case is completed; go to step 5.	NSI modification use case
<b>Step 2 (M)</b>	If the NSI to be terminated is active, the network slice provisioning management service provider de-activates the NSI. Then, the NSI to be terminated is inactive.	NSI de-activation use case
<b>Step 3 (M)</b>	The network slice provisioning management service provider identifies the network slice subnet instances used by the NSI, and for every such NSSI sends the request to the corresponding network slice subnet provisioning management service provider (s) indicating that the NSSI(s) are no longer needed for the NSI. The network slice subnet provisioning management service provider (s) may decide to terminate or modify the NSSI(s) based on the request and disassociates them with the NSI.	
<b>Step 4 (M)</b>	The network slice provisioning management service provider receives the response from the network slice subnet provisioning management service provider (s) and terminates the NSI.	
<b>Step 5 (M)</b>	The network slice provisioning management service provider notifies its consumer of the NSI deallocation.	
<b>Ends when</b>	All the steps identified above are successfully completed or skipped per condition in the Step 1.	
<b>Exceptions</b>	One of the steps identified above fails.	
<b>Post-conditions</b>	The NSI has been deallocated.	
<b>Traceability</b>	REQ-PRO_NSI-FUN-3	

## 5.1.4 Network slice subnet instance deallocation

Use case stage	Evolution/Specification	<<Uses>> Related use
<b>Goal</b>	To deallocate a network slice subnet instance.	
<b>Actors and Roles</b>	Network slice subnet provisioning management service consumer.	
<b>Telecom resources</b>	Network slice subnet instance Network slice subnet provisioning management service provider.	
<b>Assumptions</b>	N/A	
<b>Pre-conditions</b>	N/A	
<b>Begins when</b>	The network slice subnet provisioning management service provider receives network slice subnet related request from its authorized consumer indicating that an existing NSSI is no longer needed to support a particular set of network slice subnet requirements identified by a slice profile id). The NSSI identification is included in the request.	
<b>Step 1 (M)</b>	Based on the request, the network slice subnet provisioning management service provider decides whether the NSSI should be terminated.  If the decision is the NSSI should be terminated, go to the Step 2.  If the decision is that the NSSI should not be terminated (e.g., the NSSI is shared or the network slice subnet provisioning management service provider decides to keep the NSSI for later use), the network slice subnet provisioning management service provider disassociates the NSSI from its consumer and provides feedback to the authorized consumer, maybe with removing its consumer's configuration or not. Go to Step 5.	
<b>Step 2 (M)</b>	If the NSSI consists of constituent NSSIs that are not managed directly by the network slice subnet provisioning management service provider, the network slice subnet provisioning management service provider sends a request to other network slice subnet provisioning management service provider(s) indicating that the constituent NSSIs are no longer needed for the NSSI.	
<b>Step 3 (M)</b>	If the NSSI is associated with NSI, the network slice subnet provisioning management service provider disassociates the NSI from the NSSI to be terminated, and the network slice subnet provisioning management service provider may trigger request to NFVO for terminating or updating (e.g. scaling-in) the NS instance. (see note).	
<b>Step 4 (M)</b>	If there exists a transport network segment used by the NSSI, the network slice subnet provisioning management service provider may indicate that the transport network segment is no longer needed to support the NSSI.	
<b>Step 5 (M)</b>	The network slice subnet provisioning management service provider sends response to its consumer.	
<b>Ends when</b>	All the steps identified above are successfully completed.	
<b>Exceptions</b>	One of the steps identified above fails.	
<b>Post-conditions</b>	The NSSI has been deallocated.	
<b>Traceability</b>	REQ-PRO_NSSI-FUN-8, REQ-PRO_NSSI-FUN-11	
NOTE: In case where the NS instance is not dedicated for the NSSI, the network slice subnet provisioning management service provider does not terminate the NS instance.		

### 5.1.5 Obtaining network slice subnet instance information

Use case stage	Evolution/Specification	<<Uses>> Related use
<b>Goal</b>	Enable the network slice subnet provisioning management service consumer to obtain network slice subnet instance information (e.g. Slice/Service type).	
<b>Actors and Roles</b>	Network slice subnet provisioning management service consumer.	
<b>Telecom resources</b>	Network slice subnet instance Network slice subnet provisioning management service provider.	
<b>Assumptions</b>	The network slice subnet provisioning management service consumer is authorized to obtain the network slice subnet instance information from the network slice subnet provisioning management service provider.	
<b>Pre-conditions</b>	NSSI is created.	
<b>Begins when</b>	The network slice subnet provisioning management service consumer wants to obtain the network slice subnet instance information.	
<b>Step 1 (M)</b>	The network slice subnet provisioning management service consumer sends a request to the network slice subnet provisioning management service provider to obtain the network slice subnet instance information. The indication on which information needs to be obtained may be included in the request.	
<b>Step 2 (M)</b>	The network slice subnet provisioning management service provider processes this request.	
<b>Step 3 (M)</b>	The network slice subnet provisioning management service provider sends the result of network slice subnet instance information to the network slice subnet provisioning management service consumer.	
<b>Ends when</b>	All the steps identified above are successfully completed.	
<b>Exceptions</b>	One of the steps identified above fails.	
<b>Post-conditions</b>	The network slice subnet provisioning management service consumer has obtained the network slice subnet instance information.	
<b>Traceability</b>	REQ-PRO_NSSI-FUN-7.	

## 5.1.6 Network slice feasibility check

Use case stage	Evolution/Specification	<<Uses>> Related use
<b>Goal</b>	To check the feasibility of provisioning a network slice to determine whether the network slice requirements can be satisfied at a particular point in time (e.g., in terms of resources), and optionally reserve resources to satisfy the network slice requirements.	
<b>Actors and Roles</b>	Network slice management service consumer. For example, CSP providing NSaaS plays the role of network slice management service consumer.	
<b>Telecom resources</b>	Network slice management service provider.	
<b>Assumptions</b>	Network slice management service consumer has decided to check the feasibility of provisioning a network slice based on, for example, internal decision or to facilitate an external service requests. Network slice management service consumer has optionally decided to request reservation of the resources to satisfy the network slice requirements.	
<b>Pre-conditions</b>	Network slice requirements have been derived or received by network slice management service consumer.	
<b>Begins when</b>	Network slice management service provider receives the request to evaluate the feasibility of provisioning a network slice and optionally reserve resources, according to the network slice requirements at a particular point in time.	
<b>Step 1 (M)</b>	Network slice management service provider identifies the network slice subnets according to the requirements.	
<b>Step 2 (M)</b>	Network slice management service provider obtains the information necessary to evaluate the feasibility of provisioning a network slice by requesting the network slice subnet service provider(s) to evaluate the availability of resources under their control. If the Network slice management service consumer has requested reservation of resources, then Network slice management service provider requests network slice subnet service provider(s) to reserve resources.	
<b>Step 3 (M)</b>	Network slice subnet management service provider(s) checks the feasibility of provisioning a slice subnet(s) by analysing network constituents to ensure that their capabilities, e.g., resources, management services, etc. are (or will be) adequate to provision network slice subnet instance, satisfying all requirements without impacting existing services. For the purpose of checking the feasibility of provisioning a network slice subnet(s) of the network slice, network slice subnet management service provider(s) may obtain information from the network (e.g., current or predicted load level information from the NWDAF). If the Network slice management service provider has requested reservation of resources, then Network slice subnet management service provider(s) reserves the resources necessary to provision the network slice subnet instance.	5.1.21 Network slice subnet feasibility check
<b>Ends when</b>	Feasibility check results have been provided to network slice management service consumer. If the Network slice management service consumer has requested reservation of resources, then resources to satisfy the network slice requirements are reserved.	
<b>Exceptions</b>	One of the mandatory steps fails.	
<b>Post-conditions</b>	N/A	
<b>Traceability</b>	REQ-PRO_NSSI-FUN-12, REQ-PRO_NSSI-FUN-13, REQ-PRO_NSI-FUN-8.	

### 5.1.7 Network slice instance activation

Use case stage	Evolution/Specification	<<Uses>> Related use
<b>Goal</b>	To activate an existing network slice instance which is inactive	
<b>Actors and Roles</b>	Network slice provisioning management service consumer. For example, CSP providing NSaaS plays the role of Network slice management service consumer.	
<b>Telecom resources</b>	Network slice instance Network slice provisioning management service provider. Network slice subnet provisioning management service provider.	
<b>Assumptions</b>	N/A	
<b>Pre-conditions</b>	An NSI has already been created and it is inactive.	
<b>Begins when</b>	The network slice provisioning management service provider decides to activate an NSI based on the received network slice related request from its authorized consumer.	
<b>Step 1 (M)</b>	The network slice provisioning management service provider checks whether NSSIs associated with the NSI are all active, if there is an inactive NSSI, the network slice provisioning management service provider requests the network slice subnet provisioning management service provider to activate the corresponding NSSI.	Network slice subnet instance activation use case
<b>Step 2 (M)</b>	The network slice provisioning management service provider receives response from the network slice subnet provisioning management service provider indicating that the NSSI is active.	
<b>Step 3 (M)</b>	The network slice provisioning management service provider activates the NSI and sends response to the requesting consumer.	
<b>Ends when</b>	All the steps identified above are successfully completed.	
<b>Exceptions</b>	One of the steps identified above fails.	
<b>Post-conditions</b>	An NSI has been activated.	
<b>Traceability</b>	REQ-PRO_NSI-FUN-4	

### 5.1.8 Network slice instance deactivation

Use case stage	Evolution/Specification	<<Uses>> Related use
<b>Goal</b>	To deactivate an existing network slice instance which is active.	
<b>Actors and Roles</b>	Network slice provisioning management service consumer. For example, CSP providing NSaaS plays the role of network slice provisioning management service consumer.	
<b>Telecom resources</b>	Network slice instance Network slice provisioning management service provider. Network slice subnet provisioning management service provider.	
<b>Assumptions</b>	N/A	
<b>Pre-conditions</b>	NSI has already been created and it is active.	
<b>Begins when</b>	The network slice provisioning management service provider decides to deactivate an NSI based on the received network slice related request from its authorized consumer.	
<b>Step 1 (M)</b>	The network slice provisioning management service provider stops the NSI serving its subscribers.	
<b>Step 2 (M)</b>	The network slice provisioning management service provider checks whether NSSIs associated with the NSI are all inactive. If there is an active NSSI, the network slice provisioning management service provider requests the network slice subnet provisioning management service provider to deactivate the corresponding NSSI. The network slice subnet provisioning management service provider receives the request and decides if the NSSI will be disassociated and deactivated.	Network slice subnet instance deactivation use case
<b>Step 3 (M)</b>	The network slice provisioning management service provider receives response from the network slice subnet provisioning management service provider that the NSSI deactivation request has been processed.	
<b>Step 4 (M)</b>	The network slice provisioning management service provider deactivates the NSI and sends response to its authorized consumer.	
<b>Ends when</b>	All the steps identified above are successfully completed.	
<b>Exceptions</b>	One of the steps identified above fails.	
<b>Post-conditions</b>	An NSI has been deactivated.	
<b>Traceability</b>	REQ-PRO_NSI-FUN-5	

### 5.1.9 Network slice instance modification

Use case stage	Evolution/Specification	<<Uses>> Related use
<b>Goal</b>	To modify an existing network slice instance	
<b>Actors and Roles</b>	Network slice provisioning management service consumer. See NOTE.	
<b>Telecom resources</b>	Network slice instance Network slice provisioning management service provider.	
<b>Assumptions</b>	N/A	
<b>Pre-conditions</b>	N/A.	
<b>Begins when</b>	The network slice provisioning management service provider receives request from its authorized customer with new set of network slice related requirements and decides to modify an existing NSI.	
<b>Step 1 (M)</b>	The network slice provisioning management service provider identifies the NSSI(s) associated with the NSI to be modified and generates network slice subnet related requirements for the NSSI(s).	
<b>Step 2 (M)</b>	The network slice provisioning management service provider sends requests to the network slice subnet provisioning management service provider with new sets of network slice subnet related requirements. The network slice provisioning management service provider receives request and decides whether the NSSI needs to be modified.	Network slice subnet instance modification use case
<b>Step 3 (M)</b>	The network slice provisioning management service provider receives the response from the network slice subnet provisioning management service provider. If the NSSI modification request cannot be satisfied by the network slice subnet provisioning management service provider, the network slice provisioning management service provider may re-generate the network slice subnet related requirements for the NSSI and go to step 2, or the network slice provisioning management service provider may decide the modification request cannot be satisfied.	
<b>Step 4 (M)</b>	The network slice provisioning management service provider sends response to its authorized consumer.	
<b>Ends when</b>	All the steps identified above are successfully completed.	
<b>Exceptions</b>	One of the steps identified above fails.	
<b>Post-conditions</b>	The NSI is modified.	
<b>Traceability</b>	REQ-PRO_NSI-FUN-6	
NOTE: Examples of roles and actors for this use case can be found in TS 28.530 [4].		



### 5.1.10 Network slice subnet instance activation

Use case stage	Evolution/Specification	<<Uses>> Related use
<b>Goal</b>	To activate an existing network slice subnet instance which is inactive.	
<b>Actors and Roles</b>	Network slice subnet provisioning management service consumer.	
<b>Telecom resources</b>	Network slice subnet instance Network slice subnet provisioning management service provider.	
<b>Assumptions</b>	N/A	
<b>Pre-conditions</b>	An NSSI has already been created and it is inactive.	
<b>Begins when</b>	The network slice subnet provisioning management service provider decides to activate an NSSI based on the received network slice subnet related request from its authorized consumer.	
<b>Step 1 (M)</b>	The network slice subnet provisioning management service provider identifies inactive constituents (e.g. NSSI, NF) of the NSSI and decides to activate those constituents.	
<b>Step 2 (M)</b>	If the constituent of NSSI is managed directly by the network slice subnet provisioning management service provider, the network slice subnet provisioning management service provider activates the NSSI constituent directly.	
<b>Step 3 (M)</b>	If an NSSI constituent is managed by other network slice subnet provisioning management service provider, the network slice subnet provisioning management service provider requests other network slice subnet provisioning management service provider to activate the constituent NSSI.	
<b>Step 4 (M)</b>	If an NSSI constituent is an NF managed by NF related provisioning management service provider, the network slice subnet provisioning management service provider request the NF related provisioning management service provider to activate the NF (e.g., activate the NF in sleep mode, turn on the ports).	
<b>Step 5 (M)</b>	The network slice subnet provisioning management service provider receives response indicating that NSSI constituents are all activated.	
<b>Step 6 (M)</b>	The network slice subnet provisioning management service provider activates the network slice subnet instance and sends response to its authorized consumer.	
<b>Ends when</b>	All the steps identified above are successfully completed.	
<b>Exceptions</b>	One of the steps identified above fails.	
<b>Post-conditions</b>	An NSSI has been activated.	
<b>Traceability</b>	REQ-PRO_NSSI-FUN-9	

### 5.1.11 Network slice subnet instance deactivation

Use case stage	Evolution/Specification	<<Uses>> Related use
<b>Goal</b>	To deactivate an existing network slice subnet instance which is active.	
<b>Actors and Roles</b>	Network slice subnet provisioning management service consumer.	
<b>Telecom resources</b>	Network slice subnet instance. Network slice subnet provisioning management service provider.	
<b>Assumptions</b>	N/A	
<b>Pre-conditions</b>	An NSSI has already been created and is active.	
<b>Begins when</b>	The network slice subnet provisioning management service provider decides to deactivate an NSSI based on the received network slice subnet related request from its authorized customer.	
<b>Step 1 (M)</b>	The network slice subnet provisioning management service provider identifies the NSSI constituents that need to be deactivated.	
<b>Step 2 (M)</b>	If the constituent of NSSI is managed directly by the network slice subnet provisioning management service provider, the network slice subnet provisioning management service provider deactivates the NSSI constituent directly.	
<b>Step 3 (M)</b>	If an NSSI constituent is managed by other network slice subnet provisioning management service provider, the network slice subnet provisioning management service provider requests other network slice subnet provisioning management service provider to deactivate the constituent NSSI.	
<b>Step 4 (M)</b>	If an NSSI constituent is managed by the NF related provisioning management service provider, the network slice subnet provisioning management service provider requests the NF related provisioning management service provider to either deactivate the NF (if it is dedicated for this NSSI and not being used by any other NSSI) or to modify the NF (if it is shared by other NSSI).	
<b>Step 5 (M)</b>	The network slice subnet provisioning management service provider receives response indicating that corresponding NSSI constituents are deactivated or not deactivated (e.g., shared constituents cannot be deactivated).	
<b>Step 6 (M)</b>	The network slice subnet provisioning management service provider deactivates the network slice subnet instance and send response to its authorized consumer.	
<b>Ends when</b>	All the steps identified above are successfully completed.	
<b>Exceptions</b>	One of the steps identified above fails.	
<b>Post-conditions</b>	A network slice subnet instance has been deactivated.	
<b>Traceability</b>	REQ-PRO_NSSI-FUN-10	

## 5.1.12 Network slice subnet instance modification

Use case stage	Evolution/Specification	<<Uses>> Related use
<b>Goal</b>	To modify an existing network slice subnet instance	
<b>Actors and Roles</b>	Network slice subnet provisioning management service consumer.	
<b>Telecom resources</b>	Network slice subnet instance Network SliceSubnet slice subnet provisioning management service provider.	
<b>Assumptions</b>	N/A	
<b>Pre-conditions</b>	N/A	
<b>Begins when</b>	The network slice subnet provisioning management service provider receives request from its authorized consumer with new sets of network slice subnet related requirements and decides to modify an existing NSSI.	
<b>Step 1 (M)</b>	The network slice subnet provisioning management service provider identifies the NSSI constituents as well as the transport network (TN) part within the NSSI that needs to be modified, and generates new sets of requirements for the NSSI constituents and transport network if needed.	
<b>Step 2 (M)</b>	The network slice subnet provisioning management service provider checks whether the requirements for the identified NSSI constituents managed by itself could be satisfied, and then triggers the modification of the corresponding NSSI constituents if needed.	
<b>Step 3 (M)</b>	If the NSSI consists of constituent NSSI managed by other network slice subnet provisioning management service provider, and the constituent NSSI is identified to be modified, the network slice subnet provisioning management service provider sends modification request to other network slice subnet provisioning management service provider which manages the constituent NSSI with new sets of constituent NSSI requirements.	Network slice subnet instance modification use case
<b>Step 4 (M)</b>	If the NS instance associated with the NSSI needs to be modified, the network slice subnet provisioning management service provider derives the new sets of NS related requirements and triggers corresponding NS instance request to NFVO with Os-Ma-nfvo interface as described in clause 6.4.3 in TS 28.525 [2].	TS 28.525 [2] Clause 6.4.3 NS instance use cases
<b>Step 5 (M)</b>	If the related TN part of the NSSI is identified to be modified, the network slice subnet provisioning management service provider derives new sets of requirements for the TN part and coordinates with the corresponding TN management system.	
<b>Step 6 (M)</b>	The network slice subnet provisioning management service provider generates the modification result based on the received response and send response to its authorized consumer.	
<b>Ends when</b>	All the steps identified above are successfully completed.	
<b>Exceptions</b>	One of the steps identified above fails.	
<b>Post-conditions</b>	The NSSI is modified.	
<b>Traceability</b>	REQ-PRO_NSSI-FUN-11	

### 5.1.13 Network slice subnet configuration

Use case stage	Evolution/Specification	<<Uses>> Related use
<b>Goal</b>	To provide service for slice-specific (re)configuration of NSSI.	
<b>Actors and Roles</b>	Network slice subnet provisioning management service consumer (e.g., the operator)	
<b>Telecom resources</b>	Network slice subnet provisioning management service provider (e.g., NSSMF) Network slice subnet instance NF(s)	
<b>Assumptions</b>	Authorized network slice subnet provisioning management service consumer provide slice operation information (see 4.2) for (re-)configuring NSSI constituents.	
<b>Pre-conditions</b>	NSSI exists.	
<b>Begins when</b>	The network slice subnet provisioning management service consumer wants to (re-)configure the constituents of a NSSI.	
<b>Step 1 (M)</b>	The network slice subnet provisioning management service consumer sends requests to the network slice subnet provisioning NSS management service provider with slice operation information for (re-)configuring a network slice subnet.	
<b>Step 2 (M)</b>	<p>The network slice subnet provisioning management service provider (derives and) decomposes the received slice operation information, and then makes them as separate CM requests for each constituent if necessary and applicable. These (decomposed) requests may be delegated to other provisioning management service providers (e.g., other network slice subnet provisioning service providers, NF provisioning management service providers) with corresponding slice operation information.</p> <p>These requests may contain configuration for specific NFs such as 1) <i>Configuration of dedicated NFs</i> (e.g., configure the SMF with the information of new instantiated UPFs, see 5.3.2, 5.3.3 in [6]) and 2) <i>Configuration of shared NFs</i> (see 4.2 so that this information can be accessed by other constituents of the NSS (e.g., NSSF, AMF, SMF).</p>	
<b>Step 3 (M)</b>	the network slice subnet provisioning management service provider sends the processing result to the network slice subnet provisioning management service consumer (might be based on applicable processing results from other CM service providers).	
<b>Ends when</b>	All the steps identified above are successfully completed.	
<b>Exceptions</b>	One of the steps identified above fails.	
<b>Post-conditions</b>	The required (re)configuration is configured at the corresponding constituent(s).	
<b>Traceability</b>	REQ-PRO_NSSI-FUN-16	

### 5.1.14 Obtaining network slice management data

Use case stage	Evolution/Specification	<<Uses>> Related use
<b>Goal</b>	Enable network slice management service consumer to obtain network slice management data (e.g. PM data, FM data).	
<b>Actors and Roles</b>	Network slice management service consumer. Network slice management service provider.	
<b>Telecom resources</b>	Network slice instance	
<b>Assumptions</b>	The network slice management service consumer is authorized to obtain the network slice management data from the network slice management service provider.	
<b>Pre-conditions</b>	NSI is created.	
<b>Begins when</b>	The network slice management service consumer wants to obtain the network slice management data.	
<b>Step 1 (M)</b>	The network slice management service consumer sends a request to the network slice management service provider to obtain the network slice management data.	
<b>Step 2 (M)</b>	The network slice management service provider provides the network slice management service consumer with the network slice management data .	
<b>Ends when</b>	All the steps identified above are successfully completed.	
<b>Exceptions</b>	One of the steps identified above fails.	
<b>Post-conditions</b>	The network slice management service consumer obtained the network slice management data.	
<b>Traceability</b>	REQ-PRO_NSI-FUN-7	

## 5.1.15 Void

## 5.1.16 Void

## 5.1.17 Creation of a 3GPP NF

Use case stage	Evolution/Specification	<<Uses>> Related use
<b>Goal</b>	To enable the authorized consumer to request creation of an instance of 3GPP NF.	
<b>Actors and Roles</b>	An authorized consumer of the NF creation provisioning management service.	
<b>Telecom resources</b>	VNF package(s) of the virtualized part of 3GPP NF; ETSI NFV MANO system; NF provisioning management service producer.	
<b>Assumptions</b>	N/A	
<b>Pre-conditions</b>	The VNF package(s) of the virtualized part of 3GPP NF have been on-boarded to ETSI NFV MANO system.	
<b>Begins when</b>	The authorized consumer needs to create a new instance of 3GPP NF.	
<b>Step 1 (M)</b>	The authorized consumer requests the NF provisioning management service producer to create a new instance of 3GPP NF.	
<b>Step 2 (M)</b>	The NF provisioning management service producer checks the subject 3GPP NF contains virtualized part and/or non-virtualized part. If it contains virtualized part, then the NF instantiation service producer performs the step 3 and 4 to instantiate the virtualized part of the subject 3GPP NF.  How to instantiate the non-virtualized part of the subject 3GPP NF is out of scope of present specification.	
<b>Step 3 (M)</b>	The NF provisioning management service producer interacts, or requests another NF provisioning management service producer to interact, with ETSI NFV MANO system to instantiate the VNF(s) that are realizing the virtualized part of subject 3GPP NF.	
<b>Step 4 (M)</b>	If all of the contained parts (i.e., virtualized part and non-virtualized part if any) of the 3GPP NF have been successfully instantiated, the NF provisioning management service producer informs the consumer(s) (who have subscribed to the notifications for NF creation) that the instance of 3GPP NF has been created, and creates the MOI(s) for the subject 3GPP NF.	
<b>Step 5 (M)</b>	Created MOI(s) may be maintained by a Management Function which has the NF provisioning management service or the 3GPP NF. When the MOI(s) is maintained by the 3GPP NF, the NF provisioning management service producer sends a request of creating the MOI(s) to the corresponding NF provisioning management service producers in the created NF.	
<b>Ends when</b>	All the steps identified above are successfully completed.	
<b>Exceptions</b>	One of the steps identified above fails.	
<b>Post-conditions</b>	The instance of 3GPP NF has been created, and the MOI(s) of the 3GPP NF have been created.	
<b>Traceability</b>	REQ-PRO_NF-FUN-1, REQ-PRO_NF-FUN-2, REQ-PRO_NF-FUN-7	

## 5.1.18 Configuration of a 3GPP NF instance

Use case stage	Evolution/Specification	<<Uses>> Related use
<b>Goal</b>	To enable the authorized consumer to request configuration of a 3GPP NF instance.	
<b>Actors and Roles</b>	An authorized consumer of the NF provisioning management service.	
<b>Telecom resources</b>	ETSI NFV MANO system; NF provisioning management service producer.	
<b>Assumptions</b>	N/A	
<b>Pre-conditions</b>	The NF to be configured has been instantiated; The MOI of the NF has been created.	
<b>Begins when</b>	The authorized consumer needs to configure a 3GPP NF instance.	
<b>Step 1 (M)</b>	The consumer requests the NF provisioning management service producer to modify the attribute(s) of the MOI of the 3GPP NF instance.	
<b>Step 2 (O)</b>	If the 3GPP NF contains virtualized part and the corresponding VNF instance(s) need to be updated, the NF provisioning management service producer interacts, or requests another NF provisioning management service producer to interact, with ETSI NFV MANO system to update the corresponding VNF instance(s).	
<b>Step 3 (M)</b>	The NF provisioning management service producer configures the 3GPP NF instance, per the MOI attribute modification request received from the consumer.	
<b>Step 4 (M)</b>	The NF provisioning management service producer modifies the attributes of the MOI and informs the consumer that the 3GPP NF instance has been configured successfully.	
<b>Ends when</b>	All the steps identified above are successfully completed.	
<b>Exceptions</b>	One of the steps identified above fails.	
<b>Post-conditions</b>	The 3GPP NF instance has been configured.	
<b>Traceability</b>	REQ-PRO_NF-FUN-4, REQ-PRO_NF-FUN-5, REQ-PRO_NF-FUN-6, REQ-PRO_NF-FUN-3	

## 5.1.19 Creation of a 3GPP sub-network

Use case stage	Evolution/Specification	<<Uses>> Related use
<b>Goal</b>	To enable the authorized consumer to request creation of a 3GPP sub-network.	
<b>Actors and Roles</b>	An authorized consumer of the sub-network provisioning management service.	
<b>Telecom resources</b>	VNF package(s) of the virtualized part of 3GPP NF(s); NSD(s) of the NS(s); ETSI NFV MANO system; Network provisioning service producer; NF provisioning service producer.	
<b>Assumptions</b>	N/A	
<b>Pre-conditions</b>	The non-virtualized part of the NFs (including completely non-virtualized NFs) constituting the 3GPP sub-network have been deployed; The VNF package(s) of the virtualized part of 3GPP NF(s) have been on-boarded to ETSI NFV MANO system; The NSD(s) of the NS realizing the 3GPP sub-network have been on-boarded to ETSI NFV MANO system.	
<b>Begins when</b>	The authorized consumer needs to create a 3GPP sub-network.	
<b>Step 1 (M)</b>	The authorized consumer requests the sub-network provisioning management service producer to create a 3GPP sub-network. The request needs to indicate the network capacity (e.g., the number of instances of each kind of NFs, and the capacity of each NF instance, for example, number of flows with certain QoS attributes to be supported), network topology information (e.g., the connections between NF instances), and the network QoS requirements (e.g., bandwidth and latency requirements of the interface between two NF instances).	
<b>Step 2 (M)</b>	The network provisioning management service producer interacts, or requests another network provisioning management service producer to interact, with ETSI NFV MANO system to instantiate the NS(s) realizing the sub-network.	
<b>Step 3 (M)</b>	ETSI NFV MANO system informs the NF provisioning management service producer about the instantiation of the NSs and the new VNFs.	
<b>Step 4 (M)</b>	The NF provisioning management configuration service producer creates the MOI(s) of the 3GPP NFs that are realized by the newly instantiated VNF(s); there may be MOI(s) that specify the topology of the instantiated NSs.	
<b>Step 5 (M)</b>	The sub-network provisioning management service producer is using the NF provisioning management service to configure the 3GPP NF instance(s) that are constituting the subject 3GPP sub-network.	NF configuration service
<b>Ends when</b>	All the steps identified above are successfully completed.	
<b>Exceptions</b>	One of the steps identified above fails.	
<b>Post-conditions</b>	The 3GPP sub-network has been created.	
<b>Traceability</b>	REQ-PRO_NW-FUN-1, REQ-PRO_NW-FUN-2	



## 5.1.20 Configuration of a 3GPP sub-network

Use case stage	Evolution/Specification	<<Uses>> Related use
<b>Goal</b>	To enable the authorized consumer to request configuration of a 3GPP sub-network.	
<b>Actors and Roles</b>	An authorized consumer of the network provisioning management service.	
<b>Telecom resources</b>	3GPP network; 3GPP NFs; ETSI NFG MANO system; Network provisioning management service producer.	
<b>Assumptions</b>	N/A	
<b>Pre-conditions</b>	The 3GPP sub-network has been created; The MOI(s) related to the sub-network has been created.	
<b>Begins when</b>	The authorized consumer needs to configure a 3GPP sub-network.	
<b>Step 1 (M)</b>	The authorized consumer requests to configure a 3GPP sub-network.	
<b>Step 2 (M)</b>	The consumer requests the network provisioning management management service producer to modify the attribute of the MOI(s) related to the 3GPP sub-network.	
<b>Step 3 (O)</b>	If the 3GPP network is realized by NS(s) (ETSI ISG NFV concept), the network provisioning management service producer requests (directly or indirectly via another) ETSI NFV MANO system to update the NS(s) realizing the 3GPP sub-network.	
<b>Step 4 (O)</b>	If there are new VNFs instantiated by the NS update, ETSI NFV MANO system informs the NF provisioning management service producer about the instantiation of VNFs.	
<b>Step 5 (O)</b>	The NF provisioning management service producer creates the MOI(s) of the 3GPP NFs that are realized by the newly instantiated VNF(s).	
<b>Step 6 (M)</b>	The network provisioning management service producer consumes the NF provisioning management service to configure the impacted 3GPP NF instance(s).	NF configuration service
<b>Step 7 (M)</b>	The network provisioning management service producer configures the 3GPP sub-network, per the MOI attribute modification request received from the consumer.	
<b>Step 8 (M)</b>	The NF provisioning management service producer modifies the attributes of the MOI(s) of the 3GPP network and informs the consumer that the 3GPP sub-network has been configured successfully.	
<b>Ends when</b>	All the steps identified above are successfully completed.	
<b>Exceptions</b>	One of the steps identified above fails.	
<b>Post-conditions</b>	The 3GPP network has been configured.	
<b>Traceability</b>	REQ-PRO_NW-FUN-3, REQ-PRO_NW-FUN-4	

## 5.1.21 Network slice subnet feasibility check

Use case stage	Evolution/Specification	<<Uses>> Related use
<b>Goal</b>	To check the feasibility of provisioning a network slice subnet to determine whether network slice subnet requirements can be satisfied at a particular point of time (e.g., in terms of resources)	
<b>Actors and Roles</b>	Network slice subnet management service consumer. For example, when a network slice subnet instance is to be provided as a constituent of a network slice instance.	
<b>Telecom resources</b>	Network slice subnet instance Network slice management service provider. For example, a management function that plays the role of network slice management service provider.	
<b>Assumptions</b>	Network slice subnet management service consumer has decided to check the feasibility of provisioning a network slice subnet based on, for example, internal decision or to facilitate an external service requests.	
<b>Pre-conditions</b>	Network slice subnet requirements have been derived or received by network slice subnet management service consumer.	
<b>Begins when</b>	Network slice subnet management service provider receives the request to evaluate the feasibility of provisioning a network slice subnet according to the network slice requirements at a particular point in time.	
<b>Step 1 (M)</b>	Network slice subnet management service provider identifies the network slice subnets constituents according to the requirements, e.g., network services to be requested from MANO.	
<b>Step 2 (O)</b>	For the purpose of checking the feasibility of provisioning a network slice subnet(s) of the network slice instance, network slice subnet management service provider(s) may obtain information from the network (e.g., current or predicted load level information, current or predicted resource usage information from management data analytics services).	
<b>Step 3 (M)</b>	Network slice subnet management service provider sends enquiries with reservation requests to other management providers (e.g., MANO) to determine availability of network constituents, e.g., network services, network functions. If some of the responses are negative, network slice subnet management service provider may send enquiries to different management providers.	
<b>Ends when</b>	Feasibility check results have been provided to network slice subnet management service consumer.	
<b>Exceptions</b>	One of the mandatory steps fails.	
<b>Post-conditions</b>	N/A	
<b>Traceability</b>		

## 5.1.22 Void

## 5.1.23 Network slice subnet management with assigned priority

Use case stage	Evolution/Specification	<<Uses>> Related use
<b>Goal</b>	To assign priority on existing network slice subnet instance(s).	
<b>Actors and Roles</b>	Network slice subnet provisioning management service consumer. Network slice subnet provisioning management service provider (e.g. NSSMF)	
<b>Telecom resources</b>	Network slice subnet instance (i.e. NSSI) Network slice subnet provisioning management service provider	
<b>Assumptions</b>	Network slice subnet instance is deployed to support a communication service with priority, set by the operator.	
<b>Pre-conditions</b>	This use case is based on the condition that operator requires a priority assigned to network slice subnet.	
<b>Begins when</b>	The NSSI(s) should have been assigned with priority set by the operator.	
<b>Step 1 (M)</b>	The network slice provisioning management service provider identifies the NSSI(s) that needs to be associated with the priority, requested by authorized network slice subnet provisioning management service consumer. The network slice provisioning management service provider assigns priority to the identified NSSI(s)	Network slice subnet instance modification use case
<b>Step 2 (M)</b>	The network slice provisioning management service provider sends response to its authorized consumer about assigned priority on identified NSSI(s).	
<b>Ends when</b>	All the steps identified above are successfully completed. Network slice subnet priority was assigned by the network slice subnet management service provider.	
<b>Exceptions</b>	One of the steps identified above fails.	
<b>Post-conditions</b>		
<b>Traceability</b>	REQ-PRO_NSI-FUN-9	

## 5.1.24 Management interaction with NFV MANO for network service priority

Use case stage	Evolution/Specification	<<Uses>> Related use
<b>Goal</b>	To enable the authorized consumer to request creation of a 3GPP sub-network, management interactions with NFV MANO is needed. This management interaction will assign priority on NFV NS(s).	
<b>Actors and Roles</b>	An authorized consumer of 3GPP sub-network creation.	
<b>Telecom resources</b>	VNF package(s) of the virtualized part of 3GPP NF(s); NSD(s) of the NS(s); ETSI NFV MANO system;	
<b>Assumptions</b>	N/A	
<b>Pre-conditions</b>	The ETSI NFV VNF package(s) of the virtualized part of 3GPP NF(s) have been on-boarded to ETSI NFV MANO system; The ETSI NFV NSD(s) used to instantiate NS(s) for realizing the 3GPP sub-network have been on-boarded to ETSI NFV MANO system.	
<b>Begins when</b>	The authorized consumer needs to create a 3GPP sub-network. This creation operation also needs to assign priority on 3GPP sub-network and on related ETSI NFV NS(s).	
<b>Step 1 (M)</b>	The authorized consumer requests the 3GPP sub-network creation service producer to create a 3GPP sub-network.	
<b>Step 2 (M)</b>	The sub-network creation service producer interacts, or requests another sub-network creation service producer to interact, with ETSI NFV MANO system to instantiate the NS(s) realizing the 3GPP sub-network.	
<b>Step 3 (M)</b>	ETSI NFV MANO is informed about NS priority.	
<b>Ends when</b>	All the steps identified above are successfully completed.	
<b>Exceptions</b>	One of the steps identified above fails.	
<b>Post-conditions</b>	The 3GPP sub-network has been created. Network service priority is identified by NFVO to support the 3GPP sub-network.	
<b>Traceability</b>	REQ-PRO_NW-FUN-1, REQ-PRO_NW-FUN-2	

## 5.1.25 Void

## 5.1.26 Obtaining network slice subnet provider capability information

Use case stage	Evolution/Specification	<<Uses>> Related use
<b>Goal</b>	To satisfy the query for obtaining network slice subnet provider capability information.	
<b>Actors and Roles</b>	Network slice subnet provisioning management service consumer.	
<b>Telecom resources</b>	Network slice subnet provider capabilities	
<b>Assumptions</b>	N/A	
<b>Pre-conditions</b>	N/A	
<b>Begins when</b>	A network slice subnet provisioning management service consumer wants to obtain the network slice subnet provider capability information	
<b>Step 1 (M)</b>	The network slice subnet provisioning management service provider receives the request from its authorized consumer querying as to what the network slice subnet provisioning management service provider is capable of supporting.	
<b>Step 2 (M)</b>	The network slice subnet provisioning management service provider processes the request.	
<b>Step 3 (M)</b>	The network slice subnet provisioning management service provider sends the result of network slice subnet provider capability information request to the network slice subnet provisioning management service consumer.	
<b>Ends when</b>	All the steps identified above are successfully completed.	
<b>Exceptions</b>	One of the steps identified above fails.	
<b>Post-conditions</b>	The query for obtaining network slice subnet capability information has been satisfied.	
<b>Traceability</b>	REQ-PRO_NSSI-FUN-19	

## 5.2 Requirements

### 5.2.1 Requirements for network slice provisioning service

**REQ-PRO\_NSI-FUN-1** The network slice provisioning service provider shall have the capability allowing its authorized consumer to request a network slice instance.

**REQ-PRO\_NSI-FUN-2** The network slice provisioning service provider shall have the capability allowing its authorized consumer to send the network slice related requirements.

NOTE 1: The network slice related requirements include requirements such as area traffic capacity, coverage area, isolation/sharing, end-to-end latency, mobility, overall user density, priority, service availability, service reliability, UE speed; see TS 22.261 [5] where these parameters are defined for end user services.

NOTE 2: The network slice related requirements also include requirements derived from the Generic network Slice Template (GST) defined by GSMA in [9].

NOTE 3: The SLA requirements can be translated to service profile which can be used to decide on the constituent NSSIs and the topology of the NSI.

NOTE 4: Void

**REQ-PRO\_NSI-FUN-3** The network slice provisioning service provider shall have the capability allowing its authorized consumer to request the deallocation of a network slice instance.

**REQ-PRO\_NSI-FUN-4** The network slice provisioning service provider shall have the capability allowing its authorized consumer to request activation of a network slice instance.

**REQ-PRO\_NSI-FUN-5** The network slice provisioning service provider shall have the capability allowing its authorized consumer to request deactivation of a network slice instance.

**REQ-PRO\_NSI-FUN-6** The network slice provisioning service provider shall have the capability allowing its authorized consumer to request the modification of a network slice instance.

**REQ-PRO\_NSI-FUN-7** The network slice provisioning service provider shall have the capability allowing its consumer to obtain the network slice management data.

**REQ-PRO\_NSI-FUN-8** The network slice provisioning service provider shall have the capability allowing its authorized consumer to obtain the feasibility of provisioning the requested network slice instance at a particular point of time.

**REQ-PRO\_NSI-FUN-9** The network slice provisioning service provider shall have the capability to satisfy the requirements using shared or dedicated managed resources for a network slice instance.

## 5.2.2 Requirements for network slice subnet provisioning service

**REQ-PRO\_NSSI-FUN-1** The network slice subnet provisioning service provider shall have the capability allowing its authorized consumer to request a network slice subnet instance.

**REQ-PRO\_NSSI-FUN-2** The network slice subnet provisioning service provider shall have the capability of interaction with NFVO via the NS lifecycle management interface.

**REQ-PRO\_NSSI-FUN-3** The network slice subnet provisioning service provider shall have the capability allowing its authorized consumer to send network slice subnet related requirements.

**REQ-PRO\_NSSI-FUN-4** The network slice subnet provisioning service provider shall have the capability allowing its authorized consumer to request to create a new NSSI or use an existing NSSI based on the network slice subnet related requirements.

**REQ-PRO\_NSSI-FUN-5** The network slice subnet provisioning service provider shall have the capability allowing its authorized consumer to request to associate the NS instance with corresponding NSSI.

**REQ-PRO\_NSSI-FUN-6** The network slice subnet provisioning service provider shall have the capability allowing its authorized consumer to request the configuration of the RAN NSSI constituents with the RRM policy information for simultaneous support of multiple NSIs.

**REQ-PRO\_NSSI-FUN-7** The network slice subnet provisioning service provider shall have the capability allowing its authorized consumer to obtain network slice subnet instance information.

**REQ-PRO\_NSSI-FUN-8** The network slice subnet provisioning service provider shall have the capability of allowing its authorized consumer to request the deallocation of a network slice subnet instance.

**REQ-PRO\_NSSI-FUN-9** The network slice subnet provisioning service provider shall have the capability allowing its authorized consumer to request activation of a network slice subnet instance.

**REQ-PRO\_NSSI-FUN-10** The network slice subnet provisioning service provider shall have the capability allowing its authorized consumer to request deactivation of a network slice subnet instance.

**REQ-PRO\_NSSI-FUN-11** The network slice subnet provisioning service provider shall have the capability allowing its authorized consumer to request modification of a network slice subnet instance.

**REQ-PRO\_NSSI-FUN-12** The network slice subnet provisioning service provider shall have the capability allowing its consumer to obtain information regarding available network slice subnet resources.

**REQ-PRO\_NSSI-FUN-13** The network slice subnet provisioning service provider shall have the capability allowing its authorized consumer to obtain the feasibility of provisioning a network slice subnet instance at a particular point of time.

**REQ-PRO\_NSSI-FUN-14** The network slice subnet provisioning service provider shall have the capability to satisfy the request to consume the NF provisioning service.

**REQ-PRO\_NSSI-FUN-16** The network slice subnet provisioning service provider shall have the capability allowing its consumer to provide slice specific operation information for the (re)configuration to a NSSI.

**REQ-PRO\_NSI-FUN-17** The network slice subnet provisioning service provider shall have the capability allowing its authorized consumer to assign priority of a network slice subnet.

**REQ-PRO\_NSSI-FUN-18** The network slice subnet provisioning service provider shall have the capability allowing its authorized consumer to obtain network slice subnet provider capability information.

**REQ-PRO\_NSSI-FUN-19** The network slice subnet provisioning service provider shall have the capability to satisfy the requirements using shared or dedicated managed resources for a network slice subnet instance.

### 5.2.3 Requirements for NF provisioning service

**REQ-PRO\_NF-FUN-1** The NF provisioning service producer shall have the capability allowing its authorized consumer to request creation of an instance of 3GPP NF.

**REQ-PRO\_NF-FUN-2** The NF provisioning service producer shall have the capability to fulfill the consumer's request to create an instance of 3GPP NF.

**REQ-PRO\_NF-FUN-3** The NF provisioning service producer shall have the capability to provide the VNF and VNFC related information of the NF instance to its authorized consumer.

**REQ-PRO\_NF-FUN-4** The NF provisioning service producer shall have the capability allowing its authorized consumer to request configuration of a 3GPP NF instance.

**REQ-PRO\_NF-FUN-5** The NF provisioning service producer shall have the capability to request updating the VNF(s) that are realizing the virtualized part of a 3GPP NF.

**REQ-PRO\_NF-FUN-6** The NF provisioning service producer shall have the capability to fulfill the consumer's request to configure a 3GPP NF instance.

**REQ-PRO\_NF-FUN-7** The NF provisioning service producer shall have the capability to request NF management service producers working in the concerned NF instance to create and maintain the MOI(s) for it.

### 5.2.4 Requirements for sub-network provisioning service

**REQ-PRO\_NW-FUN-1** The sub-network provisioning service producer shall have the capability allowing its authorized consumer to request creation of a 3GPP sub-network.

**REQ-PRO\_NW-FUN-2** The sub-network provisioning service producer shall have the capability to fulfil the consumer's request to create a 3GPP sub-network.

**REQ-PRO\_NW-FUN-3** The sub-network provisioning service producer shall have the capability allowing its authorized consumer to request configuration of a 3GPP sub-network.

**REQ-PRO\_NW-FUN-4** The sub-network provisioning service producer shall have the capability to fulfil the consumer's request to configure a 3GPP sub-network.

---

## 6 Management services for provisioning of networks and network slicing

### 6.1 Management services for network slice provisioning

The management services for network slice provisioning are listed in table 6.1-1.

Table 6.1-1: Management services for network slice provisioning

MnS Name	MnS Component Type A (operations and notifications)	MnS Component Type B (information model)	Note
Network Slice Provisioning	<p>Operations defined in clause 11 of TS 28.532 [8]:</p> <ul style="list-style-type: none"> <li>- createMOI operation</li> <li>- deleteMOI operation</li> <li>- getMOIAttributes operation</li> <li>- modifyMOIAttributes operation</li> </ul> <p>Operations defined in clause 6.5:</p> <ul style="list-style-type: none"> <li>- allocateNsi operation</li> <li>- deallocateNsi operation</li> </ul>	<p>Network Slice NRM related information models defined in clause 6.3 of TS 28.541 [6]</p>	<p>This management service enables its consumer to request allocating, deallocating, or modifying an NSI.</p> <p>The typical scenario is "Network Slices as NOP internals" model where this MnS is consumed by operators.</p>
Network Slice Provisioning data reporting	<p>Operations defined in TS 28.532 [8]:</p> <ul style="list-style-type: none"> <li>- createMOI operation</li> <li>- deleteMOI operation</li> <li>- getMOIAttributes operation</li> <li>- modifyMOIAttributes operation</li> </ul> <p>Notifications defined in clause 11 of TS 28.532 [8]:</p> <ul style="list-style-type: none"> <li>- notifyMOICreation notification</li> <li>- notifyMOIDeletion notification</li> <li>- notifyMOIAttributeValueChanges notification</li> </ul>	<p>NtfSubscriptionControl defined in TS 28.622 [13].</p> <p>Network Slice NRM related information models defined in clause 6.3 of TS 28.541 [6]</p>	<p>This management service enables its consumer to obtain notifications about Network Slice NRM related information model data.</p> <p>The typical scenario is "Network Slices as NOP internals" model where this MnS is consumed by operators</p>

## 6.2 Management services for network slice subnet provisioning

The management services for network slice subnet provisioning are listed in table 6.2-1.

**Table 6.2-1: Management services for NSS provisioning**

MnS Name	MnS Component of type A (Operations and notifications)	MnS Component of type B (information model)
Network Slice Subnet Provisioning	Operations defined in clause 11 of TS 28.532 [8]: <ul style="list-style-type: none"> <li>- createMOI operation</li> <li>- modifyMOIAttributes operation</li> <li>- getMOIAttributes operation</li> <li>- deleteMOI operation</li> </ul> Operations defined in clause 6.5: <ul style="list-style-type: none"> <li>- allocateNssi operation</li> <li>- deallocateNssi operation</li> </ul>	Network slice subnet NRM related information models defined in clause 6.3 of TS 28.541 [6]
Network Slice Subnet Provisioning data reporting	Operations defined in TS 28.532 [8]: <ul style="list-style-type: none"> <li>- createMOI operation</li> <li>- deleteMOI operation</li> <li>- getMOIAttributes operation</li> <li>- modifyMOIAttributes operation</li> </ul> Notifications defined in clause 11 of TS 28.532 [8]: <ul style="list-style-type: none"> <li>- notifyMOICreation notification</li> <li>- notifyMOIDeletion notification</li> <li>- notifyMOIAttributeValueChanges notification</li> </ul>	NtfSubscriptionControl defined in TS 28.622 [13].  Network slice subnet NRM related information models defined in clause 6.3 of TS 28.541 [6]

### 6.3 Management services for network function provisioning

The management services for network function provisioning are listed in table 6.3-1.



Table 6.3-1: Management services for NF provisioning

MnS Name	MnS Component of type A (Operations and notifications)	MnS Component of type B (information model)
Network Function Provisioning	Operations defined in clause 11 of TS 28.532 [8]: <ul style="list-style-type: none"> <li>- createMOI operation</li> <li>- modifyMOIAttributes operation</li> <li>- getMOIAttributes operation</li> <li>- deleteMOI operation</li> </ul>	NF(s)/ME(s) information model defined in TS 28.541 [6].
Network Function Provisioning data reporting	Operations defined in TS 28.532 [8]: <ul style="list-style-type: none"> <li>- createMOI operation</li> <li>- deleteMOI operation</li> <li>- getMOIAttributes operation</li> <li>- modifyMOIAttributes operation</li> </ul> Notifications defined in clause 11 of TS 28.532 [8]: <ul style="list-style-type: none"> <li>- notifyMOICreation notification</li> <li>- notifyMOIDeletion notification</li> <li>- notifyMOIAttributeValueChanges notification</li> </ul> <p style="text-align: center;">Or</p> <ul style="list-style-type: none"> <li>- notifyMOIChanges notification</li> <li>- notifyEvent notification</li> </ul>	NtfSubscriptionControl defined in clause 4.3.22 of TS 28.622 [13]. NF(s)/ME(s) information model defined in TS 28.541 [6].

## 6.4 Void

## 6.5. Operations of provisioning

### 6.5.1 AllocateNsi operation

#### 6.5.1.1 Description

This operation is invoked by network slice provisioning MnS consumer to request the provider to allocate a network slice instance to satisfy network slice related requirements. The provider may create a new NSI or using existing NSI to satisfy the request. The requirements in the request are compared/matched against the actual capabilities

of all candidate NSIs by the provider. If an existing NSI can be found that is eligible for allocation, then this can be used, or else a new NSI is created, provided that required NSSIs can be created.

### 6.5.1.2 Input parameters

Parameter Name	Support Qualifier	Information Type / Legal Values	Comment
attributeListIn	M	LIST OF SEQUENCE< attribute name, attribute value>	This parameter specifies the network slice related requirements defined in ServiceProfile in Clause 6.3.3 in TS 28.541 [6].

### 6.5.1.3 Output parameters

Parameter name	Support Qualifier	Matching Information / Legal Values	Comment
serviceProfileId	M	A parameter that uniquely identifies the ServiceProfile	This parameter specifies the unique identifier of the service profile.
status	M	ENUM (Succeeded, Failed)	An operation may fail because of a specified or unspecified reason.

## 6.5.2 AllocateNssi operation

### 6.5.2.1 Description

This operation is invoked by `network slice subnet provisioning MnS` consumer to request the provider to allocate a network slice subnet instance to satisfy the network slice subnet related requirements. The provider may create a new NSSI or using existing NSSI to satisfy the request. The requirements in the request are compared/matched against the actual capabilities of all candidate NSSIs by the provider. If an existing NSSI can be found that is eligible for allocation, then this can be used, or else a new NSSI is created, provided that resources are available.

### 6.5.2.2 Input parameters

Parameter Name	Support Qualifier	Information Type / Legal Values	Comment
attributeListIn	M	LIST OF SEQUENCE< attribute name, attribute value>	This parameter specifies the network slice subnet related requirements defined in SliceProfile in Clause 6.3.4 in TS 28.541 [6].

### 6.5.2.3 Output parameters

Parameter name	Support Qualifier	Matching Information / Legal Values	Comment
sliceProfileId	M	A parameter that uniquely identifies the SliceProfile	This parameter specifies the unique identifier of the sliceprofile.
status	M	ENUM (Succeeded, Failed)	An operation may fail because of a specified or unspecified reason.

## 6.5.3 DeallocateNsi operation

### 6.5.3.1 Description

This operation is invoked by `network slice provisioning MnS` consumer to request the provider to deallocate a service profile in an NSI. The provider may terminate the requested NSI or modify the requested NSI without termination to satisfy the deallocateNsi request.

### 6.5.3.2 Input parameters

Parameter Name	Support Qualifier	Information Type / Legal Values	Comment
networkSliceDN	M	The DN of NetworkSlice MOI uniquely identifying the network slice instance.	
serviceProfileId	M	An attribute that globally uniquely identifies the service profile in an NSI.	It specifies the global unique identifier of the service profile in the NSI which is to be deallocated.

### 6.5.3.3 Output parameters

Parameter name	Support Qualifier	Matching Information / Legal Values	Comment
status	M	ENUM (Succeeded, Failed)	An operation may fail because of a specified or unspecified reason.

## 6.5.4 DeallocateNssi operation

### 6.5.4.1 Description

This operation is invoked by `network slice subnet provisioning` MnS consumer to request the provider to deallocate a slice profile in an NSSI. The provider may terminate the requested NSSI or modify the requested NSSI without termination to satisfy the `deallocateNssi` request.

### 6.5.4.2 Input parameters

Parameter Name	Support Qualifier	Information Type / Legal Values	Comment
networkSliceSubnetDN	M	The DN of NetworkSliceSubnet MOI identifying the network slice subnet instance.	
sliceProfileId	M	An attribute uniquely identifies the slice profile in an NSSI.	It specifies the unique identifier of the slice profile in the NSSI which is to be deallocated.

### 6.5.4.3 Output parameters

Parameter name	Support Qualifier	Matching Information / Legal Values	Comment
status	M	ENUM (Succeeded, Failed)	An operation may fail because of a specified or unspecified reason.

## 6.5.5 Void

---

# 7 Provisioning procedures of networks and network slicing

## 7.1 General

The procedures of provisioning of 5G networks are listed in this following subclauses.

## 7.2 Procedure of Network Slice Instance Allocation

The Figure 7.2-1 illustrates the procedure of creating a new NSI or using an existing NSI to satisfy the required network slice related requirements.

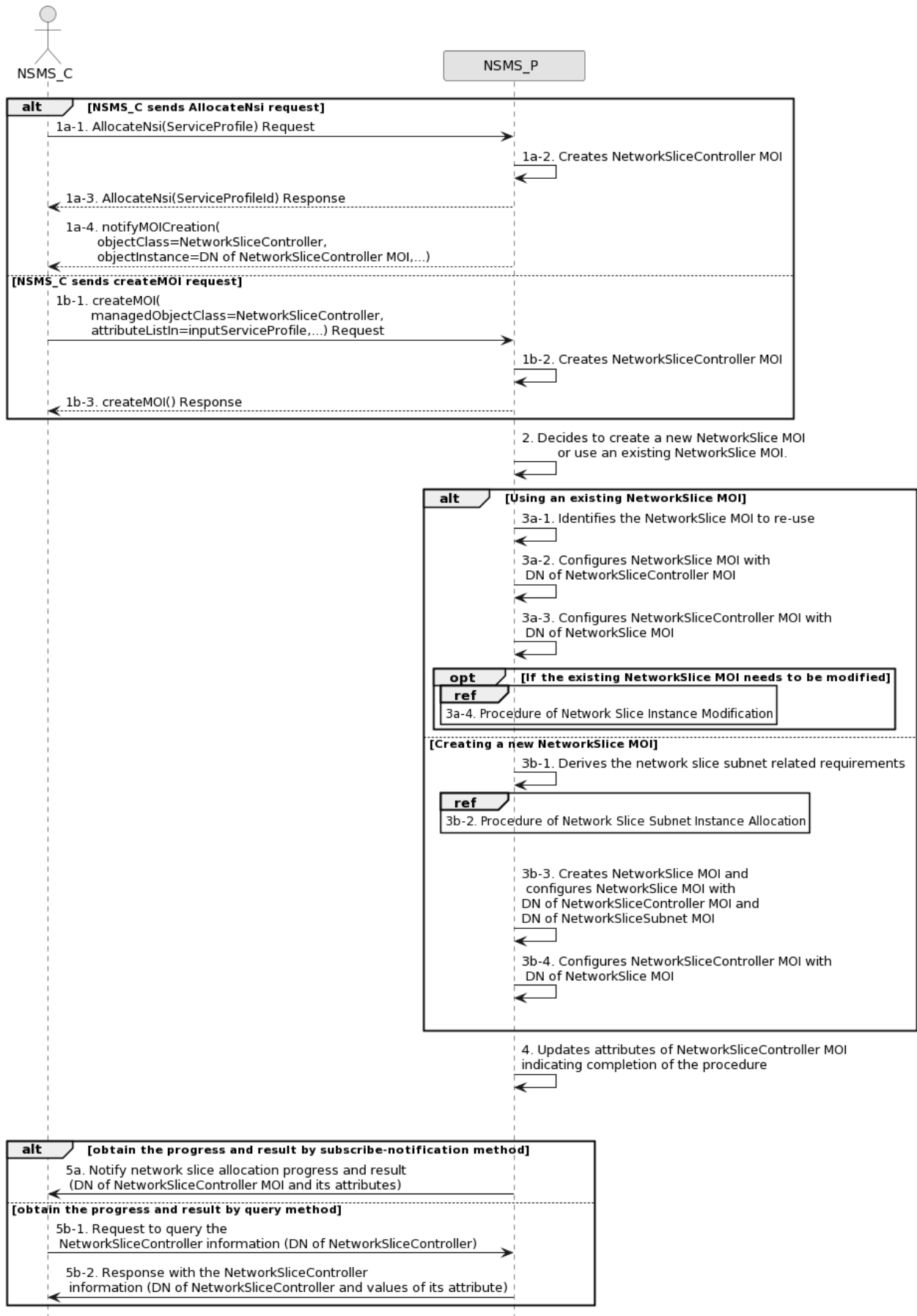

Figure 7.2-1: Network Slice Instance Allocation Request procedure

- 1a-1) Network Slice Management Service Provider (NSMS\_P) receives an `AllocateNsi` request (see `AllocateNsi` operation defined in clause 6.5.1) from Network Slice Management Service Consumer (NSMS\_C) with network slice related requirements (the network slice related requirements are defined as the attributes in the `ServiceProfile` see clause 6.3.3 in TS 28.541 [6]).
- 1a-2) The NSMS\_P creates a `NetworkSliceController` MOI and configures attribute `serviceProfileId` to control and monitor network slice allocation process. NSMS\_P starts to perform the network slice allocation process.
- 1a-3) The NSMS\_P sends `AllocateNsi` response to the NSMS\_C. The `serviceProfileId` is included in the `AllocateNsi` response.
- 1a-4) NSMS\_P sends notification (see `notifyMOICreation` defined in TS 28.532 [8]) to NSMS\_C to notify the DN of the created `NetworkSliceController` instance.
- 1b-1) NSMS\_P receives a `createMOI` request (see `createMOI` operation defined in TS 28.532 [8]) from NSMS\_C with network slice controller (see `NetworkSliceController` IOC and its attributes defined in TS 28.541[6]) including the network slice related requirements in attribute `inputServiceProfile`.
- 1b-2) The NSMS\_P creates an MOI of `NetworkSliceController`.
- 1b-3) The NSMS\_P sends the response to NSMS\_C for the `createMOI` request.

NOTE: Network slice allocation may be initiated using `AllocateNsi` operation as described in steps 1a or `createMOI` operation as described in steps 1b.

- 2) Based on the network slice related requirements and the knowledge of the capabilities of existing deployed network slices, the NSMS\_P may compare/match the provided requirements against all the candidate `NetworkSlice` MOIs, and then decides whether to use an existing `NetworkSlice` MOI or create a new `NetworkSlice` MOI. If the network slice related requirements allow the requested `NetworkSlice` MOI to be shared and if an existing suitable `NetworkSlice` MOI can be reused, the NSMS\_P may decide to use the existing `NetworkSlice` MOI.
- 3a-1) If using an existing `NetworkSlice` MOI, the NSMS\_P identifies the `NetworkSlice` MOI to be reused.
- 3a-2) The NSMS\_P configures the attribute `networkSliceControllerRef` of the `NetworkSlice` MOI with the DN of `NetworkSliceController` MOI.
- 3a-3) NSMS\_P configures the `NetworkSliceController` MOI attribute `networkSliceRef` with the DN of `NetworkSlice` MOI (identified in step 3a-1).
- 3a-4) If the existing `NetworkSlice` MOI needs to be modified to satisfy the network slice related requirements, the NSMS\_P invokes the procedure of network slice instance modification as described in clause 7.6.
- 3b-1) If creating a new `NetworkSlice` MOI, the NSMS\_P derives the network slice subnet related requirements from the received network slice related requirements. Before NSMS\_P derives the network slice subnet related requirements, NSMS\_P may invoke corresponding network slice subnet capability information querying procedure as described in clause 7.8.
- 3b-2) The NSMS\_P invokes the procedure of network slice subnet instance allocation as described in clause 7.3. Before NSMS\_P invokes the procedure, NSMS\_P may invoke corresponding procedure of feasibility check and reservation of network slice subnet as described in clause 7.14.
- 3b-3) The NSMS\_P creates the `NetworkSlice` MOI and configures the attribute `networkSliceSubnetRef` with the DN of `NetworkSliceSubnet` MOI and the attribute `networkSliceControllerRef` with the DN of `NetworkSliceController` MOI. Other configuration information may be configured for the created `NetworkSlice` MOI.

NOTE: The detailed configuration information is described in network slice NRM (see `NetworkSlice` IOC defined in clause 6.3.1 in TS 28.541 [6]).

3a-5) NSMS\_P configures the `NetworkSliceController` MOI attribute `networkSliceRef` with the DN of `NetworkSlice` MOI (created in step 3b-3).

4) NSMS\_P configures `NetworkSliceController` MOI attributes `operationalState`, `administrativeState`, `availabilityStatus` and `processMonitor` to indicate completion of the procedure.

The NSMS\_C may check the status and completion of the network slice allocation procedure any time by monitoring the values of `NetworkSliceController` MOI attributes `operationalState`, `administrativeState`, `availabilityStatus` and `processMonitor` by querying the values or by subscribing to notifications.

The following step 5 describes the procedures for NSMS\_C to monitor network slice allocation progress and result. These steps can happen anytime after the `NetworkSliceController` MOI is created and its DN is notified to the NSMS\_C (step 1a-4 or step 1b-3).

5a) The NSMS\_P sends notification (see `notifyMOIAttributeValueChanges` defined in TS 28.532 [8]) to NSMS\_C to notify the progress and result for network slice allocation process (see attributes in `NetworkSliceController` IOC).

5b-1) The NSMS\_C sends query request to NSMS\_P to query the attribute values of `NetworkSliceController` MOI (see `getMOIAttributes` operation defined in TS 28.532 [8]) to obtain the progress and result (including DN of the `NetworkSlice` MOI) for network slice allocation process.

5b-2) The NSMS\_P sends the response to NSMS\_C with the `NetworkSliceController` information

## 7.3 Procedure of Network Slice Subnet Instance Allocation

The Figure 7.3-1 illustrates the procedure of creating a new network slice subnet instance or using an existing network slice subnet instance to satisfy the required network slice subnet related requirements.

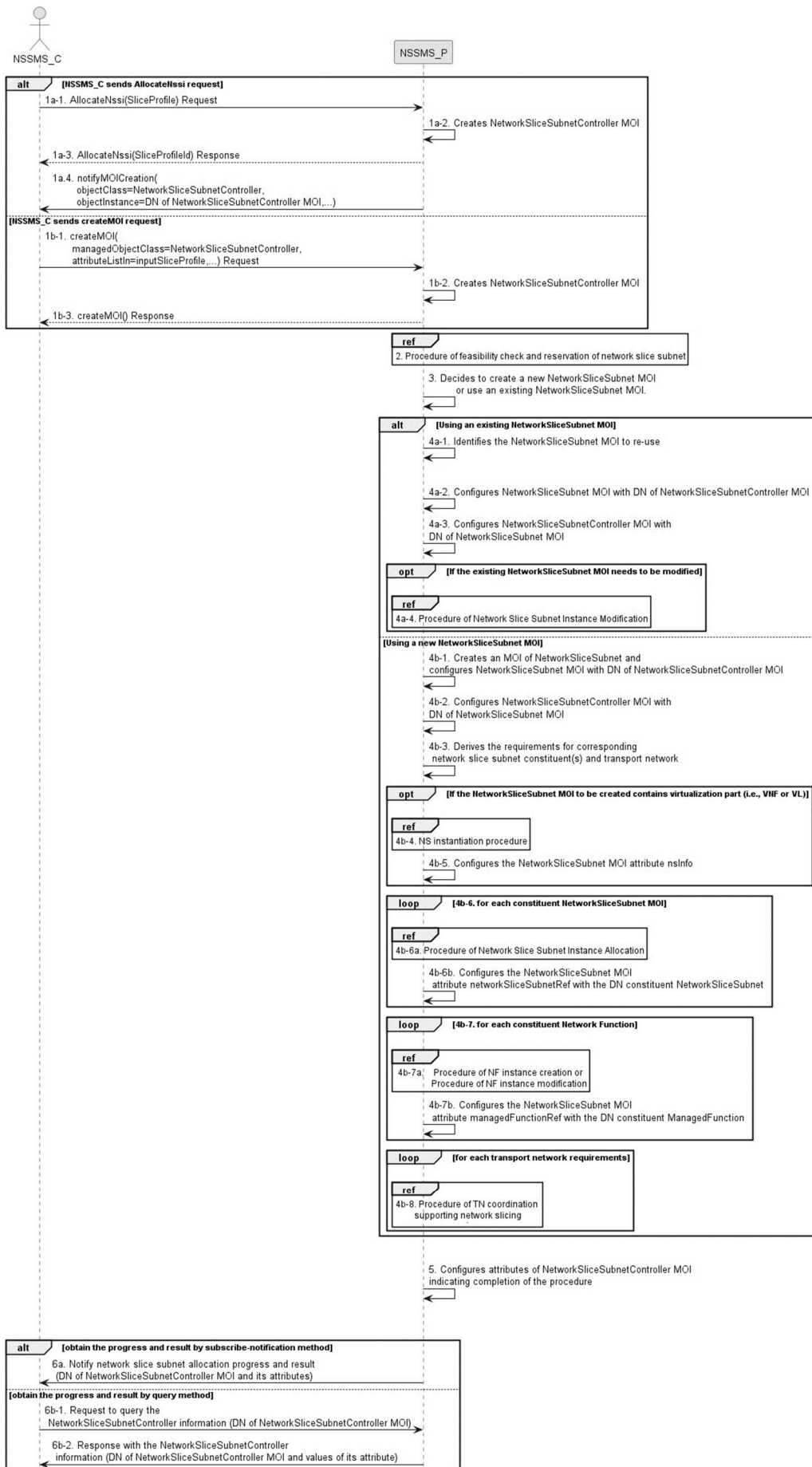



### Figure 7.3-1: Network Slice Subnet Instance Allocation Request procedure

- 1a-1) Network Slice Subnet Management Service Provider (NSSMS\_P) receives an `AllocateNssi` request (see `AllocateNssi` operation defined in clause 6.5.2) from Network Slice Subnet Management Service Consumer NSSMS\_C with network slice subnet related requirements (network slice subnet related requirements defined in `SliceProfile` see clause 6.3.4 in TS 28.541 [6]).
- 1a-2) The NSSMS\_P creates an MOI of `NetworkSliceSubnetController` and configures attribute `sliceProfileId` to control and monitor network slice subnet allocation process. NSSMS\_P starts to perform the network slice subnet allocation process.
- 1a-3) The NSSMS\_P sends `AllocateNssi` response to the NSSMS\_C. The `sliceProfileId` is included in the `AllocateNssi` response.
- 1a-4) NSSMS\_P sends notification (see `notifyMOICreation` defined in TS 28.532 [8]) to NSSMS\_C to notify the DN of the created `NetworkSliceSubnetController` instance.
- 1b-1) NSSMS\_P receives a `createMOI` request (see `createMOI` operation defined in TS 28.532 [8]) from NSSMS\_C with network slice subnet controller (see `NetworkSliceSubnetController` IOC and its attributes defined in TS 28.541[6]) including the network slice subnet related requirements in attribute `inputSliceProfile`.
- 1b-2) The NSSMS\_P creates an MOI of `NetworkSliceSubnetController`.
- 1b-3) The NSSMS\_P sends the response to NSSMS\_C for the `createMOI` request.

NOTE: Network slice subnet allocation may be initiated using `AllocateNssi` operation as described in steps 1a or `createMOI` operation as described in steps 1b.

- 2) NSSMS\_P may invoke corresponding procedure of feasibility check and reservation of network slice subnet as described in clause 7.14. If the network slice subnet related requirements can be satisfied, the following step 3) to step 5) are needed, else go to step 6).
- 3) Based on the network slice subnet related requirements and the existing `NetworkSliceSubnet` MOI capabilities, NSSMS\_P decides whether to use an existing `NetworkSliceSubnet` MOI or create a new `NetworkSliceSubnet` MOI. If the network slice subnet related requirements allow the requested `NetworkSliceSubnet` MOI to be shared and if an existing suitable `NetworkSliceSubnet` MOI can be reused, the NSSMS\_P decides to use the existing `NetworkSliceSubnet` MOI.
- 4a-1) If using an existing `NetworkSliceSubnet` MOI, the NSSMS\_P identifies the `NetworkSliceSubnet` MOI to be reused.
- 4a-2) The NSSMS\_P configures `NetworkSliceSubnet` MOI (attribute `networkSliceSubnetControllerRef`) with the DN of `NetworkSliceSubnetController` MOI.
- 4a-3) NSSMS\_P configures the `NetworkSliceSubnetController` MOI (attribute `networkSliceSubnetRef`) with DN of `NetworkSliceSubnet` MOI (identified in step 4a-1).
- 4a-4) If the existing `NetworkSliceSubnet` MOI needs to be modified to satisfy the network slice subnet related requirements, the NSSMS\_P invokes the procedure of network slice subnet instance modification as described in clause 7.7.
- 4b-1) If creating a new `NetworkSliceSubnet` MOI, the NSSMS\_P creates an MOI of `NetworkSliceSubnet`. The NSSMS\_P configures `NetworkSliceSubnet` MOI (attribute `networkSliceSubnetControllerRef`) with DN of `NetworkSliceSubnetController` MOI.
- 4b-2) NSSMS\_P configures the `NetworkSliceSubnetController` MOI (attribute `networkSliceSubnetRef`) with DN of `NetworkSliceSubnet` MOI (identified in step 4b-1).
- 4b-3) NSSMS\_P derives the corresponding network slice subnet constituent (i.e., NF, constituent `NetworkSliceSubnet`) related requirements and transport network related requirements (e.g., 3GPP endpoint information, latency requirements, bandwidth requirements and isolation requirements) from the received network slice subnet related requirements. Part of these requirements may be referenced by attribute

epTransportRef as defined in clause 6.3.2.2 in TS 28.541[6]. Before NSSMS\_P derives the constituent network slice subnet related requirements, NSSMS\_Provider may invoke corresponding network slice subnet capability information querying procedure as described in clause 7.8.2.

4b-4) If the NetworkSliceSubnet MOI contains virtualisation part (i.e. VNF or VL), NSSMS\_P derives the NS instance instantiation information (the NS instance instantiation information is described in clause 7.3.2.2 and clause 7.3.3.2 [3]) based on network slice subnet related requirements. NSSMS\_P determines new VNF instance(s) that need to be deployed and the existing VNF instance(s) that need to be reused according to the necessary network function(s) and then derives the profile of virtual link(s) according to the connection requirements between the network functions. NSSMS\_P chooses a proper NSD deployment flavour and creates data concerning the SAPs of the NS instance. NSSMS\_P invokes the NS instantiation procedures to create a NS instance.

NOTE: For the interaction with ETSI NFV MANO, NS instantiation procedure is described in clause 7.3.3 in ETSI GS NFV-IFA 013 [3].

4b-5) NSSMS\_P configures NetworkSliceSubnet MOI attribute nsInfo with NS instance information.

4b-6) For each required constituent network slice subnet (NetworkSliceSubnet MOIs), the following step 4b-6a) and 4b-6b) are needed:

4b-6a) NSSMS\_P invokes procedure of network slice subnet instance allocation.

4b-6b) NSSMS\_P configures NetworkSliceSubnet MOI attribute networkSliceSubnetRef with DN of NetworkSliceSubnet MOI.

4b-7) For each required constituent NF instance (ManagedFunction MOI), the following step 4b-7a) and 4b-7b) are needed:

4b-7a) NSSMS\_P invokes procedure of NF instance creation described in clause 7.10 or procedure of NF instance modification described in clause 7.11.

4b-7b) NSSMS\_P configures NetworkSliceSubnet MOI attribute managedFunctionRef with DN of ManagedFunction MOI.

4b-8) For each required transport network related requirements, NSSMS\_P invokes corresponding procedure of coordination with relevant TN Manager to handle the TN part as described in clause 7.9.

5) NSSMS\_P configures NetworkSliceSubnetController MOI attributes operationalState, administrativeState, availabilityStatus and processMonitor to indicate completion of the procedure.

The NSSMS\_C may check the status and completion of the network slice subnet allocation procedure any time by monitoring the values of NetworkSliceSubnetController MOI attributes operationalState, administrativeState, availabilityStatus and processMonitor by querying the values or by subscribing to notifications.

Following step 6) describes the procedures for NSSMS\_C to monitor network slice subnet allocation progress and result. These steps can happen anytime after the NetworkSliceSubnetController MOI is created and its DN is notified to the NSSMS\_C (step 1a-4 or step 1b-3).

6a) The NSSMS\_P sends notification (see notifyMOIAttributeValueChanges defined in TS 28.532 [8]) to NSSMS\_C to notify the progress and result for network slice subnet allocation process (see attributes in NetworkSliceSubnetController IOC).

6b-1) The NSSMS\_C sends query request to NSSMS\_P to query the attribute value of NetworkSliceSubnetController MOI (see getMOIAttributes operation defined in TS 28.532 [8]) to obtain the progress and result (including DN of theNetworkSliceSubnet MOI) for network slice subnet allocation process.

6b-2) The NSMS\_P sends the response to NSMS\_C with the NetworkSliceSubnetController information

## 7.4 Procedure of Network Slice Instance Deallocation

Figure 7.4-1 depicts the procedure of deallocating a network slice instance by the network slice management service provider to satisfy the NSI deallocation request received from an authorized consumer.

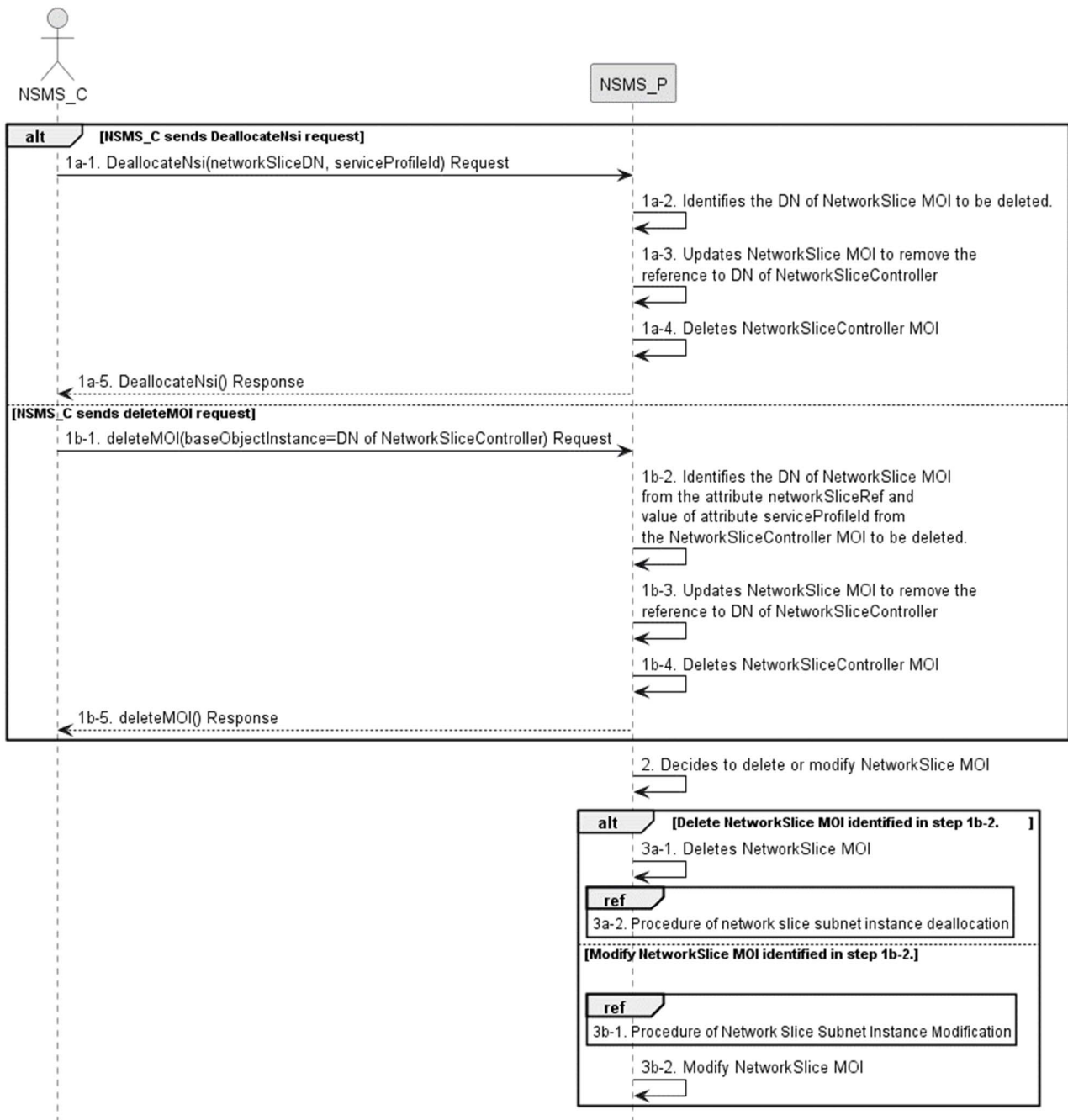

**Figure 7.4-1: Network slice instance deallocation procedure**

1a-1) Network Slice Management Service Provider (NSMS\_P) receives a DeallocateNsi request (see DeallocateNsi operation defined in clause 6.5.3) from Network Slice Management Service Consumer (NSMS\_C) indicating that the NetworkSlice MOI is no longer needed for the given requirements i.e ServiceProfile.

1a-2) NSMS\_P identifies the DN of NetworkSlice MOI from the attribute networkSliceRef and value of attribute serviceProfileId of the NetworkSliceController MOI to be deleted.

1a-3) NSMS\_P updates attribute networkSliceControllerRef of NetworkSlice MOI (identified in step 1b-2) attribute to remove the DN of NetworkSliceController MOI to be deleted.

1a-4) NSMS\_P deletes `NetworkSliceController` MOI.

1a-5) The NSMS\_P sends the `DeallocateNsi` response (see `DeallocateNsi` operation defined in clause 6.5.3) to NSMS\_C.

1b-1) NSMS\_P receives a `deleteMOI` request (see `deleteMOI` operation defined in TS 28.532 [8]) from NSMS\_C with network slice controller (see `NetworkSliceController` IOC and its attribute defined in TS 28.541[6])).

1b-2) NSMS\_P identifies the DN of `NetworkSlice` MOI from the attribute `networkSliceRef` and value of attribute `serviceProfileId` of the `NetworkSliceController` MOI to be deleted.

1b-3) NSMS\_P updates attribute `networkSliceControllerRef` of `NetworkSlice` MOI (identified in step 1b-2) attribute to remove the DN of `NetworkSliceController` MOI to be deleted.

1b-4) NSMS\_P deletes `NetworkSliceController` MOI.

1b-5) NSMS\_P sends the response to NSMS\_C for the `deleteMOI` request.

NOTE: Network slice deallocation may be initiated using `DeallocateNsi` operation as described in steps 1a or using `deleteMOI` operation as described in steps 1b.

2) The NSMS\_P may decide to delete or modify the `NetworkSlice` MOI (identified in step 1b-2).

3a-1) If NSMS\_P decides to delete the `NetworkSlice` MOI, then it deletes the `NetworkSlice` MOI.

3a-2) NSMS\_P invokes the procedure of network slice subnet instance deallocation as described in clause 7.5.

3b-1) If NSMS\_P decides to modify the `NetworkSlice` MOI, procedure of network slice subnet instance modification procedure as described in clause 7.6.

3b-2) NSMS\_P modifies the `NetworkSlice` MOI to update the `serviceProfileList` (using the `serviceProfileId` identified in step 1a-2) or 1b-2) and may update other attributes.

If the NSMS\_C has subscribed for the notification, then NSMS\_P sends notification for deletion (see `notifyMOIDeletion` operation defined in TS 28.532 [8]) and notification for the attribute value changes (see `notifyMOIAttributeValueChanges` operation defined in TS 28.532 [8]) of `NetworkSliceController` MOI and `NetworkSlice` MOI.

## 7.5 Procedure of network slice subnet instance deallocation

Figure 7.5-1 depicts the procedure of deallocating a network slice subnet instance by the network slice subnet management service provider to satisfy the NSSI deallocation request received from an authorized consumer.

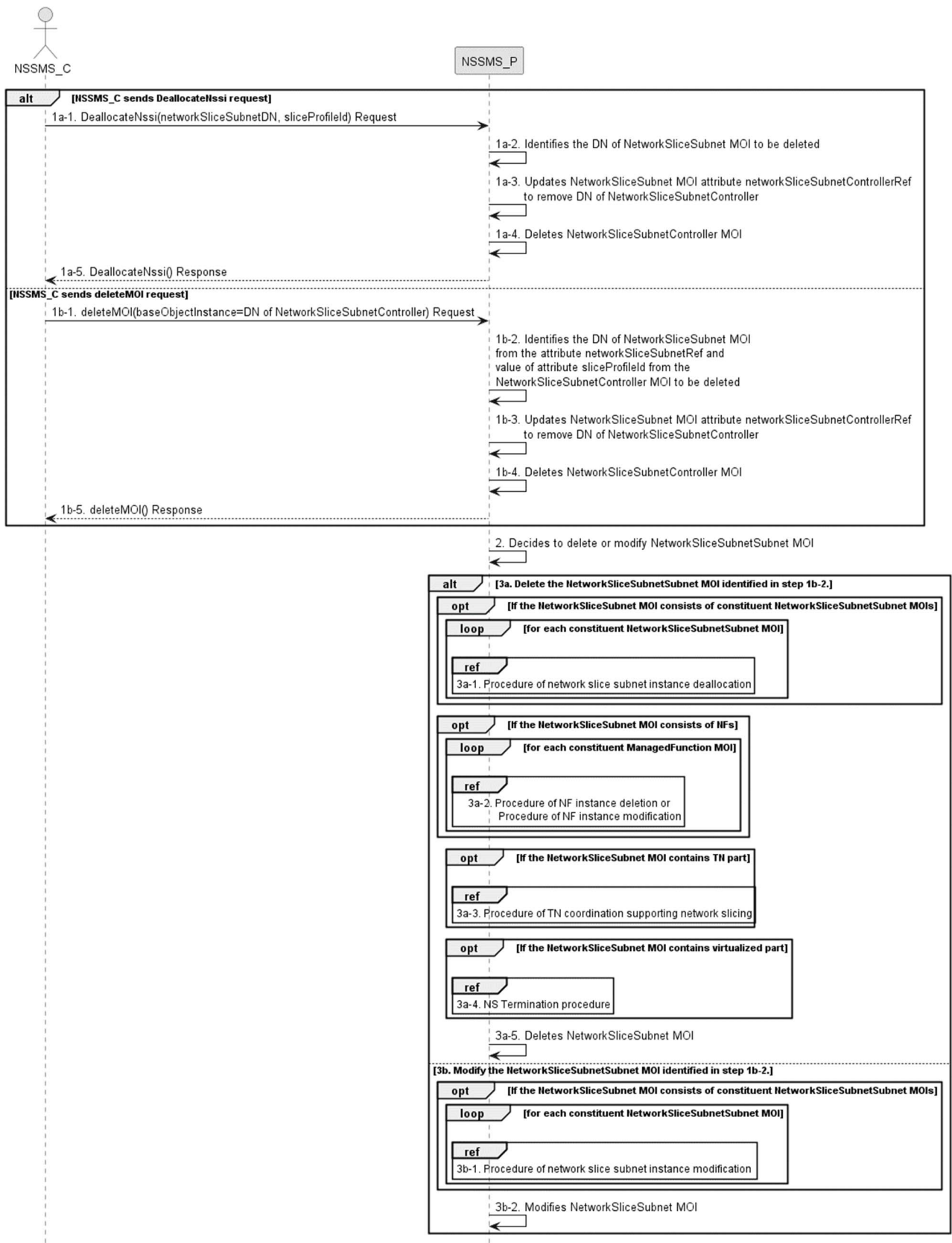

Figure 7.5-1: Network slice subnet instance deallocation procedure

1a-1) The network slice subnet management service provider (NSSMS\_P) receives DeallocateNssi request (see DeallocateNssi operation defined in clause 6.5.4) from network slice subnet management service consumer (NSSMS\_C) indicating that the NetworkSliceSubnet MOI is no longer needed for the given requirements i.e SliceProfile.

- 1a-2) NSSMS\_P identifies the DN of `NetworkSliceSubnet` MOI from the attribute `networkSliceSubnetRef` and value of attribute `sliceProfileId` from the `NetworkSliceSubnetController` MOI to be deleted.
- 1a-3) NSSMS\_P updates `NetworkSliceSubnet` MOI (identified in step 1b-2) attribute `networkSliceSubnetControllerRef` to remove the DN of `NetworkSliceSubnetController` MOI to be deleted.
- 1a-4) NSSMS\_P deletes `NetworkSliceSubnetController` MOI.
- 1a-5) NSSMS\_P sends response (see `DeallocateNssi` operation defined in clause 6.5.4) of NSSI deallocation service to NSSMS\_C.
- 1b-1) NSSMS\_P receives a `deleteMOI` request (see `deleteMOI` operation defined in TS 28.532 [8]) from NSSMS\_C with network slice controller (see `NetworkSliceSubnetController` IOC and its attribute defined in TS 28.541[6]).
- 1b-2) NSSMS\_P identifies the DN of `NetworkSliceSubnet` MOI from the attribute `networkSliceSubnetRef` and value of attribute `sliceProfileId` from the `NetworkSliceSubnetController` MOI to be deleted.
- 1b-3) NSSMS\_P updates `NetworkSliceSubnet` MOI (identified in step 1b-2) attribute `networkSliceSubnetControllerRef` to remove the DN of `NetworkSliceSubnetController` MOI to be deleted.
- 1b-4) NSSMS\_P deletes `NetworkSliceSubnetController` MOI.
- 1b-5) NSSMS\_P sends the response to NSSMS\_C for the `deleteMOI` request.

NOTE: Network slice subnet deallocation may be initiated using `DeallocateNssi` operation as described in steps 1a or using `deleteMOI` operation as described in steps 1b.

- 2) The NSSMS\_P may decide to delete or modify the `NetworkSliceSubnet` MOI (identified in step 1b-2).
- 3a) If NSSMS\_P decides to delete the `NetworkSliceSubnet` MOI, then it performs the following steps:
- 3a-1) NSSMS\_P invokes procedure of network slice subnet instance deallocation as described in clause 7.5 for each constituent `NetworkSliceSubnet` MOI(s) that is configured in attribute `networkSliceSubnetRef` of `NetworkSliceSubnet` MOI (identified in step 1b-2).
- 3a-2) For each constituent NF instance (`ManagedFunction` MOI DN that is configured in attribute of `managedFunctionRef` of `NetworkSliceSubnet` MOI identified in step 1b-2), NSSMS\_P invokes procedure of NF instance deletion as described in clause 7.12 only if the NF is dedicated for the `NetworkSliceSubnet` MOI (identified in step 1b-2) and not being used by any other `NetworkSliceSubnet` MOIs in the network, otherwise, NSSMS\_P procedure of NF instance modification as described in clause 7.11.
- 3a-3) NSSMS\_P invokes TN related coordination procedure with responsible manager as described in clause 7.9 if the `NetworkSliceSubnet` MOI consists of TN part.
- 3a-4) NSSMS\_P invokes NS termination procedure if the `NetworkSliceSubnet` MOI contains virtualized part.

NOTE: For the interaction with ETSI NFV MANO, NS termination procedure is described in clause 7.3.7 in ETSI GS NFV-IFA 013 [3].

- 3a-5) NSSMS\_P deletes the `NetworkSliceSubnet` MOI.
- 3b) If NSSMS\_P decides to modify the `NetworkSliceSubnet` MOI, then it performs the following sub steps:
- 3b-1) For each constituent `NetworkSliceSubnet` MOI, NSSMS\_P invokes the procedure of network slice subnet instance modification as described in clause 7.6.

3b-2) NSSMS\_P modifies the NetworkSliceSubnet MOI to update the sliceProfileList (using the sliceProfileId identified in step 1b-2) and may update other attributes.

If the NSSMS\_C has subscribed for the notification, then NSSMS\_P sends notification for deletion (see notifyMOIDeletion operation defined in TS 28.532 [8]) and notification for the attribute value changes (see notifyMOIAttributeValueChanges operation defined in TS 28.532 [8]) of NetworkSliceSubnetController MOI and NetworkSliceSubnet MOI.

## 7.6 Procedure of Network Slice Instance Modification

The Figure 7.6-1 illustrates the procedure of modifying an existing NSI.

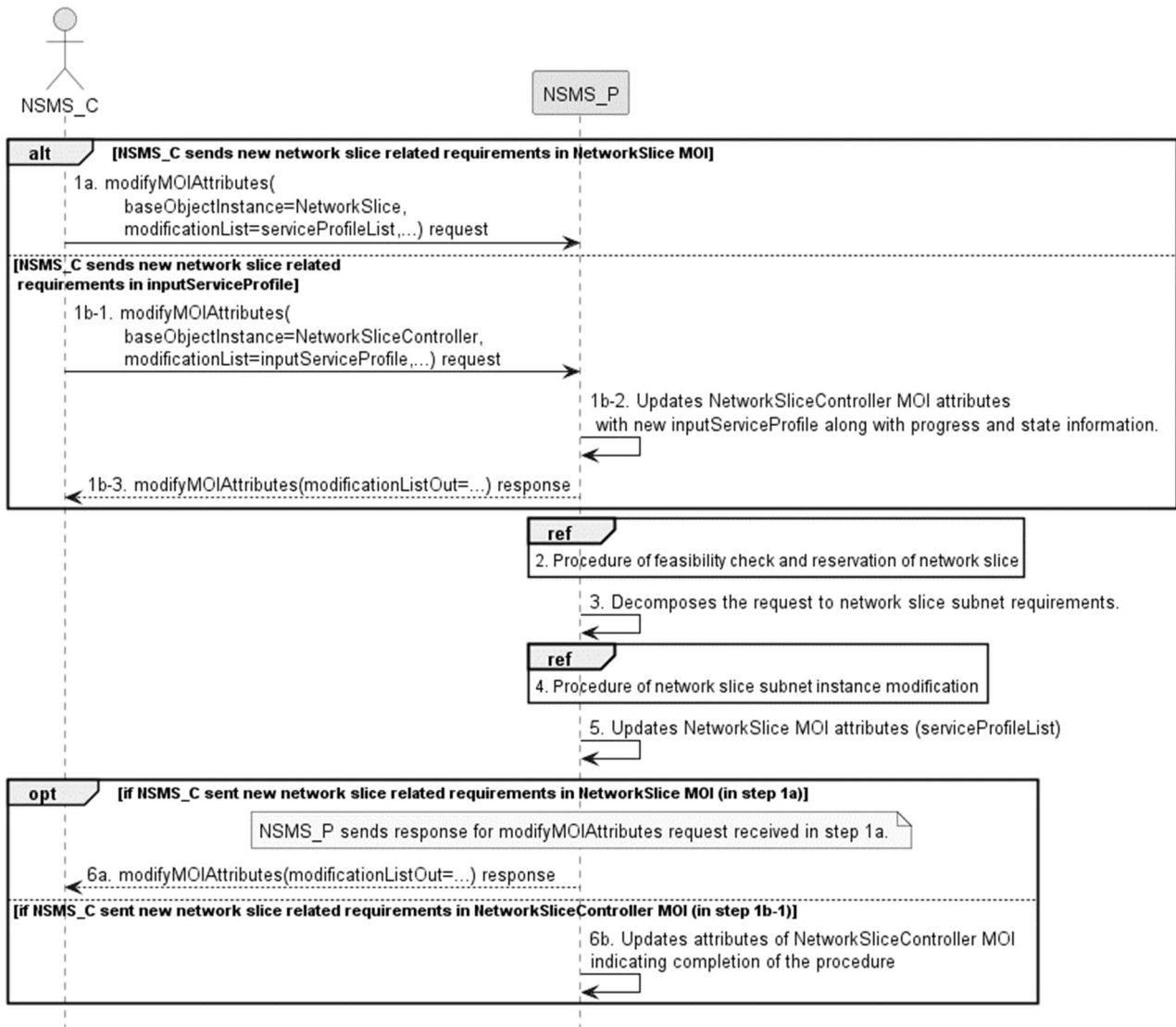

Figure 7.6-1: Network Slice Instance Modification Request procedure

1a) Network Slice Management Service Provider (NSMS\_P) receives a modifyMOIAttributes request (defined in TS 28.532 [8]) from Network Slice Management Service Consumer (NSMS\_C) with the DN of NetworkSlice MOI and the new network slice related requirements (see ServiceProfile defined in clause 6.3.3 in TS 28.541[6]).

1b-1) Network Slice Management Service Provider (NSMS\_P) receives a modifyMOIAttributes request (defined in TS 28.532 [8]) from Network Slice Management Service Consumer (NSMS\_C) with the DN of NetworkSliceController MOI (see NetworkSliceController IOC and its attribute defined in TS 28.541[6]) and the new requirements for the network slice in attribute inputServiceProfile. The

NSMS\_C may check the status and completion of the network slice instance modification procedure any time by monitoring the values of `NetworkSliceController` MOI attributes `operationalState`, `administrativeState`, `availabilityStatus` and `processMonitor` by querying the values or by subscribing to notifications.

1b-2) The NSMS\_P updates `NetworkSliceController` MOI attributes `inputServiceProfile`, and may update attributes `operationalState`, `availabilityStatus` and `processMonitor` to indicate progress.

1b-3) The NSMS\_P sends the response to NSMS\_C for the `modifyMOIAttributes` request.

NOTE: Network slice modification may be initiated using DN of `NetworkSlice` MOI in the `modifyMOIAttributes` operation as described in steps 1a or using DN of `NetworkSliceController` MOI in the `modifyMOIAttributes` operation as described in steps 1b.

- 2) Based on the new network slice related requirements, NSMS\_P invokes the procedure of feasibility check and reservation of network slice as described in clause 7.13. If the modification requirements can be satisfied, go to step 3), else go to step 6).
- 3) NSMS\_P decomposes the modification request into the new requirements for the network slice subnet related.
- 4) NSMS\_P, as the role of Network Slice Subnet Management Service Consumer (NSSMS\_C), invokes the procedure of network slice subnet instance modification as described in clause 7.7.
- 5) NSMS\_P updates `NetworkSlice` MOI attributes.
- 6a) If NSMS\_C sent new network slice related requirements in `NetworkSlice` MOI (in step 1a), then NSMS\_P sends response for `modifyMOIAttributes`.
- 6b) If NSMS\_C sent the new network slice related requirements in `NetworkSliceController` MOI (in step 1b-1), then NSMS\_P updates `NetworkSliceController` MOI attributes `operationalState`, `administrativeState`, `availabilityStatus` and `processMonitor` to indicate completion of the procedure.

## 7.7 Procedure of Network Slice Subnet Instance Modification

The Figure 7.7-1 illustrates the procedure of modifying an existing NSSI.



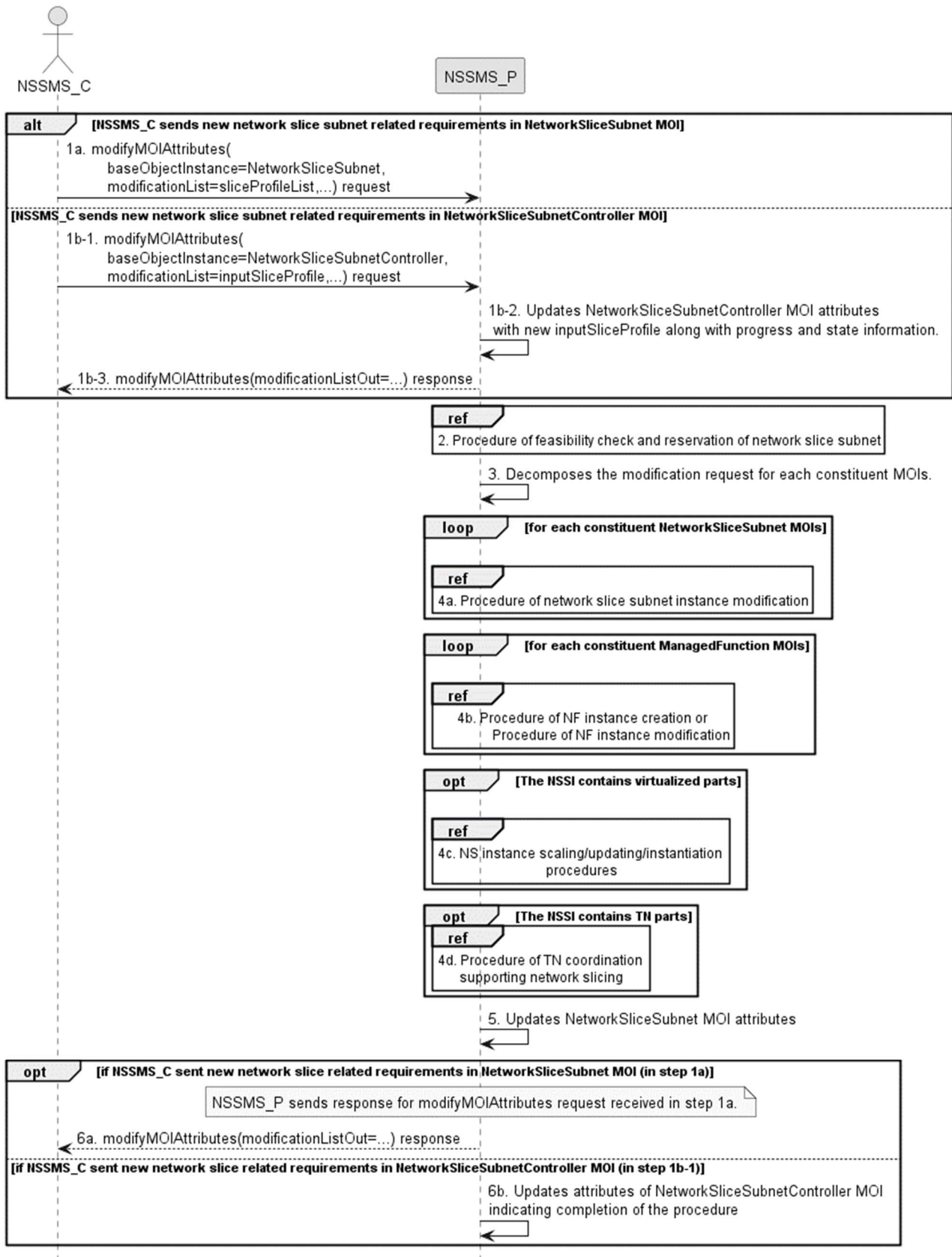

Figure 7.7-1: Network Slice Subnet Instance Modification Request procedure

1a) Network Slice Subnet Management Service Provider (NSSMS\_P) receives a modifyMOIAttributes request (defined in TS 28.532 [8]) from Network Slice Subnet Management Service Consumer (NSSMS\_C) with

the DN of NetworkSliceSubnet MOI and the new network slice subnet related requirements (see SliceProfile defined in clause 6.3.3 in TS 28.541[6]).

1b-1) Network Slice Subnet Management Service Provider (NSSMS\_P) receives a modifyMOIAttributes request (defined in TS 28.532 [8]) from Network Slice Subnet Management Service Consumer (NSSMS\_C) with the DN of NetworkSliceSubnetController MOI (see NetworkSliceSubnetController IOC and its attribute defined in TS 28.541[6]) and the new network slice subnet related requirements in attribute inputSliceProfile. The NSSMS\_C may check the status and completion of the network slice instance modification procedure any time by monitoring the values of NetworkSliceSubnetController MOI attributes operationalState, administrativeState, availabilityStatus and processMonitor by querying the values or by subscribing to notifications.

1b-2) The NSSMS\_P updates NetworkSliceSubnetController MOI attributes inputSliceProfile, and may update attributes operationalState, availabilityStatus and processMonitor to indicate progress.

1b-3) The NSSMS\_P sends the response to NSSMS\_C for the modifyMOIAttributes request.

NOTE: Network subnet slice modification may be initiated using DN of NetworkSliceSubnet MOI in the modifyMOIAttributes operation as described in step 1a or using DN of NetworkSliceSubnetController MOI in the modifyMOIAttributes operation as described in step 1b.

2) Based on the new network slice subnet related requirements, NSSMS\_P invokes the procedure of feasibility check and reservation of network slice subnet as described in clause 7.14. If the modification requirements can be satisfied, go to step 3), else go to step 6).

3) NSSMS\_P decomposes the NetworkSliceSubnet MOI modification request into modification requests for each constituent MOIs.

4a) NSSMS\_P invokes procedure of network slice subnet instance modification for each constituent NetworkSliceSubnet MOI(s) that is configured in attribute networkSliceSubnetRef of the NetworkSliceSubnet MOI.

4b) For each constituent NF instance (ManagedFunction MOI DN that is configured in attribute of managedFunctionRef of NetworkSliceSubnet MOI), NSSMS\_P invokes procedure of NF instance creation as described in clause 7.10 or procedure of NF instance modification as described in clause 7.11.

4c) If the NetworkSliceSubnet MOI contains the virtualized part, NSSMS\_P invokes the NS instance scaling and/or NS instance updating and/or NS instance instantiation procedures. For the interaction with ETSI NFV MANO the procedures are described in ETSI GS NFV-IFA 013 [3].

4d) If the NetworkSliceSubnet MOI contains the TN part, NSSMS\_P invokes the corresponding procedure of coordination with relevant TN Manager to handle the TN part as described in clause 7.9.

5) NSSMS\_P updates NetworkSliceSubnet MOI attributes.

6a) If NSSMS\_P sent new network slice subnet related requirements in NetworkSliceSubnet MOI (in step 1a), then NSSMS\_P sends response for modifyMOIAttributes.

6b) If NSSMS\_C sent the new network slice subnet related requirements in NetworkSliceSubnetController MOI (in step 1b-1), then NSSMS\_P updates NetworkSliceSubnetController MOI attributes operationalState, administrativeState, availabilityStatus and processMonitor to indicate completion of the procedure.

## 7.8 Procedure of Obtaining Network Slice Subnet Management Service Producer Capability

### 7.8.1 Introduction

The clause illustrates possible procedures of obtaining network slice subnet capability information (e.g. supported maximum latency, supported capacity (e.g. maximum user number)) of network slice subnet instance(s) which can be provided by network slice subnet management service provider.

### 7.8.2 Querying Network Slice Subnet Capability Information

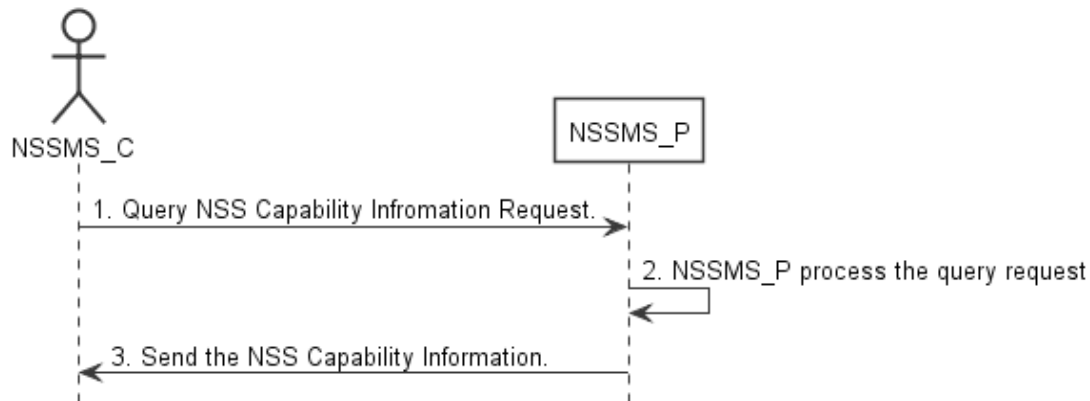

**Figure 7.8-2: Procedure of querying network slice subnet capability information**

- 1) Network Slice Subnet Management Service Consumer (NSSMS\_C) wants to query the NSS capability information of the NSSI(s) which can be provided by corresponding Network Slice Subnet Management Service Producer (NSSMS\_P). NSSMS\_C sends getMOIAttributes operation (defined in TS 28.532 [8]), for NetworkSliceSubnetProviderCapabilities IOC, to NSSMS\_P to obtain the NSS capability information of the NSSI(s) which can be provided by corresponding NSSMS\_P.
- 2) NSSMS\_P processes the NSS capability information querying request.
- 3) NSSMS\_P sends the NSS capability information (e.g. supported maximum latency, supported capacity (e.g. user number)) of NSSI(s) that can be provided by itself, as a response to getMOIAttributes operation (as defined in TS 28.532 [8]), to NSSMS\_C.

### 7.8.3 Void

## 7.9 Procedure of TN coordination supporting network slicing

### 7.9.1 Introduction

This clause describes procedures of coordination with TN Manager to handle TN part supporting network slicing.

**NOTE:** The present document: addresses interactions with NFVO as TN manager, interactions with other types of TN Manager (e.g. Optical, IP bearer transport network, etc.) have not been addressed.

### 7.9.2 Interaction with NFVO as TN Manager

This clause considers the procedure of interaction between the 3GPP management system and the NFVO, which behaves as TN Manager, to satisfy the TN related requirements for the virtual links used in NSSI. The procedure is applicable to creation and modification of the NSSI.

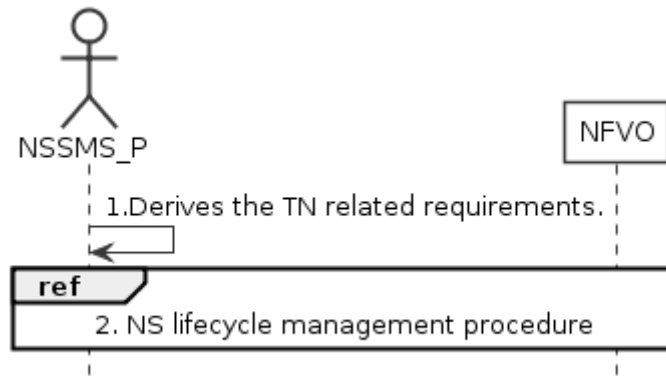
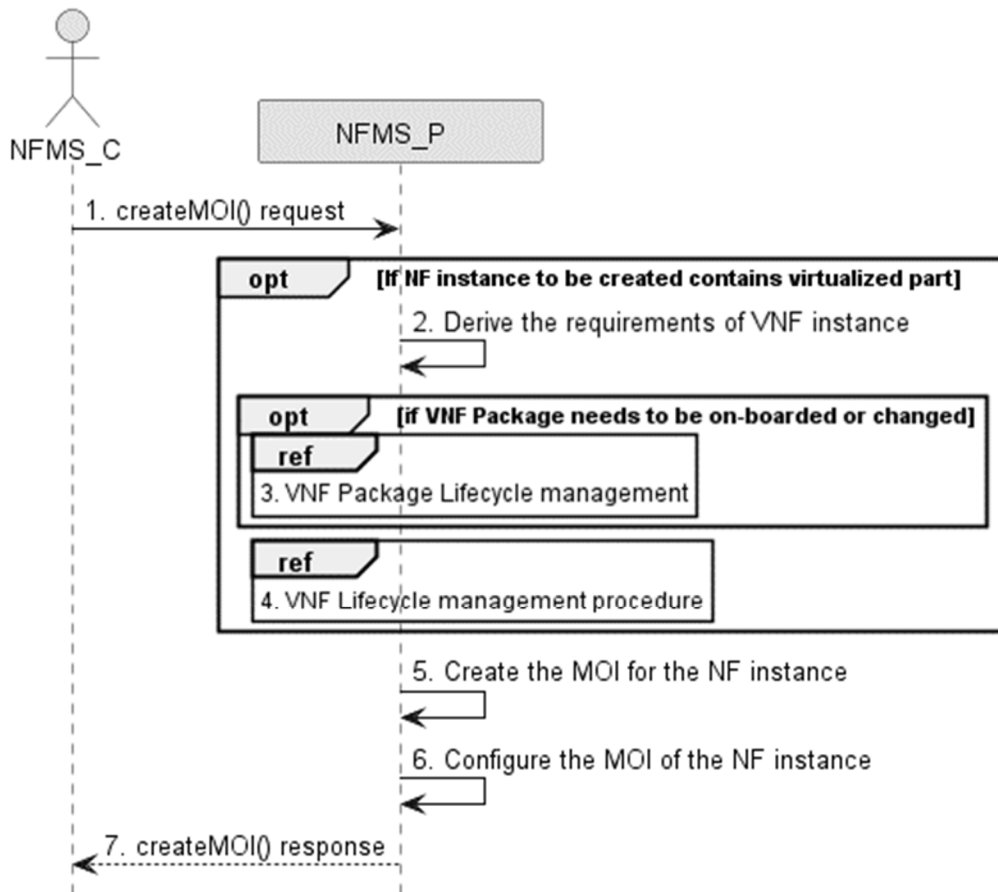

**Figure 7.9.2-1: Interaction with NFVO as TN manager to support network slicing**

- 1) Network Slice Subnet Management Service Provider (NSSMS\_P) derives the TN related requirements (e.g. 3GPP endpoint information, latency requirements, bandwidth requirements, isolation requirements) for the TN part to be used in the NSSI.
- 2) To satisfy the TN related requirements NSSMS\_P invokes the corresponding NS instance lifecycle management procedures as described in ETSI GS NFV-IFA 013 [3].
- 3) After the NFVO executes the requested operation, it sends the corresponding notification to the NSSMS\_P as described in ETSI GS NFV-IFA 013 [3].

## 7.10 Procedure of NF instance creation

The Figure 7.10-1 illustrates the procedure of creating a new network function instance to satisfy the required network function related requirements.



**Figure 7.10-1: Network Function Instance Creation procedure**

- 1) Network Function Management Service Provider (NFMS\_P) receives a createMOI, for ManagedFunction IOC, request from Network Function Management Service Consumer (NFMS\_C) with network function related requirements.

NOTE: The network function related requirements see information model definition for NR NRM in clause 4 and information model definition for 5GC NRM in clause 5 in TS 28.541[6].

- 2) If NF instance to be created contains virtualized part, NFMS\_P derives the requirements for VNF instance based on the network function related requirements.
- 3) If corresponding VNF Package needs to be on-boarded or changed, the NFMS\_P invoke corresponding VNF Package management. For the interaction with ETSI NFV MANO, the procedure is described in clause 7.7 in ETSI GS NFV-IFA013 [3]. The VNF package is compliant with ETSI GS NFV-IFA011 [14].
- 4) The NFMS\_P invokes VNF lifecycle management. For the interaction with ETSI NFV MANO, the procedure is as described in clause 7.3.5 (Update NS operation) in ETSI GS NFV-IFA013 [3] or clause 7.2.2 (Create VNF Identifier operation) and clause 7.2.3 (Instantiate VNF operation) in ETSI GS NFV-IFA008 [15].
- 5) The NFMS\_P creates the MOI for the ManagedFunction to be created. If the ManagedFunction contains virtualized part, the NFMS\_P may send the request of creating the MOI to the NFMS\_P in the ManagedFunction.
- 6) The NFMS\_P configures the new created MOI with corresponding configuration information (see information model definition for NR NRM in clause 4 and information model definition for 5GC NRM in clause 5 in TS 28.541[6]).
- 7) The NFMS\_P sends the createMOI response to NFMS\_C with DN of MOI for ManagedFunction.

## 7.11 Procedure of NF instance modification

The Figure 7.11-1 illustrates the procedure of modify NF instance.

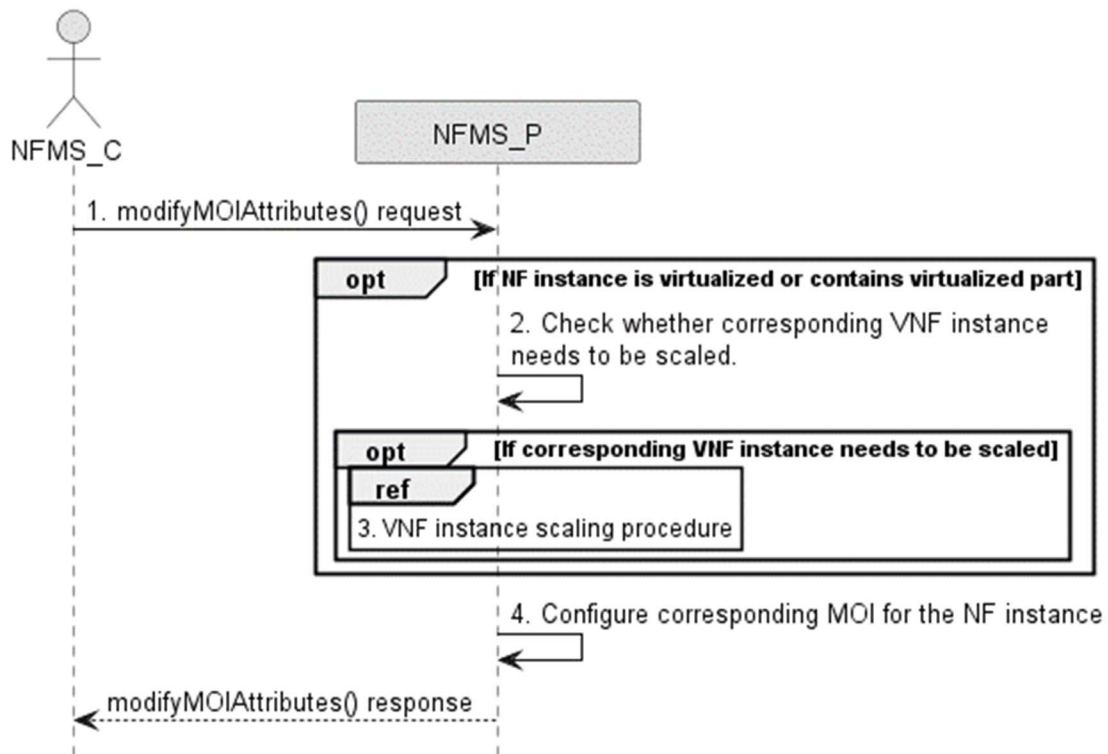

**Figure 7.11-1: Network Function Instance Modify procedure**

- 1) Network Function Management Service Provider (NFMS\_P) receives a modifyMOIAttributes operation defined in TS 28.532 [8] from Network Function Management Service Consumer (NFMS\_C) with DN of MOI for ManagedFunction and network function related requirements.

NOTE: The network function related requirements see information model definition for NR NRM in clause 4 and information model definition for 5GC NRM in clause 5 in TS 28.541[6].

- 2) If ManagedFunction instance contains virtualized part, NFMS\_P checks whether corresponding VNF instance needs to be scaled to satisfy the network function related requirements.
- 3) If corresponding VNF instance needs to be scaled, NFMS\_P invokes corresponding VNF instance scaling procedure. For the interaction with ETSI NFV MANO, the procedure is described in clause 7.2.4 in ETSI GS NFV-IFA008 [15] or clause 7.3.4 in ETSI GS NFV-IFA013 [3].
- 4) NFMS\_P reconfigures corresponding ManagedFunction MOI.
- 5) The NFMS\_P sends the response (see modifyMOIAttributes operation defined in TS 28.532 [8]) to NFMS\_C.

## 7.12 Procedure of NF instance deletion

The Figure 7.12-1 illustrates the procedure of deleting NF instance.

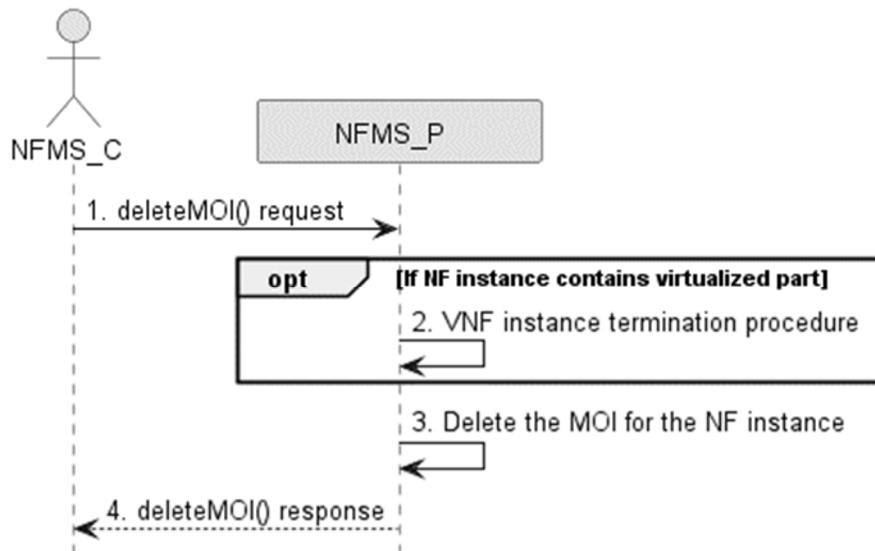

**Figure 7.12-1: Network Function Instance Deletion procedure**

- 1) Network Function Management Service Provider (NFMS\_P) receives deleteMOI from Network Function Management Service Consumer (NFMS\_C) with DN of ManagedFunction MOI.
- 2) If the ManagedFunction instance contains virtualized part, NFMS\_P invokes VNF instance termination procedure. For the interaction with ETSI NFV MANO, the procedure is with ETSI NFV MANO as described in clause 7.2.7 (Terminate VNF operation) and clause 7.2.8 (Delete VNF Identifier operation) in ETSI GS NFV-IFA008 [15] or clause 7.3.5 (Update NS operation) in ETSI GS NFV-IFA013 [3].
- 3) NFMS\_P deletes the ManagedFunction MOI.
- 4) NFMS\_P sends the response (see deleteMOI operation defined in TS 28.532 [8]) to NFMS\_C.

### 7.13 Procedure of feasibility check and reservation of NSI

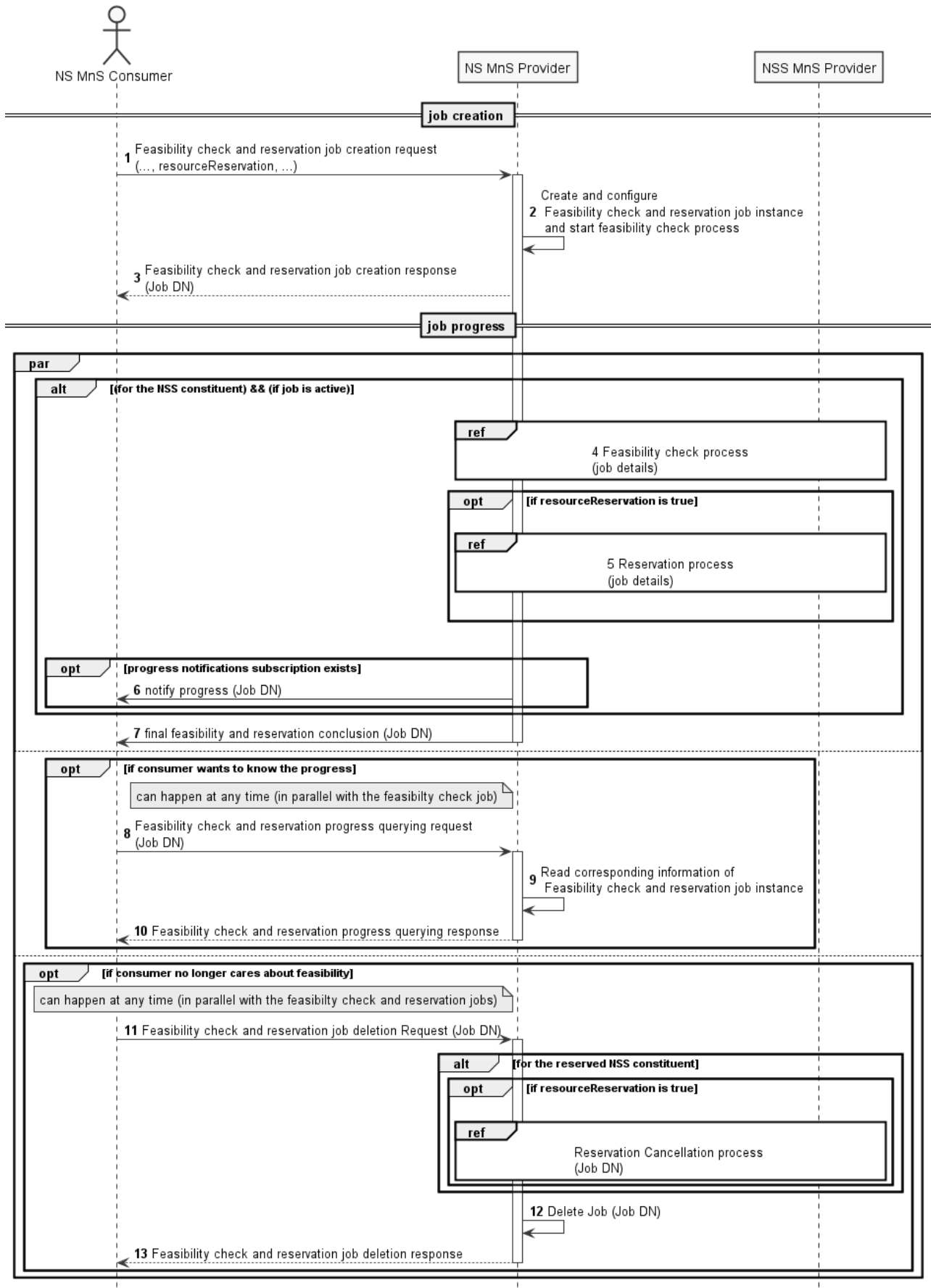



**Figure 7.13-1 Network slice feasibility check and reservation procedure**

- 1) Network Slice Management Service Provider (NS MnS Provider) receives a feasibility check with or without reservation job creation request (see createMOI operation defined in TS 28.532 [8]) from Network Slice Management Service Consumer (NS MnS Consumer) with feasibility check and reservation requirements (including serviceProfile, resourceReservation, recommendationRequest, requestedReservationExpiration and feasibilityTimeWindow of FeasibilityCheckAndReservationJob IOC defined in TS 28.541 [6]). The request is to check whether the network slice related requirements (i.e., ServiceProfile) can be satisfied and optionally be requested to be reserved. The resourceReservation attribute in the request may indicate whether reservation is also requested or not.
- 2) NS MnS Provider creates the FeasibilityCheckAndReservationJob instance and configures the attribute "ServiceProfile" and other attributes received from the request and NS MnS Provider starts executing the feasibility check process.
- 3) NS MnS Provider sends the feasibility check and reservation job creation response with the DN of the FeasibilityCheckAndReservationJob instance (see createMOI operation defined in TS 28.532 [8]) to NS MnS Consumer.
- 4) NS MnS Provider performs feasibility check locally on whether the resources are available.  
  
NS MnS Provider may invoke the feasibility check and reservation procedure for the constituent network slice subnet as described in clause 7.14
- 5) NS MnS Provider performs resource reservation process when resourceReservation is True and feasibilityResult is feasible.
- 6) The NS MnS Consumer may subscribe for the attribute value change notifications for this specific job or for any of the job(s) created by it to receive any asynchronous job progress notifications for those job(s). NS MnS Provider then sends the asynchronous job progress notification for feasibility check and reservation process with processMonitor attributes.
- 7) NS MnS Provider sends the final notification with the feasibility check and reservation status (including feasibilityResult, inFeasibleReason, resourceReservationStatus, reservationFailureReason, reservationExpiration and recommendedRequirements of FeasibilityCheckAndReservationJob IOC in TS 28.541 [6]).
- 8-10) Once after step 3, NS MnS Consumer can send query request to NS MnS Provider any time, to know the feasibility check and reservation job status and receive the feasibility check and reservation job status.
- 11-13) NS MnS consumer can request to delete the feasibility check and reservation job any time and the NS MnS Provider deletes the Job and sends the Job deletion response. NS MnS Provider will cancel the resource reservation when the feasibility check and reservation job is deleted.

## 7.14 Procedure of feasibility check and reservation of network slice subnet

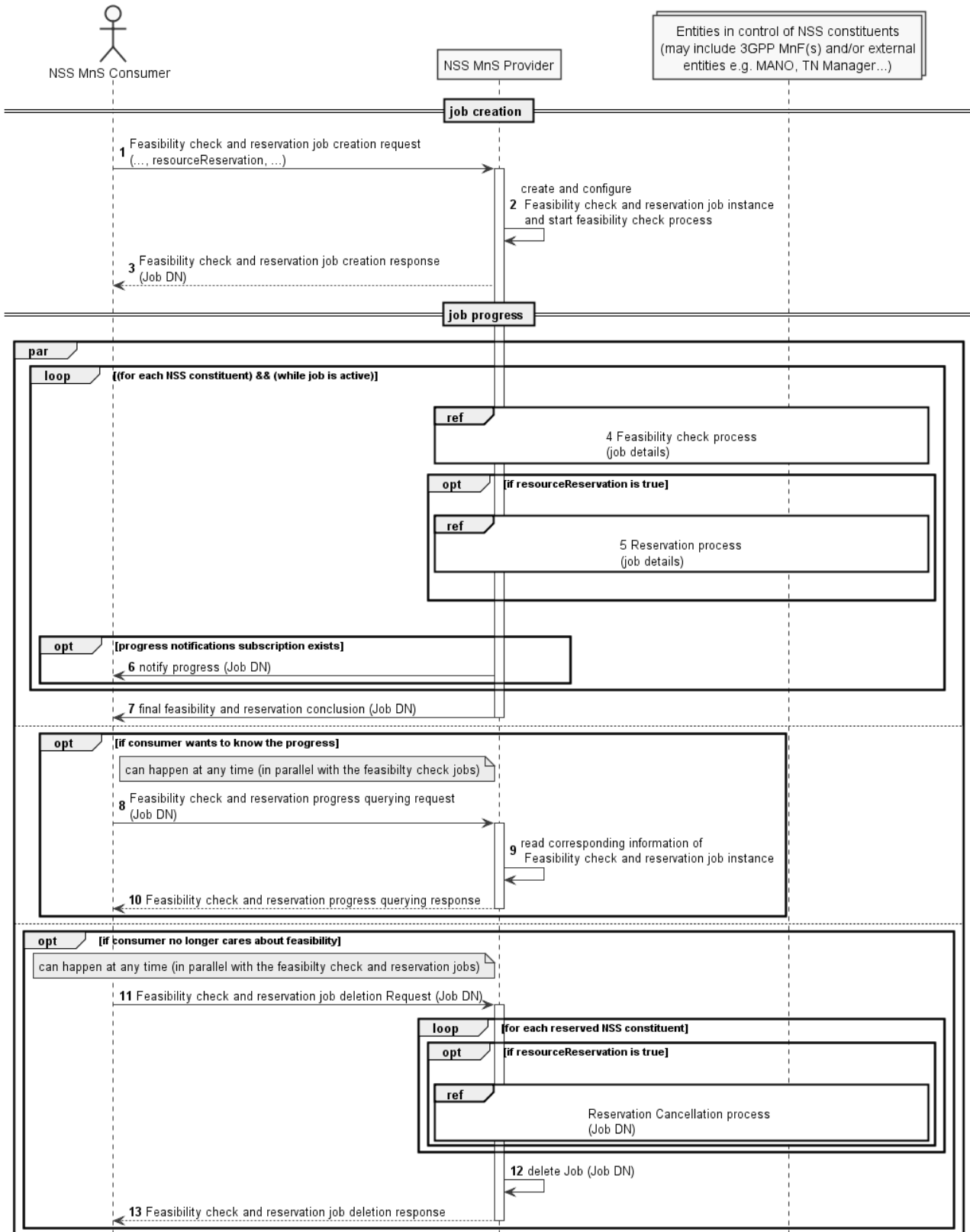

Figure 7.14-2 Network slice subnet feasibility check and reservation procedure

- 1) Network Slice Subnet Management Service Provider (NSS MnS Provider) receives a feasibility check with or without reservation job creation request (see createMOI operation defined in TS 28.532 [8]) from Network Slice Subnet Management Service Consumer (NSS MnS Consumer) with feasibility check and reservation requirements (including sliceProfile, resourceReservation, recommendationRequest, requestedReservationExpiration and feasibilityTimeWindow defined in FeasibilityCheckAndReservationJob IOC defined in TS 28.541 [6]). The request is to check whether the network slice subnet related requirements (i.e. SliceProfile) can be satisfied and optionally be requested to be reserved. The resourceReservation attribute in the request may indicate whether reservation is also requested or not.
- 2) NSS MnS Provider creates the FeasibilityCheckAndReservationJob instance and configures the attribute "SliceProfile" and other attributes received from the request and NSS MnS Provider starts executing the feasibility check process.
- 3) NSS MnS Provider sends the feasibility check and reservation job creation response for the received DN of theFeasibilityCheckAndReservationJob (see createMOI operation defined in TS 28.532 [8]) requests to NSS MnS Consumer.
- 4) NSS MnS Provider performs feasibility check locally (e.g 3GPP MnFs) on whether the resources are available.  
  
NSS MnS Provider may optionally perform feasibility check with other entities in control of the network slice subnet constituents (e.g., MANO, TN Manager) of the network slice subnet.
- 5) NSS MnS Provider performs resource reservation process when resourceReservation is True and feasibilityResult is feasible.
- 6) The NSS MnS Consumer may subscribe for the attribute value change notifications for this specific job or for any of the job(s) created by it to receive any asynchronous job progress notifications for those job(s). NSS MnS Provider then sends the asynchronous job progress notification for feasibility check and reservation process with processMonitor attributes.
- 7) NSS MnS Provider sends the final notification with the feasibility check and reservation status (including feasibilityResult, inFeasibleReason, resourceReservationStatus, reservationFailureReason, reservationExpiration and recommendedRequirements defined in FeasibilityCheckAndReservationJob IOC in TS 28.541 [6]).
- 8-10) Once after step 3, NSS MnS Consumer can send query request to NSS MnS Provider any time, to know the feasibility check and reservation job status and receive the feasibility check and reservation job status.
- 11-13) NSS MnS consumer can request to delete the feasibility check and reservation job any time and the NSS MnS Provider deletes the Job and sends the Job deletion response. NSS MnS Provider will cancel the resource reservation when the feasibility check and reservation job is deleted.

## 7.15 Void

## 7.16 Void

## 7.17 Procedure of management interaction with NFV MANO for network service priority

The Figure 7.17-1 illustrates the procedure of management interaction with NFV MANO for network service priority.

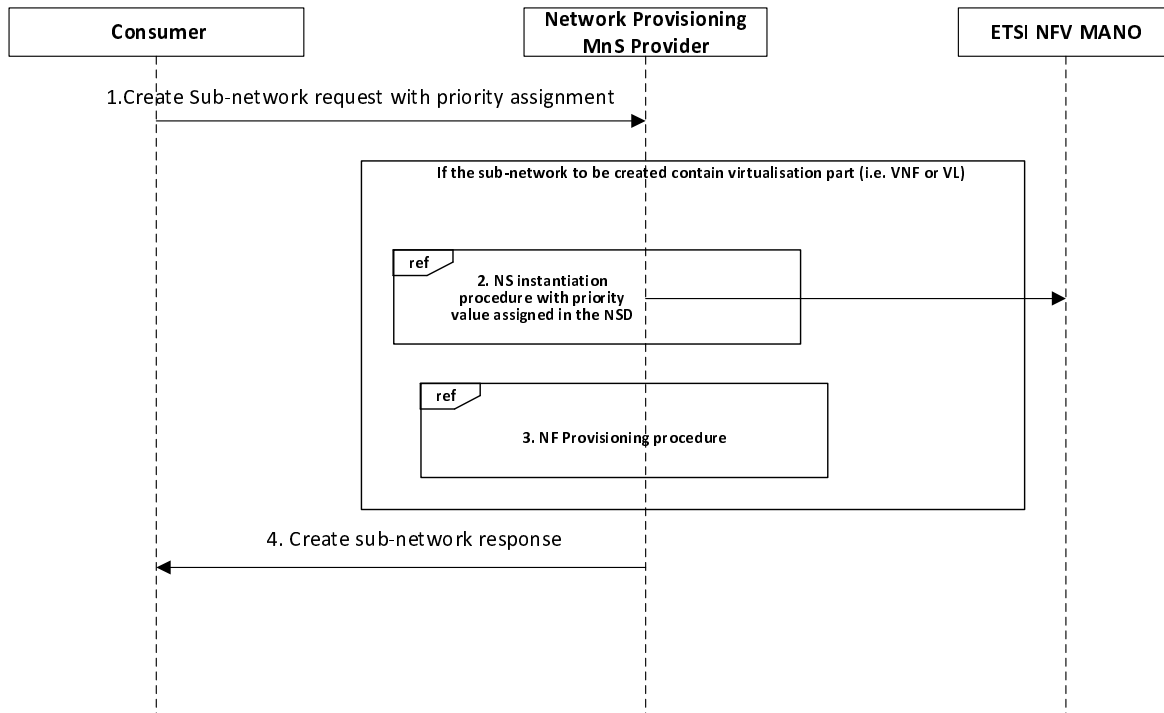

**Figure 17.1-1: Management interaction with NFV MANO**

1. Network provisioning management service provider receives a CreateMOI request for SubNetwork IOC from a consumer. In the request, the priority is assigned by providing the value to the priorityLabel attribute.
2. If the sub-network to be created contains virtualisation part (i.e. VNF or VL), Network provisioning management service provider chooses a proper NSD deployment flavour with appropriate priority (see clause 6.3.2.2 in ETSI GS NFV-IFA 014 [12] ) according to the value of priorityLabel attribute in the CreateMOI request. Network provisioning management service provider invokes the NS instantiation procedures to create a NS instance.

Note: NS instantiation procedure is described in clause 7.3.3 in ETSI GS NFV-IFA 013 [3].

3. For each constituent NF, Network provisioning management service provider invokes NF Creation Procedure as described in clause 7.10.
4. The Network provisioning management service provider sends the response to the consumer with DN of MOI for the created sub-network.

## 7.18 Procedure for Network slice instance activation

The Figure 7.18-1 illustrates the procedure for network slice instance activation.

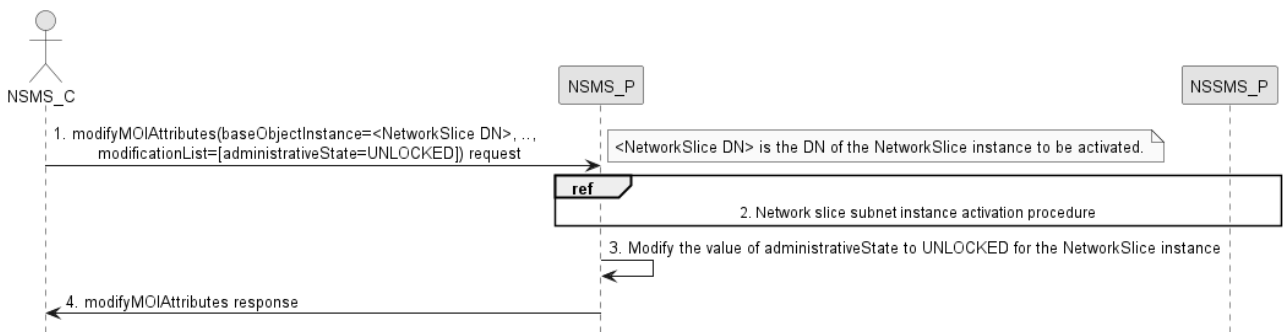
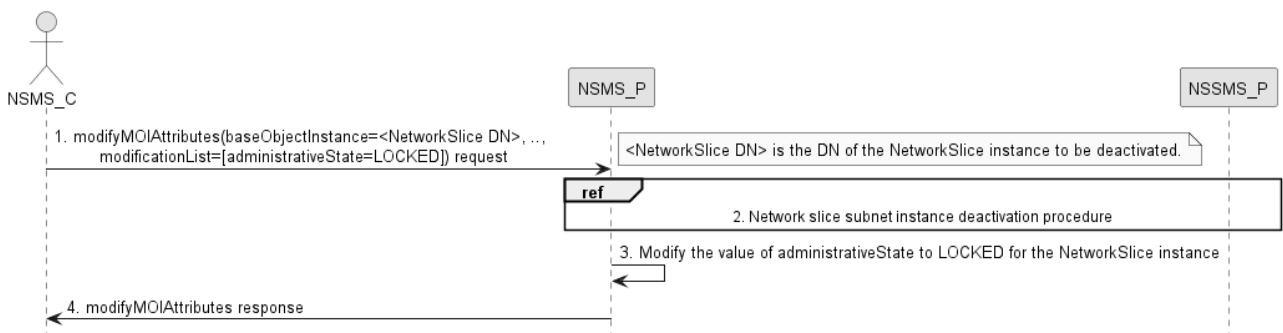

**Figure 7.18-1: Network slice instance activation**

1. Network Slice Management Service Provider (NSMS\_P) receives a modifyMOIAttributes operation (defined in TS 28.532 [8]) from Network Slice Management Service Consumer (NSMS\_C) with the DN of NetworkSlice instance and the new value of UNLOCKED for the administrative state (see NetworkSlice IOC and administrativeState attribute defined in clause 6.3.1 in TS 28.541[6]).
2. NSMS\_P, as the role of Network Slice Subnet Management Service Consumer (NSSMS\_C), invokes the network slice subnet instance activation procedure.
3. NSMS\_P modifies the value of the administrative state attribute of the NetworkSlice instance.
4. NSMS\_P sends network slice instance administrative state attribute modification result (see modifyMOIAttributes operation defined in TS 28.532 [8]) to NSMS\_C.

## 7.19 Procedure for Network slice instance deactivation

The Figure 7.19-1 illustrates the procedure for network slice instance deactivation.

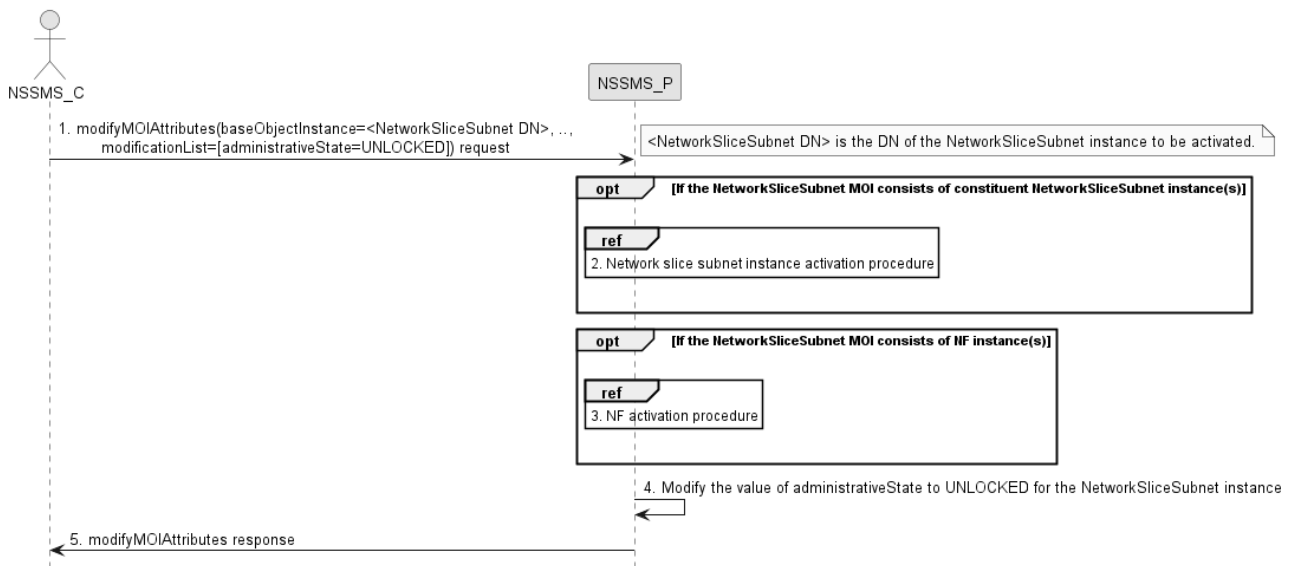

**Figure 7.19-1: Network slice instance deactivation**

1. Network Slice Management Service Provider (NSMS\_P) receives a modifyMOIAttributes operation (defined in TS 28.532 [8]) from Network Slice Management Service Consumer (NSMS\_C) with the DN of NetworkSlice instance and the new value of LOCKED for the administrative state (see NetworkSlice IOC and administrativeState attribute defined in clause 6.3.1 in TS 28.541[6]).
2. NSMS\_P, as the role of Network Slice Subnet Management Service Consumer (NSSMS\_C), invokes the Network slice subnet instance deactivation procedure.
3. NSMS\_P modifies the value of the administrative state attribute of the NetworkSlice instance.
4. NSMS\_P sends network slice instance administrative state attribute modification result (see modifyMOIAttributes operation defined in TS 28.532 [8]) to NSMS\_C.

## 7.20 Procedure for Network slice subnet instance activation

The Figure 7.20-1 illustrates the procedure for network slice subnet instance activation.

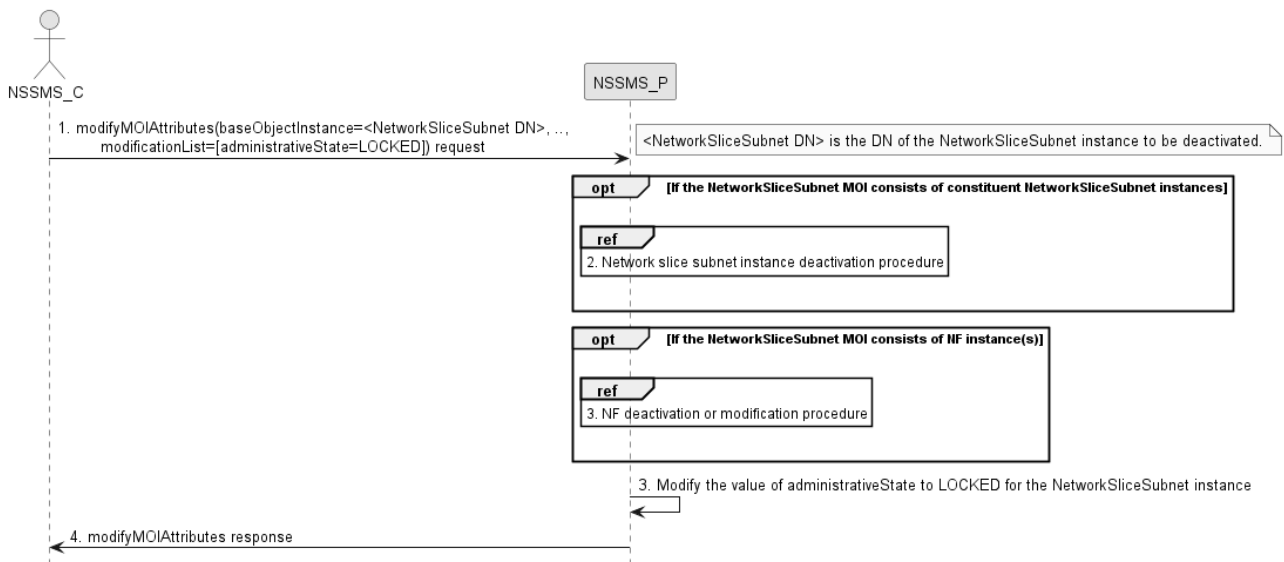

**Figure 7.20-1: Network slice subnet instance activation**

1. Network Slice Subnet Management Service Provider (NSSMS\_P) receives a modifyMOIAttributes operation (defined in TS 28.532 [8]) from Network Slice Subnet Management Service Consumer (NSSMS\_C) with the DN of NetworkSliceSubnet instance and the new value of UNLOCKED for the administrative state (see NetworkSliceSubnet IOC and administrativeState attribute defined in clause 6.3.2 in TS 28.541[6]).
2. If the network slice subnet instance consists of constituent network slice subnet instance(s), then NSSMS\_P, as the role of Network Slice Subnet Management Service Consumer (NSSMS\_C), invokes the network slice subnet instance activation procedure for the constituent network slice subnet instance(s).
3. If the network slice subnet instance consists of constituent is NF instance, then NSSMS\_P request the NF related provisioning management service provider to activate the NF (e.g., activate the NF in sleep mode, turn on the ports).
4. NSSMS\_P modifies the value of the administrative state attribute of the NetworkSliceSubnet instance.
5. NSSMS\_P sends network slice subnet instance administrative state attribute modification result (see modifyMOIAttributes operation defined in TS 28.532 [8]) to NSMS\_C.

## 7.21 Procedure for Network slice subnet instance deactivation

The Figure 7.21-1 illustrates the procedure for network slice subnet instance deactivation.



**Figure 7.21-1: Network slice subnet instance deactivation**

1. Network Slice Subnet Management Service Provider (NSSMS\_P) receives a modifyMOIAttributes operation (defined in TS 28.532 [8]) from Network Slice Subnet Management Service Consumer (NSSMS\_C) with the DN of NetworkSliceSubnet instance and the new value of LOCKED for the administrative state (see NetworkSliceSubnet IOC and administrativeState attribute defined in clause 6.3.2 in TS 28.541[6]).
2. If the network slice subnet instance consists of constituent network slice subnet instance(s), then NSSMS\_P, as the role of Network Slice Subnet Management Service Consumer (NSSMS\_C), invokes the network slice subnet instance deactivation procedure for the constituent network slice subnet instance(s).
3. If the network slice subnet instance consists of constituent is NF instance, then NSSMS\_P requests the NF related provisioning management service provider to either deactivate the NF (if it is dedicated for this network slice subnet instance and not being used by any other network slice subnet instance) or to modify the NF (if it is shared by other network slice subnet instance).
4. NSSMS\_P modifies the value of the administrative state attribute of the NetworkSliceSubnet instance.
5. NSSMS\_P sends network slice subnet instance administrative state attribute modification result (see modifyMOIAttributes operation defined in TS 28.532 [8]) to NSMS\_C.

## 8 Void

## 9 RESTful HTTP-based solution set of provisioning

### 9.1 Network slice provisioning management service

#### 9.1.1 Mapping of operations

##### 9.1.1.1 Introduction

**Table 9.1.1.1-1: Mapping of IS operations to SS equivalents**

IS operation	HTTP Method	Resource URI	S
allocateNsi	POST	{MnSRoot}/NSProvMnS/{MnSVersion}/ServiceProfiles	M
deallocateNsi	DELETE	{MnSRoot}/NSProvMnS/{MnSVersion}/ServiceProfiles/{ServiceProfileId}	M

##### 9.1.1.2 Operation allocateNsi

This operation is to allocate a network slice instance provided by the service provider, the network slice instance may be new or existing.

**Table 9.1.1.2-1: Mapping of IS operation input parameters to SS equivalents (HTTP POST)**

IS operation parameter name	SS parameter location	SS parameter name	SS parameter type	S
attributeListIn	request body	serviceProfile	ServiceProfile-Type	M

**Table 9.1.2-2: Mapping of IS operation output parameters to SS equivalents (HTTP POST)**

IS operation parameter name	SS parameter location	SS parameter name	SS parameter type	S
serviceProfileId	location header	n/a	ServiceProfileId-Type (uri-Type)	M
status	response status codes	n/a	n/a	M
	response body	error	ErrorResponse	O

The message flow for allocation is as follows:

1. The MnS consumer sends a HTTP POST request to the MnS producer.
  - The target URI is equal to the concatenation of URI of the parent resource of resource to be created, and the resource (in this case ServiceProfile) to be created.
  - The message body shall carry the complete representation of the resource to be created. The resource identifier shall be absent or carry null semantics.
2. The MnS producer sends a HTTP POST response to the MnS consumer.
  - On success, "201 Created" shall be returned. The Location header shall carry the URI of the new resource (in this case ServiceProfile).
  - On failure, an appropriate error code shall be returned. The response message body may provide additional error information.



### 9.1.1.3 Operation deallocateNsi

This operation deallocates a service profile from an NSI (delete the ServiceProfile resource). The provider may terminate the requested NSI or modify the requested NSI without termination to satisfy the request.

**Table 9.1.1.3-1: Mapping of IS operation input parameters to SS equivalents (HTTP DELETE)**

IS operation parameter name	SS parameter location	SS parameter name	SS parameter type	S
networkSliceDN	path query	n/a	Resource	M
serviceProfileId	path	/ServiceProfiles/{ServiceProfileId}	ServiceProfileId-Type (uri-Type)	M

**Table 9.1.1.3-2: Mapping of IS operation output parameters to SS equivalents (HTTP DELETE)**

IS operation parameter name	SS parameter location	SS parameter name	SS parameter type	S
status	response status codes	n/a	n/a	M
	response body	error	ErrorResponseDefault	O

The message flow for deallocation is as follows:

1. The MnS consumer sends a HTTP DELETE request to the MnS producer.
  - The target URI is equal to the concatenation of URI of the resource (in this case ServiceProfile) to be deleted.
  - The URI query part shall contain the networkSliceDN identifying the NetworkSlice MOI.
2. The MnS producer sends a HTTP DELETE response to the MnS consumer.
  - On success, "204 No content" shall be returned.
  - On failure, an appropriate error code shall be returned. The response message body may provide additional error information.

## 9.1.2 Resources

### 9.1.2.0 Resource structure

Figure 9.1.2.0-1 shows the resource structure of the network slice provisioning MnS.

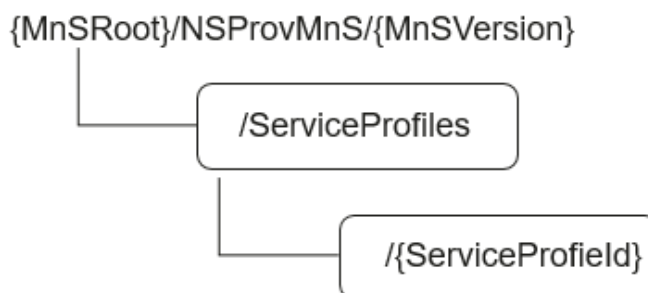

Figure 9.1.2.0-1 resource structure of the network slice provisioning MnS

Table 9.1.2.0-1 provides an overview of the resources and applicable HTTP methods.

**Table 9.1.2.0-1: Resources and methods overview**

Resource name	Resource URI	HTTP method	Description
ServiceProfiles	.../ServiceProfiles	POST	Create a new ServiceProfile resource
ServiceProfile	.../ServiceProfiles/{ServiceProfileId}	DELETE	Delete a ServiceProfile resource

### 9.1.2.1 Resource definitions

#### 9.1.2.1.1 Resource ".../ServiceProfiles

##### 9.1.2.1.1.1 Description

This resource represents collects of network slice related requirement (i.e. ServiceProfiles).

##### 9.1.2.1.1.2 URI

Resource URI: {MnSRoot}/NSProvMnS/{MnSVersion}/ServiceProfiles

The resource URI variables are defined in table 9.1.2.1.1.2-1.

**Table 9.1.2.1.1.2-1: URI variables**

Name	Definition
MnSRoot	See clause 4.4.2 of TS 32.158 [17]
MnSVersion	See clause 4.4.2 of TS 32.158 [17]

##### 9.1.2.1.1.3 HTTP methods

##### 9.1.2.1.1.3.1 POST

The POST method create a serviceProfile, the provider may create a NSI or using existing NSI to satisfy the serviceProfile.

This method shall support the URI query parameters specified in the following table.

**Table 9.1.2.1.1.3.1-1: URI query parameters supported by the POST method on this resource**

Name	Data type	Description	S
n/a	n/a	n/a	n/a

This method shall support the request data structures, the response data structures and response codes specified in the following table.

**Table 9.1.2.1.1.3.1-2: Data structures supported by the POST Request Body on this resource**

Data type	Description	S
serviceProfile-Type	The resource representation of the set of information about ServiceProfile to be posted.	M

**Table 9.1.2.1.1.3.1-3: Data structures supported by the POST Response Body on this resource**

Data type	Response codes	Description	S
serviceProfileId-Type	201 Posted	Unique ServiceProfileId assigned by the MnS producer	M
ErrorResponseDefault	4xx/5xx	Returned in case of an error	O

9.1.2.1.2 Resource “../ServiceProfiles/{ServiceProfileId}”

9.1.2.1.2.1 Description

This resource represents a network slice related requirement (i.e. ServiceProfile).

9.1.2.1.2.2 URI

Resource URI: {MnSRoot}/NSProvMnS/{MnSVersion}/ServiceProfiles/{ServiceProfileId}

The resource URI variables are defined in table 9.1.2.1.2.2-1.

**Table 9.1.2.1.2.2-1: URI variables**

Name	Definition
MnSRoot	See clause 4.4.2 of TS 32.158 [17]
MnSVersion	See clause 4.4.2 of TS 32.158 [17]

9.1.2.1.2.3 HTTP methods

9.1.2.1.2.3.1 DELETE

The DELETE method deletes a ServiceProfile.

This method shall support the URI query parameters specified in the following table.

**Table 9.1.2.1.2.3.1-1: URI query parameters supported by the DELETE method on this resource**

Name	Data type	Description	S
networkSliceDN	DN (string)	The DN of NetworkSlice MOI uniquely identifying the network slice instance	M

This method shall support the request data structures, the response data structures and response codes specified in the following table.

**Table 9.1.2.1.2.3.1-2: Data structures supported by the DELETE Request Body on this resource**

Data type	Description	S
n/a	n/a	n/a

**Table 9.1.2.1.2.3.14-3: Data structures supported by the DELETE Response Body on this resource**

Data type	Response codes	Description	SQ
n/a	204 No Content	In case of success no message body is returned	M
ErrorResponseDefault	4xx/5xx	Returned in case of an error	O

## 9.2 Network slice subnet provisioning management service

### 9.2.1 Mapping of operations

#### 9.2.1.1 Introduction

**Table 9.2.1.1-1: Mapping of IS operations to SS equivalents**

IS operation	HTTP Method	Resource URI	S
allocateNssi	POST	{MnSRoot}/NSSProvMnS/{MnSVersion}/SliceProfiles	M
deallocateNssi	DELETE	{MnSRoot}/NSSProvMnS/{MnSVersion}/SliceProfiles/{SliceProfileId}	M

#### 9.2.1.2 Operation allocateNssi

This operation is to allocate a network slice subnet instance provided by the service provider, the network slice subnet instance may be new or existing.

**Table 9.2.1.2-1: Mapping of IS operation input parameters to SS equivalents (HTTP POST)**

IS operation parameter name	SS parameter location	SS parameter name	SS parameter type	S
attributeListIn	request body	sliceProfile	SliceProfile-Type	M

**Table 9.2.1.2-2: Mapping of IS operation output parameters to SS equivalents (HTTP POST)**

IS operation parameter name	SS parameter location	SS parameter name	SS parameter type	S
sliceProfileId	Location header	n/a	ServiceProfileId-Type (uri-Type)	M
status	response status codes	n/a	n/a	M
	Response body	error	ErrorResponseDefault	O

The message flow for allocation is as follows:

1. The MnS consumer sends a HTTP POST request to the MnS producer.

- The target URI is equal to the concatenation of URI of the parent resource of resource to be created, and the resource (in this case SliceProfile) to be created.

- The message body shall carry the complete representation of the resource to be created. The resource identifier shall be absent or carry null semantics.
2. The MnS producer sends a HTTP POST response to the MnS consumer.
    - On success, "201 Created" shall be returned. The Location header shall carry the URI of the new resource (in this case SliceProfile).
    - On failure, an appropriate error code shall be returned. The response message body may provide additional error information.

### 9.2.1.3 Operation deallocateNssi

This operation deallocates slice profile fromn anNSSI (delete SliceProfile resource). The provider may terminate the requested NSSI or modify the requested NSSI without termination to satisfy the request.

**Table 9.2.1.3-1: Mapping of IS operation input parameters to SS equivalents (HTTP DELETE)**

IS operation parameter name	SS parameter location	SS parameter name	SS parameter type	S
networkSliceSubnetDN	path query	n/a	Resource	M
sliceProfileId	path	/SliceProfies/{SliceProfileId}	SliceProfileId-Type (uri-Type)	M

**Table 9.2.1.3-2: Mapping of IS operation output parameters to SS equivalents (HTTP DELETE)**

IS operation parameter name	SS parameter location	SS parameter name	SS parameter type	S
status	response status codes	n/a	n/a	M
	response body	error	ErrorResponseDefault	O

The message flow for deallocation is as follows:

1. The MnS consumer sends a HTTP DELETE request to the MnS producer.
  - The target URI is equal to the concatenation of URI of the resource (in this case SliceProfile) to be deleted.
  - The URI query part shall contain the networkSliceSubnetDN identifying the NetworkSliceSubnet MOI.
2. The MnS producer sends a HTTP DELETE response to the MnS consumer.
  - On success, "204 No content" shall be returned.
  - On failure, an appropriate error code shall be returned. The response message body may provide additional error information.

## 9.2.2 Resources

### 9.2.2.0 Resource structure

Figure 9.2.2.0-1 shows the resource structure of the network slice subnet provisioning MnS.

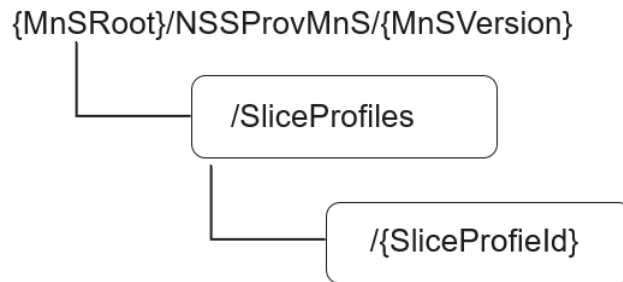

Figure 9.2.2.0-1 resource structure of the network slice subnet provisioning MnS

Table 9.2.2.0-1 provides an overview of the resources and applicable HTTP methods.

**Table 9.2.2.0-1: Resources and methods overview**

Resource name	Resource URI	HTTP method	Description
SliceProfiles	.../SliceProfies	POST	Create a new SliceProfile resource
SliceProfile	.../SliceProfiles/{SliceProfileId}	DELETE	Delete a SliceProfile resource

### 9.2.2.1 Resource definitions

#### 9.2.2.1.1 Resource “.../SliceProfiles

##### 9.2.2.1.1.1 Description

This resource represents collects of network slice subnet related requirements (i.e. SliceProfile).

##### 9.2.2.1.1.2 URI

Resource URI: {MnSRoot}/NSSProvMnS/{MnSVersion}//SliceProfile

The resource URI variables are defined in table 9.2.2.1.1.2-1.

**Table 9.2.2.1.1.2-1: URI variables**

Name	Definition
MnSRoot	See clause 4.4.2 of TS 32.158 [17]
MnSVersion	See clause 4.4.2 of TS 32.158 [17]

##### 9.2.2.1.1.3 HTTP methods

###### 9.2.2.1.1.3.1 POST

The POST method creates a SliceProfile, the provider may create a new NSSI or using existing NSSI that is eligible for it, to support the SliceProfile.

This method shall support the URI query parameters specified in the following table.

**Table 9.2.2.1.1.3.1-1: URI query parameters supported by the POST method on this resource**

Name	Data type	Description	S
n/a	n/a	n/a	n/a

This method shall support the request data structures, and the response data structures and response codes specified in the following tables.

**Table 9.2.2.1.1.3.1-2: Data structures supported by the POST Request Body on this resource**

Data type	Description	S
sliceProfile-Type	The resource representation of the set of information about SliceProfile to be posted.	M

**Table 9.2.2.1.1.3.1-2: Data structures supported by the POST Response Body on this resource**

Data type	Response codes	Description	S
sliceProfileId-Type	201 Posted	Unique SliceProfileId assigned by the MnS producer	M
ErrorResponseDefault	4xx/5xx	Returned in case of an error	O

### 9.2.2.1.2 Resource ".../SliceProfiles/{SliceProfileId}"

#### 9.2.2.1.2.1 Description

This resource represents a network slice subnet related requirement (i.e. SliceProfile).

#### 9.2.2.1.2.2 URI

Resource URI: {MnSRoot}/NSProvMnS/{MnSVersion}/SliceProfiles/{SliceProfileId}

The resource URI variables are defined in table 9.2.2.1.2.2-1.

**Table 9.2.2.1.2.2-1: URI variables**

Name	Definition
MnSRoot	See clause 4.4.2 of TS 32.158 [Y]
MnSVersion	See clause 4.4.2 of TS 32.158 [Y]

#### 9.2.2.1.2.3 HTTP methods

##### 9.2.2.1.2.3.1 DELETE

The DELETE method deletes a SliceProfile.

This method shall support the URI query parameters specified in the following table.

**Table 9.2.2.1.2.3.1-1: URI query parameters supported by the DELETE method on this resource**

Name	Data type	Description	S
networkSliceSubnetDN	DN (string)	The DN of NetworkSliceSubnet MOI uniquely identifying the network slice subnet instance	M

This method shall support the request data structures, and the response data structures and response codes specified in the following tables.

**Table 9.2.2.1.2.3.1-2: Data structures supported by the DELETE Request Body on this resource**

Data type	Description	S
n/a	n/a	n/a

**Table 9.2.2.1.2.3.1-3: Data structures supported by the DELETE Response Body on this resource**

Data type	Response codes	Description	SQ
n/a	204 No Content	In case of success no message body is returned	M
ErrorResponseDefault	4xx/5xx	Returned in case of an error	O

---

## 10 OpenAPI specification

### 10.1 OpenAPI document for network slice provisioning MnS

The OpenAPI/YAML definitions for network slice provisioning MnS are specified in 3GPP Forge , refer to clause 4.3 (OpenAPI Definitions) of TS 28.623 [16] for the Forge location. An example of Forge location is: "[https://forge.3gpp.org/rep/sa5/MnS/-/tree/Tag\\_Rel18\\_SA104/](https://forge.3gpp.org/rep/sa5/MnS/-/tree/Tag_Rel18_SA104/)".

Directory: OpenAPI

File: TS28531\_NSProvMnS.yaml

### 10.2 OpenAPI document for network slice subnet provisioning MnS

The OpenAPI/YAML definitions for network slice subnet provisioning MnS are specified in 3GPP Forge , refer to clause 4.3 (OpenAPI Definitions) of TS 28.623 [16] for the Forge location. An example of Forge location is: "[https://forge.3gpp.org/rep/sa5/MnS/-/tree/Tag\\_Rel18\\_SA104/](https://forge.3gpp.org/rep/sa5/MnS/-/tree/Tag_Rel18_SA104/)".

Directory: OpenAPI

File: TS28531\_NSSProvMnS.yaml



# Annex A (informative): A network slice journey example

The Generic Slice Template (GST) ([9]) provides a standardized list of attributes that can be used to characterise different types of network slice. GST is generic and is not tied to any:

- Type of network slice
- Agreement between a Network Slice Customer (NSC) and a Network Slice Provider (NSP).

A Network Slice Type (NEST) is a GST filled with (ranges of) values. There may be two kinds of NESTs:

- Standardized NESTs (S-NEST), i.e. NESTs which character attributes are assigned (ranges of) values by SDOs, working groups, foras, etc. such as e.g. 3GPP, GSMA, 5GAA, 5G-ACIA, etc.;
- Private NESTs (P-NEST), i.e. NESTs which character attributes are assigned (ranges of) values by the Network Slice Providers, which are different from those assigned in S-NESTs.

Network Slice Providers can build their network slice product offering based on S-NESTs and/or their P-NESTs. For example, a Standardized Network Slice Type (S-NEST) NST-A, for which the attribute ‘Packet delay budget’ (see [x] – clause 3.4.26) value range is between 1 ms and 100 ms, is specified by 3GPP. Network Slice Provider Y may offer e.g. 3 products based on NST-A:

- Platinum NST-A based network slice product, where the attribute ‘Packet delay budget’ (see [x] – clause 3.4.26) value range is between 1 ms and 10 ms;
- Gold NST-A based network slice product, where the attribute ‘Packet delay budget’ (see [x] – clause 3.4.26) value range is between 11 ms and 50 ms;
- Silver NST-A based network slice product, where the attribute ‘Packet delay budget’ (see [x] – clause 3.4.26) value range is between 51 ms and 100 ms.

NSP Y’s customers can then order network slice instances from Y’s product catalog, as depicted by Figure A.1.

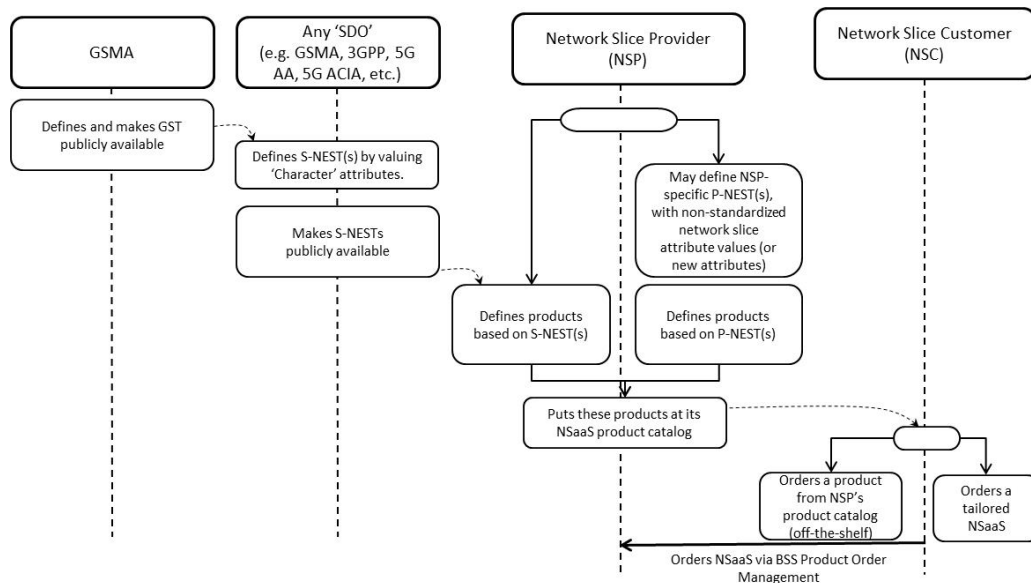

**Figure A.1: From GST to S-/(P-)NEST based product ordering**

- 1) A Network Slice Customer orders network slice instance to a Network Slice Provider, based on NSP’s product offering, by sending a request to NSP’ BSS
- 2) NSP’s BSS receives the request from NSC and translates NSC requirements into NSP technical parameter values

- 3) NSP's BSS sends a request to NSP's OSS to provide a network slice instance which fits NSC's requirements (see Table 6.1-1)
- 4) NSP's Network Slice Provisioning MnS either creates a new network slice instance or assigns an already existing network slice instance to NSC's request
- 5) NSP's Network Slice Provisioning MnS may have to request the Network Slice Subnet Provisioning MnS to provide a network slice subnet instance corresponding to the network slice instance (see Table 6.2-1)
- 6) NSP's Network Slice Subnet Provisioning MnS may have to create one or more inner network slice subnet instances
- 7) NSP's Network Function Provisioning MnS configures VNFs and/or PNFs (see Table 6.3-1).

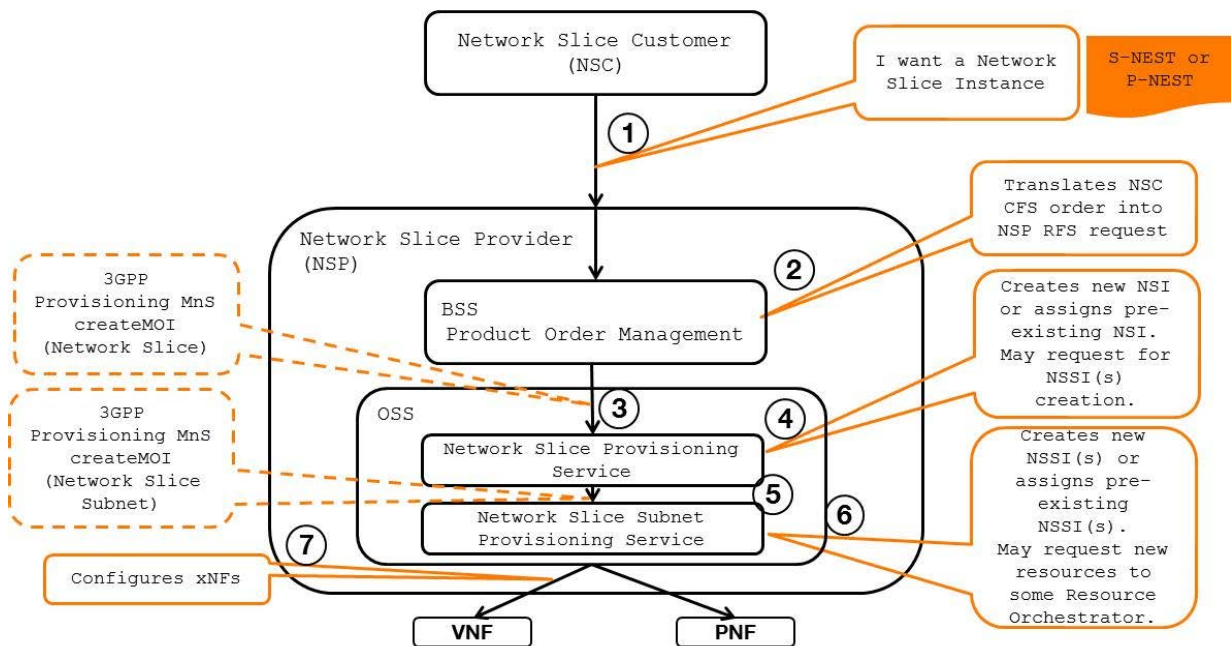

Figure A.2: Network Slice journey (NSaaS model) – high-level call flow

Depending on NSP's product offering, NSC can order network slice instances spanning one or more network domains, e.g.:

- network slice instances composed of a RAN-only network slice subnet instance

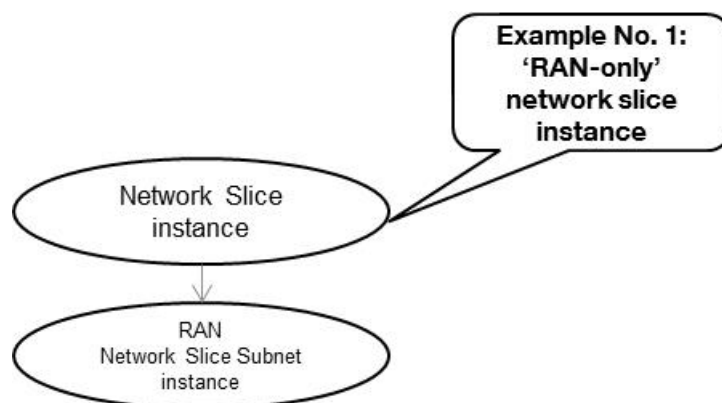
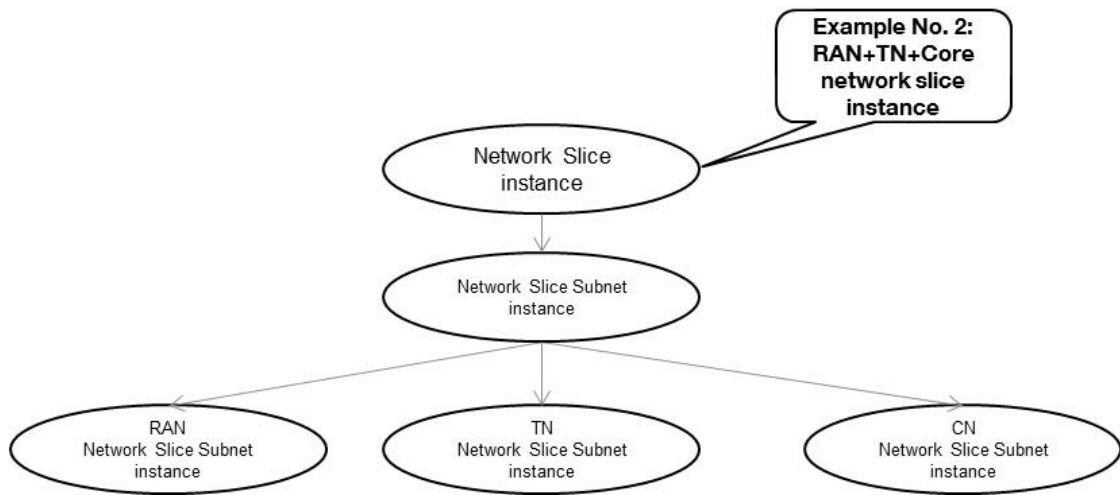

Figure A.3: RAN-only network slice subnet exposed as network slice

- network slice instances composed of a CN-only network slice subnet instance
- network slice instances composed of a RAN network slice subnet instance + Transport network slice subnet + CN network slice subnet instance



**Figure A.4: RAN+TN+CN network slice subnets exposed as network slice**

- network slice instances composed of a RAN network slice subnet instance + CN network slice subnet instance + IMS network slice subnet instance
- or more, as shown below..

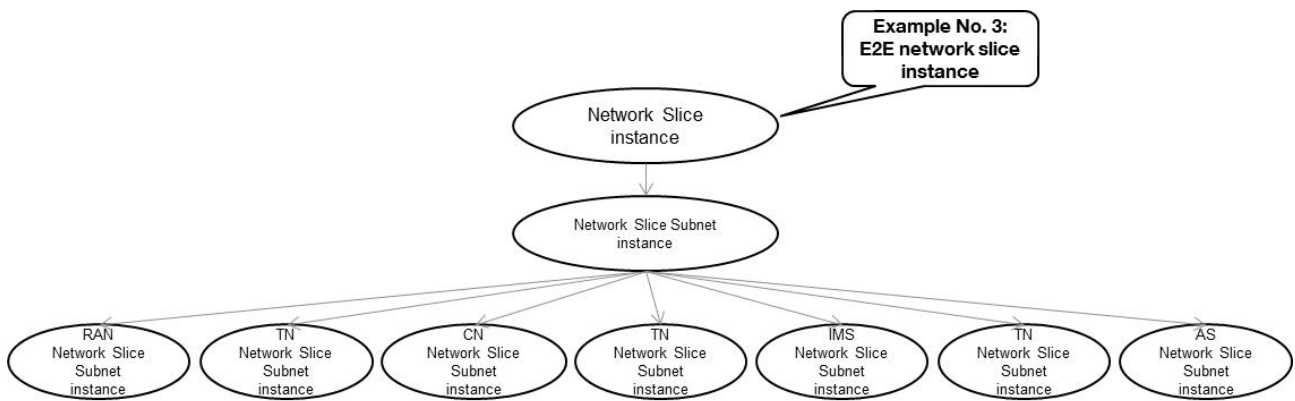

**Figure A.5: RAN+TN+CN+TN+IMS+TN+AS network slice subnets exposed as network slice**

## Annex B (informative): General information for network slice related identifiers

The following network slice related identifiers serve different purposes:

Identifier	Description
<b>Identifiers for network slice management purpose</b>	
NetworkSlice identifier	To identify a NetworkSlice instance defined in TS 28.530 (see [4]), it is DN of a managed object instance of NetworkSlice IOC, see TS 28.541 [6]
NetworkSliceSubnet identifier	To identify a NetworkSliceSubnet instance defined in TS 28.530 (see [4]), it is DN of a managed object instance of NetworkSliceSubnet IOC, see TS 28.541 [6]
<b>Identifiers for network slice signaling purpose</b>	
NSI ID	NSI ID is only for 5GC signaling use, i.e. to identify Core Network part of a Network Slice instance when multiple Network Slice instances of the same Network Slice are deployed, and there is a need to differentiate between them in the 5GC, see clause 3.1 of TS 23.501 [10]. The NRM attribute cNSIIDList of NRFunction and NSSFunction, see TS 28.541 [6], is a list for NSI ID(s).
S-NSSAI	To identify Network Slice defined in TS 23.501. Referred to TS 23.501 [10] and TS 38.300 [11]. NRM attribute sNSSAIDList defines the S-NSSAI(s) supported by the corresponding managed object, see TS 28.541 [6].
PLMN ID	Represent PLMN identifier.

The NSI ID and S-NSSAI are configuration parameters of the management system.

# Annex C (informative): Plant UML source code

## C.1 General

This annex contains the PlantUML source code for procedures defined in clause 7 of the present document.

## C.2 Procedure of network slice instance allocation

```
@startuml
skinparam shadowing false
skinparam monochrome true
hide footbox

actor "NSMS_C" as NSMS_Consumer
participant "\tNSMS_P\t\t" as NSMS_Provider

alt NSMS_C sends AllocateNsi request
    NSMS_Consumer -> NSMS_Provider: 1a-1. AllocateNsi(ServiceProfile) Request
    NSMS_Provider -> NSMS_Provider: 1a-2. Creates NetworkSliceController MOI
    NSMS_Provider --> NSMS_Consumer: 1a-3. AllocateNsi(ServiceProfileId) Response
    NSMS_Provider --> NSMS_Consumer: 1a-4. notifyMOICreation(\n\tobjectClass=NetworkSliceController,
\n\tobjectInstance=DN of NetworkSliceController MOI,...)
else NSMS_C sends createMOI request
    NSMS_Consumer -> NSMS_Provider: 1b-1. createMOI(\n\t managedObjectClass=NetworkSliceController,
\n\t attributeListIn=inputServiceProfile,...) Request
    NSMS_Provider -> NSMS_Provider: 1b-2. Creates NetworkSliceController MOI
    NSMS_Provider --> NSMS_Consumer: 1b-3. createMOI() Response
end alt

NSMS_Provider -> NSMS_Provider: 2. Decides to create a new NetworkSlice MOI\
\n\t or use an existing NetworkSlice MOI.

alt Using an existing NetworkSlice MOI
    NSMS_Provider -> NSMS_Provider: 3a-1. Identifies the NetworkSlice MOI to re-use
    NSMS_Provider -> NSMS_Provider: 3a-2. Configures NetworkSlice MOI with \n DN of
NetworkSliceController MOI
    NSMS_Provider -> NSMS_Provider: 3a-3. Configures NetworkSliceController MOI with \n DN of
NetworkSlice MOI
    opt If the existing NetworkSlice MOI needs to be modified
        ref over NSMS_Provider
            3a-4. Procedure of Network Slice Instance Modification
        end ref
    end opt

else Creating a new NetworkSlice MOI
    NSMS_Provider -> NSMS_Provider: 3b-1. Derives the network slice subnet related requirements
    ref over NSMS_Provider
        3b-2. Procedure of Network Slice Subnet Instance Allocation
    end ref
    |||
    NSMS_Provider -> NSMS_Provider: 3b-3. Creates NetworkSlice MOI and \n configures NetworkSlice MOI
with \nDN of NetworkSliceController MOI and \nDN of NetworkSliceSubnet MOI
    NSMS_Provider -> NSMS_Provider: 3b-4. Configures NetworkSliceController MOI with \n DN of
NetworkSlice MOI

    |||
end alt

NSMS_Provider -> NSMS_Provider: 4. Updates attributes of NetworkSliceController MOI\nindicating
completion of the procedure

group Monitoring network slice allocation progress and result. \nThis can be happened anytime after
step NetworkSliceController is created (i.e., step 1a-2 or step 1b-2)
alt obtain the progress and result by subscribe-notification method
```

```

NSMS_Provider -> NSMS_Consumer: 5a. Notify network slice allocation progress and result \n (DN
of NetworkSliceController MOI and its attributes)
else obtain the progress and result by query method
NSMS_Consumer -> NSMS_Provider: 5b-1. Request to query the \n NetworkSliceController information
(DN of NetworkSliceController)
NSMS_Provider -> NSMS_Consumer: 5b-2. Response with the NetworkSliceController \n information (DN
of NetworkSliceController and values of its attribute)
end alt

@enduml

```

---

## C.3 Procedure of Network Slice Subnet Instance Allocation

```

@startuml

skinparam shadowing false
skinparam monochrome true
hide footbox

actor "NSSMS_C" as NSSMS_Consumer
participant "NSSMS_P" as NSSMS_Provider

'alt CRUD operations not visible to the consumer
alt NSSMS_C sends AllocateNssi request
  NSSMS_Consumer -> NSSMS_Provider: 1a-1. AllocateNssi(SliceProfile) Request
  NSSMS_Provider -> NSSMS_Provider: 1a-2. Creates NetworkSliceSubnetController MOI
  NSSMS_Provider --> NSSMS_Consumer: 1a-3. AllocateNssi(SliceProfileId) Response
  NSSMS_Provider -> NSSMS_Consumer: 1a.4.
  notifyMOICreation(\n\tobjectClass=NetworkSliceSubnetController, \n\tobjectInstance=DN of
NetworkSliceSubnetController MOI,...)
else NSSMS_C sends createMOI request
  NSSMS_Consumer -> NSSMS_Provider: 1b-1. createMOI(\n\t
managedObjectClass=NetworkSliceSubnetController, \n\t attributeListIn=inputSliceProfile,...) Request
  NSSMS_Provider -> NSSMS_Provider: 1b-2. Creates NetworkSliceSubnetController MOI
  NSSMS_Provider --> NSSMS_Consumer: 1b-3. createMOI() Response
end

ref over NSSMS_Provider
  2. Procedure of feasibility check and reservation of network slice subnet
end ref

NSSMS_Provider -> NSSMS_Provider: 3. Decides to create a new NetworkSliceSubnet MOI\
\n\t or use an existing NetworkSliceSubnet MOI.

alt Using an existing NetworkSliceSubnet MOI
  NSSMS_Provider -> NSSMS_Provider: 4a-1. Identifies the NetworkSliceSubnet MOI to re-use
  |||
  NSSMS_Provider -> NSSMS_Provider: 4a-2. Configures NetworkSliceSubnet MOI with DN of
NetworkSliceSubnetController MOI
  NSSMS_Provider -> NSSMS_Provider: 4a-3. Configures NetworkSliceSubnetController MOI with\nDN of
NetworkSliceSubnet MOI

  opt If the existing NetworkSliceSubnet MOI needs to be modified
    |||
    ref over NSSMS_Provider
      4a-4. Procedure of Network Slice Subnet Instance Modification
    end ref
  end opt

else Using a new NetworkSliceSubnet MOI

  NSSMS_Provider -> NSSMS_Provider: 4b-1. Creates an MOI of NetworkSliceSubnet and \nconfigures
NetworkSliceSubnet MOI with DN of NetworkSliceSubnetController MOI

  NSSMS_Provider -> NSSMS_Provider: 4b-2. Configures NetworkSliceSubnetController MOI with\nDN of
NetworkSliceSubnet MOI

  NSSMS_Provider -> NSSMS_Provider: 4b-3. Derives the requirements for corresponding\n network
slice subnet constituent(s) and transport network
  opt If the NetworkSliceSubnet MOI to be created contains virtualization part (i.e., VNF or VL)
    |||

```

```

    ref over NSSMS_Provider
    4b-4. NS instantiation procedure
    end ref
    NSSMS_Provider -> NSSMS_Provider: 4b-5. Configures the NetworkSliceSubnet MOI attribute nsInfo
end opt
loop 4b-6. for each constituent NetworkSliceSubnet MOI
    |||
    ref over NSSMS_Provider
    4b-6a. Procedure of Network Slice Subnet Instance Allocation
    end ref
    NSSMS_Provider -> NSSMS_Provider: 4b-6b. Configures the NetworkSliceSubnet MOI \n attribute
networkSliceSubnetRef with the DN constituent NetworkSliceSubnet
    end loop

loop 4b-7. for each constituent Network Function
    |||
    ref over NSSMS_Provider
    4b-7a. \tProcedure of NF instance creation or
\t\tProcedure of NF instance modification
    end ref
    NSSMS_Provider -> NSSMS_Provider: 4b-7b. Configures the NetworkSliceSubnet MOI \n attribute
managedFunctionRef with the DN constituent ManagedFunction
    end loop

loop for each transport network requirements
    |||
    ref over NSSMS_Provider
    4b-8. Procedure of TN coordination
supporting network slicing
    |||
    end ref
    end loop
end alt

|||
NSSMS_Provider -> NSSMS_Provider: 5. Configures attributes of NetworkSliceSubnetController
MOI\nindicating completion of the procedure

group Monitoring network slice subnet allocation progress and result. \nThis can be happened anytime
after step NetworkSliceSubnetController is created (i.e., step 1a-2 or step 1b-2)
alt obtain the progress and result by subscribe-notification method
    NSSMS_Provider -> NSSMS_Consumer: 6a. Notify network slice subnet allocation progress and result
\n (DN of NetworkSliceSubnetController MOI and its attributes)
else obtain the progress and result by query method
    NSSMS_Consumer -> NSSMS_Provider: 6b-1. Request to query the \n NetworkSliceSubnetController
information (DN of NetworkSliceSubnetController MOI)
    NSSMS_Provider -> NSSMS_Consumer: 6b-2. Response with the NetworkSliceSubnetController \n
information (DN of NetworkSliceSubnetController MOI and values of its attribute)
end alt

@enduml

```

---

## C.4 Procedure of Network Slice Instance Deallocation

```
@startuml
```

```

skinparam shadowing false
skinparam monochrome true
hide footbox

actor "NSMS_C" as NSMS_Consumer
participant "NSMS_P" as NSMS_Provider

alt NSMS_C sends DeallocateNsi request
    NSMS_Consumer -> NSMS_Provider: 1a-1. DeallocateNsi(networkSliceDN, serviceProfileId) Request
    NSMS_Provider -> NSMS_Provider: 1a-2. Identifies the DN of NetworkSlice MOI to be deleted.
    NSMS_Provider -> NSMS_Provider: 1a-3. Updates NetworkSlice MOI to remove the \nreference to DN of
NetworkSliceController
    NSMS_Provider -> NSMS_Provider: 1a-4. Deletes NetworkSliceController MOI
    NSMS_Provider --> NSMS_Consumer: 1a-5. DeallocateNsi() Response
else NSMS_C sends deleteMOI request

```

```

    NSMS_Consumer -> NSMS_Provider: 1b-1. deleteMOI(baseObjectInstance=DN of NetworkSliceController)
Request
    NSMS_Provider -> NSMS_Provider: 1b-2. Identifies the DN of NetworkSlice MOI \nfrom the attribute
networkSliceRef and \nvalue of attribute serviceProfileId from \nthe NetworkSliceController MOI to
be deleted.
    NSMS_Provider -> NSMS_Provider: 1b-3. Updates NetworkSlice MOI to remove the \nreference to DN of
NetworkSliceController
    NSMS_Provider -> NSMS_Provider: 1b-4. Deletes NetworkSliceController MOI
    NSMS_Provider --> NSMS_Consumer: 1b-5. deleteMOI() Response
end

NSMS_Provider -> NSMS_Provider: 2. Decides to delete or modify NetworkSlice MOI

alt Delete NetworkSlice MOI identified in step 1b-2. \t
    NSMS_Provider -> NSMS_Provider: 3a-1. Deletes NetworkSlice MOI
ref over NSMS_Provider
    3a-2. Procedure of network slice subnet instance deallocation
end ref

else Modify NetworkSlice MOI identified in step 1b-2.
    |||
    ref over NSMS_Provider
    3b-1. Procedure of Network Slice Subnet Instance Modification
end ref

    NSMS_Provider -> NSMS_Provider: 3b-2. Modify NetworkSlice MOI
end

@enduml

```

---

## C.5 Procedure of network slice subnet instance deallocation

```

@startuml

skinparam shadowing false
skinparam monochrome true
hide footbox

actor "NSSMS_C" as NSSMS_Consumer
participant "NSSMS_P" as NSSMS_Provider
'participant "NSSMS_Provider" as NSSMS_Consumer

alt NSSMS_C sends DeallocateNssi request
    NSSMS_Consumer -> NSSMS_Provider: 1a-1. DeallocateNssi(networkSliceSubnetDN, sliceProfileId)
Request
    NSSMS_Provider -> NSSMS_Provider: 1a-2. Identifies the DN of NetworkSliceSubnet MOI to be deleted
    NSSMS_Provider -> NSSMS_Provider: 1a-3. Updates NetworkSliceSubnet MOI attribute
networkSliceSubnetControllerRef \n\tto remove DN of NetworkSliceSubnetController
    NSSMS_Provider -> NSSMS_Provider: 1a-4. Deletes NetworkSliceSubnetController MOI
    NSSMS_Provider --> NSSMS_Consumer: 1a-5. DeallocateNssi() Response
else NSSMS_C sends deleteMOI request
    NSSMS_Consumer -> NSSMS_Provider: 1b-1. deleteMOI(baseObjectInstance=DN of
NetworkSliceSubnetController) Request
    NSSMS_Provider -> NSSMS_Provider: 1b-2. Identifies the DN of NetworkSliceSubnet MOI \nfrom the
attribute networkSliceSubnetRef and \nvalue of attribute sliceProfileId from the
\nNetworkSliceSubnetController MOI to be deleted
    NSSMS_Provider -> NSSMS_Provider: 1b-3. Updates NetworkSliceSubnet MOI attribute
networkSliceSubnetControllerRef \n\tto remove DN of NetworkSliceSubnetController
    NSSMS_Provider -> NSSMS_Provider: 1b-4. Deletes NetworkSliceSubnetController MOI
    NSSMS_Provider --> NSSMS_Consumer: 1b-5. deleteMOI() Response
end

NSSMS_Provider -> NSSMS_Provider: 2. Decides to delete or modify NetworkSliceSubnetSubnet MOI

alt 3a. Delete the NetworkSliceSubnetSubnet MOI identified in step 1b-2.
    opt If the NetworkSliceSubnet MOI consists of constituent NetworkSliceSubnetSubnet MOIs
        loop for each constituent NetworkSliceSubnetSubnet MOI
            |||
            ref over NSSMS_Provider

```



```

        3a-1. Procedure of network slice subnet instance deallocation
    end ref
end loop
end opt

opt If the NetworkSliceSubnet MOI consists of NFs
loop for each constituent ManagedFunction MOI
|||
    ref over NSSMS_Provider
    3a-2. Procedure of NF instance deletion or
        \t\tProcedure of NF instance modification
    end ref
end loop
end opt

opt If the NetworkSliceSubnet MOI contains TN part
|||
    ref over NSSMS_Provider
    3a-3. Procedure of TN coordination supporting network slicing
    end ref
end opt

opt If the NetworkSliceSubnet MOI contains virtualized part
|||
    ref over NSSMS_Provider
    3a-4. NS Termination procedure
    end ref
end opt

NSSMS_Provider -> NSSMS_Provider: 3a-5. Deletes NetworkSliceSubnet MOI
else 3b. Modify the NetworkSliceSubnetSubnet MOI identified in step 1b-2.
opt If the NetworkSliceSubnet MOI consists of constituent NetworkSliceSubnetSubnet MOIs
loop for each constituent NetworkSliceSubnetSubnet MOI
|||
    ref over NSSMS_Provider
    3b-1. Procedure of network slice subnet instance modification
    end ref
end loop
end opt

NSSMS_Provider -> NSSMS_Provider: 3b-2. Modifies NetworkSliceSubnet MOI
end

@enduml

```

---

## C.6 Procedure of Network Slice Instance Modification

```

@startuml

skinparam shadowing false
skinparam monochrome true
hide footbox

actor "NSMS_C" as NSMS_Consumer
participant "NSMS_P" as NSMS_Provider

alt NSMS_C sends new network slice related requirements in NetworkSlice MOI
    NSMS_Consumer -> NSMS_Provider: 1a. modifyMOIAttributes(\n\t baseObjectInstance=NetworkSlice,
\n\t modificationList=serviceProfileList,...) request
else NSMS_C sends new network slice related \n requirements in inputServiceProfile
    NSMS_Consumer -> NSMS_Provider: 1b-1. modifyMOIAttributes(\n\t
baseObjectInstance=NetworkSliceController, \n\t modificationList=inputServiceProfile,...) request
    NSMS_Provider -> NSMS_Provider: 1b-2. Updates NetworkSliceController MOI attributes\n with new
inputServiceProfile along with progress and state information.
    NSMS_Consumer <-- NSMS_Provider: 1b-3. modifyMOIAttributes(modificationListOut=...) response
end alt

ref over NSMS_Provider
    2. Procedure of feasibility check and reservation of network slice
end ref

NSMS_Provider -> NSMS_Provider: 3. Decomposes the request to network slice subnet requirements.

```

```

ref over NSMS_Provider
  4. Procedure of network slice subnet instance modification
end ref

NSMS_Provider -> NSMS_Provider: 5. Updates NetworkSlice MOI attributes (serviceProfileList)
opt if NSMS_C sent new network slice related requirements in NetworkSlice MOI (in step 1a)
  Note over NSMS_Provider: NSMS_P sends response for modifyMOIAttributes request received in step
  1a.
  NSMS_Consumer <-- NSMS_Provider: 6a. modifyMOIAttributes(modificationListOut=...) response
  else if NSMS_C sent new network slice related requirements in NetworkSliceController MOI (in step
  1b-1)
  NSMS_Provider -> NSMS_Provider: 6b. Updates attributes of NetworkSliceController MOI \nindicating
  completion of the procedure
end opt
@enduml

```

---

## C.7 Procedure of Network Slice Subnet Instance Modification

```

@startuml

skinparam shadowing false
skinparam monochrome true
hide footbox

actor "NSSMS_C" as NSSMS_Consumer
participant "NSSMS_P" as NSSMS_Provider

alt NSSMS_C sends new network slice subnet related requirements in NetworkSliceSubnet MOI
  NSSMS_Consumer -> NSSMS_Provider: 1a. modifyMOIAttributes(\n\t
baseObjectInstance=NetworkSliceSubnet, \n\t modificationList=sliceProfileList,...) request
else NSSMS_C sends new network slice subnet related requirements in NetworkSliceSubnetController MOI
  NSSMS_Consumer -> NSSMS_Provider: 1b-1. modifyMOIAttributes(\n\t
baseObjectInstance=NetworkSliceSubnetController, \n\t modificationList=inputSliceProfile,...)
request
  NSSMS_Provider -> NSSMS_Provider: 1b-2. Updates NetworkSliceSubnetController MOI attributes\n
with new inputSliceProfile along with progress and state information.
  NSSMS_Consumer <-- NSSMS_Provider: 1b-3. modifyMOIAttributes(modificationListOut=...) response
end alt

ref over NSSMS_Provider
  2. Procedure of feasibility check and reservation of network slice subnet
end ref

NSSMS_Provider -> NSSMS_Provider: 3. Decomposes the modification request for each constituent MOIs.

loop for each constituent NetworkSliceSubnet MOIs
  |||
  ref over NSSMS_Provider
  4a. Procedure of network slice subnet instance modification
  end ref
end loop
loop for each constituent ManagedFunction MOIs
  |||
  ref over NSSMS_Provider
  4b. Procedure of NF instance creation or
  \t\tProcedure of NF instance modification
  end ref
end loop
opt The NSSI contains virtualized parts
  |||
  ref over NSSMS_Provider
  4c. NS instance scaling/updating/instantiation
  procedures
  end ref
end opt
opt The NSSI contains TN parts
  '|||
  ref over NSSMS_Provider
  4d. Procedure of TN coordination
  supporting network slicing

```

```
    end ref
end opt
```

```
NSSMS_Provider -> NSSMS_Provider: 5. Updates NetworkSliceSubnet MOI attributes
```

```
opt if NSSMS_C sent new network slice related requirements in NetworkSliceSubnet MOI (in step 1a)
    Note over NSSMS_Provider: NSSMS_P sends response for modifyMOIAttributes request received in step
    1a.
```

```
    NSSMS_Consumer <-- NSSMS_Provider: 6a. modifyMOIAttributes(modificationListOut=...) response
else if NSSMS_C sent new network slice related requirements in NetworkSliceSubnetController MOI (in
step 1b-1)
```

```
    NSSMS_Provider -> NSSMS_Provider: 6b. Updates attributes of NetworkSliceSubnetController MOI
    \nindicating completion of the procedure
end opt
```

```
@enduml
```



## Annex D (informative): Change history

Change history							
Date	Meeting	TDoc	CR	Rev	Cat	Subject/Comment	New version
2018-09	SA#81					Upgrade to change control version	15.0.0
2018-12	SA#82	SP-181043	0001	1	F	Complete the reference information and reword the note	15.1.0
2018-12	SA#82	SP-181043	0002	-	F	Update operation names in the procedures of NSI provisioning	15.1.0
2018-12	SA#82	SP-181043	0003	-	F	Update operation names in the procedures of NSSI provisioning	15.1.0
2018-12	SA#82	SP-181043	0004	1	F	Update operation names in the procedures of NF provisioning	15.1.0
2018-12	SA#82	SP-181043	0005	1	F	Remove release specific information from clause 7.9.1	15.1.0
2018-12	SA#82	SP-181043	0006	1	F	Correct procedures with reference to TS 28.541	15.1.0
2018-12	SA#82	SP-181043	0009	1	B	Add Network slice subnet management use case with assigned priority	15.1.0
2018-12	SA#82	SP-181043	0010	2	B	Add network slice management interactions with NFV MANO for network service priority	15.1.0
2018-12	SA#82	SP-181044	0011	2	D	Implement minor corrections	16.0.0
2019-03	SA#83	SP-190123	0013	-	A	Update management services tables	16.1.0
2019-03	SA#83	SP-190123	0015	-	A	Correction on procedure of Network Slice Subnet Instance Deallocation	16.1.0
2019-03	SA#83	SP-190123	0017	1	A	Correct management service term	16.1.0
2019-05	SA#84	SP-190370	0019	1	A	Editor's change for configuration management service	16.2.0
2019-09	SA#85	SP-190754	0022	-	A	Update the incorrect reference	16.3.0
2019-09	SA#85	SP-190750	0024	1	B	Add informative annex to describe a network slice journey	16.3.0
2019-09	SA#85	SP-190754	0026	1	A	Add the identifier description	16.3.0
2019-09	SA#85	SP-190742	0028	1	A	Fix inconsistencies related to service requirements	16.3.0
2019-12	SA#86	SP-191175	0032	1	A	Fix inconsistencies in feasibility check use cases and requirements	16.4.0
2019-12	SA#86	SP-191159	0033	1	F	Clean up for incosistence	16.4.0
2020-03	SA#87E	SP-200166	0039	-	F	Replace occurrences of Management Function by Management Service	16.5.0
2020-07	SA#88-e	SP-200498	0044	1	A	Fix Network Slice subnet termination use case	16.6.0
2020-07	SA#88-e	SP-200484	0045	1	F	Fix NSI activation and deactivation use cases	16.6.0
2020-07	SA#88-e	SP-200484	0047	1	F	Clarification on network slice related identifiers	16.6.0
2020-09	SA#89-e	SP-200724	0053	1	F	Editorial corrections to remove redundant text from use cases	16.7.0
2020-09	SA#89-e	SP-200735	0056	-	A	Add clarifying note to ServiceProfile	16.7.0
2020-09	SA#89-e	SP-200724	0057	-	F	Fix general information of network slice related identifiers	16.7.0
2020-12	SA#90e	SP-201053	0058	1	F	Move service profile definition to 28530	16.8.0
2020-12	SA#90e	SP-201050	0059	1	F	Correction of allocateNsi operations and procedures	16.8.0
2021-03	SA#91e	SP-210146	0060	-	F	Correction of URI of Resource	16.9.0
2021-03	SA#91e	SP-210146	0061	1	F	Correction of NSI and NSSI Operations	16.9.0
2021-06	SA#92e	SP-210417	0064	1	A	Clarify misleading information in network slicing use cases	16.10.0
2021-06	SA#92e	SP-210401	0065	1	F	Add reference to EP_transport for transport network requirements	17.0.0
2021-06	SA#92e	SP-210410	0066	1	B	Add the SLA management related requirements and procedure	17.0.0
2021-09	SA#93e	SP-210881	0069	1	A	Correction of network slice subnet configuration	17.1.0
2021-09	SA#93e	SP-210885	0071	1	A	Updating NSSI deallocation	17.1.0
2021-09	SA#93e	SP-210885	0074	1	A	Updating NSSI deactivation	17.1.0
2021-09	SA#93e	SP-210881	0076	-	A	Removing network slice capacity planning	17.1.0
2021-09	SA#93e	SP-210881	0079	-	A	Removing Notify Network Slice Subnet Capability Information	17.1.0
2021-09	SA#93e	SP-210885	0080	1	A	Updating NSSI allocation	17.1.0
2021-12	SA#94e	SP-211454	0087	1	A	Technical errors in use case descriptions	17.2.0
2021-12	SA#94e	SP-211455	0088	1	C	Fixing NetworkSlice and NetworkSliceSubnet Allocation and Deallocation Stage 2	17.2.0
2021-12	SA#94e	SP-211466	0098	1	B	Modification of network slice related requirements	17.2.0
2022-03	SA#95e	SP-220178	0099	-	F	Update procedure of network slice subnet instance allocation	17.3.0
2022-03	SA#95e	SP-220178	0104	1	F	Fixing Network slice and network slice subnet provisioning management service - profiles not convert to IOC - Stage 3	17.3.0
2022-06	SA#96	SP-220499	0106	-	B	Update procedure of reservation and checking feasibility of network slice subnet	17.4.0
2022-06	SA#96	SP-220499	0107	1	B	Update procedure of reservation and checking feasibility of network slice	17.4.0
2022-06	SA#96	SP-220499	0108	-	F	Deleting network slice capability exposure	17.4.0
2022-06	SA#96	SP-220499	0110	1	C	Network slice subnet capabilities	17.4.0
2022-06	SA#96	SP-220499	0113	1	B	Adding procedure for network service priority management	17.4.0
2022-06	SA#96	SP-220499	0114	-	B	Update procedure of reservation and checking feasibility of network slice subnet	17.4.0
2022-06	SA#96	SP-220499	0115	1	B	Update operations of deallocateNsi, deallocateNssi	17.4.0
2022-09	SA#97e	SP-220849	0122	1	F	Deleting capacity planning use case	17.5.0
2022-09	SA#97e	SP-220849	0125	1	F	Update feasibility check procedure to align with FeasibilityCheckAndReservationJob	17.5.0
2022-09	SA#97e	SP-220857	0131	1	A	Remove example from network slice subnet instance modification	17.5.0
2022-09	SA#97e	SP-220857	0133	1	A	Remove example from network slice instance modification	17.5.0
2022-09	SA#97e	SP-220853	0135	1	A	Correct roles in network slice subnet allocation use case	17.5.0
2022-09	SA#97e	SP-220849	0139	1	F	Clarify translation in network slice allocation use case	17.5.0

2022-09	SA#97e	SP-220856	0118	1	F	Update procedures for modification of Network Slice and Network Slice Subnet MOIs	18.0.0
2022-09	SA#97e	SP-220856	0120	-	F	Removal of redundant network slice modification use case	18.0.0
2022-09	SA#97e	SP-220856	0121	-	B	Add provisioning procedure for slice activation and deactivation using administrative state	18.0.0
2022-09	SA#97e	SP-220856	0124	1	C	Fixing provisioning data reporting service	18.0.0
2022-12	SA#98e	SP-221173	0149	1	A	Correct vocabulary	18.1.0
2022-12	SA#98e	SP-221177	0150	2	F	Fixing provisioning data reporting service	18.1.0
2022-12	SA#98e	SP-221177	0153	1	C	Deleting allocate network	18.1.0
2022-12	SA#98e	SP-221167	0154	1	A	Add missing use case and requirement for capability class	18.1.0
2022-12	SA#98e	SP-221178	0159	1	A	Clarification and update of deallocation use case	18.1.0
2023-06	SA#100	SP-230671	0170	3	A	Clarify network slicing provisioning use case	18.2.0
2023-06	SA#100	SP-230653	0173	1	B	Update Procedure of Network Slice Instance Allocation to support asynchronous operations	18.2.0
2023-06	SA#100	SP-230653	0174	1	B	Update Procedure of Network Slice Instance Deallocation to support asynchronous operations	18.2.0
2023-06	SA#100	SP-230653	0175	1	B	Update Procedure of Network Slice Instance Modification to support asynchronous operations	18.2.0
2023-06	SA#100	SP-230653	0176	1	B	Update Procedure of Network Slice Subnet Instance Allocation to support asynchronous operations	18.2.0
2023-06	SA#100	SP-230653	0177	1	B	Update Procedure of network slice subnet instance deallocation to support asynchronous operations	18.2.0
2023-06	SA#100	SP-230653	0178	1	B	Update Procedure of Network Slice Subnet Instance Modification to support asynchronous operations	18.2.0
2023-06	SA#100	SP-230649	0180	1	A	Align figure with description in Procedure of NF instance creation	18.2.0
2023-06	SA#100	SP-230649	0182	-	A	Align figure with description in Procedure of NF instance deletion	18.2.0
2023-06	SA#100	SP-230649	0184	-	A	Align figure with description in Procedure of NF instance modification	18.2.0
2023-06	SA#100	SP-230651	0188	-	F	Several editorial Corrections	18.2.0
2023-09	SA#101	SP-230953	0190	-	A	Update reference to GST	18.3.0
2023-09	SA#101	SP-230956	0191	-	B	Add UML source code for Network Slice LCM procedures	18.3.0
2023-09	SA#101	SP-230956	0192	1	B	Fix MnS for network slice provisioning information	18.3.0
2023-09	SA#101	SP-230956	0193	1	B	Fix MnS for network slice subnet provisioning information	18.3.0
2023-09	SA#101	SP-230944	0199	-	A	Correct the description of network slice subnet instance	18.3.0
2023-09	SA#101	SP-230940	0208	-	A	Fix wrong clause reference	18.3.0
2023-09	SA#101	SP-230968	0209	1	F	Add the interactions with NFV-MANO in NF instance creation procedure	18.3.0
2023-09	SA#101	SP-230968	0210	1	F	Add the interactions with NFV-MANO in NF instance deletion procedure	18.3.0
2023-09	SA#101	SP-230968	0211	1	F	Update the reference information in clause 7.17	18.3.0
2023-12	SA#102	SP-231494	0218	1	F	Update procedure of feasibility check and reservation of NSI and NSSI to align with FeasibilityCheckAndReservationJob	18.4.0
2023-12	SA#102	SP-231494	0219	1	F	Clarify initiation of Procedure of Network Slice Instance Deallocation	18.4.0
2023-12	SA#102	SP-231494	0220	1	F	Clarify initiation of Procedure of network slice subnet instance deallocation	18.4.0
2023-12	SA#102	SP-231494	0221	1	F	Clarify initiation of Procedure of Network Slice Instance Modification	18.4.0
2023-12	SA#102	SP-231494	0222	1	F	Clarify initiation of Procedure of Network Slice Subnet Instance Modification	18.4.0
2023-12	SA#102	SP-231494	0223	-	F	Corrections to description of Procedure of Network Slice Instance and Network Slice Subnet Instance allocations	18.4.0
2023-12	SA#102	SP-231479	0224	1	F	Update the scope of TS 28.531	18.4.0
2023-12	SA#102	SP-231479	0225	4	F	Update the description about the procedure of NF instance creation	18.4.0
2023-12	SA#102	SP-231479	0227	2	F	Add the introduction for the procedure of NF instance modification	18.4.0
2023-12	SA#102	SP-231469	0228	1	F	Correct the description of Procedure of Network Slice Instance allocation	18.4.0
2023-12	SA#102	SP-231481	0230	1	B	Update use case and allocate for network slice isolation	18.4.0
2023-12	SA#102	SP-231479	0231	1	F	Update references from TS 28.526 to ETSI NFV IFA 013	18.4.0
2024-03	SA#103	SP-240186	0232	1	F	Rel-18 CR TS 28.531 Add references to component table 6.3	18.5.0
2024-06	SA#104	SP-240849	0238	3	F	Rel18 CR TS 28.531 Correct stage3 definition for NSProvMnS and NSSProvMnS	18.6.0
2024-07	SA#104					Correct CR implementation	18.6.1
2024-09	SA#105	SP-241190	0239	-	F	Rel-18 CR TS 28.531 Update forge link to align with endorsed S5-242202	18.7.0
2024-12	SA#106	SP-241633	0241	-	A	Rel-18 CR TS 28.531 Management Service for NF provisioning	18.8.0

---

# History

<b>Document history</b>		
V18.5.0	May 2024	Publication
V18.6.1	August 2024	Publication
V18.7.0	October 2024	Publication
V18.8.0	January 2025	Publication