

ETSI TS 129 232 V18.0.0 (2024-05)



**Digital cellular telecommunications system (Phase 2+) (GSM);  
Universal Mobile Telecommunications System (UMTS);  
LTE;  
Media Gateway Controller (MGC)  
- Media Gateway (MGW) interface;  
Stage 3  
(3GPP TS 29.232 version 18.0.0 Release 18)**



---

**Reference**

RTS/TSGC-0429232vi00

---

**Keywords**

GSM,LTE,UMTS

**ETSI**

650 Route des Lucioles  
F-06921 Sophia Antipolis Cedex - FRANCE

---

Tel.: +33 4 92 94 42 00 Fax: +33 4 93 65 47 16

Siret N° 348 623 562 00017 - APE 7112B  
Association à but non lucratif enregistrée à la  
Sous-Préfecture de Grasse (06) N° w061004871

---

**Important notice**

The present document can be downloaded from:

<https://www.etsi.org/standards-search>

The present document may be made available in electronic versions and/or in print. The content of any electronic and/or print versions of the present document shall not be modified without the prior written authorization of ETSI. In case of any existing or perceived difference in contents between such versions and/or in print, the prevailing version of an ETSI deliverable is the one made publicly available in PDF format at [www.etsi.org/deliver](http://www.etsi.org/deliver).

Users of the present document should be aware that the document may be subject to revision or change of status.

Information on the current status of this and other ETSI documents is available at

<https://portal.etsi.org/TB/ETSIDeliverableStatus.aspx>

If you find errors in the present document, please send your comment to one of the following services:

<https://portal.etsi.org/People/CommitteeSupportStaff.aspx>

If you find a security vulnerability in the present document, please report it through our  
Coordinated Vulnerability Disclosure Program:

<https://www.etsi.org/standards/coordinated-vulnerability-disclosure>

---

**Notice of disclaimer & limitation of liability**

The information provided in the present deliverable is directed solely to professionals who have the appropriate degree of experience to understand and interpret its content in accordance with generally accepted engineering or other professional standard and applicable regulations.

No recommendation as to products and services or vendors is made or should be implied.

No representation or warranty is made that this deliverable is technically accurate or sufficient or conforms to any law and/or governmental rule and/or regulation and further, no representation or warranty is made of merchantability or fitness for any particular purpose or against infringement of intellectual property rights.

In no event shall ETSI be held liable for loss of profits or any other incidental or consequential damages.

Any software contained in this deliverable is provided "AS IS" with no warranties, express or implied, including but not limited to, the warranties of merchantability, fitness for a particular purpose and non-infringement of intellectual property rights and ETSI shall not be held liable in any event for any damages whatsoever (including, without limitation, damages for loss of profits, business interruption, loss of information, or any other pecuniary loss) arising out of or related to the use of or inability to use the software.

---

**Copyright Notification**

No part may be reproduced or utilized in any form or by any means, electronic or mechanical, including photocopying and microfilm except as authorized by written permission of ETSI.

The content of the PDF version shall not be modified without the written authorization of ETSI.

The copyright and the foregoing restriction extend to reproduction in all media.

© ETSI 2024.  
All rights reserved.

---

# Intellectual Property Rights

## Essential patents

IPRs essential or potentially essential to normative deliverables may have been declared to ETSI. The declarations pertaining to these essential IPRs, if any, are publicly available for **ETSI members and non-members**, and can be found in ETSI SR 000 314: "*Intellectual Property Rights (IPRs); Essential, or potentially Essential, IPRs notified to ETSI in respect of ETSI standards*", which is available from the ETSI Secretariat. Latest updates are available on the ETSI Web server (<https://ipr.etsi.org/>).

Pursuant to the ETSI Directives including the ETSI IPR Policy, no investigation regarding the essentiality of IPRs, including IPR searches, has been carried out by ETSI. No guarantee can be given as to the existence of other IPRs not referenced in ETSI SR 000 314 (or the updates on the ETSI Web server) which are, or may be, or may become, essential to the present document.

## Trademarks

The present document may include trademarks and/or tradenames which are asserted and/or registered by their owners. ETSI claims no ownership of these except for any which are indicated as being the property of ETSI, and conveys no right to use or reproduce any trademark and/or tradename. Mention of those trademarks in the present document does not constitute an endorsement by ETSI of products, services or organizations associated with those trademarks.

**DECT™**, **PLUGTESTS™**, **UMTS™** and the ETSI logo are trademarks of ETSI registered for the benefit of its Members. **3GPP™** and **LTE™** are trademarks of ETSI registered for the benefit of its Members and of the 3GPP Organizational Partners. **oneM2M™** logo is a trademark of ETSI registered for the benefit of its Members and of the oneM2M Partners. **GSM®** and the GSM logo are trademarks registered and owned by the GSM Association.

---

# Legal Notice

This Technical Specification (TS) has been produced by ETSI 3rd Generation Partnership Project (3GPP).

The present document may refer to technical specifications or reports using their 3GPP identities. These shall be interpreted as being references to the corresponding ETSI deliverables.

The cross reference between 3GPP and ETSI identities can be found under <https://webapp.etsi.org/key/queryform.asp>.

---

# Modal verbs terminology

In the present document "**shall**", "**shall not**", "**should**", "**should not**", "**may**", "**need not**", "**will**", "**will not**", "**can**" and "**cannot**" are to be interpreted as described in clause 3.2 of the [ETSI Drafting Rules](#) (Verbal forms for the expression of provisions).

"**must**" and "**must not**" are **NOT** allowed in ETSI deliverables except when used in direct citation.

# Contents

Intellectual Property Rights .....	2
Legal Notice .....	2
Modal verbs terminology.....	2
Foreword.....	9
1 Scope .....	10
2 References .....	10
3 Definitions, symbols and abbreviations .....	13
3.1 Definitions .....	13
3.2 Symbols.....	14
3.3 Abbreviations .....	14
4 UMTS capability set.....	14
4.1 Profile Identification.....	14
4.2 Profile Registration.....	14
5 Naming conventions.....	15
5.1 MGC/MGW naming conventions .....	15
5.2 Termination names .....	15
6 Topology descriptor .....	15
7 Transaction timers .....	15
8 Transport .....	15
9 Multiple Virtual MG .....	15
10 Formats and codes .....	16
10.1 Signalling Objects .....	16
10.2 SDP Media Parameters for RTP Terminations.....	23
10.2.1 Speech Codecs .....	23
10.2.2 DTMF .....	23
10.2.3 Auxiliary Payloads.....	23
10.2.3.1 Void.....	23
10.2.3.2 Void.....	23
10.2.3.3 Clearmode Codec .....	23
10.2.3.4 Silence suppression and Comfort Noise.....	23
10.2.3.5 CS Data Service .....	23
10.2.3.5.1 CS Data Service with no Redundancy .....	23
10.2.3.5.2 CS Data Service with Redundancy .....	24
10.2.4 Other Payload Types.....	24
11 Mandatory Support of SDP and H.248.1 annex C information elements .....	25
12 General on Packages and Transactions .....	26
13 BICC packages .....	26
13.1 Mandatory BICC packages.....	26
13.2 Optional BICC packages .....	26
14 H.248 standard packages .....	27
14.1 Call independent H.248 transactions .....	27
14.1.1 MGW Out of service/Maintenance Locking.....	28
14.1.2 MGW Communication Up.....	28
14.1.3 MGW Restoration.....	28
14.1.4 MGW Register.....	29
14.1.5 MGW Re-register .....	29
14.1.6 (G)MSC Server Ordered Re-register .....	29

14.1.7	(G)MSC Server Restoration.....	29
14.1.8	Termination Out-of-Service.....	30
14.1.9	Termination Restoration .....	30
14.1.10	Audit Value.....	31
14.1.11	Audit Capability.....	33
14.1.12	MGW Capability Change .....	33
14.1.13	(G)MSC Server Out of Service.....	34
14.1.14	MGW Resource Congestion Handling - Activate.....	34
14.1.15	MGW Resource Congestion Handling - Indication .....	34
14.1.16	Continuity Check Tone.....	35
14.1.17	Continuity Check Verify.....	35
14.1.18	Continuity Check Response.....	35
14.1.19	Inactivity Timeout - Activate.....	35
14.1.20	Inactivity Timeout – Indication .....	36
14.1.21	Realm Availability Change – Activation .....	36
14.1.22	Realm Availability Change – Indication.....	36
14.2	Call related H.248 transactions.....	37
14.2.1	Change Flow Direction.....	40
14.2.2	Isolate Bearer Termination .....	40
14.2.3	Join Bearer Termination .....	40
14.2.4	Establish Bearer .....	40
14.2.5	Prepare Bearer .....	41
14.2.6	Change Through Connection .....	43
14.2.7	Activate Interworking Function.....	43
14.2.8	Release procedures .....	43
14.2.8.1	Release Bearer.....	43
14.2.8.2	Release Termination.....	43
14.2.9	Bearer Released .....	44
14.2.10	Bearer Established .....	44
14.2.11	Send Tone .....	44
14.2.12	Play Announcement.....	44
14.2.13	Send DTMF .....	45
14.2.14	Detect DTMF.....	45
14.2.15	Report DTMF .....	45
14.2.16	Announcement Completed .....	45
14.2.17	Activate Voice Processing Function.....	45
14.2.18	Reserve Circuit .....	46
14.2.19	Tunnel Information Up .....	47
14.2.20	Tunnel Information Down .....	47
14.2.21	Tone Completed.....	47
14.2.22	Stop Announcement.....	47
14.2.23	Stop Tone.....	47
14.2.24	Stop DTMF Detection .....	47
14.2.25	Stop DTMF.....	47
14.2.26	Confirm Char .....	47
14.2.27	Modify Char.....	48
14.2.28	Reserve Char.....	48
14.2.29	Bearer Modified.....	48
14.2.30	Bearer Modification Failed .....	48
14.2.31	TFO Activation.....	48
14.2.32	Optimal Codec and Distant List_Notify .....	48
14.2.33	Codec Modify .....	49
14.2.34	Distant Codec List .....	49
14.2.35	Command Rejected.....	50
14.2.36	Modify Bearer Characteristics .....	50
14.2.37	Protocol Negotiation Result.....	51
14.2.38	Rate Change.....	51
14.2.39	Bearer Modification Support .....	51
14.2.40	CTM report .....	52
14.2.41	Prepare IP transport .....	52
14.2.42	Modify IP transport address.....	54
14.2.43	Reserve Bearer Characteristics .....	54

14.2.44	Confirm Bearer Characteristics.....	55
14.2.45	Trace activation/deactivation.....	55
14.2.46	Trace Activation result notification.....	56
14.2.47	Emergency Call Indication.....	56
14.2.48	TFO status Notify.....	58
14.2.49	TFO Status.....	58
14.2.50	Termination heartbeat indication.....	58
14.2.51	Reserve RTP Connection Point.....	59
14.2.52	Configure RTP Connection Point.....	64
14.2.53	Reserve and Configure RTP Connection Point.....	68
14.2.54	ECN Failure Indication.....	73
14.2.55	Media Inactivity Notification.....	73
15	UMTS packages.....	75
15.1	Mandatory UMTS packages.....	75
15.1.1	3GUP package.....	75
15.1.1.1	Properties.....	75
15.1.1.2	Events.....	77
15.1.1.3	Signals.....	77
15.1.1.4	Statistics.....	77
15.1.1.5	Procedures.....	77
15.2	Optional UMTS packages.....	79
15.2.1	Circuit Switched Data package.....	80
15.2.1.1	Properties.....	80
15.2.1.2	Events.....	80
15.2.1.3	Signals.....	81
15.2.1.4	Statistics.....	82
15.2.1.5	Procedures.....	82
15.2.2	TFO package.....	83
15.2.2.1	Properties.....	83
15.2.2.2	Events.....	84
15.2.2.3	Signals.....	85
15.2.2.4	Statistics.....	85
15.2.2.5	Procedures.....	85
15.2.3	3G Expanded Call Progress Tones Generator Package.....	85
15.2.3.1	Properties.....	86
15.2.3.2	Events.....	86
15.2.3.3	Signals.....	86
15.2.3.4	Statistics.....	86
15.2.3.5	Procedures.....	86
15.2.4	Modification Of Link Characteristics Bearer Capability.....	86
15.2.4.1	Properties.....	87
15.2.4.2	Events.....	87
15.2.4.3	Signals.....	87
15.2.4.4	Statistics.....	87
15.2.4.5	Procedures.....	87
15.2.5	Enhanced Circuit Switched Data package.....	87
15.2.5.1	Properties.....	87
15.2.5.2	Events.....	88
15.2.5.3	Signals.....	88
15.2.5.4	Statistics.....	88
15.2.5.5	Procedures.....	88
15.2.6	Cellular Text telephone Modem Text Transport.....	88
15.2.6.1	Properties.....	88
15.2.6.2	Events.....	89
15.2.6.3	Signals.....	90
15.2.6.4	Statistics.....	90
15.2.6.5	Procedures.....	90
15.2.7	IP transport package.....	90
15.2.8	Flexible Tone Generator Package.....	90
15.2.8.1	Properties.....	90
15.2.8.2	Events.....	90

15.2.8.3	Signals .....	91
15.2.8.4	Statistics .....	92
15.2.8.5	Procedures .....	92
15.2.9	Trace Package .....	92
15.2.9.1	Properties .....	92
15.2.9.2	Events .....	94
15.2.9.3	Signals .....	95
15.2.9.4	Statistics .....	95
15.2.9.5	Procedures .....	95
15.2.10	ASCI Group call package .....	95
15.2.10.1	Properties .....	95
15.2.10.2	Events .....	96
15.2.10.3	Signals .....	96
15.2.10.4	Statistics .....	96
15.2.10.5	Procedures .....	96
15.2.11	3G Interface Type package .....	96
15.2.11.1	Properties .....	96
15.2.11.2	Events .....	97
15.2.11.3	Signals .....	97
15.2.11.4	Statistics .....	97
15.2.11.5	Procedures .....	97
<b>Annex A (informative): Framing protocol Interworking Function (FPIF).....</b>		<b>98</b>
A.1	Introduction .....	98
A.2	FPIF procedures with respect to Iu framing protocol.....	99
A.2.1	Payload .....	99
A.2.2	RFCIs .....	99
A.2.3	FQC .....	99
A.2.4	Frame number .....	99
A.3	Relay of status information .....	100
A.3.1	Void.....	100
A.3.2	Rate Control Frames.....	100
A.3.2	Time Alignment .....	100
<b>Annex B (informative): Examples for Usage of the 3GUP Package "Initialization Direction" Property .....</b>		<b>101</b>
<b>Annex C (Normative): Profile description.....</b>		<b>103</b>
C.1	Profile Identification.....	103
C.2	Summary .....	103
C.3	Gateway Control Protocol Version .....	103
C.4	Connection Model .....	103
C.5	Context Attributes .....	104
C.6	Terminations.....	104
C.6.1	Termination Names.....	104
C.6.1.1	General.....	104
C.6.1.2	ASN.1 Coding.....	105
C.6.1.2.1	General Structure .....	105
C.6.1.2.2	Termination naming convention for TDM terminations .....	105
C.6.1.3	ABNF Coding.....	105
C.6.1.3.1	General Structure .....	105
C.6.1.3.2	Termination naming convention for TDM terminations .....	106
C.6.1.3.3	Termination naming convention for Ephemeral terminations.....	106
C.6.2	Multiplexed terminations .....	106
C.7	Descriptors .....	106
C.7.1	Stream Descriptor .....	106
C.7.1.1	LocalControl Descriptor.....	106
C.7.2	Events Descriptor.....	107
C.7.3	EventBuffer Descriptor.....	108
C.7.4	Signals Descriptor.....	109

C.7.5	DigitMap Descriptor .....	110
C.7.6	Statistics Descriptor .....	110
C.7.7	ObservedEvents Descriptor .....	110
C.7.8	Topology Descriptor .....	110
C.7.9	Error Descriptor .....	110
C.7.10	TerminationState Descriptor .....	111
C.8	Command API .....	112
C.8.1	Add .....	112
C.8.2	Modify .....	112
C.8.3	Subtract .....	112
C.8.4	Move .....	113
C.8.5	AuditValue .....	113
C.8.6	AuditCapability .....	113
C.8.7	Notify .....	114
C.8.8	ServiceChange .....	114
C.8.9	Manipulating and auditing context attributes .....	116
C.9	Generic command syntax and encoding .....	116
C.10	Transactions .....	116
C.11	Messages .....	117
C.12	Transport .....	117
C.13	Security .....	118
C.14	Packages .....	119
C.14.1	Generic Package .....	123
C.14.2	Base Root Package .....	124
C.14.3	Tone Generator Package .....	125
C.14.4	Tone Detection Package .....	126
C.14.5	Basic DTMF Generator Package .....	127
C.14.6	Basic DTMF Detection Package .....	128
C.14.7	Continuity Package .....	129
C.14.8	TDM Circuit Package .....	130
C.14.9	Text Telephony Package .....	131
C.14.10	Call Discrimination Package .....	132
C.14.11	Announcement Package .....	134
C.14.12	Media Gateway Resource Congestion handling Package .....	135
C.14.13	Hanging Termination Detection Package .....	135
C.14.14	Bearer Characteristics Package .....	136
C.14.15	Generic Bearer Connection Package .....	137
C.14.16	Bearer Control Tunnelling Package .....	138
C.14.17	Basic Call Progress Tones Generator with Directionality .....	139
C.14.18	Expanded Call Progress Tones Generator Package .....	140
C.14.19	Basic Services Tones Generation Package .....	141
C.14.20	Expanded Services Tones Generation Package .....	142
C.14.21	Intrusion Tones Generation Package .....	143
C.14.22	Business Tones Generation Package .....	144
C.14.23	3GUP Package .....	145
C.14.24	Modification of Link Characteristics Bearer Capability .....	146
C.14.25	TFO package .....	147
C.14.26	Circuit Switched Data package .....	148
C.14.27	Enhanced Circuit Switched Data package .....	149
C.14.28	3G Expanded Call Progress Tones package .....	149
C.14.29	Cellular Text Telephone Modem Text Transport Package .....	150
C.14.30	Void .....	151
C.14.31	Flexible Tone Generator package .....	152
C.14.32	Trace Package .....	153
C.14.33	ASCI Group call .....	154
C.14.34	IP domain connection .....	155
C.14.35	Inactivity Timer Package .....	156
C.14.36	3G Interface Type package .....	157
C.14.37	Differentiated Services (ds) .....	158
C.14.38	Gate Management (gm) .....	159
C.14.39	Traffic management (tman) .....	160
C.14.40	IP Realm Availability (ipra) .....	161

C.14.41	RTCP Handling Package (rtcph) .....	161
C.14.42	Application Data Inactivity Detection (adid).....	162
C.14.43	Explicit Congestion Notification for RTP-over-UDP Support (ecnrous) .....	163
C.14.44	MG Act-as STUN Server (mgastuns) .....	165
C.14.45	Originate STUN Continuity Check (ostuncc).....	166
C.14.46	Enhanced Revised Offer/Answer SDP Support (eroas).....	167
C.15	Mandatory support of SDP and Annex C information elements .....	168
C.16	Optional support of SDP and Annex C information elements.....	169
<b>Annex D (informative): Change history .....</b>		<b>170</b>
History .....		177

---

# Foreword

This Technical Specification has been produced by the 3<sup>rd</sup> Generation Partnership Project (3GPP).

The contents of the present document are subject to continuing work within the TSG and may change following formal TSG approval. Should the TSG modify the contents of the present document, it will be re-released by the TSG with an identifying change of release date and an increase in version number as follows:

Version x.y.z

where:

- x the first digit:
  - 1 presented to TSG for information;
  - 2 presented to TSG for approval;
  - 3 or greater indicates TSG approved document under change control.
- y the second digit is incremented for all changes of substance, i.e. technical enhancements, corrections, updates, etc.
- z the third digit is incremented when editorial only changes have been incorporated in the document.

---

# 1 Scope

The present document describes the protocol to be used on the Media Gateway Controller (MGC) – Media Gateway (MGW) interface. The Media Gateway Controllers covered in this specification are the MSC server and the GMSC server. The basis for this interface profile is the H.248.1 [10] protocol as specified in ITU-T. The usage of this protocol is described in 3GPP TS 23.205 [2] and 3GPP TS 29.205 [7] for BICC circuit switched core network, in 3GPP TS 23.231 [54] and 3GPP TS 29.231 [57] for SIP-I circuit switched core network.

This profile includes the support for the enhanced MSC server to provide access to IMS Centralised services as described in 3GPP TS 23.292 [59] and thus the procedures related to this interface are described in 3GPP TS 29.292 [60]. As a result the interworking with SIP and the associated MGW control procedures described in 3GPP TS 29.163[61] for the interworking between BICC/ISUP circuit switched core network and IP Multimedia core network are incorporated.

This specification describes the changes to H.248 which are needed to handle 3GPP specific traffic cases. This is done by using the H.248 standard extension mechanism. In addition certain aspects of the base protocol H.248 are not needed for this interface and thus excluded by this profile.

---

# 2 References

The following documents contain provisions which, through reference in this text, constitute provisions of the present document.

- References are either specific (identified by date of publication, edition number, version number, etc.) or non-specific.
- For a specific reference, subsequent revisions do not apply.
- For a non-specific reference, the latest version applies. In the case of a reference to a 3GPP document (including a GSM document), a non-specific reference implicitly refers to the latest version of that document *in the same Release as the present document*.

- [1] 3GPP TS 23.153: "Out of band transcoder control; Stage 2".
- [2] 3GPP TS 23.205: "Bearer independent circuit-switched core network; Stage 2".
- [3] 3GPP TS 24.008: "Mobile radio interface Layer 3 specification; Core network protocols; Stage 3".
- [4] 3GPP TS 25.415: "UTRAN Iu interface user plane protocols".
- [5] 3GPP TS 28.062: "Inband Tandem Free Operation (TFO) of speech codecs; Service description; Stage 3".
- [6] 3GPP TS 29.007: "General requirements on interworking between the Public Land Mobile Network (PLMN) and the Integrated Services Digital Network (ISDN) or Public Switched Telephone Network (PSTN)".
- [7] 3GPP TS 29.205: "Application of Q.1900 series to Bearer Independent circuit-switched network architecture; Stage 3".
- [8] 3GPP TS 29.415: "Core Network Nb interface user plane protocols".
- [9] 3GPP TS 48.008: "Mobile Switching Centre - Base Station System (MSC - BSS) interface; Layer 3 specification".
- [10] ITU-T Recommendation H.248.1 (05/2002): "Gateway control protocol: Version 2" including the Corrigendum1 for Version 2 (03/04).
- [11] ITU-T Recommendation Q.2210 (1996): "Message transfer part level 3 functions and messages using the services of ITU-T Recommendation Q.2140".
- [12] IETF RFC 2960: "Stream control transmission protocol".

- [13] 3GPP TS 29.202: "Signalling System No. 7 (SS7) signalling transport in core network; Stage 3".
- [14] ITU-T Recommendation H.248.8 (09/2005): "Error codes and service change reason description".
- [15] ITU-T Recommendation H.248.10 (07/2001): "Media gateway resource congestion handling package".
- [16] 3GPP TS 26.103: "Speech codec list for GSM and UMTS".
- [17] ITU-T Recommendation H.248.2 (01/2005): "Facsimile, text conversation and call discrimination packages".
- [18] 3GPP TS 26.226: "Cellular text telephony; Transport of text in the voice channel".
- [19] ITU-T Recommendation T.140 (02/1998): "Protocol for multimedia application text conversation".
- [20] 3GPP TS 25.413: "UTRAN Iu interface RANAP signalling".
- [21] 3GPP TS 25.414: "UTRAN Iu interface data transport and transport signalling".
- [22] 3GPP TS 23.078: "Customized Applications for Mobile network Enhanced Logic (CAMEL); Stage 2".
- [23] ITU-T Recommendation Q.1950 (12/2002): "Bearer independent call bearer control protocol".
- [24] ITU-T Recommendation Q.765.5 (04/2004): "Signalling system No. 7 - Application transport mechanism: Bearer Independent Call Control (BICC)".
- [25] ITU-T Recommendation G.711 (11/1988): "Pulse code modulation (PCM) of voice frequencies".
- [26] 3GPP TS 26.102: "Mandatory speech codec; AMR speech codec; Interface to Iu, Uu and Nb".
- [27] 3GPP TS 23.014: "Support of Dual Tone Multi-Frequency (DTMF) signalling".
- [28] ITU-T Recommendation H.248.7 (03/2004): "Generic Announcement Package".
- [29] 3GPP TS 32.421: "Subscriber and equipment trace: Trace concepts and requirements".
- [30] 3GPP TS 32.422: "Subscriber and equipment trace: Trace control and configuration management".
- [31] 3GPP TS 32.423: "Subscriber and equipment trace: Trace data definition and management".
- [32] 3GPP TS 29.414: "Core Network Nb data transport and transport signalling".
- [33] ITU-T Recommendation X.213 (11/95): "Information technology - Open systems interconnection - Network Service Definitions".
- [34] Void
- [35] 3GPP TS 43.045: "Technical Realization Of Facsimile Group 3 service - Transparent".
- [36] ITU-T Recommendation H.248.36 (09/2005): "Hanging Termination Detection Package".
- [37] 3GPP TS 23.172 : "Technical realization of Circuit Switched (CS);multimedia service UDI/RDI fallback and service modification;Stage 2".
- [38] 3GPP TS 33.210 : "3G Security; Network Domain Security; IP Network Layer Security.
- [39] 3GPP TS 43.068: " Voice Group Call Service (VGCS); Stage 2".
- [40] 3GPP TS 43.069: " Voice Broadcast Service (VBS); Stage 2".
- [41] ITU-T Recommendation X.690: "ASN.1 encoding rules: Specification of Basic Encoding Rules (BER), Canonical Encoding Rules (CER) and Distinguished Encoding Rules (DER)".
- [42] ITU-T Recommendation H.248.41 (05/2006): " IP Domain Connection package".

- [43] 3GPP TS 23.003: "Numbering, addressing and identification".
- [44] IETF RFC 3309: "Stream Control Transmission Protocol (SCTP) Checksum Change"
- [45] ITU-T Recommendation H.248.14 (03/2009): "Inactivity timer package"
- [46] Void
- [47] Void
- [48] Void
- [49] Void
- [50] Void
- [51] 3GPP TS 29.332: "Media Gateway Control Function (MGCF) - IM Media Gateway; Mn Interface".
- [52] IETF RFC 3556: "Session Description Protocol (SDP) Bandwidth Modifiers for RTP Control Protocol (RTCP) Bandwidth".
- [53] IETF RFC 4566: "SDP: Session Description Protocol".
- [54] 3GPP TS 23.231: "SIP-I based circuit switched core network; stage 2".
- [55] IETF RFC 4040: "RTP Payload Format for a 64 kbit/s Transparent Call".
- [56] Void
- [57] 3GPP TS 29.231: "Application of SIP-I Protocols to Circuit Switched (CS) core network architecture; Stage 3".
- [58] 3GPP TS 32.407: "Telecommunication Management; Performance Management (PM) Performance measurements Core Network (CN) Circuit Switched (CS) domain".
- [59] 3GPP TS 23.292: "IP Multimedia Subsystem (IMS) Centralized Services; Stage 2".
- [60] 3GPP TS 29.292: "Interworking between the IP Multimedia (IM) Core Network (CN) subsystem and MSC Server for IMS Centralized Services (ICS)".
- [61] 3GPP TS 29.163: "Interworking between the IM CN subsystem and CS networks – Stage 3".
- [62] Void
- [63] Void
- [64] IETF RFC 2198: "RTP Payload for Redundant Audio Data".
- [65] 3GPP TS 48.103: "Base Station System – Media GateWay (BSS-MGW) interface; User Plane transport mechanism".
- [66] ITU-T Recommendation H.248.57 (06/2008): "Gateway control protocol: RTP Control Protocol Package".
- [67] ITU-T Recommendation H.248.43 (06/2008): "Gateway control protocol: Gate Management and Gate Control packages".
- [69] ITU-T Recommendation H.248.53 (06/2008) inclusive *Revision 1* (03/2009): "Gateway control protocol: Traffic management packages".
- [70] ITU-T Recommendation H.248.52 (06/2008): "Gateway control protocol: QoS support packages".
- [71] ITU-T Recommendation H.248.40 (01/2007): "Gateway control protocol: Application Data Inactivity Detection package".
- [72] ITU-T Recommendation H.248.41 Amendment 1 (06/2008): "Gateway control protocol: IP domain connection package: IP Realm Availability Package".

- [73] IETF RFC 2216: "Network Element Service Specification Template".
- [74] Void
- [75] Void
- [76] Void
- [77] 3GPP TS 26.114: "IP Multimedia Subsystem (IMS); Multimedia Telephony; Media handling and interaction".
- [78] 3GPP TS 22.153: "Multimedia Priority Service".
- [79] ITU-T Recommendation H.248.82 (03/2013): "Gateway control protocol: Explicit Congestion Notification Support".
- [80] Void.
- [81] ITU-T Recommendation H.248.50 (09/2010) Corrigendum 1 (02/12): "Gateway control protocol: NAT traversal toolkit packages".
- [82] 3GPP TS 24.229: "IP Multimedia Call Control Protocol based on SIP and SDP".
- [83] 3GPP TS 26.445: "Codec for Enhanced Voice Services (EVS); Detailed Algorithmic Description".
- [84] IETF RFC 5939: "Session Description Protocol (SDP) Capability Negotiation".
- [85] ITU-T Recommendation H.248.80 (01/2014): "Gateway control protocol: Usage of the revised SDP offer/answer model with ITU-T H.248".
- [86] IETF RFC 8445: "Interactive Connectivity Establishment (ICE): A Protocol for Network Address Translator (NAT) Traversal".
- [87] IETF RFC 8839: "Session Description Protocol (SDP) Offer/Answer Procedures for Interactive Connectivity Establishment (ICE)".

---

## 3 Definitions, symbols and abbreviations

### 3.1 Definitions

For the purposes of the present document, the following terms and definitions apply:

**context (H.248):** association between a number of Terminations

The context describes the topology (who hears/sees whom) and the media mixing and/or switching parameters if more than two terminations are involved in the association.

**package (H.248):** different types of gateways may implement terminations which have differing characteristics

Variations in terminations are accommodated in the protocol by allowing terminations to have optional properties. Such options are grouped into packages, and a termination may realise a set of such packages.

**termination (H.248):** logical entity on an MGW which is the source and/or sink of media and/or control streams

A termination is described by a number of characterising properties, which are grouped in a set of descriptors which are included in commands. Each termination has a unique identity (TerminationID).

**termination property (H.248):** used to describe terminations

Related properties are grouped into descriptors. Each termination property has a unique identity (PropertyID).

For the purposes of the present document, the following terms and definitions as defined in 3GPP TS 29.292 [60] apply:

**ICE lite**

**Full ICE.**

## 3.2 Symbols

For the purposes of the present document, the following symbols apply:

Iu	Interface between the RNS and the core network. It is also considered as a reference point.
Mc	Interface between the server and the media gateway.

## 3.3 Abbreviations

For the purposes of the present document, the following abbreviations apply:

BICC	Bearer Independent Call Control
CE	Congestion Experienced
ECN	Explicit Congestion Notification
EVS	Enhanced Voice Services
ICE	Interactive Connectivity Establishment
M3UA	SS7 MTP3 – User Adaptation Layer
MGC	Media Gateway Controller
MPS	Multimedia Priority Service
MTP3	Message Transfer Part layer 3
RFC	Request For Comment; this includes both discussion documents and specifications in the IETF domain
SCTP	Stream Control Transmission Protocol
SDP	Session Description Protocol
SDPCapNeg	SDP Capability Negotiation
STUN	Session Traversal Utilities for NAT
TFO	Tandem Free Operation
TrFO	Transcoder Free Operation

---

## 4 UMTS capability set

The support of the Mc interface capability set shall be identified by the Mc profile and support of this profile shall then be indicated in ServiceChange procedure via the ServiceChangeProfile parameter as defined in H.248.1 [10] and clarified in clause 4.2. The mandatory parts of this profile shall be used in their entirety. Failure to do so will result in a non-standard implementation.

ITU-T Recommendation H.248.1 [10] shall be the basis for this profile. The compatibility rules for packages, signals, events, properties and statistics and the H.248 protocol are defined in ITU-T Recommendation H.248.1 [10] Their use or exclusion for this interface is clarified in clause 12.

### 4.1 Profile Identification

For Profile Identification see Annex C.1.

### 4.2 Profile Registration

The following description is based on H.248.1 profile registration procedure with some clarifications. The reply to the ServiceChange Request containing the SCP parameter indicates if the MSC Server supports the requested profile or if it does not support it and wants to propose an alternative profile. The profile (name and version) is only returned in the reply if the MGC cannot support the specified profile in the ServiceChangeRequest. The returned reply shall indicate the profile and version supported or "NoProfile" if no profile is supported. Upon reception of a profile in the reply, if the MGW supports the indicated profile, it shall issue a new ServiceChange Request with the agreed profile to explicitly confirm the acceptance of the profile to the MGC ; otherwise, if the MGW does not support the indicated profile, it may continue the registration or re-registration procedure by issuing a new ServiceChange Request with an alternative profile ; until such procedure is successfully completed the MGW shall remain out of service. In the instance that the MGW did not indicate a profile in the original ServiceChangeRequest and the MGC returned a profile in the reply, the MGW shall issue a new ServiceChangeRequest with the appropriate profile or "NoProfile" if no profile is supported. If

the profile is not returned the MGC shall use the capabilities specified by the Profile indicated in the service change request.

NOTE: It should be observed that the profile registration is not a "cold calling" negotiation; the operator shall have configured the network to support certain profiles and so the profile registration within the Mc interface permits network upgrade scenarios but otherwise is simply a means to confirm the connection of the profile to be used over the Mc interface between MGC and MGW.

---

## 5 Naming conventions

### 5.1 MGC/MGW naming conventions

For definition see Annex C.11.

### 5.2 Termination names

For definition see Annex C.6.1.

---

## 6 Topology descriptor

For definition see Annex C.7.8.

---

## 7 Transaction timers

For definition see Annex C.10.

---

## 8 Transport

Each implementation of the Mc interface should provide the appropriate protocol options: MTP3B as defined in ITU-T Recommendation Q.2210 [11] (for ATM signalling transport) or SCTP as defined in RFC 2960 [12] and as updated by RFC3309 [44] (for IP signalling transport) and in the case where the signalling relation consists of both ATM signalling transport and IP signalling transport the M3UA protocol layer (3GPP TS 29.202 [13]) shall be added to SCTP to provide interworking. M3UA layer may also be added to SCTP for pure IP signalling transport. IPsec shall not be used by MSC Server or MGW for the Mc interface. Normally the Mc interface lies within a single operator's secure domain. If this is not the case then a Za interface (Security Gateway deploying IPsec) may be required, however this is a separate logical function/entity and thus is not attributed to Mc profile, the MSC Server or the MGW; for further details see 3GPP TS 33.210 [38]. For further definition see Annex C.12.

---

## 9 Multiple Virtual MG.

If an MGW is connected to more than one (G)MSC, the MGW shall fulfil the requirements outlined in the clause "Multiple virtual MGW" in ITU-T Recommendation H.248.1 [10].

---

## 10 Formats and codes

### 10.1 Signalling Objects

Table 10.1 shows the parameters which are required, in addition to those defined in the clause "Formats and Codes" of ITU-T Recommendation Q.1950 [23] (see 3GPP TS 29.205 [7]).

The coding rules applied in ITU-T Recommendation H.248.1 [10] for the applicable coding technique shall be followed for the UMTS capability set.

Unsupported values of parameters or properties may be reported by the MGW and shall be supported by the MSC as such by using H.248.1 error code #449 "Unsupported or Unknown Parameter or Property Value ". **Error Text in the error Descriptor:** The unsupported or unknown value is included in the error text in the error descriptor.

**Table 10.1: Additional parameters required**

Signalling Object	H.248 Descriptor	Coding
actprot	Signal descriptor	As for the signal "Activate protocol" in clause 15. 2.1.3
Allowed RTCP APP message types	Remote Descriptor	The "a=3gpp_mtsi_app_adapt" SDP attribute defined in 3GPP TS 26.114 [77].
Bearer modification possible	ObservedEvent descriptor	As for the ObservedEventDescriptor in "Bearer Modification Support" in clause 15. 2.3.2.
Bearer Modification Support	EventDescriptor	As for the EventsDescriptor in "Bearer Modification Support" in clause 15. 2.3.2.
Bitrate	Local control	As for the property "Bitrate" in clause 15.1.7.1
Cause	ObservedEvent descriptor	As for the ObservedEventsDescriptor parameter "Protocol Negotiation Result" in clause 15. 2.1.2
Changed Realms	Observed Events	According to Observed Events Parameters for <i>Available Realms Changed</i> event in ITU-T Recommendation H.248.41 [72].
Codec List	Local Descriptor or Remote Descriptor	<fmt list> in a single SDP m-line. For a static RTP payload type, the codec type should be implied by the RTP payload type, if not then each codec type shall be provided in a separate SDP "a=rtpmap"-line and possibly additional SDP "a=fmtp"-line(s). See Clause 10.2. For a dynamic RTP payload type, for each codec information on the codec type shall be provided in a separate SDP "a=rtpmap"-line and possibly additional SDP "a=fmtp"-line(s). See Clause 10.2
Coding	Local control	As for the property "GSM channel coding" in clause 15. 2.1.1
Connchnng	ObservedEventDescriptor	As for the ObservedEventDescriptor "Connection State Change" in clause 15.2.6.2
Ctmbits	Statistics descriptor	As for the Statistics descriptor "Characters Transferred" in clause 15.2.6.4
Ctmstate	TerminationState	As for the TerminationState "Text termination connection state" in clause 15. 2.6.1.
Ctmtext version	Local control	As for the property "Text Protocol Version" in clause 15.2.6.1.
Ctmtransport	Local control	As for the property "Text Transport" in clause 15.2.6.1.
Delay Variation Tolerance	Local Control	This is the tman/dvt property from ITU-T Recommendation H.248.53 [69]
Desired listener context terminations	Local control	As for the property "Number of desired listener context terminations" in clause 15.2.10.1
Diffserv Code Point	Local Control	Defined according to the Differentiated Services Code Point property in ITU-T Recommendation H.248.52 [70].
Diffserv Tagging Behaviour	Local Control	Defined according to the Tagging Behaviour property in ITU-T Recommendation H.248.52 [70].
Distlist	ObservedEvent descriptor	As for the ObservedEventDescriptor parameter "Distant TFO List" in clause 15. 2.2.2
ECN Enabled	Local Descriptor or Remote Descriptor	Defined according to the "ECN Enabled" property in ITU-T Recommendation H.248.82 [79].
ECN Failure	Events, Observed Events	Defined according to the "ECN Failure" Event in ITU-T Recommendation H.248.82 [79].
ECN Failure Type	ObservedEvents Descriptor	As for the ObservedEventsDescriptor Parameter "Failure Type" in ITU-T Recommendation H.248.82 [79].
ECN Initiation Method	Local Descriptor or Remote Descriptor	Defined according to "Initiation Method" property in ITU-T Recommendation H.248.82 [79].
Error	Error descriptor	As defined in the clause "Command error code" in ITU-T Recommendation H.248.1 [10]
Flextone	Signal descriptor	As for the signal "Flexible Tone" in clause 15.2.8.3
ICE host candidate request	Local Descriptor	The "a=candidate" SDP attribute defined in IETF RFC 8839 [87] of type "host" with the transport, port and priority parameters with wildcard sign "\$" to request the allocation of a host candidate
ICE host candidate	Local Descriptor	The "a=candidate" SDP attribute defined in IETF RFC 8839 [87].
ICE lite indication	Local Descriptor	The "a=ice-lite" SDP attribute defined in IETF RFC 8839 [87].
ICE pacing	Local Descriptor	The "a=ice-pacing" SDP attribute defined in IETF RFC 8839 [87]. Only applicable for full ICE as specified in IETF RFC 8445 [86].
ICE pacing request	Local Descriptor	The "a=ice-pacing" SDP attribute defined in IETF RFC 8839 [87] with wildcard sign "\$". Only applicable for full ICE as specified in IETF RFC 8445 [86].
ICE password request	Local Descriptor	The "a=ice-pwd" SDP attribute defined in IETF RFC 8839 [87] with wildcard sign "\$".
ICE password	Local Descriptor	The "a=ice-pwd" SDP attribute defined in IETF RFC 8839 [87].
ICE received candidate	Remote Descriptor	The "a=candidate" SDP attribute defined in IETF RFC 8839 [87].
ICE received pacing	Remote Descriptor	The "a=ice-pacing" SDP attribute defined in IETF RFC 8839 [87]. Only applicable for full ICE as specified in IETF RFC 8445 [86].

Signalling Object	H.248 Descriptor	Coding
actprot	Signal descriptor	As for the signal "Activate protocol" in clause 15. 2.1.3
Allowed RTCP APP message types	Remote Descriptor	The "a=3gpp_mtsi_app_adapt" SDP attribute defined in 3GPP TS 26.114 [77].
Bearer modification possible	ObservedEvent descriptor	As for the ObserverdEventDescriptor in "Bearer Modification Support" in clause 15. 2.3.2.
Bearer Modification Support	EventDescriptor	As for the EventsDescriptor in "Bearer Modification Support" in clause 15. 2.3.2.
Bitrate	Local control	As for the property "Bitrate" in clause 15.1.7.1
Cause	ObservedEvent descriptor	As for the ObservedEventsDescriptor parameter "Protocol Negotiation Result" in clause 15. 2.1.2
Changed Realms	Observed Events	According to Observed Events Parameters for <i>Available Realms Changed</i> event in ITU-T Recommendation H.248.41 [72].
Codec List	Local Descriptor or Remote Descriptor	<fmt list> in a single SDP m-line. For a static RTP payload type, the codec type should be implied by the RTP payload type, if not then each codec type shall be provided in a separate SDP "a=rtpmap"-line and possibly additional SDP "a=fmtp"-line(s). See Clause 10.2. For a dynamic RTP payload type, for each codec information on the codec type shall be provided in a separate SDP "a=rtpmap"-line and possibly additional SDP "a=fmtp"-line(s). See Clause 10.2
Coding	Local control	As for the property "GSM channel coding" in clause 15. 2.1.1
Connchnng	ObservedEventDescriptor	As for the ObservedEventDescriptor "Connection State Change" in clause 15.2.6.2
Ctmtdbits	Statistics descriptor	As for the Statistics descriptor "Characters Transferred" in clause 15.2.6.4
Ctmtdstate	TerminationState	As for the TerminationState "Text termination connection state" in clause 15. 2.6.1.
Ctmtdtext version	Local control	As for the property "Text Protocol Version" in clause 15.2.6.1.
Ctmtdtransport	Local control	As for the property "Text Transport" in clause 15.2.6.1.
ICE received password	Remote Descriptor	The "a=ice-pwd" SDP attribute defined in IETF RFC 8839 [87].
ICE received Ufrag	Remote Descriptor	The "a=ice-ufrag" SDP attribute defined in IETF RFC 8839 [87].
ICE Ufrag request	Local Descriptor	The "a=ice-ufrag" SDP attribute defined in IETF RFC 8839 [87] with wildcard sign "\$".
ICE Ufrag	Local Descriptor	The "a=ice-ufrag" SDP attribute defined in IETF RFC 8839 [87].
ICE Connectivity Check Result	Events, Observed Events	Defined according to Connectivity Check Result event in ITU-T Recommendation H.248.50 [81].
ICE Send Connectivity Check	Signals	Defined as the ostuncc/scc signal in ITU-T Recommendation H.248.50 [81].
ICE New Peer Reflexive Candidate	Events, Observed Events	Defined according to New Peer Reflexive Candidate event in ITU-T Recommendation H.248.50 [81], only applicable for full ICE.
ICE Send Additional Connectivity Check	Signals	Defined as the ostuncc/sacc signal in ITU-T Recommendation H.248.50 [81], only applicable for full ICE.
IMEI(SV)	Local control	As for the property "IMEI(SV)" in clause 15.2.9.1
IMSI	Local control	As for the property "IMSI" in clause 15.2.9.1
inactivity timeout	EventDescriptor	As for the EventsDescriptor in clause 6.2/H.248.14 "Inactivity Timeout"
Inactivity timeout	ObservedEvent descriptor	As for the ObserverdEventDescriptor in clause 6.2/H.248.14 "Inactivity Timeout "
Initdirection	Local control	As for the property "Initialization Direction" in clause 15.1.1.1
Interface	Local control	As for the property "Interface" in clause 15.1.1.1
IP Address	Local Descriptor or Remote Descriptor	<connection address> in SDP "c-line"
IP interface	Local Control	As for the property "IP interface type" in clause 15.2.11.1
IP realm identifier	Local control	As for the property "IP realm identifier" in clause 5.1.1/H.248.41
IP Version	Local Descriptor or Remote Descriptor	<address type> in SDP "c-line", see C.16
Iu IP Address	Local Descriptor or Remote Descriptor control	As defined in C.16
Iu IP Port	Local Descriptor or Remote Descriptor	As defined in C.16. Port Type is not defined in the Mc profile and shall be assumed always to be UDP.
List of interfaces	Local control	As for the property "List of interfaces" in clause 15.2.9.1
MGW Resource Congestion Handling - Indication	EventDescriptor	As for the EventDescriptor in clause 4.2.1/H.248.10 "MGCongestion"

Signalling Object	H.248 Descriptor	Coding
actprot	Signal descriptor	As for the signal "Activate protocol" in clause 15. 2.1.3
Allowed RTCP APP message types	Remote Descriptor	The "a=3gpp_mtsi_app_adapt" SDP attribute defined in 3GPP TS 26.114 [77].
Bearer modification possible	ObservedEvent descriptor	As for the ObserverdEventDescriptor in "Bearer Modification Support" in clause 15. 2.3.2.
Bearer Modification Support	EventDescriptor	As for the EventsDescriptor in "Bearer Modification Support" in clause 15. 2.3.2.
Bitrate	Local control	As for the property "Bitrate" in clause 15.1.7.1
Cause	ObservedEvent descriptor	As for the ObservedEventsDescriptor parameter "Protocol Negotiation Result" in clause 15. 2.1.2
Changed Realms	Observed Events	According to Observed Events Parameters for <i>Available Realms Changed</i> event in ITU-T Recommendation H.248.41 [72].
Codec List	Local Descriptor or Remote Descriptor	<fmt list> in a single SDP m-line. For a static RTP payload type, the codec type should be implied by the RTP payload type, if not then each codec type shall be provided in a separate SDP "a=rtpmap"-line and possibly additional SDP "a=fmtp"-line(s). See Clause 10.2. For a dynamic RTP payload type, for each codec information on the codec type shall be provided in a separate SDP "a=rtpmap"-line and possibly additional SDP "a=fmtp"-line(s). See Clause 10.2
Coding	Local control	As for the property "GSM channel coding" in clause 15. 2.1.1
Connchnng	ObservedEventDescriptor	As for the ObservedEventDescriptor "Connection State Change" in clause 15.2.6.2
Ctmmbits	Statistics descriptor	As for the Statistics descriptor "Characters Transferred" in clause 15.2.6.4
Ctmstate	TerminationState	As for the TerminationState "Text termination connection state" in clause 15. 2.6.1.
Ctmtext version	Local control	As for the property "Text Protocol Version" in clause 15.2.6.1.
Ctmtransport	Local control	As for the property "Text Transport" in clause 15.2.6.1.
Maximum Burst Size	Local Control	This is the tman/mbs property from ITU-T Recommendation H.248.53 [69]
Media Inactivity Detection	Events, Observed Events	Defined according to IP Flow Stop Detection event in ITU-T Recommendation H.248.40 [71].
Media Inactivity Detection Time	Events	As for the Event Parameter in ITU-T Recommendation H.248.40 [71] "Detection Time"
Media Inactivity Detection Direction	Events	As for the Event Parameter in ITU-T Recommendation H.248.40 [71] "Direction"
Mode	Local control	As for the property "UP mode of operation" in clause 15.1.1.1
Needed conference terminations	Local control	As for the property "Number of needed conference terminations" in clause 15.2.10.1
On/Off	Local control	As for the property "Echo cancelling" in clause E.13.1 in ITU-T Recommendation H.248.1 [10] . Default value is Off.
Optimalcodec	ObservedEvent descriptor	As for the ObservedEventDescriptor parameter "Optimal Codec Type" in clause 15. 2.2.2
Peak Data Rate	Local Control	This is the tman/pdr property from ITU-T Recommendation H.248.53 [69].
PLMN bearer capability	Local control	As for the property "PLMN BC" in clause 15. 2.1.1
Policing Required	Local Control	This is the tman/pol property from ITU-T Recommendation H.248.53 [69].
Port	Local Descriptor or Remote Descriptor	<port> in SDP m-line. <transport> in SDP m-line shall be set to value "RTP/AVP" for voice service Editor's note: the value for other services in FFS.
Priority Information	NA	Priority Indicator (clause 6.1.1 of ITU-T Recommendation H.248.1 [10]). Binary Encoding: Encoding as per ITU-T Recommendation H.248.1 [10] Annex A "priority" context attribute Textual Encoding: Encoding as per ITU-T Recommendation H.248.1 [10] Annex B "priority" context attribute
Rate	ObservedEvent descriptor	As for the ObservedEventDescriptor parameter "Rate Change" in clause 15. 2.1.2
Realm Availability Change	Events, Observed Events	According to Available Realms Changed event in ITU-T Recommendation H.248.41 [72].
Reduction	ObservedEvent descriptor	As for the ObserverdEventDescriptor in clause 4.2.1/H.248.10 "MGCongestion".

Signalling Object	H.248 Descriptor	Coding
actprot	Signal descriptor	As for the signal "Activate protocol" in clause 15. 2.1.3
Allowed RTCP APP message types	Remote Descriptor	The "a=3gpp_mtsi_app_adapt" SDP attribute defined in 3GPP TS 26.114 [77].
Bearer modification possible	ObservedEvent descriptor	As for the ObservedEventDescriptor in "Bearer Modification Support" in clause 15. 2.3.2.
Bearer Modification Support	EventDescriptor	As for the EventsDescriptor in "Bearer Modification Support" in clause 15. 2.3.2.
Bitrate	Local control	As for the property "Bitrate" in clause 15.1.7.1
Cause	ObservedEvent descriptor	As for the ObservedEventsDescriptor parameter "Protocol Negotiation Result" in clause 15. 2.1.2
Changed Realms	Observed Events	According to Observed Events Parameters for <i>Available Realms Changed</i> event in ITU-T Recommendation H.248.41 [72].
Codec List	Local Descriptor or Remote Descriptor	<fmt list> in a single SDP m-line. For a static RTP payload type, the codec type should be implied by the RTP payload type, if not then each codec type shall be provided in a separate SDP "a=rtpmap"-line and possibly additional SDP "a=fmtp"-line(s). See Clause 10.2. For a dynamic RTP payload type, for each codec information on the codec type shall be provided in a separate SDP "a=rtpmap"-line and possibly additional SDP "a=fmtp"-line(s). See Clause 10.2
Coding	Local control	As for the property "GSM channel coding" in clause 15. 2.1.1
Connchnng	ObservedEventDescriptor	As for the ObservedEventDescriptor "Connection State Change" in clause 15.2.6.2
Ctmmbits	Statistics descriptor	As for the Statistics descriptor "Characters Transferred" in clause 15.2.6.4
Ctmstate	TerminationState	As for the TerminationState "Text termination connection state" in clause 15. 2.6.1.
Ctmtext version	Local control	As for the property "Text Protocol Version" in clause 15.2.6.1.
Ctmtransport	Local control	As for the property "Text Transport" in clause 15.2.6.1.
Remote Source Address Filtering	Local Control	Defined according to Remote Source Address Filtering property in ITU-T Recommendation H.248.43 [67].
Remote Source Address Mask	Local Control	Defined according to Remote Source Address Mask property in ITU-T Recommendation H.248.43 [67].
Remote Source Port Filtering	Local Control	Defined according to Remote Source Port Filtering property in ITU-T Recommendation H.248.43 [67].
Remote Source Port	Local Control	Defined according to Remote Source Port property in ITU-T Recommendation H.248.43 [67].
Remote Source Port Range	Local Control	Defined according to Remote Source Port Range property in ITU-T Recommendation H.248.43 [67].
RTCP allocation	Local Control	Defined according to RTCP Allocation Specific Behaviour property in ITU-T Recommendation H.248.57 [66].
Reserve_Value	Local Control	ITU-T Recommendation H.248.1 [10] Mode property. Binary Encoding: Encoding as per ITU-T Recommendation H.248.1 Annex A "reserveValue" Textual Encoding: Encoding as per ITU-T Recommendation H.248.1 Annex B "reservedValueMode".
Result	ObservedEvent descriptor	As for the ObservedEventDescriptor parameter "Protocol Negotiation Result" in clause 15. 2.1.2
RtcpbwRR	Local Descriptor or Remote Descriptor	<bandwidth> in SDP "b:RR"-line as per IETF RFC 3556 [52].
RtcpbwRS	Local Descriptor or Remote Descriptor	<bandwidth> in SDP "b:RS"-line as per IETF RFC 3556 [52].
RTPpayload	Local Descriptor or Remote Descriptor	<fmt list> in SDP m-line
SDPCapNeg configuration	Local Descriptor or Remote Descriptor	The SDP attributes for SDP capability negotiation according to IETF RFC 5939 [84].
SDPCapNeg Supported Capabilities	Termination State	Defined according to <i>SDPCapNeg Extensions</i> property in ITU-T Recommendation H.248.80 [85].
STUN server request	LocalControl	Encoding as per ITU-T Recommendation H.248.50 [81] "MG Act-as STUN Server" (mgastuns) package "Act-as STUN Server" (astuns, 0x0001) property.
Sustainable Data Rate	Local Control	This is the tman/sdr property from ITU-T Recommendation H.248.53 [69]
termination heartbeat	EventDescriptor	As for the EventsDescriptor in clause 5.2.1/H.248.36 "Termination Heartbeat"

Signalling Object	H.248 Descriptor	Coding
actprot	Signal descriptor	As for the signal "Activate protocol" in clause 15. 2.1.3
Allowed RTCP APP message types	Remote Descriptor	The "a=3gpp_mtsi_app_adapt" SDP attribute defined in 3GPP TS 26.114 [77].
Bearer modification possible	ObservedEvent descriptor	As for the ObservedEventDescriptor in "Bearer Modification Support" in clause 15. 2.3.2.
Bearer Modification Support	EventDescriptor	As for the EventsDescriptor in "Bearer Modification Support" in clause 15. 2.3.2.
Bitrate	Local control	As for the property "Bitrate" in clause 15.1.7.1
Cause	ObservedEvent descriptor	As for the ObservedEventsDescriptor parameter "Protocol Negotiation Result" in clause 15. 2.1.2
Changed Realms	Observed Events	According to Observed Events Parameters for <i>Available Realms Changed</i> event in ITU-T Recommendation H.248.41 [72].
Codec List	Local Descriptor or Remote Descriptor	<fmt list> in a single SDP m-line. For a static RTP payload type, the codec type should be implied by the RTP payload type, if not then each codec type shall be provided in a separate SDP "a=rtpmap"-line and possibly additional SDP "a=fmtp"-line(s). See Clause 10.2. For a dynamic RTP payload type, for each codec information on the codec type shall be provided in a separate SDP "a=rtpmap"-line and possibly additional SDP "a=fmtp"-line(s). See Clause 10.2
Coding	Local control	As for the property "GSM channel coding" in clause 15. 2.1.1
Connchnng	ObservedEventDescriptor	As for the ObservedEventDescriptor "Connection State Change" in clause 15.2.6.2
Ctmtdbits	Statistics descriptor	As for the Statistics descriptor "Characters Transferred" in clause 15.2.6.4
Ctmtdstate	TerminationState	As for the TerminationState "Text termination connection state" in clause 15. 2.6.1.
Ctmtdtext version	Local control	As for the property "Text Protocol Version" in clause 15.2.6.1.
Ctmtdtransport	Local control	As for the property "Text Transport" in clause 15.2.6.1.
Termination heartbeat	ObservedEvent descriptor	As for the ObservedEventDescriptor in clause 5.2.1/H.248.36 "Termination Heartbeat"
tfoactvalue	Local control	As for the property "TFO activity control" in clause 15. 2.2.1
TFOcodeclist (NOTE)	Local control	As for the property "TFO Codec List" in clause 15. 2.2.1
TFO Status	EventDescriptor	As for the EventsDescriptor in "TFO_Status Event" in clause 15.2.2.2
tfostatus	ObservedEvent descriptor	As for the ObservedEventsDescriptor parameter "TFO Status" in clause 15.2.2.2
Trace activativity request	Local control	As for the property "Trace Activation Control" in clause 15.2.9.1
Trace Activation Result	ObservedEvents descriptor	As for the ObservedEventDescriptor "Trace Activation result" in clause 15.2.9.2
Trace Depth	Local control	As for the property "Trace Depth" in clause 15.2.9.1
Trace Recording Session Reference	Local control	As for the property "Trace Recording Session Reference" in clause 15.2.1.1
Trace reference	Local control	As for the property "Trace Reference" in clause 15.2.9.1
Triggering events	Local control	As for the property "Triggering events" in clause 15.2.9.1
Value	Local control	As for the property "Delivery of erroneous SDUs" in clause 15.1.1.1
Version	Local control	As for the property "Upversion" in clause 15.1.1.1
Warning tone	Signal descriptor	As for the signal "CAMEL Prepaid Warning Tone" in clause 15.2.3.3

NOTE: TFOcodeclist was named Codeclist in pre-release 8.

## 10.2 SDP Media Parameters for RTP Terminations

### 10.2.1 Speech Codecs

The speech codecs and their configuration permitted for use over SIP-I and AoIP are defined in 3GPP TS 26.102 [26], Clauses 9 and 10. The SDP parameters for those codecs are defined in 3GPP TS 26.103 [16], Clause 7 and in 3GPP TS 26.445 [83], Annex A.

The speech codecs for use for Enhanced MSC at the Mb interface are defined in 3GPP TS 26.114 [77].

Codec types may have static or dynamic RTP payload types as defined by the above references.

For dynamic payload type being used the codecs shall be signalled accordingly in the SDP "a=rtpmap"-line, where the selected options are expressed as MIME parameters in SDP "a=fmtp"-line.

For static payloads type being used the codecs shall be allowed to be signalled accordingly in the SDP "a=rtpmap"-line, when the selected options are expressed as MIME parameters in SDP "a=fmtp"-line. Otherwise the codec type is implied by the RTP payload type.

### 10.2.2 DTMF

DTMF support is defined within 3GPP TS 23.231 [54] and the RTP Payload Type shall be supported as defined in 3GPP TS 26.102 [26].

### 10.2.3 Auxiliary Payloads

#### 10.2.3.1 Void

#### 10.2.3.2 Void

#### 10.2.3.3 Clearmode Codec

On RTP terminations, Clearmode codec is transported according to IETF RFC 4040[55].

When the MGC determines that a 64 kbit/s unrestricted bearer service is requested, the clearmode codec shall be used. A dynamic payload type with CLEARMODE as encoding name shall be included in both the local and remote descriptor.

The behaviour of the MGW shall then conform to IETF RFC 4040[55]. All voice and signal processing functions such as silence suppression, comfort noise insertion and gain adjustment shall be automatically turned off. The MGW shall inherit the same QoS objectives as the ISDN bearer service.

#### 10.2.3.4 Silence suppression and Comfort Noise

Support of silence suppression and comfort noise is defined in 3GPP TS 26.102 [26].

#### 10.2.3.5 CS Data Service

##### 10.2.3.5.1 CS Data Service with no Redundancy

RTP transport for CS Data services on the A-Interface User Plane over IP (AoIP) is based on RFC 4040 (CLEARMODE) [55], when this payload type is used by itself it means no redundancy is offered, which results in a 64kbps net bit stream.

A specific Payload Type value (120) is defined in TS 48.103 [65] in the range of dynamic Payload Types for CSData without redundancy.

The SDP-syntax on the Mc interface for CS Data without redundancy is:

```
m=audio <port number> RTP/AVP 120  
a=rtpmap:120 CLEARMODE/8000
```

#### 10.2.3.5.2 CS Data Service with Redundancy

A second specific Payload Type value (121) is defined in TS 48.103 [65] in the range of dynamic Payload Types for RTP Payload for Redundant Audio Data over AoIP. Redundancy for the CS Data service on AoIP is realised according to IETF RFC 2198 [64]. The SDP-syntax (red, fmp) defined in this RFC is used to inform the MGW about the negotiated redundancy level. The encapsulated payload structure for CS Data is based on IETF RFC 4040 [55]. On AoIP RTP terminations, IETF RFC 2198 [64] shall be used for redundant data of the CLEARMODE payload type being used for the CSD service. Only the redundancy level 2 and level 3 are supported on the AoIP RTP terminations. For details at start and stop of a redundant data stream as well as in handover cases see TS 48.103 [65].

The MGC determines by BSSMAP negotiation with the BSS, whether redundancy is used and if so which level to use for the CS Data service. A dynamic payload type with "red" as encoding name shall be included in both the local and remote descriptor with the fmp attribute to signal the redundancy level. The same redundancy level shall be used in the Local Descriptor and the Remote Descriptor to use the same redundancy level in both directions between the MGW with the BSS.

**NOTE:** Whether the RTP payload for Redundant Audio Data is supported by the MGW is known by the MSC due to configuration data.

The MGC shall include both the CLEARMODE payload type and the Redundant RTP Payload for Audio Data in the Mc interface towards the MGW when the Redundant RTP Payload for Audio Data encapsulating the CLEARMODE payload shall be used. The MGW shall then apply the procedures for support of RTP redundancy as described in 3GPP TS 48.103 [65].

The SDP-syntax on the Mc interface for CS Data with redundancy level 2 is:

```
m=audio <port number> RTP/AVP 121 120  
a=rtpmap:120 CLEARMODE/8000  
a=rtpmap:121 red/8000  
a=fmp:121 120/120
```

The SDP-syntax on the Mc interface for CS Data with redundancy level 3 is:

```
m=audio <port number> RTP/AVP 121 120  
a=rtpmap:120 CLEARMODE/8000  
a=rtpmap:121 red/8000  
a=fmp:121 120/120/120
```

#### 10.2.4 Other Payload Types

On RTP terminations, other payload types such as additional ITU-T codecs can be transported according to the RTP payload formats in IETF but their support is outside the scope of 3GPP specifications.

# 11 Mandatory Support of SDP and H.248.1 annex C information elements

This clause shall be in accordance with the clause "Mandatory Support of SDP and H.248.1 annex C information elements" in ITU-T Recommendation Q.1950 [23] (see 3GPP TS 29.205 [7]) with the following requirements:

- Mc Single Codec encoding:

The ACodec property in H.248 binary encoding and codeconfig attribute in H.248 text encoding are set as defined in ITU-T Recommendation Q.765.5 [24], for single codec information (figure 14/Q.765.5), where the Codec Information is defined either in ITU-T Recommendation Q.765.5 [24] or in another specification for the given Organization Identifier. For 3GPP codecs these are defined in 3GPP TS 26.103 [16]. The codeconfig and ACodec parameters contain the contents of the Single Codec IE, excluding the Single Codec Identifier, Length Indication and Compatibility Information.

The 'vsel' attribute is omitted in H.248 text encoding.

Example of encoding of an AMR codec:

ACodec = 0206959504 (binary encoding)

codeconfig = 0206959504 (text encoding)

where the AMR parameters are: ETSI, UMTS\_AMR\_2, [ACS={4.75, 5.90, 7.4, 12.2}, SCS={4.75, 5.90, 7.4, 12.2}, OM=0, MACS=4]

Example of encoding of a G.711 codec:

ACodec = 0101 (binary encoding)

codeconfig = 0101 (text encoding)

where the G.711 parameters are: ITU-T, G.711 64kps A-law

Example of encoding of an EVS codec:

ACodec = 020E01 (binary encoding)

codeconfig = 020E01 (text encoding)

where the EVS parameters are: ETSI, UMTS\_EVS, Config-EVS-Code=1, and Config-EVS-Code 2 is not present

NOTE: The "Mc Single Codec IE" differs from the ITU-T defined "Single Codec IE", while on the Nc interface (i.e. in OoBTC) the ITU-T Single Codec IE is used without deviation.

The ACodec property or codeconfig attribute set to the MuMe Dummy codec denotes a multimedia call. The ACodec property and codeconfig attribute shall never be set to the MuMe2 Dummy codec. See 3GPP TS 26.103 [16] and 3GPP TS 23.172 [37].

For further definition see Annex C.15.

---

## 12 General on Packages and Transactions

The use of "Overspecified" (e.g. range of values) and "Underspecified" (e.g. "?") parameter specification shall not be permitted except where explicitly indicated in or referenced by the Mc interface specification.

The use of wildcarding for the Termination Id shall be performed using 1 octet only.

Notifications shall not be sent by the MGW in response to Release Termination procedure.

Parameter modification and event notification shall not be permitted on non-ROOT Terminations in the NULL Context.

Commands on ROOT Termination shall only use the NULL Context.

If a command cannot be executed by the MSC Server due to a temporary congestion/ongoing task the error code 511 ("Temporarily Busy") may be returned; the MGW may then re-issue the command as the condition may have abated.

NOTE: At the time of inclusion this error code did not exist in the H.248.8 further details of this error code see ITU-T Sub-series Implementors' Guide.(13 April 2006).

If a circumstance arises at an MGW where a substantial number of notifications accumulate, either because of transmission difficulties or because the MGW recognised a number of events in a short time period, the MGW should send the notifications in a restricted manner (e.g. via configuration) until the backlog is cleared.

For further definition see Annex C.

---

## 13 BICC packages

### 13.1 Mandatory BICC packages

Mandatory BICC packages are listed in Annex C.14.

### 13.2 Optional BICC packages

Optional BICC packages are listed in Annex C.14.

## 14 H.248 standard packages

Mandatory and Optional H.248 packages are listed in Annex C.14.

### 14.1 Call independent H.248 transactions

Table 2 shows the relationship between each non call-related procedure in ITU-T Recommendation Q.1950 [23] (see 3GPP TS 29.205 [7]) and the corresponding stage 2 procedure defined in 3GPP TS 23.205 [2].

For further description of error codes and service change reasons, refer to ITU-T Recommendation H.248.8 [14].

**Table 14.1.1: Correspondence between ITU-T Recommendation Q.1950 [23] non call-related transactions and 3GPP TS 23.205 [2] procedures**

Transaction used in ITU-T Recommendation Q.1950 [23]	Procedure defined in 3GPP TS 23.205 [2]	Support	Comments
BIWF_Service_Cancellation_Indication	MGW Out of Service	Mandatory	
BIWF_Lost_Communication	MGW Communication Up	Mandatory	
BIWF_Service_Restoration_Indication	MGW Restoration	Mandatory	
BIWF_Registration	MGW Register	Mandatory	
BIWF_Re-Registration	MGW Re-register	Mandatory	
CCU Ordered BIWF Re-Registration	(G)MSC Server Ordered Re-register	Mandatory	
CCU Initiated Service Restoration	(G)MSC Server Restoration	Optional	
CCU Initiated Service Cancellation	(G)MSC Server Out of Service	Optional	
BIWF_Service_Cancellation_Indication	Termination Out-of-Service	Mandatory	Is a part of BIWF Service cancellation in Q.1950
BIWF_Service_Restoration_Indication	Termination Restoration	Mandatory	Is a part of BIWF Service cancellation in Q.1950
Audit_Values	Audit Value	Mandatory	Shall be supported for the audit of Termination State and for periodic audit of MGW (empty Audit descriptor). May be supported for the audit of packages.
Audit_Capabilities	Audit Capability	Optional	The capabilities to be audited shall be defined in clause 12.
BIWF_Capability_Change	Capability Update	Optional	This corresponds to MGW Capability Change in this document.
	MGW Resource Congestion Handling - Activate	Mandatory	
	MGW Resource Congestion Handling - Indication	Mandatory	
Continuity Check Tone		Optional	
Continuity Check Verify		Optional	
Continuity Check Response		Optional	
Not Defined	Inactivity Timeout - Activate	Optional	
Not Defined	Inactivity Timeout - Indication	Optional	
Not Defined	Realm Availability Change - Activation	Optional	
Not Defined	Realm Availability Change - Indication	Optional	

## 14.1.1 MGW Out of service/Maintenance Locking

This procedure is the same as described in the clause "BIWF Service Cancellation Indication" in ITU-T Recommendation Q.1950 [23] (see 3GPP TS 29.205 [7]), with the following clarification.

**Table 14.1.1.1: MGW Out of service/Maintenance Locking**

Address Information	Control information	Bearer information
	Transaction ID = z Context ID = Null Termination ID = Root Service Change Reason = MGW impending failure Termination Taken out of service Service Change Method = Graceful / Forced	

Delay is not used.

NOTE: The termination that is taken out of service is a Media Gateway.

## 14.1.2 MGW Communication Up

This procedure is the same as described in the clause "BIWF Lost Communication" in ITU-T Recommendation Q.1950 [23] (see 3GPP TS 29.205 [7]) with the following clarification.

Use of time stamps is optional.

Context Id value Null shall be used in this procedure.

The ServiceChangeMGCId parameter may be returned in the MGW Communication Up response if the MGC does not wish to sustain an association with the MGW. If present in the response, the MGW shall not consider itself registered and should preferably attempt to re-register with the MGC specified in the ServiceChangeMgcID before any further alternate MGCs.

## 14.1.3 MGW Restoration

This procedure is the same as described in the clause "BIWF Service Restoration Indication" in ITU-T Recommendation Q.1950 [23] (see 3GPP TS 29.205 [7]) with the following clarification.

**Table 14.1.3: MGW Restoration**

Address Information	Control information	Bearer information
	Transaction ID = z Context ID = Null Termination ID = Root	

Delay is not used.

The ServiceChangeMGCId parameter may be returned in the MGW Restoration response if the MGC does not wish to sustain an association with the MGW. If present in the response, the MGW shall not consider itself registered and should preferably attempt to re-register with the MGC specified in the ServiceChangeMgcID before any further alternate MGCs.

## 14.1.4 MGW Register

This procedure is the same as that described in the clause "BIWF Registration" in ITU-T Recommendation Q.1950 [23] (see 3GPP TS 29.205 [7]) with the following clarification.

### 14.1.4: MGW Register

Address Information	Control information	Bearer information
	ServiceChangeProfile = mcprofilename / version	

Use of time stamps is optional.

Context Id value Null shall be used in this procedure.

Non Standard Data is shall not be supported.

Service Change Address shall not be used.

The ServiceChangeMGCId parameter may be returned in the MGW Register response. If present in the Register response, the MGW shall not consider itself registered and should preferably attempt to re-register with the MGC specified in the ServiceChangeMgcID before any further alternate MGCs.

## 14.1.5 MGW Re-register

This procedure is the same as that described in the clause "BIWF Re-Registration" in ITU-T Recommendation Q.1950 [23] (see 3GPP TS 29.205 [7]) with the following clarification.

**Table 14.1.5.1: MGW Re-register**

Address Information	Control information	Bearer information
	ServiceChangeProfile = mcprofilename / version	

Use of time stamps is optional.

Context Id value Null shall be used in this procedure.

Non Standard Data is shall not be supported.

Service Change Address shall not be used.

The ServiceChangeMGCId parameter may be returned in the MGW Re-register response. If present in the response, the MGW shall not consider itself registered and should preferably attempt to re-register with the MGC specified in the ServiceChangeMgcID before any further alternate MGCs.

## 14.1.6 (G)MSC Server Ordered Re-register

This procedure is the same as described in the clause "CCU Ordered BIWF Re-registration" in ITU-T Recommendation Q.1950 [23] (see 3GPP TS 29.205 [7]) with the following clarifications:

Context Id value Null shall be used in this procedure.

## 14.1.7 (G)MSC Server Restoration

This procedure is the same as described in the clause "CCU Initiated Service Restoration" in ITU-T Recommendation Q.1950 [23] (see 3GPP TS 29.205 [7]) with the following clarification.

**Table 14.1.7.1: (G)MSC Server Restoration**

Address Information	Control information	Bearer information
	Context ID = Null Termination ID = Root Service Change Reason = Cold Boot / Warm Boot Service Change Method = Restart	

Delay is not used.

### 14.1.8 Termination Out-of-Service

This procedure is the same as described in the clause "BIWF Service Cancellation Indication" in ITU-T Recommendation Q.1950 [23] (see 3GPP TS 29.205 [7]) with the following clarifications. This procedure may be used to inform the MSC Server of the Service State of Terminations after MGW Restart or Registration.

**Table 14.1.8.1:ServiceChange.req (Termination Out-of-Service)MGW to MGC**

Address Information	Control information	Bearer information
	Transaction ID = z Context ID = Contexts / Null / All Termination ID = ALL/Termination(s) Service Change Reason = Transmission failure / Termination malfunctioning / Loss of lower layer connectivity / Termination taken out of service Service Change Method = Graceful / Forced  NOTE1: "All" shall refer to 1 TDM group. 1 TDM group is at a T1/E1.	

Delay is not used.

The MGW shall delay initiating a TDM Termination Out-of-Service procedure till completion of any on-going Termination Restoration procedure for the same TDM termination, if any, unless the MGW considers the previous transaction request or reply lost, due to e.g. failure of the control association.

The following table illustrates the allowed combinations that can be obtained with the ServiceChange Command:

**Table 14.1.8.2: Combinations of ContextID and TerminationID in Termination Out-of- Service Procedure**

ContextID	TerminationID	Description
Specific	Specific	Service Change of a specific Termination in a specific Context
Null	Wildcard	Service Change of all matching TDM T1/E1 level terminations in the Null Context
Null	Specific	Service Change of a specific termination in the Null Context
All	Wildcard	Service Change of all matching TDM T1/E1 level terminations in specific (non-Null) contexts in which the terminations currently exist.

### 14.1.9 Termination Restoration

This procedure is the same as described in the clause "BIWF Service Restoration Indication" in ITU-T Recommendation Q.1950 [23] (see 3GPP TS 29.205 [7]) with the following clarification. This procedure may be used to inform the MSC Server of the Service State of Terminations after MGW Restart or Registration and shall be used when individual trunks are commissioned.

**Table 14.1.9.1: Termination Restoration**

Address Information	Control information	Bearer information
	Transaction ID = z Context ID = Contexts / Null / All Termination ID = ALL/Termination(s) Service Change Reason = Service Restored Service Change Method = Restart  NOTE1: "All" shall refer to 1 TDM group. 1 TDM group is at a T1/E1.	

Delay shall not be used.

The MGW shall delay initiating a TDM Termination Restoration procedure till completion of any on-going Termination Out-of-Service procedure for the same TDM termination, if any, unless the MGW considers the previous transaction request or reply lost, due to e.g. failure of the control association.

The following table illustrates the allowed combinations that can be obtained with the ServiceChange Command:

**Table 14.1.9.2: Combinations of ContextID and TerminationID in Termination Restoration Procedure**

ContextID	TerminationID	Description
Specific	Specific	Service Change of a specific Termination in a specific Context
Null	Wildcard	Service Change of all matching TDM T1/E1 level terminations in the Null Context
Null	Specific	Service Change of a specific termination in the Null Context
All	Wildcard	Service Change of all matching TDM T1/E1 level terminations in specific (non-Null) contexts in which the terminations currently exist.

### 14.1.10 Audit Value

This procedure is the same as described in the clause "Audit Values" in ITU-T Recommendation Q.1950 [23] (see 3GPP TS 29.205 [7]), with the following clarifications. This procedure shall be used by the MSC Server to determine the service state of physical terminations when the MSC Server itself has restarted if it is subsequently unsure of the service state of terminations or when O&M procedures indicate new physical trunks have been commissioned to an in service MGW. It shall also be used for determining the Termination State after MGW Registration (Cold Boot) prior to deblocking devices in the network if the MSC Server has not been informed specifically by Termination Restoration or Termination Out Of Service Procedure. Table 14.1.10.1: AUD\_VAL.req (Audit\_Values) MGC to MGW

Address Information	Control information	Bearer information
	<p>Transaction ID = z                      Context ID = Null/Context ID/ALL                      Termination ID =                      Termination/Root/ALL(see NOTE1)                      Audit Descriptor =                      Empty/                      IndAuditParameter:=                      IndAudMediaDescriptor:=                      TermStateDescriptor (NOTE3)</p> <p>Packages (See NOTE2)</p> <p>Audit Descriptor = IndAuditParameter:= IndAudMediaDescriptor:=                      IndAudTerminationStateDescriptor:= SDPCapNeg Supported Capabilities (NOTE4)</p> <p>NOTE1: "All" shall refer to 1 TDM group. 1 TDM group is at a T1/E1 level It shall not be used for ATM or IP termination.                      "Termination" may be used for individual TDM, IP or ATM terminations.</p> <p>NOTE2: Packages is for                      - Null/Root Combination</p> <p>NOTE3: Pre Rel6 this is performed with Audit Token                      NOTE4: Used for auditing SDPCapNeg Extensions when SDPCapNeg signalling to the gateway is supported.</p>	

Upon reception of the command in the MGW:

- The Service State returns the current Service State
- When Packages are requested, the Package Names and Versions are returned

The following table illustrates the allowed combinations that can be obtained with the AuditValue Command:

**Table 14.1.10.2: Combinations of AuditValue Command**

ContextID	TerminationID	Information Obtained
Specific	Wildcard	Audit of matching Terminations in a Context
Specific	Specific	Audit of a single Termination in a Context
Null	Root	Audit of Media Gateway state and events
Null	Wildcard	Audit of all matching TDM T1/E1 level Terminations in the null Context
Null	Specific	Audit of a single Termination outside of any Context
All	Wildcard	Audit of all matching TDM T1/E1 level Terminations and the Context to which they are associated
All	Specific	(Non-null) ContextID in which the Termination currently exists

**Table 14.1.10.3: AUD\_VAL.resp MGW to MGC**

Address Information	Control information	Bearer information
	Transaction ID = z Context ID = Null/Context ID/ALL Termination ID = Termination/Root/ALL(see NOTE1) Audit Descriptor = Empty/ IndAuditParameter:= IndAudMediaDescriptor:= TermStateDescriptor (NOTE3)  Packages (See NOTE2)  Audit Descriptor = IndAuditParameter:= IndAudMediaDescriptor:= IndAudTerminationStateDescriptor:= SDPCapNeg Supported Capabilities (NOTE4)  NOTE1: "All" shall refer to 1 TDM group. 1 TDM group is at a T1/E1 level It shall not be used for ATM or IP termination. "Termination" may be used for individual TDM, IP or ATM terminations.  NOTE2: Packages is for - Null/Root Combination  NOTE3: Pre Rel6 this is performed with Audit Token NOTE4: Used for auditing SDPCapNeg Extensions when SDPCapNeg signalling to the gateway is supported.	

### 14.1.11 Audit Capability

This procedure is the same as described in the clause "Audit Capabilities" in ITU-T Recommendation Q.1950 [23] (see 3GPP TS 29.205 [7]).

### 14.1.12 MGW Capability Change

This procedure is the same as described in the clause "BIWF Capability Change" in ITU-T Recommendation Q.1950 [23] (see 3GPP TS 29.205 [7]) with the following clarification:

For Capability changes concerning the whole MGW:

Service Change Reason Media/Event or Signal Capability Failure shall not be used instead the following information shall be used:

ServiceChange.req (MGW Capability Change)

MGW to MGC

**Table 14.1.12.1: MGW Capability Change**

Address Information	Control information	Bearer information
	Service Change Reason = Packages Change/ Capability Change Service Change Info = changed package/property/signal/event/ statistics	
Note: The changed package/property/signal/event/ statistics information is FFS		

### 14.1.13 (G)MSC Server Out of Service

This procedure is the same as that described in the clause "CCU Initiated Service Cancellation" in ITU-T Recommendation Q.1950 [23] (see 3GPP TS 29.205 [7]) with the following clarification.

**Table 14.1.13.1: (G)MSC Server Out of Service**

Address Information	Control information	Bearer information
	Service Change Reason = Termination taken out of service	

Delay shall not be used.

### 14.1.14 MGW Resource Congestion Handling - Activate

If the procedure "MGW Resource Congestion Handling - Activate" is required the following procedure is initiated.

The MGC sends a MOD.req command with the following information.

**Table 14.1.14.1: MOD.req(MGW Resource Congestion Handling - Activate) MGC to MGW**

Address Information	Control information	Bearer information
	Transaction ID = z Context ID = Null Termination ID = Root  NotificationRequested (Event ID = x, "MGW Resource Congestion Handling - Indication")	

When the processing of command (1) is complete, the MGW initiates the following procedure.

**Table 14.1.14.2: MOD.resp (MGW Resource Congestion Handling - Activate) MGW to MGC**

Address Information	Control information	Bearer information
	Transaction ID = z Context ID = Null TerminationID = Root	

### 14.1.15 MGW Resource Congestion Handling - Indication

If the procedure "MGW Resource Congestion Handling - Indication" is required, the following procedure is initiated:

The MGW sends a NOT.req command with the following information.

**Table 14.1.15.1: NOT.req (MGW Resource Congestion Handling - Indication) MGW to MGC**

Address Information	Control information	Bearer information
	Transaction ID = z Context ID = Null Termination ID = Root  Event_ID (Event ID = x, "MGW Resource Congestion Handling - Indication (Reduction)")	

When the processing of command (1) is complete, the MGC initiates the following procedure.

**Table 14.1.15.2: NOT.resp (MGW Resource Congestion Handling - Indication) MGC to MGW**

Address Information	Control information	Bearer information
	Transaction ID = z Context ID = Null Termination ID = Root	

### 14.1.16 Continuity Check Tone

This procedure is the same as described in Annex B.7.1.1 of ITU-T Recommendation Q.1950 [23] with the following clarification:

The addition to "Prepare BNC Notify" defined in Annex B.7.1.1 of ITU-T Recommendation Q.1950 [23] shall be applied instead to "Reserve Circuit", as defined in Clause 13.2.2.1

Note: This does not preclude the use of the continuity check tone for other maintenance procedures. If the termination is audited it shall report state in service.

### 14.1.17 Continuity Check Verify

This procedure is the same as described in Annex B.7.2.1 of ITU-T Recommendation Q.1950 [23].

### 14.1.18 Continuity Check Response

This procedure is the same as described in Annex B.7.1.2 of ITU-T Recommendation Q.1950 [23] with the following clarification:

The addition to "Prepare BNC Notify" defined in Annex B.7.1.2 of ITU-T Recommendation Q.1950 [23] shall be applied instead to "Reserve Circuit", as defined in Clause 13.2.2.1

Note: This does not preclude the use of the continuity check response for other maintenance procedures. If the termination is audited is shall report state in service.

### 14.1.19 Inactivity Timeout - Activate

If the procedure "Inactivity Timeout - Activate" is required the following procedure is initiated.

The MGC sends a MOD.req command with the following information.

**Table 14.1.19.1: MOD.req (Inactivity Timeout - Activate) MGC to MGW**

Address Information	Control information	Bearer information
	Transaction ID = z Context ID = Null Termination ID = Root  NotificationRequested (Event ID = x, "Inactivity Timeout - Indication")	

When the processing of command (1) is complete, the MGW initiates the following procedure.

**Table 14.1.19.2: MOD.resp (Inactivity Timeout - Activate) MGW to MGC**

Address Information	Control information	Bearer information
	Transaction ID = z Context ID = Null TerminationID = Root	

## 14.1.20 Inactivity Timeout – Indication

When the procedure "Inactivity Timeout indication" is required the following procedure is initiated: the MGW sends a NOT.req command with the following information.

**Table 14.1.20.1: NOT.req (Inactivity Timeout - Indication) MGW to MGC**

Address Information	Control information	Bearer information
	Transaction ID = z Context ID = NULL Termination ID = Root  Event_ID (Event ID = x, " Inactivity Timeout - Indication ")	

When the processing of command is complete, the MGC initiates the following procedure.

**Table 14.1.20.2: NOT.resp (Inactivity Timeout - Indication) MGC to MGW**

Address Information	Control information	Bearer information
	Transaction ID = z Context ID = NULL Termination ID = Root	

## 14.1. 21 Realm Availability Change – Activation

The MGC sends a MODIFY request command as in Table 14.1.221.1.

**Table 14.1.21.1: Realm Availability Change – Activation**

Address Information	Control information	Bearer information
	Transaction ID = x Context ID= - Termination ID = ROOT  NotificationRequested (Event ID = x, "Realm Availability Change")	

The MGW responds as in Table 14.1.21.2.

**Table 14.1.21.2: Realm Availability Change – Activation Ack**

Address Information	Control information	Bearer information
	Transaction ID = x Context ID = - Termination ID = ROOT	

## 14.1. 22 Realm Availability Change – Indication

The MGW sends a NOTIFY request command as in Table 14.1.22.1.

**Table 14.1.22.1: Realm Availability Change – Indication**

Address Information	Control information	Bearer information
	Transaction ID = x Context ID = - Termination ID = ROOT  Event_ID (Event ID = x, "Realm Availability Change (Changed Realms)")	
NOTE: The ObservedEvent Parameters returned within the Changed Realms are defined as mandatory since it shall contain at minimum 1 parameter but may contain both Newly Available Realms and Newly Unavailable Realms.		

The MGC responds as in Table 14.1.22.2

**Table 14.1.22.2: Realm Availability Change – Indication Ack**

Address Information	Control information	Bearer information
	Transaction ID = x Context ID = - Termination ID = ROOT	

## 14.2 Call related H.248 transactions

Table 14.2.1 shows the relationship between each call-related procedure in ITU-T Recommendation Q.1950 [23] (see 3GPP TS 29.205 [7]) and the corresponding stage 2 procedure defined in 3GPP TS 23.205 [2], as well as specifying the requirement for support of each procedure on the Mc interface.

**Table 14.2.1: Correspondence between ITU-T Recommendation Q.1950 [23] call-related transactions and 3GPP TS 23.205 [2], 3GPP TS 23.153 [1], 3GPP TS 23.231 [54] and 3GPP TS 29.292 [60] procedures**

Transaction used in Q.1950	Procedure defined in 3GPP TS 23.205 [2], 23.153 [1], 23.231 [54] or 29.292 [60]	Support	Comments
Change_Topology	Change Flow Direction	Mandatory	
Join	Join Bearer Termination	Mandatory	
Isolate	Isolate Bearer Termination	Mandatory	
Establish_BNC_Notify+(tunnel)	Establish Bearer	Mandatory	
Prepare_BNC_Notify+(tunnel)	Prepare Bearer	Mandatory	
Cut_Through	Change Through Connection	Mandatory	
Not defined in Q.1950	Activate Interworking Function	Optional	
Cut_BNC (include several procedures).	Release Bearer (Release Bearer and Release termination)	Mandatory	
BNC Established	Bearer Established	Mandatory	
BNC Release	Bearer Released	Mandatory	
Insert_Tone	Send Tone	Mandatory	
Insert_Announcement	Play Announcement	Mandatory	
Signal Completion	Announcement Completed	Mandatory	
Detect_Digit	Detect DTMF	Mandatory	
Insert_Digit	Send DTMF	Mandatory	
Digit Detected	DTMF	Mandatory	
Confirm_Char	Confirm Char	Optional	
Modify_Char	Modify Char	Optional	
Reserve_Char	Reserve Char	Optional	
BNC Modified	Bearer Modified	Optional	
Echo Cancellor	Activate Voice Processing Function	Mandatory	
BNC Modification failed	Bearer Modified Failed	Optional	
Tunnel (MGC-MGW)	Tunnel Information Down	Optional	Shall be supported for BICC associated Nb interface transport protocol on IP
Tunnel (MGW-MGC)	Tunnel Information Up	Optional	Shall be supported for BICC associated Nb interface transport protocol on IP
Insert_Tone	Stop Tone	Mandatory	
Insert_Announcement	Stop Announcement	Mandatory	
Detect_Digit	Stop DTMF Detection	Optional	
Insert_Digit	Stop DTMF	Mandatory	
Signal Completion	Tone Completed	Optional	
Not defined	Reserve Circuit	Mandatory	
Not defined	Command Rejected	Mandatory	
Not defined	TFO Activation	Optional	
Not defined	Codec Modify	Optional	
Not defined	Optimal Codec and Distant List_Notify	Optional	
Not defined	Distant Codec List	Optional	
Not defined	TFO status Notify	Optional	
Not defined	TFO status	Optional	
Modify_Char	Modify Bearer Characteristics	Mandatory	
Not defined	Rate Change	Optional	
Not defined	Bearer Modification Support	Optional	
Not defined	Protocol Negotiation Result	Optional	
Reserve_Char	Reserve Bearer Characteristics	Optional	
Confirm_Char	Confirm Bearer Characteristics	Optional	
ECS_Indication	Emergency Call Indication	Optional	
Continuity Check Tone	Continuity Check Tone	Optional	See 14.1.16
Continuity Check Verify	Continuity Check Verify	Optional	See 14.1.17
Continuity Check Response	Continuity Check Response	Optional	See 14.1.18
Not Defined	Prepare IP Transport	Optional	Shall be supported if IP used on lu interface
Not Defined	Modify IP Transport Address	Optional	Shall be supported if IP used on lu interface

Not defined	Termination heartbeat	Mandatory	To allow detection of hanging contexts and terminations in the MGW that may result e.g. from a loss of communication between the MSC-S and the MGW
Not Defined	Reserve RTP Connection Point	Optional	Required for SIP-I associated Nb and A interface over IP
Not Defined	Configure RTP Connection Point	Optional	Required for SIP-I associated Nb and A interface over IP
Not defined	Reserve and Configure RTP Connection Point	Optional	Required for SIP-I associated Nb and A interface over IP
Not defined	Media Inactivity Notification	Optional	See 14.2.55
Not defined	ECN Failure Indication (NOTE 2)	Optional	Only applicable if ECN support is required
Not defined	ICE Connectivity Check Result Indication	Optional	Only applicable if full ICE is supported.
Not defined	ICE New Peer Reflexive Candidate Notification	Optional	Only applicable if full ICE is supported
NOTE 1: A procedure defined in table 3 can be combined with another procedure in the same action. This means that they can share the same contextID and termination ID(s).			
NOTE 2: ECN support is only applicable for MSC enhanced for ICS.			

## 14.2.1 Change Flow Direction

This procedure is the same as that defined in the clause "Change Connection Topology" in ITU-T Recommendation Q.1950 [23] (see 3GPP TS 29.205 [7]) with the following additions.

**Table 14.2.1.1: Change Flow Direction request additions**

Address Information	Control information	Bearer information
	Context ID = c1,? Connection Configuration = (TerminationID= x1, ? TerminationID=x2,? [type = x]),...	

This procedure shall not be used for Multiparty bridge contexts.

The Change Flow Direction response shall contain the Context ID.

A command is only required if this procedure is combined with some other procedure which changes a termination functionality.

## 14.2.2 Isolate Bearer Termination

This procedure is the same as that defined in the clause "Isolate" in ITU-T Recommendation Q.1950 [23] (see 3GPP TS 29.205 [7]).

## 14.2.3 Join Bearer Termination

This procedure is the same as that defined in the clause "Join" in ITU-T Recommendation Q.1950 [23] (see 3GPP TS 29.205 [7]).

## 14.2.4 Establish Bearer

This procedure is the same as that defined in the clause "Establish BNC\_notify" in ITU-T Recommendation Q.1950 [23] (see 3GPP TS 29.205 [7]) except that the Command MOV shall not be used, BNC events are requested optionally and independently and with additions as shown below. If IPBCP Tunnel Option 1 is required then the Command Response shall always precede the IPBCP Notify Command.

**Table 14.2.4.1: Establish Bearer additions**

Address Information	Control information	Bearer information
	UP mode = Mode UP version = version Delivery of erroneous SDUs = value Interface = interface If support mode: Initdirection = initdir  If indication on Protocol Negotiation Result requested: NotificationRequested (Event ID = x, "Prot Negotiation Result")  If indication on Rate Change requested: NotificationRequested (Event ID = x, "RateChange")  If detection of hanging termination is requested: (NOTE 3) NotificationRequested (Event ID = x, "termination heartbeat")  If Listener context: number of desired listener context terminations = required listener context terminations  If multiple IP realms: IP realm Identifier = required IP realm identifier  If indication on BNC Established requested: NotificationRequested (Event ID = x, "BNC Established")  If indication on BNC Modified requested: NotificationRequested (Event ID = x, "BNC Modified")  If indication on BNC Mod Failed requested: NotificationRequested (Event ID = x, "BNC Mod Failed")  If indication on BNC Release requested: NotificationRequested (Event ID = x, "BNC Release")	If SCUDIF multimedia call : MuMe codec (NOTE 1)  If data call other than SCUDIF multimedia call and Access Termination or Anchor MGW Network Termination: PLMN bearer capability = PLMN capability (NOTE2) If GSM data call other than SCUDIF multimedia call and (Anchor MGW Network Termination): GSM channel coding = coding
NOTE1: Bearer Service Characteristics shall be excluded when this property is included. NOTE2: Bearer Service Characteristics may be included. NOTE3: Termination heartbeat notification shall be included when requesting a new bearer termination.		

### 14.2.5 Prepare Bearer

This procedure is the same as that defined in the clause "Prepare\_BNC\_notify" in ITU-T Recommendation Q.1950 [23] (see 3GPP TS 29.205 [7]) except that the Commands MOD and MOV shall not be used, the MGW shall not choose the BNC Characteristics, the BNC-cut-through-capability shall not be used, BNC events are requested optionally and independently and with additions as shown below.

**Table 14.2.5.1: Prepare Bearer additions**

Address Information	Control information	Bearer information
	<p>UP mode = mode                      UP version = version                      Delivery of erroneous SDUs = value                      Interface = interface                      If support mode:                          Initdirection = initdir</p> <p>If CTM call and Access Termination:                      State= ctmstate                      Transport= ctmtransport                      Version= ctmtxt version                      If data call and Non-Anchor MGW RAN-side termination:                          Bitrate = bitrate (NOTE1)</p> <p>If indication on Protocol Negotiation Result requested:                      NotificationRequested (Event ID = x, "Prot Negotiation Result")</p> <p>If indication on Rate Change requested:                      NotificationRequested (Event ID = x, "RateChange")</p> <p>If indication on Bearer Modification requested:                      NotificationRequested (Event ID = x, "Bearer Modification Support")</p> <p>If notification on CTM negotiation result requested:                      NotificationRequested (Event ID = x, "connchange ")</p> <p>NotificationRequested (Event ID = x, "termination heartbeat")</p> <p>If VGCS/VBS context: number of needed conference terminations = required conference terminations</p> <p>If multiple IP realms:                      IP realm Identifier = required IP realm identifier.</p> <p>If indication on BNC Established requested:                      NotificationRequested (Event ID = x, "BNC Established")</p> <p>If indication on BNC Modified requested:                      NotificationRequested (Event ID = x, "BNC Modified")</p> <p>If indication on BNC Mod Failed requested:                      NotificationRequested (Event ID = x, "BNC Mod Failed")</p> <p>If indication on BNC Release requested:                      NotificationRequested (Event ID = x, "BNC Release")</p>	<p>If SCUDIF multimedia call and (network termination or Anchor MGW Access Termination):                      MuMe codec (NOTE2)</p> <p>If data call other than SCUDIF multimedia call and (Anchor MGW Access Termination or Anchor MGW Network Termination):                      PLMN bearer capability = PLMN capability (NOTE3)</p> <p>If GSM data call other than SCUDIF multimedia call and Anchor MGW Network Termination:                      GSM channel coding = coding</p>
<p>NOTE1 : Bearer Service Characteristics shall be excluded when this property is included except for the case when bitrate = 64000 and then Bearer Service Characteristics may be included. Bitrate is optional for transparent data calls when the data rate is 64k bits/s.</p> <p>NOTE2: Bearer Service Characteristics shall be excluded when this property is included.</p> <p>NOTE3: Bearer Service Characteristics shall be excluded when this property is included, except for Anchor MGW network termination for which it may be included.</p>		

## 14.2.6 Change Through Connection

This procedure is the same as that defined in the clause "Cut Through" in ITU-T Recommendation Q.1950 [23] (see 3GPP TS 29.205 [7]) with the following clarification and deletion.

NotificationRequested = (Event ID = x, "Cut Through") is deleted and therefore only the Explicit (MGC Controlled Cut-Through procedure is supported.

The MGW may support No\_Data RTP frames on RTP-A and RTP-CN terminations during the call establishment phase, i.e. when not in TrFO (see 3GPP TS 26.102 [26]), in which case it shall support it independently of the Stream Mode.

## 14.2.7 Activate Interworking Function

When the procedure "Activate Interworking Function" is required the following procedure is initiated:

The MGC sends a MOD.req command with the following information.

**Table 14.2.7.1: MOD.req (Activate Interworking function) MGC to MGW**

Address Information	Control information	Bearer information
	Transaction ID = z Context ID = c1 Termination ID = bearer1  Signal=actpro  If indication on Protocol Negotiation Result requested: NotificationRequested (Event ID = x, "Prot Negotiation Result")  If indication on Rate Change requested: NotificationRequested (Event ID = x, "RateChange")	

When the processing of command (1) is complete, the MGW initiates the following procedure.

**Table 14.2.7.2: MOD.resp (Activate Interworking function) MGW to MGC**

Address Information	Control information	Bearer information
	Transaction ID = z Context ID = c1 TerminationID = bearer1	

## 14.2.8 Release procedures

This clause includes a number of procedures.

### 14.2.8.1 Release Bearer

This procedure is the same as that defined in the clause "Release" in ITU-T Recommendation Q.1950 [23] (see 3GPP TS 29.205 [7]) including the Modify command in the transaction with the clarification that the Termination ID and/or Context ID may be wildcarded (ALL).

### 14.2.8.2 Release Termination

This procedure is the same as that defined in the clause "Release" in ITU-T Recommendation Q.1950 [23] (see 3GPP TS 29.205 [7]) including a Subtract command in the transaction with the following additions.

**Table 14.2.8.1 Sub.req (Release termination) MGC to MGW**

Address Information	Control information	Bearer information
	Transaction ID = z Context ID = c1/ALL Termination ID = bearer1/ALL	

**Table 14.2.8.2.2: Sub.resp (Release termination) MGW to MGC**

Address Information	Control information	Bearer information
	Transaction ID = z Context ID = c1/ALL Termination ID = bearer1/ALL If requested Statistics= Ctmbits	

### 14.2.9 Bearer Released

This procedure is the same as that defined in the clause "BNC Release" in ITU-T Recommendation Q.1950 [23] (see 3GPP TS 29.205 [7]) with the following clarification:

Termination ID shall be provided in the response. .

The MGW may, as a configurable option, inhibit the reporting of normal AAL2 bearer release on a Iu termination.

### 14.2.10 Bearer Established

This procedure is the same as that defined in the clause "BNC Established" in ITU-T Recommendation Q.1950 [23] (see 3GPP TS 29.205 [7]) with the following clarification:

Termination ID shall be provided in the response.

### 14.2.11 Send Tone

This procedure is the same as that defined in the clause "Media Content Insertion" - "Insert Tone" in ITU-T Recommendation Q.1950 [23] (see 3GPP TS 29.205 [7]) with the following additions.

**Table 14.2.11.1: Send Tone additions**

Address Information	Control information	Bearer information
	If CAMEL Prepaid Warning Tone Signal = warning tone Or Signal = flextone  If detection of hanging termination is requested: NotificationRequested (Event ID = x, "termination heartbeat")	

Signal Direction shall be either "internal" or "external".

Only the Tone Signal Ids shall be used, not the Tone Ids within the PlayTone Signal Id.

The termination heartbeat event shall be configured when requesting a new ephemeral bearer termination.

### 14.2.12 Play Announcement

This procedure is the same as that defined in the clause "Media Content Insertion" - "Insert Announcement" in ITU-T Recommendation Q.1950 [23] (see 3GPP TS 29.205 [7]) with the following clarifications:

**Table 14.2.12.1: Play Announcement additions**

Address Information	Control information	Bearer information
	If detection of hanging termination is requested: NotificationRequested (Event ID = x, "termination heartbeat")	

Signal Direction shall be either "internal" or "external".

Stream mode may be maintained as for the ongoing call or may be restricted to "send only".

Signal Lists shall be supported.

The termination heartbeat event shall be configured when requesting a new ephemeral bearer termination.

### 14.2.13 Send DTMF

This procedure is the same as that defined in the clause "Media Content Insertion" - "Insert Digit" in ITU-T Recommendation Q.1950 [23] (see 3GPP TS 29.205 [7]). The MGW shall ensure the minimum duration timing and minimum interval timing is achieved in accordance with the DTMF timing defined in TS 23.014 [27]. Maximum duration shall also be controlled by the MGW if required by the network.

### 14.2.14 Detect DTMF

This procedure is the same as that defined in the clause "Media Content Detection" - "Detect Digit" in ITU-T Recommendation Q.1950 [23] (see 3GPP TS 29.205 [7]) with the exception that "long tone detected" (Event Id ltd) shall not be used. In addition "start tone detected" (EventId std) is optional and if not supported shall result in the command error code #449 "Unsupported or Unknown Parameter or Property Value". If both a request for "start tone detected" and "end tone detected" is received by the MGW that does not support "start tone detected" then it shall only report a notification upon detecting the end of a digit.

Parameter *Duration* shall not be used.

All digits shall be requested i.e. Tone\_Id shall be wildcarded.

### 14.2.15 Report DTMF

This procedure is the same as that defined in the clause "Detected Digit" in ITU-T Recommendation Q.1950 [23] (see 3GPP TS 29.205 [7]) with the following clarification:

Termination ID shall be provided in the response.

### 14.2.16 Announcement Completed

This procedure is the same as that defined in the clause "Signal Completion" in ITU-T Recommendation Q.1950 [23] (see 3GPP TS 29.205 [7]) with the following clarification:

Termination ID shall be provided in the response.

The Signal List ID should be provided additionally if the completed Announcement belongs to a Signal List.

### 14.2.17 Activate Voice Processing Function

When the procedure "Activate Voice Processing Function" (VPF) is required the following procedure is initiated:

The MGC sends an ADD.req, MOD.req or MOV.req command with the following information.

**Table 14.2.17.1: ADD.req/MOD.req/MOV.req (Activate Voice Processing Function) MGC to MGW**

Address Information	Control information	Bearer information
	Transaction ID = z Context ID = c1 Termination ID = bearer1  ActivateVPF "ec"= on/off	

When the MGW receives the command, it shall associate the relevant voice processing function resources with the specified termination.

When the processing of command (1) is complete, the MGW may initiate the "Voice Processing Function Ack" procedure.

**14.2.17.2: ADD.resp/MOD.resp/MOV.resp (Voice Processing Function Ack) MGW to MGC**

Address Information	Control information	Bearer information
	Transaction ID = z Context ID = c1 Termination ID = bearer1	

## 14.2.18 Reserve Circuit

This procedure is activated when the "Reserve Circuit" procedure is initiated.

An ADD.req command is sent with the following information.

**Table 14.2.18.1: ADD.req (Reserve\_Circuit) CSM to BIWF**

Address Information	Control information	Bearer information
	Transaction ID = z Termination ID = bearer1  <b>Context Requested:</b> Context ID = ? <b>Context Provided:</b> Context ID = c1  If CTM call and Access Termination: State= ctmstate Transport= ctmtransport Version= ctmtext version  If indication on Protocol Negotiation Result requested: NotificationRequested (Event ID = x, "Prot Negotiation Result")  If indication on Rate Change requested: NotificationRequested (Event ID = x, "RateChange") If notification on CTM negotiation result requested: NotificationRequested (Event ID = x, " connchange ") If detection of hanging termination is requested: NotificationRequested (Event ID = x,"termination heartbeat")  If indication on Bearer Released requested: NotificationRequested (Event ID = x, "BNC Release (Cause)") – as defined in ITU-T Recommendation Q.1950 [23]  If Listener context: number of desired listener context terminations = required listener context terminations	Bearer Service Characteristics  If data call, Access Termination: PLMN capabilities If GSM data call, Access Termination: GSM channel coding = coding

Upon completion of processing command (1) an ADD.resp command (2) is sent.

**Table14.2.18.2: ADD.resp BIWF to CSM**

Address Information	Control information	Bearer information
	Transaction ID = z Context ID = c1 TerminationID = bearer1	

## 14.2.19 Tunnel Information Up

This procedure is the same as that defined in the clause "Tunnel" in ITU-T Recommendation Q.1950 [23] (see 3GPP TS 29.205 [7]) with the clarification that BT/TunOpt = ? and BT/TunOpt = NO shall not be used.

NOTE: This procedure is always initiated from the MGW.

## 14.2.20 Tunnel Information Down

This procedure is the same as that defined in the clause "Tunnel" in ITU-T Recommendation Q.1950 [23] (see 3GPP TS 29.205 [7]) with the clarification that BT/TunOpt = ? and BT/TunOpt = NO shall not be used.

NOTE: This procedure is always initiated from the MGC.

## 14.2.21 Tone Completed

This procedure is the same as that defined in the clause "Signal.Completion" in ITU-T Recommendation Q.1950 [23] (see 3GPP TS 29.205 [7]) with the following clarification:

Termination ID shall be provided in the response.

## 14.2.22 Stop Announcement

This procedure is the same as that defined in the clause "Insert Announcement" in ITU-T Recommendation Q.1950 [23] (see 3GPP TS 29.205 [7]) with the following clarification. The signal descriptor shall not include any signal.

## 14.2.23 Stop Tone

This procedure is the same as that defined in the clause "Insert Tone" in ITU-T Recommendation Q.1950 [23] (see 3GPP TS 29.205 [7]) with the following clarification. The signal descriptor shall not include any signal.

## 14.2.24 Stop DTMF Detection

This procedure is the same as that defined in the clause "Detect Digit" in ITU-T Recommendation Q.1950 [23] (see 3GPP TS 29.205 [7]) with the following clarification. The eventDescriptor shall not include any event.

## 14.2.25 Stop DTMF

This procedure is the same as that defined in the clause "Media Content Insertion" - "Insert Digit" in ITU-T Recommendation Q.1950 [23] (see 3GPP TS 29.205 [7]). The signal descriptor shall not include any signal. The MGW shall ensure the minimum duration timing and minimum interval timing is achieved in accordance with the DTMF timing defined in TS 23.014 [27]. Maximum duration shall also be controlled by the MGW if required by the network.

## 14.2.26 Confirm Char

This procedure is the same as that defined in the clause "Confirm Char" in ITU-T Recommendation Q.1950 [23] (see 3GPP TS 29.205 [7]).

### 14.2.27 Modify Char

This procedure is the same as that defined in the clause "Modify Char" in ITU-T Recommendation Q.1950 [23] (see 3GPP TS 29.205 [7]).

### 14.2.28 Reserve Char

This procedure is the same as that defined in the clause "Reserve Char" in ITU-T Recommendation Q.1950 [23] (see 3GPP TS 29.205 [7]).

### 14.2.29 Bearer Modified

This procedure is the same as that defined in the clause "BNC Modified" in ITU-T Recommendation Q.1950 [23] (see 3GPP TS 29.205 [7]).

### 14.2.30 Bearer Modification Failed

This procedure is the same as that defined in the clause "BNC Modification failure" in ITU-T Recommendation Q.1950 [23] (see 3GPP TS 29.205 [7]).

### 14.2.31 TFO Activation

When the procedure "TFO activation" is required the following procedure is initiated:

The MGC sends a ADD.req, MOD.req or MOV.req command with the following information.

**Table 14.2.31.1: ADD.req/MOD.req/MOV.req (TFO activation) MGC to MGW**

Address Information	Control information	Bearer information
	Transaction ID = z Context ID = c1 Termination ID = bearer1 tfoenable = tfoactvalue If TFO codec list: Property= TFOcodeclist	

When the processing of command (1) is complete, the MGW initiates the following procedure.

**Table 14.2.31.2: ADD.resp/MOD.resp/MOV.resp (TFO activation) MGW to MGC**

Address Information	Control information	Bearer information
	Transaction ID = z Context ID = c1 TerminationID=bearer1	

### 14.2.32 Optimal Codec and Distant List\_Notify

When the procedure "Optimal Codec and Distant List" is required the following procedure is initiated:

The MGC sends a ADD.req, MOD.req or MOV req. command with the following information.

**Table 14.2.32.1: ADD.req/MOD.req/MOV.req (Codec modify and distant list) MGC to MGW**

Address Information	Control information	Bearer information
	Transaction ID = z Context ID = c1 Termination ID = bearer1 Property= TFOcodeclist  NotificationRequested (Event ID = x, "Codec modify") NotificationRequested (Event ID = x, "Distant List")	

When the processing of command (1) is complete, the MGW initiates the following procedure.

**Table 14.2.32.2: ADD.resp/MOD.resp/MOV.resp (Optimal codec and codec list) MGW to MGC**

Address Information	Control information	Bearer information
	Transaction ID = z Context ID = c1 TerminationID= bearer1	

### 14.2.33 Codec Modify

When the procedure "Codec Modify" is required the following procedure is initiated:

The MGW sends a NOT.req command with the following information.

**Table 14.2.33.1: NOT.req (Codec modify) MGW to MGC**

Address Information	Control information	Bearer information
	Transaction ID = z Context ID = c1 Termination ID = bearer1  Event ( Event Id = x, "codec_modify (optimalcodec)")	

When the processing of command (1) is complete, the MGC initiates the following procedure.

**Table 14.2.33.2: NOT.resp (Codec modify) MGC to MGW**

Address Information	Control information	Bearer information
	Transaction ID = z Context ID = c1 Termination ID = bearer1	

### 14.2.34 Distant Codec List

When the procedure "Distant Codec List" is required the following procedure is initiated:

The MGW sends a NOT.req command with the following information.

**Table 14.2.34.1: NOT.req (Distant codec list) MGW to MGC**

Address Information	Control information	Bearer information
	Transaction ID = z Context ID = c1 Termination ID = bearer1  Event(Event ID = x, " distant_codec_list(distlist) ")	

When the processing of command (1) is complete, the MGC initiates the following procedure.

**Table 14.2.34.2: NOT.resp (Distant codec list) MGC to MGW**

Address Information	Control information	Bearer information
	Transaction ID = z Context ID = c1 Termination ID = bearer1	

### 14.2.35 Command Rejected

When the procedure "Command Reject" is required the following procedure is initiated:

The MGW/MGC sends .resp to any command.req with the following information.

**Table 14.2.34.1: NYcommand.resp (command reject ) GW/MGC to MGC/MGW**

Address Information	Control information	Bearer information
	Transaction ID = z Context ID = c1 or no context  Reason=Error	

### 14.2.36 Modify Bearer Characteristics

This procedure is the same as that defined in the clause "Modify Char" in ITU-T Recommendation Q.1950 [23] (see 3GPP TS 29.205 [7]) with additions as shown below.

**Table 14.2.36.1: Modify bearer Characteristics additions**

Address Information	Control information	Bearer information
	If framing protocol used:  UP mode = mode UPversion =version Delivery of erroneous SDUs=value Interface=interface  If support mode: Initdirection=initdir  If data call and Non-Anchor MGW RAN-side termination: Bitrate = bitrate (NOTE1) If indication on Protocol Negotiation Result requested: NotificationRequested (Event ID = x, "Prot Negotiation Result")  If indication on Rate Change requested: NotificationRequested (Event ID = x, "RateChange")	If SCUDIF multimedia call and (network termination or Anchor MGW Access Termination): MuMe codec (NOTE 2)  If data call other than SCUDIF multimedia call and (Anchor MGW Access Termination or Anchor MGW Network Termination):  PLMN bearer capability = PLMN capability (NOTE3)  If GSM data call other than SCUDIF multimedia call and Anchor MGW Network Termination: GSM channel coding=coding
NOTE1 : Bearer Service Characteristics shall be excluded when this property is included except for the case when bitrate = 64000 and then Bearer Service Characteristics may be included. Bitrate is optional for transparent data calls when the data rate is 64k bits/s. NOTE2: Bearer Service Characteristics shall be excluded when this property is included. NOTE3: Bearer Service Characteristics shall be excluded when this property is included, except for Anchor MGW network termination for which it may be included.		

If the "Modify Bearer Characteristics" procedure contains a codec that is not currently in use at the Termination when it receives this procedure, and if the framing protocol is used in support mode, the MGW shall be prepared to handle a framing protocol initialisation. If the "Modify Bearer Characteristics" contains no codec or the codec that is already in use at the Termination when it receives this procedure, the MGW does not need to be prepared to handle a framing protocol initialisation.

### 14.2.37 Protocol Negotiation Result

When the procedure "Protocol Negotiation Result" is required the following procedure is initiated:

The MGW sends a NOT.req command with the following information.

**Table 14.2.37.1: NOT.req (Protocol negotiation result) MGW to MGC**

Address Information	Control information	Bearer information
	Transaction ID = z Context ID = c1 Termination ID = bearer1  Event (Event ID = x, " protres (Result,Cause)")	

When the processing of command (1) is complete, the MGC initiates the following procedure.

**Table 14.2.37.2: NOT.resp (Protocol negotiation result) MGC to MGW**

Address Information	Control information	Bearer information
	Transaction ID = z Context ID = c1 Termination ID = bearer1	

### 14.2.38 Rate Change

When the procedure "Rate Change" is required the following procedure is initiated:

The MGW sends a NOT.req command with the following information.

**Table 14.2.38.1: NOT.req (Rate change) MGW to MGC**

Address Information	Control information	Bearer information
	Transaction ID = z Context ID = c1 Termination ID = bearer1  Event (Event ID = x, "ratechg(rate)")	

When the processing of command (1) is complete, the MGC initiates the following procedure.

**Table 14.2.38.2: NOT.resp (Rate change) MGC to MGW**

Address Information	Control information	Bearer information
	Transaction ID = z Context ID = c1 Termination ID = bearer1	

### 14.2.39 Bearer Modification Support

When the procedure "Bearer Modification Support" is required, the following procedure is initiated:

The MGW sends a NOT.req command with the following information to indicate that the bearer can be modified.

**Table 14.2.39.1: NOT.req (Bearer Modification Support) MGW to MGC**

Address Information	Control information	Bearer information
	Transaction ID = z Context ID = c1 Termination ID = bearer1  Event (Event ID = x, "mod_link_supp")	

When the processing of command (1) is complete, the MGC initiates the following procedure.

**Table 14.2.39.2: NOT.resp (Bearer Modification Support) MGC to MGW**

Address Information	Control information	Bearer information
	Transaction ID = z Context ID = c1 Termination ID = bearer1	

## 14.2.40 CTM report

When the procedure "CTM report" is required the following procedure is initiated:

The MGW sends a NOT.req command with the following information.

**Table 14.2.40.1: NOT.req (CTM report) MGW to MGC**

Address Information	Control information	Bearer information
	Transaction ID = z Context ID = c1 Termination ID = bearer1  Event (Event ID = x, "connchange (connchnng) ")	

When the processing of command (1) is complete, the MGC initiates the following procedure.

**Table 14.2.40.2: NOT.resp (CTM report) MGC to MGW**

Address Information	Control information	Bearer information
	Transaction ID = z Context ID = c1 Termination ID = bearer1	

## 14.2.41 Prepare IP transport

This procedure is activated when the "Prepare IP transport" procedure is initiated.

An ADD.req command is sent with the following information.

**Table 14.2.41.1: ADD.req (Prepare IP transport) MGC to MGW**

Address Information	Control information	Bearer information
Local Descriptor { lu IP Address = ? lu IP Port = ? }	Transaction ID = z Termination ID = ? Logical Port ID = y If Context Requested: Context ID = ? If Context Provided: Context ID = c1  UP mode = mode UP version = version Delivery of erroneous SDUs = value Interface = interface  If support mode: Initdirection = initdir  If CTM call and Access Termination: State= ctmstate Transport= ctmtransport Version= ctmtext version If data call and Non-Anchor MGW RAN-side termination: Bitrate = bitrate (NOTE1)  If indication of BNC Established requested:  Notification_Requested (Event ID = x, "BNC Connected")  If indication of BNC Release requested: Notification_Requested (Event ID = x, "BNC Release (Cause)")  If indication of BNC Modified requested: Notification_Requested (Event ID = x, "BNC Modified")  If indication of BNC Mod Failed requested: Notification_Requested (Event ID = x, "BNC Mod Failed")  (all bearer change notifications as defined in ITU-T Recommendation Q.1950 [23])  If multiple IP realms: IP realm Identifier = required IP realm identifier  NotificationRequested (Event ID = x, "termination heartbeat")	If SCUDIF multimedia call and Anchor MGW Access Termination: MuMe codec (NOTE 2)  If data call other than SCUDIF multimedia call, Anchor MGW Access Termination: PLMN bearer capability = PLMN capability (NOTE2)  If data call and Non-Achor RAN termination: Bearer Service Characteristics (NOTE 1)  If speech call, Access Termination: Codec  Bearer Characteristics = "IP"
NOTE1 : Bearer Service Characteristics shall be excluded when this property is included except for the case when bitrate = 64000 and then Bearer Service Characteristics may be included. Bitrate is optional for transparent data calls when the data rate is 64k bits/s.. NOTE2: Bearer Service Characteristics shall be excluded when this property is included.		

When the processing of command (1) is complete, the MGW initiates the following procedure.

**Table 14.2.41.2: ADD.resp (Prepare IP transport) MGW to MGC**

Address Information	Control information	Bearer information
Local Descriptor { lu IP Address = IPaddress lu IP Port = UDPport }	Transaction ID = z Context ID = c1 Termination ID = bearer1	

### 14.2.42 Modify IP transport address

This procedure is activated when the "Modify IP transport address" procedure is initiated.

A MOD.req command is sent with the following information.

**Table 14.2.42.1: MOD.req (Modify IP transport address) MSC to MGW**

Address Information	Control information	Bearer information
Remote Descriptor { lu IP Address = IPaddress lu IP Port = UDPport }	Transaction ID = z Context ID = c1 Termination ID = bearer1	

When the processing of command (1) is complete, the MGW initiates the following procedure.

**Table 14.2.42.2: MOD.resp (Modify Ip transport address) MGW to MGC**

Address Information	Control information	Bearer information
	Transaction ID = z Context ID = c1 TerminationID=bearer1	

### 14.2.43 Reserve Bearer Characteristics

This procedure is the same as that defined in the clause "Reserve Char" in ITU-T Recommendation Q.1950 [23] (see 3GPP TS 29.205 [7]) with additions as shown below.

**Table 14.2.43.1: Reserve Bearer Characteristics additions**

Address Information	Control information	Bearer information
	If framing protocol used:  UP mode = mode UPversion =version Delivery of erroneous SDUs=value Interface=interface Initdirrection=initdirection	

If the "Reserve Bearer Characteristics" procedure contains a codec that is not currently in use at the Termination when it receives this procedure, and if the framing protocol is used in support mode, the MGW shall be prepared to handle a framing protocol initialisation. If the "Reserve Bearer Characteristics" contains no codec or the codec that is already in use at the Termination when it receives this procedure, the MGW does not need to be prepared to handle a framing protocol initialisation.

### 14.2.44 Confirm Bearer Characteristics

This procedure is the same as that defined in the clause "Confirm Char" in ITU-T Recommendation Q.1950 [23] (see 3GPP TS 29.205 [7]) with additions as shown below.

**Table 14.2.44: Confirm Bearer Characteristics additions**

Address Information	Control information	Bearer information
	If framing protocol used:  UP mode = mode UPversion =version Delivery of erroneous SDUs=value Interface=interface Initdirerection=initdirection	

If the "Confirm Bearer Characteristics" procedure contains a codec that is not currently in use at the Termination when it receives this procedure, and if the framing protocol is used in support mode, the MGW shall be prepared to handle a framing protocol initialisation. If the "Confirm Bearer Characteristics" contains no codec or the codec that is already in use at the Termination when it receives this procedure, the MGW does not need to be prepared to handle a framing protocol initialisation.

### 14.2.45 Trace activation/deactivation

This procedure is activated when the "Trace activation/deactivation" procedure is initiated.

An ADD.req command is sent with the following information.

**Table 14.2.45.1: ADD.req/MOD.req (Trace activation/deactivation) MGC to MGW**

Address Information	Control information	Bearer information
	Transaction ID = z Termination ID = bearer1  Context ID = c1  Trace Reference Trace Recording Session Reference Trace Depth Triggering events List of interfaces  IMSI IMEI(SV)  Trace activity control = trace activity request  If indication on Trace Activation Result requested: NotificationRequested (Event ID = x, "Trace activation result")	

Upon completion of processing command (1) an ADD.resp or MOD.resp command (2) is sent.

**Table 14.2.45.2: ADD.resp/MOD.resp/ MGW to MGC**

Address Information	Control information	Bearer information
	Transaction ID = z Context ID = c1 TerminationID = bearer1	

## 14.2.46 Trace Activation result notification

When the procedure "Trace Activation result notification" is required, the following procedure is initiated:

The MGW sends a NOT.req command with the following information to indicate the result of the trace activation.

**Table 14.2.46.1: NOT.req (Trace Activation result Notification) MGW to MGC**

Address Information	Control information	Bearer information
	Transaction ID = z Context ID = c1 Termination ID = bearer1  Event_ID (Event ID = x, " tracact (res)")	

When the processing of command (1) is complete, the MGC initiates the following procedure.

**Table 14.2.46.2: NOT.resp (Trace Activation result Notification) MGC to MGW**

Address Information	Control information	Bearer information
	Transaction ID = z Context ID = c1 Termination ID = bearer1	

## 14.2.47 Emergency Call Indication

This procedure is the same as that defined in the clause " ECS\_Indication " in ITU-T Recommendation Q.1950 Annex F [23] (see 3GPP TS 29.205 [7]) with additions as shown below.

Table 14.2.47.1: Emergency Call Indication additions

Address Information	Control information	Bearer information
Or as per flow 14.2.4 Establish Bearer	Or as per flow 14.2.4 Establish Bearer	Or as per flow 14.2.4 Establish Bearer
Or as per flow 14.2.5 Prepare Bearer	With the following additions: If Context Requested & Emergency Call: Emergency Call Indication	Or as per flow 14.2.5 Prepare Bearer
Or as per flow 14.2.12 Play Announcement	Or as per flow 14.2.5 Prepare Bearer	Or as per flow 14.2.12 Play Announcement
Or as per flow 14.2.18 Reserve_Circuit	With the following additions: If Context Requested & Emergency Call: Emergency Call Indication	Or as per flow 14.2.18 Reserve_Circuit
Or as per flow 14.2.41 Prepare_IP_transport	Or as per flow 14.2.12 Play Announcement	Or as per flow 14.2.41 Prepare_IP_transport
Or as per flow 14.2.2 Isolate Bearer Termination	With the following additions: If Context Requested & Emergency Call: Emergency Call Indication	Or as per flow 14.2.2 Isolate Bearer Termination
Or as per flow 14.2.3 Join Bearer Termination	Or as per flow 14.2.18 Reserve_Circuit	Or as per flow 14.2.3 Join Bearer Termination
Or as per flow 14.2.51 Reserve RTP Connection Point	With the following additions: If Context Requested & Emergency Call: Emergency Call Indication	Or as per flow 14.2.51 Reserve RTP Connection Point
Or as per flow 14.2.53 Reserve and Configure RTP Connection Point	Or as per flow 14.2.41 Prepare_IP_transport	Or as per flow 14.2.53 Reserve and Configure RTP Connection Point
	With the following additions: If Context Requested & Emergency Call: Emergency Call Indication	
	Or as per flow 14.2.2 Isolate Bearer Termination	
	With the following additions: If Context Requested & Emergency Call: Emergency Call Indication	
	Or as per flow 14.2.3 Join Bearer Termination	
	With the following additions: If Context Requested & Emergency Call: Emergency Call Indication	
	Or as per flow 14.2.51 Reserve RTP Connection Point With the following additions: If Context Requested & Emergency Call: Emergency Call Indication	
	Or as per flow 14.2.53 Reserve and Configure RTP Connection Point With the following additions: If Context Requested & Emergency Call: Emergency Call Indication	

## 14.2.48 TFO status Notify

When the procedure "TFO status notify" is required the following procedure is initiated:

The MGC sends a ADD.req, MOD.req or MOV req. command with the following information.

**Table 14.2.48.1: ADD.req/MOD.req/MOV.req (TFO status) MGC to MGW**

Address Information	Control information	Bearer information
	Transaction ID = z Context ID = c1 Termination ID = bearer1  NotificationRequested (Event ID = x, "TFO Status")	

The support of the TFO status notification is optional in the TFO package. If supported, when the processing of command (1) is complete, the MGW initiates the following procedure.

**Table 14.2.48.2: ADD.resp/MOD.resp/MOV.resp (TFO status) MGW to MGC**

Address Information	Control information	Bearer information
	Transaction ID = z Context ID = c1 TerminationID= bearer1	

Otherwise it returns an error codec to the MGC indicating that the requested event is unsupported or unknown., as specified in ITU-T Recommendation H.248.8 [14].

## 14.2.49 TFO Status

When the procedure "TFO Status" is required the following procedure is initiated:

The MGW sends a NOT.req command with the following information.

**Table 14.2.49.1: NOT.req (TFO Status) MGW to MGC**

Address Information	Control information	Bearer information
	Transaction ID = z Context ID = c1 Termination ID = bearer1  Event_ID (Event ID = x, " TFO_status(tfostatus) ")	

When the processing of command (1) is complete, the MGC initiates the following procedure.

**Table 14.2.49.2: NOT.resp (TFO Status) MGC to MGW**

Address Information	Control information	Bearer information
	Transaction ID = z Context ID = c1 Termination ID = bearer1	

## 14.2.50 Termination heartbeat indication

When the procedure "Termination heartbeat indication" is required the following procedure is initiated: the MGW sends a NOT.req command with the following information.

**Table 14.2.50.1: NOT.req (Termination heartbeat) MGW to MGC**

Address Information	Control information	Bearer information
	Transaction ID = z Context ID = c1 Termination ID = bearer1  Event_ID (Event ID = x, "termination heartbeat")	

When the processing of command is complete, the MGC initiates the following procedure.

**Table 14.2.50.2: NOT.resp (Termination heartbeat) MGC to MGW**

Address Information	Control information	Bearer information
	Transaction ID = z Context ID = c1 Termination ID = bearer1	

The heartbeat timer shall be configured to a value much greater than the mean call holding time.

The MSC-S is in charge of correcting any detected mismatch, by subtracting hanging terminations or clearing hanging contexts.

### 14.2.51 Reserve RTP Connection Point

This procedure is used to reserve an RTP bearer termination for a SIP-I associated Nb user plane, as defined in 3GPP TS 29.414 [32], or for a A interface over IP termination, as defined in 3GPP TS 3GPP TS 48.103 [65]. When the procedure "Reserve RTP Connection Point" is required the following procedure is initiated.

The MGC sends an ADD.req command with the following information.

**Table 14.2.51.1: ADD.req (Reserve RTP Connection Point Request) MGC to MGW**

<b>Address Information</b>	<b>Control information</b>	<b>Bearer information</b>
----------------------------	----------------------------	---------------------------

<p>Local Descriptor {  Port = ?  IP Address = ?  IP Version = IPv4 or IPv6  }</p>	<p>Transaction ID = z  Termination ID = ?</p> <p>If Context Requested:  Context ID = ?</p> <p>If MPS call/session:  Priority Indicator = x</p> <p>If Context Provided:  Context ID = c1</p> <p>If IP Interface Type:  IP interface = "IP interface type"</p> <p>If CTM call and Access Termination:  State= ctmstate  Transport= ctmtransport  Version= ctmtext version</p> <p>If Resources for multiple Codecs shall be reserved:  Reserve_Value</p> <p>NotificationRequested (Event ID = x, "termination heartbeat")</p> <p>If indication on Bearer Released requested:  NotificationRequested (Event ID = x, "BNC Release (Cause)") – as defined in ITU-T Recommendation Q.1950</p> <p>If multiple IP realms: IP realm Identifier = required IP realm identifier</p> <p>If indication on Protocol Negotiation Result requested:  NotificationRequested (Event ID = x, "Prot Negotiation Result")</p> <p>If indication on Rate Change requested:  NotificationRequested (Event ID = x, "RateChange")</p> <p>If access termination and notification on CTM negotiation result requested:  NotificationRequested (Event ID = x, "connchange ")</p> <p>If access termination and Listener context: number of desired listener context terminations = required listener context terminations  If diffserv required (NOTE 1):-  Diffserv Code Point  If tagging behaviour  Diffserv Tagging Behaviour</p> <p>If Remote Source Address Filtering required (NOTE 1):-  Remote Source Address Filtering  If Remote Source Address range required:-  Remote Source Address Mask  If Remote Source Port Filtering required:-  Remote Source Port Filtering  If individual port:-  Remote Source Port  If range of ports:  Remote Source Port Range</p>	<p>Local Descriptor {  Codec List  RTP Payloads  RtcpbwRS  RtcpbwRR</p> <p>If ICE is applied:  ICE host candidate request  ICE password request  ICE Ufrag request  ICE pacing request</p> <p>If SDPCapNeg is signalled to the gateway:  SDPCapNeg configuration</p> <p>}</p> <p>If data call other than SCUDIF multimedia call and if Access Termination or Anchor MGW Network Termination:  PLMN bearer capability =  PLMN capability</p> <p>If GSM data call other than SCUDIF multimedia call and if Access Termination or Anchor MGW Network Termination:  GSM channel coding = coding</p>
---	--	---

	<p>If Media Inactivity Detection Required (NOTE 1): NotificationRequested (Event ID = x, "Media Inactivity Detection (Media Inactivity Detection Time, Media Inactivity Detection Direction) ") (NOTE 2)</p> <p>If Sustainable Data Rate Policing Required (NOTE 1):- Policing Required Sustainable Data Rate Maximum Burst Size</p> <p>If peak data rate policing (NOTE 1) Policing Required Peak Data Rate If Delay Variation required Delay Variation Tolerance</p> <p>If RTCP handling required (NOTE 1): RTCP allocation</p> <p>If ECN Endpoint support required ECN Enable = "True" Initiation Method = "ECN Initiation Method"</p> <p>If notification of ECN Failure Report: NotificationRequested (Event ID = x, "ECN Failure")</p> <p>If ICE is applied: STUN server request</p>	
<p>NOTE 1: Only for terminations with border control functions support. NOTE 2: The event parameters "Media Inactivity Detection Time" and "Media Inactivity Detection Direction" are optional.</p>		

When the processing of command (1) is complete, the MGW initiates the following procedure.

**Table 14.2.51.2: ADD.resp (Reserve RTP Connection Point Acknowledge) MGW to MGC**

Address Information	Control information	Bearer information
Local Descriptor { Port IP Address IP Version }	Transaction ID Termination ID Context ID	Local Descriptor { Codec List RTP Payloads RtcpbwRS RtcpbwRR  If ICE is applied: ICE host candidate ICE password ICE Ufrag ICE pacing If ICE lite implementation ICE lite indication  If SDPCapNeg is signalled to the gateway: SDPCapNeg configuration }

## 14.2.52 Configure RTP Connection Point

This procedure is used to configure or reconfigure an RTP bearer termination for a SIP-I associated Nb user plane, as defined in 3GPP TS 29.414 [32], or for a A interface over IP termination, as defined in 3GPP TS 48.103 [65].

When the procedure "Configure RTP Connection Point" is required the following procedure is initiated:

The MGC sends an MOD.req command with the following information.

**Table 14.2.52.1: MOD.req (Configure RTP Connection Point Request) MGC to MGW**

<b>Address Information</b>	<b>Control information</b>	<b>Bearer information</b>
--------------------------------	----------------------------	---------------------------

<p>If local resources are modified: Local Descriptor {   Port   IP Address   IP Version }</p> <p>If remote resources are modified: Remote Descriptor {   Port   IP Address   IP Version }</p>	<p>Transaction ID Termination ID Context ID</p> <p>If IP Interface Type:   IP interface = "IP interface type" (NOTE 1)</p> <p>If Resources for multiple Codecs shall be reserved:   Reserve_Value</p> <p>If CTM call and Access Termination:   State= ctmstate   Transport= ctmtransport   Version= ctmtext version</p> <p>If indication on Protocol Negotiation Result requested: NotificationRequested (Event ID = x, "Prot Negotiation Result")</p> <p>If indication on Rate Change requested: NotificationRequested (Event ID = x, "RateChange")</p> <p>If access termination and notification on CTM negotiation result requested: NotificationRequested (Event ID = x, "connchange ")</p> <p>If access termination and Listener context: number of desired listener context terminations = required listener context terminations</p> <p>If diffserv required (NOTE 2):-   Diffserv Code Point   If tagging behaviour   Diffserv Tagging Behaviour</p> <p>If Remote Source Address Filtering required (NOTE 2):   Remote Source Address Filtering   If Remote Source Address range required:-     Remote Source Address Mask   If Remote Source Port Filtering required:-     Remote Source Port Filtering     If individual port:-       Remote Source Port     If range of ports:       Remote Source Port Range</p> <p>If Media Inactivity Detection Required (NOTE 2): NotificationRequested (Event ID = x, "Media Inactivity Detection (Media Inactivity Detection Time, Media Inactivity Detection Direction) ") (NOTE 3)</p> <p>If Sustainable Data Rate Policing Required (NOTE 2):-   Policing Required   Sustainable Data Rate   Maximum Burst Size</p> <p>If peak data rate policing (NOTE 2)   Policing Required   Peak Data Rate   If Delay Variation required     Delay Variation Tolerance</p> <p>If RTCP handling required (NOTE 2):</p>	<p>If local resources are modified:   Local Descriptor {     Codec List     RTP Payloads     RtcpbwRS     RtcpbwRR</p> <p>If SDPCapNeg is signalled to the gateway:   SDPCapNeg configuration   }</p> <p>If remote resources are modified:   Remote Descriptor {     Codec List     RTP Payloads     RtcpbwRS     RtcpbwRR</p> <p>If RTCP APP messages allowed   Allowed RTCP APP message types</p> <p>If ICE is applied:   ICE received candidate   ICE received password   ICE received Ufrag   (NOTE 4)   ICE received pacing   (NOTE 5)</p> <p>If SDPCapNeg is signalled to the gateway:   SDPCapNeg configuration   }</p> <p>If data call other than SCUDIF multimedia call and if Access Termination or Anchor MGW Network Termination:   PLMN bearer capability =   PLMN capability</p> <p>If GSM data call other than SCUDIF multimedia call and if Access Termination or Anchor MGW Network Termination:   GSM channel coding = coding</p>
---	--	---

	RTCP allocation  If ECN Endpoint support required ECN Enable = "True" Initiation Method = "ECN Initiation Method"  If notification of ECN Failure Report: NotificationRequested (Event ID = x,"ECN Failure")	
NOTE 1: If this property is included within the Reserve Connection Point procedure or the Reserve and Configure RTP Connection Point then it shall not be modified by this procedure. NOTE 2: Only for terminations with border control functions support. NOTE 3: The event parameters "Media Inactivity Detection Time" and "Media Inactivity Detection Direction" are optional. NOTE 4: The support of ICE received candidate, ICE received password, ICE received Ufrag are optional for ICE lite, as specified in 3GPP TS 29.292 [60]. NOTE 5: The ICE received pacing is only applicable for full ICE, as specified in IETF RFC 8445 [86].		

When the processing of command (1) is complete, the MGW initiates the following procedure.

**Table 14.2.52.2: MOD.resp (Configure RTP Connection Point Acknowledge) MGW to MGC**

Address Information	Control information	Bearer information
If local resources were provided in request: Local Descriptor { Port IP Address IP Version } If remote resources were provided in request: Remote Descriptor { Port IP Address IP Version } NOTE	Transaction ID Context ID Termination ID	If local resources were provided in request: Local Descriptor { Codec List RTP Payloads RtcpbwRS RtcpbwRR } If remote resources were provided in request: Remote Descriptor { Codec List RTP Payloads RtcpbwRS RtcpbwRR } NOTE
NOTE: Sending of the Remote Descriptor is optional		

### 14.2.53 Reserve and Configure RTP Connection Point

This procedure is used to reserve and coonfigure an RTP bearer termination for a SIP-I associated Nb user plane, as defined in 3GPP TS 29.414 [32], or for a A interface over IP termination, as defined in 3GPP TS 48.103 [65].

When the procedure "Reserve and Configure RTP Connection Point" is required the following procedure is initiated:

The MGC sends a ADD.req command with the following information.

**Table 14.2.53.1: ADD.req (Reserve and Configure RTP Connection Point Request) MGC to MGW**

<b>Address Information</b>	<b>Control information</b>	<b>Bearer information</b>
----------------------------	----------------------------	---------------------------

<p>Local Descriptor {   Port = ?   IP Address =   ?   IP Version =   IPv4 or IPv6 }</p> <p>Remote Descriptor {   Port   IP Address   IP Version =   IPv4 or IPv6 }</p>	<p>Transaction ID Termination ID = ?</p> <p>If Context Requested:   Context ID = ?</p> <p>If MPS call/session:   Priority Indicator = x</p> <p>If Context Provided:   Context ID = c1</p> <p>If IP Interface Type:   IP interface = "IP interface type"</p> <p>If Resources for multiple Codecs shall be reserved:   Reserve_Value</p> <p>If CTM call and Access Termination:   State= ctmstate   Transport= ctmtransport   Version= ctmtext version</p> <p>NotificationRequested (Event ID = x, "termination heartbeat")</p> <p>If indication on Bearer Released requested: NotificationRequested (Event ID = x, "BNC Release (Cause)") – as defined in ITU-T Recommendation Q.1950</p> <p>If multiple IP realms: IP realm Identifier = required IP realm identifier</p> <p>If indication on Protocol Negotiation Result requested: NotificationRequested (Event ID = x, "Prot Negotiation Result")</p> <p>If indication on Rate Change requested: NotificationRequested (Event ID = x, "RateChange")</p> <p>If access termination and notification on CTM negotiation result requested: NotificationRequested (Event ID = x, " connchange ")</p> <p>If diffserv required (NOTE 1):-   Diffserv Code Point   If tagging behaviour   Diffserv Tagging Behaviour</p> <p>If Remote Source Address Filtering required (NOTE 1):-   Remote Source Address Filtering   If Remote Source Address range required:-     Remote Source Address Mask   If Remote Source Port Filtering   required:-     Remote Source Port Filtering     If individual port:-       Remote Source Port     If range of ports:       Remote Source Port Range</p> <p>If Media Inactivity Detection Required (NOTE 1): NotificationRequested (Event ID = x, "Media Inactivity Detection (Media Inactivity Detection Time, Media Inactivity Detection Direction) ") (NOTE2)</p> <p>If Sustainable Data Rate Policing Required (NOTE 1):-</p>	<p>Local Descriptor {   Codec List   RTP Payloads   RtcpbwRS   RtcpbwRR</p> <p>If ICE is applied:   ICE host candidate request   ICE password request   ICE Ufrag request   ICE pacing request</p> <p>If SDPCapNeg is signalled to the gateway:   SDPCapNeg configuration }</p> <p>Remote Descriptor {   Codec List   RTP Payloads   RtcpbwRS   RtcpbwRR</p> <p>If RTCP APP messages allowed   Allowed RTCP APP message   types</p> <p>If ICE is applied:   ICE received candidate   ICE received password   ICE received Ufrag   (NOTE 3)</p> <p>If SDPCapNeg is signalled to the gateway:   SDPCapNeg configuration }</p> <p>If data call other than SCUDIF multimedia call and Anchor MGW Network Termination:   PLMN bearer capability =   PLMN capability</p> <p>If GSM data call other than SCUDIF multimedia call and Anchor MGW Network Termination:   GSM channel coding = coding</p>
--	---	--

	Policing Required Sustainable Data Rate Maximum Burst Size  If peak data rate policing (NOTE 1) Policing Required Peak Data Rate If Delay Variation required Delay Variation Tolerance  If RTCP handling required (NOTE 1): RTCP allocation  If ECN Endpoint support required ECN Enable = "True" Initiation Method = "ECN Initiation Method"  If notification of ECN Failure Report: NotificationRequested (Event ID = x,"ECN Failure")	
NOTE 1: Only for terminations with border control functions support. NOTE 2: The event parameters "Media Inactivity Detection Time" and "Media Inactivity Detection Direction" are optional. NOTE 3: The support of ICE received candidate, ICE received password, ICE received Ufrag are optional for ICE lite, as specified in 3GPP TS 29.292 [60]. NOTE 4: The ICE received pacing is only applicable for full ICE, as specified in IETF RFC 8445 [86].		

When the processing of command (1) is complete, the MGW initiates the following procedure.

**Table 14.2.53.2: ADD.resp(Reserve and Configure RTP Connection Point Acknowledge) MGW to MGC**

Address Information	Control information	Bearer information
Local Descriptor { Port IP Address IP Version }	Transaction ID Termination ID Context ID	Local Descriptor { Codec List RTP Payloads RtcpbwRS RtcpbwRR
Remote Descriptor { Port IP Address IP Version } NOTE		If ICE is applied: ICE host candidate ICE password ICE Ufrag ICE pacing If ICE lite implementation ICE lite indication  If SDPCapNeg is signalled to the gateway: SDPCapNeg configuration } Remote Descriptor { Codec List RTP Payloads RtcpbwRS RtcpbwRR
		If SDPCapNeg is signalled to the gateway: SDPCapNeg configuration } NOTE

NOTE: Sending of the Remote Descriptor is optional

Editor's note: The usage of the Call Type Discrimination IE and Text Telephony IE is ffs.

## 14.2.54 ECN Failure Indication

The MGW sends a NOTIFY request command as in Table 14.2.54.1.

**Table 14.2.54.1: ECN Failure Indication**

Address Information	Control information	Bearer information
	Transaction ID = x Context ID = C1 Termination ID = T1  Event_ID (Event ID = x, "ECN Failure (ECN Failure Type)")	

The MGC responds as in Table 14.2.54.2

**Table 14.2.54.2: ECN Failure Indication Ack**

Address Information	Control information	Bearer information
	Transaction ID = x Context ID = C1 Termination ID = T1	

## 14.2.55 Media Inactivity Notification

When the procedure "Media Inactivity Notification" is required the following procedure is initiated: the MGW sends a NOT.req command with the following information.

**14.2.55.1 NOT.req (Media Inactivity) MGW to MGC**

Address Information	Control information	Bearer information
	Transaction ID = x Context ID = C1 Termination ID = T1  Event_ID (Event ID = x, "Media Inactivity Detection")	

When the processing of command is complete, the MGC initiates the following procedure.

**14.2.55.2 NOT.resp (Media Inactivity) MGC to MGW**

Address Information	Control information	Bearer information
	Transaction ID = x Context ID = C1 Termination ID = T1	

## 14.2.56 ICE Connectivity Check Result Notification

The MGW sends a NOTIFY request command as defined in Table 14.2.56.1.

**Table 14.2.56.1: ICE Connectivity Check Result Notification**

Address Information	Control information	Bearer information
	Transaction ID = x Context ID= C1 Termination ID = T1  Event_ID (Event ID = x, " Connectivity Check Result (Candidate/Transport Pair)")	

The MSC Server responds as defined in Table 14.2.56.2

**Table 14.2.56.2: ICE Connectivity Check Result Notification Ack**

Address Information	Control information	Bearer information
	Transaction ID = x Context ID = C1 Termination ID = T1	

## 14.2.57 ICE New Peer Reflexive Candidate Notification

The MGW sends a NOTIFY request command as defined in Table 14.2.57.1.

**Table 14.2.57.1: ICE New Peer Reflexive Candidate Notification**

Address Information	Control information	Bearer information
	Transaction ID = x Context ID= C1 Termination ID = T1  Event_ID (Event ID = x, " New Peer Reflexive Candidate (Candidate)")	

The MSC Server responds as defined in Table 14.2.57.2

**Table 14.2.57.2: ICE New Peer Reflexive Candidate Ack**

Address Information	Control information	Bearer information
	Transaction ID = x Context ID = C1 Termination ID = T1	

---

## 15 UMTS packages

### 15.1 Mandatory UMTS packages

The following package shall be supported for the UMTS Bearer Independent Circuit-Switched Core Network:

- 3GUP (User Plane) package (see clause 15.1.1).

#### 15.1.1 3GUP package.

PackageID: threegup (0x002f)

Version: 1

Extends: None

This package identifies that the User Plane package is used for the termination. It also contains some parameters for the User Plane functions in the MGW.

The UP Protocol operates independently of the stream mode property, i.e. type 14 UP PDUs (which are used for inband UP signalling) can be transported between UP peers, irrespective of the stream mode direction. However, other types of UP PDUs shall be handled according to the stream mode property.

##### 15.1.1.1 Properties

UP Mode of operation:

PropertyID: mode (0x0001).

Description: Defines the mode of operation of the User Plane functions , for further definitions see 3GPP TS 25.415 [4] and 29.415 [8].

Type: Enumeration.

Possible Values:

- "Trans" (0x0001) Transparent mode.
- "Supp" (0x0002) Support mode for predefined SDU sizes.

Default: "Trans" (0x0001) Transparent mode.

Defined in: Local Control descriptor.

Characteristics: Read/Write.

UP versions:

PropertyID: upversions (0x0002).

Description: Defines the required versions of the UP mode of operation.

Type: Sub-list of enumeration.

Possible Values:

- "1" (0x01) Version 1.
- "2" (0x02) Version 2.
- "3" (0x03) Version 3.
- "4" (0x04) Version 4.

- "5" (0x05) Version 5.
- "6" (0x06) Version 6.
- "7" (0x07) Version 7.
- "8" (0x08) Version 8.
- "9" (0x09) Version 9.
- "10" (0x0A) Version 10.
- "11" (0x0B) Version 11.
- "12" (0x0C) Version 12.
- "13" (0x0D) Version 13.
- "14" (0x0E) Version 14.
- "15" (0x0F) Version 15.
- "16" (0x10) Version 16.
- Default: "1" (0x01) Version 1.

Defined in: Local Control descriptor.

Characteristics: Read/Write.

Delivery of erroneous SDUs:

PropertyID: delerrrsdu (0x0003).

Description: Indicates how erroneous SDUs should be handled. If it is set to YES then the UP entity implements error checking and sets Frame Quality Classification (FQC) bits accordingly; bad frames are delivered to the UP layer. If it is set to NO then the UP entity performs error checking and if a bad frame is detected then it is discarded. These settings are required only when the payload is to be examined by upper layer services; an MGW may ignore the settings of this parameter if it passes frames transparently through the UP entities. If it is set to NA then no checking is performed.

Type: Enumeration.

Possible Values:

- "Yes" (0x0001) Yes.
- "No" (0x0002) No.
- "NA" (0x0003) Not Applicable.

Default: "NA" (0x0003) Not Applicable.

Defined in: Local Control descriptor.

Characteristics: Read/Write.

Interface:

PropertyID: interface (0x0004).

Description: Indicates the type of interface on which the termination is used.

Type: Enumeration.

Possible Values:

- "RAN" (0x0001) Iu interface.

- "CN" (0x0002) Nb interface.

Defined in: Local Control descriptor.

Characteristics: Read/Write.

Initialisation Direction:

PropertyID: initdir (0x0005).

Description: Indicates whether or not the termination in the MGW should expect initialisation information, or initiate UP initialisation itself.

For a termination with property "interface = CN":

- If Initialisation Direction is set to Incoming then the MGW shall expect to receive an initialisation either at this termination or from an other Nb or Iu termination in the same context.
- If Initialisation Direction is set to outgoing, then the MGW shall send out an initialisation procedure from this termination. If another termination in the same context is initialised with the same codec type and configuration the MGW should re-use the RFCI values for its Initialisation PDU, otherwise it must assign its own values.

For a termination with property "interface = RAN":

- If Initialisation Direction is set to "incoming", then the initialisation received at this termination is from the originating RAN and can be forwarded internally to other terminations for subsequent UP initialisations.
- If Initialisation Direction is set to "outgoing", then initialisations received are from the terminating RAN and cannot be forwarded internally. RFCI value correction can be performed at this termination, and initialisations can be sent out to the RAN.

Examples for the usage of this property are given in annex B.

Type: Enumeration.

Possible Values:

- "In" (0x0001) Incoming.
- "Out" (0x0002) Outgoing.

Defined in: Local Control descriptor.

Characteristics: Read/Write.

### 15.1.1.2 Events

None.

### 15.1.1.3 Signals

None.

### 15.1.1.4 Statistics

None.

### 15.1.1.5 Procedures

The MGC uses this package to indicate to the MGW that the Iu (or Nb) User Plane is used between the RNC (or distant MGW) and the MGW. The package is sent in the Establish bearer, Modify Bearer Characteristics and Prepare bearer procedures. For more information on the User Plane and for a description of 'UP mode of operation', 'UP versions' and 'Delivery of erroneous SDUs' see 3GPP TS 25.415 [4].

The following procedures are valid for UP in Support Mode:

- The MGW shall be able to initiate and respond to the UP control procedures (PDU type 14 frames) independently of the Stream Mode during the call establishment phase, i.e. when not in TrFO.
- Otherwise, during TrFO the MGW shall be able to forward UP control procedures (PDU type 14 frames) received at one termination to the other termination.
- The UP Initialisation procedure is always acknowledged between MGW peers. If an MGW receives a request for a notification for the bearer establishment then the MGW shall not send the notification until after it has either sent or received the acknowledgement for the UP initialisation.
- The MGW shall always store RFCI parameters against the MGW termination that received or that sent the UP initialisation.
- If an MGW has the UP termination property Initialisation Direction = Incoming then it expects to either receive an Initialisation (externally) or after receiving initialisation information internally send an initialisation (externally), based on what occurs first.
- If an MGW has UP termination property Initialisation Direction = Outgoing and interface CN, then it generates a network originated Initialisation PDU as soon as the bearer towards the succeeding node is successfully established, with RFCIs corresponding to the last codec configured on the termination. If another termination in the same context is initialised with the same codec type and configuration the MGW should re-use the RFCI values for its Initialisation PDU, otherwise it must assign its own values. The initialisation information sent by the MGW depends on the service that the bearer supports. For CSD service see 3GPP TS 29.007 [6] chapter 11.5. For speech service see 3GPP TS 26.102 [26] chapter 8.
- If an MGW has UP termination property Initialisation Direction = Outgoing and interface RAN, then it expects to receive an Initialisation externally. It shall not pass the initialisation parameters internally. It may initiate RFCI Value Correction out from this termination.
- A CN incoming or outgoing termination having already completed its UP initialisation towards a peer MGW shall not send externally any new UP initialisation except if a reserve / modify characteristic procedure occurred on that termination since the last initialisation.
- RAN Outgoing termination may perform, during its lifetime, subsequent RFCI Value corrections, e.g. due to changes of RFCIs on other terminations.
- If an MGW has two terminations in the same context defined as supporting the UP package and with Initialisation Direction incoming, then when it receives an Initialisation procedure from one side (provided the bearer connection from the other termination to its peer MGW is established) it shall start the UP initialisation procedure towards the peer MGW. The MGW shall perform this procedure independently of the through-connection of the terminations in the context. The MGW shall relay control information from the first initialisation to the UP peer for use at the subsequent initialisation. Also, subsequent control procedures received on one UP shall be relayed to the other UP entity when the two UP entities are connected within the MGW. This behaviour is described in more detail in Annex A. - When adding a new CN incoming termination to a context that has already a RAN or CN incoming termination, if the existing termination has already completed its UP initialisation, the MGW shall not start an initialisation procedure on the new termination based on the control information already stored at the initialised incoming termination in the context.
- If an MGW has one termination with properties "interface = RAN" and "initialisation direction = outgoing" and another termination with property "initialisation direction = Incoming" in the same context, then the MGW shall not forward the UP initialisation from the Incoming termination until it has received a UP initialisation at the "RAN"/"outgoing" side. If the codec type and codec modes configured on both terminations are identical, and if the RFCI values stored at the "incoming" termination do not match the RFCI values stored at the "outgoing" RAN side then "RFCI Value Correction" may be performed to the "outgoing" RAN side: The MGW starts UP initialisation with the RFCI values 'relayed' from the "Incoming" side. No "RFCI Value Correction" is permitted at an outgoing RAN termination whose Iu initialisation negotiates the version 1 of the support mode, at an "incoming" Iu termination or at any Nb termination.
- If a new RAN outgoing termination is added to a context that has already a RAN incoming or CN incoming termination, and if the existing termination has already completed its UP initialisation, the MGW may carry out a RFCI value correction on the new RAN outgoing termination., The control information to be used for the RFCI value correction shall be relayed from the initialised incoming termination in the context.

- No RFCI value correction shall be triggered for data call.
- As an implementation option, "RFCI Value Correction" may be delayed if terminations are not through-connected; it will be triggered by connection modification. Otherwise it shall be performed immediately
- If "RFCI Value Correction" is not performed the MGW shall map the indexes for frames from one side to the RFCI indexes for frames from the other side. This behaviour is described in more detail in Annex A.
- If an MGW has two RAN terminations connected to the same context then the "RFCI Value Correction" is performed by the Outgoing termination.
- If an MGW has two terminations which support the UP package connected to the same context and both RFCI sets match then the MGW may pass frames transparently through the UP entities; no monitoring of the frames is performed, provided that the terminations are through-connected. This behaviour is described further in Annex A.
- If the MGW is passing frames transparently, no UP monitoring is performed. When the MGW receives an H.248 procedure request which requires interpretation or interaction with the UP, then it shall resume its UP protocol responsibilities, i.e. perform monitoring or termination of the UP protocol.
- If an MGW sends an FP UP initialization message from a termination, the MGW shall only offer versions of the FP UP, which are given in the property "UP versions" of this termination and which are supported by the MGW for this termination.
- If an MGW receives an FP UP initialization message at a termination, the MGW shall only positively acknowledge this initialization message, if versions of the FP UP are offered, which are given in the property "UP versions" and which are supported at the MGW for this termination. In the positive FP UP initialization acknowledge message, the MGW shall select one of these versions. If none of these versions are offered in the FP UP initialization message, the MGW shall send a negative FP UP acknowledge message and it shall not forward the initialization to a possible second FP UP termination in the same context.
- If PCM is used on the Nb then FP UP initialization shall be performed by the termination with property "Outgoing". If the termination property is "Incoming" then it shall receive the RFCI's from its IuFP peer (or from internal MGW termination with IuFP and same codec). If IuFP is defined on another termination in the MGW but the codec is different, i.e. not TrFO then the relaying of RFCI's shall not be performed. These IuFP peer connection shall be seen as completely separate.
- the UP initialisation information attached to a termination (RFCI values, codec type and mode(s), UP initialisation completed or not) are kept unchanged when the termination is moved to a new context.
- the initialisation direction may be changed during the lifetime of a termination ; upon such a change, the MGW shall apply the behaviour attached to the new initialisation direction.

The procedures for a termination configured in UP Transparent Mode are those described in 3GPP TS 25.415 [4].

## 15.2 Optional UMTS packages

The following packages may be supported by the UMTS Bearer Independent Circuit-Switched Core Network as required by the network services deployed in the network:

- Circuit Switched Data package (see clause 15.2.1);
- TFO package (see clause 15.2.2);
- 3G Expanded Call Progress Tones Generator package (see clause 15.2.3);
- Modification of Link Characteristics Bearer Capability package (see clause 15.2.4);
- Enhanced Circuit Switched Data package (see clause 15.2.5);
- Cellular Text telephone Modem Text Transport package (see clause 15.2.6);
- IP transport package (see clause 15.2.7);
- Flexible Tone Generator Package (see clause 15.2.8);

- Trace Package (see clause 15.2.9);
- ASCII Group Call package (see clause 15.2.10);
- 3G Interface Type package.

## 15.2.1 Circuit Switched Data package

PackageID: threegcsd (0x0030)

Version: 1

Extends: None

This package contains the information needed to be able to support GSM and UMTS Circuit Switched Data from the media gateway.

### 15.2.1.1 Properties

PLMN BC:

PropertyID: plmnb (0x0001).

Description: The PLMN Bearer Capability.

Type: Octet string.

Possible values:

- Specified in the clause "Bearer capability" in 3GPP TS 24.008 [3] , including the Bearer Capability IEI and Length.

Defined in: Local Control Descriptor.

Characteristics: Read/Write.

GSM channel coding:

PropertyID: gsmchancod (0x0002).

Description: Channel information needed for GSM.

Type: Octet string.

Possible values:

- The second octet of Chosen Channel as specified in the clause "Chosen Channel" in 3GPP TS 48.008 [9].

Defined in: Local Control Descriptor.

Characteristics: Read/Write.

### 15.2.1.2 Events

Protocol Negotiation Result:

EventID: protres (0x0001).

Description: This event is used to report the result of the protocol negotiation.

EventsDescriptor Parameters: None.

ObservedEventsDescriptor Parameters:

- Negotiation Result:

- ParameterId: result (0x0001).
- Description: reports whether the protocol negotiation has been successful.
- Type: Enumeration.
- Possible Values:
  - "Success" (0x0001): the protocol negotiation on the termination has been successful.
  - "Failure" (0x0000): the protocol negotiation on the termination has failed.
- Possible Failure Cause:
  - ParameterId: cause (0x0002).
  - Description: indicates the possible failure cause.
  - Type: Enumeration.
  - Possible Values:
    - "Unsp" (0x0001): the protocol negotiation has failed for an unspecified reason.
    - "V8V34" (0x0002): the V.8 or the V.34 protocol negotiation has failed (modem termination only).

#### Rate Change:

EventID: ratechg (0x0002).

Description: This event is used to report a rate change. For example for GSM FAX if the detected rate does not match the channel rate the MGW shall use this to request a new channel rate. See CMM in 3GPP TS 43.045 [35].

EventsDescriptor Parameters: None.

ObservedEventsDescriptor Parameters:

- New Rate:
  - ParameterId: rate (0x0001).
  - Description: reports the new rate for the termination.
  - Type: Integer.
  - Possible Values: transmission rate in bits per second, rounded to the nearest integer value. The value must be a valid bitrate; one of the following rates: 2400, 4800, 9600, 14400, 28800, 57600. An invalid rate shall cause the call to be released by the MSC Server.

### 15.2.1.3 Signals

Activate Protocol:

SignalID: actprot (0x0001).

Description: Activate the higher layer protocol.

Signal type: Brief.

Duration: N/A.

Additional parameter:

- Local Peer Role:
  - ParameterID: localpeer (0x0001).

- Type: Enumeration.
- Possible values:
  - "Orig" (0x0000): originating.
  - "Term" (0x0001): terminating.
- Description: This parameter is optional, but is required for modem and fax calls. It is used to inform the modem whether it should act as originating or terminating peer. This parameter is only included within signal towards the radio access. This may either be an Access Termination or a CN Termination toward another MGW that serves the radio access.

#### 15.2.1.4 Statistics

None.

#### 15.2.1.5 Procedures

This package is used to set up data calls within the CS domain. For more information on the IWF, refer to 3GPP TS 29.007 [6].

When the Media Gateway Controller initiates the "Establish Bearer" procedure, the "Prepare Bearer" procedure, the "Modify Bearer Characteristics" procedure, the "Reserve Circuit" procedure, the "Reserve RTP Connection Point" procedure, the "Configure RTP Connection Point" procedure or the "Reserve and Configure RTP Connection Point" procedure, it shall provide the PLMN BC ("plmnbc" property above) for the termination on the mobile side and the ISDN BC (standard H.248 properties, clause "Bearer Capabilities") for the termination on the fixed side. For a mobile-to-mobile call, it shall provide the PLMN BC on both terminations.

The presence of the PLMN BC property may trigger the use of the IWF.

Once the bearer has been established, after B-answer, the "Activate Interworking Function" procedure is used to activate the IWF. The Activate Protocol signal ("actprot") will start the negotiation of the layer 2 protocols on both sides. If a modem or fax service is requested, the signal shall contain the Local Peer Role parameter ("localpeer"), to tell the modem whether it should act as originating or terminating peer.

**NOTE:** The Activate Protocol signal is needed only after B-answer as described above or after successful in-call modification from speech to fax, to activate the protocol timers at the correct time. This is the only time when this signal is needed (specifically, the signal is not used after a handover sequence or for lawful interception).

The IWF Protocol Indication notifications are used by the MGW to inform the MSC server about IWF protocol events. The MSC has to request the detection of the events "Protocol Negotiation Result" and "Rate Change" in the "Activate IWF" procedure, the "Establish Bearer" procedure, the "Prepare Bearer" procedure, the "Modify Bearer Characteristics" procedure, the "Reserve Circuit" procedure, the "Reserve RTP Connection Point" procedure, the "Configure RTP Connection Point" procedure or the "Reserve and Configure RTP Connection Point" procedure.

For handover to GSM, or change of channel characteristics within the GSM network, the property GSM Channel Coding ("gsmchancod"), which contains the information about the channel type and the number of channels, shall be transmitted to the termination on the mobile side in the "Establish Bearer", the "Prepare Bearer", the "Reserve Circuit", the "Reserve RTP Connection Point", the "Configure RTP Connection Point" and the "Reserve and Configure RTP Connection Point" procedures together with the PLMN BC. The presence of the GSM Channel Coding property also indicates that the termination is using a GSM access network.

If the MGW has requested a rate change due to GSM fax rate mismatch (CMM procedure see 3GPP TS 43.045 [35]) then it shall suspend transmission until the MSC Server has modified the PLMN Bearer Capability and GSM Channel Coding property to match the required rate. If this occurs while other context manipulations are occurring the MGW shall only resume transmission when the streams are bothway connected and the PLMN Bearer Capability and Channel Coding are correct. The MGW shall not send subsequent rate change notifications while the outstanding rate change has not been performed by the MSC Server.

## 15.2.2 TFO package

PackageID: threegtfo (0x0031)  
 Version: 2  
 Extends: None

This package defines events and properties for Tandem Free Operation (TFO) control. TFO uses inband signalling and procedures for Transcoders to enable compressed speech to be maintained between a tandem pair of transcoders. This package allows an MGW, which has inserted a transcoder, to support TFO.

### 15.2.2.1 Properties

TFO Activity Control:

PropertyID: tfoenable (0x0001).

Description: Defines if TFO is enabled or not.

Type: Enumeration.

Possible Values:

- "On" (0x0001): TFO is enabled, TFO protocol is supported.
- "Off" (0x0002): TFO is not enabled, TFO protocol is not initiated or terminated.

Defined in: Local Control descriptor.

Characteristics: Read/Write.

TFO Codec List:

PropertyID: codeclist (0x0002).

Description: List of codecs for use in TFO protocol, the Local Used Codec (see 3GPP TS 28.062 [5]) is always the first entry in the list. The MSC Server may enable TFO without providing a TFO Codec List ; in this case, the MGW shall behave as if it had received a TFO Codec List composed of the selected codec of the opposing termination within the Context.

Type: Sub-list of Octet string.

Possible Values:

- List of codec types; each entry:

Mc Single Codec, similar to as defined in ITU-T Recommendation Q.765.5 [24], for single codec information (figure 14/Q.765.5), where the Codec Information is defined either in ITU-T Recommendation Q.765.5 [24] or in another specification for the given Organization Identifier. For 3GPP codecs these are defined in 3GPP TS 26.103 [16]. The ACodec property in H.248 binary encoding or codeconfig attribute in H.248 text encoding contain the contents of the ITU-T Single Codec IE, excluding the Single Codec Identifier, Length Indication and Compatibility Information.

In H.248 text encoding, the value of the codeclist property shall be encoded as:

LBRKT codeconfig \*(COMMA codeconfig) RBRKT

Example: H.248 text encoding of the TFO codec list (UMTS\_AMR\_2 with Preferred Configuration set 1, and UMTS\_AMR-WB with Preferred Configuration set 0):

Threegtfo/codeclist = { 0206959504 , 020A00 }

Where:

- UMTS\_AMR\_2 parameters are: ETSI, UMTS\_AMR\_2, ACS={12.2, 7.4, 5.9, 4.75}, SCS={12.2, 7.4, 5.9, 4.75}, OM=0 plus MACS=4
- UMTS\_AMR\_WB parameters are: ETSI, UMTS\_AMR\_WB, Config-WB-Code=00

Defined in: Local Control descriptor.

Characteristics: Read/Write.

### 15.2.2.2 Events

Optimal Codec Event:

EventID: codec\_modify (0x0010).

Description: The event is used to notify the MGC that TFO negotiation has resulted in an optimal codec type being proposed.

EventsDescriptor Parameters: None.

ObservedEventsDescriptor Parameters:

- Optimal Codec Type.
  - ParameterID: optimalcodec (0x0011).
  - Description: indicates which is the proposed codec type for TFO.
  - Type: Octet string.
  - Possible Values:
    - Mc Single Codec;
    - Similar to as defined in ITU-T Recommendation Q.765.5 [24], for single codec information (figure 14/Q.765.5), where the Codec Information is defined either in ITU-T Recommendation Q.765.5 [24] or in another specification for the given Organization Identifier. For 3GPP codecs these are defined in 3GPP TS 26.103 [16]. The ACodec property in H.248 binary encoding or codeconfig attribute in H.248 text encoding contain the contents of the ITU-T Single Codec IE, excluding the Single Codec Identifier, Length Indication and Compatibility Information.

Codec List Event:

EventID: distant\_codec\_list (0x0012).

Description: The event is used to notify the MGC of the distant TFO partner's supported codec list.

EventsDescriptor Parameters: None.

ObservedEventsDescriptor Parameters:

- Distant Codec List:
  - ParameterID: distlist(0x0013).
  - Description: indicates the codec list for TFO.
  - Type: Sub-list of Octet string.
  - Possible Values:
    - List of codec types; each entry:
    - Mc Single Codec similar to as defined in ITU-T Recommendation Q.765.5 [24], for single codec information (figure 14/Q.765.5), where the Codec Information is defined either in ITU-T Recommendation Q.765.5 [24] or in another specification for the given Organization Identifier. For 3GPP codecs these are defined in 3GPP TS 26.103 [16]. The ACodec property in H.248 binary

encoding or codecconfig attribute in H.248 text encoding contain the contents of the ITU-T Single Codec IE, excluding the Single Codec Identifier, Length Indication and Compatibility Information.

The first Codec Type in the list is the Distant Used Codec, received from the distant TFO partner (see 3GPP TS 28.062 [5]). .

In H.248 text encoding, the value of the distlist parameter shall be encoded as:

LBRKT codecconfig \*(COMMA codecconfig) RBRKT

TFO Status Event:

EventID: TFO\_status (0x0014).

Description: The event is used to notify the MGC that a TFO link has been established or broken.

EventsDescriptor Parameters: None.

ObservedEventsDescriptor Parameters:

- TFO Status:
  - ParameterId: tfostatus (0x0015).
  - Description: reports whether TFO has been established or broken. Upon TFO activation, no notification is sent if TFO has not been established. A TFO\_Off notification is only reported when a TFO link previously established is broken. The MGW should not report transient TFO status change.
  - Type: Boolean
  - Possible Values:
    - "TFO\_On" : TFO has been established.
    - "TFO\_Off" : TFO is no more established.

### 15.2.2.3 Signals

None.

### 15.2.2.4 Statistics

None.

### 15.2.2.5 Procedures

For the procedures for TFO see 3GPP TS 28.062 [5].

To enable TFO, the MSC Server shall configure the properties of this package on a MGW Termination with the media stream property for Codec Type set to ITU-T Recommendation G.711 [25] (see annex C of ITU-T Recommendation H.248 [10]) or Bearer Service Characteristics set to "Speech" or "3.1 kHz Audio" in TMR or USI due to Reserve Circuit Procedure, see in ITU-T Recommendation Q.1950 (see 3GPP TS 29.205 [7]).

The TFO protocol shall be disabled if the call configuration becomes no longer TFO compatible or if the Codec Type property of the media stream at the opposing termination in the Context is reconfigured to G.711 or if the Bearer Service Characteristics of the opposing Termination is reconfigured to "Speech" or "3.1 kHz Audio". The TFO protocol may be disabled either by the MSC Server by using the TFO Activity Control property of this package or by the MGW in accordance with the TFO rules as described in [5] when it detects that TFO operation is no longer possible (for example it has G.711 encoding at opposing Terminations).

## 15.2.3 3G Expanded Call Progress Tones Generator Package

PackageID: threexcg(0x0032)

Version: 1

Extends: xcg version1

This package extends "Expanded Call Progress Tones Generator Package", as defined in ITU-T Recommendation Q.1950 [23] (see 3GPP TS 29.205 [7]). The package adds a new toneId for CAMEL prepaid warning tone.

### 15.2.3.1 Properties

None.

### 15.2.3.2 Events

None.

### 15.2.3.3 Signals

CAMEL Prepaid Warning Tone:

SignalID: cpwt (0x004f).

Description: Generate CAMEL prepaid warning tone to inform the party that the Max Call Period Duration is about to expire. CAMEL prepaid warning tone is defined in 3GPP TS 23.078 [22]. The physical characteristic of CAMEL prepaid warning tone is available in the gateway.

Signal type: Brief.

Duration: Provisioned, Not Auditable.

Additional parameters:

- Tone Direction.
- ParameterID: td (0x0010).
- Type: Enumeration.
- Values:
  - "Ext" (0x01): external.
  - "Int" (0x02): internal.
  - "Both" (0x03): Both.
- Default: "Ext".

### 15.2.3.4 Statistics

None.

### 15.2.3.5 Procedures

None.

## 15.2.4 Modification Of Link Characteristics Bearer Capability

PackageName: Modification of Link Characteristics Bearer Capability

PackageID: threegmlc(0x0046)

Description: This package contains an event that when requested by the MGC will cause the MG to notify the MGC that modification of the link characteristics is allowed. This notification is typically generated when the bearer has been established.

Version: 1

Extends: None

### 15.2.4.1 Properties

None.

### 15.2.4.2 Events

Bearer Modification Support Event.

EventID: mod\_link\_supp (0x0001).

Description: The event is used to notify the MGC that modification of the link characteristics of the current bearer connection is permitted.

EventsDescriptor Parameters: None.

ObservedEventsDescriptor Parameters: None.

### 15.2.4.3 Signals

None.

### 15.2.4.4 Statistics

None.

### 15.2.4.5 Procedures

If the MGC is interested in determining whether or not the bearer associated with a termination supports modification of its link characteristics it shall send a request (Add/Modify/Move) with the Bearer Modification Support Event. When the bearer is established the MG will indicate in a Notify request to the MGC if modification of link characteristics is supported. A notify will NOT be generated if modification is NOT supported on the bearer.

## 15.2.5 Enhanced Circuit Switched Data package

PackageID: threegcsden (0x0082)

Version: 1

Extends: threegcsd (0x030) Version 1

This package extends "Circuit Switched Data Package", as defined in clause 15.1.2. This package adds a new property to define the user bitrate at a Iu termination.

### 15.2.5.1 Properties

Bitrate

PropertyID: bitrate (0x0003).

Description: user bitrate.

Type: Integer.

Possible Values: transmission rate in bits per second, rounded to the nearest integer value. The value shall be a valid bitrate; one of the following rates: 2400, 4800, 9600, 14400, 28800, 57600, 64000.

Defined in: Local Control Descriptor.

Characteristics: Read/Write.

### 15.2.5.2 Events

None.

### 15.2.5.3 Signals

None.

### 15.2.5.4 Statistics

None.

### 15.2.5.5 Procedures

This package is used in addition to the 3GCSD package for CS data calls. It is used for indicating the user data rates for Inter-MSC SRNS Relocation and handover cases. If the Bitrate is not 64 kb/s at one termination in the MGW but its opposing termination has properties that define its bitrate to be 64 kb/s (e.g. TMR=UDI) then A-TRAU' protocol shall be applied by the MGW. For further details see 3GPP TS 29.007 [6].

## 15.2.6 Cellular Text telephone Modem Text Transport

PackageName: CTM Text Transport

PackageID: threegctm (0x0068)

Description: The CTM text transport package is intended for enabling robust real time text conversation through a voice channel primarily intended for communication over mobile networks. This package includes the mechanisms needed to transport T.140 text conversation streams [19] in a voice channel environment, using the CTM Cellular Text Telephone Modem specified in 3GPP TS 26.226 [18]. The transport mechanism allows for alternating transport of voice and text.

Version: 1

Extends: None

### 15.2.6.1 Properties

Text termination connection state:

PropertyID: connstate (0x0001).

Description: The connection state property is used to reflect details of the achieved text connection. For each new session connstate should be reset to "Prepare".

Type: Enumeration.

Possible values:

- "Idle" (0x0001) meaning that CTM availability negotiation has failed; CTM is disabled except for monitoring the incoming line for CTM signals.
- "Prepare" (0x0002) for CTM being enabled, monitoring for CTM signals and ready to send CTM signals.
- "Connected" (0x0006) for CTM being enabled and to have detected CTM availability in the current session.

Defined in: TerminationState.

Characteristics: Read/Write.

Text Transport:

PropertyID: trpt (0x0002)

Description: The transport parameter reflects the transport mechanism selected for the Text Conversation termination. In 3GPP, one possible transport mechanism is the Cellular Text Telephone Modem as in 3GPP TS 26.226 [18]. It is used when it is desired to transport the text conversation in a voice channel. CTM enables alternating use of the voice channel for voice and text during the call.

Type: Enumeration.

Possible values:

- "ctm" (0x0008) for text transport in mobile voice channel as in 3GPP TS 26.226 [18].

Defined in: LocalControl.

Characteristics: Read/Write.

Text Protocol Version:

PropertyID: textproto (0x0003).

Description: The version of the ITU-T Recommendation T.140 [19] protocol used in the connection.

Type: Integer.

Possible values:

- Any integer corresponding to a T.140 version number (currently 1) as in ITU-T Recommendation H.248 .2 [17].

Defined in: LocalControl.

Characteristics: Read/Write.

## 15.2.6.2 Events

Connection State Change:

EventID: connchange (0x0001).

Description:

- This event will occur when the text connection state for the termination has changed.
- The parameter values are the same as the Connection State property.
- If a CTM availability request timed out, the state is returned to Idle.

EventDescriptorParameters:

None.

ObservedEventDescriptorParameters:

ParameterName: Connection Change.

ParameterID: connchnng (0x0001).

Type: Enumeration.

Possible Values: As property threegctm/connstate.

### 15.2.6.3 Signals

None.

### 15.2.6.4 Statistics

Characters Transferred:

StatisticsID: chartrans (0x0001).

Description: Number of bytes of ITU-T Recommendation T.140 [19] data transferred through the termination.

Units: count.

### 15.2.6.5 Procedures

If the MGC detects a CTM indication it shall send a request (Add/Modify/Move) with the CTM Transport property. Upon receipt of it, the MGW shall allocate a termination with CTM capabilities. Normal usage is that the CTM enabled termination handles one text stream and one voice stream and alternates between transporting voice and text in the voice channel according to the functionality of CTM. This termination could for example be combined in a context with a termination with the txp and ctyp packages for gateway functionality between PSTN text telephony and mobile CTM based text telephony. These packages are described in ITU-T Recommendation H.248.2 [17].

The CTM algorithm has states. The states defined in the text termination connection state property are mapped into CTM states in the following way:

- Idle: CTM disabled because of an unsuccessful CTM availability negotiation.
- Prepare: normal initial state with CTM monitoring active.
- Connected: CTM negotiation is completed.

For each new call, the CTM termination shall be put in the Prepare state.

When the CTM availability negotiation is completed, the state is Connected.

The state transitions are automatic, except for setting Prepare state as described above.

## 15.2.7 IP transport package

This package has been replaced by the use of Annex C.6 IP and UDP properties (see clauses 14.2.41 and 14.2.42).

## 15.2.8 Flexible Tone Generator Package

PackageID: threegflex (0x0084)

Version: 1

Extends: threegxcg version 1

This package extends "3G Expanded Call Progress Tones Generator Package", as defined in chapter 15.1.4 above. This package adds a new tone for call duration control in CAMEL phase 4, supporting variable sequence of tones and burst list.

### 15.2.8.1 Properties

None.

### 15.2.8.2 Events

None.

### 15.2.8.3 Signals

Signal Name: Flexible Tone.

SignalID: ft (0x0050).

Description: Generate flexible 900 Hz tone. The physical characteristics of Flexible Tone is not described in the additional parameters. It shall be available in the Media Gateway.

SignalType: Brief.

Duration: Provisioned.

Additional Parameters:

- Parameter Name: Burst List Direction

Description: Used to indicate the direction the tone is to be sent. External indicates that the tone is sent from the MG to an external point. Internal indicates that the tone is played into the Context to the other terminations. Both way indicates both internal and external behaviour.

ParameterID: bld (0x0001).

Type: Enumeration.

Possible Values:

- "Ext" (0x01): External.
- "Int" (0x02): Internal.
- "Both" (0x03): Both way.
- Default: "Ext" (0x01).

Parameter Name: numberOfBursts.

Description: Number of bursts in the burst list.

ParameterID: nob (0x0002).

Type: Integer.

Possible values: 1 to 3.

Default: 1.

Parameter Name: burstInterval.

Description: Time interval between two consecutive bursts expressed in amount of 100 ms units.

ParameterID: bi (0x0003).

Type: Integer.

Possible values: 1 to 1200.

Default: 2.

Parameter Name: numberOfTonesInBurst.

Description: Number of tones to be played in each burst.

ParameterID: notib (0x0004).

Type: Integer.

Possible values: 1 to 3.

Default: 3.

Parameter Name: toneDuration.

Description: Duration of each tone in a burst expressed in amount of 100 ms units.

ParameterID: td (0x0005).

Type: Integer.

Possible values: 1 to 20.

Default: 2.

Parameter Name: toneInterval.

Description: Time interval between two consecutive tones in a burst expressed in amount of 100 ms units.

ParameterID: ti (0x0006).

Type: Integer.

Possible values: 1 to 20.

Default: 2.

#### 15.2.8.4 Statistics

None.

#### 15.2.8.5 Procedures

The MGW should generate the tones using the above mentioned parameters as specified in 3GPP TS 23.078 [22] clause 4.5.7.1.2

In case MGC requests to generate a flexible tone specifying a signal type "Timeout" and a "Duration" longer than the time needed to play the whole Burst List no action will be taken on the incoming stream to fill the gap. I.e. if any user plane stream is received on one side of the termination after the end of the burst list, it will be present, unchanged, on the other side of the termination as well (transparent mode).

### 15.2.9 Trace Package

PackageID: calltrace (0x0097)

Version: 1

Extends: None

This package defines properties for subscriber and equipment trace activation and deactivation properties to be attached to the trace record generated by MGW.

#### 15.2.9.1 Properties

Trace Activation Control

PropertyID: traceactivityrequest(0x0001)

Description: Defines if trace is activated or deactivated.

Type: Bool

Possible Values:

"on" (true): Trace Session is activated in MGW

"off" (false): Trace Session is deactivated in MGW

Defined in: Local Control descriptor

Characteristics: Read/Write

#### IMSI

PropertyID: imsi(0x0002)

Description: IMSI number of the traced subscriber to be attached to the trace record. Used for record identification like trace reference.

Type: Octet string

Possible Values: The IMSI is coded as defined in 3GPP TS 23.003 [43]. The IMSI is TBCD-coded with a fixed length of 8 octets. Two digits are encoded per octet, each digit is encoded 0000 to 1001 (0 to 9). Bits 8765 of octet n encodes digit 2n, bits 4321 of octet n encodes digit 2(n-1) +1 (i.e the order of digits is swapped in each octet compared to the digit order defined in 3GPP TS 23.003 [43]). 1111 is used as filler when there is an odd number of digits. Digits are packed contiguously with no internal padding.

Defined in: Local Control descriptor

Characteristics: Read/Write

#### IMEI(SV)

PropertyID: imei\_sv(0x0003)

Description: IMEI(SV) number of the traced equipment to be attached to the trace record. Used for record identification like trace reference.

Type: Octet string

Possible Values: The IMEI(SV) is coded as defined in 3GPP TS 23.003 [43]. The IMEI(SV) is TBCD encoded. Two digits are encoded per octet, each digit is encoded 0000 to 1001 (0 to 9). Bits 8765 of octet n encodes digit 2n, bits 4321 of octet n encodes digit 2(n-1) +1 (i.e the order of digits is swapped in each octet compared to the digit order defined in 3GPP TS 23.003 [43]). 1111 is used as filler when there is an odd number of digits. Digits are packed contiguously with no internal padding.

Defined in: Local Control descriptor

Characteristics: Read/Write

#### Trace Reference

PropertyID: tracereference(0x0004)

Description: Reference number to identify different Trace Session in OSS as defined in 3GPP TS 32.421 [29] and 3GPP TS 32.422 [30].

Type: Octet string

Possible Values: OSS (EM) defines when activating a Trace Session

Defined in: Local Control descriptor

Characteristics: Read/Write

#### Trace Recording Session Reference

PropertyID: tracerecsessionref(0x0005)

Description: A unique identifier within the Trace Session for identifying the Trace Recording sessions. Defined in 3GPP TS 32.421 [29] and in 3GPP TS 32.422 [30].

Type: Octet string

Possible Values: Described in 3GPP 32.422 [30]

Defined in: Local Control descriptor

Characteristics: Read/Write

#### Trace Depth

PropertyID: tracedepth(0x0006)

Description: Trace Depth as defined in 3GPP TS 32.421 [29]

Type: Enumeration

Possible Values: Defined in 3GPP TS 32.422 [30]

Defined in: Local Control descriptor

Characteristics: Read/Write

#### Triggerring Events

PropertyID: triggeringevent(0x0007)

Description: Triggerring Events as defined in 3GPP TS 32.422 [30].

Type: Octet string

Possible Values: Defined in 3GPP TS 32.422 [30].

Defined in: Local Control descriptor

Characteristics: Read/Write

#### List of interfaces

PropertyID: listofinterfaces(0x0008)

Description: List of interfaces to trace as defined in 3GPP TS 32.422 [30]

Type: Octet string

Possible Values: Defined in 3GPP TS 32.422 [30]

Defined in: Local Control descriptor

Characteristics: Read/Write

### 15.2.9.2 Events

#### Trace result

EventID: tracact (0x0001)

Description: Notification to the MSC Server if trace activation was successful/unsuccessful in the MGW.

EventDescriptor parameters: None

ObservedEventsDescriptor parameters:

Result: Trace Activation Result

res (0x0001)

Type: enumeration

Possible values:

success (0x0001): "Trace Successfully activated"

failure (0x0000): "Failure in trace activation"

### 15.2.9.3 Signals

None

### 15.2.9.4 Statistics

None

### 15.2.9.5 Procedures

For the network level procedures of the tracing see 3GPP 32.422 [30].

For the trace records of the MGW see 3GPP 32.423 [31].

In H.248 interface MSC Server uses 'Trace Activity Control' property to indicate MGW that a termination should be placed under trace or should be taken out of trace. In the call establishing phase MSC Server sets trace package information into proper command (Add or Modify) associated to the termination to be traced. Tracing can be activated either by giving IMEI(SV) or IMSI number as a further information. MSC Server shall also provide the values for all other properties described in this package that is IMSI if trace is activated based on IMSI, IMEI(SV) if trace is activated based on IMEI(SV), Trace reference, Trace recording session reference, Trace depth, triggering events in MGW, list of interfaces in MGW. When MSC Server activates the trace, it shall use 'Trace Activation Result' Event to detect if the Trace Activation was successful or not. MGW shall not reject the Add/Modify because of unsuccessful Trace Activation, but only send a Notification with this Event. Tracing is automatically deactivated in MGW when termination is taken out of the context in the end of the call. If the Termination is Moved to another Context, trace is automatically forwarded to new termination.

## 15.2.10 ASCII Group call package

PackageID: threegasci (0x00b2)

Version: 2

Extends: None

This package contains the information needed to be able to support VGCS (3GPP TS 43.068 [39]) and VBS (3GPP TS 43.069 [40]) services.

### 15.2.10.1 Properties

Number of needed conference terminations

PropertyID: nct (0x0001)

Description: Indicates the number of needed conference terminations for the call.

Type: Integer

Defined in Descriptor: Local Control Descriptor

Characteristics: Read/Write

Number of desired listener context terminations

PropertyID: nlct (0x0002)

Description: Indicates the number of desired terminations for a listener context.

Type: Integer

Defined in Descriptor: Local Control Descriptor

Characteristics: Read/Write

### 15.2.10.2 Events

None.

### 15.2.10.3 Signals

None.

### 15.2.10.4 Statistics

None

### 15.2.10.5 Procedures

The MSC server receives the number of needed conference terminations from GCR (see 3GPP TS 43.068 [39]) and 3GPP TS 43.069 [40]) and reserves the requested number of needed Conference terminations for that call. The parameter "Number of needed conference terminations" shall be included when allocating the first termination of an ASCII-conference context. It is optional when adding further terminations. If the MGW is unable to reserve the number of requested terminations for that call, it shall response with error code 510 "insufficien resources".

The parameter "Number of desired listener context terminations" should be included when allocating the first termination of a Listener context.

## 15.2.11 3G Interface Type package

PackageID: threegint (0x00e3)

Version: 1

Extends: None

This package contains a property to specify the used interface type for IP terminations.

### 15.2.11.1 Properties

IP Interface Type

PropertyID: ipint (0x0001)

Description: Indicates the type of external interface used by the termination.

Type: Enumeration.

Possible Values:

- "NboIP" (0x0001) Nb over IP with SIP-I based Nc, see 29.414 [32].
- "AoIP" (0x0002) A interface over IP.
- "MboIP" (0x0003) Mb interface
- "ExtSIPI" (0x0004) External SIP-I based network

All other values reserved.

Defined in: Local Control descriptor.

Characteristics: Read/Write.

#### 15.2.11.2 Events

None.

#### 15.2.11.3 Signals

None.

#### 15.2.11.4 Statistics

None

#### 15.2.11.5 Procedures

The MSC server may indicate the interface type (reference point) associated with the RTP bearer termination to the MGW with this package. This allows MGW to collect statistics per interface type associated with the RTP bearer termination as required by 3GPP TS 32.407[58]. The provision of these statistics is outside of the scope of this specification.

# Annex A (informative): Framing protocol Interworking Function (FPIF)

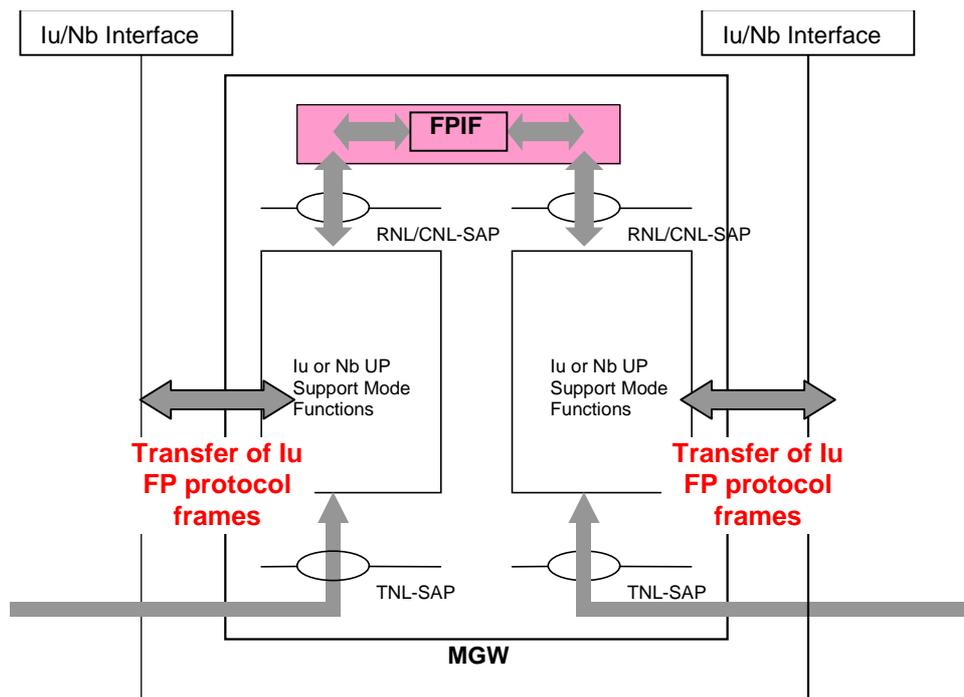
## A.1 Introduction

SDUs transmitted over an Iu or Nb interface and received at a MGW whose outgoing UP is also Iu or Nb shall be relayed to the outgoing UP MGW termination. If no interworking function (other than the FPIF) or transcoder device is inserted by the MGW, and if UP terminations are present, then PDUs and control procedures are passed between MGW terminations by the FPIF. The FPIF is the functional entity responsible for aligning or mapping control procedures (including RFCIs, frame numbers etc) on the separate UP interfaces according to the package procedures described in the main text. The FPIF determines if the two UP configurations are identical and thus the UP PDUs may be passed transparently. If the FPIF determines that the two UP configurations are not identical it applies the required mapping. The relaying of PDUs transparently can also be considered as FPIF bypass.

**NOTE:** the implementation in the MGW can perform a more efficient processing of the PDUs in this case. The MGW switching and bypassing of the protocol functions during TrFO is left to the manufacturer's implementation.

UP initialisations are not handled by the FPIF, only receipt of the Subflow combinations and the RFCI allocations are received by the FPIF for each UP.

The RFCIs are relayed by the FPIF as described in main text for the UP package procedures.



**Figure A.1: The Framing Protocol Interworking Function**

---

## A.2 FPIF procedures with respect to Iu framing protocol

This clause handles relay of user data indicated to the FPIF in a Nb- or Iu-UP-data-indication message and transmitted between peer UP layer entities in PDU types 0 and 1. The FPIF passes this information to the UP layer on the sending side in a Nb- or Iu-UP-data-request message.

### A.2.1 Payload

Received SDUs shall be forwarded unmodified to the next MGW. Note that if "delivery of erroneous SDUs" is set to 'no', faulty SDUs are already discarded by the Iu or Nb support mode functions and, hence, not delivered to the FPIF.

### A.2.2 RFCIs

If the RFCI values on the outgoing UP interface match those initialised on the incoming UP interface then the RFCI indicated by the lower layer (i.e. Iu or Nb) on the receiving side shall be forwarded unmodified to lower layer on the sending side.

If the RFCI sets on the outgoing UP interface do not match those initialised on the incoming UP interface then the FPIF performs mapping between the RFCIs on each UP for the same initialised Subflow Combination.

The FPIF is the entity that may perform the RFCI value correction procedure as described in the main text, after this procedure then relaying of the received RFCI shall be performed.

### A.2.3 FQC

The FQC indicated by the lower layer (i.e. Iu or Nb) on the receiving side shall be forwarded unmodified to lower layer on the sending side.

### A.2.4 Frame number

The frame number indicated by the lower layer (i.e. Iu or Nb) on the receiving side shall be forwarded unmodified to lower layer on the sending side.

A discontinuity in framing protocol support mode frame numbers is allowed at the end of the TrFO break.

## A.3 Relay of status information

This clause handles relay of status information indicated to the FPIF in a Nb- or Iu-UP-status-indication message and transmitted between peer UP layer entities in PDU type 14. The FPIF in general passes this information to the UP layer on the sending side.

### A.3.1 Void

### A.3.2 Rate Control Frames

The FPIF shall pass rate control request and rate control acknowledgement frames transparently between incoming UP interface and outgoing UP interface.

Before a MGW reverts from TrFO break operation (for example during handover or relocation where the rate control procedures may have been operating independently between each UP interface) the FPIF may perform rate control procedures to each UP peer. It shall then use the Maximum rate and Current rate settings from the opposite UP configurations. This is performed to align the UP's on each side of the MGW to enable relaying of all subsequent PDUs as described above.

Optionally, the UP layer protocol entity on the sending side may substitute the frame number received in a status request by another number, but shall then substitute the initial number back in the status indication containing the acknowledgement. Figure A.2 shows an example of the relay of the rate control procedure.

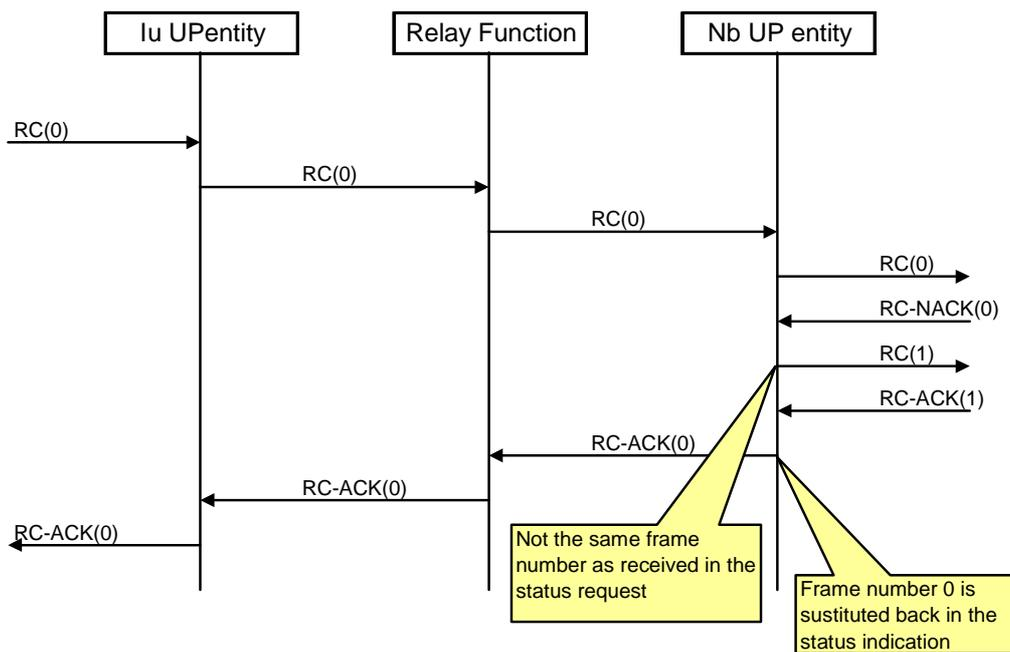
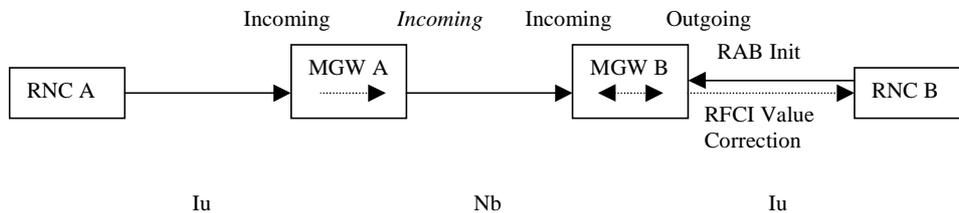


Figure A.2: Relay of a control procedure

### A.3.2 Time Alignment

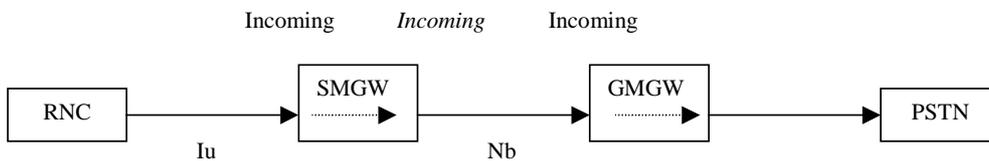
Time alignment frames shall be relayed unmodified.

# Annex B (informative): Examples for Usage of the 3GUP Package "Initialization Direction" Property



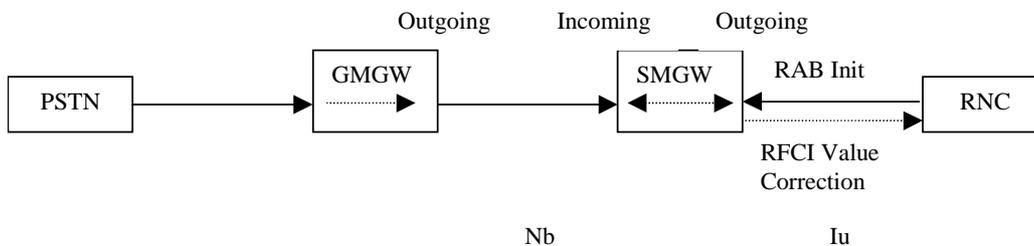
**Figure B.1: 3G to 3G Call (A to B) , originating RAB established after Nb bearer, same codec configuration on originating lu and Nb bearers**

NOTE: The Initialization Direction property of the Nb termination of MGW A could alternatively be set to 'Outgoing', but different RFCIs may then be initialized on the lu and Nb bearers.

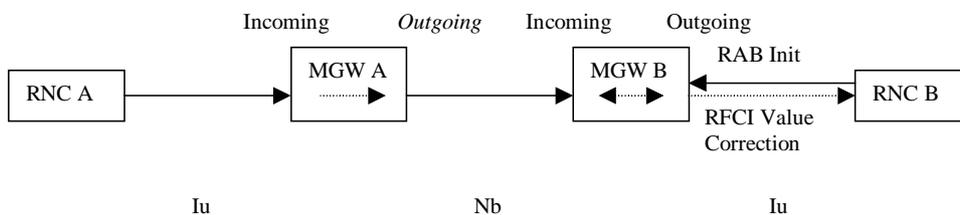


**Figure B.2: 3G Originating Call, originating RAB established after Nb bearer, same codec configuration on originating lu and Nb bearers**

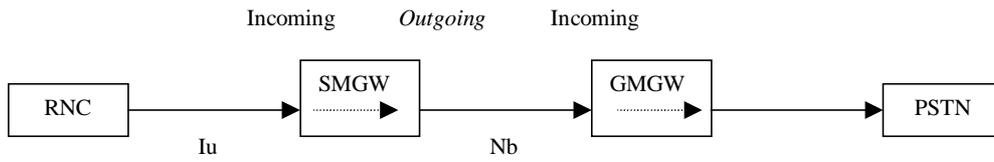
NOTE: The Initialization Direction property of the Nb termination of MGW A could alternatively be set to 'Outgoing', but different RFCIs may then be initialized on the lu and Nb bearers.



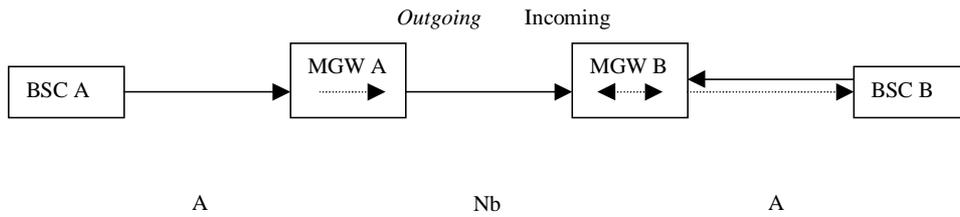
**Figure B.3: 3G Terminating Call**



**Figure B.4: 3G to 3G Call (A to B), originating RAB established before or in parallel to the Nb bearer or different codec configuration on originating lu and Nb bearers**



**Figure B.5: 3G Originating Call, originating RAB established before or in parallel to the Nb bearer or different codec configuration on originating Iu and Nb bearers**



**Figure B.6: 2G to 2G Call (A to B)**

# Annex C (Normative): Profile description

## C.1 Profile Identification

<b>Profile name:</b>	<b>Threegbicsn</b>
Version:	8

*The name and version of the profile that is sent in the service change command.*

## C.2 Summary

This Profile describes the minimum mandatory settings and procedures required to fulfil the requirements of the Mc interface media gateway control. In addition optional settings and procedures are described which fulfil optional features and where supported, the minimum mandatory settings within the optional procedures and packages are identified that must be supported in order to support that feature.

"Optional" or "O" means that it is optional for either the sender or the receiver to implement an element. If the receiving entity receives an optional element that it has not implemented it should send an Error Code (e.g. 445" Unsupported or Unknown Property", 501"Not Implemented", etc.) . "Mandatory" or "M" means that it is mandatory for the receiver to implement an element. Whether it is mandatory for the sender to implement depends on specific functions; detail of whether elements of the core protocol are mandatory to be sent are defined in the stage 2 procedures, stage 3 procedures and/or the descriptions of individual packages.

The setting or modification of elements described in the profile under the heading "Used in Command" has the meaning that the property can be set/modified with that command. The property may be present in other commands (in order to preserve its value in accordance with ITU-T H.248.1[10]) when those commands are used for other procedures that affect the same descriptor.

This profile supports Explicit Congestion Notification and Multimedia Priority Service.

## C.3 Gateway Control Protocol Version

### ITU Recommendation H.248.1 Version 2

*The minimum H.248 version required to support the profile. This should be based upon base syntax support and not an arbitrary version assignment. This is related to the ServiceChangeVersion in clause C.8.8.*

## C.4 Connection Model

**Table C.4: Connection Model**

<b>Maximum number of contexts:</b>	No restriction
<b>Maximum number of terminations per context:</b>	32
<b>Allowed termination type combinations in a context:</b>	All

## C.5 Context Attributes

**Table C.5/1: Context attributes**

Context Attribute	Supported	Values Supported
<b>Topology</b>	Yes (NOTE 1)	See clause C.7.8 Topology Descriptor
<b>Priority Indicator</b>	Optional (NOTE 3)	0-15 (NOTE 4)
<b>Emergency Indicator</b>	Yes	NA
<b>IEPS Indicator (NOTE 2)</b>	No	NA
<b>ContextAttribute Descriptor (NOTE 2)</b>	No	NA
<b>ContextIDList Parameter (NOTE 2)</b>	No	NA
NOTE 1: Stream ID in Topology Descriptor shall not be supported.		
NOTE 2: This field requires at least version 3 of the H.248.1 protocol.		
NOTE 3: This Context Attribute parameter is used for MPS as specified in 3GPP TS 22.153 [78].		
NOTE 4: Priority values 11 – 15 of the Priority Indicator are reserved for MPS.		

**Table C.5/2: AND/OR Context attributes**

AND/OR Context Attribute	No	NA
NOTE: This field requires at least version 3 of the H.248.1 protocol.		

## C.6 Terminations

### C.6.1 Termination Names

#### C.6.1.1 General

The Termination ID structure shall follow the guidelines of H.248 and the structure is either relevant or irrelevant for MGC and MGW.

The relevance depends on the utilized bearer type for termination. With ephemeral ATM/AAL2 and IP endpoint bearer types the internal structure of Termination ID is irrelevant for MGW and MGC and therefore Termination ID is only numeric identifier for termination. When bearer type is physical timeslot within TDM circuit the Termination ID structure shall follow the Termination naming convention for TDM circuit bearer.

Ephemeral terminations are further denoted in the profile by the following:

- BICC (meaning applies to terminations towards BICC)
- BICC ATM (meaning applies to terminations towards BICC with ATM transport)
- BICC IP (meaning applies to terminations towards BICC with IP transport)
- Iu (meaning applies to terminations towards Iu interface)
- RTP (meaning applies to all IP terminations, e.g. SIP-I/Nb, Mb, AoIP)
- RTP-CN (meaning applies to terminations towards SIP-I)
- RTP-A (meaning applies to terminations towards A interface over IP)

**Editor's Note: it is FFS if specific handling in the profile for the RTP-CN or RTP-A types is needed.**

## C.6.1.2 ASN.1 Coding

### C.6.1.2.1 General Structure

The following general structure of termination ID shall be used:

4 octets shall be used for the termination ID. The following defines the general structure for the termination ID:

**Table C.6.1.2.1: ASN.1 coding**

Termination type	X
------------------	---

Termination type:

Length 3 bits

Values:

000 Reserved

001 Ephemeral termination

010 TDM termination

011 - 110 Reserved

111 Reserved for ROOT termination Id (ROOT Termination ID = 0xFFFFFFFF)

X:

Length 29 bits.

Usage dependent on Termination type. TDM terminations specified below in clause C.6.1.2.2. Other usage unspecified.

### C.6.1.2.2 Termination naming convention for TDM terminations

**Table C.6.1.2.2 ASN.1 coding**

Termination type (=010)	PCM system	Individual
-------------------------	------------	------------

PCM system:

Length 24 bits

Usage unspecified. Uniquely identifies PCM interface in MGW

Individual:

Length: 5 bits

Max. of 32 individuals (timeslots) per PCM system (max. 24 for a 24 channel system)

## C.6.1.3 ABNF Coding

### C.6.1.3.1 General Structure

The following general structure of termination ID shall be used:

TerminationID = "ROOT" / pathName / "\$" / "\*" ; According to H.248.1 annex B

### C.6.1.3.2 Termination naming convention for TDM terminations

pathName = TDMToken UNDERSCORE ((PCMsystem / "\*" ) SLASH (Individual / "\*" ))

TDMToken = "TDM"

UNDERSCORE = %x5F ;" \_"

PCMsystem : Usage not specified

Individual = 1 \* 2 (DIGIT) ; 0-31

### C.6.1.3.3 Termination naming convention for Ephemeral terminations

pathName = EphTokenUNDERSCORE(EPHsystem/"\*")

EphToken = "Ephemeral"

UNDERSCORE = %x5F ;" \_"

EPHsystem : Usage is not specified

## C.6.2 Multiplexed terminations

**Table C.6.2: Multiplexed terminations**

Multiplex terminations supported?	No
-----------------------------------	----

## C.7 Descriptors

### C.7.1 Stream Descriptor

**Table C.7.1: Stream descriptors**

Maximum number of streams per termination type	All	1
--	-----	---

#### C.7.1.1 LocalControl Descriptor

**Table C.7.1.1/1: Local Control Descriptor**

If not generic list appropriate termination and stream types.		Termination Type	Stream Type
<b>ReserveGroup used:</b>	No	-	-
<b>ReserveValue used:</b>	Yes	BICC (NOTE), RTP	Not Applicable
NOTE: The support is needed for the optional procedures Modify Char (see 14.2.27) and Reserve Char (see 14.2.28). These procedures use Q.1950 procedures which define the use of the Reserve Value.			

**Table C.7.1.1/2: Allowed Stream Modes**

Termination Type	Stream Type	Allowed StreamMode Values
All	Not Applicable	SendOnly, RecvOnly, SendRecv, Inactive

## C.7.2 Events Descriptor

All events contained in this profile may be set on any termination/stream with the following exceptions.

**Table C.7.2/1: Events Descriptor**

Events settable on termination types and stream types:	Yes		
If yes	EventID	Termination Type	Stream Type
	Cause (g/cause, 0x0001/0x0001)	All except ROOT	Not Applicable
	Signal Completion (g/sc, 0x0001/0x0002)	All except ROOT	Not Applicable
	Start tone detected (tonedet/std, 0x0004/0x0001)	All except ROOT	Not Applicable
	End Tone detected (tonedet/etd, 0x0004/0x0002)	All except ROOT	Not Applicable
	DTMF character 0 (dd/d0, 0x0006/0x0010) to DTMF character D (dd/dd, 0x0006/0x001d)	All except ROOT	Not Applicable
	Completion (ct/cmp, 0x000a/0x0005)	TDM	Not Applicable
	BNC Change (GB/BNCChange, 0x0021/0x01)	BICC, lu	Not Applicable
	Tunnel Indication (BT/TIND, 0x0022/0x01)	BICC IP	Not Applicable
	MGCon (chp/mgcon, 0x0029/0x0001)	ROOT	Not Applicable
	Termination Heartbeat (hangterm/thb, 0x0098/0x0001)	All except ROOT	Not Applicable
	Protocol Negotiation Result: (threegcsd/protres, 0x0030/0x0001)	All except ROOT	Not Applicable
	Rate Change (threegcsd/ratechg, 0x0030/0x0002)	All except ROOT	Not Applicable
	Optimal Codec Event (threegtfoc/codec_modify, 0x0031/0x0010)	All except ROOT	Not Applicable
	Codec List Event (threegtfoc/distant_codec_list, 0x0031/0x0012)	All except ROOT	Not Applicable
	TFO Status Event (threegtfoc/TFO_status, 0x0031/0x0014)	All except ROOT	Not Applicable
	Bearer Modification Support Event (threegmlc/mod_link_supp, 0x0046/0x0001)	lu	Not Applicable
	Connection State Change (threegctm/connchange, 0x0068/0x0001)	All except ROOT	Not Applicable
	Trace result (calltrace/ tracact, 0x0097/0x0001)	All except ROOT	Not Applicable
	Inactivity Timeout (it/ito, 0x0045/0x0001)	ROOT	Not Applicable
	Available Realms Changed (ipra/arc, 0x00e0/0x0001)	ROOT	Not Applicable
	IP Flow Stop Detection (adid/ipstop, 0x009c/0x0001)	RTP-CN	Not Applicable
ECN Failure (ecnrous/fail, 0x010b/0x0001)	IP	Audio, Video	
ICE New Peer Reflexive Candidate (ostuncc/nprc, 0x00c3/0x0002)	IP	Any, only applicable for full ICE	
ICE Connectivity Check Result (ostuncc/ccr, 0x00c3/0x0001)	IP	Any, only applicable for full ICE	

NOTE: Stream ID may be ignored in Events Descriptor
---

**Table C.7.2/2: Event Buffer Control**

<b>EventBuffer Control used:</b>	No
----------------------------------	----

**Table C.7.2/3: Keep active**

<b>KeepActive used on events:</b>	Yes
-----------------------------------	-----

**Table C.7.2/4: Embedded events and signals**

<b>Embedded events in an Events Descriptor:</b>	No
<b>Embedded signals in an Events Descriptor:</b>	No

**Table C.7.2/5: Regulated Embedded events**

<b>Regulated Embedded events are triggered on:</b>	None
NOTE: This field requires at least version 3 of the H.248.1 protocol.	

**Table C.7.2/6: ResetEventsDescriptor**

<b>ResetEventsDescriptor used with events:</b>	None
NOTE: This field requires at least version 3 of the H.248.1 protocol.	

**Table C.7.2/7: Notification Behaviour**

<b>NotifyImmediate:</b>	ALL Events
<b>NotifyRegulated:</b>	None
<b>NeverNotify:</b>	None
NOTE: This field requires at least version 3 of the H.248.1 protocol.	

## C.7.3 EventBuffer Descriptor

**Table C.7.3: Event Buffer Descriptor**

<b>EventBuffer Descriptor used:</b>	No
-------------------------------------	----

### C.7.4 Signals Descriptor

**Table C.7.4/1: Signals Descriptor**

<b>The setting of signals is dependant on termination or streams types:</b>	Yes  NOTE: "No" means that all signals can be played on any termination or stream. If "Yes", any signal not listed below may be played on any termination or stream, except Signals on ROOT termination shall not be supported.		
If yes	<b>SignalID</b>	<b>Termination Type</b>	<b>Stream Type / ID</b>
	Establish BNC (GB/EstBNC, 0x0021/0x01)	BICC	Not Applicable
	Modify BNC (GB/ModBNC, 0x0021/0x02)	BICC	Not Applicable
	Release BNC (GB/RelBNC, 0x0021/0x03)	BICC ATM	Not Applicable
	Bearer Information Transport (BT/BIT, 0x0022/0x01)	BICC IP	Not Applicable
	Continuity Test (ct/ct, 0x000a/0x0003)	TDM	Not Applicable
	Respond (ct/rsp, 0x000a/0x0004)	TDM	Not Applicable
	Send Additional Connectivity Check (ostuncc/sacc, 0x00c3/0x0002)	IP	Any, only applicable for full ICE
	Send Connectivity Check (ostuncc/scc, 0x00c3/0x0001)	IP	Any, only applicable for full ICE
NOTE: Stream ID may be ignored for Signals Descriptor			

**Table C.7.4/2: Signal Lists**

<b>Signals Lists supported:</b>	Yes	
If yes	<b>Termination Type Supporting Lists:</b>	ALL except ROOT
	<b>Stream Type Supporting lists:</b>	ALL
	<b>Maximum number of signals to a signal list:</b>	FFS <Integer>
	<b>Intersignal delay parameter supported: (NOTE)</b>	No
NOTE: This field requires at least version 3 of the H.248.1 protocol.		

**Table C.7.4/3: Overriding Signal type and duration**

<b>Signal type and duration supported:</b>	Yes	
If yes	<b>SignalID</b>	<b>Type or duration override</b>
	All Tones, Announcements and DTMFs	Both

**Table C.7.4/4: Signal Direction**

<b>Signal Direction supported:</b>	No
NOTE: This field requires at least version 3 of the H.248.1 protocol.	

**Table C.7.4/5: Notify completion**

<b>NotifyCompletion supported:</b>	Yes	
If yes	<b>SignalID</b>	<b>Type of completion supported</b>
	All Tones and Announcements	TO, EV, SD, NC

<b>RequestID Parameter supported: (NOTE)</b>	No
NOTE: This field requires at least version 3 of the H.248.1 protocol.	

**Table C.7.4/6: Signals played simultaneously**

<b>Signals played simultaneously:</b>	No
---------------------------------------	----

**Table C.7.4/7: Keep active**

<b>KeepActive used on signals:</b>	Yes
------------------------------------	-----

## C.7.5 DigitMap Descriptor

**Table C.7.5: DigitMap Descriptor**

<b>DigitMaps supported:</b>	No
-----------------------------	----

## C.7.6 Statistics Descriptor

**Table C.7.6/1: Statistics Descriptor support**

<b>Statistics supported on:</b>	Termination
---------------------------------	-------------

**Table C.7.6/2: Statistics Report on Subtract**

<b>Statistics reported on Subtract:</b>	Yes	
If yes	<b>StatisticIDs reported:</b>	If Global Text Telephony used: Characters Transferred (threegctm/chartrans , 0x0068/0x0001)

## C.7.7 ObservedEvents Descriptor

**Table C.7.7: ObservedEvents Descriptor**

<b>Event detection time supported:</b>	No
--	----

## C.7.8 Topology Descriptor

**Table C.7.8: Topology Descriptor**

<b>Allowed triples:</b>	(T1, T2, isolate) (T1, T2, oneway) (T1, T2, bothway)
NOTE: The Topology Descriptor shall be supported by the MGW and MGC for VGCS, VBS, handover and lawful interception. It can also be used for sending tones and playing announcements.	

## C.7.9 Error Descriptor

Which H.248.8 and package defined error codes are supported?

**Table C.7.9/1: Error Codes Sent by MGC**

<b>Supported H.248.8 Error Codes:</b>	ALL H.248.8, list of individual numbers>
<b>Supported Error Codes defined in packages:</b>	For a list of error codes see clauses 5.14.x <Reference to the appropriate clause in 5.14 below>

**Table C.7.9/2: Error Codes Sent by MGW:**

<b>Supported H.248.8 Error Codes:</b>	<ALL H.248.8, list of individual numbers>
<b>Supported Error Codes defined in packages:</b>	For a list of error codes see clauses 5.14.x <Reference to the appropriate clause in 5.14 below>

## C.7.10 TerminationState Descriptor

**Table C.7.10/1: TerminationState Descriptor**

<b>TerminationState: ServiceStates:</b>	InService/OutOfService
<b>TerminationState: EventBufferControl:</b>	OFF

## C.8 Command API

NOTE – It is assumed that an Error Descriptor may be returned in any command reply.

### C.8.1 Add

**Table C.8.1/1: Descriptors used by Command Add Request**

<b>Descriptors used by Add request:</b>	Events, Signals, Media (LocalControl, Local And Remote), Audit
---	--

**Table C.8.1/2: Descriptors used by Command Add Reply**

<b>Descriptors used by Add reply:</b>	<p>Media (LocalControl, Local And Remote), Error</p> <p>When ADD commands exclude an Audit Descriptor, the MGW response shall only include descriptors which contained underspecified or overspecified properties in the command request. Furthermore, only those properties that were underspecified or overspecified in the request shall be sent in the reply. Exceptions to this rule are:</p> <ul style="list-style-type: none"> <li>- The Error Descriptor</li> <li>- SDP properties returned in "Reserve RTP Connection Point" and "Reserve and Configure RTP Connection Point" procedures, as specified in 14.2.51 and 14.2.53</li> </ul> <p>The applicability of this restriction for text encoding is FFS.</p>
---------------------------------------	--

### C.8.2 Modify

**Table C.8.2/1: Descriptors used by Command Modify Request**

<b>Descriptors used by Modify request:</b>	Events, Signals, Media (LocalControl, Local And Remote), Audit
--	--

**Table C.8.2/2: Descriptors used by Command Modify Reply**

<b>Descriptors used by Modify reply:</b>	<p>Media (LocalControl, Local And Remote), Error</p> <p>When MOD commands exclude an Audit Descriptor, the MGW response shall only include descriptors which contained underspecified or overspecified properties in the command request. Furthermore, only those properties that were underspecified or overspecified in the request shall be sent in the reply. Exceptions to this rule are:</p> <ul style="list-style-type: none"> <li>- The Error Descriptor</li> <li>- SDP properties returned in "Configure RTP Connection Point" in 14.2.52.</li> </ul> <p>The applicability of this restriction for text encoding is FFS.</p>
--	---

### C.8.3 Subtract

**Table C.8.3/1: Descriptor used by Command Subtract Request**

<b>Descriptors used by Subtract request:</b>	None
--	------

**Table C.8.3/2: Descriptor used by Command Subtract Reply**

<b>Descriptors used by Subtract reply:</b>	<p>None or Statistics</p> <p>Ctmbits statistics are returned in the Subtract reply when related to a termination with CTM capabilities. Otherwise no statistics are returned.</p>
--	---

### C.8.4 Move

**Table C.8.4/1: Command Move**

<b>Move command used:</b>	Yes
---------------------------	-----

**Table C.8.4/2: Descriptors used by Move Request**

<b>Descriptors used by Move request:</b>	Events, Signals, Media (LocalControl, Local And Remote), Audit
--	--

**Table C.8.4/3: Descriptors used by Move Reply**

<b>Descriptors used by Move reply:</b>	Media (LocalControl, Local And Remote), Error  When MOVE commands exclude an Audit Descriptor, the MGW response shall only include descriptors which contained underspecified or overspecified properties in the command request, with the exception of the Error Descriptor. Furthermore, only those properties that were underspecified or overspecified in the request shall be sent in the reply.  The applicability of this restriction for text encoding is FFS.
--	--

### C.8.5 AuditValue

**Table C.8.5: Auditvalue**

<b>Audited Properties:</b>	<b>Property Name and Identity</b>	<b>Descriptor</b>
Termination ID	TerminationState: - TDM: ALL (indicating 1 TDM group) , individual termination (NOTE2) - ATM/IP: individual termination - Root (MGW Audit)	TerminationState Descriptor
Termination ID	For Packages: - Root	Packages Descriptor (NOTE1)
Termination ID	None (MGW Audit) : - Root	Audit (empty) Descriptor
Termination ID	IP Realm Availability : - ipra/* (ROOT)	TerminationState Descriptor
Termination ID	SDPCapNeg Extensions: - sdpe/*	TerminationState Descriptor
<b>Audited Statistics:</b>	None	
<b>Audited Signals:</b>	None	
<b>Audited Events:</b>	None	
<b>Packages Audit Possible</b>	Yes	
NOTE1: Support of this capability is optional.		
NOTE2: Auditing a single termination of a TDM group is an alternative to the wildcarded audit (TDM: ALL) to derive the service state of the TDM group (all the terminations of the TDM group share the same service state).		

### C.8.6 AuditCapability

**Table C.8.6/1: Auditcapability**

<b>Audited Properties:</b>	<b>Property Name and Identity</b>	<b>Descriptor</b>
	FFS	FFS
<b>Audited Statistics:</b>	None	
<b>Audited Signals:</b>	None	
<b>Audited Events:</b>	None	

**Table C.8.6/2: Scoped Auditing**

<b>Audited Properties / ContextAttributes used for a scoped audit :</b>	None
NOTE:	This field requires at least version 3 of the H.248.1 protocol.

## C.8.7 Notify

**Table C.8.7: Descriptors Used Notify**

<b>Descriptors used by Notify Request or Reply:</b>	ObservedEvents, Error
NOTE :	The Error Descriptor shall not be used in Notify Request.

## C.8.8 ServiceChange

**Table C.8.8/1: ServiceChangeMethods and ServiceChangeReasons sent by MGC:**

<b>Service Change Methods Supported:</b>	<b>ServiceChange Reasons supported:</b>
Restart (NOTE1)	"901 Cold Boot" (Optional) "902 Warm Boot" (Optional)
Handoff (NOTE 1, NOTE 2)	"903 MGC Directed Change" (Mandatory)
Forced (NOTE1)	"905 Termination Taken Out Of Service" (Optional)
Graceful (NOTE1)	"905 Termination Taken Out Of Service" (Optional)
NOTE:	When a Service Change command on the Root termination with a method other than Graceful is sent, the command shall always be sent as the only command in a message. The sending node shall always wait for the reply to a Service Change command on the Root termination with a method other than Graceful before sending further command requests. A Service Change command on the Root termination with method Graceful may be combined with other commands in a single message.
NOTE1:	ROOT Only.
NOTE2:	Not involving more than 1 MSC-S. This does not preclude the use of the MGCIId in a ServiceChange (Handoff) scenario, nor does it change the expected MG behaviour upon receipt of such a message, as the MGW has actually no means to differentiate whether the ServiceChangeMgcId parameter that may be received in a ServiceChange (handoff) message relates to a logical MGC inside the same MSC server or is part of another MSC-Server.

**Table C.8.8/2: ServiceChangeMethods and ServiceChangeReasons sent by MG:**

Service Change Methods Supported:	ServiceChange Reasons supported:
Restart	"900 Service Restored" (Mandatory) "901 Cold Boot" (Mandatory) (NOTE1) "902 Warm Boot" (Mandatory) (NOTE1) "910 Media Capability Failure " ALL except ROOT (Optional) "913 Signal Capability Failure " ALL except ROOT (Optional)"914 Event Capability Failure " ALL except ROOT (Optional) "916 Packages Change" (Optional) "917 Capability Change "(Optional)
Graceful	"904 Termination Malfuction" , ALL except ROOT,(Mandatory) "905 Termination Taken Out Of Service" , ALL,(Mandatory) "906 Loss Of Lower Layer Connectivity" , ALL except ROOT,(Mandatory) "907 Transmission Failure" , ALL except ROOT,(Mandatory) "908 MG Impending Failure" ROOT only (Mandatory)
Forced	"904 Termination Malfuction", ALL except ROOT (Mandatory) "905 Termination Taken Out Of Service" , Mandatory) "906 Loss Of Lower Layer Connectivity" , ALL except ROOT (Mandatory) "907 Transmission Failure" , ALL except ROOT (Mandatory) "908 MG Impending Failure" ROOT only (Mandatory)
Handoff (NOTE 1, NOTE 2)	"903 MGC Directed Change" (Mandatory)
Disconnected (NOTE 1)	"900 Service Restored" (Mandatory) "916 Packages Change" (Optional) "917 Capability Change" (Optional)
<p>NOTE: When a Service Change command on the Root termination with a method other than Graceful is sent, the command shall always be sent as the only command in a message. The sending node shall always wait for the reply to a Service Change command on the Root termination with a method other than Graceful before sending further command requests. A Service Change command on the Root termination with method Graceful may be combined with other commands in a single message.</p> <p>NOTE 1: ROOT Only.</p> <p>NOTE 2: In response to a MGC Ordered Re-Register.</p>	

**Table C.8.8/3: Service Change Address**

ServiceChangeAddress used:	No
----------------------------	----

**Table C.8.8/4: Service Change Delay**

ServiceChangeDelay used:	No
--------------------------	----

**Table C.8.8/5: Service Change Incomplete Flag**

ServiceChange Incomplete Flag used:	No
NOTE: This field requires at least version 3 of the H.248.1 protocol.	

**Table C.8.8/6: Service Change Version**

Version used in ServiceChangeVersion:	2
---------------------------------------	---

**Table C.8.8/7: Service Change Profile**

ServiceChangeProfile mandatory:	Yes
---------------------------------	-----

**Table C.8.8/8: Profile negotiation**

<b>Profile negotiation as per H.248.18:</b>	No
---	----

## C.8.9 Manipulating and auditing context attributes

**Table C.8.9: Manipulating and auditing context attributes**

<b>Context Attributes Manipulated:</b>	Topology, Emergency Indicator, Priority Indicator
<b>Context Attributes Audited:</b>	None

## C.9 Generic command syntax and encoding

**Table C.9.1: Encodings**

<b>Supported Encodings:</b>	Binary (optional) (NOTE 2) Text (optional) (NOTE 1)
<b>If binary encoding, is indefinite length encoding supported:</b>	Yes (NOTE 3)
<p>NOTE 1: For a BICC network with IP transport and IPBCP is transported within H.248 messages, text encoding is not recommended to be used on Mc interface until ITU has resolved the contradiction in RFC2327 [34] and H.248.1 [10] on the usage of CR (ASCII carriage return 0x0d) and/or LF (ASCII newline 0x0a) characters e.g. in SDP these Characters are missing when using the currently specified "quotedString" type.</p> <p>NOTE 2: Binary encoding is strongly recommended if only one encoding is selected to ensure interoperability.</p> <p>NOTE 3: The binary encoding rules which are applicable to the defined Abstract Syntaxes are the Basic Encoding Rules for Abstract Syntax Notation One, defined in ITU-T Recommendation X.690 [41]. Specifically in accordance with ITU-T Recommendation X.690 [41] clause 7.3, alternative encodings based on the definite and indefinite form of length are permitted by the basic encoding rules as a sender's option. Receivers shall support both alternatives.</p>	

## C.10 Transactions

**Table C.10/1: Transactions per Message**

<b>Maximum number of TransactionRequests / TransactionReplies / TransResponseAcks / Segment Replies per message:</b>	10
--	----

**Table C.10/2: Commands per Transaction Requests**

<b>Maximum number of commands per TransactionRequest:</b>	Unspecified
---	-------------

**Table C.10/3: Commands per Transaction Reply**

<b>Maximum number of commands per TransactionReply:</b>	Unspecified
NOTE: For auditing with wildcarded requests (e.g TDM E1) then the reply may include up to 32 commands to indicate the termination state)	

**Table C.10/4: Optional Commands**

<b>Commands able to be marked "Optional":</b>	ALL
---	-----

**Table C.10/5: Commands for Wildcarded Responses**

<b>Wildcarded responses may be requested for:</b>	Modify, Subtract, AuditValue
---	------------------------------

**Table C.10/6: Procedures for Wildcarded Responses**

<b>Procedures that make use of wildcarded responses:</b>	Release Bearer, Release Termination, Audit Value
<b>NOTE:</b>	Used when multiple terminations are released with one command and in audit responses where multiple terminations are implied by the audit request.

**Table C.10/7: Transaction Timers**

Transaction Timer:	Value
normalMGExecutionTime	Provisioned
normalMGCExecutionTime	Provisioned
MGOriGinatedPendingLimit	Provisioned
MGCOriGinatedPendingLimit	Provisioned
MGPProvisionalResponseTimerValue	Provisioned
MGCProvisionalResponseTimerValue	Provisioned

## C.11 Messages

The MGC/MGW shall be named according to the naming structure of the underlying transport protocol which carries the H.248 protocol.

## C.12 Transport

**Table C.12/1: Transport**

<b>Supported Transports:</b>	<ol style="list-style-type: none"> <li>1) For pure IP connections, H.248/SCTP/IP should be used. In addition, to allow for flexible implementations of gateways and controllers in order to offer efficient use of SCTP associations the M3UA layer may also be added on top of SCTP</li> <li>2) For pure ATM connections, H.248/MTP3b/SSCF/SSCOP/AAL5/ATM should be used.</li> <li>3) For mixed IP&amp;ATM connections, H.248/M3UA/SCTP/IP shall be used as the IP transport.</li> </ol>
<b>NOTE1:</b>	If using SCTP as defined in IETF RFC 2960 [12] the MGW shall always be the node to perform the "Initiation".
<b>NOTE2:</b>	Checksum calculation for SCTP shall be supported as specified in RFC 3309 [44] instead of the method specified in RFC 2960 [12].

**Table C.12/2: Segmentation**

<b>Segmentation Supported:</b>	No
<b>NOTE:</b>	This field requires at least version 3 of the H.248.1 protocol.

**Table C.12/3: Support of Control Association Monitoring**

<b>Control Association Monitoring Supported:</b>	<ol style="list-style-type: none"><li>1. Inherent in Transport</li><li>2. H.248.14 (optional MGW-driven monitoring)</li><li>3. Empty AuditValue on Root (MGC-driven monitoring)</li></ol>
--	---

## C.13 Security

**Table C.13: Security**

<b>Supported Security:</b>	None
----------------------------	------

## C.14 Packages

**Table C.14/1: Mandatory packages**

<b>Mandatory Packages:</b>		
<b>Package Name</b>	<b>PackageID</b>	<b>Version</b>
Generic (see ITU-T Recommendation H.248.1 [10] annex E.1)	g, (0x0001)	v1
Base Root Package (see ITU-T Recommendation H.248.1 [10] annex E.2)	root, (0x0002)	v2
Tone Detection Package (see ITU-T Recommendation H.248.1 [10] annex E.4)	tonedet, (0x0004) (NOTE 1)	v1
Basic DTMF Generator Package (see ITU-T Recommendation H.248.1 [10] annex E.5)	dg, (0x0005)	v1
DTMF Detection Package (see ITU-T Recommendation H.248.1 [10] annex E.6)	dd, (0x0006)	v1
Generic Announcement Package (see ITU-T Recommendation H.248.7 [28]) – Fixed Announcements.	an, (0x001d)	v1
TDM Circuit Package (see ITU-T Recommendation H.248.1 [10] annex E.13) NOTE 2	tdmc, (0x000d)	v1
Media Gateway Resource Congestion Handling Package (see ITU-T Recommendation H.248.10 [15])	chp, (0x0029)	v1
Hanging Termination Detection package (see ITU-T Recommendation H.248.36 [36]).	hangterm, (0x0098)	v1
NOTE 1: This package is "for extension only" and shall not be published over the Mc interface.		
NOTE 2: Network Package is not supported.		

**Table C.14/2: Optional packages**

Optional Packages:			
Package Name	PackageID	Version	Support dependent on:
Basic Call Progress Tones Generator with Directionality, (see ITU-T Recommendation Q.1950 [23] annex A.8)	bcg, (0x0023)	v1	Services provided by network
Expanded Call Progress tones Generator Package (see ITU-T Recommendation Q.1950 [23] annex A.9)	xcg, (0x0024)	v1	Services provided by network
Basic Services Tones Generation Package (see ITU-T Recommendation Q.1950 [23] annex A.10)	srvtn, (0x0025)	v1	Services provided by network
Bearer Control Tunnelling Package (see ITU-T Recommendation Q.1950 [23] annex A.7)	Bt, (0x0022)	v1	Interworking with BICC and IP transport
Expanded Services Tones Generation Package (see ITU-T Recommendation Q.1950 [23] annex A.11)	xsrvtn, (0x0026)	v1	Services provided by network
Intrusion Tones Generation Package (see ITU-T Recommendation Q.1950 [23] annex A.12)	Int, (0x0027)	v1	Services provided by network
Business Tones Generation Package (see ITU-T Recommendation Q.1950 [23] annex A.13)	BIZTN, (0x0028)	v1	Services provided by network
Tone Generator Package (see ITU-T Recommendation H.248.1 [10] annex E.3)	tongen, (0x0003)	v1	(NOTE)
Generic Announcement Package (see ITU-T Recommendation H.248.7 [28]) – Variable Announcements	an, (0x001d)	v1	Variable Announcements
Text Telephony Package (see ITU-T Recommendation H.248.2 [17]).	txp, (0x0010)	v1	Global text telephony support
Call Discrimination package (see ITU-T Recommendation H.248.2 [17]).	ctyp, (0x0011)	v2	Global text telephony support
Basic Continuity Package (see ITU-T Recommendation H.248.1 [10] annex E.10).	ct, (0x000a)	v1	Only required for TDM side terminations
Circuit Switched Data package (see clause 15.2.1);	threegcds, (0x0030)	v1	Circuit Switched Data support
TFO package (see clause 15.2.2);	threegtfoc, (0x0031)	v2	TFO support
3G Expanded Call Progress Tones Generator package (see clause 15.2.3);	threegxcg, (0x0032)	v1	Services provided by network
Modification of Link Characteristics Bearer Capability package (see clause 15.2.4);	threegmlc, (0x0046)	v1	
Enhanced Circuit Switched Data package (see clause 15.2.5);	threegcdsen, (0x0082)	v1	Circuit Switched Data support
Cellular Text telephone Modem Text Transport package (see clause 15.2.6);	threegctm, (0x0068)	v1	Global text telephony support
Flexible Tone Generator Package (see clause 15.2.8).	threegflex, (0x0084)	v1	Services provided by network
Trace Package (see clause 15.2.9)	calltrace, (0x0097)	v1	
ASCI Group call package (see clause 15.2.10)	threegasci, (0x00b2)	v2	VGCS and VBS services supported
IP Domain connection package (see ITU-T Recommendation H.248.41 [42])	ipdc, (0x009d)	v1	Multiple IP realms supported
Inactivity timer package (see ITU-T Recommendation. H248.14 [45])	it, (0x0045)	v1	UDP transport supported
3GUP (User Plane) package (see clause 15.1.1)	threegup, (0x002f)	v1	Mandatory for BICC and lu terminations
Bearer Characteristics Package (see ITU-T Recommendation Q.1950 [23] annex A.3)	bcp, (0x001e)	v2	Mandatory for BICC terminations
Generic Bearer Connection Package (see ITU-T Recommendation Q.1950 [23] annex A.6)	Gb, (0x0021)	v1	Mandatory only for BICC and lu terminations
3G Interface Type package (see clause 15.2.11)	threegint (0x00e3)	v1	
RTP Control Protocol Package (ITU-T Recommendation H.248.57 [66])	rtcph. (0x00b5)	v1	Border control functions support
Gate management Source Address/Port Filtering Package (ITU-T Recommendation H.248.43, Clause 7 [67])	gm, (0x008c)	v2	Border control functions support
Traffic management (ITU-T Recommendation H.248.53 [69])	tman, (0x008d)	v1	Border control functions support
Diffserv (ITU-T Recommendation H.248.52 [70])	ds, (0x008b)	v2	Border control functions support

Application Data Inactivity Detection (ITU-T Recommendation H.248.40 [71])	adid (0x009c)	v1	Border control functions support
IP realm availability (ITU-T Recommendation H.248.41 Amendment 1) [72]	ipra (0x00e0)	v1	Border control functions support
Explicit Congestion Notification for RTP-over-UDP Support (see ITU-T Recommendation H.248.82 [79])	ecnrous(0x010b)	v1	Support of ECN feature
MG Act-as STUN Server (ITU-T Recommendation H.248.50 [81])	mgastuns (0x00c2)	v1	Support of incoming STUN connectivity checks. Applicable for ICE lite and full ICE
Originate STUN Continuity Check (see ITU-T Recommendation H.248.50 [81])	ostuncc (0x00c3)	v1	Support of originating STUN connectivity checks Only applicable for full ICE
Enhanced Revised Offer/Answer SDP Support (ITU-T Recommendation H.248.80 [85])	eroas, (0x0109)	v1	Support of the SDP Capability Negotiation syntax
NOTE: This package is "for extension only" and shall not be published over the Mc interface.			

#### Package Usage Information

This table specifies how the packages above will be used. For example:

- it lists whether the properties/signals/events/statistics are optional or mandatory
- if the value of the property/signal/event provisioned the provisioned value should be specified. (e.g. names and number of cycles for an H.248.7 announcement).

Specifies the values of properties which are specified as provisioned

Package Usage Information:

### C.14.1 Generic Package

**Table C.14.1: Package Usage Information For Generic Package**

Properties	Mandatory/Optional	Used in command:	Supported Values:	Provisioned Value:
None	-	-	-	-
Signals	Mandatory/Optional	Used in command:		Duration Provisioned Value:
None	-	-	-	-
	Signal Parameters	Mandatory/Optional	Supported Values:	Duration Provisioned Value:
	-	-	-	-
Events	Mandatory/Optional	Used in command:		
	M	ADD, MOD, NOTIFY		
	Event Parameters	Mandatory/Optional	Supported Values:	Provisioned Value:
	None	-	-	-
	ObservedEvent Parameters	Mandatory/Optional	Supported Values:	Provisioned Value:
Cause (g/cause, 0x0001/0x0001)	General Cause (GeneralCause, 0x0001)	M	"NR" (0x0001) Normal Release "UR" (0x0002) Unavailable Resources "FT" (0x0003) Failure, Temporary "FP" (0x0004) Failure, Permanent "IW" (0x0005) Interworking Error "UN" (0x0006) Unsupported	Not Applicable
	Failure Cause (FailureCause, 0x0002)	O	Octet String	Not Applicable
Events	Mandatory/Optional	Used in command:		
	M	ADD, MOD, MOVE, NOTIFY		
	Event Parameters	Mandatory/Optional	Supported Values:	Provisioned Value:
	None	-	-	-
	ObservedEvent Parameters	Mandatory/Optional	Supported Values:	Provisioned Value:
Signal Completion. (g/sc, 0x0001/0x0002)	Signal Identity (SigID, 0x0001)	M	pkgdName syntax	Not Applicable
	Termination Method (Meth,0x0002)	M	"TO" (0x0001) Signal timed out or otherwise completed on its own "EV" (0x0002) Interrupted by event "SD" (0x0003) Halted by new Signals descriptor "NC" (0x0004) Not completed, other cause	Not Applicable
	Signal List Id	O	Integer	Not Applicable
Statistics	Mandatory/Optional	Used in command:		Supported Values:
None	-	-		-
Error Codes	Mandatory/Optional			
None	-			

### C.14.2 Base Root Package

**Table C.14.2: Package Usage Information For Base Root Package**

Properties	Mandatory/ Optional	Used in command:		Supported Values:	Provisioned Value:
MaxNrOfContexts (root/maxNumberOfContexts, 0x0002/0x0001)	O	Not used in command		1 and up	Not Applicable
MaxTerminationsPerContext (root/maxTerminationPerContext, 0x0002/0x0002)	O	Not used in command		See C.4	Not Applicable
normalMGExecutionTime (root/normalMGExecutionTime, 0x0002/0x0003)	O	Not used in command		Integer	Operator Defined
normalMGCEExecutionTime (root/normalMGCEExecutionTime, 0x0002/0x0004)	O	Not used in command		Integer	Operator Defined
MGPProvisionalResponsetimerValue (root/MGPProvisionalResponseTimer Value, 0x0002/0x0005)	O	Not used in command		Integer (initially NormalMGExecuti onTime + networkdelay)	Operator Defined
MGCProvisionalResponseTimerVal ue (root/MGCProvisionalResponseTim erValue, 0x0002/0x0006)	O	Not used in command		Integer (initially NormalMGCExec utionTime + networkdelay)	Operator Defined
MGCOriginatedPendingLimit (root/MGCOriginatedPendingLimit, 0x0002/0x0007)	O	Not used in command		Integer	Operator Defined
MGOrganatedPendingLimit (root/MGOrganatedPendingLimit, 0x0002/0x0008)	O	Not used in command		Integer	Operator Defined
<b>Signals</b>	<b>Mandatory/ Optional</b>	<b>Used in command:</b>			<b>Duration Provisioned Value:</b>
None	-	-			-
	<b>Signal Parameters</b>	<b>Mandatory/ Optional</b>	<b>Supported Values:</b>	<b>Duration Provisioned Value:</b>	
	-	-	-	-	-
<b>Events</b>	<b>Mandatory/ Optional</b>	<b>Used in command:</b>			
None	-	-			
	<b>Event Parameters</b>	<b>Mandatory/ Optional</b>	<b>Supported Values:</b>	<b>Provisioned Value:</b>	
	-	-	-	-	-
	<b>ObservedEvent Parameters</b>	<b>Mandatory/ Optional</b>	<b>Supported Values:</b>	<b>Provisioned Value:</b>	
	-	-	-	-	-
<b>Statistics</b>	<b>Mandatory/ Optional</b>	<b>Used in command:</b>			<b>Supported Values:</b>
None	-	-			-
<b>Error Codes</b>	<b>Mandatory/ Optional</b>				
None	-				

## C.14.3 Tone Generator Package

Table C.14.3: Package Usage Information For Tone Generator Package

Properties	Mandatory/ Optional	Used in command:	Supported Values:	Provisioned Value:
None	-	-	-	-
Signals	Mandatory/ Optional	Used in command:		Duration Provisioned Value:
Play Tone (tonegen/pt,0x0003/0x0001)	Not Used	-		-
	Signal Parameters	Mandatory/ Optional	Supported Values:	Duration Provisioned Value:
	-	-	-	-
Events	Mandatory/ Optional	Used in command:		
None	-	-		
	Event Parameters	Mandatory/ Optional	Supported Values:	Provisioned Value:
	-	-	-	-
	ObservedEvent Parameters	Mandatory/ Optional	Supported Values:	Provisioned Value:
-	-	-	-	-
Statistics	Mandatory/ Optional	Used in command:		Supported Values:
None	-	-		-
Error Codes	Mandatory/ Optional			
None	-			

### C.14.4 Tone Detection Package

**Table C.14.4: Package Usage Information For Tone Detection Package**

Properties	Mandatory/ Optional	Used in command:	Supported Values:	Provisioned Value:
None	-	-	-	-
Signals	Mandatory/ Optional	Used in command:		Duration Provisioned Value:
None	-	-		-
	Signal Parameters	Mandatory/ Optional	Supported Values:	Duration Provisioned Value:
	-	-	-	-
Events	Mandatory/ Optional	Used in command:		
Start tone detected (tonedet/std, 0x0004/0x0001)	O	ADD, MOD, MOVE, NOTIFY		
	Event Parameters	Mandatory/ Optional	Supported Values:	Provisioned Value:
	Tone ID List (tl,0x0001)	M	wildcard	Not Applicable
	ObservedEvent Parameters	Mandatory/ Optional	Supported Values:	Provisioned Value:
	Tone ID (tid,0x0003)	M	Value	Not Applicable
Events	Mandatory/ Optional	Used in command:		
End Tone detected (tonedet/etd, 0x0004/0x0002)	M	ADD, MOD, MOVE, NOTIFY		
	Event Parameters	Mandatory/ Optional	Supported Values:	Provisioned Value:
	Tone ID List (tl,0x0001)	M	wildcard	Not Applicable
	ObservedEvent Parameters	Mandatory/ Optional	Supported Values:	Provisioned Value:
	Tone ID (tid,0x0003)	M	Value	Not Applicable
	Duration (dur,0x0002)	O	Value	Not Applicable
Events	Mandatory/ Optional	Used in command:		
Long Tone detected (tonedet/ltd, 0x0004/0x0003)	Not Used	-		
	Event Parameters	Mandatory/ Optional	Supported Values:	Provisioned Value:
	-	-	-	-
	ObservedEvent Parameters	Mandatory/ Optional	Supported Values:	Provisioned Value:
	-	-	-	-
Statistics	Mandatory/ Optional	Used in command:		Supported Values:
None	-	-		-
Error Codes	Mandatory/ Optional			
None	-			

### C.14.5 Basic DTMF Generator Package

**Table C.14.5: Package Usage Information For Basic DTMF Generator Package**

Properties	Mandatory/ Optional	Used in command:	Supported Values:	Provisioned Value:
None	-	-	-	-
Signals	Mandatory/ Optional	Used in command:		Duration Provisioned Value:
DTMF character 0 (dg/d0,0x0005/0x0010)	M	ADD, MOD, MOVE		
DTMF character 1 (dg/d1,0x0005/0x0011)	Signal Parameters	Mandatory/ Optional	Supported Values:	Duration Provisioned Value:
DTMF character 2 (dg/d2,0x0005/0x0012)	None	-	-	-
DTMF character 3 (dg/d3,0x0005/0x0013)				
DTMF character 4 (dg/d4,0x0005/0x0014)				
DTMF character 5 (dg/d5,0x0005/0x0015)				
DTMF character 6 (dg/d6,0x0005/0x0016)				
DTMF character 7 (dg/d7,0x0005/0x0017)				
DTMF character 8 (dg/d8,0x0005/0x0018)				
DTMF character 9 (dg/d9,0x0005/0x0019)				
DTMF character * (dg/ds,0x0005/0x0020)				
DTMF character # (dg/do,0x0005/0x0021)				
DTMF character A (dg/da,0x0005/0x001a)				
DTMF character B (dg/db,0x0005/0x001b)				
DTMF character C (dg/dc,0x0005/0x001c)				
DTMF character D (dg/dd,0x0005/0x001d)				
Events	Mandatory/ Optional	Used in command:		
None	-	-		
	Event Parameters	Mandatory/ Optional	Supported Values:	Provisioned Value:
	-	-	-	-
	ObservedEvent Parameters	Mandatory/ Optional	Supported Values:	Provisioned Value:
	-	-	-	-
Statistics	Mandatory/ Optional	Used in command:		Supported Values:
None	-	-		-
Error Codes	Mandatory/ Optional			
None	-			

### C.14.6 Basic DTMF Detection Package

**Table C.14.6: Package Usage Information For Basic DTMF Generator Package**

Properties	Mandatory/ Optional	Used in command:	Supported Values:	Provisioned Value:
None	-	-	-	-
Signals	Mandatory/ Optional	Used in command:		Duration Provisioned Value:
None	-	-		-
	Signal Parameters	Mandatory/ Optional	Supported Values:	Duration Provisioned Value:
	-	-	-	-
Events	Mandatory/ Optional	Used in command:		
DTMF character 0 (dd/d0,0x0006/0x0010)	M	ADD, MOD, NOTIFY		
DTMF character 1 (dd/d1,0x0006/0x0011)	Event Parameters	Mandatory/ Optional	Supported Values:	Provisioned Value:
DTMF character 2 (dd/d2,0x0006/0x0012)	None	-	-	-
DTMF character 3 (dd/d3,0x0006/0x0013)	ObservedEvent Parameters	Mandatory/ Optional	Supported Values:	Provisioned Value:
DTMF character 4 (dd/d4,0x0006/0x0014)	None	-	-	-
DTMF character 5 (dd/d5,0x0006/0x0015)				
DTMF character 6 (dd/d6,0x0006/0x0016)				
DTMF character 7 (dd/d7,0x0006/0x0017)				
DTMF character 8 (dd/d8,0x0006/0x0018)				
DTMF character 9 (dd/d9,0x0006/0x0019)				
DTMF character * (dd/ds,0x0006/0x0020)				
DTMF character # (dd/do,0x0006/0x0021)				
DTMF character A (dd/da,0x0006/0x001a)				
DTMF character B (dd/db,0x0006/0x001b)				
DTMF character C (dd/dc,0x0006/0x001c)				
DTMF character D (dd/dd,0x0006/0x001d)				
Events	Mandatory/ Optional	Used in command:		
DigitMap Completion Event (dd/ce,0x0006/0x0004)	Not used	-		
	Event Parameters	Mandatory/ Optional	Supported Values:	Provisioned Value:
	-	-	-	-
	ObservedEvent Parameters	Mandatory/ Optional	Supported Values:	Provisioned Value:
	-	-	-	-
Statistics	Mandatory/ Optional	Used in command:		Supported Values:
None	-	-		-
Error Codes	Mandatory/ Optional			
None	-			

## C.14.7 Continuity Package

Table C.14.7: Package Usage Information For Basic Continuity Package

Properties	Mandatory/ Optional	Used in command:	Supported Values:	Provisioned Value:
None	-	-	-	-
Signals	Mandatory/ Optional	Used in command:		Duration Provisioned Value:
Continuity Test (ct/ct, 0x000a/0x0003)	M	ADD, MOD, MOVE		Default
Respond (ct/rsp, 0x000a/0x0004)	<b>Signal Parameters</b>	<b>Mandatory/ Optional</b>	<b>Supported Values:</b>	<b>Duration Provisioned Value:</b>
	None	-	-	-
Events	Mandatory/ Optional	Used in command:		
Completion, (ct/cmp, 0x000a/0x0005)	M	ADD, NOTIFY		
	<b>Event Parameters</b>	<b>Mandatory/ Optional</b>	<b>Supported Values:</b>	<b>Provisioned Value:</b>
	None	-	-	-
	<b>ObservedEvent Parameters</b>	<b>Mandatory/ Optional</b>	<b>Supported Values:</b>	<b>Provisioned Value:</b>
	Result (res,0x0008)	M	success, failure	Not Applicable
Statistics	Mandatory/ Optional	Used in command:		Supported Values:
None	-	-		-
Error Codes	Mandatory/ Optional			
None	-			

## C.14.8 TDM Circuit Package

Table C.14.8: Package Usage Information For TDM Circuit Package

Properties	Mandatory/ Optional	Used in command:	Supported Values:	Provisioned Value:
Echo Cancellation (tdmc/ec,0x000d/0x0008)	M	ADD, MOD, MOVE	ALL	Default=off (False)
Gain Control (tdmc/gain,0x000d/0x000a)	Not Used	-	-	-
Signals	Mandatory/ Optional	Used in command:		Duration Provisioned Value:
None	-	-		-
	Signal Parameters	Mandatory/ Optional	Supported Values:	Duration Provisioned Value:
	-	-	-	-
Events	Mandatory/ Optional	Used in command:		
None	-	-		
	Event Parameters	Mandatory/ Optional	Supported Values:	Provisioned Value:
	-	-	-	-
	ObservedEvent Parameters	Mandatory/ Optional	Supported Values:	Provisioned Value:
	-	-	-	-
Statistics	Mandatory/ Optional	Used in command:		Supported Values:
None	-	-		-
Error Codes	Mandatory/ Optional			
None	-			

### C.14.9 Text Telephony Package

**Table C.14.9: Package Usage Information For Text Telephony Package**

Properties	Mandatory/Optional	Used in command:	Supported Values:	Provisioned Value:
Conversation mode (txp/convmode, 0x0010/0x0001)	O	ADD, MOD, MOVE	ALL	None
Communication Mode (txp/commode, 0x0010/0x0002)	O	ADD, MOD, MOVE	ALL	None
Connection Mode (txp/connmode, 0x0010/0x0003)	O	ADD, MOD, MOVE	ALL	None
Action at Loss of Connection (txp/lossconnection, 0x0010/0x0006)	O	ADD, MOD, MOVE	ALL	None
V18 Options (txp/v18opt, 0x0010/0x0007)	O	ADD, MOD, MOVE	ALL	None
Character Set (txp/characterset, 0x0010/0x0008)	O	ADD, MOD, MOVE	ALL	None
Signals	Mandatory/Optional	Used in command:		Duration Provisioned Value:
None	-	-		-
	Signal Parameters	Mandatory/Optional	Supported Values:	Duration Provisioned Value:
	-	-	-	-
Events	Mandatory/Optional	Used in command:		
Connection Mode Changed (txp/connchnng, 0x0010/0x0001)	O	ADD, MOD, MOVE, NOTIFY		
	Event Parameters	Mandatory/Optional	Supported Values:	Provisioned Value:
	None	-	-	-
	ObservedEvent Parameters	Mandatory/Optional	Supported Values:	Provisioned Value:
	Communication Mode (commode, 0x0002)	O	As property	commode
Statistics	Mandatory/Optional	Used in command:		Supported Values:
Number of Characters Transferred (txp/chartrans, 0x0010/0x0001)	O	SUBTRACT		
Number of Alternating Turns (txp/allturns, 0x0010/0x0002)	O	SUBTRACT		
Error Codes	Mandatory/ Optional			
None	-			

### C.14.10 Call Discrimination Package

**Table C.14.10: Package Usage Information For Call Discrimination Package**

Properties	Mandatory/ Optional	Used in command:	Supported Values:	Provisioned Value:
Call Types (ctyp/calltyp, 0x0011/0x0001)	O	ADD, MOD, MOVE	ALL	None
Text Call Types (ctyp/ttyp, 0x0011/0x0002)	O	ADD, MOD, MOVE	ALL	None
V8bis Support (ctyp/v8bsup, 0x0011/0x0003)	O	ADD, MOD, MOVE	ALL	None
Probe Message (ctyp/probemsg, 0x0011/0x0004)	O	ADD, MOD, MOVE	ALL	None
Probe Order (ctyp/probeorder, 0x0011/0x0005)	O	ADD, MOD, MOVE	ALL	None
Phase Reversal Detect (ctyp/phrevdet, 0x0011/0x0006)	O	ADD, MOD, MOVE	ALL	None
MG Responsible for Call Discrimination Signalling (ctyp/MGCallSig, 0x0011/0x0007)	O	ADD, MOD, MOVE	ALL	None
Signals	Mandatory/ Optional	Used in command:		Duration Provisioned Value:
V8 Signal (ctyp/v8sig, 0x0011/0x0001)	O	MOD		-
	Signal Parameters	Mandatory/ Optional	Supported Values:	Duration Provisioned Value:
	V.8 Signal Type (ctyp/v8styp, 0x0011/0x0001)	O	ALL	-
	V8Sig Cont (ctyp/v8scont, 0x0011/0x0002)	O	ALL	-
	V18 XCI Enable (ctyp/v18xcien, 0x0011/0x0003)	O	ALL	-
Answer Signal (ctyp/ans, 0x0011/0x0002)	O	MOD		-
	Signal Parameters	Mandatory/ Optional	Supported Values:	Duration Provisioned Value:
	ANS Type (ctyp/AnsType, 0x0011/0x0001)	O	ALL	-
Calling Signal (ctyp/callsig, 0x0011/0x0003)	O	MOD		-
	Signal Parameters	Mandatory/ Optional	Supported Values:	Duration Provisioned Value:
	Call Signal Name (ctyp/csn, 0x0011/0x0001)	O	ALL	-
V8bis Signal	O	MOD		-
	Signal Parameters	Mandatory/ Optional	Supported Values:	Duration Provisioned Value:
	V8bisSigname (ctyp/V8bsn, 0x0011/0x0001)	O	ALL	-
	V8bis Signal Contents (ctyp/V8bscont, 0x0011/0x0002)	O	ALL	-
V18 Probe (ctyp/v18prob, 0x0011/0x0005)	O	MOD		-
	Signal Parameters	Mandatory/ Optional	Supported Values:	Duration Provisioned Value:
	None	-	-	-

Events	Mandatory/ Optional	Used in command:		
Discriminating Tone Detected (ctyp/dtone, 0x0011/0x0001)	O	ADD, MOD, NOTIFY		
	Event Parameters	Mandatory/ Optional	Supported Values:	Provisioned Value:
	None	-	-	-
	ObservedEvent Parameters	Mandatory/ Optional	Supported Values:	Provisioned Value:
	Discriminating Tone Type (dtt,0x0001)	O	ALL	-
	Discriminating Tone Value (dtvalue, 0x0002)	O	ALL	-
	V8bis Type (v8bist, 0x0003)	O	ALL	-
Call Type Discrimination Result (ctyp/calldisres, 0x0011/0x0002)	O	ADD, MOD, NOTIFY		
	Event Parameters	Mandatory/ Optional	Supported Values:	Provisioned Value:
	None	-	-	-
	ObservedEvent Parameters	Mandatory/ Optional	Supported Values:	Provisioned Value:
	Discriminated Call Type (dct,0x0001)	O	ALL	-
Statistics	Mandatory/ Optional	Used in command:		Supported Values:
None	-	-		-
Error Codes	Mandatory/ Optional			
None	-			

### C.14.11 Announcement Package

**Table C.14.11: Package Usage Information For Announcement Package**

Properties	Mandatory/ Optional	Used in command:	Supported Values:	Provisioned Value:
None	-	-	-	-
Signals	Mandatory/ Optional	Used in command:		Duration Provisioned Value:
Fixed Announcement Play (an/apf, 0x001d/0x0001)	M	ADD, MOD, MOVE		<Value / Not Applicable
	Signal Parameters	Mandatory/ Optional	Supported Values:	Duration Provisioned Value:
	Announcement name (an,0x0001)	M	enumeration	Not Applicable
	Number Of Cycles (noc,0x0002)	M	Any Integer	-
	Announcement Variant (av,0x0003)	O	string	-
	Announcement Direction (di,0x0004)	M	Internal, External	Default=External
Variable Announcement Play (an/apv, 0x001d/0x0002)	O	ADD, MOD, MOVE		<Value / Not Applicable>
	Signal Parameters	Mandatory/ Optional	Supported Values:	Duration Provisioned Value:
	Announcement name (an,0x0001)	M	enumeration	Not Applicable
	Number Of Cycles (noc,0x0002)	M	Any Integer	-
	Announcement Variant (av,0x0003)	O	string	-
	Number (num,0x0004)	O	integer	-
	Specific parameters interpretation (spi, 0x0005)	O	enumeration	-
	Specific parameters (sp,0x0006)	O	string	-
Announcement Direction (di,0x0006)	M	Internal, External	Default=External	
Events	Mandatory/ Optional	Used in command:		
None	-	-		
	Event Parameters	Mandatory/ Optional	Supported Values:	Provisioned Value:
	-	-	-	-
	ObservedEvent Parameters	Mandatory/ Optional	Supported Values:	Provisioned Value:
-	-	-	-	
Statistics	Mandatory/ Optional	Used in command:		Supported Values:
None	-	-		-
Error Codes	Mandatory/ Optional			
None	-			

### C.14.12 Media Gateway Resource Congestion handling Package

**Table C.14.12: Package Usage Information For Media Gateway Resource Congestion handling Package**

Properties	Mandatory/Optional	Used in command:	Supported Values:	Provisioned Value:
None	-	-	-	-
Signals	Mandatory/Optional	Used in command:		Duration Provisioned Value:
None	-	-		-
	Signal Parameters	Mandatory/Optional	Supported Values:	Duration Provisioned Value:
	-	-	-	-
Events	Mandatory/Optional	Used in command:		
MGCon (chp/mgcon, 0x0029/0x0001)	M	MOD, NOTIFY		
	Event Parameters	Mandatory/Optional	Supported Values:	Provisioned Value:
	None	-	-	-
	ObservedEvent Parameters	Mandatory/Optional	Supported Values:	Provisioned Value:
	Reduction (reduction,0x0001)	M	0-100	Not Applicable
Statistics	Mandatory/Optional	Used in command:		Supported Values:
None	-	-		-
Error Codes	Mandatory/ Optional			
None	-			

### C.14.13 Hanging Termination Detection Package

**Table C.14.13: Package Usage Information For Hanging Termination Detection Package**

Properties	Mandatory/Optional	Used in command:	Supported Values:	Provisioned Value:
None	-	-	-	-
Signals	Mandatory/Optional	Used in command:		Duration Provisioned Value:
None	-	-		-
	Signal Parameters	Mandatory/Optional	Supported Values:	Duration Provisioned Value:
	-	-	-	-
Events	Mandatory/Optional	Used in command:		
Termination Heartbeat (hangterm/thb, 0x0098/0x0001)	M	ADD, MOD, MOVE, AUDITVALUE, NOTIFY		
	Event Parameters	Mandatory/Optional	Supported Values:	Provisioned Value:
	Timer X (timerx,0x0001)	M	ALL	0 (no heartbeat message)
	ObservedEvent Parameters	Mandatory/Optional	Supported Values:	Provisioned Value:
	None	-	-	-
Statistics	Mandatory/Optional	Used in command:		Supported Values:
None	-	-		-
Error Codes	Mandatory/ Optional			
None	-			

## C.14.14 Bearer Characteristics Package

Table C.14.14: Package Usage Information For Bearer Characteristics Package

Properties	Mandatory/ Optional	Used in command:	Supported Values:	Provisioned Value:
BNC Characteristics (BCP/BNCChar,0x001e/0x01)	M	ADD	AAL type 2 / IP/RTP	Not Applicable
Signals	Mandatory/ Optional	Used in command:		Duration Provisioned Value:
None	-	-		-
	Signal Parameters	Mandatory/ Optional	Supported Values:	Duration Provisioned Value:
	-	-	-	-
Events	Mandatory/ Optional	Used in command:		
None	-	-		
	Event Parameters	Mandatory/ Optional	Supported Values:	Provisioned Value:
	-	-	-	-
	ObservedEvent Parameters	Mandatory/ Optional	Supported Values:	Provisioned Value:
	-	-	-	-
Statistics	Mandatory/ Optional	Used in command:		Supported Values:
None	-	-		-
Error Codes	Mandatory/ Optional			
None	-			

## C.14.15 Generic Bearer Connection Package

Table C.14.15: Package Usage Information For Generic Bearer Connection Package

Properties	Mandatory/ Optional	Used in command:	Supported Values:	Provisioned Value:
None	-	-	-	-
Signals	Mandatory/ Optional	Used in command:		Duration Provisioned Value:
Establish BNC (GB/EstBNC, 0x0021/0x01)	M	ADD, MOD		Not Applicable
	Signal Parameters	Mandatory/ Optional	Supported Values:	Duration Provisioned Value:
	Not Applicable	-	-	Not Applicable
Modify BNC (GB/ModBNC, 0x0021/0x02)	O	MOD		Not Applicable
	Signal Parameters	Mandatory/ Optional	Supported Values:	Duration Provisioned Value:
	Not Applicable	-	-	Not Applicable
Release BNC (GB/RelBNC, 0x0021/0x03)	M (NOTE)	MOD		Not Applicable
	Signal Parameters	Mandatory/ Optional	Supported Values:	Duration Provisioned Value:
	General cause (Generalcause,0x01)	O	Normal Release/ Unavailable Resources/ Failure Temporary/ Failure Permanent/ Interworking Error/ Unsupported	Not Applicable
	Failure Cause (Failurecause,0x02)	O	OCTET STRING	Not Applicable
	Reset (Reset,0x03)	O	0/ 1	Not Applicable
Events	Mandatory/ Optional	Used in command:		
BNC Change (GB/BNCChange, 0x0021/0x01)	M	ADD, MOD, NOTIFY		
	Event Parameters	Mandatory/ Optional	Supported Values:	Provisioned Value:
	Type (Type ,0x01)	M	Bearer Established / Bearer Modified/ Bearer Modification Failure	Not Applicable
	ObservedEvent Parameters	Mandatory/ Optional	Supported Values:	Provisioned Value:
	Type (Type,0x01)	M	Bearer Established / Bearer Modified/ Bearer Modification Failure	Not Applicable
Statistics	Mandatory/ Optional	Used in command:		Supported Values:
None	-	-		-
Error Codes	Mandatory/ Optional			
None	-			
NOTE:	Mandatory for BICC ATM Terminations. If received as part of a wildcarded command including other types of terminations then for other type of terminations no action is required from MGW, but a successful command reply.			

## C.14.16 Bearer Control Tunnelling Package

Table C.14.16: Package Usage Information For Bearer Control Tunnelling Package

Properties	Mandatory/ Optional	Used in command:	Supported Values:	Provisioned Value:
Tunneling Options (BT/TunOpt, 0x0022/0x01)	M	ADD	1 /2	Not Applicable
Signals	Mandatory/ Optional	Used in command:		Duration Provisioned Value:
Bearer Information Transport (BT/BIT, 0x0022/0x01)	M	ADD, MOD		Not Applicable
	Signal Parameters	Mandatory/ Optional	Supported Values:	Duration Provisioned Value:
	Bearer Information Tunnel (BIT,0x01)	M	Octet String	Not Applicable
Events	Mandatory/ Optional	Used in command:		
Tunnel Indication (BT/TIND, 0x0022/0x01)	M	ADD, MOD, NOTIFY		
	Event Parameters	Mandatory/ Optional	Supported Values:	Provisioned Value:
	Not applicable	-	-	-
	ObservedEvent Parameters	Mandatory/ Optional	Supported Values:	Provisioned Value:
	Bearer Information transport (BIT,0x01)	M	Octet String	Not Applicable
Statistics	Mandatory/ Optional	Used in command:		Supported Values:
None	-	-		-
Error Codes	Mandatory/ Optional			
None	-			

### C.14.17 Basic Call Progress Tones Generator with Directionality

**Table C.14.17: Package Usage Information For Basic Call Progress Tones Generator with Directionality Package**

Properties	Mandatory/Optional	Used in command:	Supported Values:	Provisioned Value:
None	-	-	-	-
Signals	Mandatory/Optional	Used in command:		Duration Provisioned Value:
Dial Tone (bcg/bdt, 0x0023/0x0040) Ringing Tone (bcg/brt, 0x0023/0x0041) Busy Tone (bcg/bbt, 0x0023/0x0042) Congestion Tone (bcg/bct, 0x0023/0x0043) Special Information Tone (bcg/bsit, 0x0023/0x0044) Warning Tone (bcg/bwt, 0x0023/0x0045) Payphone Recognition Tone (bcg/bpt, 0x0023/0x0046) Call Waiting Tone (bcg/bcw, 0x0023/0x0047) Caller Waiting Tone (bcg/bcr, 0x0023/0x0048) Pay Tone (bcg/bpy, 0x0023/0x0049)	O	ADD, MOD, MOVE		Value
	Signal Parameters	Mandatory/Optional	Supported Values:	Duration Provisioned Value:
	Tone Direction (btd, 0x0001)	M	Internal / External	Default=External
Events	Mandatory/Optional	Used in command:		
None	-	-		
	Event Parameters	Mandatory/Optional	Supported Values:	Provisioned Value:
	-	-	-	-
	ObservedEvent Parameters	Mandatory/Optional	Supported Values:	Provisioned Value:
	-	-	-	-
Statistics	Mandatory/Optional	Used in command:	Supported Values:	
None	-	-	-	
Error Codes	Mandatory/ Optional			
None	-			

### C.14.18 Expanded Call Progress Tones Generator Package

**Table C.14.18: Package Usage Information For Expanded Call Progress Tones Generator Package**

Properties	Mandatory/ Optional	Used in command:	Supported Values:	Provisioned Value:
None	-	-	-	-
Signals	Mandatory/ Optional	Used in command:		Duration Provisioned Value:
Comfort Tone (xcg/cmft,0x0024/0x004a) Off-hook warning Tone (xcg/roh, 0x0024/0x004b) Negative Acknowledgement (xcg/nack,0x0024/0x004c) Vacant Number Tone (xcg/vac, 0x0024/0x004d) Special Conditions Dial Tone (xcg/spec,0x0024/0x004e)	O	ADD, MOD, MOVE		Value
	Signal Parameters	Mandatory/ Optional	Supported Values:	Duration Provisioned Value:
	Tone Direction (btd, 0x0001)	M	Internal / External	Default=External
Events	Mandatory/ Optional	Used in command:		
None	-	-		
	Event Parameters	Mandatory/ Optional	Supported Values:	Provisioned Value:
	-	-	-	-
	ObservedEvent Parameters	Mandatory/ Optional	Supported Values:	Provisioned Value:
	-	-	-	-
Statistics	Mandatory/ Optional	Used in command:	Supported Values:	
None	-	-	-	
Error Codes	Mandatory/ Optional			
None	-			

### C.14.19 Basic Services Tones Generation Package

**Table C.14.19: Package Usage Information For Basic Services Tones Generation Package**

Properties	Mandatory/ Optional	Used in command:	Supported Values:	Provisioned Value:
None	-	-	-	-
Signals	Mandatory/ Optional	Used in command:		Duration Provisioned Value:
Recall Dial Tone (srvtn/rdt,0x0025/0x004f)	O	ADD, MOD, MOVE		Value
Confirmation Tone (srvtn/conf,0x0025/0x0050)	Signal Parameters	Mandatory/ Optional	Supported Values:	Duration Provisioned Value:
Held Tone (srvtn/ht,0x0025/0x0051)	Tone Direction (btd, 0x0001)	M	Internal / External	Default=External
Message Waiting Tone (srvtn/mwt,0x0025/0x0052)				
Events	Mandatory/ Optional	Used in command:		
None	-	-		
	Event Parameters	Mandatory/ Optional	Supported Values:	Provisioned Value:
	-	-	-	-
	ObservedEvent Parameters	Mandatory/ Optional	Supported Values:	Provisioned Value:
	-	-	-	-
Statistics	Mandatory/ Optional	Used in command:	Supported Values:	
None	-	-	-	
Error Codes	Mandatory/ Optional			
None	-			

### C.14.20 Expanded Services Tones Generation Package

**Table C.14.20: Package Usage Information For Expanded Services Tones Generation Package**

Properties	Mandatory/ Optional	Used in command:	Supported Values:	Provisioned Value:
None	-	-	-	-
Signals	Mandatory/ Optional	Used in command:		Duration Provisioned Value:
Call Transfer Dial Tone (xsrvtm/xferdt,0x0026/0x0053)	O	ADD, MOD, MOVE		Value
Call Forward Tone (xsrvtm/cft,0x0026/0x0054)	Signal Parameters	Mandatory/ Optional	Supported Values:	Duration Provisioned Value:
Credit Card service Tone (xsrvtm/ccst,0x0026/0x0055)	Tone Direction (btd, 0x0001)	M	Internal / External	Default=External
Special Recall Dial Tone (xsrvtm/srdt,0x0026/0x0056)				
Events	Mandatory/ Optional	Used in command:		
None	-	-		
	Event Parameters	Mandatory/ Optional	Supported Values:	Provisioned Value:
	-	-	-	-
	ObservedEvent Parameters	Mandatory/ Optional	Supported Values:	Provisioned Value:
	-	-	-	-
Statistics	Mandatory/ Optional	Used in command:	Supported Values:	
None	-	-	-	
Error Codes	Mandatory/ Optional			
None	-			

### C.14.21 Intrusion Tones Generation Package

**Table C.14.21: Package Usage Information For Intrusion Tones Generation Package**

Properties	Mandatory/ Optional	Used in command:	Supported Values:	Provisioned Value:
None	-	-	-	-
Signals	Mandatory/ Optional	Used in command:		Duration Provisioned Value:
Intrusion Pending Tone (int/pend,0x0027/0x0057)	O	ADD, MOD, MOVE		Value
Intrusion Tone (int/int,0x0027/0x0058)	Signal Parameters	Mandatory/ Optional	Supported Values:	Duration Provisioned Value:
Intrusion Reminder Tone (int/rem,0x0027/0x0059)	Tone Direction (btd, 0x0001)	M	Internal / External	Default=External
Toll Break-In Tone (int/tbi,0x0027/0x005a)				
Intrusion Queue Tone (int/intque,0x0027/0x005b)				
Busy Verification Tone (int/bv,0x0027/0x005c)				
Events	Mandatory/ Optional	Used in command:		
None	-	-		
	Event Parameters	Mandatory/ Optional	Supported Values:	Provisioned Value:
	-	-	-	-
	ObservedEvent Parameters	Mandatory/ Optional	Supported Values:	Provisioned Value:
	-	-	-	-
Statistics	Mandatory/ Optional	Used in command:	Supported Values:	
None	-	-	-	
Error Codes	Mandatory/ Optional			
None	-			

### C.14.22 Business Tones Generation Package

**Table C.14.22: Package Usage Information For Business Tones Generation Package**

Properties	Mandatory/ Optional	Used in command:	Supported Values:	Provisioned Value:
None	-	-	-	-
Signals	Mandatory/ Optional	Used in command:		Duration Provisioned Value:
Off-Hook Queuing Tone (biztn/ofque,0x0028/0x005d) Expensive Route Warning Tone (biztn/erwt,0x0028/0x005e) Distinctive Dial Tone (biztn/ddt,0x0028/0x005f) Internal Dial Tone (biztn/idt,0x0028/0x0060)	O	ADD, MOD, MOVE		Value
	Signal Parameters	Mandatory/ Optional	Supported Values:	Duration Provisioned Value:
	Tone Direction (btd, 0x0001)	M	Internal / External	Default=External
Events	Mandatory/ Optional	Used in command:		
None	-	-		
	Event Parameters	Mandatory/ Optional	Supported Values:	Provisioned Value:
	-	-	-	-
	ObservedEvent Parameters	Mandatory/ Optional	Supported Values:	Provisioned Value:
	-	-	-	-
Statistics	Mandatory/ Optional	Used in command:	Supported Values:	
None	-	-	-	
Error Codes	Mandatory/ Optional			
None	-			

### C.14.23 3GUP Package

**Table C.14.23: Package Usage Information For 3GUP Package**

Properties	Mandatory/ Optional	Used in command:	Supported Values:	Provisioned Value:
UP Mode of operation (threegup/mode, 0x002f/0x0001)	M	ADD, MOD, MOVE	ALL	Default=1 (transparent)
UP versions (threegup/ upversions, 0x002f/0x0002)	M	ADD, MOD, MOVE	1, 2	Default = 1
Delivery of erroneous SDUs (threegup/ delerrsd, 0x002f/0x0003)	M	ADD, MOD, MOVE	ALL	Default = 3 (NA)
Interface (threegup/ interface, 0x002f/0x0004)	M	ADD, MOD, MOVE	ALL	None
Initialisation Direction (threegup/ initdir, 0x002f/0x0005)	M	ADD, MOD, MOVE	ALL	None
Signals	Mandatory/ Optional	Used in command:		Duration Provisioned Value:
None	-	-		-
	Signal Parameters	Mandatory/ Optional	Supported Values:	Duration Provisioned Value:
	-	-	-	-
Events	Mandatory/ Optional	Used in command:		
None	-	-		
	Event Parameters	Mandatory/ Optional	Supported Values:	Provisioned Value:
	-	-	-	-
	ObservedEvent Parameters	Mandatory/ Optional	Supported Values:	Provisioned Value:
	-	-	-	-
Statistics	Mandatory/ Optional	Used in command:		Supported Values:
None	-	-		-
Error Codes	Mandatory/ Optional			
None	-			

### C.14.24 Modification of Link Characteristics Bearer Capability

**Table C.14.24: Package Usage Information For Modification of Link Characteristics Package**

Properties	Mandatory/ Optional	Used in command:	Supported Values:	Provisioned Value:
None	-	-	-	-
Signals	Mandatory/ Optional	Used in command:		Duration Provisioned Value:
None	-	-	-	-
	Signal Parameters	Mandatory/ Optional	Supported Values:	Duration Provisioned Value:
	-	-	-	-
Events	Mandatory/ Optional	Used in command:		
Bearer Modification Support Event.( threegmlc/mod_link_supp, 0x0046/0x0001)	M	ADD, MOD, MOVE NOTIFY		
	Event Parameters	Mandatory/ Optional	Supported Values:	Provisioned Value:
	None	-	-	-
	ObservedEvent Parameters	Mandatory/ Optional	Supported Values:	Provisioned Value:
	None	-	-	-
Statistics	Mandatory/ Optional	Used in command:	Supported Values:	
None	-	-	-	
Error Codes	Mandatory/ Optional			
None	-			

C.14.25 TFO package

Table C.14.25: Package Usage Information For TFO

Properties	Mandatory/ Optional	Used in command:	Supported Values:	Provisioned Value:
TFO Activity Control (threegtfc /tfoenable, (0x0031/0x0001)	M	ADD, MOD, MOVE	ALL	None (default =Off)
TFO Codec List (threegtfc / codeclist, (0x0031/0x0002)	M	ADD, MOD, MOVE	See 3GPP TS 29.232 clause15.2.2	None
Signals	Mandatory/ Optional	Used in command:		Duration Provisioned Value:
None	-	-		-
	Signal Parameters	Mandatory/ Optional	Supported Values:	Duration Provisioned Value:
	-	-	-	-
Events	Mandatory/ Optional	Used in command:		
Optimal Codec Event (threegtfc / codec_modify, (0x0031/0x0010)	O	ADD, MOD, MOVE, NOTIFY		
	Event Parameters	Mandatory/ Optional	Supported Values:	Provisioned Value:
	None			
	ObservedEvent Parameters	Mandatory/ Optional	Supported Values:	Provisioned Value:
	Optimal Codec Type (optimalcodec 0x0011)	M	See 3GPP TS 29.232 clause15.2.2	None
Codec List Event (threegtfc /distant_codec_list, (0x0031/0x0012)	O	ADD, MOD, MOVE, NOTIFY		
	Event Parameters	Mandatory/ Optional	Supported Values:	Provisioned Value:
	None			
	ObservedEvent Parameters	Mandatory/ Optional	Supported Values:	Provisioned Value:
	Distant Codec List (distlist 0x0013)	M	See 3GPP TS 29.232 clause15.2.2	None
TFO Status Event (threegtfc / TFO_status) (0x0031/0x0014)	O	ADD, MOD, MOVE, NOTIFY		
	Event Parameters	Mandatory/ Optional	Supported Values:	Provisioned Value:
	None	-	-	-
	ObservedEvent Parameters	Mandatory/ Optional	Supported Values:	Provisioned Value:
	TFO Status (tfo_status 0x0015)	M	ALL	None
Statistics	Mandatory/ Optional	Used in command:		Supported Values:
None	-	-		-
Error Codes	Mandatory/ Optional			
	-			

### C.14.26 Circuit Switched Data package

**Table C.14.26: Package Usage Information For CSD**

Properties	Mandatory/Optional	Used in command:	Supported Values:	Provisioned Value:
PLMNBC (threegcsd /plmnc, 0x0030/0x0001)	M	ADD, MOD, MOVE	Specified in the clause "Bearer capability" in 3GPP TS 24.008 [3].	None
GSM Channel Coding (threegcsd / gsmchancod, 0x0030/0x0002)	M	ADD, MOD, MOVE	The second octet of Chosen Channel as specified in the clause "Chosen Channel" in 3GPP TS 48.008 [9].	None
Signals	Mandatory/Optional	Used in command:		Duration Provisioned Value:
Activate Protocol (threegcsd/ actprot, 0x0030/0x0001)	M	MOD		-
	Signal Parameters	Mandatory/Optional	Supported Values:	Duration Provisioned Value:
	Local Peer Role (Localpeer 0x0001)	O	ALL	None
Events	Mandatory/Optional	Used in command:		
Protocol Negotiation Result (threegcsd / protres, (0x0030/0x0001)	M	ADD, MOD, NOTIFY		
	Event Parameters	Mandatory/Optional	Supported Values:	Provisioned Value:
	None	-	-	-
	ObservedEvent Parameters	Mandatory/Optional	Supported Values:	Provisioned Value:
	Negotiation Result (result 0x0001)	M	ALL	None
Possible Failure Cause (cause 0x0002)	O	ALL	None	
Rate Change (threegcsd / ratechg, (0x0030/0x0002)	M	ADD, MOD, NOTIFY		
	Event Parameters	Mandatory/Optional	Supported Values:	Provisioned Value:
	None	-	-	-
	ObservedEvent Parameters	Mandatory/Optional	Supported Values:	Provisioned Value:
New Rate (rate 0x0001)	M	2400, 4800, 9600, 14400, 28800, 57600	None	
Statistics	Mandatory/Optional	Used in command:	Supported Values:	
None	-	-	-	
Error Codes	Mandatory/ Optional			
None	-			

### C.14.27 Enhanced Circuit Switched Data package

**Table C.14.27: Package Usage Information For Enhanced CSD**

Properties	Mandatory/ Optional	Used in command:	Supported Values:	Provisioned Value:
Bitrate (threegcsden /bitrate, 0x0082/0x0003)	M	ADD, MOD, MOVE	2400, 4800, 9600, 14400, 28800, 57600, 64000	None
Signals	Mandatory/ Optional	Used in command:		Duration Provisioned Value:
None	-	-		-
	Signal Parameters	Mandatory/ Optional	Supported Values:	Duration Provisioned Value:
	-	-	-	-
Events	Mandatory/ Optional	Used in command:		
None	-	-		
	Event Parameters	Mandatory/ Optional	Supported Values:	Provisioned Value:
	-	-	-	-
	ObservedEvent Parameters	Mandatory/ Optional	Supported Values:	Provisioned Value:
	-	-	-	-
Statistics	Mandatory/ Optional	Used in command:	Supported Values:	
None	-	-	-	
Error Codes	Mandatory/ Optional			
None	-			

### C.14.28 3G Expanded Call Progress Tones package

**Table C.14.28: Package Usage Information For 3G Expanded Call Progress Tones**

Properties	Mandatory/ Optional	Used in command:	Supported Values:	Provisioned Value:
None				
Signals	Mandatory/ Optional	Used in command:		Duration Provisioned Value:
CAMEL Prepaid Warning Tone (threegxcg/cpwt, 0x0032/0x004f)	M	ADD, MOD, MOVE		-
	Signal Parameters	Mandatory/ Optional	Supported Values:	Duration Provisioned Value:
	ToneDirection(td, 0x0010)	M	Ext, Int	Default=Ext
Events	Mandatory/ Optional	Used in command:		
None	-	-		
	Event Parameters	Mandatory/ Optional	Supported Values:	Provisioned Value:
	-	-	-	-
	ObservedEvent Parameters	Mandatory/ Optional	Supported Values:	Provisioned Value:
	-	-	-	-
Statistics	Mandatory/ Optional	Used in command:	Supported Values:	
None	-	-	-	
Error Codes	Mandatory/ Optional			
None	-			

## C.14.29 Cellular Text Telephone Modem Text Transport Package

Table C.14.29: Package Usage Information For CTM

Properties	Mandatory/ Optional	Used in command:	Supported Values:	Provisioned Value:
Termination connection state(threegctm/ connstate, 0x0068/0x0001)	M	ADD, MOD, MOVE	ALL	
Text Transport (threegctm/ trpt (0x0068/0x0002)	M	ADD, MOD, MOVE	CTM	
Text Protocol Version (threegctm/ textproto 0x0068/0x0003)	M	ADD, MOD, MOVE	ALL	Default=1
Signals	Mandatory/ Optional	Used in command:		Duration Provisioned Value:
None	-	-		-
	Signal Parameters	Mandatory/ Optional	Supported Values:	Duration Provisioned Value:
	-	-	--	-
Events	Mandatory/ Optional	Used in command:		
Connection State Change (threegctm/ connchange 0x0068/0x0001)	M	ADD, MOD, MOVE, NOTIFY		
	Event Parameters	Mandatory/ Optional	Supported Values:	Provisioned Value:
	None	-	-	-
	ObservedEvent Parameters	Mandatory/ Optional	Supported Values:	Provisioned Value:
Connchnng	M	As property connstate	-	-
Statistics	Mandatory/ Optional	Used in command:	Supported Values:	
Number of Characters Transferred (threegctm/ chartrans 0x0068/0x0001)	M	SUB		
Error Codes	Mandatory/ Optional			
None	-			

## C.14.30 Void

## C.14.31 Flexible Tone Generator package

Table C.14.31: Package Usage Information For Flexible Tone Generator

Properties	Mandatory/ Optional	Used in command:	Supported Values:	Provisioned Value:
None	-	-	-	-
Signals	Mandatory/ Optional	Used in command:		Duration Provisioned Value:
Flexible Tone (threegflex/ft, 0x0084/0x0050)	M	ADD, MOD, MOVE		-
	Signal Parameters	Mandatory/ Optional	Supported Values:	Duration Provisioned Value:
	Burst list direction(bld, 0x0001)	M	Int, Ext	Default=Ext
	NumberOfBursts (nob, 0x0002)	M	1-3	Default = 1
	BurstInterval (bi, 0x0003)	M	1-1200	Default = 2
	numberOfTonesInBurst (notib 0x0004)	M	1-3	Default=3
	toneDuration (td 0x0005)	M	1-20	Default=2
	toneInterval (ti 0x0006)	M	1-20	Default=2
Events	Mandatory/ Optional	Used in command:		
None	-	-		
	Event Parameters	Mandatory/ Optional	Supported Values:	Provisioned Value:
	-	-	-	-
	ObservedEvent Parameters	Mandatory/ Optional	Supported Values:	Provisioned Value:
-	-	-	-	-
Statistics	Mandatory/ Optional	Used in command:	Supported Values:	
None	-	-	-	
Error Codes	Mandatory/ Optional			
None	-			

## C.14.32 Trace Package

Table C.14.32: Package Usage Information For Trace Package

Properties	Mandatory/ Optional	Used in command:	Supported Values:	Provisioned Value:
Trace Activity Control (calltrace/traceactivityrequest, 0x0097/0x0001)	M	ADD, MOD	Trace Session is activated in MGW / Trace Session is deactivated in MGW	Not Applicable
IMSI (calltrace/imsi, 0x0097/0x0002)	M	ADD, MOD	Octet string	Not Applicable
IMEI(SV) (calltrace/imei_sv, 0x0097/0x0003)	M	ADD, MOD	Octet string	Not Applicable
Trace Reference (calltrace/tracereference, 0x0097/0x0004)	M	ADD, MOD	Octet string	Not Applicable
Trace Recording Session Reference (calltrace/tracerecsessionref, 0x0097/0x0005)	M	ADD, MOD	Octet string	Not Applicable
Trace Depth (calltrace/tracedepth, 0x0097/0x0006)	M	ADD, MOD	Octet string	Not Applicable
Triggering Events (calltrace/triggeringevent, 0x0097/0x0007)	M	ADD, MOD	Octet string	Not Applicable
List of interfaces (calltrace/listofinterfaces, 0x0097/0x0008)	M	ADD, MOD	Octet string	Not Applicable
<b>Signals</b>	<b>Mandatory/ Optional</b>	<b>Used in command:</b>		<b>Duration Provisioned Value:</b>
None	-	-		-
	<b>Signal Parameters</b>	<b>Mandatory/ Optional</b>	<b>Supported Values:</b>	<b>Duration Provisioned Value:</b>
	-	-	-	-
<b>Events</b>	<b>Mandatory/ Optional</b>	<b>Used in command:</b>		
Trace result (calltrace/tracact, 0x0097/0x0001)	M	ADD, MOD, NOTIFY		
	<b>Event Parameters</b>	<b>Mandatory/ Optional</b>	<b>Supported Values:</b>	<b>Provisioned Value:</b>
	None	-	-	-
	<b>ObservedEvent Parameters</b>	<b>Mandatory/ Optional</b>	<b>Supported Values:</b>	<b>Provisioned Value:</b>
	TraceActivation Result (res,0x0001)	M	Trace Successfully activated/ Failure in trace activation	Not Applicable
<b>Statistics</b>	<b>Mandatory/ Optional</b>	<b>Used in command:</b>	<b>Supported Values:</b>	
None	-	-	-	
<b>Error Codes</b>	<b>Mandatory/ Optional</b>			
None	-			

### C.14.33 ASCII Group call

**Table C.14.33: Package usage information for ASCII Group Call package**

Properties	Mandatory/ Optional	Used in command:	Supported Values:	Provisioned Value:
Number of needed conferenceterminations (threegasci/nct, 0x00b2/0x0001)	M	ADD	upto 32	None
Number of desired listener context terminations (threegasci/nlct, 0x00b2/0x0002)	O	ADD	upto 32	None
Signals	Mandatory/ Optional	Used in command:		Duration Provisioned Value:
None	-	-		-
	Signal Parameters	Mandatory/ Optional	Supported Values:	Duration Provisioned Value:
	-	-	-	-
Events	Mandatory/ Optional	Used in command:		
None	-	-		
	Event Parameters	Mandatory/ Optional	Supported Values:	Provisioned Value:
	-	-	-	-
	ObservedEvent Parameters	Mandatory/ Optional	Supported Values:	Provisioned Value:
	-	-	-	-
Statistics	Mandatory/ Optional	Used in command:	Supported Values:	
None	-	-	-	
Error Codes	Mandatory/ Optional			
None	-			

### C.14.34 IP domain connection

**Table C.14.34: Package usage information for IP domain connection package**

Properties	Mandatory/Optional	Used in command:	Supported Values:	Provisioned Value:
IP Realm Identifier (ipdc /realm, 0x009d /0x0001)	M	ADD	String	Operator Defined (NOTE)
Signals	Mandatory/Optional	Used in command:		Duration Provisioned Value:
None	-	-		-
	Signal Parameters	Mandatory/Optional	Supported Values:	Duration Provisioned Value:
-	-	-	-	-
Events	Mandatory/Optional	Used in command:		
None	-	-		
	Event Parameters	Mandatory/Optional	Supported Values:	Provisioned Value:
	-	-	-	-
	ObservedEvent Parameters	Mandatory/Optional	Supported Values:	Provisioned Value:
-	-	-	-	-
Statistics	Mandatory/Optional	Used in command:	Supported Values:	
None	-	-	-	
Error Codes	Mandatory/ Optional			
None	-			
NOTE: A default IP realm may be configured such that if the MGW has not received the IP realm identifier and the MGW supports multiple IP realms then the default IP realm shall be used.				

## C.14.35 Inactivity Timer Package

Table C.14.35: Package Usage Information for Inactivity Timer package

Properties	Mandatory/ Optional	Used in command:	Supported Values:	Provisioned Value:
None	-	-	-	-
Signals	Mandatory/ Optional	Used in command:		Duration Provisioned Value:
None	-	-		-
	Signal Parameters	Mandatory/ Optional	Supported Values:	Duration Provisioned Value:
	-	-	-	-
Events	Mandatory/ Optional	Used in command:		
Inactivity Timeout (it/ito, 0x0045/0x0001)	M	MOD, NOTIFY		
	Event Parameters	Mandatory/ Optional	Supported Values:	Provisioned Value:
	Maximum Inactivity Time (mit,0x0001)	M	Any integer	Unspecified, if not sent a value must be provisioned.
	ObservedEvent Parameters	Mandatory/ Optional	Supported Values:	Provisioned Value:
	None	-	-	-
Statistics	Mandatory/ Optional	Used in command:		Supported Values:
None	-	-		-
Error Codes	Mandatory/ Optional			
None	-			

### C.14.36 3G Interface Type package

**Table C.14.36: Package Usage Information for 3G Interface Type package**

Properties	Mandatory/ Optional	Used in command:	Supported Values:	Provisioned Value:
IP interface type, (threegint/ipint, 0x00e3/0x0001)	M	ADD, MOD	"NboIP" (0x0001) "AoIP" (0x0002) "MboIP" (0x0003) "ExtSIP!" (0x0004) NOTE	None
Signals	Mandatory/ Optional	Used in command:		Duration Provisioned Value:
None	-	-		-
	Signal Parameters	Mandatory/ Optional	Supported Values:	Duration Provisioned Value:
	-	-	-	-
Events	Mandatory/ Optional	Used in command:		
None	-	-		
	Event Parameters	Mandatory/ Optional	Supported Values:	Provisioned Value:
	-	-	-	-
	ObservedEvent Parameters	Mandatory/ Optional	Supported Values:	Provisioned Value:
	-	-	-	-
Statistics	Mandatory/ Optional	Used in command:		Supported Values:
None	-	-		-
Error Codes	Mandatory/ Optional			
None	-			
NOTE: Other values reserved				

### C.14.37 Differentiated Services (ds)

**Table C.14.37: Differentiated Services package**

<b>Properties</b>	<b>Mandatory/Optional</b>	<b>Used in command</b>	<b>Supported Values</b>	<b>Provisioned Value</b>
Differentiated Services Code Point (ds/dscp, 0x008b/0x0001)	M	ADD, MODIFY	ALL	Yes
Tagging Behaviour (ds/tb, 0x008b/0x0002)	O	ADD, MODIFY	ALL	Yes
<b>Signals</b>	<b>Mandatory/Optional</b>	<b>Used in command</b>		<b>Duration Provisioned Value</b>
None	-	-		-
	<b>Signal Parameters</b>	<b>Mandatory/Optional</b>	<b>Supported Values</b>	<b>Duration Provisioned Value</b>
	-	-	-	-
<b>Events</b>	<b>Mandatory/Optional</b>	<b>Used in command</b>		
None	-	-		
	<b>Event Parameters</b>	<b>Mandatory/Optional</b>	<b>Supported Values</b>	<b>Provisioned Value</b>
	-	-	-	-
	<b>ObservedEvent Parameters</b>	<b>Mandatory/Optional</b>	<b>Supported Values</b>	<b>Provisioned Value</b>
-	-	-	-	
<b>Statistics</b>	<b>Mandatory/Optional</b>	<b>Used in command</b>	<b>Supported Values</b>	
None	-	-	-	
<b>Error Codes</b>	<b>Mandatory/Optional</b>			
None	-			

## C.14.38 Gate Management (gm)

Table C.14.38: Gate Management Package

Properties	Mandatory/Optional	Used in command	Supported Values	Provisioned Value
Remote Source Address Filtering (gm/saf,0x008c/0x0001)	M	ADD, MODIFY	ALL	Not Applicable
Remote Source Address Mask (gm/sam,0x008c/0x0002)	O	ADD, MODIFY	ALL	Not Applicable
Remote Source Port Filtering (gm/spf,0x008c/0x0003)	M	ADD, MODIFY	ALL	Not Applicable
Remote Source Port (gm/spr,0x008c/0x0004)	O	ADD, MODIFY	ALL	Not Applicable
Explicit Source Address Setting (gm/esas,0x008c/0x0005)	Not Supported	NONE	-	-
Local Source Address (gm/lisa,0x008c/0x0006)	Not Supported	NONE	-	-
Explicit Source Port Setting (gm/esps,0x008c/0x0007)	Not Supported	NONE	-	-
Local Source Port (gm/lsp,0x008c/0x0008)	Not Supported	NONE	-	-
Remote Source Port Range (gm/sprp,0x008c/0x000A)	O	ADD, MODIFY	ALL	Not Applicable
Signals	Mandatory/Optional	Used in command		Duration Provisioned Value
None	-	-		-
	Signal Parameters	Mandatory/Optional	Supported Values	Duration Provisioned Value
	-	-	-	-
Events	Mandatory/Optional	Used in command		
None	-	-		
	Event Parameters	Mandatory/Optional	Supported Values	Provisioned Value
	-	-	-	-
	ObservedEvent Parameters	Mandatory/Optional	Supported Values	Provisioned Value
	-	-	-	-
Statistics	Mandatory/Optional	Used in command	Supported Values	
Discarded Packets (gm/dp,0x008c/0x0001)	Not Supported	None	-	
Error Codes	Mandatory/Optional			
None	-			
NOTE : This package extends RTP Control Protocol package (ITU-T Recommendation H.248.57 [66]) and thus inherits RTCP Allocation Specific Behaviour property ( <i>rsb</i> ).				

## C.14.39 Traffic management (tman)

Table C.14.39: Traffic Management Package

Properties	Mandatory/Optional	Used in command	Supported Values	Provisioned Value
Policing (tman/pol, 0x008d/0x0005)	M	ADD, MODIFY	ALL	Not Applicable
Peak Data Rate (tman/pdr, 0x008d/0x0001)	O	ADD, MODIFY	ALL	Not Applicable
Delay Variation Tolerance (tman/dvt, 0x008d/0x0004)	O	ADD, MODIFY	ALL	ANY
Sustainable Data Rate (tman/sdr, 0x008d/0x0002)	M	ADD, MODIFY	ALL	Not Applicable
Maximum burst size (tman/mbs, 0x008d/0x0003)	M	ADD, MODIFY	ALL	Not Applicable
Signals	Mandatory/Optional	Used in command		Duration Provisioned Value
None	-	-		-
	Signal Parameters	Mandatory/Optional	Supported Values	Duration Provisioned Value
	-	-	-	-
Events	Mandatory/Optional	Used in command		
None	-	-		
	Event Parameters	Mandatory/Optional	Supported Values	Provisioned Value
	-	-	-	-
	ObservedEvent Parameters	Mandatory/Optional	Supported Values	Provisioned Value
	-	-	-	-
Statistics	Mandatory/Optional	Used in command		Supported Values
None	-	-		-
Error Codes	Mandatory/Optional			
None	-			
NOTE: The data rate shall be calculated using the packet size from IP layer upwards. The Token Bucket method as described by ITU-T Recommendation H.248.53 [69] clause 9.4.3 (as per IETF RFC 2216 [73]) shall be followed where SDR = "r" and MBS = "b" (i.e. the additional "M" value does not apply).				

### C.14.40 IP Realm Availability (ipra)

**Table C.14.40: IP Realm Availability Package**

Properties	Mandatory/Optional	Used in command	Supported Values	Provisioned Value
Available Realms, (ipra/ar, 0x00e0/0x0001)	M	AUDITVALUE	ALL	Not Applicable
Signals	Mandatory/Optional	Used in command		Duration Provisioned Value
None	-	-		-
	Signal Parameters	Mandatory/Optional	Supported Values	Duration Provisioned Value
	-	-	-	-
Events	Mandatory/Optional	Used in command		
Available Realms Changed, (ipra/arc, 0x00e0/0x001)	M	MODIFY, NOTIFY		
	Event Parameters	Mandatory/Optional	Supported Values:	Provisioned Value
	-	-	-	-
	ObservedEvent Parameters	Mandatory/Optional	Supported Values	Provisioned Value
Newly Available Realms (nar, 0x0001)	M	M	ALL	Not applicable
Newly Unavailable Realms (nur, 0x0002)	M	M	ALL	Not applicable
Statistics	Mandatory/Optional	Used in command	Supported Values	
None	-	-	-	
Error Codes	Mandatory/Optional			
None	-			

### C.14.41 RTCP Handling Package (rtcph)

**Table C.14.41: RTCP Handling Package**

Properties	Mandatory/Optional	Used in command	Supported Values	Provisioned Value
RTCP Allocation Specific Behaviour (rtcph/rsb,0x00b5/0x0009)	M	ADD, MODIFY	ALL	OFF
Signals	Mandatory/Optional	Used in command		Duration Provisioned Value
None	-	-		-
	Signal Parameters	Mandatory/Optional	Supported Values	Duration Provisioned Value
	-	-	-	-
Events	Mandatory/Optional	Used in command		
None	-	-		
	Event Parameters	Mandatory/Optional	Supported Values	Provisioned Value
	-	-	-	-
	ObservedEvent Parameters	Mandatory/Optional	Supported Values	Provisioned Value
	-	-	-	-
Statistics	Mandatory/Optional	Used in command	Supported Values	
None	-	-	-	
Error Codes	Mandatory/Optional			
None	-			

## C.14.42 Application Data Inactivity Detection (adid)

Table C.14.42: Application Data Inactivity Detection package

Properties	Mandatory/Optional	Used in command	Supported Values	Provisioned Value
None	-	-	-	-
Signals	Mandatory/Optional	Used in command		Duration Provisioned Value
None	-	-		-
	Signal Parameters	Mandatory/Optional	Supported Values	Duration Provisioned Value
	-	-	-	-
Events	Mandatory/Optional	Used in command		
IP Flow Stop Detection (adid/ipstop, 0x009c/0x0001)	M	ADD, MODIFY, NOTIFY		
	Event Parameters	Mandatory/Optional	Supported Values	Provisioned Value
	Detection time (dt,0x0001)	M	ALL	Yes
	Direction (dir, 0x002)	M	ALL	Yes
	ObservedEvent Parameters	Mandatory/Optional	Supported Values	Provisioned Value
	-	-	-	-
Statistics	Mandatory/Optional	Used in command	Supported Values	
None	-	-	-	
Error Codes	Mandatory/Optional			
None	-			

### C.14.43 Explicit Congestion Notification for RTP-over-UDP Support (ecnrous)

**Table C.14.43.1: Explicit Congestion Notification for RTP-over-UDP Support package**

Properties	Mandatory/Optional	Used in command	Supported Values	Provisioned Value
ECN Enabled (ecnrous/ecnen, 0x010b/0x0001)	M	ADD, MODIFY	True, False	-
Congestion Response Method (ecnrous/crm, 0x010b/0x0002)	Not Signalled	-	-	"RDCC"(0x0002) NOTE
Initiation Method (ecnrous/initmethod, 0x010b/0x0003)	M	ADD, MODIFY	"leap"	"leap"
ECN Mode (ecnrous/mode, 0x010b/0x0004)	Not Signalled	-	-	"setonly" (0x0001) in the Remote Descriptor and "readonly" (0x0002) in the Local Descriptor
ECT Marking (ecnrous/ectmark, 0x010b/0x0005)	Not Signalled	-	-	"0" (0x0002)
ECN Congestion Marking (ecnrous/congestmark, 0x010b/0x0006)	Not Signalled	-	-	"nomark" (0x0003)
ECN SDP Usage (ecnrous/ecnsdp, 0x010b/0x0007)	Not Signalled	-	-	"P" (0x0001)
Signals	Mandatory/Optional	Used in command		Duration Provisioned Value
None	-	-		-
	Signal Parameters	Mandatory/Optional	Supported Values	Duration Provisioned Value
	-	-	-	-
Events	Mandatory/Optional	Used in command		
ECN Failure (ecnrous/fail, 0x010b/0x0001)	M	ADD, MODIFY, NOTIFY		
	Event Parameters	Mandatory/Optional	Supported Values	Provisioned Value
	-	-	-	-
	-	-	-	-
	ObservedEvent Parameters	Mandatory/Optional	Supported Values	Provisioned Value
	Failure Type (type,0x0001)	Mandatory	INIT, USE	-
	Media Sender SSRC (ssrc, 0x0002)	Not Supported	-	-
Statistics	Mandatory/Optional	Used in command	Supported Values	
Source (ecnrous/ssrc, 0x010b/0x0001)	Not Supported	-	-	
CE Counter (ecnrous/cecount, 0x010b/0x0002)	Not Supported	-	-	
ECT0 Counter (ecnrous/ectzero, 0x010b/0x0003)	Not Supported	-	-	
ECT1 Counter (ecnrous/ectone, 0x010b/0x0004)	Not Supported	-	-	
Not-ECT Counter (ecnrous/notect, 0x010b/0x0005)	Not Supported	-	-	
Lost Packets Counter (ecnrous/lost 0x010b/0x0006)	Not Supported	-	-	
Extended Highest Sequence number (ecnrous/ehsn, 0x010b/0x0007)	Not Supported	-	-	
Duplication Counter (ecnrous/dup, 0x010b/0x0008)	Not Supported	-	-	
Error Codes	Mandatory/Optional			
None	-			
NOTE: Application Specific Rate Adaptation shall be applied in accordance with 3GPP TS 26.114 [77]. For speech this requires support of CMR and TMMBR for video.				

### C.14.44 MG Act-as STUN Server (mgastuns)

**Table C.14.44.1: MG Act-as STUN Server**

Properties	Mandatory/Optional	Used in command	Supported Values	Provisioned Value
Act-as STUN Server (mgastuns/astuns, 0x00c2/0x0001)	M	ADD, MODIFY	ALL	-
Signals	Mandatory/Optional	Used in command		Duration Provisioned Value
None	-	-		-
	Signal Parameters	Mandatory/Optional	Supported Values	Duration Provisioned Value
	-	-	-	-
Events	Mandatory/Optional	Used in command		
None	-	-		
	Event Parameters	Mandatory/Optional	Supported Values	Provisioned Value
	-	-	-	-
	-	-	-	-
	ObservedEvent Parameters	Mandatory/Optional	Supported Values	Provisioned Value
	-	-	-	-
Statistics	Mandatory/Optional	Used in command	Supported Values	
None	-	-	-	
Error Codes	Mandatory/Optional			
None	-			

### C.14.45 Originate STUN Continuity Check (ostuncc)

**Table C.14.45.1: Originate STUN Continuity Check Package**

Properties	Mandatory/Optional	Used in command	Supported Values	Provisioned Value
Host Candidate Realm (ostuncc/hcr, 0x00c3/0x0001)	O	ADD, MODIFY	ALL	Yes
<b>Signals</b>	<b>Mandatory/Optional</b>	<b>Used in command</b>		<b>Duration Provisioned Value</b>
Send Connectivity Check (ostuncc/scc, 0x00c3/0x0001)	M	ADD, MODIFY		Not Applicable
	<b>Signal Parameters</b>	<b>Mandatory/Optional</b>	<b>Supported Values</b>	<b>Duration Provisioned Value</b>
	Control (cntrl, 0x0001)	O	"controlling", "controlled"	Not Applicable
Send Additional Connectivity Check (ostuncc/sacc, 0x00c3/0x0002)	<b>Mandatory/Optional</b>	<b>Used in command</b>		<b>Duration Provisioned Value</b>
	M	MODIFY		Not Applicable
	<b>Signal Parameters</b>	<b>Mandatory/Optional</b>	<b>Supported Values</b>	<b>Duration Provisioned Value</b>
	Control (cntrl, 0x0001)	O	"controlling", "controlled"	Not Applicable
<b>Events</b>	<b>Mandatory/Optional</b>	<b>Used in command</b>		
Connectivity Check Result (ostuncc/ccr, 0x00c3/0x0001)	M	ADD, MODIFY, NOTIFY		
	<b>Event Parameters</b>	<b>Mandatory/Optional</b>	<b>Supported Values</b>	<b>Provisioned Value</b>
	-	-	-	-
	<b>ObservedEvent Parameters</b>	<b>Mandatory/Optional</b>	<b>Supported Values</b>	<b>Provisioned Value</b>
	Candidate/Transport Pair (ctp, 0x0001)	M	ALL	Not applicable
New Peer Reflexive Candidate (ostuncc/nprc, 0x00c3/0x0002)	<b>Mandatory/Optional</b>	<b>Used in command</b>		
	M	ADD, MODIFY, NOTIFY		
	<b>Event Parameters</b>	<b>Mandatory/Optional</b>	<b>Supported Values</b>	<b>Provisioned Value</b>
	-	-	-	-
	<b>ObservedEvent Parameters</b>	<b>Mandatory/Optional</b>	<b>Supported Values</b>	<b>Provisioned Value</b>
	Candidate (can, 0x0001)	M	ALL	Not applicable
<b>Statistics</b>	<b>Mandatory/Optional</b>	<b>Used in command</b>	<b>Supported Values</b>	
None	-	-	-	
<b>Error Codes</b>	<b>Mandatory/Optional</b>			
None	-			

## C.14.46 Enhanced Revised Offer/Answer SDP Support (eroas)

Table C.14.46: Enhanced Revised Offer/Answer SDP Support package

Properties	Mandatory/Optional	Used in command	Supported Values	Provisioned Value
SDPCapNeg Extensions (eroas/sdpe, 0x0109/0x0001)	M	AuditValue	"cap-v0"	"cap-v0"
Signals	Mandatory/Optional	Used in command		Duration Provisioned Value
None	-	-		-
	Signal Parameters	Mandatory/Optional	Supported Values	Duration Provisioned Value
	-	-	-	-
Events	Mandatory/Optional	Used in command		
None	-	-		
	Event Parameters	Mandatory/Optional	Supported Values	Provisioned Value
	-	-	-	-
	ObservedEvent Parameters	Mandatory/Optional	Supported Values	Provisioned Value
	-	-	-	-
Statistics	Mandatory/Optional	Used in command	Supported Values	
None	-	-	-	
Error Codes	Mandatory/Optional			
None	-			

## C.15 Mandatory support of SDP and Annex C information elements

Mandatory support of SDP and Annex C information elements shall be in accordance with clause 11.

**Table C.15: Mandatory Annex C and SDP information elements**

Information Element	Annex C Support	SDP Support
Bearer Service Characteristics	TMR	
ISDN BC	USI	
NOTE 1: When text encoding is used, all the Information Elements shall be supported via their corresponding SDP parameters, as specified in clause 11. Annex C SDP equivalents shall not be used.		

## C.16 Optional support of SDP and Annex C information elements

**Table C.16: Optional Annex C and SDP information elements**

Information Element	Annex C Support	SDP Support
v-line	"SDP_V "	As in 3GPP TS 29.332 [51], clause A.15 (NOTE 1)
m-line	"SDP_M "	As in 3GPP TS 29.332 [51], clause A.15 (NOTE 1)
c-line	"SDP_C "	As in 3GPP TS 29.332 [51], clause A.15 (NOTE 1)
a-line	"SDP_A "	As in 3GPP TS 29.332 [51], clause A.15 (NOTE 1) (NOTE 7)
b-line	"SDP_B "	As in 3GPP TS 29.332 [51], clause A.15 (NOTE 1) (NOTE 8)
o-line	"SDP_O"	As in 3GPP TS 29.332 [51], clause A.15
s-line	"SDP_S"	The session name (s=) line contains a single field: s= <session-name>.  The MG shall return the value received from the MGC or if there is no s-line sent by the MGC, the MG shall populate this line as follows: - "s=" (NOTE 1)
Codec	Acocodec	Mandatory for BICC and lu terminations. (NOTE 2)
BNC-Id	BIR (NOTE 3)	Mandatory for BICC-ATM (NOTE 2)
BIWF_Address	NSAP (NOTE 4)	Mandatory for BICC-ATM (NOTE 2)
lu IP Address	IPv4 IPv6	As defined in ITU-T Recommendation H.248.1 [10] C6. Mandatory for lu termination with IP transport (NOTE 5)
lu IP Port	Port	As defined in ITU-T Recommendation H.248.1 [10] C6. Mandatory for lu termination with IP transport (NOTE 6)
<p>NOTE 1: If the procedures Reserve RTP Connection Point, Configure RTP Connection Point, Reserve and Configure RTP Connection Point are supported, these properties shall be supported.</p> <p>NOTE 2: When text encoding is used, all the Information Elements shall be supported via their corresponding SDP parameters, as specified in clause 11. Annex C SDP equivalents shall not be used.</p> <p>NOTE 3: The BIR length shall be fixed at 4 Octets.</p> <p>NOTE 4: The NSAP length shall be fixed at 20 Octets. The content of the RNC Transport Address or BIWF Address depends on the used transport interface but the principle is that NSAP format is used. See 3GPP TS 25.414 [21] for RNC and for core network see 3GPP TS 29.414 [32]. For IP the IANA ICP IDI format of the NSAP addressing format as specified in X.213 [33] shall be used. For Ipv4 networks the IPv4 format recommended by X.213 shall be adopted.</p> <p>NOTE 5: The value is mapped to/from the first 4(or 16) octets of the IPv4 (or IPv6) address part of the Transport Layer Address in 3GPP TS 25.413 [20].</p> <p>NOTE 6: The value is mapped to/from the Binding ID in the RANAP IE lu transport Association, 3GPP TS 25.413 [20].</p> <p>NOTE 7: For the RTP Payload for Redundant Audio Data, the encoding name with "red" and "fntp" attributes shall be provided to indicate the redundancy level and shall always be signalled in conjunction with the CLEARMODE Payload type as described in 10.2.3.5.2. No other Payload types are currently defined for use with the Redundant RTP Payload.</p> <p>NOTE 8: For RTP flows, where RTCP resources are reserved together with the RTP resources using the "RTP Specific Behaviour" property of the Gate Management package (gm) property, the MGC may also supply additional RTCP bandwidth modifiers (i.e. RR and RS, see IETF RFC 3556 [52]). The AS <i>bandwidth</i> value will include the bandwidth used by RTP. In the absence of the RTCP bandwidth modifiers, the MGW shall allow an additional 5% of the AS bandwidth value for the bandwidth for RTCP, in accordance with IETF RFC 3556 [52].</p>		

## Annex D (informative): Change history

Date	TSG #	TSG Doc.	CR	Rev	Cat	Subject/Comment	New
Sep 2000						Initial draft created after N4#4 based on N4-000620	0.1.0
Oct 2000						Updated after N4 R2000 Ad Hoc Stockholm based on N4-00823 and N4-000842	0.2.0
Nov 2000						Reference for MTP 3B corrected; RFC reference for SCTP added	0.3.0
Nov 2000						Updated according to N4-000996, N4-000998, N4-000999, N4-001000, N4-001021, N4-001028 & N4-001097 as agreed in CN4 #5	1.0.0
Nov 2000	CN#10					To TSG-CN Plenary #10 for information	1.1.0
Jan 2001						Updated according to NJ-010069, NJ-010030, NJ-010098, NJ-010094, NJ-010033, NJ-010097, NJ-010095, NJ-010112 as agreed in the Joint CN3/CN4 Meeting held during the CN4#6	1.1.1
Jan 2001						References ordered by specification/recommendation number; references to 3GPP specifications include full titles as shown on the title page; literal reference numbers and references to clauses replaced with fields; all table cells outlined with 0.5pt lines; appropriate 3GPP paragraph styles applied.	1.2.0
Feb 2001						Updated according to N4-010245, N4-010248, N4-010249, N4-010303, N4-010304, N4-010305, agreed in CN4 Release 4 ad hoc, Madrid. References to Q.1902.x replaced by references to 29.205; 3GPP styles applied consistently; form for ITU-T recommendations in text is now "ITU-T Recommendation A.NNNN".	1.3.0
Mar 2001						Updated according to N4-010384, N4-010401 (part) & N4-010472, agreed in CN4 in Sophia Antipolis. References to Q.1950, Q.1970 and Q.1990 replaced by reference to 29.205. Reference to SIP-T deleted. Editor's note in 15.1.2.3 deleted. Editorial clean-up.	2.0.0
Mar 2001						Sent to TSG CN#11 for approval	2.1.0
Mar 2001	CN#11					References updated after comments in TSG CN #11 Approved in CN#11	4.0.0
Jun 2001	CN#12	NP-010284	1	1		Text encoding of codec information on Mc interface	4.1.0
Jun 2001	CN#12	NP-010284	4	2		ATM-IP signalling transport Interworking	4.1.0
Jun 2001	CN#12	NP-010284	5	1		Alignment of Procedure names to TS 23.205 and Q.1950	4.1.0
Jun 2001	CN#12	NP-010284	6	3		Clarifications in 3GUP package	4.1.0
Jun 2001	CN#12	NP-010284	7	1		Clarification of Use of UP version property in 3GUP package	4.1.0
Jun 2001	CN#12	NP-010284	8	1		Updates to UP Relay Function, Appendix A	4.1.0
Sep 2001	CN#13					Editorial clean up	4.2.0
Sep 2001	CN#13	NP-010452	009			Addition of package numbers allocated by IANA	4.2.0
Sep 2001	CN#13	NP-010452	010	1		Mc signalling transport in IP environment	4.2.0
Dec 2001	CN#14	NP-010619	011	1		Inclusion of H.248 Annex L, "Error Codes and Service Change Reason Description"	4.3.0
Dec 2001	CN#14	NP-010619	012			Removal of the Reuse Idle Package	4.3.0
Dec 2001	CN#14	NP-010619	014			Correction of Release Procedures	4.3.0
Dec 2001	CN#14	NP-010619	015			Clarification Of Use Of 3GUP package For PCM	4.3.0
Dec 2001	CN#14	NP-010619	016			Corrections to ABNF coding of PackageIDs	4.3.0
Dec 2001	CN#14	NP-010619	017			Correction of BICC packages	4.3.0
Dec 2001	CN#14	NP-010619	020	1		Correction of 3GUP package sub-list type	4.3.0
Dec 2001	CN#14	NP-010631	013	1		Introduction of MGW Congestion Handling	5.0.0
Dec 2001	CN#14	NP-010631	019	2		Maintenance locking of MG	5.0.0
Jan 2002						A coverdheet fixed	5.0.1
Mar 2002	CN#15	NP-020029	025	2		Naming convention for TDM resources	5.1.0

Date	TSG #	TSG Doc.	CR	Rev	Cat	Subject/Comment	New
Mar 2002	CN#15	NP-020029	027	2		Correction of Bearer Modification Handling	5.1.0
Jun 2002	CN#16	NP-020260	030	1		GTT enhancement on Mc	5.2.0
Jun 2002	CN#16	NP-020260	032			Update to TFO package to explicitly reference TS 26.103 for 3GPP codecs	5.2.0
Jun 2002	CN#16	NP-020260	033	2		CTM Text Transport package	5.2.0
Jun 2002	CN#16	NP-020260	034			Allow the usage of logical port	5.2.0
Jun 2002	CN#16	NP-020249	036			Correction clause 14.1.6 of 3GPP TS 29.332	5.2.0
Sep 2002	CN#17	NP-020459	037	1		Misalignment between TS 23.226 and TS 29.232 for Global Text Telephony	5.3.0
Sep 2002	CN#17	NP-020459	038	1		Alignment of text in TS 29.232 for Global Text Telephony	5.3.0
Sep 2002	CN#17	NP-020459	039	1		Alignment between prepare bearer and reserve bearer in TS 29.232 for Global Text Telephony.	5.3.0
Sep 2002	CN#17	NP-020463	044	1		Missing Properties For Circuit Switched Data Calls	5.3.0
Dec 2002	CN#18	NP-020579	041	2		Termination ID Correction	5.4.0
Dec 2002	CN#18	NP-020597	042	3		New Procedures/Package for handling IP transport for lu interface	5.4.0
Dec 2002	CN#18	NP-020578	046	2		Updates to support Codec Modification	5.4.0
Dec 2002	CN#18	NP-020594	052	2		CAMEL4 flexible tone package	5.4.0
Mar 2003	CN#19	NP-030108	053			Update to 3GUP – clarification of luUP Initialisation handling	5.5.0
Mar 2003	CN#19	NP-030108	054	1		Update to 3GUP – addition of reference to SDU format definition for Nb interface	5.5.0
Jun 2003	CN#20	NP-030211	057	1		Alignment of references after renumbering of H248 by ITU-T	5.6.0
Jun 2003	CN#20	NP-030211	059			Clarification of handling of DTMF in split architecture – DTMF timing	5.6.0
Mar 2004	CN#23	NP-040052	061			Addition of Package Id for CTM	5.7.0
Mar 2004						Addition of Package Ids allocated by IANA (0082 - 0084)	5.7.0
Sep 2004	CN#25	NP-040392	063			Correction of Procedure "Activate Voice Processing Function"	5.8.0
Sep 2004	CN#25	NP-040418	075	2		3GUP package corrections	5.8.0
Sep 2004	CN#25	NP-040418	064			Provisioning Of Base Root package properties	5.8.0
Sep 2004	CN#25	NP-040418	065			Service Change Address	5.8.0
Sep 2004	CN#25	NP-040418	066			Use Of Event Buffers	5.8.0
Sep 2004	CN#25	NP-040418	067			Digit Maps	5.8.0
Sep 2004	CN#25	NP-040418	068			IP secured transport	5.8.0
Sep 2004	CN#25	NP-040418	074			Termination Restoration	5.8.0
Sep 2004	CN#25	NP-040392	072	1		Use Of Statistics	5.8.0
Dec 2004	CN#26	NP-040521	078			Correction of distant codec list	5.9.0
Dec 2004	CN#26	NP-040528	079			IP transport package Duplicate property ID in ASN.1 encoding	5.9.0
Dec 2004	CN#26	NP-040529	080	1		H.248 Scope	5.9.0
Dec 2004	CN#26	NP-040529	081	1		Q.1950 reference	5.9.0
Dec 2004	CN#26	NP-040529	082			Emdedded events	5.9.0
Dec 2004	CN#26	NP-040529	084			Multiple streams	5.9.0
Dec 2004	CN#26	NP-040529	085	1		Overspec/underspec parameters	5.9.0

Date	TSG #	TSG Doc.	CR	Rev	Cat	Subject/Comment	New
Dec 2004	CN#26	NP-040529	088	2		Procedures and Commands – removal of unwanted commands	5.9.0
Dec 2004	CN#26	NP-040547	092			Update of referenced H.248.1 version to version 2	6.0.0
Mar 2005	CN#27	NP-050057	060	7		Addition of the trace package	6.1.0
		NP-050029	101	1		Requirements for support of H.248 packages	
		NP-050029	104	1		Completion of specification of UMTS Packages	
		NP-050036	106			Correction of implied option for Embedded Signals and Events	
		NP-050036	108	2		Removal of the 'Test' ServiceStates value from the TerminationState Descriptor	
		NP-050036	111	1		Removal of the usage of the ContextAttributeAuditReq construct	
		NP-050036	113			Removal of the Multiplex descriptor	
		NP-050036	115			Removal of the Modem descriptor	
		NP-050133	120	4		Requirements for support of procedures	
		NP-050034	122	2		Procedure for Emergency Call Indication	
		NP-050036	128			Removal of the Error Descriptor usage in NotifyRequest	
		NP-050036	130			Updating incomplete parameter definition for MGW Resource congestion handling procedures	
		NP-050055	131			Removal of Signals on ROOT	
		NP-050055	132			Removal of usage of Stream ID in Topology descriptor	
		NP-050055	133			H.248.1 version contradiction	
		NP-050036	135			Directionality of tones and announcements	
		NP-050036	138	1		New 'TFO status' event	
		NP-050028	139	1		TFO procedure clarification	
		NP-050028	142	1		TFO activation without TFO Codec List	
		NP-050036	148	1		Commands on ROOT	
		NP-050036	149	1		Use Of Audit Value	
		NP-050036	151			Service Change Reasons Not supported	
		NP-050036	155	1		Descriptors in command replies	
		NP-050036	157	1		Introduction of formal profile name for Mc interface	
		NP-050036	158			Service Change for Failover not defined for Mc Interface	
		NP-050029	161			Removal Of VPF type	
		NP-050029	164			Alignment of TFO Actvation Procedure and associated parameters	
	NP-050055	165	2		Continuity Test		
Jun 2005	CT#28	CP-050236	184	1		BNC Cut-Through Capability Package Removed	6.2.0
		CP-050236	187	1		Format of IP address	
		CP-050101	188	2		Profile Registration Mandatory/Negotiation Clarification	
		CP-050236	196	1		Clarification of Maintenance Procedures	
		CP-050236	198	1		Clarification of Use Of Topology and Multiparty	
		CP-050236	200			Removal of Option in Prepare Bearer that the MGW can chose the BNC Characteristics	
		CP-050236	202	1		Clarification Of Use of Wildcarding	
		CP-050080	209	2		Text encoding of IPBCP for IP transport on Mc interface	
		CP-050080	212	2		Definition of requirement for support of commands	
		CP-050238	213	1		Correction to Profile registration procedures	
Sep 2005	CT#29	CP-050435	218	1		Codec IE and Codec List on the Mc interface	6.3.0
		CP-050290	224			Value range for BIR/NSAP	
		CP-050290	229			Clarification of 'extended only' packages	
		CP-050290	231			Correction to Prepare IP Transport procedure	
		CP-050290	233	1		Wildcarding of Release Procedures	
		CP-050290	235			Clarification to use of local peer for CSD	
		CP-050280	238	2		Correction to clarify use of FAX and Channel Mode Modify	
		CP-050290	242	1		Clarification to use of PLMN-BC, GSM-Chanel Coding for CSD	
		CP-050290	244	1		Clarification to use of Init Dir parameter	
		CP-050290	246	1		Clarification to Termination Restoration and Termination Out Of Service	
		CP-050290	248			Remove provisioning of Resource Congestion Event	
		CP-050290	250			Remove Priority property	
		CP-050290	252			Notifications for IP Bearer Establishment	
		CP-050290	254	1		Clarification for Use of Stream Mode Property with Announcements	
		CP-050290	256			Removal of Stream Mode Loopback	
		CP-050290	258			Correction to IPBCP Tunnel Procedures	
		CP-050290	263			Exclusion of use of Signal ID Play Tone for DTMF	
		CP-050290	265	1		Miscellaneous Open Mc corrections	
		CP-050308	266	1		Use of Individual Audit Token	
		CP-050438	268	1		Restriction of Service Change Address in MGW Restriction	
	CP-050308	271			Removal of BNC-cut-through-capability from Prepare Bearer procedure		
	CP-050308	272			Updating Mc interface profile "threegbcn" to version 2		
	CP-050290	276			Defining a default value for "Echo cancelling" property		

Date	TSG #	TSG Doc.	CR	Rev	Cat	Subject/Comment	New
		CP-050309	278	1		Correction on Burst interval duration	
		CP-050308	281	1		Clarification of "Normal Release" parameter	
Dec 2005	CT#30	CP-050603	0261	2		Correction to clarify TFO Package use	6.4.0
		CP-050607	0288	1		Clarification to client/server behaviour with regards to SCTP Initiation	
		CP-050607	0289	1		Inclusion of Error Code #449 for unsupported parameter value	
		CP-050618	0290	1		Correction to Continuity Test Procedure	
		CP-050607	0296	1		Setting of CN/Outgoing Nb termination prior to bearer establishment	
		CP-050607	0304	2		Correction to use of BITRATE for CSD calls	
		CP-050607	0308	1		Bearer Released Event to Reserve Circuit procedure	
		CP-050607	0322	1		Corrections to use of GSM-Channel Coding for CSD	
		CP-050618	0323	3		Correct MCC Error in implementing CR #238	
2005-12	CT#30	CP-050629	0302	2		Clean-up of hanging contexts and terminations	7.0.0
		CP-050629	0309	1		Clarification of MGW capability change	
2006-03	CT#31	CP-060078	0307	2		Clarification of Termination Restoration and Termination Out-of-Service procedures	7.1.0
		CP-060064	0326	2		Correction To Termination State Handling	
		CP-060064	0329	1		Send Tone procedure	
		CP-060064	0330	1		ContextID in Change Flow Direction response	
		CP-060064	0333	1		Correction To DTMF Detection	
		CP-060078	0337	1		Clarification to use of ServiceChangeMGCIid	
		CP-060078	0338			Clarification to cut-through procedure	
		CP-060064	0345	2		Adding missing termination ID to Acknowledgement part of notification procedures	
		CP-060078	0342	1		Correction to syntax for event descriptions	
		CP-060064	0348			Adding missing Codec, Bearer Characteristics and Bearer Service Characteristics to Prepare IP transport procedure	
		CP-060067	0352	1		Correction on the used descriptor for trace package	
2006-06	CT#32	CP-060315	0377	2		Introduction of Profile Description Annex to Mc interface	7.2.0
		CP-060315	0379			Corrections to Formats and Codes table	
		CP-060315	0382	1		Clarification of H.248.2 version in references	
		CP-060315	0386			Correction of the error definition of Flextone	
		CP-060307	0370			Corrigendum for H.248.1 version 2	
		CP-060301	0365	2		DTMF Detection Type	
		CP-060301	0368	1		Sequential Signal Lists	
		CP-060301	0374	2		Multimedia & CSD calls	
		CP-060301	0385	1		Clarification of ROOT termination naming	
2006-09	CT#33	CP-060411	0388	1		Profile Description Annex: Connection model and Context Attributes	7.3.0
		CP-060411	0389	2		Profile Description Annex: Terminations	
		CP-060411	0390	2		Profile Description Annex: Descriptors	
		CP-060411	0391	1		Profile Description Annex: Message, Transport and Security	
		CP-060411	0392	1		Profile Description Annex: Mandatory and optional packages	
		CP-060411	0393	2		Profile Description Annex: H.248 packages	
		CP-060411	0394	2		Profile Description Annex: BICC packages	
		CP-060411	0395	2		Profile Description Annex: Mandatory and optional 3G packages	
		CP-060411	0396	1		Profile Description Annex : Command API	
		CP-060411	0397	1		Profile Description Annex : Generic command syntax and encoding	
		CP-060411	0398	1		Profile Description Annex : Transactions	
		CP-060411	0399	1		Profile Description Annex : Mandatory support of SDP and Annex C information elements	
		CP-060411	0400	1		Profile Description Annex : Optional support of SDP and Annex C information elements	
		CP-060411	0401			Encoding of G.711 codec	
		CP-060400	0404	3		Profile registration procedure	
		CP-060411	0407	2		Definition of the use of mandatory and optional in Mc Profile Template	
		CP-060402	0409			Trace Package ID	
		CP-060400	0412			AuditValue procedure	
		CP-060400	0415	1		Use of topology for tones and announcements	
		CP-060397	0420			Modification of eventId named distant codec_list in threegtfo package	
		CP-060402	0427			Wildcarding of Release Termination Response	
		CP-060400	0430			Correction to Emergency Call Indication Procedure	
		CP-060400	0436	1		Use of IPSec for Mc Interface	
		CP-060400	0439	2		Correction to use of Local Peer for CSD when Anchor MGW	
		CP-060411	0441	2		New Error Code for Temporary Busy	
		CP-060411	0442	1		Profile Description Annex: Descriptors (complements)	
		CP-060411	0443			Profile Description Annex: Trace package	
		CP-060402	0447			Incomplete list of optional UMTS packages	
2006-12	CT#34	CP-060569	0376	6		Enhancements for VGCS/VBS in SPLIT architecture	7.4.0
		CP-060569	0452			Correct the initiator of NOT.resp command	
		CP-060569	0474	1		Removal of TBD for Number of Commands Per Transaction	
		CP-060569	0485	1		Event Tunnel indication for type BICC IP	

Date	TSG #	TSG Doc.	CR	Rev	Cat	Subject/Comment	New
		CP-060569	0486			Tunnel Option shall be used with Add.Req only	
		CP-060569	0487			IP transport package properties not used within Mov.Req	
		CP-060552	0459			Encoding of PLMN BC	
		CP-060561	0461	1		Trace package correction	
		CP-060554	0464			Commands in Change flow direction procedure	
		CP-060718	0481	3		Definite vs Indefinite encoding rules for binary H.248	
2007-03	CT#35	CP-070014	0490	3		IP domain connection indication	7.5.0
		CP-070014	0491			Commands Marked Optional	
		CP-070014	0494	1		Prevention of signalling overload due to Notifications	
		CP-070009	0497			Exclusion of use of inherited properties from network package	
		CP-070014	0498	1		Changing Profile description Annex C from Informative to Normative	
		CP-070009	0501	1		Signal List ID to Announcement Completed procedure	
		CP-070014	0508	1		Stream ID parameters in Signals and Events	
2007-06	CT#36	CP-070314	0511	1		IMSI/IMEI encoding in trace package	7.6.0
		CP-070322	0512			Adding package ID to ASCII package	
		CP-070322	0513			ServiceChangeMGCId parameter	
		CP-070308	0520			RFC 3309 for SCTP checksum	
		CP-070322	0522			Modification to EventID name definition	
2007-09	CT#37	CP-070530	0524	3		Service Change Methods and Reasons	7.7.0
		CP-070530	0527			H.248 Message Encoding	
		CP-070530	0528	1		General Corrections To Profile	
		CP-070530	0531	2		Mc profile corrections	
		CP-070530	0535	2		Support inactivity timer (H.248.14) for MGWs detecting the failure of MGC	
		CP-070530	0537	1		Completion of Text Telephony and Call Discrimination Packages	
2007-09	CT#37	CP-070569	0536	3		Mandatory use termination heartbeat (H.248.36) when establish bearer/prepare bearer	8.0.0
2007-10						Track marks removed	8.0.1
2007-12	CT#38	CP-070752	0538	2		Mc enhancements for SIP-I support	8.1.0
		CP-070756	0539	1		Examples for Usage of the 3GUP Package "Initialization Direction" Property	
		CP-070756	0541	1		Optional reporting of normal AAL2 bearer release	
		CP-070756	0556	1		Individual audit of TDM termination	
		CP-070749	0545			Heartbeat event in Send Tone and Play Announcement procedures	
		CP-070749	0551	1		Event Descriptor correction in Mc profile	
		CP-070749	0553			Reference corrections	
		CP-070749	0555	1		Number of needed listener context terminations to ASCII package	
		CP-070740	0549	1		Sequencing of Termination Out-of-Service and Termination Restoration procedures	
2008-03	CT#39	CP-080020	0557	1		Reserve / Configure RTP Connection Point, Modify Bearer Characteristics	8.2.0
		CP-080020	0558	1		Other codecs for SIP-I based Nc	
		CP-080011	0562	1		BNC events in Prepare Bearer / Establish Bearer procedures	
		CP-080025	0564			CAMEL prepaid warning tone missing from formats and codes table	
		CP-080020	0575	1		Applicability of descriptors to RTP terminations	
2008-06	CT#40	CP-080270	0585			Coding of the UDP Port Property	8.3.0
		CP-080269	0581	1		Use of Release Bearer Procedure	
		CP-080271	0576	1		Correction of the inconsistencies in several procedures' description	
		CP-080264	0577	2		A interface over IP support	
		CP-080262	0578	1		Addition of SIP-I based Nc within the scope of TS 29.232	
2008-09	CT#41	CP-080466	0591	3		IP interface type indicator	8.4.0
		CP-080466	0592	1		Use of Global Text Telephony with A over IP	
		CP-080466	0593			Use of 'plmnbc' and 'gsm channel coding' in AoIP	
		CP-080461	0594	1		Expansion of scope for IMS Centralised Service Access	
		CP-080466	0599			Support of GSM codec	
		CP-080468	0601			CTM properties setting	
		CP-080466	0604	1		Emergency Call Indication for AoIP and SIP-I terminations	
		CP-080453	0608			Service Change Reason in (G)MSC Server Out of Service	
2008-12	CT#42	CP-080686	0610	1		SDP Media Parameters For RTP Terminations	8.5.0
		CP-080705	0611	1		IP transport package properties handling	
		CP-080697	0612	2		No_Data frame handling independent of Stream Mode property	
		CP-080705	0613	-		Adding package ID to 3G Interface Type package	
			0617	2		Support of Redundancy for CSD in Mc interface for AoIP	
			0618	1		CTM transport property in the Reserve and Configure RTP connection Point procedure	
			0621			IP interface type for external SIP-I based network	
2009-03	CT#43	CP-090034	0622	-		Solving Incorrect references	8.6.0
			0623			Removing of IP transport package from packages chapter of Mc profile	
2009-06	CT#44	CP-090297	0624	1		Missing Signalling Object in Formats and Codes table	8.7.0
2009-09	CT#45	CP-090541	0625			Clarification of Use of Reserve and Configure RTP Connection Point	8.8.0
		CP-090541	0626	1		Missing RTP procedures from Circuit Switched Data package description	

Date	TSG #	TSG Doc.	CR	Rev	Cat	Subject/Comment	New
		CP-090544	0627	-		Audit of Hanging Termination Detection package	
2009-12	CT#46	CP-090763	0628	-		Commands Using IP Interface Type	8.9.0
2009-12	CT#46					Upgraded unchanged from Rel-8	9.0.0
2010-04						History table corrected	9.0.1
2011-03	CT#51	CP-110100	0629	1		Adding CS-Ix functionalities to Mc-profile	9.1.0
2011-03	CT#51	CP-110277	0630	10		ECN Support in Mc Interface	10.0.0
2011-03	CT#51	CP-110070	0631	1		Complete Inactivity Timeout Indication Procedure	
2011-06	CT#52	CP-110368	0635	1		ECN Failure improvements	10.1.0
		CP-110368	0637	1		Alignment of 3GPP profiles with SG16 ECN package definition	
2011-09	CT#53	CP-110563	0639	-		Media inactivity notification procedure	10.2.0
2011-12	CT#54	CP-110789	0640	1		ECN Improvements	10.3.0
2012-06	CT#56	CP-120226	0641	1		Reference update: draft-ietf-avtcore-ecn-for-rtp	10.4.0
2012-09	CT#57	CP-120478	0642	1		Support of Multimedia Priority Service (MPS) over Mc Interface – Stage 3	11.0.0
2012-12	CT#58	CP-120723	0646	-		Mc interface updates of ECN Support Package	11.1.0
2012-12	CT#58	CP-120727	0648	1		H.248.52 Status Update	11.1.0
2013-06	CT#60	CP-130294	0650	2		ECN relying reference change	11.2.0
2014-06	CT#64	CP-140248	0655	2		ICE support in Mc interface	12.0.0
2014-12	CT#66	CP-140788	0656	1		Adding support for EVS codec	12.1.0
2015-06	CT#68	CP-150272	0657	1		Adding support for the EVS codec over UMTS CS	13.0.0
2016-03	CT#71	CP-160048	0658	1		Removal of references to TS 26.236	13.1.0
2016-03	CT#71	CP-160027	0659	-		Resolution of Editor's note on EVS over UMTS CS	13.1.0
2016-03	CT#71	CP-160021	0660	1		Mc stage 3 to support SDP Capability Negotiation	13.1.0
2016-12	CT#74	CP-160662	0661	1		Update to example of Mc Single Codec encoding for EVS	13.2.0
2017-03	-	-	-	-		Update to Rel-14 version (MCC)	14.0.0
2018-06	CT#88e	-	-	-		Update to Rel-15 version (MCC)	15.0.0
2020-07	-	-	-	-		Update to Rel-16 version (MCC)	16.0.0
2022-03	CT#95e	CP-220052	0662	-	B	Update of IETF references for ICE	17.0.0
2024-03	-	-	-	-		Update to Rel-18 version (MCC)	18.0.0

---

# History

<b>Document history</b>		
V18.0.0	May 2024	Publication