

ETSI TS 129 244 V19.4.0 (2026-02)



TECHNICAL SPECIFICATION

**LTE;
5G;**

**Interface between the Control Plane and the User Plane nodes
(3GPP TS 29.244 version 19.4.0 Release 19)**



Reference

RTS/TSGC-0429244vj40

Keywords

5G, LTE

ETSI

650 Route des Lucioles
F-06921 Sophia Antipolis Cedex - FRANCE

Tel.: +33 4 92 94 42 00 Fax: +33 4 93 65 47 16

Siret N° 348 623 562 00017 - APE 7112B
Association à but non lucratif enregistrée à la
Sous-Préfecture de Grasse (06) N° w061004871

Important notice

The present document can be downloaded from the
[ETSI Search & Browse Standards](#) application.

The present document may be made available in electronic versions and/or in print. The content of any electronic and/or print versions of the present document shall not be modified without the prior written authorization of ETSI. In case of any existing or perceived difference in contents between such versions and/or in print, the prevailing version of an ETSI deliverable is the one made publicly available in PDF format on [ETSI deliver](#) repository.

Users should be aware that the present document may be revised or have its status changed, this information is available in the [Milestones listing](#).

If you find errors in the present document, please send your comments to the relevant service listed under [Committee Support Staff](#).

If you find a security vulnerability in the present document, please report it through our [Coordinated Vulnerability Disclosure \(CVD\)](#) program.

Notice of disclaimer & limitation of liability

The information provided in the present deliverable is directed solely to professionals who have the appropriate degree of experience to understand and interpret its content in accordance with generally accepted engineering or other professional standard and applicable regulations.

No recommendation as to products and services or vendors is made or should be implied.

No representation or warranty is made that this deliverable is technically accurate or sufficient or conforms to any law and/or governmental rule and/or regulation and further, no representation or warranty is made of merchantability or fitness for any particular purpose or against infringement of intellectual property rights.

In no event shall ETSI be held liable for loss of profits or any other incidental or consequential damages.

Any software contained in this deliverable is provided "AS IS" with no warranties, express or implied, including but not limited to, the warranties of merchantability, fitness for a particular purpose and non-infringement of intellectual property rights and ETSI shall not be held liable in any event for any damages whatsoever (including, without limitation, damages for loss of profits, business interruption, loss of information, or any other pecuniary loss) arising out of or related to the use of or inability to use the software.

Copyright Notification

No part may be reproduced or utilized in any form or by any means, electronic or mechanical, including photocopying and microfilm except as authorized by written permission of ETSI.

The content of the PDF version shall not be modified without the written authorization of ETSI.

The copyright and the foregoing restriction extend to reproduction in all media.

© ETSI 2026.
All rights reserved.

Intellectual Property Rights

Essential patents

IPRs essential or potentially essential to normative deliverables may have been declared to ETSI. The declarations pertaining to these essential IPRs, if any, are publicly available for **ETSI members and non-members**, and can be found in ETSI SR 000 314: "*Intellectual Property Rights (IPRs); Essential, or potentially Essential, IPRs notified to ETSI in respect of ETSI standards*", which is available from the ETSI Secretariat. Latest updates are available on the [ETSI IPR online database](#).

Pursuant to the ETSI Directives including the ETSI IPR Policy, no investigation regarding the essentiality of IPRs, including IPR searches, has been carried out by ETSI. No guarantee can be given as to the existence of other IPRs not referenced in ETSI SR 000 314 (or the updates on the ETSI Web server) which are, or may be, or may become, essential to the present document.

Trademarks

The present document may include trademarks and/or tradenames which are asserted and/or registered by their owners. ETSI claims no ownership of these except for any which are indicated as being the property of ETSI, and conveys no right to use or reproduce any trademark and/or tradename. Mention of those trademarks in the present document does not constitute an endorsement by ETSI of products, services or organizations associated with those trademarks.

DECT™, **PLUGTESTS™**, **UMTS™** and the ETSI logo are trademarks of ETSI registered for the benefit of its Members. **3GPP™**, **LTE™** and **5G™** logo are trademarks of ETSI registered for the benefit of its Members and of the 3GPP Organizational Partners. **oneM2M™** logo is a trademark of ETSI registered for the benefit of its Members and of the oneM2M Partners. **GSM®** and the GSM logo are trademarks registered and owned by the GSM Association.

Legal Notice

This Technical Specification (TS) has been produced by ETSI 3rd Generation Partnership Project (3GPP).

The present document may refer to technical specifications or reports using their 3GPP identities. These shall be interpreted as being references to the corresponding ETSI deliverables.

The cross reference between 3GPP and ETSI identities can be found at [3GPP to ETSI numbering cross-referencing](#).

Modal verbs terminology

In the present document "**shall**", "**shall not**", "**should**", "**should not**", "**may**", "**need not**", "**will**", "**will not**", "**can**" and "**cannot**" are to be interpreted as described in clause 3.2 of the [ETSI Drafting Rules](#) (Verbal forms for the expression of provisions).

"**must**" and "**must not**" are **NOT** allowed in ETSI deliverables except when used in direct citation.

Contents

Intellectual Property Rights	2
Legal Notice	2
Modal verbs terminology.....	2
Foreword.....	18
1 Scope	20
2 References	20
3 Definitions, symbols and abbreviations	24
3.1 Definitions	24
3.2 Abbreviations	25
4 Protocol Stack	27
4.1 Introduction	27
4.2 UDP Header and Port Numbers	28
4.2.1 General.....	28
4.2.2 Request Message	28
4.2.3 Response Message	28
4.3 IP Header and IP Addresses	28
4.3.1 General.....	28
4.3.2 Request Message	28
4.3.3 Response Message.....	29
4.4 Layer 2	29
4.5 Layer 1	29
5 General description.....	29
5.1 Introduction	29
5.2 Packet Forwarding Model	29
5.2.1 General.....	29
5.2.1A Packet Detection Rule Handling.....	32
5.2.1A.1 General	32
5.2.1A.2 PDI Optimization	33
5.2.1A.2A Provisioning of SDF filters	33
5.2.1A.3 Bidirectional SDF Filters	34
5.2.1A.4 Application detection with PFD.....	34
5.2.2 Usage Reporting Rule Handling	34
5.2.2.1 General	34
5.2.2.2 Provisioning of Usage Reporting Rule in the UP function	35
5.2.2.2.1 General	35
5.2.2.2.2 Credit pooling (for EPC)	39
5.2.2.3 Reporting of Usage Report to the CP function.....	40
5.2.2.3.1 General	40
5.2.2.3.2 Credit pooling.....	44
5.2.2.3.3 Traffic Usage Reporting with Redundant Transmission	45
5.2.2.4 Reporting of Linked Usage Reports to the CP function.....	45
5.2.2.5 End Marker Reception Reporting	45
5.2.3 Forwarding Action Rule Handling.....	46
5.2.3.1 General	46
5.2.4 Buffering Action Rule Handling.....	48
5.2.4.1 General	48
5.2.4.2 Provisioning of Buffering Action Rule in the UP function	48
5.2.4.3 Applying DL Buffering Duration in the CP function.....	49
5.2.5 QoS Enforcement Rule Handling	49
5.2.5.1 General	49
5.2.5.2 Provisioning of QoS Enforcement Rule in the UP function.....	49
5.2.5.3 Reflective QoS (for 5GC)	50
5.2.6 Combined SGW/PGW Architecture	50

5.2.7	Multi-Access Rule Handling (for 5GC).....	50
5.2.7.1	General.....	50
5.2.8	Session Reporting Rule Handling.....	52
5.2.8.1	General.....	52
5.2.8.2	Provisioning of Session Reporting Rule in the UP function.....	52
5.2.8.2.1	General.....	52
5.2.8.3	Reporting of Session Report to the CP function.....	52
5.2.8.3.1	General.....	52
5.2.9	Handling of Rules that cannot be activated.....	52
5.3	Data Forwarding between the CP and UP Functions.....	53
5.3.1	General.....	53
5.3.2	Sending of End Marker Packets.....	54
5.3.3	Forwarding of Packets Subject to Buffering in the CP Function.....	55
5.3.3.1	General.....	55
5.3.3.2	Forwarding of Packets from the UP Function to the CP Function.....	55
5.3.3.3	Forwarding of Packets from the CP Function to the UP Function.....	56
5.3.4	Data Forwarding between the CP and UP Functions with one PFCP-u Tunnel per UP Function or PDN.....	56
5.3.4.1	General.....	56
5.3.4.2	Forwarding of Packets from the UP Function to the CP Function.....	56
5.3.4.3	Forwarding of Packets from the CP Function to the UP Function.....	56
5.3.5	Forwarding of user data using Control Plane ClIoT 5GS Optimisation (for 5GC).....	57
5.3.5.1	General.....	57
5.3.5.2	Forwarding of Packets from the UP Function to the CP Function.....	57
5.3.5.3	Forwarding of Packets from the CP Function to the UP Function.....	57
5.4	Policy and Charging Control.....	58
5.4.1	General.....	58
5.4.2	Service Detection and Bearer/QoS Flow Binding.....	58
5.4.3	Gating Control.....	59
5.4.4	QoS Control.....	59
5.4.5	DL Flow Level Marking for Application Detection.....	60
5.4.6	Usage Monitoring.....	60
5.4.7	Traffic Redirection.....	61
5.4.8	Traffic Steering.....	61
5.4.9	Provisioning of Predefined PCC/ADC Rules.....	62
5.4.10	Charging.....	63
5.4.11	(Un)solicited Application Reporting.....	64
5.4.12	Service Identification for Improved Radio Utilisation for GERAN.....	65
5.4.13	Transport Level Marking.....	65
5.4.14	Deferred PDR activation and deactivation.....	66
5.4.15	Packet Rate enforcement.....	67
5.4.15.1	General.....	67
5.4.15.2	Packet rate enforcement over Sxb and N4 interfaces.....	67
5.4.15.3	PGW and SMF behaviour.....	68
5.4.16	QoS differentiation for Stand-alone Non-Public Network (SNPN).....	69
5.4.16.1	General.....	69
5.4.16.2	Access to PLMN services via SNPN.....	69
5.4.16.3	Access to SNPN services via PLMN.....	70
5.4.17	QoS differentiation for UEs behind RG.....	70
5.5	F-TEID Allocation and Release.....	70
5.5.1	General.....	70
5.5.2	Void.....	70
5.5.3	F-TEID allocation in the UP function.....	70
5.6	PFCP Session Handling.....	71
5.6.1	General.....	71
5.6.2	Session Endpoint Identifier Handling.....	71
5.6.3	Modifying the Rules of an Existing PFCP Session.....	71
5.7	Support of Lawful Interception.....	72
5.7.1	General.....	72
5.7.2	Lawful Interception in EPC.....	72
5.7.3	Lawful Interception in 5GC.....	72
5.8	PFCP Association.....	72

5.8.1	General.....	72
5.8.2	Behaviour with an Established PFCP Association.....	73
5.8.3	Behaviour without an Established PFCP Association	74
5.9	Usage of Vendor-specific IE	74
5.10	Error Indication Handling	74
5.10A	User Plane Path Failure or Recovery Handling.....	75
5.11	User plane inactivity detection and reporting.....	75
5.11.1	General.....	75
5.11.2	User plane inactivity detection and reporting per PDN connection or PDU session	75
5.11.3	User plane inactivity detection and reporting per PDR	76
5.12	Suspend and Resume Notification procedures	76
5.13	Ethernet traffic (for 5GC).....	76
5.13.1	General.....	76
5.13.2	Address Resolution Protocol or IPv6 Neighbour Solicitation Response by SMF	77
5.13.3	Address Resolution Protocol or IPv6 Neighbour Solicitation Response by UPF	78
5.13.3A	Provisioning of MAC addresses and SDF filters in Ethernet Packet Filters	78
5.13.4	Bidirectional Ethernet Filters.....	78
5.13.5	Reporting of UE MAC addresses to the SMF.....	79
5.13.6	Ethernet PDU session anchor relocation.....	79
5.13.7	Handling of allowed VLAN tags and VLAN Handling Information.....	79
5.14	Support IPv6 Prefix Delegation.....	80
5.15	Signalling based Trace (De)Activation	81
5.15A	UE level measurement (De)Activation.....	81
5.15A.1	General.....	81
5.15A.2	UE level measurement only (De)Activation	82
5.15A.3	Signalling based Trace and UE level measurement (De)Activation.....	82
5.16	Framed Routing	83
5.17	5G UPF (for 5GC).....	83
5.17.1	Introduction.....	83
5.17.2	Uplink Classifier and Branching Point	83
5.17.3	Data forwarding during handovers between 5GS and EPS.....	84
5.18	Enhanced PFCP Association Release.....	84
5.18.1	General.....	84
5.18.2	UP Function Initiated PFCP Session Release	85
5.19	Activation and Deactivation of Pre-defined PDRs	85
5.20	Support of Access Traffic Steering, Switching and Splitting (ATSSS) for 5GC	86
5.20.1	General.....	86
5.20.2	MPTCP functionality.....	88
5.20.2.1	General	88
5.20.2.2	Activate MPTCP functionality and Exchange MPTCP Parameters.....	88
5.20.2.3	Control of Multipath TCP Connection Establishment by MPTCP Proxy.....	89
5.20.2.4	Traffic Steering and IP Translation by MPTCP Proxy	89
5.20.2A	MPQUIC-based steeringfunctionalities	89
5.20.2A.1	General	89
5.20.2A.2	Activate MPQUIC-based steering functionalities and Exchange MPQUIC Parameters.....	90
5.20.2A.3	Control of Multipath QUIC Connection Establishment by MPQUIC Proxy	91
5.20.2A.4	Traffic forwarding by MPQUIC Proxy	91
5.20.3	ATSSS-LL functionality.....	92
5.20.3.1	Activate ATSSS-LL functionality and Exchange ATSSS-LL Parameters.....	92
5.20.4	Handling of GBR traffic of a MA PDU session	93
5.20.4.1	General	93
5.20.4.2	Access Availability Reporting	93
5.20.5	Access type of an MA PDU session becoming (un)available.....	93
5.20.6	PMFP message handling in UPF	94
5.21	UE IP address/prefix Allocation and Release.....	95
5.21.1	General.....	95
5.21.2	UE IP address/prefix allocation in the CP function	95
5.21.2.1	General	95
5.21.2.2	UE IP Address/prefix allocation using DHCP or AAA server.....	95
5.21.3	UE IP address/prefix allocation in the UP function	96
5.21.3.1	General	96
5.21.3.2	Reporting UE IP Address Usage to the CP function.....	97

5.22	PFCP sessions successively controlled by different SMFs of an SMF set (for 5GC)	97
5.22.1	General.....	97
5.22.2	With one PFCP association per SMF Set and UPF.....	98
5.22.3	With one PFCP association per SMF and UPF.....	99
5.22.4	Restoration of PFCP Sessions associated with an FQ-CSID, Group ID or PGW-C/SMF IP Address	101
5.23	5G VN Group Communication (for 5GC).....	102
5.23.1	General.....	102
5.23.2	5G VN group communication without N6-based forwarding.....	103
5.24	Support of Ultra Reliable Low Latency Communication for 5GC.....	103
5.24.1	General.....	103
5.24.2	Redundant Transmission on N3/N9 interfaces	104
5.24.2.1	General.....	104
5.24.2.2	GTP-U tunnel setup for redundant transmission.....	104
5.24.2.3	Duplicating downlink packets for redundant transmission	105
5.24.2.4	Eliminating duplicated uplink packets	105
5.24.3	Redundant Transmission at transport layer.....	105
5.24.4	Per QoS Flow Per UE QoS Monitoring.....	105
5.24.4.1	General.....	105
5.24.4.2	QoS Monitoring Control	106
5.24.4.3	QoS Monitoring Reporting	106
5.24.5	Per GTP-U Path QoS Monitoring.....	107
5.24.5.1	General.....	107
5.24.5.2	GTP-U path monitoring	107
5.24.5.3	QoS monitoring of a PDU session based on GTP-U path monitoring	107
5.24.5.4	QoS Monitoring Reporting	108
5.25	Support of IPTV (for 5GC)	108
5.26	Support of Time Sensitive Communication, Time Synchronization, 5GS integration with TSN and Deterministic Networking (for 5GC)	109
5.26.1	General.....	109
5.26.2	5GS User Plane Node management	110
5.26.3	Transfer of 5GS user plane node and port management information	110
5.26.3.1	General.....	110
5.26.3.2	Direct Reporting of TSC management information event to TSN AF or TSCTSF.....	111
5.26.4	Reporting clock drift between External and 5GS times from UPF to SMF.....	111
5.26A	Support of TSN enabled Transport Network.....	112
5.26A.1	General.....	112
5.27	Inter-PLMN User Plane Security	112
5.28	Downlink data delivery status with UPF buffering (for 5GC)	113
5.28.1	General.....	113
5.29	Support Reliable Data Service.....	114
5.30	Notifying Start Pause of Charging	114
5.31	Support of L2TP.....	115
5.31.1	General.....	115
5.31.2	L2TP Tunnel and L2TP Session Setup.....	116
5.31.3	L2TP Session and L2TP Tunnel Release.....	117
5.32	Support of Uplink packets buffering	117
5.32.1	General.....	117
5.32.2	Uplink packets buffering for on-line charging.....	117
5.32.3	Uplink packets buffering during EAS relocation.....	117
5.33	Support of enhancement of Edge Computing (for 5GC).....	117
5.33.1	General.....	117
5.33.2	Uplink packet buffering for low packet loss during EAS relocation	118
5.33.3	Edge Relocation using EAS IP address and Port number Replacement	118
5.33.4	EAS Discovery procedure with Local DNS Server/Resolver.....	118
5.33.5	Direct Reporting of QoS monitoring events to Local NEF or AF	118
5.33.6	EAS Discovery procedure with V-EASDF.....	119
5.33.7	DNS traffic routing for different UEs with same private UE IP address	119
5.33.8	N6 Delay Measurement and Reporting.....	120
5.33.8.1	General.....	120
5.33.8.2	Instructing the UPF to perform N6 delay measurements	120
5.33.8.3	N6 delay measurement information reporting.....	121
5.34	Support of 5G Multicast and Broadcast Service.....	122

5.34.1	General.....	122
5.34.2	N4mb requirements.....	122
5.34.2.1	General.....	122
5.34.2.1A	PFCP protocol extensions for N4mb.....	122
5.34.2.2	Instructing the MB-UPF to forward MBS data using multicast and/or unicast transport.....	123
5.34.2.3	Detecting and reporting user plane (in)activity of an MBS session.....	125
5.34.2.4	Activation and Deactivation of a Multicast MBS session.....	125
5.34.2.5	MBS data usage reporting for MBS charging.....	125
5.34.3	N4 requirements.....	126
5.34.3.1	General.....	126
5.34.3.2	Instructing the UPF to forward (or stop forwarding) multicast MBS data to associated PDU sessions.....	126
5.34.3.3	Instructing a combined UPF/MBS-UPF to forward multicast MBS data to associated PDU sessions.....	129
5.34.3.4	MBS data usage reporting for MBS charging.....	129
5.35	Support of Per Slice UP Resource Allocation and Usage Reporting by the UP Function.....	130
5.35.1	General.....	130
5.36	Paging Policy Indicator Provisioning.....	130
5.36.1	General.....	130
5.36.2	Enhanced Paging Policy Indicator Provisioning.....	131
5.37	Traffic Parameters Measurement per QoS flow.....	131
5.37.1	General.....	131
5.37.2	Traffic Parameter Measurement Control.....	131
5.37.3	Traffic Parameter Measurement Report.....	132
5.38	Support for high data rate low latency services, eXtended Reality (XR) and interactive media services.....	132
5.38.0	General.....	132
5.38.1	Support of ECN marking for L4S.....	132
5.38.2	Support of Network Exposure of 5GS information.....	133
5.38.3	Support of PDU Set based Handling.....	134
5.38.4	N6 Jitter Measurement and End of Data Burst Marking.....	135
5.38.4.1	General.....	135
5.38.4.2	N6 Jitter and UL/DL Periodicity Measurement Control.....	136
5.38.4.3	N6 Jitter and UL/DL Periodicity Measurement Report.....	136
5.38.4.4	End of Data Burst Marking.....	136
5.38.5	Supporting dynamically changing traffic characteristics via the User Plane.....	136
5.38.5.1	General.....	136
5.38.5.2	DL Data Burst Size Marking.....	136
5.38.5.3	DL Time to Next Burst Marking.....	137
5.38.5.4	Expedited Data Transfer with reflective QoS.....	137
5.38.6	Traffic identification and differentiated QoS for multiplexed media flows.....	137
5.38.7	Support of transferring media related information over N6.....	138
5.38.7.1	General.....	138
5.38.7.2	Using Media Over QUIC (MoQ).....	138
5.38.7.3	Using connect-UDP.....	138
5.38.7.4	Using UDP Option.....	139
5.39	QoS flow related QoS monitoring and reporting.....	140
5.39.1	General.....	140
5.39.2	QoS Monitoring Control.....	140
5.39.3	Measurable QoS parameters and specific requirements for their measurement.....	141
5.39.3.1	General.....	141
5.39.3.2	Packet delay monitoring.....	141
5.39.3.3	Congestion information monitoring.....	142
5.39.3.4	Data rate monitoring.....	142
5.39.3.5	Available Bitrate.....	143
5.39.4	QoS Monitoring Reporting.....	143
5.40	Support of UPF event subscription via Service Based Interface (for 5GC).....	144
5.41	Handling of Payload Headers.....	144
5.41.1	General.....	144
5.41.2	Provisioning of Header Handling Control Rules.....	144
5.41.3	Provision of Header Handling Reporting Control Info.....	146
5.42	Partial Success of a PFD management request.....	146
5.43	Energy Consumption information collection from SMF.....	147

6	Procedures	147
6.1	Introduction	147
6.2	PFCP Node Related Procedures	147
6.2.1	General	147
6.2.2	Heartbeat Procedure	147
6.2.2.1	General	147
6.2.2.2	Heartbeat Request	148
6.2.2.3	Heartbeat Response	148
6.2.3	Load Control Procedure	148
6.2.3.1	General	148
6.2.3.2	Principles	148
6.2.3.3	Load Control Information	148
6.2.3.3.1	General Description	148
6.2.3.3.2	Parameters	149
6.2.3.3.3	Frequency of Inclusion	150
6.2.4	Overload Control Procedure	150
6.2.4.1	General	150
6.2.4.2	Principles	151
6.2.4.3	Overload Control Information	151
6.2.4.3.1	General Description	151
6.2.4.3.2	Parameters	152
6.2.4.3.3	Frequency of Inclusion	153
6.2.4.4	Message Throttling	154
6.2.4.4.1	General	154
6.2.4.4.2	Throttling algorithm – "Loss"	154
6.2.4.5	Message Prioritization	155
6.2.4.5.1	Description	155
6.2.4.5.2	Based on the Message Priority Signalled in the PFCP Message	155
6.2.5	PFCP PFD Management Procedure	155
6.2.5.1	General	155
6.2.5.2	CP Function Behaviour	156
6.2.5.3	UP Function Behaviour	156
6.2.6	PFCP Association Setup Procedure	157
6.2.6.1	General	157
6.2.6.2	PFCP Association Setup Initiated by the CP Function	157
6.2.6.2.1	CP Function Behaviour	157
6.2.6.2.2	UP Function behaviour	157
6.2.6.3	PFCP Association Setup Initiated by the UP Function	158
6.2.6.3.1	UP Function Behaviour	158
6.2.6.3.2	CP Function Behaviour	158
6.2.7	PFCP Association Update Procedure	159
6.2.7.1	General	159
6.2.7.2	PFCP Association Update Procedure Initiated by the CP Function	159
6.2.7.2.1	CP Function Behaviour	159
6.2.7.2.2	UP Function Behaviour	159
6.2.7.3	PFCP Association Update Procedure Initiated by UP Function	160
6.2.7.3.1	UP Function Behaviour	160
6.2.7.3.2	CP Function Behaviour	160
6.2.8	PFCP Association Release Procedure	161
6.2.8.1	General	161
6.2.8.2	CP Function Behaviour	161
6.2.8.3	UP Function behaviour	161
6.2.9	PFCP Node Report Procedure	161
6.2.9.1	General	161
6.2.9.2	UP Function Behaviour	161
6.2.9.3	CP Function behaviour	162
6.3	PFCP Session Related Procedures	162
6.3.1	General	162
6.3.2	PFCP Session Establishment Procedure	162
6.3.2.1	General	162
6.3.2.2	CP Function Behaviour	162
6.3.2.3	UP Function Behaviour	162

6.3.3	PFPCP Session Modification Procedure	163
6.3.3.1	General	163
6.3.3.2	CP Function behaviour	163
6.3.3.3	UP Function Behaviour	163
6.3.4	PFPCP Session Deletion Procedure	164
6.3.4.1	General	164
6.3.4.2	CP Function Behaviour	164
6.3.4.3	UP Function Behaviour	164
6.3.5	PFPCP Session Report Procedure	164
6.3.5.1	General	164
6.3.5.2	UP Function Behaviour	164
6.3.5.3	CP Function Behaviour	164
6.4	Reliable Delivery of PFPCP Messages	165
6.5	PFPCP messages bundling	165
7	Messages and Message Formats	166
7.1	Transmission Order and Bit Definitions	166
7.2	Message Format	166
7.2.1	General	166
7.2.1A	PFPCP messages bundled in one UDP/IP packet	166
7.2.2	Message Header	167
7.2.2.1	General Format	167
7.2.2.2	PFPCP Header for Node Related Messages	167
7.2.2.3	PFPCP Header for Session Related Messages	168
7.2.2.4	Usage of the PFPCP Header	168
7.2.2.4.1	General	168
7.2.2.4.2	Conditions for Sending SEID=0 in PFPCP Header	169
7.2.3	Information Elements	169
7.2.3.1	General	169
7.2.3.2	Presence Requirements of Information Elements	169
7.2.3.3	Grouped Information Elements	171
7.2.3.4	Information Element Type	171
7.3	Message Types	171
7.4	PFPCP Node Related Messages	172
7.4.1	General	172
7.4.2	Heartbeat Messages	172
7.4.2.1	Heartbeat Request	172
7.4.2.2	Heartbeat Response	173
7.4.3	PFPCP PFD Management	173
7.4.3.1	PFPCP PFD Management Request	173
7.4.3.2	PFPCP PFD Management Response	174
7.4.4	PFPCP Association messages	175
7.4.4.1	PFPCP Association Setup Request	175
7.4.4.1.1	General	175
7.4.4.1.2	Clock Drift Control Information IE within PFPCP Association Setup Request	178
7.4.4.1.3	GTP-U Path QoS Control Information IE within PFPCP Association Setup Request	179
7.4.4.1.4	N6 Delay Measurement Control Information IE within PFPCP Association Setup Request	180
7.4.4.2	PFPCP Association Setup Response	183
7.4.4.3	PFPCP Association Update Request	186
7.4.4.3.1	UE IP Address Usage Information IE within PFPCP Association Update Request	189
7.4.4.4	PFPCP Association Update Response	191
7.4.4.5	PFPCP Association Release Request	192
7.4.4.6	PFPCP Association Release Response	192
7.4.4.7	PFPCP Version Not Supported Response	192
7.4.5	PFPCP Node Report Procedure	192
7.4.5.1	PFPCP Node Report Request	192
7.4.5.1.1	General	192
7.4.5.1.2	User Plane Path Failure Report IE within PFPCP Node Report Request	193
7.4.5.1.3	User Plane Path Recovery Report IE within PFPCP Node Report Request	193
7.4.5.1.4	Clock Drift Report IE within PFPCP Node Report Request	194
7.4.5.1.5	GTP-U Path QoS Report IE within PFPCP Node Report Request	194
7.4.5.1.6	QoS Information in GTP-U Path QoS Report IE	195

7.4.5.1.7	Peer UP Restart Report IE within PFCP Node Report Request	195
7.4.5.1.8	N6 Delay Measurement Report IE within PFCP Node Report Request	196
7.4.5.2	PFCP Node Report Response	196
7.4.5.2.1	General	196
7.4.6	PFCP Session Set Deletion	196
7.4.6.1	PFCP Session Set Deletion Request	196
7.4.6.2	PFCP Session Set Deletion Response	197
7.4.7	PFCP Session Set Modification	197
7.4.7.1	PFCP Session Set Modification Request	197
7.4.7.2	PFCP Session Set Modification Response	199
7.5	PFCP Session Related Messages	199
7.5.1	General	199
7.5.2	PFCP Session Establishment Request	199
7.5.2.1	General	199
7.5.2.2	Create PDR IE within PFCP Session Establishment Request	206
7.5.2.3	Create FAR IE within PFCP Session Establishment Request	216
7.5.2.4	Create URR IE within PFCP Session Establishment Request	226
7.5.2.5	Create QER IE within PFCP Session Establishment Request	231
7.5.2.6	Create BAR IE within PFCP Session Establishment Request	235
7.5.2.7	Create Traffic Endpoint IE within PFCP Session Establishment Request	236
7.5.2.8	Create MAR IE within PFCP Session Establishment Request	239
7.5.2.9	Create SRR IE within PFCP Session Establishment Request	241
7.5.2.10	Provide ATSSS Control Information IE within PFCP Session Establishment Request	245
7.5.2.11	Provide RDS Configuration Information IE within PFCP Session Establishment Request	246
7.5.3	PFCP Session Establishment Response	246
7.5.3.1	General	246
7.5.3.2	Created PDR IE within PFCP Session Establishment Response	250
7.5.3.3	Load Control Information IE within PFCP Session Establishment Response	250
7.5.3.4	Overload Control Information IE within PFCP Session Establishment Response	250
7.5.3.5	Created Traffic Endpoint IE within PFCP Session Establishment Response	251
7.5.3.6	Created Bridge/Router Info IE within PFCP Session Establishment Response	251
7.5.3.7	ATSSS Control Parameters IE within PFCP Session Establishment Response	252
7.5.3.8	Void	253
7.5.4	PFCP Session Modification Request	253
7.5.4.1	General	253
7.5.4.2	Update PDR IE within PFCP Session Modification Request	260
7.5.4.3	Update FAR IE within PFCP Session Modification Request	261
7.5.4.4	Update URR IE within PFCP Session Modification Request	264
7.5.4.5	Update QER IE within PFCP Session Modification Request	268
7.5.4.6	Remove PDR IE within PFCP Session Modification Request	273
7.5.4.7	Remove FAR IE within PFCP Session Modification Request	273
7.5.4.8	Remove URR IE within PFCP Session Modification Request	273
7.5.4.9	Remove QER IE PFCP Session Modification Request	273
7.5.4.10	Query URR IE within PFCP Session Modification Request	273
7.5.4.11	Update BAR IE within PFCP Session Modification Request	274
7.5.4.12	Remove BAR IE within PFCP Session Modification Request	275
7.5.4.13	Update Traffic Endpoint IE within PFCP Session Modification Request	276
7.5.4.14	Remove Traffic Endpoint IE within PFCP Session Modification Request	278
7.5.4.15	Remove MAR IE within PFCP Session Modification Request	278
7.5.4.16	Update MAR IE within PFCP Session Modification Request	278
7.5.4.17	Create PDR/FAR/URR/QER/BAR/MAR IEs within PFCP Session Modification Request	280
7.5.4.18	TSC Management Information IE within PFCP Session Modification Request	280
7.5.4.19	Remove SRR IE within PFCP Session Modification Request	280
7.5.4.20	Update SRR IE within PFCP Session Modification Request	281
7.5.4.21	Ethernet Context Information within PFCP Session Modification Request	281
7.5.4.22	Query Packet Rate Status IE within PFCP Session Modification Request	282
7.5.5	PFCP Session Modification Response	282
7.5.5.1	General	282
7.5.5.2	Usage Report IE within PFCP Session Modification Response	285
7.5.5.3	TSC Management Information IE within PFCP Session Modification Response	286
7.5.5.4	Packet Rate Status Report IE within PFCP Session Modification Response	287
7.5.5.5	Updated PDR IE within PFCP Session Modification Response	287

7.5.6	PFCP Session Deletion Request	287
7.5.7	PFCP Session Deletion Response	288
7.5.7.1	General	288
7.5.7.2	Usage Report IE within PFCP Session Deletion Response	290
7.5.7.3	Session Report IE within PFCP Session Deletion Response	290
7.5.8	PFCP Session Report Request	291
7.5.8.1	General	291
7.5.8.2	Downlink Data Report IE within PFCP Session Report Request	293
7.5.8.3	Usage Report IE within PFCP Session Report Request	294
7.5.8.4	Error Indication Report IE within PFCP Session Report Request	297
7.5.8.5	TSC Management Information IE within PFCP Session Report Request	297
7.5.8.6	Session Report IE within PFCP Session Report Request	298
7.5.9	PFCP Session Report Response	300
7.5.9.1	General	300
7.5.9.2	Update BAR IE within PFCP Session Report Response	302
7.6	Error Handling	303
7.6.1	Protocol Errors	303
7.6.2	Different PFCP Versions	303
7.6.3	PFCP Message of Invalid Length	303
7.6.4	Unknown PFCP Message	303
7.6.5	Unexpected PFCP Message	303
7.6.6	Missing Information Elements	304
7.6.7	Invalid Length Information Element	304
7.6.8	Semantically incorrect Information Element	304
7.6.9	Unknown or unexpected Information Element	305
7.6.10	Repeated Information Elements	305
8	Information Elements	305
8.1	Information Elements Format	305
8.1.1	Information Element Format	305
8.1.2	Information Element Types	306
8.2	Information Elements	315
8.2.1	Cause	315
8.2.2	Source Interface	318
8.2.3	F-TEID	319
8.2.4	Network Instance	320
8.2.5	SDF Filter	320
8.2.6	Application ID	324
8.2.7	Gate Status	324
8.2.8	MBR	325
8.2.9	GBR	325
8.2.10	QER Correlation ID	326
8.2.11	Precedence	326
8.2.12	Transport Level Marking	326
8.2.13	Volume Threshold	327
8.2.14	Time Threshold	327
8.2.15	Monitoring Time	327
8.2.16	Subsequent Volume Threshold	328
8.2.17	Subsequent Time Threshold	328
8.2.18	Inactivity Detection Time	329
8.2.19	Reporting Triggers	329
8.2.20	Redirect Information	330
8.2.21	Report Type	331
8.2.22	Offending IE	332
8.2.23	Forwarding Policy	332
8.2.24	Destination Interface	332
8.2.25	UP Function Features	333
8.2.26	Apply Action	338
8.2.27	Downlink Data Service Information	340
8.2.28	Downlink Data Notification Delay	340
8.2.29	DL Buffering Duration	340
8.2.30	DL Buffering Suggested Packet Count	341

8.2.31	PFCPSMReq-Flags	341
8.2.32	PFCPSRRsp-Flags	342
8.2.33	Sequence Number	343
8.2.34	Metric.....	343
8.2.35	Timer	343
8.2.36	Packet Detection Rule ID (PDR ID).....	344
8.2.37	F-SEID	344
8.2.38	Node ID	345
8.2.39	PFD Contents.....	345
8.2.40	Measurement Method	347
8.2.41	Usage Report Trigger.....	348
8.2.42	Measurement Period	349
8.2.43	Fully qualified PDN Connection Set Identifier (FQ-CSID).....	350
8.2.44	Volume Measurement.....	351
8.2.45	Duration Measurement	351
8.2.46	Time of First Packet.....	352
8.2.47	Time of Last Packet	352
8.2.48	Quota Holding Time	352
8.2.49	Dropped DL Traffic Threshold.....	353
8.2.50	Volume Quota.....	353
8.2.51	Time Quota	354
8.2.52	Start Time	354
8.2.53	End Time	354
8.2.54	URR ID.....	355
8.2.55	Linked URR ID IE.....	355
8.2.56	Outer Header Creation	355
8.2.57	BAR ID.....	357
8.2.58	CP Function Features.....	357
8.2.59	Usage Information	358
8.2.60	Application Instance ID	359
8.2.61	Flow Information	359
8.2.62	UE IP Address	359
8.2.63	Packet Rate	360
8.2.64	Outer Header Removal	362
8.2.65	Recovery Time Stamp	364
8.2.66	DL Flow Level Marking	364
8.2.67	Header Enrichment	364
8.2.68	Measurement Information.....	365
8.2.69	Node Report Type.....	366
8.2.70	Remote GTP-U Peer	367
8.2.71	UR-SEQN	367
8.2.72	Activate Predefined Rules	368
8.2.73	Deactivate Predefined Rules	368
8.2.74	FAR ID	368
8.2.75	QER ID	369
8.2.76	OCI Flags.....	369
8.2.77	PFCP Association Release Request.....	369
8.2.78	Graceful Release Period.....	370
8.2.79	PDN Type	370
8.2.80	Failed Rule ID.....	371
8.2.81	Time Quota Mechanism.....	371
8.2.82	Void	372
8.2.83	User Plane Inactivity Timer	372
8.2.84	Multiplier	372
8.2.85	Aggregated URR ID IE.....	373
8.2.86	Subsequent Volume Quota	373
8.2.87	Subsequent Time Quota	373
8.2.88	RQI	374
8.2.89	QFI.....	374
8.2.90	Query URR Reference	374
8.2.91	Additional Usage Reports Information.....	375
8.2.92	Traffic Endpoint ID	375

8.2.93	MAC address	375
8.2.94	C-TAG (Customer-VLAN tag).....	376
8.2.95	S-TAG (Service-VLAN tag).....	377
8.2.96	Ethertype.....	377
8.2.97	Proxying.....	378
8.2.98	Ethernet Filter ID	378
8.2.99	Ethernet Filter Properties	378
8.2.100	Suggested Buffering Packets Count.....	379
8.2.101	User ID	379
8.2.102	Ethernet PDU Session Information.....	380
8.2.103	MAC Addresses Detected.....	381
8.2.104	MAC Addresses Removed.....	381
8.2.105	Ethernet Inactivity Timer.....	382
8.2.106	Subsequent Event Quota.....	382
8.2.107	Subsequent Event Threshold.....	382
8.2.108	Trace Information	383
8.2.109	Framed-Route	383
8.2.110	Framed-Routing	383
8.2.111	Framed-IPv6-Route	384
8.2.112	Event Quota	384
8.2.113	Event Threshold.....	384
8.2.114	Time Stamp.....	385
8.2.115	Averaging Window.....	385
8.2.116	Paging Policy Indicator (PPI)	385
8.2.117	APN/DNN.....	386
8.2.118	3GPP Interface Type.....	386
8.2.119	PFCPSRReq-Flags.....	387
8.2.120	PFCPAUReq-Flags.....	388
8.2.121	Activation Time	388
8.2.122	Deactivation Time.....	389
8.2.123	MAR ID	389
8.2.124	Steering Functionality.....	389
8.2.125	Steering Mode.....	390
8.2.126	Weight	390
8.2.127	Priority	391
8.2.128	UE IP address Pool Identity.....	391
8.2.129	Alternative SMF IP Address.....	391
8.2.130	Packet Replication and Detection Carry-On Information.....	392
8.2.131	SMF Set ID	393
8.2.132	Quota Validity Time	393
8.2.133	Number of Reports.....	393
8.2.134	PFCPASRsp-Flags.....	393
8.2.135	CP PFCP Entity IP Address.....	394
8.2.136	PFCPSEReq-Flags.....	394
8.2.137	IP Multicast Address.....	395
8.2.138	Source IP Address.....	396
8.2.139	Packet Rate Status.....	396
8.2.140	Create Bridge/Router Info IE.....	397
8.2.141	Port Number.....	398
8.2.142	NW-TT Port Number.....	398
8.2.143	5GS User Plane Node ID	399
8.2.144	Port Management Information Container	399
8.2.145	Requested Clock Drift Information	399
8.2.146	Time Domain Number	400
8.2.147	Time Offset Threshold.....	400
8.2.148	Cumulative rateRatio Threshold	400
8.2.149	Time Offset Measurement	401
8.2.150	Cumulative rateRatio Measurement	401
8.2.151	SRR ID	401
8.2.152	Requested Access Availability Information	402
8.2.153	Access Availability Information.....	402
8.2.154	MPTCP Control Information	403

8.2.155	ATSSS-LL Control Information	403
8.2.156	PMF Control Information	403
8.2.157	MPTCP Address Information	404
8.2.158	Link-Specific Multipath IP Address	404
8.2.159	PMF Address Information	405
8.2.160	ATSSS-LL Information	406
8.2.161	Data Network Access Identifier	406
8.2.162	Average Packet Delay	407
8.2.163	Minimum Packet Delay	407
8.2.164	Maximum Packet Delay	407
8.2.165	QoS Report Trigger	407
8.2.166	GTP-U Path Interface Type	408
8.2.167	Requested QoS Monitoring	408
8.2.168	Reporting Frequency	409
8.2.169	Packet Delay Thresholds	410
8.2.170	Minimum Wait Time	410
8.2.171	QoS Monitoring Measurement	411
8.2.172	MT-EDT Control Information	412
8.2.173	DL Data Packets Size	412
8.2.174	QER Control Indications	412
8.2.175	NF Instance ID	413
8.2.176	S-NSSAI	413
8.2.177	IP version	413
8.2.178	PFCPASReq-Flags	413
8.2.179	Data Status	414
8.2.180	RDS Configuration Information	414
8.2.181	Multipath Applicable Indication	415
8.2.182	User Plane Node Management Information Container	415
8.2.183	Number of UE IP Addresses	415
8.2.184	Validity Timer	416
8.2.185	Offending IE Information	416
8.2.186	RAT Type	416
8.2.187	L2TP User Authentication	417
8.2.188	LNS Address	418
8.2.189	Tunnel Preference	418
8.2.190	Calling Number	419
8.2.191	Called Number	419
8.2.192	L2TP Session Indications	419
8.2.193	DNS Server Address	420
8.2.194	NBNS Server Address	420
8.2.195	Maximum Receive Unit	420
8.2.196	Thresholds	420
8.2.197	Steering Mode Indicator	421
8.2.198	Group Id	421
8.2.199	CP IP Address	421
8.2.200	IP Address and Port Number Replacement	422
8.2.201	DNS Query/Response Filter	423
8.2.202	Event Notification URI	423
8.2.203	Notification Correlation ID	423
8.2.204	Reporting Flags	424
8.2.205	Predefined Rules Name	424
8.2.206	MBS Session Identifier	424
8.2.207	Multicast Transport Information	425
8.2.208	MBSN4mbReq-Flags	426
8.2.209	Local Ingress Tunnel	426
8.2.210	MBS Unicast Parameters ID	427
8.2.211	MBSN4Resp-Flags	427
8.2.212	Tunnel Password	428
8.2.213	Area Session ID	428
8.2.214	DSCP to PPI Mapping Information	428
8.2.215	PFCPSDRsp-Flags	429
8.2.216	QER Indications	429

8.2.217	Vendor-Specific Node Report Type	430
8.2.218	Configured Time Domain	430
8.2.219	Metadata	431
8.2.223	Traffic Parameter Measurement Indication	432
8.2.225	MPQUIC Control Information.....	433
8.2.226	MPQUIC Address Information.....	433
8.2.227	Transport Mode	434
8.2.228	Void	435
8.2.229	Reporting Suggestion Info	435
8.2.230	TL-Container	435
8.2.231	Measurement Indication	435
8.2.232	HPLMN S-NSSAI	436
8.2.233	Media Transport Protocol	436
8.2.234	RTP Header Extension Type	436
8.2.235	RTP Header Extension ID	437
8.2.236	RTP Payload Type	437
8.2.237	RTP Payload Format.....	437
8.2.238	Extended DL Buffering Notification Policy	438
8.2.239	MT-SDT Control Information	438
8.2.240	Reporting Thresholds.....	439
8.2.241	RTP Header Extension Additional Information.....	439
8.2.242	Mapped N6 IP Address.....	440
8.2.243	N6 Routing Information.....	441
8.2.244	URI	441
8.2.245	UE Level Measurements Configuration	442
8.2.246	N6 Delay Measurement Protocols	443
8.2.247	N6 Delay Measurement Information	444
8.2.248	Measurement Endpoint Address	444
8.2.249	Operator Configurable UPF Capability	445
8.2.250	Packet Inspection functionality.....	445
8.2.251	Header Detection Reference	446
8.2.252	Header Detection Support Information.....	446
8.2.253	Reporting Endpoint ID.....	446
8.2.254	Header Handling Control Reference.....	446
8.2.255	Header Handling Action	447
8.2.256	Header Information.....	447
8.2.257	Header Value	448
8.2.258	Header Handling Condition	448
8.2.259	Header Handling Control ID.....	448
8.2.260	Header Handling Control Rule ID	449
8.2.261	On-path N6 Connection Information	449
8.2.262	Measurement Reporting Type.....	450
8.2.263	N6 Delay Measurement Failure Information	450
8.2.264	N6 Delay Measurement Control Information ID	451
8.2.265	Measurement Endpoint Port Number	451
8.2.266	Header Handling Reporting Indication.....	451
8.2.267	SMF Change Reason	452
8.2.268	PDU Set Importance	452
8.2.269	MoQ Control Information.....	454
8.2.270	MoQ Relay IP Address	454
8.2.271	Media Related Information Transfer Info.....	454
8.2.272	Reporting Control Information	455
8.2.273	Security Mode (STAMP).....	455
8.2.274	HMAC Key (STAMP).....	456
8.2.275	Security Mode (OWAMP or TWAMP).....	456
8.2.276	Key ID and Shared Secret (OWAMP or TWAMP).....	456
8.2.277	Remaining Data Reporting Indication	457
8.2.278	Expedited Transfer Indication.....	457
8.2.279	Session Reflector Mode (STAMP)	458
8.2.280	Transport Level Marking Indications	458

Annex A (Informative):	PFCP Load and Overload Control Mechanism.....	459
-------------------------------	--	------------

A.1	Throttling Algorithms.....	459
A.1.1	"Loss" Throttling Algorithm	459
A.1.1.1	Example of Possible Implementation	459
Annex B (Normative):	CP and UP Selection Functions with Control and User Plane Separation.....	460
B.1	CP Selection Function.....	460
B.1.1	General	460
B.2	UP Selection Function.....	460
B.2.1	General	460
B.2.2	SGW-U Selection Function.....	460
B.2.3	PGW-U Selection Function.....	461
B.2.4	Combined SGW-U/PGW-U Selection Function	461
B.2.5	TDF-U selection function.....	462
B.2.6	UP Selection Function Based on DNS	462
B.2.6.1	General.....	462
B.2.6.2	SGW-U Selection Function Based on DNS.....	462
B.2.6.3	PGW-U Selection Function Based on DNS.....	462
B.2.6.4	Combined SGW-U/PGW-U Selection Function Based on DNS	463
Annex C (Informative):	Examples scenarios	464
C.1	General	464
C.2	Charging Support	464
C.2.1	Online Charging	464
C.2.1.1	Online Charging Call Flow – Normal Scenario.....	464
C.2.1.2	Online Charging Call Flow with Credit Pooling.....	466
C.2.1.2.1	General	466
C.2.1.2.2	Example Call Flow 1.....	466
C.2.1.2.3	Example Call Flow 2.....	468
Annex D (Normative):	Use of PFCP over N16a for the support of traffic offload by UPF controlled by I-SMF.....	471
D.1	General	471
D.2	Procedures	472
D.2.1	Addition of PSA and UL CL/BP controlled by I-SMF	472
D.2.2	Removal of PSA and UL CL/BP	475
D.2.3	Change of PSA	476
D.2.4	Traffic Usage Reporting	476
D.2.5	Updating N4 information towards I-SMF	476
D.2.6	PDU session release	476
D.2.7	Simultaneous change of UL CL/BP and PSA controlled by I-SMF.....	477
D.2.8	Simultaneous change of UL CL/BP and PSA controlled by different I-SMFs	479
Annex E (Informative):	Procedures Related to MPTCP Functionality.....	482
E.1	General	482
E.2	Multipath TCP Connection Setup	482
E.2.1	General	482
E.2.2	Outgoing Multipath TCP Connection Setup	482
E.2.3	Incoming Multipath TCP Connection Setup	482
E.2.4	MPTCP Session Entry Stored in MPTCP Proxy	483
E.3	IP Translation Procedure	483
E.3.1	General	483
E.3.2	IP Translation on Uplink IP Packets.....	484
E.3.3	IP Translation on Downlink IP Packets.....	484
Annex F (Informative):	Change history	485

History496

Foreword

This Technical Specification has been produced by the 3rd Generation Partnership Project (3GPP).

The contents of the present document are subject to continuing work within the TSG and may change following formal TSG approval. Should the TSG modify the contents of the present document, it will be re-released by the TSG with an identifying change of release date and an increase in version number as follows:

Version x.y.z

where:

x the first digit:

- 1 presented to TSG for information;
- 2 presented to TSG for approval;
- 3 or greater indicates TSG approved document under change control.

y the second digit is incremented for all changes of substance, i.e. technical enhancements, corrections, updates, etc.

z the third digit is incremented when editorial only changes have been incorporated in the document.

In the present document, modal verbs have the following meanings:

shall indicates a mandatory requirement to do something

shall not indicates an interdiction (prohibition) to do something

The constructions "shall" and "shall not" are confined to the context of normative provisions, and do not appear in Technical Reports.

The constructions "must" and "must not" are not used as substitutes for "shall" and "shall not". Their use is avoided insofar as possible, and they are not used in a normative context except in a direct citation from an external, referenced, non-3GPP document, or so as to maintain continuity of style when extending or modifying the provisions of such a referenced document.

should indicates a recommendation to do something

should not indicates a recommendation not to do something

may indicates permission to do something

need not indicates permission not to do something

The construction "may not" is ambiguous and is not used in normative elements. The unambiguous constructions "might not" or "shall not" are used instead, depending upon the meaning intended.

can indicates that something is possible

cannot indicates that something is impossible

The constructions "can" and "cannot" are not substitutes for "may" and "need not".

will indicates that something is certain or expected to happen as a result of action taken by an agency the behaviour of which is outside the scope of the present document

will not indicates that something is certain or expected not to happen as a result of action taken by an agency the behaviour of which is outside the scope of the present document

might indicates a likelihood that something will happen as a result of action taken by some agency the behaviour of which is outside the scope of the present document

might not indicates a likelihood that something will not happen as a result of action taken by some agency the behaviour of which is outside the scope of the present document

In addition:

is (or any other verb in the indicative mood) indicates a statement of fact

is not (or any other negative verb in the indicative mood) indicates a statement of fact

The constructions "is" and "is not" do not indicate requirements.

1 Scope

The present document specifies the Packet Forwarding Control Protocol (PFCP) used on the interface between the control plane and the user plane function.

PFCP shall be used over:

- the Sxa, Sxb, Sxc and the combined Sxa/Sxb reference points specified in 3GPP TS 23.214 [2].
- the Sxa' and Sxb' reference points specified in 3GPP TS 33.107 [20]. In the rest of this specification, no difference is made between Sxa and Sxa', or between Sxb and Sxb'. The Sxa' and Sxb' reference points reuse the protocol specified for the Sxa and Sxb reference points, but comply in addition with the security requirements specified in clause 8 of 3GPP 33.107 [20].
- the N4 interface specified in 3GPP TS 23.501 [28] and 3GPP TS 23.502 [29].
- the N4mb interface specified in 3GPP TS 23.247 [72].

In this specification the term CP function applies to control plane nodes such as SGW-C, PGW-C, TDF-C, SMF and MB-SMF.

In this specification the term UP function applies to user plane nodes such as SGW-U, PGW-U, TDF-U, UPF and MB-UPF.

The prefix PFCP in message and procedure names is used to indicate that messages and procedures are common and used on Sx, N4 and N4mb reference points. A PFCP session refers to both Sx and/or N4 sessions, or to an N4mb session. A PFCP association is established between a CP function and a UP function, i.e., for EPC, between an SGW-C/PGW-C/TDF-C and an SGW-U/PGW-U/TDF-U, and for 5GC, between an SMF and a UPF or between an MB-SMF and MB-UPF.

In the related stage 2 specifications the prefix Sx, N4 and N4mb is used for these common procedures realised by PFCP.

Clauses or paragraphs that only apply to EPC or 5GC are indicated by the label "for EPC" or "for 5GC".

2 References

The following documents contain provisions which, through reference in this text, constitute provisions of the present document.

- References are either specific (identified by date of publication, edition number, version number, etc.) or non-specific.
- For a specific reference, subsequent revisions do not apply.
- For a non-specific reference, the latest version applies. In the case of a reference to a 3GPP document (including a GSM document), a non-specific reference implicitly refers to the latest version of that document *in the same Release as the present document*.

- [1] 3GPP TR 21.905: "Vocabulary for 3GPP Specifications".
- [2] 3GPP TS 23.214: "Architecture enhancements for control and user plane separation of EPC nodes; Stage 2".
- [3] 3GPP TS 29.281: "General Packet Radio System (GPRS) Tunnelling Protocol User Plane (GTPv1-U)".
- [4] IETF RFC 768: "User Datagram Protocol".
- [5] IETF RFC 791: "Internet Protocol".
- [6] IETF RFC 8200: "Internet Protocol, Version 6 (IPv6) Specification".

- [7] 3GPP TS 23.203: "Policy and charging control architecture; Stage 2".
- [8] 3GPP TS 29.212: "Policy and Charging Control (PCC); Reference points".
- [9] 3GPP TS 29.274: "3GPP Evolved Packet System. Evolved GPRS Tunnelling Protocol for EPS (GTPv2)".
- [10] 3GPP TS 36.413: "Evolved Universal Terrestrial Radio Access Network (E-UTRAN); S1 Application Protocol (S1AP)".
- [11] 3GPP TS 29.213: "Policy and Charging Control signalling flows and Quality of Service (QoS) parameter mapping".
- [12] IETF RFC 5905: "Network Time Protocol Version 4: Protocol and Algorithms Specification".
- [13] IETF RFC 2474: "Definition of the Differentiated Services Field (DS Field) in the IPv4 and IPv6 Headers".
- [14] 3GPP TS 23.401: "General Packet Radio Service (GPRS) enhancements for Evolved Universal Terrestrial Radio Access Network (E-UTRAN) access".
- [15] 3GPP TS 22.153: "Multimedia Priority Service".
- [16] IETF RFC 4006: "Diameter Credit Control Application".
- [17] 3GPP TS 32.251: "Telecommunication management; Charging management; Packet Switched (PS) domain charging".
- [18] 3GPP TS 32.299: "Telecommunication management; Charging management; Diameter charging application".
- [19] 3GPP TS 23.060: "General Packet Radio Service (GPRS); Service description; Stage 2".
- [20] 3GPP TS 33.107: "3G security; Lawful interception architecture and functions".
- [21] 3GPP TS 29.251: "Gw and Gwn reference points for sponsored data connectivity".
- [22] Void
- [23] IETF RFC 7230: "Hypertext Transfer Protocol (HTTP/1.1): Message Syntax and Routing".
- [24] 3GPP TS 23.007: "Restoration procedures".
- [25] 3GPP TS 29.303: "Domain Name System Procedures; Stage 3"
- [26] IETF RFC 5905: "Network Time Protocol Version 4: Protocol and Algorithms Specification".
- [27] IETF RFC 1035: "Domain Names - Implementation and Specification".
- [28] 3GPP TS 23.501: "System Architecture for the 5G System"
- [29] 3GPP TS 23.502: "Procedures for the 5G System"
- [30] IEEE 802.1Q: "Virtual Bridged Local Area Networks"
- [31] IEEE 802.3: "IEEE Standard for Ethernet"
- [32] IETF RFC 826: "An Ethernet Address Resolution Protocol or Converting Network Protocol Addresses".
- [33] IETF RFC 4861: "Neighbor Discovery for IP version 6 (IPv6)".
- [34] 3GPP TS 38.415: "NG-RAN; PDU Session User Plane Protocol".
- [35] 3GPP TS 32.422: "Telecommunication management; Subscriber and equipment trace; Trace control and configuration management".
- [36] IETF RFC 4282: "The Network Access Identifier".

- [37] IETF RFC 2865: "Remote Authentication Dial In User Service (RADIUS)".
- [38] IETF RFC 3162: "RADIUS and IPv6".
- [39] 3GPP TS 29.061: "Interworking between the Public Land Mobile Network (PLMN) supporting packet based services and Packet Data Networks (PDN)".
- [40] 3GPP TS 23.527: "5G System; Restoration procedures".
- [41] 3GPP TS 29.512: "5G System; Session Management Policy Control Service; Stage 3".
- [42] 3GPP TS 38.300: "NR; NR and NG-RAN Overall Description; Stage 2".
- [43] 3GPP TS 29.510: "5G System; Network Function Repository Services; Stage 3".
- [44] 3GPP TS 23.503: "Policy and Charging Control Framework for the 5G System".
- [45] 3GPP TS 32.255: "Telecommunication management; Charging management; 5G data connectivity domain charging; Stage 2".
- [46] Void
- [47] 3GPP TS 33.127: "Security; Lawful Interception (LI) architecture and functions".
- [48] 3GPP TS 23.003: "Numbering, addressing and identification".
- [49] 3GPP TS 29.561: "5G System; Interworking between 5G Network and external Data Networks; Stage 3".
- [50] 3GPP TS 29.502: "5G System, Session Management Services; Stage 3".
- [51] Void
- [52] IETF RFC 2236: "Internet Group Management Protocol, Version 2".
- [53] IETF RFC 9776: "Internet Group Management Protocol, Version 3".
- [54] IETF RFC 4604: "Using Internet Group Management Protocol Version 3 (IGMPv3) and Multicast Listener Discovery Protocol Version 2 (MLDv2) for Source-Specific Multicast".
- [55] IETF RFC 2710: "Multicast Listener Discovery (MLD) for IPv6".
- [56] Void
- [57] 3GPP TS 23.316: "Wireless and wireline convergence access support for the 5G System (5GS)".
- [58] IEEE Std 802.1AS-2020: "IEEE Standard for Local and metropolitan area networks--Timing and Synchronization for Time-Sensitive Applications".
- [59] 3GPP TS 24.193: "Access Traffic Steering, Switching and Splitting; Stage 3".
- [60] IETF RFC 8803: "0-RTT TCP Convert Protocol".
- [61] 3GPP TS 29.571: "5G System; Common Data Types for Service Based Interfaces; Stage 3".
- [62] IETF RFC 8684: "TCP Extensions for Multipath Operation with Multiple Addresses".
- [63] 3GPP TS 24.539: "5G System (5GS); Network to TSN translator (TT) protocol aspects; Stage 3".
- [64] 3GPP TS 33.501: "Security architecture and procedures for 5G system".
- [65] 3GPP TS 24.250: "Protocol for Reliable Data Service; Stage 3".
- [66] 3GPP TS 23.682: "Architecture enhancements to facilitate communications with packet data networks and applications".
- [67] IETF RFC 2661: Layer Two Tunneling Protocol "L2TP"

- [68] IETF RFC 2868: RADIUS Attributes for Tunnel Protocol Support
- [69] 3GPP TS 23.548: "5G System Enhancements for Edge Computing; Stage 2".
- [70] Void
- [71] IETF RFC 3986: "Uniform Resource Identifier (URI): Generic Syntax".
- [72] 3GPP TS 23.247: "Architectural enhancements for 5G multicast-broadcast services; Stage 2".
- [73] 3GPP TS 29.564: "5G System; User Plane Function Services; Stage 3".
- [74] 3GPP TS 29.500: "5G System; Technical Realization of Service Based Architecture; Stage 3".
- [75] IETF RFC 9562: "Universally Unique Identifiers (UUIDs)".
- [76] Void
- [77] Void
- [78] Void
- [79] 3GPP TS 26.522: "5G Real-time Media Transport Protocol Configurations".
- [80] 3GPP TS 29.585: "5G System (5GS); Session Management Function (SMF) / Centralized User Configuration (CUC) to Access Network Talker Listener (AN-TL) and Core Network Talker Listener (CN-TL) protocol aspects; Stage 3".
- [81] IETF RFC 9331: "Explicit Congestion Notification (ECN) Protocol for Very Low Queuing Delay (L4S)".
- [82] IETF RFC 3550: "RTP: A Transport Protocol for Real-Time Applications".
- [83] IETF RFC 3711: The Secure Real-time Transport Protocol (SRTP)"
- [84] IETF RFC 6184: "RTP Payload Format for H.264 Video"
- [85] IETF RFC 7798: "RTP Payload Format for High Efficiency Video Coding (HEVC)"
- [86] IETF RFC 8285: "A General Mechanism for RTP Header Extensions".
- [87] 3GPP TS 32.279: "Charging management; 5G Multicast-broadcast Services charging; Stage 2".
- [88] 3GPP TS 28.558: "Management and orchestration; User Equipment (UE) level measurements for 5G system".
- [89] 3GPP TS 29.514: "5G System; Policy Authorization Service; Stage 3".
- [90] IETF RFC 5761: "Multiplexing RTP Data and Control Packets on a Single Port".
- [91] IETF RFC 5764: "Datagram Transport Layer Security (DTLS) Extension to Establish Keys for the Secure Real-time Transport Protocol (SRTP)".
- [92] IETF RFC 7983: "Multiplexing Scheme Updates for Secure Real-time Transport Protocol (SRTP) Extension for Datagram Transport Layer Security (DTLS)".
- [93] IETF RFC 8872: "Guidelines for Using the Multiplexing Features of RTP to Support Multiple Media Streams".
- [94] IETF RFC 9143: "Negotiating Media Multiplexing Using the Session Description Protocol (SDP)".
- [95] IETF RFC 9443: "Multiplexing Scheme Updates for QUIC".
- [96] IETF RFC 9298: "Proxying UDP in HTTP".
- [97] IETF draft-ietf-masque-quick-proxy: "QUIC-Aware Proxying Using HTTP".

Editor's note: The above reference will be revised to RFC when finalized by IETF.

[98] IETF draft-ietf-moq-transport: "Media over QUIC Transport".

Editor's note: The above reference will be revised to RFC when finalized by IETF.

[99] IETF RFC 9868: "Transport Options for UDP".

[100] IETF RFC 5357: "A Two-Way Active Measurement Protocol (TWAMP)".

[101] IETF RFC 4656: "A One-way Active Measurement Protocol (OWAMP)".

[102] IETF RFC 8762: "Simple Two-Way Active Measurement Protocol".

[103] IETF RFC 9484: "Proxying IP in HTTP".

[104] IETF draft-ietf-masque-connect-ethernet-01: "Proxying Ethernet in HTTP".

Editor's note: The above reference will be revised to RFC when finalized by IETF.

[105] 3GPP TS 24.501: "Non-Access-Stratum (NAS) protocol for 5G System (5GS); Stage 3".

[106] 3GPP TS 23.380: "IMS Restoration Procedures".

3 Definitions, symbols and abbreviations

3.1 Definitions

For the purposes of the present document, the terms and definitions given in 3GPP TR 21.905 [1] and the following apply. A term defined in the present document takes precedence over the definition of the same term, if any, in 3GPP TR 21.905 [1].

Associated PDU Session: A PDU Session associated to a multicast session that is used for 5GC Individual MBS traffic delivery method and for signalling related to a user's participation in a multicast session such as join and leave requests.

Associated QoS Flow: A unicast QoS Flow that belongs to the associated PDU Session and is used for 5GC Individual MBS traffic delivery method. The associated QoS Flow is mapped from a multicast QoS Flow in a multicast MBS session.

Common Tunnel EndPoint Identifier (C-TEID): See definition in clause 3.1 of 3GPP TS 29.281 [3]. It is used for the delivery of user plane traffic using multicast transport via a common GTP-U tunnel to NG-RAN nodes over N3mb and/or to UPFs over N19mb.

CP function: A node with a Control Plane function (see 3GPP TS 23.214 [2]) supporting one or more PCF entities. A Control Plane function, i.e. a Control Plane Node, is identified by the Node ID that is set to either an FQDN or an IP address.

Low Layer Source Specific Multicast address (LLSSM): It is used to deliver user plane traffic using multicast transport to NG-RAN nodes over N3mb and/or to UPFs over N19mb. The destination multicast IP address identifies the multicast group, while the related unicast source IP address identifies the source of the multicast traffic (MB-UPF). The MB-UPF sets the outer header of the DL UP packets with the respective source IP address and destination multicast IP address.

Match Field: a field of the Packet Detection Information of a Packet Detection Rule against which a packet is attempted to be matched.

Matching: comparing the set of header fields of a packet to the match fields of the Packet Detection Information of a Packet Detection Rule.

MBS ingress address: It is used for the delivery of DL MBS UP traffic using unicast transport to the MB-UPF over N6mb or Nmb9 interface. The MBS ingress address identifies the MB-UPF's unicast IP address and port number for receiving DL data.

Multicast transport: the delivery of user plane traffic by IP multicast transport, as opposed to IP unicast transport. Multicast transport is supported over N3mb, N19mb and N6mb interfaces, but is not supported over Nmb9.

Note: Either a CP function or an UP function supporting one or more PFCP entities. A Node is identified by the Node ID, which is set to either an FQDN or an IP address.

PFCP Entity: An endpoint in a CP (or UP) function supporting PFCP, that is identified by the IP address. The IP address of a PFCP entity may or may not be the IP address included in the Node ID.

Source Specific Multicast address (SSM): It is used to deliver user plane traffic using multicast transport. The destination multicast IP address identifies the multicast group, while the related unicast source IP address identifies the source of the multicast data (e.g. AF/AS or MBSTF).

(S)RTP Multiplexed Media Identification Information: Component of the Packet filter information used to identify different media flows that are transported in (S)RTP, or the (S)RTCP that controls the (S)RTP transmission, when (S)RTP, (S)RTCP and other associated protocols are multiplexed into a single IP traffic flow as specified in IETF RFC 5761 [90], IETF RFC 5764 [91], IETF RFC 7983 [92], IETF RFC 8872 [93], IETF RFC 9143 [94] and IETF RFC 9443 [95].

Unicast transport: the delivery of user plane traffic by IP unicast transport, as opposed to IP multicast transport. For MBS, unicast transport is supported over N3mb, N19mb, N6mb and Nmb9 interfaces.

UP function: A node with a User Plane function (see 3GPP TS 23.214 [2]) supporting one or more PFCP entities. A User Plane function, i.e. a User Plane Node, is identified by the Node ID that is set to either a FQDN or an IP address.

3.2 Abbreviations

For the purposes of the present document, the abbreviations given in 3GPP TR 21.905 [1] and the following apply. An abbreviation defined in the present document takes precedence over the definition of the same abbreviation, if any, in 3GPP TR 21.905 [1].

5MBS	5G Multicast-Broadcast Service
ADC	Application Detection and Control
AS	Application Server
ATSSS	Access Traffic Steering, Switching, Splitting
ATSSS-LL	ATSSS Low Layer
BAR	Buffering Action Rule
BP	Branching Point
CN-TL	Core Network Talker Listener function
CP	Control Plane
CUC	Centralized User Configuration
DDDS	Downlink Data Delivery Status notification with UPF buffering
DDoS	Distributed Denial of Service
DEI	Drop Eligible Indicator
DetNet	Deterministic Networking
DNAI	Data Network Access Identifier
DSCP	Differentiated Services Code Point
DS-TT	Device-Side TSN Translator
EASDF	Edge Application Server Discovery Function
eMPS	enhanced Multimedia Priority Service
FAR	Forwarding Action Rule
F-SEID	Fully Qualified SEID
F-TEID	Fully Qualified TEID
HR-SBO	Home Routed Session BreakOut
IP	Internet Protocol
IPUPS	Inter-PLMN User Plane Security
IPv4	Internet Protocol version 4
IPv6	Internet Protocol version 6
I-SMF	Intermediate SMF
L2TP	Layer 2 Tunneling Protocol
L4S	Low Latency, Low Loss and Scalable Throughput
LAC	L2TP Access Concentrator

LMISF	LI Mirror IMS State Function
LNS	L2TP Network Server
MA	Multi-Access
MA	Multi-Access
MAR	Multi-Access Rule
MBS	Multicast/Broadcast Service
MB-SMF	Multicast/Broadcast Session Management Function
MB-UPF	Multicast/Broadcast User Plane Function
MBSF	Multicast/Broadcast Service Function
MBSTF	Multicast/Broadcast Service Transport Function
MoQ	Media over QUIC
MPQUIC	Multi-Path QUIC
MPQUIC-UDP	Multi-Path QUIC proxying UDP in HTTP
MPQUIC-IP	Multi-Path QUIC proxying IP in HTTP
MPQUIC-E	Multi-Path QUIC proxying Ethernet in HTTP
MPTCP	Multi-Path TCP Protocol
MT-EDT	Mobile Terminated Early Data Transmission
MT-SDT	Mobile Terminated Small Data Transmission
NPN	Non-Public Network
NR	New Radio
NW-TT	Network-side TSN Translator
PCC	Policy and Charging Control
PCP	Priority Code Point
PCEF	Policy and Charging Enforcement Function
PCRF	Policy and Charging Rule Function
PDI	Packet Detection Information
PDR	Packet Detection Rule
PFCP	Packet Forwarding Control Protocol
PF	Packet Flow Description
PGW	PDN Gateway
PGW-C	PDN Gateway Control plane function
PGW-U	PDN Gateway User plane function
PIN	Personal IoT Network
PLR	Packet Loss Rate
PMF	Performance Measurement Function
PMIC	Port Management Information Container
PSA	PDU Session Anchor
PTP	Precision Time Protocol
QER	QoS Enforcement Rule
RDS	Reliable Data Service
RTT	Round Trip Time
S8HR	S8 Home Routed
SDF	Service Data Flow
SEID	Session Endpoint Identifier
SGW	Serving Gateway
SGW-C	Serving Gateway Control plane function
SGW-U	Serving Gateway User plane function
SMF	Session Management Function
SNPN	Stand-alone Non-Public Network
SRR	Session Reporting Rule
SX3LIF	Split X3 LI Interworking Function
TDF	Traffic Detection Function
TDF-C	Traffic Detection Function Control plane function
TDF-U	Traffic Detection Function User plane function
TL	Talker Listener
TMGI	Temporary Mobile Group Identity
TN	Transport Network
ToS	Type of Service
TSC	Time Sensitive Communication
TSCTS	Time Sensitive Communication and Time Synchronization
TSCTSF	Time Sensitive Communication and Time Synchronization function
TSN	Time Sensitive Networking

TSSF	Traffic Steering Support Function
UDP	User Datagram Protocol
UL CL	Uplink Classifier
UMIC	User Plane Node Management Information Container
UP	User Plane
UPF	User Plane Function
URR	Usage Reporting Rule
VID	VLAN Identifier
XR	Extended Reality

4 Protocol Stack

4.1 Introduction

The protocol stack for the control plane over the Sxa, Sxb, Sxc, combined Sxa/Sxb, N4 and N4mb reference points shall be as depicted in Figure 4.1-1. Clauses 4.2 and 4.3 further specify the related UDP and IP requirements.

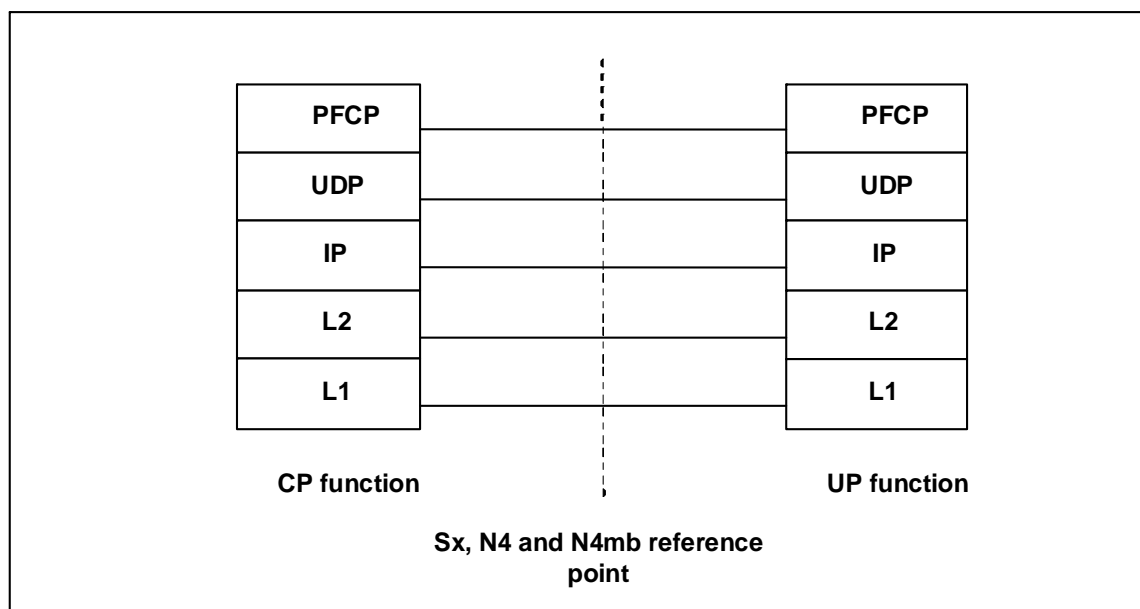

Figure 4.1-1: Control Plane stack over Sxa, Sxb, Sxc, combined Sxa/Sxb, N4 and N4mb

The protocol stack for the user plane over the Sxa, Sxb and N4 reference points (see clause 5.3) shall be as depicted in Figure 4.1-2. 3GPP TS 29.281 [3] further specifies the related GTP-U, UDP and IP requirements. Both IPv4 and IPv6 shall be supported.

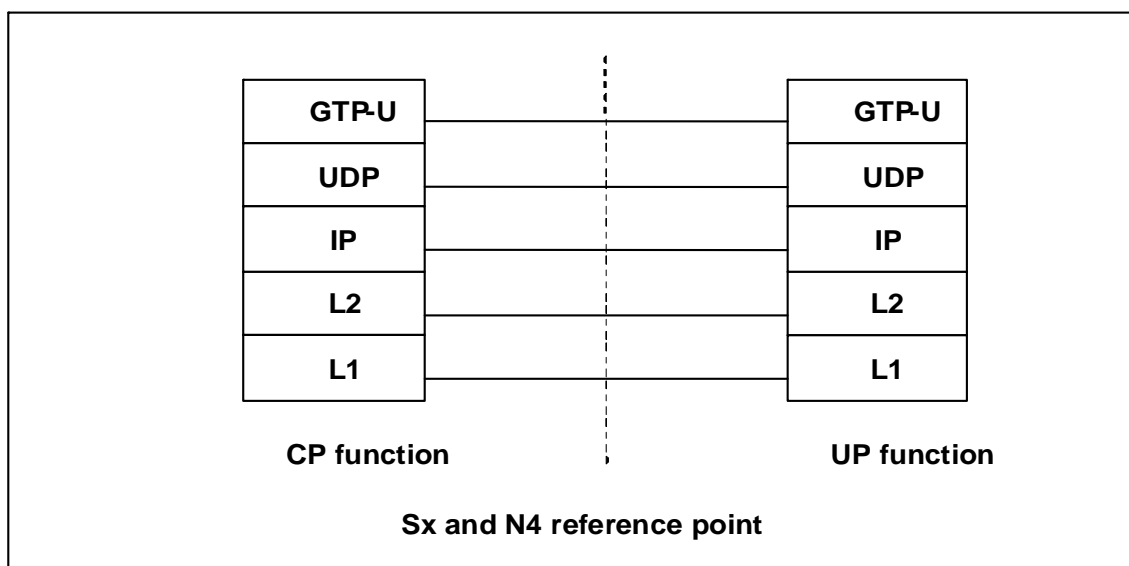

Figure 4.1-2: User Plane stack over Sxa, Sxb, combined Sxa/Sxb and N4

4.2 UDP Header and Port Numbers

4.2.1 General

A User Datagram Protocol (UDP) compliant with IETF RFC 768 [4] shall be used.

4.2.2 Request Message

The UDP Destination Port number for a Request message shall be 8805. It is the registered port number for PFCP.

The UDP Source Port for a Request message is a locally allocated port number at the sending entity.

NOTE: The locally allocated source port number can be reused for multiple Request messages.

4.2.3 Response Message

The UDP Destination Port value of a Response message shall be the value of the UDP Source Port of the corresponding Request message.

The UDP Source Port of a Response message shall be the value from the UDP Destination Port of the corresponding message.

4.3 IP Header and IP Addresses

4.3.1 General

In this clause, "IP" refers either to IPv4 as defined by IETF RFC 791 [5] or IPv6 as defined by IETF RFC 8200 [6]. A PFCP entity shall support both IPv4 and IPv6.

4.3.2 Request Message

The IP Destination Address of a Request message shall be an IP address of the peer entity.

During the establishment of a PFCP Session, the CP and the UP functions select and communicate to each other the IP Destination Address at which they expect to receive subsequent Request messages related to that PFCP Session. The CP and the UP functions may change this IP address subsequently during a PFCP Session Modification procedure.

The IP Source Address of a Request message shall be an IP address of the sending entity.

4.3.3 Response Message

The IP Destination Address of a Response message shall be copied from the IP Source Address of the corresponding Request message.

The IP Source Address of a Response message shall be copied from the IP destination address of the corresponding Request message.

4.4 Layer 2

Typically Ethernet should be used as a Layer 2 protocol, but operators may use any other technology.

4.5 Layer 1

Operators may use any appropriate Layer 1 technology.

5 General description

5.1 Introduction

The architecture reference model with Control and User Plane Separation of EPC nodes is described in clause 4.2 of 3GPP TS 23.214 [2].

The architecture reference model with SMF and UPF of 5GC nodes is described in clause 4.2 of 3GPP TS 23.501 [28].

The architecture reference model with MB-SMF and MB-UPF of 5GC nodes is described in clause 6.7 of 3GPP TS 23.247 [72].

This clause specifies the high level principles of the PFCP protocol and describe how 3GPP functionalities are realised on the Sxa, Sxb, Sxc, N4 and N4mb reference points, e.g. Packet Forwarding, Policy and Charging Control, Lawful Interception.

5.2 Packet Forwarding Model

5.2.1 General

The packet forwarding scenarios supported over the Sxa, Sxb and Sxc reference points are specified in 3GPP TS 23.214 [2].

The packet forwarding scenarios supported over the N4 reference point are specified in 3GPP TS 23.501 [28] and 3GPP TS 23.502 [29].

The packet forwarding scenarios supported over the N4mb reference point are specified in 3GPP TS 23.247 [72].

The CP function controls the packet processing in the UP function by establishing, modifying or deleting PFCP Session contexts and by provisioning (i.e. adding, modifying or deleting) PDRs, FARs, QERs, URRs, BAR and/or MAR or by activating/deactivating pre-defined PDRs, FARs, QERs, URRs, per PFCP session context, whereby a PFCP session context may correspond:

- for EPC, to an individual PDN connection, a TDF session, or a standalone session not tied to any PDN connection or TDF session used e.g. for forwarding Radius, Diameter or DHCP signalling between the PGW-C and the PDN.
- for 5GC, to an individual PDU session, a standalone PFCP session not tied to any PDU session or an MBS session.

Each PDR shall contain a PDI, i.e. one or more match fields against which incoming packets are matched, and may be associated to the following rules providing the set of instructions to apply to packets matching the PDI:

- one or more FARs, which contains instructions related to the processing of the packets as follows:
 - an Apply Action parameter, which indicates whether the UP function shall:
 - forward, duplicate, drop or buffer the packet with or without notifying the CP function about the arrival of a DL packet;
 - accept or deny UE requests to join an IP multicast group;
 - forward, duplicate, drop or buffer the UL packet; or
 - forward the MBS session data to a Low Layer Source Specific Multicast (LL SSM) address (using multicast transport) and/or forward and replicate the MBS session data to multiple GTP-u peers (using unicast transport).
 - forwarding, buffering and/or duplicating parameters, which the UP function shall use if the Apply Action parameter requests the packets to be forwarded, buffered or duplicated respectively. These parameters may remain configured in the FAR regardless of the Apply Action parameter value, to minimize the changes to the FAR during the transitions of the UE between the idle and connected modes. The buffering parameters, when present, shall be provisioned in a BAR created at the PFCP session level and referenced by the FAR.

NOTE 1: Buffering refers here to the buffering of the packet in the UP function. The UP function is instructed to forward DL packets to the CP function when applying buffering in the CP function. See clause 5.3.1.

- zero, one or more QERs, which contains instructions related to the QoS enforcement of the traffic;
- zero, one or more URRs, which contains instructions related to traffic measurement and reporting.
- zero or one MAR, which contains instructions related to Access Traffic Steering, Switching and Splitting (ATSSS) for the downlink traffic of a Multi-Access (MA) PDU session. See clause 5.2.7.

NOTE 2: A downlink PDR can be associated with two FARs for an N4 session established for an MA PDU session as an MAR contains two FARs for 3GPP and non-3GPP respectively.

A FAR, a QER, an URR and an MAR shall only be associated to one or multiple PDRs of the same PFCP session context.

The QoS Enforcement Rule Correlation ID shall be assigned by the CP function to correlate QERs from multiple PFCP session contexts. For instance, the enforcement of APN-AMBR in the PGW-U shall be achieved by setting the same QoS Enforcement Rule Correlation ID to the QERs from different PFCP sessions associated with all the PDRs corresponding to the non-GBR bearers of all the UE's PDN connections to the same APN. The QERs that are associated to the same QoS Enforcement Rule Correlation ID in multiple PFCP sessions shall be provisioned, with the same QER contents, in each of these PFCP sessions. The QoS Enforcement Rule Correlation ID shall be only used to enforce the APN-AMBR when the UE is in EPC, it may be provided by the CP function over N4 to the UP function for a PDU session may move to EPC in a later stage.

The following principles shall apply for the provisioning of PDRs in the UP function:

- Every PDR provisioned for a PFCP session shall allow to identify the PFCP session, i.e. every PDR shall contain the information element(s) to identify the PFCP session, which is either a Traffic Endpoint Identifier (if the PDI Optimization feature is supported) or equivalent information, e.g. UE IP address, Local F-TEID, Framed-Route, in the PDI IE.
- The CP function shall not provision more than one PDR with the same match fields in the PDI (i.e. with the same set of match fields and with the same value). The CP function may provision PDRs with the same value for a subset of the match fields of the PDI but not all;

- different PDRs of a same PFCP session may overlap, e.g. the CP function may provision two PDRs which differ by having one match field set to a specific value in one PDR and the same match field not included in the other PDR (thus matching any possible value);
- different PDRs of different PFCP sessions, not including the Packet Replication and Detection Carry-On Information IE, shall not overlap, i.e. PDRs in each PFCP session shall differ by at least one different (and not wildcarded) match field in their PDI, such that any incoming user plane packet may only match PDRs of a single PFCP session;
- As an exception to the previous principle, the CP function may provision a PDR with all match fields wildcarded (i.e. all match fields omitted in the PDI) in a separate PFCP session, to control how the UP function shall process packets unmatched by any PDRs of any other PFCP session. The CP function may provision the UP function to send these packets to the CP function or to drop them. The UP function shall grant the lowest precedence to this PDR.
- different PDRs of different PFCP sessions, including the Packet Replication and Detection Carry-On Information IE, may overlap. The Detection Carry-On Indication indicates that the UP function shall proceed with the look-up of other PDRs of other PFCP sessions matching the packet. This is used for broadcast traffic forwarding in 5G VN Group Communication.
- different downlink PDRs of different PFCP sessions, with a PDI including the IP multicast IP address IE, may overlap. The UP function shall proceed with the look-up of other PDRs of other PFCP sessions matching the packet. This is used for downlink IP multicast traffic for IPTV service (see clause 5.25).
- different downlink PDRs of different PFCP sessions, with a PDI including the MBS Session Identifier, may overlap. The UPF shall proceed with the look-up of other PDRs of other PFCP sessions with the same MBS Session Identifier matching the packets. This is used for multicast MBS services in 5GS using 5GC Individual Traffic Delivery (see clause 5.34).

On receipt of a user plane packet, the UP function shall perform a lookup of the provisioned PDRs in the UP function to identify only one PDR in a PFCP session according to the following steps:

- identify first the PFCP session to which the packet corresponds; and
- find the first PDR matching the incoming packet, among all the PDRs provisioned for this PFCP session, starting with the PDRs with the highest precedence and continuing then with PDRs in decreasing order of precedence. Only the highest precedence PDR matching the packet shall be selected, i.e. the UP function shall stop the PDRs lookup once a matching PDR is found.

A packet matches a PDR if all the match fields which are identified with different IE type in the PDI of the PDR are matching the corresponding packet header fields unless specified otherwise. If a match field is not included in the PDI, it shall be considered as matching all possible values in the header field of the packet. If the match field is present and does not include a mask, the match field shall be considered as matching the corresponding header field of the packet if it has the same value. If the match field is present and includes a mask (e.g. IP address with a prefix mask), the match field shall be considered as matching the corresponding header field of the packet if it has the same value for the bits which are set in the mask. If a match field has multiple instances, i.e. there are several IEs with the same IE type, a packet matches this match field if any instance is matching the corresponding packet header field.

The match fields of the PDI shall correspond to outer and/or inner packet header fields, e.g. uplink bearer binding verification in the PGW-U may be achieved by configuring a PDR with the PDI containing the local GTP-U F-TEID (for outer IP packet matching) and the SDF filters of the data flows mapped to the bearer (for inner IP packet matching).

NOTE 3: A DL PDR can be provisioned with a UE IP address together with a Framed-Route or a Framed-IPv6-Route either in the PDI IE or in the Create Traffic Endpoint IE; in such case, the PDR is matched if the packet matches either the UE IP address or the Framed-Route (Framed-IPv6-Route).

When one or more pre-defined PDR(s) are activated for a given PDR (see clause 5.19), an incoming packet matches the PDR if it matches one of activated pre-defined PDR(s).

The UP function should drop packets unmatched by any PDRs.

The packet processing flow in the UP function is illustrated in Figure 5.2.1-1.

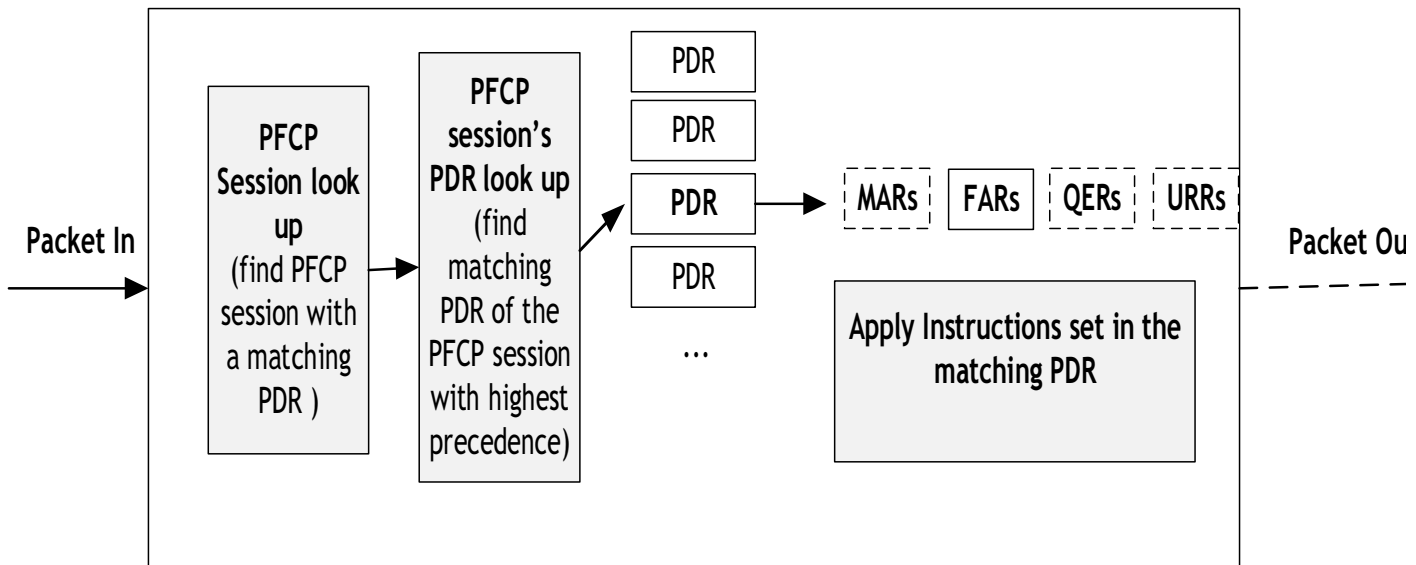

Figure 5.2.1-1: Packet processing flow in the UP function

At the deletion of a PFCP session, the UP function shall delete the PFCP session context and all the associated non-preconfigured rules.

NOTE 4: Deleting a QER in one PFCP session does not result in deleting another QER in another PFCP session even when these two QERs have the same QER ID and/or are associated with the same QER Correlation ID.

A UP Function controlled by multiple CP functions shall handle Rule IDs from the different CP functions independently from each other.

Rule ID used for PDR, FAR, BAR, QER, URR or MAR is uniquely identifying a rule of the corresponding rule type within a session.

For an MA-PDU session, IP addresses translation for MPTCP traffic (see Annex E.3) is independent from the handling of URR/QER/BAR, but it shall be performed before applying the FAR (e.g. before creating the outer header and forwarding the packet).

5.2.1A Packet Detection Rule Handling

5.2.1A.1 General

When provisioning a PDR in the UP function, the CP function shall provide the PDI with the following information:

- the source interface of the incoming packets;
- a combination of the parameters, that incoming packets are requested to match, among: Local F-TEID, Network Instance, UE IP address(es), SDF Filter(s) and/or Application ID. For 5GC, the PDI may additionally contain one or more QFI(s) to detect traffic pertaining to specific QoS flow(s), Ethernet Packet Filter(s), Ethernet PDU Session Information (see clause 5.13.1) and/or DNS Query Filter(s).

The requirements for provisioning an SDF filter in the PDI are specified in clauses 5.2.1A.2A and 5.2.1A.3.

The CP function may provision the parameters, that incoming packets are requested to match, in the UP function by:

- providing the parameters individually in each PDI of the PFCP session; or
- optionally, if the PDI Optimization feature is supported by the UP function, by providing the parameters which may be common to multiple PDIs of a same PFCP session in a Traffic Endpoint IE and by referencing this Traffic Endpoint in the PDI(s) of the PFCP session. See clause 5.2.1A.2. A Traffic Endpoint may include a Local F-TEID, Network Instance, UE IP address(es) and/or Ethernet PDU Session Information (see clause 5.13.1).

NOTE: A Traffic Endpoint can correspond to a GTP-u endpoint, an SGi or an N6 endpoint.

5.2.1A.2 PDI Optimization

The PDI Optimization feature should be supported by CP and UP functions complying with this release of the specification. This feature allows the CP function to optimize the signaling towards the UP function by creating the information that are common to multiple PDRs as a Traffic Endpoint with a Traffic Endpoint ID and then referring to this common information from multiple PDRs. The Traffic Endpoint ID shall be unique within a PFCP session. If MTE feature is supported, one PDI may refer to more than one Traffic Endpoints. When a PDI refers to a Traffic Endpoint, the parameters that are in the Traffic Endpoint shall not be once again provided in the PDI. The CP function may update the Traffic Endpoint at any time.

If a Traffic Endpoint is updated, all the PDRs that refer to this Traffic Endpoint in the UP function shall use the updated information.

The UP function shall allocate and store the F-TEID associated to the Traffic Endpoint. When the UP function provides the allocated F-TEID to the CP function in the PFCP Session Establishment response or PFCP Session Modification response message, the CP function shall update the Traffic Endpoint information stored in the CP function with the received F-TEID.

The CP function should use a Traffic Endpoint ID created in a different PFCP message only after getting the confirmation from the UP function of the Traffic Endpoint ID creation.

If the CP function deletes a Traffic Endpoint, the UP Function shall delete all the PDRs that refer to this Traffic Endpoint.

NOTE 1: The requirements specified in clause 5.2.2.3.1 for reporting usage reports to the CP function also apply if the deletion of the Traffic Endpoint results in deleting the last PDR associated to a URR.

NOTE2: For EPC, the Remove Traffic Endpoint IE can be used to delete a bearer for which multiple PDRs exist (with the same Traffic Endpoint ID).

5.2.1A.2A Provisioning of SDF filters

When provisioning an SDF Filter in a PDI, the CP function shall:

- copy the Flow Description if it is received from the PCRF (or PCF), in the corresponding PDI of a PDR regardless of whether the PDR is for matching uplink or downlink traffic;

NOTE 1 The Flow Description received from the PCRF (or PCF) is set assuming downlink flows only, see clause 5.4.2 of 3GPP TS 29.212 [8]. The CP function uses the Flow-Direction AVP received from the PCRF (or PCF) to determine the actual direction and thus the source interface of the packet flows described in the Flow Description.

- for traffic from CP-function or SGi-LAN:
 - If the traffic is intended to be forwarded to the UE, the CP function shall provision the Flow Description with IPFilterRule "source" parameters set to correspond to the CP function or SGi-LAN and the IPFilterRule "destination" parameters correspond to the UE;
 - If the traffic is intended to be forwarded to the PDN, the CP function shall provision the Flow Description with IPFilterRule "source" parameters set to correspond to the CP function or SGi-LAN and the IPFilterRule "destination" parameters correspond to the PDN.

The UP function shall apply the SDF filter based on the Source Interface of the PDR as follows (see also clause 8.2.5):

- when the Source Interface is CORE, this indicates that the filter is for downlink data flow, so the UP function shall apply the Flow Description as is;
- when the Source Interface is ACCESS, this indicates that the filter is for uplink data flow, so the UP function shall swap the source and destination address/port in the Flow Description;
- when the Source Interface is CP-function or SGi-LAN, the UP function shall use the Flow Description as is.

5.2.1A.3 Bidirectional SDF Filters

The CP function may provision bidirectional SDF Filters in the UP function (see clause 8.2.5), i.e. SDF Filters that may be associated to both uplink and downlink PDRs of a same PFCP/N4 session, as follows:

- when provisioning a bidirectional SDF Filter the first time for a PFCP/N4 session, the CP function shall provision the SDF filter definition together with a SDF Filter ID uniquely identifying the SDF Filter among all the SDF Filters provisioned for a given PFCP/N4 Session;
- the CP function may then provision a PDR for the same PFCP/N4 session but the opposite direction, by provisioning the SDF Filter ID in the SDF filter ID field of the PDI, without provisioning again the SDF filter definition;
- the UP function shall apply any modification of a bidirectional SDF Filter to all PDRs of the PFCP/N4 session making use of this SDF Filter;
- upon deletion of a PDR making use of a bidirectional SDF Filter, the UP function shall still apply the SDF Filter for any other PDR making use of the SDF Filter.

The requirements specified for provisioning SDF filters in clause 5.2.1A.2A shall also apply when provisioning bidirectional SDF Filters.

5.2.1A.4 Application detection with PFD

The detection information for a given application may be provisioned by the CP function to the UP function via PFD management procedure. See clause 6.2.5.

The PFDE (PFD Enhancement) feature may be optionally supported by the CP function and UP function. When the feature is supported in both the CP function and UP function, the CP function may provision a PFD Contents IE including a property (i.e. either flow description, or URL or Domain Name/Domain Name Protocol) with multiple values.

NOTE 1: It is assumed, when the PFDE feature is not supported, a PFD Contents can only include a property with one value.

When the UP function attempts to detect the traffic pertaining to an application by using the application's PFDs (see clause 7.4.3.1 and 8.2.39), the UP function shall consider:

- the application is detected if the incoming traffic matches at least one PFD Contents;
- one PFD Contents is matched if the incoming traffic matches every property contained in the corresponding PFD Contents IE;
- the incoming traffic matches one property (i.e. flow description, URL and Domain Name/Domain Name Protocol) if it matches at least one value of the property.

NOTE 2: Interpretation of the Custom PFD Content is implementation specific.

5.2.2 Usage Reporting Rule Handling

5.2.2.1 General

The CP function shall provision URR(s) for a PFCP session in a PFCP Session Establishment Request or a PFCP Session Modification Request to request the UP function to:

- measure the network resources usage in terms of traffic data volume, duration (i.e. time) and/or events, according to the provisioned Measurement Method; and
- send a usage report to the CP function, when the measurement reaches a certain threshold, periodically or when detecting a certain event, according to the provisioned Reporting Triggers or when an immediate report is requested within a PFCP Session Modification Request.

NOTE: The UP function sends a usage report without performing network resources usage measurements when being requested to detect and report the start of an SDF or application traffic.

5.2.2.2 Provisioning of Usage Reporting Rule in the UP function

5.2.2.2.1 General

When provisioning a URR, the CP function shall provide the reporting trigger(s) in the Reporting Triggers IE of the URR which shall cause the UP function to generate and send a Usage Report for this URR to the CP function. When adding or removing reporting trigger(s) to or from the URR, the CP function shall provide the new complete list of applicable reporting triggers in the Reporting Triggers IE in the PFCP Session Modification Request message.

For the volume-based measurement method, the CP function may provision:

- the Volume Threshold IE, to request the UP function to generate a usage report when the measured traffic reaches the threshold;
- the Volume Quota IE, to request the UP function to stop forwarding packets (or only allow forwarding of some limited user plane traffic, based on operator policy in the UP function) and, if no Volume Threshold is provisioned, to also generate a usage report, when the measured traffic reaches the quota;
- the Dropped DL Traffic Threshold IE, to request the UP function to generate a usage report when the downlink traffic that is being dropped reaches the threshold; and/or

NOTE 1: For EPC, the Dropped DL Traffic Threshold can be armed in a SGW-U for triggering the PGW Pause of Charging feature (see 3GPP TS 23.401 [14]). For 5GC, the Dropped DL Traffic Threshold can be armed in a UPF for triggering the SMF Pause of Charging feature (see 3GPP TS 23.502 [29]).

- a Measurement Information with the 'Measurement Before QoS Enforcement' flag set to "1", to request the UP function to measure the traffic usage before any enforcement, e.g. bitrate enforcement for QoS, Gate control enforcement (as specified in clause 5.4.3) or packets dropped as requested by the FAR;
- a Measurement Information with the 'Measurement of Number of Packets' flag set to "1", to request the UP function to measure the number of packets be transferred in UL/DL/Total in addition to the measurement in octets, if the UP function supports the MNOP feature.

For the time-based measurement method, the CP function may provision:

- a Time Threshold IE, to request the UP function to generate a usage report when the measured traffic reaches the threshold;
- a Time Quota, to request the UP function to stop forwarding packets (or only allow forwarding of some limited user plane traffic, based on operator policy in the UP function) and, if no Time Threshold is provisioned, to also generate a usage report, when the measured traffic reaches the quota;
- a Measurement Information with the "Immediate Start Time Metering" flag set to "1", to request the UP function to start time metering immediately at receiving the flag; otherwise, the UP function shall start time metering when the first packet is received; and/or
- an Inactivity Detection Time, to request the UP function to suspend the time measurement when no packets are received during the provisioned Inactivity Detection Time. The time measurement shall then be resumed by the UP function when subsequent traffic is received. If an Inactivity Detection Time value of zero is provided, or if no Inactivity Detection Time has been provided by the CP function, the time measurement shall be performed continuously until a new non-zero Inactivity Detection Time is received or the time-based usage measurement is stopped. See Figure 5.2.2.2-1:

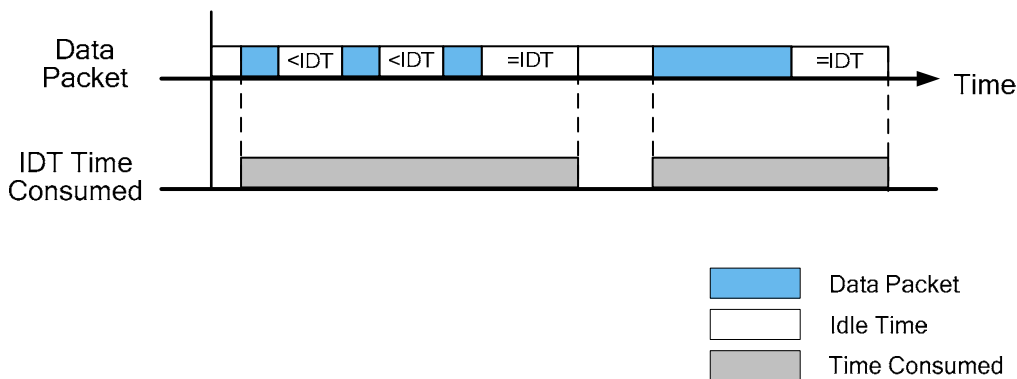

Figure 5.2.2.2-1: IDT based charging

NOTE 2: The Inactivity Detection Time can be set to the Quota Consumption Timer if received. The Inactivity Detection Time is not used to control when the time metering starts.

- For EPC, a Time Quota Mechanism, including a Base Time Interval Type, which is either Continuous Time Period (CTP) or Discrete Time Period (DTP), and a Base Time Interval (BTI), to the UP function. See clause 6.5.7 in 3GPP TS 32.299 [18].
- For CTP (Continuous Time Period), the time measurement starts from the time that traffic has occurred up to the first Base Time Interval (BTI) which contains no traffic. The time measurement shall include the last Base Time Interval, i.e. the one which contained no traffic. The time measurement resumes by the UP function when subsequent traffic is received. See Figure 5.2.2.2-2:

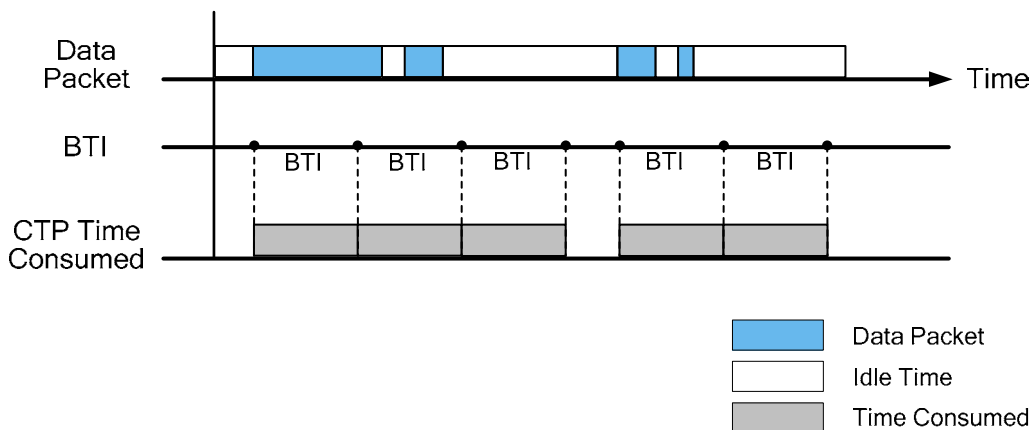

Figure 5.2.2.2-2: CTP based charging

- For DTP (Discrete Time Period), the time measurement starts from the time that traffic has occurred up to the Base Time Interval end. The time measurement shall be resumed by the UP function when subsequent traffic is received. See Figure 5.2.2.2-3:

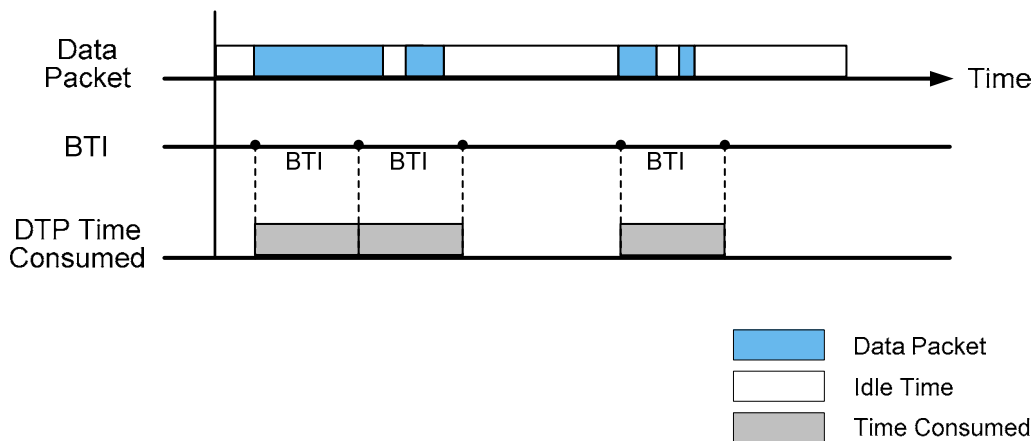

Figure 5.2.2.2-3: DTP based charging

When the time-based measurement method applies, and when the Envelope Reporting is required for EPC, the CP function shall request the UP function to report the usage by setting the reporting trigger to Envelope Closure in addition to other Reporting Trigger(s), in the Reporting Triggers IE. The CP function may indicate the UP function to report for just time, time and volume, time and events, or time and volume and number of events by setting Measurement Method accordingly. The CP function may set the Reduced Application Detection Information flag in the Measurement Information of the URR, when requesting the detection of start and stop of an application solely for the purpose of envelope reporting for EPC.

The CP function may provision a Volume Threshold IE, a Volume Quota IE, or both (and/or respectively a Time/Event Threshold IE, a Time/Event Quota IE, or both). In such a case, the CP function may set the reporting trigger for threshold (VOLTH/TIMTH/EVETH) and/or the reporting trigger for quota (VOLQU/TIMQU/EVEQU) in the Reporting Triggers IE.

When both a Volume (or Time or Event) Threshold IE and a Volume (or Time or Event) Quota IE are provisioned and only the reporting trigger for threshold (VOLTH/TIMTH/EVETH) is set, the UP function shall send a usage report only when reaching the Volume (or Time or Event) Threshold. When subsequently reaching the Volume (or Time or Event) Quota, the UP function shall stop forwarding packets (or only allow forwarding of some limited user plane traffic, based on operator policy in the UP function) without sending a new usage report to the CP function.

If both a Volume (or Time or Event) Threshold IE and a Volume (or Time or Event) Quota IE are provisioned and both of the respective Threshold and Quota reporting triggers are set, the UP function shall send a usage report when reaching the Volume (or Time or Event) Threshold and also later on when subsequently reaching the Volume (or Time or Event) Quota.

NOTE 3: A UP Function complying with Release 14 or Release 15 of the specification only sends one usage report when the threshold is reached, even if both reporting triggers (for the threshold and the quota) are set.

NOTE 4: After sending a usage report on reaching a threshold, the UP function typically gets a new quota before the earlier provisioned quota exhausts. This implies that the UP function typically sends a quota report when reaching the final quota.

NOTE 5: For online charging, the Volume Threshold (or Time Threshold) can be set in a PGW-U or TDF-U to the value of the granted volume (or time) quota minus the volume (or time) quota threshold, such as to get a usage report from the UP function when the volume (or time) based credit falls below the remaining quota thresholds provided by the OCS.

NOTE 6: The Volume Quota or Time Quota can be armed in a PGW-U or TDF-U for online charging to enable the traffic to be forwarded up to an intermediate or final quotas granted by the OCS. The CP function can provision both a Volume (or Time) Threshold and a Volume (or Time) Threshold to request the UP function to:

- send a usage report when the consumed resources reach the volume (or time) usage threshold provided by the OCS, and
- to stop forwarding packets (or only allow forwarding of some limited user plane traffic, based on operator policy in the UP function), without sending a second usage report, when the granted volume (or time) quota is exhausted.

For event based measurement method, the CP function may provision:

- the Event Threshold IE, to request the UP function to generate a usage report when the number of events reaches the event threshold;
- the Event Quota IE, to request the UP function to stop forwarding packets applicable to the event (or only allow forwarding of some limited user plane traffic, based on operator policy in the UP function) and, if no Event threshold is provisioned, to also generate a usage report, when the number of events reaches the event quota;

NOTE 7: An event is preconfigured with one or more event detection logic in the UPF. Each event detection logic is associated with an Application ID. The CP function activates the detection and reporting of an event by provisioning PDR(s) with the PDI set to an Application ID and by provisioning a URR with an event threshold or event quota reporting trigger. The CP function identifies an event reported in a Usage Report by the URR ID.

For all the measurement methods (i.e. volume, time or event), the CP function may also provision:

- a Quota Holding Time, to request the UP function to send a usage report and to also stop forwarding packets (or only allow forwarding of some limited user plane traffic, based on operator policy in the UP function) when no packets have been received for the duration indicated in this parameter;

NOTE 8: A Quota Holding Time can be armed in a PGW-U or TDF-U for online charging to request the UP function to send a Usage Report when the Quota Holding Time provided by the OCS (see 3GPP TS 32.299 [18]) expires. The UP function can be instructed in the same Usage Reporting Rule with the Report Triggers – START to generate a new Usage Report upon receiving any subsequent packets associated with this URR.

- a Quota Validity Time, if the VTIME feature is supported by UP function, to request the UP function to send a usage report after the validity duration is over. After Quota validity timer expiry, if packets are received on UPF, the UPF shall stop forwarding packets or only allow forwarding of limited user plane traffic, based on operator's policy in the UP function;

NOTE 9: After sending the usage report triggered by the QUHTI or QUVTI (i.e. the Quota Holding Time or Quota Validity Time expires), any remaining quota for the URR is discarded in the UP function.

- a Monitoring Time IE and zero or more Additional Monitoring IEs, to request the UP function to measure the network resources usage before and after the monitoring time in separate counts and to re-apply the volume and/or time, and/or event thresholds at the monitoring time. The CP function may additionally provision a Subsequent Volume (or Time or Event) Threshold IE and/or a Subsequent Volume (or Time or Event) Quota IE, for a volume (or time or event) based measurement. When being provisioned with a Monitoring Time, the UP function shall:
 - reset its usage thresholds at the monitoring time to the value provided in the Subsequent Volume (or Time or Event) Threshold IE, if provisioned in the URR, or to the remaining value of the Volume (or Time or Event) threshold used before the monitoring time (i.e. excluding the already accumulated volume or time usage);
 - shall indicate the usage up to the Monitoring time and usage after the Monitoring time in separate usage reports as specified in clause 5.2.2.3.1;
- an Measurement Period, indicating the period to generate periodic usage reports to the CP function.
- an User Plane Inactivity Timer, to request the UP function to send an usage report when no packets have been received for any of the PDRs associated to the URR for the duration indicated in this parameter.

If the UP function indicated support of the Quota Action feature in the UP Function Features IE, when the CP function provisions a Volume Quota or Time Quota or Event Quota in a URR, the CP function may also provision the "FAR ID for Quota Action" IE identifying the substitute FAR the UP function shall apply, for the traffic identified by the PDR to which the URR is associated, when exhausting any of these quotas. This FAR may require the UP function to drop the packets or buffer the packets or redirect the traffic towards a redirect destination as specified in clause 5.4.7.

If the UP function has indicated support of the QUASF feature as specified in clause 8.2.25, and when the CP function provisions a Volume Quota, Time Quota, or Event Quota in a URR, the CP function may also provision the Exempted Application ID for Quota Action IE or the Exempted SDF Filter for Quota Action IE, to instruct the UP function, that traffic matching the associated PDR(s) and matching the Application ID(s) or SDF Filter(s) shall be handled based on the FAR associated with the PDR as normal, even when the quota has been exhausted.

NOTE 10: The traffic forwarded after the quota has been exhausted need not to be measured.

NOTE 11: A PDR can be associated with multiple URRs. If one of these URRs requires the UP function to drop the user data packets, e.g. when the Quota has been exhausted, the other URRs associated to the PDR need also to stop their measurements, except for URRs including the Measurement Information with the 'Measurement Before QoS Enforcement' flag set to "1".

The CP function may request at any time the UP function to activate or deactivate a network resources usage measurement, using the Inactive Measurement flag of the Measurement Information IE of the URR.

NOTE 12: This can be used in a PGW-U for the PGW Pause of Charging procedure (see 3GPP TS 23.401 [14]).

When the NSPOC feature as specified in clause 5.30 is supported by the CP and UP function, the CP function may provision:

- an Measurement Information with the 'Send Start Pause of Charging' Flag set to "1", to request the UP function (SGW-U or I/V-UPF) to send a Start Pause of Charging indication to the upstream GTP-U entity(s) when the Dropped DL Traffic Threshold is reached.
- an Measurement Information with the 'Applicable for Start of Pause of Charging' Flag set to "1", to indicate the UP function to stop the usage measurement for the URR when receiving Start Pause of Charging indication from the peer downstream GTP-U entity.

When the NSPOC feature is supported by the CP and UP functions, the CP function may use the "SUMPC" and "RUMUC" flags in the PFCPSMReq-Flags IE, and the "SUMPC" flag in the PFCPSEReq-Flags IE, to request the UP function to stop or resume the usage measurement for all URRs with the ASPOC flag set to "1". The CP function may set the "CIAM" flag in the Measurement Information IE in a Create URR or a Update URR IE to request the UP function to stop or resume the usage measurement according to the value of the Inactive Measurement flag for a specific URR with the "ASPOC" flag set to "1" if necessary. See also clause 5.30.

The CP function may request the UP function to measure network resources usage and generate the corresponding Usage Reports only for a number of times, by provisioning the "Number of Reports" IE in a URR, if the UP function supports the NORP feature (see clause 8.2.25-1). If so, the URR shall become inactive in the UP function after the requested "Number of Reports" have been reported.

The CP function may resume the measurement for an inactive URR by setting the Inactive Measurement flag of the Measurement Information IE of the URR to "0" in the Update URR IE in a PFCP Session Modification Request message, with or without the Number of Report IE if the URR was deactivated by setting the Inactive Measurement flag of the Measurement Information IE of the URR to from "0" to "1".

For any other cases, i.e. the URR becoming inactive, which is not caused by changing the Inactive Measurement flag from "0" to "1", the CP may resume the URR:

- by provisioning a Number of Report IE with a (new) non-zero value (to receive the corresponding number of usage reports) or with a null length (to request UP function to perform continuous measurement) when the requested Number of Reports has been reached;
- by setting the CIAM flag to "1" and the INAM flag to "0" if the URR was provisioned with ASPOC bit set to "1" in the Update URR (for the URR) when the CP function has requested to stop usage measurement for pause of charging by setting the SUMPC flag to "1"; or
- by associating (new) PDR(s) with the URR when the last PDR associated with the URR has been removed.

If the CP function wishes the UP function to perform continuous measurement for a URR which was provisioned with a Number of Reports (i.e. to no longer limit the number of reports to be generated), the CP function shall provide the Number of Reports IE in the Update URR with a null length to delete the limit on the number of reports to be generated.

NOTE 13: The Number of Reports can be provisioned in an URR regardless which Measurement Method is used.

5.2.2.2.2 Credit pooling (for EPC)

For EPC, when the Credit Pool feature is supported and the CP function (e.g. PGW-C) is instructed to handle a Credit Pool for a given Gy Session, the CP function shall create a URR for the Credit Pool, and in this URR, the CP function:

- shall include one Aggregated URR ID IE per URR sharing the credit pool, including the URR ID of the URR sharing the credit pool and the associated Multiplier to measure the abstract service units the corresponding traffic consumes from the credit pool;
- shall set the Time or Volume Threshold or Quota IE to the value calculated as specified in IETF RFC 4006 [16] according to the Measurement Method.

NOTE 1: The value can be calculated using the following formula:

$$S = Q1*M1 + Q2*M2 + \dots + Qn*Mn,$$

where the S is the quota for the credit pool, Qn is the quota and Mn is the multiplier for each Rating Group (RG) which are provided via the Multiple Services Credit Control from the OCS.

An URRn is defined for each of RG.

NOTE 2: When the Measurement Method is set to the combined volume/duration, the Time and Volume Threshold or Quota are calculated independently.

- may set the Reporting Trigger to reporting upon reaching a volume or time threshold or quota;
- may set the Measurement Method to the data volume, duration (i.e. time), combined volume/duration according to the Measurement Method set in the URRs in the Credit Pool.

NOTE 3: The UP function is instructed to handle a Credit Pool when a G-S-U-Pool-Reference AVP is included within a Multiple Services Credit Control from the OCS. A Credit Pool is identified by the G-S-U-Pool-Identifier AVP. See clause 6.3.11, 6.4.3 and 6.4.4 of 3GPP TS 32.299 [18].

In addition, the CP function shall also include the Linked URR IE, set to the Credit Pool URR ID, in all the URRs which are sharing the credit pool (i.e. which are associated with RGs sharing the Credit Pool).

5.2.2.3 Reporting of Usage Report to the CP function

5.2.2.3.1 General

When detecting that a provisioned reporting trigger occurs, the UP function shall generate a Usage Report for the related URR and send it to the CP function by initiating the PFCP Session Report procedure.

When providing usage report information for a URR in a message, the UP function shall include the UR-SEQN (Usage Report Sequence Number) identifying the order in which a Usage Report is generated for the given URR. The UR-SEQN (Usage Report Sequence Number) shall be set to "0" for the first Usage Report and incremented for every subsequent Usage Report generated by the UP function for the URR. The UP function shall also indicate the trigger that causes the usage report to be generated in the Usage Report Trigger IE.

Upon generating a usage report for an URR towards the CP function, the UP function shall:

- reset its ongoing measurement counts for the related URR (i.e. the UP function shall report in a usage report the network resources usage measurement since the last usage report for that URR);
- re-apply all the thresholds (Volume/Time/Event Threshold) provisioned for the related URR, if the usage report was triggered due to one of the thresholds being reached, i.e. upon the reporting triggers VOLTH/TIMTH/EVETH; otherwise, if the usage report was triggered for other reporting triggers, adjust the thresholds (Volume/Time/Event Threshold) respectively by subtracting the (volume/time/event) reported usage in the usage report to determine when to generate the next report for reporting triggers VOLTH/TIMTH/EVETH;
- when the quota (Volume/Time/Event Quota) is provisioned in the URR:
 - adjust the quota for volume/time/event respectively by subtracting the (volume/time/event) reported usage in the usage report and use it when applying quota related handling, e.g. to drop or buffer the packets, or apply FAR ID for Quota Action (if provisioned) when the quota becomes "0" and to generate the relevant usage report if the corresponding reporting trigger(s)(VOLQU/TIMQU/EVEQU) is set;
 - consider no quota left for the URR when the usage report was triggered for the reporting triggers QUHTI and QUVTI; and

- continue to apply the remaining provisioned parameters in the URR and perform the related network resources usage measurement(s), until getting any further instruction from the CP function.

When receiving a new threshold and/or quota from the CP function for a measurement that is already ongoing in the UP function, the UP function shall consider its ongoing measurements counts for the related URR against the new threshold and/or quota to determine when to send its next usage report to the CP function or to apply quota handling, i.e. the UP function shall discard any remaining quota.

At receiving a quota with value set to zero, the UP function shall:

- handle packets based on the FAR associated with the PDR, if the packets match the Application ID(s) or the SDF Filter(s) provisioned in the IE Exempted Application ID for Quota Action or the Exempted SDF Filter for Quota Action;
- apply the FAR identified in the FAR ID for Quota Action IE if the CP function has provisioned it, otherwise the UP function shall stop forwarding packets (or only allow forwarding of some limited user plane traffic, based on operator policy in the UP function); and
- report in a usage report the network resources usage measurement since the last usage report for that URR, if applicable.

When the UP function receives a non-zero quota for the same URR in one subsequent PFCP Session Modification Request message, the UP function shall apply the (normal) FAR associated with the PDR (detecting the application traffic) for the buffered traffic if the FAR ID for Quota Action was set to buffer the application traffic at zero quota (either be provisioned with zero quota earlier or the quota has been exhausted).

NOTE 1: The UP function determines when to send its next usage report to the CP function by deducting from the newly provisioned threshold or quota the traffic it has forwarded since its last usage report. As an example, if the UP function has forwarded 10 Mbytes of traffic since its last usage report to the CP function and the CP function provisions a new volume threshold or quota of 100 Mbytes, the UP function sends its next usage report upon forwarding an additional 90 Mbytes traffic.

NOTE 2: When receiving a new threshold or quota from the CP function for a measurement that is already ongoing in the UP function and if the UP function has already generated the usage report but had not sent it, the UP function can send the usage report before performing the update of the URR.

NOTE 3: A URR with the quota set to 0 can be provisioned when a service data flow is not allowed to start before quota is allocated to the service. See clause 5.4.11.

When reporting the network resources usage before and after a Monitoring Time, the UP function shall send two Usage Reports in the PFCP message (e.g. PFCP Session Report Request) for the same URR ID. Each Usage Report shall then include the Usage Information IE indicating whether the reported network resource usage was consumed before or after the Monitoring Time. Omission of this IE in a Usage Report indicates that no monitoring time has occurred. The UP function shall send Usage Reports soon after the occurrence of the Monitoring Time. For a URR, when multiple (Additional) Monitoring Time IEs are provisioned, or a new Monitoring Time is provisioned after the previous Monitoring Time has passed, the UP function may not be able to send the usage report with the Usage Information set to "AFT" for the previous Monitoring Time if there is no Reporting Trigger armed before the next Monitoring Time is reached; in such case, the UP function may send multiple usage reports with the Usage Information set to "BEF", together with one usage report with the Usage Information set to "AFT".

NOTE 4: The UP function needs to take care to smooth the signalling load towards the CP function if Usage Reports need to be generated for a large number of PFCP sessions after the occurrence of the Monitoring Time.

For the volume-based measurement method, the UP function shall report the traffic usage after any QoS enforcement. Additionally, if the CP function requested to measure the traffic usage before QoS enforcement, the UP function shall also report corresponding measurements, when measurements need to be reported for the traffic usage after QoS enforcement, by sending two Usage Reports in the PFCP message (e.g. PFCP Session Report Request) for the same URR ID. Each Usage Report shall then include the Usage Information IE indicating whether the reported network resource usage corresponds to the traffic before or after QoS enforcement. Thresholds provisioned in a URR shall apply to the traffic usage after any QoS enforcement.

For the volume-based measurement method, the UP function shall include all the counters (Total, Uplink and Downlink) of the URR in the Volume Measurement IE in the Usage Report IE; the UP function shall also include the

number of packets counted for Total, Uplink, Downlink in the Volume Measurement IE if requested by the CP function and if the UP function supports the MNOP feature.

An usage report triggered only due to the Dropped DL Traffic Threshold (DROTH) or Start of Traffic (START), or MAC Address Reporting (MACAR), or IP Multicast Join/Leave (IPMJJL) shall not contain any measurement information, i.e. either the Volume/Duration Measurement set to zero or Volume/Duration Measurement IE is not present.

When being instructed to remove a URR or the last PDR associated to a URR, the UP function shall stop its ongoing measurements for the URR and include a Usage Report in the PFCP Session Modification Response or in an additional PFCP Session Report Request if there are non-null measurements to report for the URR. When being instructed to remove the last PDR associated to a URR, the UP function shall keep the URR and reset any measurement for the URR.

NOTE 5: A URR provisioned in a PFCP session can be provisioned/kept in the UP function without being associated with any PDR and the URR can be associated with a PDR in a later stage. The UP function will not remember any remaining quota and will consider the quota (if provisioned) as it was provisioned.

When being instructed to deactivate a network resources usage measurement via the Inactive Measurement flag of the Measurement Information IE of the URR, the UP function shall stop measuring the network resources usage (against the volume/time/event threshold/quota) and store the current measurement counts which will be resumed when the URR is activated again. The UP function shall not generate a usage report upon the deactivation of the URR and it shall send a usage report during the period when the URR is deactivated for the following scenarios:

- if the Quota Holding Time is expired and if the reporting trigger QUHTI is set;
- if the Quota Validity Time is expired and if the reporting trigger QUVTI is set;

NOTE 6: The Quota Holding Time can have been started before the URR is deactivated or starts from the moment when the URR is deactivated since no quota will be consumed.

- if it is the time for a periodic reporting and if the reporting trigger PERIO is set;
- if it is required to send a usage report for this URR when a usage report is reported for a linked URR and if the reporting trigger LIUSA is set;
- if it is required to send an immediate report upon a query for the URR, or the URR is removed, dissociated from the last PDR;

NOTE 7: Multiple usage reports can be required to be reported to the CP function when deleting a PDR that is the last one to be associated to multiple URRs.

- if the User Plane Inactivity Timer is expired and if the reporting trigger UPINT is set.

NOTE 8: The User Plane Inactivity Timer can have been started before the URR is deactivated.

The CP function may request the UP function, in a PFCP Session Modification Request, to report its ongoing network resources measurement for one or multiple URRs of the PFCP session. In this case, the UP function shall:

- generate usage report(s) (based on the existing definition of any URR(s) included in the PFCP Session Modification Request message before any update) for the URR(s) being queried and for any associated linked usage reports (see clause 5.2.2.4) for which there are non-null measurements to report;
- include them in the PFCP Session Modification Response or in additional PFCP Session Report Request messages; and
- proceed as specified above upon generating a usage report for a URR towards the CP function, with the following additions:
 - if the PFCP Session Modification Request includes the Update URR IE (for the URR being queried) with a Volume or Time Threshold, the UP function shall re-apply the threshold received in the request;
 - otherwise, if a threshold and/or a quota had been set for the URR that is queried, since the usage report is not triggered due to the threshold being reached, the UP function shall adjust the threshold and/or quota by subtracting the time/volume reported in the usage report to determine when to generate the next report.

NOTE 9: Upon reaching a threshold that was adjusted due to a URR query as specified above, the UP function re-applies then the threshold that was provisioned in the URR (i.e. not the value of the adjusted threshold).

NOTE 10: The CP function can query a URR without including a Volume or Time Threshold in the PFCP Session Modification Request e.g. when it needs to close a traffic volume/service container (see clause 5.2.3.10.3 of 3GPP TS 32.251 [17]).

NOTE 11: The CP function can query a URR including a Volume or Time Threshold in the PFCP Session Modification Request e.g. when it needs to close a CDR (see clause 5.2.3.10.3 of 3GPP TS 32.251 [17]). In such a case, the CP function can include the same threshold for the URR being queried in the Update URR IE in the PFCP Session Modification Request message to trigger the UP function to re-apply the threshold.

NOTE 12: It is up to the CP function to request the UP function to generate an immediate report (or not) as specified above when the CP function modifies a URR or any other rules of the PFCP session. As an exception, the UP function always generates an immediate report when being instructed to remove a URR.

When additional usage reports need to be sent in additional PFCP Session Report Request messages, i.e. when not all usage reports can be included in the PFCP Session Modification Response message, the UP function shall indicate, in the PFCP Session Modification Response message, either:

- that more usage reports will follow, by setting the AURI flag to 1 in the Additional Usage Reports Information IE (see clause 8.2.91); or
- the total number of additional usage reports that will be sent in all the additional PFCP Session Report Request messages (i.e. that will be sent after the PFCP Session Modification/Deletion Response message), by setting this value in the Additional Usage Reports Information IE (see clause 8.2.91).

In the former case (i.e. if the UP function indicates in the PFCP Session Modification Response message that more usage reports will follow), the UP function shall indicate, in one of the additional PFCP Session Report Request message, the total number of additional usage reports to be sent after the PFCP Session Modification Response message, by setting this value in the Additional Usage Reports Information IE. In both cases, the UP function may set the AURI flag to 1 in every additional PFCP Session Report Request message but the last one, to indicate that more usage reports will follow.

Besides, if the PFCP Session Modification Request included the Query URR Reference IE, usage reports sent in response to the query in the PFCP Session Modification Response and/or additional PFCP Session Report Request messages shall include the Query URR Reference IE set to the same value as received in the PFCP Session Modification Request.

When the reporting trigger "Envelope Closure" is set in the corresponding Usage Reporting Rule, the UP function shall generate a usage report with the measurement of the time and/or volume as instructed in the Measurement Method:

- when the Inactivity Detection Time (if included) is expired;
- when detecting no usage for the first Base Time Interval if the Base Time Interval Type in the Time Quota Mechanism is set to CTP; or
- at the end of each of base time interval if the Base Time Interval Type in the Time Quota Mechanism is set to DTP.

NOTE 13: Events (e.g. application detection information) are reported individually and independently from the usage report sent for envelope closure.

When the UP function supports the NORP feature and if a URR is provisioned with a "Number of Reports" IE, the number of Usage Reports generated according to the Reporting Trigger(s) defined in the URR shall not be more than the value of "Number of Reports". If the UP function is requested to resume the measurement for an inactive URR, the UP function shall generate a maximum number of Usage Reports equal to the new value of the Number of Reports IE received in the Update URR if any, or equal to the value of the Number of Reports IE previously provisioned in the URR if any; if no Number of Reports IE was provisioned before, there is no limit on the number of reports to send. If the CP function provisions a "Number of Reports" IE together with a Monitoring Time and/or a Measurement Information where the "Measurement Before QoS Enforcement" flag is set to "1" in a URR, the UP function shall generate usage reports as required by the Monitoring Time and/or the Measurement Information where the "Measurement Before QoS Enforcement" flag is set to "1" in a URR, which may lead UP function to generate more usage reports than the value of the "Number of Reports" IE.

NOTE 14: If the CP function expects to receive the exact number of usage reports as requested in the Number of Reports, it can abstain from provisioning a Number of Report IE together with a Monitoring Time and/or a Measurement Information where the "Measurement Before QoS Enforcement" flag is set to "1" in a URR.

At the PFCP session termination, the UP function shall indicate to the CP function, in the PFCP Session Deletion Response, the resources that have been consumed for each URR that was provisioned in the PFCP session since the last usage report (respective to each URR). A CP function may indicate support of Additional Usage Reports in PFCP Session Deletion Request by setting the ARDR flag in the CP Function Features IE (see clause 8.2.58). When additional PFCP Session Report Request messages need to be sent:

- the UP function shall:
 - set the cause to "More Usage Report to send" in the PFCP Session Deletion Response;
 - include the Additional Usage Reports Information IE in PFCP Session Deletion Response with either the AURI flag set to "1" or indicating the total number of additional usage reports that will be sent in all the additional PFCP Session Report Request messages; as described above:
 - in the former case, the UP function shall indicate in one additional PFCP Session Report Request message the total number of additional usage reports that will be sent after the PFCP Session Deletion Response;
 - in both cases, the UP function may set the AURI flag to 1 in every additional PFCP Session Report Request message but the last one, to indicate that more usage reports will follow.
 - set the PSDBU flag to 1 in the last PFCP Session Report Request message.
- when the CP function receives a PFCP Session Deletion Response with the Cause set to "More Usage Report to send", the CP function shall not delete the PFCP session until it receives a PFCP Session Report Request message with the PSDBU flag set to "1" (that indicates this is the last report), or it has received the number of usage reports indicated in the Additional Usage Reports Information IE in PFCP Session Deletion Response, or until an implementation specific timer expires otherwise.

At the PFCP session termination, the UP function shall set the PURU flag to "1" in the PFCP Session Deletion Response if it has pending PFCP Session Report Request messages which have not been acknowledged yet. This indicates that the CP function should wait for some time before deleting the PFCP Session.

Upon receiving the Usage Report from the UP function, the CP function may initiate PFCP Session Modification procedure as result of the communication with the PCRF or OCS, as described in clause 5.3 of 3GPP TS 23.214 [2], e.g. by:

- modifying the URR (e.g. changing the Volume/Time threshold, Volume/Time quota, disabling the usage monitoring);
- creating a new FAR (e.g. for redirect) and/or modifying the existing FAR; or
- modifying the QER (s) in the PFCP session.

5.2.2.3.2 Credit pooling

When a URR is received with at least one Aggregated URRs IE included, the UP function:

- shall calculate the traffic usage of the URR by applying the Multiplier(s) and aggregating the traffic usage from all URRs indicated in the Aggregated URRs IE(s), as specified in IETF RFC 4006 [16];

NOTE 1: The usage of this URR is calculated using the following formula:

$$C1*M1 + C2*M2 + \dots + Cn*Mn = U,$$

where U is the usage counted by this URR, Cn is the usage counted by each aggregated URR (i.e. URR for each RG sharing the credit pool), and Mn is the multiplier for each aggregated URR.

- shall generate a report when the counted usage exceeds the threshold;

- shall generate a report if the threshold is not provided, and stop packets forwarding (or only allow forwarding of some limited user plane traffic, based on operator policy in the UP function) for all Aggregated URRs when the counted usage exceeds the quota.

NOTE 2: The handling of the aggregated URR(s), e.g. generating a Usage Report upon the Reporting Trigger(s) is not impacted by handling of this URR for the Credit Pool.

5.2.2.3.3 Traffic Usage Reporting with Redundant Transmission

The following requirements shall apply when using Redundant Transmission on N3/N9 interfaces or Redundant Transmission at transport layer:

- the UPF shall not count redundant packets in Usage Reports (e.g. Volume Measurement), i.e. it shall count the traffic only once in Usage Reports;
- the SMF shall provide the quota for the non-redundant transmission (i.e. not counting redundant traffic).

5.2.2.4 Reporting of Linked Usage Reports to the CP function

The CP function may instruct the UP function to generate a Usage Report for a URR "X" when a Usage Report is generated for another URR "Y", by:

- provisioning the URR "X" with the Reporting Triggers IE set to Linked Usage Reporting; and
- including in the URR "X" the Linked URR ID IE set to the URR ID of the URR "Y".

NOTE 1: This can be used by the CP function e.g. to request the UP function to report a Usage Report for an SDF (i.e. URR "X") when the UP function reports a Usage Report for a bearer (i.e. URR "Y").

NOTE 2: This can be used by the CP function e.g. to request the UP function to report a Usage Report for a RG (i.e. URR "X") when the UP function reports a Usage Report for a credit pool to which this RG pertain (i.e. URR "Y").

When a usage report is to be generated for the URR "Y", regardless of the condition which triggers the report, the UP function shall also send a Usage Report for the URR "X" with the accumulated usage information, and the Usage Report Trigger IE set to Linked Usage Reporting.

NOTE 3: This also applies e.g. when an immediate usage report is requested for the URR "Y" within a PFCP session Modification Request.

The URR "Y" may be linked to more URRs than just URR "X".

A RG level URR may be linked to IP-CAN bearer level URR as well as IP-CAN Session level URR to enable the CP function to generate a CDR on the different level. In such case, a URR "X" may link to more URRs than just URR "Y".

5.2.2.5 End Marker Reception Reporting

The CP function may request the UP function to report the End Marker reception during UE Triggered Service Request with, or without I-SMF insertion/change/removal procedures (see clauses 4.2.3.2 and 4.23.4.3 in 3GPP TS 23.502 [29]):

- If a new I-UPF is selected by the SMF to replace the old I-UPF, the SMF may provide two PDRs to the new I-UPF, e.g. PDR-1 for DL data from the PSA UPF, where the Apply Action IE in FAR-1 associated with PDR-1 is set to BUFF; and e.g. PDR-2 for receiving the buffered DL data from the old I-UPF, where the Apply Action IE in FAR-2 associated with PDR-2 is set to FORW. In this case, the SMF shall indicate to the new I-UPF to report the reception of the End Marker packet from the old I-UPF, by providing a URR related to PDR-2 with REEMR flag set to 1 in the Reporting Triggers IE, which is included in a Create URR IE within PFCP Session Establishment Request.
- If the SMF removes the old I-UPF but does not replace it with a new I-UPF, then the SMF may provide two PDRs to the PSA UPF, e.g. PDR-3 for receiving DL data across N6, where the Apply Action IE in FAR-3 associated with PDR-3 is set to BUFF; and e.g. PDR-4 for receiving the buffered DL data from the old I-UPF, where the Apply Action IE in FAR-4 associated with PDR-4 is set to FORW. The SMF shall indicate to the PSA UPF to report the reception of the End Marker packet from the old I-UPF, by providing a URR related to PDR-4

with REEMR flag set to 1 in the Reporting Triggers IE which is included in a Create URR IE within PFCP Session Modification Request.

Once the End Marker packet is received from the old I-UPF, the UPF (either new I-UPF or the PSA UPF) shall inform the SMF about this by sending the PFCP Session Report Request with the Usage Report IE containing the usage measurement as instructed in the URR, where EMRRE flag shall be set to 1 in a Usage Report Trigger IE and shall discard the End Marker packet(s). The SMF shall instruct the UPF to start sending the buffered DL data identified by PDR-1 or PDR-3 by sending a PFCP Session Modification Request message, where the Apply Action IE in the FAR-1/FAR-3 related to PDR-1/PDR-3 shall be changed from BUFF to FORW.

5.2.3 Forwarding Action Rule Handling

5.2.3.1 General

The CP function shall provision one and only one FAR for each PDR provisioned in a PFCP session. The FAR provides instructions to the UP function on how to process the packets matching the PDR.

By setting the appropriate flag(s) in the Apply Action IE in the FAR (see clause 8.2.26), the CP function may request the UP function to:

- drop the packets, by setting the DROP flag;
- forward the packets, by setting the FORW flag and by provisioning the Forwarding Parameters providing instructions on how to forward the packets;
- forward the MBS session data:
 - using multicast transport, by setting the FSSM flag together with the MBS Multicast Parameters to forward the packets to a Low Layer source specific multicast address; and/or
 - using unicast transport by setting the MBSU flag together with one or more MBS Unicast Parameters to forward and replicate the packets towards one or more GTP-U DL tunnels terminated at PSA UPF(s) and/or NG-RAN(s).
- buffer downlink or uplink packets by setting the BUFF flag and by optionally provisioning buffering parameters providing instructions on how to buffer the packets;
- notify the CP function about the arrival of a first DL packet being buffered, by setting the NOCP flag;
- notify the CP function about the first discarded DL packet for each service data flow identified by a PDR, when the CP function requests the UP function to buffer DL packets but the DL Buffering Duration or the DL Buffering Suggested Packet Count is exceeded, or when the CP function requests the UP function to drop DL packets and a packet is discarded directly, by setting the DDPN flag, if the UP function supports the DDDS feature;
- notify the CP function about first buffered DL packet for each service data flow identified by a PDR, by setting the BDPN flag, if the UP function supports the DDDS feature;
- duplicate the packets, by setting the DUPL flag and by provisioning the Duplicating Parameters providing instructions on how to forward the duplicated packets;
- accept or deny UE requests to join an IP multicast group (see clause 5.25), by setting the IPMA or IPMD flag;
- duplicate the packets for redundant transmission (see clause 5.24.2), by setting the DFRT flag and by provisioning the Redundant Transmission Forwarding Parameters IE providing instructions on how to forward the duplicated packets for redundant transmission;
- eliminate duplicate packets used for redundant transmission (see clause 5.24.2), by setting the EDRT flag and by provisioning the Redundant Transmission Detection Parameters IE providing instructions on how to detect the duplicated packets for redundant transmission.

The CP function may request the UP function to duplicate packets that are to be dropped, forwarded or buffered.

The CP function may request the UP function to forward the packets and duplicate the packets for redundant transmission.

The CP function may request the UP function to forward the packets and eliminate duplicate packets used for redundant transmission.

The CP function may provision one or more FAR(s) per PFCP session. Different FARs of a same PFCP session may be provisioned with a different Apply Action flags, e.g. to enable the forwarding of downlink data packets for some PDRs while requesting to buffer downlink data packets for other PDRs.

NOTE 1: This is necessary to establish or release a partial set of radio access bearers in UTRAN.

When instructed to buffer and notify the CP function about the arrival of a DL packet, the UP function shall notify the CP function, when it receives a first downlink packet for a given FAR (in EPC), or when it receives a first downlink packet for each QoS flow for a given FAR (in 5GC), by sending a PFCP Session Report Request including a Downlink Data Report IE identifying the PDR(s) for which downlink packets have been received.

NOTE 2: Receipt of downlink packets on PDRs associated to different FARs can result in sending multiple PFCP Session Report Request messages for the same PFCP session.

NOTE 3: Receipt of downlink packets pertaining to different QoS flows associated to the same FAR can result in sending multiple PFCP Session Report Request messages for the same PFCP session. The CP function identifies the QFI based on the PDR ID (when different PDRs are used for different QoS flows) or based on the Downlink Data Service Information IE.

NOTE 4: The end marker packet is not considered as DL data packet so that it does not trigger the UP function to notify the CP function about the arrival of a DL packet. The UP function can discard the received end marker packet(s) silently, when it is not possible to be forwarded.

If the UP function indicated support of Header Enrichment of UL traffic (see clause 8.2.25), the CP function may provide the UP function with header enrichment information for uplink traffic, by including one or more Header Enrichment IE(s) in the FAR. In this case, the UP function should use this information to enrich the header of the uplink traffic (e.g. HTTP header enrichment).

NOTE 5: It is not defined how to support SGi PtP tunnelling mechanisms other than based on UDP/IP encapsulation (such as PMIPv6/GRE, L2TP, GTP-C/U, see clause 4.3.17.8.3.3.3 of 3GPP TS 23.401 [14]) for Non-IP PDN connections.

If the UP function indicated the support of Handling of Payload Headers feature (USHPH), the CP function may provide the UP function with the header handling information by including one or more Header Handling Control Rule IE(s) in the FAR (see also clause 5.41).

NOTE 6: Header Handling Control Rule IE(s) cannot be provided together with Header Enrichment IE(s). Handling of Payload Headers is expected to be used instead of Header Enrichment of UL traffic (see clause 8.2.25), if it is supported by the CP function and the UP function, as it allows more actions than just insertion, supports different protocols and allows the usage of actions in both directions.

If the UP function indicated support of PDI optimisation (see clause 8.2.25), the CP function may include in the forwarding parameters of the FAR the Linked Traffic Endpoint ID, if it is available, identifying the traffic Endpoint allocated for this PFCP session to receive the traffic in the reverse direction.

NOTE 7: This information can enable an SGW-U or PGW-U to correlate the UL and DL traffic (i.e. PDRs) sent over a same bearer.

Assuming for instance a PFCP session provisioned in a PGW-U with:

- an UL PDR 1 (for an S5/S8 bearer 1) with Source Interface "Access" associated to an UL Traffic Endpoint ID "1" (comprising the IP address, a local TEID and optionally a network instance),
- a DL PDR 1 with Source Interface "Core", UE IP address and SDF 1,

the CP function sets the Linked Traffic Endpoint in the DL FAR 1 (associated to DL PDR 1) to the UL Traffic Endpoint "1", which allows the PGW-U to correlate the uplink and downlink PDRs for the same bearer (i.e. that UL PDR 1 associated to UL Traffic Endpoint "1", and DL PDR1 associated to DL FAR 1 with Linked Traffic Endpoint set to UL Traffic Endpoint "1", use the same S5/S8 bearer).

NOTE 8: The Linked Traffic Endpoint can possibly refer to a Traffic Endpoint in the reverse direction requested to be created in the same PFCP request.

5.2.4 Buffering Action Rule Handling

5.2.4.1 General

A BAR provides instructions to control the buffering behaviour of the UP function for all the FARs of the PFCP session set with an Apply Action parameter requesting the packets to be buffered and associated to this BAR.

The CP function may create a BAR for a PFCP session and associate it to the FAR(s) of the PFCP session in a PFCP Session Establishment Request or a PFCP Session Modification Request to request the UP function to apply a specific buffering behaviour for packets requested to be buffered and associated to this BAR.

The CP function may modify the following buffering instructions provided in a BAR as follows:

- the Downlink Data Notification Delay in a PFCP Session Modification Request (for EPC); or
- the Downlink Data Notification Delay (for EPC), DL Buffering Duration with optional Extended DL Buffering Notification Policy, and/or DL Buffering Suggested Packet Count in a PFCP Session Report Response message or PFCP Session Modification Request.

NOTE: The CP function needs to provision a (possibly empty) BAR and associate it to the FARs of the PFCP session when establishing or modifying the PFCP session to be able to modify the BAR in a PFCP Session Report Response.

If the UP Function has indicated support of the feature UL/DL Buffering Control (UDBC), the CP function may provide the Suggested Buffering Packet Count IE in a BAR which is created during a PFCP Session Establishment procedure or a PFCP Session Modification procedure, and the CP function may modify it in a subsequent PFCP Session Modification Request, and/or a PFCP Session Report Response message. The same BAR may be associated with all the FARs in a PFCP session to indicate that all Service Data Flows in the PFCP Session share the same buffer in the UP function for the PFCP Session.

If the SGW-U has indicated the support of the MT-EDT feature, the CP function may provide the MT-EDT (Mobile Terminated Early Data Transmission) Control Information IE in a BAR when it is created and modified, to request the SGW-U to report the sum of DL Data Packets Size in byte when sending Downlink Data Report.

If the UPF has indicated the support of the MT-SDT feature, based on local policy and/or an indication from the AMF, e.g., the RAT type of REDCAP or the CN based MT handling indication (i.e. the cnBasedMt flag as specified in 3GPP TS 29.502 [50]), the SMF may provide the MD-SDT (Mobile Terminated Small Data Transmission) Control Information IE in a BAR when it is created and modified, to request the UPF to report the sum of DL Data Packets Size in byte per QoS flow when sending Downlink Data Report.

If the UP function supports Extended DL Buffering Notification Control (EDBNC) the UP function shall set the EDBNC feature flag in the UP function Features IE (see clause 8.2.25). If so, the CP may provide the Extended DL Buffering Notification Policy IE in addition to the Buffering Duration IE. If the EDBN bit is set to set to "1", the UP function shall send DL packet notifications to report the arrival of the first buffered DL packet for each QoS flow for a given FAR to the CP function for the duration indicated by the DL Buffering Duration.

In this release of the specification, at most one BAR may be created per PFCP session.

5.2.4.2 Provisioning of Buffering Action Rule in the UP function

The CP function may provision the following buffering parameters in a BAR:

- For EPC, the Downlink Data Notification Delay IE, to request the UP function to delay the sending of a PFCP Session Report Request, between receiving a downlink data packet and notifying the CP function about it, if the UP function indicated support of the Downlink Data Notification Delay parameter (see clause 8.2.28);
- the DL Buffering Duration IE, to request the UP function to buffer the downlink data packet for an extended duration without sending any further notification to the CP function about the arrival of DL data packets, if the UP function indicated support of the DL Buffering Duration parameter in PFCP Session Report Response feature

and/or support of the DL Buffering Duration parameter in PFCP Session Modification Request feature (see DLBD and DBDM features in clause 8.2.25);

- the DL Buffering Suggested Packet Count in PFCP Session Report Response, to request the UP function to buffer the suggested number of downlink data packets, when extended buffering of downlink data packet is required in the UP function. The DL Buffering Suggested Packet Count may also be included in PFCP Session Modification Request if the UP function indicated support of the DL Buffering Suggested Packet Count parameter in PFCP Session Modification Request feature (see DBDM feature in clause 8.2.25);
- the Suggested Buffering Packet Count IE if the UP Function has indicated support of the feature UDBC, to indicate the number of packets (including both uplink or downlink) that the CP function suggests to be buffered in the UP function, until it receives new instructions from the CP function, e.g. when the new Quota is granted.
- Extended DL Buffering Notification Policy IE if the UP Function has indicated support of the feature EDBNC, to indicate with the EDBN bit set to "1" that the UP function when buffering downlink data packets for the duration indicated in DL Buffering Duration IE shall send notifications to the CP function about the arrival of the first buffered DL packet for each QoS flow for a given FAR.

The UP function shall stop applying the DL Buffering Duration and DL Buffering Suggested Packet Count parameters and shall delete these parameters from the BAR (without explicit request from the CP function) when extended buffering of downlink data packets ends in the UP function.

NOTE: The CP function will provide the DL Buffering Duration and DL Buffering Suggested Packet Count parameters again when re-invoking extended buffering of downlink data packets.

The UP function shall stop applying buffering when new instruction is received from the CP function. The buffered packets shall be either dropped or forwarded following the packet forwarding model specified in clause 5.2.1 and taking into consideration that the buffered Packets have been already processed earlier.

5.2.4.3 Applying DL Buffering Duration in the CP function

When the UP function supports being configured with extended DL data buffering for a given APN/DNN and/or S-NSSAI, as an implementation option for a CP function, if the extended buffering is requested by the AMF or MME/SGSN by provisioning an Estimated Maximum Wait time for 5GS or a DL Buffering Duration for EPS respectively, and when the CP function wishes to receive additional DL Data Notification reports if the UP function receives subsequent DL data over another QoS flow or EPS Bearer Context, the CP function may:

- keep the Extended Buffering time (derived from the Estimated Maximum Wait time for 5GS) or the DL Data Buffer Expiration Time (derived from the Buffering Duration for EPS) without provisioning the same to the UP function, and
- keep setting NOCP to "1" to receive any potential subsequent Downlink Data Notification from UPF.

If the CP function does so, upon the expiry of the Extended Buffering time or the DL Data Buffer Expiration Time and if the user plane connection is still not established (to enable the UP function to forward the buffered DL data), the CP function may request the UP function to drop the buffered data packets by setting "DROBU" to 1 in the PFCP Session Modification Request message, so that the UP function will start buffering any further DL data packets and send a new DL data report of the arrival of such a first DL data packet.

5.2.5 QoS Enforcement Rule Handling

5.2.5.1 General

The CP function shall provision QER(s) for a PFCP session in a PFCP Session Establishment Request or a PFCP Session Modification Request to request the UP function to perform QoS enforcement of the user plane traffic.

5.2.5.2 Provisioning of QoS Enforcement Rule in the UP function

The CP function may request the UP function to perform the following QoS enforcement actions in a QER:

- Gating Control, as specified in clause 5.4.3;

- QoS Control, i.e. MBR, GBR or Packet Rate enforcement, as specified in clause 5.4.4;
- DL flow level marking for application detection, as specified in clause 5.4.5;
- SCI (Service Class Indicator) marking for service identification for improved radio utilisation for GERAN, as specified in clause 5.4.12;
- for 5GC reflective QoS for uplink traffic.

5.2.5.3 Reflective QoS (for 5GC)

The 5GS may support Reflective QoS functionality (see clauses 5.7.5 in 3GPP TS 23.501 [28]).

When the 5GC determines to use Reflective QoS for a specific SDF, the SMF shall set the Reflective QoS Indication (RQI) bit to 1 in the QER associated to the DL PDR for this SDF in a PFCP Session Establishment Request or PFCP Session Modification Request message.

The SMF may also provision the UPF to perform uplink QoS flow binding verification for the specific SDF as specified in clause 5.4.2.

When the 5GC determines to no longer use Reflective QoS for a specific SDF, the SMF shall request the UPF to stop applying Reflective QoS for the corresponding downlink traffic, e.g. by setting the Reflective QoS Indication (RQI) bit to 0 in the QER that is associated to the DL PDR or by dissociating the QER from the DL PDR (as appropriate) in a PFCP Session Modification Request message.

If the SMF had provisioned the UPF to perform uplink QoS flow binding verification for the specific SDF, after an operator configurable time, the SMF shall update the UL PDR(s) to no longer perform uplink QoS flow binding verification for the corresponding uplink traffic and QFI.

5.2.6 Combined SGW/PGW Architecture

The usage of a combined SGW/PGW remains possible in a deployment with separated control and user planes, see clause 4.2.2 of 3GPP TS 23.214 [2]. This is enabled by supporting a combined Sxa/Sxb interface with a common packet forwarding model, message and parameter structure for non-combined and combined cases.

The following additional requirements shall apply to a combined Sxa/Sxb interface between a combined SGW/PGW-C and a combined SGW/PGW-U:

- all the functionalities specified for Sxa and Sxb shall be supported, possibly concurrently, over a combined Sxa/Sxb association;
- a single PFCP session may be setup to support both the functionalities of an SGW-U and PGW-U;
- the CP function may provision PDRs, QERs, URRs, FARs (possibly with a buffering instruction) and BAR, possibly concurrently, for the same PFCP session;
- the CP function may provision concurrently parameters in a message or for the PFCP session that are applicable to Sxa and Sxb.

5.2.7 Multi-Access Rule Handling (for 5GC)

5.2.7.1 General

The UP function (i.e. the UPF) shall support the Multi-Access Rule (MAR) if it supports the ATSSS feature (see clause 5.20).

The CP function (i.e. the SMF) shall provision in the UP function acting as the PDU Session Anchor (PSA) and supporting the ATSSS feature, one and only one MAR for every downlink PDR corresponding to non-GBR traffic of a PFCP session that is established for a Multi-Access (MA) PDU session.

The CP function (i.e. the SMF) shall also provision in the UP function acting as the PDU Session Anchor (PSA) and supporting the ATSSS feature, one and only one MAR for every downlink PDR corresponding to GBR traffic of a PFCP session that is established for a Multi-Access (MA) PDU session, if the Steering Mode is "Redundant".

The MAR provides instructions to the UP function on how to forward the packets matching the PDR over 3GPP and non-3GPP accesses. See clauses 5.8.5.8 and 5.32.8 in 3GPP TS 23.501 [28]. The 3GPP access and the non-3GPP access may both be connected to the 5GC, or they may be connected to the 5GC and EPC (see clause 5.20.1).

In a MAR, the CP function (i.e. the SMF) shall:

- instruct the UPF which traffic steering functionality to use, i.e. either MPTCP, ATSSS-LL, MPQUIC-UDP, MPQUIC-IP or MPQUIC-E, using the Steering Functionality IE (see clause 8.2.124);
- set the Steering Mode to instruct how the packets shall be distributed across 3GPP and non-3GPP accesses, e.g. "Active-Standby", "Smallest Delay", "Load Balancing", "Priority-based" and "Redundant" (see clause 8.2.125);
- provision access specific forwarding action information including:
 - a FAR ID which control the packets forwarding either to 3GPP access or non-3GPP access;
 - a Weight to indicate the proportion of traffic to be forwarded by the given FAR when the Steering Mode is set to "Load Sharing";
 - a Priority to indicate at which condition the traffic is to be forwarded by the given FAR when the Steering Mode is set to "Active-Standby" or "Priority-Based";
 - a list of URR IDs to enable the SMF to request separate usage report for different accesses.

NOTE 1: How the SMF determines the steering functionality and steering mode is specified in clause 5.32.2 of 3GPP TS 23.501 [28].

As specified in clause 5.32.8 of 3GPP TS 23.501 [28], in an MAR, the CP function may:

- provision Threshold values, including a Round Trip Time (RTT) and/or a Packet Loss Rate (PLR), if the Steering Mode is Load Balancing with fixed split percentages, Priority-based, or Redundant; if the Steering Mode is Redundant, either a (maximum) RTT or a (maximum) PLR may be provided, but not both; or
- provision the Priority IE in access specific forwarding action information set to "Primary" or "Secondary" if the Steering Mode is Redundant, to indicate that an access is a primary access or a secondary access;
- include a Steering Mode Indicator to indicate that the default steering parameters provided in the Steering Mode may be adjusted:
 - set autonomous load-balance flag to allow the UPF to adjust the traffic steering based on its own decisions when the Steering Mode is Load Balancing; or
 - set UE-assistance flag to allow the UPF to adjust the traffic steering based on the UE Assistance Data from UE when the Steering Mode is Load Balancing.

NOTE 2: The autonomous load-balance flag and the UE-assistance flag can not be set to "1" at the same time.

The CP function may set the Steering Mode "Redundant" only if the steering functionality is not set to "ATSSS-LL" and if the UP function supports the REDSM (Redundant Steering Mode) feature (see clause 8.2.25).

The CP function may provision one or more MAR(s) (for different PDRs) per PFCP session. Different MARs of a same PFCP session may be provisioned with a different steering functionality and/or a different steering mode. Different MARs of a same PFCP session may be associated with the same FAR(s).

If a UE indicates it supports multiple steering functionalities (see clause 5.32.2 of 3GPP TS 23.501 [28]) and the network determines to apply different steering functionalities to different packet flows of the UE's PDU session (e.g. MPTCP and ATSSS-LL, MPQUIC-UDP and ATSSS-LL, MPTCP and MPQUIC-UDP and ATSSS-LL, MPQUIC-UDP and MPQUIC-IP), the CP function shall provision separate downlink PDRs for the different packet flows subject to each of these steering functionalities (e.g. for MPTCP traffic and for non-MPTCP traffic, MPQUIC-UDP traffic and non MPQUIC-UDP traffic, MPQUIC-UDP and MPQUIC-IP traffic). Correspondingly, different MARs shall be provisioned and associated with the separate downlink PDRs. The steering functionality shall be set to ATSSS-LL for the MAR associated with the downlink PDR for traffic that is not subject to MPTCP and/or MPQUIC steering.

The UP function shall distribute the downlink traffic across the two access networks (and the two N3/N9, S5-U/S8-U or S2b-U tunnels) according to the instructions received in the MAR and feedback information received from the UE via

the user plane (e.g. access network Unavailability or Availability reports for ATSSS-LL received by PMF, see 3GPP TS 24.193 [59]), as specified in clause 5.32.8 of 3GPP TS 23.501 [28].

If the autonomous load-balance is set in the Steering Mode Indicator, the Weight shall be treated as the default percentages, and the UPF may autonomously determine its own percentages for traffic splitting to maximize the aggregated bandwidth in the downlink direction. If the UE-assistance is set in the Steering Mode Indicator, the UE may inform the UPF on how it decided to distribute the UL traffic of the matching SDF.

5.2.8 Session Reporting Rule Handling

5.2.8.1 General

The CP function may provision SRR(s) for a PFCP session in a PFCP Session Establishment Request or a PFCP Session Modification Request to request the UP function to detect and report events for a PFCP session that are not related to specific PDRs of the PFCP session or that are not related to traffic usage measurement.

- Change of 3GPP or non-3GPP access availability, for an MA PDU session (see clause 5.20.4.2).
- Per QoS flow QoS Monitoring and Reporting (see clause 5.39).
- Per QoS Flow Traffic Parameter Measurement Report, as specified in clause 5.8.5.11 of 3GPP TS 23.501 [28].
- UE level measurements, as specified in 3GPP TS 32.422 [35] and 3GPP TS 28.558 [88].

5.2.8.2 Provisioning of Session Reporting Rule in the UP function

5.2.8.2.1 General

When provisioning an SRR, the CP function shall provide control information identifying the events that the UPF is requested to detect and report. If Direct Reporting of QoS monitoring events to a consumer (e.g. to Local NEF or AF) is supported and required, the CP function shall also provide Direct Reporting Information in the SRR (see clause 5.33.5). For UE level measurements, the CP function shall also provide the Reporting Control Information in the SRR to indicate that the measurements shall be sent to the trace collection entity (see clause 5.15A.1).

The CP function may modify an SRR in the PFCP Session Modification Request message.

The CP function may request the UP function to stop the detection and reporting of specific events by removing the SRR or, if the SRR is used to control different types of events, by updating the SRR with a control information IE for the events to stop with a null length. When so instructed, the UP function shall stop detecting and reporting the corresponding events.

5.2.8.3 Reporting of Session Report to the CP function

5.2.8.3.1 General

When detecting that a provisioned event to report occurs, the UP function shall generate a Session Report for the related SRR and send it to the CP function by initiating the PFCP Session Report procedure, unless Direct Reporting of QoS monitoring events to a consumer (e.g. to Local NEF or AF) applies (see clause 5.33.5) or the CP function instructed the UP function to send the reports to the trace collection entity using the Reporting Control Information IE (see clause 5.15A.1).

Upon generating a session report for an SRR towards the CP function or towards the consumer (e.g. the Local NEF or AF) if Direct Reporting of QoS monitoring event applies, or towards the trace collection entity, the UP function shall continue to apply all the provisioned SRR(s), until getting any further instruction from the CP function.

5.2.9 Handling of Rules that cannot be activated

The CP function shall indicate support of the Partial Success (PSUCC) feature (see clause 8.2.58) during the PFCP association setup or update procedure, if it supports PFCP session establishment or modification with Partial Success, i.e. with the UP function partially accepting a PFCP session establishment or modification request when some rules

requested to be created or modified cannot be applied, e.g. when a pre-defined rule name or pre-defined rule ID is not configured in the UP function.

If the CP function indicated support of the PSUCC feature, and if this feature is also supported by the UP function, the UP function should partially accept a PFCP session establishment or modification request, if possible, even when it fails to create or modify one or more rules. In such a case, the UP function shall set the cause to "Request partially accepted" in the response and include the Partial Failure Information IE identifying the rules that the UP function could not activate and the cause of the failure.

NOTE: Partial acceptance of a request is not possible in some cases, when the failure to activate a rule would result in a PFCP session state that is not consistent, e.g. if no PDR or FAR would end up being activated for the PFCP session. Details on the conditions when a request can be partially accepted or not are left to UP function implementation.

Upon receipt of a PFCP session establishment or modification response indicating a partial acceptance of the request, the CP function shall consider that not all rules were successfully activated in the UP function and determine those which failed to be activated based on the Partial Failure Information IE in the response.

If the CP function or the UP function does not support the PSUCC feature, the UP function shall reject a PFCP session establishment or modification request if at least one rule fails to be applied.

5.3 Data Forwarding between the CP and UP Functions

5.3.1 General

Forwarding of user plane data between the CP and UP functions may take place as part of the following scenarios (see 3GPP TS 23.214 [2] for EPC and 3GPP TS 23.501 [28] for 5GC).

Table 5.3.1-1: Data forwarding scenarios between the CP and UP functions

	Scenario description	Data forwarding direction	For EPC applicable to	For 5GC applicable to
1	Forwarding of user-plane packets between the UE and the CP function.	UP to CP function CP to UP function	PGW	UPF to SMF SMF to UPF
2	Forwarding of packets between the CP function and the external PDN (over S-Gi) / DN (over N6).	UP to CP function CP to UP function	PGW	UPF to SMF SMF to UPF
3	Forwarding of packets subject to buffering in the CP function.	UP to CP function CP to UP function	SGW	UPF to SMF SMF to UPF
4	Forwarding of End Marker Packets constructed by the CP function to a downstream node.	CP to UP function	SGW, PGW	SMF to UPF
5	Forwarding of user data using Control Plane Clot 5GS Optimisation	UP to CP function CP to UP function	-	UPF to SMF SMF to UPF

User plane packets shall be forwarded between the CP and UP functions by encapsulating the user plane packets using GTP-U encapsulation (see 3GPP TS 29.281 [3]).

For forwarding data from the UP function to the CP function, the CP function shall provision PDR(s) per PFCP session context, with the PDI identifying the user plane traffic to forward to the CP function and with a FAR set with the Destination Interface "CP function side" and set to perform GTP-U encapsulation and to forward the packets to a GTP-u F-TEID uniquely assigned in the CP function per PFCP session and PDR. The CP function shall then identify the PDN connection and the bearer to which the forwarded data belongs by the F-TEID in the header of the encapsulating GTP-U packet.

For forwarding data from the CP function to the UP function, the CP function shall provision one or more PDR(s) per PFCP session context, with the PDI set with the Source Interface "CP function side" and identifying the GTP-u F-TEID uniquely assigned in the UP function per PDR, and with a FAR set to perform GTP-U decapsulation and to forward the packets to the intended destination. URRs and QERs may also be configured.

For EPC PFCP session contexts may correspond to individual PDN connections, TDF sessions, or standalone sessions not tied to any PDN connection or TDF session used e.g. for forwarding RADIUS, Diameter or DHCP signalling

between the PGW-C and the PDN or for forwarding End Marker packets from the PGW-C or SGW-C to a downstream SGW-U or eNodeB.

For 5GC PFCP session contexts may correspond to individual PDU sessions or standalone sessions not tied to any PDU sessions used e.g. for forwarding RADIUS, Diameter or DHCP signalling between the SMF and the DN or for forwarding End Marker packets from the SMF to a downstream UPF or NG-RAN.

For EPC the CP function may establish one Sx-u tunnel per:

- bearer of PDN connection e.g. for the data forwarding scenarios 1 and 3;
- UP function or PDN e.g. for the data forwarding scenario 1, 2 and 4.

For 5GC the CP function may establish one N4-u tunnel per:

- PDU session e.g. for the data forwarding scenarios 1, 3 and 5;
- UP function or DN e.g. for the data forwarding scenario 1, 2 and 4.

Requirements for forwarding packets subject to buffering in the CP function between the UP and CP functions (scenario 3) are further specified in clause 5.3.3.

Requirements for sending End Marker packets (scenario 4) are further specified in clause 5.3.2.

Requirements for forwarding user data using Control Plane ClIoT 5GS Optimisation between the UP and CP functions (scenario 5) are further specified in clause 5.3.5.

5.3.2 Sending of End Marker Packets

The construction of End Marker packets may either be done in the CP function or UP function, based on network configuration, as specified in clause 5.8 of 3GPP TS 23.214 [2] for EPC and in clause 5.8.2.9 of 3GPP TS 23.501 [28] for 5GC. The support of End Marker packets by the UP function is optional.

A UP function complying with this release of the specification shall support constructing End Marker packets in the UP function and shall indicate so to the CP function by setting the EMPU flag in the UP Function Features (see clause 8.2.25).

A CP function complying with this release of the specification should request the UP function to construct End Marker packets. If so, the CP function shall request the UP function to construct and send End Marker packets by sending a Session Modification Request including FAR(s) with the new downstream F-TEID and with the SNDEM (Send End Marker Packets) flag set.

For End Marker packets constructed in the CP function, the CP function shall:

- establish (once) one standalone PFCP session not tied to any PDN connection, per the UP function, for forwarding End Marker packets, and provision the UP function to perform one GTP-U decapsulation and to forward the resulting packets without any further change towards the destination IP address of these packets;
- construct the GTP-U End Marker packets, with the destination IP address and TEID set according to the old F-TEID value, and with a source IP address set according to the UP function's F-TEID value (e.g. S1 or Iu SGW F-TEID or NG-u UPF F-TEID);
- encapsulate the constructed GTP-U End Marker packets in GTP-U packets according to the principles specified in clause 5.3.1 for data forwarding between the CP function and the UP function, and send them towards the F-TEID assigned in the UP function for the above PFCP session, after receipt of the PFCP Session Modification Response indicating that the UP function has switched to a new F-TEID.

Upon receipt of a PFCP Session Modification Request modifying the F-TEID in the Outer Header Creation of a FAR, the UP function shall send the Response message only after having switched to the new F-TEID.

5.3.3 Forwarding of Packets Subject to Buffering in the CP Function

5.3.3.1 General

The following requirements shall apply to the data forwarding scenario 3 of Table 5.3.1-1 in addition to the requirements specified in clause 5.3.1.

The CP function shall establish one Sx-u tunnel per bearer of a PDN connection / one N4-u tunnel per PDU session when applying the data forwarding scenario 3.

5.3.3.2 Forwarding of Packets from the UP Function to the CP Function

For EPC, regardless of whether the downlink traffic received by the UP function consists of T-PDUs (i.e. user data packet, see 3GPP TS 29.281 [3]) for a combined SGW/PGW-U, or G-PDUs (i.e. T-PDU plus a GTP-U header) for a SGW-U, the downlink traffic shall be forwarded from the UP function to the CP function as G-PDUs with the GTP-U header set to the IP address and TEID uniquely assigned in the CP function for the Sx-u tunnel corresponding to the bearer of the PDN connection.

NOTE 1: An SGW-U receiving G-PDUs from an S5/S8 bearer forwards the same G-PDUs towards the SGW-C but with the IP address and TEID in the GTP-U header changed to the SGW-C IP address and TEID of the corresponding Sx-u tunnel.

For 5GC, regardless of whether the downlink traffic received by the UP function consists of T-PDUs (i.e. user data packet, see 3GPP TS 29.281 [3]) for an PSA-UPF, or G-PDUs (i.e. T-PDU plus a GTP-U header) for an I-UPF, the downlink traffic shall be forwarded from the UP function to the CP function as G-PDUs with the GTP-U header set to the IP address and TEID uniquely assigned in the CP function for the N4-u tunnel corresponding to the PDU session of the PDN connection.

NOTE 2: An I-UPF receiving G-PDUs from an N9 GTPU tunnel forwards the same G-PDUs towards the SMF but with the IP address and TEID in the GTP-U header changed to the SMF IP address and TEID of the corresponding N4-u tunnel.

To forward the user plane data to be buffered in the CP function from the UP function, the CP function shall provision:

- for EPC, a PDR per bearer of the PDN connection, matching the received downlink user plane packets and for a (non-combined) SGW-U, with the field Outer Header Removal Description in the Outer Header Removal IE set to "0" or "1" for IPv4 or IPv6 respectively;
- for 5GC, a PDR per PDU session, matching the received downlink user plane packets and for an I-UPF, with the field Outer Header Removal Description in the Outer Header Removal IE set to "0" or "1" for IPv4 or IPv6 respectively;
- a FAR instructing the UP function to forward the received downlink data to the CP function, with the field Outer Header Creation Description in the Outer Header Creation set to "0" or "1".

NOTE 3: The PDR can be provisioned in the UP function before applying data forwarding to the CP function.

For EPC, G-PDUs sent from the UP function to the CP function over the Sx-u tunnel shall include any GTP-U extension header(s):

- possibly received by the UP function over the S5/S8 bearers and stored during the Outer Header Removal;
- possibly created by the UP function as part of a QER rule.

For 5GC, G-PDUs sent from the UP function to the CP function over the N4-u tunnel shall include any GTP-U extension header(s):

- possibly received by the UP function over the N9 PDU sessions and stored during the Outer Header Removal;
- possibly created by the UP function as part of a QER rule.

5.3.3.3 Forwarding of Packets from the CP Function to the UP Function

Likewise, when subsequently sending the downlink traffic buffered in the CP function back to the UP function, the downlink traffic shall be forwarded:

- for EPC, over Sx-u as G-PDUs with the GTP-U header set to the IP address and TEID uniquely assigned in the UP function for the Sx-u tunnel set up for the corresponding bearer of the PDN connection;
- for 5GC, over N4-u as G-PDUs with the GTP-U header set to the IP address and TEID uniquely assigned in the UP function for the N4-u tunnel set up for the corresponding PDU session.

G-PDUs sent over Sx-u / N4-u shall include GTP-U extension header(s) possibly received earlier from the UP function.

To forward the user plane data from the CP function to the UP function, the CP function shall provision:

- a PDR per bearer of the PDN connection (for EPC) or per PDU session (for 5GC), with an IP address and TEID uniquely assigned in the UP function for the Sx-u / N4-u tunnel, and with the field Outer Header Removal Description in the Outer Header Removal IE set to "0" or "1";
- a FAR enabling the UP function to forward the received downlink data from the CP function towards the RAN, with the field Outer Header Creation Description in the Outer Header Creation set to "0" or "1".

G-PDUs sent from the UP function towards the RAN shall include GTP-U extension header(s) possibly received from the CP function.

5.3.4 Data Forwarding between the CP and UP Functions with one PFCP-u Tunnel per UP Function or PDN

5.3.4.1 General

The following requirements shall apply to the data forwarding scenario 1 and 2 of Table 5.3.1-1, when establishing one PFCP-u tunnel per UP function or PDN, in addition to the requirements specified in clause 5.3.1.

5.3.4.2 Forwarding of Packets from the UP Function to the CP Function

Regardless of whether the traffic received by the UP function consists of T-PDUs (i.e. user data packet, see 3GPP TS 29.281 [3]) from SGi / N6 or G-PDUs (i.e. T-PDU plus a GTP-U header) from the UE, the traffic shall be forwarded from the UP function to the CP function as G-PDUs with the GTP-U header set to the IP address and TEID uniquely assigned in the CP function for the PFCP-u tunnel corresponding to the UP function or PDN.

To forward the user plane data to from the UP function, the CP function shall provision:

- for supporting data forwarding scenario "1" as specified in clause 5.3.1, an additional PDR for a PFCP session established for a PDN connection or a PDU session which requires such data forwarding, matching the received user plane packets from uplink direction. The Outer Header Removal IE shall not be present if the complete G-PDU is required to be forwarded, otherwise the Outer Header Removal IE shall be present and set to "0" or "1" for IPv4 or IPv6 respectively;
- for supporting data forwarding scenario "2" as specified in clause 5.3.1, a PDR matching the received user plane packets from downlink direction;
- a FAR instructing the UP function to forward the received data to the CP function, with the field Outer Header Creation Description in the Outer Header Creation set to "0" or "1" for IPv4 or IPv6 respectively, and the Outer GTP-U header set to the IP address and TEID uniquely assigned in the CP function for the Sx-u tunnel.

5.3.4.3 Forwarding of Packets from the CP Function to the UP Function

When sending user plane data from the CP function, the traffic shall be forwarded over PFCP-u as:

- T-PDUs encapsulated in GTP-U with the GTP-U header set to the IP address and TEID uniquely assigned in the UP function for the PFCP-u tunnel set up for the UP function or PDN or DN for traffic to be sent towards SGi or N6; or

- G-PDUs encapsulated in GTP-U with the outer GTP-U header set to the IP address and TEID uniquely assigned in the UP function for the PFCP-u tunnel set up for the UP function and with the inner GTP-U header set to the F-TEID assigned by the downstreams GTP-U peer (e.g. SGW, I-UPF) to the bearer over which the data shall be sent.

To forward the user plane data from the CP function to the UP function, the CP function shall provision:

- a PDR per UP function, with an IP address and TEID uniquely assigned in the UP function for the PFCP-u tunnel, and with the field Outer Header Removal Description in the Outer Header Removal IE set to "0" or "1";
- an FAR enabling the UP function to forward the received data from the CP function.

5.3.5 Forwarding of user data using Control Plane Clot 5GS Optimisation (for 5GC)

5.3.5.1 General

The following requirements shall apply to the data forwarding scenario 5 of Table 5.3.1-1 in addition to the requirements specified in clause 5.3.1.

The CP function shall establish one one N4-u tunnel per PDU session when applying the data forwarding scenario 5.

5.3.5.2 Forwarding of Packets from the UP Function to the CP Function

Regardless of whether the downlink traffic received by the UP function consists of T-PDUs (i.e. user data packet, see 3GPP TS 29.281 [3]) from N6 or G-PDUs (i.e. T-PDU plus a GTP-U header) received from N9, the downlink traffic shall be forwarded from the UP function to the CP function as G-PDUs with the GTP-U header set to the IP address and TEID uniquely assigned in the CP function for the N4-u tunnel corresponding to the PDU session.

NOTE: A UPF receiving G-PDUs from N9 forwards the G-PDUs towards the SMF but with the IP address and TEID in the GTP-U header changed to the SMF IP address and TEID of the corresponding N4-u tunnel.

To forward the user plane data from the UP function to the CP function, the CP function shall provision:

- a PDR per PDU session, matching the received downlink user plane packets, and for traffic received from N9, with the field Outer Header Removal Description in the Outer Header Removal IE set to "0" or "1" for IPv4 or IPv6 respectively;
- a FAR instructing the UP function to forward the received downlink data to the CP function, with the field Outer Header Creation Description in the Outer Header Creation set to perform GTP-U/UDP/IPv4 or GTP-U/UDP/IPv6 encapsulation.

NOTE: The PDR can be provisioned in the UP function before applying data forwarding to the CP function.

G-PDUs sent from the UP function to the CP function over the N4-u tunnel shall include any GTP-U extension header(s):

- possibly received by the UP function over the N9 interface and stored during the Outer Header Removal;
- possibly created by the UP function as part of a QER rule.

5.3.5.3 Forwarding of Packets from the CP Function to the UP Function

Likewise, when sending the uplink traffic received in the CP function to the UP function, the uplink traffic shall be forwarded over N4-u as G-PDUs with the GTP-U header set to the IP address and TEID uniquely assigned in the UP function for the N4-u tunnel set up for the corresponding PDU session.

To forward the user plane data from the CP function to the UP function, the CP function shall provision:

- a PDR per PDU session, with an IP address and TEID uniquely assigned in the UP function for the N4-u tunnel, and with the field Outer Header Removal Description in the Outer Header Removal IE set to "0" or "1";
- an FAR enabling the UP function to forward the received uplink data from the CP function.

5.4 Policy and Charging Control

5.4.1 General

This clause describe how Policy and Charging Control requirements are supported over the Sxa, Sxb, Sxc and N4 reference points.

5.4.2 Service Detection and Bearer/QoS Flow Binding

Service detection refers to the process that identifies the packets belonging to a service data flow or application. For EPC, see clauses 6.2.2.2 and 6.8.1 of 3GPP TS 23.203 [7]. For 5GC, see clause 6.2.2.2 of 3GPP TS 23.503 [44].

For EPC, bearer binding is the procedure that associates service data flow(s) to an IP-CAN bearer deemed to transport the service data flow. UL bearer binding verification refers to the process of discarding uplink packets due to no matching service data flow template for the uplink direction. See clauses 6.1.1.4 and 6.2.2.2 of 3GPP TS 23.203 [7].

For 5GC, QoS flow binding is the procedure that associates service data flow(s) to a QoS flow deemed to transport the service data flow. UL QoS flow binding verification refers to the process of discarding uplink packets due to no matching QoS flow for the uplink direction. See clause 6.1.3.2.4 of 3GPP TS 23.503 [44] and clause 5.7.1.7 of 3GPP TS 23.501 [28].

For 5MBS, QoS flow binding is the procedure that associates a PCC rule to a QoS Flow within an MBS Session. See clause 6.10 in 3GPP TS 23.247 [72].

Service detection is controlled over the Sxa, Sxb, Sxc and N4 reference points by configuring Packet Detection Information in PDRs to match the intended service data flows or application.

For EPC, the mapping of DL traffic to bearers is achieved by configuring and associating FARs to the downlink PDRs, with FARs set to forward the packets to the appropriate downstream bearers (S5/S8 or S1/S12/S4/Iu).

For 5GC, the mapping of DL traffic to QoS flows is achieved by configuring QERs with QFI(s) for the QoS flow marking and associating FARs to the downlink PDRs, with FARs set to forward the packets to the appropriate downstream GTP-U tunnel (N9 or N3).

For EPC, uplink bearer binding verification is achieved by configuring Packet Detection Information in uplink PDRs containing the local F-TEID of the uplink bearer, the UE IP address (source IP address to match for the incoming packet), and the SDF filter(s) or the Application ID. As a result, uplink packets received on the uplink bearer but that do not match the SDF filter(s) or Application detection filter associated to the uplink PDRs are discarded.

For 5GC, uplink QoS flow binding verification (see clause 5.7.1.7 of 3GPP TS 23.501 [28]) is achieved by configuring Packet Detection Information in uplink PDRs containing the local F-TEID of the uplink PDU session, the UE IP address (source IP address to match for the incoming packet), the QFI of the QoS flow and the SDF filter(s) or the Application ID. As a result, uplink packets received on the uplink PDU session but that do not match the SDF filter(s) or Application detection filter and QFI associated to the uplink PDRs are discarded.

NOTE 1: For PCC Rules that contain an application identifier (i.e. that refer to an application detection filter), uplink traffic can be received on other IP-CAN bearers than the one determined by the binding mechanism. The detection of the uplink part of the service data flow can be activated in parallel on other bearers with non-GBR QCI (e.g. the default bearer) in addition to the bearer where the PCC rule is bound to. See clauses 6.1.1.1 and 6.2.2.2 of 3GPP TS 23.203 [7]. Therefore the uplink PDRs for these bearers can be provisioned with the PDI containing this service data flow and the local F-TEID of the uplink bearer.

NOTE 2: To avoid the PGW-U discarding packets due to no matching service data flow template, the operator can apply open PCC rules (with wildcarded SDF filters) to allow for the passage of packets that do not match any other candidate SDF template. Therefore an uplink PDR can be provisioned with the PDI containing only the local F-TEID of the uplink bearer.

NOTE 3: Uplink bearer binding does not apply to Non-IP PDN connections.

NOTE 4: The UPF can be provisioned with a PDR (with low precedence) which contains the CN tunnel info, QFI and filter information that can detect any unwanted/unauthorized traffic with this QFI so that such traffic can be dropped with or without being counted before.

5.4.3 Gating Control

Gating control refers to the process within the user plane function (i.e. PGW-U and TDF-U for EPC, UPF for 5GC) of enabling or disabling the forwarding of IP packets, belonging to a service data flow or detected application's traffic, to pass through to the desired endpoint (for EPC see clause 4.3.2 of 3GPP TS 23.203 [7] and for 5GC see clause 4.3.3.1 of 3GPP TS 23.503 [44]).

The PGW-C and TDF-C (for EPC) and the SMF (for 5GC) controls the gating in the PGW-U and TDF-U (for EPC) and in the UPF (for 5GC) by creating PDR(s) for the service data flow(s) or application's traffic to be detected, and by associating a QER, including the Gate Status IE, to the PDRs.

The Gate Status IE indicates whether the service data flow or detected application traffic is allowed to be forwarded (the gate is open) or shall be discarded (the gate is closed) in the uplink and/or in downlink directions.

The PGW-U and TDF-U (for EPC) and the UPF (for 5GC) shall identify UL and DL flows by the Source Interface IE in the PDI of the PDRs or the Destination Interface IE in the FARs. The PGW-U and TDF-U (for EPC) and the UPF (for 5GC) shall apply UL and DL gating accordingly.

The UP function shall discard packets matching a PDR if the PDR is associated with at least one QER provisioned with the Gate Status set to CLOSED.

5.4.4 QoS Control

QoS control refers to the authorization and enforcement of the maximum QoS that is authorized:

- for EPC,
 - at the session level (APN-AMBR, TDF session UL and DL bitrates, or UL and DL Packet Rate of a PDN connection);
 - at the bearer level (GBR, MBR for GBR bearers);
 - at the service data flow (SDF) or application level.
- for 5GC,
 - at the session level (Session-AMBR, UL and DL Packet Rate of a PDU session or Authorized DL Session AMBR for Offloading);
 - at the QoS Flow level;
 - at the service data flow (SDF) or application level.

See clause 4.3.3 of 3GPP TS 23.203 [7] clause 4.5.5 of 3GPP TS 29.212 [8] and clause 4.7.7 of 3GPP TS 23.401 [14].

The CP function shall control the QoS enforcement in the UP function by:

- creating the necessary PDR(s) to represent the service data flow, application, QoS Flow (for 5GC), bearer or session, if not already existing;
- creating QERs for the QoS enforcement at session level, SDF/application level;
- creating QERs for the QoS enforcement of the aggregate of SDFs with the same GBR QCI;
- creating QERs for the QoS enforcement of the aggregate of SDFs with the same GBR QFI (for 5GC);
- associating the session level QER to all the PDRs defined for the session;
- associating the SDF or application QER to the PDRs associated to the SDF or application;
- associating the QER of the aggregate of SDFs to the PDRs associated to SDFs or applications that share the QER.

The same QER may be associated to UL and DL PDRs. The UP function shall identify the UL and DL flows by the Source Interface IE in the PDRs or the Destination Interface IE in the FARs. The UP function shall enforce the QoS for the UL or DL flows accordingly.

The CP function shall map the precedence of a PCC rule to the precedence of the PDRs associated to the corresponding service data flows.

5.4.5 DL Flow Level Marking for Application Detection

DL flow level marking is performed using DL DSCP marking. DL DSCP marking for application indication refers to the process in the TDF of marking detected downlink application traffic with a DSCP value received within an installed ADC rule matching this traffic. See Annex U of 3GPP TS 23.203 [7] and clauses 4.5.2.7 and 4b.5.14 of 3GPP TS 29.212 [8].

DL DSCP marking for application indication is controlled by the TDF-C by associating a QER, including the ToS or Traffic Class within the DL Flow Level Marking IE, to the PDR matching the DL traffic to be marked. The TDF-U performs the DL DSCP marking for the detected DL traffic and sends the marked packet to the PGW-U.

If a tunnelling protocol is used between the TDF-U and the PGW-U, the DSCP value for service data flow detection shall be carried in the inner IP header.

The TDF-C may stop the DL DSCP marking for the application during the PFCP session by removing the related QER or removing the DL Flow Level Marking IE from the related QER, the TDF-U shall then stop such function consequently.

Policy and charging control in the downlink direction by the PCEF for an application detected by the TDF is performed by the PGW-C configuring a PDR with a PDI containing an SDF Filter with the corresponding DSCP value.

5.4.6 Usage Monitoring

Usage Monitoring Control refers to the process of monitoring the user plane traffic in the PGW-U, TDF-U or UPF for the accumulated usage of network resources per:

- individual or group of service data flows;
- individual or group of applications;
- PDU session, possibly excluding an individual SDF or a group of service data flow(s) (for 5GC);
- IP-CAN session, possibly excluding an individual SDF or a group of service data flow(s) (for EPC); and/or
- TDF session, possibly excluding an individual application or a group of application(s) (for EPC).

For EPC, see clauses 4.4, 6.2.2.3 and 6.6 of 3GPP TS 23.203 [7] and clauses 4.5.16, 4.5.17, 4b.5.6, 4b.5.7 of 3GPP TS 29.212 [8].

For 5GC, see clauses 4.3.4 and 6.2.2.3 of 3GPP TS 23.503 [44] and clauses 4.2.2.10, 4.2.3.11, 4.2.4.10, 4.2.6.2.5, 4.2.6.5.3 of 3GPP TS 29.512 [41].

Usage Monitoring Control is supported over the Sxb, Sxc and N4 reference points by activating in the UP function the reporting of usage information towards the CP function, as specified in clauses 5.3 and 7.8.4 of 3GPP TS 23.214 [2] and in clause 5.8.2.6.2 of 3GPP TS 23.501 [28].

The CP function shall control the Usage Reporting in the UP function by:

- creating the necessary PDR(s) to represent the service data flow, application or session;
- creating a URR for each Monitoring key; and
- associating the URR to:
 - all the PDRs of the PFCP session, for usage monitoring at IP-CAN or TDF session level, possibly excluding the PDRs matching the SDFs or Applications excluded from the usage monitoring at session level; or
 - the PDR(s) of the PFCP session associated to the individual or group of SDF(s) or Application(s), for usage monitoring at SDF or application level.

5.4.7 Traffic Redirection

Traffic Redirection refers to the process of redirecting uplink application traffic, in a PGW, TDF or UPF, towards a redirect destination, e.g. redirect some HTTP flows to a service provisioning page. For EPC, see clause 6.1.13 of 3GPP TS 23.203 [7] and clauses 4.5.2.6 and 4b.5.1.4 of 3GPP TS 29.212 [8]. For 5GC, see clause 6.1.3.12 of 3GPP TS 23.503 [44] and clause 4.2.6.2.4 of 3GPP TS 29.512 [41].

The redirect destination may be provided by the PCRF/PCF or be preconfigured in the CP function or in the UP function.

For EPC and 5GC, the traffic redirection shall be enforced in the UP function. If the traffic that the UP function can support may be subject to traffic redirection, traffic redirection enforcement in the UP function shall be supported by the UP function. The UP function reports to the CP function whether it supports traffic redirection enforcement in the UP function via the UP Function Features IE (see clause 8.2.25).

NOTE: A UP function that supports traffic not requiring traffic redirection does not need to support traffic redirection enforcement in the UP function. The CP function can select a UP function supporting traffic redirection enforcement in the UP function for users or services which may require traffic redirection.

To enforce the traffic redirection in the UP function, the CP function shall:

- create the necessary PDR(s) to represent the traffic to be redirected, if not already existing;
- create a FAR with:
 - the Redirect Information IE including the redirect destination, if the traffic needs to be redirected towards a redirect destination provided by the CP function; a redirect destination provided by the CP function shall prevail over a redirect destination preconfigured in the UP function;
 - For HTTP traffic redirection, the Redirection Address Type shall be set to "URL" and the CP function shall set the Destination Interface IE in the FAR to "Access" (to forward the HTTP response message with a status code indicating redirect). For other types of traffic redirection, the Destination Interface IE in the FAR may be set to "Core";

or

- the Forwarding Policy IE including the identifier of the forwarding policy to apply, if the traffic needs to be redirected towards a redirect destination preconfigured in the UP function;
- associate the FAR to the above PDRs of the PFCP session.

5.4.8 Traffic Steering

Traffic Steering refers to the process of applying a specific (S)Gi-LAN traffic steering policy in the PCEF or TDF (or TSSF), or a specific N6-LAN traffic steering policy in the UPF (PDU Session Anchor), for the purpose of steering the subscriber's traffic to appropriate operator or 3rd party service functions (e.g. NAT, antimalware, parental control, DDoS protection) in the (S)Gi-LAN or N6-LAN, per service data flows level or applications level.

Application Function influencing traffic routing (see clause 5.6.7 of 3GPP TS 23.501 [28]) also uses traffic steering for the purpose of steering the subscriber's traffic over N6, e.g. to a local access to a Data Network.

Application Function influence on Service Function Chaining (see clause 5.6.16.2 of 3GPP TS 23.501 [28]) enables an AF to request the steering of user plane traffic to a pre-configured chain of service functions on N6-LAN.

The UP function shall set the TRST feature flag in the UP Function Features IE if it supports Traffic Steering (see clause 8.2.25). The UP function shall additionally set the AFSFC feature flag in the UP Function Features IE if it supports Traffic Steering and support using Metadata (see clause 8.2.25).

Traffic Steering is supported over the Sxb, Sxc and N4 reference points by instructing the UP function to apply a specific Forwarding Policy, that is locally configured in the UP function and that can be used for the uplink, the downlink or for both directions. A Forwarding Policy is identified by a Forwarding Policy Identifier. Traffic steering is alternatively supported over the N4 reference point by instructing the UP function to route packets according to N6 routing information in the FAR (e.g. providing an IP address in the Outer Header Creation).

When so instructed, the UP function shall perform the necessary actions to enforce the forwarding policy referenced by the CP function, e.g. performing packet marking and routing the traffic towards the service functions within the (S)Gi-LAN or N6-LAN.

See 3GPP TS 23.203 [7], 3GPP TS 29.212 [8] and 3GPP TS 23.501 [28].

The CP function shall control Traffic Steering towards SGi-LAN, N6-LAN and/or N6 in the UP function by:

- creating the necessary PDRs to represent the service data flows or applications to be steered;
- creating a FAR with the Forwarding Policy IE including the Forwarding Policy Identifier set to the Traffic Steering Policy Identifier, or creating a FAR with a Outer Header Creation with the destination IP address; and
- associating the FAR to the above PDRs of the PFCP session.

The CP function shall control the processing of the traffic received from the (S)Gi-LAN or N6-LAN in the UP function as specified in the rest of this specification for traffic received from any other interface, but with PDR(s) including a PDI with the Source Interface indicating "SGi-LAN/N6-LAN". The UP function shall distinguish packets coming from (S)Gi-LAN/N6-LAN based on local configuration.

NOTE: In some cases, the traffic needs be steered towards service chaining functions within the N6-LAN first and then the same traffic can come back to the UPF and be further steered towards the Data Network or UE. In such scenario, as an implementation and/or deployment option, e.g. for the uplink traffic, the CP function can generate two pairs of PDRs and FARs, one is to instruct the UP function to detect the relevant uplink traffic and to steer the traffic to the N6-LAN; the other is to instruct the UP function to detect the same traffic sent back from the Service Chaining Functions and steer it to the Data Network. It is assumed in both PDRs, the same packet filters and/or application ID on packet detection is used.

5.4.9 Provisioning of Predefined PCC/ADC Rules

A Predefined PCC rule is preconfigured in the PCEF, e.g. a PGW (for EPC) or SMF (for 5GC). Predefined PCC rules can be activated or deactivated by the PCRF/PCF at any time. The Predefined PCC rules may be grouped allowing the PCRF/PCF to dynamically activate a set of PCC rules.

For EPC a predefined ADC rule is preconfigured in the TDF. In the case of solicited reporting, the Predefined ADC rules can be activated or deactivated by the PCRF at any time. Predefined ADC rules within the TDF may be grouped allowing the PCRF to dynamically activate a set of ADC rules.

For the definition of PCC and ADC rules see clauses 4.3.1 and 4b.3.2 of 3GPP TS 29.212 [8] and clause 5.6.2.6 of 3GPP TS 29.512 [41].

The CP function may enforce an activated predefined PCC or ADC rule by the PCRF/PCF in the UP function by:

- determining the service data filters or application IDs referred by the activated predefined PCC or ADC rule(s) and the corresponding QoS and charging control information respectively;
- creating the necessary PDR(s) to identify the service data flow(s), application(s) that the predefined PCC or ADC rule refer to, if not already existing;
- creating the necessary QER for the QoS enforcement at service data flow or application level accordingly;
- creating the necessary FAR if a new FAR needs to be created as result of Bearer binding (for EPC) or QoS flow binding (for 5GC) and QoS control for forwarding the detected service data flow or application traffic, or to redirect or to apply traffic steering control if included in the predefined PCC/ADC rule;
- creating the necessary URR(s) for each monitoring key, charging key, combination of Charging Key and Service ID, or combination of Charging Key, Sponsor ID and Application Service Provider Id if included in the predefined PCC or ADC rule;

and then:

- associating the created URR(s) to the newly created PDR(s);
- associating the existing FAR or the new FAR to the newly created PDR(s);

Optionally, the traffic handling policies common to many PFCP sessions (i.e. predefined PDR(s) / QER(s) / FAR(s) / URR(s)) may be configured in the UP function. The CP function may activate these traffic handling policies by including the Activate Predefined Rules IE or by including predefined FAR/URR/QER ID(s) (of which the most significant bit is set to "1") within:

- the Create PDR IE in an PFCP Session Establishment Request; or
- the Update PDR IE in an PFCP Session Modification Request.

If the CP function activates the traffic handling policies by including predefined FAR/URR/QER ID(s), i.e. where bit 8 is set to "1", then Create/Update FAR/URR/QER IE(s) that shares the same ID shall not be present.

If the received Create/Update PDR IE contains both the Activate Predefined Rules IE and a predefined FAR/URR/QER ID (bit 8 set to "1"), it is an implementation matter how the UPF handles the message. The UPF shall either overwrite the FAR/URR/QER referenced by the Activate Predefined Rules IE with those referenced by the received FAR/URR/QER ID, or reject the message with the Cause value "Rule creation/modification Failure" and the Failed Rule ID IE (see clause 8.2.1).

NOTE 1: The Create/Update PDR IE can contain only dynamic FAR/URR/QER ID. Such dynamic rules provision the UPF with information that was not preconfigured, e.g. with a remote GTP-U F-TEID.

For traffic matching PDR(s) associated with the activated predefined rules, the UP function shall enforce the rules, e.g. for URR, the UP function shall generate Usage Report(s) and send it to the CP function and the CP function shall be able to handle the usage reports as described in clause 5.2.2.

NOTE 2: The URR IDs used in reports triggered by a predefined rule in UP function are also pre-configured at the CP function.

The URR ID used in the usage report may be a predefined URR ID or a URR ID dynamically provisioned by the CP function.

For deactivating predefined rules which have been activated in the UP function using a Predefined Rule Name, the CP function shall include the Deactivate Predefined Rules IE in the Update PDR IE in a PFCP Session Modification Request to inform the UP function to deactivate the corresponding predefined rules for the related PDR.

For deactivating predefined FAR(s) /URR(s) / QER(s) which have been activated in the UP function by including predefined FAR/URR/QER ID(s) in the Create PDR IE or Update PDR IE, the CP function may include Remove FAR IE(s), Remove URR IE(s) and/or Remove QER IE(s) to delete the corresponding predefined FAR/URR/QER ID in an PFCP Session Modification Request message.

NOTE 3: Using Remove FAR IE(s), Remove URR IE(s) and Remove QER IE(s) does not result in any change to predefined rules that was activated using the Activate Predefined Rules IE. Such predefined rules continue to apply if still activated for the PDR.

5.4.10 Charging

For EPC, the charging requirements for online and offline charging in the PS domain specified in 3GPP TS 32.251 [17] shall be preserved with a split SGW, PGW and TDF architecture.

For 5GC, the charging requirements for online, offline and converged charging in the 5G data connectivity domain are specified in 3GPP TS 32.255 [45] and 3GPP TS 32.279 [87].

Charging is supported by the CP function by activating in the UP function the measurement and reporting of the accumulated usage of network resources per:

- for EPC:
 - IP-CAN bearer, for an SGW;
 - IP-CAN bearer, IP-CAN session and/or individual or group of service data flows, for a PGW;
 - TDF session and/or individual or group of applications, for a TDF;
- for 5GC:

- PDU session and/or individual or group of service data flows, for an SMF;
- QoS Flow, for an SMF;
- MBS session (or location dependent part of the MBS session, for a location dependent MBS service), for an MB-SMF;
- individual or group of service data flows of an MBS session (or location dependent part of the MBS session, for a location dependent MBS service), for an MB-SMF.

See clauses 5.3 and 7.8.4 of 3GPP TS 23.214 [2] and clause 5.8.2.6 of 3GPP TS 23.501 [28].

The CP function shall control the usage measurement and reporting in the UP function by:

- creating the necessary PDR(s) to represent the service data flow, application, bearer or session, if not already existing;
- creating URR(s) for each Charging Key, combination of Charging Key and Service ID, or combination of Charging Key, Sponsor ID and Application Service Provider Id;
- associating the URR(s) to the relevant PDRs defined for the PFCP session, for usage reporting at IP-CAN bearer, IP-CAN session, TDF session, SDF or application level.

For online charging, or for converged charging making use of quotas, the CP function shall provision the URR with the Volume (or Time) Quota, and with the Volume (or Time) Quota if a quota threshold was received from the OCS, as specified in clause 5.2.2.2. Besides, when the OCS provides a final quota and requests to redirect the traffic towards a redirect destination when exhausting this quota, the CP function shall redirect the traffic towards a redirect destination as specified in clause 5.4.7 upon being notified that the final quota has been reached; to permit HTTP traffic redirection, the UP function should have at least one HTTP packet, e.g. the UP function may store one packet when reaching the Volume (or Time) Quota. An example call flow is depicted in Annex C.2.1.1.

To avoid the risk of signalling storms between the CP and UP functions at times of tariff change, the CP function may include the Monitoring Time IE and zero or more Additional Monitoring IEs in the URR and set it to the time of tariff change to request the UP function to report separately the resource usage before and after the time of tariff change (see e.g. clause 6.3.7.1 of 3GPP TS 32.299 [18]).

5.4.11 (Un)solicited Application Reporting

For EPC, (un)solicited Application Reporting refers to the process of reporting the start or stop of applications by the TDF or PCEF. See 3GPP TS 23.203 [3] and 3GPP TS 29.212 [8].

For 5GC, solicited Application Reporting refers to the process of reporting the start or stop of applications by the SMF to the PCF. See 3GPP TS 23.503 [44] and 3GPP TS 29.512 [41]. Unsolicited application reporting is not applicable for 5GC.

The CP function shall instruct the UP function to detect and report applications by:

- creating the necessary PDR(s) to represent the applications to detect;
- creating a URR with the Reporting Trigger IE set to detect the start and/or stop of Traffic;
- the CP function may include a zero quota together with a FAR ID for Quota Action IE in the URR to instruct the UP function to drop or buffer the packets pertaining to the detected application traffic before the quota is granted in the subsequent PFCP Session Modification Request message. The FAR identified by the FAR ID for Quota Action shall be provisioned according to the "sdfHandl" instruction received from the PCF or the local policies as specified in 3GPP TS 29.512 [41].

NOTE 1: The (normal) FAR associated with the PDR detecting the application traffic is used when the URR is later on provisioned with a non-zero quota.

- associating the URR to the PDR.

For unsolicited application reporting, a PFCP session which is not linked to any specific TDF session may be established and the PDI in the PDR(s) does not contain any UE IP address.

When detecting the start or stop of an application, the UP function shall then initiate the PFCP Session Report procedure and send a Usage Report with the Usage Report Trigger set to 'Start of Traffic' or 'Stop of Traffic' and an Application Detection Information. The UP function shall also include the following information in the Application Detection Information in the Usage Report:

- when reporting the start of an application:
 - the Application ID;
 - the Flow Information including the Flow Description and the Flow Direction, if the traffic flow information is deducible;
 - the Application-Instance-Identifier, if the traffic flow information is deducible; and
 - if no UE IP address was provisioned in the PDI, the UE's IP address, and the Network instance when multiple PDNs with overlapping IP addresses are used in the UP function.

NOTE 2: When the CP function instructs the UP function to perform unsolicited application reporting, the PDI in the corresponding PDR has no UE IP address.

NOTE 3: When the PCRF/PCF bypass restoration procedure as defined in clause 8.2 of 3GPP TS 23.380 [106] is deployed in a network, an application ID which is used to detect RTCP RR packets needs to be configured in the PSA UPF, so that the SMF can provision a PDR referencing the corresponding application id and associate it with a URR to request the PSA UPF to generate a report when detecting such RTCP RR packets.

- when reporting the stop of an application:
 - the Application ID;
 - the Application-Instance-Identifier, if an Application Identifier was provided when reporting the start of the application;
 - if no UE IP address was provisioned in the PDI, the UE's IP address, and the Network instance when multiple PDNs with overlapping IP addresses are used in the UP function.

The UP function shall only report the Application ID when detecting the start or stop of an application and the Reduced Application Detection Information flag is set in the Measurement Information of the URR, e.g. for envelope reporting.

5.4.12 Service Identification for Improved Radio Utilisation for GERAN

Service Identification for improved radio utilization for GERAN refers to the process in the PGW of marking DL user plane traffic with a Service Class Indicator (SCI) value. See clause 5.3.5.3 of 3GPP TS 23.060 [19].

This is controlled by the PGW-C by associating a QER, including the Service Class Indicator within the DL Flow Level Marking IE, to the PDR matching the DL traffic to be marked. The PGW-U performs the SCI marking for the detected DL traffic and sends the packet with the GTP-U Service Class Indicator Extension Header downstreams.

The PGW-C may stop the SCI marking during the PFCP session by removing the related QER or removing the DL Flow Level Marking IE from the related QER, the PGW-U shall then stop such function consequently.

5.4.13 Transport Level Marking

For EPC, transport level marking is performed on a per EPS bearer basis in the SGW and PGW. Transport level marking refers to the process of marking traffic with a DSCP value based on the locally configured mapping from the QCI and optionally the ARP priority level.

For 5GC, transport level marking is performed on a per QoS flow basis. Transport level marking refers to the process of marking traffic at the UPF/MB-UPF with a DSCP value based on the mapping from the 5QI, the Priority Level (if explicitly signalled) and optionally the ARP priority level configured at the SMF/MB-SMF.

Transport level marking shall be controlled by the CP function by providing the DSCP in the ToS or Traffic Class within the Transport Level Marking IE in the FAR that is associated to the PDR matching the traffic to be marked. The

UP function shall perform the transport level marking for the detected traffic and sends the marked packet to the peer entity.

The CP function may change transport level marking by changing the Transport Level Marking IE in the related FAR.

For 5GC, if the PSA UPF indicates the support of the PDUSM and PSITLM features as specified in clause 8.2.25, and a QoS flow is created for application traffic subject for PDU Set based handling, the SMF may request the UPF to perform PDU Set Importance based transport level packet marking by provisioning one or more Extended Transport Level Marking IE(s) in the Forwarding Parameters IE in the DL FAR which is associated with the PDR identifying the application traffic, where each Extended Transport Level Marking IE contains a DSCP value (for transport level marking) associated with one or more PDU Set Importance values.

If the CP function does not provide any transport level marking instruction in the DL and UL FARs, the PSA UPF performs transport level marking based on its pre-configured logic.

For a PDU session with an I-SMF:

- if the I-SMF receives the indication from the anchor SMF that transport level marking is being applied for one or more QoS flows, then the I-SMF may request the I-UPF to derive the transport level marking value (i.e. DiffServ Code Point value) of the outgoing packets based on the transport level marking value of the incoming packets, by setting the flag TLMIP to "1" in the Transport Level Marking Indications IE in the DL FARs and UL FARs of the corresponding QoS flows;

NOTE 1: The I-UPF needs temporarily to store the DSCP value of the incoming packet during the outer header removal.

- the I-SMF may provide a Transport Level Marking IE in the DL and UL FARs containing a DSCP code derived based on its local policy to request the I-UPF to perform the transport level marking; or
- the I-SMF may provide neither the Transport Level Marking Indications IE nor the Transport Level Marking IE in the DL and UL FARs, in which case the I-UPF performs transport level marking based on its pre-configured logic, e.g., using a pre-configured value, or deriving the outgoing transport marking value based on the incoming marking value, or using mapping tables.

NOTE 2: An I-UPF can serve as an ULCL/BP or a standalone I-UPF.

5.4.14 Deferred PDR activation and deactivation

As specified in clause 6.3.2 of 3GPP TS 23.203 [7] and clauses 4.5.13 and 4a.5.13 of 3GPP TS 29.212 [8], Policy and charging control rule operations can be also performed in a deferred mode. To support such deferred PCC rule activation or deactivation, the CP function and UP function may optionally support the Deferred PDR activation and deactivation (DPDRA) as described below.

If the feature DPDRA is supported in both CP function and UP function, and when a PCC rule is provisioned in a deferred mode, i.e. with a Rule-Activation-Time and/or Rule-Deactivation-Time, the CP function shall provision the corresponding PDR using Create PDR IE or Update PDR together with an Activation Time and/or Deactivation Time to enable the PDR being activated or deactivated at requested time.

Without being provisioned together with an Activation Time or a Deactivation Time, a PDR shall be active immediately when it is received. When the status of a PDR is changed from active to inactive, the UP function shall keep storing the inactive PDR together with its associated FAR, URR(s) and QER(s), and then UP function shall apply the same behavior as if the PDR is deleted.

The CP function shall control at what time the status of a PDR rule changes using Activation Time and/or Deactivation Time as exactly as being instructed by the PCRF using a Rule-Activation-Time and/or Rule-Deactivation-Time, as specified in clause 4.5.13 of 3GPP TS 29.212 [8].

- 1) If only Activation Time is specified and has not yet occurred, then the UP function shall set the PDR rule inactive and make it active at that time. If Activation Time has passed, then the UP function shall immediately set the PDR rule active.
- 2) If only Deactivation Time is specified and has not yet occurred, then the UP function shall set the PDR rule active and make it inactive at that time. If Deactivation Time has passed, then the UP function shall immediately set the PDR rule inactive.

- 3) If both Activation Time and Deactivation Time are specified, and the Activation Time occurs before the Deactivation Time, and also when the PDR rule is provided before or at the time specified in the Deactivation Time, the UP function shall handle the rule as defined in 1) and then as defined in 2).
- 4) If both Activation Time and Deactivation Time are specified, and the Deactivation Time occurs before the Activation Time, and also when the PDR rule is provided before or at the time specified in the Activation Time, the UP function shall handle the rule as defined in 2) and then as defined in 1).
- 5) If both Activation Time and Deactivation Time are specified but time has already occurred for both, and the Activation Time occurs before the Deactivation Time, then the UP function shall immediately set the PDR rule inactive.

NOTE 1: If the CP function receives both Rule-Activation-Time and Rule-Deactivation-Time from the PCRF, but time has already occurred for both, and the Rule-Activation-Time occurs before the Rule-Deactivation-Time, as alternative to above, the CP function can deactivate the corresponding PDR rule by provisioning a Deactivation Time which has occurred or removing the corresponding PDR rule.

- 6) If both Activation Time and Deactivation Time are specified but time has passed for both, and the Deactivation Time occurs before the Activation Time, then the UP function shall immediately set the PDR rule active.

NOTE 2: If the CP function receives both Rule-Activation-Time and Rule-Deactivation-Time from the PCRF, but time has passed for both, and the Rule-Deactivation-Time occurs before the Rule-Activation-Time, as alternative to above, the CP function can activate the corresponding PDR rule by provisioning a activation Time which has occurred in the Update PDR IE, or create the corresponding PDR rule if the PDR is not provisioned yet.

5.4.15 Packet Rate enforcement

5.4.15.1 General

Packet rate enforcement refers to the process of limiting the rate of uplink and/or downlink packets allowed to be sent for a PDN connection or a PDU session.

Packet rate enforcement shall be used to support:

- APN rate control for UE's all PDN connections for a given APN in EPC, see 3GPP TS 23.401 [14] and 3GPP TS 23.502 [29]. APN rate control is enforced across N4 interface only for 5GC interworking with EPC scenario (see clause 4.3 in 3GPP TS 23.501 [28]);
- Small data rate control for a PDU session in 5GC, see 3GPP TS 23.501 [28] and 3GPP TS 23.502 [29];
- Serving PLMN rate control, for downlink traffic, see 3GPP TS 23.401 [14] and 3GPP TS 23.501 [28].

5.4.15.2 Packet rate enforcement over Sxb and N4 interfaces

The CP function may instruct the UP function to perform packet rate enforcement, during the establishment or the modification of a PFCP session, over the Sxb and N4 reference points.

The CP function shall control packet rate enforcement in the UP function by:

- 1) creating the necessary PDR(s) to represent the uplink or downlink traffic to be enforced, if not already existing;
- 2) creating QER(s) containing the Packet Rate IE with one or more of the following enforcement rules and information:
 - Maximum Uplink/Downlink Packet Rates (i.e. Number of Uplink/Downlink Packets Allowed and Time units that determine the time periods for limiting the packet rates);
 - Additional Maximum Uplink/Downlink Packet Rates (i.e. Number of Additional Uplink/Downlink Packets Allowed and Time units that determine the time periods for limiting the packet rates), if additional packets are allowed to be sent beyond the maximum Uplink/Downlink Packet Rates;

The QER may also contain the Packet Rate Status IE to indicate remaining numbers of allowed packets until a given time.

The QER may also contain the QER Control Indications IE with the Rate Control Status Reporting (RCSR) flag, indicating the UP function shall report to the CP function the status of the packet rate usage when the PFCP session is released.

- 3) associating the QER(s) to the UL and/or DL PDRs of the traffic for which packet rate enforcement is required.

When so instructed, the UP function shall proceed as follows:

- 1) the UP function shall count UL/DL packets within the time period (e.g. per minute, per day, etc.) and if the 'maximum allowed rate' is reached, the UP function shall discard or delay further packets.
- 2) If 'Additional Maximum Uplink/Downlink Packet Rates' are provided, the UPF shall consider 'maximum allowed rate' is equal to the 'number of packets per time unit' plus the 'number of additional allowed exception report packets per time unit'. Otherwise, the UPF shall consider 'maximum allowed rate' is equal to the 'number of packets per time unit'.
- 3) If the CP function has requested to report the rate control status, the UP function shall send to the CP function the Packet Rate Status IE, when the PFCP session is released. Otherwise, the UP function shall not send the Packet Rate Status IE to the CP function during the release of the PFCP session.
- 4) If the CP function provided Packet Rate Status information, then the UP function shall first enforce the rules in the Packet Rate Status IE until either the packet rate limits are reached, or the validity time expires. Only after this shall the UP function enforce the rules in the Packet Rate IE.

5.4.15.3 PGW and SMF behaviour

A PGW, SMF or SMF/PGW shall apply APN rate control, Small Data Rate Control and Serving PLMN rate control by instructing the UP function to perform packet rate enforcement as described in clause 5.4.15.2 with the following additions:

- Serving PLMN rate control:
 - the Maximum Downlink Packet Rate shall be set to the DL rate permitted by the Serving PLMN rate control parameters;
 - the CP function shall indicate to the UP function to not report the status of the packet rate usage.

NOTE 1: Serving PLMN rate control applies only to control plane PDU sessions and PDN connections. Uplink rate for Serving PLMN rate control is enforced by the MME or SMF, so it does not require support from the UP function.

- Small Data Rate Control:
 - the CP function shall indicate to the UP function to report the status of the packet rate usage;
 - the QER shall be associated to all the DL/UL PDRs of the PDU session;
- APN rate control:
 - the CP function shall indicate to the UP function to report the status of the packet rate usage;
 - the QER shall be associated to all the PDRs of all the PDN connections of the UE to the same APN, using the QER Correlation ID (see clause 5.2.1).

If both Serving PLMN rate control and Small Data Rate Control are applied in 5GS, or both Serving PLMN rate control and APN rate control are applied in EPS, the SMF/PGW-C may control packet rate enforcement in the UP function by provisioning:

- a QER for Small Data Rate Control/APN rate control, and by associating DL/UL PDRs to the QER; or
- alternatively, different QERs for Serving PLMN rate control and for Small Data Rate Control/APN rate control, and by associating DL PDRs to both of the QER(s).

APN rate control and Small Data Rate Control are distinct functionalities that apply in EPS and 5GS respectively. For PDU sessions supporting interworking with EPC, the SMF/PGW-C shall start APN rate control (if required for the UE's

PDN connections to the APN) and stop Small Data Rate Control (if this was performed for the PDU session) upon 5GS to EPS mobility, and vice-versa upon EPS to 5GS mobility, e.g. by:

- updating the information of the QER associated to the UL/DL PDRs with the packet rates and packet rate status (if available) applicable for APN rate control or Small Data Rate Control respectively, if the same QER is associated to UL/DL PDRs when the UE is in EPC and in 5GC; in this case, the SMF/PGW-C shall also request the UPF/PGW-U to report immediately the packet rate status at the time of the mobility between 5GS and EPS by including the Query Packet Rate Status IE in the PFCP Session Modification Request; or

NOTE 2: Requesting the UPF/PGW-U to report immediately the packet rate status enables to retrieve the current rate status applicable to the source system before the UPF/PGW-U overwrites the QER parameters with the packet rates and packet rate status (if available) applicable to the target system.

- provisioning different QERs for APN rate control and for Small Data Rate Control, and by associating UL/DL PDRs to the appropriate QER, when the UE is in EPC or in 5GC. In this case, when releasing the PFCP session, the UP function shall include the packet rate status for every QER for which this information has been requested in the corresponding QER Control Indications IE.

Besides, if the SMF/PGW-C set up additional PDRs in the UP function for S5/S8 tunnels for a PDU session supporting interworking with EPS, these PDRs shall not be associated to the QER used to perform Small Data Rate Control.

5.4.16 QoS differentiation for Stand-alone Non-Public Network (SNPN)

5.4.16.1 General

Support of QoS differentiation for SNPN is described in clause 5.30.2.7 and clause 5.30.2.8 of 3GPP TS 23.501 [28].

QoS differentiation procedures as described in the following clauses are optional and may be used when:

- UE access to PLMN services via SNPN;
- UE access to SNPN services via PLMN.

5.4.16.2 Access to PLMN services via SNPN

The N3IWF in the PLMN uses the QoS profile and the Session-AMBR it receives from the SMF in the PLMN along with the mapping agreed in the SLA to derive a specific DSCP value for the User Plane IPsec Child SA.

The SMF in SNPN shall provide PDR to the UPF in SNPN, based on the mapping rules including the mapping between the DSCP markings for the IPsec child SAs on NWu and the corresponding QoS requirement of the PLMN. The PDR may include an Application ID to detect the packets associated with specific DSCP and N3IWF IP address to the UPF for detecting the DL traffic.

The SMF in SNPN may provide the QER associated to the PDR to ensure the QoS for the DL traffic if the related QoS Flow has been established in the SNPN. Otherwise, the SMF in SNPN may provide the URR associated to the PDR to request the reporting of the detected DL traffic, which may be used by the SMF in SNPN to trigger the PDU session modification procedure to establish the DL traffic related QoS Flow in SNPN. The URR may include the Reporting trigger "Start of Traffic" to enable the UPF sending Usage report with the usage report trigger "START" to the SMF upon detection of the DL traffic with such DSCP and N3IWF IP address.

NOTE: The UPF detects the start or stop of an application based on the traffic matching the Application ID in the associated PDR and send Usage report with the usage report trigger "START" or "STOP" to the SMF if the SMF instructs the UPF to report the start or stop of an application in URR, the UPF also supports the detection of the DL traffic with DSCP and N3IWF IP address that is associated with the Application ID, which is configured in the UPF based on operator policy.

The SMF in SNPN may also provide DSCP within the Transport Level Marking IE in the FAR that is associated to the PDR. UPF in SNPN shall perform the DSCP re-marking for the detected traffic and sends the marked packet to the NG-RAN.

5.4.16.3 Access to SNPN services via PLMN

The N3IWF in the SNPN uses the QoS profile and the Session-AMBR it receives from the SMF in the SNPN along with the mapping agreed in the SLA to derive a specific DSCP value for the User Plane IPsec Child SA.

The SMF in PLMN shall provide PDR to the UPF in PLMN, based on the mapping rules including the mapping between the DSCP markings for the IPsec child SAs on NWu and the corresponding QoS requirement of the SNPN. The PDR may include an Application ID to detect the packets associated with specific DSCP and N3IWF IP address to the UPF for detecting the DL traffic.

The SMF in PLMN may provide the QER associated to the PDR to ensure the QoS for the DL traffic if the related QoS Flow has been established in the PLMN. Otherwise, the SMF in PLMN may provide the URR associated to the PDR to request the reporting of the detected DL traffic, which may be used by the SMF in PLMN to trigger the PDU session modification procedure to establish the DL traffic related QoS Flow in PLMN. The URR may include the Reporting trigger "Start of Traffic" to enable the UPF sending Usage report with the usage report trigger "START" to the SMF upon detection of the DL traffic with such DSCP and N3IWF IP address.

NOTE: The UPF detects the start or stop of an application based on the traffic matching the Application ID in the associated PDR and send Usage report with the usage report trigger "START" or "STOP" to the SMF if the SMF instructs the UPF to report the start or stop of an application in URR, the UPF also supports the detection of the DL traffic with DSCP and N3IWF IP address that is associated with the Application ID, which is configured in the UPF based on operator policy.

The SMF in PLMN may also provide DSCP within the Transport Level Marking IE in the FAR that is associated to the PDR. UPF in PLMN shall perform the DSCP re-marking for the detected traffic and sends the marked packet to the NG-RAN.

5.4.17 QoS differentiation for UEs behind RG

Support of QoS differentiation for UEs behind RG is described in clause 4.10 and Annex B of 3GPP TS 23.316 [57].

QoS differentiation for UEs behind RG may be supported as described in clause 5.4.16.2 for the access to PLMN services via a SNPN, with the PLMN and SNPN being replaced by the UE's 5GC and the RG's 5GC respectively.

5.5 F-TEID Allocation and Release

5.5.1 General

For EPC and 5GC, F-TEID shall be only allocated by the UP function, see clause 5.8.2.3 of 3GPP TS 23.501 [28].

The UP function shall set the FTUP feature flag in the UP Function Features IE (see clause 8.2.25) and the CP function shall request the UP function to allocate the F-TEID. The UP function shall reject a request to establish a new PDR with an F-TEID allocation in the CP function option, with the cause "Invalid F-TEID allocation option". As an exception, the UP Function shall accept the PFCP Session Establishment Request message with a PDR including an existing F-TEID to re-establish a PFCP session during a restoration procedure as specified in clause 4.3.2 of 3GPP TS 23.527 [40] and clauses 16.1A.4 and 17.1A.4 of 3GPP TS 23.007 [24].

5.5.2 Void

5.5.3 F-TEID allocation in the UP function

The CP function shall request the UP function to allocate the F-TEID by setting the CHOOSE flag in the Local F-TEID IE of the PDR IE (see Table 7.5.2.2-1). The Source Interface IE indicates for which interface the F-TEID is to be assigned.

The CP function may request the UP function to allocate the same F-TEID to several PDRs to be created within one single PFCP Session Establishment Request or PFCP Session Modification Request by:

- setting the CHOOSE flag in the Local F-TEID IE of each PDR to be created with a new F-TEID; and

- setting the CHOOSE ID field of the Local F-TEID IE, for each PDR to be created with the same F-TEID, with the same CHOOSE ID value;

or, if the UP function indicated support of the PDI optimization (see clause 8.2.25), by:

- including the Local F-TEID IE only in the Create Traffic Endpoint IE and by setting the CHOOSE flag in the Local F-TEID IE of this IE; and
- including the Traffic Endpoint ID in all the PDRs to be created with the same F-TEID.

If the PDR(s) is created successfully, the UP function shall return the F-TEID(s) it has assigned to the PDR(s) or to the Traffic Endpoint(s) in the PFCP Session Establishment Response or PFCP Session Modification Response.

Upon receiving a request to remove a PDR or a Traffic Endpoint, or to delete a PFCP session, the UP function shall free the F-TEID(s) that was assigned to the PDR if there is no more PDR with the same F-TEID, to the Traffic Endpoint or to the PFCP Session.

When using redundant GTP-U transmission on N3/N9 interfaces (see clause 5.24.2), the CP function shall request the UP function to allocate the F-TEID for the redundant GTP-U tunnel following the same requirements as specified in this clause, using the "Local F-TEID for Redundant Transmission" IE instead of the "Local F-TEID" IE.

5.6 PFCP Session Handling

5.6.1 General

The following clauses provide details on PFCP Sessions handling.

5.6.2 Session Endpoint Identifier Handling

The SEID uniquely identifies a PFCP session at an IP address of a PFCP entity. The F-SEID is the Fully Qualified SEID and it contains the SEID and IP address. The PFCP endpoint locally assigns the SEID value the peer PFCP side has to use when transmitting message. The SEID values are exchanged between PFCP endpoints using PFCP messages. The PFCP entity communicates to the peer PFCP entity the SEID value at which it expects to receive all subsequent control plane messages related to that PFCP session via the "F-SEID" IE.

The PFCP session related messages shall share the same F-SEID for the PFCP session. An F-SEID shall be released after the PFCP session is released.

5.6.3 Modifying the Rules of an Existing PFCP Session

The following principles shall apply, unless specified otherwise in the specification.

When modifying an existing PFCP session, the CP function shall only provide in the PFCP Request message the requested changes compared to what was previously provisioned in the UP function for this PFCP session, i.e. the CP function shall:

- include IEs which needs to be newly provisioned in the UP function;
- include IEs which need to be provisioned with a modified value;
- remove IEs which need to be removed from the set of parameters previously provisioned in the UP function, as further specified below.

The CP function shall remove IEs which needs to be removed by either:

- removing the entire Rule if no other parameter of that rule needs to remain provisioned in the UP function, e.g. by including the Remove URR IE in the PFCP Session Modification Request; or
- updating the Rule including the IEs to be removed with a null length, e.g. by including the Update URR IE in the PFCP Session Modification Request with the IE(s) to be removed with a null length. For an IE with multiple occurrences, e.g. when the description of the IE contains the text "several IEs with the same IE type may be

present", one occurrence of such an IE with a null length shall result in removing all the IEs with the same IE type.

The CP function shall set a URR ID and/or QER ID with a length "0" in the Update PDR IE within PFCP Session Modification Request, to request the UP function to stop applying the URRs and/or QERs for this PDR.

Upon receipt of a PFCP Request which modifies an existing PFCP session, the UP function shall add, update or remove the parameters as instructed by the CP function, as defined above, and shall keep unchanged the set of parameters previously provisioned in the UP function which are neither modified nor removed.

5.7 Support of Lawful Interception

5.7.1 General

This clause specifies lawful interception with PFCP in EPC.

5.7.2 Lawful Interception in EPC

Requirements for support of Lawful Interception with a split SGW or PGW are specified in clauses 12.9 and 20.4 of 3GPP TS 33.107 [20].

User plane packets shall be forwarded from the UP function to the SX3LIF (or LMISF for S8HR) by encapsulating the user plane packets using GTP-U encapsulation (see 3GPP TS 29.281 [3]).

The CP function shall instruct the UP function to duplicate the packets to be intercepted and to forward them to the SX3LIF (or to the LMISF for S8HR) as specified in clause 5.2.3.

For forwarding data from the UP function to the SX3LIF (or LMISF for S8HR), the CP function shall set the DUPL flag in the Apply Action and set the Duplicating Parameters in the FAR, associated to the PDRs of the traffic to be intercepted, with the Destination Interface "LI Function" and set to perform GTP-U encapsulation and to forward the packets to a GTP-u F-TEID uniquely assigned in the SX3LIF (or LMISF for S8HR) for the traffic to be intercepted. The SX3LIF (or LMISF for S8HR) shall then identify the intercepted traffic by the F-TEID in the header of the encapsulating GTP-U packet.

5.7.3 Lawful Interception in 5GC

Requirements for support of Lawful Interception with SMF and UPF are specified in clause 6.2.3 of 3GPP TS 33.127 [47]. The PFCP protocol is not used for Lawful Interception in 5GC.

5.8 PFCP Association

5.8.1 General

A PFCP Association shall be set up between the CP function and the UP function prior to establishing PFCP sessions on that UP function. Only one PFCP association shall be setup between a given pair of CP and UP functions, even if the CP and/or UP function exposes multiple IP addresses. A single PFCP association may also be setup between a SMF set and a UPF (see clause 5.22.2).

The CP function and the UP function shall support the PFCP Association Setup procedure initiated by the CP function (see clause 6.2.6.2). The CP function and the UP function may additionally support the PFCP Association Setup procedure initiated by the UP function (see clause 6.2.6.3).

A CP function may have PFCP Associations set up with multiple UP functions. A UP function may have PFCP Associations set up with multiple CP functions.

In PFCP signaling, a CP function or a UP function shall be identified by a unique Node ID. A Node ID may be set to an FQDN or to an IP address (either IPv4 or IPv6, see clause 8.2.38). When set to an IP address, it indicates that the CP/UP function only exposes one IP address for the PFCP Association signalling. Once a PFCP association is set up between a CP function and a UP function, the same Node ID as signaled respectively by the CP function and the UP

function during the PFCP association setup procedure shall be used in all subsequent PFCP node related messages (other than Heartbeat messages) until the PFCP association is released.

NOTE 1: The control of a PFCP session can be taken over by a new SMF in an SMF set as specified in clause 5.22. When using the MPAS feature (see clause 5.22.3), when a different SMF takes over the control of the PFCP session, the UP function receives the NODE ID of the new SMF that is different from the NODE ID of the SMF that was handling the PFCP session earlier.

The PFCP entities shall accept any new IP address allocated as part of F-SEID other than the one(s) communicated in the Node Id.

NOTE 2: The source IP address to send PFCP Association Setup request can not be used as the destination IP address when the peer sends a PFCP Association Update Request message, e.g. for a scenario when a NAT is deployed in the network.

Prior to establishing a PFCP Association, the function responsible for establishing the PFCP Association (e.g. CP function) shall look up a peer function (e.g. UP function), e.g. using DNS procedures (see 3GPP TS 29.303 [25]), NRF procedures (see 3GPP TS 29.510 [43]) or local configuration. If the peer function is found to support multiple IP addresses (in the look up information), one of these addresses (any one) shall be used as destination IP address to send the PFCP Association Setup Request. Once the PFCP Association is established, any of the IP addresses of the peer function (found during the look-up) may then be used to send subsequent PFCP node related messages and PFCP session establishment requests for that PFCP Association.

NOTE 3: The look up information (e.g. in DNS, NRF or local configuration of the function responsible for establishing the PFCP association) needs to be configured consistently with the addressing information of the peer function. If a FQDN is configured to identify a function in DNS or NRF, then the Node ID of that function included in PFCP messages need to be set to the same FQDN. For instance, if the CP function is responsible for establishing the PFCP association, a UP function that exposes multiple IP addresses (for PFCP node related messages and PFCP session establishment requests) needs to be configured in the look up information as one (single) UP function that is associated to multiple IP addresses. The Node ID needs to be set to an SMF set FQDN when a single association is setup between an SMF set and UPF (see clause 5.22.2).

NOTE 4: PFCP session related messages for sessions that are already established are sent to the IP address received in the F-SEID allocated by the peer function or to the IP address of an alternative SMF in the SMF set (see clause 5.22). The former IP address needs not be configured in the look up information. See clauses 4.3.2 and 4.3.3.

5.8.2 Behaviour with an Established PFCP Association

When a PFCP Association is established with a UP function, the CP function:

- shall provision node related parameters (i.e. parameters that apply to all PFCP sessions) in the UP function, if any, e.g. PFDs;
- shall provision the UP function with the list of features (affecting the UP function behaviour) the CP function supports, if any, e.g. support of load and/or overload control;
- shall check the responsiveness of the UP function using the Heartbeat procedure as specified in clause 6.2.2;
- may establish PFCP sessions on that UP function;
- shall refrain from attempting to establish new PFCP sessions on the UP function, if the UP function has indicated it will shut down gracefully.

When a PFCP Association is established with a CP function, the UP function:

- shall update the CP function with the list of features it supports;
- shall update the CP function with its load and/or overload control information, if load and/or overload control is supported by the CP and UP functions;
- shall accept PFCP Session related messages from that CP function (unless prevented by other reasons, e.g. overload);

- shall check the responsiveness of the CP function using the Heartbeat procedure as specified in clause 6.2.2;
- shall indicate to the CP function if it will shut down within a graceful period and, when possible, if it fails and becomes out of service;
- may report UE IP address usage information to the CP function, if UE IP addresses are allocated by the UP function and the UE IP Address Usage Reporting feature is supported by the CP function (see clause 5.21.3.2).

5.8.3 Behaviour without an Established PFCP Association

When a PFCP Association is not established with a UP function, the CP function:

- shall reject any incoming PFCP Session related messages from that UP function, with a cause indicating that no PFCP association exists with the peer entity.

When a PFCP Association is not yet established with a CP function, the UP function:

- shall reject any incoming PFCP Session related messages from that CP function, with a cause indicating that no PFCP association exists with the peer entity.

5.9 Usage of Vendor-specific IE

Vendor-specific IEs are defined to cover requirements and features not specified by 3GPP.

NOTE 1: When an IE is intended to be used by more than one vendor, the definition of the IE is encouraged to be specified by 3GPP to ease implementation and interoperability.

NOTE 2: The PFCP entities can use Vendor-specific IE(s) in the PFCP message relevant to the PFCP Association Setup procedure to learn which vendor specific enhancements are supported by the peer.

Vendor-specific IE may be sent with any PFCP message. Vendor-specific IE may be added directly to a PFCP message, or by embedding it into a grouped IE.

In a network with Vendor specific enhancements, unrecognized vendor specific IEs shall be handled as unknown optional IEs.

5.10 Error Indication Handling

Upon receipt of a GTP-U Error Indication message, the UP function:

- shall identify the related PFCP session for which the message is received; and
- shall initiate a PFCP Session Report procedure, towards the CP function controlling this PFCP session, to send an Error Indication Report including the remote F-TEID signalled in the GTP-U Peer Address IE and the Tunnel Endpoint Identifier Data I IE of the GTP-U Error Indication (see clause 7.3.1 of 3GPP TS 29.281 [3]).

For EPC, upon receipt of an Error Indication Report, the CP function shall then identify the bearer for which the Error Indication Report is received using the remote F-TEID included in the report and proceed as specified in clauses 21.7 and 21.8 of 3GPP TS 23.007 [24], i.e.:

- modify the PFCP session to instruct the UP function to buffer DL packets;
- modify the PFCP session to delete the PDR and FAR, when having to delete a bearer; or
- delete the PFCP session, when having to delete the PDN connection.

For 5GC, upon receipt of an Error Indication Report, the SMF shall proceed as specified in clause 5.3 of 3GPP TS 23.527 [40].

5.10A User Plane Path Failure or Recovery Handling

Upon detection of user plane path failure or recovery, the UP function shall initiate PFCP Node Report procedure, towards the CP function controlling the affected PFCP sessions, to send a User Plane Path Failure Report or a User Plane Path Recovery Report including the IP address of the remote GTP-U peer towards which a user plane path failure or recovery has been detected.

For EPC, upon receipt of a User Plane Path Failure Report or a User Plane Path Recovery Report, the CP function shall proceed as specified in clause 20.3 of 3GPP TS 23.007 [24].

For 5GC, upon receipt of a User Plane Path Failure Report or a User Plane Path Recovery Report, the SMF shall proceed as specified in clauses 5.4 of 3GPP TS 23.527 [40].

5.11 User plane inactivity detection and reporting

5.11.1 General

This clause specifies the support of user plane inactivity detection and reporting.

5.11.2 User plane inactivity detection and reporting per PDN connection or PDU session

Clause 5.4.4.1 of 3GPP TS 23.401 [14] requires the PGW to initiate the release of an inactive emergency PDN connection.

Clauses 4.3.7 and 4.3.2.2.2 of 3GPP TS 23.502 [29] require the SMF to be able to initiate the deactivation of the UP connection of an existing PDU session without user plane activity for a given inactivity period, except for the H-SMF for the home routed roaming scenario or except for an always-on PDU session as described in clause 5.6.8 of 3GPP TS 23.501 [28].

Clauses 4.3.5.7, 4.23.9.4 and 4.23.9.5 of 3GPP TS 23.502 [29] requires the SMF to be able to initiate the deactivation of the UP connection of an existing PDU session in source UL CL or source UPF (e.g. PSA2) if no active traffic over the N9 forwarding tunnel is detected and reported by the Source UL CL. Clause 4.23.9.4 of 3GPP TS 23.502 [29] also requires the SMF to release the N9 forwarding tunnel of an existing PDU session in the target UL CL/BP if no active traffic over the N9 forwarding tunnel is detected and reported by the Source UL CL.

Clause 7.2.5.3 of 3GPP TS 23.247 [72] requires the MB-SMF to be able to initiate the deactivation of an MBS session without user plane activity.

Clauses 5.15.7.4 and 5.15.15.3 of 3GPP TS 23.501 [28] require the SMF that supports network slice usage behaviour control, to be able to configure slice specific inactivity timer for the PDU session at the UPF and initiate the release of the PDU session without user plane activity for a given slice specific inactivity time, based on the User Plane Inactivity Report from the UPF. If the slice specific inactivity timer for the PDU session is updated at SMF, the SMF shall update the UPF with the new inactivity timer for the PDU session.

NOTE: For multi-access PDU session(s), the PDU session inactivity timer is independent of the access type.

The CP function may request the UP function to detect and report when no user plane packets are received for a PFCP session, by provisioning the User Plane Inactivity Timer IE in the PFCP Session Establishment Request or PFCP Session Modification Request. The CP function may update the User Plane Inactivity Timer in the subsequent PFCP Session Modification Request messages.

Upon being provisioned with this IE, if the timer value is not zero, the UP function shall monitor the user plane activity of the PFCP session and report any user plane inactivity exceeding the duration indicated by this IE by sending a PFCP Session Report Request with the Report Type set to UPIR (User Plane Inactivity Report). When the UP function receives an updated User Plane Inactivity Timer from the CP function, the UP function shall immediately update the PDU Session inactivity timer and:

- send a User Plane Inactivity Report if the user plane inactivity has already exceeded the updated User Plane Inactivity Timer; or

- use the updated User Plane Inactivity Timer for monitoring user plane activity.

After sending the User Plane Inactivity Report, the UP function shall stop monitoring the user plane activity of the PFCP session (i.e. the UPF shall behave as if the User Plane Inactivity Timer has not been provisioned), and shall then continue to process any further user plane packets as instructed by the rules provisioned for the PFCP session, until receiving any new instruction from the CP function.

5.11.3 User plane inactivity detection and reporting per PDR

Clause 4.23.9.5 of 3GPP TS 23.502 [29] requires the target I-SMF to be able to initiate the release of the N9 forwarding tunnel of an existing PDU session in the target UL CL/BP if no active traffic over the N9 forwarding tunnel is detected and reported by the target UL CL/BP.

When both the CP function and the UP function support the UPIDP feature (see clause 8.2.25), the CP function may request the UP function to detect and report when no user plane packets are received for one or more PDRs, by provisioning a URR including the User Plane Inactivity Timer IE and by associating this URR with the PDR(s) in a PFCP Session Establishment Request or PFCP Session Modification Request.

Upon being provisioned with this URR, the UP function shall monitor the user plane activity of all the PDR(s) associated with the URR and report user plane inactivity when no traffic has been received for any PDR(s) associated with the URR for the duration indicated in the User Plane Inactivity Timer IE by sending a PFCP Session Report Request with the Report Type set to USAR (Usage Report) and with the Usage Report Trigger IE set to UPINT (User Plane Inactivity Timer).

5.12 Suspend and Resume Notification procedures

Upon receipt of a Suspend Notification message, the PGW-C should request the PGW-U to discard packets received for the suspended PDN connection by:

- setting the DROP flag in the Apply Action IE of the FARs of the corresponding PFCP session; or
- setting the gate fields in the Gate Status IE of QERs to the value CLOSED.

Upon being requested to resume the PDN connection, the PGW-C should re-allow the PGW-U to forward the packets for the PDN connection (unless not permitted for other reasons) by:

- setting the FORW flag in the Apply Action IE of the FARs of the corresponding PFCP session; or
- setting the gate fields in the Gate Status IE of QERs to the value OPEN.

5.13 Ethernet traffic (for 5GC)

5.13.1 General

An SMF and UPF may support Ethernet PDU sessions, as specified in clause 5.6.10.2 of 3GPP TS 23.501 [28].

A combined PGW-C/SMF and PGW-U/UPF may support Ethernet PDU sessions as specified in clause 4.3.17.8a of 3GPP TS 23.401 [14] and clause 5.6.10.2 of 3GPP TS 23.501 [28]. In this case, the PGW-C/SMF and PGW-U/UPF shall follow, respectively, the requirements specified for the SMF and UPF by this clause.

For a PFCP session set up for an Ethernet PDU session, the SMF shall:

- include the PDN Type IE set to "Ethernet" in the PFCP Session Establishment Request;
- provision PDR(s), for uplink and/or downlink traffic, with Ethernet Packet Filter(s), based on at least any combination of:
 - Source/destination MAC address;
 - Ethertype as defined in IEEE 802.3 [31];

- Customer-VLAN tag (C-TAG) and/or Service-VLAN tag (S-TAG) VID fields as defined in IEEE 802.1Q [30];
- Customer-VLAN tag (C-TAG) and/or Service-VLAN tag (S-TAG) PCP/DEI fields as defined in IEEE 802.1Q [30];
- IP Packet Filter Set, in case Ethertype indicates IPv4/IPv6 payload;
- Ethernet PDU Session Information, only possible for a DL PDR, that identifies all (DL) Ethernet packets matching the PDU session as follows, based on the N6 Ethernet configuration in the UPF for the associated Network Instance (see clause 5.6.10.2 of 3GPP TS 23.501 [28]):
 - DL traffic based on the MAC address(es) and/or C-TAG and/or S-TAG used by the UE for the UL traffic, for configurations where more than one PDU Session to the same DNN (e.g. for more than one UE) corresponds to the same N6 interface;
 - DL traffic from the N6 interface associated to the PDU session, for configurations where there is a one-to-one relationship between a PDU Session and a N6 interface (in which case the UPF does not need to be aware of MAC addresses and/or C-TAG and/or S-TAG used by the UE in order to route down-link traffic).

NOTE 1: For instance, the SMF can provision a DL PDR with just an "Ethernet PDU Session Information", in a Traffic Endpoint ID or in a PDI, or Ethernet Packet Filters in a PDI, or both an "Ethernet PDU Session Information" in a Traffic Endpoint ID and Ethernet Packet Filters in a PDI.

The SMF may also request a UPF, acting as a PDU session anchor, to:

- redirect Address Resolution Protocol (ARP) (see IETF RFC 826 [32]) or IPv6 Neighbour Solicitation traffic (see IETF RFC 4861 [33]) to the SMF as specified in clause 5.13.2, or to respond to ARP or IPv6 Neighbour Solicitation based on the local cache information as specified in clause 5.13.3;
- report the MAC (Ethernet) addresses and possibly associated VLAN tag(s) used as source address of frames sent UL by the UE, as specified in clause 5.13.5;
- update its list of MAC addresses and possibly associated VLAN tag(s) associated to the PDU session, during an Ethernet PDU session anchor relocation, as specified in clause 5.13.6.

For a PFCP session set up for an Ethernet PDU session, the UPF shall:

- detect Ethernet traffic, based on Ethernet Packet Filter(s) provisioned in PDR(s) by the SMF, and process the Ethernet traffic as instructed in the FAR, QER(s) and URR(s) associated to the PDR(s);
- forward Address Resolution Protocol (see IETF RFC 826 [32]) or IPv6 Neighbour Solicitation messages (see IETF RFC 4861 [33]) to the SMF, as specified in clause 5.13.2, if so required by the SMF;
- respond to Address Resolution Protocol (see IETF RFC 826 [32]) or IPv6 Neighbour Solicitation (see IETF RFC 4861 [33]) based on the local cache information, as specified in clause 5.13.3, if so required by the SMF.

NOTE 2: Ethernet Preamble and Start of Frame delimiter are not sent over 5GS.

NOTE 3: How the UPF/SMF builds the ARP or the IPv6 Neighbour cache is not specified in this release and is implementation specific.

5.13.2 Address Resolution Protocol or IPv6 Neighbour Solicitation Response by SMF

If the SMF requests the UPF to forward all Address Resolution Protocol (ARP) (see IETF RFC 826 [32]) or IPv6 Neighbour Solicitation (see IETF RFC 4861 [33]) traffic to the SMF to respond to the ARP or IPv6 Neighbour Solicitation based on the local cache information for Ethernet PDU sessions, the SMF shall provision a PDR in the UPF with:

- an Ethernet Packet Filter containing EtherType 2054 (hexadecimal 0x0806) and associate the PDR with a FAR, for forwarding ARP traffic to the SMF; and/or

- a PDI containing an application ID such that the identified application ID matches against EtherType 34525 (hexadecimal 0x86DD), IPv6 Next Header type as 58 and ICMP Field Type as 135 and associate the PDR with a FAR, for forwarding IPv6 Neighbour Solicitation traffic to the SMF.

In this case, the user plane packets shall be forwarded between the CP and UP functions by encapsulating the user plane packets using GTP-U encapsulation (see clause 5.3.1).

The SMF shall respond to ARP and/or IPv6 Neighbour Solicitation as specified in 3GPP TS 23.501 [28], clause 5.6.10.2 in this case.

5.13.3 Address Resolution Protocol or IPv6 Neighbour Solicitation Response by UPF

If the SMF requests the UPF to respond to Address Resolution Protocol (ARP) (see IETF RFC 826 [32]) or IPv6 Neighbour Solicitation (see IETF RFC 4861 [33]) based on the local cache information for an Ethernet PDU session, the SMF shall provision a PDR in the UPF with:

- an Ethernet Packet Filter containing EtherType 2054 (hexadecimal 0x0806) and associate the PDR with a FAR that has the ARP bit in Proxying IE of the Forwarding Parameters IE set to "1"; or
- a PDI containing an application ID such that the identified application ID matches against EtherType 34525 (hexadecimal 0x86DD), IPv6 Next Header type as 58 and ICMP Field Type as 135 and associate the PDR with a FAR that has the INS bit in Proxying IE of the Forwarding Parameters IE set to "1".

The UPF shall respond to ARP and/or IPv6 Neighbour Solicitation as specified in 3GPP TS 23.501 [28], clause 5.6.10.2 in this case.

5.13.3A Provisioning of MAC addresses and SDF filters in Ethernet Packet Filters

The provisioning of an SDF Filter in an Ethernet Packet Filter shall follow the requirements specified for provisioning an SDF Filter in clause 5.2.1A.2A.

NOTE The Ethernet Flow Description received from the PCF is set assuming downlink flows only, see clause 5.6.2.14 of 3GPP TS 29.512 [41]. The CP function uses the flowDirection attribute received from the PCF to determine the actual direction and thus the source interface of the ethernet packet flows described in the Ethernet Flow Description.

Likewise, the source and destination MAC addresses information, when provisioned, shall be set as for downlink Ethernet flows. The UP function shall apply source and destination MAC addresses information based on the Source Interface of the PDR, according to the same principles as specified in clause 5.2.1A.2A, e.g. swapping the source and destination MAC addresses information if the Source Interface is ACCESS, and applying them as provisioned if the Source Interface is CORE.

5.13.4 Bidirectional Ethernet Filters

The CP function may provision bidirectional Ethernet Filters in the UP function (see table 7.5.2.2-3), i.e. Ethernet filters that may be associated to both uplink and downlink PDRs of a same PFCP session, as follows:

- when provisioning a bidirectional Ethernet Filter the first time for a PFCP session, the CP function shall set the BIDE (Bidirectional Ethernet Filter) flag in the Ethernet Filter Properties IE and provision the Ethernet filter definition together with a Ethernet Filter ID uniquely identifying the Ethernet Filter among all the Ethernet Filters provisioned for a given PFCP session; the source and destination MAC addresses information, in a bidirectional Ethernet filter, shall be set as for downlink Ethernet flows;
- the CP function may then provision a PDR for the same PFCP session but the opposite direction, by provisioning the Ethernet Filter ID in the Ethernet filter ID field of the PDI, without provisioning again the Ethernet Filter Properties and Ethernet filter definition.;
- when being provisioned with a bidirectional Ethernet Filter in a PDR, the UP function shall apply the Ethernet filter according to the direction of the PDR as specified in clause 5.13.3A, i.e. the UP function shall apply the

Ethernet filter parameters provisioned for the Ethernet filter ID, but with swapping the source and destination MAC addresses, and the source and destination IP addresses if any, if the PDR is set for uplink Ethernet flows;

- the UP function shall apply any modification of a bidirectional Ethernet Filter to all PDRs of the PFCP session making use of this Ethernet Filter;
- upon deletion of a PDR making use of a bidirectional Ethernet Filter, the UP function shall still apply the Ethernet Filter for any other PDR making use of the Ethernet Filter.

The requirements specified for provisioning of MAC addresses and SDF Filters in clause 5.13.A shall also apply when provisioning bidirectional Ethernet Filters.

5.13.5 Reporting of UE MAC addresses to the SMF

In a PFCP Session Establishment Request or a PFCP Session Modification Request, the SMF may request the UPF to start or stop (in a PFCP Session Modification Request only) reporting the UE MAC addresses, i.e. the different MAC (Ethernet) addresses used as source address of frames sent UL by the UE in a PDU Session, by:

- creating a URR requesting the UPF to report Ethernet traffic information (i.e. with the Reporting Trigger set to 'MAC Addresses Reporting'); and
- associating the URR to the PDR provisioned for the UL traffic of the PDU session.

The SMF may additionally request the UPF to detect and report when no user plane packets are received for an UE MAC address, by provisioning the Ethernet Inactivity Timer IE in the URR.

When being requested to start reporting the UE MAC addresses, the UPF shall:

- report immediately any UE MAC addresses (and possibly their associated VLAN tags) known to be associated to the PDU session (e.g. if the request to start monitoring of traffic is received after the PFCP session establishment and if the UPF monitors the UE MAC addresses for the routing of DL traffic);
- report new UE MAC addresses (and possibly their associated VLAN tags) that are detected subsequently;
- report UE MAC addresses (and possibly their associated VLAN tags) that are removed subsequently from the PDU session, based on the detection of absence of traffic during the Ethernet Inactivity Timer, if this timer is provisioned in the URR.

NOTE: Numerous UE MAC addresses can be used by a same PDU session. The UP function can defer a bit the reporting of newly detected or removed UE MAC addresses to allow the reporting of multiple UE MAC addresses in a same usage report. Details are implementation specific.

5.13.6 Ethernet PDU session anchor relocation

The UPF (PSA) of an Ethernet PDU session may be relocated as specified in clause 4.3.5.8 of 3GPP TS 23.502 [29].

A UPF that supports the Ethernet PDU session relocation procedure shall set the ETHAR bit in the UP Function Features (see clause 8.2.25).

If the UPF indicated support of Ethernet PDU session anchor relocation, the SMF may request the UPF to update its list of MAC addresses and possibly associated VLAN tag(s) associated to the PDU session, during an Ethernet PDU session relocation procedure, by sending a PFCP Session Modification Request with Ethernet context information including the MAC addresses (and possibly associated VLAN tag(s)) received from the old Ethernet PDU session anchor.

Upon receipt of such information, the UPF shall consider these MAC addresses (and possibly associated VLAN tag(s)) as associated to the PDU session and the UPF may assist in the update of Ethernet forwarding tables of Ethernet switches in the DN as specified in clause 4.3.5.8 of 3GPP TS 23.502 [29].

5.13.7 Handling of allowed VLAN tags and VLAN Handling Information

The stage 2 requirements related to the handling of allowed VLAN tags and VLAN Handling Information are specified in clauses 5.6.6 and 5.6.10.2 of 3GPP TS 23.501 [28] and clause 5.2.3.3.1 of 3GPP TS 23.502 [29].

The SMF may be provisioned with a list of allowed VLAN tags (for a maximum of 16 VLAN tags) from the UDM or the DN-AAA or may be locally configured for a PDU Session. If allowed VLAN tags are available for a PDU Session, the Ethernet packets (of the PDU session) shall be only allowed when the outer VLAN tag (which is the one closest to the Ethernet header) is set to one of the allowed VLAN tags. Based on local configuration for the DNN/S-NSSAI, e.g. depending on whether the DL Ethernet packets contains one tag (which is either a C-TAG or a S-TAG) or two tags (i.e. a S-TAG and a C-TAG), the SMF shall decide whether the allowed VLAN tags correspond to a C-TAG or S-TAG and the SMF shall provision them accordingly in the UPF in the C-TAG and/or S-TAG IEs in the Ethernet Packet Filter IE (see Table 7.5.2.2-3). Ethernet packets which are not matching any Ethernet Packet Filter shall be dropped by the UPF.

The SMF shall also determine instructions on VLAN handling, based on local configuration, or VLAN handling information in subscription data received from UDM, or VLAN handling information received from the DN-AAA, as specified in clause 5.6.10.2 of 3GPP TS 23.501 [28] and it shall then provision:

- an UL FAR containing the Outer Header Creation IE to insert a C-TAG and/or S-TAG for the UL packets; and
- a DL PDR with the Ethernet Packet Filter IE including the C-TAG and/or S-TAG which was inserted in the UL direction to match the DL packets and the Outer Header Removal IE to remove the C-TAG and/or S-TAG.

NOTE: The C-TAG and/or S-TAG included in the `vlanTagHandlingInfo` are considered allowed when the UPF performs packet matching for DL packets received over N6, therefore, these tags need not be included in the `vlanTagAllowed`.

For an Ethernet PDU session having both a list of allowed VLAN tags and VLAN handling information provisioned, the SMF shall proceed as specified above with the difference that the SMF shall provision a DL PDR comprising the VLAN tag (S-TAG) from the VLAN handling instructions and the allowed VLAN tag (C-TAG).

5.14 Support IPv6 Prefix Delegation

Clause 5.3.1.2.6 of 3GPP TS 23.401 [14], clause 4.6.2.3 of 3GPP TS 23.316 [57] and clause 5.8.2.2.4 of 3GPP TS 23.501 [28] specify requirements for IPv6 Prefix Delegation via DHCPv6, that allow assigning a single network prefix shorter than the default /64 prefix to a PDN connection or a PDU session.

The CP function shall assign, or request the UP function to assign (if the UP function indicates support of the UEIP feature, see clause 8.2.25), the network prefix shorter than the default /64 prefix by provisioning the UE IP Address IE in the UP function with:

- the IPv6D flag set to "1" and the IPv6 Prefix Delegation Bits field indicating the length of IPv6 Prefix for delegation (see clause 8.2.62); or
- the IP6PL flag set to "1" and the IPv6 Prefix Length field indicating the length of IPv6 Prefix for delegation (see clause 8.2.62), if the UP function supports the IP6PL feature (see clauses 5.21.1 and 8.2.25).

When UP function is requested to perform UE IP address allocation and IPv6 prefix delegation is used, the IPv6 prefix length may be determined by the CP function or the UP function:

- if it is determined by the CP function, the IPv6 Prefix Delegation Bits or IPv6 Prefix Length fields shall be set according to the desired IPv6 prefix length by the CP function;
- or if the IPv6 prefix length is determined by the UP function, the CP function shall set the IPv6 Prefix Delegation Bits or IPv6 Prefix Length fields to "0".

NOTE: The IPv6 prefix shorter than the default /64 prefix for IPv6 Prefix Delegation can include the /64 default prefix used for IPv6 stateless autoconfiguration (in EPS and 5GS) or not (5GS). In the former case, the total IPv6 address space available for the PDU Session can be aggregated into one single IPv6 prefix and the UP function needs not support the IP6PL feature. In the latter case, the total IPv6 address space available for the PDU Session cannot be aggregated into one single IPv6 prefix; support of this latter case requires support of the IP6PL feature (see clauses 5.21.1 and 8.2.25).

When assigning additional IPv6 prefixes (i.e. prefixes in addition to the default prefix) to a UE, the CP function shall provision/update the UE IP Address IE in the PDI which may be as part of a Create PDR IE or a Update PDR IE, or in the Create Traffic EndPoint IE or Update Traffic EndPoint IE to the UP function as described above.

5.15 Signalling based Trace (De)Activation

The UP function shall set the TRACE feature flag in the UP Function Features IE if it supports Trace (see 3GPP TS 32.422 [35]).

If the UP function indicated support of Trace, the CP function may activate a trace session during a PFCP session establishment or a PFCP session modification procedure, by including the Trace Information IE in the PFCP Session Establishment Request or PFCP Session Modification Request. For Streaming based Reporting as defined in 3GPP TS 32.422 [35], the CP function may also include the Trace Collection Entity URI IE in the PFCP Session Establishment Request or PFCP Session Modification Request.

The CP function may deactivate an on-going trace session by including the Trace Information IE with a null length in a PFCP Session Modification Request.

There shall be at most one trace session activated per PFCP session at a time.

5.15A UE level measurement (De)Activation

5.15A.1 General

A UP function that supports UE level measurements shall set the ULM flag in the UP Function Feature IE. If so, the UP function shall support being instructed to activate/deactivate UE level measurement only, as specified in this clause and in clause 5.15A.2.

A UP function that supports UE level measurements shall also support per QoS flow per UE QoS monitoring for packet delay (see clause 5.39) and so shall also indicate its support of the QFQM feature in the UP Function Feature IE.

If the UP function additionally supports Signalling based Trace, the UP function shall also set the TRACE feature flag in the UP Function Feature IE as specified in clause 5.15, in which case the UP function shall support being instructed to activate/deactivate any of the following:

- trace only, as specified in clause 5.15; or
- both trace and UE level measurement, as specified in this clause and in clause 5.15A.3.

Upon receiving a request to start collecting UE level measurements (see 3GPP TS 32.422 [35]), the CP function shall activate UE level measurements in the UP function as specified in clauses 5.15A.2 (for UE level measurements only) and 5.15A.3 (for both signaling based trace and UE level measurements). Additionally, the CP function shall create one new SRR to activate QoS flow related QoS monitoring for packet delay for UE level measurements in the UP function as specified in clause 5.39.3.2 with the following additions:

- the SRR shall include the Reporting Control Information IE indicating that the measurements are requested to be reported (as UE level measurements, as defined in clauses 5.15A.2 and 5.15A.3) to the trace collection entity.
- the SRR shall include the QoS Monitoring per QoS flow Control Information IE with:
 - the QFI IE(s) indicating the QoS flow(s) for which UE level measurements are to be performed (e.g. for the default QoS flow, all QoS flows or specific QoS flows based on local policy at the SMF);
 - the Requested QoS Monitoring IE requesting to measure the DL packet Delay, UL packet delay and/or Round Trip Packet Delay according to the requested UE level measurements;
 - the Reporting Frequency IE set to "Periodic" reporting; and
 - the Measurement Period IE set to a period equal or smaller than the time period of UE level measurements.

NOTE: The CP function creates one new SRR as described above even if QoS flow related QoS monitoring for packet delay was already activated in the UP function for the same QoS flows for other reasons than UE level measurements, e.g. if QoS monitoring had been requested in a PCC rule received from the PCF.

Upon being instructed to perform UE level measurements, the UP function shall perform the requested UE level measurements whenever an SRR with QoS flow related QoS monitoring for packet delay with the Reporting Control Information IE indicating UE level Measurement is provisioned at the UP function for the corresponding

measurements. When no such SRR is provisioned at the UP function, the UP function shall store the UE level measurement control information and wait until QoS flow related QoS monitoring for packet delay with the Reporting Control Information IE indicating UE level Measurement is provisioned.

The UP function shall report the QoS monitoring results of the QoS flows as UE level measurements to the trace collection entity as specified in 3GPP TS 32.422 [35].

Upon receiving a request to stop collecting UE level measurements (see 3GPP TS 32.422 [35]), the CP function shall deactivate UE level measurements in the UP function as specified in clauses 5.15A.2 (for UE level measurements only) and 5.15A.3 (for both signaling based trace and UE level measurements). Additionally, the CP function shall instruct the UP function to stop performing QoS flow related QoS monitoring for packet delay for UE level measurements, as specified in clause 5.39.

5.15A.2 UE level measurement only (De)Activation

If the UP function indicated support of UE level measurement by setting the ULM feature flag in the UP Function Features IE, the CP function may activate UE level measurement only (i.e. without trace) during a PFCP session establishment or a PFCP session modification procedure, by including the Trace Information IE and UE Level Measurements Configuration IE with the following information in the PFCP Session Establishment Request or PFCP Session Modification Request:

- Trace Information IE: including MCC, MNC, Trace ID, Session Trace Depth and IP Address of Trace Collection Entity. Triggering Events and List of Interfaces shall not be included, so the Length of Triggering Events and the Length of List of Interfaces shall be set to 0.
- UE Level Measurements Configuration IE: including Job Type with value "5GC UE Level Measurements only", Measurement Types and Time Period.

For Streaming based Reporting as defined in 3GPP TS 32.422 [35], the CP function may also include the Trace Collection Entity URI IE in the PFCP Session Establishment Request or PFCP Session Modification Request.

The CP function may deactivate an on-going UE level measurement only (i.e. without trace) by including the Trace Information IE with a null length in a PFCP Session Modification Request.

There shall be at most one UE level measurement activated per PFCP session at a time. If the UPF does not support one or more the requested Measurement Types, the UPF shall ignore the unsupported measurement types and shall not perform UE level measurements for the unknown Measurement types.

5.15A.3 Signalling based Trace and UE level measurement (De)Activation

If the UP function indicated support of Trace by setting the TRACE feature flag and support of UE level measurement by setting the ULM feature flag in the UP Function Features IE, the CP function may activate both signaling based trace and UE level measurement during a PFCP session establishment or a PFCP session modification procedure, by including the Trace Information IE and UE Level Measurements Configuration IE in the PFCP Session Establishment Request or PFCP Session Modification Request. For Streaming based Reporting as defined in 3GPP TS 32.422 [35], the CP function may also include the Trace Collection Entity URI IE in the PFCP Session Establishment Request or PFCP Session Modification Request. The UE Level Measurements Configuration IE shall then include the Job Type with value "Trace and 5GC UE Level Measurements".

The CP function may deactivate an on-going UE level measurement and keep the on-going trace session by including the UE Level Measurements Configuration IE with a null length in a PFCP Session Modification Request.

The CP function may deactivate an on-going trace session and keep the on-going UE level measurement by including the Trace Information IE and UE Level Measurements Configuration IE with the following information in a PFCP Session Modification Request:

- Trace Information IE: including MCC, MNC, Trace ID, Session Trace Depth and IP Address of Trace Collection Entity. Triggering Events and List of Interfaces shall not be included, so the Length of Triggering Events and the Length of List of Interfaces shall be set to 0
- UE Level Measurements Configuration IE: including Job Type with value "5GC UE Level Measurements only", Measurement Types and Time Period.

The CP function may deactivate both on-going trace session and UE level measurement by including the Trace Information IE with a null length in a PFCP Session Modification Request.

5.16 Framed Routing

Framed routing allows to support an IP network behind a UE, such that a range of IP addresses or IPv6 prefixes is reachable over a single PDU session, e.g. for enterprise connectivity. Framed routes are IP routes behind the UE. The UPF advertizes relevant IP routes to receive packets destined to these destination IP addresses or IPv6 prefixes and to forward these packets over the PDU session. See clause 5.6.14 of 3GPP TS 23.501 [28], IETF RFC 2865 [37], IETF RFC 3162 [38]) and the Framed-Route, Framed-Routing and Framed-IPv6-Route AVPs specified in 3GPP TS 29.061 [39] and 3GPP TS 29.561 [49].

Framed routing is defined only for PDN connections and PDU sessions of the IP type (IPv4, IPv6, IPv4v6).

A UPF may indicate support of framed routing by setting the FRRT flag in the UP Function Features IE. If so, the CP function may include Framed-Route IEs, the Framed-Routing IE and Framed-IPv6-Route IEs in PDRs to describe framed routes associated to the PDU session.

The UP function shall:

- match the source IP address of packets with IP Address(es) or IPv6 prefixes as indicated in the the Framed-Route IE or Framed-IPv6-Route IE if it is provisioned in a UL PDRs;
- match the destination IP address of packets with IP Address(es) or IPv6 prefixes as indicated in the the Framed-Route IE or Framed-IPv6-Route IE if it is provisioned in a DL PDRs.

5.17 5G UPF (for 5GC)

5.17.1 Introduction

The following clauses describe the 5GS specific functionalities of a UP function.

5.17.2 Uplink Classifier and Branching Point

The Uplink Classifier and Branching Point functionalities refer to the capability of the UPF to route uplink traffic flows of the same PFCP session (PDU session) to two or more PDU Sessions Anchors, and to route the downlink traffic flows from these PDU Session Anchors on the tunnel towards the UE. They are defined in 3GPP TS 23.501 [28] and 3GPP TS 23.502 [29].

Uplink Classifier is supported for PDU sessions of type IPv4, IPv6, IPv4v6 or Ethernet. The routing of the uplink traffic flows to different PDU Session Anchors is based e.g. on the destination IP address/Prefix of the uplink packets for an IP PDU session.

Branching Point is supported for multi-homed PDU sessions of type IPv6, i.e. PDU sessions with multiple IPv6 prefixes. The routing of the uplink traffic flows to different PDU Session Anchors is based on the source IP prefix of the uplink packets.

The SMF may insert an Uplink Classifier or Branching Point, during a PDU session establishment or modification, by provisioning:

- two or more UL PDRs, with the appropriate Packet Detection Information, and with corresponding FARs to route the uplink traffic flows towards the appropriate PDU Session Anchors;
- two or more DL PDRs, with the appropriate Packet Detection Information, and with one (or more FARs) to route the downlink traffic flows on the tunnel towards the UE.

NOTE 1: This uses the generic functionalities of the PFCP protocol described in this specification, with two or more DL PDRs (for the traffic coming from the different PDU session anchors).

NOTE 2: A UPF acting as an Uplink Classifier or Branching Point can also behave as a PDU Session Anchor for the PDU session.

The SMF may remove an Uplink Classifier or Branching Point, during a PDU session modification, by removing the UL (or modifying the FAR associated to the UL PDR) and DL PDRs that were setup for the traffic to/from the PDU Session Anchor(s) to be removed.

5.17.3 Data forwarding during handovers between 5GS and EPS

Downlink data may be forwarded during an inter-system handover between 5GS and EPS using direct or indirect data forwarding.

NOTE: Uplink data is not forwarded during an inter-system handover between 5GS and EPS in this release of the specification.

Direct data forwarding is performed directly between the source and target RAN, without the involvement of any UPF to forward the data.

Indirect data forwarding during handovers between 5GS and EPS is supported as follows (see 3GPP TS 38.300 [42]):

- For 5G to 4G handover, the source NG-RAN node sends one or several end markers including one QFI of those QoS flows mapped to the same E-RAB and sends the end marker packets to the UPF over the PDU session tunnel. UPF removes the QFI and maps to an appropriate E-RAB tunnel towards SGW.
- For 4G to 5G handover, the source eNB forwards the received end markers in the EPS bearer tunnel to the SGW which forwards them to the UPF. The UPF adds one QFI among the QoS flows mapped to that E-RAB to the end markers and sends those end markers to the target NG-RAN node in the per PDU session tunnel.

To forward data (G-PDUs and End Marker packets) during a 5GS to EPS handover, the SMF shall:

- provision one PDR per E-RAB (that supports data forwarding for at least one QoS flow), with the list of QFIs that are mapped to the E-RAB;
- request the UPF to remove the GTP-U PDU Session Container extension header (including the QFI) from the data by including the GTP-U Extension Header Deletion field set to 'PDU Session Container' in the Outer Header Removal IE of the PDR(s);
- associate to each PDR a FAR to forward the data to the GTP-U tunnel of the corresponding E-RAB, i.e. with an Outer Header Creation IE containing the F-TEID of the (forwarding) SGW for the corresponding forwarding GTP-U tunnel.

To forward data (G-PDUs and End Marker packets) during an EPS to 5GS handover, the SMF shall:

- provision one PDR per E-RAB (that supports data forwarding for at least one QoS flow);
- create and associate one QER with each PDR, including the QFI IE set to the QFI value of one of the QoS flows mapped to the E-RAB, to request the UPF to insert a GTP-U PDU Session Container extension header including the QFI;
- create one FAR for each data forwarding tunnel in 5GS (i.e. per PDU session), with an Outer Header Creation IE containing the F-TEID of the target NG-RAN for the corresponding forwarding GTP-U tunnel;
- associate each PDR to the corresponding FAR (i.e. to forward the data of each E-RAB to the data forwarding tunnel of the corresponding PDU session).

5.18 Enhanced PFCP Association Release

5.18.1 General

To ensure no loss of usage reports and signalling efficiency, during a PFCP Association Release procedure, which is either initiated by CP function, or upon request from the UP function, the CP function and UP function may support the Enhanced PFCP Association Release feature (EPFAR) as described below.

When both the CP function and the UP function support the EPFAR feature, and when the CP (or UP) function determines that the PFCP association is to be released, the CP (or UP) function shall send a PFCP Association Update Request message with a "PFCP Association Release Preparation Start" flag to inform the peer UP (or CP) function that

the PFCP Association is going to be released and the final non-zero usage reports are to be collected for these PFCP sessions which will be affected by PFCP association release.

The CP function should stop establishing new PFCP sessions in the UP function after receiving or sending a PFCP Association Release Preparation Start indication. The CP(or UP) function shall send a PFCP Association Update Response with a successful cause value to the peer.

Then the UP function shall initiate the PFCP Session Release procedure as specified in clause 5.18.2 by sending one or more PFCP Session Report Request messages for the PFCP sessions affected by the release of the PFCP association and that have non-zero usage reports to be reported. In the PFCP Session Report Request message, the UP function shall:

- set the Usage Report Trigger to TEBUR (Termination By UP function Report) for the usage reports being reported; and
- set the PSDBU (PFCP Session Deleted By the UP function) flag to "1" to indicate to the CP function that the PFCP Session is being deleted in the UP function and the usage reports included in the message are the final usage reports for the given PFCP Session, if this is the last PFCP Session Report Request message sent for the PFCP session.

When the UP function has sent all the non-zero usage reports for the PFCP sessions affected by the release of the PFCP Association, the UP function shall send a PFCP Association Update Request with the flag URSS (non-zero Usage Reports for the affected PFCP Sessions Sent) set to "1" to indicate to the CP function that all non-zero usage reports for the affected PFCP sessions have been sent to the CP function and the corresponding PFCP sessions in the UP function have been locally deleted. The CP function shall then send a PFCP Association Update Response with a successful cause to the peer to indicate the PFCP Association Update Request is handled successfully.

The CP function shall then send a PFCP Association Release Request to release the PFCP Association as specified in clause 6.2.8.

The Enhanced PFCP Association Release procedure shall not be used by SMFs of an SMF set, when using the MPAS feature (Multiple PFCP Associations to the SMFs in an SMF set) defined in clause 5.22.3, unless the PFCP association being released is the last PFCP association that was established between the UPF and any SMF of the SMF set.

NOTE: The PFCP sessions are taken over by different SMFs of the SMF set, and not released, when using the MPAS feature, if there is at least another PFCP association remaining established between the UPF and any SMF of the SMF set.

5.18.2 UP Function Initiated PFCP Session Release

When the UP function needs delete a PFCP session, e.g. during the Enhanced PFCP Association Release as described in clause 5.18.1 or when it detects an error or partial failure, the UP function shall:

- send one or more PFCP Session Report Request messages for this PFCP session;
- set the Report Type to "USAR" (Usage Report) if there is non-zero usage report for the PFCP session, or set the Report Type to "UISR" if there is no usage report to send (e.g. for a session without an URR provisioned or with an URR provisioned but with only null usage measurements);
- set the Usage Report Trigger to "TEBUR" for non-zero usage report(s), if usage reports are included in the PFCP Session Report Request message(s); and
- set the PSDBU flag to "1" to indicate to the CP function that the PFCP session is being deleted, in the last PFCP Session Report Request message sent for that PFCP session.

NOTE: The UP Function can release one or more PFCP Sessions (without tearing down the entire PFCP Association) when there is a partial failure in the UP Function.

5.19 Activation and Deactivation of Pre-defined PDRs

To reduce the signalling overhead for establishing a PFCP session (for a PDU session or a PDN connection) and improve the signalling efficiency, the CP and UP functions may support the Activation and Deactivation of a Pre-defined PDR (ADPDP) feature as described below.

When both the CP function and the UP function support the ADPDP feature, the CP function may activate one or more pre-defined PDRs for a PFCP session during a PFCP Session Establishment or a PFCP Session Modification procedure. A pre-defined PDR shall be configured in the UP function before it can be activated in a PFCP session.

A pre-defined PDR may contain all the necessary packets detection information to identify a service data flow or application traffic which may be common to many PFCP sessions, and it may be configured in the UPF associated with a pre-defined FAR, one or more pre-defined QER(s), and/or one or more pre-defined URR(s).

Any PFCP session specific information, e.g. traffic endpoint information, may not be part of a pre-defined PDR and is provisioned before or during the activation of the pre-defined PDR.

To activate one or more pre-defined PDR(s), the CP function shall provide one or more Activate Predefined Rules IE(s) in a Create PDR IE in a PFCP Session Establishment Request, or in a Create PDR IE or an Update PDR IE in a PFCP Session Modification Request message, that references a pre-defined PDR configured in the UP function, with the following information in the Create PDR or Update PDR IE:

- the traffic endpoint that the traffic shall match (e.g. Local F-TEID, UE IP Address or Traffic Endpoint ID);
- optionally the QFI that the traffic shall match, e.g. for a UL PDR where UL QoS flow binding verification is required (see clause 5.4.2);
- the precedence to be applied by the UP function among all PDRs of the PFCP session;
- optionally, an FAR containing instructions related to the processing of the packets matching the pre-defined PDR(s); when present, the UP function shall enforce it instead of the one defined in the pre-defined PDR(s) if any;
- optionally, one or more URRs to be used in addition to any URR(s) specified in the pre-defined PDR(s) (e.g. for session level Usage Monitoring);
- optionally, one or more QERs to be applied in addition to any QER(s) specified in the pre-defined PDR (e.g. for APN-AMBR enforcement).

When a pre-defined PDR is activated for a given PDR, an incoming packet matches the PDR if it matches the traffic endpoint, and the QFI if provisioned and one of the activated pre-defined PDR(s).

The CP function may update the use of pre-defined PDRs that are already activated in a PFCP session by including one or more Activate Predefined Rules IE(s) or Deactivate Predefined Rules IE(s) in a PFCP Session Modification Request and/or by updating the parameters provisioned in the PDR.

NOTE: The CP function cannot change a pre-defined PDR via PFCP session related procedure.

The CP function may deactivate a pre-defined PDR that is already activated in a PFCP session by including the Deactivate Predefined Rules IE in a PFCP Session Modification Request requesting to deactivate the predefined PDR(s).

In addition, this feature allows to define a group of pre-defined PDRs which can be activated, updated, and deactivated together. This allows the CP function to further optimize the signaling towards the UP function.

To activate, update, or deactivate a group of pre-defined PDRs, the CP shall follow the same procedure as for activating, updating, and deactivating a pre-defined PDR, but it shall use an Activate Predefined Rules IE that refers to a group of pre-defined PDRs.

5.20 Support of Access Traffic Steering, Switching and Splitting (ATSSS) for 5GC

5.20.1 General

The Access Traffic Steering, Switching and Splitting (ATSSS) feature is an optional feature that may be supported by the SMF and the UPF.

The ATSSS feature enables the support of Multi-Access (MA) PDU sessions, using one 3GPP access network or one non-3GPP access network at a time, or simultaneously using one 3GPP access network and one non-3GPP access network as defined in clauses 4.2.10 and 5.32 of 3GPP TS 23.501 [28].

A Multi-Access (MA) PDU session may support:

- both 3GPP access and non-3GPP access connected to 5GC, as specified in clause 4.22.2.1 and 4.22.2.2 of 3GPP TS 23.502 [29];
- 3GPP access connected to EPC and non-3GPP access connected to 5GC, as specified in clause 4.22.2.3 of 3GPP TS 23.502 [29], subject to corresponding support by the UE; or
- non-3GPP access connected to ePDG/EPC and 3GPP access connected to 5GC, as specified in clause 5.32.1 of 3GPP TS 23.501 [28] and clause 4.22.2.4 of 3GPP TS 23.502 [29], subject to corresponding support by the UE.

NOTE 1: Multi-access connectivity using ATSSS established via EPC only is not supported. For the MA PDU session over 3GPP access in 5GC and non-3GPP access in EPS, when a UE moves from NG-RAN/5GC to E-UTRAN/EPC, the SMF+PGW-C can keep or release the MA PDU Session based on operator policy, as specified in clause 5.32.7.2 of 3GPP TS 23.501 [28].

The non-3GPP access network connected to 5GC may be an untrusted non-3GPP access network, a trusted non-3GPP access network or a wireline 5G access network.

The UPF may support one or more of the following types of steering functionalities:

- a) steering functionalities based on multi-path protocols i.e.:
 - i) MPTCP steering functionality which operates above the IP layer, where the UE and an associated MPTCP proxy functionality in the UPF may communicate by using the MPTCP protocol; and
 - ii) MPQUIC-based steering functionalities which operate above the UDP/IP layer, where the UE and an associated QUIC proxy in the UPF may communicate by using the QUIC protocol, i.e.:
 - the MPQUIC-UDP steering functionality;
 - the MPQUIC-IP steering functionality; and
 - the MPQUIC-E steering functionality;

and

- b) steering functionalities based on data switching, i.e.:
 - i) ATSSS-LL steering functionality which operates below the IP layer as a data switching function.

If the UPF supports ATSSS, it shall indicate which ATSSS functionalities it supports by setting the MPTCP, ATSSS-LL, MPQUIC-UDP, MPQUIC-IP and/or MPQUIC-E flags in the UP Function Feature IE (see Table 8.2.25-1).

NOTE 2: Clause 4.2.10 of 3GPP TS 23.501 [28] requires a UPF which supports ATSSS to support at least ATSSS-LL with Active Standby steering mode.

For an IP MA PDU session, different steering functionalities may be used simultaneously for different packet flows (only one steering functionality shall be used to a given packet flow). For an Ethernet MA PDU session, either the ATSSS-LL steering functionality or the MPQUIC-E steering functionality shall be used.

When establishing a PFCP session for an MA PDU session, the SMF (H-SMF for a HR PDU session) shall:

- select a PSA (UPF) supporting ATSSS (see ATSSS-LL, MPTCP, MPQUIC-UDP, MPQUIC-IP and MPQUIC-E flags in UP Function Features, Table 8.2.25-1), i.e. ATSSS-LL, MPTCP, MPQUIC-UDP, MPQUIC-IP, MPQUIC-E or all, and if necessary, supporting the Redundant steering mode (see REDSM flag in UP Function Features, Table 8.2.25-1);
- provision in the PSA (UPF) one Multi-Access Rule (MAR) for every downlink PDR matching non-GBR traffic sent towards the UE. See clause 5.2.7 for the handling of a MAR for non-GBR traffic; and

- provision in the PSA (UPF) one Multi-Access Rule (MAR) for every downlink PDR matching GBR traffic sent towards the UE, if the Steering Mode is "Redundant". See clause 5.2.7 for the handling of a MAR for GBR traffic.

For ATSSS for a MA PDU session with both 3GPP access and non-3GPP access connected to 5GC, two distinct N3/N9 tunnels shall be established for each access network of the MA PDU session by:

- providing two UL PDRs to the PSA UPF in PFCP Session Establishment Request or PFCP Session Modification Request message, e.g. PDR-1 for UL data from 3GPP access and PDR-2 for UL data from non-3GPP access, to trigger the PSA UPF to allocate two N3/N9 UL CN tunnels as specified in clause 4.22.2.1 and clause 4.22.3.2 of 3GPP TS 23.502 [29];
- providing two FARs in one MAR associated to the DL PDR to the PSA UPF in PFCP Session Establishment Request or PFCP Session Modification Request message, e.g. FAR-1 for DL data forwarding to 3GPP access and FAR-2 for DL data forwarding to non-3GPP access.

For ATSSS for a MA PDU session with one access connected to 5GC and one access connected to EPC, distinct GTP-U tunnels shall be established for each access network of the MA PDU session, as described above for the case of ATSSS with both accesses connected to 5GC, with the following additions:

- the GTP-U tunnels shall be established over N3/N9 (for the access connected to 5GC) and S5-U/S8-U or S2b-U (for the access connected to EPC); and
- several GTP-U tunnels may be established over S5-U/S8-U or S2b-U to manage dedicated bearers for the access connected to EPC; accordingly, more than two UL PDRs and DL FARs may be provisioned by the SMF/PGW-C in the UPF/PGW-U. The MAR associated with a given DL PDR shall refer to one DL FAR for sending the DL traffic towards the 5GC access and to one DL FAR for sending the DL traffic towards the EPS bearer to which the QoS flow is mapped. Different MARs of the MA PDU session associated with different DL PDRs may refer to the same DL FAR for DL traffic sent towards the 5GC access and to the same or different DL FARs for the DL traffic sent to the EPC access (same DL FAR for the DL traffic sent to the EPC access when the QoS flows are mapped to the same EPS bearer).

5.20.2 MPTCP functionality

5.20.2.1 General

The SMF shall instruct the UPF(PSA) to activate MPTCP steering functionality for a given MA-PDU session if MPTCP needs to be used for TCP traffic flows.

The UPF(PSA) shall allocate resources for MPTCP steering functionality (e.g. MPTCP Proxy address, MPTCP link-specific multipath IP addresses, etc.), and perform traffic steering, switching and splitting according to the instructions from the SMF.

5.20.2.2 Activate MPTCP functionality and Exchange MPTCP Parameters

If MPTCP steering functionality is required for a Multi-Access PDU session, the SMF shall send MPTCP Control Information to the UPF in PFCP Session Establishment Request, to instruct the UPF to activate the MPTCP functionality for this PFCP session. The SMF may also request to activate the PMF functionality for this PFCP session by sending PMF Control Information to the UPF. As a result, the UPF(PSA) shall allocate necessary resources for MPTCP and PMF and return the corresponding MPTCP and PMF Parameters (e.g. MPTCP IP address and port, MPTCP link-specific multipath IP addresses, PMF IP address and port, etc.) to the SMF in PFCP Session Establishment Response. The SMF may also activate an MPQUIC based functionality for this PFCP session as specified in clause 5.20.2A.2.

The SMF may send MPTCP Control Information and/or PMF Control Information (and/or MPQUIC Control Information if an MPQUIC based functionality is also activated) to the UPF in PFCP Session Modification Request, with updated value, e.g. if the SMF receives updated ATSSS rules from the PCF.

NOTE 1: Such MPTCP Parameters received by the SMF are sent to the UE together with the ATSSS rules, as specified in 3GPP TS 24.193 [59].

When provisioning an UL PDR for user plane traffic for which MPTCP is applicable, the SMF shall include an Multipath Applicable Indication IE with the MTAI flag set to "1" in the Create PDR IE.

NOTE 2: This indication can be used by the UPF to prepare itself for the reception of MPTCP traffic for the PDU session.

5.20.2.3 Control of Multipath TCP Connection Establishment by MPTCP Proxy

When MPTCP steering functionality is utilized, TCP connection establishment and data exchange between an UE and a remote host shall be proxied by the MPTCP Proxy in the UPF (PSA), using the mechanism specified in IETF RFC 8684 [62] and IETF RFC 8803 [60].

Once Multipath TCP connection is set up, the MPTCP Proxy shall store the MPTCP session entry which includes the following information:

- MPTCP link-specific multipath IP addresses and the associated TCP ports;
- UE's MA-PDU session IP address and its TCP port, if the MA-PDU session IP address is used by the MPTCP Proxy for IP translation;
- the N6 routable IP address and its TCP port, if N6 routable IP address is used by the MPTCP Proxy for IP translation;
- the remote host IP address and its TCP port.

The stored MPTCP session entry is used by MPTCP Proxy for subsequent IP translation when receiving uplink or downlink MPTCP traffic.

An UPF implementation may use N6 routable IP address instead of UE's MA-PDU session IP address for IP translation.

NOTE: The DL PDR from the SMF for MPTCP traffic carries the UE's MA-PDU session IP address. If the UPF uses a different N6 routable IP address, it is UPF implementation specific how to match DL PDRs for MPTCP traffic with downlink MPTCP traffic received with the destination address set to the N6 routable IP address.

5.20.2.4 Traffic Steering and IP Translation by MPTCP Proxy

Once traffic for which MPTCP is applicable is detected by the UPF, the UPF shall internally forward this traffic to the MPTCP Proxy for IP translation. The MPTCP Proxy shall use the stored information in MPTCP session entry to perform IP translation to the detected MPTCP IP packets, e.g. replace the source IP address+port and/or destination IP address+port accordingly.

The UPF may detect the uplink IP packets for which MPTCP is applicable by checking whether the UL PDR matching the user plane traffic is set with an Multipath Applicable Indication, or (UPF implementation choice) by checking whether the source or destination IP address of the user plane packets (after removing the GTP-U header) correspond to MPTCP link-specific multipath IP address(es) and the MPTCP proxy IP address.

The UPF may detect the downlink IP packets for which MPTCP is applicable, by checking the information in the associated MAR (e.g. checking if the steering functionality is set to MPTCP) or by checking the destination IP address.

5.20.2A MPQUIC-based steering functionalities

5.20.2A.1 General

The SMF shall instruct the UPF(PSA) to activate the MPQUIC-UDP, MPQUIC-IP and/or MPQUIC-E steering functionality(ies) for a given MA-PDU session, if MPQUIC needs to be used for UDP, IP and/or Ethernet traffic flows respectively. See clause 5.32.6.2.2 of 3GPP TS 23.501 [28] for the description of the different MPQUIC-based steering functionalities.

The MPQUIC-UDP functionality and MPQUIC-IP functionality shall only be applied for an IP MA PDU Session. The MPQUIC-E steering functionality shall only be applied for an Ethernet MA PDU Session. The UPF(PSA) shall allocate resources for the requested MPQUIC-based steering functionality(ies) (e.g. MPQUIC Proxy addresses, MPQUIC link-specific multipath IP addresses, etc.), and perform traffic steering, switching and splitting according to the instructions from the SMF.

NOTE: The "MPQUIC-UDP functionality" is referred to as "MPQUIC functionality" in previous releases of this specification (that do not support the MPQUIC-IP functionality and the MPQUIC-E functionality).

5.20.2A.2 Activate MPQUIC-based steering functionalities and Exchange MPQUIC Parameters

If the MPQUIC-UDP, MPQUIC-IP and/or MPQUIC-E steering functionality is required for a Multi-Access PDU session and if the UPF indicates support of the respective MPQUIC-UDP, MPQUIC-IP and/or MPQUIC-E features (see clause 8.2.25), the SMF shall send MPQUIC Control information to the UPF in PFCP Session Establishment Request, to instruct the UPF to activate one or more MPQUIC-based steering functionalities for this PFCP session. The SMF may also request to activate the PMF functionality for this PFCP session by sending PMF Control Information to the UPF.

As a result, the UPF(PSA) shall allocate necessary resources for the requested MPQUIC-based steering functionalities and PMF and return the corresponding MPQUIC Parameters (e.g. MPQUIC Proxy IP addresses and ports, MPQUIC link-specific multipath IP addresses) and PMF Parameters (e.g. PMF IP address and port, etc.) to the SMF in PFCP Session Establishment Response. The SMF may also activate the MPTCP functionality for this PFCP session as specified in clause 5.20.2.2.

For an SMF and UPF that support both MPQUIC-IP and MPQUIC-UDP, when both MPQUIC-IP and MPQUIC-UDP are used simultaneously for different packet flows of the PDU session, the UPF may (based on implementation) provide a common MPQUIC IP Address information to be used for both MPQUIC-IP and MPQUIC-UDP, or different MPQUIC IP Address Information respectively for MPQUIC-IP and MPQUIC-UDP. In the former case, the UPF shall return one single MPQUIC IP Address Information IE to the SMF, with the MPQUIC Proxy Type indicating "both MPQUIC-IP and MPQUIC-UDP". In the latter case, the UPF shall return two MPQUIC IP Address Information IEs to the SMF, wherein each MPQUIC IP Address Information IE shall indicate (via the MPQUIC Proxy Type) whether the information applies to MPQUIC-IP or MPQUIC-UDP. The same pair of MPQUIC link-specific multipath addresses shall apply to both MPQUIC-IP and MPQUIC-UDP.

When the MPQUIC-UDP or MPQUIC-IP steering functionality is required for a MA-PDU session of type IPv4IPv6, the UPF shall allocate:

- both the MPQUIC Proxy IPv4 and the MPQUIC Proxy IPv6 addresses in the MPQUIC Address Information IE; and
- both the Link-Specific Multipath IPv4 Address for 3GPP Access and the Link-Specific Multipath IPv6 Address for 3GPP Access, and both the Link-Specific Multipath IPv4 Address for Non-3GPP Access and the Link-Specific Multipath IPv6 Address for Non-3GPP Access in the Link-Specific Multipath IP Address IE.

NOTE 1: Allocating both pairs of IPv4 and IPv6 MPQUIC Proxy and Link-Specific Multipath addresses enables the UE to select IPv4 or IPv6 addresses to establish QUIC connection(s) based on whether IPv4 or IPv6 traffic is to be sent.

When the MPQUIC-E steering functionality is required for an Ethernet MA-PDU session and if the UPF supports MPQUIC-E feature, the UPF should allocate:

- both the MPQUIC Proxy IPv4 and the MPQUIC Proxy IPv6 addresses in the MPQUIC Address Information IE; and
- both the Link-Specific Multipath IPv4 Address for 3GPP Access and the Link-Specific Multipath IPv6 Address for 3GPP Access, and both the Link-Specific Multipath IPv4 Address for Non-3GPP Access and the Link-Specific Multipath IPv6 Address for Non-3GPP Access in the Link-Specific Multipath IP Address IE.

NOTE 2: Allocating both pair of IPv4 and IPv6 MPQUIC Proxy and Link-Specific Multipath addresses enables the UE to select either IPv4 or IPv6 address to establish QUIC connection(s) based on its own preference.

The SMF may send MPQUIC Control Information and/or PMF Control Information (and/or MPTCP Control Information if the MPTCP functionality is also activated) to the UPF in PFCP Session Modification Request, with updated value, e.g. if the SMF receives updated ATSSS rules from the PCF.

NOTE 3: The MPQUIC Parameters received by the SMF are sent to the UE together with the ATSSS rules, as specified in 3GPP TS 24.193 [59].

When provisioning an UL PDR for user plane traffic for which MPQUIC is applicable, the SMF shall include a Multipath Application Indication IE with the MQAI flag set to "1" in the Create PDR IE.

NOTE 4: This indication can be used by the UPF to prepare itself for the reception of MPQUIC traffic for the PDU session.

5.20.2A.3 Control of Multipath QUIC Connection Establishment by MPQUIC Proxy

When the MPQUIC-UDP, MPQUIC-IP or MPQUIC-E steering functionality is utilized, the UDP, IP or Ethernet connection establishment and data exchange between the UE and a remote host shall be proxied by the MPQUIC Proxy in the UPF(PSA), as specified in clause 5.32.6.2.2 of 3GPP TS 23.501 [28] and clause 6.1.4.1.0 of 3GPP TS 24.193 [59].

Once a multipath QUIC connection is set up, the MPQUIC Proxy shall store the MPQUIC session entry which includes the following information:

- MPQUIC link-specific multipath IP addresses for both 3GPP and non-3GPP and the associated UDP ports (as the source UDP port) for establishing the QUIC connection;
- MPQUIC Proxy IP address and the port which were allocated by the UPF;
- UE's MA-PDU session IP address (if it is routable over N6) or a N6 routable IP address together with the non-routable UE's MA-PDU session IP address, e.g. a NATed IP address, and the UDP port which are used as the source IP address and port when opening a UDP socket to the requested remote host, for an IP MA-PDU session if MPQUIC-UDP is used;
- the remote host IP address and its UDP port received as part of the HTTP Connect request message, for an IP MA-PDU session if MPQUIC-UDP is used; and
- the QFI associated with the multipath QUIC connection.

NOTE 1: The UE establishes as many multipath QUIC connections with the MPQUIC Proxy in the UPF(PSA) as the number of QoS flows of the MA PDU session, and each multipath QUIC connection carries the UDP, IP or Ethernet traffic mapped to a single QoS flow, as specified in clause 5.32.6.2.2 of 3GPP TS 23.501 [28] and clause 6.1.4.1.0 of 3GPP TS 24.193 [59]. For a MA PDU session of type IPv4v6, the UE establishes a given multipath QUIC connection using either the MPQUIC link-specific multipath IPv4 and MPQUIC Proxy IPv4 addresses, or the MPQUIC link-specific multipath IPv6 and MPQUIC Proxy IPv6 addresses, depending on whether IPv4 or IPv6 traffic is to be sent on the multipath QUIC connection.

NOTE 2: All the multipath QUIC connections established with the MPQUIC-UDP and MPQUIC-IP Proxy for the same PDU session share the same MPQUIC link-specific multipath IP addresses and associated UDP ports, and the same UE's MA-PDU session IP address and UDP port (for an IP MA-PDU session).

NOTE 3: When the MPQUIC-E steering functionality is used, or when the MPQUIC-UDP or MPQUIC-IP steering functionality is used for a MA PDU session of type IPv4v6, the MPQUIC link-specific multipath IP addresses (for both 3gpp and non-3gpp access) can contain both IPv4 and IPv6 addresses. See also clause 5.20.2A.2.

The stored MPQUIC session entry shall be used by the MPQUIC Proxy for subsequent packets forwarding when receiving uplink or sending downlink MPQUIC traffic.

A UPF implementation may use N6 routable IP address instead of UE's MA-PDU session IP address for IP translation.

NOTE 4: The DL PDR from the SMF for MPQUIC-UDP or MPQUIC-IP traffic carries the UE's MA-PDU session IP address. If the UPF uses a different N6 routable IP address, it is UPF implementation specific how to match DL PDRs for the downlink MPQUIC traffic received with the destination address set to the N6 routable IP address.

5.20.2A.4 Traffic forwarding by MPQUIC Proxy

For an IP MA-PDU session using the MPQUIC-UDP steering functionality, the MPQUIC-UDP Proxy in the UPF receives HTTP datagrams encapsulating a UDP payload sent from the link-specific multipath IP addresses which were allocated for the PDU session, where the target URI contains the target host IP address and target port number. The

MPQUIC-UDP proxy retrieves the UDP payload, adds the UDP/IP header by using the PDU session address as the source IP address and a port number as source port number and setting the target host IP address as the destination IP address and the target port number as the destination port number, and then sends the IP packets over N6. The MPQUIC-UDP proxy in the UPF does the reverse process when it receives UDP/IP payload packets from N6 matching DL PDRs associated with the MAR where the MPQUIC-UDP steering functionality is required. See also IETF RFC 9298 [96]. For an MA PDU session of type IPv4v6, the UPF shall use the PDU session's IPv4 or IPv6 address when adding the UDP/IP header as mentioned above, depending on whether the multipath QUIC connection used for transferring the UDP payload was established with a MPQUIC link-specific multipath IPv4 address and a MPQUIC Proxy IPv4 address, or with a MPQUIC link-specific multipath IPv6 address and a MPQUIC Proxy IPv6 address.

For an IP MA-PDU session using the MPQUIC-IP steering functionality, the MPQUIC-IP Proxy in the UPF receives HTTP datagrams encapsulating an IP packet sent from the link-specific multipath IP addresses which were allocated for the PDU session. The MPQUIC-IP proxy retrieves the IP packet and then sends it over N6. The MPQUIC-IP proxy in the UPF does the reverse process when it receives IP packets from N6 matching the DL PDRs associated with the MAR where the MPQUIC-IP steering functionality is required. See also IETF RFC 9484 [103].

For an Ethernet MA-PDU session using the MPQUIC-E steering functionality, the MPQUIC-E Proxy in the UPF receives HTTP datagrams encapsulating an Ethernet frame sent from the link-specific multipath IP addresses which were allocated for the PDU session. The MPQUIC-E proxy retrieves the Ethernet frame and then sends it over N6. The MPQUIC-E proxy in the UPF does the reverse process when it receives Ethernet frames from N6 matching DL PDRs associated with the MAR where the MPQUIC-E steering functionality is required. See also IETF draft-ietf-masque-connect-ethernet [104].

The MPQUIC Proxy shall send the DL traffic of a QoS flow using the multipath QUIC connection associated with the corresponding QoS flow.

The UPF may detect the uplink IP packets for which an MPQUIC-based steering functionality is applicable by checking whether the UL PDR matching the user plane traffic is set with a Multipath Applicable Indication, or (per UPF implementation choice) by checking whether the source or destination IP address of the user plane packets (after removing the GTP-U header) corresponds to MPQUIC link-specific multipath IP address(es) and the MPQUIC proxy IP address.

The UPF may detect the downlink IP packets for which an MPQUIC-based steering functionality is applicable, by checking the information in the associated MAR (e.g. checking if the steering functionality is set to MPQUIC-UDP, MPQUIC-IP or MPQUIC-E) or by checking the destination IP address, e.g. the MA PDU session IP address.

5.20.3 ATSSS-LL functionality

5.20.3.1 Activate ATSSS-LL functionality and Exchange ATSSS-LL Parameters

If ATSSS-LL steering functionality is required for a Multi-Access PDU session, the SMF shall send ATSSS-LL Control Information to the UPF in PFCP Session Establishment Request, to instruct the UPF to activate the ATSSS-LL functionality for this PFCP session. The SMF may also request to activate the PMF functionality for this PFCP session by sending PMF Control Information to the UPF.

If PMF functionality is required to be activated for this MA PDU session, the SMF shall set the PMFI flag to 1 in the PMF Control Information IE, regardless whether per QoS flow access performance measurement is required. In addition, if the SMF determines that per QoS flow access performance measurements shall be applied for the MA PDU session, e.g. the threshold value(s) are received from PCF for the UL and/or DL traffic of the QoS flow, the SMF shall set the PQPM flag to 1 together with a list of QFI values for the QoS flows for which access performance measurements may be performed in the PMF Control Information IE.

Upon receiving the request from the SMF with indicating ATSSS-LL Control Information IE and PMF Control Information IE, the UPF(PSA) shall allocate necessary resources for ATSSS-LL and PMF and return the corresponding ATSSS-LL and PMF Parameters (e.g. PMF IP address and port, etc) to the SMF in PFCP Session Establishment Response:

- If per access performance measurements are required, i.e. PMFI flag set to 1 in the PMF Control Information IE, the UPF(PSA) shall allocate a default pair of access specific UDP ports (i.e. for IP PDU sessions) or MAC addresses (i.e. for Ethernet PDU sessions) and report them to the SMF in the PMF Address Information IE of a PMF Parameters IE not including the QoS flow identifier IE.

- If per QoS flow access performance measurements are required, i.e. PQPM flag is set to 1 in addition and a list of QFIs are indicated in the PMF Control Information IE, the UPF(PSA) shall allocate access specific UDP ports (i.e. for IP PDU sessions) or MAC addresses (i.e. for Ethernet PDU sessions) for each QoS flow indicated in the PMF Control Information and, for each QoS flow, report them to the SMF in the PMF Address Information IE of a PMF Parameters IE including the QoS flow identifier IE set to the corresponding QFI.

If the SMF provisions the UPF to apply ATSSS-LL in downlink with "Smallest Delay" steering mode, the UE does not support PMF RTT measurements (see clause 5.32.2 of 3GPP TS 23.501 [28]) and the UPF supports RTT measurements without PMF, the SMF should instruct the UPF to not use PMF RTT measurements by setting the DRRTTI flag to "1" in the PMF Control Information.

NOTE 1: The UPF can measure RTT without using the PMF protocol by using other means not defined by 3GPP such as using the RTT measurements of MPTCP if there is an MPTCP connection established between the UE and UPF.

The SMF shall not set the Steering Mode "Redundant" if the steering functionality is set to "ATSSS-LL".

The SMF may send ATSSS-LL Control Information and/or PMF Control Information to the UPF in PFCP Session Modification Request, with updated value, e.g. if the SMF receives updated ATSSS rules from the PCF.

NOTE 2: Such ATSSS-LL Parameters received by the SMF are sent to the UE together with the ATSSS rules, as specified in 3GPP TS 24.193 [59].

5.20.4 Handling of GBR traffic of a MA PDU session

5.20.4.1 General

Traffic splitting of a GBR traffic is not supported (see clause 5.32.4 of 3GPP TS 23.501 [28]).

A DL PDR corresponding to GBR traffic of a MA PDU session using the Redundant steering mode shall be associated with a MAR, as specified in clause 5.20.1.

NOTE 1: The SMF establishes resources for the GBR traffic in both the 3GPP access and the non-3GPP access when using the Redundant steering mode and the UPF can steer and switch the traffic to these accesses as instructed in the MAR.

DL PDRs corresponding to GBR traffic not using the Redundant steering mode shall be associated with DL FARs (i.e. no MAR).

NOTE 2: The SMF establishes resources for the GBR traffic in only one access at a time when not using the Redundant steering mode. Switching the GBR traffic from one access to another access requires the SMF to send N1/N2 messages to the UE and AN. The SMF can request the UPF to report when it cannot send DL GBR traffic over its on-going access as defined in clause 5.20.4.2

5.20.4.2 Access Availability Reporting

For an MA PDU session using the ATSSS Low Layer (ATSSS-LL), MPTCP, MPQUIC-UDP, MPQUIC-IP or MPQUIC-E steering functionality, the SMF may request the UPF to report when it cannot send downlink GBR traffic over its on-going access, e.g. based on access availability and unavailability report from the UE, by provisioning an SRR with an Access Availability Control Information IE requesting the UPF to report when an access (3GPP or non-3GPP access) becomes available or unavailable.

If so instructed, when detecting a change in an access availability, the UPF shall send an Access Availability Report to the SMF, indicating the access type and whether the access has become available or unavailable.

5.20.5 Access type of an MA PDU session becoming (un)available

The access type of an MA PDU session may become unavailable permanently (e.g. when the UE de-registers from one access) or transiently (e.g. when the UE has lost coverage of the 3GPP access or non-3GPP access).

When an access type of an MA PDU session becomes permanently unavailable, the SMF shall send a PFCP Session Modification Request with an Update MAR IE removing the Access Forwarding Information IE corresponding to the unavailable access. As a result, the UPF shall not send any more traffic on this access type.

Reversely, when a new access type becomes available for an MA PDU session, e.g. when the UE registers on another access and requests to establish user plane resources for that access, the SMF shall send a PFCP Session Modification Request with an Update MAR IE adding the Access Forwarding Information IE corresponding to the new available access type.

When an access type of an MA PDU session becomes transiently unavailable, the SMF shall notify the UPF that the access type has become unavailable by sending a PFCP Session Modification Request with the Access Availability Information IE indicating so. The SMF should then also notify the UPF when the access type becomes available again.

When being notified by the SMF that an access type has become transiently unavailable, the UPF should stop sending DL traffic on this access until it receives the indication that the access becomes available again from the UE (i.e. PMF access available report) or the SMF.

5.20.6 PMFP message handling in UPF

The access performance measurement supports the following procedures, as specified in clause 5.32.5.1 of 3GPP TS 23.501 [28]:

- RTT measurement procedure initiated by the UE, or the UPF;
- Packet Loss Rate measurement procedure initiated by the UE, or the UPF;
- Access available/unavailable report procedure from the UE to the UPF;
- UE Assistance Data provisioning procedure from the UE to the UPF.
- Suspend or resume traffic duplication procedure from the UPF to UE.

The per QoS flow access performance measurement procedure includes the RTT measurement and the Packet Loss Rate measurement, which may be initiated by the UE or the UPF(PSA).

PMFP messages are used by the PMF functionality in the UE and the PMF functionality in the UPF (PSA) to perform the access performance measurement procedures, as specified in 3GPP TS 24.193 [59].

PMFP messages shall be exchanged between the UE and the UPF via the default QoS flow or a dedicated QoS flow, as specified in 3GPP TS 23.501 [28]. To support this, the UPF shall learn the QFI identifying the QoS flow on which PMFP messages from the UE are transmitted, and shall send downlink PMFP messages on that QoS flow when needed.

Once an uplink PMFP message is detected, the UPF shall internally forward the PMFP message to the PMF functionality in the UPF, for subsequent handling.

The PMF functionality in the UPF shall learn the UE's address information for PMFP from the received PMFP message, e.g. to detect the IP address and UDP port of the PMF in the UE (for IP PDU sessions) or the MAC address of the PMF in the UE (for Ethernet PDU sessions), and set the source and destination addresses of PMFP messages sent to the UE accordingly, as specified in clause 5.32.5.1A of 3GPP TS 23.501 [28].

If the Steering mode is set to Load-Balancing and the UE Assistance Indicator is set, when the UPF receives a PMF message with UE Assistance Data (i.e. PMF-UAD message) from the UE, the UPF may apply the split percentages in the UE Assistance Data to all DL traffic for which the SMF has enabled the UE assistance operation. Meanwhile, the UPF shall store the original split percentage (i.e. the weight included in 3GPP/Non-3GPP Access Forwarding Action Information IE in the MAR) provisioned by the SMF, and apply these when the UE assistance mode is terminated, i.e. when the UPF receives a PMF message indicating the termination of UE assistance mode (i.e. PMF-UAT message).

When the steering mode is set to Redundant, the UPF may send a PMFP TDS REQUEST message to the UE to suspend traffic duplication over an access of the MA PDU session, e.g. during UPF congestion, and later if the UPF decides to resume traffic duplication for the UE, e.g. when the UPF detects that local congestion is diminished, the UPF may send a PMFP TDR REQUEST message to the UE, as specified in clause 5.32.5.63 of TS 3GPP 23.501 [28], clauses 5.4.10 and 5.4.11 of TS 3GPP 24.193 [59].

5.21 UE IP address/prefix Allocation and Release

5.21.1 General

Stage 2 requirements for UE IP address allocation in the EPC and 5GC are specified in clause 5.3.1 of 3GPP TS 23.401 [14], clause 5.8.2.2 of 3GPP TS 23.501 [28] and clause 4.6.2 of 3GPP TS 23.316 [57]. The following types of UE IP addresses may be assigned over N4 or Sxb:

- IPv4 address;
- /64 IPv6 Prefix;
- IPv6 prefix other than default /64, including individual /128 IPv6 address, if the UPF indicates supports of the IP6PL feature (see clause 8.2.25), for IPv6 address allocation using DHCPv6 specified in clause 4.6.2.2 of 3GPP TS 23.316 [57];
- IPv6 prefix shorter than the default /64 prefix for support of IPv6 prefix delegation as specified in clause 4.6.2.3 of 3GPP TS 23.316 [57], clause 5.8.2.2.4 of 3GPP TS 23.501 [28] and clause 5.14.

More than one UE IP address may be assigned to a PDU session, if the UPF indicates supports of the IP6PL feature (see clause 8.2.25), by provisioning multiple instances of the UE IP Address IE in a same PDI or Traffic Endpoint, or by provisioning multiple PDIs or Traffic Endpoints with a different UE IP Address, where the UE IP addresses may correspond e.g. to:

- multiple /128 IPv6 addresses; or
- an /64 default prefix used for IPv6 stateless autoconfiguration and an IPv6 prefix shorter than the default /64 prefix for IPv6 Prefix Delegation not including the /64 IPv6 Prefix (i.e. when the total IPv6 address space available for the PDU Session cannot be aggregated into one single IPv6 prefix); the IPv6 prefix shorter than the default /64 prefix may be assigned by setting either the IPv6D flag or the IP6PL flag as specified in clause 5.14.

A UE IPv4 address or IPv6 prefix may be allocated by the CP function or the UP function. A given IP address pool shall be controlled by a unique entity (either the SMF/PGW-C or the UPF/PGW-U or an external server).

The support of UE IP address/prefix allocation by the CP function is mandatory. The support of UE IP address/prefix allocation by the UP function is optional. See clause 5.8.2.2 of 3GPP TS 23.501 [28]. A UPF supporting the SSET feature (see clause 5.22.2) or the MPAS feature (see clause 5.22.3) shall support UE IP address/prefix allocation in the UP function.

The UP function shall set the UEIP feature flag in the UP Function Features IE if it supports UE IP address/prefix allocation in the UP function (see clause 8.2.25). If so, the CP function shall determine whether UE IP address or prefix is allocated by the CP function or the UP function based on network configuration.

If the SSET feature (see clause 5.22.2) or the MPAS feature (see clause 5.22.3) is supported, the SMFs in an SMF set may decide that the CP function should allocate the UE IP address or prefix. In such a case, the SMFs in the SMF set may query a DHCP or AAA server for UE IP address or prefix allocation as specified in clause 5.21.2.2.

5.21.2 UE IP address/prefix allocation in the CP function

5.21.2.1 General

When performing UE IP address allocation in the CP function, the CP function shall assign the UE IP address/prefix and provide the assigned address/prefix to the UP function in the UE IP Address IE of the PDR IE (see Table 7.5.2.2-1) or of the Traffic Endpoint (see Table 7.5.2.7-1). The CP function shall always provide a full list of assigned address(es)/prefix(es) to the UP function in the PDI or Create/Update Traffic Endpoint IE.

5.21.2.2 UE IP Address/prefix allocation using DHCP or AAA server

When performing the UE IP address allocation by an SMF set, the SMFs in the SMF set may be configured to use DHCP or AAA server to allocate the UE IP address/prefix as specified in clause 10 of 3GPP TS 29.561 [49] and clauses 11 and clauses 12 of 3GPP TS 29.561 [49], with the following additions:

- one (or more) DHCPv4 or DHCPv6 server or one (or more) AAA server may be deployed within the 5GC for resiliency;
- different SMFs of an SMF set may request, renew and release the IP address assigned to a given PDU session, e.g. when the PDU session is taken over by a different SMF during the lifetime of the PDU session.

The lease time assigned by the DHCP or AAA server for IP addresses may be set by the operator to a long time to minimize the need for IP address renewal. When the lease time is approaching expiry, the SMF should request the DHCP server to renew the IP address (keeping the IP address unchanged) or the SMF should initiate a AAA re-authorization to renew the IP address (keeping the IP address unchanged).

NOTE: The lease time is stored in the PDU session context (which is shared by the SMFs of the SMF set). So any SMF in the SMF set taking over the control of the PDU session can determine whether the lease time is approaching expiry.

5.21.3 UE IP address/prefix allocation in the UP function

5.21.3.1 General

When performing UE IP address/prefix allocation in the UP function, the CP function shall request the UP function to allocate the UE IP address/prefix by:

- setting the CHOOSE flags (CHOOSE IPV4 and/or CHOOSE IPV6) in the UE IP Address IE of the PDR IE (see Table 7.5.2.2-1) or of the Traffic Endpoint (see Table 7.5.2.7-1); the IPv6 prefix length shall be indicated in the UE IP Address if an IPv6 prefix other than default /64 and other than for IPv6 prefix delegation (see clause 5.14) is to be assigned and the UPF indicated support of the IP6PL feature (see clause 8.2.25); and
- including the Network Instance IE to indicate the IP address pool from which the UE IP address/prefix is to be assigned.
- optionally including the UE IP address Pool Identity from which the UE IP address shall be allocated by the UP function.

The CP function may request the UP function to allocate the same UE IP address/prefix to several PDRs to be created (i.e. using Create PDR) within one single PFCP Session Establishment Request or PFCP Session Modification Request, or to several PDRs to be modified (i.e. using Update PDR) within one single PFCP Session Modification Request by:

- setting the CHOOSE flags (CHOOSE IPV4 and/or CHOOSE IPV6) in the UE IP Address IE of each PDR to be created with a new UE IP address/prefix or each PDR to be modified;

or, if the UP function indicated support of the PDI optimization (see clause 8.2.25), by:

- including the UE IP Address IE in the Create Traffic Endpoint IE or Update Traffic Endpoint IE, and by setting the CHOOSE flags (CHOOSE IPV4 and/or CHOOSE IPV6) in that UE IP Address IE; and
- including the Traffic Endpoint ID in all the PDRs to be created with the same UE IP address or all PDRs to be modified with additional UE IP address(es).

If the PDR(s) is created or modified successfully or the Traffic Endpoint(s) is created or modified successfully, the UP function shall always return the full list of UE IP address/prefix in the UE IP Address IE(s) it has assigned to the PDR(s) or to the Traffic Endpoint(s) in the PFCP Session Establishment Response or PFCP Session Modification Response.

Upon receiving a request to delete a PFCP session, to remove a Traffic Endpoint associated with the UE IP address/prefix, or to remove the last PDR associated with the UE IP address/prefix, the UP function shall release the UE IP address/prefix that was assigned to the PFCP session, to the Traffic Endpoint, or to the PDR.

NOTE 1: When the CP function requests additional UE IP Address in the Update PDR or Update Traffic Endpoint IE, it needs not include any existing UE IP Address(es).

If the UP Function supports the "Per Slice UP Resource management" feature and if the feature is enabled in the UP Function, the UP Function shall take the S-NSSAI associated with the PFCP session into account when allocating UE IP address, together with other information present (e.g. Network Instance, UE IP address Pool Identity).

5.21.3.2 Reporting UE IP Address Usage to the CP function

The UE IP Address Usage Reporting feature (see clause 8.2.58) is an optional feature. The following requirements shall apply if UE IP addresses are allocated by the UP function and both the CP function and UP function support the UE IP Address Usage Reporting feature.

The UP Function should report UE IP address usage information to the CP function for network instances and/or IP address pools whose ratio of occupied (i.e. already assigned) IP addresses to the configured IP addresses in the UP Function exceeds a configurable threshold. If the UP Function supports the "Per Slice UP Resource management" feature and if the feature is enabled in the UP Function, the UP Function shall additionally indicate the S-NSSAI associated with the UE IP address usage information. The UP function shall do so by sending one or more PFCP Association Update Request messages to the CP function, including a UE IP Address Usage Information IE per network instance and/or IP address pool. Each UE IP Address Usage Information IE shall include a validity timer that informs the CP function for how long the UE IP address Usage Information shall be considered as valid. Each UE IP Address Usage Information shall also contain a UE IP Address Usage Sequence Number, which enables the CP function to determine the latest UE IP Address Usage Information generated by the UP function for a given network instance and/or IP address pool.

The UP function may update the UE IP address usage information reported to the CP function if needed, by sending subsequent PFCP Association Update Request/Response messages, including updated UE IP address Usage Information IEs with a (new) validity timer. The UP function shall increment the UE IP Address Usage Sequence Number when updating UE IP address usage information. The UP function shall also increment the UE IP Address Usage Sequence Number when the IP address usage has not changed but the validity timer needs to be renewed.

NOTE 1: The threshold value in the UP function needs to be selected in such way that it avoids frequent UE IP address usage reporting for network instances and/or UE IP address pools with low usage.

The CP function shall use the latest updated UE IP address Usage Information received for a given network instance and/or UE IP Address Pool. The CP function shall ignore a UE IP Address Usage Information IE received for a given network instance and/or IP address pool with a UE IP Address Usage Sequence Number smaller or equal to the UE IP Address Usage Sequence Number of an already received and stored information.

If the validity timer has not expired, the CP function shall keep the latest updated UE IP Address Usage Information received for a given Network Instance and/or UE IP Address Pool if it receives a PFCP Association Update Request/Response not including a UE IP Address Usage Information IE for this network instance and/or UE IP Address Pool.

NOTE 2: The UE IP Address Usage Information IE may be absent e.g. if the PFCP Association Update Request/Response is sent for other regular purposes, or if the ratio remains the same, or if the ratio has not changed enough to justify being reported again.

The CP function shall delete UE IP Address Usage Information if its validity period has expired.

5.22 PFCP sessions successively controlled by different SMFs of an SMF set (for 5GC)

5.22.1 General

A PFCP session may be controlled by different SMFs of an SMF Set using either one PFCP association per SMF Set and UPF as described in clause 5.22.2 (called SSET feature), or with each SMF of the SMF set establishing its own PFCP association with the UPF as described in clause 5.22.3 (called MPAS feature).

A UPF complying with this version of the specification and that supports being controlled by an SMF set shall support the procedures specified in clauses 5.22.3 (i.e. MPAS feature) and may support the procedures specified in clause 5.22.2 (i.e. SSET feature).

The requirements specified in this clause for the UPF, SMF and SMF set shall also apply to:

- combined PGW-U/UPF, combined PGW-C/SMF and combined PGW-C/SMF Set respectively;
- MB-SMF and MB-UPF, for MB-SMFs deployed in an MB-SMF set; and

- combined SMF/MB-SMF, combined UPF/MB-UPF for combined SMF/MB-SMFs Set.

An SMF supporting the SSET feature or the MAPS feature shall be ready to take over the control of a PFCP session from another SMF within the same SMF SET, upon receiving a request from a UPF requiring an SMF change, if possible.

5.22.2 With one PFCP association per SMF Set and UPF

When a UPF supports that a PFCP session can be successively controlled by different SMF(s) in the same SMF set, the following applies:

- 1) One SMF in the SMF set shall establish one single PFCP Association with the UPF for the SMF set; the Node ID in the PFCP Association Setup Request shall be set to an FQDN representing the SMF set.

The SMF shall indicate that it supports the SSET feature in the CP Function Features IE (see clause 8.2.58); this indicates to the UPF that the PFCP sessions established with this PFCP association can be successively controlled by different SMFs of an SMF set according to the procedure defined in this clause.

The SMF may also indicate the IP addresses of alternative SMFs within the SMF Set and the IP addresses of alternative PFCP entities pertaining to the same SMF in the Alternative SMF IP Address IE(s) in the PFCP Association Setup Request and in the subsequent PFCP Association Update Request messages. Those Alternative SMF IP Address IE(s) with the PPE (Preferred PFCP Entity) flag set to "1" are alternative PFCP entities that the UPF shall select preferably when such reselection is required as specified in the following bullet 4. Optionally, the SMF may include the Alternative SMF IP Address IE at the PFCP session messages as specified in clauses 7.5.2.1, 7.5.4.1 and 7.5.9.1 to request the UPF to use it if supported, instead of the ones received at the PFCP association messages when the UPF determines to move the PFCP session to an alternative SMF.

NOTE 1: Those Alternative SMF IP Address IE(s) with the PPE flag set to "1" are PFCP entities in the preferred binding entity corresponding to the binding level in the Binding Indication of the resource context created for the PDU session when binding procedures are supported in the SMF as specified in clause 6.12 of 3GPP TS 29.500 [74].

- 2) When establishing a PFCP session, the SEID that the SMF assigns in the CP F-SEID of the PFCP Session Establishment Request may be unique or not within the SMF set. However the assigned CP F-SEID shall be unique within the SMF set.

NOTE 2: The UPF does not (need to) know whether the SEID in the CP F-SEID is uniquely assigned in the SMF set or not.

- 3) Any SMF in the SMF set may issue requests to modify or delete the PFCP session, or to update or release the PFCP association. The UPF shall allow the related PFCP request to come from any other SMF from the same SMF set.
- 4) The UPF shall initiate PFCP session related requests (e.g. PFCP Session Report Request) towards another PFCP entity pertaining to the same SMF or another SMF of the SMF Set, if the IP address included in the CP F-SEID assigned to the PFCP session is not responsive, or if the UPF receives a GTP-U Error Indication from the SMF over the N4-u tunnel assigned to the N4 session for data forwarding if any.

The UPF shall firstly use the IP addresses included in those Alternative SMF IP Address IE(s) with the PPE flag set to "1" (if available) whenever possible, then it may use the IP addresses included in the Alternative SMF IP Address IE(s) without the PPE flag set to "1", to contact an alternative PFCP entity. Otherwise the UPF shall use the SMF set FQDN in the CP Node ID to discover alternative SMFs within the SMF Set, e.g. by querying the DNS or by performing a discovery request towards the NRF.

When sending the request to another PFCP entity pertaining to the same SMF or to the new SMF, the UPF shall set the SEID field to zero in the PFCP header of the PFCP request and include the CP F-SEID assigned by the previous SMF in the request.

- 5) When receiving a request from a UPF with the SEID field set to zero and CP F-SEID assigned by previous SMF, the SMF shall take over the control of the PFCP session from the previous SMF, unless it is needed to redirect the request to a different SMF (e.g. due to high load or because the corresponding session context has already been taken over by a different SMF in the same SMF set).

An SMF may redirect a UPF initiated PFCP session related request to another PFCP entity pertaining to the same SMF or to a different SMF in the SMF set by rejecting the request with the cause "Redirection Requested" and with the IP address of the new entity to contact. When sending the redirected request to the new entity, the UPF shall set the SEID field to zero in the header of the PFCP request and include the CP F-SEID assigned by the previous SMF in the request.

Alternatively, an SMF may forward the UPF request to another PFCP entity pertaining to the same SMF or to a new SMF in the SMF set; the new PFCP entity or the new SMF answers to the UPF, including the CP F-SEID IE with the IPv4 or IPv6 address of the new entity respectively and the same or a modified SEID, and optionally including the N4-u F-TEID that the UPF shall use for sending data towards the new entity.

NOTE 3: This allows to address cases where a different SMF would have been reselected in the 5GC for the PFCP session, e.g. by an AMF.

- 6) An SMF may also update, at any time, a PFCP session by including the CP F-SEID with the IPv4 or IPv6 address of a new SMF and/or a new SEID assigned by the new SMF in a PFCP Session Modification Request.
- 7) The UPF shall trigger the SMF restoration procedures for an SMF in a SMF set specified in clause 4.4 of 3GPP TS 23.527 [40] for a PFCP session that can be controlled by different SMFs of an SMF set when a heartbeat failure is detected for the IP address of the assigned CP F-SEID.

When sending a PFCP Session Report Request message to move the PFCP session towards an alternative SMF, the UPF shall set Report Type to the "UISR" if:

- there is no other report to send, e.g. a Downlink Data Report; or
- there are pending UL payload packets to be sent towards the new SMF via a new N4-u tunnel;

For the latter case, the UPF shall also set "Pending UL Payload Packet to CP function" flag in the PFCPSRReq-Flags IE. Otherwise, when there is other report to send, e.g. a Downlink Data Report, the UPF shall set Report Type according to the report included in the message.

The UPF may also include the SMF Change Reason IE to indicate the reason for SMF change, e.g. "move the PFCP session due to the SMF not responding", "move the PFCP session due to the SMF failure", "move the PFCP session instructed by the SMF in a PFCP Session Set Modification Request".

NOTE 3: These restoration procedures cause the UPF to delete the PFCP session contexts only if heartbeat procedures fail with all the IP addresses of all the SMFs in the SMF set.8) A UPF supporting the SSET feature shall support UE IP address/prefix allocation in the UP function (see clause 5.21).

NOTE 4: The above requirements enable all SMFs of a same SMF set to successively control a given PFCP session without causing extra signalling over the N4 interface.

5.22.3 With one PFCP association per SMF and UPF

If multiple PFCP associations are setup between an UPF and the SMFs in an SMF set, the following applies:

- 1) Each SMF in the SMF set shall establish its own PFCP association with the UPF and shall provide the Node ID IE set to an FQDN or IP address of the SMF and the SMF Set ID IE set to an FQDN representing the SMF set. All SMFs of an SMF set shall indicate the same SMF Set ID. Alternatively, if PFCP Association Setup is initiated by UPF as defined in clause 6.2.6.3, each SMF in the SMF set shall provide this information in PFCP Association Setup Response message.

The SMF shall indicate that it supports the MPAS feature (Multiple PFCP Associations to the SMFs in an SMF set) in the CP Function Features IE (see clause 8.2.58); this indicates to the UPF that the PFCP sessions established with this PFCP association can be successively controlled by different SMFs of the same SMF set according to the procedure defined in this clause.

The SMF may also provide a list of alternative IP addresses of PFCP entities pertaining to the same SMF in the Alternative SMF IP Address IE in the PFCP Association Setup Request message and in the subsequent PFCP Association Update Request messages. Those Alternative SMF IP Address IE(s) with the PPE flag set to "1" are alternative PFCP entities that the UPF shall select preferably when such reselection is required as specified in the following bullet 6. Optionally, the SMF may include the Alternative SMF IP Address IE at the PFCP session

messages as specified in clauses 7.5.2.1, 7.5.4.1 and 7.5.9.1 to request the UPF to use it if supported, instead of the ones received at the PFCP association messages when the UPF determines to move the PFCP session to an alternative SMF.

The UPF and SMF shall identify the PFCP association by the Node ID of the SMF and UPF respectively.

When an SMF is added or removed from the SMF set, e.g. during a scale-out or scale-in of the SMF set, this SMF shall establish or tear down its PFCP association with the UPF. When a PFCP association with a particular SMF is released (e.g. due to an SMF shutting down / scale-in of the SMF set), any PFCP sessions that were still served by this SMF shall be maintained by the SMF set and the UPF if there is at least one PFCP association remaining established between the UPF and another SMF of the SMF set. If so, the UPF shall move such PFCP sessions towards other SMF(s) of the SMF set (as described in this clause and clause 5.22.4). Otherwise, if the PFCP association being released is the last PFCP association that was established between the UPF and any SMF of the SMF set, the PFCP sessions shall be deleted as specified in clauses 5.18 and 6.2.8.

NOTE 1: The SMF(s) of the SMF set can instruct the UPF to move the PFCP sessions to different SMFs of the SMF set (preferably) before or after the PFCP association release, e.g. like defined in clause 5.22.4 and clause 31.6.4 of 3GPP TS 23.007 [24].

NOTE 2: To move a SMF from one SMF set to another SMF set while keeping all its controlled PFCP sessions in the old SMF set, the SMF can use PFCP Association Release procedure(s) to tear down all PFCP Associations with the UPF(s) controlled by the current SMF set and then use PFCP Association Setup procedure to establish the PFCP Associations with the UPF(s) controlled by the new SMF set.

To move a SMF together with all its controlled PFCP sessions from one SMF set to another SMF set, the SMF may update its SMF SET ID corresponding to the new SMF set using the PFCP Association Update procedure. When the UPF receives a PFCP Association Update Request message containing a new SMF Set ID, the UPF shall maintain the existing PFCP sessions served by this SMF and use the new SMF Set ID of the SMF if the UPF needs to later reselect a different SMF instance for these PFCP sessions (as defined in step 6).

2) When establishing a PFCP session, the SEID that the SMF assigns in the CP F-SEID of the PFCP Session Establishment Request may be unique or not within the SMF set. However the assigned CP F-SEID shall be unique within the SMF set.

NOTE 3: The UPF does not (need to) know whether the SEID in the CP F-SEID is uniquely assigned in the SMF set or not. The SMF and the UPF identifies the PFCP session by its own CP F-SEID and UP F-SEID respectively.

3) Any SMF in the SMF set may issue requests to modify or delete the PFCP session. When the SMF controlling a PFCP session changes, the SMF that takes over the control of the PFCP session shall provide its own Node ID and may provide a new CP F-SEID.

The UPF shall allow the PFCP session modification or deletion request to come from any other PFCP association from the same SMF set.

4) At any time, an SMF may update a PFCP session by including the CP F-SEID with the IPv4 or IPv6 address of a new SMF and/or a new SEID assigned by the new SMF in a PFCP Session Modification Request.

5) When receiving a request from a UPF with the SEID field set to zero and CP F-SEID assigned by previous SMF, the SMF shall take over the control of the PFCP session from the previous SMF, unless it is needed to redirect the request to a different SMF in the same SMF set (e.g. due to high load or because the corresponding session context has already been taken over by a different SMF in the same SMF set).

An SMF may redirect a UPF initiated PFCP session related request to another PFCP entity pertaining to the same SMF or to a different SMF in the SMF set by rejecting the request with the cause "Redirection Requested" and with the IP address of the new entity to contact. When sending the redirected request to another PFCP entity pertaining to the same SMF or to the new SMF, the UPF shall set the SEID field to zero in the header of the PFCP request and include the CP F-SEID assigned by the previous SMF in the request.

Alternatively, an SMF may forward the UPF request to another PFCP entity pertaining to the same SMF or another SMF in the SMF set; the new PFCP entity or the new SMF answers to the UPF, including the CP F-SEID IE with the IPv4 or IPv6 address of the new entity respectively and the same or a modified SEID, and optionally including the N4-u F-TEID that the UPF shall use for sending data towards the new entity.

NOTE 4: This allows to address cases where a different SMF would have been reselected in the 5GC for the PFCP session, e.g. by an AMF.

- 6) The UPF shall initiate PFCP session related requests (e.g. PFCP Session Report Request) towards another PFCP entity pertaining to the same SMF or to another SMF in the SMF set with which the UPF has established associations with the same SMF Set ID, if the IP address included in the CP F-SEID assigned to the PFCP session is not responsive, heartbeat failure towards IP address of the CP F-SEID assigned to the PFCP session, or if the UPF receives a GTP-U Error Indication from the SMF over the N4-u tunnel assigned to the N4 session for data forwarding.

The UPF shall firstly use the IP addresses included in those Alternative SMF IP Address IE(s) with the PPE flag set to "1" (if available) whenever possible, then it may use the IP addresses included in the Alternative SMF IP Address IE(s) without the PPE flag set to "1", to contact an alternative PFCP entity.

When sending the request to the new entity, the UPF shall set the SEID field to zero in the PFCP header of the PFCP request and include the CP F-SEID assigned by the previous SMF in the request.

- 7) The UPF shall trigger the SMF restoration procedures for an SMF in a SMF set specified in clause 4.4 of 3GPP TS 23.527 [40] for a PFCP session that can be controlled by different SMFs of an SMF set when a heartbeat failure is detected.

When sending a PFCP Session Report Request message to move the PFCP session towards an alternative SMF, the UPF shall set Report Type to the "UISR" if:

- there is no other report to send, e.g. a Downlink Data Report; or
- there are pending UL payload packets to be sent towards the new SMF via a new N4-u tunnel;

For the latter case, the UPF shall also set "Pending UL Payload Packet to CP function" flag in the PFCPSRReq-Flags IE.

Otherwise, when there is other report to send, e.g. a Downlink Data Report, the UPF shall set Report Type according to the report included in the message.

The UPF may also include the SMF Change Reason IE to indicate the reason for SMF change, e.g. "move the PFCP session due to the SMF not responding", "move the PFCP session due to the SMF failure", "move the PFCP session instructed by the SMF in a PFCP Session Set Modification Request".

NOTE 5: These restoration procedures cause the UPF to delete the PFCP session contexts only if heartbeat procedures fail with all of the SMFs in the SMF set (i.e. the SMFs with which the UPF has established associations with the same SMF Set ID).

- 8) If an SMF or UPF fails, the peer PFCP node that detects that error shall remove the PFCP association locally. The SMF and UPF shall then handle the PFCP sessions that were served by this PFCP association as described in step 2 for a PFCP association release.
- 9) A UPF supporting the MPAS feature shall support UE IP address/prefix allocation in the UP function (see clause 5.21).

5.22.4 Restoration of PFCP Sessions associated with an FQ-CSID, Group ID or PGW-C/SMF IP Address

As specified in clause 31.6 of 3GPP TS 23.007 [24] and clauses 4.6 and 4.7 of 3GPP TS 23.527[40], for deployments with PGW-C/SMF Set, the CP function (e.g. a PGW-C or a SMF) and the UP function (a PGW-U or a UPF) may support the feature "Restoration of PFCP Sessions associated with one or more PGW-C/SMF FQ-CSID(s), Group Id(s) or PGW-C/SMF IP address(es)". A CP function and a UP function that supports this feature shall behave as specified in clause 5.22.2 or 5.22.3 with the following additional requirements:

- 1) A UP function that supports this feature shall indicate so to the CP function by setting the RESPS feature bit in the UP Function Feature IE (see clause 8.2.25).
- 2) The PGW-C/SMF in a PGW-C/SMF Set may allocate a globally unique Group Id to a PFCP session, in the PFCP Session Establishment Request message during the PFCP session establishment procedure and may update the Group Id associated to the PFCP session in a PFCP Session Modification Request message if necessary. The

UP function shall store the Group Id associated to a PFCP session. At most one Group ID may be associated to a PFCP session.

- 3) Alternatively, if partial failure handling is supported, the PGW-C/SMF may assign an FQ-CSID to a PFCP session as specified in clause 31 of 3GPP TS 23.007 [24] and clause 4.6 of 3GPP TS 23.527 [40].
- 4) The PGW-C/SMF (either the PGW-C/SMF serving the PFCP sessions or another PGW-C/SMF in the same Set taking over the control of the PFCP sessions) may send a PFCP Session Set Modification Request message to the PGW-U/UPF(s), including either one or more PGW-C/SMF FQ-CSID IE(s) allocated earlier, or one or more Group Id IE(s) allocated earlier, or one or more CP (PGW-C/SMF) IP Addresses and an Alternative SMF IP Address IE, to request the PGW-U/UPF(s) to send subsequent PFCP Session Report Request messages to the same or an alternative PGW-C/SMF (as indicated in the Alternative SMF IP Address IE) for the PFCP Sessions which are associated with the PGW-C/SMF FQ-CSID(s) or the Group Id IEs, or which have their F-SEID containing the CP IP Address. The PGW-C/SMF may instruct the UP function to move sessions associated with different PGW-C/SMF FQ-CSID(s), Group Ids or CP IP Addresses, to different PGW-C/SMF addresses.
- 5) When the PGW-U or UPF sends subsequent PFCP Session Report Request message to the indicated alternative PGW-C/SMF address, the PGW-U or UPF may receive either a new PGW-C/SMF FQ-CSID or a new Group Id for that PFCP session in the PFCP Session Report Response message from the new PGW-C/SMF.

NOTE: The above procedure enables a PGW-C/SMF to move groups of sessions to one or more different PGW-C/SMF instances, e.g. during a partial or complete failure in a PGW-C/SMF or when a PGW-C/SMF is shutting down (e.g. scale-in operation), in one signal PFCP message. This allows the PGW-C/SMF to control how PFCP sessions are re-distributed in the SMF set.

5.23 5G VN Group Communication (for 5GC)

5.23.1 General

Stage 2 requirements for the support of 5G VN communication are specified in clauses 4.4.6 and 5.8.2.13 of 3GPP TS 23.501 [28].

The 5G VN group communication includes one to one communication and one to many communication.

One to one communication supports forwarding of unicast traffic between two UEs within a 5G VN, or between a UE and a device on the DN.

One to many communication supports forwarding of multicast traffic and broadcast traffic from one UE (or device on the DN) to many/all UEs within a 5G VN and/or devices on the DN.

5G VN Group Communication is optional to support. The SMF may instruct the UPF to forward unicast and/or broadcast traffic as described below if the UPF has indicated support of 5G VN Group Communication (see feature GCOM in clause 8.2.25).

There are 3 different traffic forwarding methods, i.e. UPF local switching, N6-based forwarding and N19-based forwarding, to forward traffic within the 5G VN group.

For all methods, traffic forwarding within the 5G VN group is realized by using a UPF internal interface ("5G VN Internal") and a two-step detection and forwarding process. In the first step, the packets received from any 5G VN group member (via its PDU Session, via N6 or via N19) are forwarded to the UPF internal interface (i.e. Destination Interface set to "5G VN Internal"). In the second step, PDRs installed at the UPF internal interface (i.e. Source Interface set to "5G VN Internal") detect the packet and forward it to the respective 5G VN group member (via its PDU Session, via N6 or via N19). If more than one 5G VN group has to be supported, the Network Instance set to a value representing the 5G VN group is used in addition to the UPF internal interface to enable isolation of the 5G VN group communication during the packet detection and forwarding process.

When N19-based forwarding is used, the SMF may correlate all the PDU sessions for the 5G VN Group members to generate the PDR and FAR corresponding to the group level N4-session for UPF as specified in clause 5.29.3 of 3GPP TS 23.501 [28].

For Ethernet unicast traffic on 5G VN Group Communication, the SMF may either explicitly configure DL PDR with the MAC addresses detected by the UPF on PDU Sessions supporting a 5G VN group, or rely on MAC address learning

in UPF related with a 5G VN group by setting the Ethernet PDU Session Information indication in the DL PDR of the "5G VN internal" interface as specified in clause 5.8.2.13.0 of 3GPP TS 23.501 [28].

To enable IP or Ethernet type broadcast traffic forwarding of a 5G VN Group, the SMF may provide the PDRs related to the group level N4-session and each 5G VN group member' N4 Session to the UPF as specified in clause 5.8.2.13.3 of 3GPP TS 23.501 [28].

The details of the PDR and FAR setting over N4 for unicast traffic forwarding within a 5G VN are specified in clauses 5.8.2.13.1 and 5.8.2.13.2 of 3GPP TS 23.501 [28].

The details of the PDR and FAR setting over N4 for broadcast traffic forwarding within a 5G VN are specified in clause 5.8.2.13.3 of 3GPP TS 23.501 [28].

If a PIN has more than one PEGCs, 5G VN Group Communication may be used for the PIN as specified in clause 5.44.3 of 3GPP TS 23.501 [28]. In this case, separation of multiple PINs communication in the UPF uses different network instances as it is for 5G VN Group.

The UPF local switching may be applied to PIN indirect communication when there are multiple PDU sessions for a PIN from different PEGCs connecting to the same UPF. The N6-based forwarding may be applied to PIN-DN communication.

5.23.2 5G VN group communication without N6-based forwarding

The 5G VN group communication may be either among the UEs within a 5G VN group and the devices on the DN, or among the UEs within a 5G VN group only. In case the 5G VN group communication is among the UEs within a 5G VN group only, the DN is excluded from the 5G VN group communication and only the traffic between the UEs within a VN group shall be handled by the UPF internal interface ("5G VN Internal"). In the latter case, the N6-based traffic forwarding method is not applicable.

So, for each PFCP session of UEs within a 5G VN group, the SMF shall provide:

- different PDRs/FARs to only forward the 5G VN group communication traffic to the UPF internal interface ("5G VN Internal") based on the IP/MAC address(es) of all the UEs in SDF filter IE or multicast/broadcast IP/MAC address(es), and to send the non-5G VN communication traffic directly to DN with a match-all Packet Filter and a Precedence set to the lowest precedence value; and
- different PDRs/FARs to forward 5G VN group communication traffic from UPF internal interface ("5G VN Internal") to the UE, and to forward the non-5G VN group communication traffic from the DN directly to the UE.

Additionally, if the N19-based forwarding applies, the SMF shall not configure the group-level N4 Session to forward 5G VN group communication traffic to N6.

5.24 Support of Ultra Reliable Low Latency Communication for 5GC

5.24.1 General

Stage 2 requirements for the support of Ultra Reliable Low Latency Communication (URLLC) are specified in clause 5.33 of 3GPP TS 23.501 [28].

NOTE 1: In this release of specification redundant transmission on N3/N9 interfaces for URLLC is not supported for PDU Sessions involving an I-SMF. See 3GPP TS 23.501 [28] clauses 5.34, 5.33.2.2 and 3GPP TS 23.502 [29] clause 4.24.

Redundant transmission is applied for supporting the highly reliable URLLC services, there are three different methods: dual connectivity based end to end redundant user plane paths, redundant transmission on N3/N9 interfaces or redundant transmission at transport layer.

NOTE 2: Dual connectivity based end to end redundant user plane paths has no impact to N4 interface.

QoS Monitoring is applied for packet delay measurement. The packet delay between UE and PSA UPF is a combination of the uplink or downlink packet delay on Uu interface and uplink or downlink packet delay between NG-RAN and PSA UPF. The QoS Monitoring on uplink or downlink packet delay between NG-RAN and PSA UPF can be performed on different levels of granularities, i.e. per QoS Flow per UE level, or per GTP-U path level.

Support of the URLLC feature is an optional for the SMF and UPF, for 5GC.

5.24.2 Redundant Transmission on N3/N9 interfaces

5.24.2.1 General

Stage 2 requirements for support of Redundant Transmission on N3/N9 interfaces for high reliability communication are specified in clause 5.33.2.2 of 3GPP TS 23.501 [28].

This requires duplicating downlink and uplink packets of QoS flows requiring redundant transmission of a PDU session via two independent N3 or N9 tunnels between the RAN and the UPF (PSA).

The following requirements shall apply for QoS flows requiring redundant transmission. Requirements in clause 5.2.2.3.3 shall also apply for traffic usage reporting.

5.24.2.2 GTP-U tunnel setup for redundant transmission

The SMF shall request the UPF (PSA) to establish two N3 or N9 tunnels for a PDU session with one or more Service Data Flows associated with QoS flow(s) requiring redundant transmission as follows:

- when provisioning an UL PDR in the UPF (PSA), the SMF shall request the UPF to assign two Local F-TEIDs for the PDR, by provisioning the PDI or the Traffic Endpoint with the Redundant Transmission Detection Parameters IE. The SMF may provide two different Network Instances for these two F-TEIDs to achieve disjoint transport layer paths;
- alternatively, the SMF may request the UPF to assign one Local F-TEID for the related Network Instance when creating the UL PDR, and later request the UPF to assign another Local F-TEID with the same or a different Network Instance when updating the PDR, if the redundant transmission tunnels are not established during the PDU session establishment;
- when provisioning DL FAR in the UPF (PSA) corresponding to QoS flows requiring redundant transmission, the SMF shall request the UPF to duplicate the downlink packets for redundant transmission and the SMF shall provide two F-TEIDs of remote GTP-U tunnel endpoints in the FAR, as described in clause 5.24.2.3;
- alternatively, the SMF may provide one remote endpoint F-TEID when creating the FAR and later provide another remote endpoint F-TEID when updating the FAR, if the redundant transmission tunnels are not established during the PDU session establishment.

NOTE: To forward downlink packets pertaining to service data flows not requiring redundant transmission, the SMF can create a separate FAR not requiring to duplicate the packets.

The PSA UPF shall assign the local F-TEID(s) for establishing the redundant tunnel and include the Local F-TEID(s) for Redundant Transmission IE in the PFCP Session Establishment Response or the PFCP Session Modification Response to the SMF if the Redundant Transmission Detection Parameters IE was received in the corresponding request message.

The SMF shall request the UPF (PSA) to remove one N3 or N9 tunnel used for redundant transmission if redundant transmission is no longer needed as follows:

- request the UPF to remove the local F-TEID for redundant transmission by updating the PDI or the Traffic Endpoint in UL PDR with a null length Redundant Transmission Detection Parameters IE;
- request the UPF to remove the F-TEID of remote GTP-U tunnel endpoint for redundant transmission by updating the FAR in DL PDR with a null length Redundant Transmission Forwarding Parameters IE;
- set the DFRT and EDRT flags to 0 in the FAR associated to the corresponding UL and DL PDRs, to stop duplicating packets and eliminating duplicate packets.

When so instructed, the PSA UPF shall remove the local F-TEID for redundant transmission and the F-TEID of remote GTP-U tunnel endpoint for redundant transmission, stop duplicating packets and stop detecting/eliminating duplicate packets accordingly.

5.24.2.3 Duplicating downlink packets for redundant transmission

If redundant transmission is required for a QoS flow, the SMF shall instruct the PSA UPF to replicate each downlink packet of the QoS Flow and to assign a sequence number to them by provisioning a FAR with the following information in a PFCP Session Establishment Request or PFCP Session Modification Request:

- the Redundant Transmission Forwarding Parameters IE including an Outer Header Creation IE set to the remote F-TEID of the redundant GTP-U tunnel, and if the GTP-U tunnel for redundant transmission uses a different network instance than the primary GTP-U tunnel, the Network Instance to be used for redundant transmission;
- the Apply Action IE with both the FORW and the DFRT flags set to "1".

When so instructed, the PSA UPF shall replicate downlink packets associated to such a FAR and construct the duplicated downlink packets using the information included in the Redundant Transmission Forwarding Parameters IE and other information included in the Forwarding Parameters IE for information that is not part of the Redundant Transmission Forwarding Parameters IE. The PSA UPF shall add the same sequence number in the PDU Session Container extension header of the downlink packet and the related duplicated downlink packets as specified in 3GPP TS 38.415 [34].

5.24.2.4 Eliminating duplicated uplink packets

For QoS flows for which redundant transmission is required, the SMF shall also instruct the PSA UPF to eliminate the duplicated uplink packets of the QoS Flow, based on their sequence numbers in the PDU Session Container extension header by setting the EDRT flag and the FORW flag in the Apply Action IE in the FAR IE to request the UPF to eliminate the duplicated uplink packets based on the sequence number, i.e. to forward the uplink packets and to drop duplicated uplink packets. When so instructed, the PSA UPF shall forward the only one copy of the uplink packets and drop duplicate uplink packets.

5.24.3 Redundant Transmission at transport layer

Stage 2 requirements for support of Redundant Transmission at transport layer for high reliability communication are specified in clause 5.33.2.3 of 3GPP TS 23.501 [28].

If it supports the redundant transmission at transport layer, the UP function shall set the RTTL feature flag in the UP Function Features IE (see clause 8.2.25). If so, during the UE requested PDU session establishment procedure, the CP function may select the UPF that supports redundant transmission at transport layer for the PDU session.

Requirements in clause 5.2.2.3.3 shall apply for traffic usage reporting.

NOTE: How the UPF perform the redundant transmission at transport layer is left up to UPF implementation.

5.24.4 Per QoS Flow Per UE QoS Monitoring

5.24.4.1 General

Stage 2 requirements for support of per QoS flow per UE QoS monitoring are specified in clause 5.33.3.2 of 3GPP TS 23.501 [28].

The UPF shall set the QFQM feature flag in the UP Function Features IE if it supports per QoS flow per UE QoS monitoring for packet delay (see clause 8.2.25). If so, the SMF may request the UPF to perform per QoS flow per UE QoS monitoring during a PFCP session establishment or a PFCP session modification procedure.

The SMF shall instruct the UPF to perform per QoS flow QoS monitoring for packet delay as specified in clause 5.24.4.2.

The UPF shall report the QoS monitoring result of the QoS flows to the SMF by sending QoS Monitoring Report IEs to the SMF as specified in clause 5.24.4.3, or by reporting the QoS monitoring events directly to the Local NEF or AF (see clause 5.33.5).

5.24.4.2 QoS Monitoring Control

The SMF shall instruct the UPF to perform per QoS flow QoS monitoring for packet delay as specified in clause 5.39.2, with the following additions:

- the Requested QoS Monitoring IE in the QoS Monitoring per QoS flow Control Information IE shall indicate a request to monitor the downlink packet delay, uplink packet delay, and/or the round-trip packet delay between the UPF (PSA) and UE;
- the Packet Delay Thresholds IE shall be present in the QoS Monitoring per QoS flow Control Information IE indicating thresholds for the downlink packet delay, uplink packet delay, and/or the round-trip packet delay to generate the QoS monitoring reports to the CP function, if the Event Triggered QoS monitoring reporting is required in the reporting frequency; and
- the Measurement Period IE shall be present in the QoS Monitoring per QoS flow Control Information IE, indicating the period to generate periodic usage reports to the SMF (if the periodic QoS monitoring reporting is required in the reporting frequency) and the period used to detect and report a QoS monitoring measurement failure (if Periodic QoS monitoring reporting or Event Triggered QoS monitoring reporting is required in the reporting frequency).

5.24.4.3 QoS Monitoring Reporting

If the UPF is requested to perform QoS Monitoring (i.e. it receives one or more QoS Monitoring per QoS flow Control Information IEs from the SMF), the UPF shall select one or more downlink payload packets pertaining to every requested QoS flow(s) whenever available or create one or more dummy downlink GTP-U packets (i.e. G-PDU messages without a T-PDU as specified in clause 5.2.2.7 of 3GPP TS 29.281 [3]) otherwise, and insert the time stamp, and set the QoS Monitoring Packet (QMP) flag to "1" and the corresponding QoS Flow Identifier (for the requested QoS flow) into the GTP-U PDU Session Container extension header (see 3GPP TS 38.415 [34]) of these downlink packets.

When receiving the uplink packet related to the requested QoS flow(s), the UPF shall measure the packet delay(s) based on the time stamp(s) and packet delay(s) included in the GTP-U PDU Session Container extension header (see 3GPP TS 38.415 [34]) of the uplink packet, and generate a QoS monitoring report towards the SMF, if the packet delay(s) exceeds the defined Packet Delay Thresholds and Event Triggered QoS monitoring reporting is required in the reporting frequency. The UPF may send a next report only after the minimum waiting time indicated by the SMF.

NOTE: The dummy GTP-U packet(s) are not forwarded to the UE neither to the Packet Data Network, thus they are not measured for usage reporting. An Intermediate UPF between the PSA UPF and the NG-RAN forwards any received dummy GTP-U packets together with the GTP-U PDU Session Container extension header to the next GTP-U entity.

If the Periodic QoS monitoring reporting is required in the reporting frequency, the UPF shall generate QoS monitoring report based on the Measurement Period.

The UPF shall send QoS Monitoring Report IE to the SMF in PFCP Session Report Request; several QoS Monitoring Report IEs may be present to report the packet delay(s) for multiple QoS flows. The UPF shall include the delay value (Downlink, Uplink and/or Round trip) in the QoS Monitoring Measurement IE in the QoS Monitoring Report IE. See clause 5.33.5 for reporting the QoS monitoring events directly to the Local NEF or AF.

The UPF shall continue to apply all the provisioned SRR(s) and perform the related QoS monitoring measurement(s), until getting any further instruction from the CP function.

When receiving a new threshold (Packet Delay Thresholds, Minimum Wait Time and/or Measurement Period) from the SMF for a measurement that is already ongoing in the UPF, the UPF shall consider its ongoing measurements against the new threshold to determine when to send its next QoS monitoring report to the SMF or to the Local NEF or AF (if direct reporting of QoS monitoring event applies, see clause 5.33.5).

When receiving instruction from the SMF to stop the on-going QoS monitoring, the UPF shall generate a QoS monitoring report to the SMF or to the Local NEF or AF (if direct reporting of QoS monitoring event applies, see clause 5.33.5), to report the detected packet delay(s).

If Periodic QoS monitoring reporting or Event Triggered QoS monitoring reporting is required in the reporting frequency and no time stamp is received in uplink packet for a delay exceeding the Measurement Period (i.e. no measurement result is available in the UPF within the reporting period), the UPF shall generate a QoS monitoring report

indicating a packet delay measurement failure to the SMF or to the Local NEF or AF (if direct reporting of QoS monitoring event applies, see clause 5.33.5).

5.24.5 Per GTP-U Path QoS Monitoring

5.24.5.1 General

Stage 2 requirements for support of per GTP-U path QoS monitoring are specified in clause 5.33.3.3 of 3GPP TS 23.501 [28].

The UPF shall set the GPQM feature flag in the UP Function Features IE if it supports per GTP-U Path QoS monitoring (see clause 8.2.25).

5.24.5.2 GTP-U path monitoring

If the UPF is known to support this feature (e.g. by the UP Function Features IE), the SMF may request the UPF to measure the packet delay for transport paths towards remote GTP-U peers during a PFCP association setup or a PFCP association update procedure, by provisioning GTP-U Path QoS Control Information including:

- the identification of the GTP-U paths to be monitored, i.e.:
 - the IP destination address of one or more remote GTP-U peers, and if available, the network instance used to reach each remote GTP-U peer and the DSCP value(s) to measure the packet delay; or
 - the interface type(s) (i.e. N9 and/or N3) of the GTP-U paths;
- the values of the DSCP in the TOS/Traffic Class field to measure the packet delay, if available;
- the conditions and QoS parameters for the UPF to report measurements to the SMF, i.e. one or more of:
 - immediate report;
 - periodic report, with the reporting time period; and/or
 - event triggered report, when the average, minimum and/or maximum packet delay on a GTP-U path exceeds corresponding thresholds.

If so instructed, the UPF shall perform an estimation of the RTT for the GTP-U paths requested to be monitored, by sending Echo Request messages (with each requested DSCP value, if any) and measuring the time that elapses between the transmission of the Echo Request message and the reception of the Echo Response message. The UPF shall compute the packet delay by adding $RTT/2$ and the UPF internal processing time, thus the measured delay represents an estimated elapsed time for the GTP-U path (since a user plane packet entered the UPF and its reception by the next downstreams or upstreams GTP-U peer). The UPF shall send QoS reports to the SMF by including GTP-U Path QoS Report IE(s) in a PFCP Node Report Request message.

If the GTP-U paths to be monitored are identified by their interface types (e.g. N9 and/or N3), the UPF shall monitor all GTP-U paths of all PFCP sessions established with a FAR including a matching Destination Interface Type.

For event triggered reporting, the UPF shall send a first report when a reporting threshold is exceeded and a minimum waiting time shall be applied for the subsequent report for the same type of measurement (e.g. maximum packet delay) and the same remote GTP-U peer (if the threshold is exceeded after the waiting time).

5.24.5.3 QoS monitoring of a PDU session based on GTP-U path monitoring

The SMF may request the UPF (PSA) to monitor the Uplink, Downlink or Round-Trip delay per QoS flow per UE, as specified in clause 5.24.4.2 with the following addition:

- In the QoS Monitoring per QoS flow Control Information IE, the SMF shall indicate that QoS monitoring is performed based on GTP-U path monitoring by setting the GTPUPM flag to 1 in the Requested QoS Monitoring IE.

Additionally, for the UPF (PSA) and for any intermediate UPF in the path of the PDU session, the SMF (or I-SMF) shall request the UPF:

- to measure the one-way delay of the GTP-U path with the preceding uplink GTP-U entity; this corresponds to the N3 path for a UPF connected to the RAN, and to a N9 path for a UPF connected to an intermediate UPF;
- to add this delay to the "N3/N9 Delay Result" field received in the GTP-U PDU Session Container extension header (see 3GPP TS 38.415 [34]) of the uplink packet; and
- for an intermediate UPF, to send the resulting value in the "N3/N9 Delay Result" field in the GTP-U PDU Session Container extension header (see 3GPP TS 38.415 [34]) of the uplink packet it forwards (towards the PSA).

The SMF shall request the above to the UPF (PSA or I-UPF) by including the Transport Delay Reporting IE in the UL PDR(s) associated to the corresponding QoS flow to be monitored. Multiple QoS flows may be monitored for a given PDU session as specified in clause 5.24.5.4.

When so requested, each UPF shall, for UL GTP-U packets with the PDU Session Container extension header including the RAN Uplink and/or Downlink fields, add the delay of the GTP-U path with the preceding uplink GTP-U entity.

NOTE: The "N3/N9 Delay Result" field is computed by the intermediate UPF(s) and UPF (PSA). The RAN does not report the N3 path delay. The intermediate UPF connected to the RAN adds the N3 delay; the next intermediate UPF (if any) adds the N9 delay with the first intermediate UPF and the PSA adds the N9 delay of the last GTP-U path towards the PSA. If the PSA is directly connected to the RAN, the PSA measures the N3 delay.

5.24.5.4 QoS Monitoring Reporting

QoS monitoring reporting by the PSA shall be performed as specified in clause 5.24.4.3, with the following modifications.

The UP function shall not insert time stamps into the GTP-U PDU Session Container extension header (see 3GPP TS 38.415 [34]) of downlink packets.

When receiving the uplink packet related to the requested QoS flow(s), the PSA shall measure the Uplink or Downlink delay by computing the sum of the end to end accumulated transport delay (computed as defined in clause 5.24.5.3) and the RAN UL or DL delay included in the GTP-U PDU Session Container extension header (see 3GPP TS 38.415 [34]) of the uplink packet.

5.25 Support of IPTV (for 5GC)

IPTV service is defined in clause 4.9.1 of 3GPP TS 23.316 [57]. Stage 2 procedures to support IPTV service are defined in clauses 4.6 and 7.7.1 of 3GPP TS 23.316 [57].

Support of IPTV service is optional for the SMF and UPF. The following requirements shall apply for IPTV service if the UPF supports the IPTV feature (see clause 8.2.25).

This requires the UPF (PSA) to support:

- terminating and managing IGMP or MLD messages received from the UE;
- acting as a Multicast Router as defined in IETF RFC 2236 [52] and IETF RFC 9776 [53];
- replicating IP multicast traffic received from the N6 interface over PDU sessions having joined the corresponding IP multicast group;
- notifying the SMF when a PDU session has joined or left a multicast group, if so requested by the SMF.

NOTE: In this specification, "IGMP" refers to IGMPv2 and IGMPv3 and "MLD" refers to MLDv1 and MLDv2, unless specified otherwise.

For a PDU session used for IPTV service, the SMF shall provision the following rules in the UPF to control the UL IGMP/MLD traffic and the DL IP multicast traffic as follows:

- for the control of UL IGMP or MLD traffic:

- a PDR that shall identify IGMPv2 (see IETF RFC 2236 [52]), IGMPv3 (see IETF RFC 4604 [54]), MLD (see IETF RFC 2710 [55]) and/or MLD2 (see IETF RFC 4604 [54]) signalling, i.e.:
- with a PDI containing an SDF filter with a Flow Description identifying packets with IP Protocol number of 2, or with a pre-defined PDR matching the same, for IGMP traffic;
- with a pre-defined PDR matching traffic with IPv6 Next Header type value 58 and ICMP Field Type value 131 or 143, for MLD traffic.
- this PDR may also contain IP Multicast Addressing Info IE(s) identifying (ranges of) IP multicast group(s); if no IP Multicast Addressing Info IE is included, the PDR is meant to match any IP multicast group.
- an associated FAR containing the Apply Action IE with the IPMA (IP Multicast Accept) or the IPMD (IP Multicast Deny) flag set in order to request the UPF to accept or deny the UE requests to join the corresponding IP multicast group(s);
- for the control of DL IP multicast traffic
- a PDR including IP Multicast Addressing Info IE(s), identifying (ranges of) IP multicast addresses (DL IP multicast flows) or indicating any IP multicast address by the A (Any) flag set to "1";
- an associated FAR containing the Apply Action IE set to forward or buffer the packets, and in the former case with the Outer Header Creation IE set to add the remote N3 or N9 GTP-U tunnel IP address and TEID related with the PDU session;
- optionally an associated QER indicating the QoS to use for the PDU session for the IP Multicast traffic that has been replicated.

The UPF shall add or remove the PDU session to/from the DL replication tree associated with an IP Multicast flow, when the UE request to join the IP Multicast flow is accepted or when the UE requests to leave the IP Multicast flow. When receiving downlink IP multicast traffic, the UPF shall replicate the traffic towards each PDU session that has joined the corresponding IP multicast group and that is provisioned with a DL PDR enabling the forwarding of the corresponding IP multicast traffic.

Additionally, the SMF may provision a URR, associated with the UL PDR controlling the IGMP or MLD traffic, with a Reporting trigger set to "IP multicast join/leave" to request the UPF to report to the SMF when it adds or remove the PDU session to/from the DL replication tree associated with an IP Multicast flow. Corresponding reports shall contain the Multicast IP address of the DL multicast flow and, if available, the Source specific IP address(es) of the DL IP multicast flow.

5.26 Support of Time Sensitive Communication, Time Synchronization, 5GS integration with TSN and Deterministic Networking (for 5GC)

5.26.1 General

The 5G System may support enabling Time Sensitive Communication, Time Synchronization and Deterministic Networking including the following aspect as specified in clause 4.4.8 of 3GPP TS 23.501 [28]:

- a) Integration of 5GS into a TSN data network (DN), i.e., as a bridge in an IEEE 802.1 Time Sensitive Networking (TSN), as illustrated in Figure 4.4.8.2-1 of 3GPP TS 23.501 [28] and further specified in clause 5.28 of 3GPP TS 23.501 [28];
- b) Enablers for AF requested support of Time Synchronization and/or some aspects of Time Sensitive Communication (TSCTS) as illustrated in Figure 4.4.8.3-1 of 3GPP TS 23.501 [28] and further specified in clauses 4.4.8, 5.27 and 5.28 of 3GPP TS 23.501 [28];
- c) Integration as a router in a Deterministic Network as illustrated in Figure 4.4.8.4-1 of 3GPP TS 23.501 [28], and further specified in clauses 4.4.8, 5.27 and 5.28 of 3GPP TS 23.501 [28].

NOTE: How the above features are supported for PDU Sessions involving an I-SMF is not specified in this release of specification. See 3GPP TS 23.501 [28] clause 5.34 and 3GPP TS 23.502 [29] clause 4.24.

The related procedures between SMF and UPF defined in clauses 5.26.2, 5.26.3 and 5.26.4 to support bullet a) as described above are optional for the SMF and UPF and may apply if the UPF indicated support of the TSN feature (see clause 8.2.25).

The related procedures between SMF and UPF defined in clauses 5.26.2, 5.26.3 and 5.26.4 to support bullet b) as described above are optional for the SMF and UPF and may apply if the UPF indicated support of the TSCTS feature (see clause 8.2.25).

The related procedures between SMF and UPF defined in clauses 5.26.2, 5.26.3 to support bullet c) as described above are optional for the SMF and UPF and may apply if the UPF indicated support of the DETNET feature (see clause 8.2.25).

For UE-UE TSC communications, the SMF may configure the UPF to apply local switching with existing technologies as specified in clauses 5.13 for Ethernet traffic or 5.23 for 5G VN Group Communication, such as to enable the UPF to locally forward uplink stream from one PDU session as downlink stream in another PDU session.

5.26.2 5GS User Plane Node management

5GS Bridge information reporting is defined in Annex F.1 of 3GPP TS 23.502 [29]. This procedure enables the SMF to report 5GS Bridge/User Plane Node information of a PDU session established for Time Sensitive Communication (TSC) to the TSN AF or TSCTSF via the PCF.

5GS DetNet node information reporting is specified in Annex F.5 of 3GPP TS 23.502 [29] and clause 5.28.5.2 of 3GPP TS 23.501 [28]. This procedure enables the SMF to report 5GS User Plane Node information of a PDU session established for Deterministic Networking (DetNet) to the TSCTSF via the PCF.

Identities of 5GS User Plane Node and UPF/NW-TT ports may be pre-configured in the UPF based on deployment. When establishing the PFCP session for the PDU session for TSC, the SMF shall provide the Network Instance IE and it may provide the APN/DNN IE and S-NSSAI IE to the UPF to enable the UPF to respond with the proper 5GS User Plane Node ID based on configuration information associated with the network instance or DNN and S-NSSAI pair. For IEEE TSN the 5GS User Plane Node IE shall contain the Bridge ID and for IETF DetNet the 5GS User Plane Node IE may contain the Router ID .

In order to establish a PDU Session for TSC, the SMF shall send a PFCP Session Establishment Request to the UPF to establish the corresponding PFCP session as specified in this specification. Additionally, the SMF shall request the UPF to allocate the port number for the PDU Session and provide the related 5GS User Plane Node ID by including the Create Bridge/Router Info IE with the Bridge Information Indication (BII) bit set to "1" (for TSN and TSCTS as described in clause 5.26.1) or with the Router Information Indication (RII) bit set to "1" (for DetNet), in the PFCP Session Establishment Request. If so requested, the UPF shall provide corresponding information to the SMF in the Created Bridge/Router Info IE in the PFCP Session Establishment Response message.

NOTE 1: The port number for the PDU Session corresponds to the device side port of the 5GS bridge/router. When the device supports the DS-TT functionality, the port number represents the DS-TT port number of the PDU Session.

NOTE 2: The port number for the PDU session and 5GS User Plane Node ID are not meant to be used in PDRs.

NOTE 3: The port number is encoded differently between TSN/TSCTS and DetNet (see clauses 8.2.141 and 8.2.142).

5.26.3 Transfer of 5GS user plane node and port management information

5.26.3.1 General

5GS User Plane Node and Port management information exchange is defined in clause 5.28.3 of 3GPP TS 23.501 [28] and in Annex F of 3GPP TS 23.502 [29]; this procedure enables the SMF to relay transparently user plane node and/or port related information between the TSN AF or TSCTSF and the NW-TT (and DS-TT).

Port management information shall be transferred between the SMF and UPF in a Port Management Information Container (PMIC). If the NW-TT supports several ports, and port management information needs to be sent for several ports, a separate PMIC shall be used for each port.

User Plane Node management information shall be transferred between the SMF and UPF in a User Plane Node Management Information Container (UMIC).

The SMF and UPF may send a PMIC or a UMIC using PFCP session related procedures of any PFCP session associated with this NW-TT. The SMF may forward NW-TT related UMIC and/or PMIC(s) and/or related port number(s) to the UPF by sending a PFCP Session Modification Request to the UPF including the TSC Management Information IE. The UPF may send NW-TT related UMIC and/or PMIC(s) and/or related port number(s) to the SMF by sending a PFCP Session Modification Response or a PFCP Session Report Request including the TSC Management Information IE, if direct reporting of TSC management information event to TSN AF or TSCTSF as specified in clause 5.26.3.2 does not apply.

The details of the User Plane Node and Port Management Container communication between NW-TT and TSN AF or TSCTSF is defined in the 3GPP TS 24.539 [63].

5.26.3.2 Direct Reporting of TSC management information event to TSN AF or TSCTSF

A UPF may be instructed to report TSC management information events directly to a TSN AF or TSCTSF as specified in clause 5.28.3.1 of 3GPP TS 23.501 [28].

A UPF that supports this feature shall set the DRTSC (Direct Reporting of TSC management information events) flag in the UP Function Feature IE (see clause 8.2.25).

An SMF shall instruct an UPF that supports the DRTSC feature to report user plane node and port management information in TSC management information events directly to a TSN AF or TSCTSF by including a Direct Reporting Information IE in the TSC Management Information IE in a PFCP Session Modification Request.

NOTE: The TSN AF or TSCTSF can indicate inside the Port Management Information Container or user plane node Management Information Container that is sent to the UPF that it wants to retrieve port or user plane node management information or to subscribe for notifications as specified in clauses 6.2.1 and 6.3.1 of 3GPP TS 24.539 [63].

The Direct Reporting Information shall include the Event Notification URI towards which the events shall be sent, and if available, the Notification Correlation ID to be included in these events.

An UPF that supports this feature shall send user plane node and port management information in TSC management information events directly to the TSN AF or TSCTSF, if the Direct Reporting Information IE was received in the TSC Management Information IE in a PFCP Session Modification Request. If so, the UPF shall send these events using the UPF Event Exposure service specified in 3GPP TS 29.564 [73] and using the notification URI received in the Direct Reporting Information IE, and the UPF shall not send any further user plane node and port management information in PFCP Session Report Request and PFCP Session Modification Response towards the SMF.

If no Direct Reporting Information IE has been received in the TSC Management Information IE in any PFCP Session Modification Request, the UPF shall send user plane node and port management information to the SMF using PFCP as specified in clause 5.26.3.1.

5.26.4 Reporting clock drift between External and 5GS times from UPF to SMF

The SMF may request the UPF to measure and report the clock drift between the external time and 5GS time for one or more external time domains (see clause 5.27.2.4 of 3GPP TS 23.501 [28]), by provisioning one or more Clock Drift Control Information IE(s) in a PFCP Association Setup Request or a PFCP Association Update Request, with the following information:

- Time Domain Number IE(s), identifying the working time domain(s), e.g. PTP (Precision Time Protocol) "domainNumber", for which clock drift needs to be measured and reported. This may be present if the Configured Time Domain IE is omitted. The SMF may omit the Time Domain Number IE in the request; if neither the Time Domain Number IE nor the Configured Time Domain IE is included, the UPF shall report the clock drift for all Time domains the UPF is connected to;

- Configured Time Domain IE with the CTDI (Configured Time Domain Indicator) flag set to "1", to indicate that clock drift needs to be measured and reported for the Time Domain Number configured in the NW-TT(s). This may be present if the Time Domain Number IE is omitted.
- the requested Clock Drift Information, indicating a request to report when the Time Offset Reporting Threshold is exceeded and/or when the cumulative RateRatio Reporting Thresholds is exceeded;
- the Time offset reporting threshold (i.e. the maximum time offset between the external time and 5G system time), if Time Offset Reporting is requested;
- the Cumulative rateRatio measurement threshold (i.e. related to cumulative rateRatio calculated at NW-TT), if Cumulative RateRatio Reporting is requested.

If so requested, when detecting either of the clock drift offset triggers exceeding the defined threshold, the UPF shall send a PFCP Node Report Request to the SMF, including one or more Clock Drift Reports, with the corresponding Time Domain Number(s), measurement information and Network Instance (if available) and the combination of DNN and S-NSSAI (if available).

5.26A Support of TSN enabled Transport Network

5.26A.1 General

The 5GS may support interworking with IEEE 802.1 TSN deployed in the transport network as specified in clause 5.28a of 3GPP TS 23.501 [28] and Annex F of 3GPP TS 23.502 [29].

A UPF that supports the TSN Talker and Listener (TL) functionality (i.e. that implements the CN-TL) shall set the CN-TL flag in the UP Function Features IE (see clause 8.2.25).

If the UPF supports the CN-TL feature, the SMF/CUC may communicate with the CN-TL via a TL-Container to retrieve the capabilities of the CN-TL or to configure TSN features in the CN-TL as defined in 3GPP TS 29.585 [80] and in clause 5.28a and Annex M of 3GPP TS 23.501 [28].

To communicate with the CN-TL, the SMF/CUC shall include:

- one TL-Container IE (encapsulating a Get Request, see 3GPP TS 29.585 [80]) in the PFCP Session Establishment Request (for the related PDU session) sent to the UPF/CN-TL; or
- one or more TL-Container IE(s) (each encapsulating a Set Request for a TN stream, see 3GPP TS 29.585 [80]) in the PFCP Session Modification Request or PFCP Session Deletion Request message (for the related PDU session) sent to the UPF/CN-TL.

The UPF/CN-TL shall then include:

- one TL-Container (encapsulating a Get Response, see 3GPP TS 29.585 [80]) in the PFCP Session Establishment Response; or
- one or more TL-Container IE(s) (each encapsulating a Set Response for a TN stream, see 3GPP TS 29.585 [80]) in the PFCP Session Modification Response or PFCP Session Deletion Response message respectively.

5.27 Inter-PLMN User Plane Security

Stage 2 requirements for support of the Inter-PLMN User Plane Security (IPUPS) functionality are defined in clauses 4.2.4, 5.8.2.14, 6.2.3, and 6.3.3.3 of 3GPP TS 23.501 [28], and in clauses 4.2.2 and 5.9.3.4 of 3GPP TS 33.501 [64].

The IPUPS functionality shall be activated for the user plane traffic received over N9 interface across PLMNs, according to operator's policy. The SMF shall provision UL/DL PDR(s) to identify the user plane traffic received at the local F-TEID in the UPF and provision UL/DL FAR(s) to forward the user plane traffic to the remote F-TEID in the GTP-U peer. User plane packets not matching any PDR shall be dropped, using mechanisms defined in this specification, see e.g. clause 5.2.1.

During a PFCP Association Setup procedure, an UPF, which is configured to be used for IPUPS shall indicate this with the UPF configured for IPUPS (UUPSI) flag, as specified in clause 7.4.4.2.

NOTE: Any UPF can support the IPUPS functionality. In network deployments where specific UPFs are used to provide IPUPS, UPFs configured for providing IPUPS services (i.e. reporting the UUPSI flag) are selected to provide IPUPS function.

5.28 Downlink data delivery status with UPF buffering (for 5GC)

5.28.1 General

Stage 2 requirements for the support of Downlink data delivery status notification with UPF buffering are specified in clause 5.8.2.19.2 of 3GPP TS 23.501 [28] and clauses 4.15.3.2.8 and 4.15.3.2.9 of 3GPP TS 23.502 [29].

If the UP function supports the Downlink data delivery status notification with UPF buffering, the UP function shall set the DDDS feature flag in the UP Function Features IE (see clause 8.2.25). If so, the CP function may provide the DL Buffering Duration IE and DL Buffering Suggested Packet Count IE in the related BAR to the UP function and may request the UP function:

- to notify the first buffered DL packet for the traffic matching the downlink PDR by setting the BUFF flag, BDPN flag in the Apply Action IE of the FAR; and/or
- to notify the first discarded DL packet for the traffic matching the downlink PDR by setting the BUFF flag and DDPN flag to "1" in the Apply Action IE of the FAR.

The UP function shall report the first buffered DL packet for each service data flow identified by a PDR, by sending a PFCP Session Report Request including a Downlink Data Report IE identifying the PDR(s) for which downlink packets have been received, if the BUFF and BDPN flags are set to "1" in the Apply Action for the FAR which is associated with the PDR.

The UP function shall report the first discarded DL packet for each service data flow identified by a PDR, if the BUFF and DDPN are set to "1" in the Apply Action for the FAR which is associated with the PDR and if the DL Buffering Duration or DL Buffering Suggested Packet Count is exceeded.

The DL Data Status IE shall be included in the Downlink Data Report IE to indicate the report is triggered by the Downlink data delivery status with UPF buffering when the first DL packet is buffered or discarded.

NOTE 1: Setting the Apply Action with the BUFF together with BDPN and/or DDPN to "1" requires the UPF to report the first buffered or discarded DL packet for each service data flow identified by a PDR.

NOTE 2: Setting the Apply Action with the BUFF and the NOCP to "1" and if the DL Buffering Duration is provisioned, this is to request the UP function to buffer the downlink data packet for an extended duration without sending any further notification to the CP function about the arrival of DL data packets (See clause 5.2.4.2). As an exception, if the UPF supports EDBNC feature and if the EDBN bit is set to "1", in this case, the UP function will send DL packet notifications to report the arrival of the first buffered DL packet for each QoS flow for a given FAR to the CP function for the duration indicated by the DL Buffering Duration. (See also clause 5.2.4.1)

NOTE 3: The CP function can request the UP function to report the first buffered DL packet by setting the BDPN flag or the NOCP flag in the Apply Action IE of the FAR. The difference is that:

- If the BDPN flag is set, the UP function reports the first buffered DL packet for each service data flow identified by a PDR associated to the FAR.
- If the NOCP flag is set, the UP function reports the first buffered DL packet for each QoS flow for a given FAR, i.e. if there are subsequent DL packets (pertaining to different service data flow identified by other PDRs but being conveyed by the same QoS flow), there is no new report sent to the CP function.

If the UP function supports the Downlink data delivery status notification with UPF buffering, the CP function may also request the UP function to drop the DL packets directly and send a notification for the traffic matching the downlink PDR by set the DROP flag and DDPN flag in the Apply Action IE of the FAR.

The UP function shall report the dropped DL packets for each service data flow identified by a PDR, by sending a PFCP Session Report Request including a Downlink Data Report IE identifying the PDR(s) for which downlink packets have been received.

5.29 Support Reliable Data Service

Clause 5.31.6 of 3GPP TS 23.501 [28], clause 4.3.2 of 3GPP TS 23.502 [29] and clause 4.5.14.3 of 3GPP TS 23.682 [66], specify that The Reliable Data Service (RDS) may be used between the UE and UP function when using a PDU Session of PDU Type 'Unstructured' in 5GS or using PDN Connection of PDN Type 'Non-IP' in EPS. The service is enabled or disabled based on DNN and NSSAI Configuration per SLA in 5GS or APN Configuration per SLA in EPS.

If the UE indicates its capability of supporting RDS in the Protocol Configuration Options (PCO) and if the UP function indicated support of the RDS feature, the CP function may request the UP function to apply the RDS functionality for the PDU session by sending "Provide RDS Configuration Information" IE within PFCP Session Establishment Request message (see clause 7.5.2.11).

If the UP function supports and accepts RDS, it should respond to CP function by setting RDS flag in "RDS Configuration Information" IE within PFCP Session Establishment Response message (see clause 7.5.3.8), and the UP function should place unstructured DL data from N6/SGi in the payload of RDS protocol and then insert it as GTP-U payload, and vice versa for UL data.

Then the CP function should indicate to the UE, in the PCO, that the RDS shall be used if enabled in the DNN and NSSAI configuration in 5GS or APN configuration in EPS. The Reliable Data Service is enabled afterwards.

Reliable Data Service protocol is defined in 3GPP TS 24.250 [65].

5.30 Notifying Start Pause of Charging

The requirements for PGW Pause of Charging in EPC are specified in clause 5.3.6A of 3GPP TS 23.401 [14] and the requirements for SMF Pause of Charging feature for 5GC are specified in clause 4.4.4 of 3GPP TS 23.502 [29].

To reduce the charging discrepancy between SGW-C and PGW-C, or between I/V-SMF and (h)SMF due to the signalling latency to notify start pause of charging, the CP function (SGW-C and PGW-C for EPC, I/V-SMF and (H-)SMF for 5GC) and UP function (SGW-U and PGW-U for EPC, I/V-UPF and PSA UPF) may support the Notify Start Pause of Charging via user plane feature (NSPOC) as described below.

When both the CP function and the UP function support the NSPOC feature, and the peer CP function (PGW-C or (H-)SMF) and peer UP function (PGW-U or PSA UPF) are known to support the NSPOC feature as specified in 3GPP TS 29.274 [9] and 3GPP TS 29.502 [50], the CP function (SGW-C, or I/V-SMF) may set the SSPOC bit to "1" in the Measurement Information included in the URR when the Dropped DL Traffic Threshold is provisioned, to request the UP function (SGW-C, I/V-UPF) to send a Start Pause of Charging indication via one or more GTP-U Tunnel Status message to the upstream GTP-U entity(s) when the Dropped DL Traffic Threshold is reached.

When both the CP function and the UP function support the NSPOC feature, the CP function (PGW-C, or (H-)SMF) may set the ASPOC bit to "1" in the Measurement Information included in the URR if the URR is intended for charging, to request the UP function to stop the usage measurement for the URR when receiving Start Pause of Charging indication from the peer downstream GTP-U entity, so that the UP function shall behave as if the Inactive Measurement flag had been set for the URR when it receives a Tunnel Status message with the Start Pause of Charging indication is set to "1" from the downstream peer GTP-U entity.

Regardless of whether the NSPOC feature is supported and used, the procedures specified in clause 5.3.6A of 3GPP TS 23.401 [14] and clause 4.4.4 of 3GPP TS 23.502 [29] for starting and stopping Pause of Charging for EPC and 5GC respectively shall be performed, i.e. the UP function (SGW-U or I/V-UPF) shall still be instructed to generate a usage report when the Dropped DL Traffic Threshold is reached, the SGW-C or V/I-SMF shall request the PGW-C or (H-)SMF to start or stop charging, and the PGW-C or (H-)SMF shall instruct the UP function (PGW-U or PSA UPF) to inactivate or activate measurement for URR(s) applicable for charging.

When the NSPOC feature is supported and used, the CP function (PGW-C or (H-)SMF) may:

- set the "SUMPC" flag in PFCPSMReq-Flags IE to "1" to request the UP function to stop the usage measurement for all URRs with the "ASPOC" flag set to "1", e.g. when the CP function is informed to start Pause of Charging via control plane;
- set the "RUMUC" flag in PFCPSMReq-Flags IE to "1" to request the UP function to resume the usage measurement for all URRs with the "ASPOC" flag set to "1", e.g. when the CP function is informed to stop Pause of Charging via control plane;- set the "CIAM" flag together with Inactive Measurement flag in the Measurement Information IE in the Create URR IE or Update URR IE to stop or resume the usage measurement for a specific URR with the "ASPOC" flag set to "1".

The UP function shall stop or resume the usage measurement for all the URRs with the "ASPOC" flag set to "1" upon receipt of a PFCP Session Establishment Request or PFCP Session Modification Request with the "SUMPC" or "RUMUC" flag set respectively, regardless the current value of the Inactive Measurement flag for a given URR.

The UP function shall start the usage measurement for a URR with the "ASPOC" flag set to "1" unless both the "CIAM" and "INAM" flags are set to "1" or unless the "SUMPC" flag is set to 1 in the same message, when the URR is provisioned in a Create URR IE.

NOTE 1: Only the "SUMPC" flag can be set in the PFCP Session Establishment Request message, e.g. during a restoration procedure for a UPF failure.

The UP function shall stop or resume the usage measurement for a specific URR with the "ASPOC" flag set to "1" upon receipt of a PFCP Session Modification Request including an Update URR IE with the Measurement Information IE, according to the value of the "INAM" flag, if the "CIAM" flag is set to 1. If the "CIAM" flag is set to 0, the UP function shall ignore the "INAM" flag received in the Measurement Information for a URR with the "ASPOC" flag set to "1".

NOTE 2: Notifying Start Pause of Charging via GTP-U fastens the triggering of charging pause in the PGW-U or UPF (PSA). If the GTP-U Tunnel Status messages are lost, charging is paused when receiving the corresponding instruction from the PGW-C/SMF.

NOTE 3: The UP function will forward Tunnel Status message to the upstream GTP-U entity(s) if it is not a PSA UPF or PGW-U connecting to N6 or SGi interface. If the UP function is a UL/CL or BP, it needs send or forward the Tunnel Status message to all of PSA UPFs.

NOTE 4: The UP function resumes the usage measurement for all URRs with the "ASPOC" flag set to "1" regardless if the usage measurement was stopped by the CP function using the "SUMPC" flag or using the Inactive Measurement flag per URR, or upon being notified by the downstream GTP-U entity using Tunnel Status message.

NOTE 5: When the CP function uses Inactive Measurement flag to stop the usage measurement for a given URR, it can set the "ASPOC flag" to "0" if the CP function doesn't want that the usage measurement is resumed when applying "RUMUC".

5.31 Support of L2TP

5.31.1 General

Stage 2 requirements for the support of Layer 2 Tunneling Protocol (L2TP) are specified in clause 5.8.2.16 of 3GPP TS 23.501 [28], clause 4.3.2.4 of 3GPP TS 23.502 [29] and clause 5.5 of 3GPP TS 23.214 [2].

It is optional for both the CP function and the UP function to support the L2TP feature.

L2TP is specified in IETF RFC 2661 [67]. An L2TP Tunnel is setup between a L2TP Access Concentrator (LAC) and a L2TP Network Server (LNS) pair controlling the connection, that may contain one or more L2TP Sessions. More than one L2TP tunnel can be established between a LAC-LNS pair.

The UP function shall act as the LAC.

The CP function may request the UPF to setup an L2TP Session for a PDN connection or PDU session between the LAC and the LNS in the Data Network.

One L2TP tunnel between the UP Function and the L2TP server may be shared by multiple PDN connection / PDU session using the same N6/SGi network instance and L2TP parameters (e.g. LNS address). A single L2TP tunnel may be shared by multiple PDN connections / PDU sessions created by the same CP Function or by different CP Functions.

5.31.2 L2TP Tunnel and L2TP Session Setup

When both the CP function and the UP function support the L2TP feature (see clause 8.2.25), if an L2TP session is required to support the PDN connection/PDU session, the CP function shall send a PFCP Session Establishment Request message including the following L2TP related IEs, to request the UP Function to setup an L2TP session towards the LNS:

- one L2TP Session Information IE to control the L2TP session setup. The L2TP Session Information may include:
 - the Called Number, Calling Number and the MRU (Maximum Receive Unit in LCP/PPP, to be set as the value of the MTU received from the UE or that may be configured in the CP function);
 - the L2TP Session Indications IE to indicate that the UP function shall request the LNS to allocate an IP address for the PDN session/PDN connection, to provide DNS server address(es) and/or NBNS server address(es) for the session;
- the L2TP User Authentication IE including parameters such as authentication type, Username and Password, Challenge and Challenge Response which may either be sent by the UE through PCO or be configured in the CP0.
- One or more L2TP Tunnel Information IEs to provide parameters to control the establishment of a L2TP tunnel if such information is available in the CP function, e.g. if it is received from an AAA/Radius server or locally configured in the CP function. This IE shall include LNS IPv4/IPv6 address, and it may include Tunnel Password for L2TP tunnel authentication, Tunnel Preference if multiple L2TP Tunnel Information IEs are sent, as specified in 3GPP TS 29.061 [39] and 3GPP TS 29.561 [49].

NOTE 1: Multiple L2TP Tunnel Information IEs can be sent to provide the UP Function with a list of possible L2TP tunnels that can be used to establish the L2TP session. This can be used to ensure that the session is established even if a specific LNS is temporarily unavailable, or to load balance the setup of L2TP sessions over different LNS's. A given L2TP Tunnel Information IE includes Tunnel attributes, e.g. Tunnel-Server-Endpoint and Tunnel-Password, received over N6/SGi with the same Tag value (see IETF RFC 2868 [68]). See also 3GPP TS 29.061 [39] and 3GPP TS 29.561 [49].

NOTE 2: If the UE IP address is to be allocated by the UP function (or the LNS), the CP function indicates this in the UE IP Address IE in the Create PDR or Create Traffic Endpoint IE, regardless of whether the UE IP address is to be assigned by the LNS or the UPF.

NOTE 3: If the L2TP tunnel parameters are configured in the UP Function, the UP Function determines how to establish the L2TP tunnel based on its local configuration.

NOTE 4: An L2TP session cannot be modified once established as specified in IETF RFC 2661 [67].

Upon receiving the PFCP Session Establishment Request from the CP function, the UP function shall determine whether to use an already established L2TP tunnel (if any appropriate one has already been established) or establish a new L2TP tunnel. The UP function may have already established L2TP tunnel(s), e.g. based on locally configured L2TP Tunnel Information. If an existing L2TP Tunnel is used, the UP function shall only setup a new L2TP session within the existing L2TP tunnel. Otherwise, the UP function shall perform both L2TP tunnel and L2TP session setup.

The UP function shall send a PFCP Session Establishment Response to the CP function, carrying the Created L2TP Session IE containing information about the established L2TP session, e.g. the used LNS Address, that may be used for statistics or diagnostics. The Cause IE in the response message may carry additional L2TP specific failure information to the CP function if the L2TP tunnel or L2TP session establishment failed.

The PFCP Session Establishment Response message may also include the DNS Server Address IE(s) and/or NBNS Server Address IE(s) containing the DNS server and/or NBNS Server information, if this information was requested.

If the UE IP address was allocated by the UP Function (or the LNS), the UP function shall provide the allocated IP address to the CP function in the UE IP Address IEs in the Created PDR IE and/or Created Traffic Endpoint IE (as specified in this specification).

Upon receiving uplink user plane traffic pertaining to the PFCP session with a L2TP session established, the UP function shall forward the traffic via the L2TP tunnel towards the LNS server.

5.31.3 L2TP Session and L2TP Tunnel Release

Upon receiving a PFCP Session Deletion Request message from the CP function, the UP function shall release the corresponding L2TP session. The UP function may release the L2TP tunnel if there is no other L2TP session using the L2TP tunnel.

NOTE 1: The UPF can alternatively retain the L2TP tunnel when all L2TP sessions are terminated.

When the LNS terminates a L2TP session or an L2TP tunnel, the following applies:

- If the LNS terminates an L2TP session, the UP function shall terminate the PFCP session and report to the CP Function that the PFCP session is deleted by sending a PFCP Session Report Request message to the CP function as described in clause 5.18.2, with the Cause indicating the reason for the termination.
- If the LNS terminates an L2TP tunnel, the UP function shall terminate all the PFCP sessions using the L2TP tunnel and report to all the CP functions controlling at least one such PFCP session that the respective PFCP sessions have been deleted by sending a PFCP Session Report Request message to the CP function for each affected PFCP session, as described in clause 5.18.2, with the Cause indicating the reason for the termination.
- If the UP function detects that the connectivity with an LNS is lost, the UP function shall terminate the PFCP sessions using the L2TP tunnel(s) towards that LNS and report to the CP that all the PFCP sessions affected have been deleted by sending a PFCP Session Report Request message to the CP function for each affected PFCP session, as described in clause 5.18.2, with the Cause indicating the reason for the termination.

5.32 Support of Uplink packets buffering

5.32.1 General

This clause specifies the support of uplink packets buffering.

5.32.2 Uplink packets buffering for on-line charging

If the UP function indicated support of the Quota Action (QUOAC) feature in the UP Function Features IE and the FAR ID for Quota Action was set to buffer the application traffic at zero quota, the UP function shall buffer the related uplink packets if it is provisioned with zero quota earlier or the quota has been exhausted, as specified in clause 5.2.2.2.1. In addition, if the UP Function has indicated support of the feature UL/DL Buffering Control (UDBC), the UP function shall buffer the number of packets (including both uplink or downlink) based on the Suggested Buffering Packet Count IE in a BAR provided by the SMF, until it receives new instructions from the CP function, e.g. when the new Quota is granted.

5.32.3 Uplink packets buffering during EAS relocation

If the UP function supports uplink packets buffering during EAS relocation, the UP function shall set the UPBER bit in the UP Function Features (see clause 8.2.25).

The SMF shall request the UPF (PSA) to buffer the uplink packets related to one or more Service Data Flows sent to the new EAS by setting the BUFF flag in Apply Action IE of the related FAR. The SMF shall set the FORW flag in Apply Action IE when the EAS relocation has been performed.

5.33 Support of enhancement of Edge Computing (for 5GC)

5.33.1 General

Stage 2 requirements for support of enhancement of Edge Computing are specified in 3GPP TS 23.548 [69].

5.33.2 Uplink packet buffering for low packet loss during EAS relocation

Support of uplink packets buffering for low packet loss during EAS relocation as specified in clause 6.3.5 of 3GPP TS 23.548 [69] is defined in clause 5.32.3.

5.33.3 Edge Relocation using EAS IP address and Port number Replacement

To support Edge Relocation using EAS IP address and Port number replacement as specified in clause 6.3.3 of 3GPP TS 23.548 [69], the SMF shall instruct the UPF to replace:

- for the UL traffic, the destination IP address and/or port number of the outgoing IP packet with the Target EAS IP address and/or port number, by provisioning an UL FAR with an IP Address and Port Number Replacement IE containing the Target EAS IP address and/or port number; and
- for the DL traffic, the source IP address and/or port number of the incoming packet with the Source EAS IP address and/or port number, by provisioning a DL FAR with an IP Address and Port Number Replacement IE containing the Source EAS IP address and/or port number.

A UPF that supports replacing the source and destination IP address and Port Number of an (inner) IP packet shall set the IPREP flag in the UP Function Features IE (see clause 8.2.25) and shall replace the source or destination IP address and/or Port Number of an (inner) IP packet as instructed by the SMF.

5.33.4 EAS Discovery procedure with Local DNS Server/Resolver

Clause 6.2.3.2.3 of 3GPP TS 23.548 [69] specifies two options (C and D) for scenarios where the DNS message is to be handled by a Local DNS server/resolver.

In Option C, the SMF shall provision UL PDR(s) on the UL CL (including e.g. the Local DNS server address) or the BP (e.g. with the source IP prefix set to the IP prefix address assigned by the Local PSA) and associated FAR(s) to route traffic destined to the L-DN including the DNS query messages to the L-PSA, as specified in clause 5.17.2.

In Option D, if the SMF has been configured that DNS Queries for an FQDN (range) query can be locally routed on the UL CL, the SMF shall instruct:

- the UL CL to locally route DNS queries for the FQDN (range) to the Local DNS server, by provisioning an UL PDR with one or more DNS Query Filters or with a pre-defined PDR matching the requested DNS traffic and by associating a FAR to the UL PDR to forward the traffic towards the Local PSA. A UPF supporting this option shall indicate that it supports steering DNS traffic based on the target domain of the DNS Query by setting the DNSTS flag in the UP Function Features IE (see clause 8.2.25); and
- the Local PSA to send the DNS traffic to the Local DNS server, by provisioning a UL PDR with one or more DNS Query Filters, as described above for the UL CL, and by associating a FAR to the UL PDR to forward the traffic to the Local DNS server via tunneling (with the FAR including the Outer Header Creation IE) or via IP address replacement (with the FAR including the IP Address and Port number Replacement IE containing the IP address and/or port of the Local DNS server).

5.33.5 Direct Reporting of QoS monitoring events to Local NEF or AF

A UPF may be instructed to report QoS monitoring events directly to a local NEF or AF as specified in clause 6.4 of 3GPP TS 23.548 [69].

A UPF that supports this feature shall set the DRQOS (Direct Reporting of QoS monitoring events) flag in the UP Function Feature IE (see clause 8.2.25).

An SMF shall instruct an UPF that supports the DRQOS feature to report Per QoS Flow Per UE QoS Monitoring events directly to a local NEF or AF by applying the requirements specified in clauses 5.24.4 or 5.24.5.3, and by additionally including a Direct Reporting Information IE in the SRR as specified in clauses 5.2.8.2 and 5.39.2.

The UPF shall report the QoS monitoring result of the QoS flows as specified in clauses 5.39.4, 5.24.4.3 and 5.24.5.4.

5.33.6 EAS Discovery procedure with V-EASDF

To support EAS discovery procedure with V-EASDF using IP replacement mechanism for supporting HR-SBO as specified in clause 6.7.2.5 of 3GPP TS 23.548 [69], the SMF shall instruct:

- the UPF in VPLMN to send the DNS queries for the FQDN (range) to the V-EASDF, by provisioning an UL PDR with one or more DNS Query Filters matching the requested DNS traffic and by associating a FAR to the UL PDR to forward the traffic towards the V-EASDF via IP address replacement (with the FAR including the IP Address and Port number Replacement IE containing the Target IP address and/or port of the V-EASDF); and
- the UPF in VPLMN to replace the source IP address and/or port number of the DNS response targeting the FQDN (range), by provisioning an DL PDR with one or more DNS Response Filters matching the DNS response and by associating a FAR to the DL PDR with an IP Address and Port Number Replacement IE containing the Source DNS server of HPLMN IP address and/or port number.

5.33.7 DNS traffic routing for different UEs with same private UE IP address

To support DNS traffic routing for different UEs with same private UE IP address for HR-SBO in VPLMN as specified in clause 6.7.2.2 of 3GPP TS 23.548 [69], the V-SMF may instruct the V-UPF (acting as Local PSA):

- a) use tunnelling over N6 if the V-UPF indicates support of the UN6TU feature (see clause 8.2.25). When doing so:
 - The V-SMF shall provision a UL FAR (associated with the UL PDR(s) identifying the DNS traffic authorized to be locally offloaded) with an N6 Routing Information IE in the Forwarding Parameters to request the V-UPF to forward the packets into a N6 tunnel. The N6 Routing Information IE shall contain the information for the N6 tunnel. For example, when IP in IP tunneling or UDP/IP tunneling is used, the V-SMF may select a V-EASDF/V-UPF tunnel IP address and an optional port (for UDP/IP tunneling) according to the V-EASDF/V-UPF NF profile received from the NRF respectively and then shall set the V-UPF tunnel IP address and the port (for UDP/IP tunneling) as the Source IPv4/IPv6 address and Source Port Number, and the V-EASDF tunnel IP address and the port (for UDP/IP tunneling) as the Destination IPv4/IPv6 address and Destination Port Number in the N6 Routing Information.
 - The V-SMF shall provision one or more DL PDRs identifying the DNS traffic received from the V-EASDF via the N6 tunnel for each PFCP session using the N6 tunnel, where the PDR(s) shall contain an N6 Routing Information IE or an Traffic Endpoint Id which refers to a Traffic Endpoint provisioned with an N6 Routing Information IE, to instruct the UPF to first match the packets using the N6 tunneling addresses and further match the packets using the UE IP address to identify the PFCP session. The V-SMF shall set the V-UPF tunnel IP address and the port (for UDP/IP tunneling) as the Destination IPv4/IPv6 address and Destination Port Number, and the V-EASDF tunnel IP address and the port (for UDP/IP tunneling) as the Source IPv4/IPv6 address and Source Port Number in the N6 Routing Information IE.
 - Distinct N6 tunnels shall be used for HR-SBO PDU sessions with overlapping IP addresses, i.e. for PDU sessions from different HPLMN/S-NSSAIs/DNNs using private UE IP addresses; or
- b) to map the UE IP address to an N6 IP address, if the V-UPF indicated its support of the UMN6IP feature (see clause 8.2.25). When doing so:
 - the V-SMF shall request the V-UPF to allocate a Mapped N6 IP address by setting the CHOOSE IPV4 in the Mapped N6 IP Address IE of the DL PDR IE (see Table 7.5.2.2-1) or in the Traffic Endpoint IE (see Table 7.5.2.7-1), for DL PDRs or the DL Traffic Endpoint;
 - the V-SMF may request the V-UPF to allocate the same Mapped N6 IP address to several DL PDRs (of the same PFCP session) to be created (i.e. using the Create PDR IE) within one single PFCP Session Establishment Request or PFCP Session Modification Request, or to several DL PDRs to be modified (i.e. using the Update PDR IE) within one single PFCP Session Modification Request, or to several DL PDRs containing the same DL Traffic Endpoint ID;
 - the V-SMF shall provision an UL FAR (associated with the UL PDR(s) identifying the DNS traffic authorized to be locally offloaded) including an IP Address and Port Number Replacement IE with the UMN6RS bit set to "1" to request the V-UPF to replace the source IP address (which is the UE's private IP address) with the mapped N6 IP address that is allocated by the V-UPF;

- the V-SMF shall provision a DL FAR (associated with the DL PDR(s) containing the Mapped N6 IP address) including an IP Address and Port Number Replacement IE with the DIPV4 bit set to "1" to request the V-UPF to replace the destination IP address (which is the Mapped N6 IP address) with the UE's private IP address included in the Destination IPv4 Address field;
- the V-UPF shall assign a mapped N6 IP address and replace the source IP address (i.e. the UE's private IP address) in UL traffic (i.e. DNS requests sent to the V-EASDF) and replace the destination IP address in DL traffic (i.e. DNS response sent to the UE), according to the V-SMF instructions.

NOTE 1: The V-SMF does not provide the UE IP address IE in the DL PDR or Traffic Endpoint since the UE IP address is not used for DL packet matching.

5.33.8 N6 Delay Measurement and Reporting

5.33.8.1 General

Stage 2 requirements for N6 delay measurement and reporting are specified in clause 5.8.2.23 of 3GPP TS 23.501 [28] and in clause 4.4.3 of 3GPP TS 23.502 [29].

The UPF shall set the UN6DM feature flag to "1" in the UP Function Features IE if it supports N6 delay measurement and reporting (see clause 8.2.25). If so, the UPF should also indicate the N6 delay measurement protocols it supports in the N6 Delay Measurement Protocols IE in the PFCP Association Setup Request/Response or PFCP Association Update Request/Response.

NOTE: The requirements specified in clause 5.33.8 also apply between an I-SMF and a Local PSA controlled by the I-SMF, for a PDU session with an I-SMF as specified in clause 6.9 of 3GPP TS 23.548 [69], when I-SMF based local offloading management applies.

5.33.8.2 Instructing the UPF to perform N6 delay measurements

If the UPF is known to support N6 delay measurement and reporting (e.g. using the UP Function IE), the SMF may request the UPF to perform N6 delay measurements between the UPF and one or more measurement endpoints at the application side (represented by one or more IP addresses) and to report the N6 delay measurements to the SMF.

To do so, the SMF shall provision one or more N6 Delay Measurement Control Information IE(s) in a PFCP Association Setup Request/Response or a PFCP Association Update Request, including:

- the IP address of one or more measurement endpoints;
- the network instance at the UPF used to reach the measurement endpoints;
- the measurement protocols supported by the measurement endpoints that may be used for the N6 delay measurement;
- protocol-specific configuration parameters (e.g. measurement endpoint port number, security mode, key ID and shared secret, HMAC key);
- the measurement reporting type indicating periodic, event-triggered or immediate reporting;
- the measurement period to generate the measurement reports, for periodic reporting;
- the reporting threshold(s) for the minimum, maximum and/or average one-way packet delay, for event triggered reporting; and
- the minimum wait time between two consecutive reports for the same measurement endpoint and the same type of measurement (e.g. average packet delay), for event triggered reporting.

NOTE: If the Reporting threshold and a Minimum Wait Time are not received, the UPF can use locally configured reporting threshold and minimum wait time, e.g. per Network Instance, to control the pace to send N6 delay measurement reports.

Periodic reporting and event triggered reporting shall be exclusive from each other. Immediate reporting may be requested alone or in combination with either periodic reporting or event triggered reporting.

The SMF may provision multiple N6 Delay Control Information IEs to request the UPF to perform N6 delay measurements between the UPF and multiple measurement endpoints (e.g. with different parameters).

When it is so requested, the UPF shall perform the requested N6 delay measurements for the requested measurement endpoints using one of the measurement protocols supported by the measurement endpoints and report the measurements to the SMF as described in clause 5.33.8.3.

The SMF may request to modify an existing N6 Delay Measurement Control Information instance by provisioning a N6 Delay Measurement Control Information IE including an existing N6 Delay Measurement Control Information ID and all the IEs applicable for this N6 Delay Measurement Control Information instance in a PFCP Association Update Request message.

The SMF may provision a new N6 Delay Measurement Control Information instance including a new N6 Delay Measurement Control Information ID and all the new IEs applicable for this new N6 Delay Measurement Control Information instance in a PFCP Association Update Request message, to request to start measurements for one or more new Measurement Endpoint Addresses.

Previously provisioned N6 Delay Measurement Control Information instances which are not included in the PFCP Association Update Request message shall be kept unmodified by the UPF.

Upon receiving a PFCP Association Update Request message including an N6 Delay Measurement Control Information IE referring to an existing N6 Delay Measurement Control Information ID and including at least one IE other than the N6 Delay Measurement Control Information ID IE, the UPF shall replace all the earlier information received for the respective N6 Delay Measurement Control Information instance by the information newly received from the SMF.

The SMF may request the UPF to stop performing N6 delay measurements for one or more measurement endpoints by:

- provisioning the instance of N6 Delay Measurement Control Information IE with only the N6 Delay Measurement Control Information ID identifying the N6 Delay Measurement Control Information IE of the measurements to be stopped; or
- provisioning one N6 Delay Measurement Control Information IE with a null length in a PFCP Association Update Request, if all N6 delay measurements for all the measurement endpoints (i.e. all measurements of all the N6 Delay Measurement Control Information instances) need to be stopped.

When so requested, the UPF shall stop the measurements of the respective N6 Delay Measurement Control Information instances in the first case, or stop all the N6 delay measurements in the second case.

5.33.8.3 N6 delay measurement information reporting

The UPF shall support the Control-Client, Fetch-Client and Session-Sender roles defined in IETF RFC 4656 [101] if OWAMP is used as the N6 delay measurement protocol. The measurement endpoint supports the Server and Session-Receiver roles in this case.

The UPF shall support the Control-Client and Session-Sender roles defined in IETF RFC 5357 [100] if TWAMP is used as the N6 delay measurement protocol. The measurement endpoint supports the Server and Session-Reflector roles in this case.

The UPF shall support the STAMP Session-Sender role defined in IETF RFC 8762 [102] if STAMP is used as the N6 delay measurement protocol. The measurement endpoint supports the STAMP Session-Reflector role in this case.

For immediate reporting, the UPF shall send a measurement report to the SMF as soon as it has performed N6 delay measurements.

For periodic reporting, the UPF shall generate and send a measurement report at every measurement period to the SMF.

For event triggered reporting, the UPF shall send a measurement report to the SMF when the average, minimum or maximum N6 delay measurement matches or exceeds the indicated reporting thresholds. Subsequent reports for the same type of measurement (e.g. maximum N6 delay) and the same measurement endpoint should not be sent by the UPF during the minimum wait time. If N6 delay measurements that match or exceed the indicated reporting threshold are received during the minimum wait time, the UPF shall send a report containing the most recent N6 delay measurements immediately after the minimum wait time is over. After that, the UPF shall continue to report N6 delay measurements that match or exceed the indicated Reporting threshold.

The UPF shall send N6 delay measurement reports to the SMF by including N6 Delay Measurements Report IE(s) in PFCP Node Report Request messages. A N6 Delay Measurement Report IE shall include:

- the IP address of the measurement endpoint for which the measurement is reported;
- the network instance at the UPF used to reach the measurement endpoints;
- the measurement reporting type indicating periodic, event-triggered or immediate reporting; and
- the N6 delay measurements including the average packet delay and, if available, the minimum packet delay and maximum packet delay. Packet delays shall be reported to the SMF as one-way packet delay.

NOTE: When using a measurement protocol that provides a two-way packet delay measurement (e.g. TWAMP or STAMP), the UPF can divide the two-way packet delay measurement by two to estimate the one-way packet delay.

If the UPF cannot perform the N6 delay measurements towards a measurement endpoint (e.g. the UPF cannot establish a connection towards the measurement endpoint using the requested measurement protocol), the UPF shall report the failure to perform N6 delay measurements for that measurement endpoint to the SMF by including a N6 Delay Measurement Failure Report IE in a PFCP Node Report Request message. The N6 Delay Measurement Failure Report IE shall include:

- the IP address of the measurement endpoint for which the failure is reported;
- the network instance at the UPF used to reach the measurement endpoints;
- the cause value indicating the reason for the failure.

The UPF should then further attempt to perform N6 delay measurements for the corresponding measurement endpoint, e.g. by increasing the period after each failed attempt, until the SMF explicitly instructs the UPF to stop corresponding measurements as described in clause 5.33.8.2. Upon being newly able to perform N6 delay measurements for the corresponding measurement endpoint, the UPF shall send a new measurement report to the SMF as soon as it has performed N6 delay measurements and then proceed as described in this clause as if no failure had taken place.

5.34 Support of 5G Multicast and Broadcast Service

5.34.1 General

This clause specifies N4mb and N4 specific requirements to support 5G Multicast and Broadcast Service.

Stage 2 requirements for the support of 5G Multicast and Broadcast Service is specified in clause 6.7 of 3GPP TS 23.247 [72] and clause 5.8.5 of 3GPP TS 23.501 [28].

5.34.2 N4mb requirements

5.34.2.1 General

This clause specifies N4mb specific requirements to support 5G Multicast and Broadcast Service. For a location dependent MBS service (see clause 6.2.3 of 3GPP TS 23.247 [72]), the MB-SMF shall establish one PFCP session per MBS session and MBS Session Area, following the requirements specified in clause 5.34.2.2.

NOTE: A Location dependent MBS service enables distribution of different content data to different MBS service areas. The same MBS Session ID is used but a different Area Session ID is used for each MBS service area.

5.34.2.1A PFCP protocol extensions for N4mb

When multicast transport is used for delivering user plane MBS traffic, the MB-SMF may set one or more of the following N4mb specific flags:

- JMBSSM (Join MBS Session SSM) flag in the MBS Session N4mb Control Information IE in the PFCP Session Establishment Request. If set, the MB-UPF shall join the multicast tree towards the Source Specific Multicast

(SSM) address information (provided by AF/AS or MBSTF for the MBS Session) indicated in the IP Multicast Addressing Info IE in the downlink PDR.

- this instructs the MB-UPF to receive MBS data using multicast transport over N6mb interface.
- PLLSSM (Provide Low Layer Source Specific Multicast address) flag in the MBS Session N4mb Control Information IE in the PFCP Session Establishment Request. If set, the MB-UPF shall provide a LLSSM address and a GTP-U Common Tunnel EndPoint Identifier (C-TEID) to the MB-SMF.
- this instructs the MB-UPF to provide the MB-SMF with a Low Layer Source Specific Multicast (LLSSM) address (i.e. multicast destination address and related source unicast IP address) for the delivery of MBS data using multicast transport over N3mb and/or N19mb interfaces.

NOTE 1: The PLLSSM flag is not set in the PFCP Session Establishment Request message during the restoration procedure for an MB-UPF restart (see clause 8.2.2 in 3GPP TS 23.527 [40]) since in this procedure, the MB-SMF provides the MB-UPF with the LLSSM that was used for the MBS session before the MB-UPF restart, i.e. no new LLSSM needs to be assigned by the MB-UPF for the MBS session.

- FSSM (Forward packets to lower layer SSM) flag in the Apply-Action IE of the Create FAR IE in the PFCP Session Establishment Request or in the Update FAR IE in the PFCP Session Modification Request. If set, the MB-UPF shall forward the MBS session data using the LLSSM and the C-TEID, which the MB-UPF has earlier assigned to the MBS session.
- this instructs the MB-UPF to forward MBS data using multicast transport over N3mb and/or N19mb interfaces.

NOTE 2: The FSSM flag can be included in the Create FAR IE in the PFCP Session Establishment Request during the creation of an MBS session (see clauses 7.1.1.2 and 7.1.1.3 of 3GPP TS 23.247 [72]) or during an MBS restoration procedure (see e.g. clauses 8.2.2 and 8.2.3 in 3GPP TS 23.527 [40]). The FSSM flag can also be included in the Update FAR IE in the PFCP Session Modification Request e.g. during the Activation of a Multicast MBS session procedure (see clause 5.34.2.4).

When unicast transport is used for delivering user plane MBS traffic, the MB-SMF may set the following N4mb specific flag:

- MBSU (Forward and replicate MBS data using Unicast transport) flag in the Apply Action IE of the Update FAR IE in the PFCP Session Modification Request or in the Create FAR IE in the PFCP Session Establishment Request. If set, the MB-UPF shall either forward, or replicate and forward the MBS Session data towards the one or more GTP-U DL tunnels terminating at the NG-RAN nodes and/or PSA UPFs. The MB-SMF provides the MB-UPF with one or more DL GTP-U F-TEIDs (i.e. IP address and tunnel endpoint identifier).
- this instructs the MB-UPF to forward MBS data using unicast transport over N3mb and/or N19mb.

NOTE 3: The MBSU flag can be included in the Update FAR IE in the PFCP Session Modification e.g. after creating the MBS session when one or more NG-RAN node(s) and/or PSA UPF(s) provides a downlink GTP-U F-TEID (see clause 5.34.2.2), or e.g. during the Activation of a Multicast MBS session procedure (see clause 5.34.2.4). The MBSU flag can be included in the Create FAR IE in the PFCP Session Establishment Request during an MBS restoration procedure (see e.g. clauses 8.2.2 and 8.2.3 in 3GPP TS 23.527 [40]).

5.34.2.2 Instructing the MB-UPF to forward MBS data using multicast and/or unicast transport

When the MB-SMF receives an MBS Session Create Request from a NEF/MBSF to configure an MBS session, the MB-SMF shall select an MB-UPF and request that MB-UPF to allocate relevant user plane resource for the MBS session, or for the MBS session and MBS Service Area for a location dependent MBS service; to do so, the MB-SMF shall send a PFCP Session Establishment Request message to the MB-UPF to setup a PFCP session for the MBS Session, or for the MBS session and MBS Service Area for a location dependent MBS service, including the following information in the PFCP Session Establishment Request message:

- the MBS Session Identifier identifying the MBS session (i.e. TMGI or SSM address);
- the Area Session ID, for a location dependent MBS service;

- the JMBSSM (Join MBS Session SSM) indication, if MBS data delivery using multicast transport is used over the N6mb interface to request the MB-UPF to join the multicast tree (see clause 5.34.2.1A), towards the Source Specific Multicast (SSM) address information provided by AF/AS or MBSTF for the MBS Session
- the PLLSSM (Provide Low Layer Source Specific Multicast address) indication, if MBS data delivery using multicast transport is used over the N3mb and/or N19mb interface to request the MB-UPF to provide a LLSSM address and C-TEID (see clause 5.34.2.1A). During the restoration procedure for an MB-UPF restart however the MB-SMF shall not set the PLLSSM flag (see clause 8.2.2 in 3GPP TS 23.527 [40]);
- for each MBS QoS flow:
 - a Create PDR IE to provision a downlink PDR with PDI or a Create Tunnel Endpoint IE containing either:
 - a "Local Ingress Tunnel" IE with the CHOOSE bit set to "1" to request the MB-UPF to allocate an ingress tunnel for Nmb9, or for N6mb if unicast transport is used over N6mb (the MB-UPF shall assign a single ingress tunnel address, regardless of the number of MBS QoS flows); if the Create PDR IE contains SDF Filter(s), these SDF Filter(s) shall relate to the inner IP layer within the unicast tunnel.

or

 - an IP Multicast Addressing Info IE to request the MB-UPF to retrieve the MBS session data from the IP Multicast Address, when using multicast transport over N6mb.
 - a Create QER IE to provision a QER (associated with the PDR including the above PDI or Traffic EndPoint ID) instructing the MB-UPF to insert the QFI of the MBS QoS flow in user plane packets and possibly requesting the MB-UPF to apply specific QoS treatments; the IQFISN (Insert DL MBS QFI Sequence Number) flag in the Create QER IE shall be set to "1" to request the MB-UPF to insert the DL MBS QFI Sequence Number in the PDU session container in user plane packets;
 - a Create FAR IE to provision a FAR (associated with the PDR including the above PDI or Traffic EndPoint ID) with the Apply Action set to:
 - "FSSM", if multicast transport is used over N3mb or N19mb, with an MBS Multicast Parameters IE; and/or
 - "MBSU", if unicast transport is used over N3mb or N19mb and N3mb/N19mb DL F-TEIDs are already known, e.g. during an MBS restoration for MB-UPF failure with or without restart procedure, together with one or more Add MBS Unicast Parameters to instruct the MB-UPF to forward and replicate MBS Session data towards the one or more GTP-U DL tunnels terminating at the NG-RAN(s) and/or PSA UPF(s);

Otherwise to:

 - "DROP", if only unicast transport is used over N3mb or N19mb and N3mb/N19mb DL F-TEIDs are not known yet.

The MBS Session Identifier, Area Session ID (for a location dependent MBS service) and the MBSN4mbReq-Flags are included in the group IE "MBS Session N4mb Control Information" at the PFCP message level.

The MB-UPF shall return the allocated ingress tunnel information in the Created PDR IE or Created Traffic Endpoint IE and provide the LLSSM address if requested.

For an MBS session using unicast transport over N3mb or N19mb, when one or more NG-RAN node(s) and/or PSA UPF(s) provides a downlink GTP-U F-TEID (i.e. IP address and tunnel endpoint identifier) to receive the MBS session data, the MB-SMF shall send a PFCP Session Modification Request to change the FAR by setting the Apply Action to "MBSU", together with one or more Add MBS Unicast Parameters to instruct the MB-UPF to forward and replicate MBS Session data towards the one or more GTP-U DL tunnels terminating at the NG-RAN(s) and/or PSA UPF(s).

NOTE: FAR with the Apply Action set to "MBSU" together with one or more Add MBS Unicast Parameters is sent within a PFCP Session Establishment Request message during the MBS restoration procedures specified in 3GPP TS 23.527 [40], see e.g. clauses 8.2.2 and 8.2.3.

For an MBS session using multicast transport over N3mb or N19mb, if the "FSSM" flag is set in the Apply Action, the MB-UPF shall forward the MBS session data using the Low Layer Source Specific Multicast address (i.e. destination IP multicast address and related source IP address) and C-TEID it allocated to the MBS session.

Both the "FSSM" and "MBSU" flags shall be set in the Apply Action IE if the MB-UPF is requested to forward MBS data using both multicast and unicast transport over N3mb and/or N19mb interfaces.

5.34.2.3 Detecting and reporting user plane (in)activity of an MBS session

As specified in clauses 7.2.5.2 and 7.2.5.3 of 3GPP TS 23.247 [72], the MB-SMF may instruct the MB-UPF to detect and report when user plane inactivity or activity is detected for an MBS session, in order to deactivate or activate the MBS session (see also clause 5.34.2.4).

User plane inactivity detection and reporting for an MBS session shall be supported as specified in clause 5.11.

User plane activity detection and reporting for an MBS session shall be supported as specified in clauses 5.2.3.1, i.e. by setting the NOCP flag in the Apply Action IE of the FAR and by the MB-UPF sending a PFCP Session Report Request including a Downlink Data Report IE identifying the PDR(s) for which downlink packets have been received.

5.34.2.4 Activation and Deactivation of a Multicast MBS session

Activation and Deactivation of a Multicast MBS session is specified in clauses 7.2.5.2 and 7.2.5.3 of 3GPP TS 23.247 [72]. At deactivation of a Multicast MBS Session, e.g. triggered by receiving an user plane inactivity report from the MB-UPF, or by receiving an MBS session deactivation request from the AF, the MB-SMF shall send a PFCP Session Modification Request message to request the MB-UPF:

- to stop forwarding the MBS session data and:
 - to report the receipt of subsequent DL MBS session data, by setting the Apply Action IE from "FSSM and/or MBSU" to "BUFF and NOCP" in the FAR of the PFCP session corresponding to the MBS session, if the activation of the MBS session is to be triggered upon receiving DL data report from the MB-UPF; or
 - to change the Apply Action IE from "FSSM and/or MBSU" to "DROP" or "BUFF" in the FAR of the PFCP session corresponding to the MBS session, if the deactivation is requested by the AF;
- optionally, to delete all unicast DL N3mb F-TEIDs and all unicast DL N19mb F-TEIDs, i.e. to delete all the information earlier received in all the Add MBS Unicast Parameters IEs, by setting the "DETEID" flag to "1" in the PFCPSMReq-Flags, if the MB-SMF stores N3mb F-TEIDs and N19mb F-TEIDs and does not want to keep these F-TEIDs in the MB-UPF when the MBS session is deactivated. Otherwise, MB-UPF will keep all unicast DL N3mb F-TEIDs and all unicast DL N19mb F-TEIDs when the MBS session is deactivated.

At the (re)activation of a Multicast MBS Session, e.g. triggered by receiving the DL data report from the MB-UPF, or by receiving an MBS session activation request from the AF, the MB-SMF shall send a PFCP Session Modification Request message:

- requesting the MB-UPF to forward the MBS session data towards NG-RANs and/or UPFs, by setting the Apply Action IE from "BUFF" (with or without NOCP) or "DROP" to "FSSM and/or MBSU" in the FAR of the PFCP session;
- provisioning all unicast NG-RAN DL N3mb F-TEIDs and UPF N19mb F-TEID (which are stored and were possibly updated in the MB-SMF) in the Add MBS Unicast Parameters IEs to request the MB-UPF to forward one copy of the MBS session data to these DL tunnels when the unicast transport is used, if all the DL N3mb and N19mb F-TEIDs were deleted during the MBS session deactivation procedure; and
- optionally including a User Plane Inactivity Timer IE to provision or update the user plane inactivity timer to request the MB-UPF to report user plane inactivity, if the deactivation of the MBS session is to be triggered upon user plane inactivity report from the MB-UPF.

5.34.2.5 MBS data usage reporting for MBS charging

MBS charging is an optional feature for the MB-SMF and the MB-UPF.

When MBS charging is supported, the MB-SMF shall support MBS session charging. The MB-UPF shall set the MBSCH feature flag in the UP Function Features IE (see clause 8.2.25) if it supports MBS charging.

If the MB-SMF and the MB-UPF supports MBS charging, the MB-SMF may request the MB-UPF to measure and report the volume of MBS data transmitted for the entire MBS session (or location dependent part of the MBS session,

for a location dependent MBS service) , for a broadcast or a multicast MBS session, as specified in 3GPP TS 32.279 [87].

If so, the MB-SMF shall provision URR(s) for the related PFCP session in the MB-UPF as defined in clause 5.4.10 with the following modifications:

- no charging quotas shall be used for MBS charging over N4mb, i.e. Volume (Time/Event) Quota shall not be provisioned in a URR for MBS charging; and
- Only volume-based measurement shall be used for MBS data usage reporting over N4mb (i.e. no time nor event based measurement).

NOTE: The measured volume corresponds to the volume of MBS data received from the AF or MBSTF that is transmitted downstreams towards at least one NG-RAN or UPF. MBS data is counted only once when it is transmitted towards multiple NG-RANs and/or UPFs.

Upon being so instructed, the MB-UPF shall measure and report the requested MBS data usage as defined in clause 5.2.2.

The MB-SMF may request the MB-UPF, in a PFCP Session Modification Request, to report its ongoing volume measurement for one or multiple URRs of the PFCP session, by including one or more Query URR IEs or by setting the QAURR (Query All URRs) flag, as defined in clause 5.2.2.3.1, when a chargeable event requiring to close the counts and starts new counts occurs at the MB-SMF (see Table 5.2.1.2-2 of 3GPP TS 32.279 [87]), e.g. upon the occurrence of the Connection established with NG-RAN event.

5.34.3 N4 requirements

5.34.3.1 General

This clause specifies the N4 requirements for the support of multicast MBS services using 5GC Individual MBS traffic delivery. The MBS data may be delivered from the MB-UPF to the UPF using multicast or unicast transport. It is optional for both the SMF and the UPF to support the multicast MBS service. The following requirements shall apply if the SMF and UPF support the MBSN4 feature (see clause 8.2.25).

NOTE 1: There is no impact on N4 to support broadcast MBS services in the 5GS.

NOTE 2: For an MBS session (or an MBS session towards an MBS service area for location dependent MBS), there is only one MB-SMF (set) and one MB-UPF.

For a given multicast MBS session, or for a given multicast MBS session and MBS Service Area for a location dependent MBS service, only a single copy of MBS Session data is delivered from the MB-UPF to the UPF. The UPF shall allocate only one N19mb downlink tunnel to receive the MBS session data for the MBS session, or for the MBS session and MBS Service Area for a location dependent MBS service, if unicast transport applies over N19mb or the UPF shall join the multicast group to receive MBS session data if multicast transport applies over N19mb.

5.34.3.2 Instructing the UPF to forward (or stop forwarding) multicast MBS data to associated PDU sessions

When a PDU session needs to be associated with an MBS session (e.g. when a UE requests to join a multicast MBS session, 5GC Individual MBS traffic delivery is used and the request is accepted by the SMF), the SMF shall associate the PDU session with the multicast MBS session by sending a PFCP Session Establishment or Modification Request message to the UPF, for the PFCP session corresponding to the PDU session, with the following information:

- the MBS Session N4 Control Information IE including the MBS Session Identifier, the Area Session ID, for a location dependent MBS service and, if IP multicast transport applies over N19mb (i.e. a multicast transport address has been received from the MB-SMF):
- the Multicast Transport Information IE for the given MBS session containing the Low Layer Source Specific Multicast address, i.e. the Multicast address and the source IP address and the GTP-U Common TEID which have been allocated by the MB-UPF for the MBS session, when the SMF considers it is the first PDU session to be associated with the MBS session (or with the MBS session and Area Session ID for a location dependent MBS service) in this UPF; the SMF may provide this information even if there are already other

PDU sessions associated with the MBS session (or with the MBS session and Area Session ID for a location dependent MBS service) in this UPF;

- one or more new DL PDR(s) including:
 - the MBS Session Identifier, the Area Session ID (for a location dependent MBS service), or a Traffic Endpoint IE which is including the MBS Session Identifier, and the Area Session ID (for a location dependent MBS service); this information shall be used by the UPF to:
 - determine whether the UPF already receives the MBS session data, or if instead it needs to allocate a new N19mb DL tunnel (when using IP unicast transport over N19mb) or send an IGMP JOIN request to join the multicast tree (when using IP multicast transport over N19mb) to receive the MBS session data; the UPF shall allocate the same N19mb DL Tunnel ID when the SMF requests the UPF to allocate a DL F-TEID for N19mb and multiple UE/PDU sessions are already associated with the MBS session (or with the MBS session and Area Session ID for a location dependent MBS service) in the UPF (e.g. PDU sessions controlled by other SMFs, or when multiple PDU sessions served by the same SMF need to be associated concurrently with the MBS session).
 - identify the list of PDU sessions (served by the UPF) towards which any DL packet received for this MBS session shall be distributed;
 - if unicast transport is used over N19mb:
 - a local F-TEID to be allocated at the UPF, with the CHOOSE flag set to "1" in the "Local F-TEID" IE in the PDI IE or Create Traffic Endpoint IE, if the SMF has no "N19mb DL F-TEID" information available for the MBS Session, e.g. for the first PDU Session in the SMF to be associated with the MBS session (or with the MBS session and Area Session ID for a location dependent MBS service); otherwise
 - the Local F-TEID set to the "N19mb DL F-TEID" for the MBS Session (or for the MBS session and Area Session ID for a location dependent MBS service) which is known by the SMF.
 - multiple DL PDRs may be provisioned and associated with different QERs to apply different QoS treatments for different multicast QoS flows within the MBS session. For each multicast QoS flow, the SMF may instruct the UPF to modify the QFI of downlink packets of the multicast QoS flow (received from the MB-UPF) to the QFI assigned by the SMF for the Associated (unicast) QoS flow, by associating a DL PDR including the QFI of the multicast QoS flow with a QER including the QFI IE set to the QFI of the Associated QoS flow.
- the new DL PDR(s) may be associated with an (existing) Forwarding Action Rule to forward the received MBS session data to the UE via existing downlink N3/N9 tunnel, or with a new Forwarding Action Rule with the Apply Action set to "Drop" if the SMF wishes to maintain the MBS data reception over N19mb but suspends the delivery of the data to the UE's PDU session, e.g. when the UE is switching between 5GC Individual MBS traffic delivery and 5GC Shared MBS traffic delivery due to the UE moving back and forth between MBS non-supporting NG-RAN and MBS supporting NG-RAN.

The UPF shall respond with a PFCP Session Establishment or Modification Response message to the SMF, and the UPF shall include an MBS Session N4 Information IE if any of the following information needs to be reported:

- the allocated "N19mb DL Tunnel ID" if it was requested;
- an NN19DT (New N19mb Downlink Tunnel) indication in the MBSN4Resp-Flags IE indicating if the N19mb DL F-TEID has been newly allocated by the UPF or if a N19mb DL F-TEID had already been allocated by the UPF for the MBS session (or for the MBS session and Area Session ID for a location dependent MBS service), when the "N19mb DL Tunnel ID" is present; this information allows the SMF to determine if it needs to report this N19mb DL Tunnel ID to the MB-SMF;
- an indication "JM TI" (Joined N19mb Multicast Tree Indication) in the MBSN4Resp-Flags IE indicating if the UPF has joined the multicast tree from MB-UPF, if the Multicast Transport Information was included in the request message.

NOTE: The indications "JM TI" and "NN19DT" are defined to help the SMF to determine if it needs to communicate with the MB-SMF, e.g., to report the newly allocated N19mb DL TEID in order to let the MB-SMF inform the MB-UPF to send a copy of MBS Session data to the UPF. The indication "JM TI" indicates to the SMF that no N19mb DL TEID needs to be allocated.

If unicast transport is used over N19mb and if the NN19DT (New N19mb Downlink Tunnel) indication is not set in the MBSN4Resp-Flags IE within the PFCP Session Establishment or Modification Response (i.e. if the MBSN4Resp-Flags IE is present and the NN19DT indication is not set, or if the MBSN4Resp-Flags IE is absent), the SMF shall assume that the UPF had already allocated the N19mb DL TEID earlier than the PFCP Session Establishment or Modification Request.

When a PDU Session should no longer be associated with the MBS session, or with the MBS session and Area Session ID for a location dependent MBS service, (e.g. the PDU session leaves the MBS session, or when switching to 5GC Shared MBS traffic delivery), or when the MBS session to which the PDU session is associated is being deactivated, the SMF shall send a PFCP Session Modification Request message to remove the DL PDR(s) that were created to receive the MBS session data, unless the SMF decides to keep the UPF receiving MBS Session data from N19mb, in which case the PDR shall be associated with a FAR set to drop packets. In the former case, when all the DL PDR(s) that were created to receive the MBS session data have been removed, the UPF shall consider that the PFCP session (PDU session) is no longer associated with the MBS session (i.e. the UPF shall delete, from its PFCP session context, the MBS Session N4 Control Information corresponding to the MBS session).

In the PFCP Session Modification Response message, the UPF shall include the indication "N19DTR" (N19mb Downlink Tunnel Removal) in the MBSN4Resp-Flags IE indicating the N19mb DL Tunnel is to be removed if the UPF was requested to remove the DL PDRs of the MBS session for the PFCP session and this was the last PFCP session associated with the N19mb DL Tunnel in the UPF. This tells the SMF that it shall request the MB-SMF to inform the MB-UPF to stop sending MBS Session data towards this N19mb DL Tunnel.

The UPF shall also set the indication "N19DTR" (N19mb Downlink Tunnel Removal) in the MBSN4Resp-Flags IE indicating the N19mb DL Tunnel is to be removed in the PFCP Session Deletion Response message when the SMF deleted the last PFCP session who was associated with the N19mb DL Tunnel in the UPF.

When the MBS session to which the PDU session is associated is being re-activated, the SMF shall send a PFCP Session Modification Request message to the UPF:

- including the MBS Session N4 Control Information IE and re-creating the DL PDR(s) of the MBS QoS flows, following the same requirements as described above for associating the PDU session with the MBS session, if the SMF removed the DL PDR(s) that were created to receive the MBS session data when the MBS session was deactivated; or
- associating the DL PDR(s) of the MBS QoS flows with the FAR provisioned with the N3 DL F-TEID to forward packets, if the SMF decided to keep the UPF receiving MBS Session data from N19mb by associating these DL PDR(s) with a FAR set to drop packets when the MBS session was deactivated.

During a restoration procedure for an MB-UPF failure without Restart (see clause 8.2.3 of 3GPP TS 23.527 [1]), if multicast transport is used over N19mb:

- the SMF shall instruct the UPF to use the new Low Layer Source Specific Multicast address, i.e. the Multicast address and the source IP address and the GTP-U Common TEID which have been allocated by the new MB-UPF for the MBS session, by sending a PFCP Session Modification Request message with the MBS Session N4 Control Information IE including the MBS Session Identifier, the Area Session ID (for a location dependent MBS service) and the Multicast Transport Information IE containing the new LL SSM address and GTP-U Common TEID;
- upon receipt of such a request, the UPF shall send an IGMP JOIN request to join the multicast tree to receive the MBS session data from the new MB-UPF and it shall leave delivery from the previous multicast address that was in use for the MBS session. The UPF shall set the indication "JMTI" (Joined N19mb Multicast Tree Indication) in the MBSN4Resp-Flags IE in the PFCP Session Modification Response to indicate that the UPF has joined the multicast tree from MB-UPF.

When receiving the MBS session data for a given MBS session, or for a given MBS session and Area Session ID for a location dependent MBS service, either from the N19mb DL Tunnel allocated for this MBS Session (where the packets shall be identified by N19mb DL TEID) when unicast transport is used, or from the low layer Multicast transport address (where the packets shall be identified by the low layer Multicast transport address) when multicast transport is used, the UPF shall replicate the MBS Session data to all PFCP sessions which are associated with the MBS Session, or with the MBS session and Area Session ID for a location dependent MBS service.

The UPF shall forward the MBS DL QFI Sequence Number in the PDU Session Container (see 3GPP TS 38.415 [34]) of MBS data packets received from the MB-UPF unmodified.

5.34.3.3 Instructing a combined UPF/MBS-UPF to forward multicast MBS data to associated PDU sessions

The procedures and requirements to instruct a combined UPF/MB-UPF to associate a PDU session with an MBS session (or with the MBS session and Area Session ID for a location dependent MBS service) for which it serves as the MB-UPF shall be as specified in clauses 5.34.2.2 and 5.34.3.2, with the following additions:

- the combined UPF/MB-UPF may determine that the PDU session is being associated with an MBS session (or with an MBS session and Area Session ID for a location dependent MBS service) for which it serves as MB-UPF by determining whether a specific PFCP session has been established for the MBS session (or with the MBS session and Area Session ID for a location dependent MBS service), as specified in clause 5.34.2.2;
- the SMF shall instruct the combined UPF/MB-UPF to associate the PDU session with the MBS session (or with the MBS session and Area Session ID for a location dependent MBS service) as specified in clause 5.34.3.2, as if the UPF and MB-UPF were not combined; this means in particular that the DL PDR of the PFCP session of the PDU session to be associated with the MBS session (or with the MBS session and Area Session ID for a location dependent MBS service) shall not contain an N6mb / Nmb9 address or IP multicast addressing information;

NOTE 1: Only the PFCP session created for the MBS session (or for the MBS session and Area Session ID for a location dependent MBS service) as specified in clause 5.34.2.2 can contain a N6mb / Nmb9 address or IP multicast addressing information.

- it is an implementation choice for such combined UPF/MB-UPF to allocate a (possibly virtual / internal) N19mb DL Tunnel ID (i.e. IP address and TEID) or to indicate to the SMF that it has joined the low layer multicast group assigned by the MB-UPF for the MBS session (or for the MBS session and Area Session ID for a location dependent MBS service), and the combined UPF/MB-UPF shall respond to the SMF accordingly, as if it is the UPF and MB-UPF were not combined;
- if the combined UPF/MB-UPF returns a N19mb DL Tunnel ID with the NN19DT (New N19mb Downlink Tunnel) indication set to 1, the SMF shall request the MB-SMF to (or the combined SMF/MB-SMF shall) instruct the MB-UPF to forward and replicate MBS Session data towards the (possibly virtual / internal) N19mb DL Tunnel ID as specified in clause 5.34.2.2, as if the UPF and MB-UPF were not combined.

NOTE 2: The SMF, MB-SMF or a combined SMF/MB-SMF need not implement any additional logic when communicating with a combined UPF/MB-UPF.

5.34.3.4 MBS data usage reporting for MBS charging

MBS charging is an optional feature for the SMF. It does not require any specific capability from the UPF (other than supporting 5GS charging requirements for a PDU session).

If the SMF supports MBS charging, the SMF may request the UPF to measure and report the volume of multicast MBS data transmitted to the UE via the UE's PDU session using 5GC individual MBS traffic delivery, as specified in clause 5.1.3 of 3GPP TS 32.255 [45].

If so, the SMF shall provision URR(s) for the related PFCP session in the UPF, associated with the DL PDR(s) established for receiving the MBS data from the UPF, as defined in clause 5.4.10 with the following modifications:

- no charging quotas shall be used for MBS charging over N4, i.e. Volume (Time/Event) Quota shall not be provisioned in a URR for MBS charging; and
- Only volume-based measurement shall be used for MBS data usage reporting over N4 (i.e. no time nor event based measurement).

Upon being so instructed, the UPF shall measure and report the requested MBS data usage as defined in clause 5.2.2.

5.35 Support of Per Slice UP Resource Allocation and Usage Reporting by the UP Function

5.35.1 General

A UP Function may serve PDU sessions belonging to different network slices (i.e. S-NSSAIs).

UP resources allocation per network slice may be achieved by:

- a) the UP function allocating UP resources based on the Network Instance IE (and other N4 information such as PDU session type, IP Address Pool ID, ATSSS Control Information), with distinct Network Instance values being configured in the CP function and UP Function for different network slices; or

NOTE 1: The above behavior does not require support of any specific PFCP protocol extension and can be supported by UP function implementations complying with earlier releases of the specification.

- b) the UP function allocating UP resources based on the Network Instance IE and S-NSSAI IE (and other N4 information such as PDU session type, IP Address Pool ID, ATSSS Control Information), if the feature "Per Slice UP Resource Management" is supported by the UP function and if the UP function is configured to do so by operator policy.

A UP function that supports allocating UP resources based on the Network Instance IE and S-NSSAI IE (and other N4 information) and that is configured to do so by operator policy, shall:

- indicate support of the feature "Per Slice UP Resource Management" in the UP Function Features IE during the PFCP association setup procedure; and
- allocate resources in the UP function using the Network Instance and, if available, the S-NSSAI.

A UP function that does not support allocating UP resources based on the Network Instance IE and S-NSSAI IE or that is not configured to do so by operator policy shall allocate UP resources based on the Network Instance IE (and other N4 information).

If the UP function supports the UE IP Address Usage Reporting feature (see clause 5.21.3.2), the UP function shall report the UP IP address usage as specified in clause 5.21.3.2, by reporting the UE IP address usage:

- a) per Network Instance, if the UP function does not support allocating UP resources based on the Network Instance IE and S-NSSAI IE or it is not configured to do so by operator policy; or

NOTE 2: This allows to report UE IP address usage per network slice when using a distinct Network Instance value per network slice.

- b) per Network Instance and S-NSSAI, if the UP function supports allocating UP resources based on the Network Instance IE and S-NSSAI IE and is configured to do so by operator policy. In this case, the UP Function shall report the UE IP address usage information associated with a specific S-NSSAI, as specified in clause 5.21.3.

NOTE 3: If the UP function indicates that it supports the "Per Slice UP Resource Management" feature and if this feature is also supported by the CP function, the CP function can instruct the UP function to allocate UP resource taking into account the network slice by including the Network Instance IE and S-NSSAI IE in the PFCP session establishment procedure. Otherwise, a separate Network Instance needs to be configured for each S-NSSAI if support of multiple slices is needed.

5.36 Paging Policy Indicator Provisioning

5.36.1 General

Stage 2 requirements for Paging Policy Differentiation are specified in clause 5.4.3.2 of 3GPP TS 23.501 [28].

For a UE in RRC Inactive state the NG-RAN can be required to enforce specific paging policies in the case of NG-RAN paging, based on 5QI, ARP and PPI associated with an incoming DL PDU. To support this, the SMF shall instruct the UPF to detect the DSCP in the TOS (IPv4) / TC (IPv6) value in the IP header of the DL PDU and insert the

corresponding PPI as described below. When Paging Policy Differentiation is enabled in the network and a PPI needs to be inserted into DL PDU, the SMF shall:

- provision a PDR for each PPI containing one or more DSCP code(s) to be matched against the DSCP in the TOS (IPv4) / TC (IPv6) value in the IP header of the DL PDUs, where these DSCP code(s) are to be mapped to the same PPI, in the PDI together with or without the service data flow detection information;

NOTE 1: When service data flow level packet detection is not required, e.g. for an I/V-UPF, the PDR can be provisioned with one or more DSCP(s) to be matched in the PDI without any service data flow detection information.

NOTE 2: When service data flow level packet detection is required, several PDRs with the same service data flow detection information but with different (set of) DSCP(s) (which are mapped to different PPI) need to be provisioned.

- associate the PDR with a QER with the Paging Policy Indicator set to the mapped PPI to instruct UPF to insert the corresponding PPI into the GTP-U PDU Session Container extension header of outgoing packets.

5.36.2 Enhanced Paging Policy Indicator Provisioning

To reduce the number of PDRs/QERs to be provisioned (in order to support NG-RAN paging using Paging Policy Indicator (PPI)), the SMF and the UPF may support the Enhanced Provisioning Paging Policy Indicator (EPPPI) feature as specified below.

During a PFCP session establishment/modification procedure, if both the SMF and the UPF support the EPPPI feature, the SMF may include a DSCP to PPI Control Information in the PFCP Session Establishment/Modification Request message to instruct the UPF to insert a PPI in the GTP-U PDU Session Container extension header of downlink GTP-U packets encapsulating payload packets (to be sent to the UE). When the DSCP to PPI Control Information IE is present, the SMF may:

- include one or more DSCP to PPI Mapping Information to instruct the UPF to insert the corresponding PPI for downlink GTP-U packets, where the DSCP of its payload packet is matching one of DSCP codes in the DSCP to PPI Mapping Information;
- include one or more QFIs to instruct UPF to insert PPI only for the downlink packets received on the requested QFI(s);

5.37 Traffic Parameters Measurement per QoS flow

5.37.1 General

The UP function may be requested by the SMF to perform Traffic Parameters Measurement per QoS flow, e.g. to enable NG-RAN to configure UE power saving management scheme for connected mode DRX as specified in clauses 5.37.8 and 5.8.5 of 3GPP TS 23.501 [28]. The following clauses specify Traffic Parameters Measurement procedure.

5.37.2 Traffic Parameter Measurement Control

When requesting the UPF to perform Traffic Parameter Measurement, the SMF shall provision one or more Traffic Parameter Measurement Control Information IEs in a Session Reporting Rule to instruct the UPF to measure relevant traffic parameters for one or more QoS Flows.

The Traffic Parameter Measurement Control Information IEs shall include:

- one or more QFI IEs indicating the QoS flow(s) for which traffic parameters are requested to be measured;
- either a Measurement Period for periodic reporting or a Traffic Parameter Threshold to trigger the report;
- the Traffic Parameter Measurement Indication to indicate the traffic parameters requested to be measured.

The SMF may require the UPF to stop the on-going Traffic Parameter Measurement for a QoS flow by sending a PFCP Modification Request with the Remove SRR IE, or by sending a PFCP Modification Request with the Update SRR IE

within which the previous Traffic Parameter Measurement Control Information IE is removed or updated by removing the corresponding QFI(s) (when there are still QFI(s) left). Upon receiving such a PFCP Modification Request message, the UPF shall stop the corresponding Traffic Parameter Measurement for the QoS flow.

5.37.3 Traffic Parameter Measurement Report

If the UPF is requested to perform Traffic Parameter Measurement for a QoS flow (i.e. it receives one or more Traffic Parameter Measurement Control Information IEs from the SMF), the UPF shall measure the relevant traffic parameters according to Traffic Parameter Measurement Indication and generate a Traffic Parameter Measurement Report towards the SMF as instructed, i.e., either periodically or when the measured traffic parameter is exceeding the provisioned threshold.

5.38 Support for high data rate low latency services, eXtended Reality (XR) and interactive media services

5.38.0 General

Stage 2 requirements related to the support for high data rate low latency services, eXtended Reality (XR) and interactive media services are specified in clause 5.37 of 3GPP TS 23.501 [28] and clause 4.17 of 3GPP TS 23.316 [57], which includes the following features requiring protocol enhancement to signalling interactions between the SMF and UPF over N4:

- Support of ECN marking for L4S as specified in clause 5.37.3 of 3GPP TS 23.501 [28];
- Support of Network Exposure of 5GS information, including control of reporting the congestion information, Data rate, Round trip delay and available bitrate measurement for QoS flow(s) as specified in clause 5.37.4 of 3GPP TS 23.501 [28];
- Support of PDU Set based Handling as specified in clause 5.37.5 of 3GPP TS 23.501 [28] and clause 4.17.3 of 3GPP TS 23.316 [57];
- Support of N6 Jitter Measurement and End of Data Burst Indication for UE power saving in clause 5.37.8 of 3GPP TS 23.501 [28].
- Support of dynamically changing traffic characteristics as specified in clause 5.37.10 of 3GPP TS 23.501 [28].
- Support of traffic identification and differentiated QoS flow mapping for multiplexed media flows in the same transport layer connection, as specified in clause 5.37.11 of 3GPP TS 23.501 [28].
- Support of transferring media related information over N6 (when the end-to-end connection for XR media between the UE and Application Server is encrypted) as specified in clause 5.37.11 of 3GPP TS 23.501 [28].

It is optional for both the SMF and the UPF to support above features, hence the SMF may trigger the procedures specified in this clause only when the UPF has indicated its support of the corresponding feature via the UP Function Features IE. (see clause 8.2.25).

5.38.1 Support of ECN marking for L4S

Stage 2 requirements for the support of ECN marking for L4S are specified in clause 5.37.3 of 3GPP TS 23.501 [28]. This exposes congestion information by marking ECN bits in the IP header of the user IP packets between the UE and the application server to trigger application layer rate adaptation.

Support of this feature is optional for the SMF and UPF. A UPF that supports ECN marking for L4S on behalf of and due to congestion in NG-RAN shall indicate so to the SMF by setting the EML4S flag in the UP Function Features IE (see clause 8.2.25).

ECN marking for L4S may be enabled on a per QoS flow basis in the uplink and/or downlink direction and may be used for GBR and non-GBR QoS Flows.

NOTE 1: A QoS flow eligible for ECN marking can be determined and created:

- statically when a PDU session is established or modified based on configuration in SMF or PCF, or upon an AF request for application traffic requiring ECN marking; or
- dynamically based on the detection of the L4S traffic (e.g. matching packets with ECT(1) or CE (see IETF RFC 9331 [81]) together with IP 5 tuple in the IP header) whereby SMF or PCF triggers a setup of a QoS Flow enabled for L4S upon receiving the report of the detection of such traffic. See also clause 5.4.11 for (Un)solicited Application Reporting.

NOTE 2: In the case of 3GPP access, ECN marking for L4S in the IP header due to congestion in NG-RAN can be supported by NG-RAN itself or can be delegated to the PSA UPF. If supported by both, it is enabled by the SMF either in the NG-RAN or in the PSA UPF, based on operator's policies. This clause describes requirements for ECN marking done in the PSA UPF.

NOTE 3: In general, any network layer node that experiences congestion and is capable of performing ECN marking for L4S in the IP header can do so to contribute to the end to end L4S support. This clause describes only the marking due to congestion in NG-RAN with ECN marking delegated to the PSA UPF. It does not prevent though any other network layer node to perform ECN marking of the user IP packets due to other congestion point in the end-to-end path.

In the case of 3GPP access, if the UPF indicated support of ECN marking for L4S (i.e. the EML4S feature), the SMF may instruct the UPF to perform ECN marking for L4S for one QoS flow, in a PFCP Session Establishment Request or a PFCP Session Modification Request, by setting the ECN marking for L4S indicator in a QER associated with the UL and/or DL PDRs of this QoS flow.

NOTE 4: The PDR can use SDF filter(s) (e.g. matching packets with ECT(1) or CE (see IETF RFC 9331 [81]) together with IP 5 tuple) to steer traffic to an L4S enabled QoS Flow.

NOTE 5: The SMF also indicates to NG-RAN to report information for ECN marking (i.e. a percentage of packets to be used by the UPF for ECN marking for L4S) of the QoS Flow on UL and/or DL directions via GTP-U header extension to PSA UPF. If there is no UL packet when report for DL and/or UL needs to be provided, NG-RAN may generate an UL Dummy GTP-U Packet for such a reporting.

NOTE 6: In the case of non-3GPP access, ECN marking for L4S in the IP header is supported in the N3IWF/TNGF/W-AGF/5G-RG (see clause 5.37.3.4 of 3GPP TS 23.501 [28] and clause 4.17.2 of 3GPP TS 23.316 [57]). The ECN marking for L4S indicator in the QER is only used for 3GPP access and is not applicable for non-3GPP access.

Upon being instructed to perform ECN marking for L4S for a QoS flow, the UPF shall:

- monitor the UL and/or DL congestion information received from the NG-RAN in the GTP-U PDU Session Container header extension (see 3GPP TS 38.415 [34] and 3GPP TS 38.300 [42]) of GTP-U packets; and
- perform ECN bits marking for L4S for the percentage of IP packets of the QoS flow in the UL and/or DL direction according to the congestion information of the QoS flow in UL and/or DL directions.

During PDU session establishment procedure, if the SMF receives the ECN Marking or Congestion Monitoring Reporting Status (in the PDU Session Resource Setup Response Transfer IE) from the NG-RAN which indicates that reporting information for ECN marking at UPF for the QoS flow is not active, then the SMF shall instruct the UPF to stop ECN marking for L4S, by setting the ECN marking for L4S indicator to "0" in the QER associated with the PDRs of the QoS flows for which ECN marking was enabled, in a PFCP Session Modification Request if the SMF has instructed the UPF to perform ECN marking for L4S for a QoS flow previously.

During a NG-RAN Xn handover and N2 handover, if the reporting information for ECN marking at UPF has been enabled on source NG-RAN while the target NG-RAN does not support reporting information for ECN marking at UPF, then the SMF shall instruct the UPF to stop ECN marking for L4S, by setting the ECN marking for L4S indicator to "0" in the QER associated with the PDRs of the QoS flows for which ECN marking was enabled, in a PFCP Session Modification Request.

Upon being instructed to stop performing ECN marking for a QoS flow, the UPF shall stop doing so.

5.38.2 Support of Network Exposure of 5GS information

Stage 2 requirements for the support of Network Exposure of 5GS information are specified in clause 5.37.4 of 3GPP TS 23.501 [28]. The SMF may instruct the UPF to perform QoS monitoring of:

- UL and/or DL congestion information (see clause 5.39.3.3);
- UL and/or DL Data rate information (see clause 5.39.3.4);
- round trip delay (see clause 5.39.3.2); and/or
- UL and/or DL available bitrate (see clause 5.39.3.5).

Specific requirements for the monitoring reporting on UPF are specified in clause 5.39.4.

5.38.3 Support of PDU Set based Handling

Stage 2 requirements for the support of PDU Set based handling are specified in clause 5.37.5 of 3GPP TS 23.501 [28] and clause 4.17.3 of 3GPP TS 23.316 [57]. A PDU Set comprises one or more PDUs carrying the payload of one unit of information generated at the application level (e.g. frame(s) or video slice(s) for eXtended Reality (XR) Services). All the PDUs of a PDU set are transmitted within the same QoS Flow.

This clause specifies how the SMF instructs the UPF to identify PDUs that belong to PDU sets and to perform PDU Set marking for a QoS Flow enabled with PDU Set based handling, and how the SMF instructs the UPF to stop PDU sets identification and marking.

The support of this feature is optional for the SMF and UPF. A UPF that supports PDU Set based handling shall indicate so to the SMF by setting the PDUSM flag in the UP Function Features IE (see clause 8.2.25).

PDU Set marking at the UPF may be enabled on a per QoS flow basis in the downlink direction and may be used for GBR and non-GBR QoS Flows.

If the 5G-AN indicated support of PDU Set based handling in N2 SM Information and if the UPF indicated support of PDU Set marking (i.e. the PDUSM feature), the SMF may instruct the UPF to identify PDU sets and perform PDU sets marking for one QoS flow, in a PFCP Session Establishment Request or a PFCP Session Modification Request, by setting the PDU Set marking indicator to "1" in a QER associated with the DL PDRs of this QoS flow and by optionally providing the Protocol Description (for DL traffic) in these DL PDRs indicating the transport protocol (e.g. RTP/SRTP), RTP header extensions that may be used for PDU Set identification, payload type and/or payload format (e.g. H.264, H.265) used by the service data flow.

Upon the completion of a NG-RAN Xn handover and N2 handover from a NG-RAN supporting PDU set based handling to a NG-RAN not supporting the same, the SMF may instruct the UPF to stop identifying PDU sets and performing PDU sets marking for each QoS flow of the UE's PDU session(s) for which PDU Set based handling was enabled, by setting the PDU Set marking indicator to "0" in the QER associated with the DL PDRs of each QoS flow in a PFCP Session Modification Request.

Upon the completion of a NG-RAN Xn handover and N2 handover from a NG-RAN not supporting PDU set based handling to a NG-RAN supporting the same, the SMF may instruct the UPF to start identifying PDU sets and performing PDU sets marking for one or more QoS flow(s) of the UE's PDU session(s), by setting the PDU Set marking indicator to "1" in the QER associated with the DL PDRs of the corresponding QoS flow(s) and by optionally providing the Protocol Description (for DL traffic) used by the service data flow(s) in a PFCP Session Modification Request.

NOTE 1: The Protocol Description included in DL PDRs is not used for packets matching against the PDRs but to assist the PDU Set identification by the UPF.

NOTE 2: The SMF also provides the 5G-AN with PDU Set QoS parameters, as specified in clause 5.7.7 of 3GPP TS 23.501 [28], or with the DL PDU Set Information Marking Support Indication specified in clause 5.37.5.1 of 3GPP TS 23.501 [28].

NOTE 3: In this Release of specification, the PDU Set based handling is supported in 5GS for a UE registered in 3GPP access for single access PDU Session with IP PDU Session Type, for a UE registered in untrusted or trusted non-3GPP accesses for single access PDU Session with IP PDU Session Type, and for a 5G-RG registered in W-5GAN for single access PDU Session with IP PDU Session Type, as specified in clause 5.37.5.1 of 3GPP TS 23.501 [28]. When the UE moves to an area where the PDU Set based handling is not supported, the SMF instructs the UPF to stop identifying PDU sets and performing PDU sets marking for each QoS flow of the UE's PDU session(s) for which PDU Set based handling was enabled. When the UE moves from an area where the PDU Set based handling is not supported to an area where the PDU Set based handling is supported, the SMF instructs the UPF to start identifying PDU sets and performing PDU sets marking for one or more QoS flow(s) of the UE's PDU session(s), if the PCC rule requires so.

Upon being instructed to identify PDU sets and to perform PDU Set marking for a QoS flow, the UPF shall:

- identify the PDU sets using the Protocol Description (if available) or using implementation specific means; details of the RTP/SRTP headers, RTP header extensions and/or payloads that may be used to identify PDU Set Information are defined in 3GPP TS 26.522 [79]; when the DL traffic is end-to-end encrypted, the UPF may identify media related information using an on-path N6 signaling method (see clause 5.38.7);

and

- for each DL PDU received for the corresponding QoS flow, the UPF shall provide PDU Set information which is available to the 5G-AN in the GTP-U PDU Set Information Container extension header (see clause 6.5 of 3GPP TS 38.415 [34]), including:
 - the QoS Flow Identifier [QFI];
 - the PDU Set Sequence Number [PSSN], which indicates the sequence number of the PDU Set to which the current PDU belongs;
 - the PDU Sequence Number within the PDU Set [PSN], which indicates the sequence number of the current PDU within the PDU Set;
 - the End PDU of the PDU Set indicator [EPDU], which indicates whether the current PDU is the last PDU of the PDU set;
 - the PDU Set Importance [PSI], which identifies the relative importance of a PDU Set compared to other PDU Sets within the QoS Flow;
 - the PDU Set Size [PSSize] in bytes, which indicates the total size of all PDUs of the PDU Set to which the current PDU belongs.

Upon being instructed to stop identifying PDU sets and performing PDU Set marking for a QoS flow, the UPF shall stop doing so.

When a QoS flow is configured for PDU Set based handling, the UPF may be requested to perform PDU Set Importance based transport level packet marking if the UPF indicates its support of PSITLM. See clause 5.4.13.

5.38.4 N6 Jitter Measurement and End of Data Burst Marking

5.38.4.1 General

Stage 2 requirements related to N6 Jitter measurement and End of Data Burst marking are specified in clauses 5.37.8 and 5.8.5 of 3GPP TS 23.501 [28]. The N6 Jitter Information associated with the DL Periodicity (that is used by the PSA UPF to measure the N6 jitter), the UL Periodicity and the End of Data Burst indication (included in the PDU Set Information Container extension header in the GTP-U header of the last PDU of each data burst) are provided to NG-RAN as traffic assistance information enabling to configure UE power saving management scheme for connected mode DRX.

Support of N6 Jitter, DL Periodicity and UL Periodicity measurements and End of Data Burst marking is optional for the SMF and UPF to support. The procedures specified in this clause may apply if the UPF indicates its support of the N6JEDB feature (see clause 8.2.25).

When the UPF supports the N6JEDB feature, the SMF may request the UPF to perform N6 Jitter measurement and conditionally DL and/or UL Periodicity measurements and to set the End of Data Burst indication in the last PDU of each data burst, during a PFCP session establishment or a PFCP session modification procedure.

5.38.4.2 N6 Jitter and UL/DL Periodicity Measurement Control

When requesting the UPF to perform N6 Jitter and Periodicity Measurement, the SMF shall provision one or more Traffic Parameter Measurement Control Information IEs in a Session Reporting Rule as specified in clause 5.37.2 to instruct the UPF to measure and report N6 jitter information associated with a DL Periodicity for one or more QoS Flows in downlink direction and conditionally the DL and/or UL Periodicity.

In the Traffic Parameter Measurement Control Information IE(s) the SMF shall:

- include the DL Periodicity if this information is available; and
- set the Traffic Parameter Measurement Indication to request the UPF to measure and report N6 Jitter and conditionally the DL and/ or UL Periodicity if the SMF does not receive the DL and/or UL Periodicity from the PCF.

5.38.4.3 N6 Jitter and UL/DL Periodicity Measurement Report

If the UPF is requested to perform N6 Jitter and UL/DL Periodicity measurement for a QoS flow (i.e. it receives one or more Traffic Parameter Measurement Control Information IEs from the SMF), the UPF shall measure the UL/DL Periodicity (if required), N6 Jitter using the received DL Periodicity if available otherwise using the measured DL Periodicity, and generate a Traffic Parameter Measurement Report towards the SMF as specified in clause 5.37.3.

5.38.4.4 End of Data Burst Marking

The SMF may request the PSA UPF to detect the last PDU of each Data Burst in the application traffic and then mark the End of Data Burst (EDB) in the GTP-U PDU Set Information Container extension header of the GTP-U packet conveying that PDU, according to the PCC rule and/or the local operator policies.

When doing so, the SMF shall set the EDBMI flag to "1" in the QER Indications IE in the QER which is for the QoS flow conveying the application traffic, to instruct the PSA UPF to mark the End of Data Burst (EDB) in the GTP-U PDU Set Information Container extension header of the GTP-U packets conveying the last PDU. Additionally, the SMF may include the Protocol Description (for DL traffic) (see clause 5.38.3) used by the service data flow in the PDR providing information to the PSA UPF on how to detect the last PDU of each Data Burst within the application traffic.

Upon receiving such a request, the UPF shall identify the last PDU of each Data Burst in the DL application traffic based on the End indication according to the Protocol Description or UPF implementation, or using an on-path N6 signaling method (see clause 5.38.7), and it shall mark the End of Data Burst (EDB) in the GTP-U PDU Set Information Container extension header (see clause 6.5 of 3GPP TS 38.415 [34]) of the GTP-U packet conveying that PDU accordingly.

5.38.5 Supporting dynamically changing traffic characteristics via the User Plane

5.38.5.1 General

A UPF may support identifying and marking dynamically changing traffic characteristics in downlink GTP-U packets as specified in clause 5.37.10 of 3GPP TS 23.501 [28]. A UPF that supports this capability shall indicate the support of the DYNTR feature in the UP Function Features IE (see clause 8.2.25).

The requirements specified in clause 5.38.5 apply if the UPF supports the DYNTR feature.

5.38.5.2 DL Data Burst Size Marking

According to the PCC rule, the SMF may request the UPF to identify the Data Burst Size of the data burst of a QoS flow in downlink and mark the Data Burst Size in the GTP-U packets of the first DL packets of the data burst, by setting the DBSMI flag to "1" in the QER Indications IE in the QER for the corresponding QoS flow. Additionally, the

SMF may include the Protocol Description (for DL traffic) (see clause 5.38.3) used by the service data flow in the PDR providing assistance information to the UPF for the determination of the Data Burst Size of data bursts.

Upon receiving such a request, the UPF shall identify in the first DL packets of the data burst the Data Burst Size carried in the RTP header extension for Dynamically changing traffic characteristics as defined in 3GPP TS 26.522 [79] and the UPF shall send the identified Data Burst size to NG-RAN in the GTP-U PDU SessionContainer extension header of the DL GTP-U packets of the first PDUs of the data burst (see clause 5.5.2.1 of 3GPP TS 38.415 [34]).

5.38.5.3 DL Time to Next Burst Marking

According to the PCC rule, the SMF may request the UPF to identify the Time to Next Burst of a QoS flow in downlink and mark the Time to Next Burst in the GTP-U packets, by setting the TNBMI flag to "1" in the QER Indications IE in the QER for the corresponding QoS flow. Additionally, the SMF may include the Protocol Description (for DL traffic) (see clause 5.38.3) used by the service data flow in the PDR providing assistance information to the UPF for the determination of the Time to Next Burst.

Upon receiving such a request, the UPF shall identify in DL packets the time interval to the next Data Burst carried in the RTP header extension for Dynamically changing traffic characteristics as defined in 3GPP TS 26.522 [79] and the UPF shall send the identified Time to Next Burst to NG-RAN in the GTP-U PDU Session Container extension header of the DL GTP-U packets (see clause 5.5.2.1 of 3GPP TS 38.415 [34]).

NOTE: Time to next data burst marking is only used when the deployment is such that the time to next data burst is sufficiently accurate i.e., the jitter (e.g. the N6 jitter) is sufficiently limited without impact to the accuracy of the time to next data burst.

5.38.5.4 Expedited Data Transfer with reflective QoS

Stage 2 requirements for Expedited Data Transfer with reflective QoS are specified in clause 5.37.10.3 of 3GPP TS 23.501 [28].

According to the PCC rules, the SMF may request the PSA UPF to expedite the data transfer of DL packets marked with an Expedited Transfer Indication (contained in media related information or in RTP Header Extension) of a non-GBR service data flow.

To do so, the SMF shall provision two PDRs with the PDI including the Expedited Transfer Indication IE set to TRUE in one PDR and to FALSE in the other PDR, and associate these PDRs with respective QER rules. The SMF shall set the Reflective QoS Indication (RQI) in the QER associated with the PDR including the Expedited Transfer Indication set to TRUE and it may do so in the QER associated with the other PDR (see clause 5.2.5.3).

Additionally, the SMF may include the Protocol Description (for DL traffic) in the DL PDRs providing assistance information to the UPF for the determination of the Expedited Transfer Indication in DL packets, or instruct the UPF to receive media related information over N6 as defined in clause 5.38.7.

If UPF receives the PDRs with the Expedited Transfer Indication, it shall detect the Expedited Transfer Indication information in DL packets (as described in clause 5.38.6 for encrypted traffic or in the RTP Header Extension for Expedited Transfer Indication as defined in clause 4.7 of 3GPP TS 26.522 [79]) to process the DL packets based on one of these two PDRs.

5.38.6 Traffic identification and differentiated QoS for multiplexed media flows

Stage 2 requirements for traffic identification and differentiated QoS for media flows multiplexed on a same end-to-end transport layer connection are specified in clause 5.37.11 of 3GPP TS 23.501 [28].

A UPF may support traffic identification and differentiated QoS for multiplexed media flows. A UPF that supports this capability shall indicate its support of the MUXMF feature in the UP Function IE (see clause 8.2.25).

If the UPF supports the MUXMF feature, the SMF may provision SDF Filters in DL and/or UL PDRs which include (S)RTP Multiplexed Media Identification Information to differentiate different media flows that are transported in (S)RTP, or the (S)RTCP that controls the (S)RTP transmission, when (S)RTP, (S)RTCP and other associated protocols are multiplexed into a single IP traffic flow.

5.38.7 Support of transferring media related information over N6

5.38.7.1 General

Stage 2 requirements to support transferring media related information (i.e. information related to the media being transmitted, e.g. PDU Set information, Data Burst Size, etc) over N6, when the end-to-end connection for XR and media traffic between the UE and AS is encrypted, are specified in clause 5.37.9 of 3GPP TS 23.501 [28].

The UPF may support one or more of the following on-path N6 signaling methods to transfer media related information together with the media packet in the DL traffic sent from an AS to the UPF:

- Using Media over QUIC (MoQ) (see IETF draft-ietf-moq-transport [98]) as further defined in clause 5.38.7.2;
- Using connect-UDP for Proxying UDP in HTTP (see IETF RFC 9298 [96]) and QUIC-Aware Proxying Using HTTP (see IETF draft-ietf-masque-quic-proxy [97]) as further defined in clause 5.37.7.3; and/or
- Using UDP-Options (see IETF RFC 9868 [99]) as further defined in clause 5.38.7.4.

5.38.7.2 Using Media Over QUIC (MoQ)

A UPF may support the MoQ relay functionality to transfer media related information over N6 using the Media over QUIC protocol. Stage 2 requirements for the support of the MoQ relay functionality are specified in clause 5.37.9.2 of 3GPP TS 23.501 [28].

The UP function shall set the MOQ feature flag in the UP Function Features IE if it supports the MoQ relay functionality in the UP function.

If the UPF supports the MOQ feature, the SMF may enable the MoQ relay functionality for the PFCP session by providing the MoQ Control Information IE with the MQREI bit set to "1" and instruct the UPF:

- to identify PDU set information that belong to PDU sets and to perform PDU Set marking as specified in clause 5.38.3, with the difference that if the 5G-AN indicated support of PDU Set based handling in N2 SM Information, the SMF may instruct the UPF to identify PDU sets and perform PDU sets marking for one QoS flow, in a PFCP Session Establishment Request or a PFCP Session Modification Request, by setting the PDU Set marking indicator to "1" in a QER associated with the DL PDRs of this QoS flow and by providing the Protocol Description (for DL traffic) in these DL PDRs indicating the transport protocol (i.e. MOQT); and
- to return the MoQ relay address in a PFCP Session Establishment Request or a PFCP Session Modification Request by setting the MQRAI to "1" in the MoQ Control Information IE.

Upon being instructed, the UPF shall:

- identify the PDU sets and perform PDU Set marking for a QoS flow for downlink packets using MOQT as indicated in Protocol Description, from the MoQ Metadata of the downlink packets as defined in clause 7 of MoQ, IETF draft-ietf-moq-transport [98] that is extracted by the MoQ relay. and

NOTE: The mappings between the MoQ Metadata and the PDU Set Information can be based on local configuration, or operator-determined implementations.

- include the MoQ Relay IP Address IE in the PFCP Session Establishment Response or a PFCP Session Modification Response.

The UPF shall identify the uplink traffic by the MoQ Relay IP Address and handle the uplink traffic as the MoQ relay functionality.

5.38.7.3 Using connect-UDP

Stage 2 requirements for the usage of connect-UDP for transferring media related information over N6 are specified in clause 5.37.9.3 of 3GPP TS 23.501 [28].

A UPF that supports transferring media related information over N6 using connect-UDP shall indicate that it supports the CONUDP feature in the UP Function IE (see clause 8.2.25).

If the UPF supports the CONUDP feature, the SMF may instruct the UPF to establish a connection towards an HTTP/3 AS proxy using connect-UDP by provisioning:

- UL PDRs to detect the UDP traffic flows subject to the usage of connect-UDP and the associated FAR(s) including the On-path N6 Connection Information IE requesting to establish a connection to the AS proxy using the connect-UDP method; and
- DL PDRs to detect the UDP traffic flows and the associated QER(s) with proper QoS related marking (e.g. PDU set marking).

When being so instructed, the UPF shall act as an HTTP/3 client configured to use a UDP proxy, establish the connection towards the AS proxy using connect-UDP according to IETF RFC 9298 [96] and process the UL and DL traffic as specified in clause 5.37.9.3 of 3GPP TS 23.501 [28], clause 22.3 of 3GPP TS 29.561 [49] and clause 18.2 of 3GPP TS 33.501 [64].

The UPF shall store the necessary information allowing the UPF to map the traffic received over N6 to the UE's PDU session and to create the IP header of DL packets.

NOTE: The DL PDRs provisioned by the SMF for the DL traffic received over N6 contain the UE's PDU session IP address. If the UPF uses a different N6 routable IP address for the QUIC connection established with the AS proxy, it is implementation specific how the UPF maps the DL traffic received over the QUIC connection with the UE's PDU session. For instance, if the UPF uses the same QUIC connection for different UEs, the UPF can use the Stream ID to associate the received DL traffic with the IP address of the UE's PDU session.

5.38.7.4 Using UDP Option

Stage 2 requirements for the usage of UDP Option for transferring media related information over N6 are specified in clause 5.37.9.4 of 3GPP TS 23.501 [28].

A UPF that supports transferring media related information over N6 using UDP Option shall indicate that it supports the UDPOPT feature in the UP Function IE (see clause 8.2.25).

If the UPF supports the UDPOPT feature, the SMF may instruct the UPF to establish a connection towards an HTTP/3 AS proxy using connect-UDP and to receive media related information in UDP-Option in outer UDP datagrams over N6, by provisioning:

- UL PDRs to detect the UDP traffic flows subject to the usage of connect-UDP and the associated FAR(s) including the On-path N6 Connection Information IE requesting to establish a connection to the AS proxy using the connect-UDP method; and
- DL PDRs to detect the UDP traffic flows and the associated QER(s) with proper QoS related marking (e.g. PDU set marking); the Protocol Description in the DL PDRs shall indicate that media related information is carried in UDP-Option in UDP datagram over N6.

When being so instructed, the UPF shall act as an HTTP/3 client configured to use a UDP proxy, establish the connection towards the AS proxy using connect-UDP according to IETF RFC 9298 [96] and process the UL and DL traffic as specified in clause 5.37.9.4 of 3GPP TS 23.501 [28], clause 22.3.3 of 3GPP TS 29.561 [49] and clause 18.3 of 3GPP TS 33.501 [64].

The UPF shall store the necessary information allowing the UPF to map the traffic received over N6 to the UE's PDU session and to create the IP header of DL packets.

NOTE: The DL PDRs provisioned by the SMF for the DL traffic received over N6 contain the UE's PDU session IP address. If the UPF uses a different N6 routable IP address for the QUIC connection established with the AS proxy, it is implementation specific how the UPF maps the DL traffic received over the QUIC connection with the UE's PDU session. For instance, if the UPF uses the same QUIC connection for different UEs, the UPF can use the Stream ID to associate the received DL traffic with the IP address of the UE's PDU session.

5.39 QoS flow related QoS monitoring and reporting

5.39.1 General

Stage 2 requirements on QoS Monitoring are specified in clause 5.45 of 3GPP TS 23.501 [28], clause 6.2.2 of 3GPP TS 28.558 [88] and clause 4.15.4.5 of 3GPP TS 23.502 [29].

QoS monitoring comprises of measurements of QoS parameters for a QoS Flow.

5.39.2 QoS Monitoring Control

The CP function may be requested to apply QoS monitoring and reporting for QoS flows of a PDU session, e.g. in the following scenarios:

- upon receiving an authorized QoS Monitoring policy for a service data flow as part of a PCC rule as specified in clause 5.45 of 3GPP TS 23.501 [28];
- upon receiving a subscription request for QoS monitoring event via the Nsmf_EventExposure from a NF service consumer of UPF event exposure service as specified in clause 4.15.4.5 of 3GPP TS 23.502 [29]; or
- upon receiving a request to start UE level measurements as specified in 3GPP TS 32.422 [35] and 3GPP TS 28.558 [88].

The SMF shall instruct the UPF to perform Per QoS flow QoS monitoring, during a PFCP session establishment or a PFCP session modification procedure, by provisioning a SRR with one or more QoS Monitoring per QoS flow Control Information IEs for one or more QoS flows and for one or more QoS parameters described in clause 5.39.3, if the UPF has indicated support of the corresponding features. When QoS monitoring and reporting is requested by different network functions at the same time for the same PDU session, e.g. NWDAF and (via PCF) AF/NEF, the SMF shall create separate SRRs with the respective QoS monitoring and reporting parameters for each request even when the SRRs are intended for the same QoS flow.

NOTE 1: Provisioning separate SRRs enable the CP function to control and provision separately QoS monitoring and reporting for each request. The Direct Reporting Information contains only one instance of Event Notification URI and the Notification Correlation ID.

NOTE 2: It is up to the UPF implementation to derive how to perform the QoS measurements for QoS monitoring if multiple SRRs are provisioned for QoS monitoring for the same QoS flow.

The SMF shall provision the following IEs in the QoS Monitoring per QoS flow Control Information IE:

- one or more QFI IEs indicating the QoS flow(s) for which QoS monitoring is requested;
- the Requested QoS Monitoring IE indicating one or more QoS parameters to be measured;
- the Reporting Frequency IE indicating the type of the reporting as "Event Triggered" or "Periodic":
 - If the Reporting Frequency indicates "Event Triggered", a Reporting threshold for each parameter in Requested QoS Monitoring IE and a Minimum Wait Time IE shall be provided as well, if not specified otherwise in this specification for specific QoS parameters. The UPF shall send a report when the measurement result matches or exceeds the indicated Reporting threshold. Subsequent reports should not be sent by the UPF during the Minimum Wait Time. If measurement results that matches or exceeds the indicated Reporting threshold are received during the Minimum Wait Time, the UPF shall send a report containing the most recent measurement result immediately after the Minimum Wait Time is over. After that, the UPF shall continue to report a measurement result that matches or exceeds the indicated Reporting threshold.

NOTE 3: As an implementation option, the UPF can be configured to send subsequent report(s) during the Minimum waiting time, e.g. if the UPF determines that this report is considerably different from the previous report.

NOTE 4: For Event-Triggered QoS monitoring reporting, the consumer of the QoS monitoring reports can determine that the QoS parameter measurement has fallen below the reporting threshold when it stops receiving reports for a duration equal to the Minimum Wait Time.

- "Periodic" indicates that the UPF shall send a report each time the measurement period is over.
- the Minimum Wait Time IE, to indicate the minimum waiting time between two consecutive reports, if the Event Triggered QoS monitoring reporting is required in the reporting frequency;
- the Measurement Period IE, indicating the period to generate periodic usage reports, periodic QoS monitoring reporting is required in the reporting frequency;
- the Reporting Suggestion Info IE, i.e. Report urgency indicating whether the event report can be delayed (i.e. it is delay-tolerant) and if so, the Reporting time information defining the last valid reporting time for the UPF to report the detected event. The Reporting time information shall be present if the Report urgency indicates the event report is delay tolerant. Per Reporting suggestion info, the UPF may concatenate several QoS monitoring reports for the same PFCP session in one PFCP Session Report Request (for event reporting over N4) or in one UPF event notification towards the same notification endpoint identified by the notification URI and notification correlation id (for event reporting using the Nupf_Event_Exposure service); and/or
- the Remaining Data Reporting Indication IE which defines how to handle the collected data not yet reported when the N4 session related to the subscription is released, if the Remaining Data Reporting Indication is received from the NF service consumer of Nsmf_EventExposure service for subscribing UPF monitoring event, e.g. a NWDAF.

If the UPF supports Direct Reporting of QoS monitoring events (i.e. the DRQOS feature, see clause 8.2.25), the SMF shall include the Direct Reporting Information IE in the SRR, including the Event Notification URI towards which the events shall be sent, and if available, the Notification Correlation ID to be included in these events, if the UPF shall send the reports to a different NF than the SMF (i.e. to the Local NEF or the AF). If the events need to be sent both directly to the consumer (e.g. to the local NEF or AF) and to the SMF, the Direct Reporting Information IE shall also include the Reporting Flags IE with the DUPL flag set to "1"; if so, the UPF shall send the reports to the SMF as well. If the the Direct Reporting Information IE is not provided, the UPF shall send the reports to the SMF.

NOTE 5: The QoS measurements requested to be measured in a given SRR share the same Direct Reporting Information, including the same Event Notification URI.

The SMF may instruct to measure different QoS parameters of a same QoS flow in a same QoS Monitoring per QoS flow Control Information IE, or in separate QoS Monitoring per QoS flow Control Information IEs if different instructions need to be set in the QoS Monitoring per QoS flow Control Information IE for the different QoS parameters (e.g. different Reporting Frequency or Measurement Period).

The SMF may update the QoS parameters to be measured by an on-going Per QoS flow QoS monitoring by sending a PFCP Modification Request with the Update SRR IE with a modified QoS Monitoring per QoS flow Control Information IE adding or removing QoS parameters to be measured; the SMF shall provide the complete list of QoS Monitoring per QoS flow Control Information IEs, and the UPF shall replace any earlier list by the new received list of QoS Monitoring per QoS flow Control Information IEs. Upon receiving such a PFCP Modification Request message, the UPF shall measure the QoS parameters according to the newly received instructions from the SMF.

The SMF may require the UPF to stop an on-going Per QoS flow QoS monitoring by sending a PFCP Modification Request with the Remove SRR IE, or by sending a PFCP Modification Request with the Update SRR IE within which the previous QoS Monitoring per QoS flow Control IE is removed. Upon receiving such a PFCP Modification Request message, the UPF shall stop the on-going Per QoS flow QoS monitoring.

5.39.3 Measurable QoS parameters and specific requirements for their measurement

5.39.3.1 General

This clause describes the QoS parameters that may be measured (i.e. monitored) by the UPF and specific requirements for their measurement.

5.39.3.2 Packet delay monitoring

QoS monitoring for packet delay allows for the measurement of UL packet delay, DL packet delay or round trip packet delay between UE and PSA UPF.

The SMF may instruct the UPF to perform packet delay monitoring, if the UPF indicated support of Per QoS flow per UE QoS monitoring for packet delay, i.e. support the QFQM feature (see clause 8.2.25).

Specific requirements for the QoS Monitoring for packet delay are specified in clauses 5.24.4 and 5.24.5.

Specific requirements for UE level measurements are specified in clause 5.15A.1, if the CP function and the UP function also support the ULM feature.

5.39.3.3 Congestion information monitoring

Stage 2 requirements for the support of per QoS flow congestion information monitoring are specified in clauses 5.45.3 and 5.37.4 of 3GPP TS 23.501 [28]. QoS monitoring for congestion information allows to monitor and report the congestion information (i.e. a percentage of congestion level) of a QoS flow for the DL and/or UL directions received from the NG-RAN.

The UPF shall set the QMCON feature flag in the UP Function Features IE if it supports per QoS flow QoS monitoring for congestion information (see clause 8.2.25). If so, the SMF may request the UPF to perform congestion information monitoring during a PFCP session establishment or a PFCP session modification procedure.

The SMF shall instruct the UPF to perform per QoS flow QoS monitoring for congestion information as specified in clause 5.39.2, with the following additions:

- the Requested QoS Monitoring IE in the QoS Monitoring per QoS flow Control Information IE shall indicate a request to monitor the congestion information for DL and/or UL directions;
- the reporting frequency shall be set to "Event Triggered QoS monitoring reporting"; and
- the Measurement Period IE shall be absent.

NOTE 1: Periodical reporting of congestion information is not supported.

A UPF that indicates support of both the DRQOS and QMCON feature flags shall support reporting the congestion information report directly to the target NF or to the SMF, as specified in clause 5.39.2.

The UPF shall send reports when the congestion information exceeds the Reporting threshold as specified for Event Triggered QoS monitoring reporting in clause 5.39.2.

5.39.3.4 Data rate monitoring

Stage 2 requirements for the support of per QoS flow data rate monitoring are specified in clauses 5.45.4 and 5.37.4 of 3GPP TS 23.501 [28]. Data rate monitoring allows to monitor and report the UL and/or DL data rate of a Non-GBR or GBR QoS flow at the UPF.

The UPF shall set the QMDRM feature flag in the UP Function Features IE if it supports per QoS flow data rate monitoring (see clause 8.2.25). If so, the SMF may request the UPF to perform data rate monitoring per QoS flow during a PFCP session establishment or a PFCP session modification procedure.

The SMF shall instruct the UPF to perform per QoS flow data rate monitoring as specified in clause 5.39.2, with the following additions:

- the Requested QoS Monitoring IE in the QoS Monitoring per QoS flow Control Information IE shall indicate a request to monitor the UL and/or DL data rate; and
- the reporting frequency may be set to "Event Triggered QoS monitoring reporting" or "Periodic" QoS monitoring report.

A UPF that indicates support of both the DRQOS and QMDRM feature flags shall support reporting the UL and/or DL data rate information report directly to the target NF or to the SMF, as specified in clause 5.39.2.

The UPF shall measure the data rate over the last monitoring averaging window of the measurement period and report the average DL and/or UL throughput. The monitoring averaging window shall be set:

- to the same value as the averaging window used for computing the GBR/MBR of the QoS flow (i.e. Averaging window provisioned in the QER or default averaging window configured at the UPF) for a GBR QoS flow; or

- to the same value as the averaging window used for computing the Session-AMBR of the PDU Session (i.e. the Averaging Window provisioned in the QER (that is referenced by all the PDRs of the non-GBR QoS flows of a PDU session) or the default averaging window configured at the UPF) for a non-GBR QoS flow. The default value for Averaging Window for non-GBR QoS Flows is 2000ms.

For Event-Triggered data rate monitoring reporting, the UPF shall send reports when the UL or DL data rate exceeds the UL or DL Data Rate Reporting threshold, as specified for Event Triggered QoS monitoring reporting in clause 5.39.2.

5.39.3.5 Available Bitrate

Stage 2 requirements for available bitrate monitoring are specified in clause 5.45.6 of 3GPP TS 23.501 [28]. Available bitrate monitoring allows to monitor and report the UL and/or DL available bitrate of a GBR QoS flow without Alternative QoS Profiles at the NG-RAN.

The UPF shall set the QMABR feature flag in the UP Function Features IE if it supports per QoS flow available bitrate monitoring (see clause 8.2.25). A UPF that supports the QMABR feature shall also support the DRQoS feature, i.e. reporting the UL and/or DL available bitrate information report directly to the target NF, as specified in clause 5.39.2.

The SMF may request a UPF that supports the QMABR feature to perform available bitrate monitoring per QoS flow during a PFCP session establishment or a PFCP session modification procedure.

The SMF shall instruct the UPF to perform per QoS flow available bitrate monitoring as specified in clause 5.39.2, with the following additions:

- the SRR shall include the Direct Reporting Information IE with the target NF's information (i.e. notification URI and, if available, notification correlation ID);
- the Requested QoS Monitoring IE in the QoS Monitoring per QoS flow Control Information IE shall indicate a request to monitor the UL and/or DL available bitrate; and
- the reporting frequency shall be set to "Event Triggered QoS monitoring reporting";
- no Reporting threshold shall be provided to the UPF; and
- the Measurement Period IE shall be absent.

NOTE: The SMF provides the reporting thresholds for UL and/or DL available bitrate to the NG-RAN.

The UPF shall send event reports to the target NF when it receives UL and/or DL available bitrate information (in the PDU Session Container GTP-U extension header of UL payload packets or UL dummy packets) from the NG-RAN.

NOTE: The SMF need not stop the per QoS flow available bitrate monitoring when it learns that the target NG-RAN does not support available bitrate monitoring since the target NF, e.g. AF, will learn the same from the control plane.

5.39.4 QoS Monitoring Reporting

The UPF shall report the QoS monitoring result of the QoS flows by sending:

- QoS Monitoring Report IEs to the SMF in PFCP Session Report Request. Several QoS Monitoring Report IEs may be present to report QoS measurements for multiple QoS flows; and/or
- QoS monitoring events directly to the Local NEF or AF using the UPF Event Exposure service specified in 3GPP TS 29.564 [73]. See clause 5.33.5.

An UPF that supports Direct Reporting of QoS monitoring events to the consumer (e.g. to the Local NEF or AF) shall send the Per QoS Flow Per UE QoS Monitoring events to the SMF if the SRR does not contain the Direct Reporting Information IE, or directly to the consumer (e.g. to the Local NEF or AF) using the notification URI received in the Direct Reporting Information IE, or both if the Direct Reporting Information IE is provided with the DUPL flag set to "1", as specified in clause 5.39.2.

NOTE: The Event Notification URI and the Notification Correlation ID included in the Direct Reporting Information IE can be an NF other than an AF/NEF, e.g. an NWDAF.

The UPF shall continue to apply all the provisioned SRR(s) and perform the related QoS monitoring measurement(s), until getting any further instruction from the CP function.

Specific requirements for UE level measurements are specified in clause 5.15A.1, if the CP function and the UP function also support the ULM feature.

If the Remaining Data Reporting Indication in QoS Monitoring per QoS flow Control Information IE is set to "Send the collected data to the consumer" and/or based on local configuration, the UPF shall report any QoS monitoring result not yet reported when the related N4 session is released.

5.40 Support of UPF event subscription via Service Based Interface (for 5GC)

Stage 2 requirements for support of UPF event subscription via Service Based Interface are specified in clause 5.8.2.17 of 3GPP TS 23.501 [28] and clause 5.2.26.2.3 of 3GPP TS 23.502 [29].

Support of UPF event subscription via Service Based Interface is optional for the UPF.

A UPF that supports this feature shall set the UPSBIES (UPF Event Subscription via Service Based Interface) flag in the UP Function Feature IE (see clause 8.2.25).

If the selected PSA UPF indicated support of UPSBIES feature, the SMF should provide the DNN and S-NSSAI in PFCP Session Establishment Request or a PFCP Session Modification Request. Then, when NF service consumer subscribes to a UPF reporting related with a single UE, the DNN, S-NSSAI and IP address will uniquely identify the target of the reporting.

NOTE: If SMF does not provide DNN and S-NSSAI to UPF it could result in rejections for the Nupf_EventExposure_Subscribe service operations with application error as specified in 3GPP TS 29.564 [73], unless UPF is configured with a DNN and S-NSSAI for a specific IP address range.

5.41 Handling of Payload Headers

5.41.1 General

Stage 2 requirements related to the support of Handling of Payload Headers including the notification of Handling of Payload Header events are specified in clause 5.6.17 of 3GPP TS 23.501 [28] and clauses 4.3.6 and 4.15.12.3 of 3GPP TS 23.502 [29].

The Handling of Payload Headers feature allows exchange of information in-band in the user plane packets between the application (in the UE or in the application server) and UPF in the 5GS by supporting insertion, replacement, or removal of payload headers of PDUs.

It is optional for the SMF and the UPF to support the Handling of Payload Headers feature (USHPH), hence the SMF may trigger the procedures specified in this clause only when the UPF has indicated its support of the USHPH feature via the UP Function Features IE (see clause 8.2.25).

5.41.2 Provisioning of Header Handling Control Rules

When receiving the Header Handling Control information as part of a PCC rule during a PFCP session establishment or a PFCP session modification procedure, the SMF shall instruct the UPF to perform the handling of payload headers by provisioning a FAR containing one or more Header Handling Control Rule IEs and associate the FAR with the PDR corresponding to the PCC rule.

The SMF shall provision the following IEs in the Header Handling Control Rule IE:

- the Header Detection Reference IE which sets to a reference to a UPF configuration which defines how to detect the protocol or the message in a protocol for which to perform the header handling actions; and

- one or more Header Handling Control information IEs (when multiple actions are requested on the target traffic, the enforcement of the Header Handling Action shall be performed in the following order: Detect, Remove, Replace, and Insert). Each Header Handling Control information Info IE shall include a Header Handling Control ID IE to identify an instance of Header Handling Control information. It may further include:
 - the Header Handling Control Reference IE set to a reference to a header handling action related information pre-configured in the UPF. The Header Handling Control Reference IE may be provided alone or together with the IEs below. When the Header Handling Control Reference IE is provided with any other IEs in the Header Handling Control information IE, the data provided by those IEs shall overwrite the related information pre-configured in the UPF.
 - the Header Handling Action IE indicating the header handling action to be performed by the UPF, i.e. detect, remove, replace or insert;
 - the Header Information IE set to a reference to a UPF configuration which defines how to identify or build a specific header field for which to perform the header handling action;
 - the Header Value IE providing the value of the specific header field. Header value shall be provided when Header Handling Action IE is set to replace, and it may be provided for remove, insert and detect actions (see also clause 8.2.257);- the Header Handling Condition IE indicating whether the action shall be applied under certain events, i.e. first match or every match;
 - the Header Handling Reporting IE indicating whether reporting is requested or not for the performed Header Handling Action and for each of the Reporting Endpoint.

NOTE 1: Having multiple Header Handling Reporting IE(s) in the Header Handling Control information IE enables different NFs to receive different set of the header handling information, e.g. the SMF can be configured to receive only "detect" header handling information report while the AF/NEF can request to receive all header handling actions information report.

The SMF may provision the following IEs in the Header Handling Control Rule IE:

- the Header Detection Support Information IE (if received from the PCF) which contains any dynamic configuration required for the detection of the headers and cannot be preconfigured in the UPF; and/or
- one or more Header Handling Reporting Control Info IEs (if received from the PCF) to instruct the UPF to report the handling of payload headers information events as further described in clause 5.41.3. The SMF may modify an existing Header Handling Control Rule by referring to the corresponding Header Handling Control Rule ID with one or more new/modified/deleted IEs in the Header Handling Control Rule IE to request the UPF to update this Header Handling Control Rule in the Update FAR:
 - the SMF may provision a new Header Handling Control information, or may delete an existing Header Handling Control information by including only Header Handling Control ID. The SMF may modify an existing Header Handling Control information by referring the Header Handling Control ID and shall include all IEs applicable for the Header Handling Control information, so the UPF shall replace any earlier received for this Header Handling Control information;
 - Similar to the handling for Header Handling Control information, the SMF may modify and delete an existing Header Handling Reporting Control Info or add a new Header Handling Reporting Control Info;
 - the SMF may modify an existing IE provisioned earlier (other than the Header Handling Control information and Header Handling Reporting Control Info) with a new value, or delete it with a null length;
 - the SMF may provision a new IE defined in the Header Handling Control Rule IE which has not been provisioned earlier;
 - previously provisioned IE(s) in this Header Handling Control Rule but not included in the modification shall remain unchanged in the UPF.

The SMF may provision a new Header Handling Control Rule including a new Header Handling Control Rule ID in an Update FAR or in a Create FAR.

To delete an existing Header Handling Control Rule, the SMF shall provision the corresponding Header Handling Control Rule IE with only the Header Handling Control Rule ID IE identifying the Header Handling Control Rule IE.

Any existing Header Handling Control Rules provisioned previously shall remain unchanged in the UPF unless it is explicitly modified or deleted as described above.

To delete the complete set of Header Handling Control Rules in the Forwarding Parameters IE, the SMF shall provision an instance of Header Handling Control Rule IE with a null length.

5.41.3 Provision of Header Handling Reporting Control Info

When the Header Handling Reporting is required as indicated in the Header Handling Control information in the PCC rule, the SMF shall provide one or more Header Handling Reporting Control Info IEs in the Header Handling Control Rule IE to instruct the UPF to report the handling of payload headers information events (see clause 5.41.2).

The SMF may determine, based on local configuration, to receive notifications related to the handling of payload headers information; if so, the SMF shall provision an (additional) instance of Header Handling Reporting Control Info for receiving corresponding notifications.

Each Header Handling Reporting Control Info IE shall include:

- a Reporting Endpoint ID uniquely identifying the Header Handling Reporting Control Info configured for the Header Handling Control Rule;
- an Event Notification URI indicating the URI towards which the handling of payload header information event reports shall be sent, and a Notification Correlation Id; and
- the Minimum Wait Time IE if available, to indicate the minimum waiting time between two consecutive Notification request messages.

Each Header Handling Reporting Control Info IE may include:

- the Header Handling Reporting Indication IE indicating whether the applied action shall be reported only for the first occurrence of the action per data flow ; and/or
- the Reporting Suggestion Info IE if available, i.e. Report urgency indicating whether the event report can be delayed (i.e. it is delay-tolerant) and if so, the Reporting time information defining the last valid reporting time for the UPF to report the detected event. The Reporting time information shall be present if the Report urgency indicates the event report is delay tolerant.

When one or more Header Handling Reporting Control Info IEs are received, the UPF shall report the header handling actions applied to the payload headers by sending:

- Handling of Payload Headers event reports to the Event Notification URI by using the UPF Event Exposure service specified in clauses 5.2.1.3.7 and 5.2.2.3.1 of 3GPP TS 29.564 [73].

Based on local configuration, the UPF may report any header handling actions not yet reported when the related N4 session is released.

5.42 Partial Success of a PFD management request

The CP function shall indicate support of the Partial Acceptance of provisioning of the Application ID's PFDs (PAPFD) feature (see clause 8.2.58) during the PFCP association setup or update procedure, if it supports PFD Management with Partial Success, i.e. with the UP function partially accepting a PFCP PFD Management Request when some Application IDs' PFDs requested to be installed cannot be applied, due to a semantics or syntax error in the corresponding PFD Contents.

If the CP function indicates support of the the PAPFD feature, and if this feature is also supported by the UP function, the UP function should partially accept a PFCP PFD Management Request, if possible, even when it fails to install one or more Applications' PFDs. In such a case, the UP function shall set the cause to "Request partially accepted" in the response and include the PFD Partial Failure Information IE identifying the failed Applications' PFDs, and the cause of the failure.

Upon receipt of a PFCP PFD Management response indicating a partial acceptance of the request, the CP function shall consider that not all applications PFDs were successfully installed in the UP function, and derive and store those failed

applications, so that the CP function should avoid to provision the failed applications PFDs to other UPFs which do not support the PAPFD feature, and log the error.

NOTE: The CP function can provision the same set of Application IDs PFDs including PFDs of applications which failed to be installed in a UPF to other UPFs which support the PAPFD feature.

If the CP function or the UP function does not support the PAPFD, the UP function shall reject a PFCP PFD Management Request message if at least one application ID's PFDs fail to be installed.

5.43 Energy Consumption information collection from SMF

Stage 2 requirements for energy consumption information collection from SMF are specified in clause 5.51.2.2.2 of 3GPP TS 23.501 [28].

Upon being instructed by the EIF to report data volumes of a PDU session or SDF of a PDU session for energy consumption computation by the EIF, the SMF shall provision a URR and PDRs (when necessary) for the corresponding PDU session in the UPF as defined in clause 5.51.2.2.2 of 3GPP TS 23.501 [28] and clause 5.2.2.2, to collect the usage measurements (uplink and downlink data volumes) required for energy consumption reporting to the EIF.

In the event of a user plane path change (e.g., due to gNB handover or I-UPF change), the SMF shall request the UPF to send an immediate usage report with the on-going measurements of the URR as specified in clause 5.2.2.3.

For energy consumption information reporting to EIF, only traffic over 3GPP access in 5GS shall be considered. When the PDU Session is no longer served in 5GS and over 3GPP access (e.g., PDU session is moved to non-3GPP access or EPS), the SMF may instruct the UPF to suspend the URR that was provisioned for the purpose of collecting information for energy consumption information reporting (as defined in clause 5.2.2.2) or instruct the UPF to remove that URR.

The UPF shall generate and send usage reports to the SMF as specified in clause 5.2.2.3.

6 Procedures

6.1 Introduction

The following clauses specify the procedures supported over the Sxa, Sxb and Sxc reference points.

6.2 PFCP Node Related Procedures

6.2.1 General

The following clauses specify either node level or PFCP entity level procedures over the Sxa, Sxb, Sxc and N4 reference points. The behaviour of the CP function and UP function when sending and receiving a node related message is described.

6.2.2 Heartbeat Procedure

6.2.2.1 General

PFCP Heartbeat is a PFCP entity level procedure.

Two messages are specified for PFCP heartbeat procedure: Heartbeat Request and Heartbeat Response. The use of these messages is further specified in clause 19A of 3GPP TS 23.007 [24] for EPC, and in clause 4 of 3GPP TS 23.527 [40] for 5GC.

6.2.2.2 Heartbeat Request

An PFCP entity of a CP or UP function may send a Heartbeat Request to a PFCP entity of a peer node to find out if the peer PFCP entity is alive. If multiple PFCP entities pertain to the same CP or UP function, each PFCP entity may send Heartbeat Request messages towards each PFCP entity pertaining to the peer node with which a PFCP control association is established.

NOTE 1: If the UP function supports the MPAS feature and connected to an SMF set, each PFCP entity of the UP function can send heartbeat Requests towards each PFCP entity of every SMF with which a PFCP control association is established.

NOTE 2: If the UP function supports the SSET feature and connected to an SMF set, each PFCP entity of the UP function can send heartbeat Requests towards each PFCP entity pertaining to the same SMF or the SMFs in the SMF set with which a PFCP control association is established.

A CP function or UP function shall be prepared to receive a Heartbeat Request at any time (even from unknown peers) and it shall reply with a Heartbeat Response.

6.2.2.3 Heartbeat Response

The message shall be sent as a response to a received Heartbeat Request.

6.2.3 Load Control Procedure

6.2.3.1 General

Load Control is a node level procedure.

Load Control is an optional feature defined over the Sxa, Sxb, Sxc and N4 reference points.

Load control enables the UP function to send its load information to the CP function to adaptively balance the PFCP session load across the UP functions according to their effective load. The load information reflects the operating status of the resources of the UP function.

Load control allows for better balancing of the PFCP session load, so as to attempt to prevent overload in the first place (preventive action). Load control does not trigger overload mitigation actions even if the UP function reports a high load.

Load control and overload control may be supported and activated independently in the network, based on operator's policy.

6.2.3.2 Principles

The UP function may signal its Load Control Information to reflect the operating status of its resources, at the node level, allowing the receiving CP function to use this information to augment the UP function selection procedures.

The Load Control Information is piggybacked in PFCP request or response messages such that the exchange of Load Control Information does not trigger extra signalling.

NOTE: The inclusion of Load Control Information in existing messages means that the frequency of transmission of load control information increases as the session load increases, allowing for faster feedback and thus better regulation of the load.

The calculation of the Load Control Information is implementation dependent and its calculation and transfer shall not add significant additional load to the node itself and to its corresponding peer nodes.

6.2.3.3 Load Control Information

6.2.3.3.1 General Description

A PFCP message may contain one instance of the Load Control Information (LCI) IE.

When providing load control information in a message for the first time or subsequently, the UP function shall always include the full set of load control information, i.e. all the node level instance of the Load Control Information, even if only a subset of the load control information has changed. The Load Control Sequence Number shall be incremented whenever the load control information is changed (see clause 6.2.3.3.2.1).

Load Control Information shall be linked to the Node ID (i.e. FQDN or the IP address used during the UP function selection) of the UP function providing the Information.

The receiver shall overwrite any stored load control information of a peer with the newly received load control information from the same peer node if the new load control information is more recent than the old information as indicated by the Load Control Sequence Number, e.g. if the receiver has stored an instance of the load control information for a peer node, it overwrites this instance with the new instance received in a message from the same peer node.

The receiver shall consider all the parameters received in the same instance of the LCI IE in conjunction while using this information for UP function selection.

The parameters are further defined in clause 6.2.3.3.2.

Load control information may be extended with new parameters in future versions of the specification. Any new parameter will have to be categorized as:

- Non-critical optional parameters: the support of these parameters is *not critical* for the receiver. The receiver can successfully and correctly comprehend the load control information instance, containing one or more of these parameters, by using the other parameters and ignoring the non-critical optional parameter.
- Critical optional parameters: the support of these parameters is *critical* for the receiver to correctly comprehend the instance of the load control information containing one or more of these parameters.

The sender may include one or more non-critical optional parameters within any instance of the LCI IE without having the knowledge of the receiver's capability to support the same. However, the sender shall only include one or more critical optional parameter in an instance of the LCI IE towards a receiver if the corresponding receiver is known to support those parameters. The sender may be aware of this either via signalling methods or by configuration (this will have to be defined when introducing any such new parameter in future).

6.2.3.3.2 Parameters

6.2.3.3.2.1 Load Control Sequence Number

The Load Control Sequence number contains a value that indicates the sequence number associated with the LCI IE. This sequence number shall be used to differentiate any two LCI IEs generated at two different instances by the same UP function. The Load Control Sequence Number shall be supported (if load control is supported) and shall always be present in the LCI IE.

The UP function generating this information shall increment the Load Control Sequence Number whenever modifying some information in the Load Control Information IE. The Load Control Sequence Number shall not be incremented otherwise. The UP function may use the time, represented in an unsigned integer format, of the generation of the Load Control Information to populate the Load Control Sequence Number.

This parameter shall be used by the receiver of the Load Control Information IE to properly collate out-of-order load control information, e.g. due to PFCP retransmissions. This parameter shall also be used by the receiver of the LCI IE to determine whether the newly received load control information has changed compared to load control information previously received from the same node earlier.

NOTE: The PFCP sequence number cannot be used for collating out-of-order load control information as e.g. load control information may be sent in both PFCP requests and responses, using independent PFCP sequence numbering.

If the receiving entity has already received and stored load control information from the peer UP function, the receiving CP function shall update its load control information only if the Load Control Sequence Number received in the new load control information is higher than the stored value of the Load Control Sequence Number associated with the peer UP function. However due to roll-over of the Load Control Sequence Number or restart of the node, the Load Control Sequence Number may be reset to an appropriate base value by the peer UP function, hence the receiving entity shall be

prepared to receive (and process) a Load Control Sequence Number parameter whose value is less than the previous value.

6.2.3.3.2.2 Load Metric

The Load Metric parameter shall indicate the current load level of the originating node. The computation of the Load Metric is left to implementation. The node may consider various aspects, such as the used capacity of the UP function, the load in the node (e.g. memory/CPU usage in relationship to the total memory/CPU available, etc.).

The Load Metric represents the current load level of the sending node as a percentage within the range of 0 to 100, where 0 means no or 0% load and 100 means maximum or 100% load reached (i.e. no further load is desirable).

The Load Metric shall be supported (if load control is supported). The Load Metric shall always be included in the Load Control Information.

Considering the processing requirement of the receiver of the Load Control Information (e.g. handling of the new information, tuning the node selection algorithm to take the new information into account), the sender should refrain from advertising every small variation (e.g. with the granularity of 1 or 2), in the Load Metric which does not result in useful improvement in node selection logic at the receiver. During the typical operating condition of the sender, a larger variation in the Load Metric, e.g. 5 or more units, should be considered as reasonable enough for advertising the new Load Control Information and thus justifying the processing requirement (to handle the new information) of the receiver.

NOTE: The range of the Load Metric, i.e. 0 to 100, does not mandate the sender to collect its own load information at every increment/decrement and hence to advertise the change of Load Metric with a granularity of 1%. Based on various implementation specific criteria, such as: the architecture, session and signalling capacity, the current load and so on, the sender is free to define its own logic and periodicity with which its own load information is collected.

6.2.3.3.3 Frequency of Inclusion

How often the sender includes the load control information is implementation specific. The sender shall ensure that new/updated load control information is propagated to the target CP functions within an acceptable delay, such that the purpose of the information (i.e. effective load balancing) is achieved. The sender may include the LCI IE e.g. as follows:

- the sender may include Load Control Information towards a peer only when the new/changed value has not already been provided to that peer;
- the sender may include the Load Control Information in each and every message (extended with LCI IE) towards the peer;
- the sender may include Load Control Information periodically, i.e. include the information during a first period then cease to do so during a second period.

The sender may also implement a combination of one or more of the above approaches. Besides, the sender may also decide to include the Load Control Information only in a subset of the applicable PFCP messages.

The receiver shall be prepared to receive the load control information in any of the PFCP messages extended with an LCI IE and upon such reception, shall be able act upon the received load control information.

6.2.4 Overload Control Procedure

6.2.4.1 General

Overload Control is a node level procedure.

Overload Control is an optional feature defined over the Sxa, Sxb, Sxc and N4 reference points.

Overload control enables a UP function becoming or being overloaded to gracefully reduce its incoming signalling load by instructing its peer CP functions to reduce sending traffic according to its available signalling capacity to successfully process the traffic. A UP function is in overload when it operates over its signalling capacity which results in diminished performance (including impacts to handling of incoming and outgoing traffic).

Overload control aims at shedding the incoming traffic as close to the traffic source as possible generally when an overload has occurred (reactive action), so to avoid spreading the problem inside the network and to avoid using resources of intermediate nodes in the network for signalling that would anyhow be discarded by the overloaded node.

Load control and overload control may be supported and activated independently in the network, based on operator's policy.

6.2.4.2 Principles

When a UP function determines that the offered incoming signalling traffic is growing (or is about to grow) beyond its nominal capacity, the UP function may signal its overload, at node level granularity, to its peer CP functions by including Overload Control Information in PFCP signalling which provides guidance to the receiving CP functions to decide actions which lead to signalling traffic mitigation towards the sender of the information. This helps in preventing severe overload and hence potential breakdown of the UP function.

The Overload Control Information is piggybacked in PFCP request or response messages such that the exchange of Overload Control Information does not trigger extra signalling.

NOTE: The inclusion of Overload Control Information in existing messages means that the frequency of transmission of overload control information increases as the signalling load increases, thus allowing for faster feedback and better regulation.

The calculation of the Overload Control Information is implementation dependent and its calculation and transfer shall not add significant additional load to the node itself and to its corresponding peer nodes. The calculation of Overload Control Information should not severely impact the resource utilization of the UP function, especially considering the overload situation.

The overload control feature should continue to allow for preferential treatment of priority users (eMPS) and emergency services.

The overload mitigation actions based on the reception of the overload related information received from the UP function will not be standardized.

6.2.4.3 Overload Control Information

6.2.4.3.1 General Description

A PFCP message may contain one instance of the Overload Control Information (OCI) IE.

When providing overload control information in a message for the first time or subsequently, the UP function shall always include the full set of overload control information, i.e. all the node level instance of the Overload Control Information, even if only a subset of the overload control information has changed. The Overload Control Sequence Number shall be incremented whenever the Overload control information is changed (see clause 6.2.4.3.2.1).

The receiver shall overwrite any stored overload control information of a peer with the newly received overload control information from the same peer node if the new overload control information is more recent than the old information as indicated by the Overload Control Sequence Number, e.g. if the receiver has stored an instance of the Overload control information for a peer node, it overwrites this instance with the new instance received in a message from the same peer node.

The receiver shall consider all the parameters received in the same instance of the OCI IE in conjunction while applying the overload mitigation action.

The parameters are further defined in clause 6.2.4.3.2.

Overload control information may be extended with new parameters in future versions of the specification. Any new parameter will have to be categorized as:

- Non-critical optional parameters: the support of these parameters is *not critical* for the receiver. The receiver can successfully and correctly comprehend the Overload control information instance, containing one or more of these parameters, by using the other parameters and ignoring the non-critical optional parameter.

- Critical optional parameters: the support of these parameters is *critical* for the receiver to correctly comprehend the instance of the Overload control information containing one or more of these parameters.

The sender may include one or more non-critical optional parameters within any instance of the OCI IE without having the knowledge of the receiver's capability to support the same. However, the sender shall only include one or more critical optional parameter in an instance of the OCI IE towards a receiver if the corresponding receiver is known to support those parameters. The sender may be aware of this either via signalling methods or by configuration (this will have to be defined when introducing any such new parameter in future).

The Overload Control Information shall be associated by default to the PFCP entity corresponding to the peer node's IP address of the PFCP session, over which the OCI IE is received, i.e. to the IP address received within the "UP F-SEID" IE.

Alternatively, the UP function may send Overload Control Information which is associated with the Node ID of the UP function (i.e. FQDN or the IP address used during the UP function selection). In that case, the UP function shall provide an explicit indication that the OCI IE included in the message belongs to the Node ID.

6.2.4.3.2 Parameters

6.2.4.3.2.1 Overload Control Sequence Number

The PFCP protocol requires retransmitted messages to have the same contents as the original message. Due to PFCP retransmissions, the overload control information received by a CP function at a given time may be less recent than the overload control information already received from the same UP function. The Overload Control Sequence Number aids in sequencing the overload control information received from an overloaded UP function. The Overload Control Sequence Number contains a value that indicates the sequence number associated with the Overload Control Information IE. This sequence number shall be used to differentiate between two OCI IEs generated at two different instants, by the same UP function.

The Overload Control Sequence Number parameter shall be supported (when supporting the overload control feature) and shall always be present in the Overload Control Information IE.

The UP function generating this information shall increment the Overload Control Sequence Number whenever modifying some information in the OCI IE. The Overload Control Sequence Number shall not be incremented otherwise. The UP function may use the time, represented in an unsigned integer format, of the generation of the overload control information, to populate the Overload Control Sequence Number.

This parameter shall be used by the receiver of the OCI IE to properly collate out-of-order OCI IEs, e.g. due to PFCP retransmissions. This parameter shall also be used by the receiver of the OCI IE to determine whether the newly received overload control information has changed compared to the overload control information previously received from the same UP function. If the newly received overload control information has the same Overload Control Sequence Number as the previously received overload control information from the same UP function, then the receiver may simply discard the newly received overload control information whilst continuing to apply the overload abatement procedures, as per the previous value.

NOTE 1: The timer corresponding to the Period of Validity (see clause 6.2.4.3.2.2) is not restarted if the newly received overload control information has the same Overload Control Sequence Number as the previously received overload control information. If the overload condition persists and the overloaded UP function needs to extend the duration during which the overload information applies, the sender needs to provide a new overload control information with an incremented Overload Control Sequence Number (even if the parameters within the overload control information have not changed).

NOTE 2: The PFCP Sequence Number cannot be used for collating out-of-order overload information as e.g. overload control information may be sent in both PFCP requests and responses, using independent PFCP sequence numbering.

If the receiving CP function already received and stored overload control information, which is still valid, from the overloaded UP function, the receiving entity shall update its overload control information, only if the Overload-Sequence-Number received in the new overload control information is larger than the value of the Overload Control Sequence Number associated with the stored information. However due to roll-over of the Overload Control Sequence Number or restart of the UP function, the Overload Control Sequence Number may be reset to an appropriate base value by the peer UP function, hence the receiving entity shall be prepared to receive (and process) an Overload Control Sequence Number parameter whose value is less than the previous value.

6.2.4.3.2.2 Period of Validity

The Period of Validity indicates the length of time during which the overload condition specified by the OCI IE is to be considered as valid (unless overridden by subsequent new overload control information).

An overload condition shall be considered as valid from the time the OCI IE is received until the period of validity expires or until another OCI IE with a new set of information (identified using the Overload Control Sequence Number) is received from the same UP function (at which point the newly received overload control information shall prevail). The timer corresponding to the period of validity shall be restarted each time an OCI IE with a new set of information (identified using the Overload Control Sequence Number) is received. When this timer expires, the last received overload control information shall be considered outdated and obsolete, i.e. any associated overload condition shall be considered to have ceased.

The Period of Validity parameter shall be supported (when supporting overload control).

The Period of Validity parameter achieves the following:

- it avoids the need for the overloaded UP function to include the Overload Control Information IE in every PFCP messages it signals to its peer CP functions when the overload state does not change; thus it minimizes the processing required at the overloaded UP function and its peer CP functions upon sending/receiving PFCP signalling;
- it allows to reset the overload condition after some time in the peer CP functions having received an overload indication from the overloaded UP function, e.g. if no signalling traffic takes place between these PFCP entities for some time due to overload mitigation actions. This also removes the need for the overloaded UP function to remember the list of CP functions to which it has sent a non-null overload reduction metric and to which it would subsequently need to signal when the overload condition ceases, if the Period of Validity parameter was not defined.

6.2.4.3.2.3 Overload Reduction Metric

The Overload Reduction Metric shall have a value in the range of 0 to 100 (inclusive) which indicates the percentage of traffic reduction the sender of the overload control information requests the receiver to apply. An Overload Reduction Metric of "0" always indicates that the UP function is not in overload (that is, no overload abatement procedures need to be applied) for the indicated scope.

Considering the processing requirement of the receiver of the Overload Control Information, e.g. to perform overload control based on the updated Overload Reduction Metric, the sender should refrain from advertising every small variation, e.g. with the granularity of 1 or 2, in the Overload Reduction Metric which does not result in useful improvement for mitigating the overload situation. During the typical operating condition of the sender, a larger variation in the Overload Reduction Metric, e.g. 5 or more units, should be considered as reasonable enough for advertising a new Overload Reduction Metric Information and thus justifying the processing requirement (to handle the new information) of the receiver.

NOTE: The range of Overload Reduction Metric, i.e. 0 to 100, does not mandate the sender to collect its own overload information at every increment/decrement and hence to advertise the change of Overload Reduction Metric with a granularity of 1%. Based on various implementation specific criteria, such as the architecture, session and signalling capacity, the current load/overload situation and so on, the sender is free to define its own logic and periodicity with which its own overload control information is collected.

The computation of the exact value for this parameter is left as an implementation choice at the sending UP function.

The Overload Reduction Metric shall be supported (when supporting overload control) and shall always be present in the OCI IE.

The inclusion of the OCI IE signals an overload situation is occurring, unless the Overload Reduction Metric is set to "0", which signals that the overload condition has ceased. Conversely, the absence of the OCI IE in a message does not mean that the overload has abated.

6.2.4.3.3 Frequency of Inclusion

How often or when the sender includes the overload control information is implementation specific. The sender shall ensure that new/updated overload control information is propagated to the target receivers with an acceptable delay,

such that the purpose of the information, (i.e. the effective overload control protection) is achieved. The following are some of the potential approaches the sender may implement for including the OCI IE:

- the sender may include OCI IE towards a receiver only when the new/changed value has not already been provided to the given receiver;
- the sender may include the OCI IE in a subset of the messages towards the receiver;
- the sender may include the OCI IE periodically, i.e. include the information during a first period then cease to do so during a second period.

The sender may also implement a combination of one or more of the above approaches. Besides, the sender may also include the OCI IE only in a subset of the applicable PFCP messages.

The receiver shall be prepared to receive the overload control information received in any of the PFCP messages extended with an OCI IE and upon such reception, shall be able act upon the received information.

6.2.4.4 Message Throttling

6.2.4.4.1 General

As part of the overload mitigation, a CP function shall reduce the total number of messages, which would have been sent otherwise, towards the overloaded peer based on the information received within the Overload Control Information. This shall be achieved by discarding a fraction of the messages in proportion to the overload level of the target peer. This is called "message throttling".

Message throttling shall only apply to Request messages. Response messages should not be throttled since that would result in the retransmission of the corresponding request message by the sender.

A CP function supporting PFCP overload control shall support and use the "Loss" algorithm as specified in this clause, for message throttling.

6.2.4.4.2 Throttling algorithm – "Loss"

6.2.4.4.2.1 Description

An overloaded UP function shall ask its peers to reduce the number of requests they would ordinarily send by signalling Overload Control Information including the requested traffic reduction, as a percentage, within the "Overload-Reduction-Metric", as specified in clause 6.2.4.3.2.

The recipients of the "Overload-Reduction-Metric" shall reduce the number of requests sent by that percentage, either by redirecting them to an alternate destination if possible (e.g. the PFCP Session Establishment Request message may be redirected to an alternate UP function), or by failing the request and treating it as if it was rejected by the destination UP function.

For example, if a sender requests another peer to reduce the traffic it is sending by 10%, then that peer shall throttle 10% of the traffic that would have otherwise been sent to this UP function.

The overloaded UP function should periodically adjust the requested traffic reduction based e.g. on the traffic reduction factor that is currently in use, the current system utilization (i.e. the overload level) and the desired system utilization (i.e. the target load level), and/or the rate of the current overall received traffic.

Annex A.1 provides an (informative) example of a possible implementation of the "Loss" algorithm, amongst other possible methods.

NOTE 1: This algorithm does not guarantee that the future traffic towards the overloaded UP function will be less than the past traffic but it ensures that the total traffic sent towards the overloaded UP function is less than what would have been sent without any throttling in place. If after requesting a certain reduction in traffic, the overloaded UP function receives more traffic than in the past, whilst still in overload, leading to the worsening rather than an improvement in the overload level, then the overloaded UP function can request for more reduction in traffic. Thus, by periodically adjusting the requested traffic reduction, the overloaded node can ensure that it receives, approximately, the amount of traffic which it can handle.

NOTE 2: Since the reduction is requested as a percentage, and not as an absolute amount, this algorithm achieves a good useful throughput towards the overloaded node when the traffic conditions vary at the source nodes (depending upon the events generated towards these source nodes by other entities in the network), as a potential increase of traffic from some source nodes can possibly be compensated by a potential decrease of traffic from other source nodes.

6.2.4.5 Message Prioritization

6.2.4.5.1 Description

When performing message throttling:

- PFCP requests related to priority traffic (i.e. eMPS as described in 3GPP TS 22.153 [15]) and emergency have the highest priority. Depending on regional/national requirements and network operator policy, these PFCP requests shall be the last to be throttled, when applying traffic reduction, and the priority traffic shall be exempted from throttling due to PFCP overload control up to the point where the requested traffic reduction cannot be achieved without throttling the priority traffic;
- for other types of sessions, messages throttling should consider the relative priority of the messages so that the messages which are considered as low priority are considered for throttling before the other messages. The relative priority of the messages may be derived from the relative priority of the procedure for which the message is being sent or may be derived from the session parameters such as APN, QCI, ARP and/or Low Access Priority Indicator (LAPI).

NOTE: A random throttling mechanism, i.e. discarding the messages without any special consideration, could result in an overall poor congestion mitigation mechanism and bad user experience.

An overloaded node may also apply these message prioritization schemes when handling incoming initial messages during an overloaded condition, as part of a self-protection mechanism.

6.2.4.5.2 Based on the Message Priority Signalled in the PFCP Message

Message prioritization may be performed by an overloaded node, when handling incoming messages during an overloaded condition, based on the relative PFCP message priority signalled in the PFCP header (see clause 7.2.2.3).

A PFCP entity shall determine whether to set and use the message priority in PFCP signalling, based on operator policy. The requirements specified in this clause shall apply if message priority in PFCP signalling is used.

A sending PFCP entity shall determine the relative message priority to signal in the message according to the principles specified in clause 6.2.4.5.1. If the message affects multiple bearers, the relative message priority should be determined considering the highest priority ARP among all the bearers.

A PFCP entity should set the same message priority in a Response message as received in the corresponding Request message.

For incoming PFCP messages that do not have a message priority in the PFCP header, the receiving PFCP entity:

- shall apply a default priority, if the incoming message is a Request message;
- should apply the message priority sent in the Request message, if the incoming message is a Response message.

This feature should be supported homogeneously across the CP functions and UP functions in the network, otherwise an overloaded node will process Request messages received from the non-supporting nodes according to the default priority while Request messages received from supporting nodes will be processed according to the message priority signalled in the PFCP message.

6.2.5 PFCP PFD Management Procedure

6.2.5.1 General

PFCP PFD Management is a node level procedure.

The PFCP PFD Management procedure may be used by the CP function and UP function to provision PFDs (e.g. received from the PFD as specified in clauses 5.11.4 and 6.5.2 of 3GPP TS 23.214 [2]) to the UP function, for one or more Application Identifiers.

Support of this procedure is optional for the CP function and the UP function. The UP function shall set the PFD Management feature flag in the UP Function Features IE if it supports the PFD Management procedure (see clause 8.2.25).

The UP function shall store the PFDs provisioned per Application Identifier. These PFDs shall apply to all the PFCP sessions established in the UP function, for all the controlling CP functions, i.e. the scope of a PFD is not limited to the PFCP sessions established by the CP function which provisioned the PFD.

NOTE: Application identifiers preconfigured in the UP function, if any, need to be distinct from application identifiers provisioned via PFD management procedure.

6.2.5.2 CP Function Behaviour

The CP function initiates the PFCP PFD Management procedure to provision PFDs in the UP function, for one or more Application Identifier(s).

The CP function:

- shall send the PFCP PFD Management Request message, including the full set of PFD IDs and PFD contents to be provisioned in the UP function per Application Identifier.

When the CP function receives a PFCP PFD Management Response with the cause "Request accepted (success)", the CP function shall consider that the PFDs have been provisioned as requested. When the CP function receives a PFCP PFD Management Response with the cause "Request partially accepted", the CP function shall behave as specified in clause 5.42.

6.2.5.3 UP Function Behaviour

When the UP function receives a PFCP PFD Management Request message, it shall:

- if no Application ID's PFDs IE is present in the request (i.e. empty message):
 - delete all the PFDs received and stored earlier for all Application Identifier(s) provisioned via the PFD Management Procedure;
- if at least one Application ID's PFDs IE is present in the request:
 - delete all the PFDs received and stored earlier for the indicated Application Identifier(s);
 - store all the PFDs received in the request for the indicated Application Identifier(s);
- send a PFCP PFD Management Response with the cause "success", if the above operations were performed successfully; and
 - if a PFD is removed/modified and this PFD was used to detect application traffic related to an application identifier in a PDR created/activated for a PFCP session and the UP function has reported the application start to the CP function for the application or the application instance corresponding to this PFD as defined in clause 5.4.11 ((Un)solicited Application Reporting), the UP function shall report the application stop to the CP function for the corresponding application or the corresponding application instance identifier as defined in clause 5.4.11 if the removed/modified PFD in UP results in the stop of the application or the application instance is not being able to be detected. See clause 5.11.4 of 3GPP TS 23.214 [2].

NOTE: Multiple PFDs can be associated with the application identifier. When the removed/modified PFD is the last one which is used to detect traffic identified by application id, the UPF reports application stop.

- otherwise, if at least one Application ID's PFDs failed to be stored or applied:
 - the UP function shall return an appropriate error cause value with the offending IE indicating the Application ID's PFDs causing the error, discard all the received Application ID's PFDs as if the PFCP PFD Management Request message was not received, if the CP function or the UP function does not support the PAPFD feature (see clause 5.42); or

- alternatively, if the CP function indicated support of the PAPFD feature (see clause 8.2.58) during the PFCP association setup or update procedure, and if this feature is also supported by the UP function, the UP function should accept the request partially, if possible, and return a response indicating a partial acceptance of the request as specified in clause 5.42.

6.2.6 PFCP Association Setup Procedure

6.2.6.1 General

PFCP Association Setup is a node level procedure.

The PFCP Association Setup procedure shall be used to setup a PFCP association between a CP function and a UP function, to enable the CP function to use the resources of the UP function subsequently, i.e. establish PFCP Sessions.

The setup of a PFCP association may be initiated by the CP function (see clause 6.2.6.2) or the UP function (see clause 6.2.6.3).

The CP function and the UP function shall support the PFCP Association Setup initiated by the CP function. The CP function and the UP function may additionally support the PFCP Association Setup initiated by the UP function.

6.2.6.2 PFCP Association Setup Initiated by the CP Function

6.2.6.2.1 CP Function Behaviour

The CP function shall initiate the PFCP Association Setup procedure to request to setup a PFCP association towards a UP function prior to establishing a first PFCP session on this UP function.

The CP function shall retrieve an IP address of the UP function to send the PFCP Association Setup Request, as specified in clause 5.8.1, and shall send a PFCP Association Setup Request to the UP function with:

- the Node ID of the CP function;
- the list of optional features the CP function supports which may affect the UP function behaviour, if any;
- optionally, the PFCP Session Retention Information IE (see figure 7.4.4.1-2) to request the UP function to retain all or part of the existing PFCP sessions if a PFCP association already exists in the UP function for the same Node ID.

The CP function shall only initiate PFCP Session related signalling procedures toward a UP function after it receives the PFCP Association Setup Response with a successful cause from this UP function.

The CP function shall determine whether the UP function supports Sxa, Sxb, Sxc and/or combined Sxa/Sxb by local configuration or optionally via DNS if deployed.

6.2.6.2.2 UP Function behaviour

When receiving a PFCP Association Setup Request, the UP function:

- if the request is accepted:
 - shall store the Node ID of the CP function as the identifier of the PFCP association;
 - shall send a PFCP Association Setup Response including:
 - a successful cause;
 - its Node ID;
 - information of all supported optional features in the UP function;
 - optionally one or more UE IP address Pool Information IE which contains a list of UE IP Address Pool Identities per Network Instance, S-NSSAI and IP version;

- the NF Instance ID of the UPF if available;
 - optionally the supported Packet Inspection functionalities;
 - information about the supported Operator configurable UPF capabilities if any.
- shall send a PFCP Version Not Supported Response if the PFCP header of the request indicates a PFCP protocol version that is not supported by the UP function;
 - otherwise, shall send a PFCP Association Setup Response with an appropriate error cause if the request is rejected.

If the PFCP Association Setup Request contains a Node ID for which a PFCP association was already established, the UP function shall:

- proceed with establishing the new PFCP association (regardless of the Recovery Timestamp received in the request), overwriting the existing association;
- retain the PFCP sessions that were established with the existing PFCP association and that are requested to be retained, if the PFCP Session Retention Information IE was received in the request; otherwise, delete the PFCP sessions that were established with the existing PFCP association;
- set the PSREI (PFCP Session Retained Indication) flag to "1" in the PFCP Association Setup Response, if the PFCP Session Retention Information IE was received in the Request and the requested PFCP sessions have been retained.

If the UPF is configured to be used for IPUPS, the UPF shall set the UUPSI (UPF configured for IPUPS Indication) flag to "1" in the PFCP Association Setup Response message.

6.2.6.3 PFCP Association Setup Initiated by the UP Function

6.2.6.3.1 UP Function Behaviour

The UP function initiates the PFCP Association Setup procedure to request to setup a PFCP association towards a CP function. The UP function is configured with a set of CP functions to which it shall establish a PFCP association.

The UP function:

- shall retrieve an IP address of the CP function, e.g. based on local configuration in the UP function;
- shall send the PFCP Association Setup Request including:
 - the Node ID of the UP function;
 - information of all supported optional features in the UP function;
 - optionally one or more UE IP address Pool Information IE which contains a list of UE IP Address Pool Identities per a given Network Instance, S-NSSAI and IP version;
 - the NF Instance ID of the UPF if available.
 - the UUPSI (UPF configured for IPUPS Indication) flag set to "1" if the UPF is configured to be used for IPUPS.
 - information about the supported Operator configurable UPF capabilities if any.
 - optionally the supported Packet Inspection functionalities.

6.2.6.3.2 CP Function Behaviour

When receiving a PFCP Association Setup Request, the CP function:

- if the request is accepted:
 - shall store the Node ID of the UP function as the identifier of the PFCP association;

- shall send a PFCP Association Setup Response with a successful cause, its Node ID, and information of the list of optional features the CP function supports which may affect the UP function behaviour, if any;
- shall send a PFCP Version Not Supported Response if the PFCP header of the request indicates a PFCP protocol version that is not supported by the CP function;
- otherwise, shall send a PFCP Association Setup Response with an appropriate error cause if the request is rejected.

The CP function shall only initiate PFCP Session related signalling procedures toward a UP function after it has sent the PFCP Association Setup Response with a successful cause to the UP function.

The CP function shall determine the UP function supports Sxa, Sxb, Sxc and/or combined Sxa/Sxb by local configuration or optionally via DNS if deployed.

6.2.7 PFCP Association Update Procedure

6.2.7.1 General

PFCP Association Update is a node level procedure.

The PFCP Association Update procedure shall be used to modify an existing PFCP association between the CP function and the UP function. It may be initiated by the UP function or by the CP function to update the supported features or available resources of the UP function.

6.2.7.2 PFCP Association Update Procedure Initiated by the CP Function

6.2.7.2.1 CP Function Behaviour

The CP function initiates the PFCP Association Update procedure to report changes to the PFCP association to the UP function, e.g. to update the supported features.

When both the CP function and UP function support the EPFAR feature, the CP function may send a PFCP Association Update Request with the "PFCP Association Release Preparation Start" flag set to "1" when the CP function decides to release the PFCP association and request the UP function to report all non-zero usage reports for the PFCP session affected by the release of the PFCP association, as specified in clause 5.18.

6.2.7.2.2 UP Function Behaviour

When receiving a PFCP Association Update Request, the UP function:

- shall update the list of optional features of the CP function, when received;
- shall send a PFCP Association Update Response with an appropriate error cause if the Node ID is not known by the UP Function;
- shall return a PFCP Association Update Response with a successful cause value, if the PFCP Association Update Request is handled successfully.

When both the CP function and UP function support the EPFAR feature, and the CP function has set the "PFCP Association Release Preparation" set to "1" in the PFCP Association Update Request message, the UP function shall send the PFCP Association Update Response to CP function with successful cause value and then send PFCP Session Report Request messages to report non-zero usage reports (at least one message per PFCP Session) for the PFCP Sessions affected by the release of the PFCP association, as specified in clause 5.18.

6.2.7.3 PFCP Association Update Procedure Initiated by UP Function

6.2.7.3.1 UP Function Behaviour

The UP function initiates the PFCP Association Update procedure to report changes to the PFCP association to the CP function, e.g. change of optional features, an indication to request to release the PFCP association, change of the UE IP Address Pool Identifiers configured in the UP function.

The UP function may send a PFCP Association Update Request to request the CP function to perform the release of the PFCP association, optionally providing a Graceful Release Period.

When the Enhanced PFCP Association Release feature (EPFAR) (see clause 5.18) is supported by both the CP function and UP function, the UP function:

- may send a PFCP Association Update Request with the flag "PFCP Association Release Preparation" set to "1" when the UP function decides to release the PFCP association and thus inform the CP function that all non-zero usage reports for those PFCP sessions affected by the release of the PFCP association will be reported;
- shall then send a PFCP Association Update Request, with the URSS flag set to "1" once all non-zero usage reports for all the PFCP Sessions affected by the release of PFCP Association have been sent to the CP function.

After reception of the PFCP Association Update Response, the UP function shall consider that the PFCP association is still setup until receiving a PFCP Association Release Request. When the UP function requests to release the PFCP Association and sends a PFCP Association Update Request message with a Graceful Release Period or with the URSS flag set, if no PFCP Association Release Request is received before the Graceful Release Period or a configurable timer (when the URSS flag is set) expires, the UP function may locally release the association, behaving as if the PFCP Association Release Request had been received.

6.2.7.3.2 CP Function Behaviour

When receiving a PFCP Association Update Request, the CP function:

- shall update the list of optional features of the UP function, when received;
- shall replace any earlier stored Packet Inspection functionalities by the new Packet Inspection functionality IE that is received, if any;
- shall replace any earlier stored supported Operator Configurable UPF Capabilities by the new Operator Configurable UPF Capabilities, when received;
- shall send a PFCP Association Update Response with an appropriate error cause if the Node ID is not known by the CP Function;
- shall return a PFCP Association Update Response with a successful cause value if the PFCP Association Update Request is handled successfully.

If the UP function has requested to release the PFCP association in the PFCP Association Update Request, the CP function should initiate a PFCP Association Release Request to release the PFCP association, as soon as possible if no Graceful Release Period was included in the request or before the expiry of the Graceful Release Period. The CP function should stop creating new PFCP sessions in the UP function during the Graceful Release Period. When the final usage report(s) for a PFCP Session (upon being deleted) is required, e.g. based on operator policies, the CP function should initiate a PFCP Session Deletion Procedure to collect the usage reports per PFCP Session affected by the release of PFCP Association before the Graceful Release Period is expired.

When both the CP function and UP function support the EPFAR feature, and if the UP function has set the URSS flag to "1" in the PFCP Association Update Request message, the CP function shall send the PFCP Association Update Response with successful cause value to indicate the PFCP Association Update Request is handled successfully and then immediately initiate the PFCP Association Release Procedure, as specified in clause 5.18.

If the UP function has included UE IP address Pool Identity IE in the PFCP Association Update Request message, the CP function shall use it to overwrite the UE IP address Pool Identity previously received from the UP function.

6.2.8 PFCP Association Release Procedure

6.2.8.1 General

PFCP Association Release is a node level procedure.

The PFCP Association Release procedure shall be used to terminate the PFCP association between the CP Function and the UP Function due to e.g. OAM reasons. The PFCP Association Release Request may be initiated by the CP function.

When the final usage report(s) for a PFCP Session is required, e.g. based on the operator policies, the CP function should retrieve the final usage reports for the PFCP Sessions affected by the release of PFCP Association, i.e. by initiating a PFCP Session Deletion Procedure towards the UP function for every PFCP session, before it initiates PFCP Association Release Request.

When using the MPAS feature (Multiple PFCP Associations to the SMFs in an SMF set) defined in clause 5.22.3, the SMF and the UPF shall not release the PFCP sessions that were served over the PFCP association being released, unless the PFCP association being released is the last PFCP association that was established between the UPF and any SMF of the SMF set.

NOTE: The PFCP sessions are taken over by different SMFs of the SMF set, and not released, when using the MPAS feature, if there is at least another PFCP association remaining established between the UPF and any SMF of the SMF set.

6.2.8.2 CP Function Behaviour

If the CP function initiates the PFCP Association Release procedure to release an existing PFCP association, the CP function:

- shall delete locally all the PFCP sessions related to that PFCP association when receiving the PFCP Association Release Response with the cause value success, unless the MPAS feature (clause 5.22.3) is used and there is at least another PFCP association remaining established between the UPF and any SMF of the SMF set.

6.2.8.3 UP Function behaviour

When the UP function receives a PFCP Association Release Request, the UP function:

- shall delete all the PFCP sessions related to that PFCP association locally, unless the MPAS feature (clause 5.22.3) is used and there is at least another PFCP association remaining established between the UPF and any SMF of the SMF set;
- shall delete the PFCP association and any related information (e.g. Node ID of the CP function);
- shall send a PFCP Association Release Response with a successful cause.

NOTE: The UP function always accepts a PFCP Association Release Request.

6.2.9 PFCP Node Report Procedure

6.2.9.1 General

PFCP Node Report Procedure is a node level procedure.

The PFCP Node Report procedure shall be used by the UP function to report information to the CP function which is not related to a specific PFCP session, e.g. to report a user plane path failure affecting all the PFCP sessions towards a remote GTP-U peer.

6.2.9.2 UP Function Behaviour

The UP function shall initiate the PFCP Node Report procedure to report information to the CP function. The UP function:

- shall send the PFCP Node Report Request message, including the information to be reported.

When the UP function receives a PFCP Node Report Response with the cause success, the UP function shall consider the information successfully delivered to the CP function.

6.2.9.3 CP Function behaviour

When the CP function receives a PFCP Node Report Request message, it shall:

- process the information being reported as appropriate and send a PFCP Node Report Response with the cause "success";
- otherwise return an appropriate error cause value.

6.3 PFCP Session Related Procedures

6.3.1 General

The following clauses describe the session related procedures over the Sxa, Sxb, Sxc and N4 reference points. The behaviour of the CP function and UP function when sending and receiving session related messages is described.

6.3.2 PFCP Session Establishment Procedure

6.3.2.1 General

The PFCP Session Establishment procedure shall be used to setup a PFCP session between CP function and UP function and configure Rules in the UP function so that the UP function can handle incoming packets.

6.3.2.2 CP Function Behaviour

The CP function initiates the PFCP Session Establishment procedure to create a PFCP session for a PDN connection or a PDU session, or IP-CAN session or TDF session or for applying a certain IP packets treatment which is not associated with any PDN connection or TDF session.

The CP function:

- shall send the PFCP Session Establishment Request message with a new PFCP F-SEID together with Rules to be created;
- may include its current Recovery Time Stamp as specified in clause 19A of TS 3GPP TS 23.007 [24].

When the CP function receives a PFCP Session Establishment Response with the cause "Request accepted (success)", the CP function shall continue with the procedure which triggered the PFCP Session Establishment procedure. If the CP function indicated support of the PSUCC feature (see clause 8.2.58) during the PFCP association setup or update procedure, and if the cause in the response indicates "Request partially accepted", the CP function shall behave as specified in clause 5.2.9.

6.3.2.3 UP Function Behaviour

When the UP function receives a PFCP Session Establishment Request message:

- the UP function shall store and apply the rules received in the request and send a PFCP Session Establishment Response with cause "success", if all rules in the PFCP Session Establishment Request are stored and applied;
- Otherwise, if at least one rule failed to be stored or applied:
 - the UP function shall return an appropriate error cause value with the Rule ID of the Rule causing the first error, discard all the received rules and not create any PFCP session context, if the CP function or the UP function does not support the PSUCC feature (see clause 5.2.9); or

- alternatively, if the CP function indicated support of the PSUCC feature (see clause 8.2.58) during the PFCP association setup or update procedure, and if this feature is also supported by the UP function, the UP function should accept the request partially, if possible, and return a response indicating a partial acceptance of the request as specified in clause 5.2.9.

6.3.3 PFCP Session Modification Procedure

6.3.3.1 General

The PFCP Session Modification procedure shall be used to modify an existing PFCP session, e.g. to configure a new rule, to modify an existing rule, to delete an existing rule.

6.3.3.2 CP Function behaviour

The CP function initiates the PFCP Session Modification procedure to modify an existing PFCP session, e.g. triggered by a modification of PDN connection, PDU session, IP CAN session or TDF session.

The CP function shall:

- include a complete PDI if the PDI in the existing PDR is to be updated;
- remove locally the reference to a rule in the PDRs when the related Rule is deleted;
- provide all the new, updated or deleted Rules. The Updated Rules shall contain only the information which are changed, added and/or deleted.

The CP function shall not include multiple updates in a PFCP Modification Request message, e.g. Create PDR, Update PDR and Remove PDR, for the same rule identified by the Rule ID.

When the CP function receives a PFCP Session Modification Response with the cause "Request accepted (success)", it shall continue with the procedure which has initiated the PFCP Session Modification procedure. If the CP function indicated support of the PSUCC feature (see clause 8.2.58) during the PFCP association setup or update procedure, and if the cause in the response indicates "Request partially accepted", the CP function shall behave as specified in clause 5.2.9.

6.3.3.3 UP Function Behaviour

When the UP function receives a PFCP Session Modification Request it shall:

- send the PFCP Session Modification Response message with a rejection cause value set to "Session context not found" if the F-SEID included in the PFCP Session Modification Request message is unknown;
- reject a modification request which would relate to a rule not existing in the UP function;
- discard any updates on the PFCP session context included in the PFCP Session Modification Request message if the request is rejected and send a PFCP Session Modification Response with an appropriate error cause together with additional information e.g. indicating the first Rule ID of the Rule causing the error. In this case, the UP function shall continue with the existing PFCP session context for the PFCP session as if the PFCP Session Modification Request had not been received;
- remove all rules identified by a Rule ID to be removed and remove the Rule ID from the PDR(s) from where they are referenced;
- send the PFCP Session Modification Response with the cause "Request accepted (success)", if all the requested modifications are accepted and performed successfully;
- send the PFCP Session Modification Response with the cause "Request partially accepted", if the CP function indicated support of the PSUCC feature (see clause 8.2.58) during the PFCP association setup or update procedure, if this feature is also supported by the UP function, and if the UP function could accept the request partially as specified in clause 5.2.9.

6.3.4 PFCP Session Deletion Procedure

6.3.4.1 General

The PFCP Session Deletion procedure shall be used to delete an existing PFCP session between the CP function and the UP function.

6.3.4.2 CP Function Behaviour

The CP function initiates a PFCP Session Deletion procedure towards the UP function to delete an existing PFCP session e.g. when the corresponding PDN connection or PDU session is deleted.

The CP shall:

- send a PFCP Session Deletion Request with the F-SEID identifying the PFCP session.

When the CP function receives PFCP Session Deletion Response with cause success, the CP function shall continue with the procedure which triggers the PFCP Session Deletion procedure.

6.3.4.3 UP Function Behaviour

When the UP function receives a PFCP Session Deletion Request it shall:

- send the PFCP Session Deletion Response message with a rejection cause set to "Session context not found" if the F-SEID include in the PFCP Session Deletion Request message is unknown;
- send the PFCP Session Deletion Response message with an acceptance cause if the PFCP session and associated rules are deleted successfully, and include any pending Usage Report(s) in the message.

6.3.5 PFCP Session Report Procedure

6.3.5.1 General

The PFCP Session Report procedure shall be used by the UP function to report information related to the PFCP session to the CP function.

6.3.5.2 UP Function Behaviour

The UP function shall initiate the PFCP Session Report procedure to report information related to a PFCP session to the CP function. The UP function:

- shall send the PFCP Session Report Request message, identifying the PFCP session for which the report is sent and including the information to be reported.

If the Enhanced PFCP Association Release feature (EPFAR) is supported by both the CP function and UP function, the UP function may send a PFCP Session Report Request message with the flag PSDBU being set to "1" to the CP function to report that the PFCP session is being deleted in the UP function, as specified in clause 5.18, e.g. to report remaining non-zero usage reports for all URRs in the PFCP Session before the PFCP Session is locally deleted in the UP function during an Enhanced PFCP Association Release procedure.

When the UP function receives a PFCP Session Report Response with the cause success, the UP function shall consider the information to be successfully delivered to the CP function.

6.3.5.3 CP Function Behaviour

When the CP function receives a PFCP Session Report Request message, it shall:

- send the PFCP Session Report Response message with a rejection cause set to "Session context not found" if the F-SEID included in the PFCP Session Report Request message is unknown;

- process the information being reported as appropriate and send a PFCP Session Report Response with the cause "success";
- otherwise return an appropriate error cause value.

If the Enhanced PFCP Association Release feature (EPFAR) is supported by both the CP function and UP function, the CP function shall consider that a PFCP Session is locally deleted in the UP function upon receiving a PFCP Session Report Request message from the UP function with the flag PSDBU being set to "1".

6.4 Reliable Delivery of PFCP Messages

Reliable delivery of PFCP messages is accomplished by retransmission of these messages as specified in this clause.

A PFCP entity shall maintain, for each triplet of local IP address, local UDP port and remote peer's IP address, a sending queue with Request messages to be sent to that peer. Each message shall be sent with a Sequence Number and be held until a corresponding Response is received or until the PFCP entity ceases retransmission of that message. The Sequence Number shall be unique for each outstanding Request message sourced from the same IP/UDP endpoint. A PFCP entity may have several outstanding Requests waiting for replies.

When sending a Request message, the sending PFCP entity shall start a timer T1. The sending entity shall consider that the Request message has been lost if a corresponding Response message has not been received before the T1 timer expires. If so, the sending entity shall retransmit the Request message, if the total number of retry attempts is less than N1 times. The setting of the T1 timer and N1 counter is implementation specific.

A retransmitted PFCP message shall have the same message content, including the same PFCP header, UDP ports, source and destination IP addresses as the originally transmitted message.

A Request and its Response message shall have the same Sequence Number value, i.e. the Sequence Number in the PFCP header of the Response message shall be copied from the respective Request message. A Request and its Response messages are matched based on the Sequence Number and the IP address and UDP port.

Not counting retransmissions, a Request message shall be answered with a single Response message. Duplicated Response messages shall be discarded by the receiver. A received Response message not matching an outstanding Request message waiting for a reply should be discarded.

The PFCP entity should inform the PFCP application layer when detecting an unsuccessful transfer of a Request message to enable the controlling upper entity to take any appropriate measure.

6.5 PFCP messages bundling

PFCP messages bundling is an optional procedure that may be supported by the CP function and the UP function.

PFCP messages bundling may be used if both the CP function and the UP function have indicated support of the corresponding feature (see clauses 8.2.25 and 8.2.58) during the PFCP Association Setup or Update procedure. If so, the following requirements shall apply.

Several PFCP session related requests and/or responses messages, related to the same PFCP session or to different PFCP sessions handled by the same peer PFCP entity (i.e. with the peer's F-SEID having the same IP address, or with the same peer's IP address for PFCP Session Establishment Requests), may be bundled together in a single UDP/IP packet as specified in clause 7.2.1A, when being sent to that peer PFCP entity. PFCP messages may be bundled towards a PFCP entity of a UP function or of a CP function, independently.

NOTE 1: If the CP function bundles few PFCP session related requests in one UDP/IP packet it sends to a UP function, the UP function can return responses in separate UDP/IP packets or it can bundle some of the responses together with other PFCP session related messages.

NOTE 2: Bundling PFCP messages in a single UDP/IP packet enable to enhance performance and scalability (reduced CPU and memory cost thanks to reducing the number of packets to be packetized, exchanged and processed over N4).

PFCP session related messages handled by different peer PFCP entities (i.e. with the peer's F-SEID having different IP addresses) shall not be bundled together. PFCP node related messages shall not be bundled either.

The procedures specified in the rest of this specification shall apply for each PFCP message that is bundled in a UDP/IP packet, as if the PFCP message was sent in its own individual UDP/IP packet, i.e. PFCP messages bundling shall not incur any change to the PFCP protocol other than what is described in this clause.

NOTE 3: Each PFCP message bundled in a single UDP/IP packet has its own sequence number. Besides, if a UDP/IP packet carrying bundled PFCP messages is lost, retransmitted PFCP messages do not need to be bundled in the same manner as when sent originally.

7 Messages and Message Formats

7.1 Transmission Order and Bit Definitions

PFCP messages shall be transmitted in network octet order starting with octet 1 with the most significant bit sent first.

The most significant bit of an octet in a PFCP message is bit 8. If a field in a PFCP message spans over several octets, the most significant bit is bit 8 of the octet with the lowest number, unless specified otherwise.

7.2 Message Format

7.2.1 General

The format of a PFCP message is depicted in Figure 7.2.1-1.

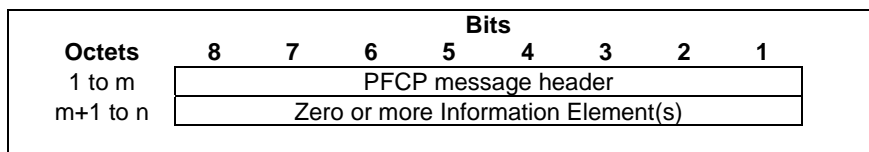

Figure 7.2.1-1: PFCP Message Format

A PFCP message shall contain the PFCP message header and may contain subsequent information element(s) dependent on the type of message.

7.2.1A PFCP messages bundled in one UDP/IP packet

When applying PFCP messages bundling (see clause 6.5), PFCP messages shall be bundled in one UDP/IP packet as depicted in Figure 7.2.1A-1.

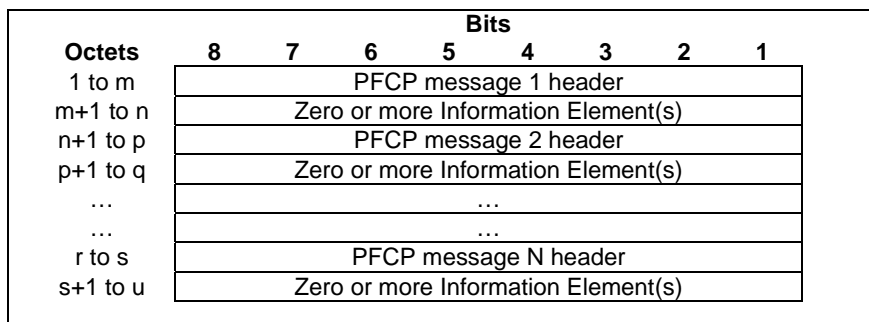

Figure 7.2.1A-1: PFCP messages bundled in one UDP/IP packet

Each bundled PFCP message shall contain its PFCP message header and may contain subsequent information element(s) dependent on the type of message.

The FO" (Follow On) flag in the PFCP message header of each PFCP message bundled in the UDP/IP packet, except the last PFCP message, shall be set to "1" to indicate that another PFCP message follows in the UDP/IP packet. See clause 7.2.2.

7.2.2 Message Header

7.2.2.1 General Format

PFCP messages use a variable length header. The message header length shall be a multiple of 4 octets. Figure 7.2.2.1-1 illustrates the format of the PFCP Header.

Octets	Bits							
	8	7	6	5	4	3	2	1
1	Version			Spare	Spare	FO	MP	S
2	Message Type							
3	Message Length (1 st Octet)							
4	Message Length (2 nd Octet)							
m to k(m+7)	If S flag is set to "1", then SEID shall be placed into octets 5-12. Otherwise, SEID field is not present at all.							
n to (n+2)	Sequence Number							
(n+3)	Spare							

Figure 7.2.2.1-1: General format of PFCP Header

Where:

- if S = 0, SEID field is not present, k = 0, m = 0 and n = 5;
- if S = 1, SEID field is present, k = 1, m = 5 and n = 13.

The usage of the PFCP header is defined in clause 7.2.2.4.

Octet 1 bits shall be encoded as follows:

- Bit 1 represents the SEID flag (T).
- Bit 2 represents the "MP" flag (see clause 7.2.2.4.1).
- Bit 3 represents the "FO" flag (see clause 7.2.2.4.1).
- Bit 4 to 5 are spare, the sender shall set them to "0" and the receiving entity shall ignore them.
- Bits 6-8 represent the Version field.

7.2.2.2 PFCP Header for Node Related Messages

The PFCP message header for the node related messages shall not contain the SEID field, but shall contain the Sequence Number field, followed by one spare octet as depicted in figure 7.2.2.2-1. The spare bits shall be set to zero by the sender and ignored by the receiver. For the Version Not Supported Response message, the Sequence Number may be set to any number and shall be ignored by the receiver.

Octets	Bits							
	8	7	6	5	4	3	2	1
1	Version		Spare	Spare	FO=0	MP=0	S=0	
2	Message Type							
3	Message Length (1 st Octet)							
4	Message Length (2 nd Octet)							
5	Sequence Number (1 st Octet)							
6	Sequence Number (2 nd Octet)							
7	Sequence Number (3 rd Octet)							
8	Spare							

Figure 7.2.2.2-1: PFCP Message Header for node related messages

7.2.2.3 PFCP Header for Session Related Messages

The PFCP message header, for session related messages, shall contain the SEID and Sequence Number fields followed by one spare octet. The PFCP header is depicted in figure 7.2.2.3-1. The spare bits shall be set to zero by the sender and ignored by the receiver.

Octets	Bits							
	8	7	6	5	4	3	2	1
1	Version		Spare	Spare	FO	MP	S=1	
2	Message Type							
3	Message Length (1 st Octet)							
4	Message Length (2 nd Octet)							
5	Session Endpoint Identifier (1 st Octet)							
6	Session Endpoint Identifier (2 nd Octet)							
7	Session Endpoint Identifier (3 rd Octet)							
8	Session Endpoint Identifier (4 th Octet)							
9	Session Endpoint Identifier (5 th Octet)							
10	Session Endpoint Identifier (6 th Octet)							
11	Session Endpoint Identifier (7 th Octet)							
12	Session Endpoint Identifier (8 th Octet)							
13	Sequence Number (1 st Octet)							
14	Sequence Number (2 nd Octet)							
15	Sequence Number (3 rd Octet)							
16	Message Priority				Spare			

Figure 7.2.2.3-1: PFCP message Header for session related messages

7.2.2.4 Usage of the PFCP Header

7.2.2.4.1 General

The format of the PFCP header is specified in clause 7.2.2.

The usage of the PFCP header shall be as defined below.

The first octet of the header shall be used is the following way:

- Bit 1 represents the "S" flag, which indicates if SEID field is present in the PFCP header or not. If the "S" flag is set to "0", then the SEID field shall not be present in the PFCP header. If the "S" flag is set to "1", then the SEID field shall immediately follow the Length field, in octets 5 to 12. Apart from the node related messages, in all PFCP messages the value of the "S" flag shall be set to "1".
- Bit 2 represents the "MP" flag. If the "MP" flag is set to "1", then bits 8 to 5 of octet 16 shall indicate the relative priority of the PFCP message. It shall be encoded as the binary value of the Message Priority and it may take any value between 0 and 15, where 0 corresponds to the highest priority and 15 the lowest priority.

- Bit 3 represents the "FO" (Follow On) flag. If the "FO" flag is set to "1", then another PFCP message follows in the UDP/IP packet (see clauses 6.5 and 7.2.1A).
- Bit 4 is a spare bit. The sending entity shall set it to "0" and the receiving entity shall ignore it.
- Bit 5 is a spare bit. The sending entity shall set it to "0" and the receiving entity shall ignore it.
- Bits 6 to 8, which represent the PFCP version, shall be set to decimal 1 ("001").

The usage of the fields in octets 2 - n of the header shall be as specified below.

- Octet 2 represents the Message type field, which shall be set to the unique value for each type of control plane message. Message type values are specified in Table 7.3-1 "Message types".
- Octets 3 to 4 represent the Message Length field. This field shall indicate the length of the message in octets excluding the mandatory part of the PFCP header (the first 4 octets). The SEID (if present) and the Sequence Number shall be included in the length count. The format of the Length field of information elements is specified in clause 8.2 "Information Element Format".
- When S=1, Octets 5 to 12 represent the Session Endpoint Identifier (SEID) field. This field shall unambiguously identify a session endpoint in the receiving Packet Forward Control entity. The Session Endpoint Identifier is set by the sending entity in the PFCP header of all control plane messages to the SEID value provided by the corresponding receiving entity (CP or UP function). If a peer's SEID is not available the SEID field shall be present in a PFCP header, but its value shall be set to "0", "Conditions for sending SEID=0 in PFCP header".

NOTE: The SEID in the PFCP header of a message is set to the SEID value provided by the corresponding receiving entity regardless of whether the source IP address of the request message and the IP Destination Address provided by the receiving entity for subsequent request messages are the same or not.

- Octets 13 to 15 represent PFCP Sequence Number field.

7.2.2.4.2 Conditions for Sending SEID=0 in PFCP Header

If a peer's SEID is not available, the SEID field shall still be present in the header and its value shall be set to "0" in the following messages:

- PFCP Session Establishment Request message on Sxa/Sxb/Sxc/N4;
- If a node receives a message for which it has no session, i.e. if SEID in the PFCP header is not known, it shall respond with "Session context not found" cause in the corresponding response message to the sender, the SEID used in the PFCP header in the response message shall be then set to "0";
- If a node receives a request message containing protocol error, e.g. Mandatory IE missing, which requires the receiver to reject the message as specified in clause 7.6, it shall reject the request message. For the response message, the node should look up the remote peer's SEID and accordingly set SEID in the PFCP header and the message cause code. As an implementation option, the node may not look up the remote peer's SEID and set the PFCP header SEID to "0" in the response message. However in this case, the cause value shall not be set to "Session not found".
- When the UP function sends PFCP Session Report Request message over N4 towards another SMF or another PFCP entity in the SMF as specified in clause 5.22.2 and clause 5.22.3.

7.2.3 Information Elements

7.2.3.1 General

The format of PFCP Information Elements are defined in clause 8.2.

7.2.3.2 Presence Requirements of Information Elements

IEs within PFCP messages shall be specified with one of the following presence requirement:

- Mandatory: this means that:

- the IE shall be included by the sending entity;
- the receiver diagnoses a "Mandatory IE missing" error when detecting that the IE is not present. If a mandatory IE is missing, then the receiver shall abort the procedure. A response including a "Mandatory IE missing" cause, shall include the type of the missing IE.
- Conditional: this means that:
 - the IE shall be included by sending entity if the conditions specified are met;
 - the receiver shall check the conditions as specified in the corresponding message type description, based on the parameter combination in the message and/or on the state of the receiving node, to infer if a conditional IE shall be expected. Only if a receiver has sufficient information, if a conditional IE, which is necessary for the receiving entity to complete the procedure, is missing, then the receiver shall abort the procedure. A response including a "Conditional IE missing" cause shall include the type of the missing IE.- Conditional-Optional: this means that:
 - the IE shall be included by a sending entity complying with the version of the specification, if the conditions specified in the relevant protocol specification are met. An entity, which is at an earlier version of the protocol and therefore is not up-to-date, cannot send this IE;
 - the receiver need not check the presence of the IE in the message. If the receiver checks the presence of the Conditional-Optional IE, then the IE's absence shall not trigger any of the error handling procedures. The handling of an absence or erroneous such IEs shall be treated as Optional IEs as specified in clause 7.6.
- Optional: this means that:
 - the IE shall be included as a service option. Therefore, the IE may be included or not in a message. The handling of an absent optional IE, or an erroneous optional IE is specified in clause 7.6.

For conditional IEs, the clause describing the PFCP message explicitly defines the conditions under which the inclusion of each IE becomes mandatory or optional for that particular message. These conditions shall be defined so that the presence of a conditional IE only becomes mandatory if it is critical for the receiving entity. The definition might reference other protocol specifications for final terms used as part of the condition.

For grouped IEs, the presence requirement of the embedded IE shall follow the rules:

- If the grouped IE is Mandatory within a given message: the presence requirements of individual embedded IEs are as stated within the Mandatory grouped IE for the given message;
- if the grouped IE is Conditional within a given message: if the embedded IE in the grouped IE is Mandatory or Conditional, this embedded IE is viewed as Conditional IE by the receiver. If the embedded IE in the grouped IE is Conditional-Optional, this embedded IE is viewed as Optional IE by the receiver. If the embedded IE in the grouped IE is Optional, this embedded IE is viewed as Optional IE by the receiver;
- if the grouped IE is Conditional-Optional within a given message: if the embedded IE in the grouped IE is Mandatory or Conditional, this embedded IE is viewed as Conditional-Optional IE by the receiver. If the embedded IE in the grouped IE is Conditional-Optional, this embedded IE is viewed as Optional IE by the receiver. If the embedded IE in the grouped IE is Optional, this embedded IE is viewed as Optional IE by the receiver;
- if the grouped IE is Optional within a given message: all embedded IEs in the grouped IE are viewed as Optional IEs by the receiver.

In all of the above cases, appropriate error handling as described in clause 7.6 shall be applied for protocol errors of the embedded IEs.

Only the Cause IE at message level shall be included in the response if the Cause contains a value that indicates that the request is not accepted, regardless of whether there are other mandatory or conditional IEs defined for a given response message. The following are exceptions:

- the Node ID and Offending IE shall be included as per the requirements specified for the corresponding response message;
- the Load Control Information, Overload Control Information and the Failed Rule ID IEs may be included in a PFCP session related message.

If the Cause IE at Grouped IE level contains a value that indicates that the Grouped IE is not handled correctly, the other IEs in this Grouped IE, other than the Cause IE, may not be included.

7.2.3.3 Grouped Information Elements

A Grouped IE is an IE which may contain other IEs.

Grouped IEs have a length value in the TLV encoding, which includes the added length of all the embedded IEs. Overall coding of a grouped IE with 4 octets long IE header is defined in clause 8.2. Each IE within a grouped IE also shall also contain 4 octets long IE header.

Grouped IEs are not marked by any flag or limited to a specific range of IE type values. The clause describing an IE in this specification shall explicitly state if it is a Grouped IE.

NOTE: Each entry into each Grouped IE creates a new scope level. Exit from the grouped IE closes the scope level. The PFCP message level is the top most scope.

If more than one grouped IEs of the same type, but for a different purpose are sent within the same message level, these IEs shall have different IE types.

If more than one grouped IEs of the same type and for the same purpose are sent within the same message level, these IEs shall have exactly the same IE type to represent a list.

Assigning the same IE type to grouped IEs which don't have the same content is not recommended, even if these grouped IEs are in different message levels.

7.2.3.4 Information Element Type

An IE in a PFCP message or Grouped IE is identified by its IE Type and described by a specific row in the corresponding tables in clause 7.

If several IEs with the same Type are included in a PFCP message or Grouped IE, they represent a list for the corresponding IE name.

An IE Type value uniquely identifies a specific IE.

One IE type value is specified for Vendor Specific IEs.

7.3 Message Types

The PFCP message types to be used over the Sxa, Sxb, Sxc, N4 and N4mb reference points are defined in Table 7.3-1.

Table 7.3-1: Message Types

Message Type value (Decimal)	Message	Applicability				
		Sxa	Sxb	Sxc	N4	N4mb

0	Reserved					
	PFCP Node related messages					
1	PFCP Heartbeat Request	X	X	X	X	X
2	PFCP Heartbeat Response	X	X	X	X	X
3	PFCP PFD Management Request	-	X	X	X	-
4	PFCP PFD Management Response	-	X	X	X	-
5	PFCP Association Setup Request	X	X	X	X	X
6	PFCP Association Setup Response	X	X	X	X	X
7	PFCP Association Update Request	X	X	X	X	X
8	PFCP Association Update Response	X	X	X	X	X
9	PFCP Association Release Request	X	X	X	X	X
10	PFCP Association Release Response	X	X	X	X	X
11	PFCP Version Not Supported Response	X	X	X	X	X
12	PFCP Node Report Request	X	X	X	X	X
13	PFCP Node Report Response	X	X	X	X	X
14	PFCP Session Set Deletion Request	X	X	-	X	-
15	PFCP Session Set Deletion Response	X	X	-	X	-
16	PFCP Session Set Modification Request	-	X	-	X	-
17	PFCP Session Set Modification Response	-	X	-	X	-
18 to 49	For future use					
	PFCP Session related messages					
50	PFCP Session Establishment Request	X	X	X	X	X
51	PFCP Session Establishment Response	X	X	X	X	X
52	PFCP Session Modification Request	X	X	X	X	X
53	PFCP Session Modification Response	X	X	X	X	X
54	PFCP Session Deletion Request	X	X	X	X	X
55	PFCP Session Deletion Response	X	X	X	X	X
56	PFCP Session Report Request	X	X	X	X	X
57	PFCP Session Report Response	X	X	X	X	X
58 to 99	For future use					
	Other messages					
100 to 255	For future use					

7.4 PFCP Node Related Messages

7.4.1 General

This clause specifies either node level or PFCP entity level messages used over the Sxa, Sxb, Sxc, N4 and N4mb reference points (see clause 6.2).

7.4.2 Heartbeat Messages

7.4.2.1 Heartbeat Request

Table 7.4.2.1-1: Information Elements in Heartbeat Request

Information elements	P	Condition / Comment	Appl.					IE Type
			Sx a	Sx b	Sx c	N4	N4 mb	
Recovery Time Stamp	M	This IE shall contain the time stamp when the PFCP entity was started see clause 19A of 3GPP TS 23.007 [24].	X	X	X	X	X	Recovery Time Stamp
Source IP Address	O	This IE may be included when a Network Address Translation device is deployed in the network. See clause 19a in 3GPP TS 23.007 [24].	X	X	X	X	X	Source IP Address

7.4.2.2 Heartbeat Response

Table 7.4.2.2-1: Information Elements in Heartbeat Response

Information elements	P	Condition / Comment	Appl.					IE Type
			Sx a	Sx b	Sx c	N4	N4 mb	
Recovery Time Stamp	M	This IE shall contain the time stamp when the PFCP entity was started see clause 19A of 3GPP TS 23.007 [24].	X	X	X	X	X	Recovery Time Stamp

7.4.3 PFCP PFD Management

7.4.3.1 PFCP PFD Management Request

Table 7.4.3.1-1: Information Elements in PFCP PFD Management Request

Information elements	P	Condition / Comment	Appl.					IE Type
			Sx a	Sx b	Sx c	N4	N4 mb	
Application ID's PFDs	C	This IE shall contain an Application Identifier and the associated PFDs to be provisioned in the UP function. Several IEs with the same IE type may be present to provision PFDs for multiple Application IDs. The UP function shall delete all the PFDs received and stored earlier for all the Application IDs if this IE is absent in the message.	-	X	X	X	-	Application ID's PFDs
Node ID	O	When present, this IE shall contain the unique identifier of the sending Node.	-	X	X	X	-	Node ID

Table 7.4.3.1-2: Application ID's PFDs

Octet 1 and 2		Application ID's PFDs IE Type = 58 (decimal)						
Octets 3 and 4		Length = n						
Information elements	P	Condition / Comment	Appl.					IE Type
			Sx a	Sx b	Sx c	N4	N4 mb	
Application ID	M	This IE shall identify the Application ID for which PFDs shall be provisioned in the UP function.	-	X	X	X	-	Application ID
PFD context	C	This IE shall be present if the PFD needs to be provisioned in the UP function. When present, it shall describe the PFD to be provisioned in the UP function. Several IEs with the same IE type may be present to provision multiple PFDs for this Application ID. When this IE is absent, the UP function shall delete all the PFDs received and stored earlier in the UP function for this Application ID.	-	X	X	X	-	PFD context

Table 7.4.3.1-3: PFD context

Octet 1 and 2		PFD context IE Type = 59 (decimal)						
Octets 3 and 4		Length = n						
Information elements	P	Condition / Comment	Appl.					IE Type
			Sx a	Sx b	Sx c	N4	N4 mb	

PFD Contents	M	This IE shall describe the PFD to be provisioned in the UP function. Several IEs with the same IE type may be present to provision multiple contents for this PFD. (NOTE 1)	-	X	X	X	-	PFD Contents
NOTE 1 The CP function shall only provision a PFD Contents including a property with multiple values if the UP function supports PFDE feature. See clauses 8.2.25 and 8.2.39.								

7.4.3.2 PFCP PFD Management Response

Table 7.4.3.2-1: Information Elements in PFCP PFD Management Response

Information elements	P	Condition / Comment	Appl.					IE Type
			Sx a	Sx b	Sx c	N4	N4 mb	
Cause	M	This IE shall indicate the acceptance, partial acceptance or rejection of the corresponding request message.	-	X	X	X	-	Cause
Offending IE	C	This IE shall be included if the rejection is due to a conditional or mandatory IE missing or faulty.	-	X	X	X	-	Offending IE
Node ID	O	When present, this IE shall contain the unique identifier of the sending Node.	-	X	X	X	-	Node ID
PFD Partial Failure Information	C	This IE shall be present if the Cause IE indicates partial acceptance of the request to provide failure information related to a failed provisioning of one or more Application IDs' PFDs. See Table Table 7.4.3.2-2. Several IEs within the same IE type may be present to report failures related to multiple Application IDs' PFDs.	-	X	X	X	-	PFD Partial Failure Information

Table 7.4.3.2-2: PFD Partial Failure Information within PFCP PFD Management Response

Octet 1 and 2		PFD Partial Failure Information IE Type = 397 (decimal)						
Octets 3 and 4		Length = n						
Information elements	P	Condition / Comment	Appl.					IE Type
			Sx a	Sx b	Sx c	N4	N4 mb	
Application ID	M	This IE shall contain the failed Application ID for which PFDs were attempted to be provisioned in the UP function.	-	X	X	X	-	Application ID
Failure Cause	M	This IE shall indicate the reason why the Application ID's PFDs could not be installed in the UPF.	-	X	X	X	-	Cause

7.4.4 PFCP Association messages

7.4.4.1 PFCP Association Setup Request

7.4.4.1.1 General

Table 7.4.4.1-1: Information Elements in a PFCP Association Setup Request

Information elements	P	Condition / Comment	Appl.					IE Type
			Sx a	Sx b	Sx c	N4	N4 mb	
Node ID	M	This IE shall contain the unique identifier of the sending Node.	X	X	X	X	X	Node ID
Recovery Time Stamp	M	This IE shall contain the time stamp when the CP or UP function was started, see clause 19A of 3GPP TS 23.007 [24]. (NOTE 1)	X	X	X	X	X	Recovery Time Stamp
UP Function Features	C	This IE shall be present if the UP function sends this message and the UP function supports at least one UP feature defined in this IE. When present, this IE shall indicate the features the UP function supports.	X	X	X	X	X	UP Function Features
CP Function Features	C	This IE shall be present if the CP function sends this message and the CP function supports at least one CP feature defined in this IE. When present, this IE shall indicate the features the CP function supports.	X	X	X	X	X	CP Function Features
Alternative SMF IP Address	O	This IE may be present if the (MB-)SMF advertises the support of the SSET and/or MPAS feature in the CP Function Features IE (see clause 8.2.58). When present, this IE shall contain an IPv4 and/or IPv6 address of an alternative (MB-)SMF or an alternative PFCP entity in the same (MB-)SMF when SSET feature is used, or an alternative PFCP entity in the same (MB-)SMF when MPAS feature is used. Several IEs with the same IE type may be present to represent multiple alternative (MB-)SMF IP addresses.	-	-	-	X	X	Alternative SMF IP Address
SMF Set ID	C	This IE shall be present if the (MB-)SMF advertises the support of the MPAS feature in the CP Function Features IE (see clause 5.22.3). When present, this IE shall contain an FQDN representing the (MB-)SMF set to which the (MB-)SMF belongs.	-	-	-	X	X	SMF Set ID
PFCP Session Retention Information	O	This IE may be present to request the UP function to keep all or part of the existing PFCP sessions upon receipt of a PFCP association setup request with a Node ID for which a PFCP association was already established. See clause 6.2.6.2.1.	X	X	X	X	X	PFCP Session Retention Information
UE IP address Pool Information	O	This IE may be present when the UP function sends this message, if UE IP Address Pools are configured in the UP function. Several IE with the same IE type may be present to represent multiple UE IP address Pool Information.	-	X	-	X	-	UE IP address Pool Information
GTP-U Path QoS Control Information	C	This IE may be present, if the CP function sends this message, to request the UPF to monitor the QoS on GTP-U paths (see clause 5.24.5). Several IEs with the same IE type may be present to represent multiple GTP-U paths (with different parameters) to monitor.	-	-	-	X	-	GTP-U Path QoS Control Information
Clock Drift Control Information	O	This IE may be present, if the CP function sends this message, to request the UPF to report clock drift between the external time and 5GS time for working domains (see clause 5.26.4). Several IEs with the same IE type may be present for multiple Time domains (with different parameters).	-	-	-	X	-	Clock Drift Control Information
UPF Instance ID	C	This IE shall be present if the UP function is a 5G UP function and if UPF Instance ID is available, and if the message is sent by the UP function.	-	-	-	X	X	NF Instance ID

PFCPASReq-Flags	O	This IE shall be included if at least one of the flags is set to "1": - UUPSI (UPF configured for IPUPS): when the message is sent by a UPF, the UP function shall set this flag to "1" if the UPF is configured to be used for IPUPS. See clause 5.27.	-	-	-	X	-	PFCPASReq-Flags
N6 Delay Measurement Control Information	C	This IE may be present, if the CP function sends this message, to request the UPF to measure the N6 delay between the UPF and one or more measurement endpoints (see clause 5.33.8). Several IEs with the same IE type may be present to represent multiple measurement endpoints to monitor.	-	-	-	X	-	N6 Delay Measurement Control Information
N6 Delay Measurement Protocols	C	This IE should be present if the UPF sends this message and if the UPF indicates support of the UN6DM feature. When present, it shall indicate the N6 delay measurement protocols that the UPF supports.	-	-	-	X	-	N6 Delay Measurement Protocols
Operator Configurable UPF Capability	O	This IE may be present if the UP function sends this message, and the UP function supports any of the Operator Configurable UPF Capabilities as described in clause 5.8.2.21 of 3GPP TS 23.501 [28]. Several IEs with the same IE type may be present to represent multiple Operator Configurable UPF Capabilities.	-	-	-	X	-	Operator Configurable UPF Capability
Packet Inspection functionality	O	This IE may be present, if the UP function sends this message, to indicate the supported packet inspection capabilities as described in clause 8.2.250. (NOTE 2)	-	-	-	X	-	Packet Inspection functionality
NOTE 1: A PFCP function shall ignore the Recovery Timestamp received in the PFCP Association Setup Request message.								
NOTE 2: A UPF not including the Packet Inspection functionality IE (e.g. UPF complying with an earlier release of the specification) may support one or more packet inspection capabilities. If the Packet Inspection functionality IE is not received by the CP function, the CP function may determine the packet inspection capabilities of the UPF based on local configuration, or by default, it shall assume that the UPF supports all the packet inspection capabilities required for all the network instances supported by the UPF.								

Table 7.4.4.1-2: PFCP Session Retention Information IE within PFCP Association Setup Request

Octet 1 and 2	PFCP Session Retention Information IE Type = 183 (decimal)							
Octets 3 and 4	Length = n							
Information elements	P	Condition / Comment	Appl.					IE Type
			Sx a	Sx b	Sx c	N4	N4 mb	

CP PFCP Entity IP Address	O	<p>This IE may be present to indicate the IP address of a CP PFCP entity for which the UP function shall retain the existing PFCP sessions, upon receipt of a PFCP association setup request with a Node ID for which a PFCP association was already established. See clause 6.2.6.2.1</p> <p>Several IEs with the same IE type may be present to represent multiple CP PFCP entities for which PFCP sessions shall be retained.</p> <p>If no CP PFCP Entity IP Address IE is present in the PFCP Session Retention Information IE, all existing PFCP sessions shall be kept upon receipt of a PFCP association setup request with a Node ID for which a PFCP association was already established.</p>	X	X	X	X	X	CP PFCP Entity IP Address
---------------------------	---	--	---	---	---	---	---	---------------------------

Table 7.4.4.1-3: UE IP address Pool Information IE within PFCP Association Setup Request

Octet 1 and 2		UE IP address Pool Information IE Type = 233 (decimal)						
Octets 3 and 4		Length = n						
Information elements	P	Condition / Comment	Appl.					IE Type
			Sx a	Sx b	Sx c	N4	N4 mb	
UE IP address Pool Identity	M	<p>When present, this IE shall contain an UE IP address Pool Identity</p> <p>Several IEs with the same IE type may be present to represent multiple UE IP address Pool Identities.</p>	-	X	-	X	-	UE IP address Pool Identity
Network Instance	O	The IE may be present to indicate for which DNN/APN the UE IP Address Pool Identities are configured.	-	X	-	X	-	Network Instance
S-NSSAI	O	The IE may be present to indicate for which S-NSSAI the UE IP Address Pool Identities are configured. Several IEs with the same IE type may be present to represent multiple S-NSSAIs.	-	-	-	X	-	S-NSSAI
IP version	O	The IE may be present to indicate for which IP version the UE IP Address Pool Identities are configured.	-	-	-	X	-	IP version

7.4.4.1.2 Clock Drift Control Information IE within PFCP Association Setup Request

The Clock Drift Control Information grouped IE shall be encoded as shown in Table 7.4.4.1.2-1.

Table 7.4.4.1.2-1: Clock Drift Control Information within PFCP Association Setup Request

Octet 1 and 2		Clock Drift Control Information IE Type = 203 (decimal)						
Octets 3 and 4		Length = n						
Information elements	P	Condition / Comment	Appl.					IE Type
			Sx a	Sx b	Sx c	N4	N4 mb	

Requested Clock Drift Information	M	This IE shall indicate the requested clock drift information.	-	-	-	X	-	Requested Clock Drift Information
Time Domain Number	C	When present, this IE shall identify the external time domain(s) for which clock drift information is requested. More than one IE with this type may be included to represent multiple Time Domain Numbers. This IE may be included if the Configured Time Domain IE is not included. (NOTE)	-	-	-	X	-	Time Domain Number
Configured Time Domain	C	When present with the CTDI (Configured Time Domain Indicator) flag set to "1", this IE indicates that the request targets the external time domain that is configured to the NW-TT(s) in the UPF. This IE may be included if the Time Domain Number IE is not included. (NOTE)	-	-	-	X	-	Configured Time Domain
Time Offset Threshold	C	This IE shall be present if Time Offset Reporting is requested. When present, it shall indicate the threshold to report the time offset, i.e. the offset shall be reported only when it exceeds the threshold compared to the previous report.	-	-	-	X	-	Time Offset Threshold
Cumulative rateRatio Threshold	C	This IE shall be present if Cumulative RateRatio Reporting is requested. When present, it shall indicate the threshold to report the cumulative rateRatio, i.e. the cumulative rateRatio shall be reported only when it exceeds the threshold compared to the previous report.	-	-	-	X	-	Cumulative rateRatio Threshold
NOTE: If neither the Time Domain Number IE nor the Configured Time Domain IE is included, this indicates that the request targets all the external time domains the UPF is connected to.								

7.4.4.1.3 GTP-U Path QoS Control Information IE within PFCP Association Setup Request

The GTP-U Path QoS Control Information grouped IE shall be encoded as shown in Table 7.4.4.1.3-1.

Table 7.4.4.1.3-1: GTP-U Path QoS Control Information within PFCP Association Setup Request

Octet 1 and 2		GTP-U Path QoS Control Information IE Type = 238 (decimal)						
Octets 3 and 4		Length = n						
Information elements	P	Condition / Comment	Appl.					IE Type
			Sx a	Sx b	Sx c	N4	N4 mb	
Remote GTP-U Peer	C	When present, this IE shall include the IP address of the remote GTP-U peer for which QoS information is to be reported, and the network instance used towards the remote GTP-U peer if available. Several IEs with the same IE type may be present to represent multiple remote GTP-U peers. (NOTE)	-	-	-	X	-	Remote GTP-U Peer
GTP-U Path Interface Type	C	When present, this IE shall include the Interface Type of the GTP-U paths for which QoS information is to be reported. (NOTE)	-	-	-	X	-	GTP-U Path Interface Type
QoS Report Trigger	M	This IE shall indicate the trigger for reporting QoS information to the SMF.	-	-	-	X	-	QoS Report Trigger
DSCP	C	This IE shall be present, if available. When present, it shall contain the value of the DSCP in the TOS/Traffic Class field to measure the packet delay. Several IEs with the same IE type may be present to represent multiple DSCP values to use for QoS monitoring.	-	-	-	X	-	Transport Level Marking
Measurement Period	C	This IE shall be present if the QoS Report Trigger indicates periodic reporting. When present, it shall contain the time period for the QoS reports towards the SMF.	-	-	-	X	-	Measurement Period
Average Packet Delay Threshold	C	This IE may be present if the QoS Report Trigger indicates reporting based on thresholds.	-	-	-	X	-	Average Packet Delay
Minimum Packet Delay Threshold	C	This IE may be present if the QoS Report Trigger indicates reporting based on thresholds.	-	-	-	X	-	Minimum Packet Delay
Maximum Packet Delay Threshold	C	This IE may be present if the QoS Report Trigger indicates reporting based on thresholds.	-	-	-	X	-	Maximum Packet Delay
Minimum Waiting Time	C	This IE may be present if the QoS Report Trigger indicates reporting based on thresholds. When present, it shall contain the minimum waiting time between two consecutive reports for the same type of measurement and the same remote GTP-U peer.	-	-	-	X	-	Timer

NOTE: At least one Remote GTP-U Peer IE or GTP-U Path Interface Type IE shall be present.

7.4.4.1.4 N6 Delay Measurement Control Information IE within PFCP Association Setup Request

The N6 Delay Measurement Control Information grouped IE shall be encoded as shown in Table 7.4.4.1.4-1.

Table 7.4.4.1.4-1: N6 Delay Measurement Control Information within PFCP Association Setup Request

Octet 1 and 2		N6 Delay Measurement Control Information IE Type = 355 (decimal)						
Octets 3 and 4		Length = n						
Information elements	P	Condition / Comment	Appl.					IE Type
			Sx a	Sx b	Sx c	N4	N4 mb	
N6 Delay Measurement Control Information ID	M	This IE shall uniquely identify the N6 Delay Measurement Control Information instance.	-	-	-	X	-	N6 Delay Measurement Control Information ID
Measurement Endpoint Address	M	This IE shall include the IP address of the measurement endpoint for which N6 delay is to be measured and reported. Several IEs with the same IE type may be present to represent multiple measurement endpoints.	-	-	-	X	-	Measurement Endpoint Address
Network Instance	M	This IE shall indicate the Network Instance at the UPF used to reach the measurement endpoints.	-	-	-	X	-	Network Instance
Measurement Protocols	M	This IE shall indicate the measurement protocols supported by the measurement endpoints that may be used for N6 delay measurements. Several IEs with the same IE type may be present to represent multiple supported measurement protocols.	-	-	-	X	-	N6 Delay Measurement Protocols
Protocol Specific Configuration Parameters	O	When present, this IE shall provide measurement protocol specific configuration parameters. See Table 7.4.4.1.4-2.	-	-	-	X	-	Protocol Specific Configuration Parameters
Measurement Reporting Type	M	This IE shall indicate the requested type of measurement reporting (periodic, event triggered or immediate reporting).	-	-	-	X	-	Measurement Reporting Type
Measurement Period	C	This IE shall be present if the Measurement Reporting Type indicates periodic reporting. When present, it shall contain the time period to generate measurement reports towards the SMF.	-	-	-	X	-	Measurement Period
Average Packet Delay Threshold	O	This IE may be present if the Measurement Reporting Type indicates event triggered reporting.	-	-	-	X	-	Average Packet Delay
Minimum Packet Delay Threshold	O	This IE may be present if the Measurement Reporting Type indicates event triggered reporting.	-	-	-	X	-	Minimum Packet Delay
Maximum Packet Delay Threshold	O	This IE may be present if the Measurement Reporting Type indicates event triggered reporting.	-	-	-	X	-	Maximum Packet Delay
Minimum Waiting Time	O	This IE may be present if the Measurement Reporting Type indicates event triggered reporting. When present, it shall contain the minimum waiting time between two consecutive reports for the same type of measurement and the same measurement endpoint.	-	-	-	X	-	Timer

Table 7.4.4.1.4-2: Protocol Specific Configuration Parameters

Octet 1 and 2		Protocol Specific Configuration Parameters IE Type = 378 (decimal)						
Octets 3 and 4		Length = n						
Information elements	P	Condition / Comment	Appl.					IE Type
			Sx a	Sx b	Sx c	N4	N4 mb	
Measurement Protocol	M	This IE shall indicate the measurement protocol for which the Protocol Specific Configuration Parameters are provided.	-	-	-	X	-	N6 Delay Measurement Protocols
Measurement EndPoint Port Number	O	When present, this IE shall indicate the port number to use for the measurement protocol.	-	-	-	X	-	Measurement EndPoint Port Number
Security Mode (STAMP)	O	This IE may be present if the Measurement Protocol IE indicates STAMP. When present, this IE shall indicate whether the communication between the UPF and the measurement endpoint shall be integrity protected and/or confidentiality protected.	-	-	-	X	-	Security Mode (STAMP)
HMAC Key (STAMP)	O	This IE may be present if the Measurement Protocol IE indicates STAMP. When present, this IE shall indicate the HMAC key for integrity protecting the communication between the UPF and the measurement endpoint.	-	-	-	X	-	HMAC Key (STAMP)
Session Reflector Mode (STAMP)	O	This IE may be present if the Measurement Protocol IE indicates STAMP. When present, this IE shall indicate whether the measurement endpoint operates as a stateless or stateful Session Reflector (as defined in IETF RFC 8762 [102]).	-	-	-	X	-	Session Reflector Mode (STAMP)
Security Mode (OWAMP or TWAMP)	O	This IE may be present if the Measurement Protocol IE indicates OWAMP or TWAMP. When present, this IE shall indicate the mode value requested to be used for protecting the communication between the UPF and the measurement endpoint.	-	-	-	X	-	Security Mode (OWAMP or TWAMP)
Key ID and Shared Secret (OWAMP or TWAMP)	O	This IE may be present if the Measurement Protocol IE indicates OWAMP or TWAMP. When present, it shall contain a pair of Key ID and its associated Shared Secret for protecting the communication between the UPF and the measurement endpoint. Several IEs with the same IE type may be present to provide multiple pairs of Key ID and Shared Secret.	-	-	-	X	-	Key ID and Shared Secret (OWAMP or TWAMP)

7.4.4.2 PFCP Association Setup Response

Table 7.4.4.2-1: Information Elements in a PFCP Association Setup Response

Information elements	P	Condition / Comment	Appl.					IE Type
			Sx a	Sx b	Sx c	N4	N4 mb	
Node ID	M	This IE shall contain the unique identifier of the sending Node.	X	X	X	X	X	Node ID
Cause	M	This IE shall indicate the acceptance or the rejection of the corresponding request message.	X	X	X	X	X	Cause
Recovery Time Stamp	M	This IE shall contain the time stamp when the CP or UP function was started, see clause 19A of 3GPP TS 23.007 [24]. (NOTE 1)	X	X	X	X	X	Recovery Time Stamp
UP Function Features	C	This IE shall be present if the UP function sends this message and the UP function supports at least one UP feature defined in this IE. When present, this IE shall indicate the features the UP function supports.	X	X	X	X	X	UP Function Features
CP Function Features	C	This IE shall be present if the CP function sends this message and the CP function supports at least one CP feature defined in this IE. When present, this IE indicates the features the CP function supports.	X	X	X	X	X	CP Function Features
Alternative SMF IP Address	O	This IE may be present if the (MB-)SMF advertises the support of the SSET and/or MPAS feature in the CP Function Features IE (see clause 8.2.58). When present, this IE shall contain an IPv4 and/or IPv6 address of an alternative (MB-)SMF or an alternative PFCP entity in the same (MB-)SMF when SSET feature is used, or an alternative PFCP entity in the same (MB-)SMF when MPAS feature is used. Several IEs with the same IE type may be present to represent multiple alternative (MB-)SMF IP addresses.	-	-	-	X	X	Alternative SMF IP Address
SMF Set ID	C	This IE shall be present if the CP function sends this message and (MB-)SMF advertises the support of the MPAS feature in the CP Function Features IE (see clause 5.22.3). When present, this IE shall contain an FQDN representing the (MB-)SMF set to which the (MB-)SMF belongs.	-	-	-	X	X	SMF Set ID
PFCPASRsp-Flags	O	This IE shall be included if at least one of the flags is set to "1": <ul style="list-style-type: none"> - PSREI (PFCP Session Retained Indication): the UP function shall set this flag to "1" if the PFCP Session Retention Information IE was received in the Request, an existing PFCP association was already established for the same Node ID and the requested PFCP sessions have been retained. See clause 6.2.6.2.2. - UUPSI (UPF configured for IPUPS): the UP function shall set this flag to "1" if the UPF is configured to be used for IPUPS. See clause 5.27. 	X	X	X	X	X	PFCPASRsp-Flags
Clock Drift Control Information	C	This IE may be present, if the CP function sends this message, to request the UPF to report clock drift between the external time and 5GS time for external working domains (see clause 5.26.4). Several IEs with the same IE type may be present to represent multiple external time domains (with different parameters). See Table 7.4.4.1.2-1.	-	-	-	X	-	Clock Drift Control Information

UE IP address Pool Information	O	This IE may be present when the UP function sends this message, if UE IP Address Pools are configured in the UP function. Several IE with the same IE type may be present to represent multiple UE IP address Pool Information. The IE shall be encoded as in Table 7.4.4.1-3.	-	X	-	X	-	UE IP address Pool Information
GTP-U Path QoS Control Information	C	This IE may be present, if the CP function sends this message, to request the UPF to monitor the QoS on GTP-U paths (see clause 5.24.5). Several IEs with the same IE type may be present to represent multiple GTP-U paths to monitor. See Table 7.4.4.1.3-1.	-	-	-	X	-	GTP-U Path QoS Control Information
UPF Instance ID	C	This IE shall be present if the UP function is a 5G UP function and if the UPF Instance ID is available, and if the message is sent by the UP function.	-	-	-	X	X	NF Instance ID
N6 Delay Measurement Control Information	C	This IE may be present, if the CP function sends this message, to request the UPF to measure the N6 delay between the UPF and one or more measurement endpoints (see clause 5.33.8). Several IEs with the same IE type may be present to represent multiple measurement endpoints (with different parameters) to monitor. See Table 7.4.4.1.4-1.	-	-	-	X	-	N6 Delay Measurement Control Information
N6 Delay Measurement Protocols	C	This IE should be present if the UPF sends this message and if the UPF indicates support of the UN6DM feature. When present, it shall indicate the N6 delay measurement protocols that the UPF supports.	-	-	-	X	-	N6 Delay Measurement Protocols
Operator Configurable UPF Capability	O	This IE may be present if the UP function sends this message, and the UP function supports any of the Operator Configurable UPF Capabilities as described in clause 5.8.2.21 of 3GPP TS 23.501 [28]. Several IEs with the same IE type may be present to represent multiple Operator Configurable UPF Capabilities.	-	-	-	X	-	Operator Configurable UPF Capability
Packet Inspection functionality	O	This IE may be present, if the UP function sends this message, to indicate the supported packet inspection capabilities as described in clause 8.2.250. (NOTE 2)	-	-	-	X	-	Packet Inspection functionality
NOTE: A PFCP function shall ignore the Recovery Timestamp received in PFCP Association Setup Response message.								

7.4.4.3 PFCP Association Update Request

Table 7.4.4.3-1: Information Elements in a PFCP Association Update Request

Information elements	P	Condition / Comment	Appl.					IE Type
			Sx a	Sx b	Sx c	N4	N4 mb	
Node ID	M	This IE shall contain the unique identifier of the sending Node.	X	X	X	X	X	Node ID
UP Function Features	O	If present, this IE shall indicate the supported Features when the sending node is the UP function.	X	X	X	X	X	UP Function Features
CP Function Features	O	If present, this IE shall indicate the supported Features when the sending node is the CP function.	X	X	X	X	X	CP Function Features
PFCP Association Release Request	C	This IE shall be present if the UP function requests the CP function to release the PFCP association.	X	X	X	X	X	PFCP Association Release Request
Graceful Release Period	C	This IE shall be present if the UP function requests a graceful release of the PFCP association.	X	X	X	X	X	Graceful Release Period
PFCPAUReq-Flags	O	This IE shall be included if at least one of the flags is set to "1". <ul style="list-style-type: none"> - PARPS (PFCP Association Release Preparation Start): if both the CP function and UP function support the EPFAR feature, the CP or UP function may set this flag to "1" to indicate that the PFCP association is to be released and all non-zero usage reports for those PFCP Sessions affected by the release of the PFCP association shall be reported. 	X	X	X	X	-	PFCPAUReq-Flags
Alternative SMF IP Address	O	This IE may be present if the (MB-)SMF advertises the support of the SSET and/or MPAS feature in the CP Function Features IE (see clause 8.2.58). When present, this IE shall contain an IPv4 and/or IPv6 address of an alternative (MB-)SMF or an alternative PFCP entity in the same (MB-)SMF when SSET feature is used, or an alternative PFCP entity in the same (MB-)SMF when MPAS feature is used. Several IEs with the same IE type may be present to represent multiple alternative (MB-)SMF IP addresses.	-	-	-	X	X	Alternative SMF IP Address
SMF Set ID	O	This IE may be present if the CP function sends this message and (MB-)SMF advertises the support of the MPAS feature in the CP Function Features IE (see clause 5.22.3), and there is a change in FQDN representing the (MB-)SMF set to which the (MB-)SMF belongs.	-	-	-	X	X	SMF Set ID
Clock Drift Control Information	C	This IE shall be present if the Clock Drift Control Information needs to be modified (see clause 5.26.4). Several IEs with the same IE type may be present to represent TSN domains. When present, the UPF shall replace any Clock Drift control information received earlier with the new received information. A Clock Drift Control Information with a null length indicates that clock drift reporting shall be stopped. See Table 7.4.4.1.2-1.	-	-	-	X	-	Clock Drift Control Information

UE IP address Pool Information	O	<p>This IE may be present when the UP function sends this message, if UE IP Address Pools are configured in the UP function.</p> <p>Several IE with the same IE type may be present to represent multiple UE IP address Pool Information.</p> <p>The IE shall be encoded as in Table 7.4.4.1-3.</p>	-	X	-	X	-	UE IP address Pool Information
GTP-U Path QoS Control Information	C	<p>This IE shall be present if the GTP-U Path QoS Control Information needs to be modified (see clause 5.24.5).</p> <p>Several IEs with the same IE type may be present to represent multiple GTP-U paths to monitor.</p> <p>When present, the UPF shall replace any GTP-U path control information received earlier with the new received information.</p> <p>A GTP-U Path QoS Control Information with a null length indicates that QoS monitoring of GTP-U paths shall be stopped.</p> <p>See Table 7.4.4.1.3-1.</p>	-	-	-	X	-	GTP-U Path QoS Control Information
UE IP Address Usage Information	O	<p>The UP function may include this IE if both UP and CP functions support the UE IP Address Usage Reporting feature.</p> <p>See Table 7.4.4.3.1-1</p> <p>Several IEs with the same type may be present to represent UE IP Address Usage Information for different UE IP Address Pools and/or Network Instances.</p> <p>See clause 5.21.3.</p>	-	X	-	X	-	UE IP Address Usage Information
N6 Delay Measurement Control Information	C	<p>This IE shall be present if one or more N6 Delay Measurement Control Information instances needs to be added, modified or stopped (see clause 5.33.8).</p> <p>Several IEs with the same IE type may be present to represent multiple measurement endpoints for which N6 delay measurement is requested to be started, modified or stopped.</p> <p>A N6 Delay Measurement Control Information with a null length indicates that all the N6 delay measurements of all the previously provisioned N6 Delay Measurement Control Information instances shall be stopped.</p> <p>See Table 7.4.4.1.4-1.</p>	-	-	-	X	-	N6 Delay Measurement Control Information
N6 Delay Measurement Protocols	C	<p>This IE should be present if the UPF sends this message and if the UPF needs to signal a change in the list of the N6 delay measurement protocols that the UPF supports.</p> <p>When present, this IE shall contain the N6 delay measurement protocols that the UPF supports and the CP function shall replace any earlier received N6 Delay Measurement Protocols by the information received in this IE.</p>	-	-	-	X	-	N6 Delay Measurement Protocols

Operator Configurable UPF Capability	C	<p>This IE shall be present if the UP function sends this message, and if the support of the Operator Configurable UPF Capabilities has been changed. See also clause 5.8.2.21 of TS 23.501 [28].</p> <p>Several IEs with the same IE type may be present to represent multiple Operator Configurable UPF Capabilities.</p> <p>When present, the SMF shall replace any Operator Configurable UPF Capabilities previously stored, by the new Operator Configurable UPF Capabilities received in this IE.</p>	-	-	-	X	-	Operator Configurable UPF Capability
Packet Inspection functionality	O	<p>This IE may be present, if the UP function sends this message, to indicate the supported packet inspection capabilities as described in clause 8.2.250 (NOTE 1)</p>	-	-	-	X	-	Packet Inspection functionality
<p>NOTE 1: A UPF not including the Packet Inspection functionality IE (e.g. UPF complying with an earlier release of the specification) may support one or more packet inspection capabilities. If the Packet Inspection functionality IE is not received by the CP function, the CP function may determine the packet inspection capabilities of the UPF based on local configuration, or by default, it shall assume that the UPF supports all the packet inspection capabilities required for all the network instances supported by the UPF.</p>								

7.4.4.3.1 UE IP Address Usage Information IE within PFCP Association Update Request

The UE IP Address Usage Information grouped IE shall be encoded as shown in Figure 7.4.4.3.1-1.

Table 7.4.4.3.1-1: UE IP Address Usage Information IE within PFCP Association Update Request

Octet 1 and 2		UE IP Address Usage Information IE Type = 267 (decimal)						
Octets 3 and 4		Length = n						
Information elements	P	Condition / Comment	Appl.					IE Type
			Sx a	Sx b	Sx c	N4	N4 mb	
UE IP Address Usage Sequence Number	M	This IE shall be used by the CP function to properly collate out-of-order UE IP Address Usage Information received for a given network instance and/or UE IP Address pool, e.g. due to PFCP retransmissions. This IE shall also be used by the receiver to determine whether the newly received UE IP Address Usage Information has changed compared to UE IP Address Usage Information previously received from the same node earlier.	-	X	-	X	-	Sequence Number
UE IP Address Usage Metric	M	This IE shall represent the current ratio of occupied UE IP addresses in the UP function for the Network Instance indicated in the Network Instance IE, or for the Network Instance indicated in the Network Instance IE and the UE IP address Pool indicated by the UE IP Address Pool Id IE when this IE is present. The value shall be expressed as a percentage within the range of 0 to 100, where 0 means no or 0% usage and 100 means maximum or 100% usage reached (i.e. it is not desirable to receive further PFCP Session Establishment Requests).	-	X	-	X	-	Metric
Validity Timer	M	This IE shall represent the period of time during which the UE IP Address Usage Information shall be considered as valid.	-	X	-	X	-	Validity Timer
Number of UE IP Addresses	M	This IE shall indicate the total number of UE IP addresses configured for the Network Instance or also for the IP address Pool, when this IE is present. (NOTE)	-	X	-	X	-	Number of UE IP Addresses
Network Instance	M	This IE shall identify the associated Network instance.	-	X	-	X	-	Network Instance
UE IP Address Pool Id	O	This IE may be present if UE IP Addresses Pools are configured in the UPF. When present, this IE shall contain the identity of the associated UE IP address Pool.	-	X	-	X	-	UE IP address Pool Identity
S-NSSAI	O	This IE may be present if the feature "Per slice UP resource management" is supported by the UP Function. When present, it shall indicate the S-NSSAI for which the UE IP addresses usage information is reported.	-	X	-	X	-	S-NSSAI
NOTE: When reporting the number of IPv6 UE Addresses for a specific Network Instance and/or IP address pool, the number of default /64 prefixes is reported by default, unless configured otherwise.								

7.4.4.4 PFCP Association Update Response

Table 7.4.4.4-1: Information Elements in a PFCP Association Update Response

Information elements	P	Condition / Comment	Appl.					IE Type
			Sx a	Sx b	Sx c	N4	N4 mb	
Node ID	M	This IE shall contain the unique identifier of the sending Node.	X	X	X	X	X	Node ID
Cause	M	This IE shall indicate the acceptance or the rejection of the corresponding request message.	X	X	X	X	X	Cause
UP Function Features	O	If present, this IE shall indicate the supported Features when the sending node is the UP function.	X	X	X	X	X	UP Function Features
CP Function Features	O	If present, this IE shall indicate the supported Features when the sending node is the CP function.	X	X	X	X	X	CP Function Features
UE IP Address Usage Information	O	The UP function may include if both UP and CP functions support the UE IP Address Usage Reporting feature. See Table 7.4.4.3.1-1. Several IEs with the same type may be present to represent UE IP Address Usage Information for different UE IP Address Pools and/or Network Instances. See clause 5.21.3.	-	X	-	X	-	UE IP Address Usage Information
N6 Delay Measurement Protocols	O	If present, this IE shall indicate the N6 delay measurement protocols that the UPF supports and the CP function shall replace any earlier received N6 Delay Measurement Protocols by the information received in this IE.	-	-	-	X	-	N6 Delay Measurement Protocols
Operator Configurable UPF Capability	C	This IE shall be present if the UP function sends this message, and if the support of the Operator Configurable UPF capabilities has been changed. See also clause 5.8.2.21 of 3GPP TS 23.501 [28]. Several IEs with the same IE type may be present to represent multiple Operator Configurable UPF Capabilities. When present, the SMF shall replace any Operator Configurable UPF Capabilities previously stored, by the new Operator Configurable UPF Capabilities received in this IE.	-	-	-	X	-	Operator Configurable UPF Capability
Packet Inspection functionality	O	This IE may be present, if the UP function sends this message, to indicate the supported packet inspection capabilities as described in clause 8.2.250. (NOTE 1)	-	-	-	X	-	Packet Inspection functionality
NOTE 1: A UPF not including the Packet Inspection functionality IE (e.g. UPF complying with an earlier release of the specification) may support one or more packet inspection capabilities. If the Packet Inspection functionality IE is not received by the CP function, the CP function may determine the packet inspection capabilities of the UPF based on local configuration, or by default, it shall assume that the UPF supports all the packet inspection capabilities required for all the network instances supported by the UPF.								

7.4.4.5 PFCP Association Release Request

Table 7.4.4.5-1: Information Elements in a PFCP Association Release Request

Information elements	P	Condition / Comment	Appl.					IE Type
			Sx a	Sx b	Sx c	N4	N4 mb	
Node ID	M	This IE shall contain the unique identifier of the sending Node.	X	X	X	X	X	Node ID

7.4.4.6 PFCP Association Release Response

Table 7.4.4.6-1: Information Elements in a PFCP Association Release Response

Information elements	P	Condition / Comment	Appl.					IE Type
			Sx a	Sx b	Sx c	N4	N4 mb	
Node ID	M	This IE shall contain the unique identifier of the sending Node.	X	X	X	X	X	Node ID
Cause	M	This IE shall indicate the acceptance or the rejection of the corresponding request message.	X	X	X	X	X	Cause

7.4.4.7 PFCP Version Not Supported Response

This message shall only contain the PFCP header. The PFCP protocol version in the PFCP header shall indicate the highest PFCP Version that the sending entity supports.

NOTE: The PFCP Version Not Supported Response message can be received by a PFCP entity when sending the very first message to a PFCP peer only supporting earlier version(s) of the protocol.

7.4.5 PFCP Node Report Procedure

7.4.5.1 PFCP Node Report Request

7.4.5.1.1 General

The PFCP Node Report Request shall be sent over the Sxa, Sxb, Sxc, N4 and N4mb interface by the UP function to report information to the CP function that is not specific to a PFCP session.

Table 7.4.5.1.1-1: Information Elements in PFCP Node Report Request

Information elements	P	Condition / Comment	Appl.					IE Type
			Sx a	Sx b	Sx c	N4	N4 mb	

Node ID	M	This IE shall contain the unique identifier of the sending Node.	X	X	X	X	X	Node ID
Node Report Type	M	This IE shall indicate the type of the report.	X	X	X	X	X	Node Report Type
Vendor-Specific Node Report Type	C	This IE shall be present if the Node Report Type IE indicates a Vendor-Specific Report. When present, this IE shall indicate the type of the Vendor-Specific Report.	X	X	X	X	X	Vendor-Specific Node Report Type
User Plane Path Failure Report	C	This IE shall be present if the Node Report Type indicates a User Plane Path Failure Report.	X	X	-	X	X	User Plane Path Failure Report
User Plane Path Recovery Report	C	This IE shall be present if the Node Report Type indicates a User Plane Path Recovery Report.	X	X	-	X	X	User Plane Path Recovery Report
Clock Drift Report	C	This IE shall be present if the Node Report Type indicates a Clock Drift Report. More than one IE with this type may be included to send Clock Drift Reports for different Time Domain Numbers.	-	-	-	X	-	Clock Drift Report
GTP-U Path QoS Report	C	This IE shall be present if the Node Report Type indicates a GTP-U Path QoS Report. More than one IE with this type may be included to represent multiple remote GTP-U peers for which QoS information is reported.	-	-	-	X	-	GTP-U Path QoS Report
Peer UP Restart Report	C	This IE shall be present if the Node Report Type Indicates a Peer GTP-U entity has restarted as specified in clause 20.3.4a of 3GPP TS 23.007 [24] and in clause 5.5 of 3GPP TS 23.527 [40].	X	X	-	X	-	Peer UP Restart Report
N6 Delay Measurement Report	C	This IE shall be present if the Node Report Type indicates a N6 Delay Measurement Report. More than one IE with this type may be included to report N6 delay measurement information for multiple measurement endpoints.	-	-	-	X	-	N6 Delay Measurement Report

7.4.5.1.2 User Plane Path Failure Report IE within PFCP Node Report Request

Table 7.4.5.1.2-1: User Plane Path Failure Report IE within PFCP Node Report Request

Octet 1 and 2	User Plane Path Failure Report IE Type = 102 (decimal)							
Octets 3 and 4	Length = n							
Information elements	P	Condition / Comment	Appl.					IE Type
			Sx a	Sx b	Sx c	N4	N4 mb	
Remote GTP-U Peer	M	This IE shall include the IP address of the remote GTP-U peer towards which a user plane path failure has been detected. More than one IE with this type may be included to represent multiple remote GTP-U peers towards which a user plane path failure has been detected.	X	X	-	X	X	Remote GTP-U Peer

7.4.5.1.3 User Plane Path Recovery Report IE within PFCP Node Report Request

Table 7.4.5.1.3-1: User Plane Path Recovery Report IE within PFCP Node Report Request

Octet 1 and 2	User Plane Path Recovery Report IE Type = 187 (decimal)							
Octets 3 and 4	Length = n							
Information elements	P	Condition / Comment	Appl.					IE Type
			Sx a	Sx b	Sx c	N4	N4 mb	

Remote GTP-U Peer	M	This IE shall include the IP address of the remote GTP-U peer towards which user plane path failure was reported and then the path has recovered within an operator configurable maximum path failure duration (see clause 20.3.4 in 3GPP TS 23.007 [24] and clause 5.4 in 3GPP TS 23.527 [40]). More than one IE with this type may be included to represent multiple remote GTP-U peers towards which a user plane path has recovered.	X	X	-	X	X	Remote GTP-U Peer
-------------------	---	---	---	---	---	---	---	-------------------

7.4.5.1.4 Clock Drift Report IE within PFCP Node Report Request

Table 7.4.5.1.4-1: Clock Drift Report IE within PFCP Node Report Request

Octet 1 and 2		Clock Drift Report IE Type = 205 (decimal)						
Octets 3 and 4		Length = n						
Information elements	P	Condition / Comment	Appl.					IE Type
			Sx a	Sx b	Sx c	N4	N4 mb	
Time Domain Number	M	This IE shall identify the Time Domain Number for which measurements are reported.	-	-	-	X	-	Time Domain Number
Time Offset Measurement	O	When present, this IE shall contain the time offset measurement.	-	-	-	X	-	Time Offset Measurement
Cumulative rateRatio Measurement	O	When present, this IE shall contain the cumulative rateRatio measurement.	-	-	-	X	-	Cumulative rateRatio Measurement
Time Stamp	O	When present, this IE shall provide the timestamp when the collection of the information in this report was generated.	-	-	-	X	-	Time Stamp
Network Instance	C	This IE shall be present, when available (NOTE).	-	-	-	X	-	Network Instance
APN/DNN	C	This IE shall be present, when available (NOTE).	-	-	-	X	-	APN/DNN
S-NSSAI	C	This IE shall be present, when available (NOTE).	-	-	-	X	-	S-NSSAI
NOTE: The UPF shall provide the Network Instance and DNN/S-NSSAI (if available) to the CP function, to enable SMF to associate the report with the corresponding PFCP sessions and NW-TT, when the UPF supports more than one NW-TT.								

7.4.5.1.5 GTP-U Path QoS Report IE within PFCP Node Report Request

Table 7.4.5.1.5-1: GTP-U Path QoS Report IE within PFCP Node Report Request

Octet 1 and 2		GTP-U Path QoS Report IE Type = 239 (decimal)						
Octets 3 and 4		Length = n						
Information elements	P	Condition / Comment	Appl.					IE Type
			Sx a	Sx b	Sx c	N4	N4 mb	

Remote GTP-U Peer	M	This IE shall include the IP address of the remote GTP-U peer for which QoS information is reported, and the network instance used towards the remote GTP-U peer if available.	-	-	-	X	-	Remote GTP-U Peer
GTP-U Path Interface Type	C	This IE shall be present, if available. When present, it shall indicate the interface type of the GTP-U path towards the remote GTP-U peer.	-	-	-	X	-	GTP-U Path Interface Type
QoS Report Trigger	M	This IE shall indicate the trigger for this report.	-	-	-	X	-	QoS Report Trigger
Time Stamp	M	This shall shall provide the timestamp when the collection of the information in this report was generated.	-	-	-	X	-	Time Stamp
Start Time	C	This shall shall provide the timestamp when the collection of the information in this report was started.	-	-	-	X	-	Start Time
QoS Information	M	This IE shall contain the measured QoS information. More than one IE with this type may be included to represent multiple QoS Information, e.g. for different DSCP values.	-	-	-	X	-	QoS Information

7.4.5.1.6 QoS Information in GTP-U Path QoS Report IE

Table 7.4.5.1.6-1: QoS Information in GTP-U Path QoS Report IE

Octet 1 and 2		QoS Information IE Type = 240 (decimal)						
Octets 3 and 4		Length = n						
Information elements	P	Condition / Comment	Appl.					IE Type
			Sx a	Sx b	Sx c	N4	N4 mb	
Average Packet Delay	M	This IE shall indicate the average packet delay of the related GTP-U path.	-	-	-	X	-	Average Packet Delay
Minimum Packet Delay	C	This IE shall indicate the minimum packet delay of the related GTP-U path, if available.	-	-	-	X	-	Minimum Packet Delay
Maximum Packet Delay	C	This IE shall indicate the maximum packet delay of the related GTP-U path, if available.	-	-	-	X	-	Maximum Packet Delay
DSCP	C	This IE shall be present, if available. When present, it shall contain the value of the DSCP in the TOS/Traffic Class field used in Echo messages to measure the packet delay.	-	-	-	X	-	Transport Level Marking

7.4.5.1.7 Peer UP Restart Report IE within PFCP Node Report Request

Table 7.4.5.1.7-1: Peer UP Restart Report IE within PFCP Node Report Request

Octet 1 and 2		Peer UP Restart Report Type = 315 (decimal)						
Octets 3 and 4		Length = n						
Information elements	P	Condition / Comment	Appl.					IE Type
			Sx a	Sx b	Sx c	N4	N4 mb	
Remote GTP-U Peer	M	This IE shall include the IP address of the remote GTP-U peer which has restarted. More than one IE with this type may be included to represent that multiple peer GTP-U entities restart.	X	X	-	X	X	Remote GTP-U Peer

* * * Next Change * * * *

7.4.5.1.8 N6 Delay Measurement Report IE within PFCP Node Report Request

Table 7.4.5.1.8-1: N6 Delay Measurement Report IE within PFCP Node Report Request

Octet 1 and 2		N6 Delay Measurement Report IE Type = 356 (decimal)						
Octets 3 and 4		Length = n						
Information elements	P	Condition / Comment	Appl.					IE Type
			Sx a	Sx b	Sx c	N4	N4 mb	
Measurement EndPoint Address	M	This IE shall include the IP address of the measurement endpoint for which N6 delay measurement information is reported.	-	-	-	X	-	Measurement EndPoint Address
Network Instance	M	This IE shall indicate the Network Instance at the UPF used to reach the measurement endpoint.	-	-	-	X	-	Network Instance
Measurement Reporting Type	M	This IE shall indicate the trigger for sending the report (periodic, event triggered or immediate reporting).	-	-	-	X	-	Measurement Reporting Type
Time Stamp	M	This IE shall provide the timestamp when the collection of the information in this report was generated.	-	-	-	X	-	Time Stamp
Start Time	C	This IE shall provide the timestamp when the collection of the information in this report was started.	-	-	-	X	-	Start Time
N6 Delay Measurement Information	C	This IE shall be present if N6 delay measurements are being reported. When present, it shall contain the N6 delay measurement information. (NOTE)	-	-	-	X	-	N6 Delay Measurement Information
N6 Delay Measurement Failure Information	C	This IE shall be present if N6 delay measurements cannot be performed towards the measurement endpoint. When present, it shall contain the failure information. (NOTE)	-	-	-	X	-	N6 Delay Measurement Failure Information
Measurement EndPoint Port Number	O	When present, this IE shall indicate the port number of the measurement endpoint for which the information is reported.	-	-	-	X	-	Measurement EndPoint Port Number
NOTE: Either the N6 Delay Measurement Information IE or the N6 Delay Measurement Failure Information IE shall be present.								

7.4.5.2 PFCP Node Report Response

7.4.5.2.1 General

The PFCP Node Report Response shall be sent over the Sxa, Sxb; Sxc, N4 and N4mb interface by the CP function to the UP function as a reply to the PFCP Node Report Request.

Table 7.4.5.2.1-1: Information Elements in PFCP Node Report Response

Information elements	P	Condition / Comment	Appl.					IE Type
			Sx a	Sx b	Sx c	N4	N4 mb	
Node ID	M	This IE shall contain the unique identifier of the sending Node.	X	X	X	X	X	Node ID
Cause	M	This IE shall indicate the acceptance or the rejection of the corresponding request message.	X	X	X	X	X	Cause
Offending IE	C	This IE shall be included if the rejection cause is due to a conditional or mandatory IE missing or faulty.	X	X	X	X	X	Offending IE

7.4.6 PFCP Session Set Deletion

7.4.6.1 PFCP Session Set Deletion Request

The PFCP Session Set Deletion Request shall be sent over the Sxa, Sxb or N4 interface by the CP function to request the UP function to delete the PFCP sessions affected by a partial failure.

The PFCP Session Set Deletion Request shall be also sent over the Sxa, Sxb or N4 interface by the UP function to request the CP function to delete the PFCP sessions affected by a partial failure.

Table 7.4.6.1-1: Information Elements in a PFCP Session Set Deletion Request

Information elements	P	Condition / Comment	Appl.					IE Type
			Sx a	Sx b	Sx c	N4	N4 mb	
Node ID	M	This IE shall contain the node identity of the originating node of the message.	X	X	-	X	-	Node ID
SGW-C FQ-CSID	C	This IE shall be included according to the requirements in clause 23 of 3GPP TS 23.007 [24].	X	X	-	-	-	FQ-CSID
PGW-C/SMF FQ-CSID	C	This IE shall be included according to the requirements in clause 23 of 3GPP TS 23.007 [24] and clause 4.6 of 3GPP TS 23.527 [40].	X	X	-	X	-	FQ-CSID
PGW-U/SGW-U/UPF FQ-CSID	C	This IE shall be included according to the requirements in clause 23 of 3GPP TS 23.007 [24] and clause 4.6 of 3GPP TS 23.527 [40].	X	X	-	X	-	FQ-CSID
TWAN FQ-CSID	C	This IE shall be included according to the requirements in clause 23 of 3GPP TS 23.007 [24].	-	X	-	-	-	FQ-CSID
ePDG FQ-CSID	C	This IE shall be included according to the requirements in clause 23 of 3GPP TS 23.007 [24].	-	X	-	-	-	FQ-CSID
MME FQ-CSID	C	This IE shall be included according to the requirements in clause 23 of 3GPP TS 23.007 [24].	X	X	-	-	-	FQ-CSID

7.4.6.2 PFCP Session Set Deletion Response

The PFCP Session Set Deletion Response shall be sent over the Sxa, Sxb or N4 interface by the UP function or the CP function as a reply to the PFCP Session Set Deletion Request.

Table 7.4.6.2-1: Information Elements in a PFCP Session Set Deletion Response

Information elements	P	Condition / Comment	Appl.					IE Type
			Sx a	Sx b	Sx c	N4	N4 mb	
Node ID	M	This IE shall contain the unique identifier of the sending node.	X	X	-	X	-	Node ID
Cause	M	This IE shall indicate the acceptance or the rejection of the corresponding request message.	X	X	-	X	-	Cause
Offending IE	C	This IE shall be included if the rejection is due to an conditional or mandatory IE missing or faulty.	X	X	-	X	-	Offending IE

7.4.7 PFCP Session Set Modification

7.4.7.1 PFCP Session Set Modification Request

The PFCP Session Set Modification Request shall be sent over the Sxb or N4 interface by the CP function to request the UP function to send any subsequent PFCP Session Report Request messages for the PFCP sessions which are identified by either FQ-CSID(s) or Group Id(s), or the CP IP Address in their F-SEIDs, towards an (alternative) SMF/PGW-C, e.g. when those PFCP sessions are affected by a partial PGW-C/SMF failure or are controlled by a PGW-C/SMF that is shutting down.

This procedure shall only be performed if the UP function indicated support of the RESPS feature (see clause 8.2.25).

Table 7.4.7.1-1: Information Elements in a PFCP Session Set Modification Request

Information elements	P	Condition / Comment	Appl.					IE Type
			Sx a	Sx b	Sx c	N4	N4 mb	

Node ID	M	This IE shall contain the node identity of the originating node of the message.	-	X	-	X	-	Node ID
PFCP Session Change Info	M	This IE shall identify the FQ-CSID(s), Group Id(s) or CP IP address(es) of the PFCP sessions for which the PGW-U/UPF shall send subsequent PFCP Session Report Request messages to an Alternative SMF/PGW-C IP Address. Several IEs with the same IE type may be present to request the PGW-U/UPF to move PFCP sessions associated with different FQ-CSIDs, Group Ids or CP IP addresses to different PGW-C/SMFs.	-	X	-	X	-	PFCP Session Change Info

Table 7.4.7.1-2: PFCP Session Change Info IE within PFCP Session Set Modification Request

Octet 1 and 2		PFCP Session Change Info IE Type = 290 (decimal)						
Octets 3 and 4		Length = n						
Information elements	P	Condition / Comment	Appl.					IE Type
			Sx a	Sx b	Sx c	N4	N4 mb	
PGW-C/SMF FQ-CSID	C	This IE shall identify the PGW-C/SMF FQ-CSID of the PFCP sessions for which the UPF shall send subsequent PFCP Session Report Request messages to the Alternative SMF/PGW-C IP Address. See also clause 31.6 of 3GPP TS 23.007 [24] and clause 4.7 of 3GPP TS 23.527 [40]. Several IEs with the same IE type may be present to represent several FQ-CSIDs of PFCP sessions that need to be moved to the same Alternative SMF/PGW-C IP Address.	-	X	-	X	-	FQ-CSID
Group Id	C	This IE shall identify the Group Id of the PFCP sessions for which the UPF shall send subsequent PFCP Session Report Request messages to the Alternative SMF/PGW-C IP Address. See also clause 31.6 of 3GPP TS 23.007 [24] and clause 4.7 of 3GPP TS 23.527 [40]. Several IEs with the same IE type may be present to represent several Group Ids of PFCP sessions that need to be moved to the same Alternative SMF/PGW-C IP Address.	-	X	-	X	-	Group-Id
CP IP Address	C	This IE shall identify the IP address in the CP F-SEID of the PFCP sessions for which the UPF shall send subsequent PFCP Session Report Request messages to the Alternative SMF/PGW-C IP Address. Several IEs with the same IE type may be present to represent several CP IP addresses of PFCP sessions that need to be moved to the same Alternative SMF/PGW-C IP Address.	-	X	-	X	-	CP IP Address
Alternative SMF/PGW-C IP Address	M	This IE shall include the alternative SMF/PGW-C IP Address to be used by the UP function to send subsequent PFCP Session Report Request messages for the PFCP Sessions associated with the PGW-C/SMF FQ-CSID(s), Group Id(s) or CP IP address(es). When present, this IE shall contain an IPv4 and/or IPv6 address of the same or an alternative SMF/PGW-C.	-	X		X	-	Alternative SMF IP Address

7.4.7.2 PFCP Session Set Modification Response

The PFCP Session Set Modification Response shall be sent over the Sxb or N4 interface by the UP function to the CP function as a reply to the PFCP Session Set Modification Request.

Table 7.4.2.2-1: Information Elements in a PFCP Session Set Modification Response

Information elements	P	Condition / Comment	Appl.					IE Type
			Sx a	Sx b	Sx c	N4	N4 mb	
Node ID	M	This IE shall contain the unique identifier of the sending node.	-	X	-	X	-	Node ID
Cause	M	This IE shall indicate the acceptance or the rejection of the corresponding request message.	-	X	-	X	-	Cause
Offending IE	C	This IE shall be included if the rejection is due to a conditional or mandatory IE missing or faulty.	-	X	-	X	-	Offending IE

7.5 PFCP Session Related Messages

7.5.1 General

This clause specifies the session related messages used over the Sxa, Sxb and Sxc reference points.

7.5.2 PFCP Session Establishment Request

7.5.2.1 General

The PFCP Session Establishment Request shall be sent over the Sxa, Sxb, Sxc, N4 and N4mb interface by the CP function to establish a new PFCP session context in the UP function.

Table 7.5.2.1-1: Information Elements in a PFCP Session Establishment Request

Information elements	P	Condition / Comment	Appl.					IE Type
			Sxa	Sxb	Sxc	N4	N4 mb	

Node ID	M	This IE shall contain the unique identifier of the sending Node.	X	X	X	X	X	Node ID
CP F-SEID	M	This IE shall contain the unique identifier allocated by the CP function identifying the session.	X	X	X	X	X	F-SEID
Create PDR	M	This IE shall be present for at least one PDR to be associated to the PFCP session. Several IEs with the same IE type may be present to represent multiple PDRs. See Table 7.5.2.2-1.	X	X	X	X	X	Create PDR
Create FAR	M	This IE shall be present for at least one FAR to be associated to the PFCP session. Several IEs with the same IE type may be present to represent multiple FARs. See Table 7.5.2.3-1.	X	X	X	X	X	Create FAR
Create URR	C	This IE shall be present if a measurement action shall be applied to packets matching one or more PDR(s) of this PFCP session. Several IEs within the same IE type may be present to represent multiple URRs. See Table 7.5.2.4-1.	X	X	X	X	X	Create URR
Create QER	C	This IE shall be present if a QoS enforcement or QoS marking action shall be applied to packets matching one or more PDR(s) of this PFCP session. Several IEs within the same IE type may be present to represent multiple QERs. See Table 7.5.2.5-1.	-	X	X	X	X	Create QER
Create BAR	O	When present, this IE shall contain the buffering instructions to be applied by the UP function to any FAR of this PFCP session set with the Apply Action requesting the packets to be buffered and with a BAR ID IE referring to this BAR. See table 7.5.2.6-1.	X	-	-	X	-	Create BAR
Create Traffic Endpoint	C	This IE may be present if the UP function has indicated support of PDI optimization. Several IEs within the same IE type may be present to represent multiple Traffic Endpoints. See Table 7.5.2.7-1.	X	X	X	X	X	Create Traffic Endpoint
PDN Type	C	This IE shall be present if the PFCP session is setup for an individual PDN connection or PDU session (see clause 5.2.1). When present, this IE shall indicate whether this is an IP or non-IP PDN connection/PDU session or, for 5GC, an Ethernet PDU session. See NOTE 3.	X	X	-	X	-	PDN Type
SGW-C FQ-CSID	C	This IE shall be included according to the requirements in clause 23 of 3GPP TS 23.007 [24].	X	X	-	-	-	FQ-CSID
MME FQ-CSID	C	This IE shall be included when received on the S11 interface or on S5/S8 interface according to the requirements in clause 23 of 3GPP TS 23.007 [24].	X	X	-	-	-	FQ-CSID
PGW-C/SMF FQ-CSID	C	This IE shall be included according to the requirements in clause 23 of 3GPP TS 23.007 [24] and clause 4.6 of 3GPP TS 23.527 [40].	X	X	-	X	-	FQ-CSID
ePDG FQ-CSID	C	This IE shall be included according to the requirements in clause 23 of 3GPP TS 23.007 [24].	-	X	-	-	-	FQ-CSID
TWAN FQ-CSID	C	This IE shall be included according to the requirements in clause 23 of 3GPP TS 23.007 [24].	-	X	-	-	-	FQ-CSID
User Plane Inactivity Timer	O	This IE may be present to request the UP function to send a User Plane Inactivity Report when no user plane packets are received for this PFCP session for a duration exceeding the User Plane Inactivity Timer. When present, it shall contain the duration of the inactivity period after which a User Plane Inactivity Report shall be generated.	-	X	X	X	X	User Plane Inactivity Timer
User ID	O	This IE may be present, based on operator policy. It shall only be sent if the UP function is in a trusted environment. See NOTE 1.	X	X	X	X	-	User ID

Trace Information	O	When present, this IE shall contain the trace instructions to be applied by the UP function for this PFCP session.	X	X	X	X	-	Trace Information
APN/DNN	O	This IE may be present, if related functionalities in the UP function require the APN/DNN information. See NOTE 2. This IE should be sent from the V-SMF to any V-UPF acting as (local) PSA for a HR-SBO PDU session and capable of enforcing NAT on N6 traffic. When present, it shall contain the full DNN of the PDU session (with the Operator ID part identifying the HPLMN ID). This IE should be sent from the SMF to the selected UPF acting as PSA if the UPF indicates to support the UPSBIES feature (see clause 8.2.25 and clause 5.40).	X	X	-	X	X	APN/DNN
Create MAR	C	This IE shall be present for a N4 session established for a MA PDU session. Several IEs with the same IE type may be present to represent multiple MARs. See Table 7.5.2.8-1.	-	-	-	X	-	Create MAR
PFCPSEReq-Flags	C	This IE shall be included if at least one of the flags is set to "1". <ul style="list-style-type: none"> - RESTI (Restoration Indication): this bit shall be set to "1" if the CP function re-establishes an existing PFCP session and the allocation of GTP-U F-TEID and/or UE IP address is performed by the UP function. (NOTE 4) - SUMPC (Stop Usage Measurement to Pause Charging): the CP function, e.g. PGW-C or (H-)SMF, shall set this flag if the usage measurement for the URRs which are applicable for charging (i.e. with the "ASPOC" flag set to "1") shall be stopped in the UP function. - HRSBOM (HR-SBO Mode): the V-SMF shall set this flag to the V-UPF acting as Local PSA in the VPLMN, if the V-SMF supports HR-SBO and if the PDU session is working in HB-SBO mode. - EPRI (Exclude PFCP session from Restoration Indication): this bit shall be set to "1" if the SSET or MPAS feature is supported by the SMF and the UPF, and if the PFCP session shall be excluded from the restoration of the PFCP sessions affected by the SMF failure if detected. 	X	X	-	X	-	PFCPSEReq-Flags
Create Bridge/Router Info	C	This IE shall be present to request the UPF to provide Bridge/Router information for a PFCP session established for TSN, TSCTS or DetNet.	-	-	-	X	-	Create Bridge/router Info
Create SRR	O	This IE may be present to request the UPF to detect and report events not related to specific PDRs. Several IEs within the same IE type may be present to represent multiple SRRs. See Table 7.5.2.9-1.	-	-	-	X	-	Create SRR
Provide ATSSS Control Information	C	This IE shall be present for N4 session establishment for a MA PDU session. When present, this IE shall contain the required ATSSS functionalities for this MA PDU session. See Table 7.5.2.10-1.	-	-	-	X	-	Provide ATSSS Control Information
Recovery Time Stamp	O	This IE may be included to contain the time stamp when the CP function was started. (See clause 19A of 3GPP TS 23.007 [24].)	X	X	X	X	-	Recovery Time Stamp

S-NSSAI	O	This IE may be present, if related functionalities in the UP function require the S-NSSAI information. (NOTE 2, NOTE 5) When present, it shall indicate the S-NSSAI of the PDU session or MBS session. This IE should be sent from the SMF to the selected UPF acting as PSA if the UPF indicates to support the UPSBIES feature (see clause 8.2.25 and clause 5.40).	-	-	-	X	X	S-NSSAI
HPLMN S-NSSAI	C	This IE should be sent from the V-SMF to any V-UPF acting as (local) PSA for a HR-SBO PDU session and capable of enforcing NAT on N6 traffic. When present, it shall contain the HPLMN S-NSSAI.	-	-	-	X	-	HPLMN S-NSSAI
Provide RDS configuration information	O	When present, this IE shall contain the RDS configuration information to be applied by the UP function for this PFCP session.	-	X	-	X	-	Provide RDS configuration information
RAT Type	O	This IE may be present to provide the UP Function the current RAT Type for the PDN connection/PDU session to which this PFCP Session is corresponding for statistics purpose if the PFCP session is not established for a MA PDU session.	X	X	-	X	-	RAT Type
L2TP Tunnel Information	C	This IE shall be present if L2TP tunnel information is received from an AAA server, e.g. Radius/Diameter server or if it is configured in the CP function. Several IE with the same IE type may be present to provide L2TP Tunnel Information for alternative LNS.	-	X	-	X	-	L2TP Tunnel Information
L2TP Session Information	C	This IE shall be present to include the information to establish a L2TP session, if an L2TP session needs to be established for this PFCP session.	-	X	-	X	-	L2TP Session Information
Group Id	O	This IE may be included by the CP function to indicate the group identifier to which the PFCP session pertains (see clause 5.22).	-	X	-	X	-	Group Id
MBS Session N4mb Control Information	M	This IE shall identify the MBS session, or the MBS session and Area Session ID for a location dependent MBS service, and it may contain further control information for the MB-UPF.	-	-	-	-	X	MBS Session N4mb Control Information
MBS Session N4 Control Information	C	This IE shall be included if the correspond PDU session shall be associated with an MBS session, or with an MBS session and Area Session ID for a location dependent MBS service. Several IEs with the same IE type may be present to provide N4 control information for several MBS sessions, e.g., when the UE requests to join several MBS sessions.	-	-	-	X	-	MBS Session N4 Control Information
DSCP to PPI Control Information	O	This IE may be present if the UPF is required to insert the Paging Policy Indicator (PPI) in the GTP-U PDU Session Container extension header of outgoing GTP-U packets (encapsulating payload packets) based on the DSCP in the TOS/Traffic Class field in the IP header of payload packet and if the UPF supports the EPPPI feature as specified in clause 5.36.2. Several IEs with the same IE type may be present to provide different DSCP to PPI Control Information for different set of QFI(s).	-	-	-	X	-	DSCP to PPI Control Information
TL-Container	C	This IE shall be present if the SMF/CUC needs to send a TL-Container to the UPF/CN-TL.	-	-	-	X	-	TL-Container

Trace Collection Entity URI	O	This IE may be present if an UP function trace is activated for this PFCP session and if the Trace Information IE is included. When present, this IE shall include the Trace Reporting Consumer URI for Streaming based Reporting as defined in 3GPP TS 32.422 [35]. If the UP function supports Streaming based Reporting and Trace Collection Entity URI IE is present, the IP Address of Trace Collection Entity in Trace Information IE shall be ignored.	X	X	X	X	-	URI
UE Level Measurements Configuration	O	This IE may be present if the Trace Information IE is present. When present, this IE shall contain the 5GC UE Level Measurement configuration data to be applied by the UP function for this PFCP session (see clause 4.1.2.18 of 3GPP TS 32.422 [35]).	-	-	-	X	-	UE Level Measurements Configuration
Alternative SMF IP Address	O	When present, this IE shall contain the Alternative SMF IP Address. (NOTE 6)	-	-	-	X	-	Alternative SMF IP Address
MoQ Control Information	C	This IE shall be present if the UPF is required to perform MoQ relay functionality.	-	-	-	X	-	MoQ Control Information

NOTE 1: This can be used for troubleshooting problems in the UP function affecting a subscriber.
 NOTE 2: The CP function may provide additional information (e.g. APN/DNN, S-NSSAI) to the UP function, e.g. used by the forwarding rules pre-defined in UP function (some forwarding rules are APN specific), used by the UP function for performance measurement, used by the UP function for resource management, or used by the UPF to include a proper User plane node/Bridge ID in the response message during a PFCP session establishment for a PDU session for TSC.
 NOTE 3: The SGW-C may set PDN type as Non-IP for an Ethernet PDN to allow interworking with a legacy SGW-U.
 NOTE 4: The UP function shall accept the CP function allocated GTP-U F-TEID and/or UE IP address in the PFCP Session Establishment Request message with the RESTI flag set to "1", if the requested GTP-U F-TEID and/or UE IP address are available. If the GTP-U F-TEID or UE IP address provided by the CP function is not available at the UP function, the UP function shall reject the PFCP Session Establishment Request with the cause "PFCP session restoration failure due to requested resource not available" (see clause 8.2.1).
 NOTE 5: A UPF shall support allocating resources using the Network Instance IE and the UPF may additionally support allocating resources using the Network Instance IE and S-NSSAI IE (see clause 5.35).
 NOTE 6: When the UPF performs the SMF restoration procedures for an SMF in a SMF set specified in 3GPP TS 23.527 [40], e.g. when it detects the SMF has failed, it shall use the Alternative SMF IP Address provisioned at the PFCP session if received and if supported by the UPF, otherwise the UPF shall use the Alternative SMF IP Address or SMF Set ID provisioned in PFCP Association Setup Request/Response messages or PFCP Association Update Request message to select an alternative SMF to restore the PFCP session.

Table 7.5.2.1-2: L2TP Tunnel Information IE in the PFCP Session Establishment Request message

Octet 1 and 2		L2TP Tunnel Information IE Type = 276 (decimal)						
Octets 3 and 4		Length = n						
Information elements	P	Condition / Comment	Appl.					IE Type
			Sxa	Sxb	Sxc	N4	N4mb	
LNS Address	M	This IE shall be present to include the Tunnel Server Endpoint, i.e. LNS IP address.	-	X	-	X	-	LNS Address
Tunnel Password	O	This IE may be present to include the password to be used to authenticate to a remote server.	-	X	-	X	-	Tunnel Password
Tunnel Preference	C	This IE shall be present if multiple L2TP Tunnel Information IEs are included in the message. If present this IE indicates the order in which the L2TP Tunnel Information IEs shall be used when trying to establish the L2TP session.	-	X	-	X	-	Tunnel Preference

Table 7.5.2.1-3: L2TP Session Information IE in the PFCP Session Establishment Request message

Octet 1 and 2		L2TP Session Information IE Type = 277 (decimal)						
Octets 3 and 4		Length = n						
Information elements	P	Condition / Comment	Appl.					IE Type
			Sx a	Sx b	Sx c	N4	N4 mb	
Calling Number	O	This IE may be present, e.g. to include an MSISDN of the UE.	-	X	-	X	-	Calling Number
Called Number	O	This IE may be present, e.g. to include an APN/DNN.	-	X	-	X	-	Called Number
Maximum Receive Unit	O	This IE may be present to include Maximum Receive Unit for LCP/PPP which may be set to the value of the MTU received from the UE or may be configured in the CP function.	-	X	-	X	-	Maximum Receive Unit
L2TP Session Indications	C	This IE shall be present if the CP function requests the UP function to get a UE IP Address, and/or DNS server information, and/or NBNS server information from the LNS.	-	X	-	X	-	L2TP session Indications
L2TP User Authentication	O	This IE may be present to include the authentication information to be used during L2TP session establishment.	-	X	-	X	-	L2TP User Authentication
NOTE: The Tunnel Password and L2TP User Authentication IE are transferred with plain text, a Network Domain Security/IP based security mechanism may be deployed between the CP function and the UP function if required by the local policies.								

Table 7.5.2.1-4: MBS Session N4mb Control Information IE within PFCP Session Establishment Request

Octet 1 and 2		MBS Session N4mb Control Information IE Type = 300 (decimal)						
Octets 3 and 4		Length = n						
Information elements	P	Condition / Comment	Appl.					IE Type
			Sx a	Sx b	Sx c	N4	N4 mb	

MBS Session Identifier	M		-	-	-	-	X	MBS Session Identifier
Area Session ID	C	This IE shall be present for a location dependent MBS service. When present, it shall contain the Area Session ID, which together with the MBS Session Identifier, uniquely identify the service area part of the content data of the MBS service.	-	-	-	-	X	Area Session ID
MBSN4mbReq-Flags	C	This IE shall be included if at least one of the flags is set to "1". <ul style="list-style-type: none"> - PLLSSM (Provide Lower Layer SSM): the MB-SMF shall set this flag to "1" to request the MB-UPF to allocate a LL SSM (i.e. multicast destination address and related source IP address) and a GTP-U Common Tunnel EndPoint Identifier (C-TEID), if multicast transport is used over N3mb and/or N19mb. See clause 5.34.2.2. - JMBSSM (Join MBS Session SSM): the MB-SMF shall set this flag to "1" to request the MB-UPF to join the multicast tree towards the Source Specific Multicast (SSM) address information provided by AF/AS for the MBS Session, if multicast transport is used over N6mb. - MBS RESTI (MBS Restoration Indication): this bit shall be set to "1" if the MB-SMF re-establishes an existing PFCP session. (NOTE) 	-	-	-	-	X	MBSN4mbReq-Flags
Multicast Transport Information for N3mb and/or N19mb	C	This IE shall be present during the restoration of a PFCP session of an MBS session after an MB-UPF restart, as defined in clause 8.2.2 of 3GPP TS 23.527 [40]. When present, it shall include the low layer source specific multicast address information (i.e. multicast destination address and related source IP address) and the GTP-U Common Tunnel EndPoint Identifier (C-TEID) that the MB-SMF requests the MB-UPF to allocate for multicast transport over N3mb and/or N19mb, if possible. (NOTE)	-	-	-	-	X	Multicast Transport Information
NOTE: The MB-UPF shall accept the MB-SMF allocated N3mb/N19mb and/or the N6mb/Nmb9 address in the PFCP Session Establishment Request message with the MBS RESTI flag set to "1", if the requested addresses are available. If one requested address is not available at the MB-UPF, the MB-UPF shall reject the PFCP Session Establishment Request with the cause "PFCP session restoration failure due to requested resource not available" (see clause 8.2.1).								

Table 7.5.2.1-5: MBS Session N4 Control Information IE within PFCP Session Establishment Request

Octet 1 and 2	MBS Session N4 Control Information IE Type = 310 (decimal)							
Octets 3 and 4	Length = n							
Information elements	P	Condition / Comment	Appl.					IE Type
			Sx a	Sx b	Sx c	N4	N4 mb	

MBS Session Identifier	M		-	-	-	X	-	MBS Session Identifier
Area Session ID	C	This IE shall be present for a location dependent MBS service. When present, it shall contain the Area Session ID, which together with the MBS Session Identifier, uniquely identify the service area part of the content data of the MBS service.	-	-	-	X	-	Area Session ID
Multicast Transport Information	C	This IE shall be present to include a low layer source specific multicast address information (i.e. multicast destination address and related source IP address) and a GTP-U Common Tunnel EndPoint Identifier (C-TEID) which was allocated by the MB-UPF, if IP multicast transport is used over N19mb.	-	-	-	X	-	Multicast Transport Information

Table 7.5.2.1-6: DSCP to PPI Control Information IE within PFCP Session Establishment Request

Octet 1 and 2		DSCP to PPI Control Information IE Type = 316 (decimal)						
Octets 3 and 4		Length = n						
Information elements	P	Condition / Comment	Appl.					IE Type
			Sx a	Sx b	Sx c	N4	N4 mb	
DSCP to PPI Mapping Information	M	This IE shall be present to instruct the UPF to insert the corresponding PPI for the downlink GTP-U packet, where the DSCP of its payload packet is matching one of DSCP codes in the DSCP to PPI Mapping Information. Several IEs with the same IE type may be present to provide different DSCP to PPI mapping information.	-	-	-	X	-	DSCP to PPI Mapping Information
QFI	O	This IE may be present to request the UPF to only insert PPI for those packets pertain to the requested QoS flow(s). Several IEs with the same IE type may be present to provide a list of QFIs. (NOTE 1)	-	-	-	X	-	QFI

NOTE 1: The absence of QFI(s) indicates that insertion of the corresponding PPI shall be applied for all DL packets (matching the DSCP(s) of the DSCP to PPI Mapping Information IE) pertaining to all QoS flows of the PFCP session.

7.5.2.2 Create PDR IE within PFCP Session Establishment Request

The Create PDR grouped IE shall be encoded as shown in Figure 7.5.2.2-1.

Table 7.5.2.2-1: Create PDR IE within PFCP Session Establishment Request

Octet 1 and 2		Create PDR IE Type = 1(decimal)						
Octets 3 and 4		Length = n						
Information elements	P	Condition / Comment	Appl.					IE Type
			Sxa	Sxb	Sxc	N4	N4 mb	

PDR ID	M	This IE shall uniquely identify the PDR among all the PDRs configured for that PFCP session.	X	X	X	X	X	PDR ID
Precedence	M	This IE shall indicate the PDR's precedence to be applied by the UP function among all PDRs of the PFCP session, when looking for a PDR matching an incoming packet.	-	X	X	X	X	Precedence
PDI	M	This IE shall contain the PDI against which incoming packets will be matched. See Table 7.5.2.2-2.	X	X	X	X	X	PDI
Outer Header Removal	C	This IE shall be present if the UP function is required to remove one or more outer header(s) from the packets matching this PDR.	X	X	-	X	X	Outer Header Removal
FAR ID	C	This IE shall be present if the Activate Predefined Rules IE is not included or if it is included but it does not result in activating a predefined FAR, and if the MAR ID is not included. This IE may be present if the CP function activated a predefined rule name with a predefined FAR but the CP function wishes to overwrite the predefined FAR by another FAR. (NOTE 2) When present this IE shall contain the FAR ID to be associated to the PDR.	X	X	X	X	X	FAR ID
URR ID	C	This IE shall be present if a measurement action shall be applied to packets matching this PDR. When present, this IE shall contain the URR IDs to be associated to the PDR. Several IEs within the same IE type may be present to represent a list of URRs to be associated to the PDR.	X	X	X	X	-	URR ID
QER ID	C	This IE shall be present if a QoS enforcement or QoS marking action shall be applied to packets matching this PDR. When present, this IE shall contain the QER IDs to be associated to the PDR. Several IEs within the same IE type may be present to represent a list of QERs to be associated to the PDR.	-	X	X	X	X	QER ID
Activate Predefined Rules	C	This IE shall be present if Predefined Rule(s) shall be activated for this PDR. When present this IE shall contain one Predefined Rules name. Several IEs with the same IE type may be present to represent multiple "Activate Predefined Rules" names.	-	X	X	X	-	Activate Predefined Rules
Activation Time	O	This IE may be present if the PDR activation shall be deferred. (NOTE 1)	-	X	X	X	-	Activation Time
Deactivation Time	O	This IE may be present if the PDR deactivation shall be deferred. (NOTE 1)	-	X	X	X	-	Deactivation Time
MAR ID	C	This IE shall be present if the PDR is provisioned to match the downlink traffic of non-GBR QoS flows towards the UE for a PFCP session established for a MA PDU session.	-	-	-	X	-	MAR ID
Packet Replication and Detection Carry-On Information	C	This IE shall be present if the PDR is provisioned to match a broadcast packet. When present, it contains the information to instruct the UPF to replicate the packet and to carry-on the look-up of other PDRs of other PFCP sessions matching the packet (see clause 5.2.1).	-	-	-	X	-	Packet Replication and Detection Carry-On Information
IP Multicast Addressing Info	O	This IE may be present in an UL PDR controlling UL IGMP/MLD traffic (see 5.25). When present, it shall contain a (range of) IP multicast address(es), and optionally source specific address(es), identifying a set of IP multicast flows. See Table 7.5.2.2-4. Several IEs with the same IE type may be present to represent multiple IP multicast flows.	-	-	-	X	-	IP Multicast Addressing Info

UE IP address Pool Identity	O	This IE may be present if UE IP Addresses Pools are configured in the UPF. When present, this IE shall contain the identity of a UE IP address Pool configured in the UPF. Two IEs with the same IE type shall be present to represent UE IPv4 Address Pool Identity and UE IPv6 Address Pool Identity if different pool identities are used for UE IPv4 address and UE IPv6 address and both an UE IPv4 and an UE IPv6 address are requested to be assigned for the PFCP session. In this case, the UE IPv4 Address Pool Identity shall be encoded before the UE IPv6 Address Pool Identity.	-	X	-	X	-	UE IP address Pool Identity
Multipath Applicable Indication	C	This IE shall be present if the PDR is used to detect UL user plane traffic for which MPTCP, MPQUIC-UDP, MPQUIC-IP or MPQUIC-E is applicable.	-	-	-	X	-	Multipath Applicable Indication
Transport Delay Reporting	C	This IE shall be present to request the UPF to add the delay of the GTP-U path with the preceding uplink GTP-U entity to the "N3/N9 Delay Result received in the GTP-U PDU Session Container extension header (see 3GPP TS 38.415 [34]) of the uplink packet, when monitoring the QoS of a PDU session based on GTP-U path monitoring (see clause 5.24.5.3). See Table 7.5.2.2-6.	-	-	-	X	-	Transport Delay Reporting
RAT Type	O	This IE may be present to provide the UP Function the current RAT Type for the UL PDR for statistics purpose if the PFCP session is established for a MA PDU session.	-	-	-	X	-	RAT Type
NOTE 1: When the Activation Time and Deactivation Time are not present, the PDR shall be activated immediately at receiving the message.								
NOTE 2: If a predefined FAR is or has been activated using a predefined rule name, it is UP function implementation specific whether this predefined FAR can be overwritten by a FAR ID pointing to another predefined FAR (i.e. with the most significant bit set to 1). If not, the UP function shall reject such a request if received from the CP function.								

Table 7.5.2.2-2: PDI IE within PFCP Session Establishment Request

Octet 1 and 2	PDI IE Type = 2 (decimal)							
Octets 3 and 4	Length = n							
Information elements	P	Condition / Comment	Appl.					IE Type
			Sxa	Sxb	Sxc	N4	N4mb	

Source Interface	M	This IE shall identify the source interface of the incoming packet.	X	X	X	X	X	Source Interface
Local F-TEID	O	This IE shall not be present if Traffic Endpoint ID is present. If present, this IE shall identify the local F-TEID to match for an incoming packet. The CP function shall set the CHOOSE (CH) bit to 1 if the CP function requests the UP function to assign a local F-TEID to the PDR.	X	X	-	X	-	F-TEID
Local Ingress Tunnel	C	This IE shall not be present if Traffic Endpoint ID is present. If present, this IE shall identify the IP address and the UDP port for a UDP/IP tunnel. The CP function shall set the CHOOSE (CH) bit to 1 if the CP function requests the UP function to assign a local ingress tunnel to the PDR.	-	-	-	-	X	Local Ingress Tunnel
Network Instance	O	This IE shall not be present if Traffic Endpoint ID is present. It shall be present if the CP function requests the UP function to allocate a UE IP address/prefix and the Traffic Endpoint ID is not present. If present, this IE shall identify the Network instance to match for the incoming packet. See NOTE 1, NOTE2.	X	X	X	X	X	Network Instance
Redundant Transmission Detection Parameters	O	If present, this IE shall contain the information used for the reception of redundant uplink packets on N3/N9 interfaces.	-	-	-	X	-	Redundant Transmission Detection Parameters
UE IP address	O	This IE shall not be present if Traffic Endpoint ID is present. If present, this IE shall identify the UE IP address as the source or destination IP address to match for the incoming packet. (NOTE 5). The CP function shall set the CHOOSE IPV4 (CHV4) and/or the CHOOSE IPV6 (CHV6) bits to 1 if the UP function supports the allocation of UE IP address/prefix and the CP function requests the UP function to assign a UE IP address/prefix to the PDR. This IE may also present to identify the IP address of the CP function as the destination IP address to match for the incoming packet, e.g. Radius, Diameter or DHCP signalling packet. (NOTE 8). This IE may be present for a PFCP session established in the V-UPF (local PSA) for a HR-SBO PDU session if the UPF supports the UN6TU feature (see clause 8.2.25). In the 5GC, several IEs with the same IE type may be present to represent multiple UE IP addresses, if the UPF indicated support of the IP6PL feature (see clause 5.21).	-	X	X	X	-	UE IP address
Mapped N6 IP Address	O	When present, the V-SMF shall set the CHOOSE IPV4 (CHV4) bit to 1 if the UP function supports the UMN6IP feature and the V-SMF requests the UP function to assign a mapped N6 IP address for one or more DL PDRs as described in clause 5.33.7.	-	-	-	X	-	Mapped N6 IP Address
N6 Routing Information	O	This IE may be present in a DL PDR when using distinct N6 tunnels from the V-EASDF to the V-UPF for differentiating HR-SBO PDU sessions with overlapping private UE IP addresses. See clause 5.33.7.	-	-	-	X	-	N6 Routing Information

Traffic Endpoint ID	C	This IE may be present if the UP function has indicated the support of PDI optimization. If present, this IE shall uniquely identify the Traffic Endpoint for that PFCP session. Several IEs with the same IE type may be present to provision several Traffic Endpoints with different Traffic Endpoint IDs, from which the UPF may receive packets pertaining to the same service data flow, which is subject for the same FAR, QER and URR, if the UPF has indicated it supports MTE feature as specified in clause 8.2.25. See NOTE 6.	X	X	X	X	X	Traffic Endpoint ID
SDF Filter	O	If present, this IE shall identify the SDF filter to match for the incoming packet. Several IEs with the same IE type may be present to provision a list of SDF Filters. The full set of applicable SDF filters, if any, shall be provided during the creation or the modification of the PDI. See NOTE 3.	-	X	X	X	X	SDF Filter
Application ID	O	If present, this IE shall identify the Application ID to match for the incoming packet.	-	X	X	X	X	Application ID
Ethernet PDU Session Information	O	This IE may be present to identify all the (DL) Ethernet packets matching an Ethernet PDU session (see clause 5.13.1).	-	-	-	X	-	Ethernet PDU Session Information
Ethernet Packet Filter	O	If present, this IE shall identify the Ethernet PDU to match for the incoming packet. Several IEs with the same IE type may be present to represent a list of Ethernet Packet Filters. The full set of applicable Ethernet Packet filters, if any, shall be provided during the creation or the modification of the PDI.	-	-	-	X	-	Ethernet Packet Filter
QFI	O	This IE shall not be present if Traffic Endpoint ID is present and the QFI(s) are included in the Traffic Endpoint. If present, this IE shall identify the QoS Flow Identifier to match for the incoming packet. Several IEs with the same IE type may be present to provision a list of QFIs. When present, the full set of applicable QFIs shall be provided during the creation or the modification of the PDI.	-	-	-	X	-	QFI
Framed-Route	O	This IE may be present for a PDR if the UPF indicated support of Framed Routing (see clauses 8.2.25 and 5.16). If present, this IE shall describe a framed route. Several IEs with the same IE type may be present to provision a list of framed routes. (NOTE 5)	-	X	-	X	-	Framed-Route
Framed-Routing	O	This IE may be present for a DL PDR if the UPF indicated support of Framed Routing (see clauses 8.2.25 and 5.16). If present, this IE shall describe the routing method for the UP function for the IP route related to Framed-Routes or Framed-IPv6-Routes. (NOTE 7)	-	X	-	X	-	Framed-Routing
Framed-IPv6-Route	O	This IE may be present for a PDR if the UPF indicated support of Framed Routing (see clauses 8.2.25 and 5.16). If present, this IE shall describe a framed IPv6 route. Several IEs with the same IE type may be present to provision a list of framed IPv6 routes. (NOTE 5)	-	X	-	X	-	Framed-IPv6-Route
Source Interface Type	C	When present, this IE shall indicate the 3GPP interface type of the source interface. This IE shall be present if this is a PDR for a DL data forwarding tunnel. Otherwise this IE may be present, if required by functionalities in the UP Function, e.g. for performance measurements.	X	X	-	X	X	3GPP Interface Type

IP Multicast Addressing Info	O	This IE may be present in a DL PDR controlling DL IP multicast traffic (see clause 5.25). When present, it shall contain a (range of) IP multicast address(es), and optionally source specific address(es), identifying a set of IP multicast flows. See Table 7.5.2.2-4. This IE shall be present over N4mb, if multicast transport is used over N6mb and if Traffic Endpoint ID is not present. Several IEs with the same IE type may be present to represent multiple IP multicast flows.	-	-	-	X	X	IP Multicast Addressing Info
DNS Query Filter	O	This IE may be present for an UL PDR if the UPF indicated support of DNS traffic steering based on FQDN in the DNS Query message. If present, this IE shall identify the DNS Query filter to match for the incoming DNS Query packets. Several IEs with the same IE type may be present to provision a list of DNS Query Filters. The full set of applicable DNS Query filters, if any, shall be provided during the creation or the modification of the PDI.	-	-	-	X	-	DNS Query/Response Filter
MBS Session Identifier	C	This IE shall be present when the PDR is created to receive MBS session data. (NOTE 9)	-	-	-	X	-	MBS Session Identifier
Area Session ID	C	This IE shall be present for a location dependent MBS service. When present, it shall contain the Area Session ID, which together with the MBS Session Identifier, uniquely identify the service area part of the content data of the MBS service. (NOTE 9)	-	-	-	X	-	Area Session ID
Protocol Description	O	For traffic that is not end-to-end encrypted, this IE may be present to indicate the transport protocol (e.g. RTP/SRTP), transport protocol header extensions (e.g. RTP Header Extension for PDU Set Marking as defined in 3GPP TS 26.522 [79]), payload type and format (e.g. H.264, H.265) used by the packets matching this PDR when PDU Set marking, End of Data Burst marking, Data Burst Size marking, Time to Next Burst marking and/or Expedited data transfer applies to the QER (i.e. QoS flow) with which the PDR is associated. See Table 7.5.2.2-7. (NOTE 10) For end-to-end encrypted traffic, the Protocol Description IE may be provided to indicate how to retrieve media related information (see clause 5.38.7.4).	-	-	-	X	-	Protocol Description
DNS Response Filter	O	This IE may be present for an DL PDR to support EAS discovery procedure with V-EASDF using IP replacement mechanism in HR-SBO. If present, this IE shall identify the DNS Response filter to match for the incoming DNS Response packets. Several IEs with the same IE type may be present to provision a list of DNS Response Filters. The full set of applicable DNS Response filters, if any, shall be provided during the creation or the modification of the PDI.	-	-	-	X	-	DNS Query/Response Filter
Expedited Transfer Indication	O	This IE may be present for a DL PDR. When present, this IE shall indicate the value of the Expedited Transfer Indication (set to TRUE or FALSE) that shall be matched by DL packets.	-	-	-	X	-	Expedited Transfer Indication

- NOTE 1: The Network Instance parameter is needed e.g. in the following cases:
- PGW/TDF UP function supports multiple PDNs with overlapping IP addresses;
 - SGW UP function is connected to PGWs in different IP domains (S5/S8);
 - PGW UP function is connected to SGWs in different IP domains (S5/S8);
 - SGW UP function is connected to eNodeBs in different IP domains;
 - UPF is connected to 5G-ANs in different IP domains;
 - Separation of multiple 5G VN groups communication in the UPF;
 - Indirect data forwarding.
- NOTE 2: When a Local F-TEID is provisioned in the PDI, the Network Instance shall relate to the IP address of the F-TEID. Otherwise, the Network Instance shall relate to the UE IP address if provisioned or the destination IP address in the SDF filter if provisioned
- NOTE 3: SDF Filter IE(s) shall not be present if Ethernet Packet Filter IE(s) is present.
- NOTE 4: When several SDF filter IEs are provisioned, the UP function shall consider that the packets are matched if matching any SDF filter. The same principle shall apply for Ethernet Packet Filters and QFIs.
- NOTE 5: If both the UE IP Address and the Framed-Route (or Framed-IPv6-Route) are present, the packets which are considered being matching the PDR shall match at least one of them.
- NOTE 6: Maximum two Traffic Endpoint ID containing different Local TEIDs per PDI may be provisioned over the N4 interface for a PFCP session which is established for a PDU session subject for 5G to EPS mobility with N26 supported. Several Traffic Endpoint ID containing different UE IP Addresses may be provisioned over the N4 interface for a PFCP session if the UPF also indicated support of the IP6PL feature (see clause 5.21.1).
- NOTE 7: In this release of specification, the UP function shall announce the IP route(s) for Framed-Route(s) or Framed-IPv6-Route(s) to the PDN regardless of the value of the Framed-Routing.
- NOTE 8: The IP address of the CP function is needed e.g. perform Router Advertisements and match the destination IP address of the incoming packet if the Radius, Diameter or DHCP signaling packets between the SMF and the external DN is forwarded by the UPF.
- NOTE 9: The Inclusion of the MBS Session Identifier, or MBS Session Identifier and Area Session ID for a location dependent MBS session, enables the UPF to allocate the same N19mb tunnel for the same MBS Session, or for the same MBS session and Area Session ID for a location dependent MBS session, when receiving multiple PFCP Session Establishment or Modification Request messages for different PFCP sessions being associated with the same MBS session, or with the same MBS session and Area Session ID for a location dependent MBS session, and also helps the UPF to identify the PFCP sessions associated with a MBS Session, or with the same MBS session and Area Session ID for a location dependent MBS session.
- NOTE 10: The Protocol Description IE is not used for packets matching against the PDR. It may be provided to assist:
- PDU Set identification when PDU Set Identification and marking applies to the PDR;
 - identification of the last packet of the Data burst in downlink when End of Data Burst identification and marking in downlink applies to the PDR;
 - determination of the Data Burst Size of the data burst to be inserted in the first DL packets of the data burst when Data Burst Size determination and marking in downlink applies to the PDR;
 - determination of the Time to Next Burst when time to next data burst determination and marking in downlink applies to the PDR; and/or
 - determination of DL packets with Expedited data transfer.

Table 7.5.2.2-3: Ethernet Packet Filter IE within PFCP Session Establishment Request

Octet 1 and 2	Ethernet Packet Filter IE Type = 132 (decimal)							
Octets 3 and 4	Length = n							
Information elements	P	Condition / Comment	Appl.					IE Type
			Sx a	Sx b	Sx c	N4	N4 mb	

Ethernet Filter ID	C	This shall be present if Bidirectional Ethernet filter is required. This IE shall uniquely identify an Ethernet Filter among all the Ethernet Filters provisioned for a given PFCP session.	-	-	-	X	-	Ethernet Filter ID
Ethernet Filter Properties	C	This IE shall be present when provisioning a bidirectional Ethernet Filter the first time (see clause 5.13.4).	-	-	-	X	-	Ethernet Filter Properties
MAC address	O	If present, this IE shall identify the MAC address. This IE may be present up to 16 times.	-	-	-	X	-	MAC address
Ethertype	O	If present, this IE shall identify the Ethertype.	-	-	-	X	-	Ethertype
C-TAG	O	If present, this IE shall identify the Customer-VLAN tag.	-	-	-	X	-	C-TAG
S-TAG	O	If present, this IE shall identify the Service-VLAN tag.	-	-	-	X	-	S-TAG
SDF Filter	O	If packet filtering is required, for Ethernet frames with Ethertype indicating IPv4 or IPv6 payload, this IE shall describe the IP Packet Filter Set. Several IEs with the same IE type may be present to represent a list of SDF filters.	-	-	-	X	-	SDF Filter

Table 7.5.2.2-4: IP Multicast Addressing Info IE within PFCP Session Establishment Request

Octet 1 and 2		IP Multicast Addressing Info IE Type = 188 (decimal)						
Octets 3 and 4		Length = n						
Information elements	P	Condition / Comment	Appl.					IE Type
			Sxa	Sxb	Sxc	N4	N4mb	
IP Multicast Address	M	This IE shall contain the IP multicast address(es) of the DL multicast flow(s) or indicate "any" IP multicast address. For N4mb, the IP Multicast Address shall be set to the value of IP Multicast Address in the SSM for the MBS Session.	-	-	-	X	X	IP Multicast Address
Source IP Address	O	When present, this IE shall contain the source specific IP address of the DL multicast flow. Several IEs with the same IE type may be present to represent multiple source specific addresses. If this IE is not present, this indicates "any" source IP address.	-	-	-	X		Source IP Address
	M	This IE shall be set to the value of the IP Source Address in the SSM for the MBS Session.	-	-	-	-	X	

Table 7.5.2.2-5: Redundant Transmission Detection Parameters IE in PDI

Octet 1 and 2		Redundant Transmission Detection Parameters IE Type = 255 (decimal)						
Octets 3 and 4		Length = n						
Information elements	P	Condition / Comment	Appl.					IE Type
			Sxa	Sxb	Sxc	N4	N4mb	
Local F-TEID for Redundant Transmission	M	This IE shall identify the local F-TEID to match for an incoming packet for redundant transmission. The CP function shall set the CHOOSE (CH) bit to 1 if it requests the UP function to assign a local F-TEID to the PDR.	-	-	-	X	-	F-TEID
Network Instance for Redundant Transmission	C	This IE shall be included if the Local F-TEID for Redundant Transmission uses a different network Instance than the Network Instance used for the Local F-TEID for the primary GTP-U tunnel.	-	-	-	X	-	Network Instance

Table 7.5.2.2-6: Transport Delay Reporting IE in Create PDR IE

Octet 1 and 2	Transport Delay Reporting IE Type = 271 (decimal)							
Octets 3 and 4	Length = n							
Information elements	P	Condition / Comment	Appl.					IE Type
			Sx a	Sx b	Sx c	N4	N4 mb	
Preceding UL GTP-U Peer	M	This IE shall identify the preceding UL GTP-U peer.	-	-	-	X	-	Remote GTP-U Peer
DSCP	O	If present, this IE shall contain the DSCP to use to measure the GTP-U path delay with the preceding UL GTP-U peer.	-	-	-	X	-	Transport Level Marking

Table 7.5.2.2-7: Protocol Description IE

Octet 1 and 2	Protocol Description IE Type = 334 (decimal)							
Octets 3 and 4	Length = n							
Information elements	P	Condition / Comment	Appl.					IE Type
			Sx a	Sx b	Sx c	N4	N4 mb	

Transport Protocol	O	When present, it shall indicate the transport protocol used by the media flow.	-	-	-	X	-	Media Transport Protocol
RTP Header Extension Information	C	<p>This IE shall be present if RTP or SRTP is used and the RTP payload packets contains a RTP Header Extension that can be used for PDU Set identification, End of Data Burst marking, Data Burst Size marking, Time to Next Burst marking and/or Expedited Transfer Indication marking.</p> <p>When present, this IE shall contain information on the RTP header extension that can be used for PDU Set identification, End of Data Burst marking, Data Burst Size marking, Time to Next Burst marking and/or Expedited Transfer Indication marking. See Table 7.5.2.2-8.</p> <p>Several IEs with the same IE type may be present to provide multiple RTP Header Extension Information.</p> <p>(NOTE 1) (NOTE 4)</p>	-	-	-	X	-	RTP Header Extension Information
RTP Payload Information	O	<p>When present, it shall contain RTP Payload information for the RTP stream, which can be used to derive the PDU Set information, End of Data Burst marking, Data Burst Size marking, Time to Next Burst marking and/or Expedited Transfer Indication marking. See Table 7.5.2.2-9.</p> <p>Several IEs with the same IE type may be present to describe multiple RTP Payload Information.</p> <p>(NOTE 1) (NOTE 2)</p>	-	-	-	X	-	RTP Payload Information
Media Related Information Transfer Info	O	This IE may be present, for end-to-end encrypted traffic, to indicate how to retrieve media related information.	-	-	-	X	-	Media Related Information Transfer Info
<p>NOTE 1: If the RTP Payload Information is present and contains one or more Payload Type values, the UPF may only parse the RTP packets with an RTP header containing any of these Payload Type value(s). Otherwise, if the RTP Payload Information is absent or does not contain any Payload Type value, the UPF should parse all the RTP packets of the media flow and use either the RTP Header Extension if included, or the Payload format to derive the PDU set information (see Guidelines for PDU Set identification in clauses A.1 and A.2 of 3GPP TS 26.522 [79]).</p> <p>NOTE 2: In this release of the specification, only one RTP Payload Information IE may be provisioned.</p> <p>NOTE 3: Vendor/operator specific attributes may be supported as defined in clauses 5.9 and 8.1.1.</p> <p>NOTE 4: If at least two RTP header extensions are signaled in the Protocol Description, the RTP header extension for PDU Set identification and/or End of Data Burst marking (if any) should be signaled as the first RTP Header Extension Information IE (implementations complying with an earlier release of the specification may support PDU set identification and/or End of Data Burst marking without supporting more than one RTP Header Extension Information IE).</p>								

Table 7.5.2.2-8: RTP Header Extension Information IE

Octet 1 and 2	RTP Header Extension Information IE Type = 340 (decimal)							
Octets 3 and 4	Length = n							
Information elements	P	Condition / Comment	Appl.					IE Type
			Sx a	Sx b	Sx c	N4	N4 mb	

RTP Header Extension Type	C	This IE shall be present if RTP or SRTP is used and the RTP payload packets contains a RTP Header Extension that can be used for PDU Set identification, End of Data Burst marking, Data Burst Size marking, Time to Next Burst marking and/or Expedited Transfer Indication marking. When present, it shall indicate the RTP header extension type.	-	-	-	X	-	RTP Header Extension Type
RTP Header Extension ID	C	This IE shall be present if the RTP Header Extension Type IE is present. When present, the RTP Header Extension ID shall be set to the Id of the RTP header extension identified by the RTP Header Extension Type IE, as defined in IETF RFC 8285 [86].	-	-	-	X	-	RTP Header Extension ID
RTP Header Extension Additional Information	O	This IE may be present to provide additional information on the RTP header extension.	-	-	-	X	-	RTP Header Extension Additional Information
NOTE: Vendor/operator specific attributes may be supported as defined in clauses 5.9 and 8.1.1.								

Table 7.5.2.2-9: RTP Payload Information IE

Octet 1 and 2	RTP Payload Information IE Type = 341 (decimal)							
Octets 3 and 4	Length = n							
Information elements	P	Condition / Comment	Appl.					IE Type
			Sxa	Sxb	Sxc	N4	N4mb	
RTP Payload Type	C	This IE shall be present when the RTP Payload Format is present, otherwise it may be present. When present, this IE shall contain the list of Payload Type (PT) values in the RTP header of RTP packets the UPF may parse to derive the PDU Set Information, End of Data Burst marking, Data Burst Size marking, Time to Next Burst marking and/or Expedited Transfer Indication marking. Several IEs with the same IE type may be present to describe multiple Payload Types. (NOTE)	-	-	-	X	-	RTP Payload Type
RTP Payload Format	O	When present, it shall indicate the RTP Payload format as defined in 3GPP TS 26.522 [79]. (NOTE)	-	-	-	X	-	RTP Payload Format
NOTE: The RTP Payload Type(s) shall correspond to the RTP Payload Format if the RTP Payload Format is present.								

7.5.2.3 Create FAR IE within PFCP Session Establishment Request

The Create FAR grouped IE shall be encoded as shown in Figure 7.5.2.3-1.

Table 7.5.2.3-1: Create FAR IE within PFCP Session Establishment Request

Octet 1 and 2	Create FAR IE Type = 3 (decimal)							
Octets 3 and 4	Length = n							
Information elements	P	Condition / Comment	Appl.					IE Type
			Sxa	Sxb	Sxc	N4	N4mb	

FAR ID	M	This IE shall uniquely identify the FAR among all the FARs configured for that PFCP session.	X	X	X	X	X	FAR ID
Apply Action	M	This IE shall indicate the action to apply to the packets, See clauses 5.2.1 and 5.2.3.	X	X	X	X	X	Apply Action
Forwarding Parameters	C	This IE shall be present when the Apply Action requests the packets to be forwarded. It may be present otherwise. When present, this IE shall contain the forwarding instructions to be applied by the UP function when the Apply Action requests the packets to be forwarded. See table 7.5.2.3-2.	X	X	X	X	-	Forwarding Parameters
Duplicating Parameters	C	This IE shall be present when the Apply Action requests the packets to be duplicated. It may be present otherwise. When present, this IE shall contain the forwarding instructions to be applied by the UP function for the traffic to be duplicated, when the Apply Action requests the packets to be duplicated. Several IEs with the same IE type may be present to represent to duplicate the packets to different destinations. See NOTE 1. See table 7.5.2.3-3.	X	X	-	-	-	Duplicating Parameters
BAR ID	O	When present, this IE shall contain the BAR ID of the BAR defining the buffering instructions to be applied by the UP function when the Apply Action requests the packets to be buffered.	X	-	-	X	-	BAR ID
Redundant Transmission Forwarding Parameters	C	This IE shall be present when the Apply Action requests the packets to be duplicated for redundant transmission and the Forwarding Parameters IE is included. It may be present otherwise. When present, this IE shall contain the forwarding instructions to be applied by the UP function for the traffic to be duplicated, when the Apply Action requests the packets to be duplicated for redundant transmission. Except for the parameters included in the Redundant Transmission Parameters IE, the duplicated packets shall apply the same parameters as those indicated in the Forwarding Parameters IE. See table 7.5.2.3-4.	-	-	-	-	-	Redundant Transmission Forwarding Parameters
MBS Multicast Parameters	C	This IE shall be present when the Apply Action is set to "FSSM". This requests the MB-UPF to forward the MBS session data to a Low Layer SSM.	-	-	-	-	X	MBS Multicast Parameters
Add MBS Unicast Parameters	C	This IE shall be present when the Apply Action is set to "MBSU". This requests the MB-UPF to forward the MBS session data to a remote GTP-U peer for unicast transport. Several IEs with the same IE type may be present to request the MB-UPF to forward the MBS session data to multiple remote GTP-U peers.	-	-	-	-	X	Add MBS Unicast Parameters
NOTE 1: The same user plane packets may be required, according to operator's policy and configuration, to be duplicated to different SX3LIFs.								

Table 7.5.2.3-2: Forwarding Parameters IE in FAR

Octet 1 and 2	Forwarding Parameters IE Type = 4 (decimal)							
Octets 3 and 4	Length = n							
Information elements	P	Condition / Comment	Appl.					IE Type
			Sx a	Sx b	Sx c	N4	N4 mb	

Destination Interface	M	This IE shall identify the destination interface of the outgoing packet.	X	X	X	X	-	Destination Interface
Network Instance	O	When present, this IE shall identify the Network instance towards which to send the outgoing packet. See NOTE 1.	X	X	X	X	-	Network Instance
Redirect Information	C	This IE shall be present if the UP function is required to enforce traffic redirection towards a redirect destination provided by the CP function.	-	X	X	X	-	Redirect Information
Outer Header Creation	C	This IE shall be present if the UP function is required to add one or more outer header(s) to the outgoing packet. If present, it shall contain the F-TEID of the remote GTP-U peer when adding a GTP-U/UDP/IP header, or the Destination IP address and/or Port Number when adding a UDP/IP header or an IP header or the C-TAG/S-TAG (for 5GC). See NOTE 2.	X	X	-	X	-	Outer Header Creation
Transport Level Marking	C	This IE shall be present if the UP function is required to mark the IP header with the DSCP marking as defined by IETF RFC 2474 [13]. When present for EPC, it shall contain the value of the DSCP in the TOS/Traffic Class field set based on the QCI, and optionally the ARP priority level, of the associated EPS bearer, as described in clause 5.10 of 3GPP TS 23.214 [2]. When present for 5GC, it shall contain the value of the DSCP in the TOS/Traffic Class field set based on the 5QI, the Priority Level (if explicitly signalled), and optionally the ARP priority level, of the associated QoS flow, as described in clause 5.8.2.7 of 3GPP TS 23.501 [28].	X	X	-	X	-	Transport Level Marking
Extended Transport Level Marking	C	This IE shall be present if the SMF requests the UPF to perform the transport level marking using a DSCP corresponding to PDU Set Importance(s) of the PDU(s) pertaining to a QoS flow and if the UPF supports PSITLM feature. When this IE is present, the Transport Level Marking IE shall not be present. When present, it shall contain the value of the DSCP in the TOS/Traffic Class field of the outer IP header and the associated one or more PDU Set Importance values. Several IEs with the same IE type may be present to contain a list of transport level marking values. See Table 7.5.2.3-10.	-	-	-	X	-	Extended Transport Level Marking
Transport Level Marking Indications	C	This IE shall be included if at least one of the flags is set to "1". <ul style="list-style-type: none">- TLMIP (Transport Level Marking based on the value of the Incoming Packets): this flag shall be set to "1" to request the UPF, e.g. a I-UPF, to derive the value of the DSCP in the TOS/Traffic Class field of the outer IP header of the outgoing packets (e.g. over N3 or N9) based on the value of the DSCP of the incoming packets (e.g. received over N9 or N3 respectively). See also clause 5.4.13.	-	-	-	X	-	Transport Level Marking Indications
Forwarding Policy	C	This IE shall be present if a specific forwarding policy is required to be applied to the packets. It shall be present if the Destination Interface IE is set to SGi-LAN / N6-LAN. It may be present if the Destination Interface is set to Core, Access, or CP-Function. See NOTE 2. When present, it shall contain an Identifier of the Forwarding Policy locally configured in the UP function.	-	X	X	X	-	Forwarding Policy

Metadata	O	<p>This IE may be included to provide the metadata by the AF which the UPF needs to add to traffic sent over a Service Function Chain.</p> <p>How the UPF transforms the metadata into actual information sent with the traffic (e.g., in the encapsulation header) is based on local policies related with the Forwarding Policy and not specified.</p>	-	-	-	X	-	Metadata
Header Enrichment	O	<p>This IE may be present if the UP function indicated support of Header Enrichment of UL traffic. When present, it shall contain information for header enrichment.</p>	-	X	X	X	-	Header Enrichment
Linked Traffic Endpoint ID	C	<p>This IE may be present, if it is available and the UP function indicated support of the PDI optimisation feature, (see clause 8.2.25). When present, it shall identify the Traffic Endpoint ID allocated for this PFCP session to receive the traffic in the reverse direction (see clause 5.2.3.1).</p>	X	X	-	X	-	Traffic Endpoint ID
Proxying	C	<p>This IE shall be present if proxying is to be performed by the UP function.</p> <p>When present, this IE shall contain the information that the UPF shall respond to Address Resolution Protocol and / or IPv6 Neighbour Solicitation based on the local cache information for the Ethernet PDUs.</p>	-	-	-	X	-	Proxying
Destination Interface Type	C	<p>When present, this IE shall indicate the 3GPP interface type of the destination interface.</p> <p>This IE shall be present if the FAR is referenced by a MAR (see NOTE 3 of Table 7.5.2.5-1).</p> <p>This IE shall also be present if this is a FAR for a DL data forwarding tunnel. Otherwise this IE may be present, if required by functionalities in the UP Function, e.g. for performance measurements.</p>	X	X	-	X	-	3GPP Interface Type
Data Network Access Identifier	C	<p>This IE shall be present over N16a to link the UL FAR in an UL CL or BP towards a specific local PSA, if more than one local PSA has been inserted by an I-SMF. It may be present over N16a otherwise. This IE shall not be sent over N4.</p> <p>When present, it shall be set to the DNAI associated to the local PSA towards which the UL traffic shall be forwarded.</p>	-	-	-	-	-	Data Network Access Identifier
IP Address and Port Number Replacement	C	<p>This IE shall be present if the UP function indicated support of replacing the source and destination IP address and Port Number of an (inner) IP packet, and if the source or destination IP address and/or port number of the (Inner) IP packet shall be modified, e.g. for Edge Relocation using EAS IP address and Port number Replacement (see clause 5.33.3) or EAS discovery procedure with V-EASDF using IP replacement mechanism for supporting HR-SBO (see clause 5.33.6).</p> <p>This IE shall also be present if the destination IP address and/or port number of the (Inner) IP packet shall be modified, e.g. for EAS Discovery procedure with Local DNS Server/Resolver using Local DNS Server/Resolver IP address and Port number Replacement (see clause 5.33.4).</p> <p>This IE shall also be present if the source IP address of the (Inner) IP packet shall be modified, e.g. for UE IP address replacement to support DNS traffic routing for different UEs with same private UE IP address (see clause 5.33.7).</p> <p>(NOTE 3)</p>	-	-	-	X	-	IP Address and Port Number Replacement

N6 Routing Information	O	This IE may be present in an UL FAR when using distinct N6 tunnels from the V-UPF to the V-EASDF for differentiating HR-SBO PDU sessions with overlapping private UE IP addresses. See clause 5.33.7.	-	-	-	X	-	N6 Routing Information
Header Handling Control Rule	C	This IE shall be present if the SMF needs to instruct the UPF to perform handling of payload headers and if the UP function indicated support of the USHPH feature. Several IEs with the same IE type may be present to represent multiple instructions. See Table 7.5.2.3-7.	-	-	-	X	-	Header Handling Control Rule
On-path N6 Connection Information	O	This IE may be present, if the UPF indicated support of the CONUDP feature or the UDPOPT feature, to request the UPF to establish a connection towards an AS proxy to get media related information.	-	-	-	X	-	On-path N6 Connection Information
<p>NOTE 1: The Network Instance parameter is needed e.g. in the following cases:</p> <ul style="list-style-type: none"> - PGW/TDF UP function supports multiple PDNs with overlapping IP addresses; - SGW UP function is connected to PGWs in different IP domains (S5/S8); - PGW UP function is connected to SGWs in different IP domains (S5/S8); - SGW UP function is connected to eNodeBs in different IP domains; - UPF is connected to 5G-ANs in different IP domains; - Separation of multiple 5G VN groups communication in the UPF; - Indirect data forwarding. <p>NOTE 2: If the Outer Header Creation and Forwarding Policy are present, the UP function shall put the user plane packets in the user plane tunnel by applying Outer Header Creation, after enforcing the required Forwarding Policy.</p> <p>NOTE 3: As opposed to the Outer Header Creation IE, this IE does not result in adding any outer header to the outgoing packet.</p>								

Table 7.5.2.3-3: Duplicating Parameters IE in FAR

Octet 1 and 2		Duplicating Parameters IE Type = 5 (decimal)						
Octets 3 and 4		Length = n						
Information elements	P	Condition / Comment	Appl.					IE Type
			Sx a	Sx b	Sx c	N4	N4 mb	
Destination Interface	M	This IE shall identify the destination interface of the outgoing packet.	X	X	-	-	-	Destination Interface
Outer Header Creation	C	This IE shall be present if the UP function is required to add one or more outer header(s) to the outgoing packet. If present, it shall contain the F-TEID of the remote GTP-U peer. See NOTE 1.	X	X	-	-	-	Outer Header Creation
Transport Level marking	C	This IE shall be present if the UP function is required to mark the IP header with the DSCP marking as defined by IETF RFC 2474 [13]. When present, it shall contain the value of the DSCP in the TOS/Traffic Class field.	X	X	-	-	-	Transport Level Marking
Forwarding Policy	C	This IE shall be present if a specific forwarding policy is required to be applied to the packets. When present, it shall contain an Identifier of the Forwarding Policy locally configured in the UP function.	X	X	-	-	-	Forwarding Policy
<p>NOTE 1: If the Outer Header Creation and Forwarding Policy are present, the UP function shall put the user plane packets in the user plane tunnel by applying Outer Header Creation, after enforcing the required Forwarding Policy.</p>								

Table 7.5.2.3-4: Redundant Transmission Forwarding Parameters IE in FAR

Octet 1 and 2		Redundant Transmission Forwarding Parameters IE Type = 270 (decimal)						
Octets 3 and 4		Length = n						
Information elements	P	Condition / Comment	Appl.					IE Type
			Sx a	Sx b	Sx c	N4	N4 mb	

Outer Header Creation	M	This IE shall be present if the UP function is required to perform the redundant transmission of the outgoing packet. If present, it shall contain the F-TEID of the remote GTP-U peer for redundant transmission.	-	-	-	X	-	Outer Header Creation
Network Instance for Redundant Transmission	C	This IE shall be included if the GTP-U tunnel used for redundant transmission uses a different network Instance than the Network Instance used for the primary GTP-U tunnel.	-	-	-	X	-	Network Instance

Table 7.5.2.3-5: MBS Multicast Parameters IE in the Create FAR IE

Octet 1 and 2		MBS Multicast Parameters IE Type = 301 (decimal)						
Octets 3 and 4		Length = n						
Information elements	P	Condition / Comment	Appl.					IE Type
			Sxa	Sxb	Sxc	N4	N4 mb	
Destination Interface	M	This IE shall identify the destination interface of the outgoing packet.	-	-	-	-	X	Destination Interface
Network Instance	O	When present, this IE shall identify the Network instance towards which to send the outgoing packet.	-	-	-	-	X	Network Instance
Outer Header Creation	M	This IE shall instruct the MB-UPF to create a GTP-U header using the Low Layer SSM and the C-TEID allocated to the MBS session.	-	-	-	-	X	Outer Header Creation
Transport Level marking	C	This IE shall be present if the UP function is required to mark the IP header with the DSCP marking as defined by IETF RFC 2474 [13]. When present, it shall contain the value of the DSCP in the TOS/Traffic Class field.	-	-	-	-	X	Transport Level Marking
Destination Interface Type	O	This IE may be present to indicate the 3GPP interface type of the destination interface, if required by functionalities in the UP Function, e.g. for performance measurements. Several IEs with the same IE type may be present to represent multiple destination interface types (e.g. N3mb and N19mb).	-	-	-	-	X	3GPP Interface Type

Table 7.5.2.3-6: Add MBS Unicast Parameters IE in the Create FAR IE

Octet 1 and 2		Add MBS Unicast Parameters IE Type = 302 (decimal)						
Octets 3 and 4		Length = n						
Information elements	P	Condition / Comment	Appl.					IE Type
			Sxa	Sxb	Sxc	N4	N4 mb	

Destination Interface	M	This IE shall identify the destination interface of the outgoing packet.	-	-	-	-	X	Destination Interface
MBS Unicast Parameters ID	M	This IE shall identify the MBS Unicast Parameters IE.	-	-	-	-	X	MBS Unicast Parameters ID
Network Instance	O	When present, this IE shall identify the Network instance towards which to send the outgoing packet.	-	-	-	-	X	Network Instance
Outer Header Creation	M	This IE shall be present to request the MB-UPF to add one outer header to the outgoing packet. It shall contain the F-TEID of the remote GTP-U peer when adding a GTP-U/UDP/IP header.	-	-	-	-	X	Outer Header Creation
Transport Level marking	C	This IE shall be present if the UP function is required to mark the IP header with the DSCP marking as defined by IETF RFC 2474 [13]. When present, it shall contain the value of the DSCP in the TOS/Traffic Class field.	-	-	-	-	X	Transport Level Marking
Destination Interface Type	O	This IE may be present to indicate the 3GPP interface type of the destination interface, if required by functionalities in the UP Function, e.g. for performance measurements.	-	-	-	-	X	3GPP Interface Type

Table 7.5.2.3-7: Header Handling Control Rule IE in Forwarding Parameters

Octet 1 and 2		Header Handling Control Rule IE = 361 (decimal)						
Octets 3 and 4		Length = n						
Information elements	P	Condition / Comment	Appl.					IE Type
			Sxa	Sxb	Sxc	N4	N4 mb	
Header Handling Control Rule ID	M	This IE shall identify an instance of Header Handling Control Rule IE.	-	-	-	X	-	Header Handling Control Rule ID
Header Detection Reference	M	This IE shall contain a reference to a UPF configuration which defines how to detect the protocol or the message in a protocol for which to perform the header handling actions.	-	-	-	X	-	Header Detection Reference
Header Detection Support Information	O	When present, this IE shall contain dynamic information provided by the NF service consumer. Its format is unspecified and operator specific.	-	-	-	X	-	Header Detection Support Information
Header Handling Reporting Control Info	O	When present, this IE shall contain instructions for the UPF to report the handling of payload headers information events. Several IEs with the same IE type may be present to represent multiple Header Handling Reporting Control Infos corresponding to different receivers. See table 7.5.2.3-8.	-	-	-	X	-	Header Handling Reporting Control Info
Header Handling Control information	M	This IE shall contain a header handling control information. Several IEs with the same IE type may be present to represent multiple Header Handling Control information containing different header handling actions. See table 7.5.2.3-9.	-	-	-	X	-	Header Handling Control information

Table 7.5.2.3-8: Header Handling Reporting Control Info IE in Header Handling Control Rule

Octet 1 and 2		Header Handling Reporting Control Info IE = 362 (decimal)						
Octets 3 and 4		Length = n						
Information elements	P	Condition / Comment	Appl.					IE Type
			Sxa	Sxb	Sxc	N4	N4 mb	

Reporting Endpoint ID	M	This IE shall uniquely identify the Header Handling Reporting Control Info configured for the Header Handling Control Rule.	-	-	-	X	-	Reporting Endpoint ID
Minimum Wait Time	C	This IE shall be present if available. When present, it shall indicate the minimum waiting time between two consecutive reports after which the UP function may send a new notification request message to report the handling of payload headers information event.	-	-	-	X	-	Minimum Wait Time
Reporting Suggestion Info	O	This IE should be present if the event report can be delayed, i.e. it is delay tolerant.	-	-	-	X	-	Reporting Suggestion Info
Event Notification URI	M	This IE shall contain the notification URI to be used for sending the UPF event notifications.	-	-	-	X	-	Event Notification URI
Notification Correlation ID	M	This IE shall indicate the notification correlation id to be included in the UPF event notifications. It shall be present if it is available.	-	-	-	X	-	Notification Correlation ID
Header Handling Reporting Indication	C	This IE shall be included if at least one of the flags is set to "1". - OTRI (One Time Report Indication): the SMF shall set this flag to "1" to request the UPF to report the applied action only for the first occurrence within a data flow.	-	-	-	X	-	Header Handling Reporting Indication

Table 7.5.2.3-9: Header Handling Control information IE in Header Handling Control Rule

Octet 1 and 2	Header Handling Control information IE = 363 (decimal)							
Octets 3 and 4	Length = n							
Information elements	P	Condition / Comment	Appl.					IE Type
			Sxa	Sxb	Sxc	N4	N4 mb	

Header Handling Control ID	M	This IE shall identify an instance of Header Handling Control information.	-	-	-	X	-	Header Handling Control ID
Header Handling Control Reference	C	This IE shall be present if available. When present, it shall indicate a reference to a header handling action related to information pre-configured in the UPF.	-	-	-	X	-	Header Handling Control Reference
Header Handling Action	C	This IE shall be present if the Header Handling Control Reference IE is not present. It may be present otherwise. When present, it shall contain the action to be performed on a specific header field. (NOTE 2)	-	-	-	X	-	Header Handling Action
Header Information	C	This IE shall be present if the Header Handling Control Reference IE is not present. It may be present otherwise. When present, it shall identify a reference to a UPF configuration which defines how to identify or build a specific header field which to perform the header handling action.	-	-	-	X	-	Header Information
Header Value	C	This IE shall be present if the Header Handling Control Reference IE is not present. It may be present otherwise. When present, it shall contain the value of the specific header field.	-	-	-	X	-	Header Value
Header Handling Condition	C	This IE shall be present if the Header Handling Control Reference IE is not present. It may be present otherwise. When present, it shall represent the condition about how to apply the header handling action.	-	-	-	X	-	Header Handling Condition
Header Handling Reporting	C	This IE shall be present if Header Handling Reporting is required. When present, it shall reference a Reporting Endpoint to which the notifications shall be sent. Several IEs with the same IE type may be present to represent multiple Reporting Endpoints.	-	-	-	X	-	Reporting Endpoint ID
NOTE 1: If Header Handling Control Reference IE is present, any other attribute included within Header Handling Control information IE shall overwrite the related information pre-configured in the UPF.								
NOTE 2: When the Header Handling Action is set to "insert", "replace" or "remove", the "detect" action shall be implicitly required.								

Table 7.5.2.3-10: Extended Transport Level Marking IE in Forwarding Parameters IE

Octet 1 and 2		Extended Transport Level Marking IE = 383 (decimal)						
Octets 3 and 4		Length = n						
Information elements	P	Condition / Comment	Appl.					IE Type
			Sxa	Sxb	Sxc	N4	N4 mb	
Transport Level Marking	M	This IE shall contain the value of the DSCP in the TOS/Traffic Class field to be set in the outer IP header.	-	-	-	X	-	Transport Level Marking
Associated PDU Set Importance values	M	This IE shall contain one or more associated PDU Set Importance value.	-	-	-	X	-	PDU Set Importance

7.5.2.4 Create URR IE within PFCP Session Establishment Request

The Create URR grouped IE shall be encoded as shown in Figure 7.5.2.4-1.

Table 7.5.2.4-1: Create URR IE within PFCP Session Establishment Request

Octet 1 and 2		Create URR IE Type = 6 (decimal)						
Octets 3 and 4		Length = n						
Information elements	P	Condition / Comment	Appl.					IE Type
			Sx a	Sx b	Sx c	N4	N4 mb	

URR ID	M	This IE shall uniquely identify the URR among all the URRs configured for this PFCP session.	X	X	X	X	X	URR ID
Measurement Method	M	This IE shall indicate the method for measuring the network resources usage, i.e. whether the data volume, duration (i.e. time), combined volume/duration, or event shall be measured.	X	X	X	X	X	Measurement Method
Reporting Triggers	M	This IE shall indicate the trigger(s) for reporting network resources usage to the CP function, e.g. periodic reporting or reporting upon reaching a threshold, or envelope closure, or when an SMF instructs an UPF to report the reception of the End Marker packet from the old I-UPF during a Service Request procedure (see clauses 4.2.3.2 and 4.23.4.3 in 3GPP TS 23.502 [29]).	X	X	X	X	X	Reporting Triggers
Measurement Period	C	This IE shall be present if periodic reporting is required. When present, it shall indicate the period for generating and reporting usage reports.	X	X	X	X	X	Measurement Period
Volume Threshold	C	This IE shall be present if volume-based measurement is used and reporting is required upon reaching a volume threshold. When present, it shall indicate the traffic volume value after which the UP function shall report network resources usage to the CP function for this URR.	X	X	X	X	X	Volume Threshold
Volume Quota	C	This IE shall be present if volume-based measurement is used and the CP function needs to provision a Volume Quota in the UP function (see clause 5.2.2.2) When present, it shall indicate the Volume Quota value.	-	X	X	X	-	Volume Quota
Event Threshold	C	This IE shall be present if event-based measurement is used and reporting is required upon reaching an event threshold. When present, it shall indicate the number of events after which the UP function shall report to the CP function for this URR.	-	X	X	X	-	Event Threshold
Event Quota	C	This IE shall be present if event-based measurement is used and the CP function needs to provision an Event Quota in the UP function (see clause 5.2.2.2) When present, it shall indicate the Event Quota value.	-	X	X	X	-	Event Quota
Time Threshold	C	This IE shall be present if time-based measurement is used and reporting is required upon reaching a time threshold. When present, it shall indicate the time usage after which the UP function shall report network resources usage to the CP function for this URR.	X	X	X	X	-	Time Threshold
Time Quota	C	This IE shall be present if time-based measurement is used and the CP function needs to provision a Time Quota in the UP function (see clause 5.2.2.2) When present, it shall indicate the Time Quota value	-	X	X	X	-	Time Quota
Quota Holding Time	C	This IE shall be present, for a time, volume or event-based measurement, if reporting is required and packets are no longer permitted to pass on when no packets are received during a given inactivity period. When present, it shall contain the duration of the inactivity period.	-	X	X	X	-	Quota Holding Time
Dropped DL Traffic Threshold	C	This IE shall be present if reporting is required when the DL traffic being dropped exceeds a threshold. When present, it shall contain the threshold of the DL traffic being dropped.	X	-	-	X	-	Dropped DL Traffic Threshold
Quota Validity Time	C	This IE shall be present if reporting is required when the Quota Validity time for a given Quota is over.	-	X	-	X	-	Quota Validity Time
Monitoring Time	O	When present, this IE shall contain the time at which the UP function shall re-apply the volume or time threshold.	X	X	X	X	-	Monitoring Time
Subsequent Volume Threshold	O	This IE may be present if the Monitoring Time IE is present and volume-based measurement is used. When present, it shall indicate the traffic volume value after which the UP function shall report network resources usage to the CP function for this URR for the period after the Monitoring Time.	X	X	X	X	-	Subsequent Volume Threshold

Subsequent Time Threshold	O	This IE may be present if the Monitoring Time IE is present and time-based measurement is used. When present, it shall indicate the time usage after which the UP function shall report network resources usage to the CP function for this URR for the period after the Monitoring Time.	X	X	X	X	-	Subsequent Time Threshold
Subsequent Volume Quota	O	This IE may be present if Monitoring Time IE is present and volume-based measurement is used (see clause 5.2.2.2). When present, it shall indicate the Volume Quota value which the UP function shall use for this URR for the period after the Monitoring Time.	-	X	X	X	-	Subsequent Volume Quota
Subsequent Time Quota	O	This IE may be present if the Monitoring Time IE is present and time-based measurement is used (see clause 5.2.2.2). When present, it shall indicate the Time Quota value which the UP function shall use for this URR for the period after the Monitoring Time.	-	X	X	X	-	Subsequent Time Quota
Subsequent Event Threshold	O	This IE may be present if the Monitoring Time IE is present and event-based measurement is used. When present, it shall indicate the number of events after which the UP function shall report to the CP function for this URR for the period after the Monitoring Time.	-	X	X	X	-	Subsequent Event Threshold
Subsequent Event Quota	O	This IE may be present if Monitoring Time IE is present and event-based measurement is used (see clause 5.2.2.2). When present, it shall indicate the Event Quota value which the UP function shall use for this URR for the period after the Monitoring Time.	-	X	X	X	-	Subsequent Event Quota
Inactivity Detection Time	C	This IE shall be present if time-based measurement is used and the time measurement need to be suspended when no packets are received during a given inactivity period. When present, it shall contain the duration of the inactivity period.	-	X	X	X	-	Inactivity Detection Time
Linked URR ID	C	This IE shall be present if linked usage reporting is required. When present, this IE shall contain the linked URR ID which is related with this URR (see clause 5.2.2.4). Several IEs with the same IE type may be present to represent multiple linked URRs which are related with this URR.	-	X	X	X	X	Linked URR ID

Measurement Information	C	<p>This IE shall be included if any of the following flag is set to "1".</p> <p>Applicable flags are:</p> <ul style="list-style-type: none"> - Measurement Before QoS Enforcement Flag: this flag shall be set to "1" if the traffic usage before any QoS Enforcement is requested to be measured. - Inactive Measurement Flag: this flag shall be set to "1" if the measurement shall be paused (inactive). The measurement shall be performed (active) if the bit is set to "0" or if the Measurement Information IE is not present in the Create URR IE. - Reduced Application Detection Information Flag: this flag may be set to "1", if the Reporting Triggers request to report the start or stop of application, to request the UP function to only report the Application ID in the Application Detection Information, e.g. for envelope reporting. - Immediate Start Time Metering Flag: this flag may be set to "1" if time-based measurement is used and the UP function is requested to start the time metering immediately at receiving the flag. . - Measurement of Number of Packets Flag: this flag may be set to "1" when the Volume-based measurement applies, to request the UP function to report the number of packets in UL/DL/Total in addition to the measurement in octet. - Send Start Pause of Charging Flag: this flag may be set to "1" by the CP function if the UP Function is requested to send a Start Pause of Charging indication to the upstream GTP-U entity(s) when the Dropped DL Traffic Threshold is reached. - Applicable for Start of Pause of Charging Flag: this flag may be set to "1" if the URR is applicable for Start of Pause of Charging, so that the UP function shall stop the usage measurement for the URR when receiving Start Pause of Charging indication from the peer downstream GTP-U entity. - Control of Inactive Measurement Flag: the flag shall be set to "1" if the CP function requests the UP function to stop or resume the usage measurement for the URR with the "ASPOC" flag set to "1" according to the value of Inactive Measurement Flag. 	-	X	X	X	-	Measurement Information
			-	X	-	X	-	
			-	X	-	X	-	
			-	X	X	X	-	
			X	X	X	X	-	
			X	-	-	X	-	
			-	X	-	X	-	
			-	X	-	X	-	
Time Quota Mechanism	C	This IE shall be present if time-based measurement based on CTP or DTP is used.	-	X	-	-	-	Time Quota Mechanism
Aggregated URRs	C	<p>This IE shall be included if the URR is used to support a Credit Pool.</p> <p>Several IEs with the same IE type may be present to provide multiple aggregated URRs.</p>	-	X	-	-	-	Aggregated URRs
FAR ID for Quota Action	C	<p>This IE may be present if the Volume Quota IE and/or the Time Quota IE and/or Event Quota IE is provisioned in the URR and the UP Function indicated support of the Quota Action feature.</p> <p>When present, it shall contain the identifier of the substitute FAR the UP function shall apply, for the traffic associated to this URR, when exhausting any of these quotas. See NOTE 1, NOTE 3.</p>	-	X	X	X	-	FAR ID

Ethernet Inactivity Timer	C	This IE shall be present if Ethernet traffic reporting is used and the SMF requests the UP function to also report inactive UE MAC addresses. When present, it shall contain the duration of the Ethernet inactivity period.	-	-	-	X	-	
Additional Monitoring Time	O	When present, this IE shall contain the time at which the UP function shall re-apply the volume or time or event threshold/quota provisioned in the IE. Several IEs with the same IE type may be present to provide multiple Monitoring Times.	X	X	X	X	-	Additional Monitoring Time
Number of Reports	O	This IE may be present if the UP function supports the NORP feature. When present, it shall indicate the number of usage reports to be generated by the URR. See also clauses 5.2.2.2.1 and 5.2.2.3.1. See NOTE 2.	X	X	X	X	-	Number of Reports
Exempted Application ID for Quota Action	O	This IE may be present if the Volume Quota IE and/or the Time Quota IE and/or Event Quota IE is provisioned in the URR and the UP Function has indicated support of the QUASF feature as specified in clause 8.2.25. When present, it shall contain an Application ID matching packets that shall be exempted from applying the FAR ID for Quota Action when the quota has been exhausted. Several IEs with the same IE type may be present to provide multiple Application IDs. See NOTE 4.	-	X	X	X	-	Application ID
Exempted SDF Filter for Quota Action	O	This IE may be present if the Volume Quota IE and/or the Time Quota IE and/or Event Quota IE is provisioned in the URR and the UP Function has indicated support of the QUASF feature as specified in clause 8.2.25. When present, it shall contain an SDF Filter matching packets that shall be exempted from applying the FAR ID for Quota Action when the quota has been exhausted. Several IEs with the same IE type may be present to provide multiple SDF Filters. See NOTE 4.	-	X	X	X	-	SDF Filter
User Plane Inactivity Timer	C	This IE shall be present, for a time, volume or event-based measurement, if reporting is required when no packets are received for any PDR(s) associated with the URR during a given inactivity period. See clause 5.11.3. When present, it shall contain the duration of the inactivity period.	-	-	-	X	-	User Plane Inactivity Timer

NOTE 1:	The substitute FAR used when exhausting a Volume Quota or Time Quota may be set to drop the packets, buffer the packets or redirect the traffic towards a redirect destination as specified in clause 5.4.7.
NOTE 2:	This IE may be provisioned and set to "1" e.g. for a URR with the Dropped DL Traffic Threshold used for the Pause of Charging feature, if the UP function supports the NORP feature.
NOTE 3:	If the FAR as indicated in the FAR ID for Quota Action is removed after being provisioned, the UP function shall behave as if the FAR ID for Quota Action is not provisioned and shall apply the default behaviour per local configuration when the quota is exhausted.
NOTE 4:	The Exempted Application ID for Quota Action IE or Exempted Filter ID for Quota Action IE may be provisioned as the Restricted-Filter-Rule AVP or Filter ID AVP which is included in Final-Unit-Indication AVP from the online charging system when the Final-Unit-Action AVP is set to "REDIRECT" or "RESTRICT_ACCESS". See also 3GPP TS 32.299 [18].

Table 7.5.2.4-2: Aggregated URRs

Octet 1 and 2		Aggregated URRs = 118 (decimal)						
Octets 3 and 4		Length = n						
Information elements	P	Condition / Comment	Appl.					IE Type
			Sx a	Sx b	Sx c	N4	N4 mb	
Aggregated URR ID	M	This IE shall be present for the aggregated URR ID of the URR sharing the credit pool.	-	X	-	-	-	Aggregated URR ID
Multiplier	M	This IE shall be included to measure the abstract service units the traffic of the corresponding aggregated URR consumes from the credit pool.	-	X	-	-	-	Multiplier

Table 7.5.2.4-3: Additional Monitoring Time

Octet 1 and 2		Additional Monitoring Time = 147 (decimal)						
Octets 3 and 4		Length = n						
Information elements	P	Condition / Comment	Appl.					IE Type
			Sx a	Sx b	Sx c	N4	N4 mb	
Monitoring Time	M	This IE shall be present and contain the time at which the UP function shall re-apply the volume or time threshold/quota.	X	X	X	X	-	Monitoring Time
Subsequent Volume Threshold	O	This IE may be present if the Monitoring Time IE is present and volume-based measurement is used. When present, it shall indicate the traffic volume value after which the UP function shall report network resources usage to the CP function for this URR for the period after the Monitoring Time.	X	X	X	X	-	Subsequent Volume Threshold
Subsequent Time Threshold	O	This IE may be present if the Monitoring Time IE is present and time-based measurement is used. When present, it shall indicate the time usage after which the UP function shall report network resources usage to the CP function for this URR for the period after the Monitoring Time.	X	X	X	X	-	Subsequent Time Threshold
Subsequent Volume Quota	O	This IE may be present if Monitoring Time IE is present and volume-based measurement is used (see clause 5.2.2.2). When present, it shall indicate the Volume Quota value which the UP function shall use for this URR for the period after the Monitoring Time.	-	X	X	X	-	Subsequent Volume Quota
Subsequent Time Quota	O	This IE may be present if Monitoring Time IE is present and time-based measurement is used (see clause 5.2.2.2). When present, it shall indicate the Time Quota value which the UP function shall use for this URR for the period after the Monitoring Time.	-	X	X	X	-	Subsequent Time Quota
Subsequent Event Threshold	O	This IE may be present if the Monitoring Time IE is present and event-based measurement is used. When present, it shall indicate the number of events after which the UP function shall report to the CP function for this URR for the period after the Monitoring Time.	-	X	X	X	-	Event Threshold
Subsequent Event Quota	O	This IE may be present if Monitoring Time IE is present and event-based measurement is used (see clause 5.2.2.2). When present, it shall indicate the Event Quota value which the UP function shall use for this URR for the period after the Monitoring Time.	-	X	X	X	-	Event Quota

7.5.2.5 Create QER IE within PFCP Session Establishment Request

The Create QER grouped IE shall be encoded as shown in Figure 7.5.2.5-1.

Table 7.5.2.5-1: Create QER IE within PFCP Session Establishment Request

Octet 1 and 2	Create QER IE Type = 7 (decimal)							
Octets 3 and 4	Length = n							
Information elements	P	Condition / Comment	Appl.					IE Type
			Sx a	Sx b	Sx c	N4	N4 mb	

QER ID	M	This IE shall uniquely identify the QER among all the QER configured for that PFCP session	-	X	X	X	X	QER ID
QER Correlation ID	C	This IE shall be present if the UP function is required to correlate the QERs of several PFCP sessions, for APN-AMBR enforcement/APN rate control of multiple UE's PDN connections to the same APN.	-	X	-	X	-	QER Correlation ID
Gate Status	M	This IE shall indicate whether the packets are allowed to be forwarded (the gate is open) or shall be discarded (the gate is closed) in the uplink and/or downlink directions.	-	X	X	X	X	Gate Status
Maximum Bitrate	C	<p>This IE shall be present if an MBR enforcement action shall be applied to packets matching this PDR. When present, this IE shall indicate the uplink and/or downlink maximum bit rate to be enforced for packets matching the PDR.</p> <p>For EPC, this IE may be set to the value of:</p> <ul style="list-style-type: none"> - the APN-AMBR, for a QER that is referenced by all the PDRs of the non-GBR bearers of a PDN connection; - the TDF session MBR, for a QER that is referenced by all the PDRs of a TDF session; - the bearer MBR, for a QER that is referenced by all the PDRs of a bearer; - the SDF MBR, for a QER that is referenced by all the PDRs of a SDF. <p>For 5GC, this IE may be set to the value of:</p> <ul style="list-style-type: none"> - the Session-AMBR, for a QER that is referenced by all the PDRs of the non-GBR QoS flows of a PDU session; - the QoS Flow MBR, for a QER that is referenced by all the PDRs of a QoS Flow; - the SDF MBR, for a QER that is referenced by all the PDRs of a SDF; - the Authorized DL Session AMBR for Offloading, for a QER that is referenced by all the PDRs of the DL non-GBR QoS flows of a PDU session authorized for offloading to the local part of DN in VPLMN. 	-	X	X	X	X	MBR
Guaranteed Bitrate	C	<p>This IE shall be present if a GBR has been authorized to packets matching this PDR. When present, this IE shall indicate the authorized uplink and/or downlink guaranteed bit rate.</p> <p>This IE may be set to the value of:</p> <ul style="list-style-type: none"> - the aggregate GBR, for a QER that is referenced by all the PDRs of a GBR bearer; - the QoS Flow GBR, for a QER that is referenced by all the PDRs of a QoS Flow (for 5GC); - the SDF GBR, for a QER that is referenced by all the PDRs of a SDF. 	-	X	X	X	X	GBR

Packet Rate	C	This IE shall be present if a Packet Rate enforcement action (in terms of number of packets per time interval) shall be applied to packets matching this PDR. When present, this IE shall indicate the uplink and/or downlink maximum packet rate to be enforced for packets matching the PDR. This IE may be set to the value of: <ul style="list-style-type: none"> - downlink packet rate for Serving PLMN Rate Control, for a QER that is referenced by all PDRs of the UE belonging to the PDN connection, or belonging to the PDU session (5GC) using Clot EPS Optimizations as described in 3GPP TS 23.401 [2] and 3GPP TS 23.501 [28], respectively; - uplink and/or downlink packet rate for APN Rate Control, for a QER that is referenced by all the PDRs of the UE belonging to all PDN connections to the same APN, or for Small Data Rate Control (5GC) for a QER related to the PDU session using Clot EPS Optimizations as described in 3GPP TS 23.401 [2] and 3GPP TS 23.501 [28], respectively. 	-	X	-	X	-	Packet Rate
Packet Rate Status	C	This IE may be present during the UE requested PDU session establishment, or UE requested PDN connection establishment. When present, the UP function shall first enforce these rules. Only after that shall the UP function enforce the rules in the Packet Rate IE.	-	X	-	X	-	Packet Rate Status
DL Flow Level Marking	C	This IE shall be set if the UP function is required to mark the packets for QoS purposes: <ul style="list-style-type: none"> - by the TDF-C, for DL flow level marking for application indication (see clause 5.4.5); - by the PGW-C, for setting the GTP-U Service Class Indicator extension header for service indication towards GERAN (see clause 5.4.12). 	-	X	X	-	-	DL Flow Level Marking
QoS flow identifier	C	This IE shall be present if the QoS flow identifier shall be inserted or modified by the UPF or shall be inserted by the MB-UPF. (NOTE 2), (NOTE 3)	-	-	-	X	X	QFI
Reflective QoS	C	This IE shall be present if the UP function is required to insert a Reflective QoS Indicator to request reflective QoS for uplink traffic. (NOTE 3)	-	-	-	X	-	RQI
Paging Policy Indicator	C	This IE shall be present if the UPF is required to set the Paging Policy Indicator (PPI) in outgoing packets (see clause 5.4.3.2 of 3GPP TS 23.501 [28]). When present, it shall be set to the PPI value to set. (NOTE 3)	-	-	-	X	-	Paging Policy Indicator
Averaging Window	O	This IE may be present if the UP function is required to use a different Averaging window than the default one. (NOTE 1)	-	-	-	X	-	Averaging Window
QER Control Indications	C	This IE shall be included if the CP function needs to provide the QoS enforcement control information: <ul style="list-style-type: none"> - RCSR (Rate Control Status Reporting): the CP function shall set this bit "1" to request the UP function to report the rate control status when the PFCP session is released. 	-	X	-	X	-	QER Control Indications

QER Indications	C	This IE shall be included if at least one of the flags is set to "1".							
		- IQFISN (Insert DL MBS QFI Sequence Number): this IE shall be set to "1" to request the MB-UPF to insert the DL MBS QFI Sequence Number in the PDU Session Container of the MBS data packets (see 3GPP TS 38.415 [34]).	-	-	-	-	X		
		- EDBMI (End Of Data Burst Marking Indication): this bit shall be set "1" to request the UPF to set the End Of Data Burst indication together with the QFI (identifying the QoS flow conveying the Data Burst) in the PDU Set Information Container of the GTP-U packet encapsulating the last PDU of each data burst (see 3GPP TS 38.415 [34]), for the DL PDRs associated with the QER (see clause 5.38.4.4).	-	-	-	X	-		
		- EML4S (ECN Marking for L4S): this IE shall be set to "1" to request the UPF to perform ECN marking for L4S for the traffic of the UL and/or DL PDRs associated with the QER (see clause 5.38.1).	-	-	-	X	-		
		- PDUSM (PDU Set Marking): this IE shall be set to "1" to request the UPF to perform PDU Set marking for the traffic of the DL PDRs associated with the QER (see clause 5.38.3).	-	-	-	X	-		QER Indications
		- DBSMI (Data Burst Size Marking Indication): this bit shall be set "1" to request the UPF to insert the Data Burst Size of the data burst in the GTP-U PDU Session Container extension header of the GTP-U packet (see 3GPP TS 38.415 [34]) of the first PDUs of the data burst, for the DL PDRs associated with the QER (see clause 5.38.5.2).	-	-	-	X	-		
		- TNBMI (Time to Next Burst Marking Indication): this bit shall be set "1" to request the UPF to insert the Time to Next Burst in the GTP-U PDU Session Container extension header of the GTP-U packet (see 3GPP TS 38.415 [34]), for the DL PDRs associated with the QER (see clause 5.38.5.3).	-	-	-	X	-		

NOTE 1: For a GBR QoS flow, as 5QI is not signalled over N4, one default averaging window shall be pre-configured in the UPF. For Non-GBR QoS Flows, e.g., for the measurement of the Session-AMBR, the averaging window to be used (if not received over N4) is implementation specific.

NOTE 2: The SMF may request the UPF to modify the QFI of downlink packets of a multicast QoS flow received from the MB-UPF to the QFI assigned by the SMF for the Associated QoS flow. See clause 5.34.3.2.

NOTE 3: In order to support ATSSS for MA PDU sessions with an access connected to EPC and an access connected to 5GC, for DL packets matching a DL PDR associated with a MAR, the UPF shall determine whether the DL packets are sent to an access connected to 5GC or to an access connected to EPC, using the Destination Interface Type IE of the DL FARs associated with the MAR, and the UPF shall include 5G specific information (e.g. QFI, RQI, PPI in the GTP-U PDU session container extension header) in the outgoing GTP-U packets only for DL packets that are sent on the access connected to 5GC, i.e. it shall not do so for DL packets sent on the access connected to EPC.

7.5.2.6 Create BAR IE within PFCP Session Establishment Request

The Create BAR grouped IE shall be encoded as shown in Figure 7.5.2.6-1.

Table 7.5.2.6-1: Create BAR IE within PFCP Session Establishment Request

Octet 1 and 2		Create BAR IE Type = 85 (decimal)						
Octets 3 and 4		Length = n						
Information elements	P	Condition / Comment	Appl.					IE Type
			Sx a	Sx b	Sx c	N4	N4 mb	
BAR ID	M	This IE shall uniquely identify the BAR provisioned for that PFCP session.	X	-	-	X	-	BAR ID
Downlink Data Notification Delay	C	This IE shall be present if the UP function indicated support of the Downlink Data Notification Delay parameter (see clause 8.2.28) and the UP function has to delay the notification to the CP function about the arrival of DL data packets. When present, it shall contain the delay the UP function shall apply between receiving a downlink data packet and notifying the CP function about it, when the Apply Action parameter requests to buffer the packets and notify the CP function.	X	-	-	-	-	Downlink Data Notification Delay
Suggested Buffering Packets Count	C	This IE may be present if the UP Function indicated support of the feature UDBC. When present, it shall contain the number of packets that are suggested to be buffered when the Apply Action parameter requests to buffer the packets. The packets that exceed the limit shall be discarded.	-	X	X	X	-	Suggested Buffering Packets Count
MT-EDT Control Information	O	This IE may be included to request the SGW-U to report the sum of DL Data Packets Size.	X	-	-	-	-	MT-EDT Control Information
MT-SDT Control Information	O	This IE may be included to request the UPF to report the sum of DL Data Packets Size per QoS flow.	-	-	-	X	-	MT-SDT Control Information
DL Buffering Duration	C	This IE shall be present when the Create BAR is included in the PFCP Session Modification Request message, and if the UP function indicated support of the DL Buffering Duration parameter in PFCP Session Modification Request feature (see DBDM feature in clause 8.2.25) and extended buffering of downlink data packet is required in the UP function. When present, this IE shall indicate the duration during which the UP function shall buffer the downlink data packets without sending any further notification to the CP function about the arrival of DL data packets.	X	-	-	X	-	DL Buffering Duration
DL Buffering Suggested Packet Count	O	This IE may be present when the Create BAR is included in the PFCP Session Modification Request message, and if the UP function indicated support of the DL Buffering Suggested Packet Count parameter in PFCP Session Modification Request feature (see DBDM feature in clause 8.2.25) and extended buffering of downlink data packet is required in the UP function. When present, this IE shall indicate the maximum number of downlink data packets suggested to be buffered in the UP function.	X	-	-	X	-	DL Buffering Suggested Packet Count

7.5.2.7 Create Traffic Endpoint IE within PFCP Session Establishment Request

The Create Traffic Endpoint grouped IE shall be encoded as shown in Figure 7.5.2.7-1.

Table 7.5.2.7-1: Create Traffic Endpoint IE within PFCP Session Establishment Request

Octet 1 and 2		Create Traffic Endpoint IE Type = 127(decimal)						
Octets 3 and 4		Length = n						
Information elements	P	Condition / Comment	Appl.					IE Type
			Sxa	Sxb	Sxc	N4	N4 mb	

Traffic Endpoint ID	M	This IE shall uniquely identify the Traffic Endpoint for that PFCP session.	X	X	X	X	X	Traffic Endpoint ID
Local F-TEID	O	If present, this IE shall identify the local F-TEID to match for an incoming packet. The CP function shall set the CHOOSE (CH) bit to 1 if the CP function requests the UP function to assign a local F-TEID to the Traffic Endpoint.	X	X	-	X	-	F-TEID
Network Instance	O	This IE shall be present if the CP function requests the UP function to allocate a UE IP address/prefix. If present, this IE shall identify the Network instance to match for the incoming packet. See NOTE 1, NOTE 2.	X	X	X	X	X	Network Instance
Redundant Transmission Detection Parameters	O	If present, this IE shall contain the information used for the reception of redundant uplink packets on N3/N9 interfaces. See Table 7.5.2.2-5.	-	-	-	X	-	Redundant Transmission Detection Parameters
UE IP address	O	If present, this IE shall identify the UE IP address as the source or destination IP address to match for the incoming packet. (NOTE 3). The CP function shall set the CHOOSE IPV4 (CHV4) and/or CHOOSE IPV6 (CHV6) bits to 1 if the UP function supports the allocation of UE IP address/ prefix and the CP function requests the UP function to assign a UE IP address/prefix to the Traffic Endpoint. This IE may also present to identify the IP address of the CP function as the destination IP address to match for the incoming packet, e.g. Radius, Diameter or DHCP signalling packet. (NOTE 6). This IE may be present for a PFCP session established in the V-UPF (local PSA) for a HR-SBO PDU session if the UPF supports the UN6TU feature (see clause 8.2.25). In the 5GC, several IEs with the same IE type may be present to represent multiple UE IP addresses, if the UPF indicated support of the IP6PL feature (see clause 5.21).	-	X	X	X	-	UE IP address
Mapped N6 IP Address	O	When present, the V-SMF shall set the CHOOSE IPV4 (CHV4) bit to 1 if the UP function supports the UMN6IP feature and the V-SMF requests the UP function to assign a mapped N6 IP address for a DL Traffic EndPoint as described in clause 5.33.7.	-	-	-	X	-	Mapped N6 IP Address
N6 Routing Information	O	This IE may be present in a DL PDR when using distinct N6 tunnels from the V-EASDF to the V-UPF for differentiating HR-SBO PDU sessions with overlapping private UE IP addresses. See clause 5.33.7.	-	-	-	X	-	N6 Routing Information
Ethernet PDU Session Information	O	This IE may be present to identify all the (DL) Ethernet packets matching an Ethernet PDU session (see clause 5.13.1).	-	-	-	X	-	Ethernet PDU Session Information
Framed-Route	O	This IE may be present for a PDR if the UPF indicated support of Framed Routing (see clauses 8.2.25 and 5.16). If present, this IE shall describe a framed route. Several IEs with the same IE type may be present to provision a list of framed routes. (NOTE 3)	-	X	-	X	-	Framed-Route

Framed-Routing	O	This IE may be present for a DL PDR if the UPF indicated support of Framed Routing (see clauses 8.2.25 and 5.16). If present, this IE shall describe the routing method for the UP function for the IP route related to Framed-Routes or Framed-IPv6-Routes. (NOTE 5)	-	X	-	X	-	Framed-Routing
Framed-IPv6-Route	O	This IE may be present for a PDR if the UPF indicated support of Framed Routing (see clauses 8.2.25 and 5.16). If present, this IE shall describe a framed IPv6 route. Several IEs with the same IE type may be present to provision a list of framed IPv6 routes. (NOTE 3)	-	X	-	X	-	Framed-IPv6-Route
QFI	O	This IE may be present if the UPF has indicated it supports MTE feature as specified in clause 8.2.25. If present, this IE shall identify the QoS Flow Identifier to match for the incoming packet received from the traffic endpoint. Several IEs with the same IE type may be present to provision a list of QFIs. When present, the full set of applicable QFIs shall be provided.	-	-	-	X	-	QFI
Source Interface Type	C	When present, this IE shall indicate the 3GPP interface type of the source interface. This IE shall be present if this is a Traffic Endpoint for a DL data forwarding tunnel. Otherwise this IE may be present, if required by functionalities in the UP Function, e.g. for performance measurements. (NOTE 4)	X	X	-	X	X	3GPP Interface Type
Local Ingress Tunnel	C	This IE shall be present over N4mb, for Nmb9, or for N6mb if unicast transport is used over N6mb, if Traffic Endpoint ID is present in the DL PDR. If present, this IE shall identify the IP address and the UDP port for a UDP/IP tunnel. The CP function shall set the CHOOSE (CH) bit to 1 if the CP function requests the UP function to assign a local ingress tunnel to the PDR.	-	-	-	-	X	Local Ingress Tunnel
IP Multicast Addressing Info	C	This IE shall be present over N4mb, if multicast transport is used over N6mb, if Traffic Endpoint ID is present in the DL PDR. See Table 7.5.2.2-4.	-	-	-	-	X	IP Multicast Addressing Info
MBS Session Identifier	C	This IE shall be present when the PDR is created to receive MBS session data. (NOTE 7)	-	-	-	X	-	MBS Session Identifier
Area Session ID	C	This IE shall be present for a location dependent MBS service. When present, it shall contain the Area Session ID, which together with the MBS Session Identifier, uniquely identify the service area part of the content data of the MBS service. (NOTE 7)	-	-	-	X	-	Area Session ID
RAT Type	O	This IE may be present to provide the UP Function the current RAT Type for the UL PDR(s) for statistics purpose if the PFCP session is established for a MA PDU session.	-	-	-	X	-	RAT Type

NOTE 1: The Network Instance parameter is needed e.g. in the following cases:

- PGW/TDF UP function supports multiple PDNs with overlapping IP addresses;
- SGW UP function is connected to PGWs in different IP domains (S5/S8);
- PGW UP function is connected to SGWs in different IP domains (S5/S8);
- SGW UP function is connected to eNodeBs in different IP domains;
- UPF is connected to 5G-ANs in different IP domains;
- Separation of multiple 5G VN groups communication in the UPF.

NOTE 2: When a Local F-TEID is provisioned in the Traffic Endpoint, the Network Instance shall relate to the IP address of the F-TEID. Otherwise, the Network Instance shall relate to the UE IP address.

NOTE 3: If both the UE IP Address and the Framed-Route (or Framed-IPv6-Route) are present, the packets which are considered being matching the PDR shall match at least one of them.

NOTE 4: If the Source Interface Type is provisioned at the traffic endpoint, it shall not be provisioned in individual PDRs associated to the traffic endpoint.

NOTE 5: In this release of specification, the UP function shall announce the IP route(s) for Framed-Route(s) or Framed-IPv6-Route(s) to the PDN regardless of the value of the Framed-Routing.

NOTE 6: The CP IP Address parameter is needed e.g. perform Router Advertisements and match the destination IP address of the incoming packet if the Radius, Diameter or DHCP signaling packets between the SMF and the external DN is forwarded by the UPF.

NOTE 7: The Inclusion of the MBS Session Identifier, or MBS Session Identifier and Area Session ID for a location dependent MBS session, enables the UPF to allocate the same N19mb tunnel for the same MBS Session, or for the same MBS Session Identifier and Area Session ID for a location dependent MBS session, when receiving multiple PFCP Session Establishment or Modification Request messages for different PFCP sessions being associated with the same MBS session, or with the same MBS session and Area Session ID for a location dependent MBS session, and also helps the UPF to identify the PFCP sessions associated with a MBS Session, or with the same MBS session and Area Session ID for a location dependent MBS session.

7.5.2.8 Create MAR IE within PFCP Session Establishment Request

The Create MAR grouped IE shall be encoded as shown in Figure 7.5.2.8-1.

Table 7.5.2.8-1: Create MAR IE within PFCP Session Establishment Request

Octet 1 and 2	Create MAR IE Type = 165 (decimal)							
Octets 3 and 4	Length = n							
Information elements	P	Condition / Comment	Appl.					IE Type
			Sx a	Sx b	Sx c	N4	N4 mb	

MAR ID	M	This IE shall uniquely identify the MAR among all the MARs configured for that PFCP session.	-	-	-	X	-	MAR ID
Steering Functionality	M	This IE shall be present to indicate the applicable traffic steering functionality.	-	-	-	X	-	Steering Functionality
Steering Mode	M	This IE shall be present to indicate the steering mode.	-	-	-	X	-	Steering Mode
3GPP Access Forwarding Action Information	C	This IE shall be present to provision 3GPP access specific forwarding action information if the UE is registered for 3GPP access, except when steering mode is set to "Active-Standby", Non-3GPP access is the active access and 3GPP access is not used as Standby access. In the latter case, this IE may be present. (NOTE 1)	-	-	-	X	-	3GPP Access Forwarding Action Information
Non-3GPP Access Forwarding Action Information	C	This IE shall be present to provision non-3GPP access specific forwarding action information if the UE is registered for non-3GPP access, except when steering mode is set to "Active-Standby", 3GPP access is the active access and Non-3GPP access is not used as Standby access. In the latter case, this IE may be present. (NOTE 1)	-	-	-	X	-	Non-3GPP Access Forwarding Action Information
Threshold Values	C	This IE shall be present if the steering mode is "Load Balancing" with fixed split percentages or "Priority-based" and if available. This IE may also be present if the steering mode is "Redundant". When present, this IE shall contain the RTT and/or a Packet Loss Rate. If the Steering Mode is Redundant, either a (maximum) RTT or a (maximum) Packet Loss Rate may be provided, but not both. (NOTE 2)	-	-	-	X	-	Thresholds
Steering Mode Indicator	C	This IE shall be included if at least one of the flags is set to "1": - ALBI (Autonomous Load Balancing Indicator): this flag shall be set to "1" if the SMF allows the UPF to apply autonomous load-balance when the Steering Mode is Load-Balancing; - UEAI (UE Assistance Indicator): this flag shall be set to "1" if the SMF allows UE assistant load-balance when the Steering Mode is Load-Balancing. (NOTE 2)	-	-	-	X	-	Steering Mode Indicator
Transport Mode	C	This IE shall be present to indicate the transport mode of the MPQUIC based functionality, if the Steering Functionality is set to the MPQUIC-UDP, MPQUIC-IP or MPQUIC-E functionality. In all other cases, this IE shall be absent.	-	-	-	X	-	Transport Mode
NOTE 1: For the "Active-Standby" steering mode, if the network determines to not define a Standby access (as specified in clause 5.32.8 of 3GPP TS 23.501 [28]), the SMF shall either set the Priority IE within (Non-)3GPP Access Forwarding Action Information IE to the value "No Standby" or not include the (Non-)3GPP Access Forwarding Action Information IE for that access not defined as Standby access.								
NOTE 2: The Threshold Values IE and the Steering Mode Indicator IE shall not be present together.								

Table 7.5.2.8-2: 3GPP Access Forwarding Action Information IE in the Create MAR IE

Octet 1 and 2	3GPP Access Forwarding Action Information 1 IE Type = 166 (decimal)							
Octets 3 and 4	Length = n							
Information elements	P	Condition / Comment	Appl.					IE Type
			Sx a	Sx b	Sx c	N4	N4 mb	

FAR ID	M	This IE shall uniquely identify the FAR among all the FARs configured for this PFCP session.	-	-	-	X	-	FAR ID
Weight	C	This IE shall be present if steering mode is set to "Load Balancing" to identify the weight of the FAR. (NOTE 1)	-	-	-	X	-	Weight
Priority	C	This IE shall be present if the steering mode is set to "Active-Standby" or "Priority-based". This IE may be present if the steering mode is set to "Redundant". (NOTE 2)	-	-	-	X	-	Priority
URR ID	C	This IE shall uniquely identify the URR among all the URRs configured for the PFCP session. This enables the SMF to request separate usage reports for different FARs (i.e. different accesses) (NOTE 3) Several IEs within the same IE type may be present to represent a list of URRs to be associated to the FAR.	-	-	-	X	-	URR ID
RAT Type	O	This IE may be present to provide the UP Function the current RAT Type for the DL FAR for statistics purpose.	-	-	-	X	-	RAT Type
<p>NOTE 1: The weights for all FARs included in both 3GPP Access Forwarding Action Information and Non 3GPP Access Forwarding Action Information need to sum up to 100. If the autonomous load balance operation is allowed, the Weights shall be treated as the default percentages.</p> <p>NOTE 2: The Priority value shall be set to "Active", "Standby" or "No Standby" if the Steering Mode is set to "Active-Standby". The Priority value shall be set to "High" or "Low" if the Steering Mode is set to "Priority-based". The Priority value shall be set to "Primary" or "Secondary" if the Steering Mode is set to "Redundant" and if the Priority IE is present. The 3GPP Access Forwarding Action Information and Non 3GPP Access Forwarding Action Information shall set different values; for the Redundant Steering Mode, this requirement shall apply only if the Priority IE is present.</p> <p>NOTE 3: One or more URRs may still be provisioned in the Create PDR IE when an MAR ID is present, while the URR(s) provisioned in this IE shall present a different set of URR(s) to request separate usage reports.</p>								

Table 7.5.2.8-3: Non-3GPP Access Forwarding Action Information IE in the Create MAR IE

Octet 1 and 2	Non-3GPP Access Forwarding Action Information IE Type = 167 (decimal)							
Octets 3 and 4	Length = n							
Information elements	P	Condition / Comment	Appl.					IE Type
			Sx a	Sx b	Sx c	N4	N4 mb	
Same IEs and requirements as defined in Table 7.5.2.8-2								

7.5.2.9 Create SRR IE within PFCP Session Establishment Request

The Create SRR grouped IE shall be encoded as shown in Figure 7.5.2.9-1.

Table 7.5.2.9-1: Create SRR IE within PFCP Session Establishment Request

Octet 1 and 2	Create SRR IE Type = 212 (decimal)							
Octets 3 and 4	Length = n							
Information elements	P	Condition / Comment	Appl.					IE Type
			Sx a	Sx b	Sx c	N4	N4 mb	

SRR ID	M	This IE shall uniquely identify the SRR among all the SRRs configured for this PFCP session.	-	-	-	X	-	SRR ID
Access Availability Control Information	C	This IE shall be present if the UPF needs to report when an access type becomes available or not available (see clause 5.20.4.2).	-	-	-	X	-	Access Availability Control Information
QoS Monitoring per QoS flow Control Information	C	This IE shall be present if per QoS Flow QoS monitoring reporting is triggered. Several IEs within the same IE type may be present to represent a list of QoS Monitoring per QoS flow Control Information for different QoS flows, or for different QoS parameters of a same QoS flow (see clause 5.39.2).	-	-	-	X	-	QoS Monitoring per QoS flow Control Information
Direct Reporting Information	C	This IE shall be present if the UPF indicated support of the DRQoS feature and if the QoS monitoring events shall be reported by the UPF directly to the consumer (e.g. to the Local NEF or AF), or both to the SMF and the consumer (e.g. to the Local NEF/AF) (see clause 5.33.5).	-	-	-	X	-	Direct Reporting Information
Traffic Parameter Measurement Control Information	C	This IE shall be present if the SMF requests the UPF to perform Traffic Parameter measurement for one or more QoS Flows. See clauses 5.37 and 5.38.4. Several IEs within the same IE type may be present to represent a list of Traffic Parameter Measurement Control Information for different QoS flows or different traffic parameters.	-	-	-	X	-	Traffic Parameter Measurement Control Information
Reporting Control Information	C	This IE shall be present if any specific reporting control information shall apply for the SRR, e.g. when per QoS flow QoS monitoring reporting is activated for UE level measurements.	-	-	-	X	-	Reporting Control Information

The Access Availability Control Information IE shall be encoded as shown in Table 7.5.2.9-2.

Table 7.5.2.9-2: Access Availability Control Information

Octet 1 and 2	Access Availability Control Information = 216 (decimal)							
Octets 3 and 4	Length = n							
Information elements	P	Condition / Comment	Appl.					IE Type
			Sx a	Sx b	Sx c	N4	N4 mb	
Requested Access Availability Information	M	This IE shall indicate the requested information to be reported.	-	-	-	X	-	Requested Access Availability Information

The QoS Monitoring per QoS flow Control Information IE shall be encoded as shown in Table 7.5.2.9-3.

Table 7.5.2.9-3: QoS Monitoring per QoS flow Control Information

Octet 1 and 2	QoS Monitoring per QoS flow Control Information = 242 (decimal)							
Octets 3 and 4	Length = n							
Information elements	P	Condition / Comment	Appl.					IE Type
			Sx a	Sx b	Sx c	N4	N4 mb	

QFI	M	This IE shall identify the QoS Flow Identifier for which QoS monitoring is required. Several IEs within the same IE type may be present to represent different QoS flows.	-	-	-	X	-	QFI
Requested QoS Monitoring	M	This IE shall indicate the QoS parameter(s) to be measured. For packet delay monitoring, it shall indicate whether the uplink, downlink and/or round trip packet delay between the UE and the UPF (PSA) shall be monitored, and whether QoS monitoring is performed based on GTP-U path monitoring. For congestion information monitoring, it shall indicate whether the uplink and/or downlink congestion information shall be monitored. For data rate monitoring, it shall indicate whether the uplink and/or downlink data rate shall be monitored. For available bitrate monitoring, it shall indicate whether the uplink and/or downlink available bitrate shall be monitored.	-	-	-	X	-	Requested QoS Monitoring
Reporting Frequency	M	This IE shall indicate the type of reporting, i.e. event triggered or periodic QoS monitoring reporting.	-	-	-	X	-	Reporting Frequency
Packet Delay Thresholds	C	This IE shall be present if the Requested QoS Monitoring indicates packet delay monitoring, event triggered QoS monitoring reporting is used and reporting is required upon reaching a delay threshold. When present, it shall indicate the packet delay after which the UP function shall report packet delay monitoring result for this SRR.	-	-	-	X	-	Packet Delay Thresholds
Minimum Wait Time	C	This IE shall be present if event triggered QoS monitoring reporting is required. When present, it shall indicate the minimum waiting time between two consecutive reports after which the UP function may report new QoS monitoring result for this SRR.	-	-	-	X	-	Minimum Wait Time
Measurement Period	C	This IE shall be present if Periodic QoS monitoring reporting or, for packet delay monitoring, if Event Triggered QoS monitoring reporting is required. When present, it shall indicate the period for generating and reporting QoS monitoring reports (if periodic QoS monitoring reporting is required) and, for packet delay monitoring, the period used for detecting and reporting a QoS monitoring measurement failure (if Periodic QoS monitoring reporting or Event Triggered QoS monitoring reporting is required). (NOTE 1) (NOTE 2)	-	-	-	X	-	Measurement Period
Reporting Suggestion Info	C	This IE should be present if the SMF receives it in a subscription to UPF QoS Monitoring event sent by the consumer via SMF. When present, it shall indicate whether the event report can be delayed, i.e. it is delay tolerant.	-	-	-	X	-	Reporting Suggestion Info
Measurement Indication	C	This IE shall be included if at least one of the flags is set to "1". - DQFI (Default QoS Flow Indication): this bit shall be set to "1" if the QoS flow to be monitored is associated with the default QoS rule and the UPF shall include the same indication in the corresponding QoS Monitoring Measurement report. See also clause 4.15.4.5.1 of 3GPP TS 23.502 [29].	-	-	-	X	-	Measurement Indication
Reporting Thresholds	C	This IE shall be present if the Reporting Frequency indicates event triggered QoS monitoring reporting is used and the Requested QoS Monitoring indicates UL and/or DL congestion information monitoring or UL and/or DL data rate monitoring. When present, it shall indicate the Reporting threshold to be used by the UPF for sending event reports.	-	-	-	X	-	Reporting Thresholds
Remaining Data Reporting Indication	O	When present, this IE shall include the indication on how to handle any QoS monitoring result not yet reported when the related N4 session is released.	-	-	-	X	-	Remaining Data Reporting Indication

NOTE 1: For packet delay monitoring, if no time stamp is received in uplink packet for a delay exceeding the Measurement Period (i.e. no measurement result is available in the UPF within the reporting period), the UP function shall generate a QoS monitoring report indicating a packet delay measurement failure to the SMF or Local NEF or AF.

NOTE 2: For packet delay monitoring, SMF implementations complying with an earlier version of the specification may not support providing the Measurement Period if the Reporting Frequency IE is set to Event Triggered QoS monitoring reporting. If so, it is implementation specific whether/how the UPF generates QoS monitoring measurement failure report.

The Direct Reporting Information IE shall be encoded as shown in Table 7.5.2.9-4.

Table 7.5.2.9-4: Direct Reporting Information

Octet 1 and 2		Direct Reporting Information = 295 (decimal)						
Octets 3 and 4		Length = n						
Information elements	P	Condition / Comment	Appl.					IE Type
			Sx a	Sx b	Sx c	N4	N4 mb	
Event Notification URI	M	This IE shall contain the notification URI to be used for sending the UPF event notifications.	-	-	-	X	-	Event Notification URI
Notification Correlation ID	C	This IE shall indicate the notification correlation id to be included in the UPF event notifications. It shall be present if it is available.	-	-	-	X	-	Notification Correlation ID
Reporting Flags	C	This IE shall be included if at least one of the flags is set to "1". <ul style="list-style-type: none"> - DUPL (Duplicate notification): this IE shall be set to "1" if event notifications shall be sent over N4 and directly to the notification URI indicated in the Event Notification URI IE. When this flag is set to "0", this indicates that the UPF shall only send the event notifications directly to the notification URI indicated in the Event Notification URI IE. 	-	-	-	X	-	Reporting Flags

The Traffic Parameter Measurement Control Information IE shall be encoded as shown in Table 7.5.2.9-5.

Table 7.5.2.9-5.: Traffic Parameter Measurement Control Information IE

Octet 1 and 2		Traffic Parameter Measurement Control Information IE Type = 323 (decimal)						
Octets 3 and 4		Length = n						
Information elements	P	Condition / Comment	Appl.					IE Type
			Sx a	Sx b	Sx c	N4	N4 mb	
QFI	M	This IE shall identify the QoS Flow Identifier for which traffic parameter is requested to be measured. Several IEs within the same IE type may be present to represent different QoS flows.	-	-	-	X	-	QFI
Traffic Parameter Measurement Indication	M	This IE shall be included to indicate the requested traffic parameter measurement(s), as follows: <ul style="list-style-type: none"> - ULPMI (UL Periodicity Measurement Indication): this bit shall be set to "1" to request the UPF to measure the UL Periodicity if the SMF does not receive the UL Periodicity from the PCF. - DLPMI (DL Periodicity Measurement Indication): this bit shall be set to "1" to request the UPF to measure the DL Periodicity if the SMF does not receive the DL Periodicity from the PCF. - N6JMI (N6 Jitter Measurement Indication): this bit shall be set to "1" to request the UPF to measure N6 Jitter. 	-	-	-	X	-	Traffic Parameter Measurement Indication
Measurement Period	C	This IE shall be present if Periodic traffic parameter measurement reporting is required. When present, it shall indicate the period for generating and reporting traffic parameter measurement reports. (NOTE)	-	-	-	X	-	Measurement Period
DL Periodicity	C	This IE shall be present, if N6 jitter measurement is requested and if the DL Periodicity is available. When available, it shall contain the DL Periodicity to perform Jitter measurement.	-	-	-	X	-	DL Periodicity
Traffic Parameter Threshold	C	This IE shall be present if Traffic Parameter measurement reporting is required only upon reaching a threshold. When present, and if N6 jitter measurement is requested, it shall contain the Downlink N6 Jitter threshold after which the UP function shall report N6 Jitter measurement to the SMF. (NOTE)	-	-	-	X	-	Traffic Parameter Threshold

NOTE: Either a Measurement Period or a Traffic Parameter Threshold shall be present.

7.5.2.10 Provide ATSSS Control Information IE within PFCP Session Establishment Request

The Provide ATSSS Control Information grouped IE shall be encoded as shown in Figure 7.5.2.10-1.

Table 7.5.2.10-1: Provide ATSSS Control Information IE within PFCP Session Establishment Request

Octet 1 and 2		Provide ATSSS Control Information IE Type = 220 (decimal)						
Octets 3 and 4		Length = n						
Information elements	P	Condition / Comment	Appl.					IE Type
			Sx a	Sx b	Sx c	N4	N4 mb	

MPTCP Control Information	C	This IE shall be present if the PDU session is an MA PDU session and the MPTCP functionality is required.	-	-	-	X	-	MPTCP Control Information
ATSSS-LL Control Information	C	This IE shall be present if the PDU session is an MA PDU session and the ATSSS-LL functionality is required.	-	-	-	X	-	ATSSS-LL Control Information
PMF Control Information	C	This IE shall be present if the PDU session is an MA PDU session and the PMF functionality is required.	-	-	-	X	-	PMF Control Information
MPQUIC Control Information	C	This IE shall be present if the PDU session is an MA PDU session and the MPQUIC-UDP, MPQUIC-IP and/or MPQUIC-E functionality is required.	-	-	-	X	-	MPQUIC Control Information

7.5.2.11 Provide RDS Configuration Information IE within PFCP Session Establishment Request

The Provide RDS Configuration Information IE shall be encoded as shown in Figure 7.5.2.11-1.

Table 7.5.2.11-1: Provide RDS Configuration Information IE within PFCP Session Establishment Request

Octet 1 and 2	Provide RDS Configuration Information IE Type = 261 (decimal)							
Octets 3 and 4	Length = n							
Information elements	P	Condition / Comment	Appl.					IE Type
			Sxa	Sxb	Sxc	N4	N4mb	
RDS Configuration Information	O	When present, this IE indicates if the RDS mechanism is supported.	-	X	-	X	-	RDS Configuration Information

7.5.3 PFCP Session Establishment Response

7.5.3.1 General

The PFCP Session Establishment Response shall be sent over the Sxa, Sxb, Sxc and N4 interface by the UP function to the CP function as a reply to the PFCP Session Establishment Request.

Table 7.5.3.1-1: Information Elements in a PFCP Session Establishment Response

Information elements	P	Condition / Comment	Appl.					IE Type
			Sxa	Sxb	Sxc	N4	N4mb	

Node ID	M	This IE shall contain the unique identifier of the sending Node.	X	X	X	X	X	Node ID
Cause	M	This IE shall indicate the acceptance, partial acceptance or rejection of the corresponding request message.	X	X	X	X	X	Cause
Offending IE	C	This IE shall be included if the rejection is due to a conditional or mandatory IE missing or faulty.	X	X	X	X	X	Offending IE
UP F-SEID	C	This IE shall be present if the cause is set to "Request accepted (success)". When present, it shall contain the unique identifier allocated by the UP function identifying the session.	X	X	X	X	X	F-SEID
Created PDR	C	This IE shall be present if the cause is set to "success" and the UP function was requested to allocate a local F-TEID or a UE IP address/prefix or a Mapped N6 IP address for the PDR. When present, this IE shall contain the PDR information associated to the PFCP session. There may be several instances of this IE. See table 7.5.3.2-1.	X	X	-	X	X	Created PDR
Load Control Information	O	The UP function may include this IE if it supports the load control feature and the feature is activated in the network. See Table 7.5.3.3-1.	X	X	X	X	X	Load Control Information
Overload Control Information	O	During an overload condition, the UP function may include this IE if it supports the overload control feature and the feature is activated in the network. See Table 7.5.3.4-1.	X	X	X	X	X	Overload Control Information
PGW-U/SGW-U /UPF FQ-CSID	C	This IE shall be included according to the requirements in clause 23 of 3GPP TS 23.007 [24] and clause 4.6 of 3GPP TS 23.527 [40].	X	X	-	X	-	FQ-CSID
Failed Rule ID	C	This IE shall be included if the Cause IE indicates a rejection due to a rule creation or modification failure.	X	X	X	X	X	Failed Rule ID
Created Traffic Endpoint	C	This IE shall be present if the cause is set to "success" and the UP function was requested to allocate a local F-TEID or a UE IP address/prefix or a Mapped N6 IP address in a Create Traffic Endpoint IE. When present, it shall contain the local F-TEID, or UE IP address/prefix, or Mapped N6 IP address to be used for this Traffic Endpoint. There may be several instances of this IE.	X	X	-	X	X	Created Traffic Endpoint
Created Bridge/Router Info	C	This IE shall be present if the UPF was requested to provide Bridge/Router information for TSN, TSC or DetNet in the PFCP Session Establishment Request. When present, it shall contain the Bridge/Router information for TSN, TSCTS or DetNet for the PFCP session. See Table 7.5.3.6-1.	-	-	-	X	-	Created Bridge/Router Info
ATSSS Control Parameters	C	This IE shall be present if ATSSS functionality is required in the request message and the UPF allocates the resources and parameters corresponding to the required ATSSS functionality. See Table 7.5.3.7-1.	-	-	-	X	-	ATSSS Control Parameters
RDS configuration information	O	When present, this IE shall contain the RDS configuration information the UP function supported for this PFCP session.	-	X	-	X	-	RDS configuration information
Partial Failure Information	C	This IE shall be present if the Cause IE indicates partial acceptance of the request to provide failure information related to a failed rule. See Table 7.5.3.1-2. Several IEs within the same IE type may be present to report failures to apply multiple rules.	-	X	X	X	X	Partial Failure Information
Created L2TP Session	O	This IE may be present to include information for the Created L2TP session if the Cause IE indicates a success.	-	X	-	X	-	Created L2TP Session
MBS Session N4mb Information	C	This IE shall be present if any IE in this grouped IE needs to be included.	-	-	-	-	X	MBS Session N4mb Information

MBS Session N4 Information	C	This IE shall be included if any IE in this grouped IE needs to be included as specified in clause 5.34.1. Several IE with the same IE type may be present to contain N4 Information for several MBS Sessions respectively.	-	-	-	X	-	MBS Session N4 Information
TL-Container	C	This IE shall be present if the UPF/CN-TL needs to send a TL-Container to the SMF/CUC to respond to TL-Container information received in the corresponding request.	-	-	-	X	-	TL-Container
MoQ Information	C	This IE shall be included if any IE in this grouped IE needs to be included. See Table 7.5.3.1-6.	-	-	-	X	-	MoQ Information

Table 7.5.3.1-2: Information Elements in a Partial Failure Information

Octet 1 and 2		Partial Failure Information IE Type = 272 (decimal)						
Octets 3 and 4		Length = n						
Information elements	P	Condition / Comment	Appl.					IE Type
			Sxa	Sxb	Sxc	N4	N4mb	
Failed Rule ID	M	This IE shall indicate the rule that failed to be applied.	-	X	X	X	X	Failed Rule ID
Failure Cause	M	This IE shall indicate the reason why the rule could not be applied.	-	X	X	X	X	Cause
Offending IE Information	M	This IE shall be included to report the offending IE which caused the rule activation failure, e.g. an unknown predefined rule name included in Activate Predefined Rules IE or an unknown Application ID in the PDI. Several IEs within the same IE type may be present to report multiple offending IEs.	-	X	X	X	X	Offending IE Information

Table 7.5.3.1-3: Created L2TP Session IE in the PFCP Session Establishment Response message

Octet 1 and 2		Created L2TP Session IE Type = 279 (decimal)						
Octets 3 and 4		Length = n						
Information elements	P	Condition / Comment	Appl.					IE Type
			Sxa	Sxb	Sxc	N4	N4mb	
DNS Server Address	O	This IE may be present to include a DNS server address. Several IEs with the same IE type may be present to represent multiple DNS server addresses. The order of the IEs in the message indicates the priority, i.e. the first IE shall contain the primary DNS server address and the second IE shall contain the secondary DNS server address.	-	X	-	X	-	DNS Server Address
NBNS Server Address	O	This IE may be present to include an NBNS server address. Several IEs with the same IE type may be present to represent multiple NBNS server addresses. The order of the IEs in the message indicates the priority, i.e. the first IE shall contain the primary NBNS server address and the second IE shall contain the secondary NBNS server address.	-	X	-	X	-	NBNS Server Address
LNS Address	O	This IE may be present to include the used Tunnel Server Endpoint, i.e., the LNS IP address, for the PFCP Session.	-	X	-	X	-	LNS Address

Table 7.5.3.1-4: MBS Session N4mb Information IE within PFCP Session Establishment Response

Octet 1 and 2		MBS Session N4mb Information IE Type = 303 (decimal)						
Octets 3 and 4		Length = n						
Information elements	P	Condition / Comment	Appl.					IE Type
			Sxa	Sxb	Sxc	N4	N4mb	
Multicast Transport Information	C	This IE shall be present to include a low layer source specific multicast address information (i.e. multicast destination address and related source IP address) and a GTP-U Common Tunnel EndPoint Identifier (C-TEID) if the CP function has requested to allocate such information for multicast transport over N3mb and/or N19mb.	-	-	-	-	X	Multicast Transport Information

Table 7.5.3.1-5: MBS Session N4 Information IE within PFCP Session Establishment Response

Octet 1 and 2		MBS Session N4 Information IE Type = 311 (decimal)						
Octets 3 and 4		Length = n						
Information elements	P	Condition / Comment	Appl.					IE Type
			Sxa	Sxb	Sxc	N4	N4mb	
MBS Session Identifier	M		-	-	-	X	-	MBS Session Identifier
Area Session ID	C	This IE shall be present for a location dependent MBS service. When present, it shall contain the Area Session ID, which together with the MBS Session Identifier, uniquely identify the service area part of the content data of the MBS service.	-	-	-	X	-	Area Session ID
N19mb DL Tunnel ID	C	This IE shall be present when the SMF has requested the UPF to allocate a Local F-TEID in the PDI or in the Create Traffic Endpoint IE. (NOTE 1)	-	-	-	X	-	F-TEID
MBSN4Resp-Flags	C	This IE shall be included if at least one of the flags is set to "1". NOTE 2. <ul style="list-style-type: none"> - NN19DT (New N19mb Downlink Tunnel): the UPF shall set this flag if it has allocated a new N19mb DL TEID for the MBS session; - JMTI (Joined N19mb Multicast Tree Indication): the UPF shall set this flag if it has joined the multicast tree from the MB-UPF; - N19DTR (N19mb Downlink Tunnel Removal): the UPF shall set this flag if it is about to remove the N19mb DL Tunnel for receiving the MBS session data. 	-	-	-	X	-	MBSN4Resp-Flags

NOTE 1: The UPF need not include Created PDR or Created Traffic Endpoint to return the newly allocated N19mb DL TEID.
NOTE 2: Clause 5.34.3.2 explains what is indicated by the absence of the MBSN4Resp-Flags.

Table 7.5.3.1-6: MoQ Information IE within PFCP Session Establishment Response

Octet 1 and 2		MoQ Information IE Type = 386 (decimal)						
Octets 3 and 4		Length = n						
Information elements	P	Condition / Comment	Appl.					IE Type
			Sxa	Sxb	Sxc	N4	N4mb	
MoQ Relay Address	C	This IE shall be present if the UPF indicates support of MoQ relay functionality and MQRAI set to "1" is received in the corresponding request.	-	-	-	X	-	MoQ Relay IP Address

7.5.3.2 Created PDR IE within PFCP Session Establishment Response

The Created PDR grouped IE shall be encoded as shown in Figure 7.5.3.2-1.

Table 7.5.3.2-1: Created PDR IE within PFCP Session Establishment Response

Octet 1 and 2		Created PDR IE Type = 8 (decimal)						
Octets 3 and 4		Length = n						
Information elements	P	Condition / Comment	Appl.					IE Type
			Sxa	Sxb	Sxc	N4	N4mb	
PDR ID	M		X	X	-	X	X	PDR ID
Local F-TEID	C	If the UP function allocates the F-TEID, this IE shall be present and shall contain the local F-TEID to be used for this PDR.	X	X	-	X	-	F-TEID
Local F-TEID for Redundant Transmission	C	This IE shall be present and shall contain the local F-TEID used for this PDR for the reception of redundant uplink packets on N3/N9 interfaces, if the CP function requested a Local F-TEID to be assigned for redundant transmission.	-	-	-	X	-	F-TEID
UE IP Address	C	If the UP function allocates the UE IP address/prefix, this IE shall be present and shall contain the UE IP address/ prefix assigned by the UP function. In the 5GC, several IEs with the same IE type may be present to represent multiple UE IP addresses, if the UPF indicated support of the IP6PL feature (see clause 5.21).	-	X	-	X	-	UE IP Address
Mapped N6 IP Address	C	If the UP function in VPLMN is requested to allocate the mapped N6 IP address for a HR-SBO PDU session, this IE shall be present and shall contain the mapped N6 IP address assigned by the UP function.	-	-	-	X	-	Mapped N6 IP Address
Local Ingress Tunnel	C	If the UP function allocates the Local Ingress Tunnel, this IE shall be present and shall contain the Local Ingress Tunnel to be used for this PDR.	-	-	-	-	X	Local Ingress Tunnel

7.5.3.3 Load Control Information IE within PFCP Session Establishment Response

The Load Control Information grouped IE shall be encoded as shown in Figure 7.5.3.3-1.

Table 7.5.3.3-1: Load Control Information IE within PFCP Session Establishment Response

Octet 1 and 2		Load Control Information IE Type = 51 (decimal)						
Octets 3 and 4		Length = n						
Information elements	P	Condition / Comment	Appl.					IE Type
			Sxa	Sxb	Sxc	N4	N4mb	
Load Control Sequence Number	M	See clause 6.2.3.3.2 for the description and use of this parameter.	X	X	X	X	X	Sequence Number
Load Metric	M	See clause 6.2.3.3.2 for the description and use of this parameter.	X	X	X	X	X	Metric

7.5.3.4 Overload Control Information IE within PFCP Session Establishment Response

The Overload Control grouped IE shall be encoded as shown in Figure 7.5.3.4-1.

Table 7.5.3.4-1: Overload Control Information IE within PFCP Session Establishment Response

Octet 1 and 2		Overload Control Information IE Type = 54 (decimal)						
Octets 3 and 4		Length = n						
Information elements	P	Condition / Comment	Appl.					IE Type
			Sx a	Sx b	Sx c	N4	N4 mb	
Overload Control Sequence Number	M	See 6.2.4.3.2 for the description and use of this parameter.	X	X	X	X	X	Sequence Number
Overload Reduction Metric	M	See clause 6.2.4.3.2 for the description and use of this parameter.	X	X	X	X	X	Metric
Period of Validity	M	See clause 6.2.4.3.2 for the description and use of this parameter.	X	X	X	X	X	Timer
Overload Control Information Flags	C	This IE shall be included if any of flag in this IE is set.	X	X	X	X	X	OCI Flags

7.5.3.5 Created Traffic Endpoint IE within PFCP Session Establishment Response

The Created Traffic Endpoint grouped IE shall be encoded as shown in Figure 7.5.3.5-1.

Table 7.5.3.5-1: Created Traffic Endpoint IE within PFCP Session Establishment Response

Octet 1 and 2		Created Traffic Endpoint IE Type = 128 (decimal)						
Octets 3 and 4		Length = n						
Information elements	P	Condition / Comment	Appl.					IE Type
			Sxa	Sxb	Sxc	N4	N4 mb	
Traffic Endpoint ID	M	This IE shall uniquely identify the Traffic Endpoint for that PFCP session.	X	X	-	X	X	Traffic Endpoint ID
Local F-TEID	C	If the UP function allocates the F-TEID, this IE shall be present and shall contain the local F-TEID to be used for this Traffic Endpoint.	X	X	-	X	-	F-TEID
Local F-TEID for Redundant Transmission	C	This IE shall be present and shall contain the local F-TEID to be used for this PDR for the reception of redundant uplink packets on N3/N9 interfaces, if the CP function requested a Local F-TEID to be assigned for redundant transmission.	-	-	-	X	-	F-TEID
UE IP Address	C	If the UP function allocates the UE IP address/prefix, this IE shall be present and shall contain the UE IP address/ prefix assigned by the UP function. In the 5GC, several IEs with the same IE type may be present to represent multiple UE IP addresses, if the UPF indicated support of the IP6PL feature (see clause 5.21).	-	X	-	X	-	UE IP Address
Mapped N6 IP Address	C	If the UP function in VPLMN is requested to allocate the mapped N6 IP address for a HR-SBO PDU session, this IE shall be present and shall contain the mapped N6 IP address assigned by the UP function.	-	-	-	X	-	Mapped N6 IP Address
Local Ingress Tunnel	C	If the UP function allocates the Local Ingress Tunnel, this IE shall be present and shall contain the Local Ingress Tunnel to be used for this PDR.	-	-	-	-	X	Local Ingress Tunnel

7.5.3.6 Created Bridge/Router Info IE within PFCP Session Establishment Response

The Created Bridge/Router Info grouped IE shall be encoded as shown in Figure 7.5.3.6-1.

Table 7.5.3.6-1: Created Bridge/Router Info IE within PFCP Session Establishment Response

Octet 1 and 2		Created Bridge/Router Info IE Type = 195 (decimal)						
Octets 3 and 4		Length = n						
Information elements	P	Condition / Comment	Appl.					IE Type
			Sx a	Sx b	Sx c	N4	N4 mb	
Port Number	C	If the BII bit or the RII bit was set to "1" in the Create Bridge/Router Info IE, this IE shall be present and shall contain the Port Number assigned by the UP function for the PDU Session.	-	-	-	X	-	Port Number
5GS User Plane Node ID	C	If the BII bit or the RII bit was set to "1" in the Create Bridge/Router Info IE, this IE shall be present and shall contain the 5GS User Plane Node ID assigned by the UP function.	-	-	-	X	-	5GS User Plane Node ID

7.5.3.7 ATSSS Control Parameters IE within PFCP Session Establishment Response

The ATSSS Control Parameters grouped IE shall be encoded as shown in Figure 7.5.3.7-1.

Table 7.5.3.7-1: ATSSS Control Parameters IE within PFCP Session Establishment Response

Octet 1 and 2		ATSSS Control Parameters IE Type = 221 (decimal)						
Octets 3 and 4		Length = n						
Information elements	P	Condition / Comment	Appl.					IE Type
			Sx a	Sx b	Sx c	N4	N4 mb	
MPTCP Parameters	C	This IE shall be present if the TCI flag in the MPTCP Control Information IE is set to "1" in the Request message and the UPF allocated resources for MPTCP.	-	-	-	X	-	MPTCP Parameters
ATSSS-LL Parameters	C	This IE shall be present if the LLI flag in ATSSS-LL Control Information IE is set to "1" in the Request message and the UPF allocated resources for ATSSS-LL.	-	-	-	X	-	ATSSS-LL Parameters
PMF Parameters	C	This IE shall be present if the PMFI flag in the PMF Control Information IE is set to "1" in the Request message and the UPF allocated resources for PMF. Several IEs with the same IE type may be present to provide multiple PMF Parameters.	-	-	-	X	-	PMF Parameters
MPQUIC Parameters	C	This IE shall be present if any flag in the MPQUIC Control Information IE is set to "1" in the Request message and the UPF allocated resources for the related MPQUIC based functionalities.	-	-	-	X	-	MPQUIC Parameters

The MPTCP Parameters grouped IE shall be encoded as shown in Figure 7.5.3.7-2.

Table 7.5.3.7-2: MPTCP Parameters IE within PFCP Session Establishment Response

Octet 1 and 2		MPTCP Parameters IE Type = 225 (decimal)						
Octets 3 and 4		Length = n						
Information elements	P	Condition / Comment	Appl.					IE Type
			Sx a	Sx b	Sx c	N4	N4 mb	
MPTCP Address Information	M	This IE shall carry the information of allocated MPTCP address.	-	-	-	X	-	MPTCP Address Information
MPTCP Link-Specific IP Address	M	This IE shall carry the information of allocated MPTCP link-specific multipath IP address.	-	-	-	X	-	Link-Specific Multipath IP Address

The ATSSS-LL Parameters grouped IE shall be encoded as shown in Figure 7.5.3.7-3.

Table 7.5.3.7-3: ATSSS-LL Parameters IE within PFCP Session Establishment Response

Octet 1 and 2		ATSSS-LL Parameters IE Type = 226 (decimal)					IE Type	
Octets 3 and 4		Length = n						
Information elements	P	Condition / Comment	Appl.					
			Sx a	Sx b	Sx c	N4	N4 mb	
ATSSS-LL Information	M	This IE shall indicate that resources have been allocated to the ATSSS functionality.	-	-	-	X	-	ATSSS-LL Information

The PMF Parameters grouped IE shall be encoded as shown in Figure 7.5.3.7-4.

Table 7.5.3.7-4: PMF Parameters IE within PFCP Session Establishment Response

Octet 1 and 2		PMF Parameters IE Type = 227 (decimal)					IE Type	
Octets 3 and 4		Length = n						
Information elements	P	Condition / Comment	Appl.					
			Sx a	Sx b	Sx c	N4	N4 mb	
PMF Address Information	M	This IE shall contain the PMF Address Information.	-	-	-	X	-	PMF Address Information
QoS flow identifier	O	If present, this IE shall identify the QoS Flow Identifier of the QoS flow related to the PMF address information.	-	-	-	X	-	QFI

The MPQUIC Parameters grouped IE shall be encoded as shown in Figure 7.5.3.7-5.

Table 7.5.3.7-5: MPQUIC Parameters IE within PFCP Session Establishment Response

Octet 1 and 2		MPQUIC Parameters IE Type = 331 (decimal)					IE Type	
Octets 3 and 4		Length = n						
Information elements	P	Condition / Comment	Appl.					
			Sx a	Sx b	Sx c	N4	N4 mb	
MPQUIC Address Information	M	This IE shall carry the information of allocated MPQUIC address for MPQUIC-UDP and/or MPQUIC-IP or MPQUIC-E steering functionalities. Two IEs with the same IE type may be included, if both MPQUIC-IP and MPQUIC-UDP steering functionalities have been requested by the CP function and the UP function (based on implementation) provides different MPQUIC Address Information for MPQUIC-IP and MPQUIC-UDP respectively. See clause 5.20.2A.2.	-	-	-	X	-	MPQUIC Address Information
MPQUIC Link-Specific IP Address	M	This IE shall carry the information of allocated MPQUIC link-specific multipath IP address.	-	-	-	X	-	Link-Specific Multipath IP Address

7.5.3.8 Void

7.5.4 PFCP Session Modification Request

7.5.4.1 General

The PFCP Session Modification Request is used over the Sxa, Sxb, Sxc, N4 and N4mb interface by the CP function to request the UP function to modify the PFCP session.

Table 7.5.4.1-1: Information Elements in a PFCP Session Modification Request

Information elements	P	Condition / Comment	Appl.					IE Type
			Sx a	Sx b	Sx c	N4	N4 mb	

CP F-SEID	C	This IE shall be present if the CP function decides to change its F-SEID for the PFCP session. The UP function shall use the new CP F-SEID for subsequent PFCP Session related messages for this PFCP Session. See Note 2.	X	X	X	X	X	F-SEID
Remove PDR	C	When present, this IE shall contain the PDR Rule which is requested to be removed. See Table 7.5.4-6-1. Several IEs within the same IE type may be present to represent a list of PDRs to remove.	X	X	X	X	X	Remove PDR
Remove FAR	C	When present, this IE shall contain the FAR Rule which is requested to be removed. See Table 7.5.4-7-1. Several IEs within the same IE type may be present to represent a list of FARs to remove.	X	X	X	X	X	Remove FAR
Remove URR	C	When present, this shall contain the URR Rule which is requested to be removed. See Table 7.5.4-8-1. Several IEs within the same IE type may be present to represent a list of URRs to remove.	X	X	X	X	X	Remove URR
Remove QER	C	When present, this IE shall contain the QER Rule which is requested to be removed. See Table 7.5.4-9-1. Several IEs within the same IE type may be present to represent a list of QERs to remove.	-	X	X	X	X	Remove QER
Remove BAR	C	When present, this IE shall contain the BAR Rule which is requested to be removed. See Table 7.5.4.12-1.	X	-	-	X	-	Remove BAR
Remove Traffic Endpoint	C	When present, this IE shall contain the Traffic Endpoint ID identifying the traffic endpoint to be removed, if the UP function has indicated support of PDI optimization. All the PDRs that refer to the removed Traffic Endpoint shall be deleted. See Table 7.5.4.14-1. Several IEs within the same IE type may be present to represent a list of Traffic Endpoints to remove.	X	X	X	X	X	Remove Traffic Endpoint
Create PDR	C	This IE shall be present if the CP function requests the UP function to create a new PDR. See Table 7.5.2.2-1. Several IEs within the same IE type may be present to represent a list of PDRs to create.	X	X	X	X	X	Create PDR
Create FAR	C	This IE shall be present if the CP function requests the UP function to create a new FAR. See Table 7.5.2.3-1. Several IEs within the same IE type may be present to represent a list of FARs to create.	X	X	X	X	X	Create FAR
Create URR	C	This IE shall be present if the CP function requests the UP function to create a new URR. See Table 7.5.2.4-1. Several IEs within the same IE type may be present to represent a list of URRs to create.	X	X	X	X	X	Create URR
Create QER	C	This IE shall be present if the CP function requests the UP function to create a new QER. See Table 7.5.2.5-1. Several IEs within the same IE type may be present to represent a list of QERs to create.	-	X	X	X	X	Create QER
Create BAR	C	This IE shall be present if the CP function requests the UP function to create a new BAR. See Table 7.5.2.6-1.	X	-	-	X	-	Create BAR
Create Traffic Endpoint	C	When present this IE shall contain the information associated with the Traffic Endpoint to be created, if the UP function has indicated support of PDI optimization. See Table 7.5.2.7-1. Several IEs within the same IE type may be present to represent a list of Traffic Endpoints to create.	X	X	X	X	X	Create Traffic Endpoint
Update PDR	C	This IE shall be present if a PDR previously created for the PFCP session need to be modified. See Table 7.5.4.2-1. Several IEs within the same IE type may be present to represent a list of PDRs to update.	X	X	X	X	X	Update PDR
Update FAR	C	This IE shall be present if a FAR previously created for the PFCP session need to be modified. See Table 7.5.4.3-1. Several IEs within the same IE type may be present to represent a list of FARs to update.	X	X	X	X	X	Update FAR

Update URR	C	This IE shall be present if URR(s) previously created for the PFCP session need to be modified. Several IEs within the same IE type may be present to represent a list of modified URRs. Previously URRs that are not modified shall not be included. See Table 7.5.4.4-1.	X	X	X	X	X	Update URR
Update QER	C	This IE shall be present if QER(s) previously created for the PFCP session need to be modified. Several IEs within the same IE type may be present to represent a list of modified QERs. Previously created QERs that are not modified shall not be included. See Table 7.5.4.5-1.	-	X	X	X	X	Update QER
Update BAR	C	This IE shall be present if a BAR previously created for the PFCP session needs to be modified. A previously created BAR that is not modified shall not be included. See Table 7.5.4.11-1.	X	-	-	X	-	Update BAR
Update Traffic Endpoint	C	When present this IE shall contain the information associated with the traffic endpoint to be updated, if the UP function has indicated support of PDI optimization. All the PDRs that refer to the Traffic Endpoint shall use the updated Traffic Endpoint information. See Table 7.5.4.13-1. Several IEs within the same IE type may be present to represent a list of Traffic Endpoints to update.	X	X	X	X	X	Update Traffic Endpoint
PFCPSMReq-Flags	C	This IE shall be included if at least one of the flags is set to "1". <ul style="list-style-type: none"> - DROBU (Drop Buffered Packets): the CP function shall set this flag if the UP function is requested to drop the packets currently buffered for this PFCP session (see NOTE 1). - QAURR (Query All URRs): the CP function shall set this flag if the CP function requests immediate usage report(s) for all the URRs previously provisioned for this PFCP session (see NOTE 3). - SUMPC (Stop Usage Measurement to Pause Charging): the CP function, e.g. PGW-C or (H-)SMF, shall set this flag if the usage measurement for the URRs which are applicable for charging (i.e. with the "ASPOC" flag set to "1") shall be stopped in the UP function. - RUMUC (Resume Usage Measurement to Un-pause Charging): the CP function, e.g. PGW-C or (H-)SMF, shall set this flag if the usage measurement for the URRs which are applicable for charging (i.e. with the "ASPOC" flag set to "1") shall be resumed in the UP function. - DETEID (Delete All DL N3mb and/or N19mb F-TEIDs): the MB-SMF shall set this flag to "1" if it requests the MB-UPF to delete all NG-RAN N3mb DL F-TEIDs and all UPF N19mb DL F-TEIDs for the MBS session when the Apply Action is changed from the "FSSM and/or MBSU" to the "BUFF" (with or without "NOCP"), or to "DROP" (see clause 5.34.2.4). - HRSBOM (HR-SBO Mode): the V-SMF shall set this flag to the V-UPF acting as Local PSA in the VPLMN, if the V-SMF supports HR-SBO and if the PDU session is working in HB-SBO mode. 	X	-	-	X	-	PFCPSMReq-Flags

Query URR	C	This IE shall be present if the CP function requests immediate usage report(s) to the UP function. Several IEs within the same IE type may be present to represent a list of URRs for which an immediate report is requested. See Table 7.5.4.10-1. See NOTE 3.	X	X	X	X	X	Query URR
PGW-C/SMF FQ-CSID	C	This IE shall be included according to the requirements in clause 23 of 3GPP TS 23.007 [24] and clause 4.6 of 3GPP TS 23.527 [40].	X	X	-	X	-	FQ-CSID
SGW-C FQ-CSID	C	This IE shall be included according to the requirements in clause 23 of 3GPP TS 23.007 [24].	X	X	-	-	-	FQ-CSID
MME FQ-CSID	C	This IE shall be included according to the requirements in clause 23 of 3GPP TS 23.007 [24].	X	X	-	-	-	FQ-CSID
ePDG FQ-CSID	C	This IE shall be included according to the requirements in clause 23 of 3GPP TS 23.007 [24].	-	X	-	-	-	FQ-CSID
TWAN FQ-CSID	C	This IE shall be included according to the requirements in clause 23 of 3GPP TS 23.007 [24].	-	X	-	-	-	FQ-CSID
User Plane Inactivity Timer	C	This IE shall be present if it needs to be changed.	-	X	X	X	X	User Plane Inactivity Timer
Query URR Reference	O	This IE may be present if the Query URR IE is present or the QAURR flag is set to "1". When present, it shall contain a reference identifying the query request, which the UP function shall return in any usage report sent in response to the query.	X	X	X	X	X	Query URR Reference
Trace Information	O	When present, this IE shall contain the trace instructions to be applied by the UP function for this PFCP session. For trace only, a Trace Information with a null length indicates that the trace session shall be deactivated. For trace and UE level measurement, the Trace Information shall be set as defined in clause 5.15A.2. See NOTE 7.	X	X	X	X	-	Trace Information
Remove MAR	C	When present, this IE shall contain the MAR Rule which is requested to be removed. See Table 7.5.4.15-1. Several IEs within the same IE type may be present to represent a list of MARs to remove.	-	-	-	X	-	Remove MAR
Update MAR	C	This IE shall be present if an MAR previously created for the PFCP session needs to be modified. See Table 7.5.4.16-1. Several IEs within the same IE type may be present to represent a list of MARs to update.	-	-	-	X	-	Update MAR
Create MAR	C	This IE shall be present if the CP function requests the UP function to create a new MAR for a new PDR. See Table 7.5.2.8-1. Several IEs within the same IE type may be present to represent a list of MARs to create.	-	-	-	X	-	Create MAR
Node ID	C	This IE shall be present if a new SMF in an SMF Set, with one PFCP association per SMF and UPF, or a new MB-SMF in an MB-SMF Set, with one PFCP association per MB-SMF and MB-UPF (see clause 5.22.3), takes over the control of the PFCP session. When present, it shall contain the unique identifier of the new SMF or MB-SMF.	-	-	-	X	X	Node ID
TSC Management Information	C	This IE shall be present if the SMF needs to send TSC Management information to the UPF. Several IEs within the same IE type may be present to transfer PMICs for different NW-TT ports. (NOTE 6).	-	-	-	X	-	TSC Management Information
Remove SRR	C	When present, this shall indicate the SRR Rule which is requested to be removed. See Table 7.5.4-19-1. Several IEs within the same IE type may be present to represent a list of SRRs to remove.	-	-	-	X	-	Remove SRR
Create SRR	C	This IE shall be present if the CP function requests the UP function to create a new SRR. See Table 7.5.2.9-1. Several IEs within the same IE type may be present to represent a list of SRRs to create.	-	-	-	X	-	Create SRR

Update SRR	C	This IE shall be present if SRR(s) previously created for the PFCP session need to be modified. Several IEs within the same IE type may be present to represent a list of modified SRRs. Previously SRRs that are not modified shall not be included. See Table 7.5.4.20-1.	-	-	-	X	-	Update SRR
Provide ATSSS Control Information	C	This IE shall be present for PFCP session modification for an MA PDU session, if the ATSSS Control Information changes. When present, this IE shall contain the required ATSSS functionalities for this MA PDU session. The UPF shall replace any value received previously by the new information received in this IE. See Note 4. See Table 7.5.2.10-1.	-	-	-	X	-	Provide ATSSS Control Information
Ethernet Context Information	C	This IE shall be present to update the list of MAC addresses associated to the PDU session during an Ethernet PDU session anchor relocation.	-	-	-	X	-	Ethernet Context Information
Access Availability Information	O	This IE may be present for an MA PDU session to signal that an access type has become transiently unavailable or has become available again (see clause 5.20.5). Two IEs with the same IE type may be present to report changes of access availability for both 3GPP and non-3GPP accesses.	-	-	-	X	-	Access Availability Information
Query Packet Rate Status	C	This IE shall be present if the CP function requests immediate packet rate status report(s) to the UP function. Several IEs within the same IE type may be present to represent a list of QERs for which an immediate packet rate status report is requested. See Table 7.5.4.22-1.	-	X	-	X	-	Query Packet Rate Status
S-NSSAI	O	This IE may be present to indicate the S-NSSAI of the PDU session or MBS session, if the S-NSSAI of the PDU Session or MBS session has been provided previously to the UP function and the S-NSSAI has changed. (NOTE 5) This IE should be present to indicate the S-NSSAI of the PDU session, if the S-NSSAI of the PDU Session has been provided previously to the UP function and the S-NSSAI has changed.	-	-	-	X	X	S-NSSAI
HPLMN S-NSSAI	C	This IE should be sent from the V-SMF to any V-UPF acting as (local) PSA for a HR-SBO PDU session and capable of enforcing NAT on N6 traffic, if the information was not provided during the PFCP session establishment. When present, it shall contain the HPLMN S-NSSAI.	-	-	-	X	-	HPLMN S-NSSAI
DNN	C	This IE should be sent from the V-SMF to any V-UPF acting as (local) PSA for a HR-SBO PDU session and capable of enforcing NAT on N6 traffic, if the information was not provided during the PFCP session establishment. When present, it shall contain the full DNN of the PDU session (with the Operator ID part identifying the HPLMN ID).	-	-	-	X	-	DNN
RAT Type		This IE shall be present if there is a RAT change and the CP function wants to inform the UP Function about the new RAT Type if the PFCP session is not established for a MA PDU session.	X	X	-	X	-	RAT Type
Group Id	C	This IE shall be included by the CP function to indicate the new group identifier to which the PFCP session pertains, if it has been changed (see clause 5.22.4). When present, the UP function shall replace any earlier value associated to the PFCP session with the new value.	-	X	-	X	-	Group Id

MBS Session N4 Control Information	C	<p>This IE shall be included if:</p> <ul style="list-style-type: none"> - the correspond PDU session is being associated with an MBS session, or with an MBS session and Area Session ID for a location dependent MBS service; or - the PDU session is already associated with an MBS session, or with an MBS session and Area Session ID for a location dependent MBS service, and the N19mb multicast transport information has changed. In this case, the Multicast Transport Information IE shall contain the new multicast transport information to use to receive MBS session data from the MB-UPF. <p>Several IEs with the same IE type may be present to provide N4 control information for several MBS sessions, e.g. when the UE requests to join several MBS sessions.</p> <p>See Table 7.5.2.1-5 for encoding.</p>	-	-	-	X	-	MBS Session N4 Control Information
DSCP to PPI Control Information	C	<p>This IE shall be present if the DSCP to PPI Control Information needs to be changed. The UPF shall replace any value received previously by the new information received in this IE.</p> <p>See Table 7.5.2.1-6 for encoding.</p>	-	-	-	X	-	DSCP to PPI Control Information
TL-Container	C	<p>This IE shall be present if the SMF/CUC needs to send a TL-Container to the UPF/CN-TL.</p> <p>Several IEs within the same IE type may be present to provide multiple TL-Containers.</p>	-	-	-	X	-	TL-Container
Trace Collection Entity URI	O	<p>This IE may be present if an UPF trace is activated for this PFCP session and if the Trace Information IE is included. When present, this IE shall include the Trace Reporting Consumer URI for Streaming based Reporting as defined in 3GPP TS 32.422 [35].</p> <p>If the UP function supports Streaming based Reporting and Trace Collection Entity URI IE is present, the IP Address of Trace Collection Entity in Trace Information IE shall be ignored.</p>	X	X	X	X	-	URI
UE Level Measurements Configuration	O	<p>When present, this IE shall contain the 5GC UE Level Measurement configuration data to be applied by the UP function for this PFCP session (see clause 4.1.2.18 of 3GPP TS 32.422 [35]).</p> <p>This IE shall be included with a null length to instruct UP function to stop the UE level measurement while continuing the trace session.</p> <p>See NOTE 7.</p>	-	-	-	X	-	UE Level Measurements Configuration
Alternative SMF IP Address	O	<p>When present, this IE shall contain the Alternative SMF IP Address.</p> <p>(NOTE 8)</p>	-	-	-	X	-	Alternative SMF IP Address
MoQ Control Information	C	<p>This IE shall be present if the UPF is required to perform MoQ relay functionality.</p>	-	-	-	X	-	MoQ Control Information

- NOTE 1: The CP function may request the UP function to drop the packets currently buffered for the PFCP session when using extended buffering of downlink data packets, buffering is performed in the UP function and the DL Data Buffer Expiration Time is handled by the CP function. In this case, when the DL Data Buffer Expiration Time expires, the CP function shall send a PFCP Session Modification Request including the DROBU flag (to drop the downlink data packets currently buffered in the UP function) and updating the Apply Action within the FARs of this PFCP session to request the UP function to start buffering the downlink data packets with notifying the arrival of subsequent downlink data packets. See clause 5.9.3 of 3GPP TS 23.214 [2].
- NOTE 2: When changing the CP F-SEID of an established PFCP Session, the CP function shall be able to handle any incoming PFCP Session related messages sent by the UP function with the previous CP F-SEID for a duration at least longer than twice the PFCP retransmission timer (N1xT1).
- NOTE 3: The QAURR (Query All URRs) flag in the PFCPSMReq-Flags IE and the Query URR IE are exclusive from each other in a PFCP Session Modification Request.
- NOTE 4: If the ATSSS resources have already been allocated to the PFCP session previously, e.g. during the PFCP session establishment, the UPF shall not allocate new values for such resources (e.g. UE Link-Specific IP Address).
- NOTE 5: S-NSSAI for the PDU session may be updated after PDU session establishment, i.e. during EPS to 5GS handover procedure, the initial AMF may use configured S-NSSAI for interworking to create the PDU session in 5GS. For home routed PDU session, if the S-NSSAI in serving PLMN (mapped from S-NSSAI in HPLMN) is different from the configured S-NSSAI for interworking and V-SMF reselection is not needed, the AMF will update V-SMF with S-NSSAI in serving PLMN for the PDU session, as specified in clause 4.11.1.3.3 of 3GPP TS 23.502 [29]. The S-NSSAI may also be updated by SMF+PGW-C during EPS to 5GS handover in non-roaming or roaming-with-LBO case. The S-NSSAI may be used by the UP function for performance measurement. The S-NSSAI may also be updated by the SMF with an alternative S-NSSAI or a replaced S-NSSAI over N4 interface for Network Slice Replacement (see clause 5.15.19 of 3GPP TS 23.501 [28]).
- NOTE 6: When transferring port and user plane node management information between the TSN AF or the TSCTSF and the NW-TT, since the NW-TT may support multiple ports, there may be several instances of the TSC Management Information IEs containing a Port Management Information Container together with a NW-TT Port Number, and only one instance of the TSC Management Information IE containing a User Plane Node Management Information Container that may also contain a Port Management Information Container together with a NW-TT Port Number.
- NOTE 7: If both Trace and UE level measurement are deactivated, the Trace Information IE with a null length shall be present and the UE Level Measurements Configuration shall be absent.
- NOTE 8: When the UPF performs the SMF restoration procedures for an SMF in a SMF set specified in 3GPP TS 23.527 [40], e.g. when it detects the SMF has failed, it shall use the Alternative SMF IP Address provisioned at the PFCP session if received and if supported by the UPF, otherwise the UPF shall use Alternative SMF IP Address or SMF Set ID provisioned in PFCP Association Setup Request/Response messages or PFCP Association Update Request message to select an alternative SMF to restore the PFCP session.

7.5.4.2 Update PDR IE within PFCP Session Modification Request

The Update PDR grouped IE shall be encoded as shown in Figure 7.5.4.2-1.

Table 7.5.4.2-1: Update PDR IE within PFCP Session Modification Request

Octet 1 and 2	Update PDR IE Type = 9 (decimal)							
Octets 3 and 4	Length = n							
Information elements	P	Condition / Comment	Appl.					IE Type
			Sx a	Sx b	Sx c	N4	N4 mb	

PDR ID	M	This IE shall uniquely identify the PDR among all the PDRs configured for that PFCP session.	X	X	X	X	X	PDR ID
Outer Header Removal	C	This IE shall be present if it needs to be changed.	X	X	-	X	X	Outer Header Removal
Precedence	C	This IE shall be present if there is a change in the PDR's precedence to be applied by the UP function among all PDRs of the PFCP session, when looking for a PDR matching an incoming packet.	-	X	X	X	X	Precedence
PDI	C	This IE shall be present if there is a change within the PDI against which incoming packets will be matched. When present, this IE shall replace the PDI previously stored in the UP function for this PDR. See Table 7.5.2.2-2.	X	X	X	X	X	PDI
FAR ID	C	This IE shall be present if it needs to be changed	X	X	X	X	X	FAR ID
URR ID	C	This IE shall be present if a measurement action shall be applied or no longer applied to packets matching this PDR. When present, this IE shall contain the list of all the URR IDs to be associated to the PDR.	X	X	X	X	-	URR ID
QER ID	C	This IE shall be present if a QoS enforcement action shall be applied or no longer applied to packets matching this PDR. When present, this IE shall contain the list of all the QER IDs to be associated to the PDR.	-	X	X	X	X	QER ID
Activate Predefined Rules	C	This IE shall be present if new Predefined Rule(s) needs to be activated for the PDR. When present this IE shall contain one Predefined Rules name. Several IEs with the same IE type may be present to represent multiple "Activate Predefined Rules" names.	-	X	X	X	-	Activate Predefined Rules
Deactivate Predefined Rules	C	This IE shall be present if Predefined Rule(s) needs to be deactivated for the PDR. When present this IE shall contain one Predefined Rules name. Several IEs with the same IE type may be present to represent multiple "Activate Predefined Rules" names.	-	X	X	X	-	Deactivate Predefined Rules
Activation Time	O	This IE may be present if the PDR activation time shall be changed. (NOTE 2)	-	X	X	X	-	Activation Time
Deactivation Time	O	This IE may be present if the PDR deactivation time shall be changed. (NOTE 2)	-	X	X	X	-	Deactivation Time
IP Multicast Addressing Info	O	This IE may be present in an UL PDR controlling UL IGMP/MLD traffic (see clause 5.25), if it needs to be changed When present, it shall contain a (range of) IP multicast address(es), and optionally source specific address(es), identifying a set of IP multicast flows. See Table 7.5.2.2-4. Several IEs with the same IE type may be present to represent multiple IP multicast flows. When present, the UPF shall replace any IP multicast address(es) previously stored for this PDR by the IP multicast address(es) received in this IE.	-	-	-	X	-	IP Multicast Addressing Info
Transport Delay Reporting	C	This IE shall be present if Transport Delay Reporting needs to be changed (e.g. transport delay reporting needs to be activated or deactivated). See Table 7.5.2.2-6.	-	-	-	X	-	Transport Delay Reporting
RAT Type	O	This IE may be present if there is a RAT change for the UL PDR if the PFCP session is established for a MA PDU session.	-	-	-	X	-	RAT Type
NOTE 1: The IEs which do not need to be modified shall not be included in the Update PDR IE. The UP function shall continue to behave according to the values previously received for IEs not present in the Update PDR IE.								
NOTE 2: When the Activation Time and Deactivation Time are not present, the PDR shall keep its current activation status, either active or inactive.								

7.5.4.3 Update FAR IE within PFCP Session Modification Request

The Update FAR grouped IE shall be encoded as shown in Figure 7.5.4.3-1.

Table 7.5.4.3-1: Update FAR IE within PFCP Session Modification Request

Octet 1 and 2		Update FAR IE Type = 10 (decimal)						
Octets 3 and 4		Length = n						
Information elements	P	Condition / Comment	Appl.					IE Type
			Sxa	Sxb	Sxc	N4	N4mb	
FAR ID	M	This IE shall identify the FAR to be updated.	X	X	X	X	X	FAR ID
Apply Action	C	This IE shall be present if it is changed.	X	X	X	X	X	Apply Action
Update Forwarding parameters	C	This IE shall be present if it is changed. See table 7.5.4.3-2.	X	X	X	X	-	Update Forwarding Parameters
Update Duplicating Parameters	C	This IE shall be present if it is changed. See table 7.5.4.3-3. Several IEs with the same IE type may be present to request to duplicate the packets to different destinations.	X	X	-	-	-	Update Duplicating Parameters
Redundant Transmission Forwarding Parameters	C	This IE shall be present if it is changed. See table 7.5.2.3-4.	-	-	-	X	-	Redundant Transmission Forwarding Parameters
BAR ID	C	This IE shall be present if the BAR ID associated to the FAR needs to be modified.	X	-	-	X	-	BAR ID
Add MBS Unicast Parameters	C	This IE shall be present when the Apply Action is set to "MBSU" to request the MB-UPF to forward the MBS session data to a remote GTP-U peer for unicast transport, if no remote GTP-U peers are provisioned yet in the MB-UPF, or if additional GTP-U peers need to be provisioned. (NOTE). Several IEs with the same IE type may be present to represent multiple remote GTP-U peers. See Table 7.5.2.3-6.	-	-	-	-	X	Add MBS Unicast Parameters
Remove MBS Unicast Parameters	C	This IE shall be present when the MB-SMF to request the MB-UPF to delete a remote GTP-U peer to stop forwarding the MBS session data to that remote GTP-U peer for unicast transport. Several IEs with the same IE type may be present to represent to delete multiple remote GTP-U peers.	-	-	-	-	X	Remove MBS Unicast Parameters
NOTE: When the Apply Action is changed to "MBSU" during an MBS session reactivation, remote GTP-U peers may already be provisioned in the MB-UPF if the MB-SMF did not request the MB-UPF to delete the N3mb/N19mb DL F-TEIDs when the MBS session was deactivated (see clause 5.34.2.4).								

Table 7.5.4.3-2: Update Forwarding Parameters IE in the Update FAR IE

Octet 1 and 2		Update Forwarding Parameters IE Type = 11 (decimal)						
Octets 3 and 4		Length = n						
Information elements	P	Condition / Comment	Appl.					IE Type
			Sxa	Sxb	Sxc	N4	N4mb	

Destination Interface	C	This IE shall only be provided if it is changed. When present, it shall indicate the destination interface of the outgoing packet.	X	X	X	X	-	Destination Interface
Network instance	C	This IE shall only be provided if it is changed.	X	X	X	X	-	Network Instance
Redirect Information	C	This IE shall be present if the instructions regarding the redirection of traffic by the UP function need to be modified.	-	X	X	X	-	Redirect Information
Outer Header Creation	C	This IE shall only be provided if it is changed. See NOTE 1.	X	X	-	X	-	Outer Header Creation
Transport Level Marking	C	This IE shall only be provided if it is changed	X	X	-	X	-	Transport Level Marking
Extended Transport Level Marking	C	This IE shall only be provided if it is changed. When present, the UP function shall replace any earlier received Extended Transport Level Marking with the newly received information. See also Table 7.5.2.3-10.	-	-	-	X	-	Extended Transport Level Marking
Transport Level Marking Indications	C	This IE shall be included if at least one of the flags is set to "1". - TLMIP (Transport Level Marking based on the value of the Incoming Packets): this flag shall be set to "1" to request the UPF, e.g. a I-UPF, to derive the value of the DSCP in the TOS/Traffic Class field of the outer IP header of the outgoing packets (e.g. over N3 or N9) based on the value of the DSCP of the incoming packets (e.g. received over N9 or N3 respectively). See also clause 5.4.13.	-	-	-	X	-	Transport Level Marking Indications
Forwarding Policy	C	This IE shall only be provided if it is changed. See NOTE 1.	-	X	X	X	-	Forwarding Policy
Metadata	C	This IE shall only be provided if it is changed. The UPF shall overwrite any metadata received earlier in this FAR.	-	-	-	X	-	Metadata
Header Enrichment	C	This IE shall only be provided if it is changed	-	X	X	X	-	Header Enrichment
PFPCSMReq-Flags	C	This IE shall be included if at least one of the flags is set to "1". - SNDEM (Send End Marker Packets): this IE shall be present if the CP function modifies the F-TEID of the downstream node in the Outer Header Creation IE and the CP function requests the UP function to construct and send GTP-U End Marker messages towards the old F-TEID of the downstream node.	X	X	-	X	-	PFPCSMReq-Flags
Linked Traffic Endpoint ID	C	This IE may be present, if it is changed and the UP function indicated support of the PDI optimization feature, (see clause 8.2.25). When present, it shall identify the Traffic Endpoint ID allocated for this PFCP session to receive the traffic in the reverse direction (see clause 5.2.3.1).	X	X	-	X	-	Traffic Endpoint ID
Destination Interface Type	C	This IE shall be present to indicate the 3GPP interface type of the destination interface, if the value has changed.	X	X	-	X	-	3GPP Interface Type
Data Network Access Identifier	C	This IE shall be provided over N16a if it is changed. This IE shall not be sent over N4.	-	-	-	-	-	Data Network Access Identifier
IP Address and Port Number Replacement	C	This IE shall only be provided if it is changed.	-	-	-	X	-	IP Address and Port Number Replacement

Header Handling Control Rule	C	This IE shall be provided if the Header Handling Control Rule needs to be changed or a new Header Handling Control Rule shall be provisioned into an existing FAR. See Table 7.5.2.3-7, 7.5.2.3-8, 7.5.2.3-9.	-	-	-	X	-	Header Handling Control Rule
NOTE 1: If the Outer Header Creation and Forwarding Policy are present, the UP function shall put the user plane packets in the user plane tunnel by applying Outer Header Creation, after enforcing the required Forwarding Policy.								

Table 7.5.4.3-3: Update Duplicating Parameters IE in the Update FAR IE

Octet 1 and 2		Update Duplicating Parameters IE Type = 105 (decimal)						
Octets 3 and 4		Length = n						
Information elements	P	Condition / Comment	Appl.					IE Type
			Sx a	Sx b	Sx c	N4	N4 mb	
Destination Interface	C	This IE shall only be provided if it is changed. When present, it shall indicate the destination interface of the outgoing packet.	X	X	-	-	-	Destination Interface
Outer Header Creation	C	This IE shall only be provided if it is changed. See NOTE 1.	X	X	-	-	-	Outer Header Creation
Transport Level Marking	C	This IE shall only be provided if it is changed.	X	X	-	-	-	Transport Level Marking
Forwarding Policy	C	This IE shall only be provided if it is changed. See NOTE 1.	-	X	-	-	-	Forwarding Policy
NOTE 1: If the Outer Header Creation and Forwarding Policy are present, the UP function shall put the user plane packets in the user plane tunnel by applying Outer Header Creation, after enforcing the required Forwarding Policy.								

Table 7.5.4.3-4: Remove MBS Unicast Parameters IE in the Update FAR IE

Octet 1 and 2		Remove MBS Unicast Parameters Type = 304 (decimal)						
Octets 3 and 4		Length = n						
Information elements	P	Condition / Comment	Appl.					IE Type
			Sxa	Sxb	Sxc	N4	N4 mb	
MBS Unicast Parameters ID	M	This IE shall identify the MBS Unicast Parameters IE to be removed.	-	-	-	-	X	MBS Unicast Parameters ID

7.5.4.4 Update URR IE within PFCP Session Modification Request

The Update URR grouped IE shall be encoded as shown in Figure 7.5.4.4-1.

Table 7.5.4.4-1: Update URR IE within PFCP Session Modification Request

Octet 1 and 2		Update URR IE Type = 13 (decimal)						
Octets 3 and 4		Length = n						
Information elements	P	Condition / Comment	Appl.					IE Type
			Sx a	Sx b	Sx c	N4	N4 mb	

URR ID	M	This IE shall uniquely identify the URR among all the URRs configured for that PFCP session	X	X	X	X	-	URR ID
Measurement Method	C	This IE shall be present if the measurement method needs to be modified. When present, this IE shall indicate the method for measuring the network resources usage, i.e. whether the data volume, duration (i.e. time), combined volume/duration, or event shall be measured.	X	X	X	X	-	Measurement Method
Reporting Triggers	C	This IE shall be present if the reporting triggers needs to be modified. When present, this IE shall indicate the trigger(s) for reporting network resources usage to the CP function, e.g. periodic reporting or reporting upon reaching a threshold, or envelope closure, or when an SMF instructs an UPF to report the reception of the End Marker packet from the old I-UPF during a Service Request procedure (see clauses 4.2.3.2 and 4.23.4.3 in 3GPP TS 23.502 [29]).	X	X	X	X	X	Reporting Triggers
Measurement Period	C	This IE shall be present if the Measurement Period needs to be modified. When present, it shall indicate the period for generating and reporting usage reports.	X	X	X	X	X	Measurement Period
Volume Threshold	C	This IE shall be present if the Volume Threshold needs to be modified. When present, it shall indicate the traffic volume value after which the UP function shall report network resources usage to the CP function for this URR.	X	X	X	X	X	Volume Threshold
Volume Quota	C	This IE shall be present if the Volume Quota needs to be modified. When present, it shall indicate the Volume Quota value.	-	X	X	X	-	Volume Quota
Time Threshold	C	This IE shall be present if the Time Threshold needs to be modified. When present, it shall indicate the time usage after which the UP function shall report network resources usage to the CP function for this URR.	X	X	X	X	-	Time Threshold
Time Quota	C	This IE shall be present if the Time Quota needs to be modified. When present, it shall indicate the Time Quota value.	-	X	X	X	-	Time Quota
Event Threshold	C	This IE shall be present if Event Threshold needs to be modified. When present, it shall indicate the number of events after which the UP function shall report to the CP function for this URR.	-	X	X	X	-	Event Threshold
Event Quota	C	This IE shall be present if Event Quota needs to be modified. When present, it shall indicate the Event Quota value.	-	X	X	X	-	Event Quota
Quota Holding Time	C	This IE shall be present if the Quota Holding Time needs to be modified. When present, it shall contain the duration of the Quota Holding Time.	-	X	X	X	-	Quota Holding Time
Dropped DL Traffic Threshold	C	This IE shall be present if the Dropped DL Threshold needs to be modified. When present, it shall contain the threshold of the DL traffic being dropped.	X	-	-	X	-	Dropped DL Traffic Threshold
Quota Validity Time	C	This IE shall be present if Quota Validity time was not sent earlier or quota validity time value needs to be modified.	-	X	-	X	-	Quota Validity Time
Monitoring Time	C	This IE shall be present if the Monitoring Time needs to be modified. When present, this IE shall contain the time at which the UP function shall re-apply the volume or time threshold.	X	X	X	X	-	Monitoring Time
Subsequent Volume Threshold	C	This IE shall be present if the Subsequent Volume Threshold needs to be modified and volume-based measurement is used. When present, it shall indicate the traffic volume value after which the UP function shall report network resources usage to the CP function for this URR for the period after the Monitoring Time.	X	X	X	X	-	Subsequent Volume Threshold

Subsequent Time Threshold	C	This IE shall be present if the Subsequent Time Threshold needs to be modified. When present, it shall indicate the time usage value after which the UP function shall report network resources usage to the CP function for this URR for the period after the Monitoring Time.	X	X	X	X	-	Subsequent Time Threshold
Subsequent Volume Quota	C	This IE shall be present if the Subsequent Volume Quota needs to be modified. When present, it shall indicate the Volume Quota value which the UP function shall use for this URR for the period after the Monitoring Time.	-	X	X	X	-	Subsequent Volume Quota
Subsequent Time Quota	C	This IE shall be present if the Subsequent Time Quota needs to be modified. When present, it shall indicate the Time Quota value which the UP function shall use for this URR for the period after the Monitoring Time.	-	X	X	X	-	Subsequent Time Quota
Subsequent Event Threshold	O	This IE shall be present if the Subsequent Event Threshold needs to be modified. When present, it shall indicate the number of events after which the UP function shall report to the CP function for this URR for the period after the Monitoring Time.	-	X	X	X	-	Subsequent Event Threshold
Subsequent Event Quota	O	This IE shall be present if the Subsequent Event Quota needs to be modified. When present, it shall indicate the Event Quota value which the UP function shall use for this URR for the period after the Monitoring Time.	-	X	X	X	-	Subsequent Event Quota
Inactivity Detection Time	C	This IE shall be present if the Inactivity Detection Time needs to be modified. When present, it shall indicate the duration of the inactivity period after which time measurement needs to be suspended when no packets are received during this inactivity period.	-	X	X	X	-	Inactivity Detection Time
Linked URR ID	C	This IE shall be present if linked usage reporting is required. When present, this IE shall contain the linked URR ID which is related with this URR (see clause 5.2.2.4). Several IEs with the same IE type may be present to represent multiple linked URRs which are related with this URR.	-	X	X	X	X	Linked URR ID

Measurement Information	C	<p>This IE shall be included if any of the following flag is set to "1" or if the change of flag(s) from "1" to "0" results in the IE becoming set to all zeros.</p> <p>Applicable flags are:</p> <ul style="list-style-type: none"> - Inactive Measurement Flag: this flag shall be set to "1" if the measurement shall be paused (inactive). The measurement shall be performed (active) if the bit is set to "0" or if the Measurement Information IE is not present in the Update URR IE. - Reduced Application Detection Information Flag: this flag may be set to "1", if the Reporting Triggers request to report the start or stop of application, to request the UP function to only report the Application ID in the Application Detection Information, e.g. for envelope reporting. - Immediate Start Time Metering Flag: this flag may be set to "1" if time-based measurement is used and the UP function is requested to start the time metering immediately at receiving the flag. - Send Start Pause of Charging Flag: this flag may be set to "1" by the CP function if the UP Function is requested to send a Start Pause of Charging indication to the upstream GTP-U entity(s) when the Dropped DL Traffic Threshold is reached. - Applicable for Start of Pause of Charging Flag: this flag may be set to "1" if the URR is applicable for Start of Pause of Charging, so that the UP function shall stop the usage measurement for the URR when receiving Start Pause of Charging indication from the peer downstream GTP-U entity. - Control of Inactive Measurement Flag: the flag shall be set to "1" if the CP function requests the UP function to stop or resume the usage measurement for the URR with the "ASPOC" flag set to "1" according to the value of Inactive Measurement Flag. 	-	X	-	X	-	Measurement Information
Time Quota Mechanism	C	This IE shall be present if time-based measurement based on CTP or DTP needs to be modified.	-	X	-	-	-	Time Quota Mechanism
Aggregated URRs	C	<p>This IE shall be included if the Aggregated URRs IE needs to be modified. See Table 7.5.2.4-2.</p> <p>Several IEs with the same IE type may be present to provision multiple aggregated URRs.</p> <p>When present, this IE shall provide the complete list of the aggregated URRs.</p>	-	X	-	-	-	Aggregated URRs
FAR ID for Quota Action	C	<p>This IE shall be present if the FAR ID for Quota Action IE needs to be modified. This IE may be present if the Volume Quota IE or the Time Quota IE or Event Quota IE is newly provisioned in the URR and the UP Function indicated support of the Quota Action.</p> <p>When present, it shall contain the identifier of the substitute FAR the UP function shall apply, for the traffic associated to this URR, when exhausting any of these quotas. See NOTE 1, NOTE 2.</p>	-	X	X	X	-	FAR ID
Ethernet Inactivity Timer	C	This IE shall be present if the Ethernet Inactivity Timer needs to be modified. When present, it shall contain the duration of the Ethernet inactivity period.	-	-	-	X	-	Ethernet Inactivity Timer

Additional Monitoring Time	O	This IE shall be present if the additional Monitoring Time needs to be modified. When present, this IE shall contain the time at which the UP function shall re-apply the volume or time or event threshold/quota. See Table 7.5.2.4-3. The CP function shall provide the full set of Additional Monitoring Times IE(s). The UP function shall replace any Additional Monitoring Times IE(s) provisioned earlier by the new set of received IE(s).	X	X	X	X	-	Additional Monitoring Time
Number of Reports	O	This IE may be present if the Number of Reports need to be changed. When present, it shall indicate the number of usage reports to be generated by the URR. See also clauses 5.2.2.2.1 and 5.2.2.3.1.	X	X	X	X	-	Number of Reports
Exempted Application ID for Quota Action	C	This IE shall be present if Application ID for Quota Action needs to be changed. When present, it shall contain an Application ID matching packets that shall be exempted from applying the FAR ID for Quota Action when the quota has been exhausted. Several IEs with the same IE type may be present to provide multiple Application IDs. The CP function shall always provide a complete list of Application IDs. See NOTE 3.	-	X	X	X	-	Application ID
Exempted SDF Filter for Quota Action	C	This IE shall be present if the SDF Filter for Quota Action needs to be changed. When present, it shall contain a SDF Filter matching packets that shall be exempted from applying the FAR ID for Quota Action when the quota has been exhausted. Several IEs with the same IE type may be present to provide multiple SDF Filters. The CP function shall always provide a complete list of SDF Filters. See NOTE 3.	-	X	X	X	-	SDF Filter
User Plane Inactivity Timer	C	This IE shall be present if the User Plane Inactivity Timer needs to be modified. When present, it shall contain the duration of the User Plane Inactivity Timer.	-	-	-	X	-	User Plane Inactivity Timer

NOTE 1: The substitute FAR used when exhausting a Volume Quota or Time Quota may be set to drop the packets, buffer the packets or redirect the traffic towards a redirect destination as specified in clause 5.4.7.

NOTE 2: If the FAR as indicated in the FAR ID for Quota Action is removed after being provisioned, the UP function shall behave as if the FAR ID for Quota Action is not provisioned and shall apply the default behaviour per local configuration when the quota is exhausted.

NOTE 3: The Exempted Application ID for Quota Action IE or Exempted Filter ID for Quota Action IE may be provisioned as the Restricted-Filter-Rule AVP or Filter ID AVP which is included in Final-Unit-Indication AVP from the online charging system when the Final-Unit-Action AVP is set to "REDIRECT" or "RESTRICT_ACCESS". See also 3GPP TS 32.299 [18].

7.5.4.5 Update QER IE within PFCP Session Modification Request

The Update QER grouped IE shall be encoded as shown in Figure 7.5.4.5-1.

Table 7.5.4.5-1: Update QER IE within PFCP Session Modification Request

Octet 1 and 2	Update QER IE Type = 14 (decimal)							
Octets 3 and 4	Length = n							
Information elements	P	Condition / Comment	Appl.					IE Type
			Sx a	Sx b	Sx c	N4	N4 mb	

QER ID	M	This IE shall uniquely identify the QER among all the QERs configured for that PFCP session	-	X	X	X	X	QER ID
QER Correlation ID	C	This IE shall be present if the QER correlation ID in this QER needs to be modified. See NOTE 1.	-	X	-	X	-	QER Correlation ID
Gate Status	C	This IE shall be present if the Gate Status needs to be modified. When present, it shall indicate whether the packets are allowed to be forwarded (the gate is open) or shall be discarded (the gate is closed) in the uplink and/or downlink directions. See NOTE 1.	-	X	X	X	X	Gate Status
Maximum Bitrate	C	This IE shall be present if an MBR enforcement action applied to packets matching this PDR need to be modified. When present, this IE shall indicate the uplink and/or downlink maximum bit rate to be enforced for packets matching the PDR. For EPC, this IE may be set to the value of: <ul style="list-style-type: none"> - the APN-AMBR, for a QER that is referenced by all the PDRs of the non-GBR bearers of a PDN connection; - the TDF session MBR, for a QER that is referenced by all the PDRs of a TDF session; - the bearer MBR, for a QER that is referenced by all the PDRs of a bearer; - the SDF MBR, for a QER that is referenced by all the PDRs of a SDF. For 5GC, this IE may be set to the value of: <ul style="list-style-type: none"> - the Session-AMBR, for a QER that is referenced by all the PDRs of the non-GBR QoS flows of a PDU session; - the QoS Flow MBR, for a QER that is referenced by all the PDRs of a QoS Flow; - the SDF MBR, for a QER that is referenced by all the PDRs of a SDF - the Authorized DL Session AMBR for Offloading, for a QER that is referenced by all the PDRs of the DL non-GBR QoS flows of a PDU session authorized for offloading to the local part of DN in VPLMN. See NOTE 1.	-	X	X	X	X	MBR
Guaranteed Bitrate	C	This IE shall be present if a GBR authorization to packets matching this PDR needs to be modified. When present, this IE shall indicate the authorized uplink and/or downlink guaranteed bit rate. This IE may be set to the value of: <ul style="list-style-type: none"> - the aggregate GBR, for a QER that is referenced by all the PDRs of a GBR bearer; - the QoS Flow GBR, for a QER that is referenced by all the PDRs of a QoS Flow (for 5GC); - the SDF GBR, for a QER that is referenced by all the PDRs of a SDF. See NOTE 1.	-	X	X	X	X	GBR
Packet Rate	C	This IE shall be present if a Packet Rate enforcement action (in terms of number of packets per time interval) need to be modified for packets matching this PDR.	-	X	-	X	-	Packet Rate
DL Flow Level Marking	C	This IE shall be set if the DL Flow Level Marking IE needs to be modified. See NOTE 1.	-	X	X	-	-	DL Flow Level Marking
QoS flow identifier	C	This IE shall be present if it needs to be modified.	-	-	-	X	X	QFI
Reflective QoS	C	This IE shall be present if the state of the Reflective QoS needs to be modified (activate if inactive, or deactivate the active Reflective QoS).	-	-	-	X	-	RQI

Paging Policy Indicator	C	This IE shall be present if it needs to be modified.	-	-	-	X	-	Paging Policy Indicator
Averaging Window	O	This IE may be present if the UP function is required to modify the Averaging Window. (NOTE 2)	-	-	-	X	-	Averaging Window
QER Control Indications	C	This IE shall be included if the CP function need to provide the updated QoS enforcement control information: <ul style="list-style-type: none"> - RCSR (Rate Control Status Reporting): the CP function shall set this bit "1" to request the UP function to report the rate control status when the PFCP session is released. 	-	X	-	X	-	QER Control Indications

QER Indications	C	<p>This IE shall be included if the CP function need to provide updated QER Indications". When present, it shall be set as follows:</p> <ul style="list-style-type: none"> - EDBMI (End Of Data Burst Marking Indication): this bit shall be set "1" to request the UPF to set the End Of Data Burst indication together with the QFI (identifying the QoS flow conveying the Data Burst) in the PDU Set Information Container of the GTP-U packet encapsulating the last PDU of each data burst (see 3GPP TS 38.415 [34]). When this indication was earlier set to "1", this IE shall be set to "0" to request the UPF to stop performing End of Data Burst marking for the DL PDRs associated with the QER. - EML4S (ECN Marking for L4S): this IE shall be set to "1" to request the UPF to perform ECN marking for L4S for the traffic of the UL and/or DL PDRs associated with the QER (see clause 5.38.1). When this indication was earlier set to "1", this IE shall be set to "0" to request the UPF to stop performing ECN marking for L4S for the traffic of the UL and/or DL PDRs associated with the QER. - PDUSM (PDU Set Marking): this IE shall be set to "1" to request the UPF to perform PDU Set marking for the traffic of the DL PDRs associated with the QER (see clause 5.38.3). When this indication was earlier set to "1", this IE shall be set to "0" to request the UPF to stop performing PDU Set identification and marking for the traffic of the DL PDRs associated with the QER. - DBSMI (Data Burst Size Marking Indication): this bit shall be set "1" to request the UPF to insert the Data Burst Size of the data burst in the GTP-U PDU Session Container extension header of the GTP-U packet (see 3GPP TS 38.415 [34]) of the first PDUs of the data burst, for the DL PDRs associated with the QER (see clause 5.38.5.2). When this indication was earlier set to "1", this IE shall be set to "0" to request the UPF to stop inserting the Data Burst Size for the DL PDRs associated with the QER. - TNBMI (Time to Next Burst Marking Indication): this bit shall be set "1" to request the UPF to insert the Time to Next Burst in the GTP-U PDU Session Container extension header of the GTP-U packet (see 3GPP TS 38.415 [34]), for the DL PDRs associated with the QER (see clause 5.38.5.3). When this indication was earlier set to "1", this IE shall be set to "0" to request the UPF to stop inserting the Time to Next Burst for the DL PDRs associated with the QER. 	-	-	-	X	-	QER Indications
			-	-	-	X	-	
			-	-	-	X	-	
			-	-	-	X	-	
			-	-	-	X	-	
<p>NOTE 1: The IEs which do not need to be modified shall not be included in the Update QER IE. The UP function shall continue to behave according to the values previously received for IEs not present in the Update QER IE.</p> <p>NOTE 2: For a GBR QoS flow, as 5QI is not signalled over N4, one default averaging window shall be pre-configured in the UPF. For Non-GBR QoS Flows, e.g., for the measurement of the Session-AMBR or Authorized DL Session AMBR for Offloading, the averaging window to be used (if not received over N4) is implementation specific.</p>								

7.5.4.6 Remove PDR IE within PFCP Session Modification Request

The Remove PDR grouped IE shall be encoded as shown in Figure 7.5.4.6-1.

R grouped IE shall be encoded as shown in Figure 7.5.4.6-1.

Table 7.5.4.6-1: Remove PDR IE within PFCP Session Modification Request

Octet 1 and 2	Remove PDR IE Type = 15 (decimal)							
Octets 3 and 4	Length = n							
Information elements	P	Condition / Comment	Appl.					IE Type
			Sx a	Sx b	Sx c	N4	N4 mb	
PDR ID	M	This IE shall identify the PDR to be deleted.	X	X	X	X	X	PDR ID

7.5.4.7 Remove FAR IE within PFCP Session Modification Request

The Remove FAR grouped IE shall be encoded as shown in Figure 7.5.4.7-1.

Table 7.5.4.7-1: Remove FAR IE within PFCP Session Modification Request

Octet 1 and 2	Remove FAR IE Type = 16 (decimal)							
Octets 3 and 4	Length = n							
Information elements	P	Condition / Comment	Appl.					IE Type
			Sx a	Sx b	Sx c	N4	N4 mb	
FAR ID	M	This IE shall identify the FAR to be deleted.	X	X	X	X	X	FAR ID

7.5.4.8 Remove URR IE within PFCP Session Modification Request

The Remove URR grouped IE shall be encoded as shown in Figure 7.5.4.7-1.

Table 7.5.4.8-1: Remove URR IE within PFCP Session Modification Request

Octet 1 and 2	Remove URR IE Type = 17 (decimal)							
Octets 3 and 4	Length = n							
Information elements	P	Condition / Comment	Appl.					IE Type
			Sx a	Sx b	Sx c	N4	N4 mb	
URR ID	M	This IE shall identify the URR to be deleted.	X	X	X	X	X	URR ID

7.5.4.9 Remove QER IE PFCP Session Modification Request

The Remove QER grouped IE shall be encoded as shown in Figure 7.5.4.9-1.

T Table 7.5.4.9-1: Remove QER IE PFCP Session Modification Request

Octet 1 and 2	Remove QER IE Type = 18 (decimal)							
Octets 3 and 4	Length = n							
Information elements	P	Condition / Comment	Appl.					IE Type
			Sx a	Sx b	Sx c	N4	N4 mb	
QER ID	M	This IE shall identify the QER to be deleted.	-	X	X	X	X	QER ID

7.5.4.10 Query URR IE within PFCP Session Modification Request

The Query URR grouped IE shall be encoded as shown in Figure 7.5.4.10-1.

R grouped IE shall be encoded as shown in Figure 7.5.4.10-1.

Table 7.5.4.10-1: Query URR IE within PCF Session Modification Request

Octet 1 and 2	Query URR IE Type = 77 (decimal)							
Octets 3 and 4	Length = n							
Information elements	P	Condition / Comment	Appl.					IE Type
			Sx a	Sx b	Sx c	N4	N4 mb	
URR ID	M	This IE shall identify the URR being queried.	X	X	X	X	X	URR ID

7.5.4.11 Update BAR IE within PCF Session Modification Request

The Update BAR grouped IE shall be encoded as shown in Figure 7.5.4.11-1.

Table 7.5.4.11-1: Update BAR IE within PCF Session Modification Request

Octet 1 and 2	Update BAR IE Type = 86 (decimal)							
Octets 3 and 4	Length = n							
Information elements	P	Condition / Comment	Appl.					IE Type
			Sx a	Sx b	Sx c	N4	N4 mb	

BAR ID	M	This IE shall identify the BAR Rule to be modified.	X	-	-	X	-	BAR ID
Downlink Data Notification Delay	C	This IE shall be present if the UP function indicated support of the Downlink Data Notification Delay parameter (see clause 8.2.28) and the Downlink Data Notification Delay needs to be modified. When present, it shall contain the delay the UP function shall apply between receiving a downlink data packet and notifying the CP function about it, when the Apply Action parameter requests to buffer the packets and notify the CP function.	X	-	-	-	-	Downlink Data Notification Delay
Suggested Buffering Packets Count	C	This IE may be present if the UP Function indicated support of the feature UDBC. When present, it shall contain the number of packets that are suggested to be buffered when the Apply Action parameter requests to buffer the packets. The packets that exceed the limit shall be discarded.	-	X	X	X	-	Suggested Buffering Packets Count
DL Buffering Duration	C	This IE shall be present if the UP function indicated support of the DL Buffering Duration parameter in PFCP Session Modification Request feature (see DBDM feature in clause 8.2.25) and extended buffering of downlink data packet is required in the UP function. When present, this IE shall indicate the duration during which the UP function shall buffer the downlink data packets and when the EDBN flag is not present refrain from sending any further notification to the CP function about the arrival of DL data packets. (NOTE 1)	X	-	-	X	-	DL Buffering Duration
DL Buffering Suggested Packet Count	O	This IE may be present if the UP function indicated support of the DL Buffering Suggested Packet Count parameter in PFCP Session Modification Request feature (see DBDM feature in clause 8.2.25) and extended buffering of downlink data packet is required in the UP function. When present, this IE shall indicate the maximum number of downlink data packets suggested to be buffered in the UP function.	X	-	-	X	-	DL Buffering Suggested Packet Count
MT-EDT Control Information	O	This IE may be included to request the SGW-U to report the sum of DL Data Packets Size.	X	-	-	-	-	MT-EDT Control Information
MT-SDT Control Information	O	This IE may be included to request the UPF to report the sum of DL Data Packets Size per QoS flow.	-	-	-	X	-	MT-SDT Control Information
Extended DL Buffering Notification Policy	C	This IE may be present if the DL Buffering Duration IE is present. When present, it shall contain the EDBN flag indicating the Extended DL Buffering Notification policy. (NOTE 1)	-	-	-	X	-	Extended DL Buffering Notification Policy
NOTE 1: If the Apply Action requests the UP function to buffer and notify the CP function, the DL Buffering Duration is set, the EDBN flag is not present, then the UP function shall not notify the CP function for the duration indicated by the DL Buffering Duration. If the Apply Action requests the UP function to buffer downlink data packets, the DL Buffering Duration is set, the EDBN bit is set to "1", then the UP function shall notify the CP function of the arrival of the first buffered DL packet for each QoS flow for a given FAR for the duration indicated by the DL Buffering Duration.								

7.5.4.12 Remove BAR IE within PFCP Session Modification Request

The Remove BAR grouped IE shall be encoded as shown in Figure 7.5.4.12-1.

Table 7.5.4.12-1: Remove BAR IE within PFCP Session Modification Request

Octet 1 and 2	Remove BAR IE Type = 87 (decimal)							
Octets 3 and 4	Length = n							
Information elements	P	Condition / Comment	Appl.					IE Type
			Sx a	Sx b	Sx c	N4	N4 mb	
BAR ID	M	This IE shall identify the BAR to be deleted.	X	-	-	X	-	BAR ID

7.5.4.13 Update Traffic Endpoint IE within PFCP Session Modification Request

The Update Traffic Endpoint grouped IE shall be encoded as shown in Figure 7.5.4.13-1.

Table 7.5.4.13-1: Update Traffic Endpoint IE within PFCP Session Modification Request

Octet 1 and 2		Update Traffic Endpoint Type = 129 (decimal)						
Octets 3 and 4		Length = n						
Information elements	P	Condition / Comment	Appl.					IE Type
			Sx a	Sx b	Sx c	N4	N4 mb	

Traffic Endpoint ID	M	This IE shall uniquely identify the Traffic Endpoint to be modified for that PFCP session.	X	X	X	X	X	Traffic Endpoint ID
Local F-TEID	C	This IE shall be present if it needs to be changed. The CP function shall set the CHOOSE (CH) bit to 1 if the CP function requests the UP function to assign a local F-TEID to the PDR. See NOTE.	X	-	-	X	-	F-TEID
Network Instance	O	If present, this IE shall identify the Network instance to match for the incoming packet. See NOTE.	X	X	X	X	X	Network Instance
Redundant Transmission Detection Parameters	C	This IE shall be present if it needs to be changed See Table 7.5.2.2-5. See NOTE.	-	-	-	X	-	Redundant Transmission Detection Parameters
UE IP address	C	This IE shall be present if it needs to be changed. In the 5GC, several IEs with the same IE type may be present to represent multiple UE IP addresses, if the UPF indicated support of the IP6PL feature (see clause 5.21). When present, the UE IP address(es) present in this IE shall replace the UE IP address(es) stored in the UP function for this traffic endpoint. See NOTE.	-	X	X	X	-	UE IP address
Framed-Route	C	This IE shall be present for a PDR if the UPF indicated support of Framed Routing (see clauses 8.2.25 and 5.16) and it needs to be changed. If present, this IE shall describe a framed route. Several IEs with the same IE type may be present to provision a list of framed routes.	-	X	-	X	-	Framed-Route
Framed-Routing	C	This IE shall be present for a DL PDR if the UPF indicated support of Framed Routing (see clauses 8.2.25 and 5.16) and it needs to be changed. If present, this IE shall describe the routing method for the UP function for the IP route related to Framed-Routes or Framed-IPv6-Routes. (NOTE 2)	-	X	-	X	-	Framed-Routing
Framed-IPv6-Route	C	This IE shall be present for a PDR if the UPF indicated support of Framed Routing (see clauses 8.2.25 and 5.16) and it needs to be changed. If present, this IE shall describe a framed IPv6 route. Several IEs with the same IE type may be present to provision a list of framed IPv6 routes.	-	X	-	X	-	Framed-IPv6-Route
QFI	C	This IE shall be present if QFI(s) applicable for the traffic endpoints need to be changed and if the UPF has indicated it supports MTE feature as specified in clause 8.2.25. If present, this IE shall identify the QoS Flow Identifier to match for the incoming packet. Several IEs with the same IE type may be present to provision a list of QFIs. When present, the full set of applicable QFIs shall be provided.	-	-	-	X	-	QFI
Source Interface Type	C	This IE shall be present if the 3GPP interface type of the traffic endpoint needs to be changed.	X	X	-	X	X	3GPP Interface Type
RAT Type	O	This IE may be present if there is a RAT change for the UL PDR(s) if the PFCP session is established for a MA PDU session.	-	-	-	X	-	RAT Type
<p>NOTE 1: The IEs which do not need to be modified shall not be included in the Update Traffic Endpoint IE. The UP function shall continue to behave according to the values previously received for IEs not present in the Update Traffic Endpoint IE. F-TEID may be changed if the SGW-C has received the "Change F-TEID support Indication" over the S11/S4 interface (for an IDLE state UE initiated TAU/RAU procedure to allow the SGW changing the GTP-U F-TEID).</p> <p>NOTE 2: In this release of specification, the UP function shall announce the IP route(s) for Framed-Route(s) or Framed-IPv6-Route(s) to the PDN regardless of the value of the Framed-Routing.</p>								

7.5.4.14 Remove Traffic Endpoint IE within PFCP Session Modification Request

The Remove Traffic Endpoint grouped IE shall be encoded as shown in Figure 7.5.4.14-1.

Table 7.5.4.14-1: Remove Traffic Endpoint IE within PFCP Session Modification Request

Octet 1 and 2	Remove Traffic Endpoint IE Type = 130 (decimal)							
Octets 3 and 4	Length = n							
Information elements	P	Condition / Comment	Appl.					IE Type
			Sx a	Sx b	Sx c	N4	N4 mb	
Traffic Endpoint ID	M	This IE shall identify the Traffic Endpoint to be deleted.	X	X	X	X	X	Traffic Endpoint ID

7.5.4.15 Remove MAR IE within PFCP Session Modification Request

The Remove MAR grouped IE shall be encoded as shown in Figure 7.5.4.15-1.

Table 7.5.4.15-1: Remove MAR IE within PFCP Session Modification Request

Octet 1 and 2	Remove MAR IE Type = 168 (decimal)							
Octets 3 and 4	Length = n							
Information elements	P	Condition / Comment	Appl.					IE Type
			Sx a	Sx b	Sx c	N4	N4 mb	
MAR ID	M	This IE shall identify the MAR to be deleted.	-	-	-	X	-	MAR ID

7.5.4.16 Update MAR IE within PFCP Session Modification Request

The Update MAR grouped IE shall be encoded as shown in Figure 7.5.4.16-1.

Table 7.5.4.16-1: Update MAR IE within PFCP Session Modification Request

Octet 1 and 2	Update MAR IE Type = 169 (decimal)							
Octets 3 and 4	Length = n							
Information elements	P	Condition / Comment	Appl.					IE Type
			Sx a	Sx b	Sx c	N4	N4 mb	

MAR ID	M	This IE shall identify the MAR to be updated.	-	-	-	X	-	MAR ID
Steering Functionality	C	This IE shall be present if it is changed.	-	-	-	X	-	Steering Functionality
Steering Mode	C	This IE shall be present if it is changed.	-	-	-	X	-	Steering Mode
Update 3GPP Access Forwarding Action Information	C	This IE shall be present if the 3GPP Access Forwarding Action Information was provisioned previously and if any of IEs is to be changed. This IE shall also be present to remove 3GPP Access Forwarding Action Information that was provisioned previously if the UE deregisters from the corresponding access. This shall be done by including this IE with a null length.	-	-	-	X	-	Update 3GPP Access Forwarding Action Information
Update Non-3GPP Access Forwarding Action Information	C	This IE shall be present if the Non-3GPP Access Forwarding Action Information was provisioned previously and if any of IEs is to be changed. This IE shall also be present to remove the Non-3GPP Access Forwarding Action Information that was provisioned previously if the UE deregisters from the corresponding access. This shall be done by including this IE with a null length.	-	-	-	X	-	Update Non-3GPP Access Forwarding Action Information
3GPP Access Forwarding Action Information	C	This IE shall be present to provision 3GPP access specific forwarding action information when this access is added, i.e. when the UE registers to 3GPP access. See Table 7.5.2.8-2.	-	-	-	X	-	3GPP Access Forwarding Action Information
Non-3GPP Access Forwarding Action Information	C	This IE shall be present to provision Non-3GPP access specific forwarding action information when this access is added, i.e. when the UE registers to non-3GPP access. See Table 7.5.2.8-3.	-	-	-	X	-	Non-3GPP Access Forwarding Action Information
Threshold values	C	This IE shall be present if it is changed.	-	-	-	X	-	Thresholds
Steering Mode Indicator	C	This IE shall be included if any of the following flag is set to "1" or if the change of flag(s) from "1" to "0" results in the IE becoming set to all zeros. Applicable flags are: - ALBI (Autonomous Load Balancing Indicator): this flag shall be set to "1" if the SMF allows the UPF to apply autonomous load-balance when the Steering Mode is Load-Balancing; - UEAI (UE Assistance Indicator): this flag shall be set to "1" if the SMF allows UE assistant load-balance when the Steering Mode is Load-Balancing.	-	-	-	X	-	Steering Mode Indicator
Transport Mode	C	This IE shall be present if it is changed.	-	-	-	X	-	Transport Mode

Table 7.5.4.16-2: Update 3GPP Access Forwarding Action Information IE in Update MAR IE

Octet 1 and 2		Update 3GPP Access Forwarding Action Information IE Type = 175 (decimal)						
Octets 3 and 4		Length = n						
Information elements	P	Condition / Comment	Appl.					IE Type
			Sx a	Sx b	Sx c	N4	N4 mb	
FAR ID	C	This IE shall be present if it is changed.	-	-	-	X	-	FAR ID
Weight	C	This IE shall be present if it is changed.	-	-	-	X	-	Weight
Priority	C	This IE shall be present if it is changed.	-	-	-	X	-	Priority
URR ID	C	This IE shall be present if a measurement action shall be applied or no longer applied to packets for this access. When present, this IE shall contain the list of all the URR IDs to be associated to this access.	-	-	-	X	-	URR ID
RAT Type	O	This IE may be present if it is changed.	-	-	-	X	-	RAT Type

Table 7.5.4.16-3: Update Non-3GPP Access Forwarding Action Information IE in Update MAR IE

Octet 1 and 2		Update Non-3GPP Access Forwarding Action Information IE Type = 176 (decimal)						
Octets 3 and 4		Length = n						
Information elements	P	Condition / Comment	Appl.					IE Type
			Sx a	Sx b	Sx c	N4	N4 mb	
Same IEs and requirements as defined in Table 7.5.4.16-2								

7.5.4.17 Create PDR/FAR/URR/QER/BAR/MAR IEs within PFCP Session Modification Request

PFCP Session Modification Request message may conditionally include Create PDR IE, Create FAR IE, Create URR IE, Create QER IE, Create BAR IE and Create MAR IE. The encoding of these IEs are specified within PFCP Session Establishment Request message (see clauses 7.5.2.2 – 7.5.2.8).

7.5.4.18 TSC Management Information IE within PFCP Session Modification Request

The TSC Management Information grouped IE shall be encoded as shown in Table 7.5.4.18-1.

Table 7.5.4.18-1: TSC Management Information IE within PFCP Session Modification Request

Octet 1 and 2		TSC Management Information IE Type = 199 (decimal)						
Octets 3 and 4		Length = n						
Information elements	P	Condition / Comment	Appl.					IE Type
			Sx a	Sx b	Sx c	N4	N4 mb	
Port Management Information Container	O	When present, this IE shall contain a Port Management Information container.	-	-	-	X	-	Port Management Information Container
User Plane Node Management Information Container	O	When present, this IE shall contain an User Plane Node Management Information container.	-	-	-	X	-	User Plane Node Management Information Container
NW-TT Port Number	C	When PMIC IE is present, this IE shall contain the related NW-TT Port Number.	-	-	-	X	-	NW-TT Port Number
Direct Reporting Information	C	This IE shall be present if the UPF indicated support of the DRTSC feature and if the TSC management information events shall be reported by the UPF directly to a TSN AF or TSCTSF (see clause 5.26.3.2).	-	-	-	X	-	Direct Reporting Information

The Direct Reporting Information IE shall be encoded as shown in Table 7.5.4.18-2.

Table 7.5.4.18-2: Direct Reporting Information

Octet 1 and 2		Direct Reporting Information = 295 (decimal)						
Octets 3 and 4		Length = n						
Information elements	P	Condition / Comment	Appl.					IE Type
			Sx a	Sx b	Sx c	N4	N4 mb	
Event Notification URI	M	This IE shall contain the notification URI to be used for sending the UPF event notifications.	-	-	-	X	-	Event Notification URI
Notification Correlation ID	C	This IE shall indicate the notification correlation id to be included in the UPF event notifications. It shall be present if it is available.	-	-	-	X	-	Notification Correlation ID

7.5.4.19 Remove SRR IE within PFCP Session Modification Request

The Remove SRR grouped IE shall be encoded as shown in Table 7.5.4.19-1.

Table 7.5.4.19-1: Remove SRR IE within PFCP Session Modification Request

Octet 1 and 2		Remove SRR IE Type = 211 (decimal)						
Octets 3 and 4		Length = n						
Information elements	P	Condition / Comment	Appl.					IE Type
			Sx a	Sx b	Sx c	N4	N4 mb	
SRR ID	M	This IE shall identify the SRR to be deleted.	-	-	-	X	-	SRR ID

7.5.4.20 Update SRR IE within PFCP Session Modification Request

The Update SRR grouped IE shall be encoded as shown in Table 7.5.4.20-1.

Table 7.5.4.20-1: Update SRR IE within PFCP Session Modification Request

Octet 1 and 2		Update SRR IE Type = 213 (decimal)						
Octets 3 and 4		Length = n						
Information elements	P	Condition / Comment	Appl.					IE Type
			Sx a	Sx b	Sx c	N4	N4 mb	
SRR ID	M	This IE shall uniquely identify the SRR among all the SRRs configured for that PFCP session	-	-	-	X	-	SRR ID
Access Availability Control Information	C	This IE shall be present if the Access Availability Control Information needs to be modified. See Table 7.5.2.9-2. The CP function shall provide the full Access Availability Control Information IE. The UP function shall replace the Access Availability Control Information IE provisioned earlier, if any, by the new received IE.	-	-	-	X	-	Access Availability Control Information
QoS Monitoring per QoS flow Control Information	C	This IE shall be present if the QoS Monitoring per QoS flow Control Information needs to be modified. See Table 7.5.2.9-3. The CP function shall provide the full set of QoS Monitoring per QoS flow Control Information IE(s). The UP function shall replace any QoS Monitoring per QoS flow Control Information IE(s) provisioned earlier by the new set of received IE(s). Several IEs within the same IE type may be present to represent a list of QoS Monitoring per QoS flow Control Information for different QoS flows.	-	-	-	X	-	QoS Monitoring per QoS flow Control Information
Direct Reporting Information	C	This IE shall be present if the Direct Reporting Information IE needs to be modified. See Table 7.5.2.9-4.	-	-	-	X	-	Direct Reporting Information
Traffic Parameter Measurement Control Information	C	This IE shall be present if the Traffic Parameter Measurement Control Information needs to be modified. See Table 7.5.2.9-4. The CP function shall provide the full set of Traffic Parameter Measurement Control Information(s). The UP function shall replace any Traffic Parameter Measurement Control Information IE(s) provisioned earlier by the new set of received IE(s). Several IEs within the same IE type may be present to represent a list of Traffic Parameter Measurement Control Information for different QoS flows or different traffic parameters.	-	-	-	X	-	Traffic Parameter Measurement Control Information

7.5.4.21 Ethernet Context Information within PFCP Session Modification Request

The Ethernet Context Information grouped IE shall be encoded as shown in Table 7.5.4.21-1.

Table 7.5.4.21-1: Ethernet Context Information IE within PFCP Session Modification Request

Octet 1 and 2		Ethernet Context Information IE Type = 254 (decimal)						
Octets 3 and 4		Length = n						
Information elements	P	Condition / Comment	Appl.					IE Type
			Sx a	Sx b	Sx c	N4	N4 mb	
MAC Addresses Detected	M	This IE shall be present if one or more MAC addresses need to be associated to the PDU session. Several IEs with the same IE type may be present to provision multiple lists of MAC addresses (e.g. with different V-LAN tags).	-	-	-	X	-	MAC Addressed Detected

7.5.4.22 Query Packet Rate Status IE within PFCP Session Modification Request

The Query Packet Rate Status grouped IE shall be encoded as shown in Table 7.5.4.22-1.

Table 7.5.4.22-1: Query Packet Rate Status IE within PFCP Session Modification Request

Octet 1 and 2		Query Packet Rate Status IE Type = 263 (decimal)						
Octets 3 and 4		Length = n						
Information elements	P	Condition / Comment	Appl.					IE Type
			Sx a	Sx b	Sx c	N4	N4 mb	
QER ID	M	This IE shall identify the QER being queried for its Packet Rate Status	-	X	-	X	-	QER ID

7.5.5 PFCP Session Modification Response

7.5.5.1 General

The PFCP Session Modification Response shall be sent over the Sxa, Sxb, Sxc and N4 interface by the UP function to the CP function as a reply to the PFCP Session Modification Request.

Table 7.5.5.1-1: Information Elements in a PFCP Session Modification Response

Information elements	P	Condition / Comment	Appl.					IE Type
			Sx a	Sx b	Sx c	N4	N4 mb	

Cause	M	This IE shall indicate the acceptance, partial acceptance or rejection of the corresponding request message.	X	X	X	X	X	Cause
Offending IE	C	This IE shall be included if the rejection is due to a conditional or mandatory IE missing or faulty.	X	X	X	X	X	Offending IE
Created PDR	C	This IE shall be present if the cause is set to "success", new PDR(s) were requested to be created and the UP function was requested to allocate the local F-TEID or a UE IP address/prefix for the PDR(s). When present, this IE shall contain the PDR information associated to the PFCP session. See Table 7.5.3.2-1. Several IEs within the same IE type may be present to represent a list of created PDRs.	X	X	-	X	X	Created PDR
Load Control Information	O	The UP function may include this IE if it supports the load control feature and the feature is activated in the network. See Table 7.5.3.3-1.	X	X	X	X	X	Load Control Information
Overload Control Information	O	During an overload condition, the UP function may include this IE if it supports the overload control feature and the feature is activated in the network.	X	X	X	X	X	Overload Control Information
Usage Report	C	This IE shall be present if: - the Query URR IE was present or the QAURR flag was set to "1" in the PFCP Session Modification Request, - traffic usage measurements for that URR are available at the UP function, and - the UP function decides to return some or all of the requested usage reports in the PFCP Session Modification Response. This IE shall be also present if: - a URR or the last PDR associated to a URR has been removed, - non-null traffic usage measurements for that URR are available in the UP function, and - the UP function decides to return some or all of the related usage reports in the PFCP Session Modification Response (see clause 5.2.2.3.1). Several IEs within the same IE type may be present to represent a list of Usage Reports.	X	X	X	X	X	Usage Report
Failed Rule ID	C	This IE shall be included if the Cause IE indicates a rejection due to a rule creation or modification failure.	X	X	X	X	X	Failed Rule ID
Additional Usage Reports Information	C	This IE shall be included if the Query URR IE was present or the QAURR flag was set to "1" in the PFCP Session Modification Request, and usage reports need to be sent in additional PFCP Session Report Request messages (see clause 5.2.2.3.1). When present, this IE shall either indicate that additional usage reports will follow, or indicate the total number of usage reports that need to be sent in PFCP Session Report Request messages.	X	X	X	X	X	Additional Usage Reports Information

Created/Updated Traffic Endpoint	C	<p>This IE shall be present if the cause is set to "success", Traffic Endpoint(s) were requested to be created or updated, and the UP function was requested to allocate the local F-TEID or a UE IP address/prefix for the Traffic Endpoint(s).</p> <p>If the UP function allocates additional UE IP address/prefix (upon receiving a Create Traffic Endpoint or Update Traffic Endpoint in the corresponding PFCP Session Modification Request message from the CP function), this IE shall be present and shall contain the complete list of UE IP address / prefix assigned by the UP function for this PFCP session.</p> <p>In the 5GC, several IEs with the same IE type may be present to represent multiple UE IP addresses, if the UPF indicated support of the IP6PL feature (see clause 5.21).</p> <p>(NOTE 1) When present, this IE shall contain the Traffic Endpoint information associated to the PFCP session. See Table 7.5.3.5-1.</p> <p>Several IEs within the same IE type may be present to represent a list of created/updated Traffic Endpoints.</p>	X	X	-	X	X	Created Traffic Endpoint
TSC Management Information	C	<p>This IE shall be present if the UPF needs to send TSC Management information to the SMF. Several IEs within the same IE type may be present to transfer PMICs for different NW-TT ports. (NOTE 2).</p>	-	-	-	X	-	TSC Management Information
ATSSS Control Parameters	C	<p>This IE shall be present if ATSSS functionality is required in the request message, and the UPF allocates the resources and parameters corresponding to the required ATSSS functionality. See Table 7.5.3.7-1.</p>	-	-	-	X	-	ATSSS Control Parameters
Updated PDR	C	<p>This IE shall be present if a Update PDR is present in the corresponding PFCP Session Modification Request and UP function is requested to allocate a new F-TEID, e.g. to support the redundant transmission on N3/N9 interfaces, or move the application traffic from a default bearer to a new dedicated bearer, or the UP function is requested to assign additional UE IP Address or Prefix, e.g. a shorter than /64 prefix delegation. See Table 7.5.5.5-1. Several IEs within the same IE type may be present to represent a list of updated PDRs.</p>	-	X	-	X	-	Updated PDR
Packet Rate Status Report	C	<p>This IE shall be present if the CP function has requested to report an immediate packet rate status in the PFCP Session Modification Request and the UP function supports the CIOT feature (see clause 8.2.25). Several IEs within the same IE type may be present to represent a list of Packet Rate Status Reports.</p>	-	X	-	X	-	Packet Rate Status Report
Partial Failure Information	C	<p>This IE shall be present if the Cause IE indicates partial acceptance of the request to provide failure information related to a failed rule. Several IEs within the same IE type may be present to report failures to apply multiple rules. See Table 7.5.3.1-2.</p>	-	X	X	X	X	Partial Failure Information
MBS Session N4 Information	C	<p>This IE shall be included if any IE in this grouped IE needs to be included as specified in clause 5.34.1. Several IE with the same IE type may be present to contain N4 Information for several MBS Sessions. See Table 7.5.3.1-5 for encoding.</p>	-	-	-	X	-	MBS Session N4 Information

TL-Container	C	This IE shall be present if the UPF/CN-TL needs to send a TL-Container to the SMF/CUC to respond to TL-Container information received in the corresponding request. Several IEs within the same IE type may be present to provide multiple TL-Containers.	-	-	-	X	-	TL-Container
MoQ Information	C	This IE shall be included if any IE in this grouped IE needs to be included. See Table 7.5.3.1-6.	-	-	-	X	-	MoQ Information
<p>NOTE 1: The UP function supporting the PDI optimization feature and the IP6PL feature (see clause 8.2.25) shall support providing the complete list of UE IP Address IEs in the Created/Updated Endpoint IE.</p> <p>NOTE 2: When transferring port and user plane node management information between the TSN AF or the TSCTSF and the NW-TT, since the NW-TT may support multiple ports, there may be several instances of the TSC Management Information IEs containing a Port Management Information Container together with a NW-TT Port Number, and only one instance of the TSC Management Information IE containing a User Plane Node Management Information Container that may also contain a Port Management Information Container together with a NW-TT Port Number.</p>								

7.5.5.2 Usage Report IE within PFCP Session Modification Response

The Usage Report grouped IE shall be encoded as shown in Table 7.5.5.2-1.

Table 7.5.5.2-1: Usage Report IE within PFCP Session Modification Response

Octet 1 and 2	Usage Report IE Type = 78 (decimal)							
Octets 3 and 4	Length = n							
Information elements	P	Condition / Comment	Appl.					IE Type
			Sx a	Sx b	Sx c	N4	N4 mb	

URR ID	M	This IE shall identify the URR for which usage is reported.	X	X	X	X	X	URR ID
UR-SEQN	M	This IE shall uniquely identify the Usage Report for the URR (see clause 5.2.2.3).	X	X	X	X	X	UR-SEQN
Usage Report Trigger	M	This IE shall identify the trigger for this report.	X	X	X	X	X	Usage Report Trigger
Start Time	C	This IE shall be present, except if the Usage Report Trigger indicates 'Start of Traffic', 'Stop of Traffic' or 'MAC Addresses Reporting'. When present, this IE shall provide the timestamp when the collection of the information in this report was started.	X	X	X	X	X	Start Time
End Time	C	This IE shall be present, except if the Usage Report Trigger indicates 'Start of Traffic', 'Stop of Traffic' or 'MAC Addresses Reporting'. When present, this IE shall provide the timestamp when the collection of the information in this report was generated.	X	X	X	X	X	End Time
Volume Measurement	C	This IE shall be present if a volume measurement needs to be reported.	X	X	X	X	X	Volume Measurement
Duration Measurement	C	This IE shall be present if a duration measurement needs to be reported.	X	X	X	X	-	Duration Measurement
Time of First Packet	C	This IE shall be present if available for this URR.	-	X	X	X	X	Time of First Packet
Time of Last Packet	C	This IE shall be present if available for this URR.	-	X	X	X	X	Time of Last Packet
Usage Information	C	This IE shall be present if the UP function reports Usage Reports before and after a Monitoring Time or before and after QoS enforcement. When present, it shall indicate whether the usage is reported for the period before or after that time, or before or after QoS enforcement.	X	X	X	X	-	Usage Information
Query URR Reference	C	This IE shall be present if this usage report is sent as a result of a query URR received in a PFCP Session Modification Request and the Query URR Reference IE was present in the PFCP Session Modification Request. When present, it shall be set to the Query URR Reference value received in the PFCP Session Modification Request.	X	X	X	X	X	Query URR Reference
Ethernet Traffic Information	C	This IE shall be present if Ethernet Traffic Information needs to be reported.	-	-	-	X	-	Ethernet Traffic Information

7.5.5.3 TSC Management Information IE within PFCP Session Modification Response

The TSC Management Information grouped IE shall be encoded as shown in Table 7.5.5.3-1.

Table 7.5.5.3-1: TSC Management Information IE within PFCP Session Modification Response

Octet 1 and 2		TSC Management Information IE Type = 200 (decimal)						
Octets 3 and 4		Length = n						
Information elements	P	Condition / Comment	Appl.					IE Type
			Sx a	Sx b	Sx c	N4	N4 mb	
Port Management Information Container	O	When present, this IE shall contain a Port Management Information container.	-	-	-	X	-	Port Management Information Container
User Plane Node Management Information Container	O	When present, this IE shall contain an User Plane Node Management Information container.	-	-	-	X	-	User Plane Node Management Information Container
NW-TT Port Number	C	When PMIC IE is present, this IE shall contain the related NW-TT Port Number.	-	-	-	X	-	NW-TT Port Number

7.5.5.4 Packet Rate Status Report IE within PFCP Session Modification Response

The Packet Rate Status Report grouped IE shall be encoded as shown in Table 7.5.5.4-1.

Table 7.5.5.4-1: Packet Rate Status Report IE within PFCP Session Modification Response message

Octet 1 and 2		Packet Rate Status Report IE Type = 264 (decimal)						
Octets 3 and 4		Length = n						
Information elements	P	Condition / Comment	Appl.					IE Type
			Sx a	Sx b	Sx c	N4	N4 mb	
QER ID	M	This IE shall uniquely identify a QER in a PFCP session.	-	X	-	X	-	QER ID
Packet Rate Status	M	This IE shall indicate the remaining validity time and the remaining number of UL/DL packets that still can be sent.	-	X	-	X	-	Packet Rate Status

7.5.5.5 Updated PDR IE within PFCP Session Modification Response

The Updated PDR grouped IE shall be encoded as shown in Table 7.5.5.5-1.

Table 7.5.5.5-1: Updated PDR IE in PFCP Session Modification Response

Octet 1 and 2		Updated PDR IE Type = 256 (decimal)						
Octets 3 and 4		Length = n						
Information elements	P	Condition / Comment	Appl.					IE Type
			Sx a	Sx b	Sx c	N4	N4 mb	
PDR ID	M	This IE shall uniquely identify the PDR among all the PDRs configured for that PFCP session.	-	-	-	X	-	PDR ID
Local F-TEID for Redundant Transmission	C	This IE shall be present and shall contain the local F-TEID to be used for this PDR for the reception of redundant uplink packets on the N3/N9 interfaces.	-	-	-	X	-	F-TEID
Local F-TEID	C	If the UP function allocates the F-TEID, this IE shall be present and shall contain the local F-TEID to be used for this PDR.	-	X	-	-	-	F-TEID
UE IP Address	C	If the UP function allocates additional UE IP address/prefix (upon receiving a Update PDR in the corresponding PFCP Session Modification Request message from the CP function), this IE shall be present and shall contain the complete list of UE IP address / prefix assigned by the UP function for this PFCP session. In the 5GC, several IEs with the same IE type may be present to represent multiple UE IP addresses, if the UPF indicated support of the IP6PL feature (see clause 5.21).	-	X	-	X	-	UE IP Address

7.5.6 PFCP Session Deletion Request

The PFCP Session Deletion Request shall be sent over the Sxa, Sxb, Sxc and N4 interface by the CP function to request the UP function to delete the PFCP session. The PFCP Header for Session Related Messages shall contain the F-SEID identifying the PFCP session (see clause 6.3.4.2).

Table 7.5.6-1: Information Elements in a PFCP Session Deletion Request

Information elements	P	Condition / Comment	Appl.					IE Type
			Sx a	Sx b	Sx c	N4	N4 mb	

TL-Container	C	This IE shall be present if the SMF/CUC needs to send a TL-Container to the UPF/CN-TL. Several IEs within the same IE type may be present to provide multiple TL-Containers.	-	-	-	X	-	TL-Container
Node ID	C	This IE shall be present if a new SMF in an SMF Set, with one PFCP association per SMF and UPF (see clause 5.22.3), takes over the control of the PFCP session. When present, it shall contain the unique identifier of the new SMF.	-	-	-	X	X	Node ID
CP F-SEID	C	This IE shall be present if the Node ID is present and if the new SMF decides to change the CP F-SEID of the PFCP session. When present, it shall contain the unique identifier allocated by the CP function identifying the session.	-	-	-	X	X	F-SEID

7.5.7 PFCP Session Deletion Response

7.5.7.1 General

The PFCP Session Deletion Response shall be sent over the Sxa, Sxb, Sxc and N4 interface by the UP function to the CP function as a reply to the PFCP Session Deletion Request.

Table 7.5.7.1-1: Information Elements in a PFCP Session Deletion Response

Information elements	P	Condition / Comment	Appl.					IE Type
			Sx a	Sx b	Sx c	N4	N4 mb	

Cause	M	This IE shall indicate the acceptance or the rejection of the corresponding request message.	X	X	X	X	X	Cause
Offending IE	C	This IE shall be included if the rejection is due to a conditional or mandatory IE missing or faulty.	X	X	X	X	X	Offending IE
Load Control Information	O	The UP function may include this IE if it supports the load control feature and the feature is activated in the network. See Table 7.5.3.3-1.	X	X	X	X	X	Load Control Information
Overload Control Information	O	During an overload condition, the UP function may include this IE if it supports the overload control feature and the feature is activated in the network. See Table 7.5.3.4-1.	X	X	X	X	X	Overload Control Information
Usage Report	C	This IE shall be present if a URR had been provisioned in the UP function for the PFCP session being deleted and traffic usage measurements for that URR are available at the UP function. Several IEs within the same IE type may be present to represent a list of Usage Reports.	X	X	X	X	X	Usage Report
Additional Usage Reports Information	C	This IE shall be included if the usage reports need to be sent in additional PFCP Session Report Request messages (see clause 5.2.2.3.1). When present, this IE shall either indicate that additional usage reports will follow, or indicate the total number of usage reports that need to be sent in PFCP Session Report Request messages.	X	X	X	X	X	Additional Usage Reports Information
Packet Rate Status Report	C	This IE shall be present if the CP function has requested in a QER to report the packet rate status when the PFCP session is released and the UP function supports CIOT feature. (See clause 8.2.25)	-	X	-	X	-	Packet Rate Status Report
MBS Session N4 Information	C	This IE shall be included if any IE in this grouped IE needs to be included as specified in clause 5.34.1. Several IE with the same IE type may be present to contain N4 Information for several MBS Sessions. See Table 7.5.3.1-5 for encoding.	-	-	-	X	-	MBS Session N4 Information
PFCPSDRsp-Flags	C	This IE shall be included if at least one of the flags is set to "1". - PURU (Pending Usage Reports Unacknowledged): the UP function shall set this flag if the UP function has pending PFCP Session Report Request messages which have not been acknowledged yet when it sends the PFCP Session Deletion Response message.	X	X	X	X	-	PFCPSDRsp-Flags
TL-Container	C	This IE shall be present if the UPF/CN-TL needs to send a TL-Container to the SMF/CUC to respond to TL-Container information received in the corresponding request. Several IEs within the same IE type may be present to provide multiple TL-Containers.	-	-	-	X	-	TL-Container
Session Report	O	This IE may be present if there are any session report not yet reported to the SMF. Several IEs within the same IE type may be present to represent a list of Session Reports.	-	-	-	X	-	Session Report

Table 7.5.7.1-2: Packet Rate Status Report IE within PFCP Session Deletion Response message

Octet 1 and 2	Packet Rate Status Report IE Type = 252 (decimal)							
Octets 3 and 4	Length = n							
Information elements	P	Condition / Comment	Appl.					IE Type
			Sx a	Sx b	Sx c	N4	N4 mb	

QER ID	M	This IE shall uniquely identify a QER in a PFCP session.	-	X	-	X	-	QER ID
Packet Rate Status	M	This IE shall indicate the remaining validity time and the remaining number of UL/DL packets that still can be sent.	-	X	-	X	-	Packet Rate Status

7.5.7.2 Usage Report IE within PFCP Session Deletion Response

The Usage Report grouped IE shall be encoded as shown in Table 7.5.7.2-1.

Table 7.5.7.2-1: Usage Report IE within PFCP Session Deletion Response

Octet 1 and 2		Usage Report IE Type = 79 (decimal)						
Octets 3 and 4		Length = n						
Information elements	P	Condition / Comment	Appl.					IE Type
			Sx a	Sx b	Sx c	N4	N4 mb	
URR ID	M	This IE shall identify the URR for which usage is reported.	X	X	X	X	X	URR ID
UR-SEQN	M	This IE shall uniquely identify the Usage Report for the URR (see clause 5.2.2.3).	X	X	X	X	X	UR-SEQN
Usage Report Trigger	M	This IE shall identify the trigger for this report.	X	X	X	X	X	Usage Report Trigger
Start Time	C	This IE shall be present, except if the Usage Report Trigger indicates 'Start of Traffic', 'Stop of Traffic' or 'MAC Addresses Reporting'. When present, this IE shall provide the timestamp when the collection of the information in this report was started.	X	X	X	X	X	Start Time
End Time	C	This IE shall be present, except if the Usage Report Trigger indicates 'Start of Traffic', 'Stop of Traffic' or 'MAC Addresses Reporting'. When present, this IE shall provide the timestamp when the collection of the information in this report was generated.	X	X	X	X	X	End Time
Volume Measurement	C	This IE shall be present if a volume needs to be reported.	X	X	X	X	X	Volume Measurement
Duration Measurement	C	This IE shall be present if a duration measurement needs to be reported.	X	X	X	X	-	Duration Measurement
Time of First Packet	C	This IE shall be present if available for this URR.	-	X	X	X	X	Time of First Packet
Time of Last Packet	C	This IE shall be present if available for this URR.	-	X	X	X	X	Time of Last Packet
Usage Information	C	This IE shall be present if the UP function reports Usage Reports before and after a Monitoring Time, or before and after QoS enforcement. When present, it shall indicate whether the usage is reported for the period before or after that time, or before or after QoS enforcement.	X	X	X	X	-	Usage Information
Ethernet Traffic Information	C	This IE shall be present if Ethernet Traffic Information needs to be reported. See Table 7.5.8.3-3.	-	-	-	X	-	Ethernet Traffic Information

7.5.7.3 Session Report IE within PFCP Session Deletion Response

The Session Report grouped IE shall be encoded as shown in Table 7.5.7.3-1.

Table 7.5.7.3-1: Session Report IE within PFCP Session Deletion Response

Octet 1 and 2		Session Report IE Type = 214 (decimal)						
Octets 3 and 4		Length = n						
Information elements	P	Condition / Comment	Appl.					IE Type
			Sx a	Sx b	Sx c	N4	N4 mb	

SRR ID	M	This IE shall identify the SRR for which usage is reported.	-	-	-	X	-	SRR ID
QoS Monitoring Report	C	This IE shall be present if there is at least a QoS Monitoring Report that needs to be reported. See Table 7.5.8.6-3. Several IEs within the same IE type may be present to represent a list of QoS Monitoring Reports, e.g. for different QoS flows.	-	-	-	X	-	QoS Monitoring Report

7.5.8 PFCP Session Report Request

7.5.8.1 General

The PFCP Session Report Request shall be sent over the Sxa, Sxb, Sxc, N4 and N4mb interface by the UP function to report information related to a PFCP session to the CP function.

Table 7.5.8.1-1: Information Elements in a PFCP Session Report Request

Information elements	P	Condition / Comment	Appl.					IE Type
			Sx a	Sx b	Sx c	N4	N4 mb	

Report Type	M	This IE shall indicate the type of the report.	X	X	X	X	X	Report Type
Downlink Data Report	C	This IE shall be present if the Report Type indicates a Downlink Data Report.	X	-	-	X	X	Downlink Data Report
Usage Report	C	This IE shall be present if the Report Type indicates a Usage Report. Several IEs within the same IE type may be present to represent a list of Usage Reports.	X	X	X	X	X	Usage Report
Error Indication Report	C	This IE shall be present if the Report Type indicates an Error Indication Report.	X	X	-	X	X	Error Indication Report
Load Control Information	O	The UP function may include this IE if it supports the load control feature and the feature is activated in the network. See Table 7.5.3.3-1.	X	X	X	X	X	Load Control Information
Overload Control Information	O	During an overload condition, the UP function may include this IE if it supports the overload control feature and the feature is activated in the network. See Table 7.5.3.4-1.	X	X	X	X	X	Overload Control Information
Additional Usage Reports Information	C	This IE shall be included in one of the additional PFCP Session Report Request messages, if the PFCP Session Modification Response or the PFCP Session Deletion Response indicated that more usage reports would follow (i.e. if the AURI flag was set to "1") (see clause 5.2.2.3.1). When present, this IE shall indicate the total number of usage reports that need to be sent in all the additional PFCP Session Report Request messages. This IE may also be included in every additional PFCP Session Report Request message but the last one, with the AURI flag set to 1, to indicate that more usage reports will follow in additional PFCP Session Report Request message.	X	X	X	X	X	Additional Usage Reports Information
PFCPSRReq-Flags	C	This IE shall be included if at least one of the flags is set to "1". <ul style="list-style-type: none"> - PSDBU (PFCP Session Deleted By the UP function): <ul style="list-style-type: none"> - if both the CP function and UP function support the EPFAR feature, the UP function may set this flag if the UP function needs to delete the PFCP session, e.g. to report all remaining non-zero usage reports for all URRs in the PFCP Session and the PFCP session is being deleted locally in the UP function. - the UP function shall also set this flag when sending the last PFCP Session Report Request message after having received a PFCP Session Deletion Request (see clause 5.2.2.3.1). - PPPCP (Pending UL Payload Packet to CP function): the UPF shall set the flag to "1" if the Report Type is set to "UISR" and if there are pending UL payload packets to be sent towards the new SMF via a new N4-u tunnel. 	X	X	X	X	X	PFCPSRReq-Flags
Old CP F-SEID	C	This IE shall be present if the UPF sends the PFCP Session Report Request to a different SMF in an SMF Set. See clauses 5.22.2 and 5.22.3. When present, it shall indicate the CP F-SEID assigned by the previous SMF to the PFCP session.	-	-	-	X	X	F-SEID
SMF Change Reason	O	This IE may be present when the Old CP F-SEID is present, to indicate the reason for sending the PFCP Session Report Request message to move PFCP session to an alternative SMF. (NOTE 2)	-	-	-	X	X	SMF Change Reason

Packet Rate Status Report	C	This IE shall be present if the EPFAR is used (see clause 5.18), UP function initiates a PFCP Session release and the CP function has requested in a QER to report the packet rate status when the PFCP session is released. See Table 7.5.7.1-1.	-	X	-	X	-	Packet Rate Status Report
TSC Management Information	C	This IE shall be present if the Report Type indicates TSC Management Information Report. Several IEs within the same IE type may be present to transfer PMICs for different NW-TT ports. (NOTE 1).	-	-	-	X	-	TSC Management Information
Session Report	C	This IE shall be present if the Report Type indicates a Session Report. See Table 7.5.8.6-1. Several IEs within the same IE type may be present to represent a list of Session Reports.	-	-	-	X	-	Session Report
Cause	O	This IE may be present to provide additional reason for sending the PFCP Session Report Request message, e.g. for a UP function initiated PFCP session deletion due to the corresponding L2TP session being terminated.	-	X	-	X	-	Cause
NOTE: When transferring port and user plane node management information between the TSN AF or the TSCTSF and NW-TT, since the NW-TT may support multiple ports, there may be several instances of the TSC Management Information IEs containing a Port Management Information Container together with a NW-TT Port Number, and only one instance of the TSC Management Information IE containing a User Plane Node Management Information Container that may also contain a Port Management Information Container together with a NW-TT Port Number.								

7.5.8.2 Downlink Data Report IE within PFCP Session Report Request

The Downlink Data Report grouped IE shall be encoded as shown in Table 7.5.8.2-1.

Table 7.5.8.2-1: Downlink Data Report IE within PFCP Session Report Request

Octet 1 and 2	Downlink Data Report IE Type = 83 (decimal)							
Octets 3 and 4	Length = n							
Information elements	P	Condition / Comment	Appl.					IE Type
			Sx a	Sx b	Sx c	N4	N4 mb	

PDR ID	M	This IE shall identify the PDR for which downlink data packets have been received or discarded at the UP function. More than one IE with this type may be included to represent multiple PDRs having received or discarded downlink data packets.	X	-	-	X	X	PDR ID
Downlink Data Service Information	C	This IE shall be included for a PFCP session with an IP PDN type, if the UP function supports the Paging Policy Differentiation feature (see clause 4.9 of 3GPP TS 23.401 [14]) and clause 5.4.3.2 of 3GPP TS 23.501 [28]). When present, for each PDR and for each packet that triggers a Downlink Data Notification, the UP function shall copy, into the Paging Policy Indication value within this IE, the value of the DSCP in TOS (IPv4) or TC (IPv6) information received in the IP payload of the GTP-U packet from the PGW (see IETF RFC 2474 [13]). For 5GC, this IE shall also be included over N4, for each PDR and for each packet that triggers a Downlink Data Notification, if the QFI of the downlink data packet is available. The UPF shall report, per QFI, the sum of the DL Data Packets size, if it supports the MT-SDT feature and the SMF requested to report the sum of the DL Data Packets Size per QoS flow. One IE with this type shall be included per PDR ID reported in the message. When multiple PDR ID IEs are present in the message, the Downlink Data Service Information IEs shall be reported according to the order of the PDR ID IEs.	X	-	-	X	-	Downlink Data Service Information
DL Data Packets Size	O	This IE may be present if the SGW-U supports the MT-EDT feature and is requested to report the sum of the DL Data Packets Size.	X	-	-	-	-	DL Data Packets Size
DL Data Status	O	This IE may be present if the first downlink data packet has been buffered or discarded at the UP function for downlink data delivery status notification.	-	-	-	X	-	Data Status

7.5.8.3 Usage Report IE within PFCP Session Report Request

The Usage Report grouped IE shall be encoded as shown in Table 7.5.8.3-1.

Table 7.5.8.3-1: Usage Report IE within PFCP Session Report Request

Octet 1 and 2	Usage Report IE Type = 80 (decimal)							
Octets 3 and 4	Length = n							
Information elements	P	Condition / Comment	Appl.					IE Type
			Sx a	Sx b	Sx c	N4	N4 mb	

URR ID	M	This IE shall identify the URR for which usage is reported.	X	X	X	X	X	URR ID
UR-SEQN	M	This IE shall uniquely identify the Usage Report for the URR (see clause 5.2.2.3).	X	X	X	X	X	UR-SEQN
Usage Report Trigger	M	This IE shall identify the trigger for this report.	X	X	X	X	X	Usage Report Trigger
Start Time	C	This IE shall be present, except if the Usage Report Trigger indicates 'Start of Traffic', 'Stop of Traffic' or 'MAC Addresses Reporting'. When present, this IE shall provide the timestamp when the collection of the information in this report was started.	X	X	X	X	X	Start Time
End Time	C	This IE shall be present, except if the Usage Report Trigger indicates 'Start of Traffic', 'Stop of Traffic' or 'MAC Addresses Reporting'. When present, this IE shall provide the timestamp when the collection of the information in this report was generated.	X	X	X	X	X	End Time
Volume Measurement	C	This IE shall be present if a volume measurement needs to be reported. (NOTE 2)	X	X	X	X	X	Volume Measurement
Duration Measurement	C	This IE shall be present if a duration measurement needs to be reported. (NOTE 2)	X	X	X	X	-	Duration Measurement
Application Detection Information	C	This IE shall be present if the start or stop of an application has been detected and then the application detection information needs to be reported. See also clause 5.4.11.	-	X	X	X	-	Application Detection Information
UE IP address	C	This IE shall be present if the start or stop of an application has been detected and no UE IP address was provisioned in the PDI. See NOTE 1.	-	-	X	X	-	UE IP address
Network Instance	C	This IE shall be present if the start or stop of an application has been detected, no UE IP address was provisioned in the PDI and multiple PDNs with overlapping IP addresses are used in the UP function. See NOTE 1.	-	-	X	X	-	Network Instance
Time of First Packet	C	This IE shall be present if available for this URR.	-	X	X	X	X	Time of First Packet
Time of Last Packet	C	This IE shall be present if available for this URR.	-	X	X	X	X	Time of Last Packet
Usage Information	C	This IE shall be present if the UP function reports Usage Reports before and after a Monitoring Time, or before and after QoS enforcement. When present, it shall indicate whether the usage is reported for the period before or after that time, or before or after QoS enforcement.	X	X	X	X	-	Usage Information
Query URR Reference	C	This IE shall be present if this usage report is sent as a result of a query URR received in a PFCP Session Modification Request and the Query URR Reference IE was present in the PFCP Session Modification Request. When present, it shall be set to the Query URR Reference value received in the PFCP Session Modification Request.	X	X	X	X	X	Query URR Reference
Event Time Stamp	C	This IE shall be present, if the report is related to an event. When present, it shall be set to the time when the event occurs. Several IEs with the same IE type may be present to report multiple occurrences for an event for this URR ID.	-	X	X	X	-	Time Stamp
Ethernet Traffic Information	C	This IE shall be present if Ethernet Traffic Information needs to be reported. See Table 7.5.8.3-3.	-	-	-	X	-	Ethernet Traffic Information
Join IP Multicast Information	C	This IE shall be present if the UPF needs to report that it has added the PDU session to the DL replication tree of a new IP multicast flow. Several IEs with the same IE type may be present to report multiple IP multicast flows added to the PDU session.	-	-	-	X	-	Join IP Multicast Information
Leave IP Multicast Information	C	This IE shall be present if the UPF needs to report that it has removed the PDU session from the DL replication tree of an IP multicast flow. Several IEs with the same IE type may be present to report multiple IP multicast flows removed from the PDU session.	-	-	-	X	-	Leave IP Multicast Information

Predefined Rules Name	O	This IE may be present to identify a predefined rule if the usage report is generated for a predefined URR which was activated via a Activate Predefined Rules IE in a Create PDR IE or an Update PDR IE. Several IEs with the same IE type may be present to represent multiple Predefined Rules with which the URR is associated.	-	X	-	X	-	Predefined Rules Name
NOTE 1: This is the case for unsolicited application reporting by the TDF. The Network instance is required when the UE IP address cannot be used to determine the corresponding PDN connection. See also clause 5.4.11.								
NOTE 2: The UP function may send a Usage Report with the Volume/Duration Measurement set to zero.								

Table 7.5.8.3-2: Application Detection Information IE within Usage Report IE

Octet 1 and 2		Application Detection Information IE Type = 68 (decimal)						
Octets 3 and 4		Length = n						
Information elements	P	Condition / Comment	Appl.					IE Type
			Sx a	Sx b	Sx c	N4	N4 mb	
Application ID	M	This IE shall identify the Application ID for which a start or stop of traffic is reported.	-	X	X	X	-	Application ID
Application Instance ID	C	When present, this IE shall identify the Application Instance Identifier for which a start or stop of traffic is reported. It shall be present, when reporting the start of an application, if the Reduced Application Detection Information flag was not set in the Measurement Information and if the flow information for the detected application is deducible. It shall be present, when reporting the stop of an application, if the Reduced Application Detection Information flag was not set in the Measurement Information and if it was provided when reporting the start of the application.	-	X	X	X	-	Application Instance ID
Flow Information	C	When present, this IE shall contain the flow information for the detected application. It shall be present, when reporting the start of an application, if the Reduced Application Detection Information flag was not set in the Measurement Information and if the flow information for the detected application is deducible.	-	X	X	X	-	Flow Information
PDR ID	O	When present, it shall contain the PDR ID which the application traffic matches.	-	X	X	X	-	PDR ID

Table 7.5.8.3-3: Ethernet Traffic Information IE within Usage Report IE

Octet 1 and 2		Ethernet Traffic Information IE Type = 143 (decimal)						
Octets 3 and 4		Length = n						
Information elements	P	Condition / Comment	Appl.					IE Type
			Sx a	Sx b	Sx c	N4	N4 mb	
MAC Addresses Detected	C	This IE shall be present if one or more new MAC addresses have been detected. When present, it shall identify the MAC (Ethernet) addresses newly detected as source address of frames sent UL by the UE. Several IEs with the same IE type may be present to provision multiple lists of MAC addresses (e.g. with different V-LAN tags).	-	-	-	X	-	MAC Addresses Detected
MAC Addresses Removed	C	This IE shall be present if one or more new MAC addresses have been removed. When present, it shall identify the MAC (Ethernet) addresses that have been inactive for a duration exceeding the Ethernet inactivity Timer. Several IEs with the same IE type may be present to provision multiple lists of MAC addresses (e.g. with different V-LAN tags).	-	-	-	X	-	MAC Addresses Removed

Table 7.5.8.3-4: Join IP Multicast Information IE within Usage Report IE

Octet 1 and 2		Join IP Multicast Information IE Type = 189 (decimal)						
Octets 3 and 4		Length = n						
Information elements	P	Condition / Comment	Appl.					IE Type
			Sx a	Sx b	Sx c	N4	N4 mb	
IP Multicast Address	M	This IE shall contain the IP multicast address of the DL multicast flow added to the PDU session.	-	-	-	X	-	IP Multicast Address
Source IP Address	C	This IE shall contain the source specific IP address of the DL multicast flow added to the PDU session, if available. Several IEs with the same IE type may be present to represent multiple source specific addresses.	-	-	-	X	-	Source IP Address

Table 7.5.8.3-5: Leave IP Multicast Information IE within Usage Report IE

Octet 1 and 2		Leave IP Multicast Information IE Type = 190 (decimal)						
Octets 3 and 4		Length = n						
Information elements	P	Condition / Comment	Appl.					IE Type
			Sx a	Sx b	Sx c	N4	N4 mb	
IP Multicast Address	M	This IE shall contain the IP multicast address of the DL multicast flow removed from the PDU session.	-	-	-	X	-	IP Multicast Address
Source IP Address	C	This IE shall contain the source specific IP address of the DL multicast flow removed from the PDU session, if available. Several IEs with the same IE type may be present to represent multiple source specific addresses.	-	-	-	X	-	Source IP Address

7.5.8.4 Error Indication Report IE within PFCP Session Report Request

The Error Indication Report grouped IE shall be encoded as shown in Table 7.5.8.4-1.

Table 7.5.8.4-1: Error Indication Report IE within PFCP Session Report Request

Octet 1 and 2		Error Indication Report IE Type = 99 (decimal)						
Octets 3 and 4		Length = n						
Information elements	P	Condition / Comment	Appl.					IE Type
			Sx a	Sx b	Sx c	N4	N4 mb	
Remote F-TEID	M	This IE shall identify the remote F-TEID of the GTP-U bearer for which an Error Indication has been received at the UP function. More than one IE with this type may be included to represent multiple remote F-TEID for which an Error Indication has been received.	X	X	-	X	X	F-TEID

7.5.8.5 TSC Management Information IE within PFCP Session Report Request

The TSC Management Information grouped IE shall be encoded as shown in Table 7.5.8.5-1.

Table 7.5.8.5-1: TSC Management Information IE within PFCP Session Report Request

Octet 1 and 2		TSC Management Information IE Type = 201 (decimal)						
Octets 3 and 4		Length = n						
Information elements	P	Condition / Comment	Appl.					IE Type
			Sx a	Sx b	Sx c	N4	N4 mb	

Port Management Information Container	O	When present, this IE shall contain a Port Management Information container.	-	-	-	X	-	Port Management Information Container
User Plane Node Management Information Container	O	When present, this IE shall contain an User Plane Node Management Information container.	-	-	-	X	-	User Plane Node Management Information Container
NW-TT Port Number	C	When PMIC IE is present, this IE shall contain the related NW-TT Port Number.	-	-	-	X	-	NW-TT Port Number

7.5.8.6 Session Report IE within PFCP Session Report Request

The Session Report grouped IE shall be encoded as shown in Table 7.5.8.6-1.

Table 7.5.8.6-1: Session Report IE within PFCP Session Report Request

Octet 1 and 2		Session Report IE Type = 214 (decimal)						
Octets 3 and 4		Length = n						
Information elements	P	Condition / Comment	Appl.					IE Type
			Sx a	Sx b	Sx c	N4	N4 mb	
SRR ID	M	This IE shall identify the SRR for which usage is reported.	-	-	-	X	-	SRR ID
Access Availability Report	C	This IE shall be present if change of access availability needs to be reported. When present, this IE shall indicate an access type and whether the access type has become available or unavailable.	-	-	-	X	-	Access Availability Report
QoS Monitoring Report	C	This IE shall be present if there is at least a QoS Monitoring Report that needs to be reported. Several IEs within the same IE type may be present to represent a list of QoS Monitoring Reports, e.g. for different QoS flows, or for the same QoS flow but conveyed by different GTP-U paths for a PDU session with redundant N3/N9 transmission.	-	-	-	X	-	QoS Monitoring Report
Traffic Parameter Measurement Report	C	This IE shall be present if there is at least a Traffic Parameter Measurement Report that needs to be reported. Several IEs within the same IE type may be present to represent a list of Traffic Parameter Measurement Reports, e.g., for different QoS flows.	-	-	-	X	-	Traffic Parameter Measurement Report

The Access Availability Report IE shall be encoded as shown in Table 7.5.8.2-2.

Table 7.5.8.6-2: Access Availability Report IE

Octet 1 and 2		Access Availability Report IE Type = 218 (decimal)						
Octets 3 and 4		Length = n						
Information elements	P	Condition / Comment	Appl.					IE Type
			Sx a	Sx b	Sx c	N4	N4 mb	
Access Availability Information	M	This IE shall indicate an access type and whether the access type has become available or not available. Up to two IEs with the same IE type may be present to report access availability changes for 3GPP and non-3GPP accesses.	-	-	-	X	-	Access Availability Information

The QoS Monitoring Report IE shall be encoded as shown in Table 7.5.8.6-3.

Table 7.5.8.6-3: QoS Monitoring Report IE

Octet 1 and 2		QoS Monitoring Report IE Type = 247 (decimal)						
Octets 3 and 4		Length = n						
Information elements	P	Condition / Comment	Appl.					IE Type
			Sx a	Sx b	Sx c	N4	N4 mb	
QFI	M	This IE shall identify the QoS Flow Identifier for which QoS monitoring is reported.	-	-	-	X	-	QFI
QoS Monitoring Measurement	M	This IE shall contain the measured packet delay(s) or the indication of packet delay measurement failure.	-	-	-	X	-	QoS Monitoring Measurement
Redundant N3/N9 Transmission Information	C	This IE shall be present if redundant N3/N9 transmission is applied for the PDU Session. When present, this IE shall contain the information identifying the N3/N9 transmission path.	-	-	-	X	-	Redundant N3/N9 Transmission Information
Time Stamp	M	This IE shall provide the timestamp when the collection of the information in this report was generated.	-	-	-	X	-	Time Stamp
Start Time	O	When present, this IE shall provide the timestamp when the collection of the information in this report was started.	-	-	-	X	-	Start Time

The Traffic Parameter Measurement Report IE shall be encoded as shown in Table 7.5.8.6-4.

Table 7.5.8.6-4: Traffic Parameter Measurement Report IE

Octet 1 and 2		Traffic Parameter Measurement Report Type = 324 (decimal)						
Octets 3 and 4		Length = n						
Information elements	P	Condition / Comment	Appl.					IE Type
			Sx a	Sx b	Sx c	N4	N4 mb	
QFI	M	This IE shall identify the QoS Flow Identifier for which traffic parameter measurement is reported.	-	-	-	X	-	QFI
N6 Jitter Measurement	C	This IE shall be present when N6 Jitter measurement available. The UPF shall include DL Periodicity field in the N6 Jitter Measurement IE.	-	-	-	X	-	N6 Jitter Measurement
UL Periodicity	C	The IE shall be included if the SMF requested to measure UL Periodicity and if this information is available.	-	-	-	X	-	UL Periodicity
Time Stamp	M	This IE shall provide the timestamp when the collection of the information in this report was generated.	-	-	-	X	-	Time Stamp
Start Time	O	When present, this IE shall provide the timestamp when the collection of the information in this report was started.	-	-	-	X	-	Start Time

Table 7.5.8.6-5: Redundant N3/N9 Transmission Information IE

Octet 1 and 2		Redundant N3/N9 Transmission Information = 399 (decimal)						
Octets 3 and 4		Length = n						
Information elements	P	Condition / Comment	Appl.					IE Type
			Sx a	Sx b	Sx c	N4	N4 mb	
Local N3/N9 Tunnel Information	M	This IE shall contain the Local N3/N9 Tunnel Information.	-	-	-	X	-	Local N3/N9 Tunnel Information
Remote N3/N9 Tunnel Information	M	This IE shall contain the N3/N9 Tunnel Information of the remote GTP-U peer.	-	-	-	X	-	Remote N3/N9 Tunnel Information

Table 7.5.8.6-6: Local N3/N9 Tunnel Information IE

Octet 1 and 2		Local N3/N9 Tunnel Information = 400 (decimal)						
Octets 3 and 4		Length = n						
Information elements	P	Condition / Comment	Appl.					IE Type
			Sx a	Sx b	Sx c	N4	N4 mb	
F-TEID	M	This IE shall contain the local F-TEID to receive the UL packets.	-	-	-	X	-	F-TEID
Network Instance	O	This IE may be present to contain the Network Instance provisioned in the PDR from which the UL packets are received if such a Network Instance is configured.	-	-	-	X	-	Network Instance

Table 7.5.8.6-7: Remote N3/N9 Tunnel Information IE

Octet 1 and 2		Remote N3/N9 Tunnel Information = 401 (decimal)						
Octets 3 and 4		Length = n						
Information elements	P	Condition / Comment	Appl.					IE Type
			Sx a	Sx b	Sx c	N4	N4 mb	
F-TEID	M	This IE shall contain the F-TEID of the remote GTP-U entity.	-	-	-	X	-	F-TEID
Network Instance	O	This IE may be present to contain the Network Instance provisioned in the FAR to reach the remote GTP-U entity if such a Network Instance is configured.	-	-	-	X	-	Network Instance

7.5.9 PFCP Session Report Response

7.5.9.1 General

The PFCP Session Report Response shall be sent over the Sxa, Sxb, Sxc, N4 and N4mb interface by the CP function to the UP function as a reply to the PFCP Session Report Request.

Table 7.5.9.1-1: Information Elements in a PFCP Session Report Response

Information elements	P	Condition / Comment	Appl.					IE Type
			Sx a	Sx b	Sx c	N4	N4 mb	

Cause	M	This IE shall indicate the acceptance or the rejection of the corresponding request message.	X	X	X	X	X	Cause
Offending IE	C	This IE shall be included if the rejection is due to a conditional or mandatory IE missing or faulty.	X	X	X	X	X	Offending IE
Update BAR	C	This IE shall be present if a BAR previously created for the PFCP session needs to be modified. A previously created BAR that is not modified shall not be included. See Table 7.5.9.2-1.	X	-	-	X	-	Update BAR
PFCPSRRsp-Flags	C	This IE shall be included if at least one of the flags is set to "1". - DROBU (Drop Buffered Packets): the CP function shall set this flag if the UP function needs to drop the packets currently buffered for this PFCP session (see NOTE 1).	X	-	-	X	-	PFCPSRRsp-Flags
CP F-SEID	O	This IE may be set by the SMF if the UPF indicated support of PFCP sessions successively controlled by different SMFs of a same SMF Set and the Cause IE indicates "Request accepted (success)"(see clause 5.22). When present, it shall be set to the new F-SEID that the UPF shall use for sending subsequent PFCP session related messages.	-	-	-	X	X	F-SEID
N4-u F-TEID	O	This IE may be set by the SMF if the UPF indicated support of PFCP sessions successively controlled by different SMFs of a same SMF Set and the Cause IE indicates "Request accepted (success)". When present, it shall be set to the new N4-u F-TEID that the UPF shall use for data forwarding towards the SMF.	-	-	-	X	-	F-TEID
Alternative SMF IP Address	O	This IE may be set by the SMF if the UPF indicated support of PFCP sessions successively controlled by different SMFs of a same SMF Set and the Cause IE indicates "Redirection Requested" (see clause 5.22). When present, it shall be set to the IP address of the new SMF to contact.	-	-	-	X	X	Alternative SMF IP Address
PGW-C/SMF FQ-CSID	O	This IE may be included by the alternative SMF or PGW-C to allocate a new PGW-C/SMF FQ-CSID for the PFCP session, during the restoration of PFCP sessions associated with one or more PGW-C/SMF FQ-CSID(s) (see clause 5.22.4), if the Cause IE indicates "Request accepted (success)". When present, the UP function shall replace any earlier value associated to the PFCP session with the new value.	-	X	-	X	-	FQ-CSID
Group Id	C	This IE may be included by the alternative SMF or PGW-C to allocate a new Group Id for the PFCP session, during the restoration of PFCP sessions associated with one or more Group Id(s) (see clause 5.22.4), if the Cause IE indicates "Request accepted (success)". When present, the UP function shall replace any earlier value associated to the PFCP session with the new value.	-	X	-	X	-	Group Id
Node ID	C	This IE should be present if the CP F-SEID IE is present. When present, it shall be set to the Node ID of the SMF or MB-SMF that has taken over the control of the PFCP session, i.e. that SMF or MB-SMF has assigned the CP F-SEID.	-	-	-	X	X	Node ID
Alternative SMF IP Address	O	When present, this IE shall contain the Alternative SMF IP Address. (NOTE 2)	-	-	-	X	-	Alternative SMF IP Address

NOTE 1: The CP function may request the UP function to drop the packets currently buffered for the PFCP session, when buffering is performed in the UP function, upon receipt of a PFCP Session Report Request notifying the CP function about the arrival of downlink data packets for which the CP function decides to throttle the corresponding Downlink Data Notification message over S11/S4 and. See clause 5.9.3 of 3GPP TS 23.214 [2].

NOTE 2: When the UPF performs the SMF restoration procedures for an SMF in a SMF set specified in 3GPP TS 23.527 [40], e.g. when it detects the SMF has failed, it shall use the Alternative SMF IP Address provisioned for the PFCP session if received and if supported by the UPF, otherwise the UPF shall use Alternative SMF IP Address or SMF Set ID provisioned in PFCP Association Setup Request/Response messages or PFCP Association Update Request message to select an alternative SMF to restore the PFCP session.

7.5.9.2 Update BAR IE within PFCP Session Report Response

The Update BAR grouped IE shall be encoded as shown in Table 7.5.9.2-1.

Table 7.5.9.2-1: Update BAR IE in PFCP Session Report Response

Octet 1 and 2		Update BAR IE Type = 12 (decimal)						
Octets 3 and 4		Length = n						
Information elements	P	Condition / Comment	Appl.					IE Type
			Sx a	Sx b	Sx c	N4	N4 mb	
BAR ID	M	This IE shall identify the BAR Rule to be modified.	X	-	-	X	-	BAR ID
Downlink Data Notification Delay	C	This IE shall be present if the UP function indicated support of the Downlink Data Notification Delay parameter (see clause 8.2.25) and the Downlink Data Notification Delay needs to be modified. When present, it shall contain the delay the UP function shall apply between receiving a downlink data packet and notifying the CP function about it, when the Apply Action parameter requests to buffer the packets and notify the CP function.	X	-	-	-	-	Downlink Data Notification Delay
DL Buffering Duration	C	This IE shall be present if the UP function indicated support of the DL Buffering Duration parameter in PFCP Session Report Response feature (see DLBD feature in clause 8.2.25) and extended buffering of downlink data packet is required in the UP function. When present, this IE shall indicate the duration during which the UP function shall buffer the downlink data packets and when the EDBN flag is not present refrain from sending any further notification to the CP function about the arrival of DL data packets. (NOTE 1)	X	-	-	X	-	DL Buffering Duration
DL Buffering Suggested Packet Count	O	This IE may be present if extended buffering of downlink data packet is required in the UP function. When present, this IE shall indicate the maximum number of downlink data packets suggested to be buffered in the UP function.	X	-	-	X	-	DL Buffering Suggested Packet Count
Suggested Buffering Packets Count	C	This IE may be present if the UP Function indicated support of the feature UDBC. When present, it shall contain the number of packets that are suggested to be buffered when the Apply Action parameter requests to buffer the packets. The packets that exceed the limit shall be discarded.	-	X	X	X	-	Suggested Buffering Packets Count
Extended DL Buffering Notification Policy	C	This IE may be present if the DL Buffering Duration IE is present. When present, it shall contain the EDBN flag indicating the Extended DL Buffering Notification policy. (NOTE 1)	-	-	-	X	-	Extended DL Buffering Notification Policy

NOTE 1: If the Apply Action requests the UP function to buffer and notify the CP function, the DL Buffering Duration is set, the EDBN flag is not present, then the UP function shall not notify the CP function for the duration indicated by the DL Buffering Duration. If the Apply Action requests the UP function to buffer downlink data packets, the DL Buffering Duration is set, the EDBN bit is set to "1", then the UP function shall notify the CP function of the arrival of the first buffered DL packet for each QoS flow for a given FAR for the duration indicated by the DL Buffering Duration.

7.6 Error Handling

7.6.1 Protocol Errors

A protocol error is defined as a message or an Information Element received from a peer entity with an unknown type, or if it is unexpected, or if it has an erroneous content.

The term silently discarded is used in the following clauses to mean that the receiving PFCP entity's implementation shall discard such a message without further processing or that the receiving PFCP entity discards such an IE and continues processing the message. The conditions for the receiving PFCP entity to silently discard an IE are specified in the subsequent clauses.

The handling of unknown, unexpected or erroneous PFCP messages and IEs shall provide for the forward compatibility of PFCP. Therefore, the sending PFCP entity shall be able to safely include in a message a new conditional-optional or an optional IE. Such an IE may also have a new type value. Any legacy receiving PFCP entity shall, however, silently discard such an IE and continue processing the message.

If a protocol error is detected by the receiving PFCP entity, it should log the event including the erroneous message and may include the error in a statistical counter.

For Response messages containing a rejection Cause value, see clause 7.2.3.2.

The receiving PFCP entity shall apply the error handling specified in the subsequent clauses.

If the received erroneous message is a reply to an outstanding PFCP message, the PFCP entity shall stop retransmissions and notify the PFCP application layer of the error even if the reply is silently discarded.

7.6.2 Different PFCP Versions

If a PFCP entity receives a message of an unsupported PFCP version, it shall return a PFCP Version Not Supported Response message and silently discard the received message.

7.6.3 PFCP Message of Invalid Length

If a PFCP entity receives a message, which is too short to contain the respective PFCP header, the PFCP-PDU shall be silently discarded.

If a PFCP entity receives a Request message within an IP/UDP packet of a length that is inconsistent with the value specified in the Length field of the PFCP header, then the receiving PFCP entity should log the error and shall send the Response message with Cause IE value set to "Invalid Length".

If a PFCP entity receives a Response message within an IP/UDP packet of a length that is inconsistent with the value specified in the Length field of the PFCP header, then the receiving PFCP entity should log the error and shall stop retransmissions of the corresponding Request message, notify the PFCP application layer of the error, and log the error.

7.6.4 Unknown PFCP Message

If a PFCP entity receives a message with an unknown Message Type value, it shall silently discard the message.

7.6.5 Unexpected PFCP Message

If a PFCP entity receives an unexpected request message, for example a known message that is sent over an interface for which the message is not defined, or a message that is sent over an interface for which the message is defined, but the direction is incorrect, then the PFCP entity shall silently discard the message and shall log an error.

If a PFCP entity receives an unexpected response message, for example a message for which there is no corresponding outstanding request, it shall discard the message and may log an error.

7.6.6 Missing Information Elements

A PFCP entity shall check if all mandatory IEs are present in the received Request message. Apart from Heartbeat Request message, if one or more mandatory information elements are missing in the received Request message, the PFCP entity should log the error and shall send a Response message with Cause IE value set to "Mandatory IE missing" with the type of the missing mandatory IE.

If a PFCP entity receives a Response message with Cause IE value set to "Mandatory IE missing", it shall notify its upper layer.

A PFCP entity shall check if all mandatory IEs are present in the received Response message without a rejection Cause value. If one or more mandatory information elements are missing, the PFCP entity shall stop retransmissions of the corresponding Request message, notify the PFCP application layer of the error, and should log the error.

A PFCP entity shall check if conditional information elements are present in the received Request message, if possible (i.e. if the receiving entity has sufficient information available to check if the respective conditions were met). If one or more conditional information elements are missing, a PFCP entity should log the error and shall send a Response message with Cause IE value set to "Conditional IE missing" together with the type of the missing conditional IE.

A PFCP entity shall check if conditional information elements are present in the received Response message without a rejection Cause value, if possible (i.e. if the receiving entity has sufficient information available to check if the respective conditions were met). If one or more conditional information elements are missing, a PFCP entity shall stop retransmissions of the corresponding Request message, notify the PFCP application layer of the error, and should log the error.

Additional information elements may be included in Response messages containing a rejection Cause value, see clause 7.2.3.2.

Absence of an optional information element shall not trigger any error handling.

7.6.7 Invalid Length Information Element

An information element has an invalid length when the actual length of the IE is different from the value of the Length field in the IE header. Here, the actual length of the IE means the length of the content field of the received IE.

If a PFCP message contains more than one information elements and one or more of them have invalid length, the receiving PFCP entity can detect which of the IEs have invalid length only in the following cases:

- If the Length value in the IE header is greater than the overall length of the message;
- If the invalid length IE is the last one in the message.

Apart from Heartbeat Request message, if a receiving PFCP entity detects information element with invalid length in a Request message, it shall send an appropriate error response with Cause IE value set to "Invalid length" together with the type of the offending IE.

7.6.8 Semantically incorrect Information Element

Apart from Echo Request message, the receiver of a PFCP signalling message Request including a mandatory or a verifiable conditional information element with a semantically invalid Value shall discard the request, should log the error, and shall send a response with Cause IE value set to "Mandatory IE incorrect" together with a type and instance of the offending IE.

The receiver of a PFCP signalling message Response including a mandatory or a verifiable conditional information element with a semantically invalid Value shall notify the upper layer that a message with this sequence number has been received and should log the error.

If a PFCP entity receives an information element with a value which is shown as reserved, it shall treat that information element as invalid and should log the error. If the invalid IE is received in a Request, and it is a mandatory IE or a verifiable conditional IE, the PFCP entity shall send a response with Cause set to "Mandatory IE incorrect" together with a type and instance of the offending IE.

The principle is: the use of reserved values invokes error handling; the use of spare values can be silently discarded and for IEs with spare values used, processing shall be continued ignoring the spare values.

The receiver of a PFCP signalling message including an optional information element with a Value that is not in the range defined for this information element value shall discard this IE, but shall treat the rest of the message as if this IE was absent and continue processing. The receiver shall not check the content of an information element field that is defined as "spare".

All semantically incorrect optional information elements in a PFCP signalling message shall be treated as not present in the message.

7.6.9 Unknown or unexpected Information Element

The receiver of a PFCP message including an unexpected information element with a known Type value that is not defined for this message shall discard the IE and log an error. The receiver shall process the message.

NOTE: An Information Element in an encoded PFCP message or grouped IE is identified by the IE Type.

7.6.10 Repeated Information Elements

An Information Element is repeated if there is more than one IE with the same IE Type in the scope of the PFCP message (or in the scope of the grouped IE). Such an IE is a member in a list.

If an information element is repeated in a PFCP signalling message in which repetition of the information element is not specified, only the contents of the information element appearing first shall be handled and all subsequent repetitions of the information element shall be ignored. When the number of repetitions of information elements is specified, only the contents of specified repeated information elements shall be handled and all subsequent repetitions of the information element shall be ignored.

8 Information Elements

8.1 Information Elements Format

8.1.1 Information Element Format

Figure 8.1.1-1 depicts the format of an Information Element.

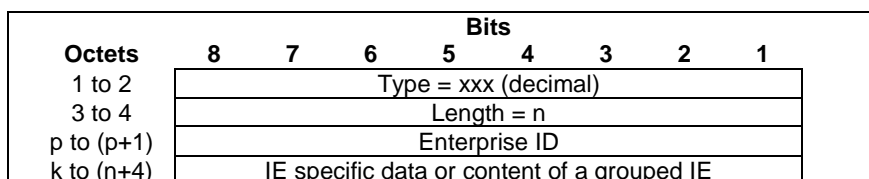

Figure 8.1.1-1: Information Element Format

NOTE 1: If the Bit 8 of Octet 1 is not set, this indicates that the IE is defined by 3GPP and the Enterprise ID is absent. If Bit 8 of Octet 1 is set, this indicates that the IE is defined by a vendor and the Enterprise ID is present identified by the Enterprise ID.

An IE has the following mandatory fields:

- Type: this field indicates the type of the Information Element. IE type values within the range of 0 to 32767 are reserved for IE defined by 3GPP and are listed in clause 8.1.2 IE type values within the range of 32768 to 65535 are used for vendor-specific IE and the value allocation is controlled by the vendor.

- Length: this field contains the length of the IE excluding the first four octets, which are common for all IEs (Type and Length) and is denoted "n" in Figure 8.1.1-1 and in Figure 8.1.1-2. Bit 8 of the lowest numbered octet is the most significant bit and bit 1 of the highest numbered octet is the least significant bit.

An IE has the following optional fields:

- Enterprise ID: if the IE type value is within the range of 32768 to 65535, this field shall contain the IANA-assigned "SMI Network Management Private Enterprise Codes" value of the vendor defining the IE. The Enterprise ID set to "10415" (IANA-assigned "SMI Network Management Private Enterprise Codes") shall not be used for the vendor specific IEs.

For illustration, Figure 8.1.1-2 depicts the format of a Information Element (IE) defined by 3GPP and is specified in this specification. For IE's defined by 3GPP, the IE type shall be within the range of 0 to 32767.

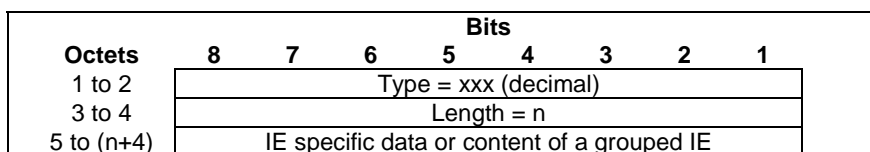

Figure 8.1.1-2: 3GPP defined Information Element Format

NOTE 2: Bit 8 of Octet 1 is not set. This indicates that the Information Element type value has been allocated by 3GPP.

For illustration, Figure 8.1.1-3 depicts the format of a vendor-specific Information Element, which content is not specified and the IE type value shall be within the range of 32768 to 65535.

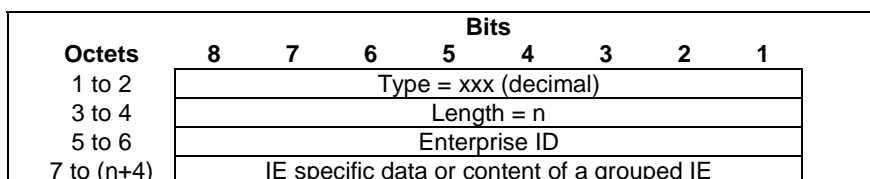

Figure 8.1.1-3: Vendor-Specific Information Element Format

NOTE 3: Bit 8 of Octet 1 is set. This indicates that the IE type value has been allocated by the vendor identified by the Enterprise ID. The content of this IE is vendor specific and therefore out of scope of this specification.

8.1.2 Information Element Types

A PFCP message may contain several IEs. In order to have forward compatible type definitions for the PFCP IEs, all of them shall be TLV (Type, Length, Value) coded. PFCP IE type values are specified in the Table 8.1.2-1.

The 3rd column of this table specifies if the IE is either Extendable or has a variable length or a fixed length and a reference to the clause where the IE is specified:

- Fixed Length: the IE has a fixed set of fields, and a fixed number of octets;
- Variable Length: the IE has a fixed set of fields, and has a variable number of octets. For example, the last octets may be numbered similar to "5 to (n+4)". In this example, if the value of the length field, n, is 0, then the last field is not present;
- Extendable: the IE has a variable number of fields, and has a variable number of octets. The last fields are typically specified with the statement: "These octet(s) is/are present only if explicitly specified". The legacy receiving entity shall ignore the unknown octets.

The 4th column of this table indicates the number of fixed Octets the IE contained when the IE was first defined in the specification, which shall be an integer value reflecting the minimum length of fixed octets defined for the IE.

An IE of any of the above types may have a null length as specified in clause 5.6.3. This shall not be considered as an error by the receiving PFCP entity.

In order to improve the efficiency of troubleshooting, it is recommended that the IEs should be arranged in the signalling messages as well as in the grouped IEs, according to the order the IEs are listed in the message definition table or grouped IE definition table in clause 7. However the receiving entity shall be prepared to handle the messages with IEs in any order.

Within IEs, certain fields may be described as spare. These bits shall be transmitted with the value set to "0". To allow for future features, the receiver shall not evaluate these bits.

Table 8.1.2-1: Information Element Types

IE Type value (Decimal)	Information elements	Comment / Reference	Number of Fixed Octets
0	Reserved		
1	Create PDR	Extendable / Table 7.5.2.2-1	Not Applicable
2	PDI	Extendable / Table 7.5.2.2-2	Not Applicable
3	Create FAR	Extendable / Table 7.5.2.3-1	Not Applicable
4	Forwarding Parameters	Extendable / Table 7.5.2.3-2	Not Applicable
5	Duplicating Parameters	Extendable / Table 7.5.2.3-3	Not Applicable
6	Create URR	Extendable / Table 7.5.2.4-1	Not Applicable
7	Create QER	Extendable / Table 7.5.2.5-1	Not Applicable
8	Created PDR	Extendable / Table 7.5.3.2-1	Not Applicable
9	Update PDR	Extendable / Table 7.5.4.2-1	Not Applicable
10	Update FAR	Extendable / Table 7.5.4.3-1	Not Applicable
11	Update Forwarding Parameters	Extendable / Table 7.5.4.3-2	Not Applicable
12	Update BAR (PFCP Session Report Response)	Extendable / Table 7.5.9.2-1	Not Applicable
13	Update URR	Extendable / Table 7.5.4.4	Not Applicable
14	Update QER	Extendable / Table 7.5.4.5	Not Applicable
15	Remove PDR	Extendable / Table 7.5.4.6	Not Applicable
16	Remove FAR	Extendable / Table 7.5.4.7	Not Applicable
17	Remove URR	Extendable / Table 7.5.4.8	Not Applicable
18	Remove QER	Extendable / Table 7.5.4.9	Not Applicable
19	Cause	Fixed / Clause 8.2.1	1
20	Source Interface	Extendable / Clause 8.2.2	1
21	F-TEID	Extendable / Clause 8.2.3	1
22	Network Instance	Variable Length / Clause 8.2.4	Not Applicable
23	SDF Filter	Extendable / Clause 8.2.5	2
24	Application ID	Variable Length / Clause 8.2.6	Not Applicable
25	Gate Status	Extendable / Clause 8.2.7	1
26	MBR	Extendable / Clause 8.2.8	10
27	GBR	Extendable / Clause 8.2.9	10
28	QER Correlation ID	Extendable / Clause 8.2.10	4
29	Precedence	Extendable / Clause 8.2.11	4
30	Transport Level Marking	Extendable / Clause 8.2.12	2
31	Volume Threshold	Extendable / Clause 8.2.13	1
32	Time Threshold	Extendable / Clause 8.2.14	4
33	Monitoring Time	Extendable / Clause 8.2.15	4
34	Subsequent Volume Threshold	Extendable / Clause 8.2.16	1
35	Subsequent Time Threshold	Extendable / Clause 8.2.17	4
36	Inactivity Detection Time	Extendable / Clause 8.2.18	4
37	Reporting Triggers	Extendable / Clause 8.2.19	2
38	Redirect Information	Extendable / Clause 8.2.20	3
39	Report Type	Extendable / Clause 8.2.21	1
40	Offending IE	Fixed / Clause 8.2.22	2
41	Forwarding Policy	Extendable / Clause 8.2.23	1
42	Destination Interface	Extendable / Clause 8.2.24	1
43	UP Function Features	Extendable / Clause 8.2.25	1
44	Apply Action	Extendable / Clause 8.2.26	1
45	Downlink Data Service Information	Extendable / Clause 8.2.27	1
46	Downlink Data Notification Delay	Extendable / Clause 8.2.28	1
47	DL Buffering Duration	Extendable / Clause 8.2.29	1
48	DL Buffering Suggested Packet Count	Variable / Clause 8.2.30	Not Applicable
49	PFCPSMReq-Flags	Extendable / Clause 8.2.31	1
50	PFCPSRRsp-Flags	Extendable / Clause 8.2.32	1
51	Load Control Information	Extendable / Table 7.5.3.3-1	Not Applicable
52	Sequence Number	Fixed Length / Clause 8.2.33	4
53	Metric	Fixed Length / Clause 8.2.34	1
54	Overload Control Information	Extendable / Table 7.5.3.4-1	Not Applicable
55	Timer	Extendable / Clause 8.2.35	1
56	PDR ID	Extendable / Clause 8.2.36	2
57	F-SEID	Extendable / Clause 8.2.37	9
58	Application ID's PFDs	Extendable / Table 7.4.3.1-2	Not Applicable
59	PFD context	Extendable / Table 7.4.3.1-3	Not Applicable
60	Node ID	Extendable / Clause 8.2.38	1
61	PFD contents	Extendable / Clause 8.2.39	2

62	Measurement Method	Extendable / Clause 8.2.40	1
63	Usage Report Trigger	Extendable / Clause 8.2.41	2
64	Measurement Period	Extendable / Clause 8.2.42	4
65	FQ-CSID	Extendable / Clause 8.2.43	1
66	Volume Measurement	Extendable / Clause 8.2.44	1
67	Duration Measurement	Extendable / Clause 8.2.45	4
68	Application Detection Information	Extendable / Table 7.5.8.3-2	Not Applicable
69	Time of First Packet	Extendable / Clause 8.2.46	4
70	Time of Last Packet	Extendable / Clause 8.2.47	4
71	Quota Holding Time	Extendable / Clause 8.2.48	4
72	Dropped DL Traffic Threshold	Extendable / Clause 8.2.49	1
73	Volume Quota	Extendable / Clause 8.2.50	1
74	Time Quota	Extendable / Clause 8.2.51	4
75	Start Time	Extendable / Clause 8.2.52	4
76	End Time	Extendable / Clause 8.2.53	4
77	Query URR	Extendable / Table 7.5.4.10-1	Not Applicable
78	Usage Report (Session Modification Response)	Extendable / Table 7.5.5.2-1	Not Applicable
79	Usage Report (Session Deletion Response)	Extendable / Table 7.5.7.2-1	Not Applicable
80	Usage Report (Session Report Request)	Extendable / Table 7.5.8.3-1	Not Applicable
81	URR ID	Extendable / Clause 8.2.54	4
82	Linked URR ID	Extendable / Clause 8.2.55	4
83	Downlink Data Report	Extendable / Table 7.5.8.2-1	Not Applicable
84	Outer Header Creation	Extendable / Clause 8.2.56	2
85	Create BAR	Extendable / Table 7.5.2.6-1	Not Applicable
86	Update BAR (Session Modification Request)	Extendable / Table 7.5.4.11-1	Not Applicable
87	Remove BAR	Extendable / Table 7.5.4.12-1	Not Applicable
88	BAR ID	Extendable / Clause 8.2.57	1
89	CP Function Features	Extendable / Clause 8.2.58	1
90	Usage Information	Extendable / Clause 8.2.59	1
91	Application Instance ID	Variable Length / Clause 8.2.60	Not Applicable
92	Flow Information	Extendable / Clause 8.2.61	3
93	UE IP Address	Extendable / Clause 8.2.62	1
94	Packet Rate	Extendable / Clause 8.2.63	1
95	Outer Header Removal	Extendable / Clause 8.2.64	1
96	Recovery Time Stamp	Extendable / Clause 8.2.65	4
97	DL Flow Level Marking	Extendable / Clause 8.2.66	1
98	Header Enrichment	Extendable / Clause 8.2.67	1
99	Error Indication Report	Extendable / Table 7.5.8.4-1	Not Applicable
100	Measurement Information	Extendable / Clause 8.2.68	1
101	Node Report Type	Extendable / Clause 8.2.69	1
102	User Plane Path Failure Report	Extendable / Table 7.4.5.1.2-1	Not Applicable
103	Remote GTP-U Peer	Extendable / Clause 8.2.70	1
104	UR-SEQN	Fixed Length / Clause 8.2.71	4
105	Update Duplicating Parameters	Extendable / Table 7.5.4.3-3	Not Applicable
106	Activate Predefined Rules	Variable Length / Clause 8.2.72	Not Applicable
107	Deactivate Predefined Rules	Variable Length / Clause 8.2.73	Not Applicable
108	FAR ID	Extendable / Clause 8.2.74	4
109	QER ID	Extendable / Clause 8.2.75	4
110	OCI Flags	Extendable / Clause 8.2.76	1
111	PFCP Association Release Request	Extendable / Clause 8.2.77	1
112	Graceful Release Period	Extendable / Clause 8.2.78	1
113	PDN Type	Extendable / Clause 8.2.79	1
114	Failed Rule ID	Extendable / Clause 8.2.80	1
115	Time Quota Mechanism	Extendable / Clause 8.2.81	1
116	Reserved		
117	User Plane Inactivity Timer	Extendable / Clause 8.2.83	4
118	Aggregated URRs	Extendable / Table 7.5.2.4-2	Not Applicable
119	Multiplier	Fixed / Clause 8.2.84	12
120	Aggregated URR ID	Fixed / Clause 8.2.85	4
121	Subsequent Volume Quota	Extendable / Clause 8.2.86	1
122	Subsequent Time Quota	Extendable / Clause 8.2.87	4
123	RQI	Extendable / Clause 8.2.88	1

124	QFI	Extendable / Clause 8.2.89	1
125	Query URR Reference	Extendable / Clause 8.2.90	4
126	Additional Usage Reports Information	Extendable / Clause 8.2.91	2
127	Create Traffic Endpoint	Extendable / Table 7.5.2.7	Not Applicable
128	Created Traffic Endpoint	Extendable / Table 7.5.3.5	Not Applicable
129	Update Traffic Endpoint	Extendable / Table 7.5.4.13	Not Applicable
130	Remove Traffic Endpoint	Extendable / Table 7.5.4.14	Not Applicable
131	Traffic Endpoint ID	Extendable / Clause 8.2.92	1
132	Ethernet Packet Filter	Extendable / Table 7.5.2.2-3	Not Applicable
133	MAC address	Extendable / Clause 8.2.93	1
134	C-TAG	Extendable / Clause 8.2.94	3
135	S-TAG	Extendable / Clause 8.2.95	3
136	Ethertype	Extendable / Clause 8.2.96	2
137	Proxying	Extendable / Clause 8.2.97	1
138	Ethernet Filter ID	Extendable / Clause 8.2.98	4
139	Ethernet Filter Properties	Extendable / Clause 8.2.99	1
140	Suggested Buffering Packets Count	Extendable / Clause 8.2.100	1
141	User ID	Extendable / Clause 8.2.101	1
142	Ethernet PDU Session Information	Extendable / Clause 8.2.102	1
143	Ethernet Traffic Information	Extendable / Table 7.5.8.3-3	Not Applicable
144	MAC Addresses Detected	Extendable / Clause 8.2.103	7
145	MAC Addresses Removed	Extendable / Clause 8.2.104	7
146	Ethernet Inactivity Timer	Extendable / Clause 8.2.105	4
147	Additional Monitoring Time	Extendable / Table 7.5.2.4-3	Not Applicable
148	Event Quota	Extendable / Clause 8.2.112	4
149	Event Threshold	Extendable / Clause 8.2.113	4
150	Subsequent Event Quota	Extendable / Clause 8.2.106	4
151	Subsequent Event Threshold	Extendable / Clause 8.2.107	4
152	Trace Information	Extendable / Clause 8.2.108	7
153	Framed-Route	Variable Length / Clause 8.2.109	Not Applicable
154	Framed-Routing	Fixed Length / Clause 8.2.110	4
155	Framed-IPv6-Route	Variable Length / Clause 8.2.111	Not Applicable
156	Time Stamp	Extendable / Clause 8.2.114	4
157	Averaging Window	Extendable / Clause 8.2.115	4
158	Paging Policy Indicator	Extendable / Clause 8.2.116	1
159	APN/DNN	Variable Length / Clause 8.2.117	Not Applicable
160	3GPP Interface Type	Extendable / Clause 8.2.118	1
161	PFCSRReq-Flags	Extendable / Clause 8.2.119	1
162	PFCAUReq-Flags	Extendable / Clause 8.2.120	1
163	Activation Time	Extendable / Clause 8.2.121	4
164	Deactivation Time	Extendable / Clause 8.2.122	4
165	Create MAR	Extendable / Table 7.5.2.8-1	Not Applicable
166	3GPP Access Forwarding Action Information	Extendable / Table 7.5.2.8-2	Not Applicable
167	Non-3GPP Access Forwarding Action Information	Extendable / Table 7.5.2.8-3	Not Applicable
168	Remove MAR	Extendable / Table 7.5.4.15-1	Not Applicable
169	Update MAR	Extendable / Table 7.5.4.16-1	Not Applicable
170	MAR ID	Extendable / Clause 8.2.123	2
171	Steering Functionality	Extendable / Clause 8.2.124	1
172	Steering Mode	Extendable / Clause 8.2.125	1
173	Weight	Fixed / Clause 8.2.126	1
174	Priority	Extendable / Clause 8.2.127	1
175	Update 3GPP Access Forwarding Action Information	Extendable / Table 7.5.4.16-2	Not Applicable
176	Update Non 3GPP Access Forwarding Action Information	Extendable / Table 7.5.4.16-3	Not Applicable
177	UE IP address Pool Identity	Extendable / Clause 8.2.128	2
178	Alternative SMF IP Address	Extendable / Clause 8.2.129	1
179	Packet Replication and Detection Carry-On Information	Extendable / Clause 8.2.130	1
180	SMF Set ID	Extendable / Clause 8.2.131	1
181	Quota Validity Time	Extendable / Clause 8.2.132	4
182	Number of Reports	Fixed / Clause 8.2.133	2

183	PFCP Session Retention Information (within PFCP Association Setup Request)	Extendable / Table 7.4.4.1-2	1
184	PFCPASP-Flags	Extendable / Clause 8.2.134	1
185	CP PFCP Entity IP Address	Extendable / Clause 8.2.135	1
186	PFCPSPReq-Flags	Extendable / Clause 8.2.136	1
187	User Plane Path Recovery Report	Extendable / Table 7.4.5.1.3-1	Not Applicable
188	IP Multicast Addressing Info within PFCP Session Establishment Request	Extendable / Clause 7.5.2.2-4	Not Applicable
189	Join IP Multicast Information IE within Usage Report	Extendable / Table 7.5.8.3-4	Not Applicable
190	Leave IP Multicast Information IE within Usage Report	Extendable / Table 7.5.8.3-5	Not Applicable
191	IP Multicast Address	Extendable / Clause 8.2.137	1
192	Source IP Address	Extendable / Clause 8.2.138	1
193	Packet Rate Status	Extendable / Clause 8.2.139	1
194	Create Bridge/Router Info	Extendable / Clause 8.2.140	1
195	Created Bridge/Router Info	Extendable / Table 7.5.3.6-1	Not Applicable
196	Port Number	Fixed Length / Clause 8.2.141	4
197	NW-TT Port Number	Fixed Length / Clause 8.2.142	4
198	5GS User Plane Node ID	Extendable / Clause 8.2.143	Not Applicable
199	TSC Management Information IE within PFCP Session Modification Request	Extendable / Table 7.5.4.18-1	Not Applicable
200	TSC Management Information IE within PFCP Session Modification Response	Extendable / Table 7.5.5.3-1	Not Applicable
201	TSC Management Information IE within PFCP Session Report Request	Extendable / Table 7.5.8.5-1	Not Applicable
202	Port Management Information Container	Variable Length / Clause 8.2.144	Not Applicable
203	Clock Drift Control Information	Extendable / Table 7.4.4.1.2-1	Not Applicable
204	Requested Clock Drift Information	Extendable / Clause 8.2.145	1
205	Clock Drift Report	Extendable / Table 7.4.5.1.4-1	Not Applicable
206	Time Domain Number	Extendable / Clause 8.2.146	1
207	Time Offset Threshold	Extendable / Clause 8.2.147	8
208	Cumulative rateRatio Threshold	Extendable / Clause 8.2.148	4
209	Time Offset Measurement	Extendable / Clause 8.2.149	8
210	Cumulative rateRatio Measurement	Extendable / Clause 8.2.150	4
211	Remove SRR	Extendable/ Table 7.5.4.19-1	Not applicable
212	Create SRR	Extendable/ Table 7.5.2.9-1	Not applicable
213	Update SRR	Extendable/ Table 7.5.4.21-1	Not applicable
214	Session Report	Extendable / Table 7.5.8.7-1	Not Applicable
215	SRR ID	Extendable / Clause 8.2.151	1
216	Access Availability Control Information	Extendable / Table 7.5.2.9-2	Not applicable
217	Requested Access Availability Information	Extendable / Clause 8.2.152	1
218	Access Availability Report	Extendable / Table 7.5.8.6-2	Not applicable
219	Access Availability Information	Extendable / Clause 8.2.153	1
220	Provide ATSSS Control Information	Extendable / Table 7.5.2.10-1	Not Applicable
221	ATSSS Control Parameters	Extendable / Table 7.5.3.7-1	Not Applicable
222	MPTCP Control Information	Extendable / Clause 8.2.154	1
223	ATSSS-LL Control Information	Extendable / Clause 8.2.155	1
224	PMF Control Information	Extendable / Clause 8.2.156	1
225	MPTCP Parameters	Extendable / Table 7.5.3.7-2	Not Applicable
226	ATSSS-LL Parameters	Extendable / Table 7.5.3.7-3	Not Applicable
227	PMF Parameters	Extendable / Table 7.5.3.7-4	Not Applicable
228	MPTCP Address Information	Extendable / Clause 8.2.157	4
229	Link-Specific Multipath IP Address	Extendable / Clause 8.2.158	1
230	PMF Address Information	Extendable / Clause 8.2.159	1
231	ATSSS-LL Information	Extendable / Clause 8.2.160	1
232	Data Network Access Identifier	Variable Length / Clause 8.2.161	Not applicable
233	UE IP address Pool Information	Extendable / Table 7.4.4.1-3	Not Applicable
234	Average Packet Delay	Extendable / Clause 8.2.162	4
235	Minimum Packet Delay	Extendable / Clause 8.2.163	4
236	Maximum Packet Delay	Extendable / Clause 8.2.164	4
237	QoS Report Trigger	Extendable / Clause 8.2.165	1
238	GTP-U Path QoS Control Information	Extendable / Table 7.4.4.1.3-1	Not Applicable

239	GTP-U Path QoS Report (PFCP Node Report Request)	Extendable / Table 7.4.5.1.5-1	Not Applicable
240	QoS Information in GTP-U Path QoS Report	Extendable / Table 7.4.5.1.6-1	Not Applicable
241	GTP-U Path Interface Type	Extendable / Clause 8.2.166	1
242	QoS Monitoring per QoS flow Control Information	Extendable / Table 7.5.2.9-3	Not applicable
243	Requested QoS Monitoring	Extendable / Clause 8.2.167	1
244	Reporting Frequency	Extendable / Clause 8.2.168	1
245	Packet Delay Thresholds	Extendable / Clause 8.2.169	1
246	Minimum Wait Time	Extendable / Clause 8.2.170	4
247	QoS Monitoring Report	Extendable / Table 7.5.8.6-3	Not applicable
248	QoS Monitoring Measurement	Extendable / Clause 8.2.171	1
249	MT-EDT Control Information	Extendable / Clause 8.2.172	1
250	DL Data Packets Size	Extendable / Clause 8.2.173	2
251	QER Control Indications	Extendable / Clause 8.2.174	1
252	Packet Rate Status Report	Extendable / Table 7.5.7.1-2	Not applicable
253	NF Instance ID	Fixed / Clause 8.2.175	16
254	Ethernet Context Information	Extendable / Table 7.5.4.21-1	Not Applicable
255	Redundant Transmission Parameters	Extendable / Table 7.5.2.2-5, Table 7.5.2.3-4	Not Applicable
256	Updated PDR	Extendable / Table 7.5.5.5-1	Not Applicable
257	S-NSSAI	Fixed Length / Clause 8.2.176	4
258	IP version	Extendable / Clause 8.2.177	1
259	PFCPASReq-Flags	Extendable / Clause 8.2.178	1
260	Data Status	Extendable / Clause 8.2.179	1
261	Provide RDS configuration information	Extendable / Table 7.5.2.11-1	Not Applicable
262	RDS configuration information	Extendable / Clause 8.2.180	1
263	Query Packet Rate Status IE within PFCP Session Modification Request	Extendable / Table 7.5.4.22-1	Not Applicable
264	Packet Rate Status Report IE within PFCP Session Modification Response	Extendable / Table 7.5.5.4-1	Not Applicable
265	Multipath Applicable Indication	Extendable / Clause 8.2.181	1
266	User Plane Node Management Information Container	Variable Length / Clause 8.2.182	Not Applicable
267	UE IP Address Usage Information	Extendable / Table 7.4.4.3.1-1	Not Applicable
268	Number of UE IP Addresses	Extendable / Clause 8.2.183	1
269	Validity Timer	Extendable / Clause 8.2.184	2
270	Redundant Transmission Forwarding Parameters	Extendable / Table 7.5.2.3-4	Not Applicable
271	Transport Delay Reporting	Extendable / Table 7.5.2.2-6	Not Applicable
272	Partial Failure Information	Extendable / Table 7.5.3.1-2	Not Applicable
273	Spare		
274	Offending IE Information	Variable Length / Clause 8.2.185	Not Applicable
275	RAT Type	Extendable / Table 8.2.186	1
276	L2TP Tunnel Information	Extendable / Table 7.5.2.1-2	Not Applicable
277	L2TP Session Information	Extendable / Table 7.5.2.1-3	Not Applicable
278	L2TP User Authentication	Extendable / Clause 8.2.187	1
279	Created L2TP Session	Extendable / Table 7.5.3.1-3	Not Applicable
280	LNS Address	Extendable / Clause 8.2.188	4
281	Tunnel Preference	Fixed Length / Clause 8.2.189	3
282	Calling Number	Variable Length / Clause 8.2.190	Not Applicable
283	Called Number	Variable Length / Clause 8.2.191	Not Applicable
284	L2TP Session Indications	Extendable / Clause 8.2.192	1
285	DNS Server Address	Extendable / Clause 8.2.193	4
286	NBNS Server Address	Extendable / Clause 8.2.194	4
287	Maximum Receive Unit	Fixed Length / Clause 8.2.195	2
288	Thresholds	Extendable / Clause 8.2.196	1
289	Steering Mode Indicator	Extendable / Clause 8.2.197	1
290	PFCP Session Change Info	Extendable / Table 7.4.7.1-2	Not Applicable
291	Group ID	Variable Length / Clause 8.2.198	Not Applicable
292	CP IP Address	Variable / Clause 8.2.199	Not Applicable
293	IP Address and Port number Replacement	Extendable / Clause 8.2.200	2
294	DNS Query/Response Filter	Extendable / Clause 8.2.201	2
295	Direct Reporting Information	Extendable / Table 7.5.2.9-4	Not applicable

296	Event Notification URI	Variable Length / Clause 8.2.202	Not Applicable
297	Notification Correlation ID	Variable Length / Clause 8.2.203	Not Applicable
298	Reporting Flags	Extendable / Clause 8.2.204	1
299	Predefined Rules Name	Variable Length / Clause 8.205	Not Applicable
300	MBS Session N4mb Control Information	Extendable / Table 7.5.2.1-4	Not Applicable
301	MBS Multicast Parameters	Extendable / Table 7.5.2.3-5	Not Applicable
302	Add MBS Unicast Parameters	Extendable / Table 7.5.2.3-6	Not Applicable
303	MBS Session N4mb Information	Extendable / Table 7.5.3.1-4	Not Applicable
304	Remove MBS Unicast Parameters	Extendable / Table 7.5.4.3-4	Not Applicable
305	MBS Session Identifier	Extendable Length / Clause 8.2.206	1
306	Multicast Transport Information	Extendable Length / Clause 8.2.207	5
307	MBSN4mbReq-Flags	Extendable Length / Clause 8.2.208	1
308	Local Ingress Tunnel	Extendable / Clause 8.2.209	1
309	MBS Unicast Parameters ID	Extendable / Clause 8.2.210	2
310	MBS Session N4 Control Information	Extendable / Table 7.5.2.1-5	Not Applicable
311	MBS Session N4 Information	Extendable / Table 7.5.3.1-5	Not Applicable
312	MBSN4Resp-Flags	Extendable / Clause 8.2.211	1
313	Tunnel Password	Variable Length / Clause 8.2.212	Not Applicable
314	Area Session ID	Fixed Length / Clause 8.2.213	2
315	Peer UP Restart Report	Extendable / Clause 7.4.5.1.7	Not Applicable
316	DSCP to PPI Control Information	Extendable / Table 7.5.2.1-6	Not Applicable
317	DSCP to PPI Mapping Information	Extendable / Clause 8.2.214	2
318	PFCPSDRsp-Flags	Extendable / Clause 8.2.215	1
319	QER Indications	Extendable / Clause 8.2.216	1
320	Vendor-Specific Node Report Type	Extendable / Clause 8.2.217	3
321	Configured Time Domain	Extendable / Clause 8.2.218	1
322	Metadata	Variable / Clause 8.2.219	Not Applicable
323	Traffic Parameter Measurement Control Information	Extendable / Table 7.5.2.9-5	Not Applicable
324	Traffic Parameter Measurement Report	Extendable / Table 7.5.8.6-4	Not Applicable
325	Traffic Parameter Threshold	Extendable / Clause 8.2.220	1
326	DL Periodicity	Extendable / Clause 8.2.221	5
327	N6 Jitter Measurement	Extendable / Clause 8.2.222	1
328	Traffic Parameter Measurement Indication	Extendable / Clause 8.2.223	1
329	UL Periodicity	Extendable / Clause 8.2.224	5
330	MPQUIC Control Information	Extendable / Clause 8.2.225	1
331	MPQUIC Parameters	Extendable / Table 7.5.3.7-5	Not Applicable
332	MPQUIC Address Information	Extendable / Clause 8.2.226	4
333	Transport Mode	Extendable / Clause 8.2.227	1
334	Protocol Description	Extendable / Table 7.5.2.2-7	Not Applicable
335	Reporting Suggestion Info	Extendable / Clause 8.2.229	1
336	TL-Container	Variable Length / Clause 8.2.230	Not Applicable
337	Measurement Indication	Extendable / Clause 8.2.231	1
338	HPLMN S-NSSAI	Fixed Length / Clause 8.2.232	4
339	Media Transport Protocol	Extendable / Clause 8.2.233	1
340	RTP Header Extension Information	Extendable / Table 7.5.2.2-8	Not Applicable
341	RTP Payload Information	Extendable / Table 7.5.2.2-9	Not Applicable
342	RTP Header Extension Type	Fixed Length / Clause 8.2.234	1
343	RTP Header Extension ID	Fixed Length / Clause 8.2.235	1
344	RTP Payload Type	Fixed Length / Clause 8.2.236	1
345	RTP Payload Format	Fixed Length / Clause 8.2.237	1
346	Extended DL Buffering Notification Policy	Extendable / Clause 8.2.238	1
347	MT-SDT Control Information	Extendable / Clause 8.2.239	1
348	Reporting Thresholds	Extendable / Clause 8.2.240	1
349	RTP Header Extension Additional Information	Extendable / Clause 8.2.241	2
350	Mapped N6 IP Address	Extendable / Clause 8.2.242	1
351	N6 Routing Information	Extendable / Clause 8.2.243	1
352	URI	Variable Length / Clause 8.2.244	Not Applicable
353	UE Level Measurements Configuration	Extendable / Clause 8.2.245	2
354	N6 Delay Measurement Protocols	Extendable / Clause 8.2.246	1

355	N6 Delay Measurement Control Information	Extendable / Table 7.4.4.1.4-1	Not Applicable
356	N6 Delay Measurement Report (PFCP Node Report Request)	Extendable / Table 7.4.5.1.8-1	Not Applicable
357	N6 Delay Measurement Information	Extendable / Clause 8.2.247	1
358	Measurement Endpoint Address	Extendable / Clause 8.2.248	1
359	Operator Configurable UPF Capability	Variable / Clause 8.2.249	Not Applicable
360	Packet Inspection functionality	Extendable / Clause 8.2.250	1
361	Header Handling Control Rule	Extendable / Table 7.5.2.3-7	Not Applicable
362	Header Handling Reporting Control Info	Extendable / Table 7.5.2.3-8	Not Applicable
363	Header Handling Control information	Extendable / Table 7.5.2.3-9	Not Applicable
364	Header Detection Reference	Variable Length / Clause 8.2.251	Not Applicable
365	Header Detection Support Information	Variable Length / Clause 8.2.252	Not Applicable
366	Reporting Endpoint ID	Fixed / Clause 8.2.253	1
367	Header Handling Control Reference	Variable Length / Clause 8.2.254	Not Applicable
368	Header Handling Action	Fixed Length / Clause 8.2.255	1
369	Header Information	Variable Length / Clause 8.2.256	Not Applicable
370	Header Value	Variable Length / Clause 8.2.257	Not Applicable
371	Header Handling Condition	Fixed / Clause 8.2.258	1
372	Header Handling Control ID	Fixed / Clause 8.2.259	1
373	Header Handling Control Rule ID	Fixed / Clause 8.2.260	1
374	On-path N6 Connection Information	Extendable / Clause 8.2.261	1
375	Measurement Reporting Type	Extendable / Clause 8.2.262	1
376	N6 Delay Measurement Failure Information	Extendable / Clause 8.2.263	1
377	N6 Delay Measurement Control Information ID	Fixed / Clause 8.2.264	2
378	Protocol Specific Configuration Parameters	Extendable / Table 7.4.4.1.4-2	1
379	Measurement Endpoint Port Number	Fixed Length / Clause 8.2.265	2
380	Header Handling Reporting Indication	Extendable / Clause 8.2.266	1
381	<i>Can be used</i>		
382	SMF Change Reason	Extendable / Clause 8.2.267	1
383	Extended Transport Level Marking	Extendable / Table 7.5.2.3-10	Not Applicable
384	PDU Set Importance	Fixed / Clause 8.2.268	2
385	MoQ Control Information	Extendable / Clause 8.2.269	1
386	MoQ Information	Extendable / Table 7.3.5.1-6	Not Applicable
387	MoQ Relay IP Address	Extendable / Clause 8.2.270	1
388	Media Related Information Transfer Info	Extendable / Clause 8.2.271	1
389	Reporting Control Information	Extendable / Clause 8.2.272	1
390	Security Mode (STAMP)	Fixed / Clause 8.2.273	1
391	HMAC Key (STAMP)	Variable Length / Clause 8.2.274	Not Applicable
392	Security Mode (OWAMP or TWAMP)	Fixed / Clause 8.2.275	4
393	Key ID and Shared Secret (OWAMP or TWAMP)	Extendable / Clause 8.2.276	1
394	Remaining Data Reporting Indication	Extendable / Clause 8.2.277	1
395	Expedited Transfer Indication	Fixed / Clause 8.2.278	1
396	Session Reflector Mode (STAMP)	Fixed / Clause 8.2.279	1
397	PFD Partial Failure Information	Extendable / Table 7.4.3.2-2	Not Applicable
398	Transport Level Marking Indications	Fixed / Clause 8.2.280	1
399	Redundant N3/N9 Transmission Information	Extendable / Table 7.5.8.6-5	Not Applicable
400	Local N3/N9 Tunnel Information	Extendable / Table 7.5.8.6-6	Not Applicable
401	Remote N3/N9 Tunnel Information	Extendable / Table 7.5.8.6-7	Not Applicable
402 to 32767	Spare. For future use.		
32768 to 65535	Reserved for vendor specific IEs		

8.2 Information Elements

8.2.1 Cause

Cause IE is coded as depicted in Figure 8.2.1-1.

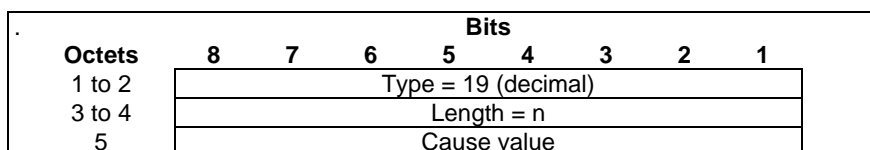

Figure 8.2.1-1: Cause

The Cause value shall be included in a response message. In a response message, the Cause value indicates the acceptance or the rejection of the corresponding request message. The Cause value indicates the explicit reason for the rejection.

Table 8.2.1-1: Cause values

Message Type	Cause value (decimal)	Meaning	Description
	0	Reserved.	Shall not be sent and if received the Cause shall be treated as an invalid IE
Acceptance in a response	1	Request accepted (success)	"Request accepted (success)" is returned when the PFCP entity has accepted a request.
	2	More Usage Report to send	This cause shall be returned by the UP function in the PFCP Session Deletion Response message when it has more usage reports to send. (See clause 5.2.2.3.1)
	3	Request partially accepted	This cause shall be returned if the PSUCC feature is supported by the CP function and the UP function, when a PFCP Session Establishment Request or PFCP Session Modification Request is partially accepted. See clause 5.2.9. This cause shall be returned if the PAPFD feature is supported by the CP function and the UP function, when a subset of Application ID's PFDs included in the PFCP PFD Management Request message are accepted. See clause 5.42.
	4-63	Spare.	This value range shall be used by Cause values in an acceptance response message. See NOTE 1.
Rejection in a response	64	Request rejected (reason not specified)	This cause shall be returned to report an unspecified rejection cause
	65	Session context not found	This cause shall be returned, if the F-SEID included in a PFCP Session Modification/Deletion Request message is unknown.
	66	Mandatory IE missing	This cause shall be returned when the PFCP entity detects that a Mandatory IE is missing in a request message
	67	Conditional IE missing	This cause shall be returned when the PFCP entity detects that a Conditional IE is missing in a request message.
	68	Invalid length	This cause shall be returned when the PFCP entity detects that an IE with an invalid length in a request message
	69	Mandatory IE incorrect	This cause shall be returned when the PFCP entity detects that a Mandatory IE is incorrect in a request message, e.g. the Mandatory IE is malformed or it carries an invalid or unexpected value.
	70	Invalid Forwarding Policy	This cause shall be used by the UP function in the PFCP Session Establishment Response or PFCP Session Modification Response message if the CP function attempted to provision a FAR with a Forwarding Policy Identifier for which no Forwarding Policy is locally configured in the UP function.

71	Invalid F-TEID allocation option	This cause shall be used by the UP function in the PFCP Session Establishment Response or PFCP Session Modification Response message if the CP function attempted to provision a PDR with a F-TEID allocation option which is incompatible with the F-TEID allocation option used for already created PDRs (by the same or a different CP function) and the Restoration Indication bit was not set to "1" in the request.
72	No established PFCP Association	This cause shall be used by the CP function or the UP function if they receive a PFCP message other than the PFCP Association Setup Request and the Heartbeat Request message from a peer with which there is no established PFCP Association.
73	Rule creation/modification Failure	This cause shall be used by the UP function if a received Rule failed to be stored and be applied in the UP function.
74	PFCP entity in congestion	This cause shall be returned when a PFCP entity has detected node level congestion and performs overload control, which does not allow the request to be processed.
75	No resources available	This cause shall be returned to indicate a temporary unavailability of resources to process the received request. This cause may also be returned in Partial Failure Information to report that a rule cannot be applied due to a limitation of resources in the UP function.
76	Service not supported	This cause shall be returned when a PFCP entity receives a message requesting a feature or service that is not supported.
77	System failure	This cause shall be returned to indicate a system error condition.
78	Redirection Requested	This cause may be returned to indicate a request to the UPF to redirect its PFCP request to a different SMF.
79	All dynamic addresses are occupied	This cause may be returned if the UE IP address is to be assigned by the UP function but all UE IP addresses configured for a given Network Instance and/or IP address pool in the UP function are occupied.
80	Unknown Pre-defined Rule	This cause may be returned in Partial Failure Information to report that a pre-defined rule cannot be applied since being unknown to the UP function.
81	Unknown Application ID	This cause may be returned in Partial Failure Information to report that a rule cannot be applied due to the Application ID being unknown by the UP function.
82	L2TP tunnel Establishment failure	This cause shall be returned if the UP function detects an L2TP tunnel failure in the PFCP Session Establishment Response other than those defined for the cause values 87 and 89.
83	L2TP session Establishment failure	This cause shall be returned if the UP function detects an L2TP session failure in the PFCP Session Establishment Response other than the one defined for the cause value 88.
84	L2TP tunnel release	This cause may be returned by the UP function when the L2TP tunnel is released, e.g. in a PFCP Session Report Request message to delete the PFCP session if the corresponding L2TP session is terminated since to the LNS initiated the release of the L2TP tunnel or the LNS is failed. See clause 5.31.3.
85	L2TP session release	This cause may be returned by the UP function when the L2TP session is released, e.g. in a PFCP Session Report Request message to delete the PFCP session if the corresponding L2TP session is terminated since the LNS initiated the release of the L2TP session. See clause 5.31.3.
86	PFCP session restoration failure due to requested resource not available	This cause should be returned by: <ul style="list-style-type: none"> - the UP function when the CP function requests the UP function to re-establish an existing PFCP session (i.e. the Restoration Indication bit set to

			<p>"1" in the request) but the GTP-U F-TEID or UE IP address provided by the CP function is not available. See clauses 4.3.2 and 4.3.4 of 3GPP TS 23.527 [40].</p> <ul style="list-style-type: none"> - the MB-UPF when the MB-SMF requests the MB-UPF to re-establish an existing PFCP session (i.e. the MBS Restoration Indication bit is set to "1" in the request) but the N3mb/N19mb LL SSM address or N6mb/Nmb9 ingress tunnel address provided by the MB-SMF is not available. See clause 8.2.2 of 3GPP TS 23.527 [40]. <p>The resource is not available means that it cannot be assigned to any PFCP session, due to e.g. the address having been decommissioned by OAM from the (MB-)UPF or e.g. the address being no longer operational due to a partial hardware failure at the (MB-)UPF.</p>
87	L2TP tunnel Establishment failure – Tunnel Auth Failure		This cause shall be returned if the UP function detects an L2TP tunnel failure due to tunnel authentication failure in the PFCP Session Establishment Response.
88	L2TP Session Establishment failure – Session Auth Failure		This cause shall be returned if the UP function detects an L2TP session establishment failure due to authentication failure in the PFCP Session Establishment Response.
89	L2TP tunnel Establishment failure – LNS not reachable		This cause shall be returned if the UP function detects an L2TP tunnel failure due to LNS not reachable in the PFCP Session Establishment Response.
90	PFD Contents Syntax Error		This cause may be returned in PFD Partial Failure Information to report that an application id's PFDs cannot be installed due to a syntax error in PFD Contents.
91	PFD Contents Semantics Error		This cause may be returned in PFD Partial Failure Information to report that an application id's PFDs cannot be installed due to a semantics error in PFD Contents, e.g. different properties included PFD Contents are mutual exclusive, which leads to impossible to match incoming packets.
92	PFD Application Id Unknown		This cause may be returned in PFD Partial Failure Information to report that an application id's PFDs can not be removed due to an unknown application id. This will help the SMF to know there is a mismatch between the SMF and the UPF.
93 to 255	Spare for future use in a response message. See NOTE 2.		This value range shall be used by Cause values in a rejection response message. See NOTE 2.
<p>NOTE 1: This value is or may be used in future version of the specification. If the receiver cannot comprehend the value, it shall be interpreted as an unspecified acceptance cause. Unspecified/unrecognized acceptance cause shall be treated in the same ways as the cause value 1 "Request accepted (success)".</p> <p>NOTE 2: This value is or may be used in a future version of the specification. If the receiver cannot comprehend the value, it shall be interpreted as an unspecified rejection cause. Unspecified/unrecognized rejection cause shall be treated in the same ways as the cause value 64 "Request rejected (reason not specified)".</p>			

8.2.2 Source Interface

The Source Interface IE type shall be encoded as shown in Figure 8.2.2-1. It indicates the type of the interface from which an incoming packet is received.

Octets	Bits						
	8	7	6	5	4	3	2
1 to 2	Type = 20 (decimal)						
3 to 4	Length = n						
5	Spare			Interface value			
6 to (n+4)	These octet(s) is/are present only if explicitly specified						

Figure 8.2.2-1: Source Interface

The Interface value shall be encoded as a 4 bits binary integer as specified in in Table 8.2.2-1.

Table 8.2.2-1: Interface value

Interface value	Values (Decimal)
Access	0
Core	1
SGi-LAN/N6-LAN	2
CP-function	3
5G VN Internal	4
Spare	5 to 15

NOTE 1: The "Access" and "Core" values denote an uplink and downlink traffic direction respectively.

NOTE 2: For indirect data forwarding, the Source Interface in the PDR and the Destination Interface in the FAR shall both be set to "Access", in the forwarding SGW(s). The Interface value does not infer any traffic direction, in PDRs and FARs set up for indirect data forwarding, i.e. with both the Source and Destination Interfaces set to Access.

8.2.3 F-TEID

The F-TEID IE type shall be encoded as shown in Figure 8.2.3-1. It indicates an F-TEID.

Octets	Bits							
	8	7	6	5	4	3	2	1
1 to 2	Type = 21 (decimal)							
3 to 4	Length = n							
5	Spare			CHID	CH	V6	V4	
6 to 9	TEID							
m to (m+3)	IPv4 address							
p to (p+15)	IPv6 address							
q	CHOOSE ID							
k to (n+4)	These octet(s) is/are present only if explicitly specified							

Figure 8.2.3-1: F-TEID

The following flags are coded within Octet 5:

- Bit 1 – V4: If this bit is set to "1" and the CH bit is not set, then the IPv4 address field shall be present, otherwise the IPv4 address field shall not be present.
- Bit 2 – V6: If this bit is set to "1" and the CH bit is not set, then the IPv6 address field shall be present, otherwise the IPv6 address field shall not be present.
- Bit 3 – CH (CHOOSE): If this bit is set to "1", then the TEID, IPv4 address and IPv6 address fields shall not be present and the UP function shall assign an F-TEID with an IP4 or an IPv6 address if the V4 or V6 bit is set respectively. This bit shall only be set by the CP function.
- Bit 4 – CHID (CHOOSE ID): If this bit is set to "1", then the UP function shall assign the same F-TEID to the PDRs requested to be created in a PFCP Session Establishment Request or PFCP Session Modification Request

with the same CHOOSE ID value. This bit may only be set to "1" if the CH bit is set to "1". This bit shall only be set by the CP function.

- Bit 5 to 8: Spare, for future use and set to "0".

At least one of the V4 and V6 flags shall be set to "1", and both may be set to "1" for both scenarios:

- when the CP function is providing F-TEID, i.e. both IPv4 address field and IPv6 address field may be present; or
- when the UP function is requested to allocate the F-TEID, i.e. when CHOOSE bit is set to "1", and the IPv4 address and IPv6 address fields are not present.

Octet 6 to 9 (TEID) shall be present and shall contain a GTP-U TEID, if the CH bit in octet 5 is not set. When the TEID is present, if both IPv4 and IPv6 addresses are present in the F-TEID IE, then the TEID value shall be shared by both addresses.

Octets "m to (m+3)" and/or "p to (p+15)" (IPv4 address / IPv6 address fields), if present, it shall contain the respective IP address values.

Octet q shall be present and shall contain a binary integer value if the CHID bit in octet 5 is set to "1".

8.2.4 Network Instance

The Network Instance IE type shall be encoded as shown in Figure 8.2.4-1. It indicates a Network instance.

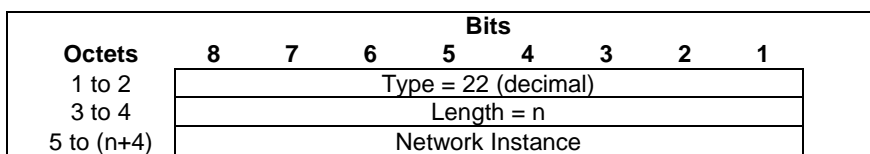

Figure 8.2.4-1: Network Instance

The Network instance field shall be encoded as an OctetString and shall contain an identifier which uniquely identifies a particular Network instance (e.g. PDN instance) in the UP function. It may be encoded as a Domain Name or an Access Point Name (APN) as per clause 9.1 of 3GPP TS 23.003 [2]. In the latter case, the PDN Instance field may contain the APN Network Identifier only or the full APN with both the APN Network Identifier and the APN Operator Identifier as specified in 3GPP TS 23.003 [2] clauses 9.1.1 and 9.1.2.

NOTE: The APN field is not encoded as a dotted string as commonly used in documentation.

8.2.5 SDF Filter

The SDF Filter IE type shall be encoded as shown in Figure 8.2.5-1. It contains an SDF Filter, i.e. a single IP flow packet filter.

Octets	Bits						
	8	7	6	5	4	3	2
1 to 2	Type = 23 (decimal)						
3 to 4	Length = n						
5	Spare	SMMII	BID	FL	SPI	TTC	FD
6	Spare						
m to (m+1)	Length of Flow Description						
(m+2) to p	Flow Description						
s to (s+1)	ToS Traffic Class						
t to (t+3)	Security Parameter Index						
v to (v+2)	Flow Label						
w to (w+3)	SDF Filter ID						
a	Number of (S)RTP Multiplexed Media Identification Information instances						
b to (b+1)	Length of (S)RTP Multiplexed Media Identification Information 1						
(b+2) to c	(S)RTP Multiplexed Media Identification Information 1						
...	...						
...	...						
d to (d+1)	Length of (S)RTP Multiplexed Media Identification Information n						
(d+2) to e	(S)RTP Multiplexed Media Identification Information n						
x to (n+4)	These octet(s) is/are present only if explicitly specified						

Figure 8.2.5-1: SDF Filter

The following flags are coded within Octet 5:

- Bit 1 – FD (Flow Description): If this bit is set to "1", then the Length of Flow Description and the Flow Description fields shall be present, otherwise they shall not be present.
- Bit 2 – TTC (ToS Traffic Class): If this bit is set to "1", then the ToS Traffic Class field shall be present, otherwise the ToS Traffic Class field shall not be present.
- Bit 3 – SPI (Security Parameter Index): If this bit is set to "1", then the Security Parameter Index field shall be present, otherwise the Security Parameter Index field shall not be present.
- Bit 4 – FL (Flow Label): If this bit is set to "1", then the Flow Label field shall be present, otherwise the Flow Label field shall not be present.
- Bit 5 – BID (Bidirectional SDF Filter): If this bit is set to "1", then the SDF Filter ID shall be present, otherwise the SDF Filter ID shall not be present.
- Bit 6 – SMMII (S(RTP) Multiplexed Media Identification Information): If this bit is set to "1", then the Number of (S)RTP Multiplexed Media Identification Information, the Length of (S)RTP Multiplexed Media Identification Information and the (S)RTP Multiplexed Media Identification Information fields shall be present, otherwise they shall not be present.
- Bit 7 to 8: Spare, for future use and set to "0".

The Flow Description field, when present, shall be encoded as an OctetString as specified in clause 5.4.2 of 3GPP TS 29.212 [8].

The ToS Traffic Class field, when present, shall be encoded as an OctetString on two octets as specified in clause 5.3.15 of 3GPP TS 29.212 [8]. The ToS/Traffic Class mask field may be set to detect packets with a specific DSCP value (e.g. "0xFC"), or with specific ECN bits (e.g. "0x03") or both (e.g. "0xFF").

The Security Parameter Index field, when present, shall be encoded as an OctetString on four octets and shall contain the IPsec security parameter index (which is a 32-bit field), as specified in clause 5.3.51 of 3GPP TS 29.212 [8].

The Flow Label field, when present, shall be encoded as an OctetString on 3 octets as specified in clause 5.3.52 of 3GPP TS 29.212 [8] and shall contain an IPv6 flow label (which is a 20-bit field). The bits 8 to 5 of the octet "v" shall be spare and set to zero, and the remaining 20 bits shall contain the IPv6 flow label.

An SDF Filter may:

- be a pattern for matching the IP 5 tuple (source IP address or IPv6 network prefix, destination IP address or IPv6 network prefix, source port number, destination port number, protocol ID of the protocol above IP). In the pattern:
 - a value left unspecified in a filter matches any value of the corresponding information in a packet;
 - an IP address may be combined with a prefix mask;
 - port numbers may be specified as port ranges;
 - the pattern can be extended by the Type of Service (TOS) (IPv4) / Traffic class (IPv6) and Mask;
- consist of the destination IP address and optional mask, protocol ID of the protocol above IP, the Type of Service (TOS) (IPv4) / Traffic class (IPv6) and Mask and the IPsec Security Parameter Index (SPI);
- consist of the destination IP address and optional mask, the Type of Service (TOS) (IPv4) / Traffic class (IPv6) and Mask and the Flow Label (IPv6);

NOTE 1: The details about the IPsec Security Parameter Index (SPI), the Type of Service (TOS) (IPv4) / Traffic class (IPv6) and Mask and the Flow Label (IPv6) are defined in 3GPP TS 23.060 [19] clause 15.3.

- extend the packet inspection beyond the possibilities described above and look further into the packet. Such service data flow filters need to be predefined in the PGW-U, as specified in clause 5.11 of 3GPP TS 23.214 [2];

NOTE 2: Such filters may be used to support filtering with respect to a service data flow based on the transport and application protocols used above IP, e.g. for HTTP and WAP. Filtering for further application protocols and services can also be supported.

- comprise (S)RTP Multiplexed Media Identification Information to identify different media flows that are transported in (S)RTP, or the (S)RTCP that controls the (S)RTP transmission, when (S)RTP, (S)RTCP and other associated protocols are multiplexed into a single IP traffic flow, as further described below.

The SDF Filter ID, when present, shall be encoded as an Unsigned32 binary integer value. It shall uniquely identify an SDF Filter among all the SDF Filters provisioned for a given PCF Session. The source/destination IP address and port information, in a bidirectional SDF Filter, shall be set as for downlink IP flows. The SDF filter for the opposite direction has the same parameters, but having the source and destination address/port parameters swapped. When being provisioned with a bidirectional SDF filter in a PDR, the UP function shall apply the SDF filter as specified in clause 5.2.1A.2A.

The Number of (S)RTP Multiplexed Media Identification Information field shall indicate the number of (S)RTP Multiplexed Media Identification Information instances (and related Length of (S)RTP Multiplexed Media Identification Information) included in the SDF Filter IE, as an integer greater or equal to 1.

When present, the (S)RTP Multiplexed Media Identification Information field shall be encoded as defined in Figure 8.2.5-2.

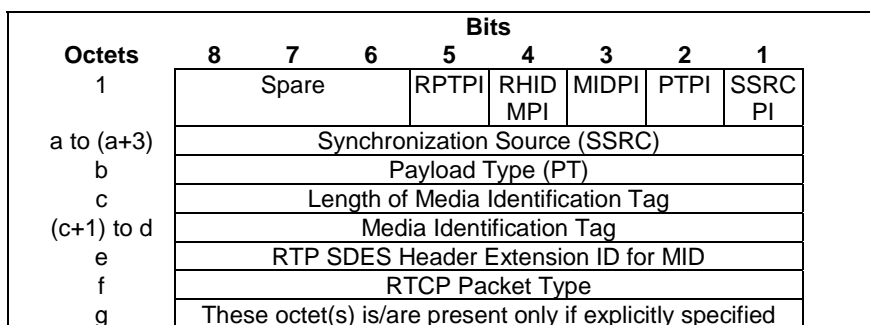

Figure 8.2.5-2: (S)RTP Multiplexed Media Identification Information

The following flags are coded within Octet 1:

- Bit 1 – SSRCPI (SSRC Presence Indicator): If this bit is set to "1", then the Synchronization Source (SSRC) field shall be present, otherwise this field shall not be present.

- Bit 2 – PTPI (Payload Type Presence Indicator): If this bit is set to "1", then the Payload Type (PT) field shall be present, otherwise this field shall not be present.
- Bit 3 – MIDPI (Media Identification Tag Presence Indicator): If this bit is set to "1", then the Length of the Media Identification Tag field and the Media Identification Tag field shall be present, otherwise these fields shall not be present.
- Bit 4 – RHIDMPI (RTP SDES Header Extension ID for MID Presence Indicator): If this bit is set to "1", then the RTP SDES Header Extension ID for MID field shall be present, otherwise this field shall not be present. This flag shall be set to "1" if the MIDPI flag is set to "1" and the RPTPI flag is not set to "1".

NOTE 3: The RTP SDES Header Extension ID for MID needs to be provided if the Media Identification tag is provided and the (S)RTP Multiplexed Media Identification Information applies to RTP traffic only or to both RTP and RTCP traffic.

- Bit 5 – RPTPI (RTCP Packet Type Presence Indicator): If this bit is set to "1", then the RTCP Packet Type field shall be present, otherwise this field shall not be present.
- Bit 6 to 8 are spare and reserved for future use, shall be set to "0" by the sender and discarded by the receiver.

The Synchronization Source (SSRC) field shall be encoded as a 32-bit identifier set to the synchronization source identifier as specified in IETF RFC 3550 [82] and IETF RFC 8872 [93].

The Payload Type (PT) field shall encode the (S)RTP payload type as an integer between (and including) 0 and 127 as specified in IETF RFC 3550 [71].

The Media Identification Tag field shall encode the Identification tag of the RTCP MID SDES item or of the RTP SDES header extension for MID (see IETF RFC 9143 [94]) assigned to the media stream for RTCP or RTP respectively. The Length of the Media Identification Tag field shall encode the length of the identification tag. The RTP SDES Header Extension ID for MID field shall encode the ID of the RTP SDES header extension for MID which contains the Identification tag as defined in IETF RFC 9143 [94], as a decimal value in the range 1 to 255 (see IETF RFC 8285 [86]).

The RTCP Packet Type field shall encode the RTCP packet type as an unsigned 8-bit integer (see IETF RFC 3550 [82]).

An (S)RTP multiplexed media identification information entry applicable to both (S)RTP and (S)RTCP traffic shall contain:

- the SSRC field; and/or
- the Media Identification Tag field and RTP SDES Header Extension ID for MID field.

An (S)RTP multiplexed media identification information instance applicable to (S)RTCP traffic only shall contain:

- the RTCP packet type field; and
- at least one of the SSRC field and the Media Identification Tag field.

An (S)RTP multiplexed media identification information entry applicable to (S)RTP traffic only shall contain:

- the Payload Type field; and

it may contain:

- the SSRC field; and/or
- the Media Identification Tag field and RTP SDES Header Extension ID for MID field.

If the SDF Filter contains one or more (S)RTP Multiplexed Media Identification Information instances, a user plane packet shall be considered to match the SDF Filter if it matches (at least) one (S)RTP Multiplexed Media Identification Information instance, and the other parameters of the SDF filter information.

A user plane packet shall be considered to match one (S)RTP Multiplexed Media Identification Information instance, if it matches all the components present in the (S)RTP Multiplexed Media Identification Information.

NOTE 4: An (S)RTP Multiplexed Media Identification Information instance can match (S)RTCP packets only (if the instance contains the RTCP Packet Type), (S)RTP packets only (if the instance contains the Payload Type), or both (S)RTP and (S)RTCP packets (if the instance contains neither the RTCP Packet Type nor the Payload Type).

NOTE 5: As specified in IETF RFC 5761 [90], RTP/RTCP endpoints that multiplex (S)RTP and (S)RTCP into the same IP traffic flow are expected to use RTP payload types (and RTP payload types plus 128) and RTCP packet type values which do not overlap. See also clause 9.11.4.13 of 3GPP TS 24.501 [105].

Multiple instances of (S)RTP Multiplexed Media Identification Information should not overlap each other in a same SDF Filter. For instance, an SDF Filter may contain a first (S)RTP Multiplexed Media Identification Information instance for RTCP traffic containing "SSRC 1" and an RTCP Packet Type, and a second (S)RTP Multiplexed Media Identification Information instance for RTP traffic containing "SSRC 1" and a PT, but should not contain the first aforementioned instance (for RTCP traffic) with a second instance that would only contain "SSRC 1" since the second instance would then be used for matching RTP and RTCP traffic and would match all RTCP packets with "SSRC 1" regardless of the RTCP packet type (thus overlapping with the first instance applying to "SSRC 1" and a specific RTCP Packet Type).

When an IP traffic flow is multiplexed with different media flows that are transported in (S)RTP, or (S)RTCP that controls the (S)RTP transmission, and different QoS handling requirements need to be applied for (S)RTP and (S)RTCP packets for the media flows from the same SSRC, the SMF may provision different PDRs with different precedence where e.g., the PDR with higher precedence contains a SDF Filter with the (S)RTP Multiplexed Media Identification Information having an SSRC and RTCP Packet Type(s) to match the RTCP packets from the SSRC (with the RTCP Packet Types to be matched), and the PDR with lower precedence contains a SDF Filter with the (S)RTP Multiplexed Media Identification Information having an SSRC only to match the RTP packets from the SSRC.

8.2.6 Application ID

The Application ID IE type shall be encoded as shown in Figure 8.2.6-1. It contains an Application Identifier referencing an application detection filter in the UP function (e.g. its value may represent an application such as a list of URLs).

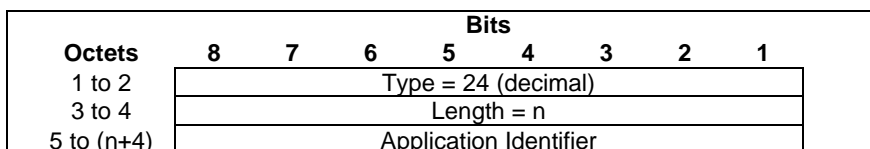

Figure 8.2.6-1: Application ID

The Application Identifier shall be encoded as an OctetString (see 3GPP TS 29.212 [8]).

8.2.7 Gate Status

The Gate Status IE shall be encoded as shown in Figure 8.2.7-1. It indicates whether the service data flow or application's traffic is allowed to be forwarded (gate is open) or shall be discarded (gate is closed) in uplink and/or in downlink direction.

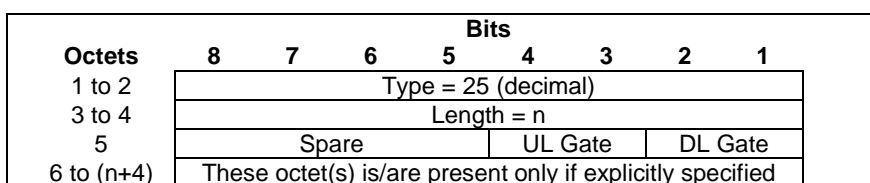

Figure 8.2.7-1: Gate Status

Table 8.2.7-1: UL Gate

UL Gate	Value (Decimal)
OPEN	0
CLOSED	1
For future use. Shall not be sent. If received, shall be interpreted as the value "1".	2, 3

Table 8.2.7-2: DL Gate

DL Gate	Value (Decimal)
OPEN	0
CLOSED	1
For future use. Shall not be sent. If received, shall be interpreted as the value "1".	2, 3

8.2.8 MBR

The MBR IE type shall be encoded as shown in Figure 8.2.8-1. It indicates the maximum bit rate allowed for the uplink and downlink directions.

Octets	Bits							
	8	7	6	5	4	3	2	1
1 to 2	Type = 26 (decimal)							
3 to 4	Length = n							
5 to 9	UL MBR							
10 to 14	DL MBR							
15 to (n+4)	These octet(s) is/are present only if explicitly specified							

Figure 8.2.8-1: MBR

The UL/DL MBR fields shall be encoded as kilobits per second (1 kbps = 1000 bps) in binary value. The UL/DL MBR fields may require converting values in bits per second to kilobits per second when the UL/DL MBR values are received from an interface other than GTPv2 interface. If such conversions result in fractions, then the value of UL/DL MBR fields shall be rounded upwards. The range of UL/DL MBR is specified in 3GPP TS 36.413 [10].

NOTE: The encoding is aligned on the encoding specified in 3GPP TS 29.274 [9].

8.2.9 GBR

The GBR IE type shall be encoded as shown in Figure 8.2.9-1. It indicates the guaranteed bit rate authorized for the uplink and/or downlink directions.

Octets	Bits							
	8	7	6	5	4	3	2	1
1 to 2	Type = 27 (decimal)							
3 to 4	Length = n							
5 to 9	UL GBR							
10 to 14	DL GBR							
15 to (n+4)	These octet(s) is/are present only if explicitly specified							

Figure 8.2.9-1: GBR

The UL/DL GBR fields shall be encoded as kilobits per second (1 kbps = 1000 bps) in binary value. The UL/DL GBR fields may require converting values in bits per second to kilobits per second when the UL/DL GBR values are received from an interface other than GTPv2 interface. If such conversions result in fractions, then the value of UL/DL GBR fields shall be rounded upwards. The range of UL/DL GBR is specified in 3GPP TS 36.413 [10].

NOTE: The encoding is aligned on the encoding specified in 3GPP TS 29.274 [9].

8.2.10 QER Correlation ID

The QER Correlation ID IE type shall be encoded as shown in Figure 8.2.10-1. It contains a QoS Enforcement Rule Correlation ID to correlate QERs from different PFCP sessions. The QER Correlation ID shall be dynamically assigned by the CP function and provisioned by the CP function in different PFCP sessions to correlate QERs used in these PFCP sessions.

NOTE: A QER Correlation ID is not a Rule ID. It is only a correlation number to correlate QERs from different PFCP sessions.

Octets	Bits							
	8	7	6	5	4	3	2	1
1 to 2	Type = 28 (decimal)							
3 to 4	Length = n							
5 to 8	QER Correlation ID value							
9 to (n+4)	These octet(s) is/are present only if explicitly specified							

Figure 8.2.10-1: QER Correlation ID

The QER Correlation ID value shall be encoded as an Unsigned32 binary integer value.

8.2.11 Precedence

The Precedence IE type shall be encoded as shown in Figure 8.2.11-1. It defines the relative precedence of a PDR among all the PDRs provisioned within a PFCP session, when looking for a PDR matching an incoming packet.

Octets	Bits							
	8	7	6	5	4	3	2	1
1 to 2	Type = 29 (decimal)							
3 to 4	Length = n							
5 to 8	Precedence value							
9 to (n+4)	These octet(s) is/are present only if explicitly specified							

Figure 8.2.11-1: Precedence

The Precedence value shall be encoded as an Unsigned32 binary integer value. The lower precedence values indicate higher precedence of the PDR, and the higher precedence values indicate lower precedence of the PDR when matching a packet.

8.2.12 Transport Level Marking

The Transport Level Marking IE type shall be encoded as shown in Figure 8.2.12-1. It indicates the DSCP to be used for UL/DL transport level marking.

Octets	Bits							
	8	7	6	5	4	3	2	1
1 to 2	Type = 30 (decimal)							
3 to 4	Length = n							
5 to 6	ToS/Traffic Class							
7 to (n+4)	These octet(s) is/are present only if explicitly specified							

Figure 8.2.12-1: Transport Level Marking

The ToS/Traffic Class shall be encoded on two octets as an OctetString. The first octet shall contain the DSCP value in the IPv4 Type-of-Service or the IPv6 Traffic-Class field and the second octet shall contain the ToS/Traffic Class mask field, which shall be set to "0xFC". See clause 5.3.15 of 3GPP TS 29.212 [8].

NOTE: The original ECN bits in the IP header of user plane packets are not changed after applying transport level marking.

8.2.13 Volume Threshold

The Volume Threshold IE contains the traffic volume thresholds to be monitored by the UP function. It shall be encoded as shown in Figure 8.2.13-1.

Octets	Bits							
	8	7	6	5	4	3	2	1
1 to 2	Type = 31 (decimal)							
3 to 4	Length = n							
5	Spare			DLVO	ULVO	TOVO		
				L	L	L		
m to (m+7)	Total Volume							
p to (p+7)	Uplink Volume							
q to (q+7)	Downlink Volume							
s to (n+4)	These octet(s) is/are present only if explicitly specified							

Figure 8.2.13-1: Volume Threshold

The following flags are coded within Octet 5:

- Bit 1 – TOVOL: If this bit is set to "1", then the Total Volume field shall be present, otherwise the Total Volume field shall not be present.
- Bit 2 – ULVOL: If this bit is set to "1", then the Uplink Volume field shall be present, otherwise the Uplink Volume field shall not be present.
- Bit 3 – DLVOL: If this bit is set to "1", then the Downlink Volume field shall be present, otherwise the Downlink Volume field shall not be present.
- Bit 4 to 8: Spare, for future use and set to "0".

At least one bit shall be set to "1". Several bits may be set to "1".

The Total Volume, Uplink Volume and Downlink Volume fields shall be encoded as an Unsigned64 binary integer value. They shall contain the total, uplink or downlink number of octets respectively.

8.2.14 Time Threshold

The Time Threshold IE contains the traffic duration threshold to be monitored by the UP function. It shall be encoded as shown in Figure 8.2.14-1.

Octets	Bits						
	8	7	6	5	4	3	2
1 to 2	Type = 32 (decimal)						
3 to 4	Length = n						
5 to 8	Time Threshold						
9 to (n+4)	These octet(s) is/are present only if explicitly specified						

Figure 8.2.14-1: Time Threshold

The Time Threshold field shall be encoded as an Unsigned32 binary integer value. It shall contain the duration in seconds.

8.2.15 Monitoring Time

The Monitoring Time IE indicates the time at which the UP function is expected to reapply the thresholds. It shall be encoded as shown in Figure 8.2.15-1.

Octets	Bits						
	8	7	6	5	4	3	2
1 to 2	Type = 33 (decimal)						
3 to 4	Length = n						
5 to 8	Monitoring Time						
9 to (n+4)	These octet(s) is/are present only if explicitly specified						

Figure 8.2.15-1: Monitoring Time

The Monitoring Time field shall indicate the monitoring time in UTC time. Octets 5 to 8 shall be encoded in the same format as the first four octets of the 64-bit timestamp format as defined in clause 6 of IETF RFC 5905 [12].

NOTE: The encoding is defined as the time in seconds relative to 00:00:00 on 1 January 1900 during the era 0, which includes dates from the prime epoch, i.e. 00:00:00 on 1 January 1900, to 06:28:15 on 7th of February 2036, or relative to 06:28:16 on 7th of February 2036 when the date enters the era 1. See also clause 6 of IETF RFC 5905 [12].

8.2.16 Subsequent Volume Threshold

The Subsequent Volume Threshold IE contains the subsequent traffic volume thresholds to be monitored by the UP function after the Monitoring Time. It shall be encoded as shown in Figure 8.2.16-1.

Octets	Bits							
	8	7	6	5	4	3	2	1
1 to 2	Type = 34 (decimal)							
3 to 4	Length = n							
5	Spare			DLVO	ULVO	TOVO		
				L	L	L		
m to (m+7)	Total Volume							
p to (p+7)	Uplink Volume							
q to (q+7)	Downlink Volume							
s to (n+4)	These octet(s) is/are present only if explicitly specified							

Figure 8.2.16-1: Subsequent Volume Threshold

The following flags are coded within Octet 5:

- Bit 1 – TOVOL: If this bit is set to "1", then the Total Volume field shall be present, otherwise the Total Volume field shall not be present.
- Bit 2 – ULVOL: If this bit is set to "1", then the Uplink Volume field shall be present, otherwise the Uplink Volume field shall not be present.
- Bit 3 – DLVOL: If this bit is set to "1", then the Downlink Volume field shall be present, otherwise the Downlink Volume field shall not be present.
- Bit 4 to 8: Spare, for future use and set to "0".

At least one bit shall be set to "1". Several bits may be set to "1".

The Total Volume, Uplink Volume and Downlink Volume fields shall be encoded as an Unsigned64 binary integer value. They shall contain the total, uplink or downlink number of octets respectively.

8.2.17 Subsequent Time Threshold

The Subsequent Time Threshold IE contains the subsequent traffic duration threshold to be monitored by the UP function after the Monitoring Time. It shall be encoded as shown in Figure 8.2.17-1.

Octets	Bits							
	8	7	6	5	4	3	2	1
1 to 2	Type = 35 (decimal)							
3 to 4	Length = n							
5 to 8	Subsequent Time Threshold							
9 to (n+4)	These octet(s) is/are present only if explicitly specified							

Figure 8.2.17-1: Subsequent Time Threshold

The Subsequent Time Threshold field shall be encoded as an Unsigned32 binary integer value. It shall contain the duration in seconds.

8.2.18 Inactivity Detection Time

The Inactivity Detection Time IE contains the inactivity time period, in seconds, to be monitored by the UP function. It shall be encoded as shown in Figure 8.2.18-1.

Octets	Bits							
	8	7	6	5	4	3	2	1
1 to 2	Type = 36 (decimal)							
3 to 4	Length = n							
5 to 8	Inactivity Detection Time							
9 to (n+4)	These octet(s) is/are present only if explicitly specified							

Figure 8.2.18-1: Inactivity Detection Time

The Inactivity Detection Time field shall be encoded as an Unsigned32 binary integer value.

8.2.19 Reporting Triggers

The Reporting Triggers IE shall be encoded as shown in Figure 8.2.19-1. It indicates the reporting trigger(s) for the UP function to send a report to the CP function.

Octets	Bits							
	8	7	6	5	4	3	2	1
1 to 2	Type = 37 (decimal)							
3 to 4	Length = n							
5	LIUSA	DROT	STOP	STAR	QUHT	TIMT	VOLT	PERI
6	QVVT	IPMJL	EVEQ	EVET	MACA	ENVC	TIMQ	VOLQ
7	I	H	U	H	R	L	U	U
8 to (n+4)	Spare	Spare	Spare	Spare	Spare	Spare	UPIN	REEM
							T	R
	These octet(s) is/are present only if explicitly specified							

Figure 8.2.19-1: Reporting Triggers

Octet 5 shall be encoded as follows:

- Bit 1 – PERIO (Periodic Reporting): when set to "1", this indicates a request for periodic reporting.
- Bit 2 – VOLTH (Volume Threshold): when set to "1", this indicates a request for reporting when the data volume usage reaches a volume threshold
- Bit 3 – TIMTH (Time Threshold): when set to "1", this indicates a request for reporting when the time usage reaches a time threshold.
- Bit 4 – QUHTI (Quota Holding Time): when set to "1", this indicates a request for reporting when no packets have been received for a period exceeding the Quota Holding Time.

- Bit 5 – START (Start of Traffic): when set to "1", this indicates a request for reporting when detecting the start of an SDF or Application traffic.
- Bit 6 – STOPT (Stop of Traffic): when set to "1", this indicates a request for reporting when detecting the stop of an SDF or Application Traffic.
- Bit 7 - DROTH (Dropped DL Traffic Threshold): when set to "1", this indicates a request for reporting when the DL traffic being dropped reaches a threshold.
- Bit 8: - LIUSA (Linked Usage Reporting): when set to "1", this indicates a request for linked usage reporting, i.e. a request for reporting a usage report for a URR when a usage report is reported for a linked URR (see clause 5.2.2.4).

Octet 6 shall be encoded as follows:

- Bit 1 –VOLQU (Volume Quota): when set to "1", this indicates a request for reporting when a Volume Quota is exhausted.
- Bit 2 – TIMQU (Time Quota): when set to "1", this indicates a request for reporting when a Time Quota is exhausted.
- Bit 3 – ENVCL (Envelope Closure): when set to "1", this indicates a request for reporting when conditions for closure of envelope is met (see clause 5.2.2.3).
- Bit 4 – MACAR (MAC Addresses Reporting): when set to "1", this indicates a request for reporting the MAC (Ethernet) addresses used as source address of frames sent UL by the UE.
- Bit 5 – EVETH (Event Threshold): when set to "1", this indicates a request for reporting when an event threshold is reached. .
- Bit 6 – EVEQU (Event Quota): when set to "1", this indicates a request for reporting when an Event Quota is reached. .
- Bit 7 – IPMJL (IP Multicast Join/Leave): when set to "1", this indicates a request for reporting when the UPF adds or removes the PDU session to/from the DL replication tree associated with an IP multicast flow.
- Bit 8: – QUVTI (Quota Validity Time): when set to "1", this indicates a usage report being reported for a URR due to the quota validity timer expiry.

Octet 7 shall be encoded as follows:

- Bit 1 – REEMR (REport the End Marker Reception): when set to "1", the SMF instructs the UPF to report the reception of the End Marker packet. See clause 5.2.2.2.1 and also clauses 4.2.3.2 and 4.23.4.3 in 3GPP TS 23.502 [29].
- Bit 2 – UPINT (User Plane Inactivity Timer): when set to "1", this indicates a request for reporting when no packets have been received for a period exceeding the User Plane Inactivity Timer.
- Bit 3 to 8: Spare, for future use and set to "0".

At least one bit shall be set to "1". Several bits may be set to "1".

8.2.20 Redirect Information

Redirect Information is coded as depicted in Figure 8.2.20-1.

Octets	Bits							
	8	7	6	5	4	3	2	1
1-2	Type = 38 (decimal)							
3-4	Length = n							
5	Spare				Redirect Address Type			
6-7	Redirect Server Address Length=a							
8-(8+a-1)	Redirect Server Address							

p-(p+1)	Other Redirect Server Address Length=b
(p+2)- (p+2+b-1)	Other Redirect Server Address
m to (m+1)	Redirect Port
s to (n+4)	These octet(s) is/are present only if explicitly specified

Figure 8.2.20-1: Redirect Information

Redirect Address Type indicates the type of the Redirect Address. It shall be encoded as defined in Table 8.2.20-1.

Table 8.2.20-1: Redirect Address Type

Redirect Address Type	Value (Decimal)
IPv4 address	0
IPv6 address	1
URL	2
SIP URI	3
IPv4 and IPv6 addresses	4
Port	5
IPv4 address and Port	6
IPv6 address and Port	7
IPv4 and IPv6 addresses and Port	8
Spare, for future use.	9 to 15

The Redirect Server Address Length shall indicate the length of the Redirect Server Address.

The Redirect Server Address shall be encoded in UTF8String format and shall contain the address of the redirect server (e.g. HTTP redirect server, SIP server) with which the end user is to be connected, as specified in clauses 8.38 and 8.39 of IETF RFC 4006 [16].

If the Redirect Address type is set to "IPv4 and IPv6 address", the Redirect Information IE shall include an IPv4 address and an IPv6 address in the Redirect Server Address IE and Other Redirect Server Address.

The Redirection Address Type may be set to "Port", "IPv4 address and Port", "IPv6 address and Port", or "IPv4 and IPv6 addresses and Port" if the UP function has indicated its support of the RATP feature as specified in clause 8.2.25.

If the Redirect Address Type is set to Port, the Redirect Address Server Address shall not be present, the UP function shall keep the destination of IP address and only change the destination port to the port as indicated in Redirect Port field.

If the Redirect Address Type is set to "IPv4 address and Port", "IPv6 address and Port", or "IPv4 and IPv6 addresses and Port", the Redirect Address Server Address and Redirect Port shall be included. When Redirect Address Type is set to "IPv4 and IPv6 addresses and Port", the Other Redirect Server Address shall also be present.

8.2.21 Report Type

The Report Type IE shall be encoded as shown in Figure 8.2.21-1. It indicates the type of the report the UP function sends to the CP function.

Octets	Bits							
	8	7	6	5	4	3	2	1
1 to 2	Type = 39 (decimal)							
3 to 4	Length = n							
5	Spare	UISR	SESR	TMIR	UPIR	ERIR	USAR	DLDR
6 to (n+4)	These octet(s) is/are present only if explicitly specified							

Figure 8.2.21-1: Report Type

Octet 5 shall be encoded as follows:

- Bit 1 – DLDR (Downlink Data Report): when set to "1", this indicates Downlink Data Report
- Bit 2 – USAR (Usage Report): when set to "1", this indicates a Usage Report

- Bit 3 – ERIR (Error Indication Report): when set to "1", this indicates an Error Indication Report.
- Bit 4 – UPIR (User Plane Inactivity Report): when set to "1", this indicates a User Plane Inactivity Report.
- Bit 5 – TMIR (TSC Management Information Report): when set to "1", this indicates a TSC Management Information Report, includes support of integration with TSN, TSCTS and DetNet.
- Bit 6 – SESR (Session Report): when set to "1", this indicates a Session Report.
- Bit 7 – UISR (UP Initiated Session Request): when set to "1", this indicates it is a UP function initiated request for a reason which is indicated by the PFCPSRReq-Flags, for the PFCP session.
- Bit 8 – Spare, for future use and set to "0".

At least one bit shall be set to "1". Several bits may be set to "1".

8.2.22 Offending IE

Offending IE IE is coded as depicted in Figure 8.2.22-1.

Octets	Bits							
	8	7	6	5	4	3	2	1
1 to 2	Type = 40 (decimal)							
3 to 4	Length = 2							
5 to 6	Type of the offending IE							

Figure 8.2.22-1: Offending IE

The offending IE shall contain a mandatory IE type, if the rejection is due to a conditional or mandatory IE is faulty or missing.

8.2.23 Forwarding Policy

The Forwarding Policy IE type shall be encoded as shown in Figure 8.2.23-1. It indicates a specific forwarding policy to apply to packets.

Octets	Bits							
	8	7	6	5	4	3	2	1
1 to 2	Type = 41 (decimal)							
3 to 4	Length = n							
5	Forwarding Policy Identifier Length							
j to k	Forwarding Policy Identifier							
m to (n+4)	These octet(s) is/are present only if explicitly specified							

Figure 8.2.23-1: Forwarding Policy

The Forwarding Policy Identifier Length shall indicate the length of the Forwarding Policy Identifier.

The Forwarding Policy Identifier shall be encoded as an Octet String containing a reference to a pre-configured Forwarding Policy in the UP function, with a maximum length of 255 octets.

8.2.24 Destination Interface

The Destination Interface IE type shall be encoded as shown in Figure 8.2.24-1. It indicates the type of the interface towards which an outgoing packet is sent.

Octets	Bits						
	8	7	6	5	4	3	2
1 to 2	Type = 42 (decimal)						
3 to 4	Length = n						
5	Spare			Interface value			
6 to (n+4)	These octet(s) is/are present only if explicitly specified						

Figure 8.2.24-1: Destination Interface

The Interface value shall be encoded as a 4 bits binary integer as specified in Table 8.2.24-1.

Table 8.2.24-1: Interface value

Interface value	Values (Decimal)
Access (NOTE 1, NOTE 3, NOTE 4)	0
Core (see NOTE 1)	1
SGi-LAN/N6-LAN	2
CP- Function	3
LI Function (see NOTE 2)	4
5G VN Internal	5
Spare	6 to 15

NOTE 1: The "Access" and "Core" values denote a downlink and uplink traffic direction respectively.

NOTE 2: LI Function may denote an SX3LIF or an LMISF. See clause 5.7.

NOTE 3: For indirect data forwarding, the Source Interface in the PDR and the Destination Interface in the FAR shall both be set to "Access", in the forwarding SGW(s). The Interface value does not infer any traffic direction, in PDRs and FARs set up for indirect data forwarding, i.e. with both the Source and Destination Interfaces set to Access.

NOTE 4: For a HTTP redirection, the Source Interface in the PDR to match the uplink packets to be redirected and the Destination Interface in the FAR to enable the HTTP redirection shall both be set to "Access".

8.2.25 UP Function Features

The UP Function Features IE indicates the features supported by the UP function. It is coded as depicted in Figure 8.2.25-1.

Octets	Bits						
	8	7	6	5	4	3	2
1 to 2	Type = 43 (decimal)						
3 to 4	Length = n						
5 to 6	Supported-Features						
7 to 8	Additional Supported-Features 1						
9 to 10	Additional Supported-Features 2						
11 to 12	Additional Supported-Features 3						
13 to 14	Additional Supported-Features 4						
15 to 16	Additional Supported-Features 5						
17 to (n+4)	These octet(s) is/are present only if explicitly specified						

Figure 8.2.25-1: UP Function Features

The UP Function Features IE takes the form of a bitmask where each bit set indicates that the corresponding feature is supported. Spare bits shall be ignored by the receiver. The same bitmask is defined for all PFCP interfaces.

The following table specifies the features defined on PFCP interfaces and the interfaces on which they apply.

Table 8.2.25-1: UP Function Features

Feature Octet / Bit	Feature	Interface	M/O	Description
5/1	BUCP	Sxa, N4	O (NOTE 2)	Downlink Data Buffering in CP function is supported by the UP function.
5/2	DDND	Sxa	O	The buffering parameter 'Downlink Data Notification Delay' is supported by the UP function.
5/3	DLBD	Sxa, N4	O	The buffering parameter 'DL Buffering Duration' in PFCP Session Report Response is supported by the UP function.
5/4	TRST	Sxb, Sxc, N4	O	Traffic Steering is supported by the UP function.
5/5	FTUP	Sxa, Sxb, N4	M	F-TEID allocation / release in the UP function is supported by the UP function.
5/6	PFDM	Sxb, Sxc, N4	O	The PFD Management procedure is supported by the UP function.
5/7	HEEU	Sxb, Sxc, N4	O	Header Enrichment of Uplink traffic is supported by the UP function.
5/8	TREU	Sxb, Sxc, N4	O (NOTE 3)	Traffic Redirection Enforcement in the UP function is supported by the UP function.
6/1	EMPU	Sxa, Sxb, N4	M	Sending of End Marker packets supported by the UP function.
6/2	PDIU	Sxa, Sxb, Sxc, N4, N4mb	O (NOTE 4)	Support of PDI optimised signalling in UP function (see clause 5.2.1A.2).
6/3	UDBC	Sxb, Sxc, N4	O	Support of UL/DL Buffering Control
6/4	QUOAC	Sxb, Sxc, N4	O	The UP function supports being provisioned with the Quota Action to apply when reaching quotas.
6/5	TRACE	Sxa, Sxb, Sxc, N4	O	The UP function supports Trace (see clause 5.15).
6/6	FRRT	Sxb, N4	O	The UP function supports Framed Routing (see IETF RFC 2865 [37] and IETF RFC 3162 [38]).
6/7	PFDE	Sxb, N4	O	The UP function supports a PFD Contents including a property with multiple values.
6/8	EPFAR	Sxa, Sxb, Sxc, N4	O	The UP function supports the Enhanced PFCP Association Release feature (see clause 5.18).
7/1	DPDRA	Sxb, Sxc, N4	O	The UP function supports Deferred PDR Activation or Deactivation.
7/2	ADPDP	Sxa, Sxb, Sxc, N4	O	The UP function supports the Activation and Deactivation of Pre-defined PDRs (see clause 5.19).
7/3	UEIP	Sxb, N4	O (NOTE 5)	The UP function supports allocating UE IP addresses or prefixes (see clause 5.21).
7/4	SSET	N4, N4mb	O	(MB-)UPF support of PFCP sessions successively controlled by different (MB-)SMFs of a same (MB-)SMF Set (see clause 5.22).
7/5	MNOP	Sxa, Sxb, Sxc, N4	O	The UP function supports measurement of number of packets which is instructed with the flag 'Measurement of Number of Packets' in a URR. See also clause 5.2.2.2.1.
7/6	MTE	N4	O	UPF supports multiple instances of Traffic Endpoint IDs in a PDI.
7/7	BUNDL	Sxa, Sxb, Sxc, N4, N4mb	O	PFCP messages bundling (see clause 6.5) is supported by the UP function.
7/8	GCOM	N4	O	UPF support of 5G VN Group Communication. (See clause 5.23)
8/1	MPAS	N4, N4mb	O	(MB-)UPF support for multiple PFCP associations to the (MB-)SMFs in an (MB-)SMF set (see clause 5.22.3).
8/2	RTTL	N4	O	UPF supports redundant transmission at transport layer.
8/3	VTIME	Sxb, N4	O	UP function support of quota validity time feature.
8/4	NORP	Sxa, Sxb, Sxc, N4	O	UP function support of Number of Reports as specified in clause 5.2.2.2.
8/5	IPTV	N4	O	UPF support of IPTV service (see clause 5.25)

8/6	IP6PL	N4	O	UPF supports: <ul style="list-style-type: none"> - UE IPv6 address(es) allocation with IPv6 prefix length other than default /64 (including allocating /128 individual IPv6 addresses), as specified in clause 4.6.2.2 of 3GPP TS 23.316 [57]; and - multiple UE IPv6 addresses allocation using multiple instances of the UE IP Address IE in a same PDI or Traffic Endpoint, or using multiple PDIs or Traffic Endpoints with a different UE IP Address as specified in clause 5.21.1.
8/7	TSN	N4	O	Integration of 5GS into a TSN data network is supported by the UPF (see clause 5.26.1).
8/8	MPTCP	N4	O	UPF support of MPTCP Proxy functionality (see clause 5.20)
9/1	ATSSS-LL	N4	O	UPF support of ATSSS-LL steering functionality (see clause 5.20)
9/2	QFQM	N4	O	UPF support of per QoS flow per UE QoS monitoring for packet delay (see clause 5.24.4).
9/3	GPQM	N4	O	UPF support of per GTP-U Path QoS monitoring (see clause 5.24.5).
9/4	MT-EDT	Sxa	O	SGW-U support of reporting the size of DL Data Packets. (see clause 5.2.4.1).
9/5	CIOT	Sxb, N4	O	UP function support of CIoT feature, e.g. small data packet rate enforcement. (see 5.4.15)
9/6	ETHAR	N4	O	UPF support of Ethernet PDU Session Anchor Relocation (see clause 5.13.6).
9/7	DDDS	N4	O	UPF support of reporting the first buffered / first discarded downlink data after buffering / directly dropped downlink data for downlink data delivery status notification.
9/8	RDS	Sxb, N4	O	UP function support of Reliable Data Service (see clause 5.29).
10/1	RTTWP	N4	O	UPF support of RTT measurements towards the UE Without PMF.
10/2	QUASF	Sxb, Sxc, N4	O	The UP function supports being provisioned in a URR with an Exempted Application ID for Quota Action or an Exempted SDF Filter for Quota Action which is to be used when the quota is exhausted. See also clauses 5.2.2.2.1 and 5.2.2.3.1.
10/3	NSPOC	Sxa, Sxb, N4	O	UP function supports notifying start of Pause of Charging via user plane.
10/4	L2TP	Sxb, N4	O	UP function supports the L2TP feature as described in clause 5.31.
10/5	UPBER	N4	O	UP function supports the uplink packets buffering during EAS relocation.
10/6	RESPTS	Sxb, N4	O	UP function supports Restoration of PFCP Sessions associated with one or more PGW-C/SMF FQ-CSID(s), Group Id(s) or CP IP address(es) (see clause 5.22.4)
10/7	IPREP	N4	O	UP function supports IP Address and Port number replacement (see clauses 5.33.3, 5.33.4 and 5.33.6).
10/8	DNSTS	N4	O	UP function support DNS Traffic Steering based on FQDN in the DNS Query message (see clause 5.33.4)
11/1	DRQOS	N4	O	UP function supports Direct Reporting of QoS monitoring events to Local NEF or AF (see clause 5.33.5).
11/2	MBSN4	N4	O	UPF supports sending MBS multicast session data to associated PDU sessions using 5GC individual delivery.
11/3	PSUPRM	N4, N4mb	O	UP function supports Per Slice UP Resource Management (see clause 5.35).

11/4	EPPPI	N4	O	UP function supports Enhanced Provisioning of Paging Policy Indicator feature as specified in clause 5.36.2.
11/5	RATP	Sxb, N4	O	UP function supports Redirection Address Types set to "Port", "IPv4 address and Port", "IPv6 address and Port", or "IPv4 and IPv6 addresses and Port".
11/6	UPIDP	N4	O	UP function supports User Plane Inactivity Detection and reporting per PDR feature as specified in clause 5.11.3.
11/7	AFSFC	N4	O	UP function supports inserting metadata when Application Function influence on Service Function Chaining is used as specified in clause 5.4.8.
11/8	MPQUIC-UDP	N4	O	UPF support of MPQUIC-UDP Proxy functionality (see clause 5.20). (NOTE 6)
12/1	REDSM	N4	O	UP function supports the Redundant Steering Mode (see clause 5.32.8 of 3GPP TS 23.501 [28] and clause 5.2.7.1)
12/2	DBDM	Sxa, N4	O	The buffering parameters 'DL Buffering Duration' and 'DL Buffering Suggested Packet Count' in PFCP Session Modification Request are supported by the UP function.
12/3	TSCTS	N4	O	AF requested support of Time Synchronization and/or Time Sensitive Communication is supported by the UP function (see clause 5.26.1).
12/4	DRTSC	N4	O	UP function supports Direct Reporting of TSC management information events to TSN AF or TSCTS (see clause 5.26.3.2).
12/5	N6JEDB	N4	O	UPF support of N6 Jitter, DL Periodicity and UL Periodicity Measurement and Reporting, and End of Data Burst marking as specified in clause 5.38.4.
12/6	QMCON	N4	O	UPF support of QoS monitoring of Congestion information (see clause 5.39.3.3).
12/7	DETNET	N4	O	Deterministic Networking is supported by the UP function (see clause 5.26.1).
12/8	EML4S	N4	O	UP function supports ECN Marking for L4S (see clause 5.38.1).
13/1	PDUSM	N4	O	UP function supports PDU Set Marking (see clause 5.38.3).
13/2	CN-TL	N4	O	UPF support of the TSN Talker and Listener (TL) functionality, i.e. CN-TL. See clause 5.26a.
13/3	QMDRM	N4	O	UPF support of QoS monitoring of Data Rate Measurement (see clause 5.39.3.4).
13/4	EDBNC	N4	O	UP function supports Extended DL Buffering Notification Control (see clause 5.2.4.1).
13/5	MT-SDT	N4	O	UPF support of reporting the size of DL Data Packets per QoS flow (see clause 5.2.4.1).
13/6	UPSBIES	N4	O	UPF support of event subscription via Service Based Interface. (See clause 5.40).
13/7	UMN6IP	N4	O	UPF supports to allocate a mapped N6 IP address and perform IP replacement as described in clause 5.33.7.
13/8	UN6TU	N4	O	UPF supports N6 tunnelling using N6 routing information as described in clause 5.33.7.
14/1	MBSCH	N4mb	O	MB-UPF support of MBS charging (see clause 5.34.2.5)
14/2	UN6DM	N4	O	UPF support of N6 Delay Measurement and Reporting
14/3	NATPUB	N4	O	UPF supports the NAT information exposure of the public IP address and port number retrieval for a particular PDU Session, based on the private IP allocated by 5GC (see clause 5.8.2.17 and clause 7.2.29 of 3GPP TS 23.501 [28]).
14/4	USHPH	N4	O	UPF support of Handling of Payload Headers as described in clause 5.41
14/5	MPQUIC-IP	N4	O	UPF support of MPQUIC-IP Proxy functionality (see clause 5.20).

14/6	MPQUIC-E	N4	O	UPF support of MPQUIC-E Proxy functionality (see clause 5.20).
14/7	DYNTR	N4	O	UPF support of dynamically changing traffic characteristics via the User Plane (see clause 5.38.5), including: - DL Data Burst Size Marking - DL Time to Next Burst Marking - Expedited Data Transfer with reflective QoS
14/8	MUXMF	N4	O	UPF support of Traffic identification and differentiated QoS for multiplexed media flows (see clause 5.38.6).
15/1	CONUDP	N4	O	UPF support of transferring media related information over N6 using connect-UDP (see clause 5.38.7.3).
15/2	MOQ	N4	O	UP function supports MoQ relay functionality (see clause 5.38.7.2).
15/3	ULM	N4	O	UE Level measurement (see clause 5.15A)
15/4	PSITLM	N4	O	UP function supports the PDU Set Importance based transport level packet marking. See also clause 5.4.13.
15/5	UDPOPT	N4	O	UPF support of transferring media related information over N6 using UDP Option (see clause 5.38.7.4).
15/6	QMABR	N4	O	UPF support of QoS monitoring of Available Bitrate measurement (see clause 5.39.3.5).
15/7	PAPFD	N4, Sxb, Sxc	O	UP function supports of partial acceptance of provisioning of the Application ID's PFDs. See also clause 5.42.
<p>NOTE 1: Features are defined as follows:</p> <ul style="list-style-type: none"> - Feature Octet / Bit: The octet and bit number within the Supported-Features IE, e.g. "5 / 1". - Feature: A short name that can be used to refer to the octet / bit and to the feature. - Interface: A list of applicable interfaces to the feature. - M/O: Defines if the implementation of the feature is mandatory ("M") or optional ("O") for a UP function complying with this release of the specification. <p>A feature defined as mandatory in this release of the specification may not necessarily be defined or mandatory to support in earlier releases (see the respective specifications), therefore a CP function complying with this release of the specification shall be prepared to receive a UP Function Features IE with a mandatory feature bit set to "0".</p> <ul style="list-style-type: none"> - Description: A clear textual description of the feature. <p>NOTE 2: Downlink data should be buffered preferably in the UP function. Downlink data may be buffered in the CP function when desired, e.g. for UEs using power saving methods.</p> <p>NOTE 3: If the traffic that the UP function can support may be subject to traffic redirection, traffic redirection enforcement in the UP function shall be supported by the UP function.</p> <p>NOTE 4: CP and UP functions complying with this release of the specification should support this feature.</p> <p>NOTE 5: A UPF that supports the SSET or MPAS feature shall support this feature.</p> <p>NOTE 6: The MPQUIC-UDP feature is referred to as "MPQUIC" feature in previous releases of this specification (that do not support the MPQUIC-IP functionality and the MPQUIC-E functionality).</p>				

8.2.26 Apply Action

The Apply Action IE indicates the action(s) the UP function is required to apply to packets. It is coded as shown in Figure 8.2.26-1.

Octets	Bits							
	8	7	6	5	4	3	2	1
1 to 2	Type = 44 (decimal)							
3 to 4	Length = n							
5	DFRT	IPMD	IPMA	DUPL	NOCP	BUFF	FOR W	DROP
6	Spare			MBSU	FSSM	DDPN	BDPN	EDRT
7 to (n+4)	These octet(s) is/are present only if explicitly specified							

Figure 8.2.26-1: Apply Action

The octet 5 shall be encoded as follows:

- Bit 1 – DROP (Drop): when set to "1", this indicates a request to drop the packets.
- Bit 2 – FORW (Forward): when set to "1", this indicates a request to forward the packets.
- Bit 3 – BUFF (Buffer): when set to "1", this indicates a request to buffer the packets.
- Bit 4 – NOCP (Notify the CP function): when set to "1", this indicates a request to notify the CP function about the arrival of a first downlink packet being buffered.
- Bit 5 – DUPL (Duplicate): when set to "1", this indicates a request to duplicate the packets.
- Bit 6 – IPMA (IP Multicast Accept): used for IPTV; when set to "1", this indicates a request to accept UE requests to join an IP multicast group.
- Bit 7 – IPMD (IP Multicast Deny): used for IPTV; when set to "1", this indicates a request to deny UE requests to join an IP multicast group.
- Bit 8 – DFRT (Duplicate for Redundant Transmission): used for URLLC; when set to "1", this indicates a request to duplicate the packets for redundant transmission (see clause 5.24.2).

The octet 6 shall be encoded as follows:

- Bit 1 – EDRT (Eliminate Duplicate Packets for Redundant Transmission): used for URLLC; when set to "1", this indicates a request to eliminate duplicate packets used for redundant transmission (see clause 5.24.2).
- Bit 2 – BDPN (Buffered Downlink Packet Notification): used for DDDS; when set to "1", this indicates a request to notify the CP function about the first buffered DL packet for downlink data delivery status notification (see clause 5.28).
- Bit 3 – DDPN (Discarded Downlink Packet Notification): used for DDDS; when set to "1", this indicates a request to notify the CP function about the first discarded DL packet for downlink data delivery status notification if the DL Buffering Duration or DL Buffering Suggested Packet Count is exceeded or it is discarded directly. See clause 5.2.3.1 and 5.28.
- Bit 4 - FSSM (Forward packets to lower layer SSM): used for 5MBS; when set to "1", this indicates a request to the MB-UPF to forward MBS session data towards a low layer SSM address allocated by the MB-UPF using multicast transport (see clause 5.34.2).
- Bit 5 – MBSU (Forward and replicate MBS data using Unicast transport): used for 5MBS; when set to "1", this indicates a request to forward and replicate MBS session data towards multiple remote GTP-U peers using unicast transport(see clause 5.34.2).
- Bit 6 to 8 – Spare, for future use and set to "0".

One and only one of the DROP, FORW, BUFF, IPMA, IPMD and (FSSM and/or MBSU) flags shall be set to "1". Both the MBSU flag and the FSSM flag may be set to "1" (to require the MB-UPF to forward MBS session data using both multicast and unicast transports).

The NOCP flag and BDPN flag may only be set if the BUFF flag is set.

The DUPL flag may be set with any of the DROP, FORW, BUFF and NOCP flags.

The DFRT flag may only be set if the FORW flag is set.

The EDRT flag may be set if the FORW flag is set.

The DDPN flag may be set with any of the DROP and BUFF flags.

8.2.27 Downlink Data Service Information

The Downlink Data Service Information IE is used to carry downlink data service information. It is coded as shown in Figure 8.2.27-1.

Octets	Bits							
	8	7	6	5	4	3	2	1
1 to 2	Type = 45 (decimal)							
3 to 4	Length = n							
5	Spare				DLPSI	QFII	PPI	
m	Spare		Paging Policy Indication value					
p	Spare		QFI					
q to (q+1)	DL Data Packets Size							
r to (n+4)	These octet(s) is/are present only if explicitly specified							

Figure 8.2.27-1: Downlink Data Service Information

The PPI flag in octet 5 indicates whether the Paging Policy Indication value in octet "m" shall be present. If PPI is set to "1", then the Paging Policy Indication value shall be present. If PPI is set to "0", then octet "m" shall not be present.

The Paging Policy Indication value, in octet "m", shall be encoded as the DSCP in TOS (IPv4) or TC (IPv6) information received in the IP payload of the GTP-U packet from the PGW (see IETF RFC 2474 [13]).

The QFII flag in octet 5 indicates whether the QFI value in octet "p" shall be present. If QFII is set to "1", then the QFI value shall be present. If QFII is set to "0", then octet "p" shall not be present.

The QFI value, in octet "p", shall be encoded as the octet 5 of the QFI IE in clause 8.2.89.

The DLPSI flag in octet 5 indicates whether the DL Data Packets Size value in octets "q" to "q+1" shall be present. If the DLPSI flag is set to "1", then the DL Data Packets Size value shall be present. If the DLPSI flag is set to "0", then octets "q" to "q+1" shall not be present.

The DL Data Packets Size value, in octets "q" to "q+1", shall be encoded as an Unsigned16 binary integer value.

8.2.28 Downlink Data Notification Delay

The Downlink Data Notification Delay IE indicates the delay the UP function shall apply between receiving a downlink data packet and notifying the CP function about the arrival of the packet. It is coded as depicted in Figure 8.2.28-1.

Octets	Bits							
	8	7	6	5	4	3	2	1
1 to 2	Type = 46 (decimal)							
3 to 4	Length = n							
5	Delay Value in integer multiples of 50 millisecs, or zero							
6 to (n+4)	These octet(s) is/are present only if explicitly specified							

Figure 8.2.28-1: Downlink Data Notification Delay

Delay Value shall be set to zero in order to clear a previously set delay condition.

8.2.29 DL Buffering Duration

The DL Buffering Duration IE indicates the duration during which the UP function is requested to buffer the downlink data packets. It is coded as shown in figure 8.2.29-1 and table 8.2.29.1.

Octets	Bits						
	8	7	6	5	4	3	2
1 to 2	Type = 47 (decimal)						
3 to 4	Length = n						
5	Timer unit			Timer value			
6 to (n+4)	These octet(s) is/are present only if explicitly specified						

Figure 8.2.29-1: DL Buffering Duration

Table 8.2.29.1: DL Buffering Duration

<p>Timer value Bits 5 to 1 represent the binary coded timer value.</p> <p>Timer unit Bits 6 to 8 defines the timer value unit as follows:</p> <p>Bits</p> <p>8 7 6</p> <p>0 0 0 value is incremented in multiples of 2 seconds 0 0 1 value is incremented in multiples of 1 minute 0 1 0 value is incremented in multiples of 10 minutes 0 1 1 value is incremented in multiples of 1 hour 1 0 0 value is incremented in multiples of 10 hours 1 1 1 value indicates that the timer is infinite</p> <p>Other values shall be interpreted as multiples of 1 minute in this version of the protocol.</p> <p>Timer unit and Timer value both set to all "zeros" shall be interpreted as an indication that the timer is stopped.</p>

8.2.30 DL Buffering Suggested Packet Count

The DL Buffering Suggested Packet Count IE indicates the maximum number of downlink data packets suggested to be buffered in the UP function for this PFCP session. It is coded as depicted in Figure 8.2.30-1.

Octets	Bits						
	8	7	6	5	4	3	2
1 to 2	Type = 48 (decimal)						
3 to 4	Length = n						
5 to n+4	Packet Count Value						

Figure 8.2.30-1: DL Buffering Suggested Packet Count

The Packet Count value is encoded with the number of octets defined in the Length field, e.g. when n=2, the range of the Packet Count value is from 0 to 65535.

The length shall be set to "1" or "2" octets.

8.2.31 PFCPSMReq-Flags

The PFCPSMReq-Flags IE indicates flags applicable to the PFCP Session Modification Request message. It is coded as depicted in Figure 8.2.31-1.

Octets	Bits							
	8	7	6	5	4	3	2	1
1 to 2	Type = 49 (decimal)							
3 to 4	Length = n							
5	Spare	HRSB OM	DETEI D	RUM UC	SUMP C	QAUR R	SNDE M	DROB U
6 to (n+4)	These octet(s) is/are present only if explicitly specified							

Figure 8.2.31-1: PFCPSMReq-Flags

The following bits within Octet 5 shall indicate:

- Bit 1 – DROBU (Drop Buffered Packets): if this bit is set to "1", it indicates that the UP function shall drop all the packets currently buffered for the PFCP session, if any, prior to further applying the action specified in the Apply Action value of the FARs.
- Bit 2 – SNDEM (Send End Marker Packets): if this bit is set to "1", it indicates that the UP function shall construct and send End Marker packets towards the old F-TEID of the downstream node when switching to the new F-TEID.
- Bit 3 – QAURR (Query All URRs): if this bit is set to "1", it indicates that the UP function shall return immediate usage report(s) for all the URRs previously provisioned for this PFCP session.
- Bit 4 - SUMPC (Stop of Usage Measurement to Pause Charging): if this bit is set to "1", it indicates that the UP function shall stop the usage measurement for all URRs with the "ASPOC" flag set to "1".
- Bit 5 - RUMUC (Resume of Usage Measurement to Un-pause of Charging): if this bit is set to "1", it indicates that the UP function shall resume the usage measurement for all URRs with the "ASPOC" flag set to "1".
- Bit 6 - DETEID (Delete All DL N3mb and/or N19mb F-TEIDs): if this bit is set to "1", it indicates that the MB-UPF shall delete all NG-RAN N3mb DL F-TEIDs and all UPF N19mb DL F-TEIDs which were provisioned in Add MBS Unicast Parameters IEs for the MBS session (see clause 5.34.2.4).
- Bit 7 – HRSBOM (HR-SBO Mode): if this bit is set to "1" at the V-UPF acting as Local PSA in the VPLMN, it indicates that the PDU session is working in HR-SBO mode.
- Bit 8 – Spare, for future use, shall be set to "0" by the sender and discarded by the receiver.

Bits 4 and 5 shall not be set both to "1".

8.2.32 PFCPSRRsp-Flags

The PFCPSRRsp-Flags IE indicates flags applicable to the PFCP Session Report Response message. It is coded as depicted in Figure 8.2.32-1.

Octets	Bits							
	8	7	6	5	4	3	2	1
1 to 2	Type = 50 (decimal)							
3 to 4	Length = n							
5	Spare	Spare	Spare	Spare	Spare	Spare	Spare	DROB U
6 to (n+4)	These octet(s) is/are present only if explicitly specified							

Figure 8.2.32-1: PFCPSRRsp-Flags

The following bits within Octet 5 shall indicate:

- Bit 1 – DROBU (Drop Buffered Packets): if this bit is set to "1", it indicates that the UP function shall drop all the packets currently buffered for the PFCP session, if any, prior to further applying the action specified in the Apply Action value of the FARs.
- Bit 2 to 8 – Spare, for future use, shall be set to "0" by the sender and discarded by the receiver.

8.2.33 Sequence Number

The Sequence Number IE shall be encoded as shown in Figure 8.2.33-1. It contains an Unsigned32 binary integer value.

Octets	Bits						
	8	7	6	5	4	3	2
1 to 2	Type = 52 (decimal)						
3 to 4	Length = n						
5 to 8	Sequence Number						

Figure 8.2.33-1: Sequence Number

8.2.34 Metric

The Metric IE shall be encoded as shown in Figure 8.2.34-1. It indicates a percentage and may take binary coded integer values from and including 0 up to and including 100. Other values shall be considered as 0.

Octets	Bits						
	8	7	6	5	4	3	2
1 to 2	Type = 53 (decimal)						
3 to 4	Length = n						
5	Metric						

Figure 8.2.34-1: Metric

8.2.35 Timer

The purpose of the Timer IE is to specify specific timer values. The Timer IE shall be encoded as shown in Figure 8.2.35-1 and table 8.2.35.1.

Octets	Bits						
	8	7	6	5	4	3	2
1 to 2	Type = 55 (decimal)						
3 to 4	Length = n						
5	Timer unit			Timer value			
6 to (n+4)	These octet(s) is/are present only if explicitly specified						

Figure 8.2.35-1: Timer

Table 8.2.35.1: Timer information element

<p>Timer value Bits 5 to 1 represent the binary coded timer value.</p> <p>Timer unit Bits 6 to 8 defines the timer value unit for the timer as follows: Bits 8 7 6 0 0 0 value is incremented in multiples of 2 seconds 0 0 1 value is incremented in multiples of 1 minute 0 1 0 value is incremented in multiples of 10 minutes 0 1 1 value is incremented in multiples of 1 hour 1 0 0 value is incremented in multiples of 10 hours 1 1 1 value indicates that the timer is infinite</p> <p>Other values shall be interpreted as multiples of 1 minute in this version of the protocol.</p> <p>Timer unit and Timer value both set to all "zeros" shall be interpreted as an indication that the timer is stopped.</p>

8.2.36 Packet Detection Rule ID (PDR ID)

The PDR ID IE is coded as depicted in Figure 8.2.36-1.

Octets	8	7	6	5	4	3	2	1
1 to 2	Type = 56 (decimal)							
3 to 4	Length = n							
5 to 6	Rule ID							
7 to (n+4)	These octet(s) is/are present only if explicitly specified							

Figure 8.2.36-1: PDR ID

Octets 5 to 6 contain the Rule ID and shall be encoded as an integer.

8.2.37 F-SEID

F-SEID is coded as depicted in Figure 8.2.37-1.

Octets	8	7	6	5	4	3	2	1
1 to 2	Type = 57 (decimal)							
3 to 4	Length = n							
5	Spare	Spare	Spare	Spare	Spare	Spare	V4	V6
6 to 13	SEID							
m to (m+3)	IPv4 address							
p to (p+15)	IPv6 address							
k to (n+4)	These octet(s) is/are present only if explicitly specified							

Figure 8.2.37-1: F-SEID

The following flags are coded within Octet 5:

- Bit 1 – V6: If this bit is set to "1", then IPv6 address field shall be present in the F-SEID, otherwise the IPv6 address field is not present at all.
- Bit 2 – V4: If this bit is set to "1", then IPv4 address field shall be present in the F-SEID, otherwise the IPv4 address field is not present at all.

- Bit 3 to 8 are spare and reserved for future use.

At least one of V4 and V6 shall be set to "1", and both may be set to "1".

Octets "m to (m+3)" and/or "p to (p+15)" (IPv4 address / IPv6 address fields), if present, contain respective address values.

8.2.38 Node ID

The Node ID IE shall contain an FQDN or an IPv4/IPv6 address. It shall be encoded as shown in Figure 8.2.38-1.

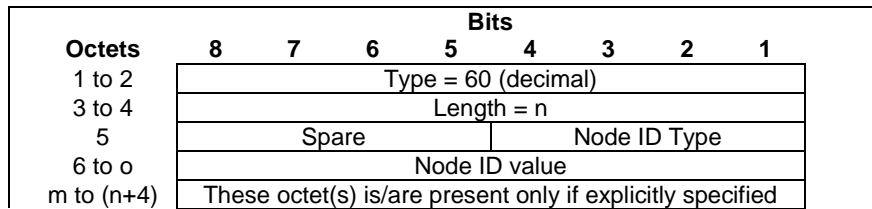

Figure 8.2.38-1: Node ID

Node ID Type indicates the type of the Node ID value. It shall be encoded as a 4 bits binary integer as specified in Table 8.2.38-2.

Table 8.2.38-2: Node ID Type

Node ID Type Value (Decimal)	Node ID Type
0	IPv4 address
1	IPv6 address
2	FQDN
3 to 15	Spare, for future use.

If the Node ID Type is set to an IPv4 address, then the Node ID value length shall be 4 Octets.

If the Node ID Type is set to an IPv6 address, then the Node ID value length shall be 16 Octets.

If the Node ID Type is set to an FQDN, then the Node ID value encoding shall be identical to the encoding of a FQDN within a DNS message of clause 3.1 of IETF RFC 1035 [27] but excluding the trailing zero byte.

NOTE 1: The FQDN field in the IE is not encoded as a dotted string as commonly used in DNS master zone files.

8.2.39 PFD Contents

The PFD Contents IE type shall be encoded as shown in Figure 8.2.39-1. It contains the description of a PFD.

Octets	Bits							
	8	7	6	5	4	3	2	1
1 to 2	Type = 61 (decimal)							
3 to 4	Length = n							
5	ADNP	AURL	AFD	DNP	CP	DN	URL	FD
6	Spare							
m to (m+1)	Length of Flow Description							
(m+2) to p	Flow Description							
q to (q+1)	Length of URL							
(q+2) to r	URL							
s to (s+1)	Length of Domain Name							
(s+2) to t	Domain Name							
u to (u+1)	Length of Custom PFD Content							
(u+2) to v	Custom PFD Content							
w to (w+1)	Length of Domain Name Protocol							
(w+2) to x	Domain Name Protocol							
y to (y+1)	Length of Additional Flow Description							
(y+2) to z	Additional Flow Description							
a to (a+1)	Length of Additional URL							
(a+2) to b	Additional URL							
c to (c+1)	Length of Additional Domain Name and Domain Name Protocol							
(c+2) to d	Additional Domain Name and Domain Name Protocol							
e to (n+4)	These octet(s) is/are present only if explicitly specified							

Figure 8.2.39-1: PFD Contents

The following flags are coded within Octet 5 in the Figure 8.2.39-1:

- Bit 1 – FD (Flow Description): If this bit is set to "1", then the Length of Flow Description and the Flow Description fields shall be present, otherwise they shall not be present.
- Bit 2 – URL (URL): If this bit is set to "1", then the Length of URL and the URL fields shall be present, otherwise they shall not be present.
- Bit 3 – DN (Domain Name): If this bit is set to "1", then the Length of Domain Name and the Domain Name fields shall be present, otherwise they shall not be present.
- Bit 4 – CP (Custom PFD Content): If this bit is set to "1", then the Length of Custom PFD Content and the Custom PFD Content fields shall be present, otherwise they shall not be present.
- Bit 5 – DNP (Domain Name Protocol): If this bit is set to "1", then the Length of Domain Name Protocol and the Domain Name Protocol shall be present, otherwise they shall not be present; and if this bit is set to "1", the Length of Domain Name and the Domain Name fields shall also be present.
- Bit 6 – AFD (Additional Flow Description): If this bit is set to "1", the Length of Additional Flow Description and the Additional Flow Description field shall be present, otherwise they shall not be present.
- Bit 7 – AURL (Additional URL): If this bit is set to "1", the Length of Additional URL and the Additional URL field shall be present, otherwise they shall not be present.
- Bit 8 – ADNP (Additional Domain Name and Domain Name Protocol): If this bit is set to "1", the Length of Additional Domain Name and Domain Name Protocol, and the Additional Domain Name and Domain Name Protocol field shall be present, otherwise they shall not be present.

The Flow Description field, when present, shall be encoded as an OctetString as specified in clause 6.4.3.7 of 3GPP TS 29.251 [21].

The Domain Name field, when present, shall be encoded as an OctetString as specified in clause 6.4.3.9 of 3GPP TS 29.251 [21].

The URL field, when present, shall be encoded as an OctetString as specified in clause 6.4.3.8 of 3GPP TS 29.251 [21].

The Domain Name Protocol field, when present, shall be encoded as an OctetString as specified in clause 6.4.3.10 of 3GPP TS 29.251 [21].

Additional instance(s) of the Flow Description shall be encoded as shown in Figure 8.2.39-2. The encoding of Flow Description 2, 3 up to m field are the same as the Flow Description field specified in clause 8.2.39.

Octets	Bits						
	8	7	6	5	4	3	2
(y+2) to (y+3)	Length of Flow Description 2						
(y+4) to i	Flow Description 2						
j to (j+1)	Length of Flow Description 3						
(j+2) to k	FlowDescription 3						
	...						
l to (l+1)	Length of Flow Description m						
(l+2) to z	Flow Description m						

Figure 8.2.39-2: Additional Flow Description field

Additional instance(s) of the URL shall be encoded as shown in Figure 8.2.39-3. The encoding of URL 2, 3 up to m fields are the same as the URL field.

Octets	Bits						
	8	7	6	5	4	3	2
(a+2) to (a+3)	Length of URL 2						
(a+4) to o	URL 2						
pa to (pa+1)	Length of URL 3						
(pa+2) to pb	URL 3						
	...						
pc to (pc+1)	Length of URL m						
(pc+2) to b	URL m						

Figure 8.2.39-3: Additional URL field

Additional instance(s) of the Domain Name and Domain Name Protocol shall be encoded as shown in Figure 8.2.39-4. The encoding of Domain Name 2, 3, up to m fields and Domain Name Protocol 2, 3 up to m fields are the same as the Domain Name field and Domain Name Protocol field respectively.

Octets	Bits						
	8	7	6	5	4	3	2
(c+2) to (c+3)	Length of Domain Name 2						
(c+4) to pd	Domain Name 2						
pe to (pe+1)	Length of Domain Name Protocol 2						
(pe+2) to pf	Domain Name Protocol 2						
pg to (pg+1)	Length of Domain Name 3						
(pg+2) to ph	Domain Name 3						
pi to (pi+1)	Length of Domain Name Protocol 3						
(pi+2) + pj	Domain Name Protocol 3						
	...						
pk to (pk+1)	Length of Domain Name m						
(pk+2) to pl	Domain Name m						
pm to (pm+1)	Length of Domain Name Protocol m						
(pm+2) to d	Domain Name Protocol m						

Figure 8.2.39-4: Additional Domain Name and Domain Name Protocol field

8.2.40 Measurement Method

The Measurement Method IE shall be encoded as shown in Figure 8.2.40-1. It indicates the method for measuring the usage of network resources.

Octets	Bits							
	8	7	6	5	4	3	2	1
1 to 2	Type = 62 (decimal)							
3 to 4	Length = n							
5	Spare	Spare	Spare	Spare	Spare	EVEN T	VOLU M	DURA T
6 to (n+4)	These octet(s) is/are present only if explicitly specified							

Figure 8.2.40-1: Measurement Method

Octet 5 shall be encoded as follows:

- Bit 1 – DURAT (Duration): when set to "1", this indicates a request for measuring the duration of the traffic.
- Bit 2 – VOLUM (Volume): when set to "1", this indicates a request for measuring the volume of the traffic.
- Bit 3 – EVENT (Event): when set to "1", this indicates a request for measuring the events.
- Bit 4 to 8: Spare, for future use and set to "0".

At least one bit shall be set to "1". Several bits may be set to "1".

8.2.41 Usage Report Trigger

The Usage Report Trigger IE shall be encoded as shown in Figure 8.2.41-1. It indicates the trigger of the usage report.

Octets	Bits							
	8	7	6	5	4	3	2	1
1 to 2	Type = 63 (decimal)							
3 to 4	Length = n							
5	IMME R	DROT H	STOP T	STAR T	QUHT I	TIMT H	VOLT H	PERI O
6	EVET H	MACA R	ENVC L	MONI T	TERM R	LIUSA	TIMQ U	VOLQ U
7	Spare	Spare	UPIN T	EMRR E	QUVT I	IPMJL	TEBU R	EVEQ U
8 to (n+4)	These octet(s) is/are present only if explicitly specified							

Figure 8.2.41-1: Usage Report Trigger

Octet 5 shall be encoded as follows:

- Bit 1 – PERIO (Periodic Reporting): when set to "1", this indicates a periodic report.
- Bit 2 – VOLTH (Volume Threshold): when set to "1", this indicates that the data volume usage reaches a volume threshold.
- Bit 3 – TIMTH (Time Threshold): when set to "1", this indicates that the time usage reaches a time threshold.
- Bit 4 – QUHTI (Quota Holding Time): when set to "1", this indicates that no packets have been received for a period exceeding the Quota Holding Time.
- Bit 5 – START (Start of Traffic): when set to "1", this indicates that the start of traffic is detected.
- Bit 6 – STOPT (Stop of Traffic): when set to "1", this indicates that the stop of traffic is detected.
- Bit 7 - DROTH (Dropped DL Traffic Threshold): when set to "1", this indicates that the DL traffic being dropped reaches a threshold.
- Bit 8 – IMMERR (Immediate Report): when set to "1", this indicates an immediate report reported on CP function demand.

Octet 6 shall be encoded as follows:

- Bit 1 – VOLQU (Volume Quota): when set to "1", this indicates that the Volume Quota has been exhausted.
- Bit 2 – TIMQU (Time Quota): when set to "1", this indicates that the Time Quota has been exhausted.
- Bit 3 - LIUSA (Linked Usage Reporting): when set to "1", this indicates a linked usage report, i.e. a usage report being reported for a URR due to a usage report being also reported for a linked URR (see clause 5.2.2.4).
- Bit 4 – TERMR (Termination Report): when set to "1", this indicates a usage report being reported (in a PFCP Session Deletion Response or a PFCP Session Report Request message) for a URR due to the termination of the PFCP session, or a usage report being reported (in a PFCP Session Modification Response or a PFCP Session Report Request message) for a URR due to the removal of the URR or dissociated from the last PDR.
- Bit 5 – MONIT (Monitoring Time): when set to "1", this indicates a usage report being reported for a URR due to the Monitoring Time being reached.
- Bit 6 – ENVCL (Envelope Closure): when set to "1", this indicates the usage report is generated for closure of an envelope (see clause 5.2.2.3).
- Bit 7 – MACAR (MAC Addresses Reporting): when set to "1", this indicates a usage report to report MAC (Ethernet) addresses used as source address of frames sent UL by the UE.
- Bits 8: EVETH (Event Threshold): when set to "1", this indicates a usage report is generated when an event threshold is reached.

Octet 7 shall be encoded as follows:

- Bit 1 – EVEQU (Event Quota): when set to "1", this indicates that the Event Quota has been exhausted.
- Bit 2 – TEBUR (Termination By UP function Report): when set to "1", this indicates a usage report being reported for a URR due to the termination of the PFCP session which is initiated by the UP function.
- Bit 3 – IPMJL (IP Multicast Join/Leave): when set to "1", this indicates a usage report being reported for a URR due to the UPF adding or removing the PDU session to/from the DL replication tree associated with an IP multicast flow.
- Bit 4 – QUVTI (Quota Validity Time): when set to "1", this indicates a usage report being reported for a URR due to the quota validity timer expiry.
- Bit 5 – EMRRE (End Marker Reception REport): this indicates that the UP function has received End Marker from the old I-UPF. See clauses 4.2.3.2 and 4.23.4.3 in 3GPP TS 23.502 [29]).
- Bit 6 – UPINT (User Plane Inactivity Timer): when set to "1", this indicates that no packets have been received for a period exceeding the User Plane Inactivity Timer.
- Bit 7 to 8: Spare, for future use and set to "0".

At least one bit shall be set to "1". Several bits may be set to "1".

8.2.42 Measurement Period

The Measurement Period IE contains the period, in seconds, for generating periodic usage reports or the periodic QoS monitoring reports, or the period used for detecting and reporting a QoS monitoring measurement failure. It shall be encoded as shown in Figure 8.2.42-1.

Octets	Bits							
	8	7	6	5	4	3	2	1
1 to 2	Type = 64 (decimal)							
3 to 4	Length = n							
5 to 8	Measurement Period							
9 to (n+4)	These octet(s) is/are present only if explicitly specified							

Figure 8.2.42-1: Measurement Period

The Measurement Period field shall be encoded as an Unsigned32 binary integer value.

8.2.43 Fully qualified PDN Connection Set Identifier (FQ-CSID)

A fully qualified PDN Connection Set Identifier (FQ-CSID) identifies a set of PDN connections belonging to an arbitrary number of UEs on a SGW-C, PGW-C, SGW-U and PGW-U, or a set of PDU sessions belonging to an arbitrary number of UEs on a SMF or UPF. The FQ-CSID is supported on the Sxa, Sxb and N4 interfaces.

The size of CSID is two octets. The FQ-CSID is coded as follows:

Octets	Bits							
	8	7	6	5	4	3	2	1
1 to 2	Type = 65 (decimal)							
3 to 4	Length = n							
5	FQ-CSID Node-ID Type				Number of CSIDs= m			
6 to p	Node-Address							
(p+1) to (p+2)	First PDN Connection Set Identifier (CSID)							
(p+3) to (p+4)	Second PDN Connection Set Identifier (CSID)							
...	...							
q to q+1	m-th PDN Connection Set Identifier (CSID)							
q+2	Spare				Node Type			
(q+3) to (n+4)	These octet(s) is/are present only if explicitly specified							

Figure 8.2.43-1: FQ-CSID

Where FQ-CSID Node-ID Type values are:

- 0 indicates that Node-Address is a global unicast IPv4 address and $p = 9$.
- 1 indicates that Node-Address is a global unicast IPv6 address and $p = 21$.
- 2 indicates that Node-Address is a 4 octets long field with a 32 bit value stored in network order, and $p = 9$. The coding of the field is specified below:
 - Most significant 20 bits are the binary encoded value of $(MCC * 1000 + MNC)$.
 - Least significant 12 bits is a 12 bit integer assigned by an operator to an MME, SGW-C, SGW-U, PGW-C, PGW-U, ePDG, TWAN, SMF or UPF.

Other values of Node-Address Type are reserved.

Values of Number of CSID greater than 1 shall only be employed in the PFCP Session Deletion Request. The value 0 shall be used in a PFCP Session Modification Request, with the FQ-CSID Node-ID Type and Node-Address fields set to all zeros, and with the Node Type indicating one node type, to remove an FQ-CSID previously provisioned for the PFCP session for the related node type.

NOTE: The CP function can remove all the FQ-CSIDs for all node types provisioned in the UP function for a given PFCP session by sending a PFCP Session Modification Request with one FQ-CSID IE with a null length.

The node that creates the FQ-CSID (i.e. SGW-C for SGW-C FQ-CSID, PGW-C or SMF for PGW-C/SMF FQ-CSID and PGW-U or SGW-U or UPF for PGW-U/SGW-U/UPF FQ-CSID) needs to ensure that the Node-ID is globally unique and the CSID value is unique within that node.

The Node Type field in bits 1 to 4 of octet (q+2) shall be encoded as defined in Table 8.2.43-2. Bits 5 to 8 of octet (q+2) shall be set to zero by the sender and ignored by the receiver.

Table 8.2.43-2: Node Type

Node Type	Value (Decimal)
MME	0
SGW-C	1
PGW-C/SMF	2
ePDG	3
TWAN	4
PGW-U/SGW-U/UPF	5
Spare, for future use.	6-15

8.2.44 Volume Measurement

The Volume Measurement IE contains the measured traffic volumes. It shall be encoded as shown in Figure 8.2.44-1.

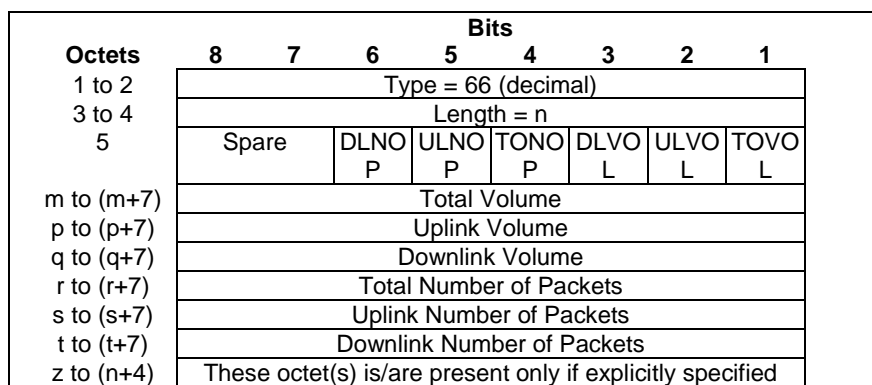

Figure 8.2.44-1: Volume Measurement

The following flags are coded within Octet 5:

- Bit 1 – TOVOL: If this bit is set to "1", then the Total Volume field shall be present, otherwise the Total Volume field shall not be present.
- Bit 2 – ULVOL: If this bit is set to "1", then the Uplink Volume field shall be present, otherwise the Uplink Volume field shall not be present.
- Bit 3 – DLVOL: If this bit is set to "1", then the Downlink Volume field shall be present, otherwise the Downlink Volume field shall not be present.
- Bit 4 – TONOP: If this bit is set to "1", then the Total Number of Packets field shall be present, otherwise the Total Number of Packets field shall not be present.
- Bit 5 – ULNOP: If this bit is set to "1", then the Uplink Number of Packets field shall be present, otherwise the Uplink Number of Packets field shall not be present.
- Bit 6 – DLNOP: If this bit is set to "1", then the Downlink Number of Packets field shall be present, otherwise the Downlink Number of Packets field shall not be present.
- Bit 7 to bit 8: Spare, for future use and set to "0".

At least one bit shall be set to "1". Several bits may be set to "1".

The Total Volume, Uplink Volume and Downlink Volume fields shall be encoded as an Unsigned64 binary integer value. They shall contain the total, uplink or downlink number of octets respectively.

8.2.45 Duration Measurement

The Duration Measurement IE type shall be encoded as shown in Figure 8.2.45-1. It contains the used time in seconds.

Octets	Bits						
	8	7	6	5	4	3	2
1 to 2	Type = 67 (decimal)						
3 to 4	Length = n						
5 to 8	Duration value						
9 to (n+4)	These octet(s) is/are present only if explicitly specified						

Figure 8.2.45-1: Duration Measurement

The Duration value shall be encoded as an Unsigned32 binary integer value.

8.2.46 Time of First Packet

The Time of First Packet IE indicates the time stamp for the first IP packet transmitted for a given usage report. It shall be encoded as shown in Figure 8.2.46-1.

Octets	Bits						
	8	7	6	5	4	3	2
1 to 2	Type = 69 (decimal)						
3 to 4	Length = n						
5 to 8	Time of First Packet						
9 to (n+4)	These octet(s) is/are present only if explicitly specified						

Figure 8.2.46-1: Time of First Packet

The Time of First Packet field shall contain a UTC time. Octets 5 to 8 shall be encoded in the same format as the first four octets of the 64-bit timestamp format as defined in clause 6 of IETF RFC 5905 [12].

NOTE: The encoding is defined as the time in seconds relative to 00:00:00 on 1 January 1900 during the era 0, which includes dates from the prime epoch, i.e. 00:00:00 on 1 January 1900, to 06:28:15 on 7th of February 2036, or relative to 06:28:16 on 7th of February 2036 when the date enters the era 1. See also clause 6 of IETF RFC 5905 [12].

8.2.47 Time of Last Packet

The Time of Last Packet IE indicates the time stamp for the last IP packet transmitted for a given usage report. It shall be encoded as shown in Figure 8.2.47-1.

Octets	Bits						
	8	7	6	5	4	3	2
1 to 2	Type = 70 (decimal)						
3 to 4	Length = n						
5 to 8	Time of Last Packet						
9 to (n+4)	These octet(s) is/are present only if explicitly specified						

Figure 8.2.47-1: Time of Last Packet

The Time of Last Packet field shall contain a UTC time. Octets 5 to 8 shall be encoded in the same format as the first four octets of the 64-bit timestamp format as defined in clause 6 of IETF RFC 5905 [12].

NOTE: The encoding is defined as the time in seconds relative to 00:00:00 on 1 January 1900 during the era 0, which includes dates from the prime epoch, i.e. 00:00:00 on 1 January 1900, to 06:28:15 on 7th of February 2036, or relative to 06:28:16 on 7th of February 2036 when the date enters the era 1. See also clause 6 of IETF RFC 5905 [12].

8.2.48 Quota Holding Time

The Quota Holding Time IE type shall be encoded as shown in Figure 8.2.48-1. It contains the quota holding time in seconds.

Octets	Bits							
	8	7	6	5	4	3	2	1
1 to 2	Type = 71 (decimal)							
3 to 4	Length = n							
5 to 8	Quota Holding Time value							
9 to (n+4)	These octet(s) is/are present only if explicitly specified							

Figure 8.2.48-1: Quota Holding Time

The Quota Holding Time value shall be encoded as an Unsigned32 binary integer value.

8.2.49 Dropped DL Traffic Threshold

The Dropped DL Traffic Threshold IE type shall be encoded as shown in Figure 8.2.49-1. It contains the dropped DL traffic volume thresholds to be monitored by the UP function.

Octets	Bits								
	8	7	6	5	4	3	2	1	
1 to 2	Type = 72 (decimal)								
3 to 4	Length = n								
5	Spare					DLBY	DLPA		
m to (m+7)	Downlink Packets								
o to (o+7)	Number of Bytes of Downlink Data								
s to (n+4)	These octet(s) is/are present only if explicitly specified								

Figure 8.2.49-1: Dropped DL Traffic Threshold

The following flags are coded within Octet 5:

- Bit 1 – DLPA: If this bit is set to "1", then the Downlink Packets field shall be present, otherwise the Downlink Packets field shall not be present.
- Bit 2 – DLBY: If this bit is set to "1", then the Number of Bytes of Downlink Data field shall be present, otherwise the Number of Bytes of Downlink Data field shall not be present.
- Bit 3 to 8: Spare, for future use and set to "0".

The Downlink Packets fields shall be encoded as an Unsigned64 binary integer value. It shall contain a number of downlink packets.

The Number of Bytes of Downlink Data fields shall be encoded as an Unsigned64 binary integer value. It shall contain the number of bytes of the downlink data.

8.2.50 Volume Quota

The Volume Quota IE type shall be encoded as shown in Figure 8.2.50-1. It contains the volume quota to be monitored by the UP function.

Octets	Bits								
	8	7	6	5	4	3	2	1	
1 to 2	Type = 73 (decimal)								
3 to 4	Length = n								
5	Spare					DLVO	ULVO	TOVO	
					L	L	L		
m to (m+7)	Total Volume								
p to (p+7)	Uplink Volume								
q to (q+7)	Downlink Volume								
S to (n+4)	These octet(s) is/are present only if explicitly specified								

Figure 8.2.50-1: Volume Quota

The following flags are coded within Octet 5:

- Bit 1 – TOVOL: If this bit is set to "1", then the Total Volume field shall be present, otherwise the Total Volume field shall not be present.
- Bit 2 – ULVOL: If this bit is set to "1", then the Uplink Volume field shall be present, otherwise the Uplink Volume field shall not be present.
- Bit 3 – DLVOL: If this bit is set to "1", then the Downlink Volume field shall be present, otherwise the Downlink Volume field shall not be present.
- Bit 4 to bit 8: Spare, for future use and set to "0".

At least one bit shall be set to "1". Several bits may be set to "1".

The Total Volume, Uplink Volume and Downlink Volume fields shall be encoded as an Unsigned64 binary integer value. They shall contain the total, uplink or downlink number of octets respectively.

8.2.51 Time Quota

The Time Quota IE type shall be encoded as shown in Figure 8.2.51-1. It contains the time quota to be monitored by the UP function.

Octets	Bits							
	8	7	6	5	4	3	2	1
1 to 2	Type = 74 (decimal)							
3 to 4	Length = n							
5 to 8	Time Quota value							
9 to (n+4)	These octet(s) is/are present only if explicitly specified							

Figure 8.2.51-1: Time Quota

The Time Quota value shall be encoded as an Unsigned32 binary integer value. It contains a duration in seconds.

8.2.52 Start Time

The Start Time IE indicates the time at which the UP function started to collect the charging information. It shall be encoded as shown in Figure 8.2.52-1.

Octets	Bits							
	8	7	6	5	4	3	2	1
1 to 2	Type = 75 (decimal)							
3 to 4	Length = n							
5 to 8	Start Time							
9 to (n+4)	These octet(s) is/are present only if explicitly specified							

Figure 8.2.52-1: Start Time

The Start Time field shall contain a UTC time. Octets 5 to 8 shall be encoded in the same format as the first four octets of the 64-bit timestamp format as defined in clause 6 of IETF RFC 5905 [12].

NOTE: The encoding is defined as the time in seconds relative to 00:00:00 on 1 January 1900 during the era 0, which includes dates from the prime epoch, i.e. 00:00:00 on 1 January 1900, to 06:28:15 on 7th of February 2036, or relative to 06:28:16 on 7th of February 2036 when the date enters the era 1. See also clause 6 of IETF RFC 5905 [12].

8.2.53 End Time

The End Time IE indicates the time at which the UP function ended to collect the charging information. It shall be encoded as shown in Figure 8.2.53-1.

Octets	Bits							
	8	7	6	5	4	3	2	1
1 to 2	Type = 76 (decimal)							
3 to 4	Length = n							
5 to 8	End Time							
9 to (n+4)	These octet(s) is/are present only if explicitly specified							

Figure 8.2.53-1: End Time

The End Time field shall contain a UTC time. Octets 5 to 8 shall be encoded in the same format as the first four octets of the 64-bit timestamp format as defined in clause 6 of IETF RFC 5905 [12].

NOTE: The encoding is defined as the time in seconds relative to 00:00:00 on 1 January 1900 during the era 0, which includes dates from the prime epoch, i.e. 00:00:00 on 1 January 1900, to 06:28:15 on 7th of February 2036, or relative to 06:28:16 on 7th of February 2036 when the date enters the era 1. See also clause 6 of IETF RFC 5905 [12].

8.2.54 URR ID

The URR ID IE type shall be encoded as shown in Figure 8.2.54-1. It contains a Usage Reporting Rule ID.

Octets	Bits							
	8	7	6	5	4	3	2	1
1 to 2	Type = 81 (decimal)							
3 to 4	Length = n							
5 to 8	URR ID value							
9 to (n+4)	These octet(s) is/are present only if explicitly specified							

Figure 8.2.54-1: URR ID

The URR ID value shall be encoded as an Unsigned32 binary integer value.

The bit 8 of octet 5 is used to indicate if the Rule ID is dynamically allocated by the CP function or predefined in the UP function. If set to "0", it indicates that the Rule is dynamically provisioned by the CP Function. If set to "1", it indicates that the Rule is predefined in the UP Function.

8.2.55 Linked URR ID IE

The Linked URR ID IE type shall be encoded as shown in Figure 8.2.55-1. It contains the URR ID of a linked URR.

Octets	Bits							
	8	7	6	5	4	3	2	1
1 to 2	Type = 82 (decimal)							
3 to 4	Length = n							
5 to 8	Linked URR ID value							
9 to (n+4)	These octet(s) is/are present only if explicitly specified							

Figure 8.2.55-1: Linked URR ID

The Linked URR ID value shall be encoded as an Unsigned32 binary integer value.

8.2.56 Outer Header Creation

The Outer Header Creation IE type shall be encoded as shown in Figure 8.2.56-1. It contains the instructions to create an Outer Header.

Octets	Bits						
	8	7	6	5	4	3	2
1 to 2	Type = 84 (decimal)						
3 to 4	Length = n						
5 to 6	Outer Header Creation Description						
m to (m+3)	TEID						
p to (p+3)	IPv4 Address						
q to (q+15)	IPv6 Address						
r to (r+1)	Port Number						
t to (t+2)	C-TAG						
u to (u+2)	S-TAG						
s to (n+4)	These octet(s) is/are present only if explicitly specified						

Figure 8.2.56-1: Outer Header Creation

The Outer Header Creation Description field, when present, shall be encoded as specified in Table 8.2.56-1. It takes the form of a bitmask where each bit indicates the outer header to be created in the outgoing packet. Spare bits shall be ignored by the receiver.

Table 8.2.56-1: Outer Header Creation Description

Octet / Bit	Outer Header to be created in the outgoing packet
5/1	GTP-U/UDP/IPv4 (NOTE 1), (NOTE 3)
5/2	GTP-U/UDP/IPv6 (NOTE 1), (NOTE 3)
5/3	UDP/IPv4 (NOTE 2, NOTE 5)
5/4	UDP/IPv6 (NOTE 2, NOTE 5)
5/5	IPv4 (NOTE 5)
5/6	IPv6 (NOTE 5)
5/7	C-TAG (see NOTE 4)
5/8	S-TAG (see NOTE 4)
6/1	N19 Indication (NOTE 6)
6/2	N6 Indication (NOTE 6)
6/3	Low Layer SSM and C-TEID (NOTE 7)
<p>NOTE 1: The SGW-U/I-UPF shall also create GTP-U extension header(s) if any has been stored for this packet, during a previous outer header removal (see clause 8.2.64).</p> <p>NOTE 2: This value may apply to UL packets sent by a PGW-U for non-IP PDN connections with SGi tunnelling based on UDP/IP encapsulation (see clause 4.3.17.8.3.3.2 of 3GPP TS 23.401 [14]).</p> <p>NOTE 3: The SGW-U/I-UPF shall set the GTP-U message type to the value stored during the previous outer header removal.</p> <p>NOTE 4: These values may apply to UL packets sent by a UPF for Ethernet PDU sessions over N6 (see clause 5.8.5.6 of 3GPP TS 23.501 [28]). Either C-TAG bit or S-TAG bit may be set to "1", or both C-TAG and S-TAG bits may be set to "1" to request the UPF to insert the C-TAG or S-TAG, or both C-TAG and S-TAG respectively for UL packets over N6.</p> <p>NOTE 5: This value may apply e.g. to UL packets sent by a UPF (PDU Session Anchor) over N6, when explicit N6 traffic routing information is provided to the SMF (see clause 5.6.7 of 3GPP TS 23.501 [28]). The IPv4 or IPv6 address shall correspond to the IP address of the tunnel endpoint in the data network.</p> <p>NOTE 6: When the "N19 Indication" or "N6 Indication" bit in the Outer Header Creation Description field is set to "1", the UPF shall associate an "N19 Indication" or "N6 Indication" internal flag with the packet to indicate that the packet has been received from a N19 or N6 interface respectively. This indication is further used to prevent the packet from being forwarded back over N19 or N6 respectively (see clause 8.2.130).</p> <p>NOTE 7: When the "Low Layer SSM and C-TEID" bit in the Outer Header Creation Description field is set to "1", the MB-UPF shall create a GTP-U header with the C-TEID and set the destination IP address and the source IP address as the IP Multicast Distribution Address and the IP Source Address in the Multicast Transport Information IE, which is the Low Layer SSM allocated to the MBS session. In this case, the TEID, IPv4/IPv6 address and Port Number fields shall not be present.</p>	

At least one bit of the Outer Header Creation Description field shall be set to "1". Bits 5/1 and 5/2 may both be set to "1" if an F-TEID with both an IPv4 and IPv6 addresses has been assigned by the GTP-U peer. In this case, the UP function shall send the outgoing packet towards the IPv4 or IPv6 address.

The TEID field shall be present if the Outer Header Creation Description requests the creation of a GTP-U header, i.e. if in Octet 5 any of the bits 5/1 and 5/2 are set. Otherwise it shall not be present. When present, it shall contain the destination GTP-U TEID to set in the GTP-U header of the outgoing packet.

The IPv4 Address field shall be present if the Outer Header Creation Description requests the creation of an IPv4 header, i.e. if in Octet 5 any of the bits 5/1, 5/3 and 5/5 are set. Otherwise it shall not be present. When present, it shall contain the destination IPv4 address to set in the IPv4 header of the outgoing packet.

The IPv6 Address field shall be present if the Outer Header Creation Description requests the creation of an IPv6 header, i.e. if in Octet 5 any of the bits 5/2, 5/4 and 5/6 are set. Otherwise it shall not be present. When present, it shall contain the destination IPv6 address to set in the IPv6 header of the outgoing packet.

The Port Number field shall be present if the Outer Header Creation Description requests the creation of a UDP/IP header, i.e. if in Octet 5 any of the bits 5/3 and 5/4 are set. Otherwise it shall not be present. When present, it shall contain the destination Port Number to set in the UDP header of the outgoing packet.

The C-TAG field shall be present if the Outer Header Creation Description requests the setting of the C-Tag in Ethernet packet. Otherwise it shall not be present. When present, it shall contain the destination Customer-VLAN tag to set in the Customer-VLAN tag header of the outgoing packet.

The S-TAG field shall be present if the Outer Header Creation Description requests the setting of the S-Tag in Ethernet packet. Otherwise it shall not be present. When present, it shall contain the destination Service-VLAN tag to set in the Service-VLAN tag header of the outgoing packet.

8.2.57 BAR ID

The BAR ID IE type shall be encoded as shown in Figure 8.2.57-1. It contains a Buffering Action Rule ID.

Octets	Bits							
	8	7	6	5	4	3	2	1
1 to 2	Type = 88 (decimal)							
3 to 4	Length = n							
5	BAR ID value							
6 to (n+4)	These octet(s) is/are present only if explicitly specified							

Figure 8.2.57-1: BAR ID

The BAR ID value shall be encoded as a binary integer value.

8.2.58 CP Function Features

The CP Function Features IE indicates the features supported by the CP function. Only features having an impact on the (system-wide) UP function behaviour are signalled in this IE. It is coded as depicted in Figure 8.2.58-1.

Octets	Bits							
	8	7	6	5	4	3	2	1
1 to 2	Type = 89 (decimal)							
3 to 4	Length = n							
5	Supported-Features							
6 to 7	Additional Supported-Features 1							
8 to (n+4)	These octet(s) is/are present only if explicitly specified							

Figure 8.2.58-1: CP Function Features

The CP Function Features IE takes the form of a bitmask where each bit set indicates that the corresponding feature is supported. Spare bits shall be ignored by the receiver. The same bitmask is defined for all PFCP interfaces.

The following table specifies the features defined on PFCP interfaces and the interfaces on which they apply.

Table 8.2.58-1: CP Function Features

Feature Octet / Bit	Feature	Interface	M/O	Description
5/1	LOAD	Sxa, Sxb, Sxc, N4, N4mb	O	Load Control is supported by the CP function.
5/2	OVRL	Sxa, Sxb, Sxc, N4, N4mb	O	Overload Control is supported by the CP function.
5/3	EPFAR	Sxa, Sxb, Sxc, N4	O	The CP function supports the Enhanced PFCP Association Release feature (see clause 5.18).
5/4	SSET	N4, N4mb	O	(MB-)SMF support of PFCP sessions successively controlled by different (MB-)SMFs of a same (MB-)SMF Set (see clause 5.22).
5/5	BUNDL	Sxa, Sxb, Sxc, N4, N4mb	O	PFCP messages bundling (see clause 6.5) is supported by the CP function.
5/6	MPAS	N4, N4mb	O	(MB-)SMF support for multiple PFCP associations from an (MB-)SMF set to a single (MB-)UPF (see clause 5.22.3).
5/7	ARDR	Sxb, N4	O	CP function supports Additional Usage Reports in the PFCP Session Deletion Response (see clause 5.2.2.3.1).
5/8	UIAUR	Sxb, N4	O	CP function supports the UE IP Address Usage Reporting feature, i.e. receiving and handling of UE IP Address Usage Information IE (see clause 5.21.3.2).
6/1	PSUCC	Sxb, Sxc, N4, N4mb	O	CP function supports PFCP session establishment or modification with Partial Success, i.e. with UP function reporting rules that cannot be activated. See clause 5.2.9.
6/2	RPGUR	Sxa, Sxb, N4, N4mb	O	CP function supports the Peer GTP-U Entity Restart Reporting as specified in clause 20.3.4a of 3GPP TS 23.007 [24] and in clause 5.5 of 3GPP TS 23.527 [40].
6/3	PAPFD	N4, Sxb, Sxc	O	CP function supports of partial acceptance of provisioning of the Application ID's PFDs. See also clause 5.42.
NOTE:	Features are defined as follows: - Feature Octet / Bit: The octet and bit number within the Supported-Features IE, e.g. "5 / 1". - Feature: A short name that can be used to refer to the octet / bit and to the feature. - Interface: A list of applicable interfaces to the feature. - M/O: Defines if the implementation of the feature is mandatory ("M") or optional ("O") for a CP function complying with this release of the specification. A feature defined as mandatory in this release of the specification may not necessarily be defined or mandatory to support in earlier releases (see the respective specifications), therefore a UP function complying with this release of the specification shall be prepared to receive a CP Function Features IE with a mandatory feature bit set to "0". - Description: A clear textual description of the feature.			

8.2.59 Usage Information

The Usage Information IE shall be encoded as shown in Figure 8.2.59-1. It provides additional information on the Usage Report.

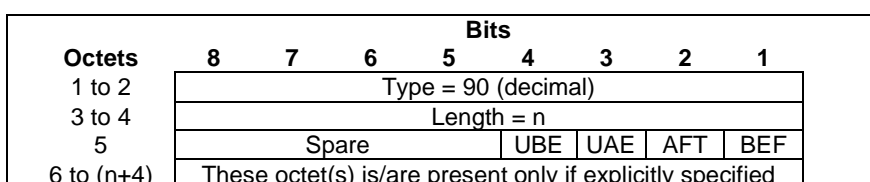

Figure 8.2.59-1: Usage Information

Octet 5 shall be encoded as follows:

- Bit 1 – BEF (Before): when set to "1", this indicates usage before a monitoring time.
- Bit 2 – AFT (After): when set to "1", this indicates a usage after a monitoring time.
- Bit 3 – UAE (Usage After Enforcement): when set to "1", this indicates a usage after QoS enforcement.
- Bit 4 – UBE (Usage Before Enforcement): when set to "1", this indicates a usage before QoS enforcement.
- Bits 5 to 8: Spare, for future use and set to "0".

8.2.60 Application Instance ID

The Application Instance ID IE type shall be encoded as shown in Figure 8.2.60-1. It contains an Application Instance Identifier referencing an application instance for which the start or stop of traffic is reported to the CP function.

Octets	Bits							
	8	7	6	5	4	3	2	1
1 to 2	Type = 91 (decimal)							
3 to 4	Length = n							
5 to (n+4)	Application Instance Identifier							

Figure 8.2.60-1: Application Instance ID

The Application Instance Identifier shall be encoded as an OctetString (see 3GPP TS 29.212 [8]).

8.2.61 Flow Information

The Flow Information IE type shall be encoded as shown in Figure 8.2.61-1. It contains the description of a flow information.

Octets	Bits							
	8	7	6	5	4	3	2	1
1 to 2	Type = 92 (decimal)							
3 to 4	Length = n							
5	Spare				Flow Direction			
6 to 7	Length of Flow Description							
8 to m	Flow Description							
p to (n+4)	These octet(s) is/are present only if explicitly specified							

Figure 8.2.61-1: Flow Information

The Flow Direction field, when present, shall be encoded as defined in Table 8.2.61-1.

Table 8.2.61-1: Flow Direction

Flow Direction	Value (Decimal)
Unspecified	0
Downlink (traffic to the UE)	1
Uplink (traffic from the UE)	2
Bidirectional	3
For future use. Shall not be sent. If received, shall be interpreted as the value "0".	4 to 7

The Flow Description field, when present, shall be encoded as an OctetString as specified in clause 5.4.2 of 3GPP TS 29.212 [8].

8.2.62 UE IP Address

The UE IP Address IE type shall be encoded as shown in Figure 8.2.62-1. It contains a source or destination IP address.

Octets	Bits							
	8	7	6	5	4	3	2	1
1 to 2	Type = 93 (decimal)							
3 to 4	Length = n							
5	Spare	IP6PL	CHV6	CHV4	IPv6D	S/D	V4	V6
m to (m+3)	IPv4 address							
p to (p+15)	IPv6 address							
r	IPv6 Prefix Delegation Bits							
s	IPv6 Prefix Length							
k to (n+4)	These octet(s) is/are present only if explicitly specified							

Figure 8.2.62-1: UE IP Address

The following flags are coded within Octet 5:

- Bit 1 – V6: If this bit is set to "1", then the CHV6 bit shall not be set and the IPv6 address field shall be present in the UE IP Address, otherwise the IPv6 address field shall not be present.
- Bit 2 – V4: If this bit is set to "1", then the CHV4 bit shall not be set and the IPv4 address field shall be present in the UE IP Address, otherwise the IPv4 address field shall not be present.
- Bit 3 – S/D: This bit is only applicable to the UE IP Address IE in the PDI IE, Create Traffic Endpoint IE and Update Traffic Endpoint IE. It shall be set to "0" and ignored by the receiver in IEs other than PDI IE. In the PDI IE, if this bit is set to "0", this indicates a Source IP address; if this bit is set to "1", this indicates a Destination IP address.
- Bit 4 – IPv6D: This bit is only applicable to the UE IP address IE in the PDI IE, Create Traffic Endpoint IE and Update Traffic Endpoint IE, when the V6 bit or CHV6 bit is set to "1". If this bit is set to "1", then the IPv6 Prefix Delegation Bits field shall be present, otherwise the UP function shall consider IPv6 prefix is default /64.
- Bit 5 – CHV4 (CHOOSE IPV4): If this bit is set to "1", then the V4 bit shall not be set, the IPv4 address shall not be present and the UP function shall assign an IPv4 address. This bit shall only be set by the CP function.
- Bit 6 – CHV6 (CHOOSE IPV6): If this bit is set to "1", then the V6 bit shall not be set, the IPv6 address shall not be present and the UP function shall assign an IPv6 address. This bit shall only be set by the CP function.
- Bit 7 – IP6PL (IPv6 Prefix Length): this bit is only applicable when the V6 bit or CHV6 bit is set to "1" and the "IPv6D" bit is set to "0", for an IPv6 prefix other than default /64, when the UP function supports the IP6PL feature as specified in clause 8.2.25. If this bit is set to "1", then the IPv6 Prefix Length field shall be present.
- Bit 8 Spare, for future use and set to "0".

Octets "m to (m+3)" or "p to (p+15)" (IPv4 address / IPv6 address fields), if present, shall contain the address value.

Octet r, if present, shall contain the number of bits allocated for IPv6 prefix delegation (relative to the default /64 IPv6 prefix), e.g. if /60 IPv6 prefix is used, the value shall be set to "4". When using UE IP address IE in a PDI to match packets, the UP function shall only use the IPv6 prefix part and ignore the interface identifier part. When the field is set to "0", the UP function shall determine a value based on the local configuration.

The IPv6 Prefix Length in octet s, when present, shall be encoded as an 8 bits binary integer, e.g. if /72 prefix is used, the value shall be set to (decimal) 72, or if /56 prefix is used, the value shall be set to (decimal) 56. The prefix length value "128" indicates an individual /128 IPv6 address. When the field is set to "0", the UP function shall determine a value based on the local configuration.

8.2.63 Packet Rate

The Packet Rate IE contains the packet rate thresholds to be enforced by the UP function. It shall be encoded as shown in Figure 8.2.63-1.

Octets	Bits							
	8	7	6	5	4	3	2	1
1 to 2	Type = 94 (decimal)							
3 to 4	Length = n							
5	Spare				APRC	DLPR	ULPR	
m	Spare				Uplink Time Unit			
(m+1) to (m+2)	Maximum Uplink Packet Rate							
p	Spare				Downlink Time Unit			
(p+1) to (p+2)	Maximum Downlink Packet Rate							
q	Spare				Additional Uplink Time Unit			
(q+1) to (q+2)	Additional Maximum Uplink Packet Rate							
r	Spare				Additional Downlink Time Unit			
(r+1) to (r+2)	Additional Maximum Downlink Packet Rate							
s to (n+4)	These octet(s) is/are present only if explicitly specified							

Figure 8.2.63-1: Packet Rate

The following flags are coded within Octet 5:

- Bit 1 – ULPR (Uplink Packet Rate): If this bit is set to "1", then octets m to (m+2) shall be present, otherwise these octets shall not be present.
- Bit 2 – DLPR (Downlink Packet Rate): If this bit is set to "1", then octets p to (p+2) shall be present, otherwise these octets shall not be present.
- Bit 3 – APRC (Additional Packet Rate Control): If this bit is set to "1", then the presence of octets q to (r+2) is determined as follows:
 - If bit 1 (ULPR) is set to "1", then octets q to (q+2), the Additional Maximum Uplink Packet Rate shall be present. Otherwise, octets q to (q+2) shall not be present;
 - If bit 2 (DLPR) is set to "1", then octets r to (r+2), the Additional Maximum Downlink Packet Rate shall be present. Otherwise, octets r to (r+2) shall not be present.
- Bits 4 to 8: Spare, for future use and set to "0".

At least one bit in Octet 5 shall be set to "1". Several bits may be set to "1".

When present, octets m to (m+2) indicate the maximum number of uplink packets allowed to be sent within the uplink time unit.

When present, octets p to (p+2) indicate the maximum number of downlink packets allowed to be sent within the downlink time unit.

When present, octets q to (q+2) indicate the additional maximum number of uplink packets allowed to be sent within the additional uplink time unit.

When present, octets r to (r+2) indicate the additional maximum number of downlink packets allowed to be sent within the additional downlink time unit.

The Additional Uplink/Downlink Time Unit shall be encoded as the Uplink/Downlink Time Unit, see Table 8.2.63.1.

Table 8.2.63.1: Uplink/Downlink Time Unit

Uplink/Downlink Time unit Bits 1 to 3 define the time unit as follows: Bits 3 2 1 0 0 0 minute 0 0 1 6 minutes 0 1 0 hour 0 1 1 day 1 0 0 week Other values shall be interpreted as 000 in this version of the protocol.
--

The Maximum Uplink/Downlink Packet Rate shall be encoded as an Unsigned16 binary integer value. They shall indicate the maximum number of uplink/downlink packets allowed to be sent in the indicated uplink/downlink time unit respectively.

The Additional Maximum Uplink/Downlink Packet Rate shall be encoded as an Unsigned16 binary integer value. They shall indicate the additional maximum number of uplink/downlink packets allowed to be sent in the indicated Additional uplink/downlink time unit respectively.

NOTE: The Serving PLMN rate control is only applicable to downlink packets with the value of Maximum Downlink Packet Rate set to equal to or higher than 10 and with the Downlink Time Unit set to 6 minutes. The Small Data Rate Control/APN rate control is applicable to both uplink/downlink packets with the Time Unit set to minute/hour/day/week.

8.2.64 Outer Header Removal

The Outer Header Removal IE type shall be encoded as shown in Figure 8.2.64-1. It contains the instructions to remove an Outer Header.

Octets	Bits						
	8	7	6	5	4	3	2
1 to 2	Type = 95 (decimal)						
3 to 4	Length = n						
5	Outer Header Removal Description						
6	GTP-U Extension Header Deletion						
7 to (n+4)	These octet(s) is/are present only if explicitly specified						

Figure 8.2.64-1: Outer Header Removal

The Outer Header Removal Description field, when present, shall be encoded as specified in Table 8.2.64-1.

Table 8.2.64-1: Outer Header Removal Description

Outer Header to be removed from the incoming packet	Value (Decimal)
GTP-U/UDP/IPv4 (NOTE 1), (NOTE 2), (NOTE 8)	0
GTP-U/UDP/IPv6 (NOTE 1), (NOTE 2)	1
UDP/IPv4 (NOTE 3, NOTE 6)	2
UDP/IPv6 (NOTE 3, NOTE 6)	3
IPv4 (NOTE 6)	4
IPv6 (NOTE 6)	5
GTP-U/UDP/IP (NOTE 4)	6
VLAN TAG POP (i.e. removal of one VLAN tag, S-TAG or C-TAG) (See NOTE 5)	7
VLAN TAGs POP-POP (i.e. removal of 2 VLAN tags, S-TAG and C-TAG) (See NOTE 5)	8
Spare, for future use. (See NOTE 7)	9 to 255
NOTE 1: The SGW-U/I-UPF shall store GTP-U extension header(s) required to be forwarded for this packet (as required by the comprehension rules of Figure 5.2.1-2 of 3GPP TS 29.281 [3]) that are not requested to be deleted by the GTP-U Extension Header Deletion field.	
NOTE 2: The SGW-U/I-UPF shall store the GTP-U message type for a GTP-U signalling message which is required to be forwarded, e.g. for an End Marker message.	
NOTE 3: This value may apply to DL packets received by a PGW-U for non-IP PDN connections with SGi tunnelling based on UDP/IP encapsulation (see clause 4.3.17.8.3.3.2 of 3GPP TS 23.401 [14]).	
NOTE 4: The CP function shall use this value to instruct UP function to remove the GTP-U/UDP/IP header regardless it is IPv4 or IPv6.	
NOTE 5: These values may apply to DL packets received by a UPF over N6 for Ethernet PDU sessions (see clause 5.8.5.3 of 3GPP TS 23.501 [28]). When the Outer Header Removal Description is set to "VLAN TAG POP", it requires the UPF to remove the VLAN tag from the top of the VLAN stack (outer VLAN tag), i.e. it removes the S-TAG or C-TAG if the user plane packet contains only one VLAN tag, or it removes the S-TAG if the user plane packet contains both a C-TAG and an S-TAG. When the Outer Header Removal Description is set to "VLAN TAGs POP-POP", it requires the UPF to remove 2 VLAN tags, S-TAG and C-TAG.	
NOTE 6: This value may apply e.g. to DL packets received by a UPF (PDU Session Anchor) over N6, when explicit N6 traffic routing information is provided to the SMF (see clause 5.6.7 of 3GPP TS 23.501 [28]).	
NOTE 7: If the UP function receives an unknown value, it shall reject the request message with the cause set to "Mandatory IE incorrect" together with the Offending IE set to the IE type of Outer Header Removal IE.	
NOTE 8: The PSA UPF shall store GTP-U extension header(s) required to be forwarded and that are not requested to be deleted by the GTP-U Extension Header Deletion field, e.g. the PDU Session Container received from the MB-UPF (for MBS session data) over N19mb interface, and modify it as instructed by the SMF, e.g. the PSA UPF may be instructed to modify the QFI field in the PDU Session Container extension header for the packets received from the MB-UPF.	

If the GTP-U extension header(s) in incoming GTP-PDUs is not required to be forwarded in the outgoing GTP-PDUs, the GTP-U Extension Header Deletion field (octet 6) shall be present to delete GTP-U extension header(s) from incoming GTP-PDUs. Octet 6 shall be absent if all GTP-U extension headers required to be forwarded shall be stored as indicated in NOTE 1 and NOTE 8 of Table 8.2.64-1.

The GTP-U Extension Header Deletion field, when present, shall be encoded as specified in Table 8.2.64-2. It takes the form of a bitmask where each bit provides instructions on the information to be deleted from the incoming GTP-PDU packet. Spare bits shall be ignored by the receiver.

Table 8.2.64-2: GTP-U Extension Header Deletion

Octet / Bit	GTP-U Extension Header to be deleted from incoming packet
6/1	PDU Session Container (NOTE)
Bit 2 to 8	Spare, for future use
NOTE: This value shall be used for data forwarding during a 5GS to EPS handover for a UPF that supports EPS-5GS interworking (see clause 5.17.3).	

8.2.65 Recovery Time Stamp

The Recovery Time Stamp IE is coded as shown in Figure 8.2.65-1. It indicates the UTC time when the PFCP entity started. Octets 5 to 8 are encoded in the same format as the first four octets of the 64-bit timestamp format as defined in clause 6 of IETF RFC 5905 [26].

NOTE: The encoding is defined as the time in seconds relative to 00:00:00 on 1 January 1900 during the era 0, which includes dates from the prime epoch, i.e. 00:00:00 on 1 January 1900, to 06:28:15 on 7th of February 2036, or relative to 06:28:16 on 7th of February 2036 when the date enters the era 1. See also clause 6 of IETF RFC 5905 [12].

Octets	Bits							
	8	7	6	5	4	3	2	1
1 to 2	Type = 96 (decimal)							
3 to 4	Length = n							
5 to 8	Recovery Time Stamp value							
9 to (n+4)	These octet(s) is/are present only if explicitly specified							

Figure 8.2.65-1: Recovery Time Stamp

8.2.66 DL Flow Level Marking

The DL Flow Level Marking IE type shall be encoded as shown in Figure 8.2.66-1.

Octets	Bits							
	8	7	6	5	4	3	2	1
1 to 2	Type = 97 (decimal)							
3 to 4	Length = n							
5	Spare					SCI	TTC	
m to (m+1)	ToS/Traffic Class							
p to (p+1)	Service Class Indicator							
q to (n+4)	These octet(s) is/are present only if explicitly specified							

Figure 8.2.66-1: DL Flow Level Marking

The following flags are coded within Octet 5:

- Bit 1 – TTC (ToS/Traffic Class): If this bit is set to "1", then the ToS/Traffic Class field shall be present, otherwise the ToS/Traffic Class field shall not be present.
- Bit 2 – SCI (Service Class Indicator): If this bit is set to "1", then the Service Class Indicator field shall be present, otherwise the Service Class Indicator field shall not be present.
- Bit 3 to 8: Spare, for future use and set to "0".

The ToS/Traffic Class field, when present, shall be encoded on two octets as an OctetString. The first octet shall contain the IPv4 Type-of-Service or the IPv6 Traffic-Class field and the second octet shall contain the ToS/Traffic Class mask field. See clause 5.3.15 of 3GPP TS 29.212 [8].

Octets p and (p+1) of the Service Class Indicator field, when present, shall be encoded respectively as octets 2 and 3 of the Service Class Indicator Extension Header specified in Figure 5.2.2.3-1 of 3GPP TS 29.281 [3].

8.2.67 Header Enrichment

The Header Enrichment IE type shall be encoded as shown in Figure 8.2.67-1. It contains information for header enrichment.

Octets	Bits						
	8	7	6	5	4	3	2
1 to 2	Type = 98 (decimal)						
3 to 4	Length = n						
5	Spare			Header Type			
6	Length of Header Field Name						
7 to m	Header Field Name						
p	Length of Header Field Value						
(p+1) to q	Header Field Value						
s to (n+4)	These octet(s) is/are present only if explicitly specified						

Figure 8.2.67-1: Header Enrichment

Header Type indicates the type of the Header. It shall be encoded as defined in Table 8.2.67-1.

Table 8.2.67-1: Header Type

Header Type	Value (Decimal)
HTTP	0
Spare, for future use.	1 to 31

Length of Header Field Name indicates the length of the Header Field Name.

Header Field Name shall be encoded as an OctetString.

Length of Header Field Value indicates the length of the Header Field Value.

Header Field Value shall be encoded as an OctetString.

For a HTTP Header Type, the contents of the Header Field Name and Header Field Value shall comply with the HTTP header field format (see clause 3.2 of IETF RFC 7230 [23]).

8.2.68 Measurement Information

The Measurement Information IE shall be encoded as shown in Figure 8.2.68-1. It provides information on the requested measurement information.

Octets	Bits							
	8	7	6	5	4	3	2	1
1 to 2	Type = 100 (decimal)							
3 to 4	Length = n							
5	CIAM	ASPO	SSPO	MNOP	ISTM	RADI	INAM	MBQE
		C	C					
6 to (n+4)	These octet(s) is/are present only if explicitly specified							

Figure 8.2.68-1: Measurement Information

Octet 5 shall be encoded as follows:

- Bit 1 – MBQE (Measurement Before QoS Enforcement): when set to "1", this indicates a request to measure the traffic usage before QoS enforcement.
- Bit 2 – INAM (Inactive Measurement): when set to "1", this indicates that the measurement shall be paused (inactive).
- Bit 3 – RADI (Reduced Application Detection Information): when set to "1", this indicates that the Application Detection Information reported to the CP function, upon detecting the start or stop of an application, shall only contain the Application ID.
- Bit 4 – ISTM (Immediate Start Time Metering): when set to "1", this indicates that time metering shall start immediately when the flag is received.

- Bit 5 – MNOP (Measurement of Number of Packets): when set to "1", this indicate a request to measure the number of packets transferred in UL/DL/Total in addition to the measurement in octets when Volume based measurement applies.
- Bit 6 – SSPOC (Send Start Pause of Charging): when set to "1", this indicate that the UP Function shall send a Start Pause of Charging indication to the upstream GTP-U entity(s) when the Dropped DL Traffic Threshold is reached.
- Bits 7 – ASPOC (Applicable for Start of Pause of Charging): when set to "1", this indicate that UP Function the the URR is applicable for Start of Pause of Charging, so that it shall stop the usage measurement for the URR when receiving Start Pause of Charging indication from the peer downstream GTP-U entity.
- Bits 8 – CIAM (Control of Inactive Measurement): when set to "1", this indicates that the UP function shall read the current value of the "INAM" flag and stop (if "INAM" is set to "1") or resume (if "INAM" is set to "0") the usage measurement accordingly for the given URR with the "APSOC" flag set to "1". If the "CIAM" flag is set to 0 for a URR with the "ASPOC" flag set to "1", the UP function shall ignore the "INAM" flag received in the Measurement Information. The "CIAM" flag shall be ignored for a URR without the ASPOC" flag set to "1".

At least one bit shall be set to "1". Several bits may be set to "1", e.g. both MBQE and MNOP bits are set to "1".

8.2.69 Node Report Type

The Node Report Type IE shall be encoded as shown in Figure 8.2.69-1. It indicates the type of the node report the UP function sends to the CP function.

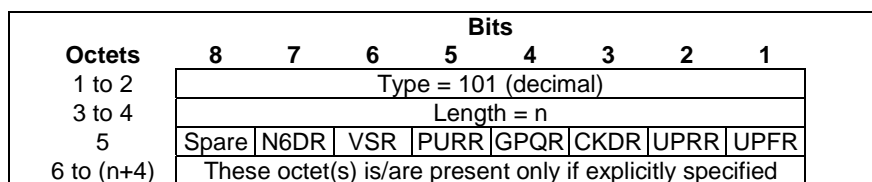

Figure 8.2.69-1: Node Report Type

Octet 5 shall be encoded as follows:

- Bit 1 – UPFR (User Plane Path Failure Report): when set to "1", this indicates a User Plane Path Failure Report.
- Bit 2 – UPRR (User Plane Path Recovery Report): when set to "1", this indicates a User Plane Path Recovery Report.
- Bit 3 – CKDR (Clock Drift Report): when set to "1", this indicates a Clock Drift Report.
- Bit 4 – GPQR (GTP-U Path QoS Report): when set to "1", this indicates a GTP-U Path QoS Report.
- Bit 5 – PURR (peer GTP-U entity Restart Report): when set to "1", this indicates a Peer GTP-U Restart report.
- Bit 6 – VSR (Vendor-Specific Report): when set to "1", this indicates a Vendor-Specific Report.
- Bit 7 – N6DR (N6 Delay Measurement Report): when set to "1", this indicates a N6 Delay Measurement Report.
- Bit 8 – Spare, for future use and set to "0".

At least one bit shall be set to "1". Several bits may be set to "1".

NOTE 1: If UPFR, UPRR and/or PURR bits are set to "1", the Remote GTP-U Peer IEs in the User Plane Path Failure Report IE, in the User Plane Path Recovery Report IE and/or Peer UP Restart Report IE are different.

NOTE 2: A Vendor-Specific Report can be used in the PFCP Node Report Request message by non-3GPP Standards Development Organizations for interfaces relying on PFCP as the protocol for Control and User Plane Separation, for reports not defined by 3GPP. See clauses 5.9 and 8.1.1 for the definition and usage of Vendor Specific IEs.

8.2.70 Remote GTP-U Peer

The Remote GTP-U Peer IE shall be encoded as depicted in Figure 8.2.70-1.

Octets	Bits						
	8	7	6	5	4	3	2
1 to 2	Type = 103 (decimal)						
3 to 4	Length = n						
5	Spare		RTS	NI	DI	V4	V6
m to (m+3)	IPv4 address						
p to (p+15)	IPv6 address						
q to (q+1)	Length of Destination Interface field						
(q+2) to r	Destination Interface field						
s to (s+1)	Length of Network Instance field						
(s+2) to t	Network Instance field						
u to (u+3)	Recovery Timestamp						
k to (n+4)	These octet(s) is/are present only if explicitly specified						

Figure 8.2.70-1: Remote GTP-U Peer

The following flags are coded within Octet 5:

- Bit 1 – V6: If this bit is set to "1", then the IPv6 address field shall be present, otherwise the IPv6 address field shall not be present.
- Bit 2 – V4: If this bit is set to "1", then the IPv4 address field shall be present, otherwise the IPv4 address field shall not be present.
- Bit 3 – DI: If this bit is set to "1", then the Length of Destination Interface field and the Destination Interface field shall be present, otherwise both the Length of Destination Interface field and the Destination Interface field shall not be present.
- Bit 4 – NI: If this bit is set to "1", then the Length of Network Instance field and the Network Instance field shall be present, otherwise both the Length of Network Instance field and the Network Instance field shall not be present.
- Bit 5 – RTS: If this bit is set to "1", then the Recovery Timestamp field shall be present.
- Bit 6 to 8 - Spare, for future use and set to "0".

Either the V4 or the V6 bit shall be set to "1".

Octets "m to (m+3)" and/or "p to (p+15)" (IPv4 address / IPv6 address fields), if present, shall contain the respective address values.

The Destination Interface field, when present, shall be encoded as the same as Destination Interface IE (from octet 5, i.e. excluding Type and Length) specified in clause 8.2.24.

The Network Instance field, when present, shall be encoded as the same as Network Instance IE (from octet 5, i.e. excluding Type and Length) specified in clause 8.2.4.

The Recovery Timestamp field shall contain the Recovery Timestamp of the peer GTP-U entity, and when present, shall be encoded as the same as the Time Stamp IE (from octet 5, i.e. excluding Type and Length) specified in clause 8.2.114.

8.2.71 UR-SEQN

The UR-SEQN (Usage Report Sequence Number) IE identifies the order in which a usage report is generated for a given URR. It shall be encoded as shown in Figure 8.2.71-1.

Octets	Bits						
	8	7	6	5	4	3	2
1 to 2	Type = 104 (decimal)						
3 to 4	Length = n						
5 to 8	UR-SEQN						

Figure 8.2.71-1: UR-SEQN

The UR-SEQN value shall be encoded as an Unsigned32 binary integer value.

8.2.72 Activate Predefined Rules

The Activate Predefined Rules IE type shall be coded as shown in Figure 8.2.72-1. It shall indicate a Predefined Rules Name, referring to one or more predefined rules which need to be activated in the UP function.

Octets	Bits						
	8	7	6	5	4	3	2
1 to 2	Type = 106 (decimal)						
3 to 4	Length = n						
5 to (n+4)	Predefined Rules Name						

Figure 8.2.72-1: Activate Predefined Rules

The Predefined Rules Name field shall be encoded as an OctetString.

8.2.73 Deactivate Predefined Rules

The Deactivate Predefined Rules IE type shall be coded as shown in Figure 8.2.73-1. It shall indicate a Predefined Rules Name, referring to one or more predefined rules which need to be deactivated in the UP function.

Octets	Bits						
	8	7	6	5	4	3	2
1 to 2	Type = 107 (decimal)						
3 to 4	Length = n						
5 to (n+4)	Predefined Rules Name						

Figure 8.2.73-1: Deactivate Predefined Rules

The Predefined Rules Name field shall be encoded as an OctetString.

8.2.74 FAR ID

The FAR ID IE type shall be encoded as shown in Figure 8.2.74-1. It shall contain a Forwarding Action Rule ID.

Octets	Bits						
	8	7	6	5	4	3	2
1 to 2	Type = 108 (decimal)						
3 to 4	Length = n						
5 to 8	FAR ID value						
9 to (n+4)	These octet(s) is/are present only if explicitly specified						

Figure 8.2.74-1: FAR ID

The FAR ID value shall be encoded as an Unsigned32 binary integer value.

The bit 8 of octet 5 is used to indicate if the Rule ID is dynamically allocated by the CP function or predefined in the UP function. If set to "0", it indicates that the Rule is dynamically provisioned by the CP Function. If set to "1", it indicates that the Rule is predefined in the UP Function.

8.2.75 QER ID

The QER ID IE type shall be encoded as shown in Figure 8.2.75-1. It shall contain a QoS Enforcement Rule ID.

Octets	Bits							
	8	7	6	5	4	3	2	1
1 to 2	Type = 109 (decimal)							
3 to 4	Length = n							
5 to 8	QER ID value							
9 to (n+4)	These octet(s) is/are present only if explicitly specified							

Figure 8.2.75-1: QER ID

The QER ID value shall be encoded as an Unsigned32 binary integer value.

The bit 8 of octet 5 is used to indicate if the Rule ID is dynamically allocated by the CP function or predefined in the UP function. If set to "0", it indicates that the Rule is dynamically provisioned by the CP Function. If set to "1", it indicates that the Rule is predefined in the UP Function.

8.2.76 OCI Flags

The OCI Flags IE shall contain the flags for overload control related information. It shall be encoded as shown in Figure 8.2.76-1.

Octets	Bits							
	8	7	6	5	4	3	2	1
1 to 2	Type = 110 (decimal)							
3 to 4	Length = n							
5	Spare						AOCI	
6 to (n+4)	These octet(s) is/are present only if explicitly specified							

Figure 8.2.76-1: OCI Flags

The following flags are coded within Octet 5:

- Bit 1 – AOCI: Associate OCI with Node ID: The UP function shall set this flag to "1" if it has included the "Overload Control Information" and if this information is to be associated with the Node ID (i.e. FQDN or the IP address used during the UP function selection) of the serving UP function. This flag shall be set to "1" by the UP function, if the "Overload Control Information" is included in the PFCP Session Establishment Response and the Cause IE is set to a rejection cause value.
- Bit 2 to 8: Spare, for future use and set to "0".

8.2.77 PFCP Association Release Request

The PFCP Association Release Request IE shall be encoded as shown in Figure 8.2.77-1.

Octets	Bits							
	8	7	6	5	4	3	2	1
1 to 2	Type = 111 (decimal)							
3 to 4	Length = n							
5	Spare						URSS	SARR
6 to (n+4)	These octet(s) is/are present only if explicitly specified							

Figure 8.2.77-1: PFCP Association Release Request

The following flags are coded within Octet 5:

- Bit 1 – SARR (PFCP Association Release Request): If this bit is set to "1", then the UP function requests the release of the PFCP association.
- Bit 2 – URSS (non-zero Usage Reports for the affected PFCP Sessions Sent): If this bit is set to "1", it indicates that the UP function has sent all the non-zero usage reports to the CP function for all PFCP sessions affected by the PFCP Association Release.
- Bit 3 to 8: Spare, for future use and set to "0".

8.2.78 Graceful Release Period

The purpose of the Graceful Release Period IE is to specify a specific time for a graceful release. The Graceful Release Period IE shall be encoded as shown in Figure 8.2.78-1 and table 8.2.78.1.

Octets	Bits						
	8	7	6	5	4	3	2
1 to 2	Type = 112 (decimal)						
3 to 4	Length = n						
5	Timer unit			Timer value			
6 to (n+4)	These octet(s) is/are present only if explicitly specified						

Figure 8.2.78-1: Graceful Release Period

Table 8.2.78.1: Graceful Release Period information element

<p>Timer value Bits 5 to 1 represent the binary coded timer value.</p> <p>Timer unit Bits 6 to 8 defines the timer value unit for the timer as follows:</p> <p>Bits</p> <p>8 7 6</p> <p>0 0 0 value is incremented in multiples of 2 seconds 0 0 1 value is incremented in multiples of 1 minute 0 1 0 value is incremented in multiples of 10 minutes 0 1 1 value is incremented in multiples of 1 hour 1 0 0 value is incremented in multiples of 10 hours 1 1 1 value indicates that the timer is infinite</p> <p>Other values shall be interpreted as multiples of 1 minute in this version of the protocol.</p> <p>Timer unit and Timer value both set to all "zeros" shall be interpreted as an indication that the timer is stopped.</p>

8.2.79 PDN Type

The PDN Type IE shall be encoded as shown in Figure 8.2.79-1. It indicates the type of a PDN connection (IP, Ethernet or Unstructured).

Octets	Bits						
	8	7	6	5	4	3	2
1 to 2	Type = 113 (decimal)						
3 to 4	Length = n						
5	Spare			PDN Type			
6 to (n+4)	These octet(s) is/are present only if explicitly specified						

Figure 8.2.79-1: PDN Type

The PDN Type shall be encoded as a 3 bits binary integer value as specified in Table 8.2.79-1.

Table 8.2.79-1: PDN Type

PDN Type	Value (Decimal)
IPv4	1
IPv6	2
IPv4v6	3
Non-IP	4
Ethernet	5
For future use. Shall not be sent.	0, 6, 7

8.2.80 Failed Rule ID

The Failed Rule ID IE type shall be encoded as shown in Figure 8.2.80-1. It shall identify the Rule which failed to be created or modified.

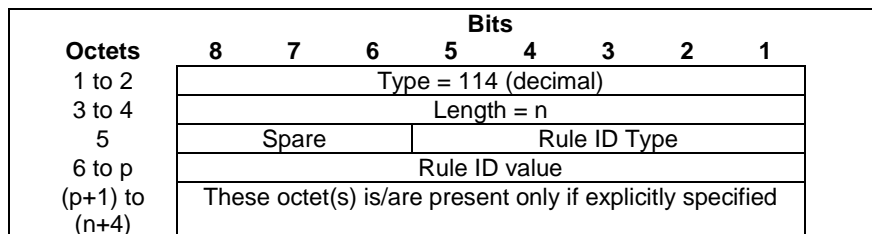

Figure 8.2.80-1: Failed Rule ID

The Rule ID Type shall be encoded as a 5 bits binary integer value as specified in Table 8.2.80-1.

Table 8.2.80-1: Rule ID Type

Rule ID Type	Value (Decimal)
PDR	0
FAR	1
QER	2
URR	3
BAR	4
MAR	5
SRR	6
For future use. Shall not be sent. If received, shall be interpreted as the value "1".	7 to 31

The length and the value of the Rule ID value field shall be set as specified for the PDR ID, FAR ID, QER ID, URR ID, BAR ID, MAR ID and SRR ID IE types respectively.

8.2.81 Time Quota Mechanism

The Time Quota Mechanism type shall be encoded as shown in Figure 8.2.81-1.

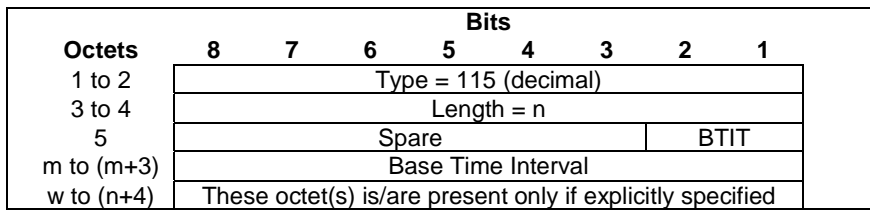

Figure 8.2.81-1: Time Quota Mechanism

BTIT (Base Time Interval Type) indicates the type of the interval to be provided in the Base Time Interval field.

Table 8.2.81-1: Base Time Interval Type

Base Time Interval Type	Value (Decimal)
CTP	0
DTP	1
Spare, for future use.	2 to 3

The Base Time Interval, shall be encoded as Unsigned32 as specified in clause 7.2.29 of 3GPP TS 32.299 [18].

8.2.82 Void

8.2.83 User Plane Inactivity Timer

The User Plane Inactivity Timer IE contains the inactivity time period, in seconds, to be monitored by the UP function. It shall be encoded as shown in Figure 8.2.83-1.

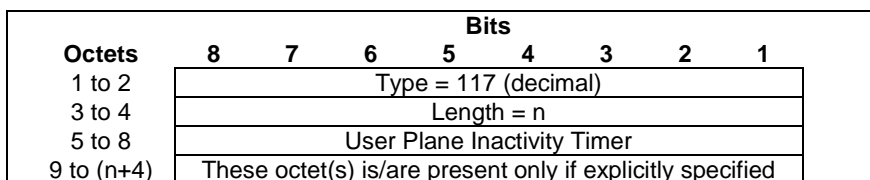

Figure 8.2.83-1: User Plane Inactivity Timer

The User Plane Inactivity Timer field shall be encoded as an Unsigned32 binary integer value. The timer value "0" shall be interpreted as an indication that user plane inactivity detection and reporting is stopped.

8.2.84 Multiplier

The Multiplier IE type shall be encoded as shown in Figure 8.2.84-1. It contains a Multiplier (see IETF RFC 4006 [16]) to measure the abstract service units the traffic of an aggregated URR consumes from the credit pool.

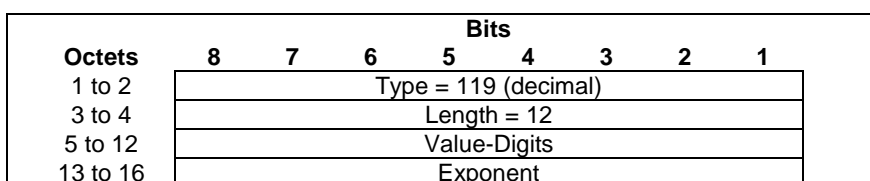

Figure 8.2.84-1: Multiplier

The Value-Digit value and Exponent value shall be encoded as binary integer value, and set the value as in Value-Digit AVP and Exponent AVP as specified in 3GPP TS 32.299 [18].

8.2.85 Aggregated URR ID IE

The Aggregated URR ID IE type shall be encoded as shown in Figure 8.2.85-1. It contains a URR ID.

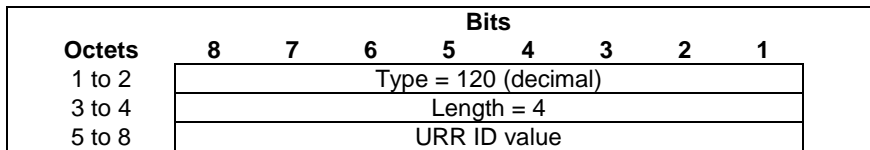

Figure 8.2.85-1: Aggregated URR ID

Each URR ID value shall be encoded as an Unsigned32 binary integer value.

8.2.86 Subsequent Volume Quota

The Subsequent Volume Quota IE type shall be encoded as shown in Figure 8.2.86-1. It contains the volume quota to be monitored by the UP function after the Monitoring Time.

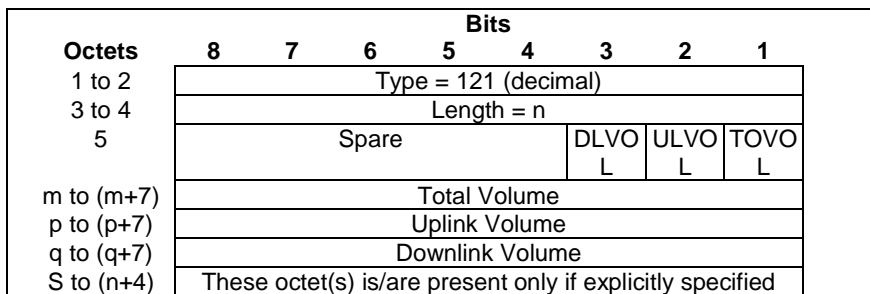

Figure 8.2.86-1: Subsequent Volume Quota

The following flags are coded within Octet 5:

- Bit 1 – TOVOL: If this bit is set to "1", then the Total Volume field shall be present, otherwise the Total Volume field shall not be present.
- Bit 2 – ULVOL: If this bit is set to "1", then the Uplink Volume field shall be present, otherwise the Uplink Volume field shall not be present.
- Bit 3 – DLVOL: If this bit is set to "1", then the Downlink Volume field shall be present, otherwise the Downlink Volume field shall not be present.
- Bit 4 to bit 8: Spare, for future use and set to "0".

At least one bit shall be set to "1". Several bits may be set to "1".

The Total Volume, Uplink Volume and Downlink Volume fields shall be encoded as an Unsigned64 binary integer value. They shall contain the total, uplink or downlink number of octets respectively.

8.2.87 Subsequent Time Quota

The Subsequent Time Quota IE type shall be encoded as shown in Figure 8.2.87-1. It contains the time quota to be monitored by the UP function after the Monitoring Time.

Octets	Bits							
	8	7	6	5	4	3	2	1
1 to 2	Type = 122 (decimal)							
3 to 4	Length = n							
5 to 8	Time Quota value							
9 to (n+4)	These octet(s) is/are present only if explicitly specified							

Figure 8.2.87-1: Subsequent Time Quota

The Time Quota value shall be encoded as an Unsigned32 binary integer value. It contains a duration in seconds.

8.2.88 RQI

The Reflective QoS Indicator (RQI) IE shall be encoded as shown in Figure 8.2.88-1. It indicates if Reflective QoS applies for the UL.

Octets	Bits							
	8	7	6	5	4	3	2	1
1 to 2	Type = 123 (decimal)							
3 to 4	Length = n							
5	Spare						RQI	
6 to (n+4)	These octet(s) is/are present only if explicitly specified							

Figure 8.2.88-1: RQI

The value of RQI flag shall be set as follows:

- RQI set to 0: deactivate Reflective QoS;
- RQI set to 1: activate Reflective QoS.

See also clause 5.5.3.4 of 3GPP TS 38.415 [34].

8.2.89 QFI

The QFI IE type shall be encoded as shown in Figure 8.2.89-1. It contains an QoS flow identifier identifying a QoS flow in a 5G system filter.

Octets	Bits							
	8	7	6	5	4	3	2	1
1 to 2	Type = 124 (decimal)							
3 to 4	Length = n							
5	Spare			QFI value				
p to (n+4)	These octet(s) is/are present only if explicitly specified							

Figure 8.2.89-1: QFI

The QFI value shall be encoded as binary integer value, as specified in clause 5.5.3.3 of 3GPP TS 38.415 [34].

8.2.90 Query URR Reference

The Query URR Reference IE type shall be encoded as shown in Figure 8.2.90-1. It shall contain the reference of a query request for URR(s).

Octets	Bits						
	8	7	6	5	4	3	2
1 to 2	Type = 125 (decimal)						
3 to 4	Length = n						
5 to 8	Query URR Reference value						
9 to (n+4)	These octet(s) is/are present only if explicitly specified						

Figure 8.2.90-1: Query URR Reference

The Query URR Reference value shall be encoded as an Unsigned32 binary integer value.

8.2.91 Additional Usage Reports Information

The Additional Usage Reports Information IE type shall be encoded as shown in Figure 8.2.91-1. It shall either indicate that additional usage reports will follow, or contain the total number of usage reports that need to be sent in all the additional PCFP Session Report Request messages after the PCFP Session Modification Response or PCFP Session Deletion Response (see clause 5.2.2.3.1).

Octets	Bits						
	8	7	6	5	4	3	2
1 to 2	Type = 126 (decimal)						
3 to 4	Length = n						
5	AURI	Number of Additional Usage Reports value					
6	Number of Additional Usage Reports value						
7 to (n+4)	These octet(s) is/are present only if explicitly specified						

Figure 8.2.91-1: Additional Usage Reports Information

The Number of Additional Usage Reports value shall be encoded as an unsigned binary integer value on 15 bits. Bit 7 of Octet 5 is the most significant bit and bit 1 of Octet 6 is the least significant bit.

The bit 8 of octet 5 shall encode the AURI (Additional Usage Reports Indication) flag:

- when set to "1", it indicates that additional usage reports will follow. In this case, the Number of Additional Usage Reports value shall be set to "0" by the sender and ignored by the receiver;
- when set to "0", the Number of Additional Usage Reports value shall be set to the total number of additional usage reports to be sent in PCFP Session Report Request messages.

8.2.92 Traffic Endpoint ID

The Traffic Endpoint ID IE type shall be encoded as shown in Figure 8.2.92-1. It shall contain a Traffic Endpoint ID.

Octets	Bits						
	8	7	6	5	4	3	2
1 to 2	Type = 131 (decimal)						
3 to 4	Length = n						
5	Traffic Endpoint ID value						
6 to (n+4)	These octet(s) is/are present only if explicitly specified						

Figure 8.2.92-1: Traffic Endpoint ID

The Traffic Endpoint ID value shall be encoded as a binary integer value within the range of 0 to 255.

8.2.93 MAC address

The MAC address IE shall be encoded as shown in Figure 8.2.93-1. It shall contain an MAC address value.

Octets	Bits							
	8	7	6	5	4	3	2	1
1 to 2	Type = 133 (decimal)							
3 to 4	Length = n							
5	spare				UDES	USO	DEST	SOU
m to (m+5)	Source MAC address value							
n to (n+5)	Destination MAC address value							
o to (o+5)	Upper Source MAC address value							
p to (p+5)	Upper Destination MAC address value							
s to (n+4)	These octet(s) is/are present only if explicitly specified							

Figure 8.2.93-1: MAC address

The following flags are coded within Octet 5:

- Bit 1 – SOUR (Source): If this bit is set to "1", then the source MAC address value is provided.
- Bit 2 – DEST (Destination): If this bit is set to "1", then the destination MAC address value is provided.
- Bit 3 – USOU (Source): If this bit is set to "1", then the source MAC address value contains the lower value and Upper Source MAC address value contains the upper value of an MAC address range.
- Bit 4 – UDES (Destination): If this bit is set to "1", then the destination MAC address value contains the lower value and Upper Destination MAC address value contains the upper value of an MAC address range.- Bit 5 to 8: Spare, for future use and set to "0".

Octets "m to (m+5)" or "n to (n+5)" and "o to (o+5)" or "p to (p+5)", if present, shall contain an MAC address value (12-digit hexadecimal numbers).

8.2.94 C-TAG (Customer-VLAN tag)

The C-TAG IE shall be encoded as shown in Figure 8.2.94-1. It shall contain the Customer-VLAN tag (C-TAG) as defined in IEEE 802.1Q [30].

Octets	Bits							
	8	7	6	5	4	3	2	1
1 to 2	Type = 134 (decimal)							
3 to 4	Length = n							
5	Spare				VID	DEI	PCP	
6	C-VID value				DEI Flag	PCP value		
7	C-VID Value							
8 to (n+4)	These octet(s) is/are present only if explicitly specified							

Figure 8.2.94-1: C-TAG (Customer-VLAN tag)

The following flags are coded within Octet 5:

- Bit 1 – PCP: If this bit is set to "1", then PCP Value field shall used by the receiver, otherwise the PCP Value field shall be ignored.
- Bit 2 – DEI: If this bit is set to "1", then DEI flag field shall used by the receiver, otherwise the DEI flag field shall be ignored.
- Bit 3 – VID: If this bit is set to "1", then C-VID value field shall used by the receiver, otherwise the VID Value field shall be ignored.
- Bit 4 to 8 – spare and reserved for future use.

The PCP value, DEI flag and C-VID Value are specified in IEEE 802.1Q [30] tag format.

Octet 6 / Bit 3 shall contain the most significant bit of the PCP value.

Octet 6 / Bit 8 shall be the most significant bit of the C-VID value and Octet 7 / Bit 1 shall be the least significant bit (see clause 7.1).

NOTE: The encoding of the C-Tag in PFCP differs from the encoding of the C-Tag defined in IEEE 802.1Q [30].

8.2.95 S-TAG (Service-VLAN tag)

The S-TAG IE type shall be encoded as shown in Figure 8.2.95-1. It shall contain Service-VLAN tag (S-TAG) as defined in IEEE 802.1Q [30]

Octets	Bits							
	8	7	6	5	4	3	2	1
1 to 2	Type = 135 (decimal)							
3 to 4	Length = n							
5	Spare				VID	DEI	PCP	
6	S-VID value				DEI Flag	PCP value		
7	S-VID value							
8 to (n+4)	These octet(s) is/are present only if explicitly specified							

Figure 8.2.95-1: S-TAG (Service-VLAN tag)

The following flags are coded within Octet 5:

- Bit 1 – PCP: If this bit is set to "1", then PCP Value field shall used by the receiver, otherwise the PCP Value field shall be ignored.
- Bit 2 – DEI: If this bit is set to "1", then DEI flag field shall used by the receiver, otherwise the DEI flag field shall be ignored.
- Bit 3 – VID: If this bit is set to "1", then VID value field shall used by the receiver, otherwise the VID Value field shall be ignored.
- Bit 4 to 8 – spare and reserved for future use.

The PCP value, DEI flag and S-VID Value are specified in IEEE 802.1Q [30] tag format.

Octet 6 / Bit 3 shall contain the most significant bit of the PCP value.

Octet 6 / Bit 8 shall be the most significant bit of the S-VID value and Octet 7 / Bit 1 shall be the least significant bit (see clause 7.1).

NOTE: The encoding of the S-Tag in PFCP differs from the encoding of the S-Tag defined in IEEE 802.1Q [30].

8.2.96 Ethertype

The Ethertype IE type shall be encoded as shown in Figure 8.2.96-1. It contains an Ethertype as defined in IEEE 802.3 [31].

Octets	Bits							
	8	7	6	5	4	3	2	1
1 to 2	Type = 136 (decimal)							
3 to 4	Length = n							
5 to 6	Ethertype							
7 to (n+4)	These octet(s) is/are present only if explicitly specified							

Figure 8.2.96-1: Ethertype

8.2.97 Proxying

The Proxying IE shall be encoded as shown in Figure 8.2.97-1. It specifies if responding to Address Resolution Protocol (ARP) (see IETF RFC 826 [32]) and / or IPv6 Neighbour Solicitation (see IETF RFC 4861 [33]) as specified in clause 5.6.10.2 of 3GPP TS 23.501 [28], functionality for the Ethernet PDUs is performed in UPF.

Octets	Bits							
	8	7	6	5	4	3	2	1
1 to 2	Type = 137 (decimal)							
3 to 4	Length = n							
5	Spare						INS	ARP
6 to (n+4)	These octet(s) is/are present only if explicitly specified							

Figure 8.2.97-1: Proxying

The following flags are coded within Octet 5:

- Bit 1 – ARP: If this bit is set to "1", then responding ARP is performed in UPF based on local cache information.
- Bit 2 – INS: If this bit is set to "1", then responding to IPv6 Neighbour Solicitation is performed in UPF based on local cache information.
- Bit 3 to 8 – spare and reserved for future use.

8.2.98 Ethernet Filter ID

The Ethernet Filter ID IE type shall be encoded as shown in Figure 8.2.98-1.

Octets	Bits							
	8	7	6	5	4	3	2	1
1 to 2	Type = 138 (decimal)							
3 to 4	Length = n							
5 to 8	Ethernet Filter ID value							
10 to (n+4)	These octet(s) is/are present only if explicitly specified							

Figure 8.2.98-1: Ethernet Filter ID

The Ethernet Filter ID value shall be encoded as an Unsigned32 binary integer value.

8.2.99 Ethernet Filter Properties

The Ethernet Filter Properties IE type shall be encoded as shown in Figure 8.2.99-1.

Octets	Bits							
	8	7	6	5	4	3	2	1
1 to 2	Type = 139 (decimal)							
3 to 4	Length = n							
5	Spare						BIDE	
6 to (n+4)	These octet(s) is/are present only if explicitly specified							

Figure 8.2.99-1: Ethernet Filter Properties

The following flags are coded within Octet 5:

- Bit 1 – BIDE (Bidirectional Ethernet Filter): If this bit is set to "1", then the Ethernet Filter identified by the Ethernet Filter ID is bidirectional.

- Bit 2 to 8 – spare and reserved for future use.

8.2.100 Suggested Buffering Packets Count

The Suggested Buffering Packets Count IE indicates the number of packets (including both UL and DL packets) that are suggested to be buffered by the UP function while waiting for the new instruction from the CP function. It is coded as depicted in Figure 8.2.100-1.

Octets	Bits							
	8	7	6	5	4	3	2	1
1 to 2	Type = 140 (decimal)							
3 to 4	Length = n							
5	Packet Count value							
6 to (n+4)	These octet(s) is/are present only if explicitly specified							

Figure 8.2.100-1: Suggested Buffering Packets Count

The Packet Count value is encoded in octet 5 and the range of the Packet Count value is from 0 to 255.

8.2.101 User ID

The User ID IE type shall be encoded as shown in Figure 8.2.101-1.

Octets	Bits							
	8	7	6	5	4	3	2	1
1 to 2	Type = 141 (decimal)							
3 to 4	Length = n							
5	Spare	PEIF	GPSI F	SUPIF	NAIF	MSIS DNF	IMEIF	IMSIF
6	Length of IMSI							
7 to a	IMSI							
b	Length of IMEI							
(b+1) to c	IMEI							
d	Length of MSISDN							
(d+1) to e	MSISDN							
f	Length of NAI							
(f+1) to g	NAI							
h	Length of SUPI							
(h+1) to i	SUPI							
j	Length of GPSI							
(j+1) to k	GPSI							
l	Length of PEI							
(l+1) to m	PEI							
p to (n+4)	These octet(s) is/are present only if explicitly specified							

Figure 8.2.101-1: User ID

The following flags are coded within Octet 5:

- Bit 1 – IMSIF: If this bit is set to "1", then the Length of IMSI and IMSI fields shall be present, otherwise these fields shall not be present.
- Bit 2 – IMEIF: If this bit is set to "1", then the Length of IMEI and IMEI fields shall be present, otherwise these fields shall not be present.
- Bit 3 – MSISDNF: If this bit is set to "1", then the Length of MSISDN and MSISDN fields shall be present, otherwise these fields shall not be present.
- Bit 4 – NAIF: If this bit is set to "1", then the Length of NAI and NAI fields shall be present, otherwise these fields shall not be present.

- Bit 5 – SUPIF: If this bit is set to "1", then the Length of SUPI and SUPI fields shall be present, otherwise these fields shall not be present.
- Bit 6 – GPSIF: If this bit is set to "1", then the Length of GPSI and GPSI fields shall be present, otherwise these fields shall not be present.
- Bit 7 – PEIF: If this bit is set to "1", then the Length of PEI and PEI fields shall be present, otherwise these fields shall not be present.- Bit 8: Spare, for future use and set to "0".

One or more flags may be set to "1".

For 5GS User Identities:

- The SUPI field shall only be used for carrying a Global Cable Identifier (GCI) or a Global Line Identifier (GLI). The IMSI and NAI, if received by the SMF in the SUPI, shall be included in the IMSI and NAI field respectively.
- The GPSI field shall only be used for carrying an External Identifier. The MSISDN, if received by the SMF in the SUPI, shall be included in the MSISDN field.
- The PEI field shall only be used for carrying an MAC address or an Extended Unique Identifier. The IMEI, if received by the SMF in the PEI, shall be included in the IMEI field.

The coding of IMSI field, from octets 7 to 'a' shall be encoded as the octets 5 to n+4 of the IMSI IE type specified in clause 8.3 of 3GPP TS 29.274 [9].

The coding of IMEI field, in octets 'b+1' to 'c' shall be encoded as the octets 5 to n+4 of the MEI IE type specified in clause 8.10 of 3GPP TS 29.274 [9].

The coding of MSISDN field, in octets 'd+1' to 'e' shall be encoded as the octets 5 to n+4 of the MSISDN IE type specified in clause 8.11 of 3GPP TS 29.274 [9].

The coding of the SUPI field, in octets 'h+1' to 'i' shall be encoded as the Supi data type specified in clause 5.3.2 of 3GPP TS 29.571 [61].

The coding of the GPSI field, in octets 'j+1' to 'k' shall be encoded as the Gpsi data type specified in clause 5.3.2 of 3GPP TS 29.571 [61].

The coding of the PEI field, in octets 'l+1' to 'm' shall be encoded as the Pei data type specified in clause 5.3.2 of 3GPP TS 29.571 [61].

The NAI field, in octets 'f+1' to 'g' shall be encoded as an Octet String (see IETF RFC 4282 [36]).

8.2.102 Ethernet PDU Session Information

Ethernet PDU Session Indication is coded as depicted in Figure 8.2.102-1.

Octets	Bits							
	8	7	6	5	4	3	2	1
1 to 2	Type = 142 (decimal)							
3 to 4	Length = n							
5	Spare							ETHI
k to (n+4)	These octet(s) is/are present only if explicitly specified							

Figure 8.2.102-1: Ethernet PDU Session Information

The following flags are coded within Octet 5:

- Bit 1 – ETHI (Ethernet Indication): This bit shall be set to "1". This refers to all the DL traffic matching the Ethernet PDU session (see clause 5.13.1).
- Bit 2 to 8 are spare and reserved for future use.

8.2.103 MAC Addresses Detected

The MAC Addresses Detected IE shall be encoded as shown in Figure 8.2.103-1. It shall contain a list of MAC address values.

Octets	Bits						
	8	7	6	5	4	3	2
1 to 2	Type = 144 (decimal)						
3 to 4	Length = n						
5	Number of MAC addresses (k)						
6 to 11	MAC address value 1						
o to (o+5)	MAC address value 2						
p to (p+5)	...						
q to (q+5)	MAC address value k						
s	Length of C-TAG field						
(s+1) to t	C-TAG						
u	Length of S-TAG field						
(u+1) to v	S-TAG						
w to (n+4)	These octet(s) is/are present only if explicitly specified						

Figure 8.2.103-1: MAC addresses Detected

Octet 5 shall encode the number of 48-bit MAC addresses.

MAC address values shall be encoded as 12-digit hexadecimal numbers.

The Length of C-TAG field shall indicate the length of the C-TAG field. It shall be set to 0 if the C-TAG field is absent.

When present, the C-TAG field shall be encoded as the Customer-VLAN tag defined in clause 8.2.94, excluding octets 1 to 4.

The Length of S-TAG field shall indicate the length of the S-TAG field. It shall be set to 0 if the S-TAG field is absent.

When present, the S-TAG field shall be encoded as the Service-VLAN Tag defined in clause 8.2.95, excluding octets 1 to 4.

8.2.104 MAC Addresses Removed

The MAC Addresses Removed IE shall be encoded as shown in Figure 8.2.104-1. It shall contain a list of MAC address values.

Octets	Bits						
	8	7	6	5	4	3	2
1 to 2	Type = 145 (decimal)						
3 to 4	Length = n						
5	Number of MAC addresses (k)						
6 to 11	MAC address value 1						
o to (o+5)	MAC address value 2						
p to (p+5)	...						
q to (q+5)	MAC address value k						
s	Length of C-TAG field						
(s+1) to t	C-TAG						
u	Length of S-TAG field						
(u+1) to v	S-TAG						
w to (n+4)	These octet(s) is/are present only if explicitly specified						

Figure 8.2.104-1: MAC addresses Removed

Octet 5 shall encode the number of 48-bit MAC addresses.

MAC address values shall be encoded as 12-digit hexadecimal numbers.

The Length of C-TAG field shall indicate the length of the C-TAG field. It shall be set to 0 if the C-TAG field is absent. When present, the C-TAG field shall be encoded as the Customer-VLAN tag defined in clause 8.2.94, excluding octets 1 to 4.

The Length of S-TAG field shall indicate the length of the S-TAG field. It shall be set to 0 if the S-TAG field is absent. When present, the S-TAG field shall be encoded as the Service-VLAN Tag defined in clause 8.2.95, excluding octets 1 to 4.

8.2.105 Ethernet Inactivity Timer

The Ethernet Inactivity Timer IE contains the inactivity time period, in seconds, to be monitored by the UP function, to detect that a UE MAC address is inactive. It shall be encoded as shown in Figure 8.2.105-1.

Octets	Bits							
	8	7	6	5	4	3	2	1
1 to 2	Type = 146 (decimal)							
3 to 4	Length = n							
5 to 8	Ethernet Inactivity Timer							
9 to (n+4)	These octet(s) is/are present only if explicitly specified							

Figure 8.2.105-1: Ethernet Inactivity Timer

The Ethernet Inactivity Timer field shall be encoded as an Unsigned32 binary integer value.

8.2.106 Subsequent Event Quota

The Subsequent Event Quota IE type shall be encoded as shown in Figure 8.2.106-1. It contains the event quota to be monitored by the UP function.

Octets	Bits							
	8	7	6	5	4	3	2	1
1 to 2	Type = 150 (decimal)							
3 to 4	Length = n							
5 to 8	Subsequent Event Quota							
9 to (n+4)	These octet(s) is/are present only if explicitly specified							

Figure 8.2.106-1: Subsequent Event Quota

The Subsequent Event Quota field shall be encoded as an Unsigned32 binary integer value.

8.2.107 Subsequent Event Threshold

The Subsequent Event Threshold IE contains the Number of events after which the measurement report is to be generated by the UP function. It shall be encoded as shown in Figure 8.2.107-1.

Octets	Bits							
	8	7	6	5	4	3	2	1
1 to 2	Type = 151 (decimal)							
3 to 4	Length = n							
5 to 8	Subsequent Event Threshold							
9 to (n+4)	These octet(s) is/are present only if explicitly specified							

Figure 8.2.107-1: Subsequent Event Threshold

The Subsequent Event Threshold field shall be encoded as an Unsigned32 binary integer value.

8.2.108 Trace Information

The Trace Information IE type shall be encoded as shown in Figure 8.2.108-1. It contains the trace control and configuration parameters to apply for the PFCP session.

Octets	Bits							
	8	7	6	5	4	3	2	1
1 to 2	Type = 152 (decimal)							
3 to 4	Length = n							
5	MCC digit 2				MCC digit 1			
6	MNC digit 3				MCC digit 3			
7	MNC digit 2				MNC digit 1			
8 to 10	Trace ID							
11	Length of Triggering Events							
12 to m	Triggering Events							
m+1	Session Trace Depth							
m+2	Length of List of Interfaces							
(m+3) to p	List of Interfaces							
p+1	Length of IP Address of Trace Collection Entity							
(p+2) to q	IP Address of Trace Collection Entity							
(q+1) to (n-4)	These octet(s) is/are present only if explicitly specified							

Figure 8.2.108-1: Trace Information

Octets 5 to 10 represent the Trace Reference parameter as defined in clause 5.6 of 3GPP TS 32.422 [35].

Triggering Events, Session Trace Depth, List of Interfaces and IP Address of Trace Collection Entity are specified in 3GPP TS 32.422 [35].

Octets "(p+2) to q" shall contain an IPv4 address value (4 octets) or IPv6 address value (16 octets).

See 3GPP TS 24.008 [5], clause 10.5.1.4, Mobile Identity, for the coding of MCC and MNC. If MNC is 2 digits long, bits 5 to 8 of octet 6 are coded as "1111".

8.2.109 Framed-Route

The Framed-Route IE describes a framed route. It shall be encoded as shown in Figure 8.2.109-1.

Octets	Bits							
	8	7	6	5	4	3	2	1
1 to 2	Type = 153 (decimal)							
3 to 4	Length = n							
5 to (n+4)	Framed-Route							

Figure 8.2.109-1: Framed-Route

The Framed-Route field shall be encoded as an Octet String as the value part of the Framed-Route AVP specified in IETF RFC 2865 [37].

8.2.110 Framed-Routing

The Framed-Routing IE describes the frame routing of a framed route. It shall be encoded as shown in Figure 8.2.110-1.

Octets	Bits						
	8	7	6	5	4	3	2
1 to 2	Type = 154 (decimal)						
3 to 4	Length = 4						
5 to 8	Framed-Routing						

Figure 8.2.110-1: Framed-Routing

The Framed-Routing field shall be encoded as the value part of the Framed-Routing AVP specified in IETF RFC 2865 [37].

8.2.111 Framed-IPv6-Route

The Framed-IPv6-Route IE describes a framed IPv6 route. It shall be encoded as shown in Figure 8.2.111-1.

Octets	Bits						
	8	7	6	5	4	3	2
1 to 2	Type = 155 (decimal)						
3 to 4	Length = n						
5 to (n+4)	Framed-IPv6-Route						

Figure 8.2.111-1: Framed-IPv6-Route

The Framed-IPv6-Route field shall be encoded as an Octet String as the value part of the Framed-IPv6-Route AVP specified in IETF RFC 3162 [38].

8.2.112 Event Quota

The Event Quota IE type shall be encoded as shown in Figure 8.2.112-1. It contains the event quota to be monitored by the UP function.

Octets	Bits						
	8	7	6	5	4	3	2
1 to 2	Type = 148 (decimal)						
3 to 4	Length = n						
5 to 8	Subsequent Event Quota						
9 to (n+4)	These octet(s) is/are present only if explicitly specified						

Figure 8.2.112-1: Event Quota

The Event Quota field shall be encoded as an Unsigned32 binary integer value.

8.2.113 Event Threshold

The Event Threshold IE contains the Number of events after which the measurement report is to be generated by the UP function. It shall be encoded as shown in Figure 8.2.113-1.

Octets	Bits						
	8	7	6	5	4	3	2
1 to 2	Type = 149 (decimal)						
3 to 4	Length = n						
5 to 8	Event Threshold						
9 to (n+4)	These octet(s) is/are present only if explicitly specified						

Figure 8.2.113-1: Event Threshold

The Event Threshold field shall be encoded as an Unsigned32 binary integer value.

8.2.114 Time Stamp

The Time Stamp IE indicates the time stamp when certain event occurs or certain operation occurs. It shall be encoded as shown in Figure 8.2.114-1.

Octets	Bits						
	8	7	6	5	4	3	2
1 to 2	Type = 156 (decimal)						
3 to 4	Length = n						
5 to 8	Time Stamp						
9 to (n+4)	These octet(s) is/are present only if explicitly specified						

Figure 8.2.114-1: Time Stamp

The Time Stamp field shall contain a UTC time. Octets 5 to 8 shall be encoded in the same format as the first four octets of the 64-bit timestamp format as defined in clause 6 of IETF RFC 5905 [12].

NOTE: The encoding is defined as the time in seconds relative to 00:00:00 on 1 January 1900 during the era 0, which includes dates from the prime epoch, i.e. 00:00:00 on 1 January 1900, to 06:28:15 on 7th of February 2036, or relative to 06:28:16 on 7th of February 2036 when the date enters the era 1. See also clause 6 of IETF RFC 5905 [12].

8.2.115 Averaging Window

The Averaging Window IE shall contain the duration over which the GFBR and MFBR is calculated (see clause 5.7.3.6 of 3GPP TS 23.501 [28]), or the duration over which the Session-AMBR is measured (see clause 5.7.2.6 of 3GPP TS 23.501 [28]), or the duration over which the Authorized DL Session AMBR for Offloading is measured. It shall be encoded as shown in Figure 8.2.115-1.

Octets	Bits						
	8	7	6	5	4	3	2
1 to 2	Type = 157 (decimal)						
3 to 4	Length = n						
5 to 8	Averaging Window						
9 to (n+4)	These octet(s) is/are present only if explicitly specified						

Figure 8.2.115-1: Averaging Window

The Averaging Window field shall be encoded as an Unsigned32 binary integer value. It shall contain the duration in ms.

8.2.116 Paging Policy Indicator (PPI)

The Paging Policy Indicator (PPI) IE indicates a PPI value for paging policy differentiation. It shall be encoded as shown in Figure 8.2.116-1.

Octets	Bits						
	8	7	6	5	4	3	2
1 to 2	Type = 158 (decimal)						
3 to 4	Length = n						
5	Spare				PPI value		
6 to (n+4)	These octet(s) is/are present only if explicitly specified						

Figure 8.2.116-1: Paging Policy Indicator (PPI)

The PPI value shall be encoded as a value between 0 and 7, as specified in clause 5.5.3.7 of 3GPP TS 38.415 [34].

8.2.117 APN/DNN

Access Point Name (APN) / Data Network Name (DNN) is transferred from CP function to UP function.

Octets	Bits						
	8	7	6	5	4	3	2
1 to 2	Type = 159 (decimal)						
3 to 4	Length = n						
5 to (n+4)	APN/DNN						

Figure 8.2.117-1: APN/DNN

The encoding the APN/DNN field follows 3GPP TS 23.003 [2] clause 9.1. The content of the APN/DNN field shall be the full APN/DNN with both the APN/DNN Network Identifier and APN/DNN Operator Identifier being present as specified in 3GPP TS 23.003 [2] clauses 9.1.1 and 9.1.2, 3GPP TS 23.060 [19] Annex A and 3GPP TS 23.401 [14] clauses 4.3.8.1.

NOTE: The APN/DNN field is not encoded as a dotted string as commonly used in documentation.

8.2.118 3GPP Interface Type

The 3GPP Interface Type IE shall be encoded as shown in Figure 8.2.118-1. It indicates the 3GPP interface type of the Source Interface within the PDR IE, or the 3GPP interface type of the Destination Interface within the FAR IE.

Octets	Bits						
	8	7	6	5	4	3	2
1 to 2	Type = 160 (decimal)						
3 to 4	Length = n						
5	Spare	Interface Type value					
6 to (n+4)	These octet(s) is/are present only if explicitly specified						

Figure 8.2.118-1: 3GPP Interface Type

The 3GPP Interface Type value shall be encoded as a 6 bits binary integer as specified in in Table 8.2.118-1.

Table 8.2.118-1: Interface Type value

Interface value	Values (Decimal)
S1-U	0
S5 /S8-U (NOTE 1)	1
S4-U	2
S11-U	3
S12	4
Gn/Gp-U (NOTE 2)	5
S2a-U	6
S2b-U	7
eNodeB GTP-U interface for DL data forwarding	8
eNodeB GTP-U interface for UL data forwarding	9
SGW/UPF GTP-U interface for DL data forwarding	10
N3 3GPP Access	11
N3 Trusted Non-3GPP Access	12
N3 Untrusted Non-3GPP Access	13
N3 for data forwarding	14
N9 (or N9 for non-roaming, see NOTE 3)	15
SGi	16
N6	17
N19	18
S8-U	19
Gp-U	20
N9 for roaming	21
lu-U	22
N9 for data forwarding	23
Sxa-U	24
Sxb-U	25
Sxc-U	26
N4-U	27
SGW/UPF GTP-U interface for UL data forwarding	28
N6mb/Nmb9	29
N3mb	30
N19mb	31
Spare	32 to 63
NOTE 1: If separation of roaming and non-roaming traffic is desired this value should only be used for the S5-U interface and "S8-U" (decimal 19) should be used for the S8-U interface.	
NOTE 2: If separation of roaming and non-roaming traffic is desired this value should only be used for the Gn-U interface and "Gp-U" (decimal 20) should be used for the Gp-U interface.	
NOTE 3: If separation of roaming and non-roaming traffic is desired, this value should only be used for N9 non-roaming interfaces and (decimal value "21") should be used for N9 roaming interfaces.	
NOTE 4: There is no 3GPP interface Type value defined for the Source Interface Type or Destination Interface Type if the Source Interface IE in PDR or the Destination Interface IE in FAR is set to "5G VN Internal".	

8.2.119 PFCPSRReq-Flags

The PFCPSRReq-Flags IE indicates flags applicable to the PFCP Session Report Request message. It is coded as depicted in Figure 8.2.119-1.

Octets	Bits							
	8	7	6	5	4	3	2	1
1 to 2	Type = 161 (decimal)							
3 to 4	Length = n							
5	Spare	Spare	Spare	Spare	Spare	Spare	PPPC P	PSDB U
6 to (n+4)	These octet(s) is/are present only if explicitly specified							

Figure 8.2.199-1: PFCPSRReq-Flags

The following bits within Octet 5 shall indicate:

- Bit 1 – PSDBU (PCF Session Deleted By the UP function): if this bit is set to "1", it indicates that the UP function has reported all non-zero Usage Reports for all URRs in the PCF Session and the PCF Session is being deleted in the UP function locally.
- Bit 2 – PPPCP (Pending UL Payload Packet to CP function): if this bit is set to "1", it indicates if there are pending UL payload packets to be sent towards the new SMF via a new N4-u tunnel.
- Bit 3 to 8 – Spare, for future use, shall be set to "0" by the sender and discarded by the receiver.

8.2.120 PFCPAUReq-Flags

The PFCPAUReq-Flags IE indicates flags applicable to the PCF Association Update Request message. It is coded as depicted in Figure 8.2.120-1.

Octets	Bits							
	8	7	6	5	4	3	2	1
1 to 2	Type = 162 (decimal)							
3 to 4	Length = n							
5	Spare	Spare	Spare	Spare	Spare	Spare	Spare	PARP S
6 to (n+4)	These octet(s) is/are present only if explicitly specified							

Figure 8.2.120-1: PFCPAUReq-Flags

The following bits within Octet 5 shall indicate:

- Bit 1 – PARPS (PCF Association Release Preparation Start): if this bit is set to "1", it indicates that the PCF association is to be released and all non-zero usage reports for the PCF Sessions affected by the release of the PCF association shall be reported.
- Bit 2 to 8 – Spare, for future use, shall be set to "0" by the sender and discarded by the receiver.

8.2.121 Activation Time

The Activation Time IE indicates the time that the PDR shall be set to be active in the UP function. It shall be encoded as shown in Figure 8.2.121-1.

Octets	Bits							
	8	7	6	5	4	3	2	1
1 to 2	Type = 163 (decimal)							
3 to 4	Length = n							
5 to 8	Activation Time							
9 to (n+4)	These octet(s) is/are present only if explicitly specified							

Figure 8.2.121-1: Activation Time

The Activation Time field shall indicate the activation time in UTC time. Octets 5 to 8 shall be encoded in the same format as the first four octets of the 64-bit timestamp format as defined in clause 6 of IETF RFC 5905 [12].

NOTE: The encoding is defined as the time in seconds relative to 00:00:00 on 1 January 1900 during the era 0, which includes dates from the prime epoch, i.e. 00:00:00 on 1 January 1900, to 06:28:15 on 7th of February 2036, or relative to 06:28:16 on 7th of February 2036 when the date enters the era 1. See also clause 6 of IETF RFC 5905 [12].

8.2.122 Deactivation Time

The Deactivation Time IE indicates the time that the PDR shall be set to be inactive in the UP function. It shall be encoded as shown in Figure 8.2.122-1.

Octets	Bits							
	8	7	6	5	4	3	2	1
1 to 2	Type = 164 (decimal)							
3 to 4	Length = n							
5 to 8	Deactivation Time							
9 to (n+4)	These octet(s) is/are present only if explicitly specified							

Figure 8.2.122-1: Deactivation Time

The Deactivation Time field shall indicate the deactivation time in UTC time. Octets 5 to 8 shall be encoded in the same format as the first four octets of the 64-bit timestamp format as defined in clause 6 of IETF RFC 5905 [12].

NOTE: The encoding is defined as the time in seconds relative to 00:00:00 on 1 January 1900 during the era 0, which includes dates from the prime epoch, i.e. 00:00:00 on 1 January 1900, to 06:28:15 on 7th of February 2036, or relative to 06:28:16 on 7th of February 2036 when the date enters the era 1. See also clause 6 of IETF RFC 5905 [12].

8.2.123 MAR ID

The MAR ID IE type shall be encoded as shown in Figure 8.2.123-1. It shall contain a Multi-Access Rule ID.

Octets	Bits							
	8	7	6	5	4	3	2	1
1 to 2	Type = 170 (decimal)							
3 to 4	Length = n							
5 to 6	MAR ID value							
7 to (n+4)	These octet(s) is/are present only if explicitly specified							

Figure 8.2.123-1: MAR ID

The MAR ID value field shall be encoded as an Unsigned16 binary integer value.

8.2.124 Steering Functionality

The Steering Functionality IE type shall be encoded as shown in Figure 8.2.124-1. It indicates the steering functionality (ATSSS feature) to be used in a MAR.

Octets	Bits							
	8	7	6	5	4	3	2	1
1 to 2	Type = 171 (decimal)							
3 to 4	Length = n							
5	Spare				Steering Functionality Value			
6 to (n+4)	These octet(s) is/are present only if explicitly specified							

Figure 8.2.124-1: Steering Functionality

The Steering Functionality value shall be encoded as a 4 bits binary integer as specified in Table 8.2.124-1.

Table 8.2.124-1: Steering Functionality value

Steering Functionality Value	Values (Decimal)
ATSSS-LL	0
MPTCP	1
MPQUIC-UDP	2
MPQUIC-IP	3
MPQUIC-E	4
Spare	5 to 15

8.2.125 Steering Mode

The Steering Mode IE type shall be encoded as shown in Figure 8.2.125-1. It indicates the steering mode to be used in a MAR.

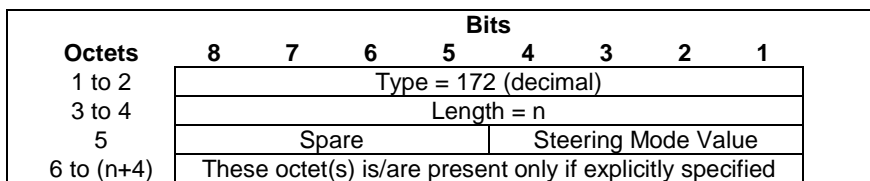

Figure 8.2.125-1: Steering Mode

The Steering Mode value shall be encoded as a 4 bits binary integer as specified in Table 8.2.125-1.

Table 8.2.125-1: Steering Mode value

Steering Mode Value	Values (Decimal)
Active-Standby	0
Smallest Delay	1
Load Balancing	2
Priority-based	3
Redundant	4
Spare	5 to 15

8.2.126 Weight

The Weight IE shall be encoded as shown in Figure 8.2.126-1. It indicates the percentage of the traffic to be transferred over one access.

The Weight Value field shall take binary coded integer values from 0 up to 100. Other values shall be considered as 0.

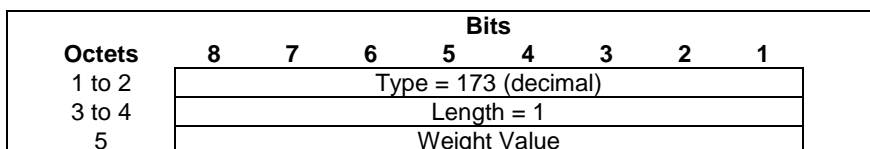

Figure 8.2.126-1: Weight

8.2.127 Priority

The Priority IE type shall be encoded as shown in Figure 8.2.127-1. It indicates whether it is active or standby or no standby for a given access when the Steering Mode is set to Active-Standby, or whether it is high or low priority for a given access when the Steering Mode is set to Priority-based.

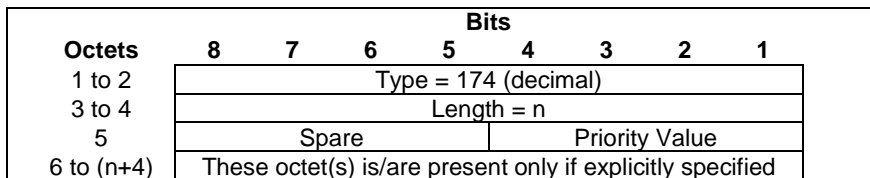

Figure 8.2.127-1: Priority

The Priority Value shall be encoded as a 4 bits binary integer as specified in Table 8.2.127-1.

Table 8.2.127-1: Priority value

Priority Value	Values (Decimal)
Active	0
Standby	1
No Standby	2
High	3
Low	4
Primary	5
Secondary	6
Spare	7 to 15

The "No Standby" Priority value may be used when the network determines to not define a Standby access.

8.2.128 UE IP address Pool Identity

The User Plane UE IP Pool Identity IE type shall be encoded as shown in Figure 8.2.128-1.

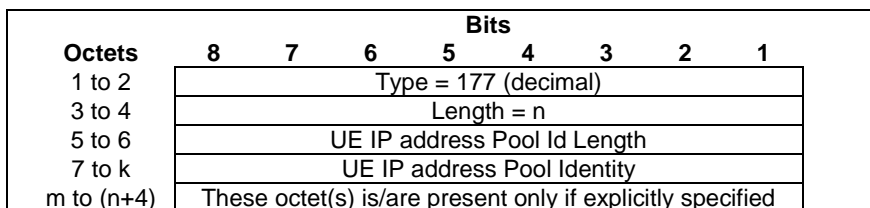

Figure 8.2.128-1: UE IP address Pool Identity

Octets 7 to "k": The UE IP address Pool Identity shall be encoded as an OctetString (see the Framed-Ipv6-Pool and Framed-Pool in clause 12.6.3 of 3GPP TS 29.561 [49]); the value part of Framed-Pool or Framed-Ipv6-Pool is copied into the UE IP address Pool Identity field of the UE IP address Pool Identity IE if the CP function receives the corresponding information from an external server.

8.2.129 Alternative SMF IP Address

The Alternative SMF IP Address IE shall contain an IPv4 and/or IPv6 address. It shall be encoded as shown in Figure 8.2.129-1.

Octets	Bits							
	8	7	6	5	4	3	2	1
1 to 2	Type = 178 (decimal)							
3 to 4	Length = n							
5	Spare				PPE	V4	V6	
p to (p+3)	IPv4 Address							
q to (q+15)	IPv6 Address							
m to (n+4)	These octet(s) is/are present only if explicitly specified							

Figure 8.2.129-1: Alternative SMF IP Address

The following flags are coded within Octet 5:

- Bit 1 – V6: If this bit is set to "1", then the IPv6 address field shall be present in the Alternative SMF IP Address, otherwise the IPv6 address field shall not be present.
- Bit 2 – V4: If this bit is set to "1", then the IPv4 address field shall be present in the Alternative SMF IP Address, otherwise the IPv4 address field shall not be present.
- Bit 3 – PPE (Preferred PCF Entity): If this bit is set to "1", then the alternative SMF IP address shall be used by the UPF as a preferred address when reselecting a PCF entity as specified in clauses 5.22.2 and 5.22.3.
- Bit 4 to 8 Spare, for future use and set to "0".

Octets "p to (p+3)" or "q to (q+15)" (IPv4 address / IPv6 address fields), if present, shall contain the address value.

8.2.130 Packet Replication and Detection Carry-On Information

The Packet Replication and Detection Carry-On Information IE shall be encoded as shown in Figure 8.2.130-1.

Octets	Bits							
	8	7	6	5	4	3	2	1
1 to 2	Type = 179 (decimal)							
3 to 4	Length = n							
5	Spare				DCA RONI	PRIN6I	PRIN1 9I	PRIU EAI
6 to (n+4)	These octet(s) is/are present only if explicitly specified							

Figure 8.2.130-1: Packet Replication and Detection Carry-On Information

The following flags are coded within Octet 5:

- Bit 1 – PRIUEAI (Packet Replication Information – UE/PDU Session Address Indication): This bit shall be set to "1" to indicate that if the packet has been received from the UE's PDU session (e.g. the source IP address is set to the UE's PDU IP session address, or the source MAC address is an Ethernet MAC address associated to the PDU session for an Ethernet PDU session), the UP function shall neither create a copy of the packet nor apply the corresponding processing (i.e. FAR, QER, URR). Otherwise the UPF shall perform a copy of the packet and apply the corresponding processing (i.e. FAR, QER, URR).
- Bit 2 – PRIN19I (Packet Replication Information - N19 Indication): This bit shall be set to "1" to indicate that if the packet has been received from a N19 interface (i.e. a "N19 Indication" internal flag is associated with the packet, see clause 8.2.56), the UP function shall neither create a copy of the packet nor apply the corresponding processing (i.e. FAR, QER, URR). Otherwise the UPF shall perform a copy of the packet and apply the corresponding processing (i.e. FAR, QER, URR).
- Bit 3 – PRIN6I (Packet Replication Information - N6 Indication): This bit shall be set to "1" to indicate that if the packet has been received from a N6 interface (i.e. a "N6 Indication" internal flag is associated with the packet, see clause 8.2.56), the UP function shall neither create a copy of the packet nor apply the corresponding processing (i.e. FAR, QER, URR). Otherwise the UPF shall perform a copy of the packet and apply the corresponding processing (i.e. FAR, QER, URR).

- Bit 4 – DCARONI (Detection Carry-On Indication): This bit shall be set to "1" to request the UP function to continue the packet detection process, i.e. look up of other PDRs of other PFCP sessions matching the packet (see clause 5.2.1).
- Bit 5 to 8 are spare and reserved for future use.

8.2.131 SMF Set ID

The SMF Set ID IE shall contain an FQDN representing the SMF Set. It shall be encoded as shown in Figure 8.2.131-1.

Octets	Bits							
	8	7	6	5	4	3	2	1
1 to 2	Type = 180 (decimal)							
3 to 4	Length = n							
5	Spare							
6 to m	FQDN							
(m+1) to (n+4)	These octet(s) is/are present only if explicitly specified							

Figure 8.2.131-1: SMF Set ID

FQDN encoding shall be identical to the encoding of a FQDN within a DNS message of clause 3.1 of IETF RFC 1035 [27] but excluding the trailing zero byte.

NOTE: The FQDN field in the IE is not encoded as a dotted string as commonly used in DNS master zone files.

8.2.132 Quota Validity Time

The Quota Validity Time IE type shall be encoded as shown in Figure 8.2.132-1. It contains the quota validity time in seconds.

Octets	Bits							
	8	7	6	5	4	3	2	1
1 to 2	Type = 181 (decimal)							
3 to 4	Length = n							
5 to 8	Validity Time value							
9 to (n+4)	These octet(s) is/are present only if explicitly specified							

Figure 8.2.132-1: Quota Validity Time

The Quota Validity Time value shall be encoded as an Unsigned32 binary integer value.

8.2.133 Number of Reports

The Number of Reports IE shall be encoded as shown in Figure 8.2.133-1. It contains an Unsigned16 binary integer value excluding the first value "0".

Octets	Bits							
	8	7	6	5	4	3	2	1
1 to 2	Type = 182 (decimal)							
3 to 4	Length = n							
5 to 6	Number of Reports							

Figure 8.2.133-1: Number of Reports

8.2.134 PFCPASRsp-Flags

The PFCPASRsp-Flags IE indicates flags applicable to the PFCP Association Setup Response message. It is coded as depicted in Figure 8.2.134-1.

Octets	Bits								
	8	7	6	5	4	3	2	1	
1 to 2	Type = 184 (decimal)								
3 to 4	Length = n								
5	Spare					UUPS	PSRE		
6 to (n+4)	These octet(s) is/are present only if explicitly specified								

Figure 8.2.134-1: PFCPASRsp-Flags

The following bits within Octet 5 shall indicate:

- Bit 1 – PSREI (PFCP Session Retained Indication): if this bit is set to "1", it indicates that an existing PFCP association was already established for the same Node ID and the requested PFCP sessions have been retained. See clause 6.2.6.2.2.
- Bit 2 – UUPSI (UPF configured for IPUPS Indication): if this bit is set to "1", it indicates that the UPF is configured to be used for IPUPS. See clause 5.27.
- Bit 3 to 8 – Spare, for future use, shall be set to "0" by the sender and discarded by the receiver.

8.2.135 CP PFCP Entity IP Address

The CP PFCP Entity IP Address IE shall contain an IPv4 and/or IPv6 address. It shall be encoded as shown in Figure 8.2.135-1.

Octets	Bits								
	8	7	6	5	4	3	2	1	
1 to 2	Type = 135 (decimal)								
3 to 4	Length = n								
5	Spare					V4	V6		
p to (p+3)	IPv4 Address								
q to (q+15)	IPv6 Address								
m to (n+4)	These octet(s) is/are present only if explicitly specified								

Figure 8.2.135-1: CP PFCP Entity IP Address

The following flags are coded within Octet 5:

- Bit 1 – V6: If this bit is set to "1", then the IPv6 address field shall be present in the CP PFCP Entity IP Address, otherwise the IPv6 address field shall not be present.
- Bit 2 – V4: If this bit is set to "1", then the IPv4 address field shall be present in the CP PFCP Entity IP Address, otherwise the IPv4 address field shall not be present.
- Bit 3 to 8 Spare, for future use and set to "0".

Octets "p to (p+3)" or "q to (q+15)" (IPv4 address / IPv6 address fields), if present, shall contain the address value.

8.2.136 PFCPSEReq-Flags

The PFCPSEReq-Flags IE indicates flags applicable to the PFCP Session Establishment Request message. It is coded as depicted in Figure 8.2.136-1.

Octets	Bits							
	8	7	6	5	4	3	2	1
1 to 2	Type = 186 (decimal)							
3 to 4	Length = n							
5	Spare	Spare	Spare	Spare	EPRI	HRSB OM	SUMP C	RESTI
6 to (n+4)	These octet(s) is/are present only if explicitly specified							

Figure 8.2.136-1: PFCPSEReq-Flags

The following bits within Octet 5 shall indicate:

- Bit 1 – RESTI (Restoration Indication): if this bit is set to "1", it indicates to the UP function that the PFCP session to be established is to restore an existing PFCP session.
- Bit 2 – SUMPC (Stop of Usage Measurement to Pause Charging): if this bit is set to "1", it indicates that the UP function shall stop the usage measurement for all URRs with the "ASPOC" flag set to "1".
- Bit 3 – HRSBOM (HR-SBO Mode): if this bit is set to "1" at the V-UPF acting as Local PSA in the VPLMN, it indicates that the PDU session is working in HR-SBO mode.
- Bit 4 – EPRI (Exclude PFCP session from Restoration Indication): if this bit is set to "1", it indicates to the UPF that the PFCP session is excluded from the restoration for those PFCP sessions affected by an SMF failure if detected, i.e. the UPF shall delete the PFCP session as if the SMF set feature is not deployed. (See also clause 4.4.3 of 3GPP TS 23.527 [40].)
- Bit 5 to 8 – Spare, for future use, shall be set to "0" by the sender and discarded by the receiver.

8.2.137 IP Multicast Address

The IP Multicast Address IE type shall be encoded as shown in Figure 8.2.137-1. It contains an IP multicast address or a range of IP multicast addresses.

Octets	Bits							
	8	7	6	5	4	3	2	1
1 to 2	Type = 191 (decimal)							
3 to 4	Length = n							
5	Spare				A	R	V4	V6
m to (m+3)	(start) IPv4 address							
p to (p+15)	(start) IPv6 address							
q to (q+3)	(end) IPv4 address							
r to (r+15)	(end) IPv6 address							
k to (n+4)	These octet(s) is/are present only if explicitly specified							

Figure 8.2.137-1: IP Multicast Address

The following flags are coded within Octet 5:

- Bit 1 – V6: If this bit is set to "1", then the (start) IPv6 address field shall be present, otherwise the (start) IPv6 address field shall not be present.
- Bit 2 – V4: If this bit is set to "1", then the (start) IPv4 address field shall be present, otherwise the (start) IPv4 address field shall not be present.
- Bit 3 – R (Range): If this bit is set to "1", this indicates that a range of addresses is included, i.e. that
 - the (start) IPv4 address and (end) IPv4 address fields shall be present if bit 2 (V4) is set to "1";
 - the (start) IPv6 address and (end) IPv6 address fields shall be present if bit 1 (V6) is set to "1",

otherwise (end) address fields shall not be present.

- Bit 4 – Any: If this bit is set to "1", this indicates any IP multicast address; in this case, no IP address field shall be included.
- Bit 5 to 8 Spare, for future use and set to "0".

One and only one of the V6, V4 and A flags shall be set to "1". The R flag may be set if the V6 or the V4 flag is set to "1".

Octets "m to (m+3)", "p to (p+15)", "q to (q+3)", "r to (r+15)" (IPv4 address / IPv6 address fields), if present, shall contain the address value.

8.2.138 Source IP Address

The Source IP Address IE type shall be encoded as shown in Figure 8.2.138-1

Octets	Bits							
	8	7	6	5	4	3	2	1
1 to 2	Type = 192 (decimal)							
3 to 4	Length = n							
5	Spare				MPL	V4	V6	
m to (m+3)	IPv4 address							
p to (p+15)	IPv6 address							
q	mask/prefix length							
k to (n+4)	These octet(s) is/are present only if explicitly specified							

Figure 8.2.138-1: Source IP Address

The following flags are coded within Octet 5:

- Bit 1 – V6: If this bit is set to "1", then the IPv6 address field shall be present, otherwise the IPv6 address field shall not be present.
- Bit 2 – V4: If this bit is set to "1", then the IPv4 address field shall be present, otherwise the IPv4 address field shall not be present.
- Bit 3 – Mask/Prefix Length: If this bit is set to "1", then the mask (for IPv4) / prefix (for IPv6) length field shall be present, otherwise this field shall not be present.
- Bit 4 to 8 Spare, for future use and set to "0".

Octets "m to (m+3)", "p to (p+15)" (IPv4 address / IPv6 address fields), if present, shall contain the address value.

The mask/prefix length field, if present, shall be encoded as a 8 bits binary integer.

EXAMPLE 1: this field encodes the value 24 for the IPv4 subnet 192.0.2.10/24.

EXAMPLE 2: this field encodes the value 64 for the /64 IPv6 prefix.

8.2.139 Packet Rate Status

Packet Rate Status shall be encoded as shown in Figure 8.2.139-1.

Octets	Bits							
	8	7	6	5	4	3	2	1
1 to 2	Type = 193 (decimal)							
3 to 4	Length = n							
5	Spare				APR	DL	UL	
a to (a+1)	Number of Remaining Uplink Packets Allowed							
b to (b+1)	Number of Remaining Additional Uplink Packets Allowed							
c to (c+1)	Number of Remaining Downlink Packets Allowed							
d to (d+1)	Number of Remaining Additional Downlink Packets Allowed							
e to (e+7)	Rate Control Status Validity Time							
m to (n+4)	These octet(s) is/are present only if explicitly specified							

Figure 8.2.139-1: Packet Rate Status

The following flags are coded within Octet 5:

- Bit 1 – UL (remaining uplink packet limit): If this bit is set to "1", then octets 'a' to (a+1), the Number of Remaining Uplink Packets Allowed shall be present, otherwise these octets shall not present.
- Bit 2 – DL (remaining downlink packet limit): If this bit is set to "1", then octets 'c' to (c+1), the Number of Remaining Downlink Packets Allowed shall be present, otherwise these octets shall not present.
- Bit 3 – APR (Additional Packet Rates, i.e. remaining additional packet limit): If this bit is set to "1", then the presence of Number of Remaining Additional Uplink/Downlink Packets Allowed is determined as follows:
 - If bit 1 (UL) is set to "1", then octets b to (b+1), the Number of Remaining Additional Uplink Packets Allowed shall be present. Otherwise, octets b to (b+1) shall not be present;
 - If bit 2 (DL) is set to "1", then octets d to (d+1), the Number of Remaining Additional Downlink Packets Allowed shall be present. Otherwise, octets d to (d+1) shall not be present.
- Bits 4 to 8: Spare, for future use and set to "0".

If either bit 1 or bit 2 is set to '1', then octets 'e' to (e+7), the Rate Control Status Validity Time shall be present.

If present, the Number of Remaining Uplink Packets Allowed in octets 'a' to (a+1) shall indicate the number of uplink packets that are still allowed to be sent within the Rate Control Status Validity Time.

If present, the Number of Remaining Additional Uplink Packets Allowed in octets 'b' to (b+1) shall indicate the number of additional uplink packets that are still allowed to be sent within the Rate Control Status Validity Time.

If present, the Number of Remaining Downlink Packets Allowed in octets 'c' to (c+1) shall indicate the number of downlink packets that are still allowed to be sent within the Rate Control Status Validity Time.

If present, the Number of Remaining Additional Downlink Packets Allowed in octets 'd' to (d+1) indicate the number of additional downlink packets that are still allowed to be sent within the Rate Control Status Validity Time.

If present, the Rate Control Status Validity Time shall be coded as the time in seconds relative to 00:00:00 on 1 January 1900 during the era 0 (which includes dates from the prime epoch, i.e. 00:00:00 on 1 January 1900, to 06:28:15 on 7th of February 2036) or relative to 06:28:16 on 7th of February 2036 (when the date enters the era 1) (calculated as continuous time without leap seconds and traceable to a common time reference) where binary encoding of the integer part is in the 32 most significant bits and binary encoding of the fraction part in the 32 least significant bits. The fraction part is expressed with a granularity of $1/2^{32}$ second (see clause 8.135 in 3GPP TS 29.274 [9]).

8.2.140 Create Bridge/Router Info IE

The Create Bridge/Router Info IE shall be encoded as shown in Figure 8.2.140-1.

Octets	Bits							
	8	7	6	5	4	3	2	1
1 to 2	Type = 194 (decimal)							
3 to 4	Length = n							
5	Spare					RII	BII	
m to (n+4)	These octet(s) is/are present only if explicitly specified							

Figure 8.2.140-1: Create Bridge/Router Info IE

The following flags are coded within Octet 5:

- Bit 1 – BII (Bridge Information Indication): If this bit is set to "1", then the Bridge Information comprising a DS-TT port number and the related 5GS User Plane Node ID are requested to be provided.
- Bit 2 – RII (Router Information Indication): If this bit is set to "1", then the Router Information comprising a port number for the PDU Session and the related 5GS User Plane Node ID are requested to be provided.
- Bit 3 to 8 Spare, for future use and set to "0".

8.2.141 Port Number

The Port Number IE shall be encoded as shown in Figure 8.2.141-1. It shall contain one Port Number value.

Octets	Bits						
	8	7	6	5	4	3	2
1 to 2	Type = 196 (decimal)						
3 to 4	Length = 4						
5 to 8	Port Number value						

Figure 8.2.141-1: Port Number

For TSN and TSCTS (i.e. if the BII flag was set to 1 in the Create Bridge/Router Info IE), the Port Number value may refer either to an Ethernet port or an IEEE PTP port and it shall be encoded as an Unsigned16 binary integer value in octets 7 and 8. Octets 5 and 6 shall be set to all zeros.

For DetNet (i.e. if the RII flag was set to 1 in the Create Bridge/Router Info IE), the port number value shall be encoded as an Unsigned32 binary integer.

For Ethernet type PDU Sessions, it is assumed that the PTP port number is the same as the associated Ethernet port number.

8.2.142 NW-TT Port Number

The NW-TT Port Number IE shall be encoded as shown in Figure 8.2.142-1. It shall contain one Port Number value.

Octets	Bits						
	8	7	6	5	4	3	2
1 to 2	Type = 197 (decimal)						
3 to 4	Length = 4						
5 to 8	Port Number value						

Figure 8.2.142-1: NW-TT Port Number

For TSN and TSCTS (i.e. if the BII flag was set to 1 in the Create Bridge/Router Info IE), the Port Number value may refer either to an Ethernet port or an IEEE PTP port and it shall be encoded as an Unsigned16 binary integer in octets 7 and 8. Octets 5 and 6 shall be set to all zeros.

For DetNet (i.e. if the RII flag was set to 1 in the Create Bridge/Router Info IE), the port number value shall be encoded as an Unsigned32 binary integer.

For Ethernet type PDU Sessions, it is assumed that the PTP port number is the same as the associated Ethernet port number.

8.2.143 5GS User Plane Node ID

The 5GS User Plane Node ID IE shall be encoded as shown in Figure 8.2.143-1.

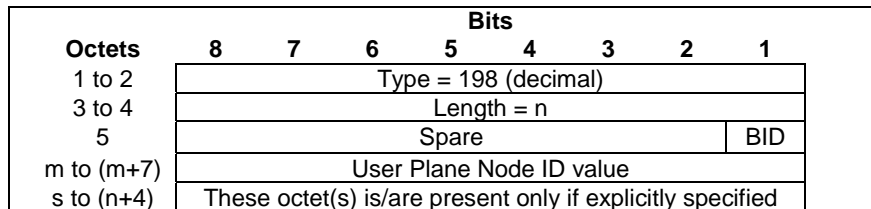

Figure 8.2.143-1: 5GS User Plane Node ID

The following flags are coded within Octet 5:

- Bit 1 – BID: If this bit is set to "1", then the User Plane Node ID value field shall be present.
- Bit 2 to 8: Spare, for future use and set to "0".

The User Plane Node ID value field shall be encoded as an Unsigned64 binary integer. To support IEEE TSN, the User Plane Node ID value field encodes the Bridge ID as defined in IEEE 802.1Q [30] clause 14.2.5. Without IEEE TSN, the User Plane Node ID may encode any value within the range, e.g. to support integration with IETF DetNet, the User Plane Node ID value field may be encoded as the Router ID.

8.2.144 Port Management Information Container

The Port Management Information Container IE shall be encoded as shown in Figure 8.2.144-1. It contains an opaque container of port management information.

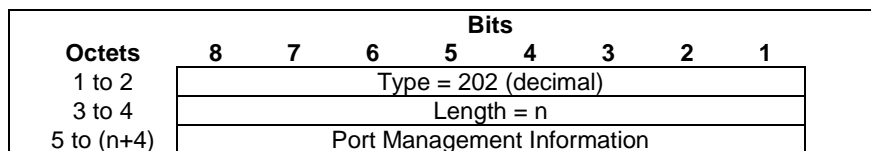

Figure 8.2.144-1: Port Management Information Container

The Port Management Information field shall be encoded as an Octet String. It shall encode a Port management message defined in clause 8 of 3GPP TS 24.539 [63].

8.2.145 Requested Clock Drift Information

The Requested Clock Drift Information IE shall be encoded as shown in Figure 8.2.145-1. It indicates the clock drift information to report to the CP function.

Octets	Bits							
	8	7	6	5	4	3	2	1
1 to 2	Type = 204 (decimal)							
3 to 4	Length = n							
5	Spare					RRC	RRTO	
7 to (n+4)	These octet(s) is/are present only if explicitly specified							

Figure 8.2.145-1: Requested Clock Drift Information

Octet 5 shall be encoded as follows:

- Bit 1: (RRTO) Request to Report Time Offset: when set to "1", this indicates a request to report when the Time Offset Reporting Threshold is exceeded.
- Bit 2: (RRCR) Request to Report Cumulative RateRatio: when set to "1", this indicates a request to report when the cumulative RateRatio Reporting Thresholds is exceeded.
- Bits 3 to 8: Spare, for future use and set to "0".

At least one bit shall be set to "1". Several bits may be set to "1".

8.2.146 Time Domain Number

The Time Domain Number IE type shall be encoded as shown in Figure 8.2.146-1. It shall contain a external timing related Domain Number.

Octets	Bits						
	8	7	6	5	4	3	2
1 to 2	Type = 206 (decimal)						
3 to 4	Length = n						
5	Time Domain Number value						
6 to (n+4)	These octet(s) is/are present only if explicitly specified						

Figure 8.2.146-1: Time Domain Number

The Time Domain Number value field shall be encoded as a binary integer value.

8.2.147 Time Offset Threshold

The Time Offset Threshold IE type shall be encoded as shown in Figure 8.2.147-1.

Octets	Bits						
	8	7	6	5	4	3	2
1 to 2	Type = 207 (decimal)						
3 to 4	Length = n						
5 to 12	Time Offset Threshold						
13 to (n+4)	These octet(s) is/are present only if explicitly specified						

Figure 8.2.147-1: Time Offset Threshold

The Time Offset Threshold field shall be encoded as a signed64 binary integer value. It shall contain the Time Offset Threshold in nanoseconds.

8.2.148 Cumulative rateRatio Threshold

The Cumulative rateRatio Threshold IE type shall be encoded as shown in Figure 8.2.148-1.

Octets	Bits						
	8	7	6	5	4	3	2
1 to 2	Type = 208 (decimal)						
3 to 4	Length = n						
5 to 8	Cumulative rateRatio Threshold						
9 to (n+4)	These octet(s) is/are present only if explicitly specified						

Figure 8.2.148-1: Cumulative rateRatio Threshold

The Cumulative rateRatio Threshold field shall be encoded as the cumulativeRateRatio (Integer32) specified in clauses 14.4.2 and 15.6 of IEEE Std 802.1AS-2020 [58], i.e. the quantity $(rateRatio - 1.0)(2^{41})$.

8.2.149 Time Offset Measurement

The Time Offset Measurement IE type shall be encoded as shown in Figure 8.2.149-1.

Octets	Bits						
	8	7	6	5	4	3	2
1 to 2	Type = 209 (decimal)						
3 to 4	Length = n						
5 to 12	Time Offset Measurement						
13 to (n+4)	These octet(s) is/are present only if explicitly specified						

Figure 8.2.149-1: Time Offset Measurement

The Time Offset Measurement field shall be encoded as a signed64 binary integer value. It shall contain the Time Offset Measurement in nanoseconds. It shall contain the time offset between the 5GS clock and the clock of the external time domain.

8.2.150 Cumulative rateRatio Measurement

The Cumulative rateRatio Measurement IE type shall be encoded as shown in Figure 8.2.150-1.

Octets	Bits						
	8	7	6	5	4	3	2
1 to 2	Type = 210 (decimal)						
3 to 4	Length = n						
5 to 8	Cumulative rateRatio Measurement						
9 to (n+4)	These octet(s) is/are present only if explicitly specified						

Figure 8.2.150-1: Cumulative rateRatio Measurement

The Cumulative rateRatio Measurement field shall be encoded as the cumulativeRateRatio (Integer32) specified in clauses 14.4.2 and 15.6 of IEEE Std 802.1AS-2020 [58], i.e. the quantity $(rateRatio - 1.0)(2^{41})$. It shall be equal to the cumulative ratio of the frequency of the 5GS clock to the frequency of the clock of the external time domain.

8.2.151 SRR ID

The SRR ID IE type shall be encoded as shown in Figure 8.2.151-1. It contains a Session Reporting Rule ID.

Octets	Bits						
	8	7	6	5	4	3	2
1 to 2	Type = 215 (decimal)						
3 to 4	Length = n						
5	SRR ID value						
6 to (n+4)	These octet(s) is/are present only if explicitly specified						

Figure 8.2.151-1: SRR ID

The SRR ID value shall be encoded as a binary integer value.

8.2.152 Requested Access Availability Information

The Requested Access Availability Information IE shall be encoded as shown in Figure 8.2.152-1. It indicates the access availability information requested to be reported to the CP function.

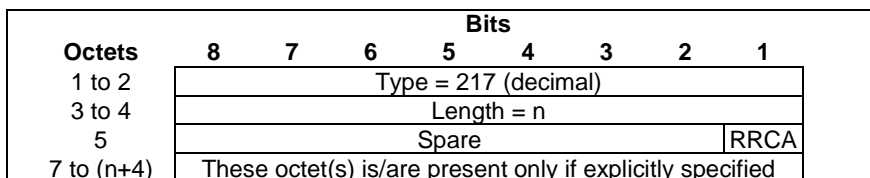

Figure 8.2.152-1: Requested Access Availability Information

Octet 5 shall be encoded as follows:

- Bit 1: (RRCA) Request to Report Change in Access availability: when set to "1", this indicates a request to the UPF to report when an access (3GPP or non-3GPP access) becomes available or unavailable.
- Bits 2 to 8: Spare, for future use and set to "0".

At least one bit shall be set to "1". Several bits may be set to "1".

8.2.153 Access Availability Information

The Access Availability Information IE shall indicate an access type and whether the access type has become available or not available. It shall be encoded as shown in Figure 8.2.153-1.

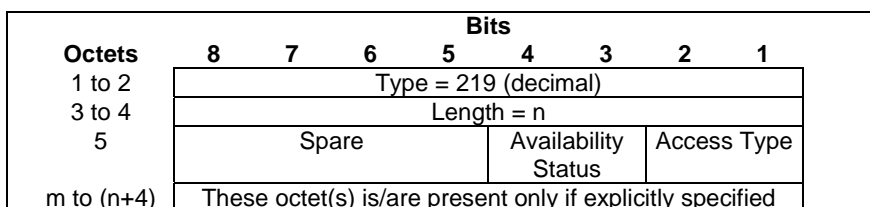

Figure 8.2.153-1: Access Availability Information

The Access Type shall be encoded as a 2 bits binary integer as specified in Table 8.2.153-1.

Table 8.2.153-1: Access Type

Access Type	Values (Decimal)
3GPP access type	0
Non-3GPP access type	1
Spare	2 to 3

The Availability Status shall be encoded as a 2 bits binary integer as specified in Table 8.2.153-2.

Table 8.2.153-2: Availability Status

Availability Status	Values (Decimal)
Access has become unavailable	0
Access has become available	1
Spare	2 to 3

8.2.154 MPTCP Control Information

The MPTCP Control Information IE shall provide details of the required MPTCP functionality. It shall be encoded as shown in Figure 8.2.154-1.

Octets	Bits							
	8	7	6	5	4	3	2	1
1 to 2	Type = 222 (decimal)							
3 to 4	Length = n							
5	Spare							TCI
m to (n+4)	These octet(s) is/are present only if explicitly specified							

Figure 8.2.154-1: MPTCP Control Information

The following flags are coded within Octet 5:

- Bit 1 – TCI (Transport Converter Indication): If this bit is set to "1", it indicates that the required MPTCP steering functionality is of type Transport Converter (see IETF RFC 8803 [60]) and the UPF shall allocate relevant resource as specified in clause 5.20.2.1.
- Bit 2 to 8 Spare, for future use and set to "0".

8.2.155 ATSSS-LL Control Information

The ATSSS-LL Control Information IE shall provide details of the required ATSSS-LL functionality. It shall be encoded as shown in Figure 8.2.155-1.

Octets	Bits							
	8	7	6	5	4	3	2	1
1 to 2	Type = 223 (decimal)							
3 to 4	Length = n							
5	Spare							LLI
m to (n+4)	These octet(s) is/are present only if explicitly specified							

Figure 8.2.155-1: ATSSS-LL Control Information

The following flags are coded within Octet 5:

- Bit 1 – LLI: If this bit is set to "1", it indicates that the ATSSS-LL steering functionality is required.
- Bit 2 to 8 Spare, for future use and set to "0".

8.2.156 PMF Control Information

The PMF Control Information IE shall provide details of the required PMF functionality. It shall be encoded as shown in Figure 8.2.156-1.

Octets	Bits							
	8	7	6	5	4	3	2	1
1 to 2	Type = 224 (decimal)							
3 to 4	Length = n							
5	Spare				PQPM	DRTTI	PMFI	
6	Number of QFI (=p)							
7	value of QFI 1							
8	value of QFI 2							
...	...							
7-(7+p-1)	value of QFI p							
m to (n+4)	These octet(s) is/are present only if explicitly specified							

Figure 8.2.156-1: PMF Control Information

The following flags are coded within Octet 5:

- Bit 1 – PMFI: If this bit is set to "1", it indicates that the PMF functionality is required and the UPF shall allocate relevant resource as specified in 5.20.3.1.
- Bit 2 – DRTTI (Disallow PMF RTT Indication): If this bit is set to "1", it indicates that PMF RTT measurements are not allowed. This bit shall be set to "1" if the UE does not support PMF RTT measurements (i.e. if the UE supports MPTCP with any steering mode and ATSSS-LL with only the Active-Standby steering mode, see clauses 5.32.2 and 5.32.5.1 of 3GPP TS 23.501 [28]).
- Bit 3 – PQPM (Per QoS flow Performance Measurement indication): If this bit is set to "1", it indicates that per QoS flow access performance measurement is applicable to this PDU session. A list of QFI values shall be present to indicate a list of QoS flows over which access performance measurement may be performed.
- Bit 4 to 8 Spare, for future use and set to "0".

The Number of QFI shall indicate the total number of the QFI values. Each subsequent Octet after the Number of QFI shall carry one QFI value (i.e. the Octet 5 of the QFI IE, as specified in clause 8.2.89).

8.2.157 MPTCP Address Information

The MPTCP Address Information IE shall carry the address information of MPTCP proxy in the UPF. It shall be encoded as shown in Figure 8.2.157-1.

Octets	Bits							
	8	7	6	5	4	3	2	1
1 to 2	Type = 228 (decimal)							
3 to 4	Length = n							
5	Spare						V6	V4
6	MPTCP Proxy Type							
7 to 8	MPTCP Proxy Port							
p to (p+3)	MPTCP Proxy IPv4 Address							
q to (q+15)	MPTCP Proxy IPv6 Address							
m to (n+4)	These octet(s) is/are present only if explicitly specified							

Figure 8.2.157-1: MPTCP Address Information

The following flags are coded within Octet 5:

- Bit 1 – V4: If this bit is set to "1", then the MPTCP Proxy IPv4 Address field shall be present in the MPTCP Address Information IE.
- Bit 1 – V6: If this bit is set to "1", then the MPTCP IPv6 Address field shall be present in the MPTCP Address Information IE.
- Bit 3 to 8 Spare, for future use and set to "0".

Octets 6 shall indicate the MPTCP Proxy Type, with the value specified in clause 6.1.4 of 3GPP TS 24.193 [59].

Octets 7 to 8 shall indicate the allocated TCP port number of the MPTCP Proxy.

Octets "p to (p+3)" or "q to (q+15)" (IPv4 address / IPv6 address fields), if present, shall contain the address value.

8.2.158 Link-Specific Multipath IP Address

The Link-Specific Multipath IP Address IE shall carry link-specific IP address used for MPTCP, MPQUIC-UDP, MPQUIC-IP or MPQUIC-E steering function. It shall be encoded as shown in Figure 8.2.158-1.

Octets	Bits							
	8	7	6	5	4	3	2	1
1 to 2	Type = 229 (decimal)							
3 to 4	Length = n							
5	Spare			NV6	NV4	V6	V4	
p to (p+3)	Link-Specific Multipath IPv4 Address for 3GPP Access							
q to (q+15)	Link-Specific Multipath IPv6 Address for 3GPP Access							
r to (r+3)	Link-Specific Multipath IPv4 Address for Non-3GPP Access							
s to (s+3)	Link-Specific Multipath IPv6 Address for Non-3GPP Access							
m to (n+4)	These octet(s) is/are present only if explicitly specified							

Figure 8.2.158-1: Link-Specific Multipath IP Address

The following flags are coded within Octet 5:

- Bit 1 – V4: If this bit is set to "1", then the Link-Specific Multipath IPv4 Address for 3GPP Access shall be present in the Link-Specific Multipath IP Address IE.
- Bit 2 – V6: If this bit is set to "1", then the Link-Specific Multipath IPv6 Address for 3GPP Access shall be present in the Link-Specific Multipath IP Address IE.
- Bit 3 – NV4: If this bit is set to "1", then the Link-Specific Multipath IPv4 Address for Non-3GPP Access shall be present in the Link-Specific Multipath IP Address IE.
- Bit 4 – NV6: If this bit is set to "1", then the Link-Specific Multipath IPv6 Address for Non-3GPP Access shall be present in the Link-Specific Multipath IP Address IE.
- Bit 5 to 8 Spare, for future use and set to "0".

Octets "p to (p+3)" or "q to (q+15)" (IPv4 address / IPv6 address fields), if present, shall contain the value for Link-Specific Multipath IP Address for 3GPP access.

Octets "r to (r+3)" or "s to (s+15)" (IPv4 address / IPv6 address fields), if present, shall contain the value for Link-Specific Multipath IP Address for Non-3GPP access.

If the PDU session is of type IPv4v6, both Link-Specific Multipath IPv4 Addresses and Link-Specific Multipath IPv6 Addresses for both 3GPP Access and non-3GPP Access shall be included when the MPQUIC-UDP or MPQUIC-IP steering functionality is required for the PFCP session. See also clause 5.20.2A.2.

Both Link-Specific Multipath IPv4 Addresses and Link-Specific Multipath IPv6 Addresses for both 3GPP Access and non-3GPP Access should be included when the MPQUIC-E steering functionality is required for the PFCP session. See also clause 5.20.2A.2.

8.2.159 PMF Address Information

The PMF Address Information IE shall contain the address information of Performance Measure Function (PMF). It shall be encoded as shown in Figure 8.2.159-1.

Octets	Bits							
	8	7	6	5	4	3	2	1
1 to 2	Type = 230 (decimal)							
3 to 4	Length = n							
5	Spare			MAC	V6	V4		
p to (p+3)	PMF IPv4 Address							
q to (q+15)	PMF IPv6 Address							
r to (r+1)	PMF Port for 3GPP Access							
s to (s+1)	PMF Port for Non-3GPP Access							
t to (t+5)	PMF MAC Address for 3GPP Access							
u to (u+5)	PMF MAC Address for Non-3GPP Access							
m to (n+4)	These octet(s) is/are present only if explicitly specified							

Figure 8.2.159-1: PMF Address Information

The following flags are coded within Octet 5:

- Bit 1 – V4: If this bit is set to "1", it indicates the PMF IPv4 Address field shall be present in the PMF Address Information IE, together with: PMF Port for 3GPP Access, PMF Port for Non-3GPP Access.
- Bit 2 – V6: If this bit is set to "1", it indicates the PMF IPv6 Address field shall be present in the PMF Address Information IE, together with: PMF Port for 3GPP Access, PMF Port for Non-3GPP Access.
- Bit 3 – MAC: If this bit is set to "1", it indicates the PMF MAC Address for 3GPP Access, PMF MAC Address for Non-3GPP Access field shall be present in the PMF Address Information IE.
- Bit 4 to 8 Spare, for future use and set to "0".

Octets "p to (p+3)" or "q to (q+15)" (IPv4 address / IPv6 address fields), if present, shall contain the value for PMF IP Address.

Octets "r to (r+1)" shall carry the allocated UDP port number associated with the 3GPP access network, for IP PDU session.

Octets "s to (s+1)" shall carry the allocated UDP port number associated with the Non-3GPP access network, for IP PDU session.

Octets "t to (t+5)" shall carry the allocated PMF MAC address for 3GPP access, for Ethernet PDU session.

Octets "u to (u+5)" shall carry the allocated PMF MAC address for Non-3GPP access, for Ethernet PDU session.

8.2.160 ATSSS-LL Information

The ATSSS-LL Information IE shall contain ATSSS-LL information. It shall be encoded as shown in Figure 8.2.160-1.

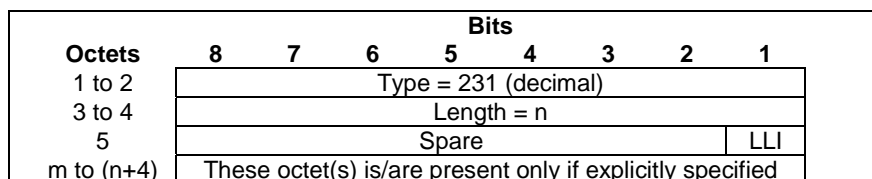

Figure 8.2.160-1: ATSSS-LL Information

The following flags are coded within Octet 5:

- Bit 1 – LLI: If this bit is set to "1", it indicates that resources for the ATSSS-LL steering functionality have been allocated.
- Bit 2 to 8 Spare, for future use and set to "0".

8.2.161 Data Network Access Identifier

The Data Network Access Identifier IE type shall be encoded as shown in Figure 8.2.161-1. It contains an identifier of a Data Network Access.

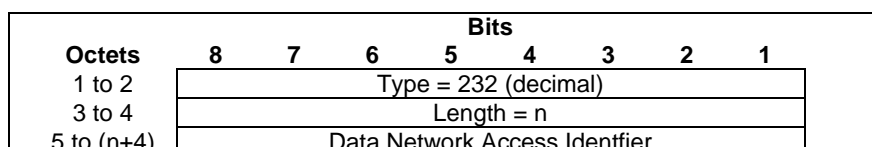

Figure 8.2.161-1: Data Network Access Identifier

The Data Network Access Identifier field shall be encoded as an OctetString.

8.2.162 Average Packet Delay

The Average Packet Delay IE indicates the average packet delay experienced by user plane packets on a GTP-U path. It shall be coded as depicted in Figure 8.2.162-1.

Octets	Bits							
	8	7	6	5	4	3	2	1
1 to 2	Type = 234 (decimal)							
3 to 4	Length = n							
5 to 8	Delay Value in milliseconds							
9 to (n+4)	These octet(s) is/are present only if explicitly specified							

Figure 8.2.162-1: Average Packet Delay

The Delay Value shall be encoded as an Unsigned 32 binary integer value, in milliseconds.

8.2.163 Minimum Packet Delay

The Minimum Packet Delay IE indicates the minimum packet delay experienced by user plane packets on a GTP-U path. It shall be coded as depicted in Figure 8.2.163-1.

Octets	Bits							
	8	7	6	5	4	3	2	1
1 to 2	Type = 235 (decimal)							
3 to 4	Length = n							
5 to 8	Delay Value in milliseconds							
9 to (n+4)	These octet(s) is/are present only if explicitly specified							

Figure 8.2.163-1: Minimum Packet Delay

The Delay Value shall be encoded as an Unsigned 32 binary integer value, in milliseconds.

8.2.164 Maximum Packet Delay

The Maximum Packet Delay IE indicates the maximum packet delay experienced by user plane packets on a GTP-U path. It shall be coded as depicted in Figure 8.2.164-1.

Octets	Bits							
	8	7	6	5	4	3	2	1
1 to 2	Type = 236 (decimal)							
3 to 4	Length = n							
5 to 8	Delay Value in milliseconds							
9 to (n+4)	These octet(s) is/are present only if explicitly specified							

Figure 8.2.164-1: Maximum Packet Delay

The Delay Value shall be encoded as an Unsigned 32 binary integer value, in milliseconds.

8.2.165 QoS Report Trigger

The QoS Report Trigger IE shall be encoded as shown in Figure 8.2.165-1. It indicates the trigger of the QoS report.

Octets	Bits							
	8	7	6	5	4	3	2	1
1 to 2	Type = 237 (decimal)							
3 to 4	Length = n							
5	Spare				IRE	THR	PER	
6 to (n+4)	These octet(s) is/are present only if explicitly specified							

Figure 8.2.165-1: QoS Report Trigger

Octet 5 shall be encoded as follows:

- Bit 1 – PER (Periodic Reporting): when set to "1", this indicates a periodic report.
- Bit 2 –THR (Event triggered based on Threshold): when set to "1", this indicates a report caused by QoS exceeding a threshold.
- Bit 3 – IRE (Immediate Report): when set to "1", this indicates an immediate report requested by CP function.
- Bit 4 to 8: Spare, for future use and set to "0".

8.2.166 GTP-U Path Interface Type

The GTP-U Path Interface Type IE shall be encoded as shown in Figure 8.2.166-1.

Octets	Bits							
	8	7	6	5	4	3	2	1
1 to 2	Type = 241 (decimal)							
3 to 4	Length = n							
5	Spare				N3	N9		
6 to (n+4)	These octet(s) is/are present only if explicitly specified							

Figure 8.2.166-1: GTP-U Path Interface Type

Octet 5 shall be encoded as follows:

- Bit 1 – N9: when set to "1", this indicates the N9 interface type.
- Bit 2 –N3: when set to "1", this indicates the N3 interface type.
- Bit 3 to 8: Spare, for future use and set to "0".

8.2.167 Requested QoS Monitoring

The Requested QoS Monitoring IE shall be encoded as shown in Figure 8.2.167-1.

Octets	Bits							
	8	7	6	5	4	3	2	1
1 to 2	Type = 243 (decimal)							
3 to 4	Length = n							
5	ULDR	DLDR	ULCI	DLCI	GTPU PM	RPPD	ULPD	DLPD
6	Spare						ULAB	DLAB
7 to (n+4)	These octet(s) is/are present only if explicitly specified							

Figure 8.2.167-1: Requested QoS Monitoring

Octet 5 shall be encoded as follows:

- Bit 1 – DLPD (Downlink Packet Delay): when set to "1", this indicates a request for measuring the downlink packet delay from the UPF (PSA) to the UE.

- Bit 2 – ULPD (Uplink Packet Delay): when set to "1", this indicates a request for measuring the uplink packet delay from the UE to the UPF (PSA).
- Bit 3 – RPPD (Round Trip Packet Delay): when set to "1", this indicates a request for measuring the round trip packet delay between the UPF (PSA) and UE.
- Bit 4 – GTPUPM (GTP-U Path Monitoring):
 - when set to "1", this indicates that the Downlink, Uplink or Round Trip delay shall be measured by using GTP-U path monitoring, i.e. by the I-UPF reporting the one-way end to end accumulated transport delay in UL GTP-U packets towards the PSA; see clause 5.33.3.3 of 3GPP TS 23.501 [28];
 - when set to "0", this indicates that the Downlink, Uplink or Round Trip delay shall be measured by using RAN and UPF time information in GTP-U packets; see clause 5.33.3.2 of 3GPP TS 23.501 [28].
- Bit 5 – DLCI (Downlink Congestion Information): when set to "1", this indicates a request for monitoring the congestion information of the QoS flow for the downlink direction received from the NG-RAN.
- Bit 6 – ULCI (Uplink Congestion Information): when set to "1", this indicates a request for monitoring the congestion information of the QoS flow for the uplink direction received from the NG-RAN.
- Bit 7 – DLDR (Downlink Data Rate): when set to "1", this indicates a request for monitoring the data rate of the QoS flow for the downlink direction.
- Bit 8 – ULDR (Uplink Data Rate): when set to "1", this indicates a request for monitoring the data rate of the QoS flow for the uplink direction.

Octet 6 shall be encoded as follows:

- Bit 1 – DLAB (Downlink Available Bitrate): when set to "1", this indicates a request for monitoring the downlink available bitrate.
- Bit 2 – ULAB (Uplink Available Bitrate): when set to "1", this indicates a request for monitoring the uplink available bitrate.
- Bits 3 to 8, Spare, for future use, set to zero.

At least one bit shall be set to "1". Several bits may be set to "1".

8.2.168 Reporting Frequency

The Reporting Frequency IE shall be encoded as shown in Figure 8.2.168-1. It indicates the type of requested QoS Monitoring reports.

	Bits								
Octets	8	7	6	5	4	3	2	1	
1 to 2	Type = 244 (decimal)								
3 to 4	Length = n								
5	Spare					Reser ved	PERI O	EVET T	
6 to (n+4)	These octet(s) is/are present only if explicitly specified								

Figure 8.2.19-1: Reporting Frequency

Octet 5 shall be encoded as follows:

- Bit 1 – EVETT (Event Triggered QoS monitoring reporting): when set to "1", this indicates the delay for QoS monitoring is reported when the delay exceeds a threshold.
- Bit 2 – PERIO (Periodic QoS monitoring reporting): when set to "1", this indicates the delay for QoS monitoring is reported periodically.
- Bit 3: Reserved. It shall be set to "0" by the sender and it shall be ignored by the receiver.

NOTE: Bit 3 was allocated in earlier versions of the specification but its usage has been deprecated.

- Bits 4 to 8: Spare, for future use and set to "0".

At least one bit shall be set to "1". Several bits may be set to "1".

8.2.169 Packet Delay Thresholds

The Packet Delay Thresholds IE contains a packet delay thresholds in milliseconds to be monitored by the UP function. It shall be encoded as shown in Figure 8.2.169-1.

Octets	Bits							
	8	7	6	5	4	3	2	1
1 to 2	Type = 245 (decimal)							
3 to 4	Length = n							
5	Spare				RP	UL	DL	
m to (m+3)	Downlink packet delay threshold							
p to (p+3)	Uplink packet delay threshold							
q to (q+3)	Round trip packet delay threshold							
s to (n+4)	These octet(s) is/are present only if explicitly specified							

Figure 8.2.169-1: Packet Delay Thresholds

The following flags are coded within Octet 5:

- Bit 1 – DL: If this bit is set to "1", then the Downlink packet delay threshold field shall be present, otherwise the Downlink packet delay threshold field shall not be present.
- Bit 2 – UL: If this bit is set to "1", then the Uplink packet delay threshold field shall be present, otherwise the Uplink packet delay threshold field shall not be present.
- Bit 3 – RP: If this bit is set to "1", then the Round trip packet delay threshold field shall be present, otherwise the Round trip packet delay threshold field shall not be present.
- Bit 4 to 8: Spare, for future use and set to "0".

At least one bit shall be set to "1". Several bits may be set to "1".

The Downlink packet delay threshold, Uplink packet delay threshold and Round trip packet delay threshold fields shall be encoded as an Unsigned32 binary integer value. They shall contain the downlink, uplink or round trip packet delay in milliseconds respectively.

8.2.170 Minimum Wait Time

The Minimum Wait Time IE contains the minimum waiting time between two consecutive reports, e.g., for event triggered QoS monitoring reporting. It shall be encoded as shown in Figure 8.2.170-1.

Octets	Bits							
	8	7	6	5	4	3	2	1
1 to 2	Type = 246 (decimal)							
3 to 4	Length = n							
5 to 8	Minimum Wait Time							
9 to (n+4)	These octet(s) is/are present only if explicitly specified							

Figure 8.2.170-1: Minimum Wait Time

The Minimum Wait Time field shall be encoded as an Unsigned32 binary integer value. It shall contain the duration in seconds.

8.2.171 QoS Monitoring Measurement

The QoS Monitoring Measurement IE contains the QoS measurements from the UP function. It shall be encoded as shown in Figure 8.2.171-1.

Octets	Bits							
	8	7	6	5	4	3	2	1
1 to 2	Type = 248 (decimal)							
3 to 4	Length = n							
5	ULDR	DLDR	ULCI	DLCI	PLMF	RPPD	ULPD	DLPD
m to (m+3)	Downlink packet delay							
p to (p+3)	Uplink packet delay							
q to (q+3)	Round trip packet delay							
r to (r+1)	Downlink Congestion information							
s to (s+1)	Uplink Congestion information							
t to (t+4)	Average downlink data rate							
u to (u+4)	Average uplink data rate							
v to (n+4)	These octet(s) is/are present only if explicitly specified							

Figure 8.2.171-1: QoS Monitoring Measurement

The following flags are coded within Octet 5:

- Bit 1 – DLPD (Downlink Packet Delay): If this bit is set to "1", then the Downlink packet delay field shall be present, otherwise the Downlink packet delay field shall not be present.
- Bit 2 – ULPD (Uplink Packet Delay): If this bit is set to "1", then the Uplink packet delay field shall be present, otherwise the Uplink packet delay field shall not be present.
- Bit 3 – RPPD (Round Trip Packet Delay): If this bit is set to "1", then the Round trip packet delay field shall be present, otherwise the Round trip packet delay field shall not be present.
- Bit 4 – PLMF (Packet Delay Measurement Failure): If this bit is set to "1", this indicates no timestamp is received in uplink packet for a delay exceeding the Measurement Period.
- Bit 5 – DLCI (Downlink Congestion Info): If this bit is set to "1", then the Downlink Congestion information field shall be present, otherwise the Downlink Congestion information field shall not be present.
- Bit 6 – ULCI (Uplink Congestion Info): If this bit is set to "1", then the Uplink Congestion information field shall be present, otherwise the Uplink Congestion information field shall not be present.
- Bit 7 – DLDR (Downlink Data Rate): If this bit is set to "1", then the Average downlink data rate field shall be present, otherwise it shall not be present.
- Bit 8 – ULDR (Uplink Data Rate): If this bit is set to "1", then the Average uplink data rate field shall be present, otherwise it shall not be present.

At least one bit shall be set to "1". Several bits may be set to "1".

When the PLMF flag is set to "1", the RP, UL and DL bits shall not be set to "1", i.e. the DL/UL/Round Trip packet delay fields shall not be present when reporting a packet delay measurement failure.

The Downlink packet delay, Uplink packet delay and Round trip packet delay fields shall be encoded as an Unsigned32 binary integer value. They shall contain the downlink, uplink or round trip packet delay in milliseconds respectively.

The Downlink Congestion information field and the Uplink Congestion information field shall be encoded as an Unsigned16 binary integer value, in the (decimal) values range 0 to 10000 (included), representing the percentage of congestion level in the downlink and in the uplink directions respectively, up to two decimal points, for the QoS flow. As an example, the (decimal) value 9574 corresponds to a percentage of 95.74%.

The Average downlink data rate and the Average uplink data rate fields shall be encoded as kilobits per second (1 kbps = 1000 bps) in binary value (rounded upwards).

8.2.172 MT-EDT Control Information

MT-EDT Control Information is coded as depicted in Figure 8.2.172-1.

Octets	Bits						
	8	7	6	5	4	3	2
1 to 2	Type = 249 (decimal)						
3 to 4	Length = n						
5	Spare						RDSI
k to (n+4)	These octet(s) is/are present only if explicitly specified						

Figure 8.2.172-1: MT-EDT Control Information

The following flags are coded within Octet 5:

- Bit 1 – RDSI (Reporting DL data packets Size Indication): This bit shall be set to "1" if the UP function is requested to report the sum of DL data packets size.
- Bit 2 to 8 are spare and reserved for future use.

8.2.173 DL Data Packets Size

The DL Data Packets Size IE type shall be encoded as shown in Figure 8.2.173-1. It contains the sum of DL data packets size in byte which triggers to send Downlink Data Report.

Octets	Bits						
	8	7	6	5	4	3	2
1 to 2	Type = 250 (decimal)						
3 to 4	Length = n						
5 to 6	DL Data Packets Size						
7 to (n+4)	These octet(s) is/are present only if explicitly specified						

Figure 8.2.173-1: DL Data Packets Size

The DL Data Packets Size shall be encoded as an Unsigned16 binary integer value.

8.2.174 QER Control Indications

The QER Control Indications IE indicates flags applicable to a QER. It is coded as depicted in Figure 8.2.174-1.

Octets	Bits							
	8	7	6	5	4	3	2	1
1 to 2	Type = 251 (decimal)							
3 to 4	Length = n							
5	Spare	Spare	Spare	Spare	Spare	Spare	Spare	RCSR
6 to (n+4)	These octet(s) is/are present only if explicitly specified							

Figure 8.2.174-1: QER Control Indications

The following bits within Octet 5 shall indicate:

- Bit 1 – RCSR (Rate Control Status Reporting): If this bit is set to "1", then the UP function shall report the rate control status when the PFCP session is released. If this bit is set to "0", then the UPF shall not report the rate control status (see clause 5.4.15).
- Bit 2 to 8 – Spare, for future use, shall be set to "0" by the sender and discarded by the receiver.

8.2.175 NF Instance ID

The NF Instance ID IE type shall be encoded as shown in Figure 8.2.175-1. It contains the NF Instance ID of a UPF.

Octets	Bits						
	8	7	6	5	4	3	2
1 to 2	Type = 253 (decimal)						
3 to 4	Length = 16						
5 to 20	NF Instance ID						

Figure 8.2.175-1: NF Instance ID

The format of the NF Instance ID field shall be a Universally Unique Identifier (UUID) version 4, as specified in IETF RFC 9562 [75].

8.2.176 S-NSSAI

The S-NSSAI IE indicates the S-NSSAI of a PDU session. It shall be encoded as shown in Figure 8.2.176-1.

Octets	Bits						
	8	7	6	5	4	3	2
1 to 2	Type = 257 (decimal)						
3 to 4	Length = 4						
5	SST						
6 to 8	SD						

Figure 8.2.176-1: S-NSSAI

The SST (Slice/Service Type) and SD (Slice Differentiator) fields shall be encoded as defined in clause 28.4.2 of 3GPP TS 23.003 [2].

8.2.177 IP version

IP version shall be encoded as shown in Figure 8.2.177-1.

Octets	Bits							
	8	7	6	5	4	3	2	1
1 to 2	Type = 258 (decimal)							
3 to 4	Length = n							
5	Spare					V6	V4	
6 to (n+4)	These octet(s) is/are present only if explicitly specified							

Figure 8.2.177-1: IP version

The following flags are coded within Octet 5:

- Bit 1 – V4: when set to "1", this indicate the IP version is V4;
- Bit 2 – V6: when set to "1", this indicate the IP version is V6;
- Bit 3 to 8: Spare, for future use and set to "0".

At least one of V4 and V6 shall be set to "1", and both may be set to "1".

8.2.178 PFCPASReq-Flags

The PFCPASReq-Flags IE indicates flags applicable to the PFCP Association Setup Request message. It is coded as depicted in Figure 8.2.178-1.

Octets	Bits							
	8	7	6	5	4	3	2	1
1 to 2	Type = 259 (decimal)							
3 to 4	Length = n							
5	Spare						UUPS	1
6 to (n+4)	These octet(s) is/are present only if explicitly specified							

Figure 8.2.178: PFCPASReq-Flags

The following bits within Octet 5 shall indicate:

- Bit 1 – UUPSI (UPF configured for IPUPS Indication): if this bit is set to "1", it indicates that the UPF is configured to be used for IPUPS. See clause 5.27.
- Bit 2 to 8 – Spare, for future use, shall be set to "0" by the sender and discarded by the receiver.

8.2.179 Data Status

The Data Status IE indicates the status of the data packets in the UP function. It is coded as shown in Figure 8.2.179-1.

Octets	Bits							
	8	7	6	5	4	3	2	1
1 to 2	Type = 260 (decimal)							
3 to 4	Length = n							
5	Spare					BUFF	DROP	
6 to (n+4)	These octet(s) is/are present only if explicitly specified							

Figure 8.2.179-1: Data Status

The following flags are coded within Octet 5:

- Bit 1 – DROP: when set to "1", this indicates first DL packet is discarded by the UP function.
- Bit 2 – BUFF: when set to "1", this indicates first DL packet is received and buffered by the UP function.
- Bit 3 to 8 Spare, for future use and set to "0".

8.2.180 RDS Configuration Information

The RDS Configuration Information IE shall provide details of the RDS Configuration Information. It shall be encoded as shown in Figure 8.2.180-1.

Octets	Bits							
	8	7	6	5	4	3	2	1
1 to 2	Type = 262 (decimal)							
3 to 4	Length = n							
5	Spare						RDS	
m to (n+4)	These octet(s) is/are present only if explicitly specified							

Figure 8.2.180-1: RDS Configuration Information

The following flags are coded within Octet 5:

- Bit 1 – RDS (Reliable Data Service): If this bit is set to "1", it indicates that the RDS is requested to be applied (in request) / applied (in response).
- Bit 2 to 8 Spare, for future use and set to "0".

8.2.181 Multipath Applicable Indication

Multipath Applicable Indication shall be coded as depicted in Figure 8.2.181-1.

Octets	Bits							
	8	7	6	5	4	3	2	1
1 to 2	Type = 265 (decimal)							
3 to 4	Length = n							
5	Spare						MQAI	MTAI
6 to (n+4)	These octet(s) is/are present only if explicitly specified							

Figure 8.2.181-1: Multipath Applicable Indication

The following flags are coded within Octet 5:

- Bit 1 – MTAI (MPTCP Applicable Indication): When this bit is set to "1", it indicates that the PDR is used to detect user plane traffic for which MPTCP is applicable (see clause 5.20.2.4).
- Bit 2 – MQAI (MPQUIC Applicable Indication): When this bit is set to "1", it indicates that the PDR is used to detect user plane traffic for which MPQUIC-UDP, MPQUIC-IP or MPQUIC-E is applicable (see clause 5.20.2A.4).
- Bit 3 to 8 are spare and reserved for future use.

8.2.182 User Plane Node Management Information Container

The User Plane Node Management Information Container IE shall be encoded as shown in Figure 8.2.182-1. It contains an opaque container of User Plane Node management information.

Octets	Bits							
	8	7	6	5	4	3	2	1
1 to 2	Type = 266 (decimal)							
3 to 4	Length = n							
5 to (n+4)	User Plane Node Management Information							

Figure 8.2.182-1: User Plane Node Management Information Container

The User Plane Node Management Information field shall be encoded as an Octet String. It shall encode a User plane node management message defined in clause 9 of 3GPP TS 24.539 [63].

8.2.183 Number of UE IP Addresses

Number of UE IP Addresses IE shall be coded as depicted in Figure 8.2.183-1. It contains an Unsigned32 binary integer value in octets "a to (a+3)" and "b to (b+3)".

Octets	Bits							
	8	7	6	5	4	3	2	1
1 to 2	Type = 268 (decimal)							
3 to 4	Length = n							
5	Spare	Spare	Spare	Spare	Spare	Spare	IPv6	IPv4
a to (a+3)	Number of UE IPv4 Addresses							
b to (b+3)	Number of UE IPv6 Addresses							
k to (n+4)	These octet(s) is/are present only if explicitly specified							

Figure 8.2.183-1: Number of UE IP Addresses

The following flags are coded within Octet 5:

- Bit 1 – IPv4: If this bit is set to "1", Number of UE IPv4 Addresses field shall be present. Otherwise the Number of UE IPv4 Addresses field shall not be present.

- Bit 2 – IPv6: If this bit is set to "1", Number of UE IPv6 Addresses field shall be present. Otherwise the Number of UE IPv6 Addresses field shall not be present.

Octets "a to (a+3)" and/or "b to (b+3)" shall be present if Bis 1 and/or Bit 2 in octet 5 is present. Otherwise, these octets shall not be present.

8.2.184 Validity Timer

Validity Timer IE shall be coded as depicted in Figure 8.2.184-1. It shall contain two octets long Unsigned16 binary integer value representing a time interval in seconds.

Octets	Bits							
	8	7	6	5	4	3	2	1
1 to 2	Type = 269 (decimal)							
3 to 4	Length = n							
5 to 6	Validity Timer							
k to (n+4)	These octet(s) is/are present only if explicitly specified							

Figure 8.2.184-1: Validity Timer

8.2.185 Offending IE Information

Offending IE Information shall be coded as depicted in Figure 8.2.185-1.

Octets	Bits							
	8	7	6	5	4	3	2	1
1 to 2	Type = 274 (decimal)							
3 to 4	Length = n							
5 to 6	Type of the offending IE							
7 to (n+4)	Value of the offending IE							

Figure 8.2.185-1: Offending IE Information

The Type of the offending IE field in octets 5 to 6 shall contain the IE type (as defined in clause 8.2.1) that caused the failure.

The Value of the offending IE field in octets 7 to (n+4) shall contain the value of the offending IE that caused the failure.

8.2.186 RAT Type

The RAT Type IE indicates the RAT type for the PFCP Session. The RAT Type IE type shall be encoded as shown in Figure 8.2.186-1.

Octets	Bits							
	8	7	6	5	4	3	2	1
1 to 2	Type = 275							
3 to 4	Length = n							
5	RAT Type							
6 to (n+4)	These octet(s) is/are present only if explicitly specified							

Figure 8.2.186-1: RAT Type IE

RAT Type indicates the type of RAT for the PFCP Session. It shall be encoded as defined in Table 8.2.186-1.

Table 8.2.186-1: RAT Type values

RAT Type	Values (Decimal)
<reserved>	0
UTRAN	1
GERAN	2
WLAN	3
GAN	4
HSPA Evolution	5
EUTRAN (WB-E-UTRAN)	6
Virtual	7
EUTRAN-NB-IoT	8
LTE-M	9
NR	10
WB-E-UTRAN (LEO)	11
WB-E-UTRAN (MEO)	12
WB-E-UTRAN (GEO)	13
WB-E-UTRAN (OTHERSAT)	14
EUTRAN-NB-IoT (LEO)	15
EUTRAN-NB-IoT (MEO)	16
EUTRAN-NB-IoT (GEO)	17
EUTRAN-NB-IoT (OTHERSAT)	18
LTE-M (LEO)	19
LTE-M (MEO)	20
LTE-M (GEO)	21
LTE-M (OTHERSAT)	22
NR (LEO)	23
NR (MEO)	24
NR (GEO)	25
NR (OTHERSAT)	26
NR-REDCAP	27
NR-EREDCAP	28
Spare, for future use	29-255

8.2.187 L2TP User Authentication

The L2TP User Authentication IE shall be encoded as shown in Figure 8.2.187-1.

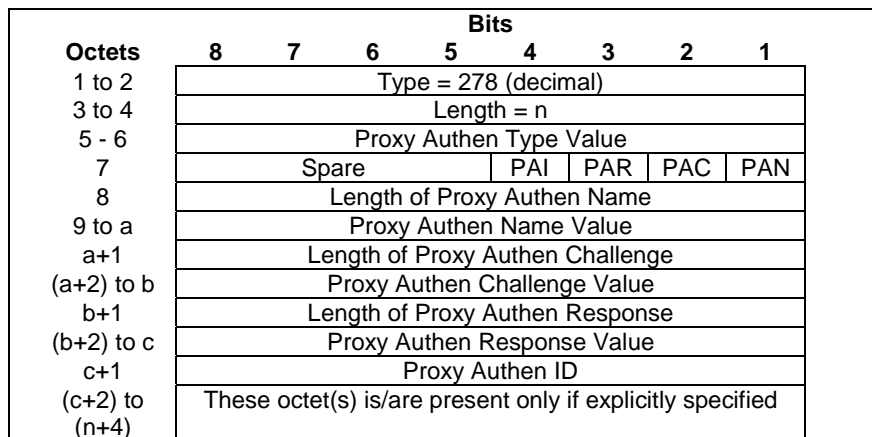

Figure 8.2.187-1: L2TP User Authentication

The following flags are coded within Octet 7:

- Bit 1 – PAN: If this bit is set to "1", then the Length of Proxy Authen Name and Proxy Authen Name Value shall be present; otherwise, the Length of Proxy Authen Name and Proxy Authen Name Value shall not be present.
- Bit 2 – PAC: If this bit is set to "1", then the Length of Proxy Authen Challenge and Proxy Authen Challenge Value shall be present; otherwise, the Length of Proxy Authen Challenge and Proxy Authen Challenge Value shall not be present.
- Bit 3 – PAR: If this bit is set to "1", then the Length of Proxy Authen Response and Proxy Authen Response Value shall be present; otherwise, the Length of Proxy Authen Response and Proxy Authen Response Value shall not be present.
- Bit 4 – PAI: If this bit is set to "1", then the Proxy Authen ID shall be present; otherwise, the Proxy Authen ID shall not be present.

Proxy Authen Type Value, Proxy Authen Name Value, Proxy Authen Challenge Value, Proxy Authen Response Value and Proxy Authen ID shall be encoded as the Attribute Value field for the Proxy Authen Type AVP, Proxy Authen Name AVP, Proxy Authen Challenge AVP, Proxy Authen Response AVP and Proxy Authen ID respectively as specified in IETF RFC 2661 [67].

If Proxy Authen Type Value is 1, then the PAN and PAR flags shall be set.

If Proxy Authen Type Value is 2, then the PAN, PAC, PAR, and PAI flags shall be set.

If Proxy Authen Type Value is 3, then the PAN, PAR, and PAI flags shall be set.

If Proxy Authen Type Value is 5, then the PAN, PAC, PAR, and PAI flags shall be set.

8.2.188 LNS Address

The LNS Address IE shall contain an IPv4/IPv6 address. It shall be encoded as shown in Figure 8.2.188-1.

Octets	Bits							
	8	7	6	5	4	3	2	1
1 to 2	Type = 280 (decimal)							
3 to 4	Length = n							
5 to o	LNS Address value							
m to (n+4)	These octet(s) is/are present only if explicitly specified							

Figure 8.2.188-1: LNS Address

If the LNS Address is an IPv4 address, the LNS Address value length shall be "4".

If the LNS Address is an IPv6 address, the LNS Address value length shall be "16".

8.2.189 Tunnel Preference

The Tunnel Preference IE type shall be encoded as shown in Figure 8.2.189-1. It contains a Tunnel Preference value which indicates the preference to be given to the L2TP tunnel to which it refers; higher preference is given to lower values, with 0x000000 being most preferred and 0xFFFFFFFF least preferred (see 3GPP TS 29.061 [39]).

Octets	Bits							
	8	7	6	5	4	3	2	1
1 to 2	Type = 281 (decimal)							
3 to 4	Length = 3							
5 to 7	Tunnel Preference value							

Figure 8.2.189-1: Tunnel Preference

The Tunnel Preference value shall be encoded as three octets binary integer value.

8.2.190 Calling Number

The Calling Number IE type shall be encoded as shown in Figure 8.2.190-1. It contains a Calling Number value which may contain a MSISDN (see 3GPP TS 29.061 [39]).

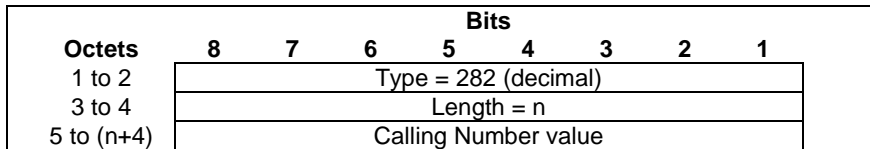

Figure 8.2.190-1: Calling Number

The Calling Number value shall be encoded in UTF8String format.

8.2.191 Called Number

The Called Number IE type shall be encoded as shown in Figure 8.2.191-1. It contains a Called Number value which may contain a DNN/APN. (see 3GPP TS 29.061 [39]).

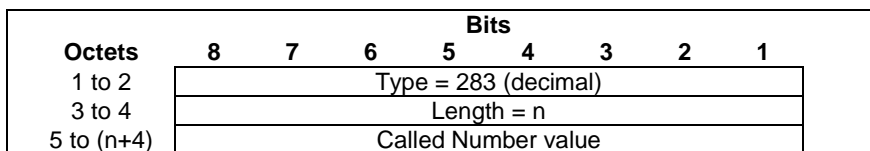

Figure 8.2.191-1: Called Number

The Called Number value shall be encoded in UTF8String format.

8.2.192 L2TP Session Indications

The L2TP Session Indications IE shall be encoded as shown in Figure 8.2.192-1.

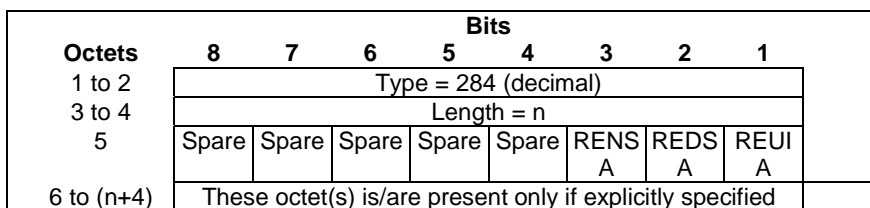

Figure 8.2.192-1: L2TP Session Indications

The following bits within Octet 5 shall indicate:

- Bit 1 – REUIA (Request UE IP Address): if this bit is set to "1", it indicates to the UP function that the UP function shall request the UE IP address from the LNS.
- Bit 2 – REDSA (Request DNS Server Address): if this bit is set to "1", it indicates to the UP function that the UP function shall request DNS Server Address from the LNS.
- Bit 3 – RENSA (Request NBNS Server Address): if this bit is set to "1", it indicates to the UP function that the UP function shall request NBNS Server Address from the LNS.
- Bit 4 to 8 – Spare, for future use, shall be set to "0" by the sender and discarded by the receiver.

NOTE: REDSA and RENSA are only applicable for PDN connections/PDU sessions with IPv4 address.

8.2.193 DNS Server Address

The DNS Server Address IE shall contain an IPv4 address. It shall be encoded as shown in Figure 8.2.193-1.

Octets	Bits						
	8	7	6	5	4	3	2
1 to 2	Type = 285 (decimal)						
3 to 4	Length = n						
5 to 8	DNS Server Address value						
9 to (n+4)	These octet(s) is/are present only if explicitly specified						

Figure 8.2.193-1: DNS Server Address

8.2.194 NBNS Server Address

The NBNS Server Address IE shall contain an IPv4 address. It shall be encoded as shown in Figure 8.2.194-1.

Octets	Bits						
	8	7	6	5	4	3	2
1 to 2	Type = 286 (decimal)						
3 to 4	Length = n						
5 to 8	NBNS Server Address value						
9 to (n+4)	These octet(s) is/are present only if explicitly specified						

Figure 8.2.194-1: NBNS Server Address

8.2.195 Maximum Receive Unit

The Maximum Receive Unit shall be encoded as shown in Figure 8.2.195-1. The Maximum Receive Unit value shall contain the link MTU size value received from the UE via the Protocol Configuration Options (see 3GPP TS 24.008 [5]).

Octets	Bits						
	8	7	6	5	4	3	2
1 to 2	Type = 287 (decimal)						
3 to 4	Length = 2						
5 to 6	Maximum Receive Unit value						

Figure 8.2.195-1: Maximum Receive Unit

The Maximum Receive Unit value shall be encoded as two octet's binary integer value.

8.2.196 Thresholds

The Thresholds IE shall be encoded as shown in Figure 8.2.196-1. It indicates the RTT and/or a Packet Loss Rate.

Octets	Bits						
	8	7	6	5	4	3	2
1 to 2	Type = 288 (decimal)						
3 to 4	Length = n						
5	Spare					PLR	RTT
m to (m+1)	RTT value						
p	Packet Loss Rate value						
q to (n+4)	These octet(s) is/are present only if explicitly specified						

Figure 8.2.196-1: Thresholds

The following flags are coded within Octet 5:

- Bit 1 – RTT: If this bit is set to "1", then the RTT value field shall be present, otherwise the RTT value shall not be present.
- Bit 2 – PLR: If this bit is set to "1", then the Packet Loss Rate value field shall be present, otherwise the Packet Loss Rate value shall not be present.
- Bit 3 to 8 Spare, for future use and set to "0".

At least one bit shall be set to "1". Several bits may be set to "1".

The RTT value field shall be encoded as an Unsigned16 binary integer value. It shall contain the RTT in milliseconds.

The Packet Loss Rate value field shall indicate a percentage and may take binary coded integer values from and including 0 up to and including 100. Other values shall be considered as 0.

8.2.197 Steering Mode Indicator

The Steering Mode Indicator IE shall be encoded as shown in Figure 8.2.197-1.

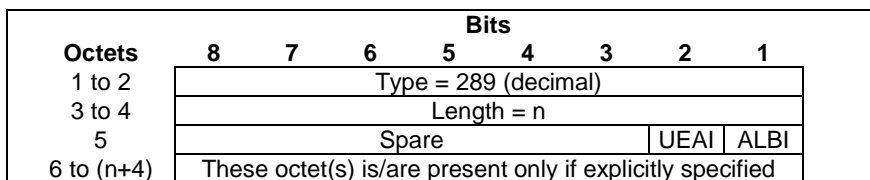

Figure 8.2.197.-1: Steering Mode Indicator

The following flags are coded within Octet 5:

- Bit 1 –ALBI (Autonomous Load Balancing Indicator): If this bit is set to "1", the autonomous load-balance is allowed.
- Bit 2 –UEAI (UE Assistance Indicator): If this bit is set to "1", the UE-assistance operation is allowed.
- Bit 3 to 8 Spare, for future use and set to "0".

The ALBI and UEAI shall not be set to "1" at the same time.

8.2.198 Group Id

The Group Id IE type shall be encoded as shown in Figure 8.2.198-1. It shall contain an octet string as a global unique identifier for a group and it may be encoded using the same mechanism for the NfInstanceId as specified in 3GPP TS 29.571 [61].

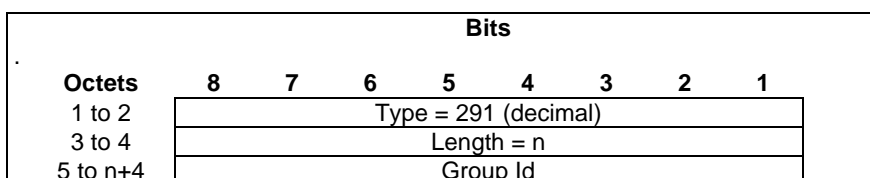

Figure 8.2.198-1: Group Id

8.2.199 CP IP Address

The CP IP Address IE shall contain an IPv4 and/or IPv6 address. It shall be encoded as shown in Figure 8.2.199-1.

Octets	Bits						
	8	7	6	5	4	3	2
1 to 2	Type = 292 (decimal)						
3 to 4	Length = n						
5	Spare				V4		V6
p to (p+3)	IPv4 Address						
q to (q+15)	IPv6 Address						

Figure 8.2.199-1: CP IP Address

The following flags are coded within Octet 5:

- Bit 1 – V6: If this bit is set to "1", then the IPv6 address field shall be present in the CP IP Address, otherwise the IPv6 address field shall not be present.
- Bit 2 – V4: If this bit is set to "1", then the IPv4 address field shall be present in the CP IP Address, otherwise the IPv4 address field shall not be present.
- Bit 3 to 8 Spare, for future use and set to "0".

Octets "p to (p+3)" or "q to (q+15)" (IPv4 address / IPv6 address fields), if present, shall contain the address value.

8.2.200 IP Address and Port Number Replacement

The IP Address and Port Number Replacement IE type shall be encoded as shown in Figure 8.2.200-1. It contains instructions to modify the contents of the (inner) packet.

Octets	Bits							
	8	7	6	5	4	3	2	1
1 to 2	Type = 293 (decimal)							
3 to 4	Length = n							
5 to 6	Spare	UMN6 RS	SPN	SIPV6	SIPV4	DPN	DIPV6	DIPV4
p to (p+3)	Destination IPv4 Address							
q to (q+15)	Destination IPv6 Address							
r to (r+1)	Destination Port Number							
s to (s+3)	Source IPv4 Address							
t to (t+15)	Source IPv6 Address							
u to (u+1)	Source Port Number							
v to (n+4)	These octet(s) is/are present only if explicitly specified							

Figure 8.2.200-1: IP Address and Port Number Replacement

The following flags are coded within Octet 5:

- Bit 1 – DIPV4: If this bit is set to "1", then the Destination IPv4 field shall be present, otherwise the Destination IPv4 field shall not be present.
- Bit 2 – DIPV6: If this bit is set to "1", then the Destination IPv6 field shall be present, otherwise the Destination IPv6 field shall not be present.
- Bit 3 – DPN: If this bit is set to "1", then the Destination Port Number field shall be present, otherwise the Destination Port Number field shall not be present.
- Bit 4 – SIPV4: If this bit is set to "1", then the Source IPv4 field shall be present, otherwise the Source IPv4 field shall not be present.
- Bit 5 – SIPV6: If this bit is set to "1", then the Source IPv6 field shall be present, otherwise the Source IPv6 field shall not be present.
- Bit 6 – SPN: If this bit is set to "1", then the Source Port Number field shall be present, otherwise the Source Port Number field shall not be present.

- Bit 7 – UMN6RS (Use Mapped N6 address to Replace Source IP address): if this bit is set to "1", it indicates that the V-UPF shall use the Mapped N6 IP address to replace the source IP address (which is set to the UE's private IP address) for the traffic sent to N6. This bit may be set in the IP Address and Port Number Replacement IE provided in a UL FAR.
- Bit 8 Spare, for future use and set to "0".

When present, the Destination IPv4 Address field or the Source IPv4 Address field shall contain the destination or source IPv4 address respectively to set in the IPv4 header of the outgoing packet.

When present, the Destination IPv6 Address field or the Source IPv6 Address field shall contain the destination or source IPv6 address respectively to set in the IPv6 header of the outgoing packet.

When present, the Destination Port Number field or the Source Port Number field shall contain the destination or source Port Number respectively to set in the UDP header of the outgoing packet.

At least one IP address shall be present if the UMN6RS flag is not set.

Neither of the Destination IPv4 Address, Destination IPv6 Address, Destination Port Number, Source IPv4 Address, Source IPv6 Address and Source Port Number IEs shall be present if the UMN6RS flag is set.

8.2.201 DNS Query/Response Filter

The DNS Query/Response Filter IE type shall be encoded as shown in Figure 8.2.201-1. It contains a DNS Query Filter or the DNS Response Filter.

Octets	Bits						
	8	7	6	5	4	3	2
1 to 2	Type = 294 (decimal)						
3 to 4	Length = n						
5 to 6	Length of Domain Name Pattern						
7 to p	Domain Name Pattern						
x to (n+4)	These octet(s) is/are present only if explicitly specified						

Figure 8.2.201-1: DNS Query/Response Filter

The Domain Name Pattern field, in octets 7 to p, shall be encoded as Octetstring representing a JSON object defined as FqdnPatternMatchingRule data type specified in clause 5.2.4.23 of 3GPP TS 29.571 [61].

8.2.202 Event Notification URI

The Event Notification URI IE type shall be encoded as shown in Figure 8.2.202-1.

Octets	Bits						
	8	7	6	5	4	3	2
1 to 2	Type = 296 (decimal)						
3 to 4	Length = n						
5 to n+4	Event Notification URI						

Figure 8.2.202-1: Event Notification URI

The Event Notification URI field in octets 5 to (n+4) shall contain an octet string representing the Event Notification URI (i.e. string providing an URI formatted according to IETF RFC 3986 [71]) to be used for sending the UPF event notifications.

8.2.203 Notification Correlation ID

The Notification Correlation ID IE type shall be encoded as shown in Figure 8.2.203-1.

		Bits							
Octets		8	7	6	5	4	3	2	1
1 to 2	Type = 297 (decimal)								
3 to 4	Length = n								
5 to n+4	Notification Correlation ID								

Figure 8.2.203-1: Notification Correlation ID

The Notification Correlation ID field in octets 5 to (n+4) shall contain an octet string representing the value of the Notification Correlation ID to be sent in UPF event notifications.

8.2.204 Reporting Flags

The Reporting Flags IE indicates flags providing additional information for direct event notification reporting. It is coded as depicted in Figure 8.2.204-1.

		Bits							
Octets		8	7	6	5	4	3	2	1
1 to 2	Type = 298 (decimal)								
3 to 4	Length = n								
5	Spare	Spare	Spare	Spare	Spare	Spare	Spare	Spare	DUPL
6 to (n+4)	These octet(s) is/are present only if explicitly specified								

Figure 8.2.204-1: Reporting Flags

The following bits within Octet 5 shall indicate:

- Bit 1 – DUPL (Duplicated notification): if this bit is set to "1", it indicates that the UP function shall also report the event notifications over N4 (in addition to reporting them directly to the Event Notification URI).
- Bit 2 to 8 – Spare, for future use, shall be set to "0" by the sender and discarded by the receiver.

8.2.205 Predefined Rules Name

The Predefined Rules Name IE type shall be coded as shown in Figure 8.2.205-1. It shall contain a Predefined Rules Name, referring to one or more predefined rules which are activated in the UP function.

		Bits							
Octets		8	7	6	5	4	3	2	1
1 to 2	Type = 299 (decimal)								
3 to 4	Length = n								
5 to (n+4)	Predefined Rules Name								

Figure 8.2.205-1: Predefined Rules Name

The Predefined Rules Name field shall be encoded as an OctetString.

8.2.206 MBS Session Identifier

The MBS Session Identifier is used to identify a 5G MBS Session. It contains the Temporary Mobile Group Identity as defined in 3GPP TS 23.003 [2] or a Source Specific IP multicast address which consists of two IP addresses, one is an IP unicast address used as source address in IP packets for identifying the source of the multicast service (e.g. AF/AS), the other is an IP multicast address used as destination address in related IP packets for identifying a multicast service associated with the source.

It is coded as specified in Figure 8.2.206-1.

Octets	Bits							
	8	7	6	5	4	3	2	1
1 to 2	Type = 305 (decimal)							
3 to 4	Length = n							
5	Spare				NIDI	SSMI	TMGI	
6-11	TMGI							
12-m	Source Specific IP Multicast Address							
o to (o+5)	NID							
q-(n+4)	These octet(s) is/are present only if explicitly specified							

Figure 8.2.206-1: MBS Session Identifier

The following bits within Octet 5 shall indicate:

- Bit 1 – TMGI: if this bit is set to "1", it indicates that the TMGI field shall be present, otherwise it shall not be present;
- Bit 2 – SSMI: if this bit is set to "1", it indicates that the Source Specific IP Multicast Address field shall be present, otherwise it shall not be present;
- Bit 3 – NIDI: if this bit is set to "1", it indicates that the Network Identifier (NID) field shall be present, otherwise it shall not be present;
- Bit 4 to 8 – Spare, for future use, shall be set to "0" by the sender and discarded by the receiver.

The TMGI field shall be encoded as octets 3 to octet 8 in the figure 10.5.154 of 3GPP TS 24.008 [5].

The Source Specific IP Multicast Address field shall be encoded the octets 10 to m of IE Multicast Transport Information as specified in 8.2.207.

The NID field shall be encoded with 11 hexadecimal digit, bit 8 to bit 5 of the octet "o" is the most significant digit and bit 8 to bit 5 of the octet "o+5" is the least significant digit, and bits 4 to 1 of octets (o+5) shall all be encoded as 0.

8.2.207 Multicast Transport Information

The Multicast Transport Information IE contains the Low Layer Source Specific IP Multicast Address allocated by the MB-UPF. It is coded as specified in Figure 8.2.207-1.

The IP Multicast Distribution Address and the IP Source Address fields contain the IPv4 or IPv6 address. The Address Type and Address Length fields shall be included in each field:

- The Address Type, which is a fixed length code (of 2 bits) identifying the type of address that is used in the Address field.
- The Address Length, which is a fixed length code (of 6 bits) identifying the length of the Address field.
- The Address, which is a variable length field shall contain either an IPv4 address or an IPv6 address.

Address Type 0 and Address Length 4 shall be used when Address is an IPv4 address.

Address Type 1 and Address Length 16 shall be used when Address is an IPv6 address.

Other combinations of values are not valid.

Common Tunnel Endpoint Identifier is allocated at the source Tunnel Endpoint and signalled to the destination Tunnel Endpoint. There is one Common Tunnel Endpoint Identifier allocated per MBS session.

Octets	Bits						
	8	7	6	5	4	3	2
1 to 2	Type = 306 (decimal)						
3 to 4	Length=n						
5	Spare						
6 to 9	Common Tunnel Endpoint Identifier						
10	Address Type		Address Length				
11 to K	IP Multicast Distribution Address (IPv4 or IPv6)						
K+1	Address Type		Address Length				
(k+2) to m	IP Source Address (IPv4 or IPv6)						
(m+1) to n	These octet(s) is/are present only if explicitly specified						

Figure 8.2.207-1: Multicast Transport Information

8.2.208 MBSN4mbReq-Flags

The MBSN4mbReq-Flags IE indicates flags applicable to the PFCP Session Establishment Request. It is coded as depicted in Figure 8.2.208-1.

Octets	Bits							
	8	7	6	5	4	3	2	1
1 to 2	Type = 307 (decimal)							
3 to 4	Length = n							
5	Spare			MBS RESTI		JMBS SM	PLLS SM	
6 to (n+4)	These octet(s) is/are present only if explicitly specified							

Figure 8.2.208-1: MBSN4mbReq-Flags

The following bits within Octet 5 shall indicate:

- Bit 1 – PLLSSM (Provide Lower Layer SSM): if this bit is set to "1", it indicates that the MB-UPF shall allocate a lower layer SSM (i.e. multicast destination address and related source IP address) and a GTP-U Common Tunnel EndPoint Identifier (C-TEID) in the Multicast Transport Address IE. See clause 5.34.2.2.
- Bit 2 – JMBSSM (Join MBS Session SSM): if this bit is set to "1", it indicates that the MB-UPF shall join the multicast tree towards the Source Specific Multicast (SSM) address information provided by AF/AS or MBSTF for the MBS Session.
- Bit 3 – MBS RESTI (MBS Restoration Indication): if this bit is set to "1", it indicates to the MB-UPF that the PFCP session to be established is to restore an existing PFCP session of an MBS session.
- Bit 4 to 8 – Spare, for future use, shall be set to "0" by the sender and discarded by the receiver.

8.2.209 Local Ingress Tunnel

The Local Ingress Tunnel IE type shall be encoded as shown in Figure 8.2.209-1. It indicates a UDP/IP tunnel.

Octets	Bits							
	8	7	6	5	4	3	2	1
1 to 2	Type = 308 (decimal)							
3 to 4	Length = n							
5	Spare			CH		V6	V4	
6-7	UDP Port							
m to (m+3)	IPv4 address							
p to (p+15)	IPv6 address							
k to (n+4)	These octet(s) is/are present only if explicitly specified							

Figure 8.2.209-1: Local Ingress Tunnel

The following flags are coded within Octet 5:

- Bit 1 – V4: If this bit is set to "1" and the CH bit is not set, then the IPv4 address field shall be present, otherwise the IPv4 address field shall not be present.
- Bit 2 – V6: If this bit is set to "1" and the CH bit is not set, then the IPv6 address field shall be present, otherwise the IPv6 address field shall not be present.
- Bit 3 – CH (CHOOSE): If this bit is set to "1", then the UDP Port, IPv4 address and IPv6 address fields shall not be present and the UP function shall assign a UDP Port with either an IP4 or an IPv6 address, depending on whether the CP function has set the V4 or the V6 bit, respectively. This bit shall only be set by the CP function.
- Bit 4 to 8: Spare, for future use and set to "0".

Only one of the V4 and V6 flags shall be set to "1".

Octets "m to (m+3)" and/or "p to (p+15)" (IPv4 address / IPv6 address fields), if present, it shall contain the respective IP address values.

8.2.210 MBS Unicast Parameters ID

The MBS Unicast Parameters ID IE type shall be encoded as shown in Figure 8.2.210-1. It shall contain a MBS Unicast Parameters ID.

Octets	Bits							
	8	7	6	5	4	3	2	1
1 to 2	Type = 309 (decimal)							
3 to 4	Length = n							
5 to 6	MBS Unicast Parameters ID value							
7 to (n+4)	These octet(s) is/are present only if explicitly specified							

Figure 8.2.210-1: MBS Unicast Parameters ID

The MBS Unicast Parameters ID value field shall be encoded as an Unsigned16 binary integer value.

8.2.211 MBSN4Resp-Flags

The MBSN4Resp-Flags IE indicates flags applicable to the PFCP Session Establishment/Modification/Deletion Response message for a PFCP session that is associated with an MBS Session. It is coded as depicted in Figure 8.2.211-1.

Octets	Bits								
	8	7	6	5	4	3	2	1	
1 to 2	Type = 312 (decimal)								
3 to 4	Length = n								
5	Spare				N19D	JMTI	NN19		
6 to (n+4)	These octet(s) is/are present only if explicitly specified								
					TR		DT		

Figure 8.2.211-1: MBSN4Resp-Flags

The following bits within Octet 5 shall indicate:

- Bit 1 – NN19DT (New N19mb Downlink Tunnel): if this bit is set to "1", it indicates that the UPF has allocated a new N19mb DL Tunnel ID for the MBS Session;
- Bit 2 – JMTI (Joined N19mb Multicast Tree Indication): if this bit is set to "1", it indicates that the UPF has joined the multicast tree from MB-UPF;
- Bit 3 – N19DTR (N19mb Downlink Tunnel Removal): if this bit is set to "1", it indicates that the UPF is going to remove the N19mb DL Tunnel for receiving the MBS session data, because the PFCP session removing the PDR is the last PFCP session which was associated with the N19mb DL Tunnel in the UPF;

- Bit 4 to 8 – Spare, for future use, shall be set to "0" by the sender and discarded by the receiver.

NOTE: See clause 5.34.3.2 for further description of the setting and use of the bits in the MBSN4Resp-Flags.

8.2.212 Tunnel Password

The Tunnel Password IE type shall be encoded as shown in Figure 8.2.212-1. It contains the value of Tunnel Password (in plain text) to be used for the L2TP tunnel.

NOTE: The CP function obtains the plain text value of Tunnel Password after decoding and de-encrypting the Tunnel-Password AVP, which is received from AAA/Radius Server, as specified in clause 3.5 of IETF RFC 2868 [68].

Octets	Bits							
	8	7	6	5	4	3	2	1
1 to 2	Type = 313 (decimal)							
3 to 4	Length = n							
5 to (n+4)	Tunnel Password value							

Figure 8.2.212-1: Tunnel Password

The Tunnel Password value shall be encoded in UTF8String format.

8.2.213 Area Session ID

The Area Session ID together with the MBS Session Identifier uniquely identifies the service area part of the content data of a location dependent MBS service (see clause 30.3 of 3GPP TS 23.003 [2]). It shall be coded as specified in Figure 8.2.213-1.

Octets	Bits							
	8	7	6	5	4	3	2	1
1 to 2	Type = 314 (decimal)							
3 to 4	Length = 2							
5 to 6	Area Session ID value							

Figure 8.2.213-1: Area Session ID

The Area Session ID value shall be encoded as an Unsigned16 binary integer value.

8.2.214 DSCP to PPI Mapping Information

The DSCP to PPI Mapping Information IE shall be encoded as shown in Figure 8.2.214-1. It contains the mapping from DSCP(s) to a PPI.

Octets	Bits							
	8	7	6	5	4	3	2	1
1 to 2	Type = 317 (decimal)							
3 to 4	Length = n							
5	Spare				PPI Value			
6	Spare		DSCP Value 1					
7	Spare		DSCP Value 2					
...	Spare		...					
(5+x)	Spare		DSCP Value x					
(6+x) to (n+4)	These octet(s) is/are present only if explicitly specified							

Figure 8.2.214-1: DSCP to PPI Mapping Information

The PPI Value in octet 5 shall be encoded as a value between 0 and 7, as specified in clause 5.5.3.7 of 3GPP TS 38.415 [34].

The DSCP Value 1 to x, in octet 6 to octet (5+x), where X shall not be larger than 63, shall be encoded as the DSCP in TOS (IPv4) or TC (IPv6) information (see IETF RFC 2474 [13]).

8.2.215 PFCPSDRsp-Flags

The PFCPSDRsp-Flags IE indicates flags applicable to the PFCP Session Report Response message. It is coded as depicted in Figure 8.2.215-1.

Octets	Bits							
	8	7	6	5	4	3	2	1
1 to 2	Type = 318 (decimal)							
3 to 4	Length = n							
5	Spare	Spare	Spare	Spare	Spare	Spare	Spare	PURU
6 to (n+4)	These octet(s) is/are present only if explicitly specified							

Figure 8.2.215-1: PFCPSDRsp-Flags

The following bits within Octet 5 shall indicate:

- Bit 1 – PURU (Pending Usage Reports Unacknowledged): if this bit is set to "1", it indicates that there are pending PFCP Session Report Request messages which have not been acknowledged yet.
- Bit 2 to 8 – Spare, for future use, shall be set to "0" by the sender and discarded by the receiver.

8.2.216 QER Indications

The QER Indications IE indicates flags applicable to a QER. It shall be coded as depicted in Figure 8.2.216-1.

Octets	Bits							
	8	7	6	5	4	3	2	1
1 to 2	Type = 319 (decimal)							
3 to 4	Length = n							
5	Spare	Spare	TNBM	DBSM	PDUS	EML4	EDBM	IQFIS
			I	I	M	S	I	N
6 to (n+4)	These octet(s) is/are present only if explicitly specified							

Figure 8.2.216-1: QER Indications

The following bits within Octet 5 shall indicate:

- Bit 1 – IQFISN (Insert DL MBS QFI SN): If this bit is set to "1", then the MB-UPF shall insert the DL MBS QFI Sequence Number in the GTP-U PDU Session Container extension header of MBS data packets (see 3GPP TS 38.415 [34]).
- Bit 2 – EDBMI (End Of Data Burst Marking Indication): If this bit is set "1", then the UPF shall set the End Of Data Burst indication together with the QFI (identifying the QoS flow conveying the Data Burst) in the GTP-U PDU Set Information Container extension header of the GTP-U packet encapsulating the last PDU of each data burst (see 3GPP TS 38.415 [34]).
- Bit 3 – EML4S (ECN Marking for L4S): If this bit is set to "1", then the UPF shall perform ECN marking for L4S (see clause 5.38.1).
- Bit 4 – PDUSM (PDU Set Marking): If this bit is set to "1", then the UPF shall perform PDU Set marking in the GTP-U PDU Set Information Container extension header of the GTP-U packet (see clause 5.38.3).
- Bit 5 – DBSMI (Data Burst Size Marking Indication): If this bit is set "1", then the UPF shall insert the Data Burst Size of the data burst in the GTP-U PDU Session Container extension header of the GTP-U packet (see 3GPP TS 38.415 [34]) of the first PDUs of the data burst.

- Bit 6 – TNBMI (Time to Next Burst Marking Indication): If this bit is set "1", then the UPF shall insert the Time to Next Burst in the GTP-U PDU Session Container extension header of the GTP-U packet (see 3GPP TS 38.415 [34]).
- Bit 7 to 8 – Spare, for future use, shall be set to "0" by the sender and discarded by the receiver.

8.2.217 Vendor-Specific Node Report Type

The Vendor-Specific Node Report Type IE shall be encoded as shown in Figure 8.2.217-1. It indicates the type of the Vendor-Specific node report the UP function sends to the CP function.

Octets	Bits							
	8	7	6	5	4	3	2	1
1 to 2	Type = 320 (decimal)							
3 to 4	Length = n							
5 to 6	Enterprise ID							
7	Spare	Spare	Spare	Spare	Spare	Spare	Spare	Spare
8 to (n+4)	These octet(s) is/are present only if explicitly specified							

Figure 8.2.217-1: Vendor-Specific Node Report Type

Octet 7 (and following octets if needed) shall be encoded as a bitmask, where each bit in the bitmask shall indicate a Vendor-Specific Node Report Type. The definition and semantic of the bits in the bitmask are out of scope of 3GPP.

Enterprise ID in octets 5 to 6 shall be encoded as defined in clause 8.1.1. The Enterprise ID may identify a Standards Development Organization. The report types indicated by octet 7 (and following octets if needed) are specific to the Standards Development Organization or enterprise identified by the Enterprise ID.

Spare bits are for future use and shall be set to "0".

At least one bit shall be set to "1".

NOTE: The Vendor-Specific Node Report Type IE in the PFCP Node Report Request message can be used by non-3GPP Standards Development Organizations for interfaces relying on PFCP as the protocol for Control and User Plane Separation, for identifying the type of vendor-specific node reports not defined by 3GPP. The definition and semantic of the bits within the bitmask are to be specified by each non-3GPP Standards Development Organization (without liaising with 3GPP CT4). See clauses 5.9 and 8.1.1 for the definition and usage of Vendor Specific IEs.

8.2.218 Configured Time Domain

The Configured Time Domain IE type shall be encoded as shown in Figure 8.2.218-1. It shall contain

Octets	Bits							
	8	7	6	5	4	3	2	1
1 to 2	Type = 321 (decimal)							
3 to 4	Length = n							
5	Spare							CTDI
6 to (n+4)	These octet(s) is/are present only if explicitly specified							

Figure 8.2.218-1: Configured Time Domain

Octet 5 shall be encoded as follows:

- Bit 1 (CTDI – Configured Time Domain Indicator): when set to "1", this indicates that the Time Domain Number configured to the NW-TT(s) is used.
- Bits 2 to 8: Spare, for future use and set to "0".

8.2.219 Metadata

The Metadata IE type shall be encoded as shown in Figure 8.2.219-1. It contains the Metadata which the UPF needs to apply to traffic sent over a Service Function Chain.

Octets	Bits							
	8	7	6	5	4	3	2	1
1 to 2	Type = 322 (decimal)							
3 to 4	Length = n							
5 to n+4	Metadata							

Figure 8.2.219-1: Metadata

The Metadata field shall contain an octet string set to base64-encoded characters as specified in clause 5.5.2 of 3GPP TS 29.571 [61].

8.2.220 Traffic Parameter Threshold

The N6 Jitter Threshold IE contains a N6 Jitter threshold in milliseconds. It shall be encoded as shown in Figure 8.2.220-1.

Octets	Bits							
	8	7	6	5	4	3	2	1
1 to 2	Type = 325 (decimal)							
3 to 4	Length = n							
5	Spare						DL	
6 to 9	Downlink N6 Jitter threshold							
10 to (n+4)	These octet(s) is/are present only if explicitly specified							

Figure 8.2.220-1: Traffic Parameter Threshold

The following flags are coded within Octet 5:

- Bit 1 – DL: If this bit is set to "1", then the Downlink packet N6 Jitter threshold field shall be present, otherwise the Downlink packet N6 Jitter threshold field shall not be present.
- Bit 2 to 8: Spare, for future use and set to "0".

The Downlink N6 Jitter threshold field shall be encoded as an Unsigned32 binary integer value containing the downlink packet Jitter threshold in milliseconds.

8.2.221 DL Periodicity

The DL Periodicity IE contains a DL Periodicity in milliseconds to be used to measure N6 Jitter by the UP function. It shall be encoded as shown in Figure 8.2.221-1.

Octets	Bits							
	8	7	6	5	4	3	2	1
1 to 2	Type = 326 (decimal)							
3 to 4	Length = n							
5	Spare							
6 to 9	DL Periodicity							
10 to (n+4)	These octet(s) is/are present only if explicitly specified							

Figure 8.2.221-1: DL Periodicity

The DL Periodicity fields shall be encoded as an Unsigned32 binary integer value containing the DL Periodicity in milliseconds.

8.2.222 N6 Jitter Measurement

The N6 Jitter Measurement IE contains a N6 jitter measurement in milliseconds measured by the UP function. It shall be encoded as shown in Figure 8.2.222-1.

Octets	Bits							
	8	7	6	5	4	3	2	1
1 to 2	Type = 327 (decimal)							
3 to 4	Length = n							
5	Spare						DL	
6 to 9	DL Periodicity							
10 to 13	Lower DL Jitter Measurement							
14 to 17	Higher DL Jitter Measurement							
18 to (n+4)	These octet(s) is/are present only if explicitly specified							

Figure 8.2.222-1: N6 Jitter Measurement

The following flags are coded within Octet 5:

- Bit 1 – DL: If this bit is set to "1", then the DL Periodicity, Lower DL Jitter Measurement and Higher DL Jitter Measurement fields shall be present, otherwise the DL Periodicity, Lower DL Jitter Measurement and Higher DL Jitter Measurement fields shall not be present.
- Bit 2 to 8: Spare, for future use and set to "0".

When present, the DL Periodicity field shall be encoded as an Unsigned32 binary integer value containing the DL Periodicity in milliseconds used for the N6 Jitter Measurement.

When present, the Lower DL Jitter Measurement and the Higher DL Jitter Measurement fields shall indicate the downlink packet Jitter range over N6. The Lower DL Jitter Measurement and the Higher DL Jitter Measurement fields shall be encoded as a signed32 binary integer value containing the downlink packet Jitter (i.e. positive or negative deviation of the arrival time of first packet of a Data Burst compared to the ideal Data Burst start time which is determined based on the DL periodicity) measured in milliseconds.

8.2.223 Traffic Parameter Measurement Indication

The Traffic Parameter Measurement Indication IE indicates to the UPF to perform the relevant traffic parameter measurement for a QoS flow. It shall be coded as depicted in Figure 8.2.223-1.

Octets	Bits								
	8	7	6	5	4	3	2	1	
1 to 2	Type = 328 (decimal)								
3 to 4	Length = n								
5	Spare						N6JMI	DLPM	ULPM
6 to (n+4)	These octet(s) is/are present only if explicitly specified								

Figure 8.2.223-1: Traffic Parameter Measurement Indication

The following bits within Octet 5 shall indicate:

- Bit 1 – ULPMI (UL Periodicity Measurement Indication): If this bit is set to "1", then the UPF shall measure and report the UL Periodicity for the QoS flow as specified in clause 5.38.4.
- Bit 2 – DLPMI (DL Periodicity Measurement Indication): If this bit is set to "1", then the UPF shall measure the DL Periodicity for the QoS flow as specified in clause 5.38.4.
- Bit 3 – N6JMI (N6 Jitter Measurement Indication): If this bit is set to "1", then the UPF shall measure N6 Jitter as specified in clause 5.38.4.
- Bit 4 to 8 – Spare, for future use, shall be set to "0" by the sender and discarded by the receiver.

8.2.224 UL Periodicity

The UL Periodicity IE contains a UL Periodicity in milliseconds measured by the UP function when requested by the SMF. It shall be encoded as shown in Figure 8.2.224-1.

Octets	Bits						
	8	7	6	5	4	3	2
1 to 2	Type = 329 (decimal)						
3 to 4	Length = n						
5	Spare						
6 to 9	UL Periodicity						
10 to (n+4)	These octet(s) is/are present only if explicitly specified						

Figure 8.2.224-1: UL Periodicity

The UL Periodicity fields shall be encoded as an Unsigned32 binary integer value containing the UL Periodicity in milliseconds.

8.2.225 MPQUIC Control Information

The MPQUIC Control Information IE shall provide details of the required MPQUIC based functionality. It shall be encoded as shown in Figure 8.2.a-1.

Octets	Bits						
	8	7	6	5	4	3	2
1 to 2	Type = 330 (decimal)						
3 to 4	Length = n						
5	Spare			CETH	CIP	CUDP	
m to (n+4)	These octet(s) is/are present only if explicitly specified						

Figure 8.2.225-1: MPQUIC Control Information

The following flags are coded within Octet 5:

- Bit 1– CUDP (CONNECT-UDP): If this bit is set to "1", it indicates that the proxy type of required MPQUIC is "connect-udp" (see clause 5.32.6.2.2 of 3GPP TS 23.501 [28]) and the UPF shall allocate relevant resource as specified in clause 5.20.2A.1
- Bit 2– CIP (CONNECT-IP): If this bit is set to "1", it indicates that the proxy type of required MPQUIC is "connect-ip" (see clause 5.32.6.2.2 of 3GPP TS 23.501 [28]) and the UPF shall allocate relevant resource as specified in clause 5.20.2A.1
- Bit 3– CETH (CONNECT-Ethernet): If this bit is set to "1", it indicates that the proxy type of required MPQUIC is "connect-ethernet" (see clause 5.32.6.2.2 of 3GPP TS 23.501 [28]) and the UPF shall allocate relevant resource as specified in clause 5.20.2A.1
- Bit 4 to 8 Spare, for future use and set to "0".

At least one bit shall be set to 1. Several bits may be set to 1.

8.2.226 MPQUIC Address Information

The MPQUIC Address Information IE shall carry the address information of MPQUIC proxy in the UPF, when using the MPQUIC-UDP, MPQUIC-IP or MPQUIC-E steering functionality. It shall be encoded as shown in Figure 8.2.226-1.

Octets	Bits							
	8	7	6	5	4	3	2	1
1 to 2	Type = 332 (decimal)							
3 to 4	Length = n							
5	Spare					V6	V4	
6	MPQUIC Proxy Type							
7 to 8	MPQUIC Proxy Port							
p to (p+3)	MPQUIC Proxy IPv4 Address							
q to (q+15)	MPQUIC Proxy IPv6 Address							
m to (n+4)	These octet(s) is/are present only if explicitly specified							

Figure 8.2.226-1: MPQUIC Address Information

The following flags are coded within Octet 5:

- Bit 1 – V4: If this bit is set to "1", then the MPQUIC Proxy IPv4 Address field shall be present in the MPQUIC Address Information IE.
- Bit 2 – V6: If this bit is set to "1", then the MPQUIC IPv6 Address field shall be present in the MPQUIC Address Information IE.
- Bit 3 to 8 Spare, for future use and set to "0".

Octets 6 shall indicate the MPQUIC Proxy Type, with the value specified in clause 6.1.4 of 3GPP TS 24.193 [59].

Octets 7 to 8 shall indicate the allocated UDP port number of the MPQUIC Proxy.

Octets "p to (p+3)" or "q to (q+15)" (IPv4 address / IPv6 address fields), if present, shall contain the address value.

If the PDU session is of type IPv4v6, both MPQUIC Proxy IPv4 Address and MPQUIC Proxy IPv6 Address shall be included when the MPQUIC-UDP or MPQUIC-IP steering functionality is required for the PFCP session. See also clause 5.20.2A.2.

Both MPQUIC Proxy IPv4 Address and MPQUIC Proxy IPv6 Address should be included when the MPQUIC-E steering functionality is required for the PFCP session. See also clause 5.20.2A.2.

8.2.227 Transport Mode

The transport mode IE shall be encoded as shown in Figure 8.2.227-1. It indicates the transport mode for transmitting a UDP, IP or Ethernet flow, when using the MPQUIC-UDP, MPQUIC-IP or MPQUIC-E steering functionality.

Octets	Bits							
	8	7	6	5	4	3	2	1
1 to 2	Type = 333 (decimal)							
3 to 4	Length = n							
5	Spare				Transport Mode Value			
6 to (n+4)	These octet(s) is/are present only if explicitly specified							

Figure 8.2.227-1: Transport Mode

The Transport Mode value shall be encoded as a 4 bits binary integer as specified in Table 8.2.e-1.

Table 8.2.227-1: Transport Mode value

Transport Mode Value	Values (Decimal)
Datagram mode 1	0
Datagram mode 2	1
Stream mode	2
Spare	3 to 15
NOTE: See clause 5.32.6.2.2.1 of 3GPP TS 23.501 [28] for the definition of the different transport modes.	

8.2.228 Void

8.2.229 Reporting Suggestion Info

The Reporting Suggestion Info IE shall be encoded as shown in Figure 8.2.229-1.

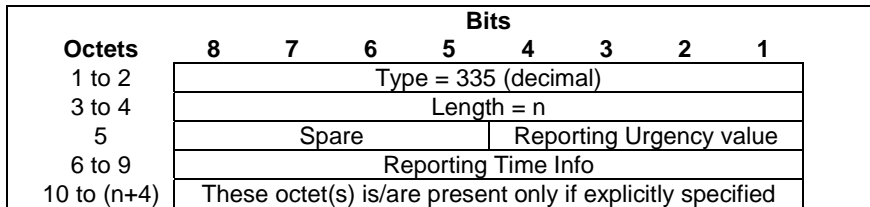

Figure 8.2.229-1: Reporting Suggestion Info

The Reporting Urgency value shall be encoded as a 4 bits binary integer as specified in Table 8.2.229-1.

Table 8.2.229-1: Reporting Urgency value

Reporting Urgency Value	Values (Decimal)
Delay tolerant	0
Non delay tolerant	1
Spare	2 to 15

The Reporting Time Info field shall be present if the Reporting Urgency indicates the event report is delay tolerant. When present, it shall be encoded as an Unsigned32 binary integer value indicating the latest time for the UPF to report the detected event, expressed as a duration in seconds.

8.2.230 TL-Container

The TL-Container IE shall be encoded as shown in Figure 8.2.230-1. It contains an opaque container of TL-Container information.

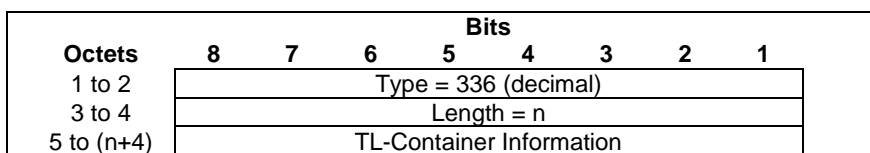

Figure 8.2.230-1: TL-Container

The TL-Container Information field shall be encoded as an Octet String. It shall encode a Get or Set Request or Response message defined in 3GPP TS 29.585 [80].

8.2.231 Measurement Indication

The Measurement Indication IE shall be encoded as shown in Figure 8.2.231-1.

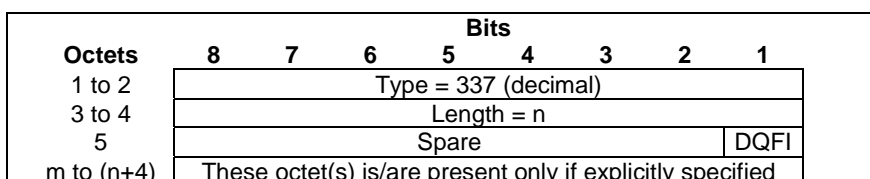

Figure 8.2.231-1: Measurement Indication

The following flags are coded within Octet 5:

- Bit 1 – DQFI (Default QoS Flow Indication): If this bit is set to "1", it indicates that the UPF is requested to perform QoS Monitoring measurements on the QoS flow associated with the default QoS rule and the UPF shall include the same indication in the corresponding QoS Monitoring Measurement report (see clause 4.15.4.5.1 of 3GPP TS 23.502 [29]).
- Bit 2 to 8 Spare, for future use and set to "0".

8.2.232 HPLMN S-NSSAI

The HPLMN S-NSSAI IE indicates the HPLMN S-NSSAI of a PDU session. It shall be encoded as shown in Figure 8.2.232-1.

Octets	Bits							
	8	7	6	5	4	3	2	1
1 to 2	Type = 338 (decimal)							
3 to 4	Length = 4							
5	SST							
6 to 8	SD							

Figure 8.2.232-1: HPLMN S-NSSAI

The SST (Slice/Service Type) and SD (Slice Differentiator) fields shall be encoded as defined in clause 28.4.2 of 3GPP TS 23.003 [2].

8.2.233 Media Transport Protocol

The Media Transport Protocol IE indicates the transport protocol used by the packets of the media flow. It shall be coded as depicted in Figure 8.2.233-1.

Octets	Bits							
	8	7	6	5	4	3	2	1
1 to 2	Type = 339 (decimal)							
3 to 4	Length = n							
5	Spare				Media Transport Protocol			
6 to (n+4)	These octet(s) is/are present only if explicitly specified							

Figure 8.2.233-1: Media Transport Protocol

The Media Transport Protocol field in octet 5 shall be encoded as defined in Table 8.2.233-1.

Table 8.2.233-1: Media Transport Protocol

Value (Decimal)	Media Transport Protocol
0	Unspecified
1	RTP (Real-time Transport Protocol) – see IETF RFC 3550 [82]
2	SRTP (Secure Real-Time Protocol) – see IETF RFC 3711 [83]
3	MOQT (Media Over QUIC Transport protocol) – see IETF draft-ietf-moq-transport [98]
4-15	Spare, for future use.

8.2.234 RTP Header Extension Type

The RTP Header Extension Type IE indicates the type of the RTP header extension. It shall be coded as depicted in Figure 8.2.234-1.

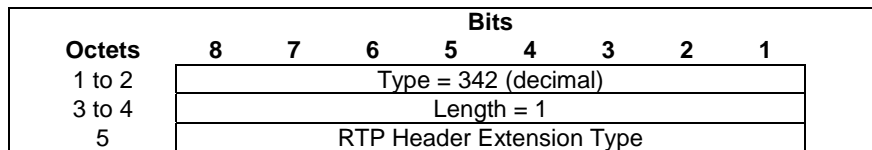

Figure 8.2.234-1: RTP Header Extension Type

The RTP Header Extension Type field in octet 5 shall be encoded as defined in Table 8.2.234-1.

Table 8.2.234-1: RTP Header Extension Type

Value (Decimal)	Header Extension
1	RTP Header Extension for PDU Set Marking (see clause 4.4.2.2 of 3GPP TS 26.522 [79])
2	RTP header extension for Dynamically changing traffic characteristics (see clause 4.5 of 3GPP TS 26.522 [59])
3	RTP header extension for Expedited Transfer Indication (see clause 4.6 of 3GPP TS 26.522 [59])
4-255	Spare, for future use.

8.2.235 RTP Header Extension ID

The RTP Header Extension ID IE indicates the ID of the RTP header extension. It shall be coded as depicted in Figure 8.2.235-1.

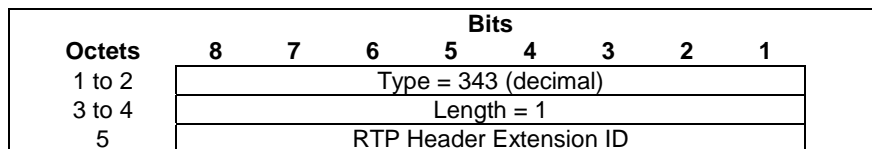

Figure 8.2.235-1: RTP Header Extension ID

The RTP Header Extension ID field shall be encoded as a decimal value in the range 1 to 255 (see IETF RFC 8285 [86]).

8.2.236 RTP Payload Type

The RTP Payload Type indicates the payload type of RTP packets. It shall be coded as depicted in Figure 8.2.336-1.

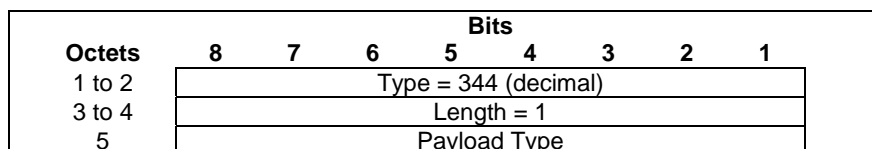

Figure 8.2.236-1: RTP Payload Type

The Payload Type field shall encode the (S)RTP payload type, as an integer between (and including) 0 and 127.

8.2.237 RTP Payload Format

The RTP Payload Format indicates the payload format of RTP packets. It shall be coded as depicted in Figure 8.2.337-1.

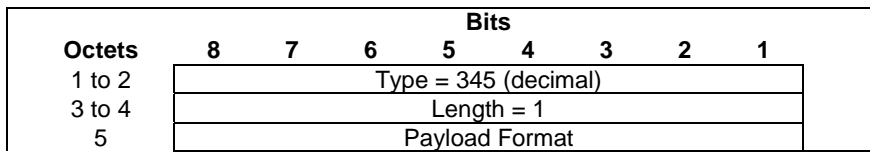

Figure 8.2.237-1: RTP Payload Format

The Payload Format field shall be encoded as defined in Table 8.2.237-1.

Table 8.2.237-1: Payload Format

Value (Decimal)	Payload Format
1	H.264 – see IETF RFC 6184 [84]
2	H.265 – see IETF RFC 7798 [85]
3-255	Spare, for future use.

8.2.238 Extended DL Buffering Notification Policy

Extended DL Buffering Notification Policy is coded as depicted in Figure 8.2.238-1.

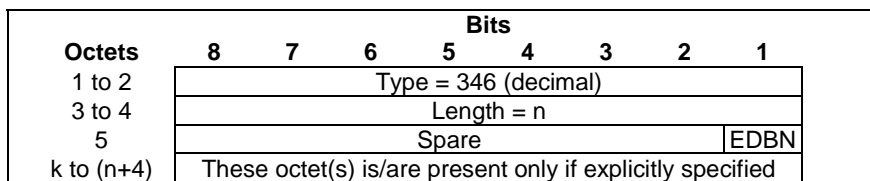

Figure 8.2.238-1: Extended DL Buffering Notification Policy

The following flags are coded within Octet 5:

- Bit 1 – EDBN (Extended DL Buffer Notification): This bit shall be set to "1" when the UP function shall send DL packet notification for the duration indicated by the DL Buffering Duration to report the arrival of the first buffered DL packet for each QoS flow for a given FAR. (see clause 7.5.4.11 and 7.5.9.2).
- Bit 2 to 8 are spare and reserved for future use, shall be set to "0" by the sender and discarded by the receiver.

8.2.239 MT-SDT Control Information

MT-SDT Control Information is coded as depicted in Figure 8.2.239-1.

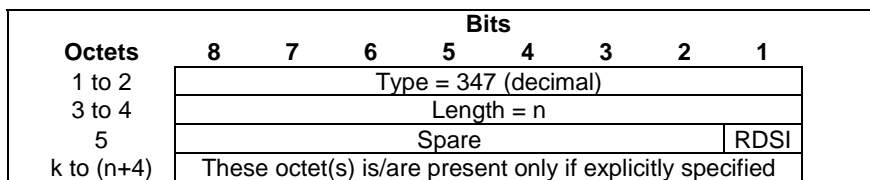

Figure 8.2.239-1: MT-SDT Control Information

The following flags are coded within Octet 5:

- Bit 1 – RDSI (Reporting DL data packets Size Indication): This bit shall be set to "1" if the UP function is requested to report the sum of DL data packets size per QoS flow.
- Bit 2 to 8 are spare and reserved for future use.

8.2.240 Reporting Thresholds

The Reporting Thresholds IE contains reporting thresholds to be monitored by the UP function for event triggered QoS monitoring reporting. It shall be encoded as shown in Figure 8.2.240-1.

Octets	Bits							
	8	7	6	5	4	3	2	1
1 to 2	Type = 348 (decimal)							
3 to 4	Length = n							
5	Spare			ULDR	DLDR	ULCI	DLCI	
m to (m+1)	DL Congestion information threshold							
p to (p+1)	UL Congestion information threshold							
q to (q+4)	DL Data Rate threshold							
r to (r+4)	UL Data Rate threshold							
s to (n+4)	These octet(s) is/are present only if explicitly specified							

Figure 8.2.240-1: Reporting Thresholds

The following flags are coded within Octet 5:

- Bit 1 – DLCI: If this bit is set to "1", then the Downlink Congestion Information threshold field shall be present, otherwise the Downlink Congestion Information threshold field shall not be present.
- Bit 2 – ULCI: If this bit is set to "1", then the Uplink Congestion Information threshold field shall be present, otherwise the Uplink Congestion Information threshold field shall not be present.
- Bit 3 – DLDR: If this bit is set to "1", then the Downlink Data Rate threshold field shall be present, otherwise the Downlink Data Rate threshold field shall not be present.
- Bit 4 – ULDR: If this bit is set to "1", then the Uplink Data Rate threshold field shall be present, otherwise the Uplink Data Rate threshold field shall not be present.
- Bit 5 to 8: Spare, for future use and set to "0".

At least one bit shall be set to "1". Several bits may be set to "1".

The Downlink Congestion information threshold field and the Uplink Congestion information threshold field shall be encoded as an Unsigned16 binary integer value, in the (decimal) values range 0 to 10000 (included), representing the percentage of congestion level in the downlink and in the uplink directions respectively, up to two decimal points, for the QoS flow. As an example, the (decimal) value 7500 corresponds to a percentage of 75.00%.

The Downlink Data Rate threshold field and the Uplink Data Rate threshold field shall be encoded as kilobits per second (1 kbps = 1000 bps) in binary value (rounded upwards).

8.2.241 RTP Header Extension Additional Information

The RTP Header Extension Additional Information provides additional information on the RTP Header Extension. It shall be coded as depicted in Figure 8.2.241-1.

Octets	Bits							
	8	7	6	5	4	3	2	1
1 to 2	Type = 349 (decimal)							
3 to 4	Length = n							
5	Spare			NPDSI	PSSAI	FI		
6	Spare			NPDS	PSSA	Format		
7 to (n+4)	These octet(s) is/are present only if explicitly specified							

Figure 8.2.241-1: RTP Extension Header Additional Information

The following flags are coded within Octet 5:

- Bit 1 – FI (Format Indication): If this bit is set to "1", it indicates that the Format field in octet 6 indicates the RTP header extension format. If this bit is set to "0", the format field in octet 6 shall be coded as all "0" and be ignored by the receiver.
- Bit 2 – PSSAI (PDU Set Size Active Indication): If this bit is set to "1", it indicates that the PSSA field in octet 6 indicates whether the PDU Set size in bytes is present in the RTP header extension of every RTP packet. If this bit is set to "0", the PSSA field in octet 6 shall be coded as all "0" and be ignored by the receiver. This bit may be set to "1" for the RTP Header Extension for PDU Set Marking.
- Bit 3 – NPDSI (Number of PDUs in the PDU Set): If this bit is set to "1", it indicates that the NPDS field in octet 6 indicates whether the Number of PDUs in the PDU Set in bytes is present in the RTP header extension of every RTP packet. If this bit is set to "0", the NPDS field in octet 6 shall be coded as all "0" and be ignored by the receiver. This bit may be set to "1" for the RTP Header Extension for PDU Set Marking.
- Bit 4 to 8 Spare, for future use and set to "0".

The Format field in octet 6 shall be encoded as defined in Table 8.2.241-1.

Table 8.2.241-1: Format field

Value (Decimal)	Format field
1	1-byte (short) format is used
2	2-byte (long) format is used
0, 3	Spare, for future use.

The PDU Set Size Active (PSSA) field in octet 6 shall be encoded as "1" if the PSSAI flag is set to 1 and the PDU Set Size is present in the RTP header extension of every RTP packet, and as "0" otherwise.

The Number of PDUs in the PDU Set (NPDS) field in octet 6 shall be encoded as "1" if the NPDSI flag is set to 1 and the Number of PDUs in the PDU Set is present in the RTP header extension of every RTP packet, and as "0" otherwise.

8.2.242 Mapped N6 IP Address

The Mapped N6 IP Address IE type shall be encoded as shown in Figure 8.2.242-1. It contains an N6 IP address mapped to a UE IP address.

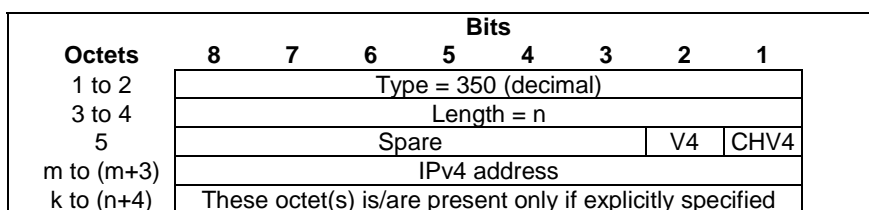

Figure 8.2.242-1: Mapped N6 IP Address

The following flags are coded within Octet 5:

- Bit 1 – CHV4 (CHOOSE IPV4): If this bit is set to "1", then the IPv4 address shall not be present and the UP function shall assign an IPv4 address as a mapped N6 IP address. This bit shall only be set by the CP function.
- Bit 2 – V4: If this bit is set to "1", then the CHV4 bit shall not be set and the IPv4 address field shall be present in the Mapped N6 IP Address, otherwise the IPv4 address field shall not be present.
- Bit 3 - 8 Spare, for future use and set to "0".

Octets "m to (m+3)" (IPv4 address fields), if present, shall contain the address value.

8.2.243 N6 Routing Information

The N6 Routing Information IE type shall be encoded as shown in Figure 8.2.243-1. It contains N6 tunneling information.

Octets	Bits						
	8	7	6	5	4	3	2
1 to 2	Type = 351 (decimal)						
3 to 4	Length = n						
5	Spare	DPO	DIPV6	DIPV4	SPO	SIPV6	SIPV4
m to (m+3)	Source IPv4 address						
p to (p+15)	Source IPv6 address						
q to (q+1)	Source Port Number						
r to (r+3)	Destination IPv4 address						
s to (s+15)	Destination IPv6 address						
t to (t+1)	Destination Port Number						
k to (n+4)	These octet(s) is/are present only if explicitly specified						

Figure 8.2.243-1: N6 Routing Information

The following flags are coded within Octet 5:

- Bit 1 – SIPV4: If this bit is set to "1", then the Source IPv4 address field shall be present in the N6 Routing Information, otherwise the Source IPv4 address field shall not be present.
- Bit 2 – SIPV6: If this bit is set to "1", then the Source IPv6 address field shall be present in the N6 Routing Information, otherwise the Source IPv6 address field shall not be present.
- Bit 3 – SPO: If this bit is set to "1", then the Source Port Number field shall be present in the N6 Routing Information, otherwise the Source Port Number field shall not be present.
- Bit 4 – DIPV4: If this bit is set to "1", then the Destination IPv4 address field shall be present in the N6 Routing Information, otherwise the Destination IPv4 address field shall not be present.
- Bit 5 – DIPV6: If this bit is set to "1", then the Destination IPv6 address field shall be present in the N6 Routing Information, otherwise the Destination IPv6 address field shall not be present.
- Bit 6 – DPO: If this bit is set to "1", then the Destination Port Number field shall be present in the N6 Routing Information, otherwise the Destination Port Number field shall not be present.
- Bit 7 - 8 Spare, for future use and set to "0".

Octets "m to (m+3)" or "p to (p+15)" (Source IPv4 address / Source IPv6 address fields) and Octets "r to (r+3)" or "s to (s+15)" (Destination IPv4 address / Destination IPv6 address fields), if present, shall contain the address value.

When present, the Destination Port Number field or the Source Port Number field shall contain the destination or source Port Number respectively to set in the UDP header of the outgoing packet.

8.2.244 URI

The URI IE type shall be encoded as shown in Figure 8.2.244-1.

Octets	Bits						
	8	7	6	5	4	3	2
1 to 2	Type = 352 (decimal)						
3 to 4	Length = n						
5 to n+4	URI						

Figure 8.2.244 -1: URI

The URI field in octets 5 to (n+4) shall contain an octet string representing the URI formatted according to IETF RFC 3986 [71].

8.2.245 UE Level Measurements Configuration

The UE Level Measurements Configuration IE shall be encoded as shown in Figure 8.2.245-1. It contains the 5GC UE level measurements configuration parameters to apply for the PFCP session.

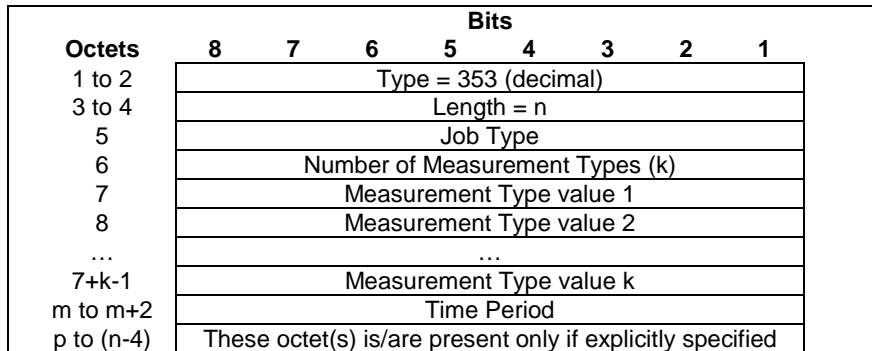

Figure 8.2.245-1: UE Level Measurements Configuration

Octets 5 represent the Job type for 5GC UE level measurements as defined in 3GPP TS 32.422 [35]. It shall be encoded as defined in Table 8.2.245-1.

Table 8.2.245-1: Job Type values

Job Type	Values (Decimal)
<reserved>	0
5GC UE Level Measurements only	1
Trace and 5GC UE Level Measurements	2
Spare, for future use	3-255

The Number of Measurement Types shall indicate the total number of the Measurement Type values. Each subsequent Octet after the Number of Measurement Types shall carry one Measurement Type value as defined in 3GPP TS 28.558 [88]. The Measurement Type value shall be encoded as defined in Table 8.2.245-2.

Table 8.2.245-2: Measurement Type values

Measurement Type	Values (Decimal)
<reserved>	0
Average DL packet delay between PSA UPF and UE for a QoS flow	1
Average UL packet delay between PSA UPF and UE for a QoS flow (excluding D1)	2
Average UL packet delay between PSA UPF and UE for a QoS flow (including D1)	3
Average UL packet delay between PSA UPF and NG-RAN for a QoS flow	4
Average DL packet delay between PSA UPF and NG-RAN for a QoS flow	5
Average round-trip packet delay between PSA UPF and NG-RAN	6
Average round-trip packet delay between PSA UPF and NG-RAN for a S-NSSAI	7
Average round-trip packet delay between PSA UPF and NG-RAN for a QFI	8
Average round-trip packet delay between PSA UPF and NG-RAN for a S-NSSAI and QFI	9
Spare, for future use	10-255

NOTE: The measurement Types 6, 7, 8 and 9 are same for UPF to measure the average round-trip packet delay for a QoS Flow.

Time Period Field Value shall indicate the period time for every Trace Recording Session of 5GC UE level measurement as defined in 3GPP TS 32.422 [35]. It shall be encoded as binary integer value in 3 octets with a unit second.

8.2.246 N6 Delay Measurement Protocols

The N6 Delay Measurement Protocols IE shall be encoded as shown in Figure 8.2.246-1.

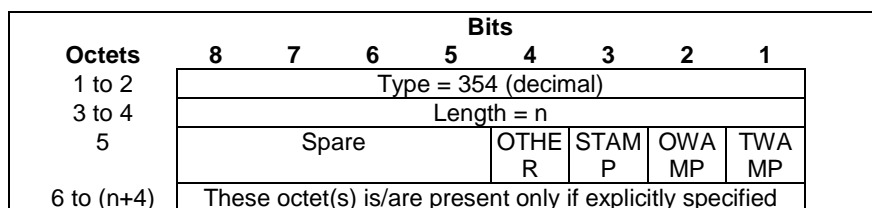

Figure 8.2.246-1: N6 Delay Measurement Protocols

Octet 5 shall be encoded as follows:

- Bit 1 – TWAMP (A Two-Way Active Measurement Protocol): when set to "1", this indicates that TWAMP (see IETF RFC 5357 [100]) is supported.
- Bit 2 – OWAMP (A One-way Active Measurement Protocol): when set to "1", this indicates that OWAMP (see IETF RFC 4656 [101]) is supported.
- Bit 3 – STAMP (Simple Two-Way Active Measurement Protocol): when set to "1", this indicates that STAMP (see IETF RFC 8762 [102]) is supported.
- Bit 4 – OTHER: when set to "1", this indicates that another measurement protocol is supported for which no specific bit has been defined.
- Bit 5 to 8: Spare, for future use and set to "0".

Several bits may be set to "1" when this IE is used by the UPF to report the list of N6 delay measurement protocols supported by the UPF.

One and only one bit shall be set to "1" when this IE is used by the SMF to indicate the N6 delay measurement protocol to use for performing N6 delay measurements.

8.2.247 N6 Delay Measurement Information

The N6 Delay Measurement Information IE shall be encoded as shown in Figure 8.2.247-1. It provides N6 delay measurement information.

Octets	Bits							
	8	7	6	5	4	3	2	1
1 to 2	Type = 357 (decimal)							
3 to 4	Length = n							
5	Spare						MAXD	MIND
6 to 9	Average Packet Delay							
p to (p+3)	Minimum Packet Delay							
q to (q+3)	Maximum Packet Delay							
r to (n+4)	These octet(s) is/are present only if explicitly specified							

Figure 8.2.247-1: N6 Delay Measurement Information

Octet 5 shall be encoded as follows:

- Bit 1 – MIND (Minimum Packet Delay): If this bit is set to "1", then the Minimum Packet Delay field shall be present, otherwise the Minimum Packet Delay field shall not be present.
- Bit 2 – MAXD (Maximum Packet Delay): If this bit is set to "1", then the Maximum Packet Delay field shall be present, otherwise the Maximum Packet Delay field shall not be present.
- Bit 3 to 8: Spare, for future use and set to "0".

The Average Packet Delay value, Minimum Packet Delay value and Maximum Packet Delay value shall be encoded as an Unsigned 32 binary integer value, in milliseconds.

8.2.248 Measurement Endpoint Address

The Measurement Endpoint Address IE shall contain the address information of the measurement endpoint. It shall be encoded as shown in Figure 8.2.248-1.

Octets	Bits							
	8	7	6	5	4	3	2	1
1 to 2	Type = 358 (decimal)							
3 to 4	Length = n							
5	Spare						V6	V4
p to (p+3)	IPv4 Address							
q to (q+15)	IPv6 Address							
s to (n+4)	These octet(s) is/are present only if explicitly specified							

Figure 8.2.248-1: Measurement Endpoint Address

The following flags are coded within Octet 5:

- Bit 1 – V4: If this bit is set to "1", then the IPv4 Address field shall be present, otherwise the IPv4 Address field shall not be present.
- Bit 2 – V6: If this bit is set to "1", then the IPv6 Address field shall be present, otherwise the IPv6 Address field shall not be present.

- Bit 3 to 8 Spare, for future use and set to "0".

Either the V4 flag or the V6 flag shall be set to 1.

Octets "p to (p+3)" or "q to (q+15)" (IPv4 address / IPv6 address fields), if present, shall contain the address value.

8.2.249 Operator Configurable UPF Capability

The Operator Configurable UPF Capability IE indicates the operator defined non-standardized or partially supported feature(s) provided by the UPF as described in clause 5.8.2.21 of 3GPP TS 23.501 [28]. It shall be encoded as shown in Figure 8.2.249-1.

Octets	Bits							
	8	7	6	5	4	3	2	1
1 to 2	Type = 359 (decimal)							
3 to 4	Length = n							
5 to (n+4)	Operator-Configurable-UPF-Capability							

Figure 8.2.249-1: Operator Configurable UPF Capability

The Operator Configurable UPF Capability field shall be encoded as the OpConfiguredCapability data type specified in clause 5.2.2 of 3GPP TS 29.571 [61].

8.2.250 Packet Inspection functionality

The Packet Inspection functionality IE indicates the Packet Inspection capabilities supported by the UPF. It shall be encoded as shown in Figure 8.2.250-1.

Octets	Bits							
	8	7	6	5	4	3	2	1
1 to 2	Type = 360 (decimal)							
3 to 4	Length = n							
5	Spare	Spare	Spare	Spare	Spare	DPID	MACD	IPBD
6 to (n+4)	These octet(s) is/are present only if explicitly specified							

Figure 8.2.250-1: Packet Inspection functionality

Octet 5 shall be encoded as follows:

- Bit 1 – IPBD (IP filter Based packet Detection): when set to "1", this indicates that the UPF supports packet detection using L3/L4 packet filters provisioned in the SDF Filter IE. A UPF not supporting this capability does not support the SDF Filter IE in PDI.
- Bit 2 – MACD (MAC filter based packet Detection): when set to "1", this indicates that the UPF supports packet detection using ethernet packet filters provisioned in the Ethernet Packet Filter IE. A UPF not supporting this capability does not support the Ethernet Packet Filter IE in PDI.
- Bit 3 – DPID (Deep Packet Inspection Detection): when set to "1", this indicates that the UPF supports higher layer (beyond L3/L4 layer) packet inspection, e.g. layer 7 Deep Packet Inspection. If so, the SMF may provision a PDR or activate a predefined PDR which requires deep packet inspection logic predefined in the UPF.

Several bits may be set to "1". A UPF supporting none of the above capabilities shall set all bits to "0".

NOTE 1: A UPF always supports to use a Local F-TEID, Network Instance, UE IP address, QFI to perform the packet inspection.

NOTE 2: The packet inspection functionality in a UPF supporting any of above packet inspection capabilities can be further enhanced by supporting packet inspection related feature(s), e.g. a UPF using IPBD supports to use PFD Contents to do packet inspection if it supports also the PFD feature. A UPF supporting DPID cannot be assumed to support the DNS Query/Response Filter IE if it doesn't support DNSTS feature.

8.2.251 Header Detection Reference

The Header Detection Reference IE type shall be encoded as shown in Figure 8.2.251-1. It contains a reference to a UPF configuration.

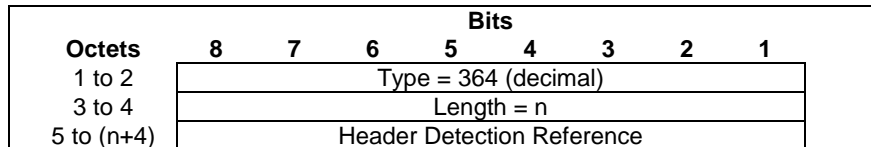

Figure 8.2.251-1: Header Detection Reference

The Header Detection Reference shall be encoded as an OctetString. The parameter refers to the attribute "hDetectionReference" specified in 3GPP TS 29.514 [89].

8.2.252 Header Detection Support Information

The Header Detection Support Information IE type shall be encoded as shown in Figure 8.2.252-1. It contains Any dynamic information which is required for the detection of the headers.

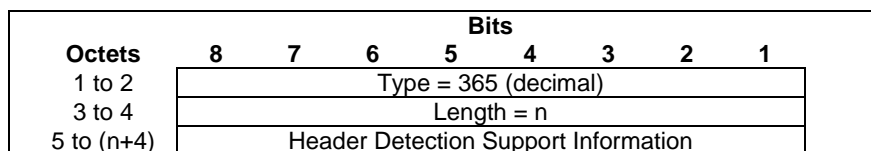

Figure 8.2.252-1: Header Detection Support Information

The Header Detection Support Information shall be encoded as an OctetString, The parameter refers to the attribute "hDetectionSuppInfo" specified in 3GPP TS 29.514 [89].

8.2.253 Reporting Endpoint ID

The Reporting Endpoint ID IE type shall be encoded as shown in Figure 8.2.253-1. It contains a Reporting Endpoint ID.

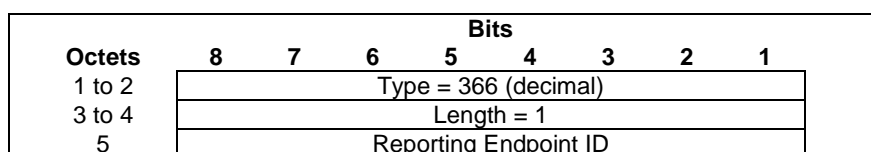

Figure 8.2.253-1: Reporting Endpoint ID

The Reporting Endpoint ID value shall be encoded as a binary integer value.

8.2.254 Header Handling Control Reference

The Header Handling Control Reference IE type shall be encoded as shown in Figure 8.2.254-1. It contains reference to a UPF configuration which defines the header handling control information locally in the UPF.

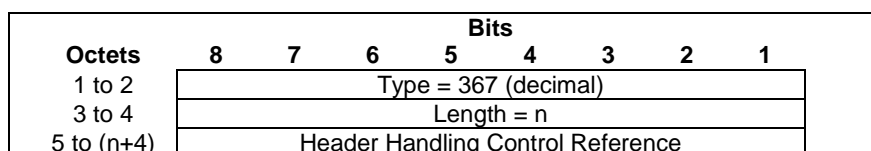

Figure 8.2.254-1: Header Handling Control Reference

The Header Handling Control Reference shall be encoded as an OctetString, The parameter refers to the attribute "hHndlCtrlRef" specified in 3GPP TS 29.514 [89].

8.2.255 Header Handling Action

Header Handling Action IE is coded as depicted in Figure 8.2.255-1.

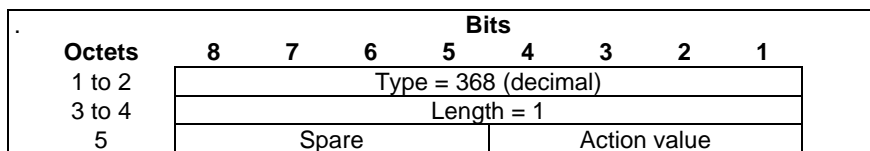

Figure 8.2.255-1: Header Handling Action

The Header Handling Action indicates the explicit action to be performed on a specific header field.

Table 8.2.255-2: Action value

Action value	Value (Decimal)
DETECT (NOTE 1)	0
REMOVE (NOTE 2)	1
REPLACE (NOTE 3)	2
INSERT (NOTE 4)	3
Spare	4-15
NOTE 1: "DETECT" shall be used to request the detection of a header field that is identified based on the UPF configuration referenced by the Header Information parameter and the information contained in the Header Value parameter, if it is provided.	
NOTE 2: "REMOVE" shall be used to request the removal of a header field that is identified based on the UPF configuration referenced by the Header Information parameter and the information contained in the Header Value parameter, if it is provided.	
NOTE 3: "REPLACE" shall be used to request the replacement of information in a header field that is identified based on the UPF configuration referenced by the Header Information parameter. The information to be replaced in the header field is also defined by that UPF configuration. The Header Value contains information that is used for the replacement.	
NOTE 4: "INSERT" shall be used to add a header field according to the UPF configuration referenced by the Header Information parameter. The Header Value contains information that is used for the insertion, if it is provided.	

8.2.256 Header Information

The Header Information IE type shall be encoded as shown in Figure 8.2.256-1. It contains reference to a UPF configuration which defines how to identify or build a specific header field for which to perform the header handling action.

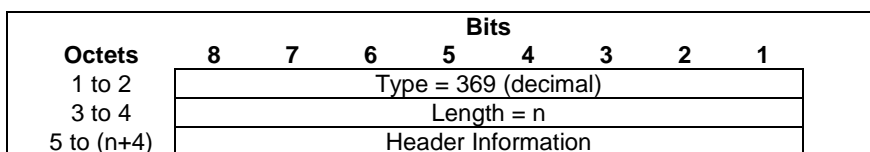

Figure 8.2.256-1: Header Information

The Header Information shall be encoded as an OctetString, The parameter refers to the attribute "hInfo" specified in 3GPP TS 29.514 [89].

8.2.257 Header Value

The Header Value IE type shall be encoded as shown in Figure 8.2.257-1. It contains a value of the specific header field.

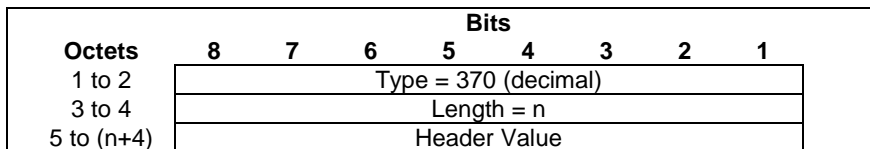

Figure 8.2.257-1: Header Information

The Header Value shall be encoded as an OctetString, The parameter refers to the attribute " hVal" specified in 3GPP TS 29.514 [89].

8.2.258 Header Handling Condition

Header Handling Condition IE is coded as depicted in Figure 8.2.258-1.

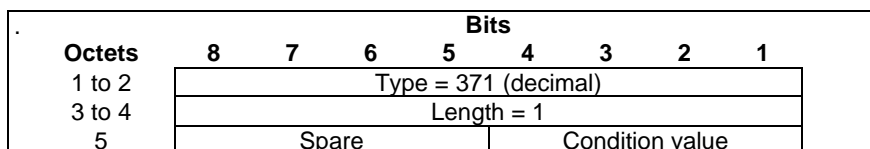

Figure 8.2.258-1: Header Handling Condition

Header Handling Condition indicates the explicit condition for performing the header handling action.

Table 8.2.258-2: Condition value

Condition value	Value (Decimal)
EVERY_MATCH	0
FIRST_MATCH_ONLY	1
Spare	2-15

8.2.259 Header Handling Control ID

The Header Handling Control ID IE type shall be encoded as shown in Figure 8.2.259-1. It identifies an instance of Header Handling Control Information.

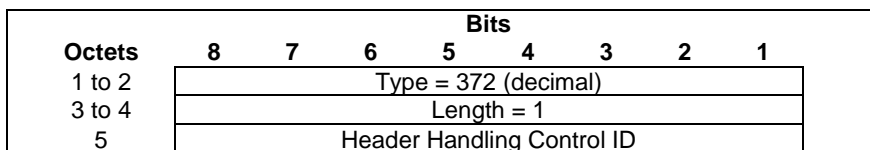

Figure 8.2.259-1: Header Handling Control ID

The Header Handling Control ID value shall be encoded as a binary integer value.

8.2.260 Header Handling Control Rule ID

The Header Handling Control Rule ID IE type shall be encoded as shown in Figure 8.2.260-11. It identifies an instance of Header Handling Control Rule IE.

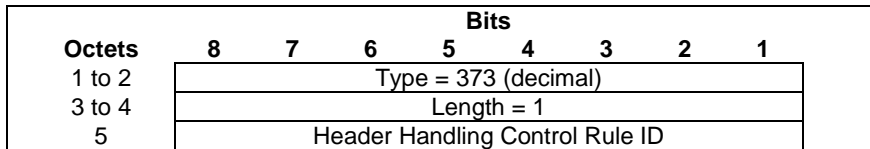

Figure 8.2.260-1: Header Handling Control Rule ID

The Header Handling Control Rule ID value shall be encoded as a binary integer value.

8.2.261 On-path N6 Connection Information

The On-path N6 Connection Information IE shall be encoded as shown in Figure 8.2.261-1.

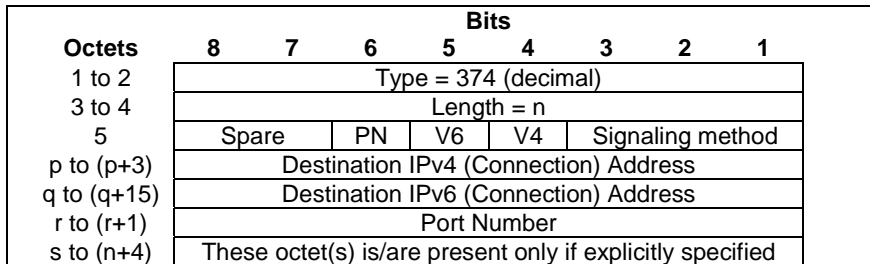

Figure 8.2.261-1: On-path N6 Connection Information

The Signaling method field shall be encoded as defined in Table 8.2.261-1.

Table 8.2.261-1: Signaling method

Signaling method	Value (Decimal)
Unspecified	0
Connect-UDP	1
Spare, for future use.	2 to 7

The following flags are coded within Octet 5:

- Bit 4 – V4: If this bit is set to "1", then the Destination IPv4 (Connection) Address field shall be present, otherwise the Destination IPv4 (Connection) Address field shall not be present.
- Bit 5 – V6: If this bit is set to "1", then the Destination IPv6 (Connection) Address field shall be present, otherwise the Destination IPv6 (Connection) Address field shall not be present.
- Bit 6 – PN: If this bit is set to "1", then the Port Number field shall be present, otherwise the Port Number field shall not be present.
- Bit 7 to 8 Spare, for future use and set to "0".

Octets "p to (p+3)" or "q to (q+15)" (Destination IPv4 (Connection) Address / Destination IPv6 (Connection) Address fields), if present, shall contain the address value of the AS Proxy towards which the connection shall be established.

When present, the Port Number field shall contain the destination Port Number to be used to establish the connection.

8.2.262 Measurement Reporting Type

The Measurement Reporting Type IE shall be encoded as shown in Figure 8.2.262-1.

Octets	Bits							
	8	7	6	5	4	3	2	1
1 to 2	Type = 375 (decimal)							
3 to 4	Length = n							
5	Spare			IRE	EVT	PER		
6 to (n+4)	These octet(s) is/are present only if explicitly specified							

Figure 8.2.262-1: Measurement Reporting Type

Octet 5 shall be encoded as follows:

- Bit 1 – PER (Periodic Reporting): when set to "1", this indicates periodic reporting.
- Bit 2 –EVT (Event Triggered Reporting): when set to "1", this indicates event triggered reporting.
- Bit 3 – IRE (Immediate Report): when set to "1", this indicates immediate reporting.
- Bit 4 to 8: Spare, for future use and set to "0".

At least one bit shall be set to 1.

Periodic reporting and Event triggered Reporting are exclusive from each other, i.e. either the PER bit or the EVT bit may be set to 1.

Both the PER and IRE bits may be set to 1. Both the EVT and IRE bits may be set to 1.

8.2.263 N6 Delay Measurement Failure Information

The N6 Delay Measurement Failure Information IE shall be encoded as shown in Figure 8.2.263-1. It provides N6 delay measurement failure information.

Octets	Bits						
	8	7	6	5	4	3	2
1 to 2	Type = 376 (decimal)						
3 to 4	Length = n						
5	Failure cause						
6 to (n+4)	These octet(s) is/are present only if explicitly specified						

Figure 8.2.263-1: N6 Delay Measurement Failure Information

Table 8.2.263-1: Failure cause values

Cause value (decimal)	Meaning	Description
0	Unspecified	The failure cause does not correspond to any cause value specified in this table.
1	Connection Establishment Failure	The UPF cannot connect to the measurement endpoint using the measurement protocol that was requested (e.g. the measurement endpoint address is not responsive, or the measurement endpoint rejects the connection setup request e.g. due to temporary or permanent resource limitations).
2	Connection Lost	The connection to the measurement endpoint address was lost and cannot be reestablished.
3	Authentication Failure	Authentication failure with the measurement endpoint
4 to 255	Spare for future use (NOTE)	
NOTE: This value may be used in a future version of the specification. If the receiver cannot comprehend the value, it shall be interpreted as an unspecified failure cause.		

8.2.264 N6 Delay Measurement Control Information ID

The N6 Delay Measurement Control Information ID IE type shall be encoded as shown in Figure 8.2.264-1. It identifies an instance of N6 Delay Measurement Control Information.

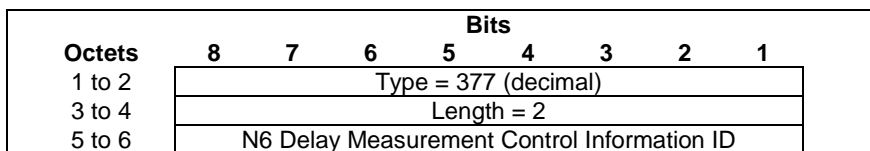

Figure 8.2.264-1: N6 Delay Measurement Control Information ID

The N6 Delay Measurement Control Information ID value shall be encoded as a binary integer value.

8.2.265 Measurement Endpoint Port Number

The Measurement Endpoint Port Number IE shall be encoded as shown in Figure 8.2.265-1. It shall contain one Port Number value.

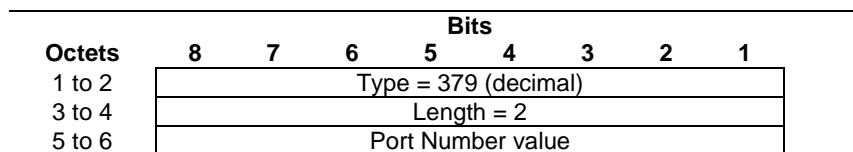

Figure 8.2.265-1: Measurement Endpoint Port Number

The port number value shall be encoded as an Unsigned16 binary integer.

8.2.266 Header Handling Reporting Indication

The Header Handling Reporting Indication IE shall be encoded as shown in Figure 8.2.266-1.

Octets	Bits							
	8	7	6	5	4	3	2	1
1 to 2	Type = 380 (decimal)							
3 to 4	Length = n							
5	Spare							OTRI
m to (n+4)	These octet(s) is/are present only if explicitly specified							

Figure 8.2.266-1: Header Handling Reporting Indication

The following flags are coded within Octet 5:

- Bit 1 – OTRI (One Time Report Indication): If this bit is set to "1", it indicates that only the first occurrence of the action per data flow with the same header information is reported.
- Bit 2 to 8 Spare, for future use and set to "0".

8.2.267 SMF Change Reason

The SMF Change Reason IE indicates the reason for the UPF sending a PFCP Session Report Request message to move the PFCP session to an alternative SMF pertaining to the same SMF set. It is coded as depicted in Figure 8.2.268-1.

Octets	Bits							
	8	7	6	5	4	3	2	1
1 to 2	Type = 382 (decimal)							
3 to 4	Length = n							
5	Spare	Spare	Spare	Spare	Spare	MPSA I	MPSS F	MPSN R
6 to (n+4)	These octet(s) is/are present only if explicitly specified							

Figure 8.2.267-1: SMF Change Reason

The following bits within Octet 5 shall indicate:

- Bit 1 – MPSNR (Move PFCP Session due to SMF no responding): if this bit is set to "1", it indicates that the UP function moves the PFCP session due to the SMF not responding.
- Bit 2 – MPSSF (Move PFCP Session due to SMF Failure): if this bit is set to "1", it indicates that the UP function moves the PFCP session due to the SMF failure.
- Bit 3 – MPSAI (Move PFCP Session As Instructed): if this bit is set to "1", it indicates that the UP function moves the PFCP session as instructed by the SMF in a PFCP Session Set Modification Request.
- Bit 4 to 8 – Spare, for future use, shall be set to "0" by the sender and discarded by the receiver.

8.2.268 PDU Set Importance

The PDU Set Importance IE shall be encoded as shown in Figure 8.2.269-1. It indicates the importance of the current PDU Set compared to other PDU Sets within the same QoS flow, the PDU Set with the highest importance PDU Set is indicated by 1 and the lowest importance PDU Set is indicated by 15. PSI value 0 is used when the RTP sender can not define an importance for the PDU set as specified in 3GPP TS 26.522 [79]. See also clause 6.5.3.9 of 3GPP TS 38.415 [34].

Octets	Bits							
	8	7	6	5	4	3	2	1
1 to 2	Type = 384 (decimal)							
3 to 4	Length = 2							
5	PSI7	PSI6	PSI5	PSI4	PSI3	PSI2	PSI1	PSI0
6	PSI15	PSI14	PSI13	PSI12	PSI11	PSI10	PSI9	PSI8

Figure 8.2.268-1: PDU Set Importance

The following bits within Octet 5 shall indicate:

- Bit 1 – PSI0 (PDU Set Importance 0): if this flag is set to "1", it indicates the PSI value 0 is present, otherwise it shall be set to "0".
- Bit 2 – PSI1 (PDU Set Importance 1): if this flag is set to "1", it indicates the PSI value 1 is present, otherwise it shall be set to "0".
- Bit 3 – PSI2 (PDU Set Importance 2): if this flag is set to "1", it indicates the PSI value 2 is present, otherwise it shall be set to "0".
- Bit 4 – PSI3 (PDU Set Importance 3): if this flag is set to "1", it indicates the PSI value 3 is present, otherwise it shall be set to "0".
- Bit 5 – PSI4 (PDU Set Importance 4): if this flag is set to "1", it indicates the PSI value 4 is present, otherwise it shall be set to "0".
- Bit 6 – PSI5 (PDU Set Importance 5): if this flag is set to "1", it indicates the PSI value 5 is present, otherwise it shall be set to "0".
- Bit 7 – PSI6 (PDU Set Importance 6): if this flag is set to "1", it indicates the PSI value 6 is present, otherwise it shall be set to "0".
- Bit 8 – PSI7 (PDU Set Importance 7): if this flag is set to "1", it indicates the PSI value 7 is present, otherwise it shall be set to "0".

The following bits within Octet 6 shall indicate:

- Bit 1 – PSI8 (PDU Set Importance 8): if this flag is set to "1", it indicates the PSI value 8 is present, otherwise it shall be set to "0".
- Bit 2 – PSI9 (PDU Set Importance 9): if this flag is set to "1", it indicates the PSI value 9 is present, otherwise it shall be set to "0".
- Bit 3 – PSI10 (PDU Set Importance 10): if this flag is set to "1", it indicates the PSI value 10 is present, otherwise it shall be set to "0".
- Bit 4 – PSI11 (PDU Set Importance 11): if this flag is set to "1", it indicates the PSI value 11 is present, otherwise it shall be set to "0".
- Bit 5 – PSI12 (PDU Set Importance 12): if this flag is set to "1", it indicates the PSI value 12 is present, otherwise it shall be set to "0".
- Bit 6 – PSI13 (PDU Set Importance 13): if this flag is set to "1", it indicates the PSI value 13 is present, otherwise it shall be set to "0".
- Bit 7 – PSI14 (PDU Set Importance 14): if this flag is set to "1", it indicates the PSI value 14 is present, otherwise it shall be set to "0".
- Bit 8 – PSI15 (PDU Set Importance 15): if this flag is set to "1", it indicates the PSI value 15 is present, otherwise it shall be set to "0".

At least one bit shall be set to 1. Several bits may be set to 1.

8.2.269 MoQ Control Information

The MoQ Control Information IE shall provide details of the required MoQ functionality. It shall be encoded as shown in Figure 8.2.269-1.

Octets	Bits							
	8	7	6	5	4	3	2	1
1 to 2	Type = 385 (decimal)							
3 to 4	Length = n							
5	Spare						MQR AI	MQR EI
m to (n+4)	These octet(s) is/are present only if explicitly specified							

Figure 8.2.269-1: MoQ Control Information

The following flags are coded within Octet 5:

- Bit 1 – MQREI (MoQ Relay Enabled Indication): If this bit is set to "1", it indicates that the MoQ relay functionality is enabled.
- Bit 2 – MQRAI (MoQ Relay Address Indication): If this bit is set to "1", this indicates that the CP function requests the UP function to provide a MoQ relay address for the PDU session.
- Bit 3 to 8 Spare, for future use and set to "0".

8.2.270 MoQ Relay IP Address

The MoQ Relay IP Address IE shall contain an IPv4 and/or IPv6 address. It shall be encoded as shown in Figure 8.2.270-1.

Octets	Bits							
	8	7	6	5	4	3	2	1
1 to 2	Type = 387 (decimal)							
3 to 4	Length = n							
5	Spare						V4	V6
p to (p+3)	IPv4 Address							
q to (q+15)	IPv6 Address							
k to (n+4)	These octet(s) is/are present only if explicitly specified							

Figure 8.2.270-1: MoQ Relay IP Address

The following flags are coded within Octet 5:

- Bit 1 – V6: If this bit is set to "1", then the IPv6 address field shall be present in the MoQ Relay IPv6 Address, otherwise the IPv6 address field shall not be present.
- Bit 2 – V4: If this bit is set to "1", then the IPv4 address field shall be present in the MoQ Relay IPv4 Address, otherwise the IPv4 address field shall not be present.
- Bit 3 to 8 Spare, for future use and set to "0".

Octets "p to (p+3)" or "q to (q+15)" (IPv4 address / IPv6 address fields), if present, shall contain the address value.

8.2.271 Media Related Information Transfer Info

The Media Related Information Transfer Info IE indicates how media related information is transferred, for end-to-end encrypted traffic. It shall be coded as depicted in Figure 8.2.271-1.

Octets	Bits						
	8	7	6	5	4	3	2
1 to 2	Type = 388 (decimal)						
3 to 4	Length = n						
5	Spare			Transferring method			
6 to (n+4)	These octet(s) is/are present only if explicitly specified						

Figure 8.2.271-1: Media Related Information Transfer Info

The Transferring method field in octet 5 shall be encoded as defined in Table 8.2.271-1.

Table 8.2.271-1: Transferring method

Value (Decimal)	Transferring method
0	Unspecified
1	UDP Option (of outer UDP datagram)
2-15	Spare, for future use.

8.2.272 Reporting Control Information

The Reporting Control Information IE shall be encoded as shown in Figure 8.2.272-1.

Octets	Bits						
	8	7	6	5	4	3	2
1 to 2	Type = 389 (decimal)						
3 to 4	Length = n						
5	Spare						UELM
6 to (n+4)	These octet(s) is/are present only if explicitly specified						

Figure 8.2.272-1: Reporting Control Information

The following bits within Octet 5 shall indicate:

- Bit 1 – UELM (UE Level Measurement): if this flag is set to "1", it indicates that QoS monitoring is triggered for UE level measurement and that corresponding measurements shall be sent to the IP Address of Trace Collection Entity (when using file-based reporting) or the Trace Collection Entity URI (when using streaming-based reporting) as specified in clause 5.15A.
- Bits 2 to 8 – Spare, for future use and set to "0".

8.2.273 Security Mode (STAMP)

The Security Mode (STAMP) IE shall be encoded as shown in Figure 8.2.273-1. It indicates whether the communication between the UPF and the measurement endpoint shall be integrity protected and/or confidentiality protected.

Octets	Bits						
	8	7	6	5	4	3	2
1 to 2	Type = 390 (decimal)						
3 to 4	Length = 1						
5	Spare					CONP	INTP

Figure 8.2.273-1: Security Mode (STAMP)

Octet 5 shall be encoded as follows:

- Bit 1 – INTP (Integrity Protection): If this bit is set to "1", this indicates that the communication between the UPF and the measurement endpoint should be integrity protected, i.e. it should use the authenticated mode of

STAMP defined in IETF RFC 8762 [102]. If this bit is set to "0", this indicates that the communication between the UPF and the measurement endpoint may use the unauthenticated mode of STAMP defined in IETF RFC 8762 [102].

- Bit 2 – CONP (Confidentiality Protection): If this bit is set to "1", this indicates that the communication between the UPF and the measurement endpoint should be confidentiality protected, i.e. it should use a secure transport as defined in clause 4.5 of IETF RFC 8762 [102]. If this bit is set to "0", this indicates that the communication between the UPF and the measurement endpoint does not require confidentiality protection.
- Bits 3 to 8: Spare, for future use and set to "0".

See Annex T.5 of 3GPP TS 33.501 [64] for security requirements for N6 delay measurements.

8.2.274 HMAC Key (STAMP)

The HMAC Key (STAMP) IE shall be encoded as shown in Figure 8.2.274-1. It contains the HMAC key used for integrity protecting the communication between the UPF and the measurement endpoint.

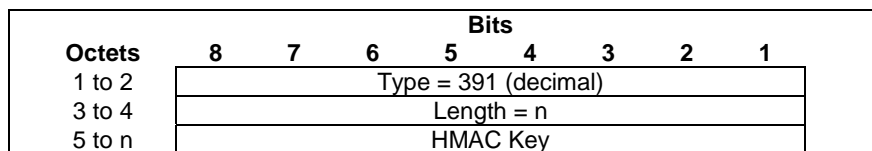

Figure 8.2.274-1: HMAC Key (STAMP)

The HMAC Key field shall be encoded as an OctetString containing the Hashed Message Authentication Code (HMAC) key. See clause 4.4 of IETF RFC 8762 [102].

8.2.275 Security Mode (OWAMP or TWAMP)

The Security Mode (OWAMP or TWAMP) IE shall be encoded as shown in Figure 8.2.275-1. It indicates the security mode value requested to be used for protecting the communication between the UPF and the measurement endpoint.

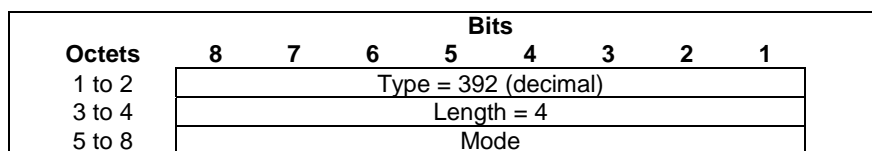

Figure 8.2.275-1: Security Mode (OWAMP or TWAMP)

The Mode field in octets 5 to 8 shall be encoded as the Mode field in clause 3.1 of IETF RFC 4656 [101].

See Annex T.5 of 3GPP TS 33.501 [64] for security requirements for N6 delay measurements.

8.2.276 Key ID and Shared Secret (OWAMP or TWAMP)

The Key ID and Shared Secret (OWAMP or TWAMP) IE shall be encoded as shown in Figure 8.2.276-1. It contains information for protecting the communication between the UPF and the measurement endpoint.

Octets	Bits						
	8	7	6	5	4	3	2
1 to 2	Type = 393 (decimal)						
3 to 4	Length = n						
5	Length of Key ID						
6 to p	Key ID						
p+1	Length of Shared Secret						
(p+2) to q	Shared Secret						
r to (n+4)	These octet(s) is/are present only if explicitly specified						

Figure 8.2.276-1: Key ID and Shared Secret (OWAMP or TWAMP)

The Key ID is used by the UPF to tell the measurement endpoint which shared secret the UPF wishes to use to authenticate or encrypt the communication. The Length of Key ID field shall indicate the length in bytes of the Key ID field, with a maximum of 80 octets. The Key ID field shall be encoded in UTF8String format as the Key ID defined in clause 3.1 of IETF RFC 4656 [101], without padding with zero octets.

NOTE 1: Both the UPF and the measurement endpoint use the same mappings from Key IDs to shared secrets.

NOTE 2: If the length of the Key ID is smaller than 80 octets, the UPF adds padding with zero octets up to 80 octets to generate the Key ID it sends towards the measurement endpoint.

The Shared Secret field shall encode a passphrase as defined in clause 3.1 of IETF RFC 4656 [101]. The Length of Shared Secret field shall indicate the length in bytes of the Shared Secret field. The Shared Secret field shall be encoded in UTF8String format and shall encode a passphrase as defined in clause 3.1 of IETF RFC 4656 [101] and clause 3.1 of IETF RFC 5357 [100].

8.2.277 Remaining Data Reporting Indication

The Remaining Data Reporting Indication IE shall be encoded as shown in Figure 8.2.77-1.

Octets	Bits						
	8	7	6	5	4	3	2
1 to 2	Type = 394 (decimal)						
3 to 4	Length = n						
5	Spare			Remaining Data Reporting Indication value			
6 to (n+4)	These octet(s) is/are present only if explicitly specified						

Figure 8.2.277-1: Remaining Data Reporting Indication

The Remaining Data Reporting Indication value shall be encoded as a 4 bits binary integer as specified in Table 8.2.277-1.

Table 8.2.277-1: Remaining Data Reporting Indication value

Remaining Data Reporting Indication Value	Values (Decimal)
Discard the collected data	0
Send the collected data to the consumer	1
Spare	2 to 15

8.2.278 Expedited Transfer Indication

The Expedited Transfer Indication IE shall be encoded as shown in Figure 8.2.278-1.

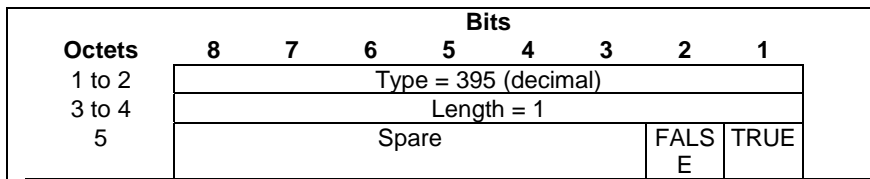

Figure 8.2.278-1: Expedited Transfer Indication

The following bits within Octet 5 shall indicate:

- Bit 1 – TRUE: if this flag is set to "1", it indicates "Expedited Transfer Indication" is TRUE.
- Bit 2 – FALSE: if this flag is set to "1", it indicates "Expedited Transfer Indication" is FALSE.
- Bits 3 to 8 – Spare, for future use and set to "0".

Either Bit 1 or Bit 2 shall be set to "1".

8.2.279 Session Reflector Mode (STAMP)

The Session Reflector Mode (STAMP) IE shall be encoded as shown in Figure 8.2.279-1.

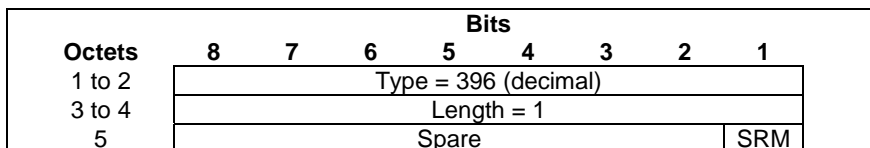

Figure 8.2.279-1: Session Reflector Mode (STAMP)

The following bits within Octet 5 shall indicate:

- Bit 1 – Session Reflector Mode (SRM): value "0" indicates stateless mode, value "1" indicates stateful mode
- Bits 2 to 8 – Spare, for future use and set to "0".

8.2.280 Transport Level Marking Indications

It shall be coded as depicted in Figure 8.2.280-1.

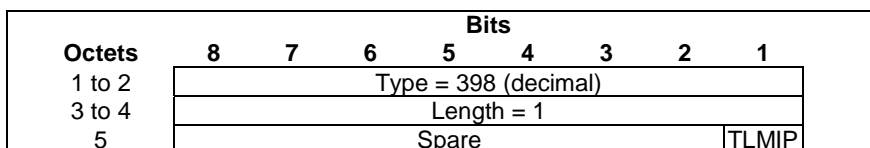

Figure 8.2.280-1: Transport Level Marking Indications

The following bits within Octet 5 shall indicate:

- Bit 1 – TLMIP (Transport Level Marking based on the value of the Incoming Packets): if this flag is set to "1", the UPF, e.g. a I-UPF, shall derive the value of the DSCP in the TOS/Traffic Class field of the outer IP header of the outgoing packets (e.g. over N3 or N9) based on the value of the DSCP in the incoming packets (e.g. received over N9 or N3 respectively). See also clause 5.4.13.
- Bit 2 to 8 – Spare, for future use, shall be set to "0" by the sender and discarded by the receiver.

Annex A (Informative): PFCP Load and Overload Control Mechanism

A.1 Throttling Algorithms

A.1.1 "Loss" Throttling Algorithm

A.1.1.1 Example of Possible Implementation

This clause provides an example of a possible implementation of the "Loss" algorithm, amongst other possible methods.

It is possible to make use of a statistical loss function (e.g., random selection of messages to throttle based on the indicated percentage) to decide if the given message can be sent or need to be throttled. For example, the source node generates a random number between (0, 100) for each message which is a potential candidate for throttling. To realize 10% throttling, messages with a random number 10 or less are throttled and hence this achieves approximately a 10% reduction in the overall traffic. The actual traffic reduction might vary slightly from the requested percentage, albeit by an insignificant amount.

The algorithm can select certain messages to throttle in priority. For example, implementations can distinguish between higher-priority and lower-priority messages, and drop the lower-priority messages in favour of dropping the higher priority messages, as long as the total reduction in traffic conforms to the requested reduction in effect at the time. For example, in the 50-50 distribution of high priority and low priority messages, 20% reduction to low priority messages and 0% reduction to high priority messages need to be applied in order to achieve the effective reduction in traffic by 10% towards the overloaded node.

Annex B (Normative): CP and UP Selection Functions with Control and User Plane Separation

B.1 CP Selection Function

B.1.1 General

The SGW-C and PGW-C selection function shall follow the principles specified in 3GPP TS 29.303 [25] for the SGW and PGW selection functions without Control and User Plane Separation.

The following additional considerations apply with Control and User Plane Separation:

1. At most one SGW-C shall be selected per user at any time.
2. The service area of an SGW-C function shall be aligned with the service area of the corresponding SGW-U functions (see clause 4.3.4 of 3GPP TS 23.214 [2]). All the SGW-U functions in the service area shall have a full meshed connectivity with all the eNBs of TAs and/or all RNCs/BSCs of RAs served by that service area.
3. The SGW dynamic load reported to the MME/SGSN and the PGW dynamic load reported to the MME/SGSN or TWAN/ePDG should take into account the operating status of the CP and UP functions' resources that the SGW-C/PGW-C is controlling. See clause 6.2.3 for how the CP function obtains load control information from the UP function.
4. For Dedicated Core Networks (see clause 5.8 of 3GPP TS 29.303 [25]), an SGW-C or PGW-C function shall be declared in DNS as dedicated to certain mapped UE usage types if the CP function or if all the UP functions it controls are dedicated to certain mapped UE usage types. In this case, the CP function shall be provisioned in DNS with all the mapped UE usage types that both the CP function and its UP functions support.
5. The MME/SGSN shall be able to select an SGW-C and a PGW-C optimized for NR, e.g. for UEs indicating support of dual connectivity with NR in NAS signalling to the MME or SGSN and without subscription restriction to use NR as secondary RAT, according to the requirements specified in clause 5.12.2 of 3GPP TS 29.303 [25]. The SGW-C and the PGW-C optimized for NR may be a combined SGW-C/PGW-C function optimized for the NR.

B.2 UP Selection Function

B.2.1 General

The following requirements apply for the selection of the UP function:

- the SGW-C, PGW-C and TDF-C shall be responsible for the selection of the SGW-U, PGW-U and TDF-U respectively;
- an SGW-C may select different SGW-U functions for different PDN connections of a same user.

It is implementation specific how to support the UP selection function requirements specified in this clause. Clause B.2.6 specifies one possible implementation.

B.2.2 SGW-U Selection Function

The SGW-C shall be able to select the SGW-U considering the following parameters:

- the SGW-U location and the user 's location (i.e. ECGI, eNodeB ID or TAI for E-UTRAN, RAI or RNC-ID for UTRAN);
- the SGW-U's capabilities and the capabilities required for the particular UE session to establish;
- the mapped UE Usage Type (when dedicating SGW-U to specific Dedicated Core Networks);
- the SGW-U's dynamic load;
- the SGW-U's relative static capacity (versus other SGW-U's);
- the UP Function Selection Information Flags, indicating whether it is desired to select an SGW-U optimized for NR, as specified in 3GPP TS 29.274 [9].

Based on local policy, if the user's location information is required to be used for selecting the UP function, the SGW-C shall determine the list of candidate SGW-U's taking into account the user's location (ECGI, eNodeB ID or TAI for E-UTRAN, RAI or RNC-ID for UTRAN).

The SGW-C shall select, among the candidate SGW-U functions, an SGW-U function which supports all the capabilities required for the particular UE session, considering the information received during the PFCP Association Setup.

B.2.3 PGW-U Selection Function

The PGW-C shall be able to select the PGW-U considering the following parameters:

- the requested APN for the PDN connection;
- the PGW-U location and the user 's location;
- the PGW-U's capabilities and the capabilities required for the particular UE session to establish;
- the mapped UE Usage Type (when dedicating PGW-U to specific Dedicated Core Networks);
- the PGW-U's dynamic load;
- the PGW-U's relative static capacity (versus other PGW-U's);
- whether a PDN connection already exists for the same UE and APN, in which case the same PGW-U shall be selected (to enable APN-AMBR enforcement);
- the UP Function Selection Information Flags, indicating whether it is desired to select a PGW-U optimized for NR, as specified in 3GPP TS 29.274 [9].

NOTE: The SGW-U and PGW-U location can be configured in the SGW-C and PGW-C or derived from DNS procedures as specified in clause B.2.2.

If the PGW-C already assigned a PGW-U to the UE for the requested APN (e.g. UE with multiple PDN connections to the same APN), the PGW-C shall select the same PGW-U for the new PDN connection.

If a non-null IPv4 address and/or an IPv6 prefix is received in the PDN Address Allocation (PAA) IE in the Create Session Request, e.g. static address assignment in the user subscription, the PGW-C shall select a PGW-U which can support the requested UE's IP address and/or IPv6 prefix.

Otherwise, the PGW-C shall determine the list of candidate PGW-U's taking into account the requested APN.

The PGW-C shall select, among the candidate PGW-U functions, a PGW-U function which supports all the capabilities required for the particular UE session, considering the information received during the PFCP Association Setup.

B.2.4 Combined SGW-U/PGW-U Selection Function

A Combined SGW-C/PGW-C function shall be able to select a combined SGW-U/PGW-U function. This shall be possible for all the UE's PDN connections, as shown in Figure B.2.1-1.

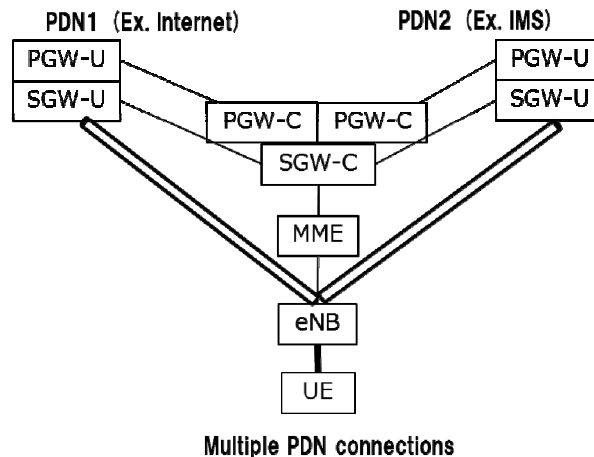

Figure B.2.4-1: SGW-U/PGW-U collocation with Control and User Plane Separation

A combined SGW-C/PGW-C function shall select the SGW-U and PGW-U as defined respectively in B.2.2 and B.2.3, with the following additions:

- the combined SGW-C/PGW-C function shall select the best couple of SGW-U and PGW-U (e.g. the combined SGW-U/PGW-U function), for the requested APN, among all candidate couples of (SGW-U, PGW-U), instead of selecting independently the SGW-U and the PGW-U.

B.2.5 TDF-U selection function

The TDF-C shall be able to select the TDF-U as specified in clause 5.12.5 of 3GPP TS 23.214 [2].

B.2.6 UP Selection Function Based on DNS

B.2.6.1 General

This clause specifies optional DNS procedures to select the SGW-U and PGW-U functions and the requirements which apply when these procedures are supported.

The relative static capacity of an SGW-U and PGW-U may be configured in the DNS.

The Node ID of an SGW-U and PGW-U may take the form of a canonical node name to allow the selection of a SGW-U and PGW-U with the best topological match.

B.2.6.2 SGW-U Selection Function Based on DNS

The SGW-C shall retrieve the list of candidate SGW-U's using DNS procedures taking into account the user's location (ECGI, eNodeB ID or TAI for E-UTRAN, RAI or RNC-ID for UTRAN), as specified in 3GPP TS 29.303 [25].

In non-roaming or LBO scenarios where the PGW-U is already selected (e.g. TAU with SGW change) and when it is preferred to select a collocated node or a topologically closer node, the SGW-C shall try to select an SGW-U collocated with the PGW-U.

B.2.6.3 PGW-U Selection Function Based on DNS

The PGW-C shall retrieve the list of candidate PGW-U's using DNS procedures taking into account the requested APN, as specified in 3GPP TS 29.303 [25].

In non-roaming or LBO scenarios, when it is preferred to select a collocated node or a topologically closer node, i.e. when such preference is indicated in the canonical node names of the PGW-U functions in the DNS (using "topon" as the first label of canonical node name), the PGW-C shall give precedence to collocation of SGW-U and PGW-U, then

to topological closeness (i.e. pairs of SGW-U and PGW-U with canonical node names with the highest number of matching labels). This requires the SGW-C to provide the SGW-U Node ID to the PGW-C.

B.2.6.4 Combined SGW-U/PGW-U Selection Function Based on DNS

A combined SGW-C/PGW-C function shall select the SGW-U and PGW-U as defined respectively in B.2.4, B.2.6.2 and B.2.6.3.

Annex C (Informative): Examples scenarios

C.1 General

This clause provides example call flows illustrating how the CP function can provision the UP function to support certain functionalities.

This Annex is informative and the normative descriptions in this specification and in 3GPP TS 23.214 [2] prevail over the descriptions in this Annex if there is any difference.

C.2 Charging Support

C.2.1 Online Charging

C.2.1.1 Online Charging Call Flow – Normal Scenario

Figure C.2.1.1-1 illustrates the exchanges taking place over the Sxb or Sxc reference points when applying online charging. In this example, the OCS grants quotas by chunks of 100 Mbytes and requests the CP function to request new credits when the remaining credit falls below 10 Mbytes.

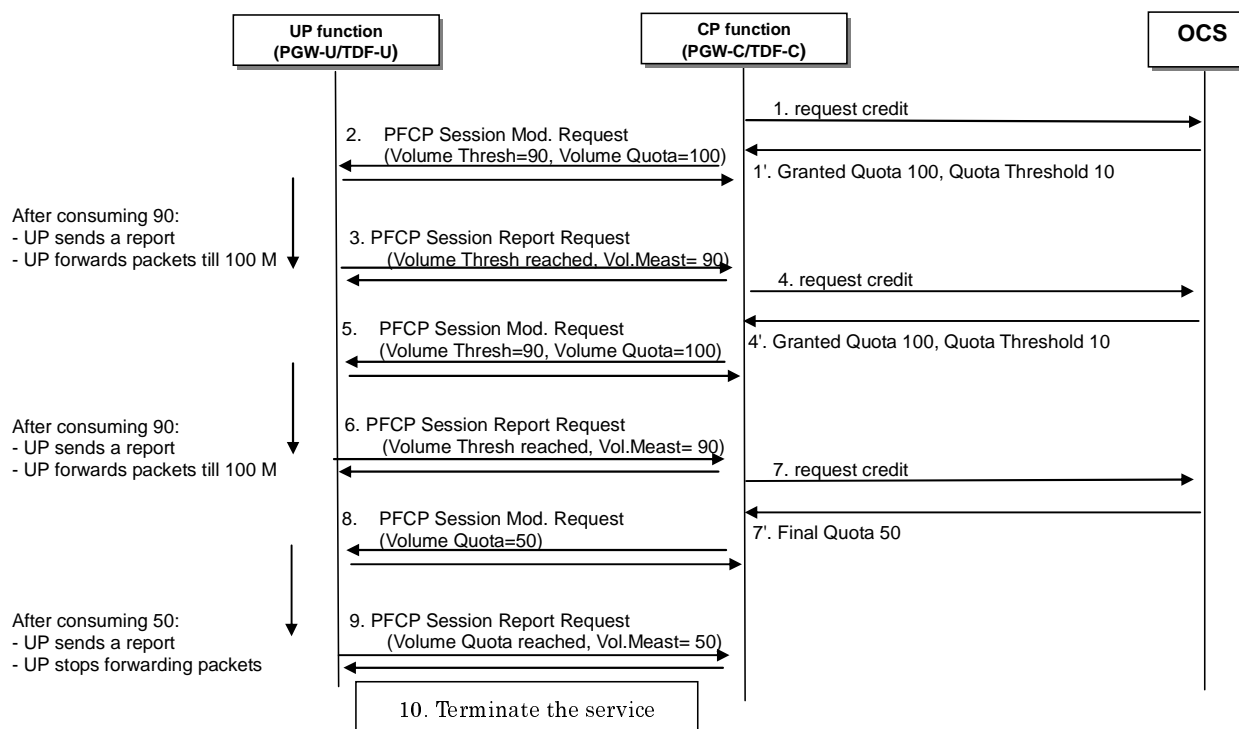

Figure C.2.1.1-1: Online charging with intermediate and final quotas

1. Upon the request from the CP function, the OCS grants an intermediate quota of 100 Mbytes and requests the CP function to request a new credit when the remaining credit falls below 10 Mbytes.
2. The CP function sends a PFCP Session Modification Request to the UP function with an Update URR IE including the Volume Threshold IE set to 90 Mbytes and the Volume Quota IE set to 100 Mbytes.

3. Upon reaching the Volume Threshold (i.e. 90 Mbytes), the UP function sends a PFCP Session Report Request to the CP function with a Usage Report IE including the Usage Report Trigger set to "Volume Threshold" and the Volume Measurement set to 90 Mbytes. The UP function continues to pass on traffic until reaching the Volume Quota (i.e. an extra 10 Mbytes of traffic can be passed on).
4. Upon the request from the CP function, the OCS grants a new intermediate quota of 100 Mbytes and requests the CP function to request a new credit when the remaining credit falls below 10 Mbytes.
5. The CP function sends a PFCP Session Modification Request to the UP function with an Update URR IE including the Volume Threshold IE set to 90 Mbytes and the Volume Quota IE set to 100 Mbytes. If the UP function had forwarded e.g. 5 Mbytes of traffic since the last usage report, the UP function knows that it shall send the next usage report upon passing on an extra 85 Mbytes of traffic.
6. Upon reaching the Volume Threshold (i.e. 90 Mbytes), the UP function sends a PFCP Session Report Request to the CP function with a Usage Report IE including the Usage Report Trigger set to "Volume Threshold" and the Volume Measurement set to 90 Mbytes. The UP function continues to pass on traffic until reaching the Volume Quota (i.e. an extra 10 Mbytes of traffic can be passed on).
7. Upon the request from the CP function, the OCS grants a new final quota of 50 Mbytes and requests the CP function to terminate the service or to redirect the traffic towards a redirect destination when the quota is consumed.
8. The CP function sends a PFCP Session Modification Request to the UP function with an Update URR IE including the Volume Quota IE set to 50 Mbytes. If the UP function had forwarded e.g. 5 Mbytes of traffic since the last usage report, the UP function knows that it shall send the next usage report upon passing on an extra 45 Mbytes of traffic.
9. Upon reaching the Volume Quota (i.e. 50 Mbytes), the UP function sends a PFCP Session Report Request to the CP function with a Usage Report IE including the Usage Report Trigger set to "Volume Quota" and the Volume Measurement set to 50 Mbytes. The UP function stops passing on traffic.
10. Upon being notified that the final quota has been reached, the CP function terminates the service (e.g. by preventing the traffic of the corresponding SDF to further pass on in the UP function) or redirects the traffic towards a redirect destination by provisioning a Redirect Information IE within the FAR associated to the traffic.

Figure C.2.1.1-2 illustrates the exchanges taking place over the Sxb or Sxc reference points when applying online charging and the UP function supports being provisioned with the Quota Action to apply when reaching quotas. This example is similar to the previous one, but the CP function provisions the UP function with the action to apply when reaching the final quota.

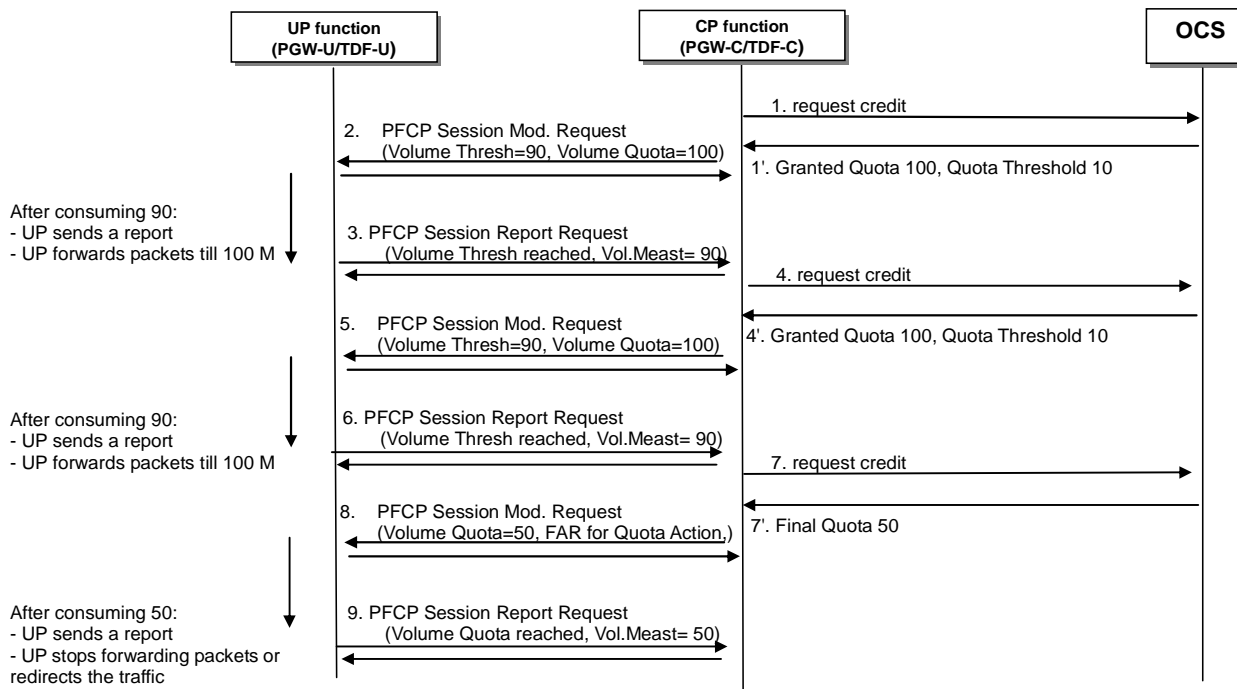

Figure C.2.1.1-2: Online charging with Quota Action provisioned in the UP function

1 to 7'. Same as for figure C.2.1.1-1.

- The CP function sends a PFCP Session Modification Request to the UP function with a Create FAR IE provisioning the action the UP function shall apply when reaching the quota, and with an Update URR IE including the Volume Quota IE set to 50 Mbytes and the FAR ID for Quota Action IE set to the new FAR ID). If the UP function had forwarded e.g. 5 Mbytes of traffic since the last usage report, the UP function knows that it shall send the next usage report upon passing on an extra 45 Mbytes of traffic.
- Upon reaching the Volume Quota (i.e. 50 Mbytes), the UP function sends a PFCP Session Report Request to the CP function with a Usage Report IE including the Usage Report Trigger set to "Volume Quota" and the Volume Measurement set to 50 Mbytes.
- The UP function applies the quota action provisioned at step 8, i.e. it stops forwarding packets or it redirects the traffic towards a redirect destination, according to the FAR identified in the FAR ID for Quota Action.

C.2.1.2 Online Charging Call Flow with Credit Pooling

C.2.1.2.1 General

Figure C.2.1.2-1 illustrates a signalling flow over the Sxb and Gy reference points when applying online charging, and when the CP function (i.e. PGW-C) is instructed by the OCS to handle a Credit Pool for a given Gy Session.

C.2.1.2.2 Example Call Flow 1

In this example, the PGW-C is instructed by the OCS to handle a credit pool for two Rating Groups, RG1 and RG2. The PGW-C provisions two URRs, URR1 and URR2, for the two RGs respectively, and a URR3 for the Credit Pool. The PGW-C provisions the URR1 and URR2 with the quota received from the OCS respectively for RG1 and RG2 (like if there was no credit pooling).

This reflects one possible implementation option, whereby each quota remains managed independently from the others. This approach can result in extra usage reports being sent over Sxb for RG1 or RG2 before the credit pool is exhausted.

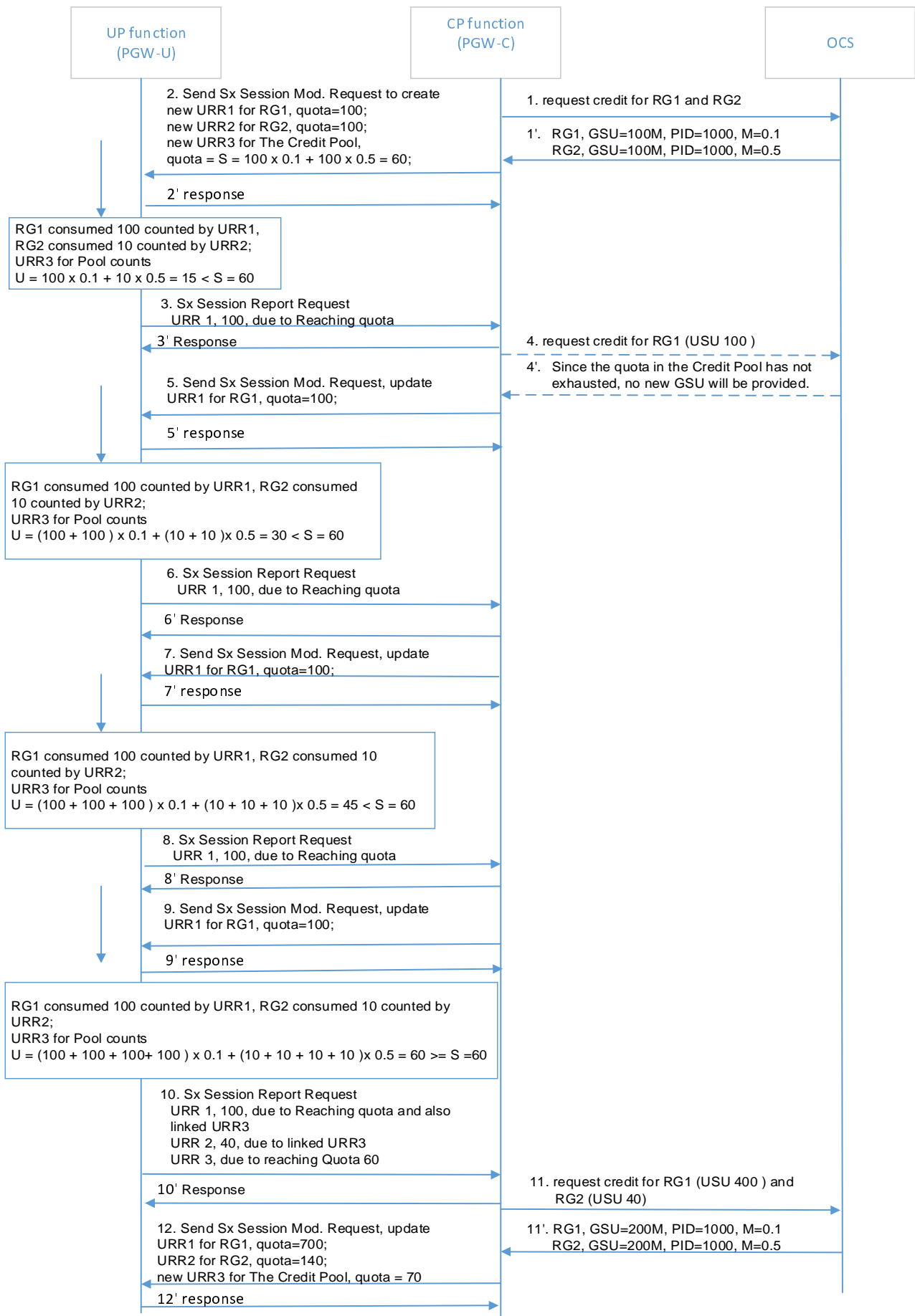

Figure C.2.2.2-1: Online charging with Credit Pooling (alt 1)

1. Upon the request from the CP function for RG1 and RG2, the OCS grants:

RG1: quota 100 Mbytes, together with a G-S-U-Pool-Reference AVP included within the Multiple Services Credit Control (for RG1), where the G-S-U-Pool-Identifier AVP indicating the identifier (e.g. 1000) of the Credit Pool to which the RG1 pertains, the CC-Unit-Type AVP specifies the type of units for which credit is (e.g. total octets), the Unit-Value AVP specifies the multiplier (e.g. 0.1);

RG2: quotas 100 Mbytes, together with a G-S-U-Pool-Reference AVP included within the Multiple Services Credit Control (for RG2), where the G-S-U-Pool-Identifier AVP indicating the identifier (e.g. 1000) of the Credit Pool to which the RG2 pertains, the CC-Unit-Type AVP specifies the type of units for which credit is (e.g. total octets), the Unit-Value AVP specifies the multiplier (e.g. 0.5);

2. The CP function sends a PFCP Session Modification Request to the UP function, to create:

A new URR1 for RG1, quota=100, Linked URR = URR3;

A new URR2 for RG2, quota=100, Linked URR = URR3;

A new URR3 for Pool, quota = $S = 100 \times 0.1 + 100 \times 0.5 = 60$, Aggregated URRs: URR1 with Multiplier 0.1 and URR2 with Multiplier 0.5.

The UP function accepts the request.

3. The RG1 has consumed 100 counted by URR1, RG2 consumed 10 counted by URR2; the URR3 for the Credit Pool counts $U = 100 \times 0.1 + 10 \times 0.5 = 15 < S$. The URR1 triggers sending a usage report towards the CP function due to reaching the Quota 100. So the UP function sends a PFCP Session Report Request, including the Usage Reports for the URR1. The CP function sends the response message.
4. Based on operator's policies, the CP function reports used quota for the RG1 to the OCS. The OCS does not grant any quota since the quota for the Credit Pool has not been consumed yet.

NOTE: This step is skipped in the rest flow.

5. The CP function sends a PFCP Session Modification Request to the UP function with the modified URR1, with new quota 100.

Step 6, 7, 8 and 9 repeats step 3 and 5.

10. The RG1 has consumed another 100 counted by URR1, RG2 consumed another 10 counted by URR2; the URR3 for the Credit Pool counts $U = (100 + 100 + 100 + 100) \times 0.1 + (10 + 10 + 10 + 10) \times 0.5 = 60 \geq S = 60$. So the UP function sends a PFCP Session Report Request, including the Usage Reports for:

- the URR3, generated due to reaching quota (60),

- for the URR1, generated due to that it is linked to the URR3 and it has reached the quota 100, and

- for the URR2 generated due to that it is linked to the URR3.

The CP function sends the response message.

11. The CP function requests new Quota for RG1 and RG2 to the OCS. The OCS grants 200M for RG1 and 100M for RG2, with the same pool ID and Multipliers.

12. The CP function sends a PFCP Session Modification Request to the UP function with the modified URRs, for URR1, URR2 and URR3.

C.2.1.2.3 Example Call Flow 2

In this example, the PGW-C is instructed by the OCS to handle a credit pool for two Rating Groups, RG1 and RG2. The PGW-C provisions two URRs, URR1 and URR2, for the two RGs respectively, and a URR3 for the Credit Pool. The PGW-C provisions the quotas for URR1 and URR2 taking into account the credit pool quota and the multipliers of the RGs.

This reflects another possible implementation option. This approach avoids extra usage reports being sent over Sxb for RG1 or RG2 before the credit pool is exhausted, and thus reduces Sxb signalling.

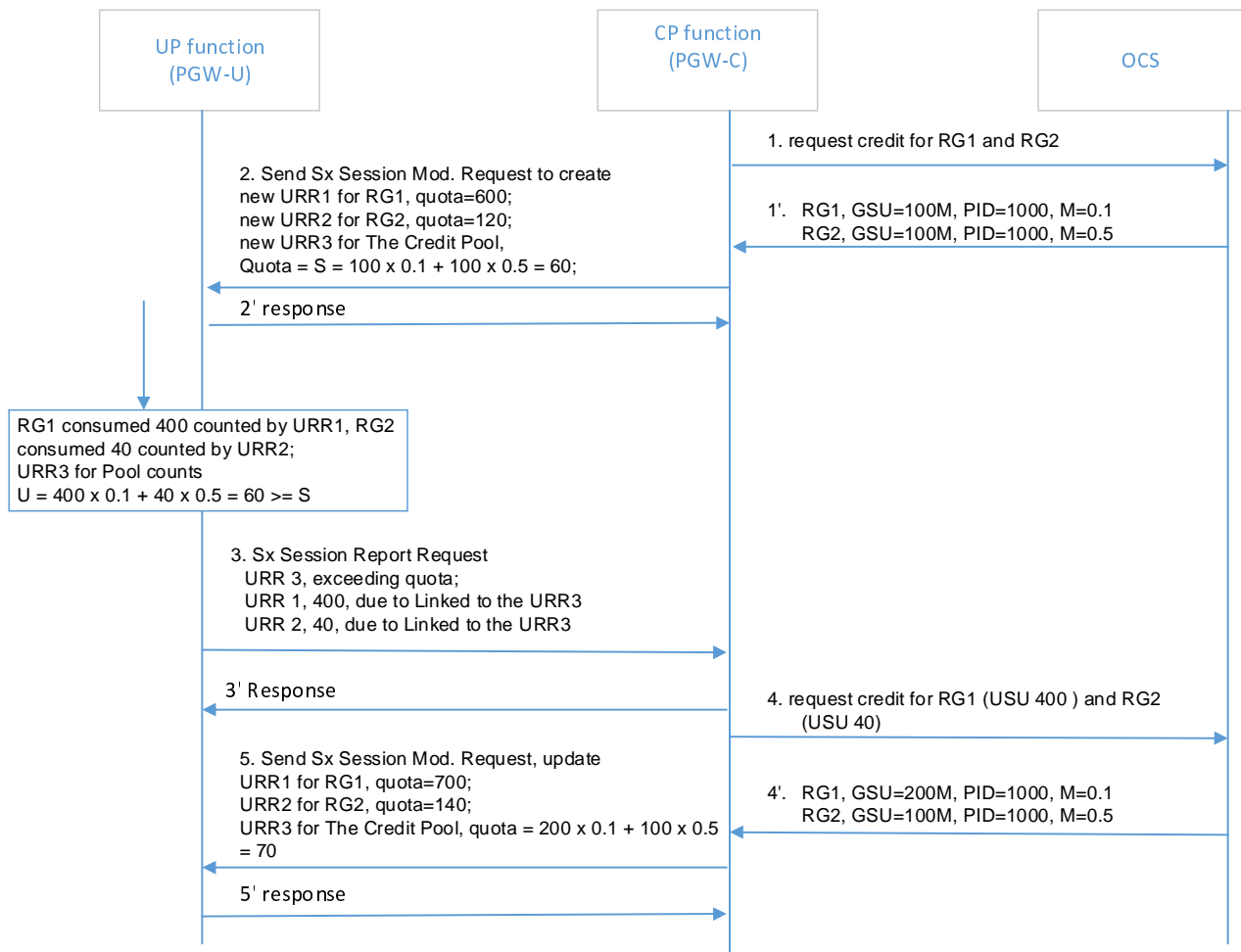

Figure C.2.2.3-2: Online charging with Credit Pooling (alt 2)

1. Upon the request from the CP function for RG1 and RG2, the OCS grants:

RG1: quota 100 Mbytes, together with a G-S-U-Pool-Reference AVP included within the Multiple Services Credit Control (for RG1), where the G-S-U-Pool-Identifier AVP indicating the identifier (e.g. 1000) of the Credit Pool to which the RG1 pertains, the CC-Unit-Type AVP specifies the type of units for which credit is (e.g. total octets), the Unit-Value AVP specifies the multiplier (e.g. 0.1);

RG2: quotas 100 Mbytes, together with a G-S-U-Pool-Reference AVP included within the Multiple Services Credit Control (for RG2), where the G-S-U-Pool-Identifier AVP indicating the identifier (e.g. 1000) of the Credit Pool to which the RG2 pertains, the CC-Unit-Type AVP specifies the type of units for which credit is (e.g. total octets), the Unit-Value AVP specifies the multiplier (e.g. 0.5);

2. The CP function sends a PFCP Session Modification Request to the UP function, to create:

A new URR1 for RG1, quota=600, Linked URR = URR3;
 A new URR2 for RG2, quota=120, Linked URR = URR3;
 And new URR3 for Pool, quota = $S = 100 \times 0.1 + 100 \times 0.5 = 60$, Aggregated URRs: URR1 with Multiplier 0.1 and URR2 with Multiplier 0.5.

The UP function accepts the request.

NOTE 1: To avoid receiving usage report upon exceeding the original Quota for RG1 or RG2, the quota can be set to $60 / 0.1 = 600$ for RG1, assuming RG1 consumes the complete Quota for the pool; similarly, for RG2, the quota can be set to $60 / 0.5 = 120$;

3. The URR3 always first reaches the Quota, e.g. when the URR1 has counted 400, and URR2 has counted 40, this results the counted usage for the Credit Pool $U=400 \times 0.1 + 40 \times 0.5 = 60$. So the UP function sends a PFCP Session Report Request, including the Usage Reports:

- for the URR3, generated due to that it has reached quota (60);
- for the URR1, generated due to that it is linked to the URR3; and
- for the URR2, generated due to that it is linked to the URR3.

The CP function sends the response message.

4. The CP function requests new Quota for RG1 and RG2 to the OCS. The OCS grants 200M for RG1 and 100M for RG2, with the same pool ID and Multipliers.
5. The CP function sends a PFCP Session Modification Request to the UP function with the modified URRs, for URR1, URR2 and URR3.

URR1 for RG1, $\text{quota} = 70 / 0.1 = 700$; 

URR2 for RG2, $\text{quota} = 70 / 0.5 = 140$; 

URR3 for The Credit Pool, $\text{quota} = 200 \times 0.1 + 100 \times 0.5 = 70$.

Annex D (Normative): Use of PFCP over N16a for the support of traffic offload by UPF controlled by I-SMF

D.1 General

This Annex applies to PDU sessions involving an Intermediate SMF (I-SMF), when the I-SMF has inserted an Uplink Classifier (UL CL) or Banching Point (BP) into the data path of the PDU session and a local PDU Session Anchor (PSA) further called PSA2 in this Annex, for local traffic offload.

For such PDU sessions, PFCP session related messages shall be exchanged between the SMF and I-SMF for:

- the SMF to provide N4 information to the I-SMF regarding how the traffic shall be detected, enforced and monitored in the UPF(s) controlled by the I-SMF;
- the I-SMF to forward N4 information with traffic usage reporting to the SMF.

See clause 5.34.6 of 3GPP TS 23.501 [28].

Whether the UL CL or BP and PSA2 are supported by the same UPF or not shall be transparent to the SMF.

When exchanging N4 information over N16a, the SMF and I-SMF shall assume the model in Figure D.1-1 where the UL CL or BP and PSA2 are supported by separate UPFs, i.e. separate PFCP session related messages shall be exchanged over N4 for the UL CL/BP and for the PSA2.

NOTE 1: This allows the SMF and I-SMF to exchange unambiguous information on whether N4 information exchanged over N16a relates to the UL CL/BP or the PSA2, e.g. whether a QER is to be enforced in the UL CL/BP or PSA2.

NOTE 2: The UL CL/BP and PSA2 inserted by the I-SMF can be co-located or located on different UPFs, regardless of the model assumed over N16a for the exchange of N4 information.

NOTE 3: Only one local PSA (i.e. PSA2) is shown in this figure; in real deployment, more than one local PSAs can be inserted.

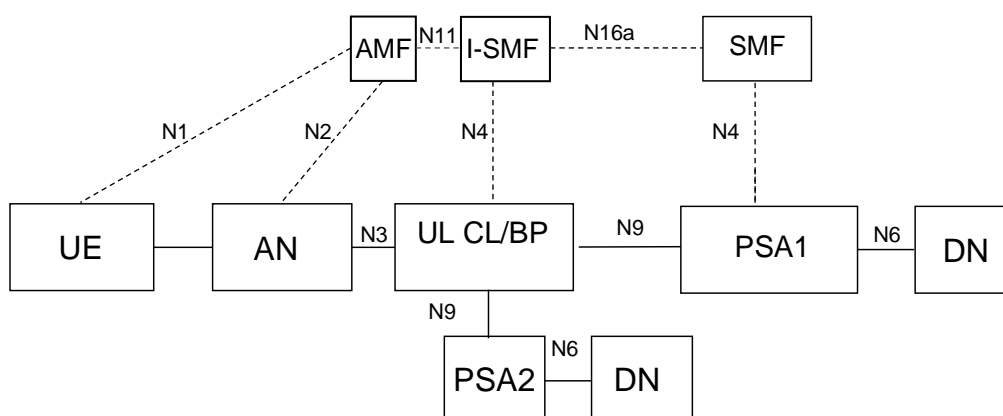

Figure D.1-1: UL CL/BP and PSA2 model for N4 information exchanged over N16a

The I-SMF shall translate the N4 information received from the SMF into appropriate N4 rules towards the UL CL/BP and the PSA2; the I-SMF shall merge the N4 information received for the UL CL/BP and the PSA2 if the UL CL/BP and PSA2 are located on the same UPF.

The N4 information exchanged over N16a shall only include the rules related to the UL and DL traffic to offload via PSA2, and not include the rules to the non-offload UL and DL traffic via PSA1. The I-SMF shall generate on its own

N4 rules towards the UL CL/BP for UL and DL traffic exchanged between the AN and PSA1. The PDR, FAR, URR, QER ID(s) allocated by the I-SMF and the SMF for the PFCP sessions between I-SMF and UL CL and between I-SMF and PSA2 shall be distinct; the Precedence of the PDRs set by the I-SMF and the SMF shall also be distinct (see clause D.2.1).

All the PFCP session related messages specified in clause 7.5 shall be supported over N16a. Unless specified otherwise in this Annex, the requirements specified in the rest of this specification for PFCP session related procedures and messages are also applicable to N16a.

None of the PFCP Node related messages specified in clause 7.4 shall be sent over N16a. PFCP Load and Overload control information shall not be exchanged over N16a.

Data forwarding procedures (see clause 5.3) shall not be used over N16a.

PFCP session related messages shall be sent over N16a in a binary body part of an HTTP multipart message using the Nsmf_PDUSession as specified in 3GPP TS 29.502 [50]. The Json body part of a HTTP multipart message shall indicate whether a given PFCP session related message relates to the UL CL/BP or to the PSA2. Presence of the DNAI IE indicates the PFCP session message relates to PSA2 and absence of the DNAI IE indicates the PFCP session message relates to UL CL/BP.

D.2 Procedures

D.2.1 Addition of PSA and UL CL/BP controlled by I-SMF

The corresponding stage 2 call flow is specified in clause 4.23.9.1 of 3GPP TS 23.502 [29].

When the I-SMF decides to select a new PSA2 and/or a UL CL/BP (replacing the current I-UPF) for the PDU session, e.g. using the list of DNAI(s) of interest for this PDU Session received from the SMF, it shall establish PFCP sessions towards UL CL/BP and/or PSA2 respectively.

The I-SMF shall allocate PDR/FAR/URR/QER ID not larger than 255 and shall set Precedence value not smaller than 65536. The SMF shall allocate PDR/FAR/URR/QER ID from 256 onwards and shall set Precedence value not larger than 65535.

NOTE 1: Since PDRs provided by the SMF to control the traffic via PSA2 have higher precedence than PDRs generated by the I-SMF, the I-SMF need not modify the PDRs generated by its own. See the example further down.

For the PFCP session established between I-SMF and UL CL/BP:

- the I-SMF shall create at least a UL PDR to identify the UL traffic received from AN and a UL FAR to forward the traffic towards PSA1;
- the I-SMF shall create a DL PDR to identify the DL traffic from the PSA1 and a DL FAR to forward the traffic towards the AN;

NOTE 2: The I-SMF needs to include DL N9 F-TEID in the SMF PDUSession Update Request sent to SMF as specified in 3GPP TS 29.502 [50].

For the PFCP session established between I-SMF and PSA2:

- the I-SMF shall create at least an UL PDR to identify the UL traffic received from UL CL/BP and a UL FAR to forward the traffic towards the DN;
- the I-SMF shall create a DL PDR to identify the DL traffic from the DN and a DL FAR to forward the traffic towards the UL CL/BP;

NOTE 3: If IPv6 multi-homing applies to the PDU session, a new IPv6 prefix can be allocated by the PSA2, which is sent in SMF PDUSession Update Request to SMF.

Upon successful establishment of the PFCP sessions, the I-SMF indicates to the SMF that it has inserted an UL CL/BP and PSA by sending a SMF PDUSession Update Request to the SMF (see step 4 clause 4.23.9.1 of 3GPP TS 23.502 [29]).

When the I-SMF indicates to the SMF that it has inserted an UL CL/BP and PSA, the SMF shall send two PFCP Session Establishment Requests towards the I-SMF, one targeting the UL CL/BP and another one targeting the PSA2, with the following information:

1) PFCP Session Establishment Request for the UL CL/BP:

- For the support of the UL traffic offloaded towards PSA2:
 - one Create Traffic Endpoint IE, just including a Traffic EndPoint ID; the UL traffic endpoint corresponds to the N3 endpoint of UL CL/BP; the UL traffic endpoint shall not contain information about the N3 interface, i.e. the Network Instance IE and the Local F-TEID IE shall not be included;
 - at least one Create PDR IE with:
 - the Source Interface set to "Access";
 - the Traffic Endpoint IE referring to the UL traffic endpoint;
 - any additional Packet Detection Information to define the UL traffic to match (e.g. SDF Filter, Application ID, Ethernet Packet Filter);
 - any applicable PDR information, e.g. FAR ID, URR ID, QER ID.

UL PDRs shall not contain the Outer Header Removal IE.

- one UL FAR set to forward (or drop) the UL traffic, with the Destination Interface set to "Core". If more than one local PSA has been inserted by the I-SMF, the UL FAR shall indicate the Data Network Access Identifier associated to the local PSA towards which the UL traffic shall be forwarded; the UL FAR may do so otherwise.
- For the support of the DL traffic offloaded from PSA2:
 - one Create Traffic Endpoint IE, including a Traffic EndPoint ID; the DL traffic endpoint shall not contain information about the N9 interface, i.e. the Network Instance IE and the Local F-TEID IE shall not be included;
 - at least one Create PDR IE with:
 - the Source Interface set to "Core";
 - the Traffic Endpoint IE referring to the DL traffic endpoint;
 - any applicable PDR information, e.g. FAR ID, URR ID, QER ID;
 - one DL FAR set to forward (or drop) the DL traffic to the access network, with the Destination Interface set to "Access"; the DL FAR shall not contain the Outer Header Creation IE;

NOTE 4: The I-SMF is responsible for all the N3 and N9 protocol aspects (e.g. Network Instance, Local F-TEID, outer header creation or removal).

- any applicable QERs and/or URRs.

2) PFCP Session Establishment Request for the PSA2:

- For the support of the UL traffic offloaded at PSA2:
 - one Create Traffic Endpoint IE, just including a Traffic EndPoint ID; the UL traffic endpoint shall not contain information about the N9 interface, i.e. the Network Instance IE and the Local F-TEID IE shall not be included;
 - at least one Create PDR IE with:
 - the Source Interface set to " Access ";

- the Traffic Endpoint IE referring to the UL traffic endpoint;
- any applicable PDR information, e.g. FAR ID, URR ID, QER ID;

UL PDRs shall not contain the Outer Header Removal IE;

- one UL FAR set to forward (or drop) the UL traffic, with the Destination Interface set to "Core".
- For the support of the DL traffic offloaded at PSA2:
 - one Create Traffic Endpoint IE, including a Traffic EndPoint ID and any additional information to define the DL traffic endpoint (e.g. Network Instance IE, UE IP Address IE); the DL traffic endpoint corresponds to the N6 endpoint of PSA2;
 - at least one Create PDR IE with:
 - the Source Interface set to "Core";
 - the Traffic Endpoint IE referring to the DL traffic endpoint;
 - any additional Packet Detection Information to define the DL traffic to match (e.g. SDF Filter, Application ID, Ethernet Packet Filter);
- any applicable PDR information, e.g. FAR ID, URR ID, QER ID;
 - one DL FAR set to forward (or drop) the DL traffic, with the Destination Interface set to " Access "; the DL FAR shall not contain the Outer Header Creation IE.

NOTE 5: The I-SMF is responsible for all the N3 and N9 protocol aspects (e.g. Network Instance, Local F-TEID, outer header creation or removal).

- Any applicable QERs and/or URRs.

In the PFCP Session Establishment Request for the UL CL/BP, the SMF shall not include any N4 rules for the UL and DL traffic via PSA1 (i.e. non-offload traffic exchanged between AN and PSA1).

The I-SMF shall translate the SMF instructions into N4 instructions to send to the UL CL/BP and PSA2, for the UL and DL traffic in one or more PFCP Session Modification Request message(s) (the I-SMF has already created a PFCP session in the UL CL/BP and PSA2 in steps 2 and 3 of Figure 4.23.9.1-1 of 3GPP TS 23.502 [29]). In particular:

- the I-SMF shall map the UL and DL traffic endpoints requested to be created by the SMF in the UL CL/BP and PSA2 respectively to the UL and DL traffic endpoints created in the UL CL/BP and in PSA2 for UL and DL traffic; the I-SMF shall update the DL traffic endpoint in PSA2 if necessary, e.g. with any Framed-Route or Framed-IPv6-Route information received from the SMF;
- the I-SMF shall add the Outer Header Removal IE to the UL PDR of the UL CL/BP;
- the I-SMF shall add an Outer Header Creation IE to DL PDR(s) of the UL CL/BP to add a GTP-U header set to the 5G-AN F-TEID, and to add a Network Instance IE if needed;
- the I-SMF shall update the UL FAR of the UL CL/BP and the DL FAR of the PSA2 with N9 protocol information, if the UL CL/BP and PSA2 are located on different UPFs; if more than one local PSA has been inserted by the I-SMF, the I-SMF shall derive the local PSA towards which the UL traffic shall be forwarded from the Data Network Access Identifier IE indicated in the UL FAR over N16a.
- the I-SMF shall overwrite the Apply Action IE of the DL FAR received from the SMF according to the User Plane connection state of the PDU session, e.g. to request the UPF to buffer packets if the PDU session is deactivated, or to forward the DL packets otherwise;
- the I-SMF shall merge the N4 information received for the UL CL/BP and the PSA2 if the UL CL/BP and PSA2 are located on the same UPF.

The I-SMF shall return two PFCP Session Establishment Response messages to the SMF for UL CL/BP and PSA2 respectively. In the PFCP Session Establishment Response messages, the I-SMF may set the Node ID IE and UP F-SEID IE to the ones provided by the UL CL/BP and the PSA2. The Created PDR and Created Traffic Endpoint shall not be included.

The I-SMF shall generate by itself the N4 rules to control the UL and DL traffic via PSA1 (i.e. non-offload traffic exchanged between AN and PSA1), and send such N4 rules to the UL CL/BP together with the N4 rules mapped from the N4 information sent by the SMF.

EXAMPLE: Example of addition of PSA2 and UL CL controlled by I-SMF:

- 1) in step 3 of clause 4.23.9.1 of 3GPP TS 23.502 [29], when establishing the PFCP session between I-SMF and UL CL/BP, the I-SMF can provide the following PDRs/FARs to the UL CL/BP:

UL PDR1 (UL F-TEID 1 is allocated to receive UL traffic from NG-RAN) and
UL FAR1 (forward all traffic towards PSA1);

DL PDR2 (N9 DL F-TEID is allocated to receive DL traffic from PSA1 which will be reported in SMF PDUSession Update Request towards SMF) and
DL FAR2 (forward all traffic towards NG-RAN N3 F-TEID).

- 2) in step 2 of clause 4.23.9.1 of 3GPP TS 23.502 [29], when establishing the PFCP session between I-SMF and PSA2, the I-SMF can provide the following PDRs/FARs to PSA2:

UL PDR1 (to receive traffic from UL CL, i.e. including the UL F-TEID of UL CL) and
UL FAR1 (forward all traffic towards DN);

DL PDR2 (to receive traffic from DN) and
DL FAR2 (forward all traffic towards UL CL's N9 DL F-TEID).

- 3) in step 6 of clause 4.23.9.1 of 3GPP TS 23.502 [29], the SMF sends an SMF PDUSession Update Request to the I-SMF encapsulating binary encoded PFCP Session Establishment Request messages to request to offload service traffic towards PSA2, e.g. for a service which is identified by app-id 100;

In the PFCP Session Establishment Request message for PSA2, the SMF includes:

UL PDR 256 (where the PDI includes app-id =100) and
UL FAR 256 (forward all traffic towards DN);

DL PDR 257 (sending traffic to UL CL, where the PDI includes app-id=100) and
DL FAR 257 (sending traffic to UL CL).

In the PFCP Session Establishment Request message for UL CL, the SMF includes:

UL PDR 256 (where the PDI includes app-id =100) and
UL FAR 256 (forward traffic towards PSA2);

DL PDR 257 (identifying all traffic received from PSA2) and
DL FAR 257 (forward traffic toward access);

- 4) in step 7 of clause 4.23.9.1 of 3GPP TS 23.502 [29], the I-SMF maps rules received in 3) in the PFCP Session Modification Request message to the PSA2, and the PDR1 and PDR2 provisioned earlier by I-SMF during the PFCP session establishment procedure will not be matched for the application traffic identified by app-id 100 due to a lower precedence.
- 5) in step 8 of clause 4.23.9.1 of 3GPP TS 23.502 [29], the I-SMF can maps rules received in 3) in the PFCP Session Modification Request message to the UL CL, the PDR1 (forwarding all traffic to PSA1) provisioned earlier by I-SMF during the PFCP session establishment procedure will not be matched for the application traffic identified by app-id 100 due to a lower precedence.

D.2.2 Removal of PSA and UL CL/BP

The corresponding stage 2 call flow is specified in clause 4.23.9.2 of 3GPP TS 23.502 [29].

When the I-SMF indicates to the SMF that it is removing a UL CL/BP and PSA, the SMF shall send two PFCP Session Deletion Requests towards the I-SMF, one for the UL CL/BP and another one for the PSA2. The I-SMF shall return two PFCP Session Deletion Responses to the SMF (including usage reports if applicable, see clause 7.5.7.1).

D.2.3 Change of PSA

The corresponding stage 2 call flow is specified in clause 4.23.9.3 of 3GPP TS 23.502 [29].

When the I-SMF indicates to the SMF a change of traffic offload, the SMF shall send a PFCP Session Establishment Request (for the new DNAI), a PFCP Session Deletion Request (for the old DNAI) towards the I-SMF, and a PFCP Session Modification Request for the UL CL/BP if needed. The I-SMF shall behave as described in clauses D.2.1 and D.2.2 and return a PFCP Session Establishment Response, a PFCP Session Deletion Response and a PFCP Session Modification Response if needed.

D.2.4 Traffic Usage Reporting

The SMF may request the I-SMF to report traffic usage measurements as specified in the rest of this specification.

The I-SMF shall report traffic usage measurements to the SMF as specified in the rest of this specification, i.e. in PFCP Session Report Request, PFCP Session Modification Response and PFCP Session Deletion Response messages.

D.2.5 Updating N4 information towards I-SMF

The SMF may send PFCP Session Modification Requests with updated PFCP rules (e.g. updated PDR, QER URR), targeting the UL CL/BP or PSA2, as specified in the rest of this specification. The I-SMF shall return PFCP Session Modification Responses accordingly.

D.2.6 PDU session release

Corresponding stage 2 requirements are specified in clauses 4.23.3a and 4.23.5.2 of 3GPP TS 23.502 [29].

If an UL/CL or BP was inserted in the data path by the I-SMF:

- In scenarios where the I-SMF sends a Release Request to the SMF, e.g. UE deregistration procedure, the I-SMF shall first send a PFCP Session Deletion Request to the UL CL/BP and local PSA to retrieve non-zero traffic usage reports, before sending the Release Request over N16a to the SMF. If the I-SMF needs to report traffic usage measurements to the SMF for the UL CL/BP and/or for the local PSA, the I-SMF shall encapsulate one PFCP Session Report Request for the UL CL/BP and/or one PFCP Session Report Request for the local PSA in the Release Request sent over N16a to the SMF. The SMF shall encapsulate corresponding PFCP Session Report Response(s) in the Release Response.

If more traffic usage measurements need to be reported to the SMF, the I-SMF shall send one or more Update Request(s) towards the SMF before sending a Release Request.

Upon receiving the Release Request from the I-SMF, the SMF shall consider that the PFCP sessions between the I-SMF and UL CL/BP and local PSA have been deleted.

- In scenarios where the I-SMF sends an Update Request to the SMF, e.g. UE initiated PDU session release, if the I-SMF needs to report traffic usage measurements to the SMF for the UL CL/BP and/or for the local PSA, the I-SMF may encapsulate one PFCP Session Report Request for the UL CL/BP and/or one PFCP Session Report Request for the local PSA in the Update Request sent over N16a to the SMF (i.e. in step 3a of Figure 4.3.4.3-1 of 3GPP TS 23.502 [29]). If so, the SMF shall encapsulate corresponding PFCP Session Report Response(s) in the Update Response.

The SMF shall then send two PFCP Session Deletion Requests towards the I-SMF, one for the UL CL/BP and another one for the local PSA, in the subsequent Update Request initiated by the SMF towards the I-SMF to trigger the release of the PDU session (i.e. in step 3a of Figure 4.3.4.3-1 of 3GPP TS 23.502 [29]). The I-SMF shall encapsulate corresponding PFCP Session Deletion Response(s) in the Update Response (i.e. in step 14 of Figure 4.3.4.3-1 of 3GPP TS 23.502 [29]), including usage reports if applicable, see clause 7.5.7.1. The PFCP Session Deletion Response may indicate that additional usage reports need to be signalled; if so, the I-SMF shall send additional Update Request(s) towards the SMF encapsulating PFCP Session Report Requests and the SMF shall return Update Response (s) encapsulating PFCP Session Report Responses. When the last usage report has

been received, the SMF shall notify the I-SMF that the PDU session is released (in step 16a of Figure 4.3.4.3-1 of 3GPP TS 23.502 [29]).

D.2.7 Simultaneous change of UL CL/BP and PSA controlled by I-SMF

The corresponding stage 2 call flow is specified in clause 4.23.9.4 of 3GPP TS 23.502 [29]. Figure D.2.7-1 specifies the details of the signalling interactions between the SMF and the I-SMF, and between the I-SMF and the UL CL/BPs and PSAs.

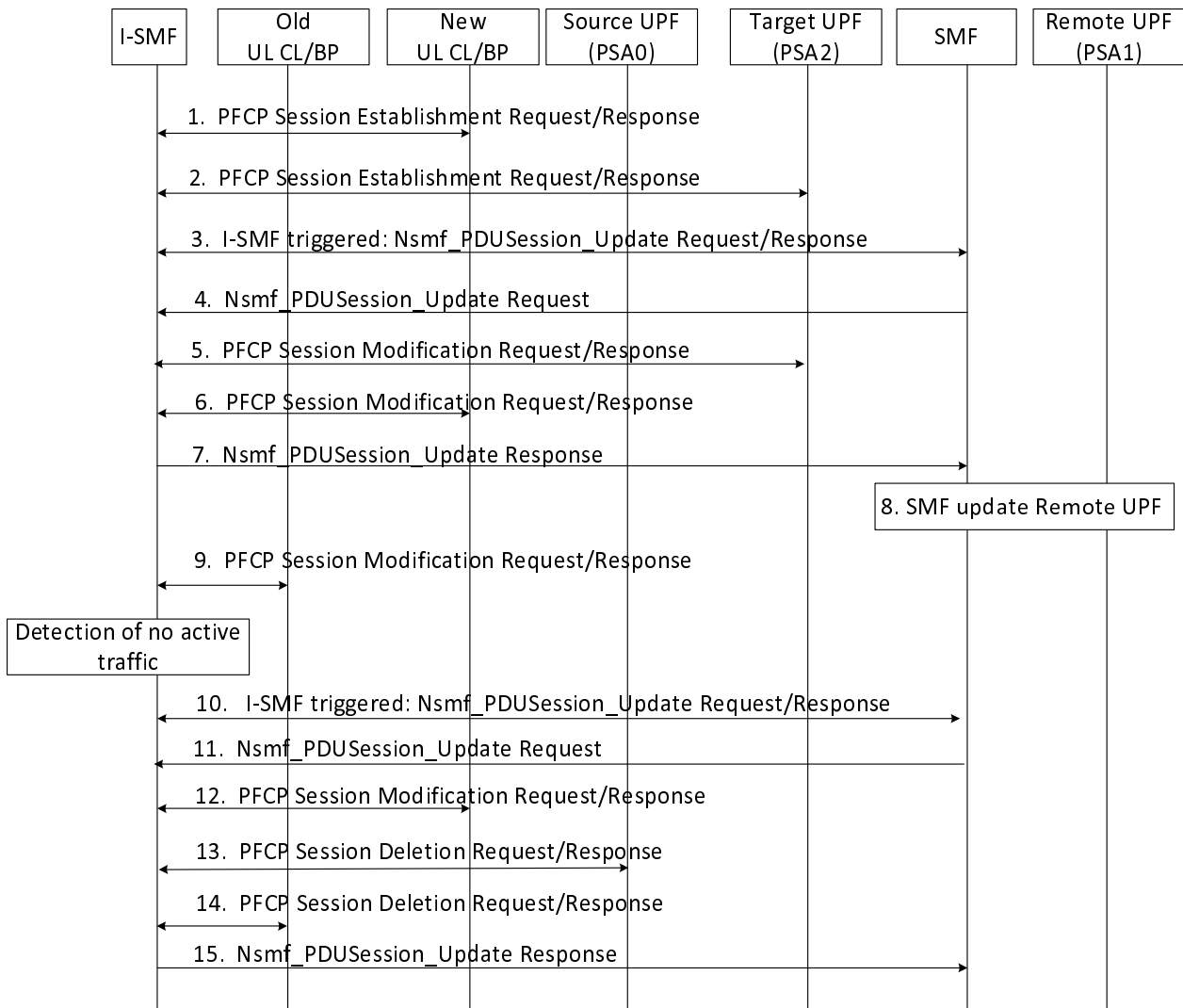

Figure D.2.7-1 – Simultaneous change of UL CL/BP and PSA controlled by I-SMF

1-2. These steps are the same as described in clause D.2.1 and correspond to steps 2 and 3 of Figure 4.23.9.4-1 of 3GPP TS 23.502 [29].

3. The I-SMF indicates to the SMF that it has inserted an UL CL/BP and PSA if both the I-SMF and the SMF support the "N9FSC" feature defined in clause 6.1.8 of 3GPP TS 29.502 [50], or the I-SMF indicates to the SMF a change of UL CL/BP and PSA if either the I-SMF or the SMF does not support the "N9FSC" feature.

4. When the I-SMF indicates to the SMF an insertion of UL CL/BP and PSA, and data forwarding between the new and old UL CL/BPs for EAS session continuity is required, the SMF shall send to the I-SMF a PFCP Session Establishment Request (for the new DNAI) and a PFCP Session Establishment Request for the new UL CL/BP.

When the I-SMF indicates to the SMF a change of UL CL/BP and PSA, or when the I-SMF indicates to the SMF an insertion of UL CL/BP and PSA and data forwarding between the new and old UL CL/BPs for EAS session continuity

is not required, the SMF shall send to the I-SMF a PFCP Session Establishment Request (for the new DNAI), a PFCP Session Deletion Request (for the old DNAI), a PFCP Session Deletion Request for the old UL CL/BP and a PFCP Session Establishment Request for the new UL CL/BP. The I-SMF shall behave as described in clauses D.2.1 and D.2.2 and return two PFCP Session Establishment Responses and two PFCP Session Deletion Responses.

The following signalling applies if both the I-SMF and the SMF support the "N9FSC" feature and data forwarding between the new and old UL CL/BPs for EAS session continuity is required.

Step 4 is same as described in clause D.2.1, in addition, the SMF shall send the following additional information to the I-SMF:

- in the PFCP Session Establishment Request for the new UL CL/BP:
 - Create PDR(s) IE for the UL traffic to forward to the old UL CL/BP with:
 - the Source Interface set to "Access";
 - the Traffic Endpoint IE referring to the UL traffic endpoint;
 - any additional Packet Detection Information to define the UL traffic to match for N9 forwarding (e.g. SDF Filter, Application ID, Ethernet Packet Filter);
 - any applicable PDR information, e.g. FAR ID, QER ID;
 - the UL PDR shall not contain the Outer Header Removal IE;
 - the Precedence value of the above UL PDR for N9 forwarding to the old UL CL/BP shall be set to a higher precedence than the UL PDR for the new UL CL/BP to support the UL traffic offloaded towards the PSA2, if the same Packet Detection Information applies.
 - one UL FAR, set to "forward" the UL traffic to the old UL CL/BP, with the Destination Interface set to "Core"; the UL FAR shall not contain the Outer Header Creation IE.
- the following additional information in the Update Request:
 - the indication that a N9 forwarding tunnel between UL CLs/BPs is required;
 - the list of Rule IDs pointing to the UL PDRs included in the PFCP Session Establishment Request for the new UL CL/BP to establish the UL N9 data forwarding in the new UL CL/BP;
 - the value of the timer to detect the end of activity on the N9 forwarding tunnel.

NOTE: The UL PDR(s) for UL traffic offloaded towards PSA2 will not be matched as long as the UL PDR(s) for UL traffic forwarding to the old UL CL/BP is installed in the target UL CL/BP if the same Packet Detection Information applies, since the latter PDR(s) has a higher precedence than the former.

5. The step is same as described in clause D.2.1, i.e. the SMF updates the remote PSA (PSA1) via N4 with the DL Tunnel Info of the Target UL CL/BP for the downlink traffic.
6. The I-SMF shall map the above rules received in the PFCP Session Establishment Request message to the new UL CL/BP. In particular:
 - the I-SMF shall add the Outer Header Removal IE to the UL PDR(s) of the UL CL/BP for the UL traffic to be forwarded to the old UL CL/BP;
 - the I-SMF shall add an Outer Header Creation IE to the UL FAR of the UL CL/BP to add a GTP-U header set to the old N3 UL F-TEID in the old UL CL/BP if it can be reused;
 - the I-SMF shall provision a DL PDR to receive DL traffic forwarded from the old UL CL/BP and a DL FAR to forward the received DL traffic towards the NG-RAN. The new UL CL/BP shall assign a new N9 DL F-TEID for the old UL CL/BP.
7. The I-SMF returns two PFCP Session Establishment Responses to the SMF.
8. The step is same as described in clause D.2.1.

9. The I-SMF shall send the following information to the old UL CL/BP in the PFCP Session Modification Request based on the additional information received in the Update Request from the SMF and the PFCP Session Establishment Response from the new UL CL/BP:
- the I-SMF shall update the Outer Header Creation IE in the DL FAR of the old UL CL/BP to add a GTP-U header set to the F-TEID assigned by the new UL CL/BP for DL traffic forwarding;
 - the I-SMF shall update the UL PDR(s) to receive UL traffic forwarded from the new UL CL/BP, if the old UL CL/BP needs to assign a new N9 DL F-TEID for the new UL CL/BP;
 - instruct the old UL CL/BP to report user inactivity on the N9 forwarding tunnel by provisioning the received time in the User Plane Inactivity Timer IE (as specified in clause 5.11.2).

If the old UL CL/BP assigns a new N9 DL F-TEID to receive the UL traffic from the new UL CL/BP, the I-SMF shall send a PFCP Session Modification Request message to the new UL CL/BP to add an Outer Header Creation IE to the UL FAR of the UL CL/BP to add a GTP-U header set to the new N9 UL F-TEID assigned by the old UL CL/BP for UL traffic forwarding, and to add a Network Instance IE if needed.

10. If the User Plane Inactivity Report is received from the old UL CL/BP due to the User Plane Inactivity Timer expires, the I-SMF indicates to the SMF that it is removing the old UL CL/BP and PSA0.
11. The SMF shall send to the I-SMF a PFCP Session Deletion Request (for the old DNAI) and a PFCP Session Deletion Request for the old UL CL/BP.
- 12-14. The I-SMF shall remove the UL PDR(s) identified by the received Rule ID(s) in the target UL CL/BP and the PFCP sessions in old UL CL/BP/PSA0.
15. The I-SMF returns two PFCP Session Deletion Responses to the SMF.

D.2.8 Simultaneous change of UL CL/BP and PSA controlled by different I-SMFs

The corresponding stage 2 call flow is specified in clause 4.23.9.5 of 3GPP TS 23.502 [29]. Figure D.2.8-1 specifies the details of the signalling between the SMF and the I-SMF, and between the I-SMFs and the UL CL/BPs and PSAs.

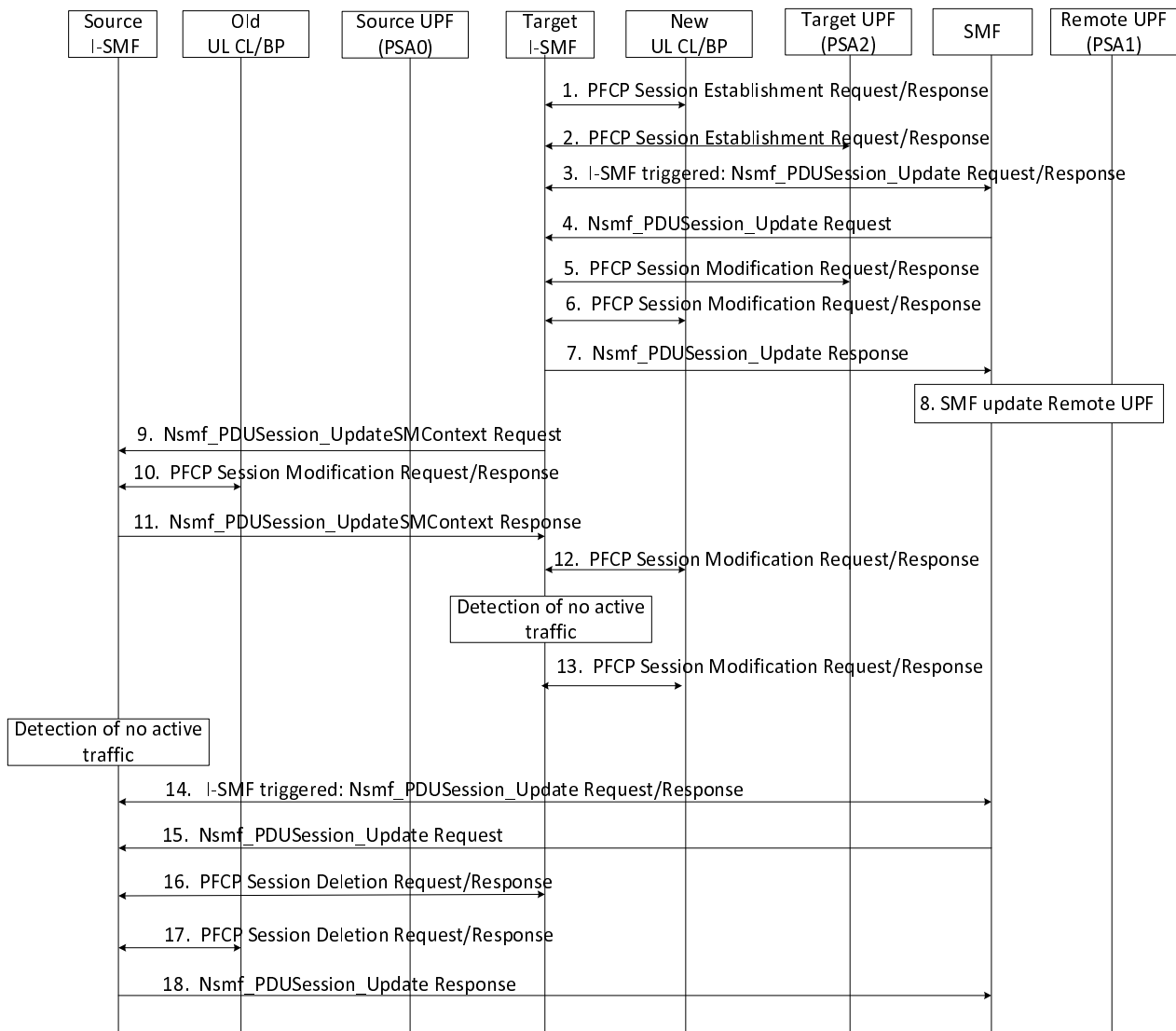

Figure D.2.8-1 – Simultaneous change of UL CL/BP and PSA controlled by different I-SMFs

1-2. These steps are the same as described in clause D.2.7.

3. The target I-SMF indicates to the SMF the insertion of UL CL/BP and PSA.

4. The SMF shall send to the target I-SMF a PFCP Session Establishment Request (for the new DNAI) and a PFCP Session Establishment Request for the new UL CL/BP.

In addition, to support the EAS session continuity, the SMF may send additional information to the target I-SMF as defined in step 4 of clause D.2.7.

5-6. The target I-SMF shall behave as described in step 5 and 6 of clause D.2.7. In addition, the target I-SMF shall provision a URR with a User Plane Inactivity Timer IE in the new UL CL/BP, based on the user plane inactivity time received from the SMF, and associate it to the UL PDR(s) used detecting the UL traffic to forward towards the old UL CL/BP and the DL PDR(s) used for detecting the DL traffic from the old UL CL/BP (as specified in clause 5.11.3).

7-8. These steps are the same as described in clause D.2.7.

9. The target I-SMF shall send an Nsmf_PDUSession_UpdateSMContext Request (N9 forwarding tunnel required, target UL CL N9 forwarding tunnel info, value of the timer to detect the end of activity on the N9 forwarding tunnel to support the EAS session continuity) to the source I-SMF, as specified in clause 5.2.2.3.21 of 3GPP TS 29.502 [50].

10. The source I-SMF shall send the following information to the old UL CL/BP in the PFCP Session Modification Request based on the information received from the target I-SMF:
 - the source I-SMF shall update the Outer Header Creation IE in the DL FAR of the old UL CL/BP to add a GTP-U header set to the F-TEID assigned by the new UL CL/BP for DL traffic forwarding;
 - instruct the old UL CL/BP to report user inactivity on the N9 forwarding tunnel by provisioning the received time in the User Plane Inactivity Timer IE (as specified in clause 5.11.2).
11. The source I-SMF shall return information to the target I-SMF, e.g. F-TEID in old UL CL/BP on receiving the UL traffic from the new UL CL/BP, as specified in clause 5.2.2.3.21 of 3GPP TS 29.502 [50]. The source I-SMF may return the old N3 UL F-TEID if it can be reused or a new N9 UL F-TEID assigned by the old UL CL/BP for UL traffic forwarding.
12. The target I-SMF shall update the UL FAR of the UL PDR(s) for UL data forwarding (to the old UL CL/BP) in new UL CL/BP with the F-TEID received.
13. Upon being notified about user plane inactivity of the N9 forwarding tunnel by the new UL CL/BP, the target I-SMF shall release the UL PDR(s) for UL data forwarding (to the old UL CL/BP) and the DL PDR(s) for DL data received (from the old UL CL/BP) in the new UL CL/BP.
14. Upon being notified about user plane inactivity of the N9 forwarding tunnel by the old UL CL/BP, the source I-SMF indicates to the SMF that it is removing the old UL CL/BP and PSA0.
15. The SMF shall send to the source I-SMF a PFCP Session Deletion Request (for the old DNAI) and a PFCP Session Deletion Request for the old UL CL/BP.
- 16-17. The source I-SMF shall remove the PFCP sessions in old UL CL/BP/PSA0.
18. The source I-SMF returns two PFCP Session Deletion Responses to the SMF.

Annex E (Informative): Procedures Related to MPTCP Functionality

E.1 General

This clause provides example MPTCP flows.

This Annex is informative and the normative descriptions in this specification and in 3GPP TS 23.501 [28], 3GPP TS 23.502 [29] and in 3GPP TS 24.193 [59], prevail over the descriptions in this Annex if there is any difference.

E.2 Multipath TCP Connection Setup

E.2.1 General

Multipath TCP Connection is setup between the MPTCP Client in the UE and the MPTCP Proxy in the UPF (PSA). The outgoing Multipath is initiated by the MPTCP Client in the UE towards the MPTCP Proxy in the UPF.

NOTE: The incoming Multipath which is assumed to be initiated by the MPTCP Proxy in the UPF towards the MPTCP Client in the UE is not supported in this release of the specification.

The RTT TCP Convert Protocol (specified in IETF RFC 8803 [60]) is used to setup Multipath TCP connection and used for data exchange. The MPTCP Proxy implements the Transport Converter functionality.

E.2.2 Outgoing Multipath TCP Connection Setup

Figure E.2.2-1 describes the establishment of an outgoing multipath TCP connection through a Transport Converter.

The MPTCP Client initiates a Multipath TCP connection towards the Transport Converter, by sending a SYN with the MP_CAPABLE option (MPC in Figure E.2.2-1). The SYN includes the address and port number of the Server (i.e. remote host), that are extracted by the Transport Converter and used to initiate a Multipath TCP connection towards this Server. As the Server does not support Multipath TCP, it replies with a SYN+ACK that does not contain the MP_CAPABLE option. The Transport Converter notes that the connection with the Server does not support Multipath TCP and returns the extended TCP header received from the Server to the Client.

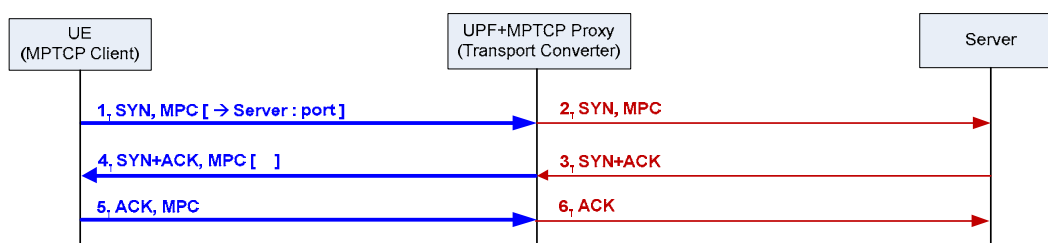

Figure E.2.2-1 – Outgoing Converter-Assisted Multipath TCP Connection Setup

E.2.3 Incoming Multipath TCP Connection Setup

Incoming Multipath TCP Connection Setup as described in clause 5.2 of IETF RFC 8803 [60] is not supported in this release of the specification.

E.2.4 MPTCP Session Entry Stored in MPTCP Proxy

Once Multipath TCP Connection is successfully setup between the MPTCP Client in the UE and the MPTCP Proxy in the UPF, the MPTCP Proxy stores the MPTCP session entry in its storage.

The MPTCP session entry includes the following information:

- MPTCP link-specific multipath IP address and the associated TCP ports;
- UE's MA-PDU session IP address and its TCP port, if the MA-PDU session IP address is used by MPTCP Proxy for IP translation;
- N6 routable IP address and its TCP port, if N6 routable IP address is used by the MPTCP Proxy for IP translation;
- the remote host IP address and its TCP port.

The stored MPTCP session entry is used by the MPTCP Proxy for IP translation when receiving uplink or downlink MPTCP traffic.

E.3 IP Translation Procedure

E.3.1 General

On receiving uplink or downlink MPTCP traffic, the UPF internally forwards the MPTCP traffic to the MPTCP Proxy. The MPTCP Proxy detects the MPTCP traffic is for data exchange, and performs IP translation before sending out the translated MPTCP traffic.

Figure E.3.1-1 illustrates the IP translation model for uplink and downlink MPTCP traffics, both on the UE side and the UPF side.

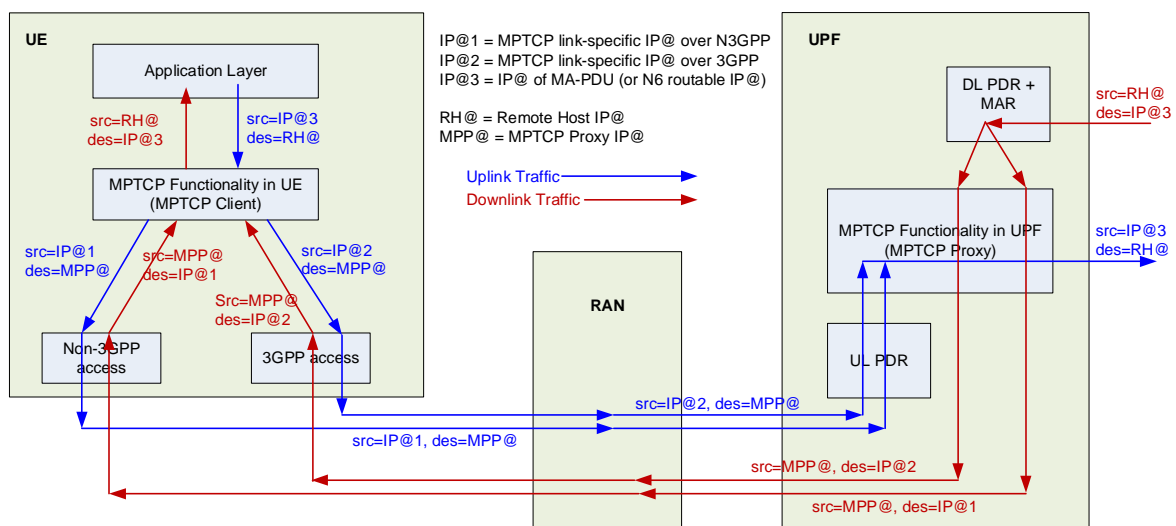

Figure E.3.1-1 IP Translation Model

When UE's MA-PDU session IP address is used by MPTCP Proxy for IP translation, port collision and port exhaustion can potentially occur because the UE also uses the MA-PDU session IP address for non-MPTCP traffic. To avoid this, an N6 routable IP address can be used by the MPTCP Proxy for IP translation, based on the UPF implementation.

E.3.2 IP Translation on Uplink IP Packets

Once uplink MPTCP traffic is detected by the UPF, the UPF internally forwards the uplink IP packets to the MPTCP Proxy.

The MPTCP Proxy performs IP translation to the uplink IP packets, based on the stored MPTCP session entry:

- replace the source IP address and port, from the UE's MPTCP link-specific multipath IP@ and its ports, to the UE's MA-PDU session IP@ and its port (or N6 routable IP@ and its port);
- replace the destination IP address and port, from the MPTCP Proxy IP@ and its port, to the remote host IP@ and its port.

After performing IP translation, the MPTCP Proxy forwards the translated uplink IP packets to N6 interface.

E.3.3 IP Translation on Downlink IP Packets

Once downlink MPTCP traffic is detected by the UPF, the UPF internally forwards the downlink IP packets to the MPTCP Proxy.

The MPTCP Proxy performs IP translation to the downlink IP packets, based on the stored MPTCP session entry:

- replace the source IP address and port, from the remote host IP@ and its port, to the MPTCP Proxy IP@ and its port;
- replace the destination IP address and port, from the UE's MA-PDU session IP@ and its port (or N6 routable IP@ and its port), to the UE's MPTCP link-specific multipath IP@ and its port.

After performing IP translation, the MPTCP Proxy forwards the translated downlink IP packets to N3 or N9 interface.

Annex F (Informative): Change history

Date	TSG #	TSG Doc.	CR	Rev	Cat	Subject/Comment	New
2016-07	CT4#74	C4-164286				First version after CT4#74	0.1.0
2016-10	CT4#74 bis	C4-165318				Version after CT4#74bis	0.2.0
2016-11	CT4#75	C4-166347				Version after CT4#75	0.3.0
2017-01	CT4#75 bis	C4-170124				Version after CT4#75bis	0.4.0
2017-02	CT4#76	C4-171423				Version after CT4#76	0.5.0
2017-03	CT#75	CP-170016				This version was sent for information	1.0.0
2017-04	C4#77	C4-172285				Version after CT4#77	1.1.0
2017-05	C4#78	C4-173360				Version after CT4#78	1.2.0
2017-06	CT#76	CP-171047				This version was sent for approval	2.0.0
2017-06	CT#76	CP-171183				Editorial correction	2.0.1
2017-06	CT#76	CP-171183				Approved in CT#76	14.0.0
2017-09	CT#77	CP-172020	0001	-		PDN Instance over Sx	14.1.0
2017-09	CT#77	CP-172020	0002	1		Transport Level Marking & DL Flow Level Marking	14.1.0
2017-09	CT#77	CP-172020	0003	2		Clarifications and corrections to Usage Reporting	14.1.0
2017-09	CT#77	CP-172020	0004	-		PDN Type over Sx	14.1.0
2017-09	CT#77	CP-172020	0005	1		Creating multiple PDRs in one Sx message with F-TEID allocation in UP function	14.1.0
2017-09	CT#77	CP-172020	0006	1		Message with a rejection cause	14.1.0
2017-09	CT#77	CP-172020	0007	-		Corrections to the number of Fixed Octets	14.1.0
2017-09	CT#77	CP-172020	0008	1		QER correlation ID	14.1.0
2017-09	CT#77	CP-172020	0009	3		Sx Protocol extension to support Envelope Reporting	14.1.0
2017-09	CT#77	CP-172020	0010	1		OCI Flags	14.1.0
2017-09	CT#77	CP-172020	0011	2		IP Address(es) and TEIDs of a UP function	14.1.0
2017-09	CT#77	CP-172020	0012	1		Clarification on bearer of a PDN connection and description on UP function feature	14.1.0
2017-09	CT#77	CP-172020	0013	2		Clarification on Rule IDs	14.1.0
2017-09	CT#77	CP-172020	0014	1		Clarification on creating rules	14.1.0
2017-09	CT#77	CP-172020	0018	2		URR and QER handling	14.1.0
2017-12	CT#78	CP-173023	0026	4		Reporting User Plane Inactivity	14.2.0
2017-12	CT#78	CP-173023	0027	-		Reporting of Usage Reports to the CP function	14.2.0
2017-12	CT#78	CP-173023	0028	-		Suspend and Resume Notification procedures	14.2.0
2017-12	CT#78	CP-173023	0029	-		Network Instance parameter	14.2.0
2017-12	CT#78	CP-173023	0030	1		User Plane traffic handling upon reaching quotas based on operator policies	14.2.0
2017-12	CT#78	CP-173023	0031	-		Reduced Application Detection Information for Envelope Reporting	14.2.0
2017-12	CT#78	CP-173023	0034	3		Sx protocol extension to support Credit Pool	14.2.0
2017-12	CT#78	CP-173023	0035	-		Clarification on the Setting of Precedence	14.2.0
2017-12	CT#78	CP-173023	0036	1		Presence of UP F-SEID in Sx Session Establishment Response	14.2.0
2017-12	CT#78	CP-173023	0042	1		Change the Title of the TS	14.2.0
2017-12	CT#78	CP-173023	0043	1		Clarification on Create PDR and Create FAR IEs in Sx Session Establishment Request	14.2.0
2017-12	CT#78	CP-173023	0047	1		Outer Header Creation	14.2.0
2017-12	CT#78	CP-173023	0048	1		Clarification on presence of Activate Predefined Rule Name	14.2.0
2017-12	CT#78	CP-173023	0056	-		Correction on Load Control Information IE Type value	14.2.0
2017-12	CT#78	CP-173023	0058	2		Provisioning of Subsequent Time Quota and Subsequent Volume Quota	14.2.0
2017-12	CT#78	CP-173027	0032			Quota Action to apply upon reaching quotas	15.0.0
2017-12	CT#78	CP-173036	0033	2		SGW/PGW selection for NR	15.0.0
2017-12	CT#78	CP-173034	0037	2		Update of the TS to prepare it for 5GC/N4	15.0.0
2017-12	CT#78	CP-173034	0038	1		Update introduction clause to 5GC	15.0.0
2017-12	CT#78	CP-173034	0039	2		Update on general procedures for N4	15.0.0
2017-12	CT#78	CP-173034	0040	1		Node related Messages supported on N4 interface	15.0.0
2017-12	CT#78	CP-173034	0041	1		User plane reporting	15.0.0
2017-12	CT#78	CP-173034	0049	2		Session establishment on N4	15.0.0
2017-12	CT#78	CP-173034	0050	2		Session Modification on N4	15.0.0
2017-12	CT#78	CP-173034	0051	1		Session deletion on N4	15.0.0
2017-12	CT#78	CP-173034	0052	2		Session Reporting on N4	15.0.0
2017-12	CT#78	CP-173034	0053	2		Load-overload control on N4	15.0.0
2017-12	CT#78	CP-173034	0054	2		QOS enhancements on N4 for 5G	15.0.0
2018-03	CT#79	CP-180018	0062	1		PDR with multiple SDFs	15.1.0
2018-03	CT#79	CP-180018	0064	1		Bidirectional SDF Filters	15.1.0
2018-03	CT#79	CP-180018	0066	-		Source and Destination Interface setting for Indirect Data Forwarding	15.1.0
2018-03	CT#79	CP-180018	0068	2		Correlating additional usage reports with the query URR request	15.1.0

2018-03	CT#79	CP-180019	0071	5		PDI optimisation	15.1.0
2018-03	CT#79	CP-180018	0078			Corrections to the Association Setup, Update and Release Procedures	15.1.0
2018-03	CT#79	CP-180018	0087	1		Error correction for Cause IE and Online-Charging Call Flow Alternative 2 example	15.1.0
2018-03	CT#79	CP-180019	0075	1		Missing Feature Description on Transport Level Marking	15.1.0
2018-03	CT#79	CP-180026	0055	6		Support of Ethernet frames on N4	15.1.0
2018-03	CT#79	CP-180026	0059	4		N4 alignment	15.1.0
2018-03	CT#79	CP-180026	0060	-		Reporting User Plane Inactivity on N4	15.1.0
2018-03	CT#79	CP-180026	0079	1		Adding QFIs to the Packet Detection Information	15.1.0
2018-03	CT#79	CP-180020	0069	1		Condition correction for SGW-U/PGW-U selection based on DCNR	15.1.0
2018-03	CT#79	CP-180020	0076	2		Selection of SGW-C/PGW-C for Dual Connectivity with NR	15.1.0
2018-06	CT#80	CP-181119	0093	2		Clarification of volume-based measurement report from UP to CP	15.2.0
2018-06	CT#80	CP-181119	0095	-		Usage reports queried by the CP function	15.2.0
2018-06	CT#80	CP-181119	0103	1		Linked URR	15.2.0
2018-06	CT#80	CP-181119	0106	1		Duplicating the user plane packets to multiple destinations	15.2.0
2018-06	CT#80	CP-181119	0108	2		The Source Interface in the User Plane IP Resource Information	15.2.0
2018-06	CT#80	CP-181125	0097	2		Quota Action Buffering	15.2.0
2018-06	CT#80	CP-181125	0100	1		Quota Action to apply upon reaching quotas	15.2.0
2018-06	CT#80	CP-181125	0104	1		The report and update of a URR	15.2.0
2018-06	CT#80	CP-181132	0089	1		User ID	15.2.0
2018-06	CT#80	CP-181132	0090	1		PDN Type of ethernet	15.2.0
2018-06	CT#80	CP-181132	0091	1		Update attributes in QER	15.2.0
2018-06	CT#80	CP-181132	0101	-		Ethernet traffic	15.2.0
2018-06	CT#80	CP-181132	0111	1		Resolve editor's notes	15.2.0
2018-06	CT#80	CP-181132	0112	1		PDR for Ethernet PDU session	15.2.0
2018-06	CT#80	CP-181132	0113	1		Reporting of UE MAC addresses to the SMF	15.2.0
2018-09	CT#81	CP-182079	0118	2		Essential correction on UE IP address	15.3.0
2018-09	CT#81	CP-182079	0120	1		Essential correction on Monitoring Time	15.3.0
2018-09	CT#81	CP-182079	0122	1		Essential clarification on the CHOOSE bit in F-TEID IE	15.3.0
2018-09	CT#81	CP-182079	0124	2		Essential correction on the Forward Policy	15.3.0
2018-09	CT#81	CP-182079	0128	2		Usage Report Trigger IMMEDIATE	15.3.0
2018-09	CT#81	CP-182079	0132	1		Essential clarification on the zero quota	15.3.0
2018-09	CT#81	CP-182079	0134	1		Essential clarification on the provision of several SDF filters in a PDI	15.3.0
2018-09	CT#81	CP-182079	0142	3		Event reporting	15.3.0
2018-09	CT#81	CP-182079	0154	2		Application detection report when the PFDs are removed	15.3.0
2018-09	CT#81	CP-182079	0158	1		Essential correction on reporting the usage	15.3.0
2018-09	CT#81	CP-182079	0160	1		Essential clarification on the provision of SDF filter	15.3.0
2018-09	CT#81	CP-182079	0162	2		Essential correction on the Dropped DL Traffic Threshold	15.3.0
2018-09	CT#81	CP-182068	0136	1		Add support for 5G Trace	15.3.0
2018-09	CT#81	CP-182084	0137	-		QFI in Downlink Data Report	15.3.0
2018-09	CT#81	CP-182084	0138	1		User ID extensions	15.3.0
2018-09	CT#81	CP-182084	0139	2		Framed Routing	15.3.0
2018-09	CT#81	CP-182084	0143	-		5GS restoration procedures	15.3.0
2018-09	CT#81	CP-182084	0144	1		Uplink Classifier and Branching Point functionalities	15.3.0
2018-09	CT#81	CP-182084	0145	1		Pause of charging.	15.3.0
2018-09	CT#81	CP-182084	0146	2		Data forwarding	15.3.0
2018-09	CT#81	CP-182084	0147	1		Sending of endmarker packets in 5GC	15.3.0
2018-09	CT#81	CP-182084	0148	1		Predefined Rules PCC/ADC Rules	15.3.0
2018-09	CT#81	CP-182084	0149	1		Downlink Data Notification Delay	15.3.0
2018-09	CT#81	CP-182084	0150	1		Clarification on Editor's notes and cleanup of the specification.	15.3.0
2018-09	CT#81	CP-182076	0152	3		Linked usage report	15.3.0
2018-12	CT#82	CP-183103	0166	1		Clarification on UL/DL MBR	15.4.0
2018-12	CT#82	CP-183103	0171	2		Forwarding End Marker	15.4.0
2018-12	CT#82	CP-183103	0173	1		Reapplying Thresholds	15.4.0
2018-12	CT#82	CP-183103	0175	1		Support of event based reporting for charging	15.4.0
2018-12	CT#82	CP-183103	0177	1		Usage Report Sequence Number Starting Value	15.4.0
2018-12	CT#82	CP-183103	0179	1		Transport Level Marking	15.4.0
2018-12	CT#82	CP-183103	0181	2		Correction on the support of PGW Pause of Charging	15.4.0
2018-12	CT#82	CP-183103	0183	1		Network Instance in relation to IP Address	15.4.0
2018-12	CT#82	CP-183103	0185	-		Time of First (Last) Packet	15.4.0
2018-12	CT#82	CP-183103	0187	1		Outer Header Removal for IPv4v6 GTP-U tunnel	15.4.0
2018-12	CT#82	CP-183103	0203	1		Essential correction on the start point of time based measurement	15.4.0
2018-12	CT#82	CP-183103	0205	2		FAR for HTTP Redirection	15.4.0
2018-12	CT#82	CP-183092	0163	1		Cleanup and Alignment	15.4.0
2018-12	CT#82	CP-183092	0169	6		VLAN Tag support in outer header creation	15.4.0
2018-12	CT#82	CP-183092	0191	1		The VIDs handling in N4 aligned with 23.501	15.4.0
2018-12	CT#82	CP-183092	0193	-		QFI Correction	15.4.0
2018-12	CT#82	CP-183092	0194	1		Clarification to ARP / IPv6 ND Proxying	15.4.0
2018-12	CT#82	CP-183092	0195	6		Adding Averaging Window parameter on N4	15.4.0
2018-12	CT#82	CP-183092	0196	4		Adding 5G Session-AMBR	15.4.0
2018-12	CT#82	CP-183092	0197	1		Paging Policy Differentiation in 5GC	15.4.0

2018-12	CT#82	CP-183092	0198	3		Clarification on forwarding user plane data via a shared Sx-u tunnel	15.4.0
2018-12	CT#82	CP-183092	0199	1		5G UPF Introduction	15.4.0
2018-12	CT#82	CP-183092	0206	2		PFD Procedure	15.4.0
2018-12	CT#82	CP-183092	0209	1		Traffic steering control with AF provided N6 traffic routing information	15.4.0
2018-12	CT#82	CP-183092	0210	2		Data forwarding between 5GS and EPS	15.4.0
2018-12	CT#82	CP-183099	0188	-		Corrections for wrong references	15.4.0
2018-12	CT#82	CP-183099	0200	2		Interpretation of predefined Rules	15.4.0
2019-03	CT#83	CP-190040	0215	1		Clarifications to CP/UP function, Node, PFCP entity and PFCP Association concepts	15.5.0
2019-03	CT#83	CP-190032	0211	1		(Un)solicited Application Reporting	15.5.0
2019-03	CT#83	CP-190032	0212	2		Policy and Charging Control	15.5.0
2019-03	CT#83	CP-190032	0213	1		Legal Interception support for 5GC SMF/UPF	15.5.0
2019-03	CT#83	CP-190032	0216	1		PFD Contents and Management	15.5.0
2019-03	CT#83	CP-190032	222	1		Clarification on ARP Proxy	15.5.0
2019-03	CT#83	CP-190032	0230	1		Inactivity timer for Always-on PDU session	15.5.0
2019-03	CT#83	CP-190032	0231	1		SMF Derivation of DSCP on N4	15.5.0
2019-03	CT#83	CP-190039	0217	2		Clarification on the use of Graceful Release Period	15.5.0
2019-03	CT#83	CP-190039	0219	2		PFCP Association Release Procedure	15.5.0
2019-03	CT#83	CP-190039	0221	3		URR triggered packets dropping or redirection	15.5.0
2019-03	CT#83	CP-190039	0232	1		IE Name Corrections	15.5.0
2019-06	CT#84	CP-191021	0248	1		Correct the length of redirection server address	15.6.0
2019-06	CT#84	CP-191021	0257	-		Correct the length of Multiplier	15.6.0
2019-06	CT#84	CP-191024	0235	1		Release of F-TEID by the UP Function upon removal of PDR	15.6.0
2019-06	CT#84	CP-191024	0242	1		Essential correction on report of user plane path failure	15.6.0
2019-06	CT#84	CP-191024	0244	2		Parameters for Performance Measurement	15.6.0
2019-06	CT#84	CP-191024	0243	3		Accurate Interface Type for Supporting Performance Measurement	15.6.0
2019-06	CT#84	CP-191024	0245	3		Update the redirection server address to support dual stack UE	15.6.0
2019-06	CT#84	CP-191024	0262	1		Framed-Route and Framed-IPv6-Route in a PDR	15.6.0
2019-06	CT#84	CP-191024	0258	1		Corrections to the Recovery Time Stamp	15.6.0
2019-06	CT#84	CP-191024	0251	1		Matching a PFD	15.6.0
2019-06	CT#84	CP-191058	0233	-		Correction to Framed Routing	15.6.0
2019-06	CT#84	CP-191058	0260	-		Reverting N4 requirements for Lawful Interception support in 5GC	15.6.0
2019-06	CT#84	CP-191047	0240	1		Enhancement to the PFCP Association Release Procedure	16.0.0
2019-06	CT#84	CP-191047	0241	2		Deferred PDR Activation and Deactivation	16.0.0
2019-06	CT#84	CP-191047	0263	1		Activation and Deactivation of Pre-defined PDRs	16.0.0
2019-06	CT#84	CP-191050	0247	1		User Plane Forwarding with Control Plane ClO/T 5GS Optimisation	16.0.0
2019-06	CT#84	CP-191051	0237	1		Support for ATSSS	16.0.0
2019-06	CT#84	CP-191051	0236	1		Update on the Packet Forwarding Model	16.0.0
2019-06	CT#84	CP-191051	0238	2		Multi-Access Action Rule	16.0.0
2019-06	CT#84	CP-191054	0259	1		UE IP addresses/prefixes allocation by UPF	16.0.0
2019-06	CT#84	CP-191054	0252	3		Update the PFCP association setup to support UE IP address Allocation by AAA/DHCP	16.0.0
2019-06	CT#84	CP-191055	0261	1		PFCP sessions successively controlled by different SMFs of a same SMF set	16.0.0
2019-06	CT#84	CP-191056	0253	2		Update description of 5G UPF with redundant transmission	16.0.0
2019-09	CT#85	CP-192129	0293	1		Editorial and style corrections	16.1.0
2019-09	CT#85	CP-192129	0267	-		Application report when the PFDs are removed or modified	16.1.0
2019-09	CT#85	CP-192129	0273	1		Measurement Before QoS Enforcement Clarification	16.1.0
2019-09	CT#85	CP-192129	0274	1		Number of packets	16.1.0
2019-09	CT#85	CP-192129	0278	1		F-TEID in a PDR	16.1.0
2019-09	CT#85	CP-192129	0282	-		Clarification to C-Tag and S-Tag encoding	16.1.0
2019-09	CT#85	CP-192129	0285	1		PFCP messages bundling	16.1.0
2019-09	CT#85	CP-192096	0280	-		Essential Correction on Heartbeat procedure	16.1.0
2019-09	CT#85	CP-192133	0271	1		Support 5G VN Group Communication – unicast traffic	16.1.0
2019-09	CT#85	CP-192133	0272	1		Support 5G VN Group Communication – broadcast traffic	16.1.0
2019-09	CT#85	CP-192133	0283	1		3GPP Interface Type values	16.1.0
2019-09	CT#85	CP-192194	0270	3		PFCP sessions controlled by different SMFs in a set	16.1.0
2019-09	CT#85	CP-192194	0294	-		Support of SMF set and association establishment between SMF and UPF initiated by the UPF.	16.1.0
2019-09	CT#85	CP-192193	0265	3		Enhancing UE IP address Pool Identity IE type	16.1.0
2019-09	CT#85	CP-192193	0266	2		PFCP usage over N16a for the support of traffic offload by UPF controlled by I-SMF	16.1.0
2019-09	CT#85	CP-192126	0281	1		Protocol support for Ethernet PDN in EPS	16.1.0
2019-09	CT#85	CP-192187	0287	2		Supporting redundant transmission at transport layer Negotiation	16.1.0
2019-09	CT#85	CP-192187	0269	3		Validity time in Create URR IE	16.1.0
2019-12	CT#86	CP-193023	0398	1		Correct Terminology of Sx Session to PFCP Session	16.2.0
2019-12	CT#86	CP-193041	0318	3		Correction to number of fixed octets in table 8.1.2	16.2.0
2019-12	CT#86	CP-193045	0277	3		Controlling of number of reports	16.2.0
2019-12	CT#86	CP-193045	0295	1		Clarification to Create PDR/FAR/URR/QR/BAR/MAR IEs in a modification message	16.2.0
2019-12	CT#86	CP-193045	0302	1		PFCP Association Setup Request with same Node ID	16.2.0
2019-12	CT#86	CP-193045	0315	2		Null Usage Report	16.2.0

2019-12	CT#86	CP-193045	0317	3	Clarifications to Vendor-specific IE handling	16.2.0
2019-12	CT#86	CP-193045	0329	2	Reestablishment of PFCP sessions after a UP function restart	16.2.0
2019-12	CT#86	CP-193045	0335	1	Cause No established PFCP Association	16.2.0
2019-12	CT#86	CP-193045	0340	1	User Plane Path Recovery Report	16.2.0
2019-12	CT#86	CP-193045	0341	1	UE IP address allocation	16.2.0
2019-12	CT#86	CP-193045	0342	4	Additional PFCP Session Report Request	16.2.0
2019-12	CT#86	CP-193045	0349	1	Reporting PDR ID in a Usage Report	16.2.0
2019-12	CT#86	CP-193046	0310	2	Support of IPTV service	16.2.0
2019-12	CT#86	CP-193046	0327	1	IPv6 address allocation and IPv6 prefix delegation for RG connecting to 5GC	16.2.0
2019-12	CT#86	CP-193049	0288	7	Small Data Rate Control Parameters	16.2.0
2019-12	CT#86	CP-193050	0309	2	5GS Bridge information reporting for Time Sensitive Communication	16.2.0
2019-12	CT#86	CP-193050	0314	1	Network Instance representing the 5G VN group	16.2.0
2019-12	CT#86	CP-193050	0316	1	Transfer of TSN bridge port management information	16.2.0
2019-12	CT#86	CP-193050	0347	2	Reporting the clock drift between TSN and 5GS times	16.2.0
2019-12	CT#86	CP-193051	0298	1	General description of ATSSS and Multi-Access Rule	16.2.0
2019-12	CT#86	CP-193051	0300	4	Handling of GBR traffic of a MA PDU session	16.2.0
2019-12	CT#86	CP-193051	0322	2	Session Reporting Rule	16.2.0
2019-12	CT#86	CP-193051	0301	1	Access type of a MA PDU session becoming (un)available	16.2.0
2019-12	CT#86	CP-193051	0304	4	ATSSS Functionality Required and ATSSS Control Parameters Returned	16.2.0
2019-12	CT#86	CP-193051	0325	3	Clarifications to ATSSS feature	16.2.0
2019-12	CT#86	CP-193056	0297	1	UL FAR in UL CL or BP towards Local PSA	16.2.0
2019-12	CT#86	CP-193056	0306	2	Clarification on N4 Rules Exchanged via N16a Interface	16.2.0
2019-12	CT#86	CP-193056	0330	1	UE IP Address Pool ID in PFCP Association Procedure	16.2.0
2019-12	CT#86	CP-193056	0331	1	UE IP address Pool Identity	16.2.0
2019-12	CT#86	CP-193057	0296	2	PFCP sessions successively controlled by different SMFs of an SMF set	16.2.0
2019-12	CT#86	CP-193060	0312	4	Function description for URLLC	16.2.0
2019-12	CT#86	CP-193060	0326	1	GTP-U Path QoS Monitoring	16.2.0
2019-12	CT#86	CP-193060	0346	2	Per QoS Flow per UE QoS Monitoring	16.2.0
2020-03	CT#87e	CP-200035	0350	2	IETF reference update for IPv6 multicast	16.3.0
2020-03	CT#87e	CP-200033	0352	1	Support of MT-EDT	16.3.0
2020-03	CT#87e	CP-200033	0385	2	MO Exception Data Indication	16.3.0
2020-03	CT#87e	CP-200033	0386	2	Packet Rate Status Reporting and Control	16.3.0
2020-03	CT#87e	CP-200016	0354	1	Provision alternative SMF IP addresses of PFCP entities pertaining to the same SMF	16.3.0
2020-03	CT#87e	CP-200017	0355	1	Transferring N4 messages over N16a	16.3.0
2020-03	CT#87e	CP-200017	0388	-	Clarification to N4 information	16.3.0
2020-03	CT#87e	CP-200038	0357	4	Removing a URR	16.3.0
2020-03	CT#87e	CP-200038	0358	2	UPF ID	16.3.0
2020-03	CT#87e	CP-200038	0359	1	3GPP Interface Type	16.3.0
2020-03	CT#87e	CP-200038	0360	2	Miscellaneous small corrections	16.3.0
2020-03	CT#87e	CP-200038	0361	1	The Source IP Address in Heartbeat Request message	16.3.0
2020-03	CT#87e	CP-200038	0362	2	UP function Initiated PFCP Association Release at timeout	16.3.0
2020-03	CT#87e	CP-200038	0363	1	UP function initiated PFCP session release	16.3.0
2020-03	CT#87e	CP-200038	0366	1	The Recovery Time Stamp in PFCP Session Establishment Request message	16.3.0
2020-03	CT#87e	CP-200038	0374	2	F-TEID allocation	16.3.0
2020-03	CT#87e	CP-200038	0376	2	Reflective QoS	16.3.0
2020-03	CT#87e	CP-200038	0384	1	SDF Handling when waiting for credit	16.3.0
2020-03	CT#87e	CP-200023	0364	-	Ethernet PDU Session Anchor Relocation	16.3.0
2020-03	CT#87e	CP-200023	0375	2	Support of Redundant Transmission	16.3.0
2020-03	CT#87e	CP-200031	0367	2	Steering Mode Value	16.3.0
2020-03	CT#87e	CP-200031	0368	-	Port Type of MPTCP Proxy and PMF	16.3.0
2020-03	CT#87e	CP-200031	0369	1	Apply ATSSS-LL together with MPTCP	16.3.0
2020-03	CT#87e	CP-200031	0370	2	More Description for MPTCP Functionality	16.3.0
2020-03	CT#87e	CP-200031	0381	1	Signalling to the UPF that an access of a MA PDU session is unavailable	16.3.0
2020-03	CT#87e	CP-200032	0379	1	Update of 5G VN Group Communication	16.3.0
2020-03	CT#87e	CP-200032	0380	1	TSN Domain and Time Domain	16.3.0
2020-03	CT#87e	CP-200032	0382	1	5GS Bridge information reporting cleanup for Time Sensitive Communication	16.3.0
2020-04	CT#87e				Clause 5.24.3 was deleted by mistake during implementation after CT#87e	16.3.1
2020-06	CT#88e	CP-201029	0415	1	Restoring deleted statement	16.4.0
2020-06	CT#88e	CP-201029	0441	1	DL Data Notification for the subsequent DL data pertaining to a different QoS flow	16.4.0
2020-06	CT#88e	CP-201051	0356	1	Activating a predefined FAR/URR/QER	16.4.0
2020-06	CT#88e	CP-201051	0390	-	Miscellaneous small correction on Figures	16.4.0
2020-06	CT#88e	CP-201051	0395	1	New S-NSSAI IE	16.4.0
2020-06	CT#88e	CP-201051	0396	-	Inconsistent description for the use of Activation/Deactivation time	16.4.0

2020-06	CT#88e	CP-201051	0397	-	F-TEID allocation cleanup	16.4.0
2020-06	CT#88e	CP-201051	0398	-	Encoding of the Remote GTP-U Peer IE	16.4.0
2020-06	CT#88e	CP-201051	0403	-	UE IP address allocation	16.4.0
2020-06	CT#88e	CP-201051	0404	1	UE IP address pool based on S-NSSAI	16.4.0
2020-06	CT#88e	CP-201051	0406	1	Report Trigger for Quota Validity Time Expiry	16.4.0
2020-06	CT#88e	CP-201051	0411	1	Clarification on Partial Failure of UP Function	16.4.0
2020-06	CT#88e	CP-201051	0413	2	Node level vs PFCP entity level procedures	16.4.0
2020-06	CT#88e	CP-201051	0417	2	Heartbeat procedure clarification	16.4.0
2020-06	CT#88e	CP-201051	0418	2	Alternative IP Address in SSET	16.4.0
2020-06	CT#88e	CP-201051	0419	2	Clarification when Node ID is set to an IP address	16.4.0
2020-06	CT#88e	CP-201051	0420	2	Association Update Response for EPFAR	16.4.0
2020-06	CT#88e	CP-201051	0422	1	UP function features description update	16.4.0
2020-06	CT#88e	CP-201051	0427	3	Downlink data reordering - new feature definition	16.4.0
2020-06	CT#88e	CP-201051	0438	2	UE IP address pool based on IP version	16.4.0
2020-06	CT#88e	CP-201051	0444	1	Remaining Quota in the UP function	16.4.0
2020-06	CT#88e	CP-201051	0445	1	Adjust Threshold/Quota after a usage report in the UP function	16.4.0
2020-06	CT#88e	CP-201051	0446	2	Quota Reporting Trigger Clarification	16.4.0
2020-06	CT#88e	CP-201051	0449	1	Editorial corrections	16.4.0
2020-06	CT#88e	CP-201050	0389	1	Support of IPUPS Functionality	16.4.0
2020-06	CT#88e	CP-201046	0391	3	First discarded downlink packet notification	16.4.0
2020-06	CT#88e	CP-201046	0392	2	Add RDS configuration information	16.4.0
2020-06	CT#88e	CP-201046	0394	2	Data rate control during mobility between 5GS and EPS	16.4.0
2020-06	CT#88e	CP-201046	0414	1	Aligning "MO Exception data" handling with stage 2 - UPF	16.4.0
2020-06	CT#88e	CP-201044	0393	1	MPTCP Indication for a Uplink PDR for traffic applicable for MPTCP	16.4.0
2020-06	CT#88e	CP-201044	0408	1	Packet Forwarding Model for MPTCP	16.4.0
2020-06	CT#88e	CP-201044	0423	1	Update IETF References for MPTCP	16.4.0
2020-06	CT#88e	CP-201044	0425	1	PMFP Message Handling	16.4.0
2020-06	CT#88e	CP-201044	0426	1	N6 Routable IP address	16.4.0
2020-06	CT#88e	CP-201044	0434	1	DL PDRs of a MA PDU session	16.4.0
2020-06	CT#88e	CP-201044	0435	1	PMF control information to enable/disable PMF RTT measurements	16.4.0
2020-06	CT#88e	CP-201037	0400	1	Redundant Transmission on transport layer	16.4.0
2020-06	CT#88e	CP-201045	0401	1	Clarification for TSN NW-TT port number	16.4.0
2020-06	CT#88e	CP-201045	0402	2	Support of QoS differentiation for NPN	16.4.0
2020-06	CT#88e	CP-201045	0436	1	5GS Bridge ID clarification	16.4.0
2020-06	CT#88e	CP-201045	0437	1	5GS Bridge and port information separation for Time Sensitive Communication	16.4.0
2020-06	CT#88e	CP-201031	0433	1	N4 information exchanged over N16a during PDU session release	16.4.0
2020-06	CT#88e	CP-201068	0412	1	Inter-system handover with direct data forwarding	16.4.0
2020-06	CT#88e	CP-201070	0447	1	Data Forwarding Info	16.4.0
2020-09	CT#89e	CP-202114	0466	2	Interworking between ETSUN and URLLC/TSC	16.5.0
2020-09	CT#89e	CP-202114	0475	1	End marker handling in service request procedure	16.5.0
2020-09	CT#89e	CP-202114	0482	-	Correcting the example of addition of PSA2 and UL CL controlled by I-SMF	16.5.0
2020-09	CT#89e	CP-202102	0471	3	Reporting UE IP Address Usage	16.5.0
2020-09	CT#89e	CP-202102	0479	-	Interface Type of Traffic Endpoint	16.5.0
2020-09	CT#89e	CP-202102	0484	2	SMF-Set ID in PFCP Association Messages	16.5.0
2020-09	CT#89e	CP-202107	0472	2	Correct IE Type of Redundant Transmission Parameters	16.5.0
2020-09	CT#89e	CP-202107	0473	1	Time Stamp in QoS Monitoring Report IE	16.5.0
2020-09	CT#89e	CP-202105	0474	1	Small data rate control and Serving PLMN rate control	16.5.0
2020-09	CT#89e	CP-202106	0477	1	Editor's Note on TSN Bridge Name	16.5.0
2020-09	CT#89e	CP-202106	0478	1	Editor's Note on TSN NW-TT Port relation to PDU session	16.5.0
2020-09	CT#89e	CP-202103	0480	1	IPv6 Prefix Delegation via DHCPv6	16.5.0
2020-12	CT#90e	CP-203038	0492	-	Message Priority encoding	16.6.0
2020-12	CT#90e	CP-203038	0494	1	Essential clarification on the Additional Usage Reports	16.6.0
2020-12	CT#90e	CP-203038	0496	2	Essential clarification on the Framed-Route	16.6.0
2020-12	CT#90e	CP-203038	0497	1	IPv6 Prefix delegation when the UP function allocating UE IP Address	16.6.0
2020-12	CT#90e	CP-203038	0499	1	Implicitly allowing packets be forwarded via provisioning a non-zero quota	16.6.0
2020-12	CT#90e	CP-203038	0500	1	Miscellaneous corrections	16.6.0
2020-12	CT#90e	CP-203041	0501	2	Notify the discarded downlink packet	16.6.0
2020-12	CT#90e	CP-203042	0490	-	PFCP session used to send PMIC and BMIC	16.6.0
2020-12	CT#90e	CP-203042	0491	-	Removing NW-TT Port Number from Created Bridge Info for TSC IE	16.6.0
2020-12	CT#90e	CP-203043	0485	1	Replace reference draft-ietf-tcpm-converters-19 by reference to RFC 8803	16.6.0
2020-12	CT#90e	CP-203043	0489	1	Incorrect IE type values	16.6.0
2020-12	CT#90e	CP-203043	0498	1	Procedures Related to MPTCP Functionality	16.6.0
2020-12	CT#90e	CP-203046	0487	-	GTP-U path interface type IE in GTP-U Path QoS Report	16.6.0
2020-12	CT#90e	CP-203046	0488	3	QoS monitoring of a PDU session based on GTP-U path monitoring	16.6.0
2020-12	CT#90e	CP-203051	0495	1	End Marker Reception Reporting Corrections	16.6.0
2021-03	CT#91e	CP-210045	0504	3	Stop of QoS Monitoring	16.7.0
2021-03	CT#91e	CP-210045	0508	2	Usage Reporting when using Redundant Transmission on N3/N9 interfaces	16.7.0

2021-03	CT#91e	CP-210051	0509	1		Distinguishing FQ-CSIDs in PFCP messages	16.7.0
2021-03	CT#91e	CP-210051	0511	2		Essential correction on the use of the Updated PDR	16.7.0
2021-03	CT#91e	CP-210051	0512	1		Clarification on the deletion of several IEs with the same IE Type	16.7.0
2021-03	CT#91e	CP-210051	0514	1		Clarification on the FAR ID for Quota Action	16.7.0
2021-03	CT#91e	CP-210051	0515	1		Adding MAR and SRR in Failed Rule ID	16.7.0
2021-03	CT#91e	CP-210051	0518	2		Clarification on the update for a bitmap style IE	16.7.0
2021-03	CT#91e	CP-210051	0525	1		N9 forwarding tunnel removal	16.7.0
2021-03	CT#91e	CP-210051	0526	1		UE IP address / prefix Allocation	16.7.0
2021-03	CT#91e	CP-210051	0527	2		Interface Type	16.7.0
2021-03	CT#91e	CP-210037	0517	1		Essential correction on the use of null SEID	16.7.0
2021-03	CT#91e	CP-210049	0520	1		SNSSAI Update in PFCP Session Modification	16.7.0
2021-03	CT#91e	CP-210022	0506	1		Implementation of conclusions agreed for KI#3 of TR 29.820	17.0.0
2021-03	CT#91e	CP-210032	0507	-		Rule activation failure	17.0.0
2021-03	CT#91e	CP-210032	0513	1		Editorial Correction	17.0.0
2021-03	CT#91e	CP-210032	0516	1		Filter ID	17.0.0
2021-03	CT#91e	CP-210032	0519	2		Addition of RAT Type IE on PFCP Interface	17.0.0
2021-03	CT#91e	CP-210032	0528	1		Support of Radius, Diameter or DHCP communication via UPF	17.0.0
2021-03	CT#91e	CP-210033	0510	2		Enhancement on the support of Pause of Charging	17.0.0
2021-03	CT#91e	CP-210030	0521	1		Partial failure handling support over N4	17.0.0
2021-06	CT#92e	CP-211070	0543	1		Essential Clarification on PDR Provisioning and 2-Steps Packet Matching	17.1.0
2021-06	CT#92e	CP-211025	0545	3		Control of Start and Stop Usage Measurement for a PFCP session	17.1.0
2021-06	CT#92e	CP-211029	0554	2		Support of L2TP	17.1.0
2021-06	CT#92e	CP-211031	0535	2		UL packet buffering during EAS relocation	17.1.0
2021-06	CT#92e	CP-211033	0536	4		Support of thresholds in ATSSS	17.1.0
2021-06	CT#92e	CP-211033	0537	4		Steering Mode Indicator	17.1.0
2021-06	CT#92e	CP-211033	0540	1		Support of MA PDU with 3GPP access connected to EPC and Non-3GPP access connected to 5GC	17.1.0
2021-06	CT#92e	CP-211033	0551	1		Per QoS Flow Performance Measurement	17.1.0
2021-06	CT#92e	CP-211035	0529	-		Generalization Time Sensitive Communication to other than IEEE TSN	17.1.0
2021-06	CT#92e	CP-211035	0530	-		External time and Time domain terms	17.1.0
2021-06	CT#92e	CP-211035	0548	1		Terminology of the Time Sensitive Communication MIC and Bridge ID	17.1.0
2021-06	CT#92e	CP-211035	0549	1		UE-UE communication for TSC	17.1.0
2021-06	CT#92e	CP-211042	0546	-		Editorial Corrections	17.1.0
2021-06	CT#92e	CP-211042	0547	-		Correction to interface type value	17.1.0
2021-06	CT#92e	CP-211043	0544	2		PFCP Session Set Modification to restore PFCP Sessions	17.1.0
2021-06	CT#92e	CP-211046	0539	1		Simultaneous change of Branching Point or UL CL and additional PSA	17.1.0
2021-06	CT#92e	CP-211059	0532	1		SMF and UPF behaviour in SSET / MAPS cases	17.1.0
2021-09	CT#93e	CP-212068	0575	1	A	IEEE 802.1AS-2020 reference update	17.2.0
2021-09	CT#93e	CP-212027	0556	1	F	Correction on references	17.2.0
2021-09	CT#93e	CP-212027	0561	1	B	L2TP Corrections	17.2.0
2021-09	CT#93e	CP-212027	0562	1	B	LNS Address	17.2.0
2021-09	CT#93e	CP-212038	0557	1	B	PMF address information per QoS flow	17.2.0
2021-09	CT#93e	CP-212038	0563	2	B	Handling of PMF Message with UE Assistance Data	17.2.0
2021-09	CT#93e	CP-212031	0564	-	B	Edge Relocation using EAS IP address Replacement	17.2.0
2021-09	CT#93e	CP-212031	0565	1	B	EAS Discovery procedure with Local DNS Server/Resolver	17.2.0
2021-09	CT#93e	CP-212031	0566	-	B	Direct Reporting of QoS monitoring events to Local NEF or AF	17.2.0
2021-09	CT#93e	CP-212044	0558	-	F	5GS User Plane Node	17.2.0
2021-09	CT#93e	CP-212044	0569	1	B	SNSSAI Update after EPS to 5GS Handover	17.2.0
2021-09	CT#93e	CP-212044	0570	1	F	Partial Failure Information	17.2.0
2021-09	CT#93e	CP-212044	0571	1	B	Add SUPI, GPSI, and PEI to User ID	17.2.0
2021-09	CT#93e	CP-212044	0572	1	F	Predefined Rule Name	17.2.0
2021-09	CT#93e	CP-212035	0559	1	B	Protocol impact on N4mb for 5G MBS	17.2.0
2021-09	CT#93e	CP-212040	0573	1	B	Introduction of TSCTSF and other stage2 and 3 alignments	17.2.0
2021-09	CT#93e					Editorial corrections	17.2.1
2021-12	CT#94e	CP-213097	0560	2	B	Protocol impact on N4 for 5G MBS	17.3.0
2021-12	CT#94e	CP-213097	0587	1	F	5MBS corrections	17.3.0
2021-12	CT#94e	CP-213093	0578	1	F	Reference to UPF service specification	17.3.0
2021-12	CT#94e	CP-213099	0579	2	B	Enabling and disabling the adjustment of DL traffic steering rules	17.3.0
2021-12	CT#94e	CP-213099	0580	1	B	UPF behaviour of setting source and destination addresses of PMF message	17.3.0
2021-12	CT#94e	CP-213099	0581	1	B	Condition of Inclusion of Threshold Values IE and Steering Mode Indicator IE	17.3.0
2021-12	CT#94e	CP-213090	0582	2	B	Per Slice UP Resource Allocation and Usage Report	17.3.0
2021-12	CT#94e	CP-213090	0583	2	B	Per Slice UE IP Address Usage Report	17.3.0
2021-12	CT#94e	CP-213090	0584	2	B	Adding S-NSSAI as a factor in managing UPF resources	17.3.0
2021-12	CT#94e	CP-213101	0585	-	F	Updates for Bridge/User plane Node ID configuration	17.3.0
2021-12	CT#94e	CP-213089	0589	1	F	Outer Header Removal	17.3.0
2021-12	CT#94e	CP-213129	0590	1	F	Usage Reporting for Monitoring Time	17.3.0
2021-12	CT#94e	CP-213125	0591	-	F	Traffic usage reporting on Redundant Transmission at transport layer	17.3.0
2022-03	CT#95e	CP-220027	0599	1	B	UE IP allocation in CP function with SSET and MPAS	17.4.0
2022-03	CT#95e	CP-220027	0602	2	F	Missing Definition for Tunnel Password IE	17.4.0

2022-03	CT#95e	CP-220031	0610	-	B	IP Address and Port number Replacement IE in EAS Discovery procedure with Local DNS Server/Resolver	17.4.0
2022-03	CT#95e	CP-220035	0592	1	F	Clarification to the MBS Session N4 Information	17.4.0
2022-03	CT#95e	CP-220035	0595	1	F	Associated QoS Flow	17.4.0
2022-03	CT#95e	CP-220035	0597	-	B	Location dependent MBS service	17.4.0
2022-03	CT#95e	CP-220035	0603	-	F	Incorrect IE Type Value - MBS Session N4 Information IE	17.4.0
2022-03	CT#95e	CP-220035	0606	-	B	PCF Node related messages supported over N4mb	17.4.0
2022-03	CT#95e	CP-220035	0607	1	B	Mapping MBS QoS Flows to Associated QoS Flows	17.4.0
2022-03	CT#95e	CP-220035	0608	1	B	User Plane (In)Activity Detection and Reporting over N4mb	17.4.0
2022-03	CT#95e	CP-220037	0600	1	B	Reporting of the restart of a GTP-U entity	17.4.0
2022-03	CT#95e	CP-220046	0600	1	B	Clarification on Allocation of Access Specific UDP Ports or MAC Addresses	17.4.0
2022-03	CT#95e	CP-220086	0593	-	D	Editorial corrections	17.4.0
2022-03	CT#95e	CP-220086	0596	1	F	Correcting PCF Associations setup description	17.4.0
2022-03	CT#95e	CP-220086	0598	-	F	CVLAN tag removal from DL traffic received on N6	17.4.0
2022-03	CT#95e	CP-220086	0604	-	F	Corrections to IE Definitions	17.4.0
2022-03	CT#95e	CP-220086	0605	1	F	Return Node ID in PCF Session Report Response	17.4.0
2022-03	CT#95e	CP-220086	0609	1	F	PCF session related procedures apply to 5GC	17.4.0
2022-03	CT#95e	CP-220086	0611	2	B	Paging Policy Differentiation	17.4.0
2022-03	CT#95e	CP-220086	0612	1	F	Additional Usage Reports Information	17.4.0
2022-03	CT#95e	CP-220086	0613	1	B	Redirect Port Information	17.4.0
2022-06	CT#96	CP-221023	0622	1	B	Transport Level Marking information for PCF sessions over N4mb	17.5.0
2022-06	CT#96	CP-221023	0621	1	B	MBS Session Identifier	17.5.0
2022-06	CT#96	CP-221023	0617	1	B	Restoration procedure for MB-UPF restart	17.5.0
2022-06	CT#96	CP-221023	0616	-	F	Incorrect references to N19mb and Nmb9 reference points	17.5.0
2022-06	CT#96	CP-221023	0615	-	B	DL MBS QFI Sequence Number in PDU Session Container	17.5.0
2022-06	CT#96	CP-221024	0644	1	B	Outer Header Removal for PSA UPF	17.5.0
2022-06	CT#96	CP-221024	0637	-	F	MB-UPF failure without restart	17.5.0
2022-06	CT#96	CP-221024	0636	-	F	3GPP Interface Type extensions for MBS	17.5.0
2022-06	CT#96	CP-221024	0635	-	F	CP and UP function features supported over N4mb	17.5.0
2022-06	CT#96	CP-221024	0634	-	F	N4mb requirements for PCF Node Related messages	17.5.0
2022-06	CT#96	CP-221024	0633	-	F	N4mb requirements for PCF Session Related messages	17.5.0
2022-06	CT#96	CP-221034	0642	1	B	DNS Query Filter Encoding	17.5.0
2022-06	CT#96	CP-221035	0630	1	F	Two N3 UL CN tunnels information	17.5.0
2022-06	CT#96	CP-221045	0619	1	F	PCF Node ID	17.5.0
2022-06	CT#96	CP-221045	0618	1	F	Failure to restore a PCF session at UPF restart	17.5.0
2022-06	CT#96	CP-221045	0614	3	F	Node Report Type value for PCF node reports not defined by 3GPP	17.5.0
2022-06	CT#96	CP-221046	0646	-	F	UE IP address	17.5.0
2022-06	CT#96	CP-221046	0645	1	F	Corrections on QoS Monitoring per QoS flow	17.5.0
2022-06	CT#96	CP-221046	0643	-	F	Corrections on PCF Session Deletion Response with Additional Usage Report Info	17.5.0
2022-06	CT#96	CP-221046	0641	-	F	Incomplete CR implementation on Partial failure handling support over N4	17.5.0
2022-06	CT#96	CP-221046	0632	1	F	Format of Tunnel Password	17.5.0
2022-06	CT#96	CP-221046	0629	1	F	Clarification on the Threshold and Quota	17.5.0
2022-06	CT#96	CP-221046	0628	1	F	Number of Reports and Monitoring Time/Masurement Before QoS Enforcement	17.5.0
2022-06	CT#96	CP-221046	0627	-	F	Resolving editor's note for IPUPS	17.5.0
2022-06	CT#96	CP-221046	0626	1	F	Clarification on reactivation of an inactive URR	17.5.0
2022-06	CT#96	CP-221046	0625	-	F	Usage Report at expiry of the Quota Validity Timer	17.5.0
2022-06	CT#96	CP-221046	0624	-	F	Packet Rate for N4	17.5.0
2022-06	CT#96	CP-221046	0623	1	F	Essential Correction on the support of the SMF Set	17.5.0
2022-06	CT#96	CP-221050	0631	1	F	N9 forwarding tunnel between ULCLs controlled by I-SMF	17.5.0
2022-06	CT#96	CP-221065	0620	2	A	Time domain identification in the clock drift reporting	17.5.0
2022-06	CT#96	CP-221067	0640	-	A	PDRs and Traffic Endpoints in PCF Session Modification Request and Response	17.5.0
2022-09	CT#97e	CP-222031	0649	2	F	Outer header creation	17.6.0
2022-09	CT#97e	CP-222031	0650	2	F	Clarifications to Add MBS Unicast Parameters	17.6.0
2022-09	CT#97e	CP-222031	0651	4	F	PLLSSM and FSSM flags	17.6.0
2022-09	CT#97e	CP-222031	0653	-	F	Ingress address over N6mb or Nmb9	17.6.0
2022-09	CT#97e	CP-222031	0655	1	F	No URR support over N4mb	17.6.0
2022-09	CT#97e	CP-222031	0656	-	F	FSSM Flag	17.6.0
2022-09	CT#97e	CP-222031	0658	-	F	Unicast transport is used over Nmb9	17.6.0
2022-09	CT#97e	CP-222041	0652	1	F	Corrections on applicability of Flags	17.6.0
2022-09	CT#97e	CP-222041	0654	1	F	Corrections to FQ-CSID node types	17.6.0
2022-09	CT#97e	CP-222041	0660	-	D	Remove duplicate tables	17.6.0
2022-09	CT#97e	CP-222042	0647	1	F	Uplink packets buffering during EAS relocation	17.6.0
2022-12	CT#98e	CP-223036	0665	1	F	MBS Session Deactivation and (Re)activation	17.7.0
2022-12	CT#98e	CP-223036	0667	-	F	Incorrect implementation of CR 29.244 #0650	17.7.0
2022-12	CT#98e	CP-223036	0668	-	F	Incomplete implementation of CR 29.244 #0658	17.7.0
2022-12	CT#98e	CP-223036	0669	-	F	N4 requirements for MBS session deactivation and reactivation	17.7.0

2022-12	CT#98e	CP-223059	0663	3	F	Clarifications and corrections on Time Sensitive Communication	17.7.0
2022-12	CT#98e	CP-223059	0666	1	F	Essential clarification on Gate Status	17.7.0
2022-12	CT#98e	CP-223043	0670	2	F	L2TP tunnel failure cause	18.0.0
2022-12	CT#98e					Astyle of header 7.5.4.10 corrected to H4.	18.0.1
2023-03	CT#99	CP-230092	0681	1	A	QoS monitoring measurement failure	18.1.0
2023-03	CT#99	CP-230040	0688	1	B	Support IPv6 Prefix Delegation in 5GS	18.1.0
2023-03	CT#99	CP-230043	0687	2	B	Support of integration with IETF Deterministic Networking	18.1.0
2023-03	CT#99	CP-230044	0682	1	B	Metadata for Service Function Chain	18.1.0
2023-03	CT#99	CP-230045	0674	1	B	Introduction of MPQUIC Steering Functionality	18.1.0
2023-03	CT#99	CP-230045	0678	-	B	Introducing the Redundant steering mode	18.1.0
2023-03	CT#99	CP-230049	0662	1	F	Overhaul of 5MBS description in TS 29.244	18.1.0
2023-03	CT#99	CP-230049	0671	2	F	Mutually exclusive flags in Apply Action IE	18.1.0
2023-03	CT#99	CP-230061	0686	1	F	Clarification of the Time Sensitive Communications and Time Synchronization	18.1.0
2023-03	CT#99	CP-230069	0689	-	F	Support of RAT Type with NR_REDCAP	18.1.0
2023-03	CT#99	CP-230097	0677	1	F	IE Name Corrections to Framed Routing	18.1.0
2023-06	CT#100	CP-231035	0725	2	B	Direct reporting of TSC Management Information from UPF to TSN AF or TSCTSF	18.2.0
2023-06	CT#100	CP-231036	0697	2	B	N6 Jitter Measurement and Reporting and Marking End of Data Burst Indication	18.2.0
2023-06	CT#100	CP-231044	0701	1	B	UP Function Features for Time Sensitive Communication, Time Synchronization, Time Sensitive Networking and Deterministic Networking	18.2.0
2023-06	CT#100	CP-231044	0702	1	B	Support of integration with IETF Deterministic Networking	18.2.0
2023-06	CT#100	CP-231045	0706	2	F	Service Function Chaining Support	18.2.0
2023-06	CT#100	CP-231046	0698	1	B	MA-PDU with non-3GPP leg connected to ePDG/EPC while 3GPP leg connected to 5GC	18.2.0
2023-06	CT#100	CP-231046	0713	1	B	Support of MPQUIC Steering Functionality	18.2.0
2023-06	CT#100	CP-231046	0715	1	B	Support of Redundant of steering mode	18.2.0
2023-06	CT#100	CP-231046	0719	1	B	Correct IE Name in Annex E	18.2.0
2023-06	CT#100	CP-231046	0720	1	B	SMF decision of steering parameters	18.2.0
2023-06	CT#100	CP-231057	0696	1	B	Support of high data rate low latency services, XR and interactive media services	18.2.0
2023-06	CT#100	CP-231057	0721	2	B	ECN marking for L4S	18.2.0
2023-06	CT#100	CP-231057	0722	1	B	PDU Set based QoS handling	18.2.0
2023-06	CT#100	CP-231057	0723	-	B	Generalization of QoS monitoring control description	18.2.0
2023-06	CT#100	CP-231057	0724	1	B	Congestion information monitoring	18.2.0
2023-06	CT#100	CP-231067	0703	1	F	QoS Monitoring Reporting Type	18.2.0
2023-06	CT#100	CP-231067	0704	1	F	Clarification to the Local Ingress Tunnel IE	18.2.0
2023-06	CT#100	CP-231067	0726	1	F	Substitute FAR when exhausting a Volume Quota or a Time Quota	18.2.0
2023-06	CT#100	CP-231083	0728	2	A	Correction the format of NF Instance Id	18.2.0
2023-06	CT#100	CP-231089	0718	1	A	Extended Buffering Support in UPF	18.2.0
2023-09	CT#101	CP-232038	0733	2	B	Reporting suggestion information for QoS flow related QoS monitoring	18.3.0
2023-09	CT#101	CP-232040	0734	-	B	TL-Container for the support of TSN enabled Transport Network	18.3.0
2023-09	CT#101	CP-232041	0742	1	B	Remove the Editor's note on Redundant steering mode for GBR traffic	18.3.0
2023-09	CT#101	CP-232043	0730	1	B	Update N4 Session modification procedure to support network slice replacement feature	18.3.0
2023-09	CT#101	CP-232043	0731	1	B	User plane inactivity detection update	18.3.0
2023-09	CT#101	CP-232051	0741	3	B	Clarification on the 5G VN Group Communication used for PIN	18.3.0
2023-09	CT#101	CP-232054	0735	1	B	Data rate monitoring	18.3.0
2023-09	CT#101	CP-232054	0736	-	F	Correction to N6 Jitter measurement	18.3.0
2023-09	CT#101	CP-232054	0737	1	B	PDU Set QoS handling during Xn and N2 Handover	18.3.0
2023-09	CT#101	CP-232054	0738	-	F	Removal of UPF exposure of QoS Notification Control	18.3.0
2023-09	CT#101	CP-232054	0739	2	B	Exposure of congestion information	18.3.0
2023-09	CT#101	CP-232054	0744	1	B	Remove the Editor's Note of End of Data Burst Marking	18.3.0
2023-09	CT#101	CP-232058	0740	1	F	PFCP Error Handling Corrections	18.3.0
2023-12	CT#102	CP-233032	0771	1	B	Indication of QoS Flow associated with the default QoS Rule	18.4.0
2023-12	CT#102	CP-233032	0776	-	F	Correction on Reporting Urgency	18.4.0
2023-12	CT#102	CP-233038	0750	1	B	PFCP extensions for HR-SBO PDU sessions	18.4.0
2023-12	CT#102	CP-233041	0767	-	B	TL-Containers in PFCP Session Modification/Deletion Request/Response	18.4.0
2023-12	CT#102	CP-233042	0777	1	F	Correction on User Plane Node ID	18.4.0
2023-12	CT#102	CP-233043	0752	-	F	Incorrect implementation of CR 29.244 #0742	18.4.0
2023-12	CT#102	CP-233044	0757	-	D	Editorial corrections	18.4.0
2023-12	CT#102	CP-233044	0760	1	F	Ethernet PDU Session Information	18.4.0
2023-12	CT#102	CP-233044	0761	1	F	Averaging Window for Session AMBR on N4	18.4.0
2023-12	CT#102	CP-233044	0762	1	F	Clarification for C/S-TAG operation	18.4.0
2023-12	CT#102	CP-233044	0770	-	F	Flow description within MBS Service Information if MBS data are transported in IP tunnel toward MB-UPF	18.4.0
2023-12	CT#102	CP-233046	0781	1	F	User plane inactivity timer update from SMF towards UPF	18.4.0
2023-12	CT#102	CP-233047	0759	2	B	Update to support the VN group communication without N6-based forwarding	18.4.0

2023-12	CT#102	CP-233053	0749	1	B	SMF Decision of PDU Set Handling Activation	18.4.0
2023-12	CT#102	CP-233053	0753	2	B	Traffic steering to an L4S enabled QoS flow	18.4.0
2023-12	CT#102	CP-233053	0754	-	B	PDU Set QoS handling during Xn and N2 Handover	18.4.0
2023-12	CT#102	CP-233053	0755	-	B	ECN marking during Xn and N2 Handover	18.4.0
2023-12	CT#102	CP-233053	0756	1	B	Protocol Description for End of Data Burst marking	18.4.0
2023-12	CT#102	CP-233053	0768	-	F	Per QoS flow data rate monitoring	18.4.0
2023-12	CT#102	CP-233053	0769	3	B	Protocol Description	18.4.0
2023-12	CT#102	CP-233053	0772	-	B	ECN marking during PDU session establishment procedure	18.4.0
2023-12	CT#102	CP-233054	0751	-	B	QoS differentiation for UEs behind RG	18.4.0
2023-12	CT#102	CP-233056	0774	1	F	Populating the recovery timestamp of the remote GTP-U entity	18.4.0
2023-12	CT#102	CP-233056	0782	-	F	Source/Destination Interface Type for Indirect DL Data Forwarding Tunnels	18.4.0
2024-03	CT#103	CP-240054	0817	1	A	Create BAR in the PFCP Session Modification Request	18.5.0
2024-03	CT#103	CP-240063	0831	1	A	RAT TYPE update for NR satellite access	18.5.0
2024-03	CT#103	CP-240064	0806	1	A	ATSSS between EPC and 5GC accesses	18.5.0
2024-03	CT#103	CP-240029	0766	6	B	DL data notifications during Extended Buffering - Option1	18.5.0
2024-03	CT#103	CP-240029	0795	2	B	Reporting the DL data size over N4	18.5.0
2024-03	CT#103	CP-240029	0809	1	B	Support of subsequent DL data notifications while extended buffering	18.5.0
2024-03	CT#103	CP-240031	0823	1	B	EAS discovery procedure with V-EASDF using IP replacement mechanism for supporting HR-SBO	18.5.0
2024-03	CT#103	CP-240031	0824	-	B	Support of DL Session AMBR in HR-SBO session	18.5.0
2024-03	CT#103	CP-240031	0825	2	B	Support of DNS traffic routing in multiple DNN networks with the same IP address range	18.5.0
2024-03	CT#103	CP-240033	0832	2	B	Add S-NSSAI and DNN information in Session Establishment procedure	18.5.0
2024-03	CT#103	CP-240034	0785	1	B	Update to Fields of PDU Set Information	18.5.0
2024-03	CT#103	CP-240034	0787	1	B	New GTP-U PDU Set Information Container extension header	18.5.0
2024-03	CT#103	CP-240034	0789	-	B	Congestion information and data rate monitoring	18.5.0
2024-03	CT#103	CP-240034	0790	1	B	Encoding of UL/DL Congestion Information	18.5.0
2024-03	CT#103	CP-240034	0791	1	F	Removal of Editor's note on ECN marking	18.5.0
2024-03	CT#103	CP-240034	0792	-	F	Correction of the QER Indications	18.5.0
2024-03	CT#103	CP-240034	0793	1	F	Corrections to Protocol Description	18.5.0
2024-03	CT#103	CP-240034	0794	-	B	Extensions to Protocol Description requested by SA4	18.5.0
2024-03	CT#103	CP-240034	0808	2	F	The minimum and the maximum measurement result	18.5.0
2024-03	CT#103	CP-240034	0811	2	B	Monitoring averaging window for Non-GBR QoS flows	18.5.0
2024-03	CT#103	CP-240034	0814	-	B	PDU Set based handling clarification	18.5.0
2024-03	CT#103	CP-240034	0829	-	B	Support of Network Exposure of 5GS information	18.5.0
2024-03	CT#103	CP-240035	0821	-	D	Editorial correction of MBS Session N4mb Information IE	18.5.0
2024-03	CT#103	CP-240039	0796	1	F	Incorrect references	18.5.0
2024-03	CT#103	CP-240040	0799	-	F	Handling of GBR traffic using the Redundant steering mode	18.5.0
2024-03	CT#103	CP-240040	0800	-	F	Corrections to the MPQUIC steering functionality	18.5.0
2024-03	CT#103	CP-240040	0801	-	F	Miscellaneous ATSSS corrections	18.5.0
2024-03	CT#103	CP-240040	0812	1	B	Clarifications on interworking with EPS	18.5.0
2024-03	CT#103	CP-240042	0818	1	F	User Plane Inactivity Timer update	18.5.0
2024-03	CT#103	CP-240042	0828	1	F	Support of slice replacement with replaced S-NSSAI on N4	18.5.0
2024-03	CT#103	CP-240053	0802	-	F	PFCP Association Release procedure with the MPAS feature	18.5.0
2024-03	CT#103	CP-240053	0803	1	F	SMF restoration procedures for SMF in an SMF set	18.5.0
2024-03	CT#103	CP-240053	0807	-	F	Remove Session Report for QoS monitoring measurement at PFCP session deletion	18.5.0
2024-03	CT#103	CP-240053	0810	-	F	Framed-Route AVP	18.5.0
2024-03	CT#103	CP-240053	0834	1	F	Clarification presence of Bridge ID and Router ID	18.5.0
2024-06	CT#104	CP-241029	0858	-	F	Support of NR_EREDCAP	18.6.0
2024-06	CT#104	CP-241029	0855	1	F	Activation of DL data size reporting for support of MT-SDT	18.6.0
2024-06	CT#104	CP-241031	0841	1	F	HR-SBO indication	18.6.0
2024-06	CT#104	CP-241031	0846	1	B	UE source IP address mapping for HR-SBO sessions with overlapping IP addresses	18.6.0
2024-06	CT#104	CP-241031	0847	1	B	N6 tunneling between V-UPF and V-EASDF for HR-SBO PDU sessions with overlapping IP addresses	18.6.0
2024-06	CT#104	CP-241049	0839	-	F	Definition of congestion information for exposure	18.6.0
2024-06	CT#104	CP-241049	0838	1	F	UPF reports for Congestion information and Data Rate monitoring	18.6.0
2024-06	CT#104	CP-241049	0840	1	F	Resolving Editor's notes on EDB Indication and RTP Header Extension Type	18.6.0
2024-06	CT#104	CP-241049	0849	1	F	Description of IEs in congestion information monitoring	18.6.0
2024-06	CT#104	CP-241049	0851	1	F	Update the description of PDU set marking	18.6.0
2024-06	CT#104	CP-241050	0853	-	F	Corrections on IE definition	18.6.0
2024-06	CT#104	CP-241050	0837	1	F	PFCP session deletion when new SMF takes over the PDU session	18.6.0
2024-06	CT#104	CP-241050	0844	1	F	User Plane Inactivity Timer after the User Plane Inactivity Report is sent	18.6.0
2024-06	CT#104	CP-241050	0852	1	F	Add MB-SMF and MB-UPF to NodeID over N4mb	18.6.0
2024-06	CT#104	CP-241050	0854	1	F	Clarification on Downlink data delivery status feature	18.6.0
2024-06	CT#104	CP-241050	0856	1	F	Clarification on the usage of TERMR	18.6.0
2024-06	CT#104	CP-241050	0859	1	F	Correction on Ethernet Packet Filter	18.6.0

2024-06	CT#104	CP-241050	0860	2	F	Interface Type for 5G VN Internal	18.6.0
2024-06	CT#104	CP-241054	0845	1	F	Updating User Plane Inactivity Timer	18.6.0
2024-06	CT#104	CP-241070	0797	1	B	MBS data usage reporting over N4mb for MBS charging	18.6.0
2024-06	CT#104	CP-241070	0798	1	B	MBS data usage reporting over N4 for MBS charging	18.6.0
2024-09	CT#105	CP-242041	0862	1	F	Removal of MBS Flow Based charging	18.7.0
2024-09	CT#105	CP-242051	0864	-	F	Correction on UPF L4S	18.7.0
2024-09	CT#105	CP-242053	0863	-	F	Correction to the PFCPSEReq-Flags IE	18.7.0
2024-09	CT#105	CP-242053	0865	1	F	Path Failure Handling	18.7.0
2024-09	CT#105	CP-242053	0866	1	F	Correction on GTP-U Extension Header Deletion field	18.7.0
2024-12	CT#106	CP-243022	0904	1	F	Support of Trace Reporting Consumer URI	18.8.0
2024-12	CT#106	CP-243022	0905	2	F	Support of UE level measurements configuration	18.8.0
2024-12	CT#106	CP-243029	0872	1	F	Correction on End of Data Burst Indication	18.8.0
2024-12	CT#106	CP-243032	0869	-	F	Clarification on the Downlink Data Notification Delay for 5GC	19.0.0
2024-12	CT#106	CP-243032	0878	-	F	Wrong reference to the Domain Name Protocol field	19.0.0
2024-12	CT#106	CP-243032	0870	1	F	Correction on the length of IEs	19.0.0
2024-12	CT#106	CP-243040	0888	1	B	N6 Delay Measurement and Reporting	19.0.0
2024-12	CT#106	CP-243043	0868	2	B	Support of Operator Configurable UPF capability	19.0.0
2024-12	CT#106	CP-243043	0876	2	B	Supported functionality of NAT information exposure	19.0.0
2024-12	CT#106	CP-243043	0882	1	B	Support of handling of headers in N4 interface	19.0.0
2024-12	CT#106	CP-243043	0881	4	B	UPF Packet Inspection functionalities	19.0.0
2024-12	CT#106	CP-243059	0887	-	F	GTP-U Path QoS Control Information	19.0.0
2024-12	CT#106	CP-243059	0896	-	F	Extra reference to 3GPP TS 29.512	19.0.0
2024-12	CT#106	CP-243059	0895	1	B	PFCP sessions excluded from the restoration upon a SMF failure with SMF set being deployed	19.0.0
2024-12	CT#106	CP-243059	0886	1	F	Correction of RTP Header Extension Additional Information	19.0.0
2024-12	CT#106	CP-243061	0889	1	B	MPQUIC-IP and MPQUIC-E support	19.0.0
2024-12	CT#106	CP-243064	0894	-	B	Transferring media related information over N6 using connect-UDP for e2e encrypted traffic	19.0.0
2024-12	CT#106	CP-243064	0890	1	B	PDU Set based handling for non-3GPP accesses	19.0.0
2024-12	CT#106	CP-243064	0891	1	B	L4S support for non-3GPP accesses	19.0.0
2024-12	CT#106	CP-243064	0892	1	B	Identification and marking of Data Burst Size in DL GTP-U packets	19.0.0
2024-12	CT#106	CP-243064	0897	1	B	Support of MoQ Transport protocol on N4	19.0.0
2024-12	CT#106	CP-243064	0898	2	B	Support of MoQ on N4 for encrypted XRM traffic	19.0.0
2024-12	CT#106	CP-243064	0893	2	B	Support of differentiated QoS handling for multiplexed media flows	19.0.0
2024-12	CT#106	CP-243065	0884	1	B	Description for handling of allowed VLAN tags and use of VLAN Handling Information in SMF	19.0.0
2024-12	CT#106	CP-243287	0906	-	F	Additional Support Features	19.0.0
2025-03	CT#107	CP-250023	0918	2	A	Function description on UE level measurement	19.1.0
2025-03	CT#107	CP-250037	0928	2	B	N6 Delay measurement and reporting	19.1.0
2025-03	CT#107	CP-250044	0910	3	B	Correction on the Header Handling	19.1.0
2025-03	CT#107	CP-250044	0935	1	B	Modification of Header Handling Control Rules	19.1.0
2025-03	CT#107	CP-250044	0934	1	B	Removing Editor's Note for Packet Inspection Functionalities	19.1.0
2025-03	CT#107	CP-250044	0937	-	B	Header Handling parameters alignment with 29.514 specification	19.1.0
2025-03	CT#107	CP-250046	0911	1	B	Providing alternative SMF(s) per PFCP Session	19.1.0
2025-03	CT#107	CP-250046	0914	2	F	Restore PFCP Sessions at an alternative SMF	19.1.0
2025-03	CT#107	CP-250046	0917	-	F	Corrections on Apply Action descriptions	19.1.0
2025-03	CT#107	CP-250046	0919	1	F	Update the MeasurementType to support UE level measurement	19.1.0
2025-03	CT#107	CP-250046	0938	-	F	Correction of references to Reporting Suggestion Info IE	19.1.0
2025-03	CT#107	CP-250049	0926	1	F	Terminology of MPQUIC-based steering functionalities	19.1.0
2025-03	CT#107	CP-250049	0927	3	F	MPQUIC Proxy Enhancements	19.1.0
2025-03	CT#107	CP-250049	0929	1	B	MPQUIC-IP and MPQUIC-E steering functionalities	19.1.0
2025-03	CT#107	CP-250051	0912	1	B	Leveraging PDU Set QoS information for DSCP marking over N3/N9 in the transport network	19.1.0
2025-03	CT#107	CP-250051	0921	1	B	Procedure description on support of MoQ protocol	19.1.0
2025-03	CT#107	CP-250051	0924	1	B	Support of Time to Next Burst	19.1.0
2025-03	CT#107	CP-250051	0930	1	B	Support of differentiated QoS handling for multiplexed media flows	19.1.0
2025-03	CT#107	CP-250051	0932	1	B	Transferring media related information over N6 using connect-UDP	19.1.0
2025-03	CT#107	CP-250051	0933	1	B	Transferring media related information over N6 using UDP Option	19.1.0
2025-06	CT#108	CP-251047	0957	1	A	PFCP corrections for UE level measurements	19.2.0
2025-06	CT#108	CP-251053	0946	-	A	Correct UPF Behavior of ECN Marking for L4S	19.2.0
2025-06	CT#108	CP-251053	0952	-	A	Essential correction on the RTP Payload Type range for Protocol Description	19.2.0
2025-06	CT#108	CP-251191	0943	2	A	Subscription to QoS Monitoring via SMF	19.2.0
2025-06	CT#108	CP-251059	0974	-	B	UPF roles when using OWAMP, TWAMP and STAMP	19.2.0
2025-06	CT#108	CP-251059	0975	-	B	Security related protocol-specific configuration parameters for N6 delay measurement	19.2.0
2025-06	CT#108	CP-251065	0963	-	B	Support of Remaining Data Reporting Indication	19.2.0
2025-06	CT#108	CP-251067	0944	1	F	Clarification on the addition and removal of a SMF to a SMF set	19.2.0
2025-06	CT#108	CP-251067	0949	1	F	Correct the presence condition of the Reporting Suggestion Info IE in SRR	19.2.0
2025-06	CT#108	CP-251067	0966	1	F	Update the References	19.2.0
2025-06	CT#108	CP-251067	0971	1	F	User Plane Inactivity Timer clarification	19.2.0

2025-06	CT#108	CP-251067	0972	1	D	Editorial corrections	19.2.0
2025-06	CT#108	CP-251067	0976	1	F	QoS flow for L4S	19.2.0
2025-06	CT#108	CP-251067	0977	-	F	NTP Timestamp roll-over	19.2.0
2025-06	CT#108	CP-251067	0978	2	F	Correction of traffic detection reporting	19.2.0
2025-06	CT#108	CP-251070	0940	3	B	Sending both MPQUIC Proxy IPv4 and IPv6 address when using MPQUIC-E steering functionality	19.2.0
2025-06	CT#108	CP-251070	0955	1	B	Clarification on the support MPQUIC-based steering functionality	19.2.0
2025-06	CT#108	CP-251071	0958	-	F	Correction of the PDU Set Importance IE type definition	19.2.0
2025-06	CT#108	CP-251071	0959	1	B	Encoding of (S)RTP Multiplexed Media Identification Information	19.2.0
2025-06	CT#108	CP-251071	0960	1	B	Expedited Data Transfer with reflective QoS	19.2.0
2025-06	CT#108	CP-251071	0961	-	B	RTP header extension for dynamically changing traffic characteristics	19.2.0
2025-06	CT#108	CP-251071	0962	3	B	Available bitrate monitoring	19.2.0
2025-06	CT#108	CP-251071	0969	2	F	Update the scenarios for DL PDU Set Information Marking	19.2.0
2025-09	CT#109	CP-252042	0980	-	F	Protocol-specific configuration parameters for N6 delay measurements	19.3.0
2025-09	CT#109	CP-252042	0986	1	F	Add a reference to stage 2 specification	19.3.0
2025-09	CT#109	CP-252049	0979	-	F	Correction to End of Data Burst marking	19.3.0
2025-09	CT#109	CP-252049	0990	1	B	Enhancements on the PFD Provisioning	19.3.0
2025-09	CT#109	CP-252049	0991	2	F	(Un)Solicited Application Reporting and Application Detection Information	19.3.0
2025-09	CT#109	CP-252049	0992	-	D	Editorial corrections	19.3.0
2025-09	CT#109	CP-252053	0981	1	F	Data Burst Size and Time to Next Burst marking	19.3.0
2025-09	CT#109	CP-252053	0982	1	F	Corrections to (S)RTP Multiplexed Media Identification Information encoding	19.3.0
2025-09	CT#109	CP-252053	0983	1	F	Corrections on Transferring media related information over N6	19.3.0
2025-09	CT#109	CP-252053	0984	-	B	RTP header extension for Expedited Transfer Indication	19.3.0
2025-09	CT#109	CP-252053	0987	1	B	Transport Level Marking Indication	19.3.0
2025-09	CT#109	CP-252054	0993	1	B	Usage Reporting for EIF Energy Consumption Support	19.3.0
2025-09	CT#109	CP-252054	0985	3	B	Provision of I-UPF ID over N4 Interface	19.3.0
2025-12	CT#110	CP-253158	0996	4	B	Add new condition to support IMS restoration procedures after PCRF/PCF failure	19.4.0
2025-12	CT#110	CP-253151	0997	-	F	Update and replace obsoleted HTTP RFC 2460	19.4.0
2025-12	CT#110	CP-253151	0998	-	F	Update and replace obsoleted HTTP RFC 3376	19.4.0
2025-12	CT#110	CP-253151	1000	-	F	Link-specific and MPQUIC Proxy IP addresses for IPv4v6 PDU sessions	19.4.0
2025-12	CT#110	CP-253151	1003	-	F	GTPUPM flag in the Requested QoS Monitoring	19.4.0
2025-12	CT#110	CP-253159	1005	1	F	Allowed VLAN tags and VLAN Handling Information	19.4.0
2025-12	CT#110	CP-253154	1006	3	F	QoS Monitoring for redundant N3/N9	19.4.0
2025-12	CT#110	CP-253156	1007	2	F	Update and replace ietf draft	19.4.0

History

Version	Date	Status
V19.3.0	January 2026	Publication
V19.4.0	February 2026	Publication