

ETSI TS 129 520 V18.7.0 (2024-09)



**5G;
5G System;
Network Data Analytics Services;
Stage 3
(3GPP TS 29.520 version 18.7.0 Release 18)**



Reference

RTS/TSGC-0329520vi70

Keywords

5G

ETSI

650 Route des Lucioles
F-06921 Sophia Antipolis Cedex - FRANCE

Tel.: +33 4 92 94 42 00 Fax: +33 4 93 65 47 16

Siret N° 348 623 562 00017 - APE 7112B
Association à but non lucratif enregistrée à la
Sous-Préfecture de Grasse (06) N° w061004871

Important notice

The present document can be downloaded from:

<https://www.etsi.org/standards-search>

The present document may be made available in electronic versions and/or in print. The content of any electronic and/or print versions of the present document shall not be modified without the prior written authorization of ETSI. In case of any existing or perceived difference in contents between such versions and/or in print, the prevailing version of an ETSI deliverable is the one made publicly available in PDF format at www.etsi.org/deliver.

Users of the present document should be aware that the document may be subject to revision or change of status.

Information on the current status of this and other ETSI documents is available at

<https://portal.etsi.org/TB/ETSIDeliverableStatus.aspx>

If you find errors in the present document, please send your comment to one of the following services:

<https://portal.etsi.org/People/CommitteeSupportStaff.aspx>

If you find a security vulnerability in the present document, please report it through our
Coordinated Vulnerability Disclosure Program:

<https://www.etsi.org/standards/coordinated-vulnerability-disclosure>

Notice of disclaimer & limitation of liability

The information provided in the present deliverable is directed solely to professionals who have the appropriate degree of experience to understand and interpret its content in accordance with generally accepted engineering or other professional standard and applicable regulations.

No recommendation as to products and services or vendors is made or should be implied.

No representation or warranty is made that this deliverable is technically accurate or sufficient or conforms to any law and/or governmental rule and/or regulation and further, no representation or warranty is made of merchantability or fitness for any particular purpose or against infringement of intellectual property rights.

In no event shall ETSI be held liable for loss of profits or any other incidental or consequential damages.

Any software contained in this deliverable is provided "AS IS" with no warranties, express or implied, including but not limited to, the warranties of merchantability, fitness for a particular purpose and non-infringement of intellectual property rights and ETSI shall not be held liable in any event for any damages whatsoever (including, without limitation, damages for loss of profits, business interruption, loss of information, or any other pecuniary loss) arising out of or related to the use of or inability to use the software.

Copyright Notification

No part may be reproduced or utilized in any form or by any means, electronic or mechanical, including photocopying and microfilm except as authorized by written permission of ETSI.

The content of the PDF version shall not be modified without the written authorization of ETSI.

The copyright and the foregoing restriction extend to reproduction in all media.

© ETSI 2024.
All rights reserved.

Intellectual Property Rights

Essential patents

IPRs essential or potentially essential to normative deliverables may have been declared to ETSI. The declarations pertaining to these essential IPRs, if any, are publicly available for **ETSI members and non-members**, and can be found in ETSI SR 000 314: "*Intellectual Property Rights (IPRs); Essential, or potentially Essential, IPRs notified to ETSI in respect of ETSI standards*", which is available from the ETSI Secretariat. Latest updates are available on the ETSI Web server (<https://ipr.etsi.org/>).

Pursuant to the ETSI Directives including the ETSI IPR Policy, no investigation regarding the essentiality of IPRs, including IPR searches, has been carried out by ETSI. No guarantee can be given as to the existence of other IPRs not referenced in ETSI SR 000 314 (or the updates on the ETSI Web server) which are, or may be, or may become, essential to the present document.

Trademarks

The present document may include trademarks and/or tradenames which are asserted and/or registered by their owners. ETSI claims no ownership of these except for any which are indicated as being the property of ETSI, and conveys no right to use or reproduce any trademark and/or tradename. Mention of those trademarks in the present document does not constitute an endorsement by ETSI of products, services or organizations associated with those trademarks.

DECT™, **PLUGTESTS™**, **UMTS™** and the ETSI logo are trademarks of ETSI registered for the benefit of its Members. **3GPP™** and **LTE™** are trademarks of ETSI registered for the benefit of its Members and of the 3GPP Organizational Partners. **oneM2M™** logo is a trademark of ETSI registered for the benefit of its Members and of the oneM2M Partners. **GSM®** and the GSM logo are trademarks registered and owned by the GSM Association.

Legal Notice

This Technical Specification (TS) has been produced by ETSI 3rd Generation Partnership Project (3GPP).

The present document may refer to technical specifications or reports using their 3GPP identities. These shall be interpreted as being references to the corresponding ETSI deliverables.

The cross reference between 3GPP and ETSI identities can be found under <https://webapp.etsi.org/key/queryform.asp>.

Modal verbs terminology

In the present document "**shall**", "**shall not**", "**should**", "**should not**", "**may**", "**need not**", "**will**", "**will not**", "**can**" and "**cannot**" are to be interpreted as described in clause 3.2 of the [ETSI Drafting Rules](#) (Verbal forms for the expression of provisions).

"**must**" and "**must not**" are **NOT** allowed in ETSI deliverables except when used in direct citation.

Contents

| | |
|---|----|
| Intellectual Property Rights | 2 |
| Legal Notice | 2 |
| Modal verbs terminology..... | 2 |
| Foreword..... | 16 |
| 1 Scope | 17 |
| 2 References | 17 |
| 3 Definitions and abbreviations..... | 18 |
| 3.1 Definitions | 18 |
| 3.2 Abbreviations | 18 |
| 4 Services offered by the NWDAF | 19 |
| 4.1 Introduction | 19 |
| 4.2 Nnwdaf_EventsSubscription Service | 22 |
| 4.2.1 Service Description..... | 22 |
| 4.2.1.1 Overview..... | 22 |
| 4.2.1.2 Service Architecture..... | 23 |
| 4.2.1.3 Network Functions..... | 24 |
| 4.2.1.3.1 Network Data Analytics Function (NWDAF)..... | 24 |
| 4.2.1.3.2 NF Service Consumers | 24 |
| 4.2.2 Service Operations | 28 |
| 4.2.2.1 Introduction..... | 28 |
| 4.2.2.2 Nnwdaf_EventsSubscription_Subscribe service operation | 28 |
| 4.2.2.2.1 General | 28 |
| 4.2.2.2.2 Subscription for event notifications..... | 28 |
| 4.2.2.2.3 Update subscription for event notifications..... | 40 |
| 4.2.2.3 Nnwdaf_EventsSubscription_Unsubscribe service operation..... | 41 |
| 4.2.2.3.1 General | 41 |
| 4.2.2.3.2 Unsubscribe from event notifications..... | 41 |
| 4.2.2.4 Nnwdaf_EventsSubscription_Notify service operation | 42 |
| 4.2.2.4.1 General | 42 |
| 4.2.2.4.2 Notification about subscribed event | 42 |
| 4.2.2.5 Nnwdaf_EventsSubscription_Transfer service operation | 45 |
| 4.2.2.5.1 General | 45 |
| 4.2.2.5.2 Creation of request for analytics subscription transfer | 45 |
| 4.2.2.5.3 Update a request for analytics subscription transfer | 46 |
| 4.2.2.5.4 Cancel a request for analytics subscription transfer | 48 |
| 4.3 Nnwdaf_AnalyticsInfo Service | 48 |
| 4.3.1 Service Description..... | 48 |
| 4.3.1.1 Overview..... | 48 |
| 4.3.1.2 Service Architecture..... | 49 |
| 4.3.1.3 Network Functions..... | 50 |
| 4.3.1.3.1 Network Data Analytics Function (NWDAF)..... | 50 |
| 4.3.1.3.2 NF Service Consumers | 50 |
| 4.3.2 Service Operations | 53 |
| 4.3.2.1 Introduction..... | 53 |
| 4.3.2.2 Nnwdaf_AnalyticsInfo_Request service operation | 53 |
| 4.3.2.2.1 General | 53 |
| 4.3.2.2.2 Request and get from NWDAF Analytics information | 53 |
| 4.3.2.3 Nnwdaf_AnalyticsInfo_ContextTransfer service operation..... | 64 |
| 4.3.2.3.1 General | 64 |
| 4.3.2.3.2 Request and get from NWDAF context of a subscription | 64 |
| 4.4 Nnwdaf_DataManagement Service..... | 65 |
| 4.4.1 Service Description..... | 65 |
| 4.4.1.1 Overview..... | 65 |
| 4.4.1.2 Service Architecture..... | 65 |

| | | |
|-----------|---|----|
| 4.4.1.3 | Network Functions | 66 |
| 4.4.1.3.1 | Network Data Analytics Function (NWDAF) | 66 |
| 4.4.1.3.2 | NF Service Consumers | 66 |
| 4.4.2 | Service Operations | 67 |
| 4.4.2.1 | Introduction | 67 |
| 4.4.2.2 | Nnwdaf_DataManagement_Subscribe service operation | 67 |
| 4.4.2.2.1 | General | 67 |
| 4.4.2.2.2 | Subscription for data notifications | 67 |
| 4.4.2.2.3 | Update subscription for data notifications | 70 |
| 4.4.2.3 | Nnwdaf_DataManagement_Unsubscribe service operation | 71 |
| 4.4.2.3.1 | General | 71 |
| 4.4.2.3.2 | Unsubscribe from data notifications | 72 |
| 4.4.2.4 | Nnwdaf_DataManagement_Notify service operation | 72 |
| 4.4.2.4.1 | General | 72 |
| 4.4.2.4.2 | Notification about subscribed data | 72 |
| 4.4.2.5 | Nnwdaf_DataManagement_Fetch service operation | 74 |
| 4.4.2.5.1 | General | 74 |
| 4.4.2.5.2 | Retrieve data from the NWDAF | 74 |
| 4.5 | Nnwdaf_MLModelProvision Service | 75 |
| 4.5.1 | Service Description | 75 |
| 4.5.1.1 | Overview | 75 |
| 4.5.1.2 | Service Architecture | 75 |
| 4.5.1.3 | Network Functions | 76 |
| 4.5.1.3.1 | Network Data Analytics Function (NWDAF) | 76 |
| 4.5.1.3.2 | NF Service Consumers | 76 |
| 4.5.2 | Service Operations | 76 |
| 4.5.2.1 | Introduction | 76 |
| 4.5.2.2 | Nnwdaf_MLModelProvision_Subscribe service operation | 76 |
| 4.5.2.2.1 | General | 76 |
| 4.5.2.2.2 | Subscription for event notifications | 77 |
| 4.5.2.2.3 | Update subscription for event notifications | 78 |
| 4.5.2.3 | Nnwdaf_MLModelProvision_Unsubscribe service operation | 79 |
| 4.5.2.3.1 | General | 79 |
| 4.5.2.3.2 | Unsubscribe from event notifications | 79 |
| 4.5.2.4 | Nnwdaf_MLModelProvision_Notify service operation | 80 |
| 4.5.2.4.1 | General | 80 |
| 4.5.2.4.2 | Notification about subscribed event | 80 |
| 4.6 | Nnwdaf_MLModelTraining Service | 81 |
| 4.6.1 | Service Description | 81 |
| 4.6.1.1 | Overview | 81 |
| 4.6.1.2 | Service Architecture | 81 |
| 4.6.1.3 | Network Functions | 82 |
| 4.6.1.3.1 | Network Data Analytics Function (NWDAF) | 82 |
| 4.6.1.3.2 | NF Service Consumers | 82 |
| 4.6.2 | Service Operations | 82 |
| 4.6.2.1 | Introduction | 82 |
| 4.6.2.2 | Nnwdaf_MLModelTraining_Subscribe service operation | 83 |
| 4.6.2.2.1 | General | 83 |
| 4.6.2.2.2 | Subscription for event notifications | 83 |
| 4.6.2.2.3 | Update subscription for event notifications | 84 |
| 4.6.2.2.4 | Partial update subscription for event notifications | 86 |
| 4.6.2.3 | Nnwdaf_MLModelTraining_Unsubscribe service operation | 87 |
| 4.6.2.3.1 | General | 87 |
| 4.6.2.3.2 | Unsubscribe from event notifications | 87 |
| 4.6.2.4 | Nnwdaf_MLModelTraining_Notify service operation | 87 |
| 4.6.2.4.1 | General | 87 |
| 4.6.2.4.2 | Notification about subscribed event | 87 |
| 4.7 | Nnwdaf_MLModelMonitor Service | 88 |
| 4.7.1 | Service Description | 88 |
| 4.7.1.1 | Overview | 88 |
| 4.7.1.2 | Service Architecture | 89 |
| 4.7.1.3 | Network Functions | 90 |

| | | |
|-----------|---|-----|
| 4.7.1.3.1 | Network Data Analytics Function (NWDAF) | 90 |
| 4.7.1.3.2 | NF Service Consumers | 90 |
| 4.7.2 | Service Operations | 90 |
| 4.7.2.1 | Introduction | 90 |
| 4.7.2.2 | Nnwdaf_MLModelMonitor_Register service operation | 90 |
| 4.7.2.2.1 | General | 90 |
| 4.7.2.2.2 | Registering the monitoring of the analytics accuracy of an ML Model | 90 |
| 4.7.2.3 | Nnwdaf_MLModelMonitor_Deregister service operation | 92 |
| 4.7.2.3.1 | General | 92 |
| 4.7.2.3.2 | Deregistering the monitoring of the analytics accuracy of an ML Model | 92 |
| 4.7.2.4 | Nnwdaf_MLModelMonitor_Subscribe service operation | 92 |
| 4.7.2.4.1 | General | 92 |
| 4.7.2.4.2 | Subscription for monitoring notifications | 93 |
| 4.7.2.4.3 | Update of subscription for monitoring notifications | 94 |
| 4.7.2.5 | Nnwdaf_MLModelMonitor_Unsubscribe service operation | 94 |
| 4.7.2.5.1 | General | 94 |
| 4.7.2.5.2 | Unsubscribe from monitoring notifications | 95 |
| 4.7.2.6 | Nnwdaf_MLModelMonitor_Notify service operation | 95 |
| 4.7.2.6.1 | General | 95 |
| 4.7.2.6.2 | Notification about subscribed event | 95 |
| 4.8 | Nnwdaf_RoamingData Service | 96 |
| 4.8.1 | Service Description | 96 |
| 4.8.1.1 | Overview | 96 |
| 4.8.1.2 | Service Architecture | 97 |
| 4.8.1.3 | Network Functions | 97 |
| 4.8.1.3.1 | Network Data Analytics Function (NWDAF) | 97 |
| 4.8.1.3.2 | NF Service Consumers | 97 |
| 4.8.2 | Service Operations | 98 |
| 4.8.2.1 | Introduction | 98 |
| 4.8.2.2 | Nnwdaf_RoamingData_Subscribe service operation | 98 |
| 4.8.2.2.1 | General | 98 |
| 4.8.2.2.2 | Subscription for event notifications | 98 |
| 4.8.2.2.3 | Update of subscription for event notifications | 99 |
| 4.8.2.3 | Nnwdaf_RoamingData_Unsubscribe service operation | 100 |
| 4.8.2.3.1 | General | 100 |
| 4.8.2.3.2 | Unsubscribe from event notifications | 100 |
| 4.8.2.4 | Nnwdaf_RoamingData_Notify service operation | 101 |
| 4.8.2.4.1 | General | 101 |
| 4.8.2.4.2 | Notification about subscribed event | 101 |
| 4.9.1.2 | Service Architecture | 102 |
| 4.9.1.3 | Network Functions | 103 |
| 4.9.1.3.1 | Network Data Analytics Function (NWDAF) | 103 |
| 4.9.1.3.2 | NF Service Consumers | 103 |
| 4.9.2 | Service Operations | 103 |
| 4.9.2.1 | Introduction | 103 |
| 4.9.2.2 | Nnwdaf_RoamingAnalytics_Subscribe service operation | 103 |
| 4.9.2.2.1 | General | 103 |
| 4.9.2.2.2 | Subscription for event notifications | 103 |
| 4.9.2.4 | Nnwdaf_RoamingAnalytics_Notify service operation | 107 |
| 4.9.2.4.1 | General | 107 |
| 4.9.2.4.2 | Notification about subscribed event | 107 |
| 5 | API Definitions | 108 |
| 5.1 | Nnwdaf_EventsSubscription Service API | 108 |
| 5.1.1 | Introduction | 108 |
| 5.1.2 | Usage of HTTP | 109 |
| 5.1.2.1 | General | 109 |
| 5.1.2.2 | HTTP standard headers | 109 |
| 5.1.2.2.1 | General | 109 |
| 5.1.2.2.2 | Content type | 109 |
| 5.1.2.3 | HTTP custom headers | 109 |
| 5.1.3 | Resources | 109 |

| | | |
|-------------|--|-----|
| 5.1.3.1 | Resource Structure | 109 |
| 5.1.3.2 | Resource: NWDAF Events Subscriptions..... | 110 |
| 5.1.3.2.1 | Description | 110 |
| 5.1.3.2.2 | Resource definition..... | 110 |
| 5.1.3.2.3 | Resource Standard Methods | 110 |
| 5.1.3.2.3.1 | POST..... | 110 |
| 5.1.3.2.4 | Resource Custom Operations | 111 |
| 5.1.3.3 | Resource: Individual NWDAF Event Subscription | 111 |
| 5.1.3.3.1 | Description | 111 |
| 5.1.3.3.2 | Resource definition..... | 111 |
| 5.1.3.3.3 | Resource Standard Methods | 112 |
| 5.1.3.3.3.1 | DELETE | 112 |
| 5.1.3.3.3.2 | PUT..... | 113 |
| 5.1.3.3.4 | Resource Custom Operations | 114 |
| 5.1.3.4 | Resource: NWDAF Event Subscription Transfers..... | 114 |
| 5.1.3.4.1 | Description | 114 |
| 5.1.3.4.2 | Resource definition..... | 114 |
| 5.1.3.4.3 | Resource Standard Methods | 115 |
| 5.1.3.4.3.1 | POST..... | 115 |
| 5.1.3.4.4 | Resource Custom Operations | 115 |
| 5.1.3.5 | Resource: Individual NWDAF Event Subscription Transfer | 115 |
| 5.1.3.5.1 | Description | 115 |
| 5.1.3.5.2 | Resource definition..... | 115 |
| 5.1.3.5.3 | Resource Standard Methods | 116 |
| 5.1.3.5.3.1 | DELETE | 116 |
| 5.1.3.5.3.2 | PUT..... | 117 |
| 5.1.3.5.4 | Resource Custom Operations | 118 |
| 5.1.4 | Custom Operations without associated resources | 118 |
| 5.1.5 | Notifications | 118 |
| 5.1.5.1 | General | 118 |
| 5.1.5.2 | Event Notification | 118 |
| 5.1.5.2.1 | Description | 118 |
| 5.1.5.2.2 | Operation Definition..... | 119 |
| 5.1.6 | Data Model | 120 |
| 5.1.6.1 | General | 120 |
| 5.1.6.2 | Structured data types | 132 |
| 5.1.6.2.1 | Introduction | 132 |
| 5.1.6.2.2 | Type NnwdafeventsSubscription | 133 |
| 5.1.6.2.3 | Type EventSubscription | 136 |
| 5.1.6.2.4 | Type NnwdafeventsSubscriptionNotification | 144 |
| 5.1.6.2.5 | Type EventNotification | 145 |
| 5.1.6.2.6 | Type SliceLoadLevelInformation..... | 149 |
| 5.1.6.2.7 | Type EventReportingRequirement | 150 |
| 5.1.6.2.8 | Type TargetUeInformation..... | 153 |
| 5.1.6.2.9 | Void..... | 154 |
| 5.1.6.2.10 | Type UeMobility | 154 |
| 5.1.6.2.11 | Type LocationInfo | 155 |
| 5.1.6.2.12 | Void..... | 156 |
| 5.1.6.2.13 | Type UeCommunication..... | 156 |
| 5.1.6.2.14 | Type TrafficCharacterization | 159 |
| 5.1.6.2.15 | Type AbnormalBehaviour | 160 |
| 5.1.6.2.16 | Type Exception..... | 160 |
| 5.1.6.2.17 | Type UserDataCongestionInfo | 161 |
| 5.1.6.2.18 | Type CongestionInfo | 161 |
| 5.1.6.2.19 | Type QoSsustainabilityInfo | 162 |
| 5.1.6.2.20 | Type QoSRequirement | 163 |
| 5.1.6.2.21 | Type RetainabilityThreshold | 163 |
| 5.1.6.2.22 | Type NetworkPerfRequirement..... | 164 |
| 5.1.6.2.23 | Type NetworkPerfInfo..... | 165 |
| 5.1.6.2.24 | Type ServiceExperienceInfo | 166 |
| 5.1.6.2.25 | Type BwRequirement..... | 169 |
| 5.1.6.2.26 | Type AdditionalMeasurement | 170 |

| | | |
|------------|---|-----|
| 5.1.6.2.27 | Type IpEthFlowDescription | 170 |
| 5.1.6.2.28 | Type AddressList..... | 171 |
| 5.1.6.2.29 | Type CircumstanceDescription | 171 |
| 5.1.6.2.30 | Type ThresholdLevel..... | 172 |
| 5.1.6.2.31 | Type NfLoadLevelInformation | 175 |
| 5.1.6.2.32 | Type NfStatus..... | 175 |
| 5.1.6.2.33 | Type NsiIdInfo | 176 |
| 5.1.6.2.34 | Type NsiLoadLevelInfo | 177 |
| 5.1.6.2.35 | Type FailureEventInfo..... | 179 |
| 5.1.6.2.36 | Type AnalyticsMetadataIndication..... | 179 |
| 5.1.6.2.37 | Type AnalyticsMetadataInfo | 180 |
| 5.1.6.2.38 | Type NumberAverage | 180 |
| 5.1.6.2.39 | Type TopApplication..... | 180 |
| 5.1.6.2.40 | Type AnalyticsSubscriptionsTransfer | 180 |
| 5.1.6.2.41 | Type SubscriptionTransferInfo..... | 181 |
| 5.1.6.2.42 | Type ModelInfo..... | 181 |
| 5.1.6.2.43 | Type AnalyticsContextIdentifier | 181 |
| 5.1.6.2.44 | Type UeAnalyticsContextDescriptor..... | 182 |
| 5.1.6.2.45 | Type DnPerfInfo..... | 182 |
| 5.1.6.2.46 | Type DnPerf | 183 |
| 5.1.6.2.47 | Type PerfData..... | 184 |
| 5.1.6.2.48 | Type ResourceUsage | 185 |
| 5.1.6.2.49 | Type ConsumerNfInformation | 185 |
| 5.1.6.2.50 | Type DispersionRequirement | 185 |
| 5.1.6.2.51 | Type ClassCriterion..... | 186 |
| 5.1.6.2.52 | Type RankingCriterion | 186 |
| 5.1.6.2.53 | Type DispersionInfo | 186 |
| 5.1.6.2.54 | Type DispersionCollection | 187 |
| 5.1.6.2.55 | Type ApplicationVolume | 189 |
| 5.1.6.2.56 | Type RedundantTransmissionExpReq | 189 |
| 5.1.6.2.57 | Type RedundantTransmissionExpInfo | 190 |
| 5.1.6.2.58 | Type RedundantTransmissionExpPerTS | 190 |
| 5.1.6.2.59 | Type WlanPerformanceReq | 191 |
| 5.1.6.2.60 | Type WlanPerformanceInfo | 191 |
| 5.1.6.2.61 | Type WlanPerSsIdPerformanceInfo | 191 |
| 5.1.6.2.62 | Type WlanPerTsPerformanceInfo | 192 |
| 5.1.6.2.63 | Type TrafficInformation..... | 192 |
| 5.1.6.2.64 | Type AppListForUeComm..... | 193 |
| 5.1.6.2.65 | Type SessInactTimerForUeComm | 193 |
| 5.1.6.2.66 | Type DnPerformanceReq | 193 |
| 5.1.6.2.67 | Type: RatFreqInformation..... | 194 |
| 5.1.6.2.68 | Type PrevSubInfo..... | 194 |
| 5.1.6.2.69 | Type MLModelInfo..... | 195 |
| 5.1.6.2.70 | Type ObservedRedundantTransExp..... | 196 |
| 5.1.6.2.71 | Type UeMobilityReq..... | 199 |
| 5.1.6.2.72 | Type UeCommReq..... | 199 |
| 5.1.6.2.73 | Type PfdDeterminationInfo..... | 199 |
| 5.1.6.2.74 | Type PduSessionInfo | 200 |
| 5.1.6.2.75 | Type DirectionInfo | 200 |
| 5.1.6.2.76 | Type GeoDistributionInfo | 200 |
| 5.1.6.2.77 | Type PduSesTrafficInfo | 201 |
| 5.1.6.2.78 | Type TdTraffic | 201 |
| 5.1.6.2.79 | Type PduSesTrafficReq..... | 202 |
| 5.1.6.2.80 | Type WlanPerUeIdPerformanceInfo | 202 |
| 5.1.6.2.81 | Type ResourceUsageRequirement..... | 202 |
| 5.1.6.2.82 | Type E2eDataVolTransTimeReq | 203 |
| 5.1.6.2.83 | Type E2eDataVolTransTimeInfo | 204 |
| 5.1.6.2.84 | Type E2eDataVolTransTimePerTS..... | 204 |
| 5.1.6.2.85 | Type DataVolume | 204 |
| 5.1.6.2.86 | Type E2eDataVolTransTimePerUe..... | 205 |
| 5.1.6.2.87 | Type E2eDataVolTransTimeUeList..... | 206 |
| 5.1.6.2.88 | Type AccuracyReq | 207 |

| | | |
|-------------|---|-----|
| 5.1.6.2.89 | Type AccuracyInfo | 207 |
| 5.1.6.2.90 | Type DataVolumeTransferTime | 208 |
| 5.1.6.2.91 | Type MovBehavReq | 208 |
| 5.1.6.2.92 | Type MovBehavInfo | 208 |
| 5.1.6.2.93 | Type MovBehav | 209 |
| 5.1.6.2.94 | Type SpeedThresholdInfo | 209 |
| 5.1.6.2.95 | Type GeoLocation | 210 |
| 5.1.6.2.96 | Type LocAccuracyReq | 211 |
| 5.1.6.2.97 | Type LocAccuracyInfo | 212 |
| 5.1.6.2.98 | Type LocAccuracyPerMethod | 213 |
| 5.1.6.2.99 | Type RelProxReq | 213 |
| 5.1.6.2.100 | Type RelProxInfo | 214 |
| 5.1.6.2.101 | Type UeProximity | 215 |
| 5.1.6.2.102 | Type UeTrajectory | 215 |
| 5.1.6.2.103 | Type TimestampedLocation | 215 |
| 5.1.6.2.104 | Type TimeToCollisionInfo | 216 |
| 5.1.6.2.105 | Type AnalyticsFeedbackInfo | 216 |
| 5.1.6.2.106 | Type RoamingInfo | 217 |
| 5.1.6.2.107 | Type SuggestedPfdInfo | 218 |
| 5.1.6.3 | Simple data types and enumerations | 218 |
| 5.1.6.3.1 | Introduction | 218 |
| 5.1.6.3.2 | Simple data types | 218 |
| 5.1.6.3.3 | Enumeration: NotificationMethod | 219 |
| 5.1.6.3.4 | Enumeration: NwdafEvent | 220 |
| 5.1.6.3.5 | Enumeration: Accuracy | 220 |
| 5.1.6.3.6 | Enumeration: ExceptionId | 221 |
| 5.1.6.3.7 | Enumeration: ExceptionTrend | 221 |
| 5.1.6.3.8 | Enumeration: CongestionType | 221 |
| 5.1.6.3.9 | Enumeration: TimeUnit | 221 |
| 5.1.6.3.10 | Enumeration: NetworkPerfType | 222 |
| 5.1.6.3.11 | Enumeration: ExpectedAnalyticsType | 222 |
| 5.1.6.3.12 | Enumeration: MatchingDirection | 222 |
| 5.1.6.3.14 | Enumeration: AnalyticsMetadata | 223 |
| 5.1.6.3.15 | Enumeration: DatasetStatisticalProperty | 223 |
| 5.1.6.3.16 | Enumeration: OutputStrategy | 224 |
| 5.1.6.3.17 | Enumeration: TransferRequestType | 224 |
| 5.1.6.3.18 | Enumeration: AnalyticsSubset | 225 |
| 5.1.6.3.19 | Enumeration: DispersionType | 228 |
| 5.1.6.3.20 | Enumeration: DispersionClass | 228 |
| 5.1.6.3.21 | Enumeration: DispersionOrderingCriterion | 229 |
| 5.1.6.3.22 | Enumeration: RedTransExpOrderingCriterion | 229 |
| 5.1.6.3.23 | Enumeration: WlanOrderingCriterion | 229 |
| 5.1.6.3.24 | Enumeration: ServiceExperienceType | 229 |
| 5.1.6.3.25 | Enumeration: DnPerfOrderingCriterion | 229 |
| 5.1.6.3.26 | Enumeration: TermCause | 230 |
| 5.1.6.3.27 | Enumeration: UserDataConOrderCrit | 230 |
| 5.1.6.3.28 | Enumeration: UeMobilityOrderCriterion | 230 |
| 5.1.6.3.29 | Enumeration: UeCommOrderCriterion | 230 |
| 5.1.6.3.30 | Enumeration: NetworkPerfOrderCriterion | 230 |
| 5.1.6.3.31 | Enumeration: DeviceType | 231 |
| 5.1.6.3.32 | Enumeration: LocInfoGranularity | 231 |
| 5.1.6.3.33 | Enumeration: TrafficDirection | 231 |
| 5.1.6.3.34 | Enumeration: ValueExpression | 231 |
| 5.1.6.3.35 | Enumeration: E2eDataVolTransTimeCriterion | 231 |
| 5.1.6.3.36 | Void | 232 |
| 5.1.6.3.37 | Enumeration: AnalyticsAccuracyIndication | 232 |
| 5.1.6.3.38 | Enumeration: LocationOrientation | 232 |
| 5.1.6.3.39 | Enumeration: Direction | 232 |
| 5.1.6.3.40 | Enumeration: ProximityCriterion | 232 |
| 5.1.7 | Error handling | 232 |
| 5.1.7.1 | General | 232 |
| 5.1.7.2 | Protocol Errors | 233 |

| | | |
|-------------|--|-----|
| 5.1.8 | Feature negotiation | 233 |
| 5.1.9 | Security | 237 |
| 5.2 | Nnwdaf_AnalyticsInfo Service API | 238 |
| 5.2.1 | Introduction | 238 |
| 5.2.2 | Usage of HTTP | 238 |
| 5.2.2.1 | General | 238 |
| 5.2.2.2 | HTTP standard headers | 238 |
| 5.2.2.2.1 | General | 238 |
| 5.2.2.2.2 | Content type | 238 |
| 5.2.2.3 | HTTP custom headers | 239 |
| 5.2.3 | Resources | 239 |
| 5.2.3.1 | Resource Structure | 239 |
| 5.2.3.2 | Resource: NWDAF Analytics | 239 |
| 5.2.3.2.1 | Description | 239 |
| 5.2.3.2.2 | Resource definition | 239 |
| 5.2.3.2.3 | Resource Standard Methods | 240 |
| 5.2.3.2.3.1 | GET | 240 |
| 5.2.3.2.4 | Resource Custom Operations | 240 |
| 5.2.3.3 | Resource: NWDAF Context | 241 |
| 5.2.3.3.1 | Description | 241 |
| 5.2.3.3.2 | Resource definition | 241 |
| 5.2.3.3.3 | Resource Standard Methods | 241 |
| 5.2.3.3.3.1 | GET | 241 |
| 5.2.4 | Custom Operations without associated resources | 242 |
| 5.2.5 | Notifications | 242 |
| 5.2.6 | Data Model | 242 |
| 5.2.6.1 | General | 242 |
| 5.2.6.2 | Structured data types | 250 |
| 5.2.6.2.1 | Introduction | 250 |
| 5.2.6.2.2 | Type AnalyticsData | 251 |
| 5.2.6.2.3 | Type EventFilter | 255 |
| 5.2.6.2.4 | Type Void | 262 |
| 5.2.6.2.5 | Type AdditionInfoAnalyticsInfoRequest | 262 |
| 5.2.6.2.6 | Type ContextData | 262 |
| 5.2.6.2.7 | Type ContextElement | 263 |
| 5.2.6.2.8 | Type ContextIdList | 265 |
| 5.2.6.2.9 | Type HistoricalData | 265 |
| 5.2.6.2.10 | Type SpecificAnalyticsSubscription | 266 |
| 5.2.6.2.11 | Type RequestedContext | 266 |
| 5.2.6.2.12 | Type SmcceInfo | 266 |
| 5.2.6.2.13 | Type SmcceUeList | 267 |
| 5.2.6.2.14 | Type SpecificDataSubscription | 267 |
| 5.2.6.2.15 | Type UserDataCongestReq | 268 |
| 5.2.6.2.16 | Type NetworkPerfReq | 268 |
| 5.2.6.2.17 | Type ResourceUsageRequPerNwPerfType | 268 |
| 5.2.6.2.18 | Type AnalyticsAccuracyInfo | 269 |
| 5.2.6.2.19 | Type GroundTruthInfo | 269 |
| 5.2.6.2.20 | Type MIModelAccuracyInfo | 269 |
| 5.2.6.3 | Simple data types and enumerations | 270 |
| 5.2.6.3.1 | Introduction | 270 |
| 5.2.6.3.2 | Simple data types | 270 |
| 5.2.6.3.3 | Enumeration: EventId | 271 |
| 5.2.6.3.4 | Enumeration: ContextType | 272 |
| 5.2.6.3.5 | Enumeration: AdrfDataType | 272 |
| 5.2.6.4 | Data types describing alternative data types or combinations of data types | 272 |
| 5.2.6.4.1 | Type ProblemDetailsAnalyticsInfoRequest | 272 |
| 5.2.7 | Error handling | 272 |
| 5.2.7.1 | General | 272 |
| 5.2.7.2 | Protocol Errors | 273 |
| 5.2.8 | Feature negotiation | 273 |
| 5.2.9 | Security | 277 |
| 5.3 | Nnwdaf_DataManagement Service API | 277 |

| | | |
|-------------|--|-----|
| 5.3.1 | Introduction..... | 277 |
| 5.3.2 | Usage of HTTP..... | 278 |
| 5.3.2.1 | General..... | 278 |
| 5.3.2.2 | HTTP standard headers..... | 278 |
| 5.3.2.2.1 | General..... | 278 |
| 5.3.2.2.2 | Content type..... | 278 |
| 5.3.2.3 | HTTP custom headers..... | 278 |
| 5.3.3 | Resources..... | 278 |
| 5.3.3.1 | Resource Structure..... | 278 |
| 5.3.3.2 | Resource: NWDAF Data Management Subscriptions..... | 279 |
| 5.3.3.2.1 | Description..... | 279 |
| 5.3.3.2.2 | Resource Definition..... | 279 |
| 5.3.3.2.3 | Resource Standard Methods..... | 280 |
| 5.3.3.2.3.1 | POST..... | 280 |
| 5.3.3.2.4 | Resource Custom Operations..... | 280 |
| 5.3.3.3 | Resource: Individual NWDAF Data Management Subscription..... | 280 |
| 5.3.3.3.1 | Description..... | 280 |
| 5.3.3.3.2 | Resource definition..... | 280 |
| 5.3.3.3.3 | Resource Standard Methods..... | 281 |
| 5.3.3.3.3.1 | PUT..... | 281 |
| 5.3.3.3.3.2 | DELETE..... | 282 |
| 5.3.3.3.4 | Resource Custom Operations..... | 283 |
| 5.3.4 | Custom Operations without associated resources..... | 283 |
| 5.3.5 | Notifications..... | 284 |
| 5.3.5.1 | General..... | 284 |
| 5.3.5.2 | Event Notification..... | 284 |
| 5.3.5.2.1 | Description..... | 284 |
| 5.3.5.2.2 | Operation Definition..... | 284 |
| 5.3.5.3 | Fetch Notification..... | 285 |
| 5.3.5.3.1 | Description..... | 285 |
| 5.3.5.3.2 | Target URI..... | 285 |
| 5.3.5.3.3 | Standard Methods..... | 285 |
| 5.3.5.3.3.1 | POST..... | 285 |
| 5.3.6 | Data Model..... | 286 |
| 5.3.6.1 | General..... | 286 |
| 5.3.6.2 | Structured data types..... | 288 |
| 5.3.6.2.1 | Introduction..... | 288 |
| 5.3.6.2.2 | Type NnwdafDataManagementSubsc..... | 289 |
| 5.3.6.2.3 | Type NnwdafDataManagementNotif..... | 293 |
| 5.3.6.3 | Simple data types and enumerations..... | 293 |
| 5.3.6.3.1 | Introduction..... | 293 |
| 5.3.6.3.2 | Simple data types..... | 294 |
| 5.3.6.3.3 | Enumeration: PendingNotificationCause..... | 294 |
| 5.3.7 | Error handling..... | 294 |
| 5.3.7.1 | General..... | 294 |
| 5.3.7.2 | Protocol Errors..... | 294 |
| 5.3.7.3 | Application Errors..... | 294 |
| 5.3.8 | Feature negotiation..... | 295 |
| 5.3.9 | Security..... | 295 |
| 5.4 | Nnwdaf_MLModelProvision Service API..... | 295 |
| 5.4.1 | Introduction..... | 295 |
| 5.4.2 | Usage of HTTP..... | 296 |
| 5.4.2.1 | General..... | 296 |
| 5.4.2.2 | HTTP standard headers..... | 296 |
| 5.4.2.2.1 | General..... | 296 |
| 5.4.2.2.2 | Content type..... | 296 |
| 5.4.2.3 | HTTP custom headers..... | 296 |
| 5.4.3 | Resources..... | 296 |
| 5.4.3.1 | Resource Structure..... | 296 |
| 5.4.3.2 | Resource: NWDAF ML Model Provision Subscriptions..... | 297 |
| 5.4.3.2.1 | Description..... | 297 |
| 5.4.3.2.2 | Resource definition..... | 297 |

| | | |
|-------------|--|-----|
| 5.4.3.2.3 | Resource Standard Methods | 297 |
| 5.4.3.2.3.1 | POST | 297 |
| 5.4.3.2.4 | Resource Custom Operations | 298 |
| 5.4.3.3 | Resource: Individual NWDAF ML Model Provision Subscription | 298 |
| 5.4.3.3.1 | Description | 298 |
| 5.4.3.3.2 | Resource definition | 298 |
| 5.4.3.3.3 | Resource Standard Methods | 298 |
| 5.4.3.3.3.1 | PUT | 298 |
| 5.4.3.3.3.2 | DELETE | 300 |
| 5.4.3.3.4 | Resource Custom Operations | 301 |
| 5.4.4 | Custom Operations without associated resources | 301 |
| 5.4.5 | Notifications | 301 |
| 5.4.5.1 | General | 301 |
| 5.4.5.2 | Event Notification | 301 |
| 5.4.5.2.1 | Description | 301 |
| 5.4.5.2.2 | Operation Definition | 302 |
| 5.4.6 | Data Model | 303 |
| 5.4.6.1 | General | 303 |
| 5.4.6.2 | Structured data types | 304 |
| 5.4.6.2.1 | Introduction | 304 |
| 5.4.6.2.2 | Type NwdafMLModelProvSubsc | 305 |
| 5.4.6.2.3 | Type MLEventSubscription | 306 |
| 5.4.6.2.4 | Void | 307 |
| 5.4.6.2.5 | Type NwdafMLModelProvNotif | 307 |
| 5.4.6.2.6 | Type MLEventNotif | 308 |
| 5.4.6.2.7 | Type FailureEventInfoForMLModel | 310 |
| 5.4.6.2.8 | Type MLModelAddr | 310 |
| 5.4.6.2.9 | Void | 310 |
| 5.4.6.2.10 | Void | 310 |
| 5.4.6.2.11 | Type MLRepEventCondition | 310 |
| 5.4.6.2.12 | Type InputDataInfo | 311 |
| 5.4.6.2.13 | Type ModelProvisionParamsExt | 312 |
| 5.4.6.2.14 | Type AdditionalMLModelInformation | 313 |
| 5.4.6.2.15 | Type MLModelAdrf | 313 |
| 5.4.6.2.16 | Type TrainInputDataInfo | 314 |
| 5.4.6.2.17 | Type InferenceDataForModelTrain | 314 |
| 5.4.6.3 | Simple data types and enumerations | 314 |
| 5.4.6.3.1 | Introduction | 314 |
| 5.4.6.3.2 | Simple data types | 314 |
| 5.4.6.3.3 | Enumeration: FailureCode | 315 |
| 5.4.6.3.4 | Enumeration: MLModelMetric | 315 |
| 5.4.7 | Error handling | 315 |
| 5.4.7.1 | General | 315 |
| 5.4.7.2 | Protocol Errors | 315 |
| 5.4.7.3 | Application Errors | 315 |
| 5.4.8 | Feature negotiation | 316 |
| 5.4.9 | Security | 316 |
| 5.5 | Nnwdaf_MLModelTraining Service API | 316 |
| 5.5.1 | Introduction | 316 |
| 5.5.2 | Usage of HTTP | 317 |
| 5.5.2.1 | General | 317 |
| 5.5.2.2 | HTTP standard headers | 317 |
| 5.5.2.2.1 | General | 317 |
| 5.5.2.2.2 | Content type | 317 |
| 5.5.2.3 | HTTP custom headers | 317 |
| 5.5.3 | Resources | 317 |
| 5.5.3.1 | Resource Structure | 317 |
| 5.5.3.2 | Resource: NWDAF ML Model Training Subscriptions | 318 |
| 5.5.3.2.1 | Description | 318 |
| 5.5.3.2.2 | Resource definition | 318 |
| 5.5.3.2.3 | Resource Standard Methods | 318 |
| 5.5.3.2.3.1 | POST | 318 |

| | | |
|-------------|---|-----|
| 5.5.3.2.4 | Resource Custom Operations | 319 |
| 5.5.3.3 | Resource: Individual NWDAF ML Model Training Subscription..... | 319 |
| 5.5.3.3.1 | Description | 319 |
| 5.5.3.3.2 | Resource definition..... | 319 |
| 5.5.3.3.3 | Resource Standard Methods | 320 |
| 5.5.3.3.3.1 | PUT..... | 320 |
| 5.5.3.3.3.2 | PATCH | 321 |
| 5.5.3.3.3.3 | DELETE | 322 |
| 5.5.3.3.4 | Resource Custom Operations | 323 |
| 5.5.4 | Custom Operations without associated resources | 323 |
| 5.5.5 | Notifications | 323 |
| 5.5.5.1 | General | 323 |
| 5.5.5.2 | Event Notification | 323 |
| 5.5.5.2.1 | Description | 323 |
| 5.5.5.2.2 | Operation Definition..... | 323 |
| 5.5.6 | Data Model | 324 |
| 5.5.6.1 | General | 324 |
| 5.5.6.2 | Structured data types | 326 |
| 5.5.6.2.1 | Introduction | 326 |
| 5.5.6.2.2 | Type NwdafMLModelTrainSubsc..... | 327 |
| 5.5.6.2.3 | Type NwdafMLModelTrainSubscPatch..... | 330 |
| 5.5.6.2.5 | Type MLModelTrainInfo | 331 |
| 5.5.6.2.6 | Type MLTrainReportInfo..... | 331 |
| 5.5.6.2.7 | Type FailureEventInfoForMLModelTrain | 331 |
| 5.5.6.2.8 | Type NwdafMLModelTrainNotif..... | 332 |
| 5.5.6.2.9 | Void..... | 333 |
| 5.5.6.2.10 | Type DataAvReq | 333 |
| 5.5.6.2.11 | Type DelayEventNotif..... | 333 |
| 5.5.6.2.12 | Type StatusReportInfo..... | 333 |
| 5.5.6.2.13 | Type TrainDataInfo | 334 |
| 5.5.6.3 | Simple data types and enumerations | 334 |
| 5.5.6.3.1 | Introduction | 334 |
| 5.5.6.3.2 | Simple data types..... | 334 |
| 5.5.6.3.3 | Enumeration: FailureCodeTrain | 334 |
| 5.5.6.3.4 | Enumeration: TermTrainCause | 335 |
| 5.5.6.3.5 | Enumeration: DelayCause | 335 |
| 5.5.7 | Error handling | 335 |
| 5.5.7.1 | General | 335 |
| 5.5.7.2 | Protocol Errors | 335 |
| 5.5.7.3 | Application Errors | 335 |
| 5.5.8 | Feature negotiation | 336 |
| 5.5.9 | Security | 336 |
| 5.6 | Nnwdaf_MLModelMonitor Service API | 336 |
| 5.6.1 | Introduction..... | 336 |
| 5.6.2 | Usage of HTTP | 337 |
| 5.6.2.1 | General | 337 |
| 5.6.2.2 | HTTP standard headers | 337 |
| 5.6.2.2.1 | General | 337 |
| 5.6.2.2.2 | Content type | 337 |
| 5.6.2.3 | HTTP custom headers | 337 |
| 5.6.3 | Resources..... | 337 |
| 5.6.3.1 | Resource Structure | 337 |
| 5.6.3.2 | Resource: NWDAF ML model monitoring registrations | 338 |
| 5.6.3.2.1 | Description | 338 |
| 5.6.3.2.2 | Resource Definition..... | 338 |
| 5.6.3.2.3 | Resource Standard Methods | 339 |
| 5.6.3.2.3.1 | POST..... | 339 |
| 5.6.3.2.4 | Resource Custom Operations | 339 |
| 5.6.3.3 | Resource: Individual NWDAF ML model monitoring registration | 339 |
| 5.6.3.3.1 | Description | 339 |
| 5.6.3.3.2 | Resource definition..... | 340 |
| 5.6.3.3.3 | Resource Standard Methods | 340 |

| | | |
|-------------|---|-----|
| 5.6.3.3.3.1 | DELETE | 340 |
| 5.6.3.3.4 | Resource Custom Operations | 341 |
| 5.6.3.4 | Resource: NWDAF ML model monitoring Subscriptions | 341 |
| 5.6.3.4.1 | Description | 341 |
| 5.6.3.4.2 | Resource Definition | 341 |
| 5.6.3.4.3 | Resource Standard Methods | 341 |
| 5.6.3.4.3.1 | POST | 341 |
| 5.6.3.4.4 | Resource Custom Operations | 342 |
| 5.6.3.5 | Resource: Individual NWDAF ML model monitoring Subscription | 342 |
| 5.6.3.5.1 | Description | 342 |
| 5.6.3.5.2 | Resource definition | 342 |
| 5.6.3.5.3 | Resource Standard Methods | 343 |
| 5.6.3.5.3.1 | PUT | 343 |
| 5.6.3.5.3.2 | DELETE | 344 |
| 5.6.3.5.4 | Resource Custom Operations | 345 |
| 5.6.4 | Custom Operations without associated resources | 345 |
| 5.6.5 | Notifications | 345 |
| 5.6.5.1 | General | 345 |
| 5.6.5.2 | Event Notification | 345 |
| 5.6.5.2.1 | Description | 345 |
| 5.6.5.2.2 | Operation Definition | 345 |
| 5.6.6 | Data Model | 347 |
| 5.6.6.1 | General | 347 |
| 5.6.6.2 | Structured data types | 347 |
| 5.6.6.2.1 | Introduction | 347 |
| 5.6.6.2.2 | Type MLModelMonitorReg | 348 |
| 5.6.6.2.3 | Type MLModelMonitorSub | 349 |
| 5.6.6.2.4 | Type MLModelMonitorNotify | 350 |
| 5.6.6.2.5 | Type MLModelAccuracyInfo | 351 |
| 5.6.6.2.6 | Type AnalyticsFeedback | 351 |
| 5.6.7 | Error handling | 352 |
| 5.6.7.1 | General | 352 |
| 5.6.7.2 | Protocol Errors | 352 |
| 5.6.7.3 | Application Errors | 352 |
| 5.6.8 | Feature negotiation | 352 |
| 5.6.9 | Security | 352 |
| 5.7 | Nnwdaf_RoamingData Service API | 352 |
| 5.7.1 | Introduction | 352 |
| 5.7.2 | Usage of HTTP | 353 |
| 5.7.2.1 | General | 353 |
| 5.7.2.2 | HTTP standard headers | 353 |
| 5.7.2.2.1 | General | 353 |
| 5.7.2.2.2 | Content type | 353 |
| 5.7.2.3 | HTTP custom headers | 353 |
| 5.7.3 | Resources | 353 |
| 5.7.3.1 | Resource Structure | 353 |
| 5.7.3.2 | Resource: NWDAF Roaming Data Subscriptions | 354 |
| 5.7.3.2.1 | Description | 354 |
| 5.7.3.2.2 | Resource Definition | 354 |
| 5.7.3.2.3 | Resource Standard Methods | 354 |
| 5.7.3.2.3.1 | POST | 354 |
| 5.7.3.2.4 | Resource Custom Operations | 355 |
| 5.7.3.3 | Resource: Individual NWDAF Roaming Data Subscription | 355 |
| 5.7.3.3.1 | Description | 355 |
| 5.7.3.3.2 | Resource definition | 355 |
| 5.7.3.3.3 | Resource Standard Methods | 356 |
| 5.7.3.3.3.1 | PUT | 356 |
| 5.7.3.3.3.2 | DELETE | 357 |
| 5.7.3.3.4 | Resource Custom Operations | 358 |
| 5.7.4 | Custom Operations without associated resources | 358 |
| 5.7.5 | Notifications | 358 |
| 5.7.5.1 | General | 358 |

| | | |
|---|---|------------|
| 5.7.5.2 | Event Notification | 358 |
| 5.7.5.2.1 | Description | 358 |
| 5.7.5.2.2 | Operation Definition | 358 |
| 5.7.6 | Data Model | 360 |
| 5.7.6.1 | General | 360 |
| 5.7.6.2 | Structured data types | 360 |
| 5.7.6.2.1 | Introduction | 360 |
| 5.7.6.2.2 | Type RoamingDataSub | 361 |
| 5.7.7 | Error handling | 363 |
| 5.7.7.1 | General | 363 |
| 5.7.7.2 | Protocol Errors | 363 |
| 5.7.8 | Feature negotiation | 363 |
| 5.7.9 | Security | 363 |
| 5.8 | Nnwdaf_RoamingAnalytics Service API | 364 |
| 5.8.1 | Introduction | 364 |
| 5.8.2 | Usage of HTTP | 364 |
| 5.8.2.1 | General | 364 |
| 5.8.2.2 | HTTP standard headers | 364 |
| 5.8.2.2.1 | General | 364 |
| 5.8.2.2.2 | Content type | 364 |
| 5.8.2.3 | HTTP custom headers | 364 |
| 5.8.3 | Resources | 365 |
| 5.8.3.1 | Resource Structure | 365 |
| 5.8.3.2 | Resource: NWDAF Roaming Analytics Subscriptions | 365 |
| 5.8.3.2.1 | Description | 365 |
| 5.8.3.2.2 | Resource Definition | 365 |
| 5.8.3.2.3 | Resource Standard Methods | 366 |
| 5.8.3.2.4 | Resource Custom Operations | 366 |
| 5.8.3.3 | Resource: Individual NWDAF Roaming Analytics Subscription | 367 |
| 5.8.3.3.1 | Description | 367 |
| 5.8.3.3.2 | Resource definition | 367 |
| 5.8.3.3.3 | Resource Standard Methods | 367 |
| 5.8.3.3.4 | Resource Custom Operations | 370 |
| 5.8.4 | Custom Operations without associated resources | 370 |
| 5.8.5 | Notifications | 370 |
| 5.8.5.1 | General | 370 |
| 5.8.5.2 | Roaming Analytics Notification | 370 |
| 5.8.5.2.1 | Description | 370 |
| 5.8.5.2.2 | Operation Definition | 370 |
| 5.8.6 | Data Model | 371 |
| 5.8.6.1 | General | 371 |
| 5.8.6.2 | Structured data types | 372 |
| 5.8.6.2.1 | Introduction | 372 |
| 5.8.6.2.2 | Type RoamingAnalyticsSubscription | 373 |
| 5.8.6.2.3 | Type RoamingAnalyticsNotification | 374 |
| 5.8.7 | Error handling | 374 |
| 5.8.7.1 | General | 374 |
| 5.8.7.2 | Protocol Errors | 374 |
| 5.8.8 | Feature negotiation | 375 |
| 5.8.9 | Security | 375 |
| Annex A (normative): OpenAPI specification | | 376 |
| A.1 | General | 376 |
| A.2 | Nnwdaf_EventsSubscription API | 376 |
| A.3 | Nnwdaf_AnalyticsInfo API | 428 |
| A.4 | Nnwdaf_DataManagement API | 441 |
| A.5 | Nnwdaf_MLModelProvision API | 447 |
| A.6 | Nnwdaf_MLModelTraining API | 454 |

A.7 Nnwdaf_MLModelMonitor API462

A.8 Nnwdaf_RoamingData API468

Annex B (informative): Change history476

History489

Foreword

This Technical Specification has been produced by the 3rd Generation Partnership Project (3GPP).

The contents of the present document are subject to continuing work within the TSG and may change following formal TSG approval. Should the TSG modify the contents of the present document, it will be re-released by the TSG with an identifying change of release date and an increase in version number as follows:

Version x.y.z

where:

- x the first digit:
 - 1 presented to TSG for information;
 - 2 presented to TSG for approval;
 - 3 or greater indicates TSG approved document under change control.
- y the second digit is incremented for all changes of substance, i.e. technical enhancements, corrections, updates, etc.
- z the third digit is incremented when editorial only changes have been incorporated in the document.

1 Scope

The present specification provides the stage 3 definition of the Network Data Analytics Function Services of the 5G System.

The 5G System Architecture is defined in 3GPP TS 23.501 [2]. The stage 2 definition and related procedures for Network Data Analytics Function Services are specified in 3GPP TS 23.288 [17] and 3GPP TS 23.503 [4].

The 5G System stage 3 call flows are provided in 3GPP TS 29.552 [25] and 3GPP TS 29.513 [5].

The Technical Realization of the Service Based Architecture and the Principles and Guidelines for Services Definition are specified in 3GPP TS 29.500 [6] and 3GPP TS 29.501 [7].

The Network Data Analytics Function Services are provided by the Network Data Analytics Function (NWDAF).

2 References

The following documents contain provisions which, through reference in this text, constitute provisions of the present document.

- References are either specific (identified by date of publication, edition number, version number, etc.) or non-specific.
- For a specific reference, subsequent revisions do not apply.
- For a non-specific reference, the latest version applies. In the case of a reference to a 3GPP document (including a GSM document), a non-specific reference implicitly refers to the latest version of that document *in the same Release as the present document*.

- [1] 3GPP TR 21.905: "Vocabulary for 3GPP Specifications".
- [2] 3GPP TS 23.501: "System Architecture for the 5G System; Stage 2".
- [3] Void.
- [4] 3GPP TS 23.503: "Policy and Charging Control Framework for the 5G System; Stage 2".
- [5] 3GPP TS 29.513: "5G System; Policy and Charging Control signalling flows and QoS parameter mapping; Stage 3".
- [6] 3GPP TS 29.500: "5G System; Technical Realization of Service Based Architecture; Stage 3".
- [7] 3GPP TS 29.501: "5G System; Principles and Guidelines for Services Definition; Stage 3".
- [8] 3GPP TS 29.571: "5G System; Common Data Types for Service Based Interfaces; Stage 3".
- [9] IETF RFC 9113: "HTTP/2".
- [10] IETF RFC 8259: "The JavaScript Object Notation (JSON) Data Interchange Format".
- [11] OpenAPI: "OpenAPI Specification Version 3.0.0", <https://spec.openapis.org/oas/v3.0.0>
- [12] 3GPP TS 29.510: "5G System; Network Function Repository Services; Stage 3".
- [13] 3GPP TS 33.501: "Security architecture and procedures for 5G system".
- [14] IETF RFC 6749: "The OAuth 2.0 Authorization Framework".
- [15] IETF RFC 9457: "Problem Details for HTTP APIs".
- [16] 3GPP TR 21.900: "Technical Specification Group working methods".
- [17] 3GPP TS 23.288: "Architecture enhancements for 5G System (5GS) to support network data analytics services".

- [18] 3GPP TS 29.554: "5G System; Background Data Transfer Policy Control Service; Stage 3".
- [19] 3GPP TS 29.122: "T8 reference point for Northbound APIs".
- [20] 3GPP TS 29.523: "5G System; Policy Control Event Exposure Service; Stage 3".
- [21] 3GPP TS 29.514: "5G System; Policy Authorization Service; Stage 3".
- [22] 3GPP TS 29.517: "5G System; Application Function (AF) event exposure service".
- [23] 3GPP TS 29.503: "5G System; Unified Data Management Services; Stage 3".
- [24] 3GPP TS 29.531: "5G System; Network Slice Selection Services; Stage 3".
- [25] 3GPP TS 29.552: "5G System; Network Data Analytics signalling flows; Stage 3".
- [26] 3GPP TS 29.574: "5G System; Data Collection Coordination Services; Stage 3".
- [27] 3GPP TS 29.575: "5G System; Analytics Data Repository Services; Stage 3".
- [28] 3GPP TS 29.576: "5G System; Messaging Framework Adaptor Services; Stage 3".
- [29] 3GPP TS 29.508: "5G System; Session Management Event Exposure Service; Stage 3".
- [30] 3GPP TS 29.572: "5G System; Location Management Services; Stage 3".
- [31] IANA: "SMI Network Management Private Enterprise Codes",
<http://www.iana.org/assignments/enterprise-numbers>.
- [32] 3GPP TS 29.522: "5G System; Network Exposure Function Northbound APIs; Stage 3".
- [33] IETF RFC 6733: "Diameter Base Protocol".

3 Definitions and abbreviations

3.1 Definitions

For the purposes of the present document, the terms and definitions given in 3GPP TR 21.905 [1] and the following apply. A term defined in the present document takes precedence over the definition of the same term, if any, in 3GPP TR 21.905 [1].

3.2 Abbreviations

For the purposes of the present document, the abbreviations given in 3GPP TR 21.905 [1] and the following apply. An abbreviation defined in the present document takes precedence over the definition of the same abbreviation, if any, in 3GPP TR 21.905 [1].

| | |
|-------|--|
| 5QI | 5G QoS Identifier |
| ADRF | Analytics Data Repository Function |
| AF | Application Function |
| AI/ML | Artificial Intelligence/Machine Learning |
| AMF | Access and Mobility Management Function |
| AOI | Area of Interest |
| API | Application Programming Interface |
| CEF | Charging Enablement Function |
| DCCF | Data Collection Coordination Function |
| DNN | Data Network Name |
| FL | Federated Learning |
| GFBR | Guaranteed Flow Bit Rate |
| GMLC | Gateway Mobile Location Centre |
| HTTP | Hypertext Transfer Protocol |

| | |
|---------|---|
| JSON | JavaScript Object Notation |
| LADN | Local Area Data Network |
| LMF | Location Management Function |
| MFAF | Messaging Framework Adaptor Function |
| ML | Machine Learning |
| MTLF | Model Training Logical Function |
| NEF | Network Exposure Function |
| NF | Network Function |
| NLOS | Non Line Of Sight |
| NRF | Network Repository Function |
| NSSF | Network Slice Selection Function |
| NWDAF | Network Data Analytics Function |
| OAM | Operation, Administration, and Maintenance |
| PCF | Policy Control Function |
| PFD | Packet Flow Description |
| PFDf | Packet Flow Description Function |
| S-NSSAI | Single Network Slice Selection Assistance Information |
| SMCC | Session Management Congestion Control |
| SMCCE | Session Management Congestion Control Experience |
| SMF | Session Management Function |
| SSC | Session and Service Continuity |
| SUPI | Subscription Permanent Identifier |
| UDM | Unified Data Management |
| UPF | User Plane Function |
| URI | Uniform Resource Identifier |
| URSP | UE Route Selection Policy |
| UTC | Universal Time Coordinated |

4 Services offered by the NWDAF

4.1 Introduction

The Nnwdaf services are used by the NWDAF to provide specific analytics information and ML models.

Analytics information is either statistical information of past events, or predictive information.

The following services are specified for the NWDAF:

Table 4.1-1: Services provided by NWDAF

| Service Name | Description | Service Operations | Operation Semantics | Example Consumer (s) |
|------------------------------------|---|--------------------|---------------------|--|
| Nnwdaf_EventsSubscription (NOTE 1) | This service enables the NF service consumers to subscribe to/unsubscribe from notifications for different analytics information from the NWDAF. It also enables the transfer of subscriptions between NWDAFs | Subscribe | Subscribe / Notify | PCF, NSSF, AMF, SMF, NEF, AF, LMF, OAM, CEF, NWDAF, DCCF |
| | | Unsubscribe | | |
| | | Notify | | |
| | | Transfer | Request / Response | NWDAF |

| | | | | |
|----------------------------------|--|-----------------|--------------------|---|
| Nnwdaf_AnalyticsInfo | This service enables the NF service consumers to request and get specific analytics or context information related to analytics subscriptions from the NWDAF. | Request | Request / Response | PCF, NSSF, AMF, SMF, NEF, AF, LMF, OAM, NWDAF, DCCF |
| | | ContextTransfer | Request / Response | NWDAF |
| Nnwdaf_DataManagement | This service enables the NF service consumers to subscribe to/unsubscribe from notifications when subscribed event(s) are detected or retrieve the subscribed data from the NWDAF. | Subscribe | Subscribe / Notify | NWDAF, DCCF, MFAF |
| | | Unsubscribe | | |
| | | Notify | | |
| Nnwdaf_MLModelProvision (NOTE 2) | This service enables the NF service consumers to subscribe to/unsubscribe from notifications when a ML model matching the subscription parameters becomes available. | Fetch | Request / Response | NWDAF, DCCF, MFAF |
| | | Subscribe | Subscribe / Notify | NWDAF |
| Unsubscribe | | | | |
| | | Notify | | |

| | | | | |
|--|--|--------------------|-----------------------|---------------------------|
| Nnwdaf_MLModelTraining (NOTE 3) | This service enables the NF service consumers to subscribe to/unsubscribe/modify from notifications for a ML model training. | Subscribe | Subscribe / Notify | NWDAF |
| | | Unsubscribe | | |
| | | Notify | | |
| Nnwdaf_MLModelMonitor | This service enables the NF service consumer to subscribe/unsubscribe for ML model accuracy, provide Analytics feedback information for the analytics generated by an NWDAF and enable the NWDAF containing AnLF registers the use and monitoring capability for an ML model into the model provider NWDAF | Subscribe | Subscribe / Notify | NWDAF |
| | | Unsubscribe | | |
| | | Notify | | |
| | | Register | Request / Response | |
| | | Deregister | | |
| Nnwdaf_RoamingData | This service enables the consumer to subscribe/unsubscribe for input data related to roaming UE(s) for NWDAF analytics. | Subscribe | Subscribe / Notify | H-RE-NWDAF, V-RE-NWDAF |
| | | Unsubscribe | | |
| | | Notify | | |
| Nnwdaf_RoamingAnalytics | This service enables the NF service consumers to subscribe (or modify subscriptions) to and unsubscribe from notifications for network data analytics related to roaming UE(s). | Subscribe (NOTE 4) | Subscribe / Notify | H-RE-NWDAF, V-RE-NWDAF |
| | | Unsubscribe | | |
| | | Notify | | |
| <p>NOTE 1: This service corresponds to the Nnwdaf_AnalyticsSubscription service defined in 3GPP TS 23.288 [17].</p> <p>NOTE 2: This service implements also the Nnwdaf_MLModelInfo service as specified in 3GPP TS 23.288 [17] by using immediate and one-time reporting requirement.</p> <p>NOTE 3: This service implements also the Nnwdaf_MLModelTrainingInfo service as specified in 3GPP TS 23.288 [17] by using immediate and one-time reporting requirement.</p> <p>NOTE 4: The Nnwdaf_RoamingAnalytics_Subscribe service operation implements also the Nnwdaf_RoamingAnalytics_Request service operation specified in 3GPP TS 23.288 [17] by using immediate and one-time reporting requirement.</p> | | | | |

Table 4.1-2 summarizes the corresponding APIs defined in this specification.

Table 4.1-2: API Descriptions

| Service Name | Clause | Description | OpenAPI Specification File | apiName | Annex |
|---------------------------|--------|--------------------------------------|--|---------------------------|-------|
| Nnwdaf_EventsSubscription | 5.1 | Nnwdaf Events Subscription Service. | TS29520_Nnwdaf_EventsSubscription.yaml | nnwdaf-eventssubscription | A.2 |
| Nnwdaf_AnalyticsInfo | 5.2 | Nnwdaf Analytics Information Service | TS29520_Nnwdaf_AnalyticsInfo.yaml | nnwdaf-analyticsinfo | A.3 |
| Nnwdaf_DataManagement | 5.3 | NWDAF Data Management Service | TS29520_Nnwdaf_DataManagement.yaml | nnwdaf-datamanagement | A.4 |
| Nnwdaf_MLModelProvision | 5.4 | NWDAF ML Model Provision Service | TS29520_Nnwdaf_MLModelProvision.yaml | nnwdaf-mlmodelprovision | A.5 |
| Nnwdaf_MLModelTraining | 5.5 | NWDAF ML Model Training Service | TS29520_Nnwdaf_MLModelTraining.yaml | nnwdaf-mlmodeltraining | A.6 |
| Nnwdaf_MLModelMonitor | 5.6 | NWDAF ML model monitoring Service | TS29520_Nnwdaf_MLModelMonitoring.yaml | nnwdaf-mlmodelmonitor | A.7 |
| Nnwdaf_RoamingData | 5.7 | NWDAF Roaming Data Service | TS29520_Nnwdaf_RoamingData.yaml | nnwdaf-roamingdata | A.8 |
| Nnwdaf_RoamingAnalytics | 5.8 | NWDAF Roaming Analytics service | TS29520_Nnwdaf_RoamingAnalytics.yaml | nnwdaf-roaminganalytics | A.9 |

4.2 Nnwdaf_EventsSubscription Service

4.2.1 Service Description

4.2.1.1 Overview

The Nnwdaf_EventsSubscription service corresponding to Nnwdaf_AnalyticsSubscription service as defined in 3GPP TS 23.501 [2], 3GPP TS 23.288 [17] and 3GPP TS 23.503 [4], is provided by the Network Data Analytics Function (NWDAF).

This service:

- allows NF service consumers to subscribe to and unsubscribe from different analytics events;
- notifies NF service consumers with a corresponding subscription about observed events. and
- allows NF service consumers to request the transfer of subscriptions for analytics events.

The types of observed events include:

- Slice load level information;
- Network slice instance load level information;
- Service experience;
- NF load;
- Network performance;
- Abnormal behaviour;
- UE mobility;
- UE communication;
- User data congestion;
- QoS sustainability;

- Dispersion;
- Redundant transmission experience;
- SM congestion control experience;
- WLAN performance;
- DN performance;
- PFD determination;
- PDU Session traffic.
- Movement Behaviour;
- Location Accuracy;
- Relative Proximity.
- End-to-end data volume transfer time.

4.2.1.2 Service Architecture

The 5G System Architecture is defined in 3GPP TS 23.501 [2]. The Network Data Analytics Exposure architecture is defined in 3GPP TS 23.288 [17]. The Network Data Analytics signalling flows are defined in 3GPP TS 29.552 [25], the Policy and Charging related 5G architecture is also described in 3GPP TS 23.503 [4] and 3GPP TS 29.513 [5].

The Nnwdaf_EventsSubscription service is part of the Nnwdaf service-based interface exhibited by the Network Data Analytics Function (NWDAF).

Known consumers of the Nnwdaf_EventsSubscription service are:

- Policy Control Function (PCF)
- Network Slice Selection Function (NSSF)
- Access and Mobility Management Function (AMF)
- Session Management Function (SMF)
- Network Exposure Function (NEF)
- Application Function (AF)
- Location Management Function (LMF)
- Operation, Administration, and Maintenance (OAM)
- Charging Enablement Function (CEF)
- Network Data Analytics Function (NWDAF)
- Data Collection Coordination Function (DCCF)

The PCF accesses the Nnwdaf_EventsSubscription service at the NWDAF via the N23 Reference point. The NSSF accesses the Nnwdaf_EventsSubscription service at the NWDAF via the N34 Reference point.

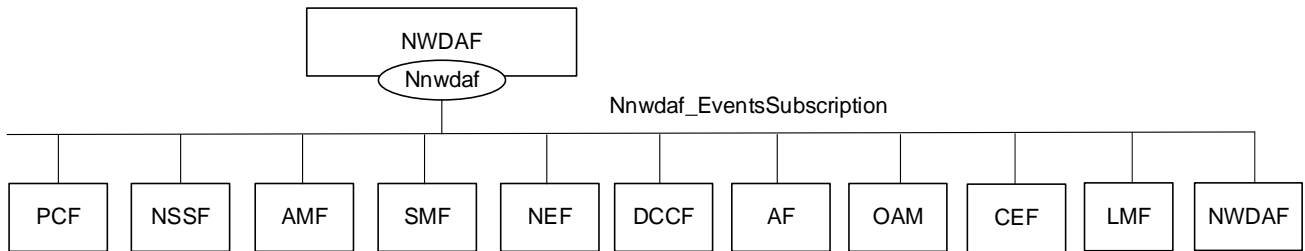

Figure 4.2.1.2-1: Reference Architecture for the Nnwdaf_EventsSubscription Service; SBI representation

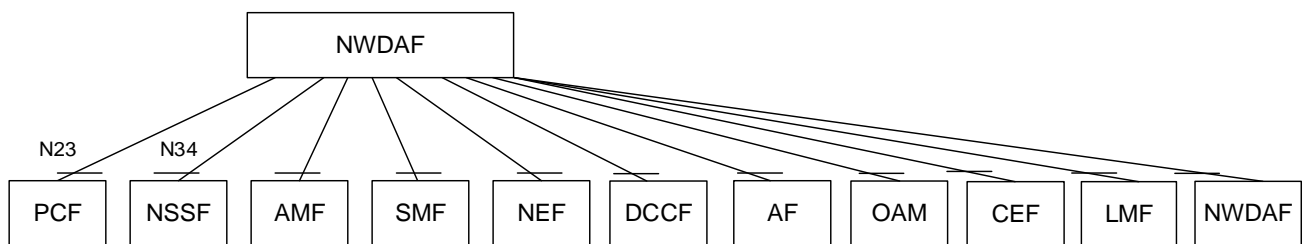

Figure 4.2.1.2-2: Reference Architecture for the Nnwdaf_EventsSubscription Service: reference point representation

NOTE: When the NEF subscribes the PFD Determination Analytics to the NWDAF, the NEF needs to support PFD function as NEF (PFD).

4.2.1.3 Network Functions

4.2.1.3.1 Network Data Analytics Function (NWDAF)

The Network Data Analytics Function (NWDAF) provides analytics information for different analytics events to NF service consumers.

The Network Data Analytics Function (NWDAF) allows NF service consumers to subscribe to and unsubscribe from one-time, periodic notification or notification when an event is detected.

The Network Data Analytics Function (NWDAF) allows NF service consumers to request the transfer of subscriptions for analytics events.

4.2.1.3.2 NF Service Consumers

The Policy Control Function (PCF):

- supports (un)subscription to the notification of analytics information for slice load level information from the NWDAF;
- supports (un)subscription to the notification of analytics information for service experience related network data from the NWDAF;
- supports (un)subscription to the notification of analytics information for network performance from the NWDAF;
- supports (un)subscription to the notification of analytics information for abnormal UE behaviour from the NWDAF;
- supports (un)subscription to the notification of analytics information for UE mobility from the NWDAF;
- supports (un)subscription to the notification of analytics information for UE communication from the NWDAF;

- supports (un)subscription to the notification of analytics information for user data congestion from the NWDAF;
- supports (un)subscription to the notification of analytics information for dispersion from the NWDAF;
- supports (un)subscription to the notification of analytics information for session management congestion control experience from the NWDAF;
- supports (un)subscription to the notification of analytics information for redundant transmission experience from the NWDAF;
- supports (un)subscription to the notification of analytics information for DN performance from the NWDAF;
- supports (un)subscription to the notification of analytics information for WLAN performance from the NWDAF;
- supports (un)subscription to the notification of analytics information for PDU Session traffic from the NWDAF; and
- supports taking one or more above input from the NWDAF into consideration for policies on assignment of network resources and/or for traffic steering policies.

NOTE: How this information is used by the PCF is not standardized in this specification.

The Network Slice Selection Function (NSSF):

- supports (un)subscription to the notification of analytics information for slice load level information or network slice instance load level information from the NWDAF to determine slice selection;
- supports (un)subscription to the notification of analytics information for service experience related network data from the NWDAF; and
- supports (un)subscription to the notification of analytics information for dispersion at the slice from the NWDAF.

The Access and Mobility Management Function (AMF):

- supports (un)subscription to the notification of analytics information for slice load level information from the NWDAF;
- supports (un)subscription to the notification of analytics information for service experience related network data from the NWDAF;
- supports (un)subscription to the notification of analytics information for SMF load information from the NWDAF to determine SMF selection;-supports (un)subscription to the notification of analytics information for expected UE behavioural information (UE mobility and/or UE communication) from the NWDAF to monitor UE behaviour;
- supports (un)subscription to the notification of analytics information for abnormal UE behaviour information from the NWDAF to determine adjustment of UE mobility related network parameters to solve the abnormal risk; and
- supports (un)subscription to the notification of analytics information for dispersion at the slice from the NWDAF.

The Session Management Function (SMF):

- supports (un)subscription to the notification of analytics information for UPF load information from the NWDAF to determine UPF selection;
- supports (un)subscription to the notification of analytics information for UE mobility information from the NWDAF to determine UPF selection;
- supports (un)subscription to the notification of analytics information for Session Management Congestion Control Experience from the NWDAF;
- supports (un)subscription to the notification of analytics information for expected UE behavioural information (UE mobility and/or UE communication) from the NWDAF to monitor UE behaviour;

- supports (un)subscription to the notification of analytics information for abnormal UE behaviour information from the NWDAF to determine adjustment of UE communication related network parameters to solve the abnormal risk;
- supports (un)subscription to the notification of analytics information for slice load level information or network slice instance load level information from the NWDAF to determine slice selection.
- supports (un)subscription to the notification of analytics information for service experience related network data from the NWDAF;
- supports (un)subscription to the notification of analytics information for redundant transmission experience from the NWDAF to consider whether redundant transmission shall be performed, or (if it had been activated) shall be stopped; and
- supports (un)subscription to the notification of analytics information for DN performance from the NWDAF.

The Network Exposure Function (NEF):

- supports (un)subscription to the notification of analytics information for UE mobility from the NWDAF;
- supports (un)subscription to the notification of analytics information for UE communication from the NWDAF;
- supports (un)subscription to the notification of analytics information for expected UE behavioural (UE mobility and/or UE communication) from the NWDAF;
- supports (un)subscription to the notification of analytics information for abnormal behaviour from the NWDAF;
- supports (un)subscription to the notification of analytics information for user data congestion from the NWDAF;
- supports (un)subscription to the notification of analytics information for network performance from the NWDAF;
- supports (un)subscription to the notification of analytics information for QoS Sustainability from the NWDAF;
- supports (un)subscription to the notification of analytics information for Dispersion from the NWDAF;
- supports (un)subscription to the notification of analytics information for DN performance from the NWDAF;
- supports (un)subscription to the notification of analytics information for WLAN performance from the NWDAF;
- supports (un)subscription to the notification of analytics information for Observed Service Experience from NWDAF;
- with PFDF function supports (un)subscription to the notification of analytics information for NWDAF assisted PFD Determination from the NWDAF;
- supports (un)subscription to the notification of analytics information for E2E data volume transfer time from NWDAF;
- supports (un)subscription to the notification of analytics information for Relative Proximity from NWDAF; and
- supports (un)subscription to the notification of analytics information for movement behaviour from NWDAF.

The Application Function (AF):

- supports receiving UE mobility information from NWDAF or via the NEF;
- supports receiving UE communication information from NWDAF or via the NEF;
- supports receiving expected UE behavioural information (UE mobility and/or UE communication) from NWDAF or via the NEF;
- supports receiving abnormal behaviour information from the NWDAF or via the NEF;
- supports receiving user data congestion information from the NWDAF or via the NEF;
- supports receiving network performance information from the NWDAF or via the NEF;

- supports receiving QoS Sustainability information from the NWDAF or via the NEF;
- supports receiving Dispersion information from the NWDAF or via the NEF;
- supports receiving DN performance information from the NWDAF or via the NEF;
- supports receiving WLAN performance information from the NWDAF or via the NEF;
- supports receiving Observed Service Experience information from NWDAF or via the NEF;
- supports receiving E2E data volume transfer time from NWDAF or via the NEF;
- supports receiving Movement Behaviour information from NWDAF or via the NEF; and
- supports receiving Relative Proximity information from NWDAF or via the NEF.

The Operation, Administration, and Maintenance (OAM):

- supports receiving slice load level information from the NWDAF;
- supports receiving observed service experience from the NWDAF;
- supports receiving NF load information from the NWDAF;
- supports receiving network performance information from the NWDAF;
- supports receiving UE mobility information from the NWDAF;
- supports receiving UE communication information from the NWDAF;
- supports receiving expected UE behaviour information (UE mobility and/or UE communication) from the NWDAF; and
- supports receiving abnormal UE behaviour information from the NWDAF.

The Charging Enablement Function (CEF):

- supports (un)subscription to the notification of analytics information for slice load level information from the NWDAF; and
- supports (un)subscription to the notification of analytics information for service experience statistics information from the NWDAF.

The Location Management Function (LMF):

- supports (un)subscription to the notification of analytics information for location accuracy analytics from the NWDAF.

The Network Data Analytics Function (NWDAF):

- supports (un)subscription to the notification of analytics information for all types of network analytics from the NWDAF; and
- supports requesting the transfer of subscriptions to another NWDAF.

The Data Collection Coordination Function (DCCF):

- supports (un)subscription to the notification of analytics information for all types of network analytics from the NWDAF.

4.2.2 Service Operations

4.2.2.1 Introduction

Table 4.2.2.1-1: Operations of the Nnwdaf_EventsSubscription Service

| Service operation name | Description | Initiated by |
|---------------------------------------|--|--|
| Nnwdaf_EventsSubscription_Subscribe | This service operation is used by an NF to subscribe or update subscription for event notifications of the analytics information. One-time, periodic notification or notification upon event detected can be subscribed. | NF service consumer (PCF, NSSF, AMF, SMF, NEF, AF, LMF, OAM, CEF, NWDAF, DCCF) |
| Nnwdaf_EventsSubscription_Unsubscribe | This service operation is used by an NF to unsubscribe from event notifications. | NF service consumer (PCF, NSSF, AMF, SMF, NEF, AF, LMF, OAM, CEF, NWDAF, DCCF) |
| Nnwdaf_EventsSubscription_Notify | This service operation is used by an NWDAF to notify NF service consumers about subscribed events. | NWDAF |
| Nnwdaf_EventsSubscription_Transfer | This service operation is used by an NWDAF to request the transfer of subscription(s) for analytics events. | NWDAF |

4.2.2.2 Nnwdaf_EventsSubscription_Subscribe service operation

4.2.2.2.1 General

The Nnwdaf_EventsSubscription_Subscribe service operation is used by an NF service consumer to subscribe or update subscription for event notifications from the NWDAF.

4.2.2.2.2 Subscription for event notifications

Figure 4.2.2.2.2-1 shows a scenario where the NF service consumer sends a request to the NWDAF to subscribe for event notification(s) (as shown in 3GPP TS 23.288 [17]).

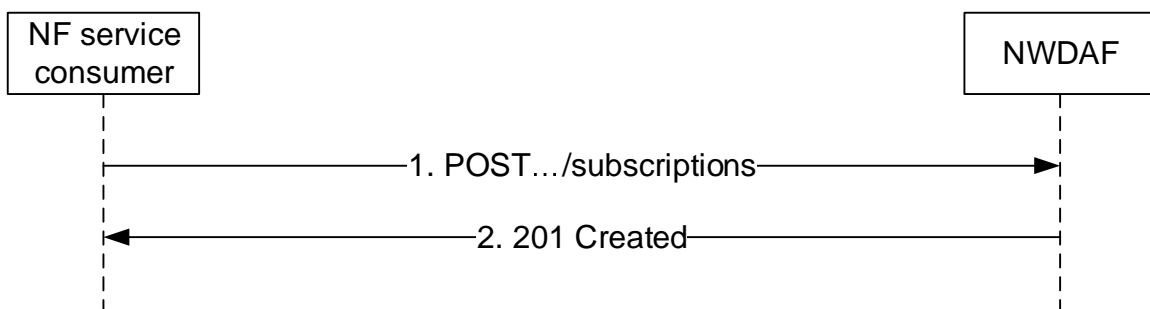

Figure 4.2.2.2.2-1: NF service consumer subscribes to notifications

The NF service consumer shall invoke the Nnwdaf_EventsSubscription_Subscribe service operation to subscribe to event notification(s). The NF service consumer shall send an HTTP POST request with "{apiRoot}/nnwdaf-eventssubscription/<apiVersion>/subscriptions" as Resource URI representing the "NWDAF Events Subscriptions", as shown in figure 4.2.2.2.2-1, step 1, to create a subscription for an "Individual NWDAF Event Subscription" according to the information in message body. The NnwdafEventsSubscription data structure provided in the request body shall include:

- an URI where to receive the requested notifications as "notificationURI" attribute; and
- a description of the subscribed events as "eventSubscriptions" attribute that, for each event, the EventSubscription data type shall include:

- 1) an event identifier as "event" attribute; and
- 2) if the event notification method "PERIODIC" is selected via the "notificationMethod" attribute, repetition period as "repetitionPeriod" attribute;

and the EventSubscription data type may include the "extraReportReq" attribute with the following attributes:

- 1) maximum number of objects in the "maxObjectNbr" attribute;
- 2) maximum number of SUPIs expected for an analytics report in the "maxSupiNbr" attribute;
- 3) identification of time window to which the subscription applies via identification of date-time(s) in the "startTs" and "endTs" attributes;
- 4) preferred level of accuracy of the analytics in the "accuracy" attribute;
- 5) identification of time when analytics information is needed in the "timeAnaNeeded" attribute if the feature "EneNA" is supported;
- 6) indication of which analytics metadata is requested to be delivered with the notification in the "anaMeta" attribute if the feature "Aggregation" is supported;
- 7) requested values for analytics metadata information to be used for the generation of the analytics in the "anaMetaInd" attribute if the feature "Aggregation" is supported;
- 8) offset period to the periodic reporting in the "offsetPeriod" attribute if the feature "EneNA" is supported. It may be present if the "repPeriod" attribute within the "evtReq" attribute or the "repetitionPeriod" attribute within the EventSubscription data type is included;
- 9) preferred accuracy level per analytics subset in the "accPerSubset" attribute if the "listOfAnaSubsets" attribute is present and the "EneNA" feature is supported; and/or
- 10) the time period of historical analytics in the "histAnaTimePeriod" attribute, if the "EneNA" feature is supported.

The NnwdafEventsSubscription data structure provided in the request body may include:

- event reporting information as the "evtReq" attribute, which applies for each event and may contain the following attributes:
 - 1) event notification method (periodic, one time, on event detection) in the "notifMethod" attribute;
 - 2) maximum Number of Reports in the "maxReportNbr" attribute;
 - 3) monitoring duration in the "monDur" attribute;
 - 4) repetition period for periodic reporting in the "repPeriod" attribute;
 - 5) immediate reporting indication in the "immRep" attribute;
 - 6) percentage of sampling among impacted UEs in the "sampRatio" attribute;
 - 7) partitioning criteria for partitioning the impacted UEs before performing sampling as "partitionCriteria" attribute if the "EneNA" feature is supported;
 - 8) group reporting guard time for aggregating the reports for a group of UEs in the "grpRepTime" attribute; and/or
 - 9) a notification flag (used for muting and retrieving notifications) as "notifFlag" attribute if the "EneNA" feature is supported

NOTE 1: The notification method indicated as the "notifMethod" attribute and the periodic reporting time indicated as the "repPeriod" attributes within the event reporting information as the "evtReq" attribute provided in NnwdafEventsSubscription data type, if present, supersedes the event notification method as the "notificationMethod" attribute and repetition period as the "repetitionPeriod" attribute respectively in the EventSubscription data type.

EventSubscription data type.

- information of previous analytics subscription in the "prevSub" attribute if the "AnaCtxTransfer" feature is supported;
- the notification correlation identifier in the "notifCorrId" attribute, if the "EneNA" feature is supported; and/or
- analytics consumer information as "consNfInfo" attribute, if the "AnaSubTransfer" feature is supported;

NOTE 2: The "consNfInfo" attribute enables the NWDAF to determine whether an analytics subscription transfer procedure is applicable. Otherwise, if the "consNfInfo" attribute is not provided in a subscription and the NWDAF cannot serve anymore or transfer this subscription, the NWDAF can notify the analytics consumer with a Termination Request so that the analytics consumer can select a new target NWDAF.

For all the event types, the "eventSubscriptions" attribute may include:

- the analytics accuracy requirement information in "accuReq" attribute as indication to the NWDAF to activate checking the analytics accuracy information of the subscribed event, if the "AnalyticsAccuracy" feature is supported and the NF service consumer discovered or local configured the NWDAF containing an AnLF supporting accuracy checking capability.
- the pause analytics consumption flag in "pauseFlg" attribute if the "AnalyticsAccuracy" feature is supported.
- the resume analytics consumption flag in "resumeFlg" attribute if the "AnalyticsAccuracy" feature is supported.
- use case context as "useCaseCxt" attribute, if the "ENAEExt" feature is supported.

NOTE 3: The NWDAF can use the parameter "Use case context" to select the most relevant ML model, when several ML models are available for the requested Analytics ID(s). The NWDAF containing AnLF can additionally provide the parameter "Use case context" when requesting an ML model from an NWDAF containing MTLF. The values of this parameter are not standardized.

NOTE 4: The subscription for analytics accuracy information independently from subscription of the analytics event output is not supported in this release.

- information related to roaming within the "roamingInfo" attribute if the "RoamingAnalytics" feature is supported;

For different event types, the "eventSubscriptions" attribute:

- if the event is "SLICE_LOAD_LEVEL", shall provide:
 - 1) network slice level load level threshold in the "loadLevelThreshold" attribute if the "notifMethod" attribute in "evtReq" attribute is set to "ON_EVENT_DETECTION" or the "notificationMethod" attribute in "eventSubscriptions" attribute is set to "THRESHOLD" or omitted; and
 - 2) identification of network slice(s) to which the subscription applies via identification of network slice(s) in the "snssais" attribute or any slices indication in the "anySlice" attribute;
- if the feature "NsiLoad" is supported and the event is "NSI_LOAD_LEVEL", shall provide:
 - 1) identification of network slice and the optionally associated network slice instance(s) if available, via the "nsiIdInfos" attribute or any slices indication in the "anySlice" attribute; and

NOTE 5: The network slice instance of a PDU session is not available in the PCF.

- 2) the network slice or network slice instance load level thresholds in the "nsiLevelThrds" attribute if the "notifMethod" attribute in "evtReq" attribute is set to "ON_EVENT_DETECTION" or the "notificationMethod" attribute in "eventSubscriptions" attribute is set to "THRESHOLD" or omitted;

and may include:

- 1) a list of analytics subsets carried by "listOfAnaSubsets" attribute with value(s) only applicable to "NSI_LOAD_LEVEL" event, if the "EneNA" feature is supported;
- 2) identification of network area to which the subscription applies via identification of network area(s) by "networkArea" attribute, if the "NsiLoadExt" feature is supported;

- 3) a matching direction in the "matchingDir" attribute if the "nsiLevelThrds" attribute is provided and the "NsiLoadExt" feature is supported; and/or
 - 4) list of NF instance types in the "nfTypes" attribute, if the "NsiLoadExt" feature is supported.
- if the feature "NfLoad" is supported and the event is "NF_LOAD", shall provide:
- 1) identification of target UE(s) to which the subscription applies by "supis" or "anyUe" attribute set to "true" in the "tgtUe" attribute; and

NOTE 6: Only NF instances of type AMF and SMF which are serving the UE can be determined using a SUPI in "supis" attribute.

NOTE 7: If a list of the NF Instance IDs (or respectively of NF Set IDs) is provided, the NWDAF needs to provide the analytics for each designated NF instance (or respectively for each NF instance belonging to each designated NF Set). In such case the target UE(s) of the Analytics Reporting need be ignored.

- 2) NF load level thresholds in the "nfLoadLvlThds" attribute if the "notifMethod" attribute in "evtReq" attribute is set to "ON_EVENT_DETECTION" or the "notificationMethod" attribute in "eventSubscriptions" attribute is set to "THRESHOLD" or omitted;

and may include:

- 1) either list of NF instance IDs in the "nfInstanceIds" attribute or list of NF set IDs in the "nfSetIds" attribute if the identification of target UE(s) applies to all UEs;
 - 2) list of NF instance types in the "nfTypes" attribute;
 - 3) identification of network slice(s) by "snssais" attribute;
 - 4) a matching direction in the "matchingDir" attribute if the "nfLoadLvlThds" attribute is provided;
 - 5) optional area of interest by "networkArea" attribute, if the "NfLoadExt" feature is supported; and/or
 - 6) an optional list of analytics subsets by "listOfAnaSubsets" attribute with value(s) only applicable to NF_LOAD event, if the "EneNA" feature is supported;
- if the feature "NetworkPerformance" is supported and the event is "NETWORK_PERFORMANCE", it shall provide:
- 1) identification of target UE(s) to which the subscription applies by "supis", "intGroupIds" or "anyUe" attribute set to "true" in the "tgtUe" attribute; and
 - 2) the network performance requirements via "nwPerfRequs" attribute;

and may provide:

- 1) identification of network area to which the subscription applies via identification of network area(s) by "networkArea" attribute (mandatory if "anyUe" attribute is set to true);
 - 2) a matching direction in the "matchingDir" attribute if the "nwPerfRequs" attribute is provided;
 - 3) the spatial granularity size of TA in the "spatialGranSizeTa" attribute if the "NetworkPerformanceExt_eNA" feature is supported;
 - 4) the spatial granularity size of cell in the "spatialGranSizeCell" attribute if the "NetworkPerformanceExt_eNA" feature is supported; and/or
 - 5) the temporal granularity size in the "temporalGranSize" attribute if the "NetworkPerformanceExt_eNA" feature is supported.
- if the feature "ServiceExperience" is supported and the event is "SERVICE_EXPERIENCE", shall provide:
- 1) identification of target UE(s) to which the subscription applies by "supis", "intGroupIds" or "anyUe" attribute set to "true" in the "tgtUe" attribute; and

- 2) any slices indication in the "anySlice" attribute or identification of network slice(s) together with the optionally associated network slice instance(s) if available, via the "nsiIdInfos" attribute;

NOTE 8: The network slice instance of a PDU session is not available in the PCF.

and may provide:

- 1) identification of application to which the subscription applies via identification of application(s) by "appIds" attribute;
 - 2) identification of network area to which the subscription applies via identification of network area(s) by "networkArea" attribute (mandatory if "anyUe" attribute is set to true);
 - 3) identification of DNN to which the subscription applies via identification of application(s) by "dnns" attribute;
 - 4) identification of user plane access to DN(s) which the subscription applies as the "dnais" attribute;
 - 5) identification of a user plane access to one or more DN(s) where applications are deployed by "dnais" attribute;
 - 6) if "appIds" attribute is provided, the bandwidth requirement of each application by "bwReques" attribute;
 - 7) indication of all the RAT types and/or all the frequencies that the NWDAF received for the application or specific RAT type(s) and/or frequency(ies) and the service experience threshold value(s) for the RAT Type(s) and/or Frequency value(s) where the UE camps on by "ratFreqs" attribute if the feature "ServiceExperienceExt" is also supported;
 - 8) a list of analytics subsets carried by "listOfAnaSubsets" attribute with value(s) only applicable to "SERVICE_EXPERIENCE" event, if the "EneNA" feature is supported;
 - 9) the identification of the UPF as the "upfInfo" attribute if the feature "ServiceExperienceExt" is also supported;
 - 10) IP address(s)/FQDN(s) of the Application Server(s) as the "appServerAddrs" attribute if the feature "ServiceExperienceExt" is also supported;
 - 11) combination of PDU Session parameters as the "pduSesInfos" attribute if the feature "ServiceExperienceExt2_eNA" is also supported; and/or
 - 12) preferred granularity of location information as the "locGranularity" attribute if the feature "ServiceExperienceExt2_eNA" is supported; and/or
 - 13) the fine granularity areas as the "fineGranAreas" attribute if the feature "ServiceExperienceExt2_eNA" is supported.
- if the feature "UeMobility" is supported and the event is "UE_MOBILITY", shall provide:
- 1) identification of target UE(s) to which the subscription applies by "supis" or "intGroupIds" attribute in the "tgtUe" attribute;

NOTE 9: For LADN service, the consumer (e.g. SMF) provides the LADN DNN to refer the LADN service area as the AOI.

and may provide:

- 1) identification of network area to which the subscription applies via identification of network area(s) by "networkArea" attribute;
- 2) preferred granularity of location information as the "locGranularity" attribute if the feature "UeMobilityExt2_eNA" is supported.
- 3) identification of the preferred orientation of location information by "locOrientation" attribute if the feature "UeMobilityExt2_eNA" is supported.

- 4) if the feature "UeMobilityExt" is supported,
 - i) identification of LADN DNN in the "ladnDnns" attribute;
 - ii) Visited Area(s) of Interest as the "visitedAreas" attribute;
 - 5) other UE mobility analytics requirements in "ueMobilityReqs" attribute, which may include ordering criterion and ordering direction, if the "UeMobilityExt2_eNA" feature is supported;
 - 6) an optional list of analytics subsets carried by "listOfAnaSubsets" attribute with value(s) only applicable to "UE_MOBILITY" event, if the "UeMobilityExt2_eNA" and "EneNA" features are supported;
 - 7) the spatial granularity size of TA in the "spatialGranSizeTa" attribute if the "UeMobilityExt2_eNA" feature is supported;
 - 8) the spatial granularity size of cell in the "spatialGranSizeCell" attribute if the "UeMobilityExt2_eNA" feature is supported;
 - 9) the fine granularity areas as the "fineGranAreas" attribute if the feature "UeMobilityExt2_eNA" is supported.
- if the feature "UeCommunication" is supported and the event is "UE_COMM", shall provide:
- 1) identification of target UE(s) to which the subscription applies by "supis" or "intGroupIds" attribute in the "tgtUe" attribute;
- and may include:
- 1) identification of the application in the "appIds" attribute;
 - 2) identification of network area to which the subscription applies via identification of network area(s) by "networkArea" attribute;
 - 3) an identification of DNN in the "dnns" attribute;
 - 4) identification of network slice in the "snssais" attribute;
 - 5) a list of analytics subsets carried by "listOfAnaSubsets" attribute with value(s) only applicable to "UE_COMM" event, if the "EneNA" feature is supported;
 - 6) other UE communication analytics requirements in "ueCommReqs" attribute, which may include ordering criterion and ordering direction, if the "EnUeCommunication" feature is supported;
 - 7) the spatial granularity size of TA in the "spatialGranSizeTa" attribute if the "UeCommunicationExt_eNA" feature is supported;
 - 8) the spatial granularity size of cell in the "spatialGranSizeCell" attribute if the "UeCommunicationExt_eNA" feature is supported.
- if the feature "QoS_Sustainability" is supported and the event is "QOS_SUSTAINABILITY", shall provide:
- 1) identification of network area to which the subscription applies via identification of network area by "networkArea" attribute;
 - 2) the QoS requirements via "qosRequ" attribute;
 - 3) QoS flow retainability threshold(s) by the "qosFlowRetThds" attribute for the 5QI of GBR resource type or RAN UE throughout threshold(s) by the "ranUeThrouThds" attribute for the 5QI of non-GBR resource type, if the "notifMethod" attribute in "evtReq" attribute is set to "ON_EVENT_DETECTION" or the "notificationMethod" attribute in "eventSubscriptions" attribute is set to "THRESHOLD" or omitted; and
 - 4) identification of target UE(s) to which the subscription applies by "anyUe" attribute set to "true" in the "tgtUe" attribute;
- and may include:
- 1) identification of network slice(s) by "snssais" attribute;

- 2) a matching direction in the "matchingDir" attribute if the "qosFlowRetThds" attribute or the "ranUeThrouThds" attribute is provided;
 - 3) acceptable deviations from the threshold levels in the "deviations" attribute, if the "EnQoSsustainability" feature is supported;
 - 4) the spatial granularity size of TA in the "spatialGranSizeTa" attribute if the "QoSSustainabilityExt_eNA" feature is supported;
 - 5) the spatial granularity size of cell in the "spatialGranSizeCell" attribute if the "QoSSustainabilityExt_eNA" feature is supported;
 - 6) the temporal granularity size in the "temporalGranSize" attribute if the "QoSSustainabilityExt_eNA" feature is supported; and/or
 - 7) the fine granularity areas as the "fineGranAreas" attribute if the feature "QoSSustainabilityExt_eNA" is supported.
- if the feature "AbnormalBehaviour" is supported and the event is "ABNORMAL_BEHAVIOUR", shall provide:
- 1) identification of target UE(s) to which the subscription applies by "supis", "intGroupIds" or "anyUe" attribute set to "true" in the "tgtUe" attribute; and
 - 2) either the expected analytics type via "exptAnaType" attribute or a list of exception Ids with the associated thresholds via "excepRequs" attribute. If the expected analytics type via "exptAnaType" attribute is provided, the NWDAF shall derive the corresponding Exception Ids from the received expected analytics type as follows:
 - a) if "exptAnaType" attribute sets to "MOBILITY", the corresponding list of Exception Ids are "UNEXPECTED_UE_LOCATION", "PING_PONG_ACROSS_CELLS", "UNEXPECTED_WAKEUP" and "UNEXPECTED_RADIO_LINK_FAILURES";
 - b) if "exptAnaType" attribute sets to "COMMUN", the corresponding list of Exception Ids are "UNEXPECTED_LONG_LIVE_FLOW", "UNEXPECTED_LARGE_RATE_FLOW", "SUSPICION_OF_DDOS_ATTACK", "WRONG_DESTINATION_ADDRESS" and "TOO_FREQUENT_SERVICE_ACCESS"; and
 - c) if "exptAnaType" attribute sets to "MOBILITY_AND_COMMUN", the corresponding list of Exception Ids includes all above derived exception Ids.

The derived list of Exception Ids is used by the NWDAF to notify the NF service consumer when UE's behaviour is exceptional based on one or more Exception Ids within the list.

If the "anyUe" attribute in the "tgtUe" attribute sets to "true":

- a) the expected analytics type via the "exptAnaType" attribute or the list of Exception Ids via "excepRequs" attribute shall not be requested for both mobility and communication related analytics at the same time;
- b) if the expected analytics type via the "exptAnaType" attribute or the list of Exception Ids via "excepRequs" attribute is mobility related, at least one of identification of network area(s) by "networkArea" attribute and identification of network slice(s) by "snssais" attribute should be provided; and
- c) if the expected analytics type via the "exptAnaType" attribute or the list of Exception Ids via "excepRequs" attribute is communication related, at least one of identification of network area(s) by "networkArea" attribute, identification of application(s) by "appIds" attribute, identification of DNN(s) in the "dnns" attribute and identification of network slice(s) by "snssais" attribute should be provided;

and may provide:

- 1) expected UE behaviour via "exptUeBehav" attribute.
- if the feature "UserDataCongestion" is supported and the event is "USER_DATA_CONGESTION", shall provide:

- 1) identification of target UE(s) to which the subscription applies by "supis", "gpsis" (if feature "UserDataCongestionExt" is supported) or "anyUe" attribute set to "true";

and may include:

- 1) congestion threshold by the "congThresholds" attribute if the "notifMethod" attribute in "evtReq" attribute is set to "ON_EVENT_DETECTION" or the "notificationMethod" attribute in "eventSubscriptions" attribute is set to "THRESHOLD" or omitted;
 - 2) identification of network area to which the subscription applies via identification of network area(s) by "networkArea" attribute (mandatory if "anyUe" attribute is set to true);
 - 3) identification of network slice(s) by "snssais" attribute;
 - 4) a matching direction in the "matchingDir" attribute if the "congThresholds" attribute is provided;
 - 5) if the feature "UserDataCongestionExt" is also supported, request a list of top applications with maximum number that contribute the most to the traffic in uplink and/or downlink directions by the "maxTopAppUINbr" attribute and/or the "maxTopAppDINbr" attribute;
 - 6) a list of analytics subsets carried by "listOfAnaSubsets" attribute with value(s) only applicable to "USER_DATA_CONGESTION" event, if the "EneNA" feature is supported; and/or
 - 7) the ordering criterion for the list of User Data Congestion analytics in "userDataConOrderCri" attribute, if the "UserDataCongestionExt2_eNA" feature is supported;
 - 8) the temporal granularity size in the "temporalGranSize" attribute if the "UserDataCongestionExt2_eNA" feature is supported.
- if the feature "Dispersion" is supported and the event is "DISPERSION", shall provide:
- 1) identification of target UE(s) to which the subscription applies by "supis", "intGroupIds" or "anyUe" attribute set to "true" in the "tgtUe" attribute, "anyUe" attribute set to "true" is only supported in combination with "snssais" attribute, "networkArea" attribute and/or "disperClass" attribute;

and may include:

- 1) identification of network area to which the subscription applies via identification of network area by "networkArea" attribute, if the "supis" attribute or "intGroupIds" attribute is included in the "tgtUe" attribute;
 - 2) identification of network slice(s) by "snssais" attribute;
 - 3) application identifier(s) in "appIds" attribute;
 - 4) dispersion analytics requirements in "disperReqs" attribute, which for the requested dispersion type may include dispersion class, preferred ordering requirements;
 - 5) an optional list of analytics subsets by "listOfAnaSubsets" attribute with value(s) only applicable to DISPERSION event, if the "EneNA" feature is supported; and/or
 - 6) preferred granularity of location information as the "locGranularity" attribute if the feature "DispersionExt_eNA" is supported;
 - 7) the spatial granularity size of TA in the "spatialGranSizeTa" attribute if the "DispersionExt_eNA" feature is supported;
 - 8) the spatial granularity size of cell in the "spatialGranSizeCell" attribute if the "DispersionExt_eNA" feature is supported; and/or
 - 9) the temporal granularity size in the "temporalGranSize" attribute if the "DispersionExt_eNA" feature is supported.
- if the feature "RedundantTransmissionExp" is supported and the event is "RED_TRANS_EXP", shall provide:
- 1) identification of target UE(s) to which the subscription applies by "supis", "intGroupIds" or "anyUe" attribute set to "true" in the "tgtUe" attribute;

- and may include:
 - 1) identification of network area to which the subscription applies via identification of network area by "networkArea" attribute;
 - 2) identification of network slice(s) by "snssais" attribute;
 - 3) identification of DNN in the "dnns" attribute;
 - 4) other redundant transmission experience analysis requirements in "redTransReqs" attribute, which may include preferred order of results for the list of Redundant Transmission Experience; and/or
 - 5) an optional list of analytics subsets by "listOfAnaSubsets" attribute with value(s) only applicable to RED_TRANS_EXP event, if the "EneNA" feature is supported;
 - 6) the temporal granularity size in the "temporalGranSize" attribute if the "RedundantTransExpExt_eNA" feature is supported.
- if the feature "WlanPerformance" is supported and the event is "WLAN_PERFORMANCE", shall provide:
 - 1) identification of target UE(s) to which the subscription applies by "supis", "intGroupIds" or "anyUe" attribute set to "true" in the "tgtUe" attribute. If "anyUe" attribute set to "true" is included in the "tgtUe" attribute, then any of "networkArea" attribute, "ssIds" or "bssIds" attribute within "wlanReqs" attribute shall be present;and may include:
 - 1) identification of network area to which the subscription applies via identification of network area by "networkArea" attribute;
 - 2) other WLAN performance analytics requirements in "wlanReqs" attribute, which may include SSID(s), BSSID(s), preferred order of results for the list of WLAN performance information and/or accuracy per analytics subset; and/or
 - 3) an optional list of analytics subsets by "listOfAnaSubsets" attribute with value(s) only applicable to WLAN_PERFORMANCE event, if the "EneNA" feature is supported;
 - 4) the temporal granularity size in the "temporalGranSize" attribute if the "WlanPerfExt_eNA" feature is supported.
- if the feature "DnPerformance" is supported and the event is "DN_PERFORMANCE", shall provide:
 - 1) identification of target UE(s) to which the subscription applies by "supis", "intGroupIds" or "anyUe" attribute set to "true" in the "tgtUe" attribute;and may include:
 - 1) identification of network area to which the subscription applies via identification of network area by "networkArea" attribute;
 - 2) identification of network slice(s) in the "snssais" attribute;
 - 3) identification of network slice and the optionally associated network slice instance(s) if available, via the "nsiIdInfos" attribute or any slices indication in the "anySlice" attribute;
 - 4) application identifier(s) in "appIds" attribute;
 - 5) an identification of DNN in the "dnns" attribute;
 - 6) identification of a user plane access to one or more DN(s) where applications are deployed by "dnais" attribute;
 - 7) the identification of the UPF as the "upfInfo" attribute;
 - 8) IP address(s)/FQDN(s) of the Application Server(s) as the "appServerAddrs" attribute;

- 9) other DN performance analytics requirements in "dnPerfReqs" attribute, which may include the preferred order of results for the list of DN performance information and/or the reporting threshold of each applicable analytics subset; and/or
 - 10) an optional list of analytics subsets by "listOfAnaSubsets" attribute with value(s) only applicable to "DN_PERFORMANCE" event, if the "EneNA" feature is supported and may include the attribute with value(s) only applicable to "DN_PERFORMANCE" event and the "DnPerformanceExt_AIML" feature if supported;
 - 11) the spatial granularity size of TA in the "spatialGranSizeTa" attribute if the "DnPerformanceExt_eNA" feature is supported;
 - 12) the spatial granularity size of cell in the "spatialGranSizeCell" attribute if the "DnPerformanceExt_eNA" feature is supported; and/or
 - 13) the temporal granularity size in the "temporalGranSize" attribute if the "DnPerformanceExt_eNA" feature is supported.
- if the feature "SMCCE" is supported and the event is "SM_CONGESTION", shall provide:
- 1) an identification of DNN in the "dnns" attribute;
 - 2) identification of network slice in the "snssais" attribute; and/or
 - 3) identification of target UE(s) via "supis" attribute in the "tgtUe" attribute where the target UE(s) are one have the PDU Session for the DNN and/or S-NSSAI;

and may include:

- 1) an optional list of analytics subsets by "listOfAnaSubsets" attribute with value(s) only applicable to "SM_CONGESTION" event, if the "EneNA" feature is supported.

NOTE 10: The predictions are not applicable for Session Management Congestion Control Experience analytics.

- if the feature "PfdDetermination" is supported and the event is "PFD_DETERMINATION", it shall provide:

- 1) a list of application identifier(s) in the "appIds" attribute.

and may provide:

- 1) identification of DNN in the "dnns" attribute; and/or
- 2) identification of network slice in the "snssais" attribute.

NOTE 11: PFD Determination analytics do not have a target UE, they are always for any UE. The predictions are not applicable for PFD Determination analytics.

- if the feature "E2eDataVolTransTime" is supported and the event is "E2E_DATA_VOL_TRANS_TIME", shall provide:

- 1) identification of target UE(s) to which the subscription applies by "supis" or "gpsis" attribute in the "tgtUe" attribute.

and may include:

- 1) an identification of DNN in the "dnns" attribute;
- 2) identification of network slice in the "snssais" attribute;
- 3) application identifier(s) in "appIds" attribute;
- 4) area of interest of the UEs by "networkArea" attribute; restricts the scope of the E2E data volume transfer time analytics to the provided area;
- 5) an optional list of analytics subsets by "listOfAnaSubsets" attribute with value(s) only applicable to "E2E_DATA_VOL_TRANS_TIME" event, if the "EneNA" feature is supported;

- 6) the QoS requirements via "qosRequ" attribute; and/or
- 7) E2E data volume transfer time requirements in the "dataVITrmsTmRqs" attribute;
- if the feature "PduSesTraffic" is supported and the event is "PDU_SESSION_TRAFFIC", shall provide:
 - 1) identification of target UE(s) to which the subscription applies by "supis", "intGroupIds" or "anyUe" attribute set to "true" in the "tgtUe" attribute;
 - 2) PDU Session traffic analytics requirements in "pduSesTrafReqs" attribute, which includes the known Application Identifier, IP Descriptions or Domain Descriptors; and
 - 3) DNN and/or S-NSSAI for the PDU Session(s) in the "dnns" and/or "snssais" attributes.

and may include:

- 1) identification of network area to which the subscription applies by "networkArea" attribute and/or
- 2) an optional list of analytics subsets by "listOfAnaSubsets" attribute with value(s) only applicable to "PDU_SESSION_TRAFFIC" event, if the "EneNA" features is supported.

NOTE 12: The predictions are not applicable for PDU Session traffic analytics.

- if the feature "MovementBehaviour" is supported and the event is "MOVEMENT_BEHAVIOUR", shall provide:
 - 1) identification of network area to which the subscription applies to restricts the scope of the movement behaviour analytics to the provided area by the "networkArea" attribute and/or the "fineGranAreas" attribute;
- and may include:
 - 1) identification of the preferred orientation of location information by the "locOrientation" attribute;
 - 2) Movement Behaviour analytics requirements in the "movBehavReqs" attribute, which includes preferred granularity of location information or preferred orientation of location information; and/or
 - 3) an optional list of analytics subsets by the "listOfAnaSubsets" attribute with value(s) only applicable to the "MOVEMENT_BEHAVIOUR" event, if the "EneNA" features is supported.
- if the feature "LocAccuracy" is supported and the event is "LOC_ACCURACY", it shall provide:
 - 1) either a network area to which the subscription applies within the "networkArea" attribute or an exact location to which the subscription applies within the "location" attribute;
- and may include:
 - 1) Location accuracy analytics requirements within the "locAccReqs" attribute; and/or
 - 2) an optional list of analytics subsets within the "listOfAnaSubsets" attribute with value(s) only applicable to the "LOC_ACCURACY" event, if the "EneNA" features is supported.

NOTE 13: Location accuracy analytics do not have a target UE, they are always for any UE.

- if the feature "RelativeProximity" is supported and the event is "RELATIVE_PROXIMITY", shall provide:
 - 1) identification of target UE(s) to which the subscription applies by "supis" or "intGroupIds" attribute in the "tgtUe" attribute;
- and may include:
 - 1) identification of DNN in the "dnns" attribute;
 - 2) identification of network slice in the "snssais" attribute;
 - 3) identification of network area to which the subscription applies by "networkArea" attribute;
 - 4) Relative Proximity analytics requirements in "relProxReqs" attribute; and/or

- 5) an optional list of analytics subsets by "listOfAnaSubsets" attribute with value(s) only applicable to "RELATIVE_PROXIMITY" event prediction, if the "EneNA" features is supported.

Upon the reception of an HTTP POST request with: "{apiRoot}/nnwdafeventssubscription/<apiVersion>/subscriptions" as Resource URI and NnwdafeventsSubscription data structure as request body, if no errors occur, the NWDAF shall:

- create a new subscription;
- assign an event subscriptionId; and
- store the subscription.

If the NWDAF created an "Individual NWDAF Event Subscription" resource, the NWDAF shall respond with "201 Created" status code with the message body containing a representation of the created subscription, as shown in figure 4.2.2.2.2-1, step 2. If not all the requested analytics events in the subscription are accepted, then the NWDAF may include the "failEventReports" attribute indicating the event(s) for which the subscription failed and the associated reason(s). The NWDAF shall include a Location HTTP header field. The Location header field shall contain the URI of the created subscription i.e. "{apiRoot}/nnwdafeventssubscription/<apiVersion>/subscriptions/{subscriptionId}". If the immediate reporting indication in the "immRep" attribute within the "evtReq" attribute sets to true in the event subscription, the NWDAF shall include the reports of the events subscribed, if available, in the HTTP POST response.

When the "notifFlag" attribute is included and set to "DEACTIVATE" in the request, the NWDAF shall mute the event notification and store the available events until the NF service consumer requests to retrieve them by setting the "notifFlag" attribute to "RETRIEVAL" or until a muting exception occurs (e.g. full buffer).

If the analytics target period provided in the body of the HTTP POST request includes the start time in the past and the end time in the future, the NWDAF shall reject the request with an HTTP "400 Bad Request" response including the "cause" attribute set to "BOTH_STAT_PRED_NOT_ALLOWED".

When the "PredictionError" feature is supported, if the analytics target period provided in the body of the HTTP POST request includes the prediction time period in the future and the event is "SM_CONGESTION", "PFD_DETERMINATION" and/or "PDU_SESSION_TRAFFIC", the NWDAF shall reject the request with an HTTP "400 Bad Request" response including the "cause" attribute set to "PREDICTION_NOT_ALLOWED".

If the statistics in the past are requested but the necessary data to perform the service is unavailable, the NWDAF shall reject the request with an HTTP "500 Internal Server Error" response including the "cause" attribute set to "UNAVAILABLE_DATA".

If the user consent has not been checked by the NF service consumer and is required for the requested analytics collection depending on local policy and regulations, then the NWDAF shall check user consent for the targeted UE(s) based on the user consent subscription data that is retrieved via the Nudm_SDM service API of the UDM as described in clause 5.2.2.24 and clause 6.1.3.32 of 3GPP TS 29.503 [23]. If the user consent subscription data retrieved from the UDM indicate that the user consent is not granted for the impacted user(s), then the NWDAF shall send an HTTP "403 Forbidden" error response including the "cause" attribute set to "USER_CONSENT_NOT_GRANTED".

NOTE 14: When the target of reporting is a SUPI or a GPSI then the subscription can be rejected, e.g. because user consent is not granted, and the error is sent to the consumer. When the target of reporting is an Internal Group Id, or a list of SUPIs/GPSI(s) or any UE, and the user consent is not granted for a subset of the impacted users, then no error is sent, but a subset of the SUPIs/GPSIs is skipped if user consent is not granted.

Otherwise, if the user consent subscription data retrieved from the UDM indicate that the user consent is granted for the impacted user(s), the NWDAF shall subscribe to notification of changes of the user consent (unless it is already subscribed) by invoking the Nudm_SDM_Subscribe service operation by sending an HTTP POST request targeting the resource "SdmSubscriptions" to the UDM as described in clause 5.2.2.3 of 3GPP TS 29.503 [23].

If the RoamingAnalytics feature is supported and the NWDAF determines based on operator configuration and the requested analytics that analytics or input data from the VPLMN are required, and the NWDAF does not support roaming exchange and it cannot forward the request to another NWDAF, then the NWDAF shall reject the request with an HTTP "403 Forbidden" response including the "cause" attribute set to "NO_ROAMING_SUPPORT".

If an error occurs when processing the HTTP POST request, the NWDAF shall send an HTTP error response as specified in clause 5.1.7.

4.2.2.2.3 Update subscription for event notifications

Figure 4.2.2.2.3-1 shows a scenario where the NF service consumer sends a request to the NWDAF to update the subscription for event notifications (see also 3GPP TS 23.288 [17]).

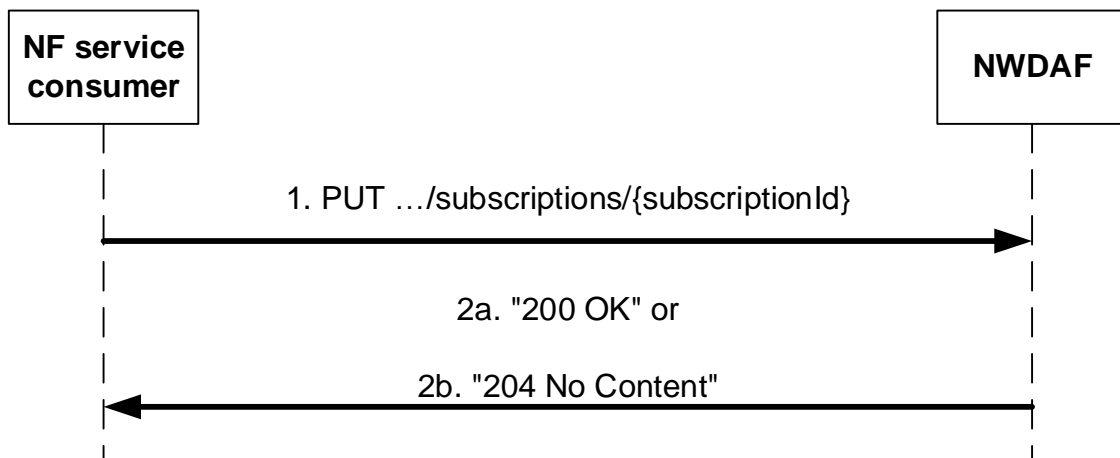

Figure 4.2.2.2.3-1: NF service consumer updates subscription to notifications

The NF service consumer shall invoke the `NnwdafeventsSubscription_Subscribe` service operation to update subscription to event notifications. The NF service consumer shall send an HTTP PUT request with `"{apiRoot}/nnwdafeventssubscription/<apiVersion>/subscriptions/{subscriptionId}"` as Resource URI representing the "Individual NWDAF Event Subscription", as shown in figure 4.2.2.2.3-1, step 1, to update the subscription for an "Individual NWDAF Event Subscription" resource identified by the `{subscriptionId}`. The `NnwdafeventsSubscription` data structure provided in the request body shall include the same contents as described in clause 4.2.2.2.2. In addition, each element of the "eventSubscriptions" may contain the following:

- Analytics feedback information within the "feedback" attribute, if the "AnalyticsAccuracy" feature is supported and the subscription is for a prediction.

Upon the reception of an HTTP PUT request with: `"{apiRoot}/nnwdafeventssubscription/<apiVersion>/subscriptions/{subscriptionId}"` as Resource URI and `NnwdafeventsSubscription` data structure as request body, the NWDAF shall:

- update the subscription of corresponding `subscriptionId`; and
- store the subscription.

NOTE 1: The "notificationURI" attribute within the `NnwdafeventsSubscription` data structure can be modified to request that subsequent notifications are sent to a new NF service consumer.

If the NWDAF successfully processed and accepted the received HTTP PUT request, the NWDAF shall update an "Individual NWDAF Event Subscription" resource, and shall respond with:

- HTTP "200 OK" status code with the message body containing a representation of the updated subscription, as shown in figure 4.2.2.2.3-1, step 2a. If not all the requested analytics events in the subscription are modified successfully, then the NWDAF may include the "failEventReports" attribute indicating the event(s) for which the modification failed and the associated reason(s); or
- HTTP "204 No Content" status code, as shown in figure 4.2.2.2.3-1, step 2b.

If errors occur when processing the HTTP PUT request, the NWDAF shall send an HTTP error response as specified in clause 5.1.7.

If the analytics target period provided in the body of the HTTP PUT request includes the start time in the past and the end time in the future, the NWDAF shall reject the request with an HTTP "400 Bad Request" response including the "cause" attribute set to "BOTH_STAT_PRED_NOT_ALLOWED".

When the "PredictionError" feature is supported, if the analytics target period provided in the body of the HTTP PUT request includes the prediction time period in the future and the event is "SM_CONGESTION",

"PFD_DETERMINATION" and/or "PDU_SESSION_TRAFFIC", the NWDAF shall reject the request with an HTTP "400 Bad Request" response including the "cause" attribute set to "PREDICTION_NOT_ALLOWED".

If the statistics in the past are requested but the necessary data to perform the service is unavailable, the NWDAF shall reject the request with an HTTP "500 Internal Server Error" response including the "cause" attribute set to "UNAVAILABLE_DATA".

If the user consent has not been checked by the NF service consumer and is required for the requested analytics collection depending on local policy and regulations, then the NWDAF shall check user consent for the targeted UE(s) based on the user consent subscription data that is retrieved via the Nudm_SDM service API of the UDM as described in clause 5.2.2.24 and clause 6.1.3.32 of 3GPP TS 29.503 [23]. If the user consent subscription data retrieved from the UDM indicate that the user consent is not granted for the impacted user(s), then the NWDAF shall send an HTTP "403 Forbidden" error response including the "cause" attribute set to "USER_CONSENT_NOT_GRANTED".

NOTE 2: When the target of reporting is a SUPI or a GPSI then the subscription can be rejected, e.g. because user consent is not granted, and the error is sent to the consumer. When the target of reporting is an Internal Group Id, or a list of SUPIs/GPSI(s) or any UE, and the user consent is not granted for a subset of the impacted users, then no error is sent, but a subset of the SUPIs/GPSIs is skipped if user consent is not granted.

Otherwise, if the user consent subscription data retrieved from the UDM indicate that the user consent is granted for the impacted user(s), the NWDAF shall subscribe to notification of changes of the user consent (unless it is already subscribed) by invoking the Nudm_SDM_Subscribe service operation by sending an HTTP POST request targeting the resource "SdmSubscriptions" to the UDM as described in clause 5.2.2.3 of 3GPP TS 29.503 [23].

If the RoamingAnalytics feature is supported and the NWDAF determines based on operator configuration and the requested analytics that analytics or input data from the VPLMN are required, and the NWDAF does not support roaming exchange and it cannot forward the request to another NWDAF, then the NWDAF shall reject the request with an HTTP "403 Forbidden" response including the "cause" attribute set to "NO_ROAMING_SUPPORT".

If the feature "ES3XX" is supported, and the NWDAF determines the received HTTP PUT request needs to be redirected, the NWDAF shall send an HTTP redirect response as specified in clause 6.10.9 of 3GPP TS 29.500 [6].

When the "notifFlag" attribute is included in the request with the value "DEACTIVATE", the NWDAF shall mute the event notification and store the available events until the NF service consumer requests to retrieve them by setting the "notifFlag" attribute to "RETRIEVAL" or until a muting exception occurs (e.g. full buffer); if the "notifFlag" attribute is set to the value "RETRIEVAL", the NWDAF shall send the stored events to the NF service consumer, mute the event notification again and store available events; if the "notifFlag" attribute is set to the value "ACTIVATE" and the event notifications are muted (due to a previously received "DECATIVATE" value), the NWDAF shall unmute the event notification, i.e. start sending again notifications for available events.

4.2.2.3 Nnwdaf_EventsSubscription_Unsubscribe service operation

4.2.2.3.1 General

The Nnwdaf_EventsSubscription_Unsubscribe service operation is used by an NF service consumer to unsubscribe from event notifications.

4.2.2.3.2 Unsubscribe from event notifications

Figure 4.2.2.3.2-1 shows a scenario where the NF service consumer sends a request to the NWDAF to unsubscribe from event notifications (see also 3GPP TS 23.288 [17]).

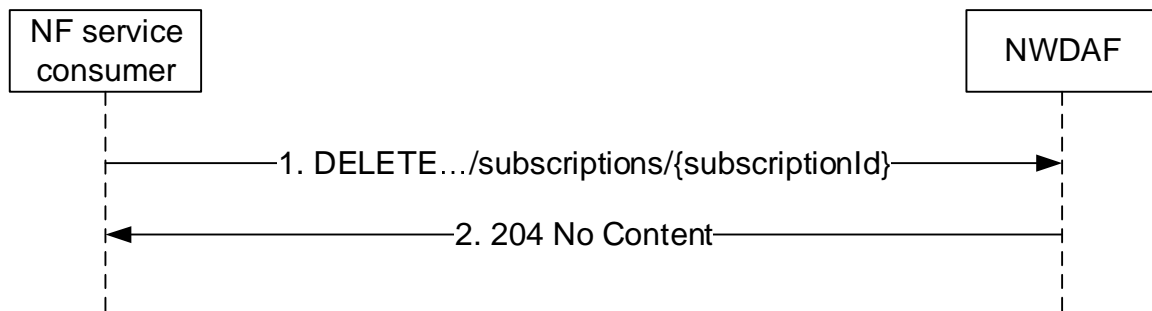

Figure 4.2.2.3.2-1: NF service consumer unsubscribes from notifications

The NF service consumer shall invoke the `Nnwdaf_EventsSubscription_Unsubscribe` service operation to unsubscribe to event notifications. The NF service consumer shall send an HTTP DELETE request with: "`{apiRoot}/nnwdaf-eventssubscription/<apiVersion>/subscriptions/{subscriptionId}`" as Resource URI, where "`{subscriptionId}`" is the event subscriptionId of the existing subscription that is to be deleted.

Upon the reception of an HTTP DELETE request with: "`{apiRoot}/nnwdaf-eventssubscription/<apiVersion>/subscriptions/{subscriptionId}`" as Resource URI, if the NWDAF successfully processed and accepted the received HTTP DELETE request, the NWDAF shall:

- remove the corresponding subscription; and
- respond with HTTP "204 No Content" status code.

If errors occur when processing the HTTP DELETE request, the NWDAF shall send an HTTP error response as specified in clause 5.1.7.

If the feature "ES3XX" is supported, and the NWDAF determines the received HTTP DELETE request needs to be redirected, the NWDAF shall send an HTTP redirect response as specified in clause 6.10.9 of 3GPP TS 29.500 [6].

4.2.2.4 Nnwdaf_EventsSubscription_Notify service operation

4.2.2.4.1 General

The `Nnwdaf_EventsSubscription_Notify` service operation is used by an NWDAF to notify NF consumers about subscribed events or by the target NWDAF to notify the consumer of the successful analytics subscription transfer.

4.2.2.4.2 Notification about subscribed event

Figure 4.2.2.4.2-1 shows a scenario where the NWDAF sends a request to the NF service consumer to notify for event notifications or notify for the successful analytics subscription transfer (see also 3GPP TS 23.288 [17]).

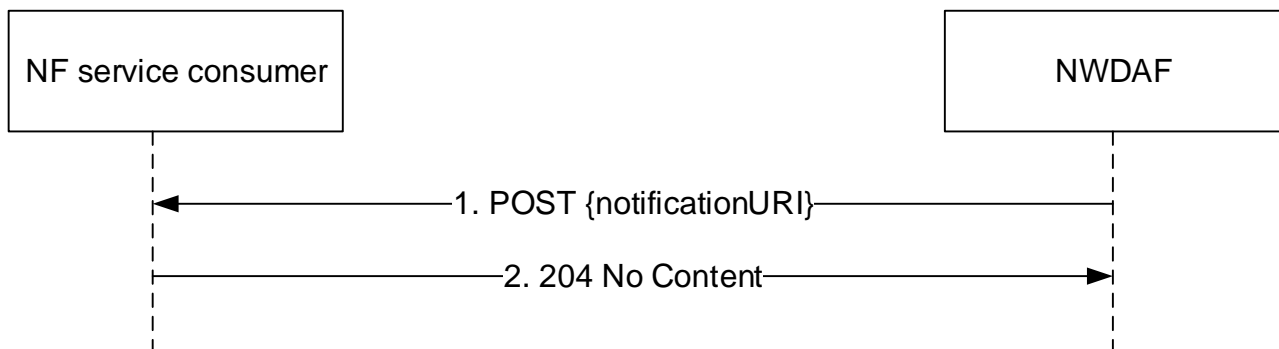

Figure 4.2.2.4.2-1: NWDAF notifies the subscribed event

The NWDAF shall invoke the `Nnwdaf_EventsSubscription_Notify` service operation to notify the subscribed event or the successful analytics subscription transfer. The NWDAF shall send an HTTP POST request with "`{notificationURI}`"

received in the Nnwdaf_EventsSubscription_Subscribe service operation as Resource URI, as shown in figure 4.2.2.4.2-1, step 1.

If both the repetition period ("repPeriod" or "repetitionPeriod") attribute and the "offsetPeriod" attribute are present in the subscription request for periodical notification, the NWDAF shall produce a notification in every repetition period seconds, including the statistics in the past offset period if the "offsetPeriod" attribute value is negative, or including the prediction for the future offset period if the "offsetPeriod" attribute value is positive.

The NnwdafEventsSubscriptionNotification data structure provided in the request body shall include:

- If the notification is for notifying about the analytics information of subscribed events, a description of the notified event as "eventNotifications" attribute that for each event shall include:
 - a) an event identifier as "event" attribute;
 - b) network slice load level information in the "sliceLoadLevelInfo" attribute when subscribed event is "SLICE_LOAD_LEVEL";
 - c) service experience information as "svcExps" attribute when subscribed event is "SERVICE_EXPERIENCE";
 - d) UE mobility information in the "ueMobs" attribute when subscribed event is "UE_MOBILITY";
 - e) UE communication information in the "ueComms" attribute when subscribed event is "UE_COMM";
 - f) abnormal behaviour information in the "abnorBehavrs" attribute when subscribed event is "ABNORMAL_BEHAVIOUR";
 - g) user data congestion information in the "userDataCongInfos" attribute when subscribed event is "USER_DATA_CONGESTION";
 - h) QoS sustainability information in the "qosSustainInfos" attribute when subscribed event is "QOS_SUSTAINABILITY";
 - i) NF load information in "nfLoadLevelInfos" attribute when subscribed event is "NF_LOAD";
 - j) network performance information in the "nwPerfs" attribute when subscribed event is "NETWORK_PERFORMANCE";
 - k) Load level information for the network slice(s) and the optionally associated network slice instance(s) in "nsiLoadLevelInfos" attribute when subscribed event is "NSI_LOAD_LEVEL";
 - l) Dispersion information in the "disperInfos" attribute when subscribed event is "DISPERSION";
 - m) Redundant transmission experience information in the "redTransInfos" attribute when subscribed event is "RED_TRANS_EXP";
 - n) WLAN performance information in the "wlanInfos" attribute when subscribed event is "WLAN_PERFORMANCE";
 - o) DN performance information in the "dnPerfInfos" attribute when subscribed event is "DN_PERFORMANCE";
 - p) SMCCE performance information in the "smccExps" attribute when subscribed event is "SM_CONGESTION";
 - q) PFD Determination information for known application identifier(s) in the "pfdDetermInfos" attribute when subscribed event is "PFD_DETERMINATION";
 - r) PDU Session traffic information in the "pduSesTraffInfos" attribute when subscribed event is "PDU_SESSION_TRAFFIC";
 - s) E2E data volume transfer time in the "dataVITrnsTmInfos" attribute when subscribed event is "E2E_DATA_VOL_TRANS_TIME";
 - t) Movement Behaviour information in the "movBehavInfos" attribute when subscribed event is "MOVEMENT_BEHAVIOUR";

- u) Location Accuracy information in the "locAccInfos" attribute when the subscribed event is "LOC_ACCURACY"; and
- v) Relative Proximity information in the "relProxInfos" attribute when subscribed event is "RELATIVE_PROXIMITY";

and may include:

- a) information about analytics metadata required for aggregation of the analytics in the "anaMetaInfo" attribute if the feature "Aggregation" is supported;
 - b) the start time of which the analytics information will become valid in the "start" attribute, if the "EneNA" feature is supported;
 - c) the expiration time after which the analytics information will become invalid in the "expiry" attribute.
- If the feature "AnalyticsAccuracy" is supported and the notification is for notifying about the accuracy information of subscribed events (which requires that the "accuReq" attribute was set to "true" in the subscription request), a description of the notified event as "eventNotifications" attribute that for each event shall include:
- a) an event identifier as "event" attribute; and
 - b) the analytics accuracy information in "accuInfo" attribute, if the "cancelAccuInd" attribute is set to "false" or omitted;

and may include:

- c) an indication that the NWDAF cancelled subscription of analytics accuracy information in "cancelAccuInd" attribute;
- d) the pause analytics consumption indication in "pauseInd" attribute;
- e) the resume analytics consumption indication in "resumeInd" attribute.

NOTE 1: In this version of the specification, the NWDAF containing AnLF can provide the accuracy information to an NF consumer that subscribes to the analytics.

NOTE 2: When receiving a subscription from an NF service consumer that includes the request for accuracy information, the analytics and/or the accuracy information can be provided by NWDAF containing AnLF in one notification or via different notifications.

NOTE 3: In this version of the specification, only subscribing or requesting accuracy information without requesting analytics is not supported.

- If the "EneNA" feature is supported and the target NWDAF notifies a successful analytics subscription transfer, the old subscription ID which had been allocated by the source NWDAF within the "oldSubscriptionId" attribute and the resource URI of the Individual NWDAF Event Subscription resource created by the target NWDAF within "resourceUri" attribute, and if the "PartialAnalyticsSubTransfer" feature is supported and not all the analytics events in the subscription transfer are accepted, the successful transferred subscription event(s) within the "transEvents" attribute; and
- an event subscription Id as "subscriptionId" attribute;

and may include:

- a) the notification correlation identifier in the "notifCorrId" attribute, if the "EneNA" feature is supported.
- b) a cause for termination in the "termCause" attribute, if the "TermRequest" feature is supported and the NWDAF wants to request the termination of this subscription, i.e. to indicate that it will send no further notifications for it.

If the feature "EneNA" is supported and the time when analytics information is needed has been provided (via the "timeAnaNeeded" attribute within the "extraReportReq" attribute) during the subscription for an event (via the "event" attribute within the EventSubscription data type), if the time when analytics information is needed is reached but the subscribed analytics information is not ready, the consumer does not need to wait for the analytics information any longer. In this case, the NWDAF may send an HTTP POST request as shown in step 1 of figure 4.2.2.4.2-1, which shall

only provide (within the EventNotification data type in the NnwdafEventsSubscriptionNotification data type) an indication of the failure event via the "event" attribute and the corresponding failure reason via a "failNotifyCode" attribute, and may also provide a minimum time interval recommended by the NWDAF for the event via a "rvWaitTime" attribute which will be used by the NF service consumer to determine the time when analytics information is needed in similar future analytics subscriptions.

Upon the reception of an HTTP POST request with: "{notificationURI}" as Resource URI and NnwdafEventsSubscriptionNotification data structure as request body, if the NF service consumer successfully processed and accepted the received HTTP POST request, the NF service consumer shall:

- store the notification; and
- respond with HTTP "204 No Content" status code.

If errors occur when processing the HTTP POST request, the NF service consumer shall send an HTTP error response as specified in clause 5.1.7.

If the feature "ES3XX" is supported, and the NF service consumer determines the received HTTP POST request needs to be redirected, the NF service consumer shall send an HTTP redirect response as specified in clause 6.10.9 of 3GPP TS 29.500 [6].

4.2.2.5 Nnwdaf_EventsSubscription_Transfer service operation

4.2.2.5.1 General

The Nnwdaf_EventsSubscription_Transfer service operation is used by an NWDAF instance to request the transfer of analytics subscription(s) to another NWDAF instance. If the source NWDAF discovers that the analytics consumer may change concurrently to this procedure, the source NWDAF should not perform the procedure. In such a case, the source NWDAF may send a message to indicate to the analytics consumer that it will not serve this subscription anymore.

NOTE 1: To discover the possible change of analytics consumer, if the Analytics ID is UE related, the source NWDAF takes actions responding to external trigger (such as UE mobility), for example, checking if the Target of Analytics Reporting is still within the serving area of the analytics consumer, if the serving area information of the consumer is available.

NOTE 2: Handling of overload situation or preparation for a graceful shutdown are preferably executed inside an NWDAF Set, when available, therefore, not requiring an analytics subscription transfer as described in this clause.

4.2.2.5.2 Creation of request for analytics subscription transfer

Figure 4.2.2.5.2-1 shows a scenario where the NF Service Consumer (e.g. NWDAF) sends a request to the NWDAF to request the transfer of analytics subscription(s) from the NF Service Consumer to the NF Service Producer (see also 3GPP TS 23.288 [17]).

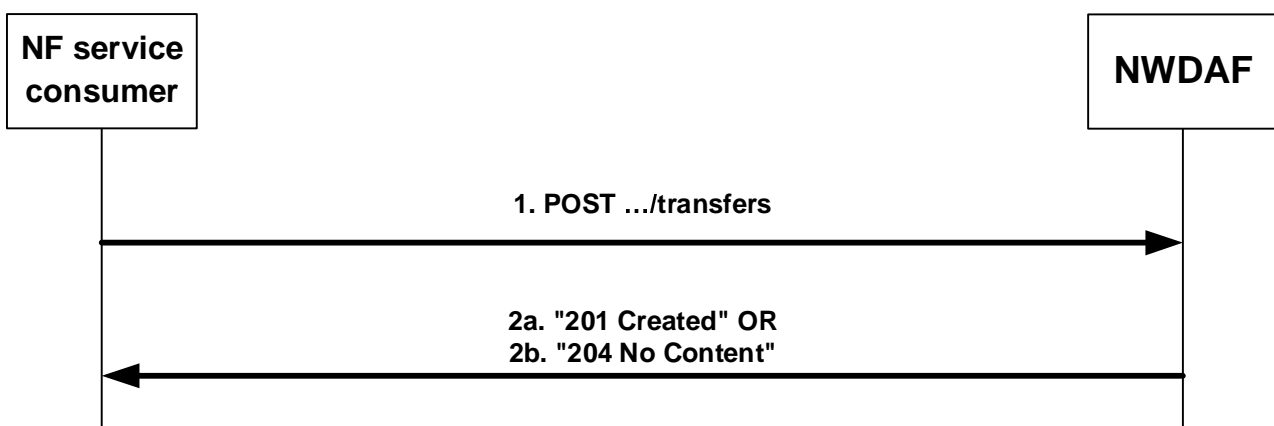

Figure 4.2.2.5.2-1: NF service consumer requests an analytics subscription transfer

The NF service consumer shall invoke the `Nnwdaf_EventsSubscription_Transfer` service operation to request the transfer of analytics subscription(s). The NF service consumer shall send an HTTP POST request with "`{apiRoot}/nnwdaf-eventssubscription/<apiVersion>/transfers`" as Resource URI representing the "NWDAF Event Subscription Transfers", as shown in figure 4.2.2.5.2-1, step 1, to create a request for an "Individual NWDAF Event Subscription Transfer" according to the information in the message body. The `AnalyticsSubscriptionsTransfer` data structure provided in the request body shall include:

- information about the subscription(s) transfer request as "subsTransInfos" attribute, which, for each subscription that is requested to be transferred, shall include:
 - a) the type of the transfer request (i.e. if it is a request for transfer preparation or transfer execution) in the "transReqType" attribute;
 - b) information about the analytics subscription in the "nwdafEvSub" attribute, its contents being as defined for the `NnwdafEventsSubscription` data structure in clause 4.2.2.2.2; and
 - c) the NF instance identifier of the consumer of the analytics subscription in the "consumerId" attribute;
 and may include:
 - a) analytics context identifier information about the context that is available at the NF service consumer in the "contextId" attribute;
 - b) NF instance identifier(s) of active data source(s) the NF service consumer is currently using for the analytics of this analytics subscription in the "sourceNfIds" attribute;
 - c) NF set identifier(s) of active data source(s) the NF service consumer is currently using for the analytics of this analytics subscription in the "sourceSetIds" attribute;
 - d) information identifying the ML model(s) that the NF service consumer is currently using for the analytics in the "modelInfos" attribute.

Upon the reception of an HTTP POST request with: "`{apiRoot}/nnwdaf-eventssubscription/<apiVersion>/transfers`" as Resource URI and `AnalyticsSubscriptionsTransfer` data structure as request body, in the successful case the NWDAF shall:

- if the "transReqType" attribute has the value `PREPARE`, perform the steps required for the preparation of an analytics subscription transfer as described in clause 5.4.3 of TS 29.552 [25], create a new Individual NWDAF Event Subscription Transfer resource and send an HTTP "201 Created" response with the URI for the created resource in the "Location" header field, as shown in figure 4.2.2.5.2-1, step 2a; If the "PartialAnalyticsSubTransfer" feature is supported and not all the analytics events in the subscription transfer are accepted, then the NWDAF includes the "failTransEventReports" attribute indicating the failure event(s).
- if the "transReqType" attribute has the value `TRANSFER`, perform the steps required for the execution of an analytics subscription transfer as described in clause 5.4.2 of TS 29.552 [25],
 - a) if the "PartialAnalyticsSubTransfer" feature is not supported, or if the "PartialAnalyticsSubTransfer" feature is supported and all the analytics events in the subscription transfer are accepted, send an HTTP "204 No Content" response, as shown in figure 4.2.2.5.2-1, step 2b;
 - b) if the "PartialAnalyticsSubTransfer" feature is supported and not all the analytics events in the subscription transfer are accepted, the NWDAF creates a new Individual NWDAF Event Subscription Transfer resource and sends an HTTP "201 Created" response with the URI for the created resource in the "Location" header field and with the message body containing a representation of the created subscription transfer including the "failTransEventReports" attribute indicating the failure event(s), as shown in figure 4.2.2.5.2-1, step 2a. The NWDAF then removes the Individual NWDAF Event Subscription Transfer resource.

If errors occur when processing the HTTP POST request, the NF service consumer shall send an HTTP error response as specified in clause 5.1.7.

4.2.2.5.3 Update a request for analytics subscription transfer

Figure 4.2.2.5.3-1 shows a scenario where the NF Service Consumer (e.g. NWDAF) sends a request to the NWDAF to update a request for the transfer of analytics subscription(s) from the NF Service Consumer to the NF Service Producer (see also 3GPP TS 23.288 [17]).

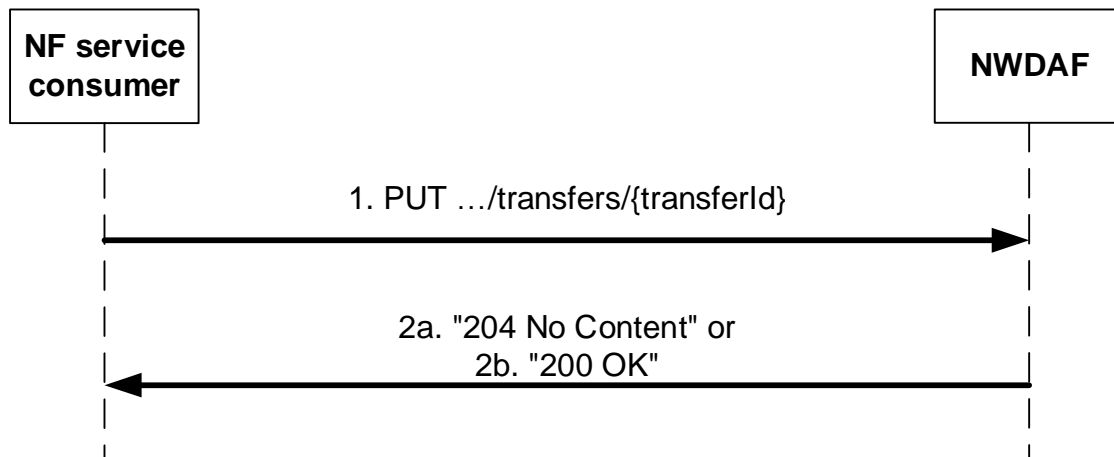

Figure 4.2.2.5.3-1: NF service consumer updates a request for an analytics subscription transfer

The NF service consumer shall invoke the `NnwdafeventsSubscriptionTransfer` service operation to update a request for the transfer of analytics subscription(s). The NF service consumer shall send an HTTP PUT request with `{apiRoot}/nnwdafeventssubscription/<apiVersion>/transfers/{transferId}` as Resource URI representing the "Individual NWDAF Event Subscription Transfer", as shown in figure 4.2.2.5.3-1, step 1, to update the "Individual NWDAF Event Subscription Transfer" resource identified by the `{transferId}`. The `AnalyticsSubscriptionsTransfer` data structure provided in the request body shall include the same contents as described in clause 4.2.2.5.2.

Upon the reception of an HTTP PUT request with: `{apiRoot}/nnwdafeventssubscription/<apiVersion>/transfers/{transferId}` as Resource URI and `AnalyticsSubscriptionsTransfer` data structure as request body, the NWDAF shall:

- if the `transReqType` attribute has the value `PREPARE`, perform the steps required for the preparation of an analytics subscription transfer as described in clause 5.4.3 of TS 29.552 [25], update the Individual NWDAF Event Subscription Transfer resource identified by `transferId`,
 - a) if the `PartialAnalyticsSubTransfer` feature is not supported, or if the `PartialAnalyticsSubTransfer` feature is supported and all the analytics events in the subscription transfer are accepted, send an HTTP "204 No Content" response, as shown in figure 4.2.2.5.3-1, step 2a;
 - b) if the `PartialAnalyticsSubTransfer` feature is supported and not all the analytics events in the subscription transfer are accepted, send an HTTP "200 OK" response with the message body containing a representation of the updated subscription transfer, as shown in figure 4.2.2.5.3-1, step 2b, and the NWDAF includes the `failTransEventReports` attribute indicating the failure event(s).
- if the `transReqType` attribute has the value `TRANSFER`, perform the steps required for the execution of an analytics subscription transfer as described in clause 5.4.2 of TS 29.552 [25], where:
 - a) if the `PartialAnalyticsSubTransfer` feature is not supported, or if the `PartialAnalyticsSubTransfer` feature is supported and all the analytics events in the subscription transfer are accepted, remove the Individual NWDAF Event Subscription Transfer resource identified by `transferId`, and send an HTTP "204 No Content" response, as shown in figure 4.2.2.5.3-1, step 2a;
 - b) if the `PartialAnalyticsSubTransfer` feature is supported and not all the analytics events in the subscription transfer are accepted, update the Individual NWDAF Event Subscription Transfer resource identified by `transferId`, and send an HTTP "200 OK" response with the message body containing a representation of the updated subscription transfer including the `failTransEventReports` attribute indicating the failure event(s), as shown in figure 4.2.2.5.3-1, step 2b. The NWDAF then removes the Individual NWDAF Event Subscription Transfer resource.

If errors occur when processing the HTTP PUT request, the NWDAF shall send an HTTP error response as specified in clause 5.1.7.

If the NWDAF determines the received HTTP PUT request needs to be redirected, the NWDAF shall send an HTTP redirect response as specified in clause 6.10.9 of 3GPP TS 29.500 [6].

4.2.2.5.4 Cancel a request for analytics subscription transfer

Figure 4.2.2.5.4-1 shows a scenario where the NF service consumer (e.g. NWDAF) sends a request to the NWDAF to cancel a request for the transfer of analytics subscription(s) from the NF service consumer to the NF Service Producer (see also 3GPP TS 23.288 [17]).

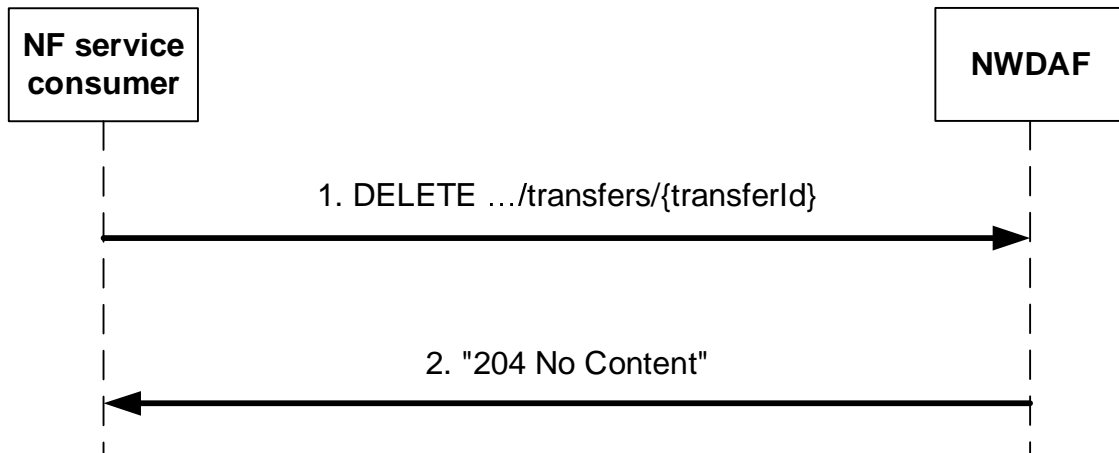

Figure 4.2.2.5.4-1: NF service consumer cancels a request for an analytics subscription transfer

The NF service consumer shall invoke the `NnwdafeventsSubscriptionTransfer` service operation to cancel a request for the transfer of analytics subscription(s). The NF service consumer shall send an HTTP DELETE request with "`{apiRoot}/nnwdafeventssubscription/<apiVersion>/transfers/{transferId}`" as Resource URI representing the "Individual NWDAF Event Subscription Transfer", as shown in figure 4.2.2.5.4-1, step 1, to cancel the "Individual NWDAF Event Subscription Transfer" resource identified by the `{transferId}`.

Upon the reception of an HTTP DELETE request with: "`{apiRoot}/nnwdafeventssubscription/<apiVersion>/transfers/{transferId}`" as Resource URI, if the NWDAF successfully processed and accepted the received HTTP DELETE request, the NWDAF shall:

- if applicable, delete any analytics data that is no longer needed and unsubscribe to entities for data collection or ML model acquisition, if the subscriptions are not needed for other active analytics subscriptions;
- remove the corresponding Individual NWDAF Event Subscription Transfer resource; and
- respond with HTTP "204 No Content" status code, as shown in figure 4.2.2.5.4-1, step 2.

If errors occur when processing the HTTP DELETE request, the NWDAF shall send an HTTP error response as specified in clause 5.1.7.

If the NWDAF determines the received HTTP DELETE request needs to be redirected, the NWDAF shall send an HTTP redirect response as specified in clause 6.10.9 of 3GPP TS 29.500 [6].

4.3 NnwdafeventsSubscriptionTransfer Service

4.3.1 Service Description

4.3.1.1 Overview

The `NnwdafeventsSubscriptionTransfer` service as defined in 3GPP TS 23.501 [2], 3GPP TS 23.288 [17] and 3GPP TS 23.503 [4], is provided by the Network Data Analytics Function (NWDAF).

This service:

- allows NF service consumers to request and get different type of analytic event information; and
- allows NF service consumers to request and get context information related to analytics subscriptions.

The types of observed events include:

- Slice load level information;
- Network slice instance load level information;
- Service experience;
- NF load;
- Network performance;
- Abnormal behaviour;
- UE mobility;
- UE communication;
- User data congestion;
- QoS sustainability;
- SM congestion control experience;
- Dispersion;
- Redundant transmission experience;
- WLAN performance;
- DN performance;
- PDU Session traffic;
- Movement Behaviour;
- Location Accuracy; and
- Relative Proximity.

4.3.1.2 Service Architecture

The 5G System Architecture is defined in 3GPP TS 23.501 [2]. The Network Data Analytics Exposure architecture is defined in 3GPP TS 23.288 [17]. The Network Data Analytics signalling flows are defined in 3GPP TS 29.552 [25], the Policy and Charging related 5G architecture is also described in 3GPP TS 23.503 [4] and 3GPP TS 29.513 [5].

The Nnwdaf_AnalyticsInfo service is part of the Nnwdaf service-based interface exhibited by the Network Data Analytics Function (NWDAF).

Known consumers of the Nnwdaf_AnalyticsInfo service are:

- Policy Control Function (PCF)
- Network Slice Selection Function (NSSF)
- Access and Mobility Management Function (AMF)
- Session Management Function (SMF)
- Network Exposure Function (NEF)
- Application Function (AF)
- Location Management Function (LMF)
- Operation, Administration, and Maintenance (OAM)

- Network Data Analytics Function (NWDAF)
- Data Collection Coordination Function (DCCF)

The PCF accesses the Nnwdaf_AnalyticsInfo service at the NWDAF via the N23 Reference point. The NSSF accesses the Nnwdaf_AnalyticsInfo service at the NWDAF via the N34 Reference point.

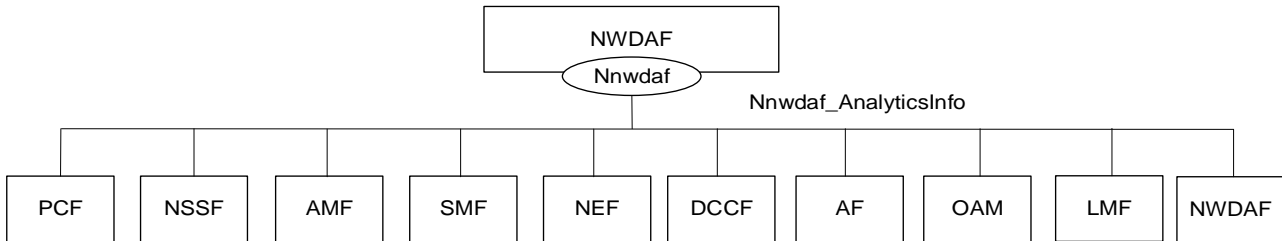

Figure 4.3.1.2-1: Reference Architecture for the Nnwdaf_AnalyticsInfo Service; SBI representation

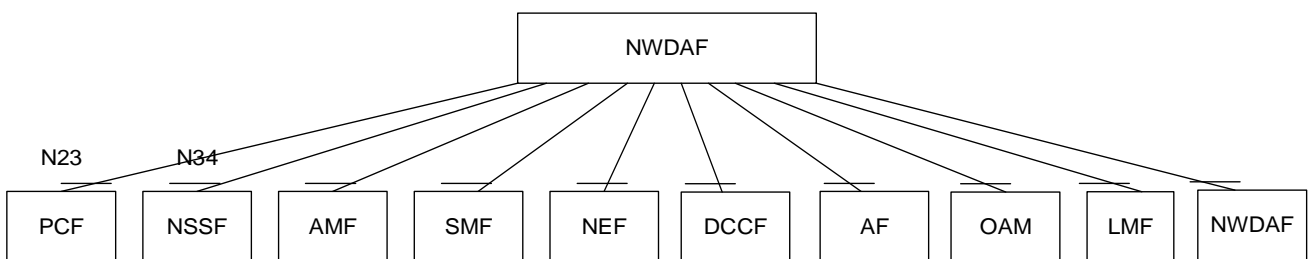

Figure 4.3.1.2-2: Reference Architecture for the Nnwdaf_AnalyticsInfo Service: reference point representation

4.3.1.3 Network Functions

4.3.1.3.1 Network Data Analytics Function (NWDAF)

The Network Data Analytics Function (NWDAF) provides specific analytics information for different analytic events and, if the "AnaCtxTransfer" feature is supported, context information related to analytics subscriptions to NF service consumers.

4.3.1.3.2 NF Service Consumers

The Policy Control Function (PCF):

- supports taking analytics information for slice load level information from the NWDAF;
- supports taking analytics information for service experience related network data from the NWDAF;
- supports taking analytics information for network performance from the NWDAF;
- supports taking analytics information for abnormal UE behaviour from the NWDAF;
- supports taking analytics information for UE mobility from the NWDAF;
- supports taking analytics information for UE communication from the NWDAF;
- supports taking analytics information for user data congestion from the NWDAF.
- supports taking analytics information for dispersion from the NWDAF;
- supports taking analytics information for session management congestion control experience from the NWDAF;
- supports taking analytics information for redundant transmission experience from the NWDAF;
- supports taking analytics information for DN performance from the NWDAF;

- supports taking analytics information for WLAN performance from the NWDAF;
- supports taking one or more above input from NWDAF into consideration for policies on assignment of network resources and/or for traffic steering policies; and
- supports taking analytics information for PDU Session traffic from the NWDAF.

NOTE: How this information is used by the PCF is not standardized in this specification.

The Network Slice Selection Function (NSSF):

- supports taking slice load level information or network slice instance load level information from the NWDAF into consideration for slice selection;
- supports taking analytics information for service experience related network data from the NWDAF; and
- supports taking analytics information for dispersion at the slice from the NWDAF.

The Access and Mobility Management Function (AMF):

- supports taking SMF load information from the NWDAF into consideration for SMF selection;
- supports taking expected UE behaviour information (UE mobility and/or UE communication) from the NWDAF into consideration for monitoring UE behaviour;
- supports taking abnormal UE behaviour information from the NWDAF into consideration for adjustment of UE mobility related network parameters to solve the abnormal risk;
- supports taking slice load level information or network slice instance load level information from NWDAF into consideration for slice selection;
- supports taking analytics information for service experience related network data from the NWDAF; and
- supports taking analytics information for dispersion at the slice from the NWDAF.

The Session Management Function (SMF):

- supports taking UPF load information from the NWDAF into consideration for UPF selection;
- supports taking expected UE behaviour information (UE mobility and/or UE communication) from the NWDAF into consideration for monitoring UE behaviour;
- supports taking UE mobility information from the NWDAF into consideration for UPF selection;
- supports taking abnormal UE behaviour information from the NWDAF into consideration for adjustment of UE mobility related network parameters to solve the abnormal risk;
- supports taking analytics information for SM congestion control experience from the NWDAF into consideration for determining back-off timer provided to UE;
- supports taking analytics information for slice load level or network slice instance load level from the NWDAF into consideration to determine slice selection;
- supports taking analytics information for service experience from the NWDAF into consideration to (re)select UP paths;
- supports taking analytics information for redundant transmission experience from the NWDAF to consider whether redundant transmission shall be performed, or (if it had been activated) shall be stopped; and
- supports taking analytics information for DN performance from the NWDAF into consideration for user plane performance.

The Network Exposure Function (NEF):

- supports taking analytics information for UE mobility from the NWDAF;
- supports taking analytics information for UE communication from the NWDAF;

- supports taking analytics information for expected UE behavioural (UE mobility and/or UE communication) from the NWDAF;
- supports taking analytics information for abnormal behaviour from the NWDAF;
- supports taking analytics information for user data congestion from the NWDAF;
- supports taking analytics information for network performance from the NWDAF;
- supports taking analytics information for QoS Sustainability from the NWDAF;
- supports taking analytics information for Dispersion from the NWDAF;
- supports taking analytics information for DN performance from the NWDAF;
- supports taking analytics information for WLAN performance from the NWDAF;
- supports taking analytics information for Observed Service Experience from NWDAF;
- supports taking analytics information for E2E data volume transfer time from NWDAF;
- supports taking analytics information for Relative Proximity from NWDAF; and
- supports taking analytics information for movement behaviour from NWDAF.

The Application Function (AF):

- supports receiving UE mobility information from the NWDAF or via the NEF;
- supports receiving UE communication information from the NWDAF or via the NEF;
- supports receiving expected UE behavioural information (UE mobility and/or UE communication) from the NWDAF or via the NEF;
- supports receiving abnormal behaviour information from the NWDAF or via the NEF;
- supports receiving user data congestion information from the NWDAF or via the NEF;
- supports receiving network performance information from the NWDAF or via the NEF;
- supports receiving QoS Sustainability information from the NWDAF or via the NEF;
- supports receiving Dispersion information from the NWDAF or via the NEF;
- supports receiving DN performance information from NWDAF or via the NEF;
- supports receiving WLAN performance information from NWDAF or via the NEF;
- supports receiving Observed Service Experience information from NWDAF or via the NEF;
- supports receiving E2E data volume transfer time from NWDAF or via the NEF.
- supports receiving Movement Behaviour information from NWDAF or via the NEF. and
- supports receiving Relative Proximity information from NWDAF or via the NEF.

The Location Management Function (LMF):

- supports taking Location Accuracy analytics from the NWDAF into consideration as assistance for location services.

The Operation, Administration, and Maintenance (OAM):

- supports receiving slice load level information from the NWDAF;
- supports receiving observed service experience from the NWDAF;
- supports receiving NF load information from the NWDAF;

- supports receiving network performance information from the NWDAF;
- supports receiving UE mobility information from the NWDAF;
- supports receiving UE communication information from the NWDAF;
- supports receiving expected UE behaviour information (UE mobility and/or UE communication) from the NWDAF; and
- supports receiving abnormal UE behaviour information from the NWDAF.

The Network Data Analytics Function (NWDAF):

- supports receiving information for all types of network data analytics from the NWDAF; and
- supports receiving context information related to analytics subscriptions from the NWDAF.

The Data Collection Coordination Function (DCCF):

- supports receiving information for all types of network data analytics from the NWDAF.

4.3.2 Service Operations

4.3.2.1 Introduction

Table 4.3.2.1-1: Operations of the Nnwdafl_AnalyticsInfo Service

| Service operation name | Description | Initiated by |
|---------------------------------------|---|---|
| Nnwdafl_AnalyticsInfo_Request | This service operation is used by an NF to request and get specific analytics from NWDAF. | NF consumer (PCF, NSSF, AMF, SMF, NEF, AF, LMF, OAM, NWDAF, DCCF) |
| Nnwdafl_AnalyticsInfo_ContextTransfer | This service operation is used by an NF to request and get context information related to analytics subscriptions from NWDAF. | NF consumer (NWDAF) |

4.3.2.2 Nnwdafl_AnalyticsInfo_Request service operation

4.3.2.2.1 General

The Nnwdafl_AnalyticsInfo_Request service operation is used by an NF service consumer to request and get specific analytics information from the NWDAF.

4.3.2.2.2 Request and get from NWDAF Analytics information

Figure 4.3.2.2.2-1 shows a scenario where the NF service consumer (e.g. PCF) sends a request to the NWDAF to request and get from the NWDAF analytics information (as shown in 3GPP TS 23.288 [17]).

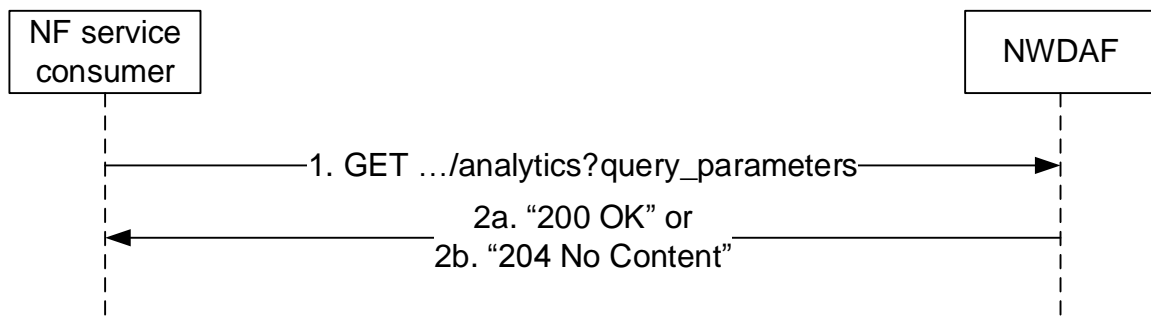

Figure 4.3.2.2.2-1: Requesting a NWDAF Analytics information

The NF service consumer (e.g. PCF) shall invoke the `Nnwdaf_AnalyticsInfo_Request` service operation when requesting the NWDAF analytics information. The NF service consumer shall send an HTTP GET request on the resource URI "`{apiRoot}/nnwdaf-analyticsinfo/<apiVersion>/analytics`" representing the "NWDAF Analytics" (as shown in figure 4.3.2.2.2-1, step 1), to request analytics data according to the query parameter value of the "event-id" attribute. In addition, the following information may be provided:

- common reporting requirement in the "ana-req" attribute as follows:
 - 1) identification of time window for the requested analytics data applies via identification of date-time(s) in the "startTs" and "endTs" attributes;
 - 2) preferred level of accuracy of the analytics in "accuracy" attribute;
 - 3) percentage of sampling among impacted UEs in the "sampRatio" attribute;
 - 4) maximum number of objects in the "maxObjectNbr" attribute;
 - 5) maximum number of SUPIs expected for an analytics report in the "maxSupiNbr" attribute;
 - 6) identification of time when analytics information is needed in the "timeAnaNeeded" attribute if the feature "EneNA" is supported;
 - 7) indication of which analytics metadata is requested to be delivered with the response in the "anaMeta" attribute if the feature "Aggregation" is supported;
 - 8) requested values for the analytics metadata information to be used for the generation of the analytics in the "anaMetaInd" attribute if the feature "Aggregation" is supported;
 - 9) preferred accuracy level per analytics subset in the "accPerSubset" attribute if the "listOfAnaSubsets" attribute is present and the EneNA feature is supported; and/or
 - 10) the time period of historical analytics in the "histAnaTimePeriod" attribute if the "EneNA" feature is supported;

NOTE 1: The NWDAF can use the use case context to select the most relevant ML model, when several ML models are available for the requested Analytics ID(s). The NWDAF containing AnLF can additionally provide the use case context when requesting an ML model from an NWDAF containing MTLF. The values of this parameter are not standardized.

For all the event types, the "event-filter" attribute may include:

- the analytics accuracy requirement information in "accuReq" attribute as indication to the NWDAF to activate checking the analytics accuracy information of the requested event, if the "AnalyticsAccuracy" feature is supported and the NF service consumer discovered or local configured the NWDAF containing an AnLF supporting the accuracy checking capability.
- use case context as "useCaseCxt" attribute, if the "ENAExt" feature is supported.
- information related to roaming within the "roamingInfo" attribute if the "RoamingAnalytics" feature is supported;

NOTE 2: The request for analytics accuracy information independently from request of the analytics event output is not supported in this release.

For different event types:

- if the event is "LOAD_LEVEL_INFORMATION", it shall provide the event specific filter information within "event-filter" attribute including identification(s) of the network slice via:
 - 1) identification of network slice(s) in the "snssais" attribute; or
 - 2) any slices indication in the "anySlice" attribute;
- if the feature "NsiLoad" is supported and the event is "NSI_LOAD_LEVEL", it shall provide the event specific filter information within "event-filter" attribute including identification(s) of the network slice via:
 - 1) identification of network slice(s) and the optionally associated instance(s) if available, in the "nsiIdInfos" attribute; or

NOTE 3: The network slice instance of a PDU session is not available in the PCF.

- 2) any slices indication in the "anySlice" attribute;
- and may include:
- 1) a list of analytics subsets carried by "listOfAnaSubsets" attribute with value(s) only applicable to "NSI_LOAD_LEVEL" event, if the "EneNA" feature is supported;
 - 2) event specific filter information in the "event-filter" attribute:
 - a) list of NF instance types in the "nfTypes" attribute, if the "NsiLoadExt" feature is supported; and/or
 - b) identification of network area to which the request applies via identification of network area by "networkArea" attribute, if the "NsiLoadExt" feature is supported.
- if the feature "NfLoad" is supported and the event is "NF_LOAD", it shall provide:
 - 1) identification of target UE(s) to which the request applies by "supis" or "anyUe" attribute set to "true" in the "tgt-ue" attribute; and

NOTE 4: Only NF instances of type AMF and SMF which are serving the UE can be determined using a SUPI in "supis" attribute.

NOTE 5: If a list of the NF Instance IDs (or respectively of NF Set IDs) is provided, the NWDAF needs to provide the analytics for each designated NF instance (or respectively for each NF instance belonging to each designated NF Set). In such case the target UE(s) of the Analytics Reporting need be ignored.

- the "event-filter" attribute may provide:
 - a) either list of NF instance IDs in the "nfInstanceIds" attribute or list of NF set IDs in the "nfSetIds" attribute if the identification of target UE(s) applies to all UEs;
 - b) list of NF instance types in the "nfTypes" attribute;
 - c) identification of network slice(s) in the "snssais" attribute;
 - d) optional area of interest by "networkArea" attribute; and/or
 - e) an optional list of analytics subsets by "listOfAnaSubsets" attribute with value(s) only applicable to NF_LOAD event, if the "EneNA" feature is supported;
- if the feature "UeMobility" is supported and the event is "UE_MOBILITY", it shall provide:
 - 1) identification of target UE(s) to which the request applies by "supis" or "intGroupIds" attribute in the "tgt-ue" attribute;

and may include:

- a) identification of network area to which the request applies via identification of network area by "networkArea" attribute;
- b) if the feature "UeMobilityExt" is supported,
 - i) identification of LADN DNN in the "ladnDnns" attribute;
 - ii) visited Area(s) of Interest as the "visitedAreas" attribute;
- c) other UE mobility requirements in "ueMobilityReqs" attribute, if the "UeMobilityExt2_eNA" feature is supported;
- d) preferred granularity of location information as the "locGranularity" attribute if the feature "UeMobilityExt2_eNA" is also supported;
- e) identification of the preferred orientation of location information by "locOrientation" attribute if the feature "UeMobilityExt2_eNA" is supported
- f) a list of analytics subsets carried by "listOfAnaSubsets" attribute with value(s) only applicable to "UE_MOBILITY" event, if the "UeMobilityExt2_eNA" and "EneNA" features are supported;
- g) the spatial granularity size of TA in the "spatialGranSizeTa" attribute if the "UeMobilityExt2_eNA" feature is supported;
- h) the spatial granularity size of cell in the "spatialGranSizeCell" attribute if the "UeMobilityExt2_eNA" feature is supported;
- i) the temporal granularity size in the "temporalGranSize" attribute if the "UeMobilityExt2_eNA" feature is supported; and/or
- j) the fine granularity areas as the "fineGranAreas" attribute if the feature "UeMobilityExt2_eNA" is supported.

NOTE 6: For LADN service, the consumer (e.g. SMF) provides the LADN DNN to refer the LADN service area as the AOI.

- if the feature "UeCommunication" is supported and the event is "UE_COMM", it shall provide:

- 1) identification of target UE(s) to which the request applies by "supis" or "intGroupIds" attribute in the "tgt-ue" attribute;

and may include:

- 1) event specific filter information in the "event-filter" attribute:
 - a) identification of the application as "appIds" attribute;
 - b) identification of network area to which the request applies via identification of network area by "networkArea" attribute;
 - c) identification of DNN in the "dnns" attribute;
 - d) identification of network slice(s) in the "snssais" attribute;
 - e) a list of analytics subsets carried by "listOfAnaSubsets" attribute with value(s) only applicable to "UE_COMM" event, if the "EneNA" feature is supported;
 - f) other UE communication requirements in "ueCommReqs" attribute, if the "UeCommunicationExt_eNA" feature is supported; and/or
 - g) the spatial granularity size of TA in the "spatialGranSizeTa" attribute if the "UeCommunicationExt_eNA" feature is supported.
 - h) the spatial granularity size of cell in the "spatialGranSizeCell" attribute if the "UeCommunicationExt_eNA" feature is supported.

- if the feature "NetworkPerformance" is supported and the event is "NETWORK_PERFORMANCE", it shall provide:
 - 1) identification of target UE(s) to which the request applies by "supis", "intGroupIds" or "anyUe" attribute set to "true" in the "tgt-ue" attribute;
 - 2) event specific filter information in the "event-filter" attribute which shall provide:
 - a) the network performance types via "nwPerfTypes" attribute;
 - b) the network performance requirements via "nwPerfReqs" attribute, if the feature "NetworkPerformanceExt_eNA" is supported;

the "event-filter" attribute may provide:

 - a) identification of network area to which the request applies via identification of network area(s) by "networkArea" attribute (mandatory if "anyUe" attribute is set to true);
 - b) for each network performance type identified by "nwPerfTypes" attribute, the additional requirement by "addNwPerfReqs" attribute if the "NetworkPerformanceExt_AIML" feature is supported; and/or
 - c) the spatial granularity size of TA in the "spatialGranSizeTa" attribute if the "DnPerfExt_eNA" feature is supported;
 - d) the spatial granularity size of TA in the "spatialGranSizeCell" attribute if the "DnPerfExt_eNA" feature is supported; and/or
- e) the temporal granularity size of cell in the "temporalGranSize" attribute if the "DnPerfExt_eNA" feature is supported.- if the feature "ServiceExperience" is supported and the event is "SERVICE_EXPERIENCE", it shall provide:
 - 1) identification of target UE(s) to which the request applies by "supis", "intGroupIds" or "anyUe" attribute set to "true" in the "tgt-ue" attribute;
 - 2) event specific filter information in the "event-filter" attribute which shall provide:
 - a) any slices indication in the "anySlice" attribute or identification of network slice(s) together with the optionally associated network slice instance(s) if available, via the "nsiIdInfos" attribute; and

NOTE 7: The network slice instance of a PDU session is not available in the PCF.

the "event-filter" attribute may provide:

- a) identification of application(s) to which the request applies via "appIds" attribute;
- b) identification of DNN via identification of Dnn(s) by "dnns" attribute;
- c) identification of user plane accesses to one or more DN(s) where applications are deployed via "dnais" attribute;
- d) identification of network area to which the request applies via identification of network area(s) by "networkArea" attribute (mandatory if "anyUe" attribute is set to true);
- e) if "appIds" attribute is provided, the bandwidth requirement of each application by "bwRequs" attribute;
- f) identification of all the RAT types and/or all the frequencies that the NWDAF received for the application or specific RAT type(s) and/or frequency(ies) by "ratFreqs" attribute if the feature "ServiceExperienceExt" is also supported;
- g) a list of analytics subsets carried by "listOfAnaSubsets" attribute with value(s) only applicable to "SERVICE_EXPERIENCE" event, if the "EneNA" feature is supported;
- h) the identification of the UPF as the "upfInfo" attribute if the feature "ServiceExperienceExt" is also supported;
- i) IP address(s)/FQDN(s) of the Application Server(s) as the "appServerAddrs" attribute if the feature "ServiceExperienceExt" is also supported;

- j) combination of PDU Session parameters as the "pduSesInfos" attribute if the feature "ServiceExperienceExt2_eNA" is also supported;
 - k) preferred granularity of location information as the "locGranularity" attribute if the feature "ServiceExperienceExt2_eNA" is supported; and/or
 - l) the fine granularity areas as the "fineGranAreas" attribute if the feature "ServiceExperienceExt2_eNA" is supported.
- if the feature "QoS_Sustainability" is supported and the event is "QOS_SUSTAINABILITY", it shall provide:
- 1) event specific filter information in the "event-filter" attribute which shall provide:
 - a) identification of network area to which the request applies via identification of network area by "networkArea" attribute; and
 - b) QoS requirements via "qosRequ" attribute;
 - 2) identification of target UE(s) to which the request applies by "anyUe" attribute set to "true" in the "tgt-ue" attribute;

the "event-filter" attribute may provide:

- a) identification of network slice(s) by "snssais" attribute;
 - b) the spatial granularity size of TA in the "spatialGranSizeTa" attribute if the "QoS_SustainExt_eNA" feature is supported;
 - c) the spatial granularity size of cell in the "spatialGranSizeCell" attribute if the "QoS_SustainExt_eNA" feature is supported;
 - d) the temporal granularity size in the "temporalGranSize" attribute if the "QoS_SustainExt_eNA" feature is supported;
 - e) the fine granularity areas as the "fineGranAreas" attribute if the feature "QoS_SustainExt_eNA" is supported.
- if the feature "AbnormalBehaviour" is supported and the event is "ABNORMAL_BEHAVIOUR", it shall provide:
- 1) identification of target UE(s) to which the request applies by "supis", "intGroupIds" or "anyUe" attribute set to "true" in the "tgt-ue" attribute; and
 - 2) event specific filter information in the "event-filter" attribute which shall provide
 - a) either the expected analytics type via "exptAnaType" attribute or a list of exception Ids via "excepIds" attribute. If the expected analytics type via "exptAnaType" attribute is provided, the NWDAF shall derive the corresponding Exception Ids from the received expected analytics type as follows:
 - if "exptAnaType" attribute sets to "MOBILITY", the corresponding list of Exception Ids are "UNEXPECTED_UE_LOCATION", "PING_PONG_ACROSS_CELLS", "UNEXPECTED_WAKEUP" and "UNEXPECTED_RADIO_LINK_FAILURES";
 - if "exptAnaType" attribute sets to "COMMUN", the corresponding list of Exception Ids are "UNEXPECTED_LONG_LIVE_FLOW", "UNEXPECTED_LARGE_RATE_FLOW", "SUSPICION_OF_DDOS_ATTACK", "WRONG_DESTINATION_ADDRESS" and "TOO_FREQUENT_SERVICE_ACCESS";
 - if "exptAnaType" attribute sets to "MOBILITY_AND_COMMUN", the corresponding list of Exception Ids includes all above derived exception Ids.

The derived list of Exception Ids are used by the NWDAF to notify the NF service consumer when UE's behaviour is exceptional based on one or more Exception Ids within the list.

If the "anyUe" attribute in the "tgt-ue" attribute sets to "true":

- a) the expected analytics type via the "exptAnaType" attribute or the list of Exception Ids via "excepIds" attribute shall not be requested for both mobility and communication related analytics at the same time;
- b) if the expected analytics type via the "exptAnaType" attribute or the list of Exception Ids via "excepIds" attribute is mobility related, at least one of identification of network area by "networkArea" attribute and identification of network slice(s) by "snssais" attribute should be provided; and
- c) if the expected analytics type via the "exptAnaType" attribute or the list of Exception Ids via "excepIds" attribute is communication related, at least one of identification of network area by "networkArea" attribute, identification of application(s) by "appIds" attribute, identification of DNN(s) in the "dnns" attribute and identification of network slice(s) by "snssais" attribute should be provided;

the "event-filter" attribute may provide:

- a) expected UE behaviour via "exptUeBehav" attribute;
- if the feature "UserDataCongestion" is supported and the event is "USER_DATA_CONGESTION", it shall provide one of the following attributes:
 - 1) identification of target UE(s) via "supis" "gpsis" (if feature "UserDataCongestionExt" is supported) or "anyUe" attribute set to "true" within "tgt-ue" attribute;
 - 2) event specific filter information in the "event-filter" attribute which shall provide:
 - a) the user data congestion requirements via "userDataConReqs" attribute, if the feature "UserDataCongestionExt2_eNA" is supported;

and may provide:

- 1) event specific filter information in the "event-filter" attribute which may provide:
 - a) identification of network slice(s) by "snssais" attribute;
 - b) identification of network area to which the request applies via identification of network area by "networkArea" attribute (mandatory if "anyUe" attribute is set to true);
 - c) if the feature "UserDataCongestionExt" is also supported, request a list of top applications with maximum number that contribute the most to the traffic in uplink and/or downlink directions by the "maxTopAppUINbr" attribute and/or the "maxTopAppDINbr" attribute; and/or
 - d) a list of analytics subsets carried by "listOfAnaSubsets" attribute with value(s) only applicable to "USER_DATA_CONGESTION" event, if the "EneNA" feature is supported;
 - e) the temporal granularity size in the "temporalGranSize" attribute if the "UserDataCongestionExt2_eNA" feature is supported.
- if the feature "SMCCCE" is supported and the event is "SM_CONGESTION", it shall provide:
 - 1) event specific filter information in the "event-filter" attribute which shall provide:
 - a) identification of DNN in the "dnns" attribute; and/or
 - b) identification of network slice(s) in the "snssais" attribute; and
 - 2) identification of target UE(s) via "supis" attribute in the "tgt-ue" attribute where the target UE(s) are one have the PDU Session for the DNN and/or S-NSSAI indicated by the event specific filter information;

and may include:

- 1) a list of analytics subsets carried by "listOfAnaSubsets" attribute with value(s) only applicable to "SM_CONGESTION" event, if the "EneNA" feature is supported;

NOTE 8: The predictions are not applicable for Session Management Congestion Control Experience analytics.

- if the feature "Dispersion" is supported and the event is "DISPERSION", shall provide:
 - 1) identification of target UE(s) applies by "supis", "intGroupIds" or "anyUe" attribute set to "true" within "tgt-ue" attribute, "anyUe" attribute set to "true" is only supported in combination with "snssais" attribute, "networkArea" attribute and/or "disperClass" attribute;
 and may include:
 - 1) identification of network area applies via identification of network area by "networkArea" attribute;
 - 2) identification of network slice(s) by "snssais" attribute;
 - 3) application identifier(s) in "appIds" attribute;
 - 4) dispersion analytics requirements in "disperReqs" attribute, which for the requested dispersion type may include dispersion class, ranking, ordering and/or accuracy requirements;
 - 5) an optional list of analytics subsets by "listOfAnaSubsets" attribute with value(s) only applicable to "DISPERSION" event;
 - 6) preferred granularity of location information as the "locGranularity" attribute if the feature "DispersionExt_eNA" is supported;
 - 7) the spatial granularity size of TA in the "spatialGranSizeTa" attribute if the "DispersionExt_eNA" feature is supported;
 - 7) the spatial granularity size of cell in the "spatialGranSizeCell" attribute if the "DispersionExt_eNA" feature is supported; and/or
 - 8) the temporal granularity size in the "temporalGranSize" attribute if the "DispersionExt_eNA" feature is supported.
- if the feature "RedundantTransmissionExp" is supported and the event is "RED_TRANS_EXP", shall provide:
 - 1) identification of target UE(s) applies by "supis", "intGroupIds" or "anyUe" attribute set to "true" within "tgt-ue" attribute;
 and may include:
 - 1) identification of network area applies via identification of network area by "networkArea" attribute, if the "supis" attribute or "intGroupIds" attribute is included in the "tgt-ue" attribute;
 - 2) identification of network slice(s) by "snssais" attribute;
 - 3) identification of DNN in the "dnns" attribute;
 - 4) other redundant transmission experience analysis requirements in "redTransReqs" attribute, which may include preferred order of results for the list of Redundant Transmission Experience;
 - 5) an optional list of analytics subsets by "listOfAnaSubsets" attribute with value(s) only applicable to RED_TRANS_EXP event, if the "EneNA" feature is supported; and/or
 - 6) the temporal granularity size in the "temporalGranSize" attribute if the "RedundantTransExpExt_eNA" feature is supported.
- if the feature "WlanPerformance" is supported and the event is "WLAN_PERFORMANCE", shall provide:
 - 1) identification of target UE(s) by "supis", "intGroupIds" or "anyUe" attribute set to "true" in the "tgt-ue" attribute. If "anyUe" attribute set to "true" is included in the "tgt-ue" attribute, then any of "networkArea" attribute, "ssIds" or "bssIds" attribute shall be present in the "wlanReqs" attribute;
 and may include:
 - 1) identification of network area to which the request applies via identification of network area by "networkArea" attribute;

- 2) other WLAN performance analytics requirements in "wlanReqs" attribute, which may include SSID(s), BSSID(s), preferred order of results for the list of WLAN performance information and/or accuracy per analytics subset;
 - 3) an optional list of analytics subsets by "listOfAnaSubsets" attribute with value(s) only applicable to WLAN_PERFORMANCE event, if the "EneNA" feature is supported; and/or
 - 4) the temporal granularity size in the "temporalGranSize" attribute if the "WlanPerfExt_eNA" feature is supported.
- if the feature "DnPerformance" is supported and the event is "DN_PERFORMANCE", shall provide:
- 1) identification of target UE(s) to which the request applies by "supis", "intGroupIds" or "anyUe" attribute set to "true" in the "tgt-ue" attribute;
- and may include:
- 1) identification of network area to which the request applies via identification of network area by "networkArea" attribute;
 - 2) identification of network slice(s) in the "snssais" attribute;
 - 3) identification of network slice and the optionally associated network slice instance(s) if available, via the "nsiIdInfos" attribute or any slices indication in the "anySlice" attribute;
 - 4) application identifier(s) in "appIds" attribute;
 - 5) an identification of DNN in the "dnns" attribute;
 - 6) identification of a user plane access to one or more DN(s) where applications are deployed by "dnais" attribute;
 - 7) the identification of the UPF as the "upfInfo" attribute;
 - 8) IP address(s)/FQDN(s) of the Application Server(s) as the "appServerAdrrs" attribute;
 - 9) DN performance analytics requirements in "dnPerfReqs" attribute, which may include the preferred order of results for the list of DN performance information and/or the reporting threshold of each applicable analytics subset; and/or
 - 10) an optional list of analytics subsets by "listOfAnaSubsets" attribute with value(s) only applicable to "DN_PERFORMANCE" event, if the "EneNA" feature is supported and may include the attribute with value(s) only applicable to "DN_PERFORMANCE" event and "DnPerformanceExt_AIML" feature if supported.
 - 11) the spatial granularity size of TA in the "spatialGranSizeTa" attribute if the "DnPerfExt_eNA" feature is supported.
 - 11) the spatial granularity size of cell in the "spatialGranSizeCell" attribute if the "DnPerfExt_eNA" feature is supported.
 - 12) the temporal granularity size in the "temporalGranSize" attribute if the "DnPerfExt_eNA" feature is supported.
- if the feature "E2eDataVolTransTime" is supported and the event is "E2E_DATA_VOL_TRANS_TIME", shall provide:
- 1) identification of target UE(s) to which the subscription applies by "supis" or "gpsis" attribute in the "tgt-ue" attribute.
- and may include:
- 1) an identification of DNN in the "dnns" attribute;
 - 2) identification of network slice in the "snssais" attribute;
 - 3) application identifier(s) in "appIds" attribute;

- 4) area of interest of the UEs by "networkArea" attribute; restricts the scope of the E2E data volume transfer time analytics to the provided area;
- 5) an optional list of analytics subsets by "listOfAnaSubsets" attribute with value(s) only applicable to "E2E_DATA_VOL_TRANS_TIME" event, if the "EneNA" feature is supported;
- 6) the QoS requirements via "qosRequ" attribute; and
- 7) E2E data volume transfer time requirements in the "dataVITrmsTmRqs" attribute;
- if the feature "PduSesTraffic" is supported and the event is "PDU_SESSION_TRAFFIC", shall provide:
 - 1) identification of target UE(s) to which the subscription applies by "supis", "intGroupIds" or "anyUe" attribute set to "true" in the "tgt-ue" attribute;
 - 2) PDU Session traffic analytics requirements in "pduSesTrafReqs" attribute, which includes the known Application Identifier, IP Descriptions or Domain Descriptors.
 - 3) DNN and/or S-NSSAI for the PDU Session(s) in the "dnns" and/or "snssais" attributes.

and may include:

- 1) identification of network area to which the request applies via identification of network area by "networkArea" attribute; and/or
- 2) an optional list of analytics subsets by "listOfAnaSubsets" attribute with value(s) only applicable to "PDU_SESSION_TRAFFIC" event, if the "EneNA" feature is supported.

NOTE 10: The predictions are not applicable for PDU Session traffic analytics.

- if the feature "MovementBehaviour" is supported and the event is "MOVEMENT_BEHAVIOUR", shall provide:
 - 1) identification of network area to which the request applies to restrict the scope of the movement behaviour analytics to the provided area by the "networkArea" attribute and/or the "fineGranAreas" attribute;
- and may include:
 - 1) identification of the preferred orientation of location information by the "locOrientation" attribute;
 - 2) Movement Behaviour analytics requirements in the "movBehavReqs" attribute, which includes preferred granularity of location information or preferred orientation of location information; and/or
 - 3) an optional list of analytics subsets by the "listOfAnaSubsets" attribute with value(s) only applicable to the "MOVEMENT_BEHAVIOUR" event, if the "EneNA" features is supported.
- if the feature "LocAccuracy" is supported and the event is "LOC_ACCURACY", the "event-filter" attribute shall include:
 - 1) either a network area to which the request applies within the "networkArea" attribute or an exact location to which the request applies within the "location" attribute;
- and the "event-filter" attribute may include:
 - 1) Location accuracy analytics requirements within the "locAccReqs" attribute; and/or
 - 2) an optional list of analytics subsets within the "listOfAnaSubsets" attribute with value(s) only applicable to the "LOC_ACCURACY" event, if the "EneNA" features is supported.

NOTE 11: Location accuracy analytics do not have a target UE, they are always for any UE.

- if the feature "RelativeProximity" is supported and the event is "RELATIVE_PROXIMITY", shall provide:
 - 1) identification of target UE(s) to which the request applies by "supis" or "intGroupIds" attribute in the "tgt-ue" attribute;
- and may include in the "event-filter" attribute:

- 1) identification of DNN in the "dnns" attribute;
- 2) identification of network slice in the "snssais" attribute;
- 3) identification of network area to which the request applies via identification of network area by "networkArea" attribute;
- 4) Relative Proximity analytics requirements in "relProxReqs" attribute; and/or
- 5) an optional list of analytics subsets by "listOfAnaSubsets" attribute with value(s) only applicable to "RELATIVE_PROXIMITY" event prediction, if the "EneNA" features is supported.

Upon the reception of the HTTP GET request, the NWDAF shall:

- analyse the requested analytic data according to the requested event.

If the HTTP request message from the NF service consumer is accepted, the NWDAF shall respond with "200 OK" status code with the message body containing the analytics with parameters as relevant for the requesting NF service consumer. The AnalyticsData data structure in the response body shall include:

- analytics with the corresponding information as described in clause 4.2.2.4.2.
- the analytics accuracy information in the "accuInfo" attribute, if the feature "AnalyticsAccuracy" is supported and the analytics accuracy requirement was requested in the "accuReq" attribute.

NOTE 12: In this version of the specification, NWDAF containing AnLF can provide accuracy information to an NF consumer that requests both the analytics and the accuracy information.

NOTE 13: When receiving a request from an NF consumer that includes a request for accuracy information, the analytics and the accuracy information can be provided by NWDAF containing AnLF within the single response.

If the requested NWDAF Analytics data does not exist, the NWDAF shall respond with "204 No Content" status code.

If the "timeAnaNeeded" attribute within EventReportingRequirement is provided during the request, if the time is reached but the requested analytics information is not ready, the consumer does not need to wait for the analytics information any longer, the NWDAF may send a "500 Internal Server Error" status code to the NF service consumer. In addition, if the EneNA feature is supported, the NWDAF may provide, within the ProblemDetailsAnalyticsInfoRequestdata in the response, the corresponding failure reason via a "problemDetails" attribute with the "cause" attribute set to "UNSATISFIED_REQUESTED_ANALYTICS_TIME" and a minimum time interval recommended by the NWDAF via a "rvWaitTime" attribute which is used by the NF service consumer to determine the time when analytics information is needed in similar future analytics requests.

If the analytics target period provided in the body of the HTTP GET request includes the start time in the past and the end time in the future, the NWDAF shall reject the request with an HTTP "400 Bad Request" response including the "cause" attribute set to "BOTH_STAT_PRED_NOT_ALLOWED".

When the "PredictionError" feature is supported, if the analytics target period provided in the body of the HTTP GET request includes the prediction time period in the future and the event is "SM_CONGESTION" and/or "PDU_SESSION_TRAFFIC", the NWDAF shall reject the request with an HTTP "400 Bad Request" response including the "cause" attribute set to "PREDICTION_NOT_ALLOWED".

If the statistics in the past are requested but the necessary data to perform the service is unavailable, the NWDAF shall reject the request with an HTTP "500 Internal Server Error" response including the "cause" attribute set to "UNAVAILABLE_DATA".

If the user consent has not been checked by the NF service consumer and is required for the requested analytics collection depending on local policy and regulations, then the NWDAF shall check user consent for the targeted UE(s) by retrieving the user consent subscription data via the Nudm_SDM service API of the UDM as described in clause 5.2.2 of 3GPP TS 29.503 [23]. If the NWDAF receive the response from the UDM that it is not granted for the impacted user(s), then the NWDAF shall send an HTTP "403 Forbidden" error response including the "cause" attribute set to "USER_CONSENT_NOT_GRANTED".

NOTE 13: When the target of reporting is a SUPI or a GPSI then the subscription can be rejected, e.g. because user consent is not granted, and the error is sent to the consumer. When the target of reporting is an Internal Group Id, or a list of SUPIs/GPSI(s) or any UE, and the user consent is not granted for a subset of the impacted users, then no error is sent, but a subset of the SUPIs/GPSIs is skipped if user consent is not granted.

If the RoamingAnalytics feature is supported and the NWDAF determines based on operator configuration and the requested analytics that analytics or input data from the VPLMN are required, and the NWDAF does not support roaming exchange and it cannot forward the request to another NWDAF, then the NWDAF shall reject the request with an HTTP "403 Forbidden" response including the "cause" attribute set to "NO_ROAMING_SUPPORT".

If an error occurs when processing the HTTP GET request, the NWDAF shall send an HTTP error response as specified in clause 5.2.7.

4.3.2.3 NnwdaF_AnalyticsInfo_ContextTransfer service operation

4.3.2.3.1 General

The NnwdaF_AnalyticsInfo_ContextTransfer service operation is used by an NF service consumer to request and get context information related to analytics subscriptions from the NWDAF.

4.3.2.3.2 Request and get from NWDAF context of a subscription

Figure 4.3.2.3.2-1 shows a scenario where the NF service consumer (e.g. NWDAF) sends a request to the NWDAF to request and get from NWDAF context information related to analytics subscriptions (see also 3GPP TS 23.288 [17]).

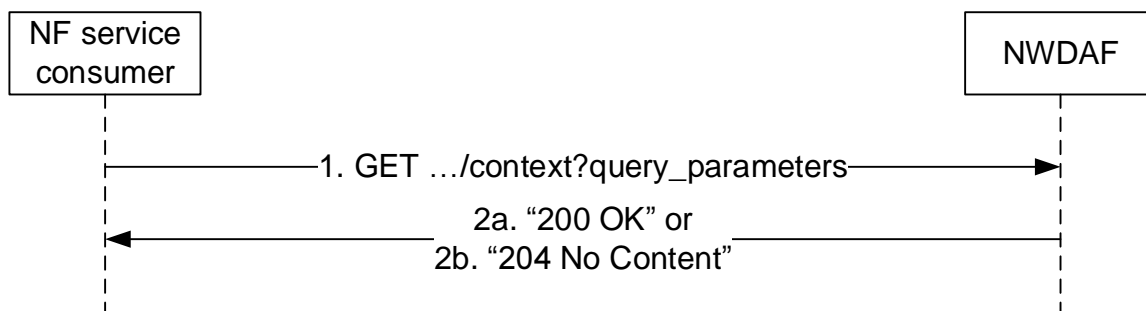

Figure 4.3.2.3.2-1: Requesting NWDAF context information related to analytics subscriptions

The NF service consumer (e.g. NWDAF) shall invoke the NnwdaF_AnalyticsInfo_ContextTransfer service operation when requesting context information related to analytics subscriptions. The NF service consumer shall send an HTTP GET request on the resource URI "{apiRoot}/nnwdaF-analyticsinfo/<apiVersion>/context" representing the "NWDAF Context" (as shown in figure 4.3.2.3.2-1, step 1), to request context information related to analytics subscriptions according to the query parameter values of the attributes "context-ids" and "req-context".

Upon the reception of the HTTP GET request, the NWDAF shall retrieve the context information for the requested context identifiers.

If the HTTP request message from the NF service consumer is accepted, the NWDAF shall respond with "200 OK" status code with the message body containing the retrieved context information. The ContextData data structure in the response body shall include for each of the context elements contained in the "contextElems" attribute:

- the context identifier that this context element refers to in the "contextId" attribute, which indicates among others the analytics subscription that this context element is associated with.
- the pending output analytics for the indicated analytics subscription in the "pendAnalytics" attribute if such analytics are available and the NF service consumer has indicated the "PENDING_ANALYTICS" context type in the "req-context" attribute of the request.

- the historical output analytics for the indicated analytics subscription in the "histAnalytics" attribute if such analytics are available and the NF service consumer has indicated the "HISTORICAL_ANALYTICS" context type in the "req-context" attribute of the request.
- a timestamp of the last provided output analytics in the "lastOutputTime" if the NF service consumer has indicated the "PENDING_ANALYTICS" and/or "HISTORICAL_ANALYTICS" context type in the "req-context" attribute of the request and output analytics had been provided to the analytics consumer.
- information about aggregation related analytics subscriptions that the NWDAF has with other NWDAFs in the "aggrSubs" attribute if such subscriptions exist and the NF service consumer has indicated the "AGGR_SUBS" context type in the "req-context" attribute of the request.
- historical data related to the indicated analytics subscription in the "histData" attribute if such data exists and the NF service consumer has indicated the "DATA" context type in the "req-context" attribute of the request.
- identifier of ADRF instance in the "adrfId" attribute if the NWDAF stores data in the ADRF.
- the types of data stored in the ADRF in the "adrfDataTypes" attribute if the "adrfId" attribute is provided.
- identifiers of NWDAF instances used when aggregating multiple analytics subscriptions in the "aggrNwdafIds" if such information is available and the NF service consumer has indicated the "AGGR_INFO" context type in the "req-context" attribute of the request.
- information about used ML models in the "modelInfos" attribute if such information is available and the NF service consumer has indicated the "ML_MODELS" context type in the "req-context" attribute of the request.
- if the "EnAnaCtxTransfer" feature is supported, the Analytics Accuracy related information in the "anaAccuInfos" attribute if such information is available and the NF service consumer has indicated the "ANALYTICS_ACCU_INFO" context type in the "req-context" attribute of the request.
- if the "EnAnaCtxTransfer" feature is supported, the ML Model accuracy related information in the "modelAccuInfos" attribute if such information is available and the NF service consumer has indicated the "ML_MODEL_ACCU_INFO" context type in the "req-context" attribute of the request.

If the requested context information does not exist, the NWDAF shall respond with "204 No Content" status code.

4.4 Nnwdaf_DataManagement Service

4.4.1 Service Description

4.4.1.1 Overview

The Nnwdaf_DataManagement Service as defined in 3GPP TS 23.288 [17] is provided by the Network Data Analytics Function (NWDAF).

This service:

- allows the NF service consumers to subscribe to and unsubscribe from data management related events;
- notifies the NF service consumers with the subscribed events which are detected by the NWDAF; and
- allows the NF service consumers to retrieve the subscribed data from the NWDAF.

4.4.1.2 Service Architecture

The 5G System Architecture is defined in 3GPP TS 23.501 [2]. The Network Data Analytics Exposure architecture is defined in 3GPP TS 23.288 [17]. The Network Data Analytics signalling flows are defined in 3GPP TS 29.552 [25].

The Nnwdaf_DataManagement service is part of the Nnwdaf service-based interface exhibited by the Network Data Analytics Function (NWDAF).

Known consumers of the Nnwdaf_DataManagement service are:

- Network Data Analytics Function (NWDAF)
- Data Collection Coordination Function (DCCF)
- Messaging Framework Adaptor Function (MFAF)
- Analytics Data Repository Function (ADRF)

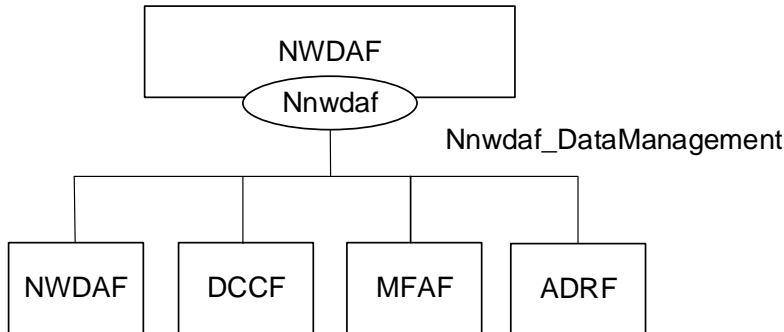

Figure 4.4.1.2-1: Reference Architecture for the Nnwdaf_DataManagement Service; SBI representation

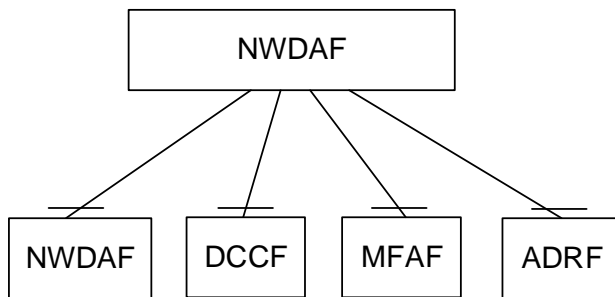

Figure 4.4.1.2-2: Reference Architecture for the Nnwdaf_DataManagement Service: reference point representation

4.4.1.3 Network Functions

4.4.1.3.1 Network Data Analytics Function (NWDAF)

The Network Data Analytics Function (NWDAF) provides requested data to NF consumers.

The Network Data Analytics Function (NWDAF) allows NF consumers to subscribe to and unsubscribe from the notification of detected event(s).

The Network Data Analytics Function (NWDAF) allows NF consumers to retrieve data that was collected based on their subscriptions.

4.4.1.3.2 NF Service Consumers

The Network Data Analytics Function (NWDAF):

- supports (un)subscription to the notification of data exposed by the NWDAF;
- supports retrieving data from the NWDAF.

The Data Collection Coordination Function (DCCF):

- supports (un)subscription to the notification of data exposed by the NWDAF;

- supports retrieving data from the NWDAF.

The Messaging Framework Adaptor Function (MFAF):

- supports receiving notifications of data provided by the NWDAF;
- supports retrieving data from the NWDAF.

The Analytics Data Repository Function (ADRF):

- supports receiving notifications of data provided by the NWDAF.
- supports retrieving data from the NWDAF.

4.4.2 Service Operations

4.4.2.1 Introduction

Table 4.4.2.1-1: Operations of the Nnwdaf_DataManagement Service

| Service operation name | Description | Initiated by |
|-----------------------------------|--|---|
| Nnwdaf_DataManagement_Subscribe | This service operation is used by an NF service consumer to subscribe to data management related event(s) from NWDAF. | NF service consumer (NWDAF, DCCF, MFAF, ADRF) |
| Nnwdaf_DataManagement_Unsubscribe | This service operation is used by an NF service consumer to unsubscribe to data management related event(s). | NF service consumer (NWDAF, DCCF, MFAF, ADRF) |
| Nnwdaf_DataManagement_Notify | This service operation is used by the NWDAF to notify the detected event(s) to the NF service consumer instance which has subscribed to. | NWDAF |
| Nnwdaf_DataManagement_Fetch | This service operation is used by an NF service consumer to retrieve the subscribed data. | NF service consumer (NWDAF, DCCF, MFAF) |

4.4.2.2 Nnwdaf_DataManagement_Subscribe service operation

4.4.2.2.1 General

The Nnwdaf_DataManagement_Subscribe service operation is used by an NF service consumer to create or update a subscription for data notifications from the NWDAF.

NOTE: If the data is to be collected for a user, i.e. SUPI or GPSI, the consumer needs to check the user consent by retrieving the user consent information from the UDM as described in clause 5.5 of 3GPP TS 29.552 [25] before invoking this service operation.

4.4.2.2.2 Subscription for data notifications

Figure 4.4.2.2.2-1 shows a scenario where the NF service consumer sends a request to the NWDAF to subscribe for data notification(s).

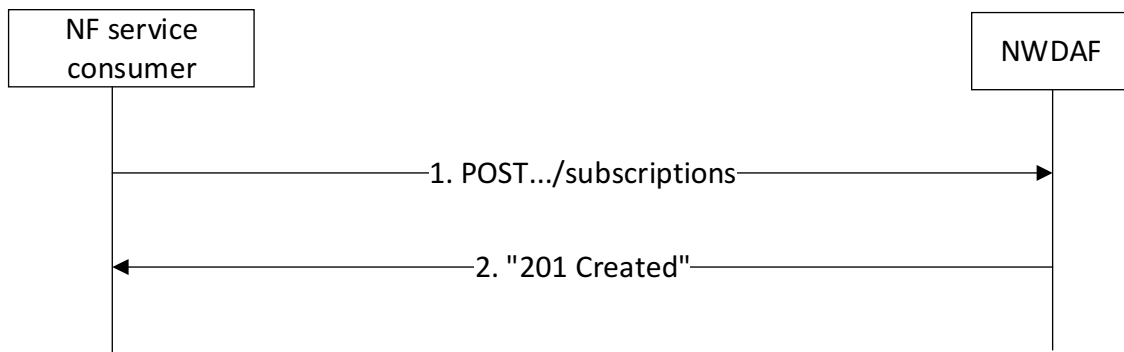

Figure 4.4.2.2.2-1: NF service consumer subscribes to data notifications

The NF service consumer shall invoke the `Nnwdaf_DataManagement_Subscribe` service operation to subscribe to data notification(s). The NF service consumer shall send an HTTP POST request with "`{apiRoot}/nnwdaf-datamanagement/<apiVersion>/subscriptions`" as Resource URI representing the "NWDAF Data Management Subscriptions", as shown in figure 4.4.2.2.2-1, step 1, to create a subscription for an "Individual NWDAF Data Management Subscription" according to the information in message body.

The `NnwdafDataManagementSubsc` data structure provided in the request body shall include:

- an URI where to receive the requested notifications as "notificURI" attribute;
- notification correlation identifier within the "notifCorrId" attribute; and
- one of the following:
 - analytics subscription information to be used to determine which data shall be collected and reported within the "anaSub" attribute;
 - data subscription information within the "dataSub" attribute;

The `NnwdafDataManagementSubsc` data structure provided in the request body may include:

- the notification endpoints within the "notifEndpoints" attribute if the "DataAnaCollect" feature is supported;
- formatting instructions within the "formatInstruct" attribute;
- processing instructions within the "procInstruct" attribute or the "multiProcInstructs" attribute if the "MultiProcessingInstruction" feature is supported;
- one of the following identifiers related to the ADRF:
 - ADRF instance identifier within the "adrfId" attribute;
 - ADRF set identifier within the "adrfSetId" attribute;
- one of the following target identifiers:
 - NF instance identifier within the "targetNfId" attribute;
 - NF set identifier within the "targetNfSetId" attribute;
- time window of the occurrence of the requested data collection within the "timePeriod" attribute;
- the purpose of data collection within the "dataCollectPurposes" attribute.
- the indication that the NF service consumer has already checked the user consent within the "checkedConsentInd" attribute, if the "UserConsent" feature is supported.
- storage handling information within the "storeHandl" attribute, if the "EnhDataMgmt" feature is supported.

Upon the reception of an HTTP POST request with: "`{apiRoot}/nnwdaf-datamanagement/<apiVersion>/subscriptions`" as Resource URI and `NnwdafDataManagementSubsc` data structure as request body, the NWDAF shall use the contents of the request to determine whether the subscription can already be served or interactions with the ADRF and/or data

sources are required. If the NWDAF cannot use the contents of the request to determine this, the NWDAF shall send an HTTP "400 Bad Request" error response including the "cause" attribute set to "SUBSCRIPTION_CANNOT_BE_SERVED".

NOTE 1: The "SUBSCRIPTION_CANNOT_BE_SERVED" error can occur, for example, in the case where the "dataSub" or "anaSub" attributes are provided, when the request is syntactically valid and there is no NWDAF internal error, but the NWDAF can neither find an existing subscription to a data source nor construct one based on the received subscription contents.

If the user consent has not been checked by the NF service consumer and is required for the requested data collection depending on local policy and regulations, then the NWDAF shall check user consent for the targeted UE(s) based on the user consent subscription data that is retrieved via the Nudm_SDM service API of the UDM as described in clause 5.2.2.24 and clause 6.1.3.32 of 3GPP TS 29.503 [23]. If the user consent subscription data retrieved from the UDM indicate that the user consent is not granted for the impacted user(s), then the NWDAF shall send an HTTP "403 Forbidden" error response including the "cause" attribute set to "USER_CONSENT_NOT_GRANTED".

NOTE 2: When the target of reporting is a SUPI or a GPSI then the subscription can be rejected, e.g. because user consent is not granted, and the error is sent to the consumer. When the target of reporting is an Internal Group Id, or a list of SUPIs/GPSI(s) or any UE, and the user consent is not granted for a subset of the impacted users, then no error is sent, but a subset of the SUPIs/GPSIs is skipped if user consent is not granted.

Otherwise, if the user consent subscription data retrieved from the UDM indicate that the user consent is granted for the impacted user(s), the NWDAF shall subscribe to notification of changes of the user consent (unless it is already subscribed) by invoking the Nudm_SDM_Subscribe service operation by sending an HTTP POST request targeting the resource "SdmSubscriptions" to the UDM as described in clause 5.2.2.3 of 3GPP TS 29.503 [23].

If the NWDAF determines that the subscription can already be served (without requiring further interactions with ADRF and/or data sources) or a successful response from the ADRF and/or data sources is received for the creation or modification of subscription(s) to serve this subscription, the NWDAF shall:

- create a new subscription;
- assign a subscriptionId;
- store the subscription.

If the NWDAF created an "Individual NWDAF Data Management Subscription" resource, the NWDAF shall respond with "201 Created" with the message body containing a representation of the created subscription, as shown in figure 4.4.2.2.2-1, step 2. The NWDAF shall include a Location HTTP header field. The Location header field shall contain the URI of the created subscription i.e. "{apiRoot}/nnwda-datamanagement/<apiVersion>/subscriptions/{subscriptionId}". If an immediate reporting indication is provided in the subscription, the NWDAF shall include the reports of the events subscribed, if available, in the HTTP POST response within the "dataSub" attribute, or, if the DataAnaCollect feature is supported, potentially within the "immReport" attribute.

If the NWDAF receives storage handling information in the request but determines (e.g. based on local policy) that a different storage approach shall be followed, it indicates the determined storage approach to the consumer by setting accordingly the "storeHandl" attribute (e.g. providing a different lifetime, or setting the indication about deletion alerts to "false") in the message body of the response. When more than one consumer has requested storage lifetime for the same analytics, the storage approach should be based on the longest requested storage lifetime.

NOTE 3: The default operator policy for how long analytics is to be stored can be longer or shorter than the lifetime requested by the consumer. A default operator policy can for example accept only consumer requested lifetimes that are shorter or longer than the default policy.

When the notification flag of the "dataSub" attribute (e.g. the "notifFlag" attribute within the "eventsRepInfo" attribute in the case of AF events) is included and set to "DEACTIVATE" in the request, the NWDAF shall mute the event notification and store the available events until the NF service consumer requests to retrieve them by setting the notification flag to "RETRIEVAL" or until a muting exception occurs (e.g. full buffer). When a muting exception occurs, if the EnhDataMgmt feature is supported, the NWDAF may consider the contents of the muting instructions of the "dataSub" attribute (if provided; e.g. the "notifFlagInstruct" attribute within the "eventsRepInfo" attribute in the case of AF events) and/or local configuration to determine its actions.

If the EnhDataMgmt feature is supported and the NWDAF accepts the provided notification flag and muting instructions, it may indicate the applied muting notification settings in the response (e.g. within the "mutingSetting" attribute in the case of AF events). If the NWDAF does not accept the provided notification flag and muting instructions, it shall send an HTTP "403 Forbidden" error response including the "cause" attribute set to "MUTING_INSTR_NOT_ACCEPTED".

If an error occurs when processing the HTTP POST request, the NWDAF shall send an HTTP error response as specified in clause 5.3.7.

4.4.2.2.3 Update subscription for data notifications

Figure 4.4.2.2.3-1 shows a scenario where the NF service consumer sends a request to the NWDAF to update the subscription for data notifications.

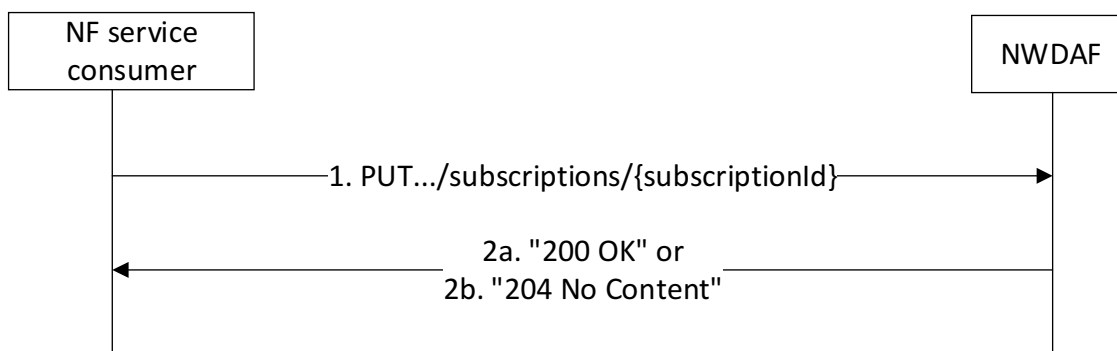

Figure 4.4.2.2.3-1: NF service consumer updates subscription to data notifications

The NF service consumer shall invoke the `Nnwdaf_DataManagement_Subscribe` service operation to update subscription to data notifications. The NF service consumer shall send an HTTP PUT request with "`{apiRoot}/nnwdaf-datamanagement/<apiVersion>/subscriptions/{subscriptionId}`" as Resource URI representing the "Individual NWDAF Data Management Subscription", as shown in figure 4.4.2.2.3-1, step 1, to update the subscription for an "Individual NWDAF Data Management Subscription" resource identified by the `{subscriptionId}`. The `NnwdafDataManagementSubsc` data structure provided in the request body shall include the same contents as described in clause 4.4.2.2.2.

Upon the reception of an HTTP PUT request with: "`{apiRoot}/nnwdaf-datamanagement/<apiVersion>/subscriptions/{subscriptionId}`" as Resource URI and `NnwdafDataManagementSubsc` data structure as request body, the NWDAF shall use the contents of the request to determine whether the updated subscription can already be served or interactions with the ADRF and/or data sources are required. If the NWDAF cannot use the contents of the request to determine this, the NWDAF shall send an HTTP "400 Bad Request" error response including the "cause" attribute set to "SUBSCRIPTION_CANNOT_BE_SERVED".

NOTE 1: The "SUBSCRIPTION_CANNOT_BE_SERVED" error can occur, for example, in the case when the "dataSub" or "anaSub" attributes are provided, when the request is syntactically valid and there is no NWDAF internal error, but the NWDAF can neither find an existing subscription to a data source nor construct one based on the received subscription contents.

If the user consent has not been checked by the NF service consumer and is required for the requested data collection depending on local policy and regulations, then the NWDAF shall check user consent for the targeted UE(s) based on the user consent subscription data that is retrieved via the `Nudm_SDM` service API of the UDM as described in clause 5.2.2.24 and clause 6.1.3.32 of 3GPP TS 29.503 [23]. If the user consent subscription data retrieved from the UDM indicate that the user consent is not granted for the impacted user(s), then the NWDAF shall send an HTTP "403 Forbidden" error response including the "cause" attribute set to "USER_CONSENT_NOT_GRANTED".

NOTE 2: When the target of reporting is a SUPI or a GPSI then the subscription can be rejected, e.g. because user consent is not granted, and the error is sent to the consumer. When the target of reporting is an Internal Group Id, or a list of SUPIs/GPSI(s) or any UE, and the user consent is not granted for a subset of the impacted users, then no error is sent, but a subset of the SUPIs/GPSIs is skipped if user consent is not granted.

Otherwise, if the user consent subscription data retrieved from the UDM indicate that the user consent is granted for the impacted user(s), the NWDAF shall subscribe to notification of changes of the user consent (unless it is already subscribed) by invoking the Nudm_SDM_Subscribe service operation by sending an HTTP POST request targeting the resource "SdmSubscriptions" to the UDM as described in clause 5.2.2.3 of 3GPP TS 29.503 [23].

If the NWDAF determines that the updated subscription can already be served (without requiring further interactions with the ADRF and/or data sources) or a successful response from the ADRF and/or data sources is received for the creation or modification of subscription(s) to serve this subscription, the NWDAF shall:

- update the subscription of corresponding subscriptionId; and
- store the subscription.

If the NWDAF successfully processed and accepted the received HTTP PUT request, the NWDAF shall update an "Individual NWDAF Data Management Subscription" resource, and shall respond with:

- a) HTTP "200 OK" status code with the message body containing a representation of the updated subscription, as shown in figure 4.4.2.2.3-1, step 2a; If an immediate reporting indication is provided in the request, the NWDAF shall include the reports of the events subscribed, if available, in the HTTP PUT response within the "dataSub" attribute, or, if the DataAnaCollect feature is supported, potentially within the "immReport" attribute; or
- b) HTTP "204 No Content" status code, as shown in figure 4.4.2.2.3-1, step 2b.

If the NWDAF receives storage handling information in the request but determines (e.g. based on local policy) that a different storage approach shall be followed, it indicates the determined storage approach to the consumer by setting accordingly the "storeHandl" attribute (e.g. providing a different lifetime, or setting the indication about deletion alerts to "false") in the message body of the response. When more than one consumer has requested storage lifetime for the same analytics, the storage approach should be based on the longest requested storage lifetime.

NOTE 3: The default operator policy for how long analytics is to be stored can be longer or shorter than the lifetime requested by the consumer. A default operator policy can for example accept only consumer requested lifetimes that are shorter or longer than the default policy.

When the notification flag of the "dataSub" attribute (e.g. the "notifFlag" attribute within the "eventsRepInfo" attribute in the case of AF events) is included in the request with the value "DEACTIVATE", the NWDAF shall mute the event notification and store the available events until the NF service consumer requests to retrieve them by setting the notification flag attribute to "RETRIEVAL" or until a muting exception occurs (e.g. full buffer). When a muting exception occurs, if the EnhDataMgmt feature is supported, the NWDAF may consider the contents of the muting instructions of the "dataSub" attribute (if provided; e.g. the "notifFlagInstruct" attribute within the "eventsRepInfo" attribute in the case of AF events) and/or local configuration to determine its actions; if the notification flag is set to the value "RETRIEVAL", the NWDAF shall send the stored events to the NF service consumer, mute the event notification again and store available events; if the notification flag is set to the value "ACTIVATE" and the event notifications are muted (due to a previously received "DECATIVATE" value), the NWDAF shall unmute the event notification, i.e. start sending again notifications for available events.

If the EnhDataMgmt feature is supported and the NWDAF accepts the provided notification flag and muting instructions, it may indicate the applied muting notification settings in the response (e.g. within the "mutingSetting" attribute in the case of AF events). If the NWDAF does not accept the provided notification flag and muting instructions, it shall send an HTTP "403 Forbidden" error response including the "cause" attribute set to "MUTING_INSTR_NOT_ACCEPTED". If errors occur when processing the HTTP PUT request, the NWDAF shall send an HTTP error response as specified in clause 5.3.7.

If the NWDAF determines the received HTTP PUT request needs to be redirected, the NWDAF shall send an HTTP redirect response as specified in clause 6.10.9 of 3GPP TS 29.500 [6].

4.4.2.3 NnwdaF_DataManagement_Unsubscribe service operation

4.4.2.3.1 General

The NnwdaF_DataManagement_Unsubscribe service operation is used by an NF service consumer to remove a subscription for data notifications from the NWDAF.

4.4.2.3.2 Unsubscribe from data notifications

Figure 4.4.2.3.2-1 shows a scenario where the NF service consumer sends a request to the NWDAF to unsubscribe from data notifications.

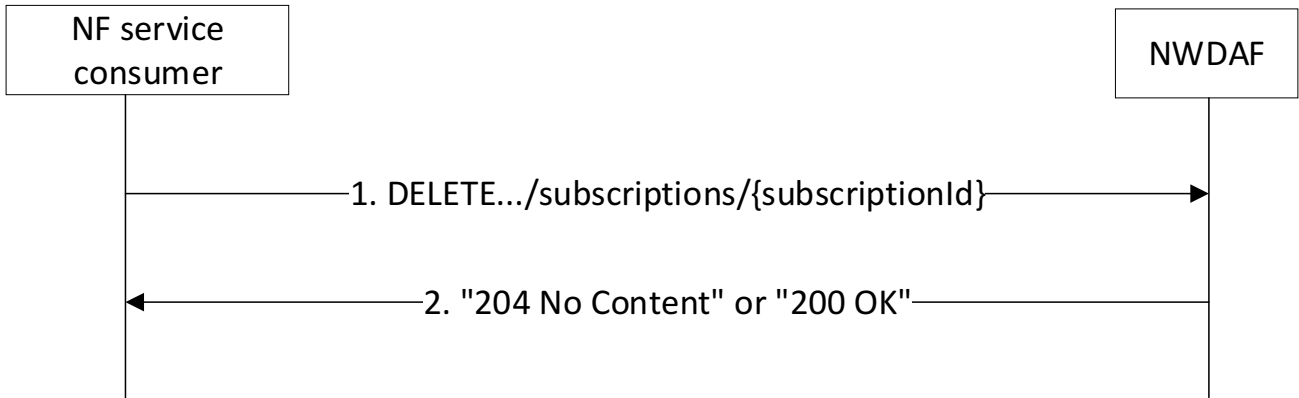

Figure 4.4.2.3.2-1: NF service consumer unsubscribes from data notifications

The NF service consumer shall invoke the `NnwdaF_DataManagement_Unsubscribe` service operation to unsubscribe from data notifications. The NF service consumer shall send an HTTP DELETE request with: "`{apiRoot}/nnwdaF-datamanagement/<apiVersion>/subscriptions/{subscriptionId}`" as Resource URI, where "`{subscriptionId}`" is the identifier of the existing subscription that is to be deleted.

Upon the reception of an HTTP DELETE request, if the NWDAF successfully processed and accepted the received HTTP DELETE request, the NWDAF shall:

- remove the corresponding subscription;
- respond to the NF service consumer:
 - respond with HTTP "204 No Content" status code if the "EnhDataMgmt" feature is not supported or no stored unspent events to be included in the response; or
 - respond with HTTP "200 OK" status code if the "EnhDataMgmt" feature is supported and including the stored unspent events in the `NnwdaFDataManagementNotif` data type in the response.

If errors occur when processing the HTTP DELETE request, the NWDAF shall send an HTTP error response as specified in clause 5.3.7.

If the NWDAF determines the received HTTP DELETE request needs to be redirected, the NWDAF shall send an HTTP redirect response as specified in clause 6.10.9 of 3GPP TS 29.500 [6].

4.4.2.4 NnwdaF_DataManagement_Notify service operation

4.4.2.4.1 General

The `NnwdaF_DataManagement_Notify` service operation is used by the NWDAF to notify NF service consumers about subscribed events related to data.

4.4.2.4.2 Notification about subscribed data

Figure 4.2.2.4.2-1 shows a scenario where the NWDAF sends a request to the NF service consumer to notify for event notifications (see also 3GPP TS 23.288 [17]).

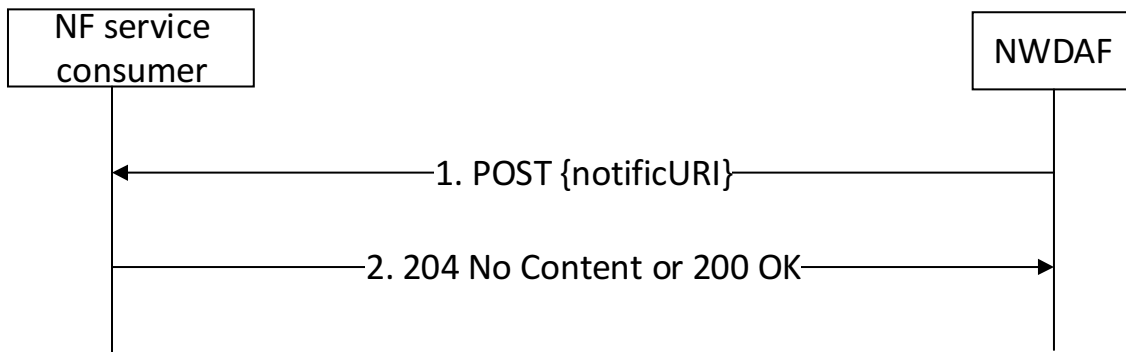

Figure 4.4.2.4.2-1: NWDAF notifies the subscribed event

The NWDAF shall invoke the `Nnwdaf_DataManagement_Notify` service operation to notify the subscribed event. The NWDAF shall send an HTTP POST request with "`{notificURI}`" received in the `Nnwdaf_DataManagement_Subscribe` service operation as Resource URI, as shown in figure 4.4.2.4.2-1, step 1.

The `NnwdafDataManagementNotif` data structure provided in the request body that shall include:

- the notification correlation identifier within the "`notifCorrId`" attribute;
- the timestamp of the notification within the "`notifTimestamp`" attribute;
- one of the following:
 - data collected from data sources (e.g. SMF, NEF) in the "`dataNotification`" attribute;
 - summarized data derived from events that occurred based on processing and formatting instructions in the "`dataReports`" attribute;
 - information for fetching the contents of the notification in the "`fetchInstruct`" attribute.
 - a deletion alert in the "`delAlert`" attribute, if the "`EnhDataMgmt`" feature is supported.

The `NnwdafDataManagementNotif` data structure provided in the request body may include:

- an indication that the NWDAF has requested a termination of the subscription within the "`terminationReq`" attribute; and/or
- a pending notification cause for the stored unsent data in the "`pendNotifCause`" attribute if the "`EnhDataMgmt`" feature is supported.

Upon the reception of an HTTP POST request, if the NF service consumer successfully processed and accepted the received HTTP POST request, the NF Service Consumer shall store the notification and respond with HTTP "204 No Content" status code, or with HTTP "200 OK" status code and the `NotifResponse` data structure in the response body if the "`EnhDataMgmt`" feature is supported.

After the successful processing of the HTTP POST request:

- if the NWDAF requests the NF service consumer with the "`fetchInstruct`" attribute to retrieve the data, the NF service consumer may invoke the `Nnwdaf_DataManagement_Fetch` service operation to retrieve the notified data as defined in clause 4.4.2.5.
- if the NWDAF provided a deletion alert to the NF service consumer, the NF service consumer may invoke the `Nadrf_DataManagement_RetrievalRequest` service operation as defined in 3GPP TS 29.575 [27] clause 4.2.2.5, using the storage transaction identifier received within the "`alertStorTransId`" attribute of the "`delAlert`" attribute, in order to retrieve the data that are about to be deleted.

NOTE: The "`alertStorTransId`" attribute, which is used for retrieving data prior to deletion, does not have to be the same with or related to the storage transaction identifier that is assigned and returned during the storage of the data in the ADRF.

If errors occur when processing the HTTP POST request, the NF service consumer shall send an HTTP error response as specified in clause 5.3.7.

If the NF service consumer determines the received HTTP POST request needs to be redirected, the NF service consumer shall send an HTTP redirect response as specified in clause 6.10.9 of 3GPP TS 29.500 [6].

4.4.2.5 Nnwdaf_DataManagement_Fetch service operation

4.4.2.5.1 General

The Nnwdaf_DataManagement_Fetch service operation is used by an NF service consumer to retrieve data notifications indicated by fetch instructions from the NWDAF.

4.4.2.5.2 Retrieve data from the NWDAF

Figure 4.4.2.5.2-1 shows a scenario where the NF service consumer sends a request to the NWDAF to retrieve notified data.

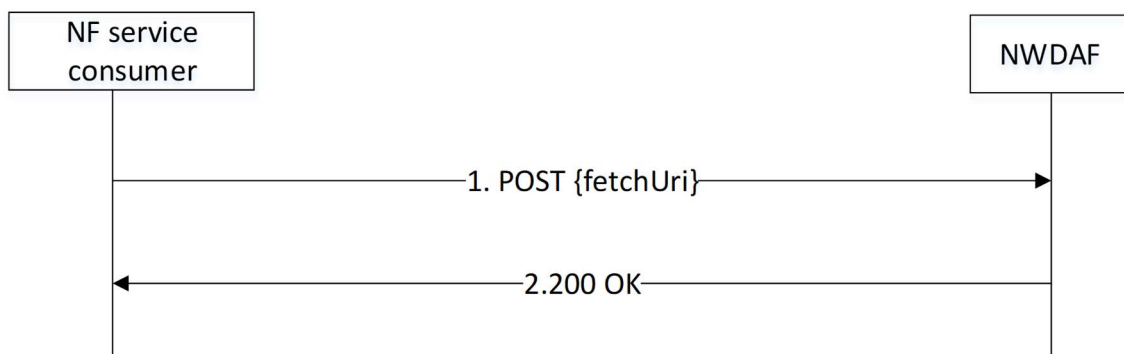

Figure 4.4.2.5.2-1: Requesting to retrieve notified data

The NF service consumer shall invoke the Nnwdaf_DataManagement_Fetch service operation to retrieve notified data. The NF service consumer shall send an HTTP POST request with "{fetchUri}" URI previously provided by the NWDAF in "fetchInstruct" attribute within NnwdafDataManagementNotif data type, as shown in figure 4.4.2.5.2-1, step 1, to fetch NWDAF data. The request body shall include fetch correlation identifiers, which was previously provided by the NWDAF in the "fetchCorrIds" attribute within FetchInstruction data structure in the NWDAF notification.

Upon the reception of the HTTP POST request, the NWDAF shall:

- find the data according to the requested parameters.

If the requested data is found, the NWDAF shall respond with "200 OK" status code with the message body containing the NnwdafDataManagementNotif data structure. The NnwdafDataManagementNotif data structure in the response body shall include the data collected from data sources (e.g. SMF, NEF) in the "dataNotification" attribute.

If an error occurs when processing the HTTP POST request, the NWDAF shall send an HTTP error response as specified in clause 5.3.7.

If the NWDAF determines that the received HTTP POST request needs to be redirected, the NWDAF shall send an HTTP redirect response as specified in clause 6.10.9 of 3GPP TS 29.500 [6].

4.5 Nnwdaf_MLModelProvision Service

4.5.1 Service Description

4.5.1.1 Overview

The Nnwdaf_MLModelProvision service as defined in 3GPP TS 23.501 [2] and 3GPP TS 23.288 [17], is provided by the Network Data Analytics Function (NWDAF) containing Model Training Logical Function (MTLF).

This service:

- allows the NF service consumers to subscribe to and unsubscribe from different ML model analytics events;
- allows MTLF-based ML Model Accuracy monitoring procedure between the AnLF and MTLF. and
- notifies the NF service consumers with a corresponding subscription about ML model information.

The types of analytics events supported by this service are the same as defined in clause 4.2.1.1.

NOTE: ML model provisioning is limited to a single vendor environment in this release of current specification.

4.5.1.2 Service Architecture

The 5G System Architecture is defined in 3GPP TS 23.501 [2]. The Network Data Analytics Exposure architecture is defined in 3GPP TS 23.288 [17]. The ML Model provisioning signalling flows are defined in 3GPP TS 29.552 [25].

The Nnwdaf_MLModelProvision service is part of the Nnwdaf service-based interface exhibited by the Network Data Analytics Function (NWDAF) containing Model Training Logical Function (MTLF).

Known consumers of the Nnwdaf_MLModelProvision service are:

- Network Data Analytics Function (NWDAF) containing Analytics Logical Function (AnLF); and
- Network Data Analytics Function (NWDAF) containing Model Training Logical Function (MTLF).

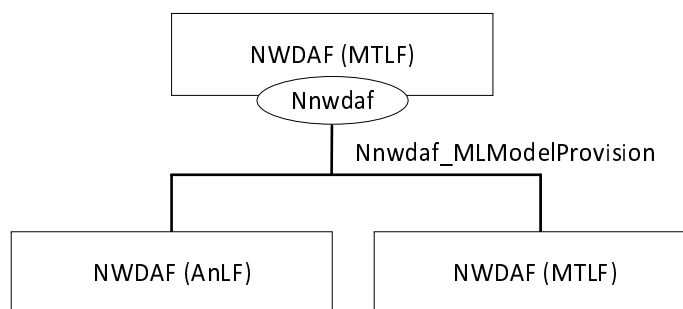

Figure 4.5.1.2-1: Reference Architecture for the Nnwdaf_MLModelProvision Service; SBI representation

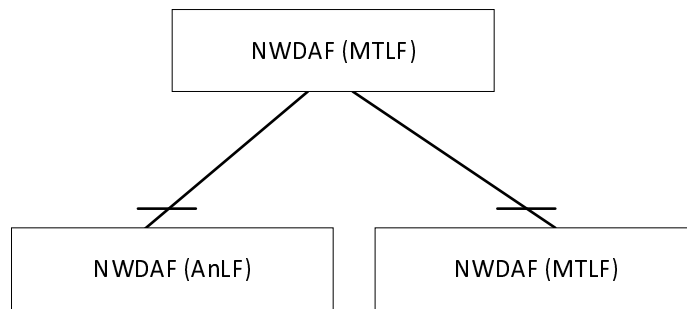

Figure 4.5.1.2-2: Reference Architecture for the Nnwdaf_MLModelProvision Service: reference point representation

4.5.1.3 Network Functions

4.5.1.3.1 Network Data Analytics Function (NWDAF)

The Network Data Analytics Function (NWDAF), containing Model Training Logical Function (MTLF), provides ML model information for different analytic events to NF service consumers.

The Network Data Analytics Function (NWDAF) allows NF service consumers to subscribe to and unsubscribe from one-time, periodic notification or notification when an event is detected.

4.5.1.3.2 NF Service Consumers

The Network Data Analytics Function (NWDAF) supports (un)subscription to the notification of different ML model information from the NWDAF which contains Model Training Logical Function (MTLF).

4.5.2 Service Operations

4.5.2.1 Introduction

Table 4.5.2.1-1: Operations of the Nnwdaf_MLModelProvision Service

| Service operation name | Description | Initiated by |
|-------------------------------------|---|-----------------------------|
| Nnwdaf_MLModelProvision_Subscribe | This service operation is used by an NF service consumer to subscribe to ML model provision from NWDAF. | NF service consumer (NWDAF) |
| Nnwdaf_MLModelProvision_Unsubscribe | This service operation is used by an NF service consumer to unsubscribe to ML model provision. | NF service consumer (NWDAF) |
| Nnwdaf_MLModelProvision_Notify | This service operation is used by the NWDAF to notify the ML model information to the NF service consumer instance which has subscribed to. | NWDAF |

4.5.2.2 Nnwdaf_MLModelProvision_Subscribe service operation

4.5.2.2.1 General

The Nnwdaf_MLModelProvision_Subscribe service operation is used by an NF service consumer to subscribe or update subscription for event notifications from the NWDAF which contains Model Training Logical Function (MTLF).

4.5.2.2.2 Subscription for event notifications

Figure 4.5.2.2.2-1 shows a scenario where the NF service consumer sends a request to the NWDAF to subscribe for event notification(s) (as shown in 3GPP TS 23.288 [17]).

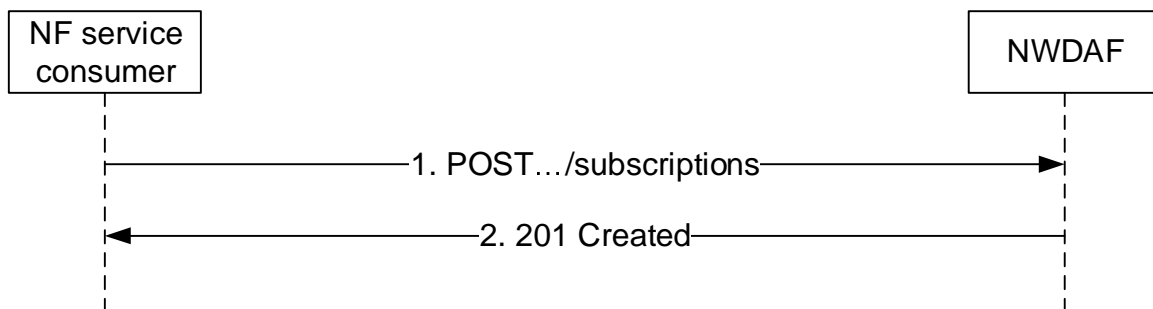

Figure 4.5.2.2.2-1: NF service consumer subscribes to notifications

The NF service consumer shall invoke the `NnwdaflMLModelProvision_Subscribe` service operation to subscribe to event notification(s). The NF service consumer shall send an HTTP POST request with "`{apiRoot}/nnwdaflmlmodelprovision/<apiVersion>/subscriptions`" as Resource URI representing the "NWDAF ML Model Provision Subscriptions", as shown in figure 4.5.2.2.2-1, step 1, to create a subscription for an "Individual NWDAF ML Model Provision Subscription" according to the information in message body.

The `NwdafMLModelProvSubsc` data structure provided in the request body shall include:

- an URI where to receive the requested notifications as the "notifUri" attribute; and
- a description of the subscribed events as the "mLEventSubscs" attribute that, for each event, the `MLEventSubscription` data type shall include:
 - 1) an event identifier as the "mLEvent" attribute; and
 - 2) event filter information as the "mLEventFilter" attribute;
 and may include:
 - 1) an identification of target UE information as the "tgtUe" attribute;
 - 2) a time interval for which the ML model for the analytics is requested as the "mLTargetPeriod" attribute;
 - 3) the time when the subscription expired as the "expiryTime" attribute;
 - 4) the ML model metric as the "modelMetric" attribute if the "FederatedLearning" feature or the "ModelProvisionExt" feature is supported;
 - 5) a pre-determined status for the ML model or training as the "preDetStatus" attribute if the "FederatedLearning" feature is supported; and
 - 6) the ML event reporting condition as the "mlEvRepCon" if the "FederatedLearning" feature or the "ModelProvisionExt" feature is supported.
 - 7) the ML Model Interoperability Information as the "modelInterInfo" attribute if the "ModelSharing" feature is supported; and
 - 8) NF consumer information as the "nfConsumerInfo" attributed if the "ModelSharing" feature is supported.
 - 9) use case context as "useCaseCxt" attribute, if the "ENExt" feature is supported.

NOTE 1: The NWDAF containing MTLF can use the "useCaseCxt" attribute to select the most relevant ML model, when several ML models are available for the requested Analytics ID(s). The values of this parameter are not standardized.

- 10) extended parameters for ML model provisioning as the "modelProvExt" attribute, if the feature "ModelProvisionExt" is supported;

- 11) UTC time indicating the time when the ML model is needed as the "timeModelNeeded" attribute.
- 12) the inference data stored in ADRF which can be used by MTLF as the "inferDataForModel" attribute, if the feature "ModelProvisionExt" is supported.
- 13) the ML model Identifier as the "modelId" attribute, if the feature "EnAnaCtxTransfer" is supported.

The NwdafMLModelProvSubsc data structure provided in the request body may include:

- a notification correlation identifier assigned by the NF service consumer for the requested notifications as "notifCorreId" attribute; and
- the reporting requirement information of the subscription as the "eventReq" attribute.

For different event types, the filter information in "mLEventFilter" attribute within the MLEventSubscription data type is the same as described in clause 4.3.2.2.2 for the filter information contained in "event-filter" attribute.

NOTE 2: The features described in clause 4.3.2.2.2 has no impact on this service.

Editor's Note: The type EventFilter includes attributes (and/or attributes within attributes) that have been introduced in Rel-18. For these attributes, the present API shall either define new features to indicate that the attributes are supported based on these features or it shall indicate that they are not applicable. This feature handing is FFS.

Upon the reception of an HTTP POST request with: "{apiRoot}/nwdaf-mlmodelprovision/<apiVersion>/subscriptions" as Resource URI and NwdafMLModelProvSubsc data structure as request body, the NWDAF shall create a new subscription and store the subscription.

If the NWDAF created an "Individual NWDAF ML Model Provision Subscription" resource, the NWDAF shall respond with "201 Created" with the message body containing a representation of the created subscription, as shown in figure 4.5.2.2.2-1, step 2. The NWDAF shall include a Location HTTP header field. The Location header field shall contain the URI of the created subscription i.e. "{apiRoot}/nwdaf-mlmodelprovision/<apiVersion>/subscriptions/{subscriptionId}".

If the immediate reporting indication in the "immRep" attribute within the "eventReq" attribute sets to true during the event subscription, the NWDAF shall include the reports of the subscribed events, if available, as the "mLEventNotifs" attribute in the HTTP POST response.

If not all the requested events in the subscription are accepted, then the NWDAF may include the "failEventReports" attribute indicating the event(s) for which the subscription failed and the associated reason(s).

If there is no associated ML model available for all the listed "mLEvent" attribute, the NWDAF which contains MTLF shall send a "500 Internal Server Error" status code to the NF service consumer. Also, the corresponding failure reason via a "problemDetails" attribute with the "cause" attribute set to "UNAVAILABLE_ML_MODEL_FOR_ALLEVENTS".

If other errors occur when processing the HTTP POST request, the NWDAF shall send an HTTP error response as specified in clause 5.4.7.

4.5.2.2.3 Update subscription for event notifications

Figure 4.5.2.2.3-1 shows a scenario that the NF service consumer sends an HTTP PUT request to the NWDAF to modify an existing subscription (as shown in 3GPP TS 23.288 [17]).

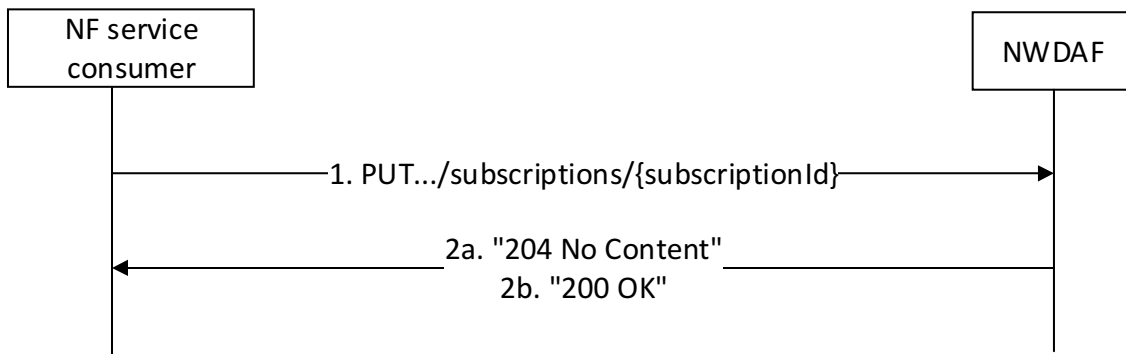

Figure 4.5.2.2.3-1: Modification of events subscription information using HTTP PUT

The NF service consumer shall invoke the `NnwdaflMLModelProvision_Subscribe` service operation to modify an existing ML Model subscription. The NF service consumer shall send an HTTP PUT request with: "`{apiRoot}/nnwdaflmlmodelprovision/<apiVersion>/subscriptions/{subscriptionId}`" as Resource URI, where "`{subscriptionId}`" is the event subscriptionId of the existing subscription to be modified, to update an "Individual NWDAF ML Model Provision Subscription" according to the information in the message body. The `NwdafMLModelProvSubsc` data structure provided in the request body shall include the same contents as described in clause 4.5.2.2.2.

Upon receipt of an HTTP PUT request with: "`{apiRoot}/nnwdaflmlmodelprovision/<apiVersion>/subscriptions/{subscriptionId}`" as Resource URI and `NwdafMLModelProvSubsc` data type as request body, if the request is successfully processed and accepted, the NWDAF shall:

- modify the concerned subscription; and
- store the subscription.

NOTE: The "notifUri" attribute within the `NwdafMLModelProvSubsc` data structure can be modified to request that subsequent notifications are sent to a new NF service consumer.

If the NWDAF successfully processed and accepted the received HTTP PUT request, the NWDAF shall update an "Individual NWDAF ML Model Provision Subscription" resource, and shall respond with:

- HTTP "204 No Content" response (as shown in figure 4.5.2.2.3-1, step 2a); or
- HTTP "200 OK" response (as shown in figure 4.5.2.2.3-1, step 2b) with a response body containing a representation of the updated subscription in the `NwdafMLModelProvSubsc` data type.

If not all the requested events in the subscription are modified successfully, then the NWDAF may include the "failEventReports" attribute indicating the event(s) for which the subscription failed and the associated reason(s).

If other errors occur when processing the HTTP PUT request, the NWDAF shall send an HTTP error response as specified in clause 5.4.7.

If the NWDAF determines that the received HTTP PUT request needs to be redirected, the NWDAF shall send an HTTP redirect response as specified in clause 6.10.9 of 3GPP TS 29.500 [6].

4.5.2.3 NnwdaflMLModelProvision_Unsubscribe service operation

4.5.2.3.1 General

The `NnwdaflMLModelProvision_Unsubscribe` service operation is used by an NF service consumer to unsubscribe from event notifications.

4.5.2.3.2 Unsubscribe from event notifications

Figure 4.5.2.3.2-1 shows a scenario where the NF service consumer sends a request to the NWDAF to unsubscribe from event notifications (see also 3GPP TS 23.288 [17]).

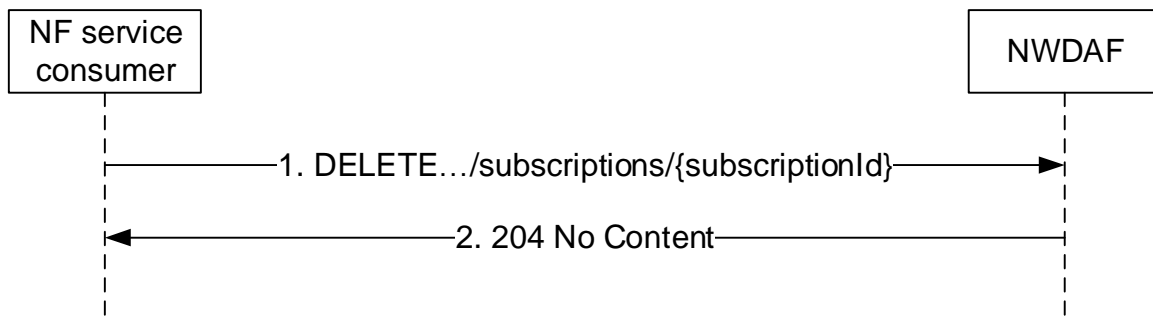

Figure 4.5.2.3.2-1: NF service consumer unsubscribes from notifications

The NF service consumer shall invoke the `Nnwdaf_MLModelProvision_Unsubscribe` service operation to unsubscribe to event notifications. The NF service consumer shall send an HTTP DELETE request with: "`{apiRoot}/nwdaf-mlmodelprovision/<apiVersion>/subscriptions/{subscriptionId}`" as Resource URI, where "`{subscriptionId}`" is the event subscriptionId of the existing subscription that is to be deleted.

Upon the reception of an HTTP DELETE request, if the NWDAF successfully processed and accepted the received HTTP DELETE request, the NWDAF shall:

- remove the corresponding subscription; and
- respond with HTTP "204 No Content" status code.

If the NWDAF determines the received HTTP DELETE request needs to be redirected, the NWDAF shall send an HTTP redirect response as specified in clause 6.10.9 of 3GPP TS 29.500 [6].

If errors occur when processing the HTTP DELETE request, the NWDAF shall send an HTTP error response as specified in clause 5.4.7.

4.5.2.4 Nnwdaf_MLModelProvision_Notify service operation

4.5.2.4.1 General

The `Nnwdaf_MLModelProvision_Notify` service operation is used by an NWDAF to notify NF consumers about subscribed events.

4.5.2.4.2 Notification about subscribed event

Figure 4.5.2.4.2-1 shows a scenario where the NWDAF sends a request to the NF Service Consumer to notify for event notifications (see also 3GPP TS 23.288 [17]).

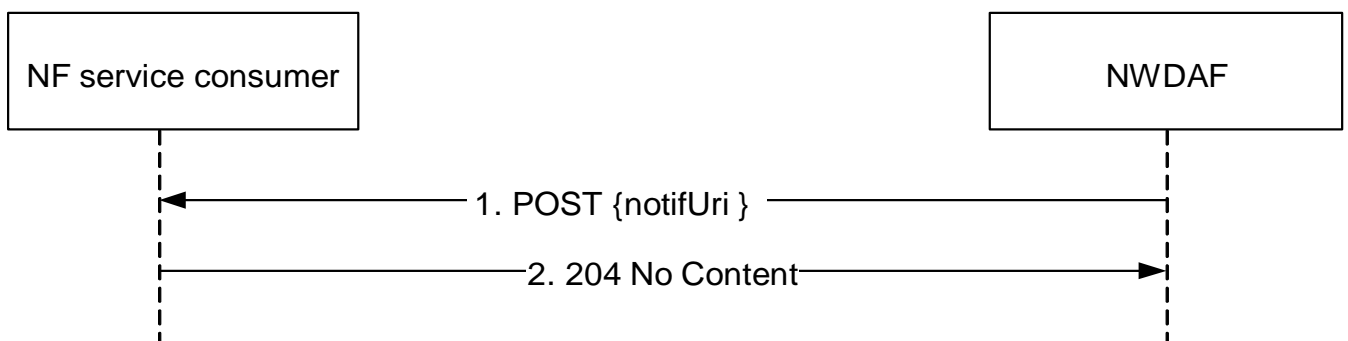

Figure 4.5.2.4.2-1: NWDAF notifies the subscribed event

The NWDAF shall invoke the `Nnwdaf_MLModelProvision_Notify` service operation to notify the subscribed event. The NWDAF shall send an HTTP POST request with "`{notifUri}`" received in the `Nnwdaf_MLModelProvision_Subscribe` service operation as Resource URI, as shown in figure 4.2.2.4.2-1, step 1. The `NwdafMLModelProvNotif` data structure provided in the request body that shall include:

- an event subscriptionId as "subscriptionId" attribute; and
 - description of the notified event as "eventNotifs" attribute, that for each event, the MLEventNotif data type shall include:
 - an event identifier as the "event" attribute;
 - an address (e.g. a URL or an FQDN) of the ML model file as the "mLFileAddr" attribute or if the "ModelProvisionExt" feature is supported, the ADRF (Set) information of the ML Model as the "mLModelAdrf" attribute and an unique identifier for the ML model as "modelUniqueId" attribute; and
- the MLEventNotif data type may include:
- a notification correlation identifier as "notifCorreId" attribute; and
 - a time period when the provided ML model applies as the "validityPeriod" attribute; and
 - an area where the provided ML model applies as the "spatialValidity" attribute; and
 - if the feature "ModelProvisionExt" is supported, the additional ML model information as "addModelInfo" attribute; and
 - if the feature "ModelProvisionExt" is supported, the filtering information of the ML Model as the "mLEventFilter" attribute; and
 - if the feature "ModelProvisionExt" is supported, the target UEs of the ML Model as the "tgtUe" attribute.

Upon the reception of an HTTP POST request, if the NF service consumer successfully processed and accepted the received HTTP POST request, the NF Service Consumer shall store the notification and respond with HTTP "204 No Content" status code.

If the NF service consumer receives the ADRF ID as the "adrfId" attribute or the ADRF Set ID as the "adrfSetId" attribute in the NwdafMLModelProvNotif data structure of the HTTP POST request, it may invoke Ndrf_MLModelManagement_RetrievalRequest service operation to retrieve ML Model from the ADRF (Set) as specified in 3GPP TS 29.575 [27].

If the NF service consumer determines the received HTTP POST request needs to be redirected, the NF service consumer shall send an HTTP redirect response as specified in clause 6.10.9 of 3GPP TS 29.500 [6].

If errors occur when processing the HTTP POST request, the NWDAF shall send an HTTP error response as specified in clause 5.4.7.

4.6 Nnwdaf_MLModelTraining Service

4.6.1 Service Description

4.6.1.1 Overview

The Nnwdaf_MLModelTraining service as defined in 3GPP TS 23.288 [17], is provided by the Network Data Analytics Function (NWDAF) containing Model Training Logical Function (MTLF).

This service:

- allows the NF service consumers to subscribe to and unsubscribe from different ML model training events;
- allows the NF service consumers to modify different ML model training events; and
- notifies the NF service consumers with a corresponding subscription about ML model information.

4.6.1.2 Service Architecture

The 5G System Architecture is defined in 3GPP TS 23.501 [2]. The Network Data Analytics Exposure architecture is defined in 3GPP TS 23.288 [17]. The ML Model training signalling flows are defined in 3GPP TS 29.552 [25].

The Nnwdaf_MLModelTraining service is part of the Nnwdaf service-based interface exhibited by the Network Data Analytics Function (NWDAF) containing Model Training Logical Function (MTLF).

Known consumers of the Nnwdaf_MLModelTraining service are:

- Network Data Analytics Function (NWDAF) containing Model Training Logical Function (MTLF)

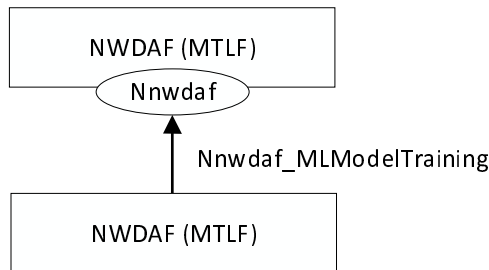

Figure 4.6.1.2-1: Reference Architecture for the Nnwdaf_MLModelTraining Service; SBI representation

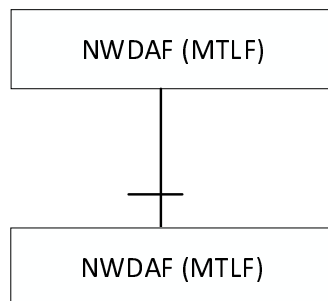

Figure 4.6.1.2-2: Reference Architecture for the Nnwdaf_MLModelTraining Service: reference point representation

4.6.1.3 Network Functions

4.6.1.3.1 Network Data Analytics Function (NWDAF)

The Network Data Analytics Function (NWDAF), containing Model Training Logical Function (MTLF), provides ML model information for different analytic events to NF service consumers.

The Network Data Analytics Function (NWDAF) allows NF service consumers to subscribe to and unsubscribe from one-time, periodic notification or notification when an event is detected.

4.6.1.3.2 NF Service Consumers

The Network Data Analytics Function (NWDAF) supports (un)subscription to the notification of different ML model information from the NWDAF which contains Model Training Logical Function (MTLF).

4.6.2 Service Operations

4.6.2.1 Introduction

Table 4.6.2.1-1: Operations of the Nnwdaf_MLModelTraining Service

| Service operation name | Description | Initiated by |
|----------------------------------|--|-----------------------------|
| Nnwdaf_MLModelTraining_Subscribe | This service operation is used by an NF service consumer to subscribe to ML model training from NWDAF. | NF service consumer (NWDAF) |

| Service operation name | Description | Initiated by |
|------------------------------------|---|-----------------------------|
| Nnwdaf_MLModelTraining_Unsubscribe | This service operation is used by an NF service consumer to unsubscribe to ML model training. | NF service consumer (NWDAF) |
| Nnwdaf_MLModelTraining_Notify | This service operation is used by the NWDAF to notify the ML model information to the NF service consumer instance which has subscribed to. | NWDAF |

4.6.2.2 Nnwdaf_MLModelTraining_Subscribe service operation

4.6.2.2.1 General

The Nnwdaf_MLModelTraining_Subscribe service operation is used by an NF service consumer to subscribe or update subscription for event notifications from the NWDAF which contains Model Training Logical Function (MTLF).

4.6.2.2.2 Subscription for event notifications

Figure 4.6.2.2.2-1 shows a scenario where the NF service consumer sends a request to the NWDAF to subscribe for event notification(s) (as shown in 3GPP TS 23.288 [17]).

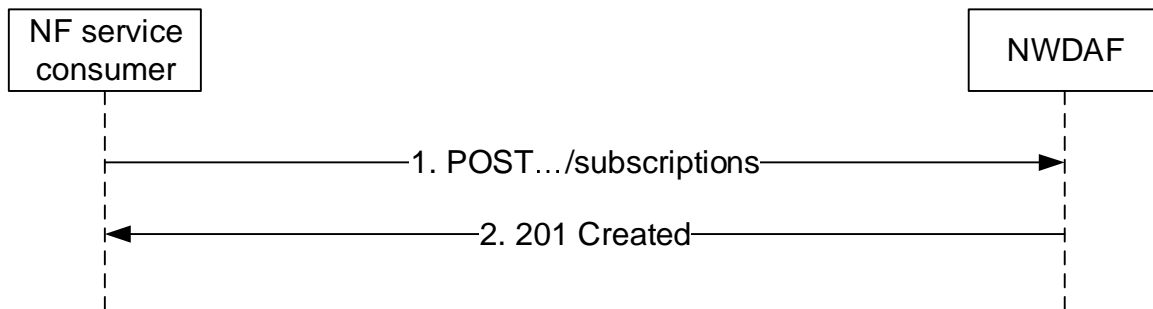

Figure 4.6.2.2.2-1: NF service consumer subscribes to notifications

The NF service consumer shall invoke the Nnwdaf_MLModelTraining_Subscribe service operation to subscribe to event notification(s). The NF service consumer shall send an HTTP POST request with "{apiRoot}/nnwdf-mlmodeltraining/<apiVersion>/subscriptions" as Resource URI representing the "NWDAF ML Model Training Subscriptions", as shown in figure 4.6.2.2.2-1, step 1, to create a subscription for an "Individual NWDAF ML Model Training Subscription" according to the information in message body.

The NwdafMLModelTrainSubsc data structure provided in the request body shall include:

- an URI where to receive the requested notifications as the "notifUri" attribute;
- a description of the subscribed events as the "mLEventSubscs" attribute that, for each event, the MLEventSubscription data type shall include:
 - 1) an event identifier as the "mLEvent" attribute;
 - 2) event filter information as the "mLEventFilter" attribute; and
 - 3) the ML Model Interoperability Information as the "modelInterInfo" attribute;
- a notification correlation identifier assigned by the NF service consumer for the requested notifications as "notifCorreId" attribute;

and may include:

- an identification of UE information for which data for ML model training is requested as the "tgtRepUe" attribute;
- the ML model information as the "mLModelInfos" attribute;
- the ML model training information as the "mLModelTrainInfos" attribute;

- identification of the ML procedure for training the ML model as the "mlCorreId" attribute;
- an indication of preparation request for ML model training as the "mlPreFlag" attribute;
- an indication of request using the local training data as the testing dataset to calculate the Model Accuracy of the global ML model provided by the consumer as the "mlAccChkFlg" attribute;
- the ML model training reporting information as the "mlTrainRepInfo" attribute;
- the round number of the training in a multi-round training process as the "roundInd" attribute;
- the reporting requirement information of the subscription as the "eventReq" attribute; and
- the indication of skipping the current FL round as the "skipFlInd" attribute.

Upon the reception of an HTTP POST request with: "{apiRoot}/nnwdaflmlmodeltraining/<apiVersion>/subscriptions" as Resource URI and NwdafMLModelTrainSubsc data structure as request body, the NWDAF shall create a new subscription and store the subscription.

If the NWDAF created an "Individual NWDAF ML Model Training Subscription" resource, the NWDAF shall respond with "201 Created" with the message body containing a representation of the created subscription, as shown in figure 4.6.2.2.2-1, step 2. The NWDAF shall include a Location HTTP header field. The Location header field shall contain the URI of the created subscription i.e. "{apiRoot}/nnwdaflmlmodeltraining/<apiVersion>/subscriptions/{subscriptionId}".

If the immediate reporting indication in the "immRep" attribute within the "eventReq" attribute sets to "true" during the event subscription, the NWDAF shall include the reports of the subscribed events, if available, as the "immReport" attribute in the HTTP POST response.

NOTE: Immediate and one-time reporting can be used in order to implement the NnwdaflMLModelTrainingInfo service, which is defined in 3GPP TS 23.288 [17].

If not all the requested events in the subscription are accepted, then the NWDAF may include the "failEventReports" attribute indicating the event(s) for which the subscription failed and the associated reason(s).

If there is no associated ML model training available for all provided "mlEvent" attributes, the NWDAF shall send a "500 Internal Server Error" status code to the NF service consumer, including the "cause" attribute set to "UNAVAILABLE_ML_MODEL_TRAINING_FOR_ALLEVENTS".

If there is no ML model training satisfying the requirements listed in "mlModelTrainInfos" attribute or the ML model cannot be downloaded successfully, the NWDAF which contains MTLF shall send a "403 Forbidden" status code to the NF service consumer, and it may include also the corresponding failure reason via a "problemDetails" attribute with the "cause" attribute set to "ML_MODEL_TRAINING_REQS_NOT_MET", "ML_TRAINING_NOT_COMPLETE", "OVERLOAD", or "NOT_AVAILABLE_FOR_FL_PROCESS_ANYMORE".

If other errors occur when processing the HTTP POST request, the NWDAF shall send an HTTP error response as specified in clause 5.5.7.

4.6.2.2.3 Update subscription for event notifications

Figure 4.6.2.2.3-1 shows a scenario that the NF service consumer sends an HTTP PUT request to the NWDAF to modify an existing subscription (as shown in 3GPP TS 23.288 [17]).

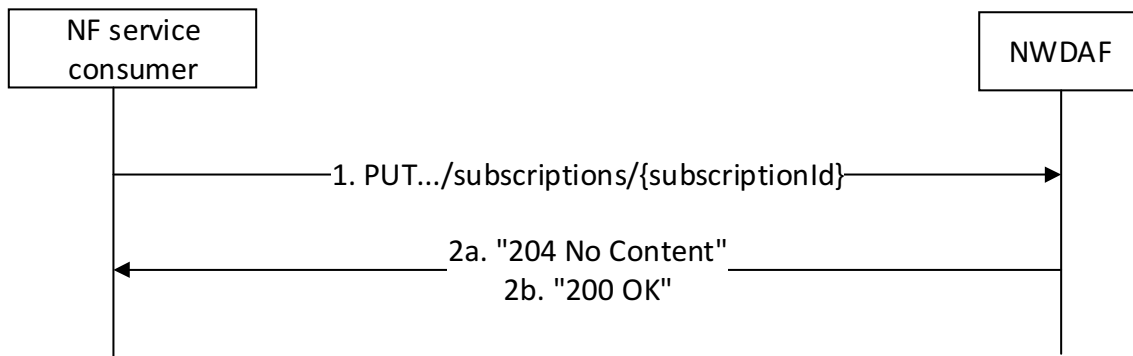

Figure 4.6.2.2.3-1: Modification of events subscription information using HTTP PUT

The NF service consumer shall invoke the `Nnwdaf_MLModelTraining_Subscribe` service operation to modify an existing ML Model Training subscription. The NF service consumer shall send an HTTP PUT request with: "`{apiRoot}/nnwdaf-mlmodeltraining/<apiVersion>/subscriptions/{subscriptionId}`" as Resource URI, where "`{subscriptionId}`" is the event subscriptionId of the existing subscription to be modified, to update an "Individual NWDAF ML Model Training Subscription" according to the information in the message body. The `NwdafMLModelTrainSubsc` data structure provided in the request body shall include the same contents as described in clause 4.6.2.2.2.

Upon receipt of an HTTP PUT request with: "`{apiRoot}/nnwdaf-mlmodeltraining/<apiVersion>/subscriptions/{subscriptionId}`" as Resource URI and `NwdafMLModelTrainSubsc` data type as request body, if the request is successfully processed and accepted, the NWDAF shall:

- modify the concerned subscription; and
- store the subscription.

If the NWDAF successfully processed and accepted the received HTTP PUT request, the NWDAF shall update an "Individual NWDAF ML Model Training Subscription" resource, and shall respond with:

- HTTP "204 No Content" response (as shown in figure 4.6.2.2.3-1, step 2a); or
- HTTP "200 OK" response (as shown in figure 4.6.2.2.3-1, step 2b) with a response body containing a representation of the updated subscription in the `NwdafMLModelTrainSubsc` data type.

If not all the requested events in the subscription are modified successfully, then the NWDAF may include the "failEventReports" attribute indicating the event(s) for which the subscription failed and the associated reason(s).

If the immediate reporting indication in the "immRep" attribute within the "eventReq" attribute sets to "true" during the event subscription update, the NWDAF shall include the reports of the subscribed events, if available, as the "immReport" attribute in the HTTP PUT response.

NOTE: Immediate and one-time reporting can be used in order to implement the `Nnwdaf_MLModelTrainingInfo` service, which is defined in 3GPP TS 23.288 [17].

If there is no associated ML model training available for all provided "mLEvent" attributes, the NWDAF shall send a "500 Internal Server Error" status code to the NF service consumer, including the "cause" attribute set to "UNAVAILABLE_ML_MODEL_TRAINING_FOR_ALLEVENTS".

If there is no ML model training satisfying the requirements listed in "mLModelTrainInfos" attribute or the ML model cannot be downloaded successfully, the NWDAF which contains MTLF shall send a "403 Forbidden" status code to the NF service consumer, and it may include also the corresponding failure reason via a "problemDetails" attribute with the "cause" attribute set to "ML_MODEL_TRAINING_REQS_NOT_MET", "ML_TRAINING_NOT_COMPLETE", "OVERLOAD", or "NOT_AVAILABLE_FOR_FL_PROCESS_ANYMORE".

If other errors occur when processing the HTTP PUT request, the NWDAF shall send an HTTP error response as specified in clause 5.5.7.

If the NWDAF determines that the received HTTP PUT request needs to be redirected, the NWDAF shall send an HTTP redirect response as specified in clause 6.10.9 of 3GPP TS 29.500 [6].

4.6.2.2.4 Partial update subscription for event notifications

Figure 4.6.2.2.4-1 shows a scenario that the NF service consumer sends an HTTP PATCH request to the NWDAF to partial modify an existing subscription (as shown in 3GPP TS 23.288 [17]).

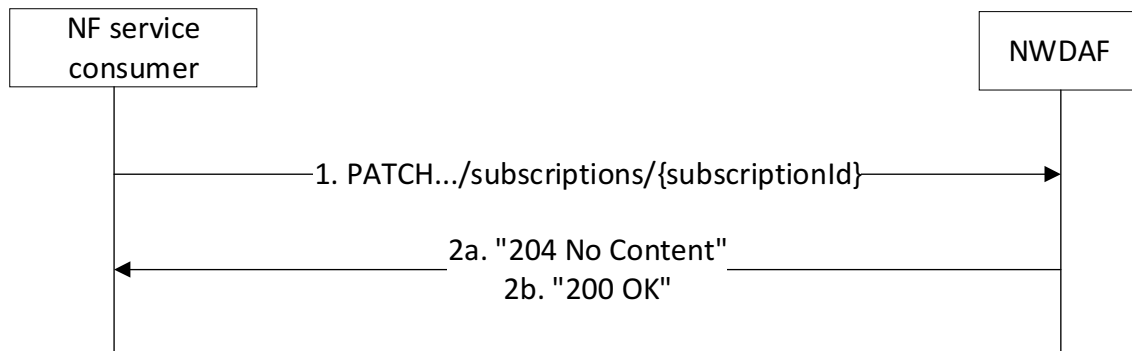

Figure 4.6.2.2.4-1: Partial modification of events subscription information using HTTP PATCH

The NF service consumer shall invoke the `NnwdaflMLModelTraining_Subscribe` service operation to partial modify an existing ML Model Training subscription. The NF service consumer shall send an HTTP PATCH request with: `"{apiRoot}/nnwdaflmlmodeltraining/<apiVersion>/subscriptions/{subscriptionId}"` as Resource URI, where `"{subscriptionId}"` is the event subscriptionId of the existing subscription to be modified, to update an "Individual NWDAF ML Model Training Subscription" according to the information in the message body.

Upon receipt of an HTTP PATCH request with: `"{apiRoot}/nnwdaflmlmodeltraining/<apiVersion>/subscriptions/{subscriptionId}"` as Resource URI and `NwdafMLModelTrainSubscPatch` data type as request body, if the request is successfully processed and accepted, the NWDAF shall:

- partial modify the concerned subscription; and
- store the subscription.

If the NWDAF successfully processed and accepted the received HTTP PATCH request, the NWDAF shall partial update an "Individual NWDAF ML Model Training Subscription" resource, and shall respond with:

- HTTP "204 No Content" response (as shown in figure 4.6.2.2.4-1, step 2a); or
- HTTP "200 OK" response (as shown in figure 4.6.2.2.4-1, step 2b) with a response body containing a representation of the updated subscription in the `NwdafMLModelTrainSubsc` data type.

If not all the requested events in the subscription are modified successfully, then the NWDAF may include the `"failEventReports"` attribute indicating the event(s) for which the subscription failed and the associated reason(s).

If the immediate reporting indication in the `"immRep"` attribute within the `"eventReq"` attribute sets to `"true"` during the event subscription update, the NWDAF shall include the reports of the subscribed events, if available, as the `"immReport"` attribute in the HTTP PATCH response.

NOTE: Immediate and one-time reporting can be used in order to implement the `NnwdaflMLModelTrainingInfo` service, which is defined in 3GPP TS 23.288 [17].

If there is no associated ML model training available for all provided `"mLEvent"` attributes, the NWDAF shall send a "500 Internal Server Error" status code to the NF service consumer, including the `"cause"` attribute set to `"UNAVAILABLE_ML_MODEL_TRAINING_FOR_ALLEVENTS"`.

If there is no ML model training satisfying the requirements listed in `"mLModelTrainInfos"` attribute or the ML model cannot be downloaded successfully, the NWDAF which contains MTLF shall send a "403 Forbidden" status code to the NF service consumer, and it may include also the corresponding failure reason via a `"problemDetails"` attribute with the `"cause"` attribute set to `"ML_MODEL_TRAINING_REQS_NOT_MET"`, `"ML_TRAINING_NOT_COMPLETE"`, `"OVERLOAD"`, or `"NOT_AVAILABLE_FOR_FL_PROCESS_ANYMORE"`.

If other errors occur when processing the HTTP PATCH request, the NWDAF shall send an HTTP error response as specified in clause 5.5.7.

If the NWDAF determines that the received HTTP PATCH request needs to be redirected, the NWDAF shall send an HTTP redirect response as specified in clause 6.10.9 of 3GPP TS 29.500 [6].

4.6.2.3 Nnwaf_MLModelTraining_Unsubscribe service operation

4.6.2.3.1 General

The Nnwaf_MLModelTraining_Unsubscribe service operation is used by an NF service consumer to unsubscribe from event notifications.

4.6.2.3.2 Unsubscribe from event notifications

Figure 4.6.2.3.2-1 shows a scenario where the NF service consumer sends a request to the NWDAF to unsubscribe from event notifications (see also 3GPP TS 23.288 [17]).

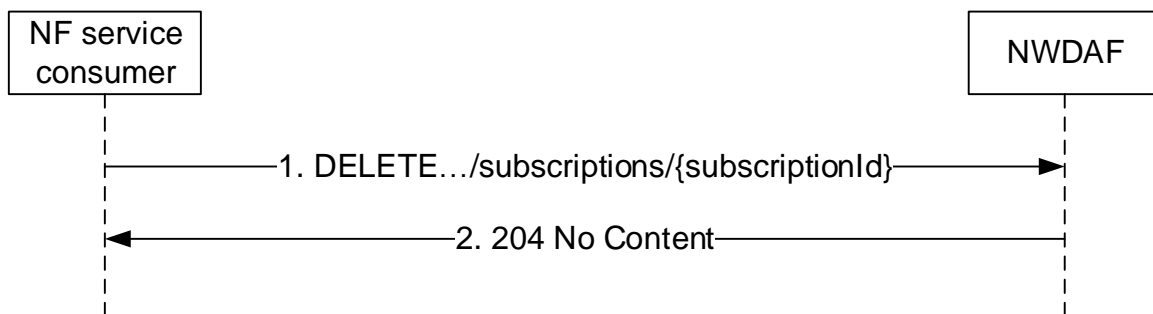

Figure 4.6.2.3.2-1: NF service consumer unsubscribes from notifications

The NF service consumer shall invoke the Nnwaf_MLModelTraining_Unsubscribe service operation to unsubscribe to event notifications. The NF service consumer shall send an HTTP DELETE request with: "{apiRoot}/nnwaf-mlmodeltraining/<apiVersion>/subscriptions/{subscriptionId}" as Resource URI, where "{subscriptionId}" is the event subscriptionId of the existing subscription that is to be deleted.

Upon the reception of an HTTP DELETE request, if the NWDAF successfully processed and accepted the received HTTP DELETE request, the NWDAF shall:

- remove the corresponding subscription; and
- respond with HTTP "204 No Content" status code.

If the NWDAF determines the received HTTP DELETE request needs to be redirected, the NWDAF shall send an HTTP redirect response as specified in clause 6.10.9 of 3GPP TS 29.500 [6].

If errors occur when processing the HTTP DELETE request, the NWDAF shall send an HTTP error response as specified in clause 5.5.7.

4.6.2.4 Nnwaf_MLModelTraining_Notify service operation

4.6.2.4.1 General

The Nnwaf_MLModelTraining_Notify service operation is used by an NWDAF to notify NF consumers about subscribed events.

4.6.2.4.2 Notification about subscribed event

Figure 4.6.2.4.2-1 shows a scenario where the NWDAF sends a request to the NF Service Consumer to notify for event notifications (see also 3GPP TS 23.288 [17]).

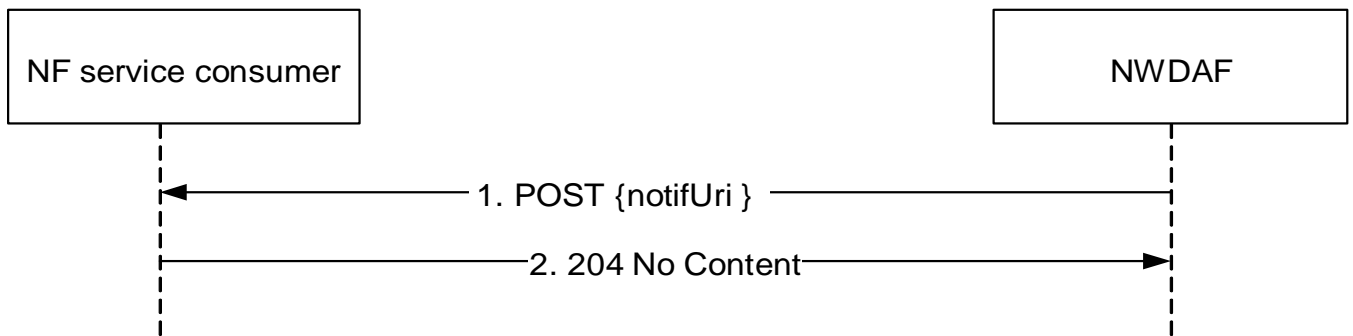

Figure 4.6.2.4.2-1: NWDAF notifies the subscribed event

The NWDAF shall invoke the `NnwdaflMLModelTraining_Notify` service operation to notify the subscribed event. The NWDAF shall send an HTTP POST request with "`{notifUri}`" received in the `NnwdaflMLModelTraining_Subscribe` service operation as Resource URI, as shown in figure 4.6.2.4.2-1, step 1. The `NwdafMLModelTrainNotif` data structure provided in the request body that shall include:

- a notification correlation identifier as "`notifCorreId`" attribute;
- at least one of the notification detailed information:
 - description of the notified event as "`mLModelInfos`" attribute;
 - a delay event notification for training the ML model as "`delayEventNotif`" attribute when the service is for Federated Learning;
 - an indication that the subscription is requested to be terminated, i.e. no further notifications related to this subscription will be provided, as "`termTrainReq`";

and may include:

- an identification of the Machine Learning procedure for training the ML model as "`mlCorreId`" attribute when the service is for Federated Learning;
- an identification of the round number of the training in a multi-round training process as "`roundInd`" attribute; and/or
- the status report for the ML model training as "`statusReport`" attribute when the service is for Federated Learning.

Upon the reception of an HTTP POST request, if the NF service consumer successfully processed and accepted the received HTTP POST request, the NF Service Consumer shall store the notification and respond with HTTP "204 No Content" status code.

If the NF service consumer determines the received HTTP POST request needs to be redirected, the NF service consumer shall send an HTTP redirect response as specified in clause 6.10.9 of 3GPP TS 29.500 [6].

If errors occur when processing the HTTP POST request, the NWDAF shall send an HTTP error response as specified in clause 5.5.7.

4.7 NnwdaflMLModelMonitor Service

4.7.1 Service Description

4.7.1.1 Overview

The `NnwdaflMLModelMonitor` service as defined in 3GPP TS 23.288 [17], is provided by the Network Data Analytics Function (NWDAF).

This service:

- allows the NF service consumer (i.e. NWDAF containing AnLF) to register the use and monitoring capability of the analytics accuracy of an ML Model at the NWDAF containing MTLF;
- allows the NF service consumer (i.e. NWDAF containing AnLF) to deregister a previous registration of the monitoring capability of the analytics accuracy of an ML Model at the NWDAF containing MTLF;
- allows the NF service consumer (i.e. NWDAF containing MTLF) to subscribe to and unsubscribe from the analytics accuracy monitoring event of an ML Model and analytics feedback information from the NWDAF containing AnLF;
- allows the NF service consumer (i.e. NWDAF containing MTLF) to modify an analytics accuracy monitoring event of an ML Model and analytics feedback information from the NWDAF containing AnLF; and
- allow the NWDAF containing AnLF notifies the NF service consumer (i.e. NWDAF containing MTLF) about the monitored analytics accuracy information of an ML Model and/or analytics feedback information.

4.7.1.2 Service Architecture

The 5G System Architecture is defined in 3GPP TS 23.501 [2]. The Network Data Analytics Exposure architecture is defined in 3GPP TS 23.288 [17].

The Nnwdaf_MLModelMonitor service is part of the Nnwdaf service-based interface exhibited by the Network Data Analytics Function (NWDAF).

Known consumers of the Nnwdaf_MLModelMonitor service are:

- Network Data Analytics Function (NWDAF)

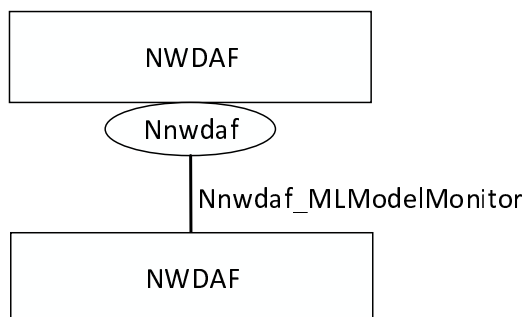

Figure 4.7.1.2-1: Reference Architecture for the Nnwdaf_MLModelMonitor Service; SBI representation

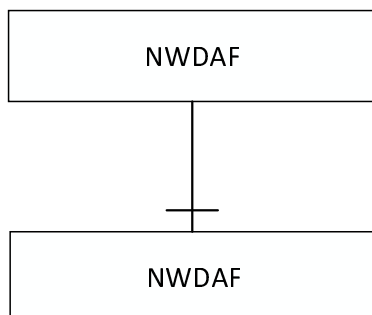

Figure 4.7.1.2-2: Reference Architecture for the Nnwdaf_MLModelMonitor Service: reference point representation

4.7.1.3 Network Functions

4.7.1.3.1 Network Data Analytics Function (NWDAF)

The Network Data Analytics Function (NWDAF) containing MTLF allows NF service consumer (i.e. NWDAF containing AnLF) to register and deregister the use and monitoring capability of the analytics accuracy of an ML Model.

The Network Data Analytics Function (NWDAF) containing AnLF allows NF service consumer (i.e. NWDAF containing MTLF) to subscribe to and unsubscribe from notification of monitored analytics accuracy information of an ML Model and analytics feedback information.

4.7.1.3.2 NF Service Consumers

The Network Data Analytics Function (NWDAF) containing AnLF supports (de)registering the use and monitoring capability of the analytics accuracy of an ML Model.

The Network Data Analytics Function (NWDAF) containing MTLF supports (un)subscription to the notification of analytics accuracy monitoring of an ML Model and analytics feedback information.

4.7.2 Service Operations

4.7.2.1 Introduction

Table 4.7.2.1-1: Operations of the Nnwdaf_MLModelMonitor Service

| Service operation name | Description | Initiated by |
|-----------------------------------|--|-----------------------------|
| Nnwdaf_MLModelMonitor_Register | This service operation is used by an NF service consumer to register the monitoring capability of the analytics accuracy of an ML Model at an NWDAF containing MTLF. | NF service consumer (NWDAF) |
| Nnwdaf_MLModelMonitor_Deregister | This service operation is used by an NF service consumer to deregister a previous registration from an NWDAF containing MTLF. | NF service consumer (NWDAF) |
| Nnwdaf_MLModelMonitor_Subscribe | This service operation is used by an NF service consumer to subscribe to the analytics accuracy monitoring event of an ML Model. | NF service consumer (NWDAF) |
| Nnwdaf_MLModelMonitor_Unsubscribe | This service operation is used by an NF service consumer to unsubscribe from the analytics accuracy monitoring event of an ML Model. | NF service consumer (NWDAF) |
| Nnwdaf_MLModelMonitor_Notify | This service operation is used by the NWDAF to notify the monitored analytics accuracy information of an ML Model. | NWDAF |

4.7.2.2 Nnwdaf_MLModelMonitor_Register service operation

4.7.2.2.1 General

The Nnwdaf_MLModelMonitor_Register service operation is used by an NF service consumer (i.e. NWDAF containing AnLF) to register the monitoring capability of the analytics accuracy of an ML Model and analytics feedback information.

4.7.2.2.2 Registering the monitoring of the analytics accuracy of an ML Model

Figure 4.7.2.2.2-1 shows a scenario where the NF service consumer sends a request to the NWDAF containing MTLF to register the use and monitoring capability of the analytics accuracy of an ML Model.

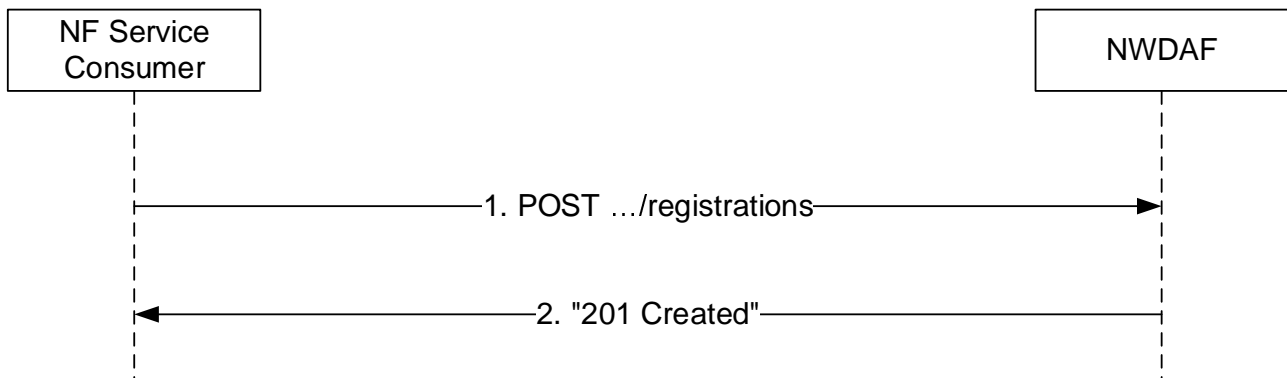

Figure 4.7.2.2.2-1: NF service consumer registers the use and monitoring capability of the analytics accuracy of an ML Model

The NF service consumer shall invoke the `Nnwdaf_MLModelMonitor_Register` service operation to register the use and indicate the monitoring capability of the analytics accuracy of an ML Model and analytics feedback information. The NF service consumer shall send an HTTP POST request with "`{apiRoot}/nnwdaf-mlmodelmonitor/<apiVersion>/registrations`" as Resource URI representing the "NWDAF ML model monitoring registrations", as shown in figure 4.7.2.2.2-1, step 1, to create an "Individual NWDAF ML model monitoring registration" according to the information in the message body. The `MLModelMonitorReg` data structure provided in the request body shall include:

- the ML model ID within the "modelId" attribute; and
- one of the following identifiers related to the NF service consumer:
 - the NF instance ID of the consumer within the "consumerId" attribute;
 - NF set ID of the consumer within the "consumerSetId" attribute.

and may include:

- ML Model accuracy transfer indication within the "modelAccuInd" attribute;
- an event identifier as the "mLEvent" attribute;
- event filter information as the "mLEventFilter" attribute; and
- an identification of target UE information as the "tgtUe" attribute.

Upon the reception of an HTTP POST request with "`{apiRoot}/nnwdaf-mlmodelmonitor/<apiVersion>/registrations`" as Resource URI and `MLModelMonitorReg` data structure as request body, the NWDAF shall:

- create a new registration;
- assign a registrationId;
- store the registration information.

If the NWDAF created an "Individual NWDAF ML model monitoring registration" resource, the NWDAF shall respond with "201 Created" with the message body containing a representation of the created registration, as shown in figure 4.7.2.2.2-1, step 2. The NWDAF shall include a Location HTTP header field. The Location header field shall contain the URI of the created profile, i.e. "`{apiRoot}/nnwdaf-mlmodelmonitor/<apiVersion>/registrations/{registrationId}`".

If an error occurs when processing the HTTP POST request, the NWDAF shall send an HTTP error response as specified in clause 5.6.7.

4.7.2.3 Nnwdaf_MLModelMonitor_Deregister service operation

4.7.2.3.1 General

The Nnwdaf_MLModelMonitor_Deregister service operation is used by an NF service consumer (i.e. NWDAF containing AnLF) to deregister a previous registration from an NWDAF containing MTLF.

4.7.2.3.2 Deregistering the monitoring of the analytics accuracy of an ML Model

Figure 4.7.2.3.2-1 shows a scenario where the NF service consumer sends a request to the NWDAF containing MTLF to deregister the use or monitoring capability of the analytics accuracy of an ML Model.



Figure 4.7.2.3.2-1: NF service consumer deregisters the use or monitoring capability of the analytics accuracy of an ML Model

The NF service consumer shall invoke the Nnwdaf_MLModelMonitor_Deregister service operation to delete a registration of the use or monitoring capability of the analytics accuracy of an ML Model. The NF service consumer shall send an HTTP DELETE request with "{apiRoot}/nnwdf-mlmodelmonitor/<apiVersion>/registrations/{registrationId}" as Resource URI representing an "Individual NWDAF ML model monitoring registration" resource, as shown in figure 4.7.2.3.2-1, step 1, where "{registrationId}" is the identifier of the existing registration that is to be deleted.

Upon the reception of an HTTP DELETE request with "{apiRoot}/nnwdf-mlmodelmonitor/<apiVersion>/registrations/{registrationId}" as Resource URI, if the NWDAF successfully processed and accepted the received HTTP DELETE request, the NWDAF shall:

- remove the corresponding registration;
- respond with HTTP "204 No Content" status.

If the NWDAF determines the received HTTP DELETE request needs to be redirected, the NWDAF shall send an HTTP redirect response as specified in clause 6.10.9 of 3GPP TS 29.500 [4].

If errors occur when processing the HTTP DELETE request, the NWDAF shall send an HTTP error response as specified in clause 5.6.7.

4.7.2.4 Nnwdaf_MLModelMonitor_Subscribe service operation

4.7.2.4.1 General

The Nnwdaf_MLModelMonitor_Subscribe service operation is used by an NF service consumer (i.e. NWDAF containing MTLF) to subscribe or update subscription for analytics accuracy monitoring event of an ML Model and analytics feedback information.

4.7.2.4.2 Subscription for monitoring notifications

Figure 4.7.2.4.2-1 shows a scenario where the NF service consumer sends a request to the NWDAF containing AnLF to subscribe for event notification(s) and analytics feedback information.

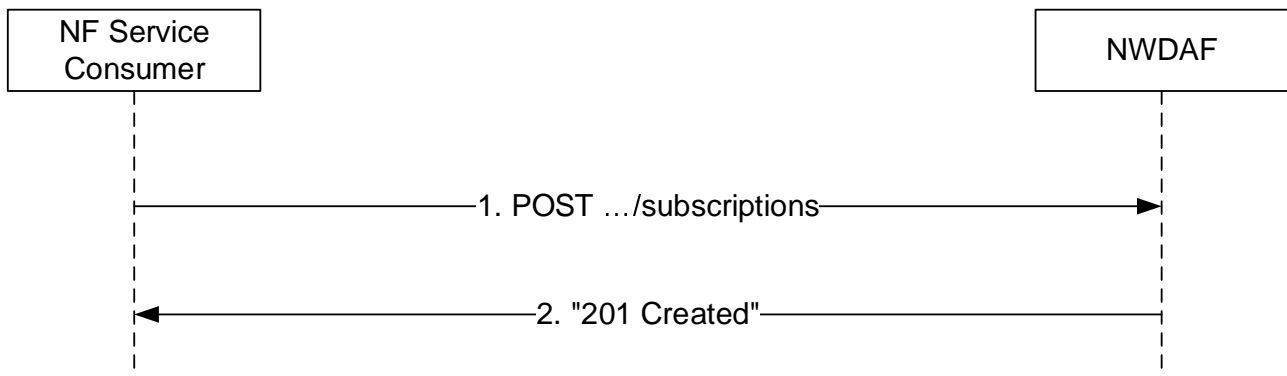

Figure 4.7.2.4.2-1: NF service consumer subscribes to notifications

The NF service consumer shall invoke the `Nnwdaf_MLModelMonitor_Subscribe` service operation to subscribe to event notification(s). The NF service consumer shall send an HTTP POST request with "`{apiRoot}/nnwdaf-mlmodelmonitor/<apiVersion>/subscriptions`" as Resource URI representing the "NWDAF ML model monitoring Subscriptions", as shown in figure 4.7.2.4.2-1, step 1, to create a subscription for an "Individual NWDAF ML model monitoring Subscription" according to the information in message body. The `MLModelMonitorSub` data structure provided in the request body shall include:

- the ML model IDs within "modelIds" attribute;
- the notification URI within "notificationUri" attribute;
- the notification correlation identifier within "notifCorrId" attribute;

and may include:

- the ML model metrics within "modelMetric" attribute;
- the accuracy reporting threshold within "accuThreshold" attribute;
- the reporting requirements of the event subscription within "eventReportReq" attribute;
- an event identifier as the "mLEvent" attribute;
- event filter information as the "mLEventFilter" attribute; and
- an identification of target UE information as the "tgtUe" attribute.

Upon the reception of an HTTP POST request with "`{apiRoot}/nnwdaf-mlmodelmonitor/<apiVersion>/subscriptions`" as Resource URI and `MLModelMonitorSub` data structure as request body, the NWDAF containing AnLF shall:

- create a new new subscription;
- assign a subscriptionId;
- store the subscription.

If the NWDAF created an "Individual NWDAF ML model monitoring Subscription" resource, the NWDAF shall respond with "201 Created" with the message body containing a representation of the created subscription, as shown in figure 4.7.2.4.2-1, step 2. The NWDAF shall include a Location HTTP header field. The Location header field shall contain the URI of the created profile, i.e. "`{apiRoot}/nnwdaf-mlmodelmonitor/<apiVersion>/subscriptions/{subscriptionId}`".

If the immediate reporting indication in the "immRep" attribute within the "eventReportReq" attribute sets to true in the event subscription, the NWDAF shall include the reports of the events subscribed within "immReport" attribute, if available, in the HTTP POST response.

If an error occurs when processing the HTTP POST request, the NWDAF shall send an HTTP error response as specified in clause 5.6.7.

4.7.2.4.3 Update of subscription for monitoring notifications

Figure 4.7.2.4.3-1 shows a scenario where the NF service consumer (i.e. NWDAF containing MTLF) sends a request to the NWDAF containing AnLF to update a subscription for event notification(s).

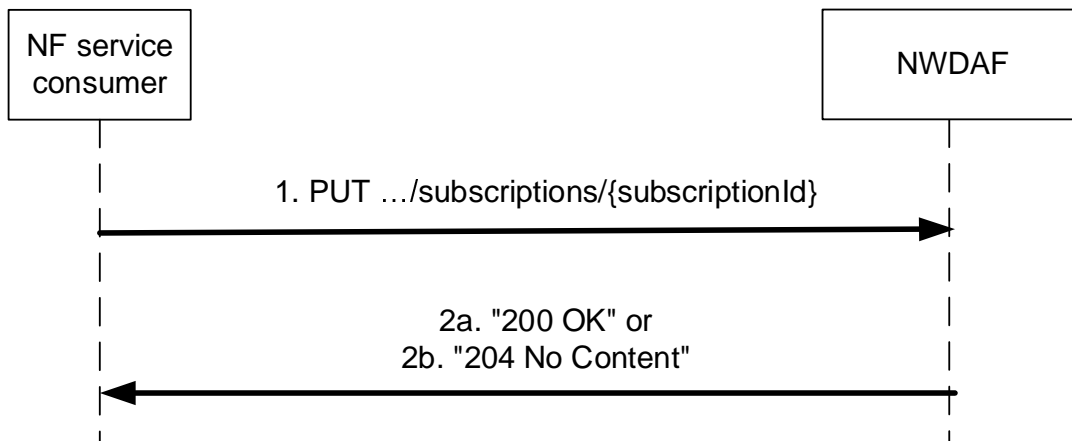

Figure 4.7.2.4.3-1: NF service consumer updates subscription to notifications

The NF service consumer shall invoke the `Nnwdafl_MLModelMonitor_Subscribe` service operation to update a subscription to event notification(s) by sending an HTTP PUT request with "`{apiRoot}/nnwdafl-mlmodelmonitor/<apiVersion>/subscriptions/{subscriptionId}`" as Resource URI representing the "Individual NWDAF ML model monitoring subscription", as shown in figure 4.7.2.4.3-1, step 1, to update this "Individual NWDAF ML model monitoring subscription" according to the information in message body. The `MLModelMonitorSub` data structure provided in the request body shall include the same contents as in clause 4.7.2.4.2.

Upon the reception of an HTTP PUT request with "`{apiRoot}/nnwdafl-mlmodelmonitor/<apiVersion>/subscriptions{subscriptionId}`" as Resource URI and `MLModelMonitorSub` data structure as request body, the NWDAF shall:

- update the subscription of corresponding `subscriptionId`; and
- store the subscription.

If the NWDAF successfully update the "Individual NWDAF ML model monitoring Subscription" resource, the NWDAF shall respond with "200 OK" with the message body containing a representation of the created subscription, as shown in figure 4.7.2.4.3-1, step 2a, or with "204 No Content" as shown in figure 4.7.2.4.3-1, step 2b.

If the immediate reporting indication in the "immRep" attribute within the "eventReportReq" attribute sets to true in the request, the NWDAF shall include the reports of the events subscribed within "immReport" attribute, if available, in the HTTP PUT response.

If an error occurs when processing the HTTP PUT request, the NWDAF shall send an HTTP error response as specified in clause 5.6.7.

4.7.2.5 Nnwdafl_MLModelMonitor_Unsubscribe service operation

4.7.2.5.1 General

The `Nnwdafl_MLModelMonitor_Unsubscribe` service operation is used by an NF service consumer (i.e. NWDAF containing MTLF) to unsubscribe from analytics accuracy monitoring event of an ML Model.

4.7.2.5.2 Unsubscribe from monitoring notifications

Figure 4.7.2.5.2-1 shows a scenario where the NF service consumer sends a request to the NWDAF containing AnLF to unsubscribe from notifications.

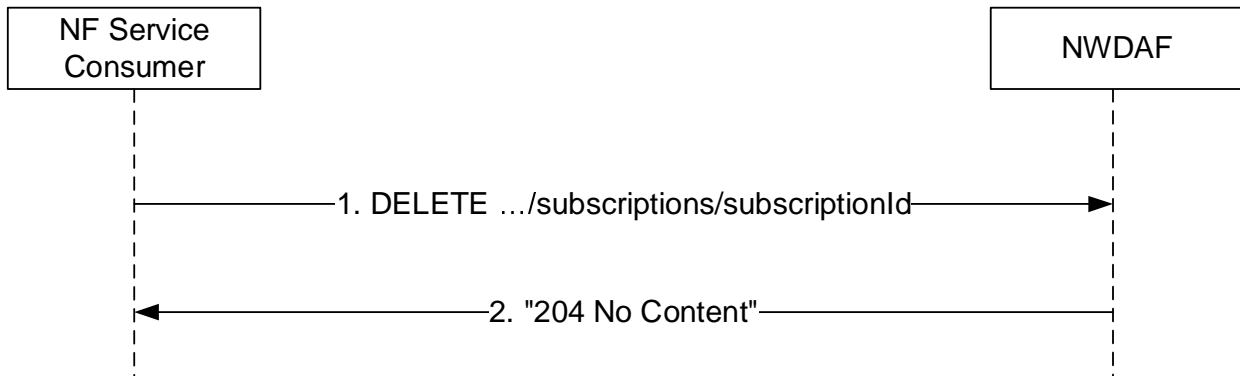

Figure 4.7.2.5.2-1: NF service consumer unsubscribes from notifications

The NF service consumer shall invoke the `Nnwdaf_MLModelMonitor_Unsubscribe` service operation to unsubscribe to event notifications. The NF service consumer shall send an HTTP DELETE request with: "`{apiRoot}/nnwdaf-mlmodelmonitor/<apiVersion>/subscriptions/{subscriptionId}`" as Resource URI, where "`{subscriptionId}`" is the event subscription ID of the existing subscription that is to be deleted.

Upon the reception of an HTTP DELETE request with: "`{apiRoot}/nnwdaf-mlmodelmonitor/<apiVersion>/subscriptions/{subscriptionId}`" as Resource URI, if the NWDAF successfully processed and accepted the received HTTP DELETE request, the NWDAF shall:

- remove the corresponding subscription; and
- respond with HTTP "204 No Content" status code.

If the NWDAF determines the received HTTP DELETE request needs to be redirected, the NWDAF shall send an HTTP redirect response as specified in clause 6.10.9 of 3GPP TS 29.500 [6].

If an error occurs when processing the HTTP DELETE request, the NWDAF shall send an HTTP error response as specified in clause 5.6.7.

4.7.2.6 Nnwdaf_MLModelMonitor_Notify service operation

4.7.2.6.1 General

The `Nnwdaf_MLModelMonitor_Notify` service operation is used by an NWDAF containing AnLF to notify NF service consumer (i.e. NWDAF containing MTLF) about the subscribed analytics accuracy monitoring event of an ML Model.

4.7.2.6.2 Notification about subscribed event

Figure 4.7.2.6.2-1 shows a scenario where the NWDAF containing AnLF sends a request to notify for event notifications.

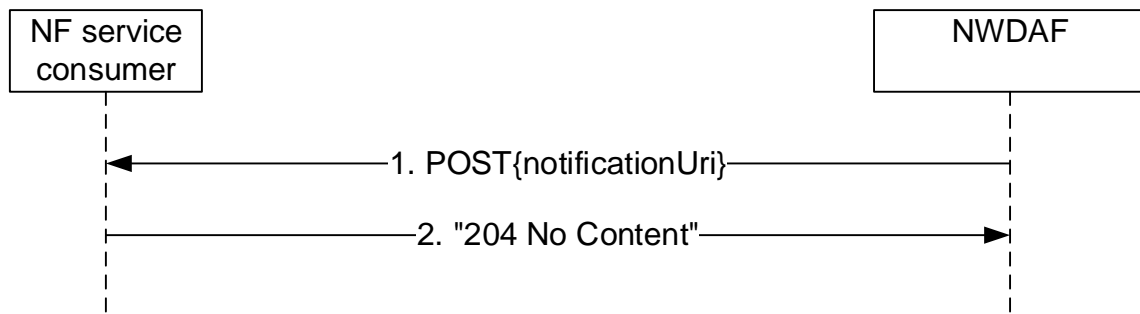

Figure 4.7.2.6.2-1: NWDAF notifies the subscribed event

The NWDAF shall invoke the `Nnwdaf_MLModelMonitor_Notify` service operation to notify the subscribed event. The NWDAF shall send an HTTP POST request with "{notificationUri}" received in the `Nnwdaf_MLModelMonitor_Subscribe` service operation as Resource URI, as shown in figure 4.7.2.6.2-1, step 1. The `MLModelMonitorNotify` data structure provided in the request body that shall include:

- a notification correlation identifier as "notifCorrId" attribute;
- at least one of:
 - the accuracy related information of the ML model within "modelAccuInfos" attribute;
 - the analytics feedback information within "anaFeedbacks" attribute;

and may include:

- the indication that the analytics accuracy of the ML model does not meet the requirement of accuracy for the ML model within "accuMeetInd" attribute;
- an event identifier as the "mLEvent" attribute;
- event filter information as the "mLEventFilter" attribute; and
- an identification of target UE information as the "tgtUe" attribute.

Upon the reception of an HTTP POST request, if the NF service consumer successfully processed and accepted the received HTTP POST request, the NF Service Consumer shall store the notification and respond with HTTP "204 No Content" status code.

If the NWDAF determines the received HTTP POST request needs to be redirected, the NWDAF shall send an HTTP redirect response as specified in clause 6.10.9 of 3GPP TS 29.500 [6].

If an error occurs when processing the HTTP POST request, the NWDAF shall send an HTTP error response as specified in clause 5.6.7.

4.8 Nnwdaf_RoamingData Service

4.8.1 Service Description

4.8.1.1 Overview

The `Nnwdaf_RoamingData` service as defined in 3GPP TS 23.288 [17], is provided by the Network Data Analytics Function (NWDAF) with roaming exchange capability, which is called Roaming Exchange NWDAF (RE-NWDAF).

This service:

- allows the NF service consumers to subscribe to and unsubscribe from the data of roaming UEs exposed by an RE-NWDAF;
- allows the NF service consumers to modify the subscription to the data of roaming UEs exposed by an RE-NWDAF; and

- notifies the NF service consumers about the data of roaming UEs exposed by an RE-NWDAF.

4.8.1.2 Service Architecture

The 5G System Architecture is defined in 3GPP TS 23.501 [2]. The Network Data Analytics Exposure architecture is defined in 3GPP TS 23.288 [17].

The Nnwdaq_RoamingData service is part of the Nnwdaq service-based interface exhibited by the Network Data Analytics Function (NWDAF).

Known consumers of the Nnwdaq_RoamingData service are:

- Network Data Analytics Function with Roaming Exchange capability in HPLMN(H-RE-NWDAF), collecting data from V-RE-NWDAF for outbound roaming user(s);
- Network Data Analytics Function with Roaming Exchange capability in VPLMN(V-RE-NWDAF), collecting data from H-RE-NWDAF for inbound roaming user(s);



Figure 4.8.1.2-1: Reference Architecture for the Nnwdaq_RoamingData Service; SBI representation

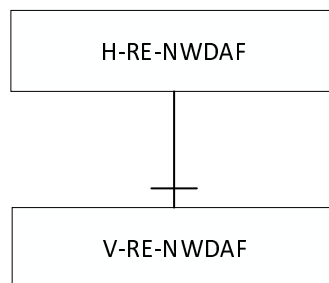

Figure 4.8.1.2-2: Reference Architecture for the Nnwdaq_RoamingData Service: reference point representation

4.8.1.3 Network Functions

4.8.1.3.1 Network Data Analytics Function (NWDAF)

The Network Data Analytics Function (NWDAF) with roaming exchange capability, i.e. the V-RE-NWDAF or H-RE-NWDAF, provides data information related to roaming UE(s) to NF service consumers.

The Network Data Analytics Function (NWDAF) allows NF service consumers to subscribe to and unsubscribe from one-time, periodic notification or notification when an event is detected.

4.8.1.3.2 NF Service Consumers

The Network Data Analytics Function (NWDAF) with roaming exchange capability, i.e. the H-RE-NWDAF or V-RE-NWDAF, supports (un)subscription to the notification of the data of roaming UEs exposed by an NWDAF.

4.8.2 Service Operations

4.8.2.1 Introduction

Table 4.8.2.1-1: Operations of the Nnwdaf_RoamingData Service

| Service operation name | Description | Initiated by |
|--------------------------------|--|--------------------------------|
| Nnwdaf_RoamingData_Subscribe | This service operation is used by an NF service consumer to subscribe to the data of roaming UEs exposed by an RE-NWDAF. | NF service consumer (RE-NWDAF) |
| Nnwdaf_RoamingData_Unsubscribe | This service operation is used by an NF service consumer to unsubscribe from the data of roaming UEs exposed by an RE-NWDAF. | NF service consumer (RE-NWDAF) |
| Nnwdaf_RoamingData_Notify | This service operation is used by the NWDAF to notify the data of roaming UEs exposed by an RE-NWDAF. | RE-NWDAF |

4.8.2.2 Nnwdaf_RoamingData_Subscribe service operation

4.8.2.2.1 General

The Nnwdaf_RoamingData_Subscribe service operation is used by an NF service consumer to subscribe or update subscription for the data of roaming UEs exposed by an RE-NWDAF.

4.8.2.2.2 Subscription for event notifications

Figure 4.8.2.2.2-1 shows a scenario where the NF service consumer sends a request to the RE-NWDAF to subscribe for event notification(s).

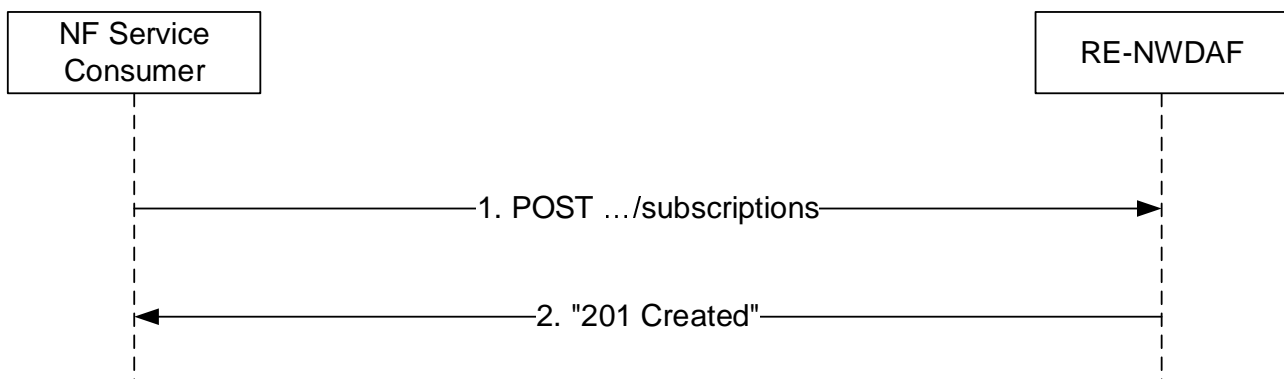

Figure 4.8.2.2.2-1: NF service consumer subscribes to notifications

The NF service consumer shall invoke the Nnwdaf_RoamingData_Subscribe service operation to subscribe to event notification(s). The NF service consumer shall send an HTTP POST request with "{apiRoot}/nnwdaf-roamingdata/<apiVersion>/subscriptions" as Resource URI representing the "NWDAF Roaming Data Subscriptions", as shown in figure 4.8.2.2.2-1, step 1, to create a subscription for an "Individual NWDAF Roaming Data Subscription" according to the information in message body. The RoamingDataSub data structure provided in the request body shall include:

- the notification URI within "notificationUri" attribute;
- the notification correlation identifier within "notifCorrId" attribute;
- the PLMN ID of the consumer within "plmnId" attribute;
- either the analytics subscription information to be used by the NWDAF to determine the data that can be used to generate these analytics within the "anaSub" attribute or subscribed data events within the "dataSub" attribute;

and may include:

- formatting instructions within the "formatInstruct" attribute;
- processing instructions within the "procInstructs" attribute;
- time window of the occurrence of the requested data collection within the "timePeriod" attribute; and
- either a target NF identifier within the "targetNfId" attribute" or a target NF set identifier within the "targetNfSetId" attribute".

Upon the reception of an HTTP POST request with "{apiRoot}/nnwdaf-roamingdata/<apiVersion>/subscriptions" as Resource URI and RoamingDataSub data structure as request body, the RE-NWDAF shall:

- create a new new subscription;
- assign a subscriptionId;
- store the subscription.

If the RE-NWDAF created an "Individual NWDAF Roaming Data Subscription" resource, the RE-NWDAF shall respond with "201 Created" with the message body containing a representation of the created subscription, as shown in figure 4.8.2.2.2-1, step 2. The RE-NWDAF shall include a Location HTTP header field. The Location header field shall contain the URI of the created profile, i.e. "{apiRoot}/nnwdaf-roamingdata/<apiVersion>/subscriptions/{subscriptionId}".

If an indication to perform immediate reporting is provided in the event subscription, the NWDAF shall include the reports of the events subscribed within "immReport" attribute, if available, in the HTTP POST response.

If the RE-NWDAF does not accept the request upon missing the corresponding roaming agreements, the RE-NWDAF shall reject the request with an HTTP "403 Forbidden" response including the "cause" attribute set to "MISSING_ROAMING_AGREEMENT".

If an error occurs when processing the HTTP POST request, the RE-NWDAF shall send an HTTP error response as specified in clause 5.7.7.

4.8.2.2.3 Update of subscription for event notifications

Figure 4.8.2.2.3-1 shows a scenario where the NF service consumer sends a request to the RE-NWDAF to update a subscription for event notification(s).

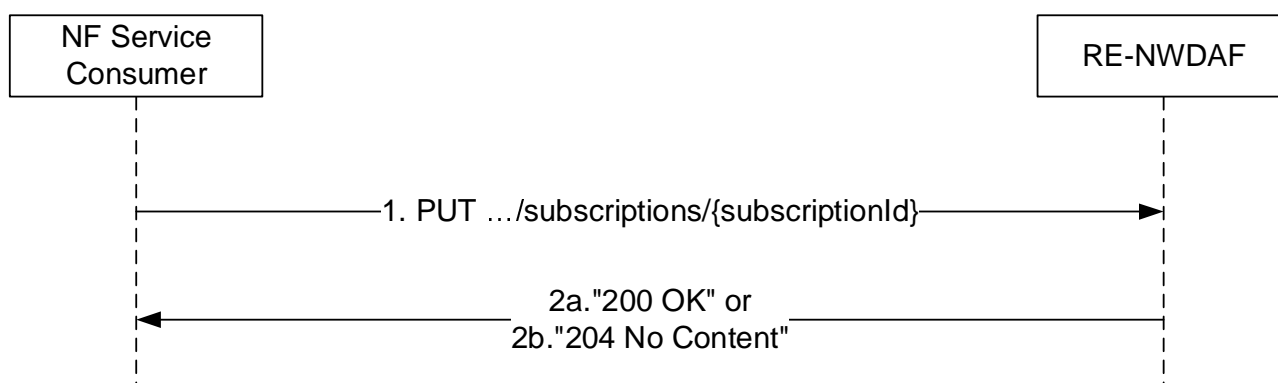

Figure 4.8.2.2.3-1: NF service consumer updates subscription to notifications

The NF service consumer shall invoke the Nnwdaf_RoamingData_Subscribe service operation to update a subscription to event notification(s) by sending an HTTP PUT request with "{apiRoot}/nnwdaf-roamingdata/<apiVersion>/subscriptions/{subscriptionId}" as Resource URI representing the "Individual NWDAF Roaming Data Subscription", as shown in figure 4.8.2.2.3-1, step 1, to update this "Individual NWDAF Roaming Data Subscription" according to the information in message body. The RoamingDataSub data structure provided in the request body shall include the same contents as in clause 4.8.2.2.2.

Upon the reception of an HTTP PUT request with "{apiRoot}/nnwdafroutingdata/<apiVersion>/subscriptions{subscriptionId}" as Resource URI and RoamingDataSub data structure as request body, the RE-NWDAF shall:

- update the subscription of corresponding subscriptionId; and
- store the subscription.

If the RE-NWDAF successfully update the "Individual NWDAF Roaming Data Subscription" resource, the RE-NWDAF shall respond with "200 OK" with the message body containing a representation of the created subscription, as shown in figure 4.8.2.2.3-1-1, step 2a, or with "204 No Content" as shown in figure 4.8.2.2.3-1-1, step 2b.

If an indication to perform immediate reporting is provided in the request, the RE-NWDAF shall include the reports of the events subscribed within "immReport" attribute, if available, in the HTTP PUT response.

If the RE-NWDAF does not accept the request upon missing the corresponding roaming agreements, the RE-NWDAF shall reject the request with an HTTP "403 Forbidden" response including the "cause" attribute set to "MISSING_ROAMING_AGREEMENT".

If an error occurs when processing the HTTP PUT request, the RE-NWDAF shall send an HTTP error response as specified in clause 5.7.7.

4.8.2.3 Nnwdafroutingdata_Unsubscribe service operation

4.8.2.3.1 General

The Nnwdafroutingdata_Unsubscribe service operation is used by an NF service consumer to unsubscribe from the data of roaming UEs exposed by an RE-NWDAF.

4.8.2.3.2 Unsubscribe from event notifications

Figure 4.8.2.3.2-1 shows a scenario where the NF service consumer sends a request to the RE-NWDAF to unsubscribe from notifications.

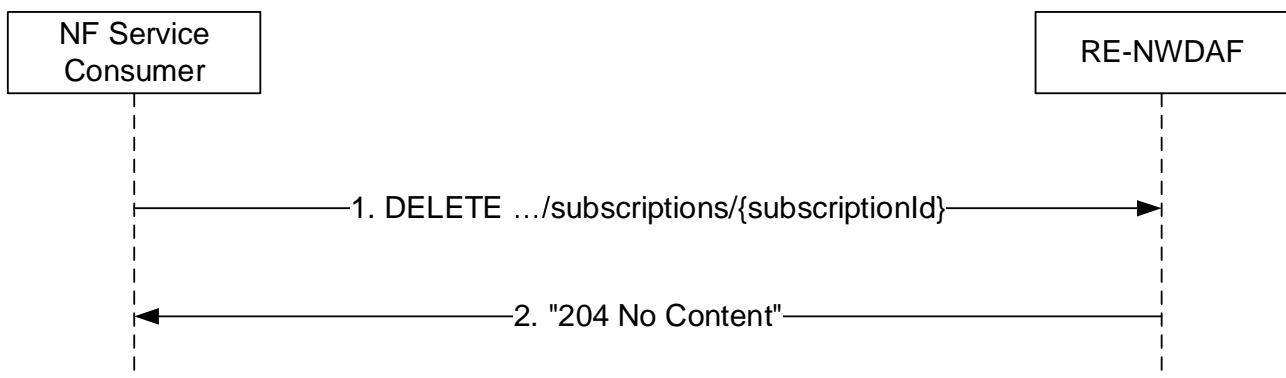

Figure 4.8.2.3.2-1: NF service consumer unsubscribes from notifications

The NF service consumer shall invoke the Nnwdafroutingdata_Unsubscribe service operation to unsubscribe to event notifications. The NF service consumer shall send an HTTP DELETE request with: "{apiRoot}/nnwdafroutingdata/<apiVersion>/subscriptions/{subscriptionId}" as Resource URI, where "{subscriptionId}" is the event subscription ID of the existing subscription that is to be deleted.

Upon the reception of an HTTP DELETE request with: "{apiRoot}/nnwdafroutingdata/<apiVersion>/subscriptions/{subscriptionId}" as Resource URI, if the RE-NWDAF successfully processed and accepted the received HTTP DELETE request, the RE-NWDAF shall:

- remove the corresponding subscription; and
- respond with HTTP "204 No Content" status code.

If the RE-NWDAF determines the received HTTP DELETE request needs to be redirected, the NWDAF shall send an HTTP redirect response as specified in clause 6.10.9 of 3GPP TS 29.500 [6].

If an error occurs when processing the HTTP DELETE request, the RE-NWDAF shall send an HTTP error response as specified in clause 5.7.7.

4.8.2.4 Nnwdaf_RoamingData_Notify service operation

4.8.2.4.1 General

The Nnwdaf_RoamingData_Notify service operation is used by an RE-NWDAF to notify NF service consumer about the subscribed data of roaming UEs exposed by an RE-NWDAF.

4.8.2.4.2 Notification about subscribed event

Figure 4.8.2.4.2-1 shows a scenario where the RE-NWDAF sends a request to notify for event notifications.

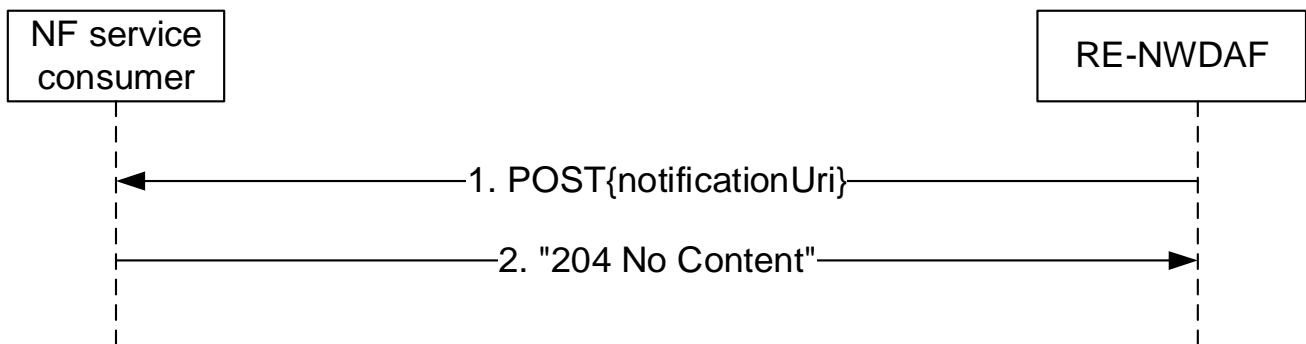

Figure 4.8.2.4.2-1: RE-NWDAF notifies the subscribed event

The RE-NWDAF shall invoke the Nnwdaf_RoamingData_Notify service operation to notify the subscribed event. The RE-NWDAF shall send an HTTP POST request with "{notificationUri}" received in the Nnwdaf_RoamingData_Notify service operation as Resource URI, as shown in figure 4.8.2.4.2-1, step 1. The HTTP POST message shall include NnwdafDataManagementNotif data structure as described in clause 5.3.6.2.2.

Upon the reception of an HTTP POST request, if the NF service consumer successfully processed and accepted the received HTTP POST request, the NF Service Consumer shall store the notification and respond with HTTP "204 No Content" status code.

If the RE-NWDAF determines the received HTTP POST request needs to be redirected, the RE-NWDAF shall send an HTTP redirect response as specified in clause 6.10.9 of 3GPP TS 29.500 [6].

If an error occurs when processing the HTTP POST request, the RE-NWDAF shall send an HTTP error response as specified in clause 5.7.7.

4.9 Nnwdaf_RoamingAnalytics Service

4.9.1 Service Description

4.9.1.1 Overview

The Nnwdaf_RoamingAnalytics service is provided by the Network Data Analytics Function (NWDAF) with roaming exchange capability, which is called Roaming Exchange NWDAF (RE-NWDAF).

This service:

- allows NF service consumers to subscribe to and unsubscribe from different analytics events related to roaming UE(s); and
- notifies NF service consumers with a corresponding subscription about observed events related to roaming UE(s).

4.9.1.2 Service Architecture

The 5G System Architecture is defined in 3GPP TS 23.501 [2]. The Network Data Analytics Exposure architecture, including the case of roaming, is defined in 3GPP TS 23.288 [17]. The Network Data Analytics signalling flows are defined in 3GPP TS 29.552 [25], the Policy and Charging related 5G architecture is also described in 3GPP TS 23.503 [4] and 3GPP TS 29.513 [5].

The Nnwdaf_RoamingAnalytics service is part of the Nnwdaf service-based interface exhibited by the Network Data Analytics Function (NWDAF), but it can be provided only by an NWDAF with the roaming exchange capability, which is called Roaming Exchange NWDAF (RE-NWDAF).

The only known consumer of the Nnwdaf_RoamingAnalytics service is the Roaming Exchange NWDAF (RE-NWDAF).

Both the RE-NWDAF that provides the Nnwdaf_RoamingAnalytics service and the RE-NWDAF that consumes the Nnwdaf_RoamingAnalytics service may be in the HPLMN (in which case it is denoted as H-RE-NWDAF) or in the VPLMN (in which case it is denoted as V-RE-NWDAF). If the NF service producer is the H-RE-NWDAF then the NF service consumer is the V-RE-NWDAF and vice versa.

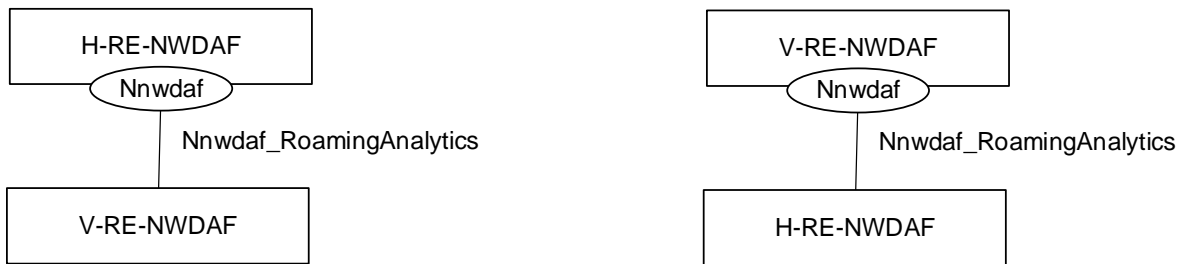

Figure 4.9.1.2-1: Reference Architecture for the Nnwdaf_RoamingAnalytics Service; SBI representation

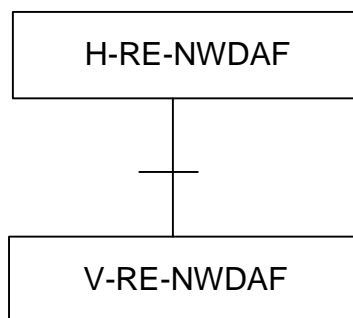

Figure 4.9.1.2-2: Reference Architecture for the Nnwdaf_RoamingAnalytics Service: reference point representation

4.9.1.3 Network Functions

4.9.1.3.1 Network Data Analytics Function (NWDAF)

The Network Data Analytics Function (NWDAF) with roaming exchange capability, i.e. the RE-NWDAF, provides analytics information for different analytics events related to roaming UE(s) to NF service consumers.

The Network Data Analytics Function (NWDAF) allows NF service consumers to subscribe to and unsubscribe from one-time, periodic notification or notification when an event is detected.

4.9.1.3.2 NF Service Consumers

The Network Data Analytics Function (NWDAF) with roaming exchange capability, i.e. the RE-NWDAF, supports (un)subscription to the notification of analytics information for all types of network analytics related to roaming UE(s) from the NWDAF.

4.9.2 Service Operations

4.9.2.1 Introduction

Table 4.9.2.1-1: Operations of the NnwdaF_RoamingAnalytics Service

| Service operation name | Description | Initiated by |
|-------------------------------------|---|--------------------------------|
| NnwdaF_RoamingAnalytics_Subscribe | This service operation is used by an NF to subscribe or update subscription for event notifications of the analytics information related to roaming UE(s). One-time, periodic notification or notification upon event detection can be subscribed. | NF service consumer (RE-NWDAF) |
| NnwdaF_RoamingAnalytics_Unsubscribe | This service operation is used by an NF to unsubscribe from event notifications. | NF service consumer (RE-NWDAF) |
| NnwdaF_RoamingAnalytics_Notify | This service operation is used by an RE-NWDAF to notify NF service consumers about subscribed events. | RE-NWDAF |

4.9.2.2 NnwdaF_RoamingAnalytics_Subscribe service operation

4.9.2.2.1 General

The NnwdaF_RoamingAnalytics_Subscribe service operation is used by an NF service consumer to subscribe or update subscription for event notifications related to roaming UE(s) from the NWDAF.

4.9.2.2.2 Subscription for event notifications

Figure 4.9.2.2.2-1 shows a scenario where the NF service consumer sends a request to the RE-NWDAF to subscribe for event notification(s).

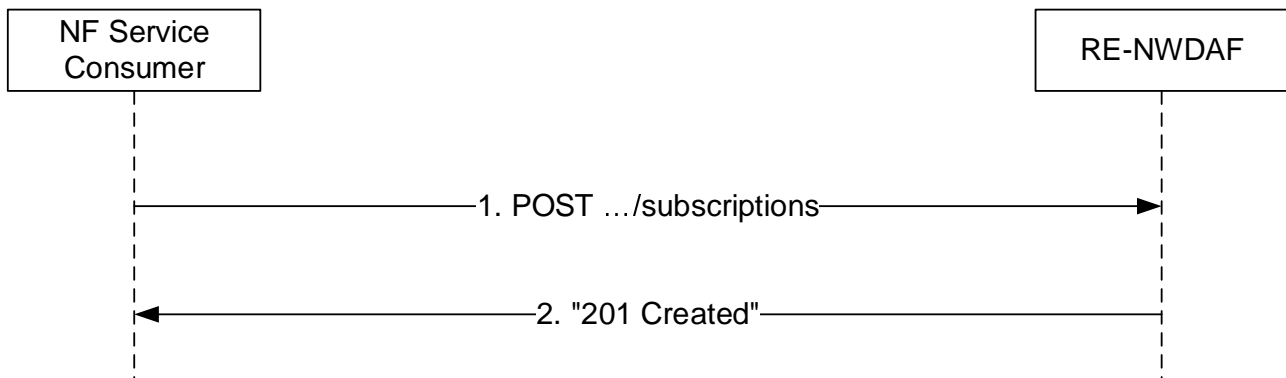

Figure 4.9.2.2.2-1: NF service consumer subscribes to notifications

The NF service consumer shall invoke the `Nnwdafl_RoamingAnalytics_Subscribe` service operation to subscribe to event notification(s) related to roaming UE(s) by sending an HTTP POST request with "`{apiRoot}/nnwdafl-roaminganalytics/<apiVersion>/subscriptions`" as Resource URI representing the "NWDAF Roaming Analytics Subscriptions" resource, as shown in figure 4.9.2.2.2-1, step 1, to create an "Individual NWDAF Roaming Analytics Subscription" resource according to the information in message body. The `RoamingAnalyticsSubscription` data structure provided in the request body shall include:

- a URI where to receive the requested notifications as "notifUri" attribute;
- a notification correlation identifier as "notifCorrId" attribute;
- the PLMN ID of the NF service consumer as "consPlmnId" attribute;
- a description of the subscribed events as "roamEventSubs" attribute with the same contents as specified for the "eventSubscriptions" attribute in clause 4.2.2.2.2 but excluding the attributes that are indicated as non applicable in Table 5.7.6.2.2-1.

NOTE: The features mentioned in clause 4.2.2.2.2 are not relevant here.

and may include:

- event reporting information as the "evtReq" attribute with the same contents as specified for the "evtReq" attribute in clause 4.2.2.2.2.

Upon the reception of an HTTP POST request with: "`{apiRoot}/nnwdafl-roaminganalytics/<apiVersion>/subscriptions`" as Resource URI and `RoamingAnalyticsSubscription` data structure as request body, if no errors occur, the RE-NWDAF shall:

- create a new subscription;
- assign an event subscriptionId; and
- store the subscription.

If the RE-NWDAF created an "Individual NWDAF Roaming Analytics Subscription" resource, the RE-NWDAF shall respond with "201 Created" status code with the message body containing a representation of the created subscription, as shown in figure 4.9.2.2.2-1, step 2. If not all the requested analytics events in the subscription are accepted, then the NWDAF may include the "failEventReports" attribute indicating the event(s) for which the subscription failed and the associated reason(s). The NWDAF shall include a Location HTTP header field. The Location header field shall contain the URI of the created subscription i.e. "`{apiRoot}/nnwdafl-roaminganalytics/<apiVersion>/subscriptions/{subscriptionId}`". If the immediate reporting indication in the "immRep" attribute within the "evtReq" attribute was set to true in the event subscription, the RE-NWDAF shall include the reports of the events subscribed, if available, in the HTTP POST response within the "roamEventNotifs" attribute.

When the "notifFlag" attribute is included and set to "DEACTIVATE" in the request, the RE-NWDAF shall mute the event notification and store the available events until the NF service consumer requests to retrieve them by setting the "notifFlag" attribute to "RETRIEVAL" or until a muting exception occurs (e.g. full buffer).

If the analytics target period provided in the body of the HTTP POST request includes the start time in the past and the end time in the future, the NWDAF shall reject the request with an HTTP "400 Bad Request" response including the "cause" attribute set to "BOTH_STAT_PRED_NOT_ALLOWED".

If the RE-NWDAF does not accept the upon missing the corresponding roaming agreements, the RE-NWDAF shall reject the request with an HTTP "403 Forbidden" response including the "cause" attribute set to "MISSING_ROAMING_AGREEMENT".

If the statistics in the past are requested but the necessary data to perform the service is unavailable, the RE-NWDAF shall reject the request with an HTTP "500 Internal Server Error" response including the "cause" attribute set to "UNAVAILABLE_DATA".

Editor's Note: The applicability and the handling of user consent is FFS and depends on stage 2 updates.

If an error occurs when processing the HTTP POST request, the NWDAF shall send an HTTP error response as specified in clause 5.8.7.

4.9.2.2.3 Update subscription for event notifications

Figure 4.9.2.2.3-1 shows a scenario where the NF service consumer sends a request to the RE-NWDAF to update the subscription for event notifications.

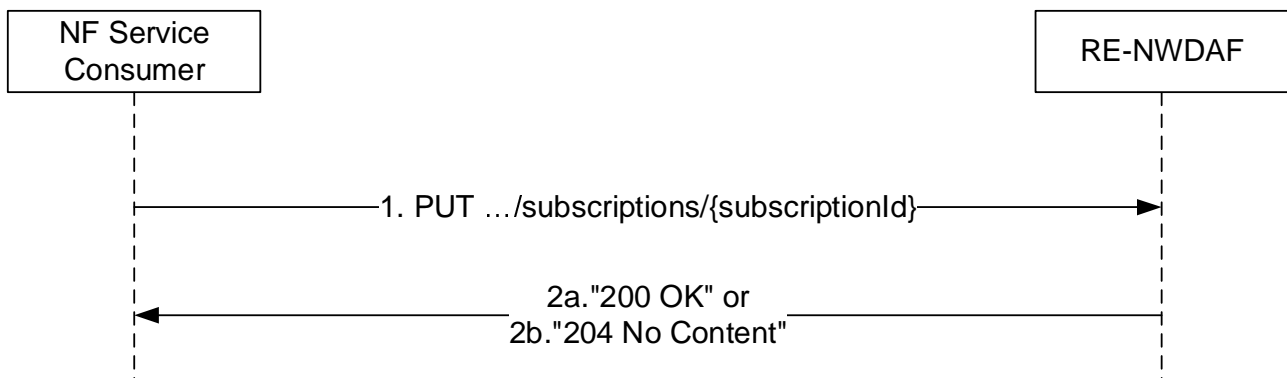

Figure 4.9.2.2.3-1: NF service consumer updates subscription to notifications

The NF service consumer shall invoke the `NnwdaF_RoamingAnalytics_Subscribe` service operation to update subscription to event notifications related to roaming UE(s) by sending an HTTP PUT request with "`{apiRoot}/nnwdaF-roaminganalytics/<apiVersion>/subscriptions/{subscriptionId}`" as Resource URI representing the "Individual NWDAF Roaming Analytics Subscription", as shown in figure 4.9.2.2.3-1, step 1, to update the subscription for an "Individual NWDAF Roaming Analytics Subscription" resource identified by the `{subscriptionId}`. The `RoamingAnalyticsSubscription` data structure provided in the request body shall include the same contents as described in clause 4.9.2.2.2.

Upon the reception of an HTTP PUT request with: "`{apiRoot}/nnwdaF-roaminganalytics/<apiVersion>/subscriptions/{subscriptionId}`" as Resource URI and `RoamingAnalyticsSubscription` data structure as request body, the NWDAF shall:

- update the subscription of corresponding `subscriptionId`; and
- store the subscription.

If the RE-NWDAF successfully processed and accepted the received HTTP PUT request, the RE-NWDAF shall update an "Individual NWDAF Roaming Analytics Subscription" resource, and shall respond with:

- a) HTTP "200 OK" status code with the message body containing a representation of the updated subscription, as shown in figure 4.9.2.2.3-1, step 2a. If not all the requested analytics events in the subscription are modified successfully, then the RE-NWDAF may include the "failEventReports" attribute indicating the event(s) for which the modification failed and the associated reason(s). If the immediate reporting indication in the "immRep" attribute within the "evtReq" attribute was set to true in the request, the RE-NWDAF shall include the

reports of the events subscribed, if available, in the HTTP PUT response within the "roamEventNotifs" attribute;
or

b) HTTP "204 No Content" status code, as shown in figure 4.9.2.2.3-1, step 2b.

If errors occur when processing the HTTP PUT request, the RE-NWDAF shall send an HTTP error response as specified in clause 5.8.7.

If the analytics target period provided in the body of the HTTP PUT request includes the start time in the past and the end time in the future, the NWDAF shall reject the request with an HTTP "400 Bad Request" response including the "cause" attribute set to "BOTH_STAT_PRED_NOT_ALLOWED".

If the statistics in the past are requested but the necessary data to perform the service is unavailable, the RE-NWDAF shall reject the request with an HTTP "500 Internal Server Error" response including the "cause" attribute set to "UNAVAILABLE_DATA".

If the RE-NWDAF does not accept the request upon missing the corresponding roaming agreements, the RE-NWDAF shall reject the request with an HTTP "403 Forbidden" response including the "cause" attribute set to "MISSING_ROAMING_AGREEMENT".

If the RE-NWDAF determines that the received HTTP PUT request needs to be redirected, the RE-NWDAF shall send an HTTP redirect response as specified in clause 6.10.9 of 3GPP TS 29.500 [6].

When the "notifFlag" attribute is included in the request with the value "DEACTIVATE", the RE-NWDAF shall mute the event notification and store the available events until the NF service consumer requests to retrieve them by setting the "notifFlag" attribute to "RETRIEVAL" or until a muting exception occurs (e.g. full buffer); if the "notifFlag" attribute is set to the value "RETRIEVAL", the NWDAF shall send the stored events to the NF service consumer, mute the event notification again and store available events; if the "notifFlag" attribute is set to the value "ACTIVATE" and the event notifications are muted (due to a previously received "DEACTIVATE" value), the NWDAF shall unmute the event notification, i.e. start sending again notifications for available events.

4.9.2.3 NnwdaF_RoamingAnalytics_Unsubscribe service operation

4.9.2.3.1 General

The NnwdaF_RoamingAnalytics_Unsubscribe service operation is used by an NF service consumer to unsubscribe from event notifications related to roaming UE(s).

4.9.2.3.2 Unsubscribe from event notifications

Figure 4.9.2.3.2-1 shows a scenario where the NF service consumer sends a request to the NWDAF to unsubscribe from event notifications related to roaming UE(s).

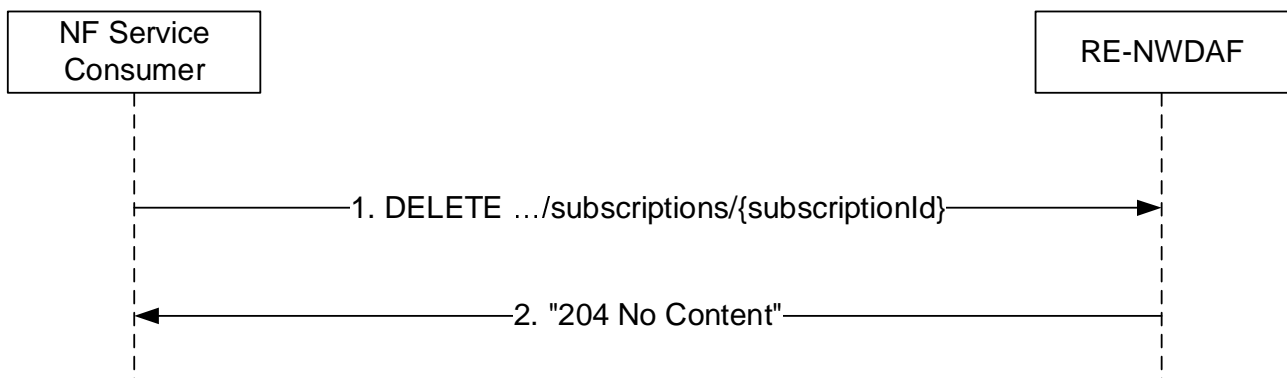

Figure 4.9.2.3.2-1: NF service consumer unsubscribes from notifications

The NF service consumer shall invoke the NnwdaF_RoamingAnalytics_Unsubscribe service operation to unsubscribe to event notifications related to roaming UE(s) by sending an HTTP DELETE request with: "{apiRoot}/nnwdaF-

roaminganalytics/<apiVersion>/subscriptions/{subscriptionId}" as Resource URI, where "{subscriptionId}" is the event subscriptionId of the existing subscription that is to be deleted.

Upon the reception of an HTTP DELETE request with: "{apiRoot}/nnwdaf-roaminganalytics/<apiVersion>/subscriptions/{subscriptionId}" as Resource URI, if the RE-NWDAF successfully processed and accepted the received HTTP DELETE request, the RE-NWDAF shall:

- remove the corresponding subscription; and
- respond with HTTP "204 No Content" status code.

If errors occur when processing the HTTP DELETE request, the RE-NWDAF shall send an HTTP error response as specified in clause 5.8.7.

If the RE-NWDAF determines that the received HTTP DELETE request needs to be redirected, the NWDAF shall send an HTTP redirect response as specified in clause 6.10.9 of 3GPP TS 29.500 [6].

4.9.2.4 Nnwdaf_RoamingAnalytics_Notify service operation

4.9.2.4.1 General

The Nnwdaf_RoamingAnalytics_Notify service operation is used by an RE-NWDAF to notify NF consumers about subscribed events related to roaming UE(s).

4.9.2.4.2 Notification about subscribed event

Figure 4.9.2.4.2-1 shows a scenario where the RE-NWDAF sends a request to the NF service consumer to notify for event notifications related to roaming UE(s).

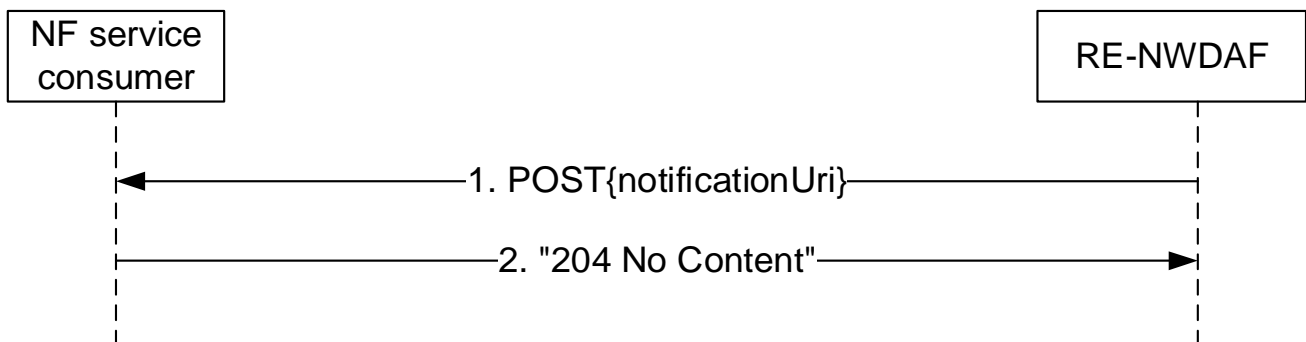

Figure 4.9.2.4.2-1: RE-NWDAF notifies the subscribed event

The RE-NWDAF shall invoke the Nnwdaf_RoamingAnalytics_Notify service operation to notify the subscribed event related to roaming UE(s) by sending an HTTP POST request with the "{notifUri}" that was received in the Nnwdaf_RoamingAnalytics_Subscribe service operation as Resource URI, as shown in figure 4.9.2.4.2-1, step 1.

If both the repetition period ("repPeriod" or "repetitionPeriod") attribute and the "offsetPeriod" attribute were present in the subscription request for periodical notification, the RE-NWDAF shall produce a notification in every repetition period seconds, including the statistics in the past offset period if the "offsetPeriod" attribute value is negative, or including the prediction for the future offset period if the "offsetPeriod" attribute value is positive.

The RoamingAnalyticsNotification data structure provided in the request body shall include:

- the notification correlation identifier as "notifCorrId" attribute;
- a description of the notified event(s) as "roamEventNotifs" attribute with the same contents as specified for the "eventNotifications" attribute in clause 4.2.2.4.2 but excluding the attributes that are indicated as non applicable in Table 5.7.6.2.3-1.

NOTE: The features mentioned in clause 4.2.2.4.2 are not relevant here.

and may include:

- a cause for termination in the "termCause" attribute if the RE-NWDAF wants to request the termination of this subscription, i.e. to indicate that it will send no further notifications for it.

If the time when analytics information is needed has been provided (via the "timeAnaNeeded" attribute within the "extraReportReq" attribute) during the subscription for an event (via the "event" attribute within the EventSubscription data type), if the time when analytics information is needed is reached but the subscribed analytics information is not ready, the consumer does not need to wait for the analytics information any longer. In this case, the RE-NWDAF may send an HTTP POST request as shown in step 1 of figure 4.9.2.4.2-1, which shall only provide (within the EventNotification data type in the RoamingAnalyticsNotification data type) an indication of the failure event via the "event" attribute and the corresponding failure reason via a "failNotifyCode" attribute, and may also provide a minimum time interval recommended by the RE-NWDAF for the event via a "rvWaitTime" attribute which will be used by the NF service consumer to determine the time when analytics information is needed in similar future analytics subscriptions.

Upon the reception of an HTTP POST request with: "{notifUri}" as Resource URI and RoamingAnalyticsNotification data structure as request body, if the NF service consumer successfully processed and accepted the received HTTP POST request, the NF service consumer shall:

- store the notification; and
- respond with HTTP "204 No Content" status code.

If errors occur when processing the HTTP POST request, the NF service consumer shall send an HTTP error response as specified in clause 5.8.7.

If the NF service consumer determines that the received HTTP POST request needs to be redirected, the NF service consumer shall send an HTTP redirect response as specified in clause 6.10.9 of 3GPP TS 29.500 [6].

5 API Definitions

5.1 Nnwdaf_EventsSubscription Service API

5.1.1 Introduction

The Nnwdaf_EventsSubscription service shall use the Nnwdaf_EventsSubscription API.

The API URI of the Nnwdaf_EventsSubscription API shall be:

{apiRoot}/<apiName>/<apiVersion>

The request URIs used in each HTTP requests from the NF service consumer towards the NWDAF shall have the Resource URI structure defined in clause 4.4.1 of 3GPP TS 29.501 [7], i.e.:

{apiRoot}/<apiName>/<apiVersion>/<apiSpecificResourceUriPart>

with the following components:

- The {apiRoot} shall be set as described in 3GPP TS 29.501 [7].
- The <apiName> shall be "nwdaf-eventssubscription".
- The <apiVersion> shall be "v1".
- The <apiSpecificResourceUriPart> shall be set as described in clause 5.1.3.

5.1.2 Usage of HTTP

5.1.2.1 General

HTTP/2, IETF RFC 9113 [9], shall be used as specified in clause 5 of 3GPP TS 29.500 [6].

HTTP/2 shall be transported as specified in clause 5.3 of 3GPP TS 29.500 [6].

The OpenAPI [11] specification of HTTP messages and content bodies for the Nnwdaf_EventsSubscription is contained in Annex A.

5.1.2.2 HTTP standard headers

5.1.2.2.1 General

See clause 5.2.2 of 3GPP TS 29.500 [6] for the usage of HTTP standard headers.

5.1.2.2.2 Content type

JSON, IETF RFC 8259 [10], shall be used as content type of the HTTP bodies specified in the present specification as specified in clause 5.4 of 3GPP TS 29.500 [6]. The use of the JSON format shall be signalled by the content type "application/json".

"Problem Details" JSON object shall be used to indicate additional details of the error in a HTTP response body and shall be signalled by the content type "application/problem+json", as defined in IETF RFC 9457 [15].

5.1.2.3 HTTP custom headers

The Nnwdaf_EventsSubscription service API shall support the mandatory HTTP custom header fields specified in clause 5.2.3.2 of 3GPP TS 29.500 [6] and may support the optional HTTP custom header fields specified in clause 5.2.3.3 of 3GPP TS 29.500 [6].

In this release of the specification, no specific custom headers are defined for the Nnwdaf_EventsSubscription service API.

5.1.3 Resources

5.1.3.1 Resource Structure

This clause describes the structure for the Resource URIs, the resources and methods used for the service.

Figure 5.1.3.1-1 depicts the resource URIs structure for the Nnwdaf_EventsSubscription API.

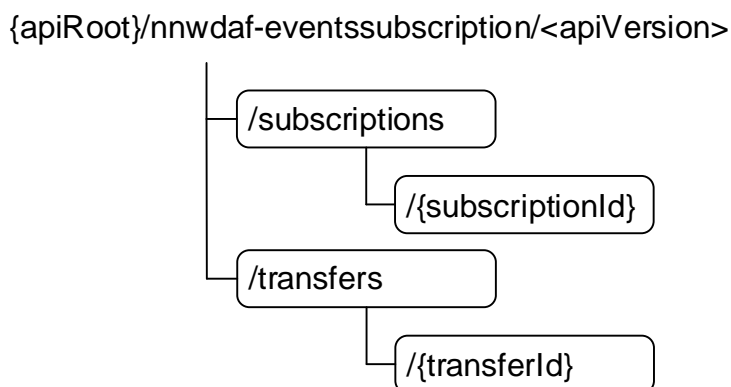

Figure 5.1.3.1-1: Resource URI structure of the Nnwdaf_EventsSubscription API

Table 5.1.3.1-1 provides an overview of the resources and applicable HTTP methods.

Table 5.1.3.1-1: Resources and methods overview

| Resource name | Resource URI | HTTP method or custom operation | Description |
|--|---------------------------------|---------------------------------|--|
| NWDAF Events Subscriptions | /subscriptions | POST | Creates a new Individual NWDAF Event Subscription resource. |
| Individual NWDAF Event Subscription | /subscriptions/{subscriptionId} | DELETE | Deletes an Individual NWDAF Event Subscription identified by subresource {subscriptionId}. |
| | | PUT | Modifies an existing Individual Event Subscription subresource. |
| NWDAF Event Subscription Transfers | /transfers | POST | Provides information about the requested analytics subscription transfer(s), potentially creating a new Individual NWDAF Event Subscription Transfer resource. |
| Individual NWDAF Event Subscription Transfer | /transfers/{transferId} | DELETE | Deletes an Individual NWDAF Event Subscription Transfer resource identified by subresource {transferId}. |
| | | PUT | Modifies an existing Individual NWDAF Event Subscription Transfer resource. |

5.1.3.2 Resource: NWDAF Events Subscriptions

5.1.3.2.1 Description

The NWDAF Events Subscriptions resource represents all subscriptions to the NnwdafeventsSubscription service at a given NWDAF. The resource allows an NF service consumer to create a new Individual NWDAF Event Subscription resource.

5.1.3.2.2 Resource definition

Resource URI: **{apiRoot}/nnwdafeventsSubscription/<apiVersion>/subscriptions**

The <apiVersion> shall be set as described in clause 5.1.1.

This resource shall support the resource URI variables defined in table 5.1.3.2.2-1.

Table 5.1.3.2.2-1: Resource URI variables for this resource

| Name | Data type | Definition |
|---------|-----------|------------------|
| apiRoot | string | See clause 5.1.1 |

5.1.3.2.3 Resource Standard Methods

5.1.3.2.3.1 POST

This method shall support the URI query parameters specified in table 5.1.3.2.3.1-1.

Table 5.1.3.2.3.1-1: URI query parameters supported by the POST method on this resource

| Name | Data type | P | Cardinality | Description |
|------|-----------|---|-------------|-------------|
| n/a | | | | |

This method shall support the request data structures specified in table 5.1.3.2.3.1-2 and the response data structures and response codes specified in table 5.1.3.2.3.1-3.

Table 5.1.3.2.3.1-2: Data structures supported by the POST Request Body on this resource

| Data type | P | Cardinality | Description |
|--------------------------|---|-------------|---|
| NnwdafEventsSubscription | M | 1 | Creates a new Individual NWDAF Event Subscription resource. |

Table 5.1.3.2.3.1-3: Data structures supported by the POST Response Body on this resource

| Data type | P | Cardinality | Response codes | Description |
|---|---|-------------|---------------------------|---|
| NnwdafEventsSubscription | M | 1 | 201 Created | The creation of an Individual NWDAF Event Subscription resource is confirmed and a representation of that resource is returned. |
| ProblemDetails | O | 0..1 | 400 Bad Request | (NOTE 2) |
| ProblemDetails | O | 0..1 | 403 Forbidden | (NOTE 2) |
| ProblemDetails | O | 0..1 | 500 Internal Server Error | (NOTE 2) |
| NOTE 1: The mandatory HTTP error status codes for the POST method listed in table 5.2.7.1-1 of 3GPP TS 29.500 [6] also apply. | | | | |
| NOTE 2: Failure cases are described in clause 5.1.7. | | | | |

Table 5.1.3.2.3.1-4: Headers supported by the 201 Response Code on this resource

| Name | Data type | P | Cardinality | Description |
|----------|-----------|---|-------------|---|
| Location | string | M | 1 | Contains the URI of the newly created resource, according to the structure: {apiRoot}/nnwdaf-eventsubscription/<apiVersion>/subscriptions/{subscriptionId}. |

5.1.3.2.4 Resource Custom Operations

None in this release of the specification.

5.1.3.3 Resource: Individual NWDAF Event Subscription

5.1.3.3.1 Description

The Individual NWDAF Event Subscription resource represents a single subscription to the Nnwdaf_EventsSubscription service at a given NWDAF.

5.1.3.3.2 Resource definition

Resource URI: {apiRoot}/nnwdaf-eventsubscription/<apiVersion>/subscriptions/{subscriptionId}

The <apiVersion> shall be set as described in clause 5.1.1.

This resource shall support the resource URI variables defined in table 5.1.3.3.2-1.

Table 5.1.3.3.2-1: Resource URI variables for this resource

| Name | Data type | Definition |
|----------------|-----------|---|
| apiRoot | string | See clause 5.1.1. |
| subscriptionId | string | Identifies a subscription to the Nnwdaf_EventsSubscription service. |

5.1.3.3.3 Resource Standard Methods

5.1.3.3.3.1 DELETE

This method shall support the URI query parameters specified in table 5.1.3.3.3.1-1.

Table 5.1.3.3.3.1-1: URI query parameters supported by the DELETE method on this resource

| Name | Data type | P | Cardinality | Description |
|------|-----------|---|-------------|-------------|
| n/a | | | | |

This method shall support the request data structures specified in table 5.1.3.3.3.1-2 and the response data structures and response codes specified in table 5.1.3.3.3.1-3.

Table 5.1.3.3.3.1-2: Data structures supported by the DELETE Request Body on this resource

| Data type | P | Cardinality | Description |
|-----------|---|-------------|-------------|
| n/a | | | |

Table 5.1.3.3.3.1-3: Data structures supported by the DELETE Response Body on this resource

| Data type | P | Cardinality | Response codes | Description |
|---|---|-------------|------------------------|--|
| n/a | | | 204 No Content | Successful case: The Individual NWDAF Event Subscription resource matching the subscriptionId was deleted. |
| RedirectResponse | O | 0..1 | 307 Temporary Redirect | Temporary redirection, during Individual NWDAF Event Subscription deletion. Applicable if the feature "ES3XX" is supported. (NOTE 2) |
| RedirectResponse | O | 0..1 | 308 Permanent Redirect | Permanent redirection, during Individual NWDAF Event Subscription deletion. Applicable if the feature "ES3XX" is supported. (NOTE 2) |
| NOTE 1: The mandatory HTTP error status codes for the DELETE method listed in table 5.2.7.1-1 of 3GPP TS 29.500 [6] also apply. | | | | |
| NOTE 2: The RedirectResponse data structure may be provided by an SCP (cf. clause 6.10.9.1 of 3GPP TS 29.500 [6]). | | | | |

Table 5.1.3.3.3.1-4: Headers supported by the 307 Response Code on this resource

| Name | Data type | P | Cardinality | Description |
|-----------------------|-----------|---|-------------|---|
| Location | string | M | 1 | Contains an alternative URI of the resource located in an alternative NWDAF (service) instance towards which the request is redirected. For the case where the request is redirected to the same target via a different SCP, refer to clause 6.10.9.1 of 3GPP TS 29.500 [6]. |
| 3gpp-Sbi-Target-Nf-Id | string | O | 0..1 | Identifier of the target NWDAF (service) instance towards which the request is redirected. |

Table 5.1.3.3.1-5: Headers supported by the 308 Response Code on this resource

| Name | Data type | P | Cardinality | Description |
|-----------------------|-----------|---|-------------|---|
| Location | string | M | 1 | Contains an alternative URI of the resource located in an alternative NWDAF (service) instance towards which the request is redirected. For the case where the request is redirected to the same target via a different SCP, refer to clause 6.10.9.1 of 3GPP TS 29.500 [6]. |
| 3gpp-Sbi-Target-Nf-Id | string | O | 0..1 | Identifier of the target NWDAF (service) instance towards which the request is redirected. |

5.1.3.3.3.2 PUT

This method shall support the URI query parameters specified in table 5.1.3.3.2-1.

Table 5.1.3.3.2-1: URI query parameters supported by the PUT method on this resource

| Name | Data type | P | Cardinality | Description |
|------|-----------|---|-------------|-------------|
| n/a | | | | |

This method shall support the request data structures specified in table 5.1.3.3.2-2 and the response data structures and response codes specified in table 5.1.3.3.2-3.

Table 5.1.3.3.2-2: Data structures supported by the PUT Request Body on this resource

| Data type | P | Cardinality | Description |
|--------------------------|---|-------------|--|
| NnwdafeventsSubscription | M | 1 | Parameters to replace a subscription to NWDAF Event Subscription resource. |

Table 5.1.3.3.2-3: Data structures supported by the PUT Response Body on this resource

| Data type | P | Cardinality | Response codes | Description |
|--------------------------|---|-------------|---------------------------|--|
| NnwdafeventsSubscription | M | 1 | 200 OK | The Individual NWDAF Event Subscription resource was modified successfully and a representation of that resource is returned. |
| n/a | | | 204 No Content | The Individual NWDAF Event Subscription resource was modified successfully. |
| RedirectResponse | O | 0..1 | 307 Temporary Redirect | Temporary redirection, during Individual NWDAF Event Subscription modification. Applicable if the feature "ES3XX" is supported. (NOTE 3) |
| RedirectResponse | O | 0..1 | 308 Permanent Redirect | Permanent redirection, during Individual NWDAF Event Subscription modification. Applicable if the feature "ES3XX" is supported. (NOTE 3) |
| ProblemDetails | O | 0..1 | 400 Bad Request | (NOTE 2) |
| ProblemDetails | O | 0..1 | 403 Forbidden | (NOTE 2) |
| ProblemDetails | O | 0..1 | 500 Internal Server Error | (NOTE 2) |

NOTE 1: The mandatory HTTP error status codes for the PUT method listed in table 5.2.7.1-1 of 3GPP TS 29.500 [6] also apply.

NOTE 2: Failure cases are described in clause 5.1.7.

NOTE 3: The RedirectResponse data structure may be provided by an SCP (cf. clause 6.10.9.1 of 3GPP TS 29.500 [6]).

Table 5.1.3.3.3.2-4: Headers supported by the 307 Response Code on this resource

| Name | Data type | P | Cardinality | Description |
|-----------------------|-----------|---|-------------|---|
| Location | string | M | 1 | Contains an alternative URI of the resource located in an alternative NWDAF (service) instance towards which the request is redirected. For the case where the request is redirected to the same target via a different SCP, refer to clause 6.10.9.1 of 3GPP TS 29.500 [6]. |
| 3gpp-Sbi-Target-Nf-Id | string | O | 0..1 | Identifier of the target NWDAF (service) instance towards which the request is redirected. |

Table 5.1.3.3.3.2-5: Headers supported by the 308 Response Code on this resource

| Name | Data type | P | Cardinality | Description |
|-----------------------|-----------|---|-------------|---|
| Location | string | M | 1 | Contains an alternative URI of the resource located in an alternative NWDAF (service) instance towards which the request is redirected. For the case where the request is redirected to the same target via a different SCP, refer to clause 6.10.9.1 of 3GPP TS 29.500 [6]. |
| 3gpp-Sbi-Target-Nf-Id | string | O | 0..1 | Identifier of the target NWDAF (service) instance towards which the request is redirected. |

5.1.3.3.4 Resource Custom Operations

None in this release of the specification.

5.1.3.4 Resource: NWDAF Event Subscription Transfers

5.1.3.4.1 Description

The NWDAF Event Subscription Transfers resource represents all requests to transfer subscription(s) of the Nnwdaf_EventsSubscription service at a given NWDAF. The resource allows an NF service consumer to provide information about analytics subscriptions that are requested to be:

- prepared for transfer, leading to the creation of a new Individual NWDAF Event Subscription Transfer resource, which can be later modified, removed, or requested to be transferred; and
- transferred, leading to the execution of the necessary steps for transferring the analytics subscription.

5.1.3.4.2 Resource definition

Resource URI: **{apiRoot}/nnwdaf-eventssubscription/<apiVersion>/transfers**

The <apiVersion> shall be set as described in clause 5.1.1.

This resource shall support the resource URI variables defined in table 5.1.3.4.2-1.

Table 5.1.3.4.2-1: Resource URI variables for this resource

| Name | Data type | Definition |
|---------|-----------|------------------|
| apiRoot | string | See clause 5.1.1 |

5.1.3.4.3 Resource Standard Methods

5.1.3.4.3.1 POST

This method shall support the URI query parameters specified in table 5.1.3.4.3.1-1.

Table 5.1.3.4.3.1-1: URI query parameters supported by the POST method on this resource

| Name | Data type | P | Cardinality | Description |
|------|-----------|---|-------------|-------------|
| n/a | | | | |

This method shall support the request data structures specified in table 5.1.3.4.3.1-2 and the response data structures and response codes specified in table 5.1.3.4.3.1-3.

Table 5.1.3.4.3.1-2: Data structures supported by the POST Request Body on this resource

| Data type | P | Cardinality | Description |
|--------------------------------|---|-------------|--|
| AnalyticsSubscriptionsTransfer | M | 1 | Information about analytics subscription(s) that are requested to be transferred or prepared for transfer. |

Table 5.1.3.4.3.1-3: Data structures supported by the POST Response Body on this resource

| Data type | P | Cardinality | Response codes | Description |
|---|---|-------------|----------------|---|
| AnalyticsSubscriptionsTransfer | M | 1 | 201 Created | The creation of an Individual NWDAF Event Subscription Transfer resource is confirmed and a representation of that resource is returned. |
| n/a | | | 204 No Content | The receipt of the information about analytics subscription(s) that are requested to be transferred and the ability to handle this information (e.g. execute the steps required to transfer an analytics subscription directly) is confirmed. |
| NOTE: The mandatory HTTP error status codes for the POST method listed in table 5.2.7.1-1 of 3GPP TS 29.500 [6] also apply. | | | | |

Table 5.1.3.4.3.1-4: Headers supported by the 201 Response Code on this resource

| Name | Data type | P | Cardinality | Description |
|----------|-----------|---|-------------|--|
| Location | string | M | 1 | Contains the URI of the newly created resource, according to the structure: {apiRoot}/nnwdafeventsubscription/<apiVersion>/transfers/{transferId}. |

5.1.3.4.4 Resource Custom Operations

None in this release of the specification.

5.1.3.5 Resource: Individual NWDAF Event Subscription Transfer

5.1.3.5.1 Description

The Individual NWDAF Event Subscription Transfer resource represents a single request to transfer subscription(s) of the Nnwdafeventsubscription service at a given NWDAF.

5.1.3.5.2 Resource definition

Resource URI: {apiRoot}/nnwdafeventsubscription/<apiVersion>/transfers/{transferId}

The <apiVersion> shall be set as described in clause 5.1.1.

This resource shall support the resource URI variables defined in table 5.1.3.5.2-1.

Table 5.1.3.5.2-1: Resource URI variables for this resource

| Name | Data type | Definition |
|------------|-----------|--|
| apiRoot | string | See clause 5.1.1. |
| transferId | string | Identifies a request to transfer subscription(s) of the Nnwdaf_EventsSubscription service. |

5.1.3.5.3 Resource Standard Methods

5.1.3.5.3.1 DELETE

This method shall support the URI query parameters specified in table 5.1.3.5.3.1-1.

Table 5.1.3.5.3.1-1: URI query parameters supported by the DELETE method on this resource

| Name | Data type | P | Cardinality | Description |
|------|-----------|---|-------------|-------------|
| n/a | | | | |

This method shall support the request data structures specified in table 5.1.3.5.3.1-2 and the response data structures and response codes specified in table 5.1.3.5.3.1-3.

Table 5.1.3.5.3.1-2: Data structures supported by the DELETE Request Body on this resource

| Data type | P | Cardinality | Description |
|-----------|---|-------------|-------------|
| n/a | | | |

Table 5.1.3.5.3.1-3: Data structures supported by the DELETE Response Body on this resource

| Data type | P | Cardinality | Response codes | Description |
|---|---|-------------|------------------------|---|
| n/a | | | 204 No Content | Successful case: The Individual NWDAF Event Subscription Transfer resource matching the transferId was deleted. |
| RedirectResponse | O | 0..1 | 307 Temporary Redirect | Temporary redirection, during Individual NWDAF Event Subscription Transfer deletion. (NOTE 2) |
| RedirectResponse | O | 0..1 | 308 Permanent Redirect | Permanent redirection, during Individual NWDAF Event Subscription Transfer deletion. (NOTE 2) |
| NOTE 1: The mandatory HTTP error status codes for the DELETE method listed in table 5.2.7.1-1 of 3GPP TS 29.500 [6] also apply. | | | | |
| NOTE 2: The RedirectResponse data structure may be provided by an SCP (cf. clause 6.10.9.1 of 3GPP TS 29.500 [6]). | | | | |

Table 5.1.3.5.3.1-4: Headers supported by the 307 Response Code on this resource

| Name | Data type | P | Cardinality | Description |
|-----------------------|-----------|---|-------------|---|
| Location | string | M | 1 | Contains an alternative URI of the resource located in an alternative NWDAF (service) instance towards which the request is redirected. For the case where the request is redirected to the same target via a different SCP, refer to clause 6.10.9.1 of 3GPP TS 29.500 [6]. |
| 3gpp-Sbi-Target-Nf-Id | string | O | 0..1 | Identifier of the target NWDAF (service) instance towards which the request is redirected. |

Table 5.1.3.5.3.1-5: Headers supported by the 308 Response Code on this resource

| Name | Data type | P | Cardinality | Description |
|-----------------------|-----------|---|-------------|---|
| Location | string | M | 1 | Contains an alternative URI of the resource located in an alternative NWDAF (service) instance towards which the request is redirected. For the case where the request is redirected to the same target via a different SCP, refer to clause 6.10.9.1 of 3GPP TS 29.500 [6]. |
| 3gpp-Sbi-Target-Nf-Id | string | O | 0..1 | Identifier of the target NWDAF (service) instance towards which the request is redirected. |

5.1.3.5.3.2 PUT

This method shall support the URI query parameters specified in table 5.1.3.5.3.2-1.

Table 5.1.3.5.3.2-1: URI query parameters supported by the PUT method on this resource

| Name | Data type | P | Cardinality | Description |
|------|-----------|---|-------------|-------------|
| n/a | | | | |

This method shall support the request data structures specified in table 5.1.3.5.3.2-2 and the response data structures and response codes specified in table 5.1.3.5.3.2-3.

Table 5.1.3.5.3.2-2: Data structures supported by the PUT Request Body on this resource

| Data type | P | Cardinality | Description |
|--------------------------------|---|-------------|--|
| AnalyticsSubscriptionsTransfer | M | 1 | Parameters to replace in an Individual NWDAF Event Subscription Transfer resource. |

Table 5.1.3.5.3.2-3: Data structures supported by the PUT Response Body on this resource

| Data type | P | Cardinality | Response codes | Description |
|--|---|-------------|------------------------|--|
| AnalyticsSubscriptionsTransfer | M | 1 | 200 OK | The Individual NWDAF Event Subscription Transfer resource was modified successfully and a representation of that resource is returned. |
| n/a | | | 204 No Content | The Individual NWDAF Event Subscription Transfer resource was modified successfully. |
| RedirectResponse | O | 0..1 | 307 Temporary Redirect | Temporary redirection, during Individual NWDAF Event Subscription Transfer modification. (NOTE 2) |
| RedirectResponse | O | 0..1 | 308 Permanent Redirect | Permanent redirection, during Individual NWDAF Event Subscription Transfer modification. (NOTE 2) |
| NOTE 1: The mandatory HTTP error status codes for the PUT method listed in table 5.2.7.1-1 of 3GPP TS 29.500 [6] also apply. | | | | |
| NOTE 2: The RedirectResponse data structure may be provided by an SCP (cf. clause 6.10.9.1 of 3GPP TS 29.500 [6]). | | | | |

Table 5.1.3.5.3.2-4: Headers supported by the 307 Response Code on this resource

| Name | Data type | P | Cardinality | Description |
|-----------------------|-----------|---|-------------|---|
| Location | string | M | 1 | Contains an alternative URI of the resource located in an alternative NWDAF (service) instance towards which the request is redirected. For the case where the request is redirected to the same target via a different SCP, refer to clause 6.10.9.1 of 3GPP TS 29.500 [6]. |
| 3gpp-Sbi-Target-Nf-Id | string | O | 0..1 | Identifier of the target NWDAF (service) instance towards which the request is redirected. |

Table 5.1.3.5.3.2-5: Headers supported by the 308 Response Code on this resource

| Name | Data type | P | Cardinality | Description |
|-----------------------|-----------|---|-------------|---|
| Location | string | M | 1 | Contains an alternative URI of the resource located in an alternative NWDAF (service) instance towards which the request is redirected. For the case where the request is redirected to the same target via a different SCP, refer to clause 6.10.9.1 of 3GPP TS 29.500 [6]. |
| 3gpp-Sbi-Target-Nf-Id | string | O | 0..1 | Identifier of the target NWDAF (service) instance towards which the request is redirected. |

5.1.3.5.4 Resource Custom Operations

None in this release of the specification.

5.1.4 Custom Operations without associated resources

None in this release of the specification.

5.1.5 Notifications

5.1.5.1 General

Notifications shall comply with clause 6.2 of 3GPP TS 29.500 [6] and clause 4.6.2.3 of 3GPP TS 29.501 [7].

Table 5.3.3.4.1-1: Notifications overview

| Notification | Callback URI | HTTP method or custom operation | Description (service operation) |
|--------------------|-------------------|---------------------------------|---|
| Event Notification | {notificationURI} | POST | Reports one or several observed Events. |

5.1.5.2 Event Notification

5.1.5.2.1 Description

The Event Notification is used by the NWDAF to report one or several observed Events to an NF service consumer that has subscribed to such Notifications or used by the target NWDAF to report the successful analytics subscription transfer via the Individual NWDAF Event Subscription Resource.

5.1.5.2.2 Operation Definition

Callback URI: {notificationURI}

The operation shall support the callback URI variables defined in table 5.1.5.2.2-1, the request data structures specified in table 5.1.5.2.2-2 and the response data structure and response codes specified in table 5.1.5.2.2-3.

Table 5.1.5.2.2-1: Callback URI variables

| Name | Data type | Definition |
|-----------------|-----------|---|
| notificationURI | Uri | The Notification Uri as assigned within the Individual NWDaf Event Subscription and described within the NnwdafEventsSubscription type (see table 5.1.6.2.2-1). |

Table 5.1.5.2.2-2: Data structures supported by the POST Request Body on this resource

| Data type | P | Cardinality | Description |
|---|---|-------------|---|
| array(NnwdafEventsSubscriptionNotification) | M | 1..N | Provides Information about observed Events or the successful analytics subscription transfer. |

Table 5.1.5.2.2-3: Data structures supported by the POST Response Body on this resource

| Data type | P | Cardinality | Response codes | Description |
|---|---|-------------|------------------------|---|
| n/a | | | 204 No Content | The receipt of the Notification is acknowledged. |
| RedirectResponse | O | 0..1 | 307 Temporary Redirect | Temporary redirection, during the event notification. The response shall include a Location header field containing an alternative URI representing the end point of an alternative NF consumer (service) instance where the notification should be sent. Applicable if the feature "ES3XX" is supported. |
| RedirectResponse | O | 0..1 | 308 Permanent Redirect | Permanent redirection, during the event notification. The response shall include a Location header field containing an alternative URI representing the end point of an alternative NF consumer (service) instance where the notification should be sent. Applicable if the feature "ES3XX" is supported. |
| NOTE: The mandatory HTTP error status codes for the POST method listed in table 5.2.7.1-1 of 3GPP TS 29.500 [6] also apply. | | | | |

Table 5.1.5.2.2-4: Headers supported by the 307 Response Code on this resource

| Name | Data type | P | Cardinality | Description |
|-----------------------|-----------|---|-------------|---|
| Location | string | M | 1 | An alternative URI representing the end point of an alternative NF consumer (service) instance towards which the notification should be redirected. |
| 3gpp-Sbi-Target-Nf-Id | string | O | 0..1 | Identifier of the target NF (service) instance towards which the notification request is redirected. |

Table 5.1.5.2.2-5: Headers supported by the 308 Response Code on this resource

| Name | Data type | P | Cardinality | Description |
|-----------------------|-----------|---|-------------|---|
| Location | string | M | 1 | An alternative URI representing the end point of an alternative NF consumer (service) instance towards which the notification should be redirected. |
| 3gpp-Sbi-Target-Nf-Id | string | O | 0..1 | Identifier of the target NF (service) instance towards which the notification request is redirected. |

5.1.6 Data Model

5.1.6.1 General

This clause specifies the application data model supported by the API.

Table 5.1.6.1-1 specifies the data types defined for the Nnwdaf_EventsSubscription service based interface protocol.

Table 5.1.6.1-1: Nnwdaf_EventsSubscription specific Data Types

| Data type | Section defined | Description | Applicability |
|--------------------------------|-----------------|--|--------------------|
| AbnormalBehaviour | 5.1.6.2.15 | Represents the abnormal behaviour information. | AbnormalBehaviour |
| Accuracy | 5.1.6.3.5 | Represents the preferred level of accuracy of the analytics. | |
| AccuracyInfo | 5.1.6.2.89 | The analytics accuracy information. | AnalyticsAccuracy |
| AccuracyReq | 5.1.6.3.88 | Represents the analytics accuracy requirement information. | AnalyticsAccuracy |
| AdditionalMeasurement | 5.1.6.2.26 | Represents additional measurement information. | AbnormalBehaviour |
| AddressList | 5.1.6.2.28 | Represents a list of IPv4 and/or IPv6 addresses. | AbnormalBehaviour |
| AnalyticsContextIdentifier | 5.1.6.2.43 | Contains information about available analytics contexts. | AnaSubTransfer |
| AnalyticsAccuracyIndication | 5.1.6.3.37 | Represents the analytics accuracy indication. | AnalyticsAccuracy |
| AnalyticsFeedbackInfo | 5.1.6.2.105 | Contains analytics feedback information. | AnalyticsAccuracy |
| AnalyticsMetadata | 5.1.6.3.14 | Represents the types of analytics metadata information that can be requested. | Aggregation |
| AnalyticsMetadataIndication | 5.1.6.2.36 | Contains analytics metadata values indicated to be used during analytics generation. | Aggregation |
| AnalyticsMetadataInfo | 5.1.6.2.37 | Contains analytics metadata information required for analytics aggregation. | Aggregation |
| AnalyticsSubscriptionsTransfer | 5.1.6.2.40 | Contains information about a request to transfer analytics subscriptions. | AnaSubTransfer |
| AnalyticsSubset | 5.1.6.3.18 | Analytics subset used to indicate the content of the analytics. | EneNA |
| AnySlice | 5.1.6.3.2 | Represents the any slices. | |
| ApplicationVolume | 5.1.6.2.55 | Application data volume per application Id. | Dispersion |
| AppListForUeComm | 5.1.6.2.64 | Represents the analytics of the application list used by UE. | UeCommunicationExt |
| BwRequirement | 5.1.6.2.25 | Represents bandwidth requirement. | ServiceExperience |
| ClassCriterion | 5.1.6.2.51 | Dispersion class criterion. | Dispersion |
| CircumstanceDescription | 5.1.6.2.29 | Contains the description of a circumstance. | AbnormalBehaviour |
| CongestionInfo | 5.1.6.2.18 | Represents the congestion information | UserDataCongestion |
| CongestionType | 5.1.6.3.8 | Identification congestion analytics type. | UserDataCongestion |
| ConsumerNfInformation | 5.1.6.2.49 | Represents the analytics consumer NF information. | AnaSubTransfer |

| | | | |
|------------------------------|------------|---|---|
| DatasetStatisticalProperty | 5.1.6.3.15 | Dataset statistical properties of the data used to generate the analytics. | Aggregation |
| DataVolume | 5.1.6.2.85 | Indicates a specific data volume transmitted once from UE to AF and/or from AF to UE | E2eDataVolTransTime |
| DataVolumeTransferTime | 5.1.6.2.90 | Indicates the E2E data volume transfer time and the data volume used to derive the transfer time. | E2eDataVolTransTime |
| DeviceType | 5.1.6.3.31 | The type of device. | QoS SustainabilityExt_eNA |
| Direction | 5.1.6.3.39 | Heading directions of the UE flow in the target area. | MovementBehaviour |
| DirectionInfo | 5.1.6.2.75 | Represents the UE direction information. | UeMobilityExt2_eNA MovementBehaviour |
| DispersionClass | 5.1.6.3.20 | Dispersion class. | Dispersion |
| DispersionCollection | 5.1.6.2.54 | Dispersion collections per UE location or or per slice. | Dispersion |
| DispersionInfo | 5.1.6.2.53 | Dispersion analytics information. | Dispersion |
| DispersionRequirement | 5.1.6.2.50 | Dispersion analytics requirement. | Dispersion |
| DispersionType | 5.1.6.3.19 | Dispersion type. | Dispersion |
| DispersionOrderingCriterion | 5.1.6.3.21 | Ordering criterion for the list of Dispersion. | Dispersion |
| DnPerf | 5.1.6.2.46 | Represents DN performance information. | DnPerformance |
| DnPerfInfo | 5.1.6.2.45 | Represents DN performances for the application. | DnPerformance |
| DnPerfOrderingCriterion | 5.1.6.3.25 | Ordering criterion for the list of DN performance analytics. | DnPerformance |
| DnPerformanceReq | 5.1.6.2.66 | Represents DN performance analytics requirement. | DnPerformance |
| E2eDataVolTransTimeCriterion | 5.1.6.3.35 | Ordering criterion for the list of E2E data volume transfer time. | E2eDataVolTransTime |
| E2eDataVolTransTimeInfo | 5.1.6.2.83 | Represents the E2E data volume transfer time Information. | E2eDataVolTransTime |
| E2eDataVolTransTimeReq | 5.1.6.2.82 | Represents the E2E data volume transfer time requirement. | E2eDataVolTransTime |
| E2eDataVolTransTimePerTS | 5.1.6.2.84 | Represents the E2E data volume transfer time requirement per Time slot. | E2eDataVolTransTime |
| E2eDataVolTransTimePerUe | 5.1.6.2.86 | Represents the E2E data volume transfer time per UE. | E2eDataVolTransTime |
| E2eDataVolTransTimeUeList | 5.1.6.2.87 | Represents the E2E data volume transfer time per UE list. | E2eDataVolTransTime |
| EventNotification | 5.1.6.2.5 | Describes Notifications about events that occurred. | |
| EventReportingRequirement | 5.1.6.2.7 | Represents the type of reporting the subscription requires. | |

| | | | |
|-----------------------|------------|---|--|
| EventSubscription | 5.1.6.2.3 | Represents the subscription to a single event. | |
| Exception | 5.1.6.2.16 | Describes the Exception information. | AbnormalBehaviour |
| ExceptionId | 5.1.6.3.6 | Describes the Exception Id. | AbnormalBehaviour |
| ExceptionTrend | 5.1.6.3.7 | Describes the Exception Trend. | AbnormalBehaviour |
| ExpectedAnalyticsType | 5.1.6.3.11 | Represents expected UE analytics type. | AbnormalBehaviour |
| FailureEventInfo | 5.1.6.2.35 | Contains information on the event for which the subscription is not successful. | |
| GeoDistributionInfo | 5.1.6.2.76 | Represents the geographical distribution of the UEs. | UeMobilityExt_AIML E2eDataVolTransTime |
| GeoLocation | 5.1.6.2.95 | Represents a geographic location, using either standard or local coordinates and optionally including the altitude. | LocAccuracy |
| IpEthFlowDescription | 5.1.6.2.27 | Contains the description of an Uplink and/or Downlink Ethernet flow. | AbnormalBehaviour |
| LoadLevelInformation | 5.1.6.3.2 | Represents load level information of the network slice and the optionally associated network slice instance. | |
| LocAccuracyInfo | 5.1.6.2.97 | Contains Location Accuracy information. | LocAccuracy |
| LocAccuracyPerMethod | 5.1.6.2.98 | Contains Location Accuracy information per Positioning Method. | LocAccuracy |
| LocAccuracyReq | 5.1.6.2.96 | Contains Location Accuracy analytics requirements. | LocAccuracy |
| LocationInfo | 5.1.6.2.11 | Represents UE location information. | UeMobility |
| LocInfoGranularity | 5.1.6.3.32 | Represents the preferred granularity of location information. | ServiceExperienceExt2_eNA UeMobilityExt2_eNA DispersionExt_eNA MovementBehaviour |
| LocationOrientation | 5.1.6.3.38 | Represents preferred orientation of location information. | MovementBehaviour |
| MatchingDirection | 5.1.6.3.12 | Defines the matching direction when crossing a threshold. | NfLoad, QoSsustainability, UserDataCongestion, NetworkPerformance Dispersion RedundantTransmissionExp WlanPerformance ServiceExperienceExt NsiLoadExt LocAccuracy E2eDataVolTransTime |
| MLModelInfo | 5.1.6.2.69 | The information of the ML model. | AnaSubTransfer |
| ModelInfo | 5.1.6.2.42 | Contains information about an ML model. | AnaSubTransfer |
| MovBehav | 5.1.6.2.93 | Represents the Movement Behaviour information per time slot. | MovementBehaviour |

| | | | |
|--------------------------------------|------------|--|---|
| MovBehavInfo | 5.1.6.2.92 | Represents the Movement Behaviour information. | MovementBehaviour |
| MovBehavReq | 5.1.6.2.91 | Represents the Movement Behaviour analytics requirements. | MovementBehaviour |
| NetworkPerfInfo | 5.1.6.2.23 | Represents the network performance information. | NetworkPerformance |
| NetworkPerfOrderCriterion | 5.1.6.3.30 | The ordering criterion for the list of network performance analytics. | NetworkPerformanceExt_eNA |
| NetworkPerfRequirement | 5.1.6.2.22 | Represents a network performance requirement. | NetworkPerformance |
| NetworkPerfType | 5.1.6.3.10 | Represents the network performance types. | NetworkPerformance |
| NfLoadLevelInformation | 5.1.6.2.31 | Represents load level information of a given NF instance. | NfLoad |
| NfStatus | 5.1.6.2.32 | Provides the percentage of time spent on various NF states. | NfLoad |
| NnwdafeventsSubscription | 5.1.6.2.2 | Represents an Individual NWDAF Event Subscription resource. | |
| NnwdafeventsSubscriptionNotification | 5.1.6.2.4 | Represents an Individual NWDAF Event Subscription Notification resource. | |
| NumberAverage | 5.1.6.2.38 | Represents average and variance information. | NsiLoadExt |
| NwdafEvent | 5.1.6.3.4 | Describes the NWDAF Events. | |
| NwdafFailureCode | 5.1.6.3.13 | Identifies the failure reason. | |
| NotificationMethod | 5.1.6.3.3 | Represents the notification methods that can be subscribed. | |
| NsildInfo | 5.1.6.2.33 | Represents the S-NSSAI and the optionally associated Network Slice Instance Identifier(s). | ServiceExperience NsiLoad DnPerformance |
| NsiLoadLevelInfo | 5.1.6.2.34 | Represents the load level information for an S-NSSAI and the optionally associated network slice instance. | NsiLoad |
| ObservedRedundantTransExp | 5.1.6.2.70 | Represents the observed Redundant Transmission Experience. | RedundantTransmissionExp |
| OutputStrategy | 5.1.6.3.16 | Represents the output strategy used for the reporting of the analytics. | Aggregation |
| PerfData | 5.1.6.2.47 | Represents DN performance information. | DnPerformance |
| PfdDeterminationInfo | 5.1.6.2.73 | Represents the PFD Determination information. | PfdDetermination |
| PrevSubInfo | 5.1.6.2.68 | Information of the previous subscription. | AnaCtxTransfer |
| QosRequirement | 5.1.6.2.20 | Represents the QoS requirements. | QoSsustainability E2eDataVolTransTime |

| | | | |
|-------------------------------|-------------|---|----------------------------|
| QoSustainabilityInfo | 5.1.6.2.19 | Represents the QoS Sustainability information. | QoSSustainability |
| RankingCriterion | 5.1.6.2.52 | Ranking criterion. | Dispersion |
| RatFreqInformation | 5.1.6.2.67 | Represents the RAT type and/or Frequency information. | ServiceExperienceExt |
| RedTransExpOrderingCriterion | 5.1.6.3.22 | Ordering criterion for the list of Redundant Transmission Experience. | RedundantTransmissionExp |
| RedundantTransmissionExpInfo | 5.1.6.2.57 | Redundant transmission experience analytics information. | RedundantTransmissionExp |
| RedundantTransmissionExpPerTS | 5.1.6.2.58 | Redundant Transmission Experience per Time Slot. | RedundantTransmissionExp |
| RedundantTransmissionExpReq | 5.1.6.2.56 | Redundant transmission experience analytics requirement. | RedundantTransmissionExp |
| RelProxInfo | 5.1.6.2.100 | Relative Proximity analytics information. | RelativeProximity |
| RelProxReq | 5.1.6.2.99 | Relative Proximity analytics requirements. | RelativeProximity |
| ResourceUsage | 5.1.6.2.48 | The current usage of the virtual resources assigned to the NF instances belonging to a particular network slice instance. | NsiLoadExt |
| ResourceUsageRequirement | 5.1.6.2.81 | Indicates more requirements when providing resource usage information for network performance. | NetworkPerformanceExt_AIML |
| RetainabilityThreshold | 5.1.6.2.21 | Represents a QoS flow retainability threshold. | QoS Sustainability |
| RoamingInfo | 5.1.6.2.106 | Contains information related to roaming analytics. | RoamingAnalytics |
| PduSessionInfo | 5.1.6.2.74 | Represents combination of PDU Session parameters. | ServiceExperienceExt2_eNA |
| ServiceExperienceInfo | 5.1.6.2.24 | Represents the service experience information. | ServiceExperience |
| ServiceExperienceType | 5.1.6.3.24 | Represents the type of Service Experience Analytics. | ServiceExperienceExt |
| SessInactTimerForUeComm | 5.1.6.2.65 | Represents the N4 Session inactivity timer. | UeCommunicationExt |
| SliceLoadLevelInformation | 5.1.6.2.6 | Represents the slices and their load level information. | |
| SpeedThresholdInfo | 5.1.6.2.94 | UEs information whose speed is faster than the speed threshold. | MovementBehaviour |
| SubscriptionTransferInfo | 5.1.6.2.41 | Contains information about subscriptions that are requested to be transferred. | AnaSubTransfer |
| SuggestedPfdInfo | 5.1.6.2.107 | Represents the suggested PFD information for the application identifier. | PfdDetermination |

| | | | |
|------------------------------|-------------|--|--|
| TargetUeInformation | 5.1.6.2.8 | Identifies the target UE information. | ServiceExperience NfLoad NetworkPerformance UserDataCongestion UeMobility UeCommunication AbnormalBehaviour QoSsustainability Dispersion RedundantTransmissionExp WlanPerformance DnPerformance PduSesTraffic E2eDataVolTransTime |
| TdTraffic | 5.1.6.2.78 | Represents traffic that matches or unmatches Traffic Descriptor over the established PDU Session(s). | PduSesTraffic |
| TermCause | 5.1.6.3.26 | Represents a cause for requesting to terminate an analytics subscription. | TermRequest |
| ThresholdLevel | 5.1.6.2.30 | Describes a threshold level. | UserDataCongestion NfLoad DnPerformance ServiceExperienceExt MovementBehaviour |
| TimestampedLocation | 5.1.6.2.103 | The timestamped locations of the trajectory of the UE. | RelativeProximity |
| TimeToCollisionInfo | 5.1.6.2.104 | Time To Collision (TTC) information. | RelativeProximity |
| TimeUnit | 5.1.6.3.9 | Represents the unit for the session active time. | QoSsustainability |
| TopApplication | 5.1.6.2.39 | Top application that contributes the most to the traffic. | UserDataCongestionExt |
| TrafficCharacterization | 5.1.6.2.14 | Identifies the detailed traffic characterization. | UeCommunication |
| TrafficDirection | 5.1.6.3.33 | The traffic direction for the resource usage information. | NetworkPerformanceExt_AIML |
| TrafficInformation | 5.1.6.2.63 | Traffic information including UL/DL data rate and/or Traffic volume. | WlanPerformance |
| TransferRequestType | 5.1.6.3.17 | Represents the type of a request for analytics subscription transfer. | AnaSubTransfer |
| UeAnalyticsContextDescriptor | 5.1.6.2.44 | Contains information about available UE related analytics contexts. | AnaSubTransfer |
| UeCommunication | 5.1.6.2.13 | Represents UE communication information. | UeCommunication |
| UeCommOrderCriterion | 5.1.6.3.29 | The ordering criterion for the list of UE communication analytics. | UeCommunicationExt_eNA |
| UeCommReq | 5.1.6.2.72 | UE communication analytics requirement. | UeCommunicationExt_eNA |
| UeMobilityOrderCriterion | 5.1.6.3.28 | The ordering criterion for the list of UE mobility analytics. | UeMobilityExt2_eNA |

| | | | |
|----------------------------|-------------|--|----------------------------|
| UeMobilityReq | 5.1.6.2.71 | UE mobility analytics requirement. | UeMobilityExt2_eNA |
| UeMobility | 5.1.6.2.10 | Represents UE mobility information. | UeMobility |
| UeProximity | 5.1.6.2.101 | Observed or Predicted proximity information. | RelativeProximity |
| UeTrajectory | 5.1.6.2.102 | Relative timestamped UE positions. | RelativeProximity |
| PduSesTrafficInfo | 5.1.6.2.77 | Represents PDU Session traffic analytics information. | PduSesTraffic |
| PduSesTrafficReq | 5.1.6.2.79 | Represents PDU Session traffic analytics requirement. | PduSesTraffic |
| UserDataConOrderCrit | 5.1.6.3.27 | The ordering criterion for the list of User Data Congestion analytics. | UserDataCongestionExt2_eNA |
| UserDataCongestionInfo | 5.1.6.2.17 | Represents the user data congestion information. | UserDataCongestion |
| ValueExpression | 5.1.6.3.34 | Indicates average or peak value of the resource usage for the network performance type | NetworkPerformanceExt_AIML |
| WlanOrderingCriterion | 5.1.6.3.23 | Ordering criterion for the list of WLAN performance information. | WlanPerformance |
| WlanPerformanceReq | 5.1.6.2.59 | WLAN performance analytics requirement. | WlanPerformance |
| WlanPerformanceInfo | 5.1.6.2.60 | WLAN performance analytics information. | WlanPerformance |
| WlanPerSsidPerformanceInfo | 5.1.6.2.61 | WLAN performance information per SSID of WLAN access points deployed in the Area of Interest. | WlanPerformance |
| WlanPerTsPerformanceInfo | 5.1.6.2.62 | WLAN performance information per Time Slot during the analytics target period. | WlanPerformance |
| WlanPerUeidPerformanceInfo | 5.1.6.2.80 | WLAN performance information per UE ID of WLAN access points deployed in the Area of Interest. | WlanPerformanceExt_AIML |

Table 5.1.6.1-2 specifies data types re-used by the Nnwdaf_EventsSubscription service based interface protocol from other specifications, including a reference to their respective specifications and when needed, a short description of their use within the Nnwdaf service based interface.

Table 5.1.6.1-2: Nnwdaf_EventsSubscription re-used Data Types

| Data type | Reference | Comments | Applicability |
|-------------------------|---------------------|---|--|
| 5Qi | 3GPP TS 29.571 [8] | Identifies the 5G QoS identifier | QoSsustainability E2eDataVolTransTime |
| AccessType | 3GPP TS 29.571 [8] | Identifies the access type. | ServiceExperienceExt2_eNA E2eDataVolTransTime |
| AddrFqdn | 3GPP TS 29.517 [22] | Represents the IP address or FQDN of the Application Server. | DnPerformance ServiceExperienceExt |
| ApplicationId | 3GPP TS 29.571 [8] | Identifies the application identifier. | ServiceExperience UeCommunication AbnormalBehaviour Dispersion DnPerformance PduSesTraffic E2eDataVolTransTime |
| ArfcnValueNR | 3GPP TS 29.571 [8] | Integer value indicating the ARFCN applicable for a downlink, uplink or bi-directional (TDD) NR global frequency raster. Minimum = 0. Maximum = 3279165. | ServiceExperienceExt |
| BitRate | 3GPP TS 29.571 [8] | String representing a bit rate that shall be formatted as follows: pattern: "^\\d+(\\.\\d+)?(bps Kbps Mbps Gbps Tbps)\$" Examples: "125 Mbps", "0.125 Gbps", "125000 Kbps". | ServiceExperience QoSsustainability WlanPerformance DnPerformance E2eDataVolTransTime |
| DateTime | 3GPP TS 29.571 [8] | Identifies the time. | |
| Dnai | 3GPP TS 29.571 [8] | Identifies a user plane access to one or more DN(s). | ServiceExperience DnPerformance |
| Dnn | 3GPP TS 29.571 [8] | Identifies the DNN. | ServiceExperience AbnormalBehaviour UeCommunication DnPerformance SMCCE PduSesTraffic E2eDataVolTransTime |
| DomainNameProtocol | 3GPP TS 29.122 [19] | Indicates the additional protocol and protocol field for domain names to be matched. | PfdDetermination |
| DurationSec | 3GPP TS 29.571 [8] | | |
| EthFlowDescription | 3GPP TS 29.514 [21] | | UeCommunication AbnormalBehaviour |
| ExpectedUeBehaviourData | 3GPP TS 29.503 [23] | | AbnormalBehaviour |
| Float | 3GPP TS 29.571 [8] | | |
| FlowDescription | 3GPP TS 29.514 [21] | | UeCommunication AbnormalBehaviour PduSesTraffic |
| FlowInfo | 3GPP TS 29.122 [19] | | UserDataCongestionExt |
| GeographicalArea | 3GPP TS 29.522 [32] | Identifies the geographical location (longitude and latitude level). | UeMobilityExt2_eNA ServiceExperienceExt2_eNA QoSsustainabilityExt_eNA MovementBehaviour |
| Gpsi | 3GPP TS 29.571 [8] | The GPSI for an UE. | UserDataCongestionExt UeMobilityExt_AIML E2eDataVolTransTime |

| | | | |
|---------------------------|---------------------|--|--|
| GroupId | 3GPP TS 29.571 [8] | Identifies a group of UEs. | UeMobility UeCommunication NetworkPerformance AbnormalBehaviour ServiceExperience Dispersion RedundantTransmissionExp WlanPerformance PduSesTraffic |
| Ipv4Addr | 3GPP TS 29.571 [8] | | |
| Ipv6Addr | 3GPP TS 29.571 [8] | | |
| LocalOrigin | 3GPP TS 29.572 [30] | Represents a reference point for modelling locations in relation to it. | LocAccuracy |
| NetworkAreaInfo | 3GPP TS 29.554 [18] | Identifies the network area. | ServiceExperience QoSsustainability AbnormalBehaviour UeMobility UserDataCongestion NetworkPerformance NsiLoadExt NfLoadExt Dispersion RedundantTransmissionExp WlanPerformance UeCommunication DnPerformance PduSesTraffic E2eDataVolTransTime MovementBehaviour |
| NfInstanceId | 3GPP TS 29.571 [8] | Identifies an NF instance. | NfLoad |
| NfSetId | 3GPP TS 29.571 [8] | Identifies an NF Set instance. | NfLoad |
| NFType | 3GPP TS 29.510 [12] | Identifies a type of NF. | NfLoad |
| NsId | 3GPP TS 29.531 [24] | Identifies a Network Slice Instance. | ServiceExperience NsiLoad DnPerformance |
| PacketDelBudget | 3GPP TS 29.571 [8] | | QoSsustainability DnPerformance RedundantTransExpExt_eNA |
| PacketErrRate | 3GPP TS 29.571 [8] | | QoSsustainability |
| PacketLossRate | 3GPP TS 29.517 [22] | Indicates Packet Loss Rate. | DnPerformance RedundantTransExpExt_eNA |
| PduSessionId | 3GPP TS 29.571 [8] | Identifies PDU Session | |
| PduSessionType | 3GPP TS 29.571 [8] | Identifies the PDU Session Type. | ServiceExperienceExt2_eNA |
| PlmnIdNid | 3GPP TS 29.571 [8] | PLMN identifier. | RoamingAnalytics |
| Point | 3GPP TS 29.572 [30] | Represents a location in geographical co-ordinates. | LocAccuracy |
| PointAltitude | 3GPP TS 29.572 [30] | Represents a location including an altitude in geographical co-ordinates. | LocAccuracy |
| PositioningMethod | 3GPP TS 29.572 [30] | Represents a positioning method. | LocAccuracy |
| ProblemDetails | 3GPP TS 29.571 [8] | Used in error responses to provide more detailed information about an error. | |
| QosResourceType | 3GPP TS 29.571 [8] | Identifies the resource type in QoS characteristics. | QoSsustainability |
| RatType | 3GPP TS 29.571 [8] | Identifies the RAT type. | ServiceExperienceExt E2eDataVolTransTime |
| RedirectResponse | 3GPP TS 29.571 [8] | Contains redirection related information. | ES3XX |
| RelativeCartesianLocation | 3GPP TS 29.572 [30] | Represents distances from a reference point. | LocAccuracy |

| | | | |
|----------------------------|---------------------|---|---|
| ReportingInformation | 3GPP TS 29.523 [20] | Represents the type of reporting the subscription requires. | |
| SamplingRatio | 3GPP TS 29.571 [8] | | |
| ScheduledCommunicationTime | 3GPP TS 29.122 [19] | | UeMobility UeCommunication |
| SmccelInfo | 5.2.6.2.12 | Represents the analytics of Session Management Congestion Control Experience information. | SMCCE |
| Snssai | 3GPP TS 29.571 [8] | Identifies the S-NSSAI (Single Network Slice Selection Assistance Information). | |
| SscMode | 3GPP TS 29.571 [8] | Identifies the SSC Mode of the PDU Session. | ServiceExperienceExt2_eNA |
| Supi | 3GPP TS 29.571 [8] | The SUPI for an UE. | ServiceExperience, NfLoad NetworkPerformance, UserDataCongestion UeMobility UeCommunication AbnormalBehaviour Dispersion RedundantTransmissionExp WlanPerformance PduSesTraffic |
| SupportedFeatures | 3GPP TS 29.571 [8] | Used to negotiate the applicability of the optional features defined in table 5.1.8-1. | |
| SvcExperience | 3GPP TS 29.517 [22] | | ServiceExperience |
| Tai | 3GPP TS 29.571 [8] | Tracking Area Information. | AnaSubTransfer |
| TimeWindow | 3GPP TS 29.122 [19] | | |
| UInteger | 3GPP TS 29.571 [8] | Unsigned Integer, i.e. only value 0 and integers above 0 are permissible. | |
| UpfInformation | 3GPP TS 29.508 [29] | The information of the UPF serving the UE. | ServiceExperienceExt DnPerformance |
| Uri | 3GPP TS 29.571 [8] | | |
| UserLocation | 3GPP TS 29.571 [8] | | UeMobility Dispersion E2eDataVolTransTime |
| VelocityEstimate | 3GPP TS 29.572 [30] | Velocity estimate | QoSsustainabilityExt_eNA |
| Volume | 3GPP TS 29.122 [19] | | UeCommunication AbnormalBehaviour Dispersion WlanPerformance PduSesTraffic E2eDataVolTransTime |

5.1.6.2 Structured data types

5.1.6.2.1 Introduction

This clause defines the structures to be used in resource representations.

5.1.6.2.2 Type NnwdafEventsSubscription

Table 5.1.6.2.2-1: Definition of type NnwdafEventsSubscription

| Attribute name | Data type | P | Cardinality | Description | Applicability |
|--------------------|--------------------------|---|-------------|---|----------------|
| eventSubscriptions | array(EventSubscription) | M | 1..N | Subscribed events. | |
| evtReq | ReportingInformation | O | 0..1 | Represents the reporting requirements of the event subscription. (NOTE 1, NOTE 2, NOTE 4) If omitted, the default values within the ReportingInformation data type apply. | |
| notificationURI | Uri | C | 0..1 | Identifies the recipient of Notifications sent by the NWDAF. This parameter shall be supplied by the NF service consumer in the HTTP POST requests that create the subscriptions for event notifications and in the HTTP PUT requests that update the subscriptions for event notifications. | |
| notifCorrId | string | O | 0..1 | Notification correlation identifier. | EneNA |
| eventNotifications | array(EventNotification) | C | 1..N | Notifications about Individual Events. Shall only be present if the immediate reporting indication in the "immRep" attribute within the "evtReq" attribute sets to true in the event subscription, and the reports are available. | |
| failEventReports | array(FailureEventInfo) | O | 1..N | Supplied by the NWDAF. When available, shall contain the event(s) for which the subscription is not successful including the failure reason(s). | |
| consNfInfo | ConsumerNfInformation | O | 0..1 | Represents the analytics consumer NF Information. | AnaSubTransfer |
| prevSub | PrevSubInfo | O | 0..1 | Contains information about the previous analytics subscription that the NF service consumer had with the source NWDAF. (NOTE 3) | AnaCtxTransfer |

| | | | | | |
|--|-------------------|---|------|---|--|
| supportedFeatures | SupportedFeatures | C | 0..1 | List of Supported features used as described in clause 5.1.8. This parameter shall be supplied by NF service consumer in the POST request that request the creation of an NWDAF Event Subscriptions resource, and shall be supplied by the NWDAF in the reply of corresponding request. | |
| <p>NOTE 1: If the "evtReq" attribute (of data type ReportingInformation) is provided and contains the "notifMethod" attribute, the notification method indicated by the "notifMethod" attribute within the ReportingInformation data type takes preference over the notification method indicated by the "notificationMethod" attribute within the EventSubscription data type.</p> <p>NOTE 2: If the "evtReq" attribute (of data type ReportingInformation) is provided and contains the "repPeriod" attribute, the periodic reporting time indicated by the "repPeriod" attribute in the ReportingInformation data type takes preference over the periodic reporting time indicated by the "repetitionPeriod" attribute in the EventSubscription data type.</p> <p>NOTE 3: The "prevSub" attribute may be used by the NWDAF to derive analytics context identifier(s), which may be used in the Nnwdaf_AnalyticsInfo_ContextTransfer service operation invoked by the NWDAF. NOTE 4: Void.</p> | | | | | |

5.1.6.2.3 Type EventSubscription

Table 5.1.6.2.3-1: Definition of type EventSubscription

| Attribute name | Data type | P | Cardinality | Description | Applicability |
|--------------------|-------------------------------|---|-------------|---|---|
| anySlice | AnySlice | C | 0..1 | Default is "false". (NOTE 1) | |
| appls | array(ApplicationId) | C | 1..N | Represents the Application Identifier(s) to which the subscription applies. The absence of appls means subscription to all applications. (NOTE 8) (NOTE 15) (NOTE 16) | ServiceExperience UeCommunication AbnormalBehaviour Dispersion DnPerformance PfdDetermination E2eDataVolTransTime |
| deviations | array(Uinteger) | O | 1..N | Each element indicates an acceptable deviation from the threshold level included in "ranUeThrouThds" attribute or "qosFlowRetThds" attribute. This attribute may only be present if either the "ranUeThrouThds" attribute or "qosFlowRetThds" attribute is provided. | EnQoSsustainability |
| dnns | array(Dnn) | C | 1..N | Represents the DNN(s) to which the subscription applies. Each DNN is a full DNN with both the Network Identifier and Operator Identifier, or a DNN with the Network Identifier only. The absence of dnns means subscription to all DNNs. (NOTE 8) (NOTE 17) | ServiceExperience, AbnormalBehaviour UeCommunication RedundantTransmissionExp DnPerformance SMCCE PfdDetermination PduSesTraffic E2eDataVolTransTime RelativeProximity |
| dnais | array(Dnai) | O | 1..N | Represents the Data Network Access Identifier(s) of user plane access to DN(s) which the subscription applies. | ServiceExperience DnPerformance |
| dataVITrnsTmRqs | array(E2eDataVolTransTimeReq) | O | 1..N | Represents the E2E data volume transfer time requirements | E2eDataVolTransTime |
| event | NwdafEvent | M | 1 | Event that is subscribed. | |
| extraReportReq | EventReportingRequirement | O | 0..1 | The extra event reporting requirement information. | |
| ladnDnns | array(Dnn) | O | 1..N | LADN DNN(s) to indicate the LADN service area(s) as the AoI(s). | UeMobilityExt |
| loadLevelThreshold | integer | C | 0..1 | Indicates that the NWDAF shall report the corresponding network slice load level to the NF service consumer where the load level of the network slice identified by snssais is reached. (NOTE 4) May be included when subscribed event is "SLICE_LOAD_LEVEL". Minimum = 0. Maximum = 100. | |

| | | | | | |
|------------------|-----------------------|---|------|---|--|
| matchingDir | MatchingDirection | O | 0..1 | A matching direction may be provided alongside a threshold. If omitted, the default value is CROSSED. | NfLoad, QoSsustainability, UserDataCongestion, NetworkPerformance, NsiLoadExt |
| nfLoadLvlThds | array(ThresholdLevel) | C | 1..N | Shall be supplied in order to start reporting when an average load level is reached. (NOTE 4) | NfLoad |
| networkArea | NetworkAreaInfo | C | 0..1 | Identification of network area to which the subscription applies. The absence of "networkArea" and "fineGranAreas" means subscription to all network areas. (NOTE 7, NOTE 8, NOTE 20 , NOTE 22) | ServiceExperience UeMobility UeCommunication QoSsustainability AbnormalBehaviour UserDataCongestion NetworkPerformance NsiLoadExt NfLoadExt Dispersion RedundantTransmissionExp WlanPerformance DnPerformance PduSesTraffic E2eDataVolTransTime MovementBehaviour LocAccuracy RelativeProximity |
| location | GeoLocation | C | 0..1 | A location (i.e. geographical location or location in local coordinates) to which the subscription applies. (NOTE 22) | LocAccuracy |
| temporalGranSize | DurationSec | O | 0..1 | Indicates the minimum duration of each time slot for which the analytics are provided. (NOTE 18) | NetworkPerformanceExt_eNA UeMobilityExt2_eNA UserDataCongestionExt2_eNA QoSsustainabilityExt_eNA DispersionExt_eNA WlanPerfExt_eNA RedundantTransmissionExpExt_eNA DnPerformanceExt_eNA |

| | | | | | |
|-------------------------|-------------------------|---|------|--|---|
| spatialGranSizeT a | UInteger | O | 0..1 | Indicates the maximum number of TAs used to define an area for which the analytics are provided. May be included when the "networkArea" attribute in the EventSubscription data type is provided. (NOTE 19) | NetworkPerformanceExt_eNA UeMobilityExt2_eNA UeCommunicationExt_eNA QoS SustainabilityExt_eNA DispersionExt_eNA DnPerformanceExt_eNA |
| spatialGranSizeC ell | UInteger | O | 0..1 | Indicates the maximum number of cells used to define an area for which the analytics are provided. May be included when the "networkArea" attribute in the EventSubscription data type is provided. (NOTE 19) | NetworkPerformanceExt_eNA UeMobilityExt2_eNA UeCommunicationExt_eNA QoS SustainabilityExt_eNA DispersionExt_eNA DnPerformanceExt_eNA |
| fineGranAreas | array(GeographicalArea) | O | 1..N | Indicates the fine granularity areas to which the subscription applies. (i.e. with a finer granularity than cell). (NOTE 7, NOTE 20) | ServiceExperienceExt2_eNA UeMobilityExt2_eNA QoS SustainabilityExt_eNA MovementBehaviour |
| visitedAreas | array(NetworkAreaInfo) | O | 1..N | Indicates the visited network area(s) which the UEs had previously been in at least one of the Visited Area(s) of Interest. (NOTE 10) | UeMobilityExt |
| maxTopAppUINbr | UInteger | O | 0..1 | Indicates the requested maximum number of top applications that contribute the most to the traffic in Uplink direction. Minimum = 1. May be included when one of the elements in the "listOfAnaSubsets" attribute is set to LIST_OF_TOP_APP_UL. | UserDataCongestionExt |
| maxTopAppDINbr | UInteger | O | 0..1 | Indicates the requested maximum number of top applications that contribute the most to the traffic in Downlink direction. Minimum = 1. May be included when one of the elements in the "listOfAnaSubsets" attribute is set to LIST_OF_TOP_APP_DL. | UserDataCongestionExt |
| nfInstanceIds | array(NfInstanceId) | O | 1..N | Identification(s) of NF instance(s). | NfLoad |
| nfSetIds | array(NfSetId) | O | 1..N | Identification(s) of NF instance set(s). | NfLoad |
| nfTypes | array(NfType) | O | 1..N | Identification(s) of NF type(s). (NOTE 13) | NfLoad NsiLoadExt |
| notificationMethod | NotificationMethod | O | 0..1 | Indicate the notification method. (NOTE 2) | |

| | | | | | |
|------------------|-------------------------------|---|------|---|---|
| nsildInfos | array(NsildInfo) | O | 1..N | Each element identifies the S-NSSAI and the optionally associated network slice instance(s). May be included when subscribed event is "NSI_LOAD_LEVEL", "SERVICE_EXPERIENCE" or "DN_PERFORMANCE". (NOTE 1) | ServiceExperience NsiLoad DnPerformance |
| nsiLevelThrds | array(Uinteger) | O | 1..N | Identifies the load threshold for each S-NSSAI or S-NSSAI and the optionally associated network slice instance identified by the "nsilds" attribute within the "nsildInfos" attribute. (NOTE 4) Minimum = 0. Maximum = 100. | NsiLoad |
| qosRequ | QosRequirement | C | 0..1 | Indicates the QoS requirements. It shall be included when subscribed event is "QOS_SUSTAINABILITY" or "E2E_DATA_VOL_TRANS_TIME". | QoS Sustainability E2eDataVolTransTime |
| qosFlowRetThds | array(RetainabilityThreshold) | C | 1..N | Represents the QoS flow retainability thresholds. Shall be supplied for the 5QI ("5qi" in "qosRequ") or resource type ("resType" in "qosRequ") of GBR resource type. (NOTE 4) | QoS Sustainability |
| ranUeThrouThds | array(BitRate) | C | 1..N | Represents the RAN UE throughput thresholds. Shall be supplied for the 5QI ("5qi" in "qosRequ") or resource type ("resType" in "qosRequ") of non-GBR resource type. (NOTE 4) | QoS Sustainability |
| repetitionPeriod | DurationSec | C | 0..1 | Shall be supplied for notification method "PERIODIC" by the "notificationMethod" attribute. | |
| snssais | array(Snssai) | C | 1..N | Identification(s) of network slice(s) to which the subscription applies. (NOTE 1, NOTE 8) (NOTE 17) | |
| tgtUe | TargetUeInformation | O | 0..1 | Identifies target UE information. (NOTE 3) | |
| roamingInfo | RoamingInfo | O | 0..1 | Information about roaming analytics. When this attribute is provided, the request should contain only attributes that are applicable also in the Nnwdaf_RoamingAnalytics service. | RoamingAnalytics |
| congThresholds | array(ThresholdLevel) | C | 1..N | Represents the congestion threshold levels. (NOTE 4) | UserDataCongestion |
| nwPerfRequs | array(NetworkPerfRequirement) | C | 1..N | Represents the network performance requirements. This attribute shall be included when subscribed event is "NETWORK_PERFORMANCE". | NetworkPerformance |
| bwRequs | array(BwRequirement) | O | 1..N | Represents the bandwidth requirement for each application. It may only be present if "applds" attribute is provided. | ServiceExperience |

| | | | | | |
|---------------------|------------------------------------|---|------|--|---------------------------------------|
| excepReqs | array(Exception) | C | 1..N | Represents a list of Exception Ids with associated thresholds. May only be present when subscribed event is "ABNORMAL_BEHAVIOUR". (NOTE 5, NOTE 6, NOTE 8) | AbnormalBehaviour |
| exptAnaType | ExpectedAnalyticsType | C | 0..1 | Represents expected UE analytics type. It shall not be present if the "excepReqs" attribute is provided. (NOTE 6, NOTE 8) | AbnormalBehaviour |
| exptUeBehav | ExpectedUeBehaviourData | O | 0..1 | Represents expected UE behaviour. | AbnormalBehaviour |
| ratFreqs | array(RatFreqInformation) | O | 1..N | Identification(s) of the RAT type(s) and/or frequency(ies) of UE's serving cell(s) which the subscription applies. (NOTE 9) | ServiceExperienceExt |
| listOfAnaSubsets | array(AnalyticsSubset) | O | 1..N | The list of analytics subsets can be used to indicate the content of the analytics. | EneNA |
| disperReqs | array(DispersionRequirement) | O | 1..N | Represents the dispersion analytics requirements. | Dispersion |
| redTransReqs | array(RedundantTransmissionExpReq) | O | 1..N | Represents the redundant transmission experience analytics requirements. | RedundantTransmissionExp |
| wlanReqs | array(WlanPerformanceReq) | O | 1..N | Represents other WLAN performance analytics requirements. If the attribute contains no content, may take default handling action. | WlanPerformance |
| ueCommReqs | array(UeCommReq) | O | 1..N | Represents the UE communication requirements. This attribute may be included when the subscribed event is "UE_COMM". | UeCommunicationExt_eNA |
| ueMobilityReqs | array(UeMobilityReq) | O | 1..N | Represents the UE mobility requirements. This attribute may be included when the subscribed event is "UE_MOBILITY". | UeMobilityExt2_eNA |
| upflInfo | UpfInformation | O | 0..1 | Identifies the UPF. (NOTE 12) | ServiceExperienceExt DnPerformance |
| userDataConOrderCri | UserDataConOrderCri | O | 0..1 | The ordering criterion for the list of User Data Congestion analytics. (NOTE 14) | userDataConOrderCri |
| appServerAdrs | array(AddrFqdn) | C | 1..N | Each element represents the Application Server Instance (IP address/FQDN of the Application Server). (NOTE 11) | ServiceExperienceExt DnPerformance |
| dnPerfReqs | array(DnPerformanceReq) | O | 1..N | Represents the DN performance analytics requirements. | DnPerformance |
| pduSesInfos | array(PduSessionInfo) | C | 1..N | Represents combination of PDU Session parameter(s). (NOTE 15) | ServiceExperienceExt2_eNA |
| useCaseCxt | string | O | 0..1 | Indicates the context of usage of the analytics. The value and format of this parameter are not standardized. | ENAEExt |
| pduSesTrafReqs | array(PduSesTrafficReq) | C | 1..N | Represents the PDU Session traffic analytics requirements. This attribute shall be included when subscribed event is "PDU_SESSION_TRAFFIC". | PduSesTraffic |

| | | | | | |
|----------------|-----------------------|---|------|---|---|
| locAccReqs | array(LocAccuracyReq) | O | 1..N | Represents the Location Accuracy analytics requirements. This attribute may only be included when the subscribed event is "LOC_ACCURACY". | LocAccuracy |
| locGranularity | LocInfoGranularity | O | 0..1 | The preferred granularity of UE location information. (NOTE 21) | ServiceExperienceExt2_eNA UeMobilityExt2_eNA DispersionExt_eNA MovementBehaviour |
| locOrientation | LocationOrientation | O | 0..1 | Indicates the preferred orientation of location information. | MovementBehaviour UeMobilityExt2_eNA |
| accuReq | AccuracyReq | O | 0..1 | Represents the analytics accuracy requirement information. May be included as indication to the NWDAF (containing an AnLF supporting Accuracy checking capability) to activate checking the analytics accuracy information of the event. | AnalyticsAccuracy |
| movBehavReqs | array(MovBehavReq) | O | 1..N | Represents the Movement Behaviour analytics requirements. | MovementBehaviour |
| relProxReqs | array(RelProxReq) | O | 1..N | Represents the Relative Proximity analytics requirements. | RelativeProximity |
| pauseFlg | boolean | O | 0..1 | Pause analytics consumption flag applicable on analytics ID level. Set to "true" to indicate the NWDAF to stop including analytics of this event type in its notifications (without cancelling the subscription), because the accuracy level needs to be increased. Default value is "false" if omitted. This attribute may be present in a update request message if the "pauseInd" attribute was provided in the notification. | AnalyticsAccuracy |
| resumeFlg | boolean | O | 0..1 | Resume analytics consumption flag applicable on analytics ID level. Set to "true" to indicate the NWDAF to resume sending the notifications of analytics because the accuracy has been improved. Default value is "false" if omitted. This attribute may be present in a update request message if the "resumeInd" attribute was provided in the notification. | AnalyticsAccuracy |
| feedback | AnalyticsFeedbackInfo | O | 0..1 | Analytics feedback information. It may only be provided in requests to update an existing analytics subscription for predictions. | AnalyticsAccuracy |

- NOTE 1: The "anySlice" attribute is not applicable to features "UeMobility" and "NetworkPerformance". The "snssais" attribute is not applicable to features "ServiceExperience", "NsiLoad", "UeMobility" and "NetworkPerformance". When subscribed event is "SLICE_LOAD_LEVEL", the identifications of network slices, either information about slice(s) identified by "snssais", or "anySlice" set to "true" shall be included. When subscribed event is "QOS_SUSTAINABILITY", "NF_LOAD", "UE_COMM", "ABNORMAL_BEHAVIOUR", "USER_DATA_CONGESTION", "DISPERSION", "RED_TRANS_EXP", "PDU_SESSION_TRAFFIC", "PFD_DETERMINATION" or "RELATIVE_PROXIMITY", the identifications of network slices identified by "snssais" is optional. When subscribed event is "NSI_LOAD_LEVEL", "SERVICE_EXPERIENCE" or "DN_PERFORMANCE", either the "nsiIdInfos" attribute or "anySlice" set to "true" shall be included.
- NOTE 2: When notificationMethod is not supplied, the default value is "THRESHOLD".
- NOTE 3: Applicability is further described in the corresponding data type. All target UE(s) indicated by this attribute shall belong to the same PLMN. When the RoamingAnalytics feature is supported and the target UE(s) indicated by this attribute belong to a PLMN different than the PLMN of the NF service consumer, the request should contain only attributes that are applicable also in the Nnwdaf_RoamingAnalytics service.
- NOTE 4: This property shall be provided if the "notifMethod" in "evtReq" is set to "ON_EVENT_DETECTION" or "notificationMethod" in "eventSubscriptions" is set to "THRESHOLD" or omitted.
- NOTE 5: Only "exceptId" and "exceptLevel" within the Exception data type apply to the "exceptRequs" attribute within EventSubscription data type.
- NOTE 6: Either "exceptRequs" or "exptAnaType" shall be provided if subscribed event is "ABNORMAL_BEHAVIOUR".
- NOTE 7: For different events, the following rules apply:
- For "NETWORK_PERFORMANCE", "USER_DATA_CONGESTION" or "DN_PERFORMANCE" event, the "networkArea" attribute shall be provided if the event applied for all UEs (i.e. "anyUe" attribute set to true within the "tgtUe" attribute).
 - For "QOS_SUSTAINABILITY", at least one of "networkArea" and "fineGranAreas" attributes shall be provided.
 - For "E2E_DATA_VOL_TRANS_TIME" event, this attribute shall be provided if the event applied for single UE or group of UEs.
 - For "SERVICE_EXPERIENCE" event, if the event applied for all UEs (i.e. "anyUe" attribute set to true within the "tgtUe" attribute): at least one of "networkArea" or "fineGranAreas" attributes shall be provided.
 - For "MOVEMENT_BEHAVIOUR" event, at least one of the "networkArea" or "fineGranAreas" attributes shall be provided.
- NOTE 8: For "ABNORMAL_BEHAVIOUR" event with "anyUe" attribute in "tgtUe" attribute sets to true,
- at least one of the "networkArea" and the "snssais" attribute should be included, if the expected analytics type via the "exptAnaType" attribute or the list of Exception Ids via the "exceptRequs" attribute is mobility related;
 - at least one of the "networkArea", "applds", "dnns" and "snssais" attribute should be included, if the expected analytics type via the "exptAnaType" attribute or the list of Exception Ids via the "exceptRequs" attribute is communication related;
 - the expected analytics type via the "exptAnaType" attribute or the list of Exception Ids via "exceptRequs" attribute shall not be requested for both mobility and communication related analytics at the same time.
- NOTE 9: If both the "allFreq" attribute and the "allRat" attribute are present within the RatFreqInformation data type, then only one instance of the RatFreqInformation data type shall be present to indicate for all the RAT type and all the Frequency values the NWDAF has received for the application.
- NOTE 10: If this attribute is provided, the analytics target period shall be a past time period (i.e. only statistics is supported).
- NOTE 11: For service experience analytics, this parameter shall be provided when a consumer requires analytics for an edge application over a UP path.
- NOTE 12: For service experience analytics, this parameter may be provided when a consumer requires analytics for an edge application over a UP path, and it is only needed when the target of the service experience analytics is a specific UPF included in this UP path.
- NOTE 13: When subscribed event is "NSI_LOAD_LEVEL" and the NsiLoadExt feature is supported, and the NF service consumer provides the "nfTypes" attribute, then the NWDAF accounts only for the resource usage of the NF types included in "nfTypes" to derive the output analytics. If the "nfTypes" attribute is not provided, then NWDAF accounts for the resource usage of all NF types.
- NOTE 14: If the the value of "userDataConOrderCri" attribute is "APPLICABLE_TIME_WINDOW", the "ASCENDING" direction indicates that the list of User Data Congestion analytics are in chronological order and the "DESCENDING" direction indicates that the list of User Data Congestion analytics are in reverse chronological order.
- NOTE 15: When the "pduSesInfos" attribute is provided, the associated "applds" attribute shall also be provided for the NWDAF to be able to compute the service experience per application.
- NOTE 16: When subscribed event is "PFD_DETERMINATION" and the PfdDetermination feature is supported, the "applds" attribute shall be included.

| |
|---|
| NOTE 17: When the subscribed event is "PDU_SESSION_TRAFFIC" and the PduSesTraffic feature is supported, at least one of the "dnns" and/or "snssais" attributes as the route selection descriptor(s) for the URSP rule shall be included. |
| NOTE 18: When this attribute is provided, the NWDAF shall provide the analytics per elementary time slot accordingly. |
| NOTE 19: When this attribute is provided, the NWDAF shall provide the analytics per group of TAs or cells accordingly. |
| NOTE 20: If both "networkArea" and "fineGranAreas" attributes are provided, the Area of Interest is interpreted as the intersection area indicated by these two attributes. |
| NOTE 21: The "LON_AND_LAT_LEVEL" value of "locGranularity" attribute is not applicable to features "DispersionExt_eNA". The "TA_LEVEL" or "CELL_LEVEL" value of "locGranularity" attribute is not applicable to features "MovementBehaviour". |
| NOTE 22: When the subscribed event is "LOC_ACCURACY", only one of the "networkArea" attribute or "location" attribute shall be included. |

NOTE: Care needs to be taken to avoid excessive signalling.

5.1.6.2.4 Type NnwdafeventsSubscriptionNotification

Table 5.1.6.2.4-1: Definition of type NnwdafeventsSubscriptionNotification

| Attribute name | Data type | P | Cardinality | Description | Applicability |
|--|---------------------------|---|-------------|--|-----------------------------|
| eventNotifications | array(EventNotifications) | C | 1..N | Notifications about Individual Events. (NOTE 1) | |
| subscriptionId | string | M | 1 | String identifying a subscription to the NnwdafeventsSubscription service. (NOTE 2) | |
| notifCorrId | string | O | 0..1 | Notification correlation identifier. | EneNA |
| oldSubscriptionId | string | C | 0..1 | Subscription ID which was allocated by the source NWDAF. This parameter shall be present if the notification is for informing the assignment of a new Subscription Id by the target NWDAF in the analytics transfer procedure. (NOTE 1) | EneNA |
| resourceUri | Uri | C | 0..1 | The resource URI of the Individual NWDAF Event Subscription resource created by the target NWDAF. Shall be present when the target NWDAF notifies a successful analytics subscription transfer. (NOTE 1) (NOTE 2) | EneNA |
| termCause | TermCause | O | 0..1 | A cause for which the NWDAF will send no further notifications for this subscription. Its presence indicates that the NWDAF requests the termination of the subscription. | TermRequest |
| transEvents | array(Nnwdafevent) | C | 1..N | Indicates the successful transferred subscription event(s) for a partial successful analytics subscription transfer. It shall be supplied by the Target NWDAF if not all the analytics events in the subscription transfer are accepted. | PartialAnalyticsSubTransfer |
| NOTE 1: Either "eventNotifications" attribute, or "resourceUri" and "oldSubscriptionId" attributes shall be provided. | | | | | |
| NOTE 2: It shall be the same as the last segment of the "resourceUri" attribute when the target NWDAF notifies the consumer of the successful analytics subscription transfer. | | | | | |

5.1.6.2.5 Type EventNotification

Table 5.1.6.2.5-1: Definition of type EventNotification

| Attribute name | Data type | P | Cardinality | Description | Applicability |
|-------------------|--------------------------------|---|-------------|---|---------------------|
| event | NwdafEvent | M | 1 | Event that is notified. | |
| start | DateTime | O | 0..1 | It defines the start time of which the statistics analytics information is applicable or predictions analytics information is valid. (NOTE 1) (NOTE 4) | |
| dataVITrnsTmInfos | array(E2eDataVolTransTimeInfo) | C | 1..N | E2E data volume transfer time information. Shall be present if the subscribed event is "E2E_DATA_VOL_TRANS_TIME". (NOTE 5) | E2eDataVolTransTime |
| expiry | DateTime | O | 0..1 | It defines the expiration time after which the statistics analytics information is not applicable or predictions analytics information is invalid. (NOTE 1) (NOTE 4) | |
| timeStampGen | DateTime | C | 0..1 | It defines the timestamp of analytics generation. (NOTE 3) | |
| failNotifyCode | NwdafFailureCode | C | 0..1 | Identifies the failure reason for the event notification. It shall only be included if the event notification is failed or the analytics information is not ready. (NOTE 2) | EneNA |
| rvWaitTime | DurationSec | O | 0..1 | Indicate a recommended time interval (in seconds) which is used to determine the time when analytics information is needed in similar future event subscriptions. It may only be included if the "failNotifyCode" attribute sets to "UNSATISFIED_REQUESTED_ANALYTICS_TIME". | EneNA |
| anaMetaInfo | AnalyticsMetadataInfo | C | 0..1 | Contains information about analytics metadata required to aggregate the analytics. It shall be present if the "anaMeta" attribute was included in the subscription, containing the information indicated by the "anaMeta" attribute. | Aggregation |
| nwPerfs | array(NetworkPerformanceInfo) | C | 1..N | The network performance information. Shall be present when subscribed event is "NETWORK_PERFORMANCE". (NOTE 5) | NetworkPerformance |
| nfLoadLevelInfos | array(NfLoadLevelInformation) | C | 1..N | The NF load level information. When subscribed event is "NF_LOAD", the nfLoadLevelInfos shall be included. (NOTE 5) | NfLoad |
| nsiLoadLevelInfos | array(NsiLoadLevelInfo) | C | 1..N | Each element identifies the load level information for each S-NSSAI and the optionally associated network slice instance. Shall be included when subscribed event is "NSI_LOAD_LEVEL". (NOTE 5) | NsiLoad |

| | | | | | |
|--------------------|-------------------------------------|---|------|--|--------------------------|
| pfDetermInfos | array(PfdDeterminationInfo) | C | 1..N | Represents the PFD Determination information for a known application identifier. Shall be included when subscribed event is "PFD_DETERMINATION". (NOTE 5) | PfdDetermination |
| qoSsustainInfos | array(QoSsustainabilityInfo) | C | 1..N | The QoS sustainability information. When subscribed event is "QOS_SUSTAINABILITY", the qoSSustainInfos shall be included. (NOTE 5) | QoSSustainability |
| sliceLoadLevelInfo | SliceLoadLevelInfo | C | 0..1 | The slices and the load level information. When subscribed event is "SLICE_LOAD_LEVEL", the sliceLoadLevelInfo shall be included. (NOTE 5) | |
| svcExps | array(ServiceExperienceInfo) | C | 1..N | The service experience information. When subscribed event is "SERVICE_EXPERIENCE", the svcExps shall be included. (NOTE 5) | ServiceExperience |
| ueComms | array(UeCommunication) | C | 1..N | The UE communication information. When subscribed event is "UE_COMM", the ueComms shall be included. (NOTE 5) | UeCommunication |
| ueMobs | array(UeMobility) | C | 1..N | The UE mobility information. When subscribed event is "UE_MOBILITY", the ueMobs shall be included. (NOTE 5) | UeMobility |
| abnorBehavrs | array(AbnormalBehaviour) | C | 1..N | The Abnormal Behaviour information. When subscribed event is "ABNORMAL_BEHAVIOUR", the abnorBehavrs shall be included. (NOTE 5) | AbnormalBehaviour |
| userDataCongInfos | array(UserDataCongestionInfo) | C | 1..N | The location and user data congestion information. Shall be present if the subscribed event is "USER_DATA_CONGESTION". (NOTE 5) | UserDataCongestion |
| dnPerfInfos | array(DnPerfInfo) | C | 1..N | The DN performance information. Shall be present if the subscribed event is "DN_PERFORMANCE". (NOTE 5) | DnPerformance |
| disperInfos | array(DispersionInfo) | C | 1..N | The Dispersion information. When subscribed event is "DISPERSION", the "disperInfos" attribute shall be included. (NOTE 5) | Dispersion |
| redTransInfos | array(RedundantTransmissionExpInfo) | C | 1..N | The redundant transmission experience related information. When subscribed event is "RED_TRANS_EXP", the "redTransInfos" attribute shall be included. (NOTE 5) | RedundantTransmissionExp |

| | | | | | |
|------------------|----------------------------|---|------|---|-------------------|
| wlanInfos | array(WlanPerformanceInfo) | C | 1..N | The WLAN performance related information. When subscribed event is "WLAN_PERFORMANCE", the "wlanInfos" attribute shall be included. (NOTE 5) | WlanPerformance |
| smccExps | array(SmccelInfo) | C | 1..N | The Session Management Congestion Control Experience information. Shall be present when the requested event is "SM_CONGESTION". (NOTE 5) | SMCCE |
| pduSesTraffInfos | array(PduSesTrafficInfo) | C | 1..N | The PDU Session traffic related information. When subscribed event is "PDU_SESSION_TRAFFIC", the "pduSesTraffInfos" attribute shall be included. (NOTE 5) | PduSesTraffic |
| accuInfo | AccuracyInfo | C | 0..1 | The analytics accuracy information. Shall be provided if the analytics accuracy requirement was subscribed in the "accuReq" attribute and the "cancelAccuInd" attribute is set to "false" or omitted. | AnalyticsAccuracy |
| cancelAccuInd | boolean | O | 0..1 | Indicates cancelled subscription of the analytics accuracy information. Set to "true" indicates the NWDAF cancelled subscription of analytics accuracy information as the NWDAF does not support the accuracy checking capability. Otherwise set to "false". Default value is "false" if omitted. | AnalyticsAccuracy |
| pauseInd | boolean | O | 0..1 | Pause analytics consumption indication applicable on analytics ID level. Set to "true" to indicate the consumer to stop the consumption of the analytics because the accuracy level needs to be increased. Default value is "false" if omitted. | AnalyticsAccuracy |
| resumeInd | boolean | O | 0..1 | Resume analytics consumption indication applicable on analytics ID level. Set to "true" to indicate the consumer to resume the consumption of the analytics because the accuracy has been improved. Default value is "false" if omitted. | AnalyticsAccuracy |
| movBehavInfos | array(MovBehaviourInfo) | C | 1..N | The Movement Behaviour information. When subscribed event is "MOVEMENT_BEHAVIOUR", the "movBehavInfos" attribute shall be included. (NOTE 5) | MovementBehaviour |

| | | | | | |
|--------------|-------------------------|---|------|---|-------------------|
| relProxInfos | array(RelProximityInfo) | C | 1..N | The Relative Proximity information. When subscribed event is "RELATIVE_PROXIMITY", the "relProxInfos" attribute shall be included. (NOTE 5) | RelativeProximity |
| locAccInfos | array(LocAccuracyInfo) | C | 1..N | The Location Accuracy related information. It shall be present when the subscribed event is "LOC_ACCURACY". (NOTE 5) | LocAccuracy |

NOTE 1: If the "start" attribute and the "expiry" attribute are both provided, the DateTime of the "expiry" attribute shall not be earlier than the DateTime of the "start" attribute.

NOTE 2: The value of "PREDICTION_NOT_ALLOWED" and "BOTH_STAT_PRED_NOT_ALLOWED" of the NwdafFailureCode data type is not applicable for the "failNotifyCode" attribute. The value of "UNAVAILABLE_DATA" of the NwdafFailureCode data type is applicable for the the "failNotifyCode" attribute only when the "StatisticsFailure" feature is supported.

NOTE 3: This attribute shall be included when ADRF is deployed.

NOTE 4: The validity period specified by "start" and "expiry" attributes is determined by NWDAF internal logic, and is a subset of the analytics target period indicated by "startTs" and "endTs", or "offsetPeriod" attributes contained in "extraReportReq" attribute of the subscription. If the analytics target period refers to the past, the period specified by these two attributes indicate the time period over which the statistics are applicable. If the analytics target period refers to the future, the period specified by these two attributes indicate the time period over which the predictions are valid.

NOTE 5: If the AnalyticsAccuracy feature is supported and the notification is only for notifying about the accuracy information of subscribed events, this attribute is not required to be included even if the respective event was subscribed.

5.1.6.2.6 Type SliceLoadLevelInformation

Table 5.1.6.2.6-1: Definition of type SliceLoadLevelInformation

| Attribute name | Data type | P | Cardinality | Description | Applicability |
|----------------------|----------------------|---|-------------|--|---------------|
| loadLevelInformation | LoadLevelInformation | M | 1 | Load level information which applies for each network slice identified by snssais. | |
| snssais | array(Snssai) | M | 1..N | Identification(s) of network slice to which the subscription applies. | |

NOTE: The functionality of the Slice Load Level Information is a subset of the functionality of the NSI Load Level Information, does not need to be used if the NsiLoadExt feature is supported, and is maintained only for backwards compatibility purposes.

5.1.6.2.7 Type EventReportingRequirement

Table 5.1.6.2.7-1: Definition of type EventReportingRequirement

| Attribute name | Data type | P | Cardinality | Description | Applicability |
|----------------|-----------------------------|---|-------------|--|---------------|
| accuracy | Accuracy | O | 0..1 | Preferred level of accuracy of the analytics. (NOTE 5) | |
| accPerSubset | array(Accuracy) | O | 1..N | Each element indicates the preferred accuracy level per analytics subset. It may be present if the "listOfAnaSubsets" attribute is present in the subscription request (NOTE 4, NOTE 5) | EneNA |
| startTs | DateTime | O | 0..1 | UTC time indicating the start time of the observation period. The absence of this attribute means subscription at the present time unless the "offsetPeriod" attribute is included. (NOTE 3) | |
| endTs | DateTime | O | 0..1 | UTC time indicating the end time of the observation period. If the start time is in the past, then the absence of this attribute means that the end time of the subscription is at the present time, unless the "offsetPeriod" attribute is included. If provided, it shall not be less than the start time. (NOTE 3) | |
| offsetPeriod | integer | O | 0..1 | Offset period in units of seconds to the reporting time, if the value is negative means statistics in the past offset period, otherwise a positive value means prediction in the future offset period. May be present if the "repPeriod" attribute is included within the "evtReq" attribute or the "repetitionPeriod" attribute is included within the EventSubscription type. (NOTE 3) | EneNA |
| sampRatio | SamplingRatio | O | 0..1 | Percentage of sampling (1%...100%) among impacted UEs. Applicable to event targeting a group of UEs or any UE. (NOTE 1) | |
| maxSupiNbr | UInteger | O | 0..1 | Represents the maximum number of SUPIs expected in an object. Applicable for the event(s) providing a list of SUPIs during the analytics response. | |
| maxObjectNbr | UInteger | O | 0..1 | Maximum number of objects expected for an analytics report. It's only applicable for the event(s) which may provide more than one entries or objects during event notification. | |
| timeAnaNeeded | DateTime | O | 0..1 | UTC time indicating the time when analytics information is needed. | EneNA |
| anaMeta | array(AnalyticsMetadata) | O | 1..N | List of analytics metadata that are requested to be included. | Aggregation |
| anaMetaInd | AnalyticsMetadataIndication | O | 0..1 | Contains values for the analytics metadata that the NF service consumer wants to be used for generating the analytics. | Aggregation |

| | | | | | |
|---|------------|---|------|--|-------|
| histAnaTimePeriod | TimeWindow | O | 0..1 | The time period of historical analytics indicates the start time and end time during which the historical analytics was generated. If this attribute is included, the NWDAF only needs to provide the existing analytics, and does not need to generate new analytics. | EneNA |
| <p>NOTE 1: The "sampRatio" attribute within EventReportingRequirement data type is not applicable for the Nnwdaf_EventsSubscription API.</p> <p>NOTE 2: Void.</p> <p>NOTE 3: When the "offsetPeriod" attribute is included, the "startTs" and "endTs" attributes shall not be included. If the analytics target period is indicated either by providing a "startTs" attribute and an "endTs" attribute that are equal, or by providing an "offsetPeriod" attribute equal to zero (which means there is no offset to the periodic reporting time indicated by the "repPeriod" attribute or "repetitionPeriod" attribute), then this is a request for analytics for a specific time of the same "startTs" attribute and "endTs" attribute or each specific time periodically indicated by the "repPeriod" attribute, rather than for a time interval. If none of the attributes "startTs", "endTs" and "offsetPeriod" is provided, the analytics target period starts at the present time and there is no specified end time.</p> <p>NOTE 4: If multiple accuracy entries are included, the order of the entries of the "accPerSubset" attribute corresponds with the order of the entries of the "listOfAnaSubsets" attribute, i.e. the first entry of the "accPerSubset" attribute holds the requested accuracy for the analytics subset that is indicated by the first entry of the "listOfAnaSubsets" attribute, and so on.</p> <p>NOTE 5: If both the "accuracy" attribute and "accPerSubset" attribute were provided in the request, the "accPerSubset" attribute takes precedence over the "accuracy" attribute.</p> | | | | | |

5.1.6.2.8 Type TargetUeInformation

Table 5.1.6.2.8-1: Definition of type TargetUeInformation

| Attribute name | Data type | P | Cardinality | Description | Applicability |
|---|----------------|---|-------------|---|---|
| anyUe | boolean | O | 0..1 | Identifies whether any UE is applicable. - Set to "true" if applicable for any UE. - Set to "false" if not applicable for any UE. - Default value is "false" if omitted. (NOTE 3) | ServiceExperience NetworkPerformance NfLoad UserDataCongestion AbnormalBehaviour QoSsustainability Dispersion RedundantTransmissionExp WlanPerformance DnPerformance PduSesTraffic |
| supis | array(Supi) | O | 1..N | Each element represents a SUPI for a UE. (NOTE 2) | UeMobility UeCommunication NetworkPerformance AbnormalBehaviour UserDataCongestion NfLoad ServiceExperience Dispersion RedundantTransmissionExp WlanPerformance SMCCE DnPerformance PduSesTraffic RelativeProximity E2eDataVolTransTime |
| gpsis | array(Gpsi) | O | 1..N | Each element represents a GPSI for a UE. (NOTE 2) | UserDataCongestionExt DnPerformance E2eDataVolTransTime |
| intGroupIds | array(GroupId) | O | 1..N | Each element represents an internal group identifier and identifies a group of UEs. (NOTE 2) | UeMobility UeCommunication NetworkPerformance AbnormalBehaviour ServiceExperience Dispersion RedundantTransmissionExp WlanPerformance DnPerformance PduSesTraffic RelativeProximity |
| NOTE 1: For an applicable feature or UserDataCongestion and UserDataCongestionExt features are both applicable, only one attribute identifying the target UE shall be provided. If only the "anyUe" attribute is provided, shall set the attribute value as "true". | | | | | |
| NOTE 2: Only one element in the attribute shall be provided for the applicable events except the "SERVICE_EXPERIENCE" event, the "DISPERSION" event and/or the "SMCCE" event. | | | | | |
| NOTE 3: For feature "Dispersion", any UE is only supported in combination with S-NSSAI, Area of Interest and/or Dispersion Class. | | | | | |

5.1.6.2.9 Void

5.1.6.2.10 Type UeMobility

Table 5.1.6.2.10-1: Definition of type UeMobility

| Attribute name | Data type | P | Cardinality | Description | Applicability |
|--|----------------------------|---|-------------|---|--------------------|
| ts | DateTime | C | 0..1 | This attribute identifies the timestamp when the UE arrives the location. (NOTE 1) | |
| recurringTime | ScheduledCommunicationTime | C | 0..1 | Identifies time of the day and day of the week which are valid within the observation period when the UE moves. (NOTE 1, NOTE 2) | |
| duration | DurationSec | M | 1 | This attribute identifies the time duration the UE stays in the location. If the analytics result applies for a group of UEs, it indicates the average duration for the group of UEs. (NOTE 3) | |
| durationVariance | Float | C | 0..1 | This attribute indicates the variance of the analysed durations for the group of UEs. It shall be provided if the analytics result applies for a group of UEs. | |
| locInfos | array(LocationInfo) | M | 1..N | This attribute includes a list of UE location information during the time duration. (NOTE 4) | |
| directionInfos | array(DirectionInfo) | C | 1..N | This attribute includes a list of UE direction information. Shall be present if one of the elements in the "listOfAnaSubsets" attribute in the request was set to "UE_DIRECTION". | UeMobilityExt_AIML |
| NOTE 1: Either "ts" or "recurringTime" shall be provided. | | | | | |
| NOTE 2: If this attribute is present, it indicates the UE movement is periodic. This attribute is suitable to be present for a recurring mobility in a long observation time. | | | | | |
| NOTE 3: If the "temporalGranSize" attribute is provided in the request, the duration indicated by the "duration" attribute shall be greater than or equal to the value of the "temporalGranSize" attribute. | | | | | |
| NOTE 4: If the "spatialGranSizeTa" and/or "spatialGranSizeCell" attributes are provided in the request, the number of TAs or cells contained in "arealInfo" attribute shall be smaller than or equal to the values of the "spatialGranSizeTa" and/or "spatialGranSizeCell" attributes. | | | | | |

5.1.6.2.11 Type LocationInfo

Table 5.1.6.2.11-1: Definition of type LocationInfo

| Attribute name | Data type | P | Cardinality | Description | Applicability |
|--|----------------------------|---|-------------|--|--|
| loc | UserLocation | M | 1 | This attribute contains the detailed location, the ueLocationTimestamp attribute in the 3GPP access type of UserLocation data type shall not be provided. (NOTE 3) | |
| geoLoc | GeographicalArea | C | 0..1 | This attribute contains the geographical location in a fine granularity (e.g. smaller than a cell). Shall be present if one of the elements in the "listOfAnaSubsets" attribute in the request was set to "USER_LOCATION". (NOTE 2) (NOTE 3) | UeMobilityExt2_eNA ServiceExperienceExt2_eNA |
| ratio | SamplingRatio | C | 0..1 | This attribute contains the percentage of UEs with same analytics result in the group. Shall be present if the analytics result applies for a group of UEs. | |
| confidence | UInteger | C | 0..1 | Indicates the confidence of the prediction. (NOTE 1) Shall be present if the analytics result is a prediction. Minimum = 0. Maximum = 100. | |
| geoDistrInfos | array(GeoDistributionInfo) | C | 1..N | Indicates the geographical distribution of the UEs that may be selected by the AF for application service. Shall be present if one of the elements in the "listOfAnaSubsets" attribute in the request was set to "UE_GEOG_DIST". | UeMobilityExt_AIML |
| distThreshold | UInteger | O | 0..1 | Indicates the linear distance threshold which has been reached. This attribute will be provided only if more than one thresholds were provided in "distThresholds" attribute contained in UeMobilityReq data type and the target is a single UE. | UeMobilityExt2_eNA |
| <p>NOTE 1: If the requested period identified by the "startTs" and "endTs" attributes in the "EventReportingRequirement" type is a future time period, which means the analytics result is a prediction. If no sufficient data is collected to provide the confidence of the prediction before the time deadline, the NWDAF shall return a zero confidence.</p> <p>NOTE 2: When possible and applicable to the access type, the UE location is provided according to the preferred granularity subscribed or requested in the "locGranularity" attribute.</p> <p>NOTE 3: When the "geoLoc" attribute is present, the "loc" attribute shall be ignored.</p> | | | | | |

5.1.6.2.12 Void

5.1.6.2.13 Type UeCommunication

Table 5.1.6.2.13-1: Definition of type UeCommunication

| Attribute name | Data type | P | Cardinality | Description | Applicability |
|-------------------|----------------------------|---|-------------|--|--------------------|
| commDur | DurationSec | M | 1 | Identifies the duration of the communication. If the analytics result applies for a group of UEs, it indicates the average duration for the subset of UEs indicated by a given ratio in the group. | |
| commDurVariance | Float | C | 0..1 | This attribute indicates the variance of the analysed durations for the subset of UEs indicated by a given ratio in the group. It shall be provided if the analytics result applies for a group of UEs. | |
| perioTime | DurationSec | O | 0..1 | Identifies interval time of periodic communication, e.g. every 10 minutes or 1 hour. (NOTE 2) If the analytics result applies for a group of UEs, it indicates the average interval time of periodic communication for the subset of UEs indicated by a given ratio in the group. | |
| perioTimeVariance | Float | C | 0..1 | This attribute indicates the variance of the analysed intervals of periodic communication for the subset of UEs indicated by a given ratio in the group. It shall be provided if the analytics result applies for a group of UEs. | |
| ts | DateTime | C | 0..1 | Identifies the start time of the communication. (NOTE 1) | |
| tsVariance | Float | O | 0..1 | This attribute indicates the variance of the analysed start time for the subset of UEs indicated by a given ratio in the group. It may only be provided if the ts attribute is provided. | |
| recurringTime | ScheduledCommunicationTime | C | 0..1 | Identifies time of the day and day of the week which are valid within the observation period when the UE has communication. Providing the end time in ScheduledCommunicationTime data type is not required. (NOTE 1, NOTE 3) | |
| trafChar | TrafficCharacterization | M | 1 | Identifies the detailed traffic characterization. | |
| ratio | SamplingRatio | C | 0..1 | This attribute contains the percentage of UEs with same analytics result in the group. Shall be present if the analytics result applies for a group of UEs. | |
| perioCommInd | boolean | O | 0..1 | This attribute indicates whether the UE communicates periodically or not. Set to "true" to indicate the UE communicates periodically, set to "false" to indicate the UE does not communicate periodically. Default value is "false" if omitted. | UeCommunicationExt |
| confidence | UInteger | C | 0..1 | Indicates the confidence of the prediction. (NOTE 4) Shall be present if the analytics result is a prediction. Minimum = 0. Maximum = 100. | |

| | | | | | |
|----------------|-------------------------|---|------|--|--------------------|
| anaOfAppList | AppListForUeComm | C | 0..1 | Represents the analytics of the application list used by UE. Shall be present if one of the elements in the "listOfAnaSubsets" attribute was set to APP_LIST_FOR_UE_COMM. | UeCommunicationExt |
| sessInactTimer | SessInactTimerForUeComm | C | 0..1 | Represents the N4 Session inactivity timer. Shall be present only if one of the elements in the "listOfAnaSubsets" attribute was set to N4_SESS_INACT_TIMER_FOR_UE_COMM and the identified NF service consumer is an SMF. (NOTE 5) | UeCommunicationExt |

NOTE 1: Either "ts" or "recurringTime" shall be provided.

NOTE 2: If this attribute is present, it indicates the communication is periodic and its value shall be larger than the commDur value. If this attribute is present with the ts attribute, it indicates the periodic communication time valid within the observation period; if it is present with the recurringTime attribute, it indicates the periodic communication time valid within the day(s).

NOTE 3: If this attribute is present, it indicates the communication is periodic. This attribute is suitable to be present for a recurring communication in a long observation time.

NOTE 4: If the requested period identified by the "startTs" and "endTs" attributes in the EventReportingRequirement type is a future time period, which means the analytics result is a prediction. If no sufficient data is collected to provide the confidence of the prediction before the time deadline, the NWDAF shall return a zero confidence.

NOTE 5: This attribute shall not be provided if the NWDAF does not know the NF service consumer type or if the NWDAF knows that the NF service consumer is not an SMF.

5.1.6.2.14 Type TrafficCharacterization

Table 5.1.6.2.14-1: Definition of type TrafficCharacterization

| Attribute name | Data type | P | Cardinality | Description | Applicability |
|---|-----------------------------|---|-------------|--|---------------|
| appld | ApplicationId | O | 0..1 | Contains the application identifier. | |
| dnn | Dnn | O | 0..1 | Identifies DNN, a full DNN with both the Network Identifier and Operator Identifier, or a DNN with the Network Identifier only. Shall be present if the "dnns" was provided within EventSubscription during the subscription for event notification procedure. | |
| snssai | Snssai | C | 0..1 | Identifies the network slice. Shall be present if the "snssais" was provided within EventSubscription during the subscription for event notification procedure. | |
| fDescs | array(IpEthFlowDescription) | O | 1..2 | Contains the flow description for the Uplink and/or Downlink flows. | |
| ulVol | Volume | C | 0..1 | Identifies the uplink traffic volume. (NOTE) If the analytics result applies for a group of UEs, it indicates the average uplink traffic volume for the subset of UEs indicated by a given ratio in the group. | |
| ulVolVariance | Float | C | 0..1 | This attribute indicates the variance of the uplink traffic volumes for the subset of UEs indicated by a given ratio in the group. It shall be provided if the analytics result applies for a group of UEs. | |
| dlVol | Volume | C | 0..1 | Identifies the downlink traffic volume. (NOTE) If the analytics result applies for a group of UEs, it indicates the average downlink traffic volume for the subset of UEs indicated by a given ratio in the group. | |
| dlVolVariance | Float | C | 0..1 | This attribute indicates the variance of the downlink traffic volumes for the subset of UEs indicated by a given ratio in the group. It shall be provided if the analytics result applies for a group of UEs. | |
| NOTE: At least one of "ulVol" or "dlVol" shall be provided. | | | | | |

5.1.6.2.15 Type AbnormalBehaviour

Table 5.1.6.2.15-1: Definition of type AbnormalBehaviour

| Attribute name | Data type | P | Cardinality | Description | Applicability |
|--|-----------------------|---|-------------|--|---------------|
| supis | array(Supi) | C | 1..N | Each element identifies a UE which is affected with the Exception. Shall be present if the subscription request applies to more than one UE. | |
| dnn | Dnn | C | 0..1 | Identifies DNN, a full DNN with both the Network Identifier and Operator Identifier, or a DNN with the Network Identifier only. Shall be present if the "dnns" was provided within EventSubscription during the subscription for event notification procedure. | |
| excep | Exception | M | 1 | Contains the exception information. | |
| snssai | Snssai | C | 0..1 | Identifies the network slice information. Shall be present if the "snssais" was provided within EventSubscription during the subscription for event notification procedure. | |
| ratio | SamplingRatio | C | 0..1 | Contains the percentage of UEs with same analytics result in the group or among all UEs. Shall be present if the analytics result applies for a group of UEs or any UE. | |
| confidence | UInteger | C | 0..1 | Indicates the confidence of the prediction. (NOTE) Shall be present if the analytics result is a prediction. Minimum = 0. Maximum = 100. | |
| addtMeasInfo | AdditionalMeasurement | O | 0..1 | Additional measurement. | |
| NOTE: If the requested period identified by the "startTs" and "endTs" attributes in the "EventReportingRequirement" type is a future time period, which means the analytics result is a prediction. If no sufficient data is collected to provide the confidence of the prediction before the time deadline, the NWDAF shall return a zero confidence. | | | | | |

5.1.6.2.16 Type Exception

Table 5.1.6.2.16-1: Definition of type Exception

| Attribute name | Data type | P | Cardinality | Description | Applicability |
|----------------|----------------|---|-------------|---|---------------|
| exceptId | ExceptionId | M | 1 | Indicating the Exception ID. | |
| exceptLevel | integer | O | 0..1 | Measured level, compared to the threshold | |
| exceptTrend | ExceptionTrend | O | 0..1 | Measured trend | |

5.1.6.2.17 Type UserDataCongestionInfo

Table 5.1.6.2.17-1: Definition of type UserDataCongestionInfo

| Attribute name | Data type | P | Cardinality | Description | Applicability |
|----------------|-----------------|---|-------------|--|---------------|
| networkArea | NetworkAreaInfo | M | 1 | Identification of network area to which the subscription applies. | |
| congestionInfo | CongestionInfo | M | 1 | The congestion information of the specific location. | |
| snssai | Snssai | C | 0..1 | Identifies an S-NSSAI. Shall be present if the "snssais" was provided within EventSubscription during the subscription for event notification procedure. | |

5.1.6.2.18 Type CongestionInfo

Table 5.1.6.2.18-1: Definition of type CongestionInfo

| Attribute name | Data type | P | Cardinality | Description | Applicability |
|--|-----------------------|---|-------------|--|-----------------------|
| congType | CongestionType | M | 1 | Identification congestion analytics type. | |
| timeIntev | TimeWindow | M | 1 | Represents the start time and the stop time to which requested for the congestion information applies. (NOTE 2) | |
| nsi | ThresholdLevel | M | 1 | Network Status Indication. | |
| confidence | UInteger | C | 0..1 | Indicates the confidence of the prediction. (NOTE 1) Shall be present if the analytics result is a prediction. Minimum = 0. Maximum = 100. | |
| topAppListUl | array(TopApplication) | C | 1..N | List of top applications in Uplink. Shall be present if one of the elements in the "listOfAnaSubsets" attribute was set to LIST_OF_TOP_APP_UL. | UserDataCongestionExt |
| topAppListDl | array(TopApplication) | C | 1..N | List of top applications in Downlink. Shall be present if one of the elements in the "listOfAnaSubsets" attribute was set to LIST_OF_TOP_APP_DL. | UserDataCongestionExt |
| NOTE 1: If the requested period identified by the "startTs" and "endTs" attributes in the EventReportingRequirement type is a future time period, which means the analytics result is a prediction. If no sufficient data is collected to provide the confidence of the prediction before the time deadline, the NWDAF shall return a zero confidence. | | | | | |
| NOTE 2: If the "temporalGranSize" attribute is provided in the request, the duration indicated by the "timeIntev" attribute shall be greater than or equal to the value of the "temporalGranSize" attribute. | | | | | |

5.1.6.2.19 Type QoSustainabilityInfo

Table 5.1.6.2.19-1: Definition of type QoSustainabilityInfo

| Attribute name | Data type | P | Cardinality | Description | Applicability |
|---|-------------------------|---|-------------|---|-------------------------|
| areaInfo | NetworkAreaInfo | M | 1 | Identification(s) of applicable location areas to which the subscription. (NOTE 4) | |
| fineAreaInfos | array(GeographicalArea) | O | 1..N | This attribute contains the geographical locations in a fine granularity (e.g. smaller than a cell). May be provided when the "fineGranAreas" attribute is provided in the request. | QoSustainabilityExt_eNA |
| startTs | DateTime | M | 1 | Represents the start time of the applicable observing period. (NOTE 3) | |
| endTs | DateTime | M | 1 | Represents the end time of the applicable observing period. (NOTE 3) | |
| qosFlowRetThd | RetainabilityThreshold | C | 0..1 | The reporting QoS Flow Retainability Threshold that are met or crossed for 5QI of GBR resource type. (NOTE 1) | |
| ranUeThrouThd | BitRate | C | 0..1 | The reporting RAN UE Throughput Threshold that are met or crossed for 5QI of non-GBR resource type. (NOTE 1) | |
| snssai | Snssai | C | 0..1 | Identifies an S-NSSAI. Shall be present if the "snssais" was provided within EventSubscription during the subscription for event notification procedure. | |
| confidence | UInteger | C | 0..1 | Indicates the confidence of the prediction. (NOTE 2) Shall be present if the analytics result is a prediction. Minimum = 0. Maximum = 100. | |
| <p>NOTE 1: Either "qosFlowRetThd" or "ranUeThrouThd" attribute shall be provided.</p> <p>NOTE 2: If the requested period identified by the "startTs" and "endTs" attributes in the EventReportingRequirement type is a future time period, which means the analytics result is a prediction. If no sufficient data is collected to provide the confidence of the prediction before the time deadline, the NWDAF shall return a zero confidence.</p> <p>NOTE 3: If the "temporalGranSize" attribute is provided in the request, the duration indicated by the "startTs" and "endTs" attributes shall be greater than or equal to the value of the "temporalGranSize" attribute.</p> <p>NOTE 4: If the "spatialGranSizeTa" and/or "spatialGranSizeCell" attributes are provided in the request, the number of TAs or cells contained in "areaInfo" attribute shall be smaller than or equal to the values of the "spatialGranSizeTa" and/or "spatialGranSizeCell" attributes.</p> | | | | | |

5.1.6.2.20 Type QosRequirement

Table 5.1.6.2.20-1: Definition of type QosRequirement

| Attribute name | Data type | P | Cardinality | Description | Applicability |
|--|------------------|---|-------------|---|--------------------------|
| 5qi | 5Qi | C | 0..1 | Represents a 5G QoS Identifier. It shall be included for standardized or preconfigured 5QIs. (NOTE) | |
| gfbrUI | BitRate | C | 0..1 | Indicates GFBR in the uplink. It shall be included for GBR 5QIs. | |
| gfbrDI | BitRate | C | 0..1 | Indicates GFBR in the downlink. It shall be included for GBR 5QIs. | |
| resType | QosResourceType | C | 0..1 | Resource type. Shall be provided for the non-standardized and non-preconfigured QoS characteristics. (NOTE) | |
| pdb | PacketDelBudget | O | 0..1 | Packet Delay Budget. May be supplied for the non-standardized and non-pre-configured QoS characteristics. | |
| per | PacketErrRate | O | 0..1 | Packet Error Rate. May be supplied for the non-standardized and non-pre-configured QoS characteristics. | |
| deviceSpeed | VelocityEstimate | O | 0..1 | Velocity Estimate. | QoSsustainabilityExt_eNA |
| deviceType | DeviceType | O | 0..1 | The device type. | QoSsustainabilityExt_eNA |
| NOTE: Either 5QI within "5qi" attribute or the resource type within "resType" attribute shall be provided. | | | | | |

5.1.6.2.21 Type RetainabilityThreshold

Table 5.1.6.2.21-1: Definition of type RetainabilityThreshold

| Attribute name | Data type | P | Cardinality | Description | Applicability |
|--|---------------|---|-------------|--|---------------|
| relFlowNum | UInteger | C | 0..1 | Represents the number of abnormally released QoS flows. (NOTE) | |
| relTimeUnit | TimeUnit | C | 0..1 | Represents the unit for the session active time, shall be present if relFlowNum is present. (NOTE) | |
| relFlowRatio | SamplingRatio | C | 0..1 | Represents the ratio of abnormally released QoS flows to the total released QoS flows, expressed in percentage. (NOTE) | |
| NOTE: Either "relFlowNum" and its associated "relTimeUnit" attributes or "relFlowRatio" attributes shall be provided. The "relFlowNum" and "relTimeUnit" attributes together represents the number of abnormally released QoS flows (i.e. relFlowNum) within the time unit (i.e. relTimeUnit). | | | | | |

5.1.6.2.22 Type NetworkPerfRequirement

Table 5.1.6.2.22-1: Definition of type NetworkPerfRequirement

| Attribute name | Data type | P | Cardinality | Description | Applicability |
|--|---------------------------|---|-------------|--|----------------------------|
| nwPerfType | NetworkPerfType | M | 1 | The type of the network performance. | |
| relativeRatio | SamplingRatio | C | 0..1 | The relative ratio expressed in percentage. (NOTE 1) | |
| absoluteNum | UInteger | C | 0..1 | The absolute number (NOTE 1) | |
| orderCriterion | NetworkPerfOrderCriterion | O | 0..1 | The ordering criterion for the list of network performance analytics. (NOTE 2) | NetworkPerformanceExt_eNA |
| rscUsgReq | ResourceUsageRequirement | O | 0..1 | Indicates more requirements when providing resource usage information for the network performance type indicated by the "nwPerfType" attribute. (NOTE 3) | NetworkPerformanceExt_AIML |
| <p>NOTE 1: Either "relativeRatio" or "absoluteNum" shall be provided if the "notifMethod" in "evtReq" is set to "ON_EVENT_DETECTION" or "notificationMethod" in "eventSubscriptions" is set to "THRESHOLD" or omitted.</p> <p>NOTE 2: The "CROSSED" value in "MatchingDirection" data type is not applicable for this attribute.</p> <p>NOTE 3: The "rscUsgReq" value is only applicable when the "nwPerfType" attribute is set to "GNB_RSC_USAGE_OVERALL_TRAFFIC", "GNB_RSC_USAGE_GBR_TRAFFIC" or "GNB_RSC_USAGE_DELAY_CRIT_GBR_TRAFFIC".</p> | | | | | |

5.1.6.2.23 Type NetworkPerfInfo

Table 5.1.6.2.23-1: Definition of type NetworkPerfInfo

| Attribute name | Data type | P | Cardinality | Description | Applicability |
|---|--------------------------|---|-------------|---|----------------------------|
| networkArea | NetworkAreaInfo | M | 1 | Identification of network area to which the subscription applies. (NOTE 5) | |
| nwPerfType | NetworkPerfType | M | 1 | The type of the network performance | |
| anaPeriod | TimeWindow | O | 0..1 | Indicates the analytics target period subset within the requested analytics target period. (NOTE 4) | NetworkPerformanceExt_eNA |
| relativeRatio | SamplingRatio | C | 0..1 | The reported relative ratio expressed in percentage. (NOTE 1) | |
| absoluteNum | UInteger | C | 0..1 | The reported absolute number (NOTE 1) | |
| rscUsgReq | ResourceUsageRequirement | O | 0..1 | Indicates more information when providing resource usage information for the network performance type indicated by the "nwPerfType" attribute. (NOTE 3) | NetworkPerformanceExt_AIML |
| confidence | UInteger | C | 0..1 | Indicates the confidence of the prediction. (NOTE 2) Shall be present if the analytics result is a prediction. Minimum = 0. Maximum = 100. | |
| <p>NOTE 1: Either "relativeRatio" or "absoluteNum" shall be provided.</p> <p>NOTE 2: If the requested period identified by the "startTs" and "endTs" attributes in the EventReportingRequirement type is a future time period, which means the analytics result is a prediction. If no sufficient data is collected to provide the confidence of the prediction before the time deadline, the NWDAF shall return a zero confidence.</p> <p>NOTE 3: The "rscUsgReq" value is only applicable when the "nwPerfType" attribute is set to "GNB_RSC_USAGE_OVERALL_TRAFFIC", "GNB_RSC_USAGE_GBR_TRAFFIC" or "GNB_RSC_USAGE_DELAY_CRIT_GBR_TRAFFIC".</p> <p>NOTE 4: If the "temporalGranSize" attribute is provided in the request, the duration indicated by the "anaPeriod" attribute shall be greater than or equal to the value of the "temporalGranSize" attribute.</p> <p>NOTE 5: If the "spatialGranSizeTa" and/or "spatialGranSizeCell" attributes are provided in the request, the number of TAs or cells contained in "networkArea" attribute shall be smaller than or equal to the values of the "spatialGranSizeTa" and/or "spatialGranSizeCell" attributes.</p> | | | | | |

5.1.6.2.24 Type ServiceExperienceInfo

Table 5.1.6.2.24-1: Definition of type ServiceExperienceInfo

| Attribute name | Data type | P | Cardinality | Description | Applicability |
|------------------|-----------------------|---|-------------|--|----------------------|
| svcExprc | SvcExperience | M | 1 | Service experience | |
| svcExprcVariance | Float | O | 0..1 | This attribute indicates the variance . | |
| supis | array(Supi) | O | 1..N | Each element identifies a UE. May only be present if the subscription request applies to more than one UE. (NOTE 3) | |
| snssai | Snssai | C | 0..1 | Identifies an S-NSSAI. Shall be presented if the "snssais" was provided within EventSubscription during the subscription for event notification procedure. | |
| appld | ApplicationId | C | 0..1 | Identifies an application. Shall be present if the "applds" was provided within EventSubscription during the subscription for event notification procedure. | |
| srvExpctype | ServiceExperienceType | O | 0..1 | Indicates the type of Service Experience analytics. | ServiceExperienceExt |
| ueLocs | array(LocationInfo) | C | 1..N | This attribute includes a list of UE location information during the time duration. Shall be present if one of the elements in the "listOfAnaSubsets" attribute was set to UE_LOCATION. (NOTE 2) | ServiceExperienceExt |
| upfInfo | UpfInformation | C | 0..1 | Represents the information of the UPF serving the UE. Shall be present only if the "upfInfo" attribute was provided in the request or subscription and the NF service consumer is identified as not an AF or a NEF. (NOTE 4) | ServiceExperienceExt |
| dnai | Dnai | C | 0..1 | Indicates the DN Access Identifier representing location of the service flow. Shall be present if the "dnais" attribute was provided in the request or subscription. | ServiceExperienceExt |
| appServerInst | AddrFqdn | C | 0..1 | Represents the Application Server Instance (IP address or FQDN of the Application Server). Shall be present if the "appServerAddrs" attribute was provided in the request or subscription. | ServiceExperienceExt |

| | | | | | |
|-------------|-----------------|---|------|---|--|
| confidence | UInteger | C | 0..1 | Indicates the confidence of the prediction. (NOTE 1) Shall be present if the analytics result is a prediction. Minimum = 0. Maximum = 100. | |
| dnn | Dnn | C | 0..1 | Identifies DNN, a full DNN with both the Network Identifier and Operator Identifier, or a DNN with the Network Identifier only. Shall be present if the "dnns" was provided within EventSubscription during the subscription for event notification procedure. | |
| networkArea | NetworkAreaInfo | C | 0..1 | Identifies the network area where the service experience applies. Shall be presented if the "networkArea" was provided within EventSubscription during the subscription for event notification procedure. | |
| nsild | Nsild | C | 0..1 | Identifies a network slice instance which is associated with the S-NSSAI identified by the "snssai" attribute. Shall be presented if the "nsilds" was provided within the NsildInfo data in the EventSubscription data during the subscription. | |
| ratio | SamplingRatio | C | 0..1 | Contains the percentage of UEs with same analytics result in the group or among all UEs. Shall be present if the analytics result applies for a group of UEs or any UE. (NOTE 3) | |

| | | | | | |
|---|--------------------|---|------|--|---------------------------|
| ratFreq | RatFreqInformation | C | 0..1 | <p>Identification of the RAT type(s) and/or frequency(ies) of UE's serving cell(s) which the service experience applies.</p> <p>Shall be present if the "ratFreqs" was provided in the EventSubscription data during the subscription.</p> <p>When "allRat" and/or "allFreq" are included in the subscription, the NWDAF provides an instance of the Application service experience per combination of RAT Type(s) and/or Frequency value(s) having the same Service Experience.</p> | ServiceExperienceExt |
| pduSesInfo | PduSessionInfo | C | 0..1 | <p>Represents the PDU Session parameters.</p> <p>Shall be present if the "pduSesInfos" attribute was provided in the EventSubscription data type during the subscription.</p> | ServiceExperienceExt2_eNA |
| <p>NOTE 1: If the requested period identified by the "startTs" and "endTs" attributes in the "EventReportingRequirement" type is a future time period, which means the analytics result is a prediction. If no sufficient data is collected to provide the confidence of the prediction before the time deadline, the NWDAF shall return a zero confidence.</p> <p>NOTE 2: The "ueLocs" attribute shall only be included if the consumer analytics request is for a single UE or a list of UEs. Inclusion of such UE location requires user consent during the UE location data collection.</p> <p>NOTE 3: The SUPI list and Ratio in the service experience information for an application may be omitted if the reported service experience information is provided and is assigned with the same value(s) for the slice instance which the application belongs to. Otherwise, the SUPI list and Ratio shall be provided for an application service experience.</p> <p>NOTE 4: This attribute shall not be provided if the NWDAF does not know the NF service consumer type or if the NWDAF knows that the NF service consumer is an AF or a NEF.</p> | | | | | |

5.1.6.2.25 Type BwRequirement

Table 5.1.6.2.25-1: Definition of type BwRequirement

| Attribute name | Data type | P | Cardinality | Description | Applicability |
|--|---------------|---|-------------|---|---------------|
| appld | ApplicationId | M | 1 | Represents an application. (NOTE) | |
| marBwUI | BitRate | O | 0..1 | Maximum requested bandwidth for the Uplink. | |
| marBwDI | BitRate | O | 0..1 | Maximum requested bandwidth for the Downlink. | |
| mirBwUI | BitRate | O | 0..1 | Minimum requested bandwidth for the Uplink. | |
| mirBwDI | BitRate | O | 0..1 | Minimum requested bandwidth for the Downlink. | |
| <p>NOTE: If the "applds" attribute is provided within EventSubscription data, this attribute shall be indicated by the "applds" attribute.</p> | | | | | |

5.1.6.2.26 Type AdditionalMeasurement

Table 5.1.6.2.26-1: Definition of type AdditionalMeasurement

| Attribute name | Data type | P | Cardinality | Description | Applicability |
|----------------|--------------------------------|---|-------------|--|---------------|
| unexpLoc | NetworkAreaInfo | C | 0..1 | The unexpected locations which the UE stays. It may only be present when the "exceptId" within the Exception data sets to "UNEXPECTED_UE_LOCATION". | |
| unexpFlowTeps | array(IpEthFlowDescription) | C | 1..N | Unexpected IP or Ethernet flow templates. It may only be present when the "exceptId" within the Exception data sets to "UNEXPECTED_LONG_LIVE_FLOW" or "UNEXPECTED_LARGE_RATE_FLOW". | |
| unexpWakes | array(DateTime) | C | 1..N | Unexpected wake up times. It may only be present when the "exceptId" within the Exception data sets to "UNEXPECTED_WAKEUP". | |
| ddosAttack | AddressList | C | 0..1 | Victim's address list. It may only be present when the "exceptId" within the Exception data sets to "SUSPICION_OF_DDOS_ATTACK". | |
| wrgDest | AddressList | C | 0..1 | Wrong destination address list. It may only be present when the "exceptId" within the Exception data sets to "WRONG_DESTINATION_ADDRESSES". | |
| circums | array(CircumstanceDescription) | C | 1..N | The description of circumstances. It may only be present when the "exceptId" within the Exception data sets to "TOO_FREQUENT_SERVICE_ACCESS", "UNEXPECTED_RADIO_LINK_FAILURES" or "PING_PONG_ACROSS_CELLS". | |

5.1.6.2.27 Type IpEthFlowDescription

Table 5.1.6.2.27-1: Definition of type FlowDescription

| Attribute name | Data type | P | Cardinality | Description | Applicability |
|---|--------------------|---|-------------|--|---------------|
| ipTrafficFilter | FlowDescription | C | 0..1 | Identifies IP packet filter.(NOTE) | |
| ethTrafficFilter | EthFlowDescription | C | 0..1 | Identifies Ethernet packet filter.(NOTE) | |
| NOTE: Either "ipTrafficFilter" or "ethTrafficFilter" shall be provided. | | | | | |

5.1.6.2.28 Type AddressList

Table 5.1.6.2.28-1: Definition of type AddressList

| Attribute name | Data type | P | Cardinality | Description | Applicability |
|---|-----------------|---|-------------|--|---------------|
| ipv4Addrs | array(Ipv4Addr) | O | 1..N | Each element identifies an IPv4 address. | |
| ipv6Addrs | array(Ipv6Addr) | O | 1..N | Each element identifies an IPv6 address. | |
| NOTE: At least one of "ipv4Addrs" or "ipv6Addrs" shall be provided. | | | | | |

5.1.6.2.29 Type CircumstanceDescription

Table 5.1.6.2.29-1: Definition of type CircumstanceDescription

| Attribute name | Data type | P | Cardinality | Description | Applicability |
|----------------|-----------------|---|-------------|--|---------------|
| freq | Float | O | 0..1 | Communication frequency of the UE in units of MHz. | |
| tm | DateTime | O | 0..1 | Time when UE enters the location. | |
| locArea | NetworkAreaInfo | C | 0..1 | The location of the UE. It shall be present when the "exceptId" within the Exception data sets to "UNEXPECTED_RADIO_LINK_FAILURES" or "PING_PONG_ACROSS_CELLS". | |
| vol | Volume | C | 0..1 | The traffic volume. It shall be present when the "exceptId" within the Exception data sets to "TOO_FREQUENT_SERVICE_ACCESS" or "UNEXPECTED_LARGE_RATE_FLOW". | |

5.1.6.2.30 Type ThresholdLevel

Table 5.1.6.2.30 -1: Definition of type ThresholdLevel

| Attribute name | Data type | P | Cardinality | Description | Applicability |
|----------------|-----------------|---|-------------|---|-----------------------|
| congLevel | integer | C | 0..1 | Value of Congestion that triggers notification. (NOTE 1) | UserDataCongestion |
| nfLoadLevel | integer | C | 0..1 | Value of NF Load that triggers notification. (NOTE 2) Minimum = 0. Maximum = 100. | NfLoad |
| nfCpuUsage | integer | C | 0..1 | Value of NF CPU Usage that triggers notification. (NOTE 2) Minimum = 0. Maximum = 100. | NfLoad |
| nfMemoryUsage | integer | C | 0..1 | Average usage of memory (NOTE 2) Minimum = 0. Maximum = 100. | NfLoad |
| nfStorageUsage | integer | C | 0..1 | Average usage of storage. (NOTE 2) Minimum = 0. Maximum = 100. | NfLoad |
| avgTrafficRate | BitRate | C | 0..1 | Threshold level of average traffic rate. Shall be present if one of the elements in the "listOfAnaSubsets" attribute was set to AVG_TRAFFIC_RATE. (NOTE 3) | DnPerformance |
| maxTrafficRate | BitRate | C | 0..1 | Threshold level of maximum traffic rate. Shall be present if one of the elements in the "listOfAnaSubsets" attribute was set to MAX_TRAFFIC_RATE. (NOTE 3) | DnPerformance |
| minTrafficRate | BitRate | C | 0..1 | Threshold level of minimum traffic rate. The minimum traffic rate measurements are only derived from active traffic. (NOTE 4) | DnPerformanceExt_AIML |
| aggTrafficRate | BitRate | C | 0..1 | Threshold level of aggregated traffic rate. Shall be present if one of the elements in the "listOfAnaSubsets" attribute was set to AGG_TRAFFIC_RATE. (NOTE 4) | DnPerformanceExt_AIML |
| varTrafficRate | Float | C | 0..1 | Threshold level of variance of traffic rate. Shall be present if one of the elements in the "listOfAnaSubsets" attribute was set to VAR_TRAFFIC_RATE. (NOTE 4) | DnPerformanceExt_AIML |
| avgPacketDelay | PacketDelBudget | C | 0..1 | Threshold level of average Packet Delay. Shall be present if one of the elements in the "listOfAnaSubsets" attribute was set to AVG_PACKET_DELAY. (NOTE 3) | DnPerformance |

| | | | | | |
|--|-----------------|---|------|---|-----------------------|
| maxPacketDelay | PacketDelBudget | C | 0..1 | Threshold level of maximum Packet Delay. Shall be present if one of the elements in the "listOfAnaSubsets" attribute was set to MAX_PACKET_DELAY. (NOTE 3) | DnPerformance |
| varPacketDelay | Float | C | 0..1 | Threshold level of variance of Packet Delay. Shall be present if one of the elements in the "listOfAnaSubsets" attribute was set to VAR_PACKET_DELAY. (NOTE 4) | DnPerformanceExt_AIML |
| avgPacketLossRate | PacketLossRate | C | 0..1 | Threshold level of average Loss Rate. Shall be present if one of the elements in the "listOfAnaSubsets" attribute was set to AVG_PACKET_LOSS_RATE. (NOTE 3) | DnPerformance |
| maxPacketLossRate | PacketLossRate | C | 0..1 | Threshold level of maximum Loss Rate. Shall be present if one of the elements in the "listOfAnaSubsets" attribute was set to MAX_PACKET_LOSS_RATE. (NOTE 4) | DnPerformanceExt_AIML |
| varPacketLossRate | Float | C | 0..1 | Threshold level of variance of Loss Rate. Shall be present if one of the elements in the "listOfAnaSubsets" attribute was set to VAR_PACKET_LOSS_RATE. (NOTE 4) | DnPerformanceExt_AIML |
| svcExpLevel | Float | C | 0..1 | Service Experience MOS value. Shall be present when subscribed event is "SERVICE_EXPERIENCE". | ServiceExperienceExt |
| speed | Float | C | 0..1 | Speed threshold utilized to filter the UEs, expressed in kilometres per hour. Shall be present if one of the elements in the "listOfAnaSubsets" attribute was set to "SPEED_THRESHOLD". | MovementBehaviour |
| <p>NOTE 1: This attribute shall be provided when subscribed event is "USER_DATA_CONGESTION".</p> <p>NOTE 2: At least one attribute should be provided when subscribed event is "NF_LOAD".</p> <p>NOTE 3: At least one attribute should be provided when subscribed event is "DN_PERFORMANCE".</p> <p>NOTE 4: This attribute may only be provided if the "DnPerformanceExt_AIML" feature is supported and the subscribed event is "DN_PERFORMANCE".</p> | | | | | |

5.1.6.2.31 Type NfLoadLevelInformation

Table 5.1.6.2.31-1: Definition of type NfLoadLevelInformation

| Attribute name | Data type | P | Cardinality | Description | Applicability |
|--|---------------|---|-------------|--|---------------|
| nfType | NFType | M | 1 | Type of the NF instance | |
| nfInstancelid | NfInstancelid | M | 1 | Identification of the NF instance | |
| nfSetId | NfSetId | O | 0..1 | Identification of the NF instance set | |
| nfStatus | NfStatus | C | 0..1 | Availability status of the NF (NOTE 1) | |
| nfCpuUsage | integer | C | 0..1 | Average usage CPU (NOTE 1, NOTE 2) Minimum = 0. Maximum = 100. | |
| nfMemoryUsage | integer | C | 0..1 | Average usage of memory (NOTE 1, NOTE 2) Minimum = 0. Maximum = 100. | |
| nfStorageUsage | integer | C | 0..1 | Average usage of storage (NOTE 1, NOTE 2) Minimum = 0. Maximum = 100. | |
| nfLoadLevelAverage | integer | C | 0..1 | Average load information (NOTE 1, NOTE 2) Minimum = 0. Maximum = 100. | |
| nfLoadLevelPeak | integer | C | 0..1 | Peak load information (NOTE 1, NOTE 2) Minimum = 0. Maximum = 100. | |
| nfLoadAvgInAoi | integer | C | 0..1 | The average load of the NF instances over the area of interest. (NOTE 1, NOTE 2, NOTE 4) Minimum = 0. Maximum = 100. | NfLoadExt |
| snssai | Snssai | C | 0..1 | Identifies an S-NSSAI. Shall be present if the "snssais" was provided within EventSubscription during the subscription for event notification procedure. | |
| confidence | UInteger | C | 0..1 | Indicates the confidence of the prediction. (NOTE 3) Shall be present if the analytics result is a prediction. Minimum = 0. Maximum = 100. | |
| <p>NOTE 1: At least one value shall be provided. If the "listofAnaSubsets" attribute with value only applicable to NF_LOAD event is present in the subscription request, then only the corresponding attribute(s) shall be present.</p> <p>NOTE 2: The values are percentages which are provided as estimated over a given period.</p> <p>NOTE 3: If the requested period identified by the "startTs" and "endTs" attributes in the EventReportingRequirement type is a future time period, which means the analytics result is a prediction. If no sufficient data is collected to provide the confidence of the prediction before the time deadline, the NWDAF shall return a zero confidence.</p> <p>NOTE 4: Applicable only to AMF load if the "networkArea" attribute is present in the subscription request.</p> | | | | | |

5.1.6.2.32 Type NfStatus

Table 5.1.6.2.32-1: Definition of type NfStatus

| Attribute name | Data type | P | Cardinality | Description | Applicability |
|---|---------------|---|-------------|--|---------------|
| statusRegistered | SamplingRatio | C | 0..1 | Percentage of time with status "registered" (NOTE) | |
| statusUnregistered | SamplingRatio | C | 0..1 | Percentage of time with status "unregistered" (NOTE) | |
| statusUndiscoverable | SamplingRatio | C | 0..1 | Percentage of time with status "undiscoverable" (NOTE) | |
| <p>NOTE: The availability statuses of the NF on the Analytics target period are expressed as a percentage of time. The total of status values should be equal or lower than 100%. At least one value shall be provided.</p> | | | | | |

5.1.6.2.33 Type NsildInfo

Table 5.1.6.2.33-1: Definition of type NsildInfo

| Attribute name | Data type | P | Cardinality | Description | Applicability |
|--|--------------|---|-------------|---|---------------|
| snsai | Snsai | M | 1 | Identification of network slice to which the subscription for event notification procedure applies. | |
| nsilds | array(Nsild) | O | 1..N | Identification of network slice instance(s) associated with the subscribed S-NSSAI identified by the "snsai" attribute. May be included when subscribed event is "NSI_LOAD_LEVEL" or "SERVICE_EXPERIENCE". (NOTE) | |
| NOTE: This attribute is not applicable when the NF service consumer is CEF or PCF. | | | | | |

5.1.6.2.34 Type NsiLoadLevelInfo

Table 5.1.6.2.34-1: Definition of type NsiLoadLevelInfo

| Attribute name | Data type | P | Cardinality | Description | Applicability |
|--------------------------|----------------------|---|-------------|---|---------------|
| loadLevelInformation | LoadLevelInformation | M | 1 | Load level information of the network slice identified by the "snssai" attribute and if provided, the associated NSI ID identified by the "nsild" attribute. | |
| snssai | Snssai | M | 1 | Identification of network slice to which the subscription applies. | |
| nsild | Nsild | C | 0..1 | Identification of network slice instance associated with the S-NSSAI identified by the "snssai" attribute. Shall be presented if the "nsilds" attribute was provided within the NsildInfo data in the EventSubscription data during the subscription. | |
| resUsage | ResourceUsage | C | 0..1 | The current usage of the virtual resources assigned to the NF instances belonging to a particular network slice instance. Shall be present if one of the element in the "listOfAnaSubsets" attribute was set to RES_USAGE. | NsiLoadExt |
| numOfExceedLoadLevelThr | integer | C | 0..1 | Indicates the number of times the resource usage threshold of the network slice instance is reached or exceeded if a threshold value is provided by the consumer. Shall be present if one of the element in the "listOfAnaSubsets" attribute was set to NUM_OF_EXCEED_RES_USAGE_LOAD_LEVEL_THR. | NsiLoadExt |
| exceedLoadLevelThrInd | boolean | C | 0..1 | Indicates whether the Load Level Threshold is met or exceeded by the statistics value. Set to "true" if the Load Level Threshold is met or exceeded, set to "false" to indicate the Load Level Threshold is not met by the statistics value. Default value is "false" if omitted. Shall be present if one of the element in the "listOfAnaSubsets" attribute was set to EXCEED_LOAD_LEVEL_THR_IND. | NsiLoadExt |
| networkArea | NetworkAreaInfo | O | 0..1 | Identification of network area to which the subscription or analytics request applies. | NsiLoadExt |
| timePeriod | TimeWindow | O | 0..1 | Indicates a start time and a stop time of the load level information identified by the "loadLevelInformation" attribute. | NsiLoadExt |
| resUsgThrCrossTimePeriod | array(TimeWindow) | O | 1..N | Each element indicates the time elapsed between times each threshold is met or exceeded or crossed. The start time and end time are the exact time stamps of the resource usage threshold is reached or exceeded. May be present if the "listOfAnaSubsets" attribute is provided and the maximum number of instances shall not exceed the value provided in the "numOfExceedLoadLevelThr" attribute. | NsiLoadExt |

| | | | | | |
|--|---------------|---|------|--|------------|
| numOfUes | NumberAverage | C | 0..1 | Indicates the average and variance number of UE registered at the S-NSSAI and the optionally associated network slice instance. Shall be present if one of the element in the "listOfAnaSubsets" attribute was set to NUM_OF_UE_REG. | NsiLoadExt |
| numOfPduSess | NumberAverage | C | 0..1 | Indicates the average and variance number of PDU session established at the S-NSSAI and the optionally associated network slice instance. Shall be present if one of the element in the "listOfAnaSubsets" attribute was set to NUM_OF_PDU_SESS_ESTBL. | NsiLoadExt |
| confidence | UInteger | C | 0..1 | Indicates the confidence of the prediction. (NOTE) Shall be present if the analytics result is a prediction. Minimum = 0. Maximum = 100. | NsiLoadExt |
| NOTE: If the requested period identified by the "startTs" and "endTs" attributes in the "EventReportingRequirement" type is a future time period, which means the analytics result is a prediction. If no sufficient data is collected to provide the confidence of the prediction before the time deadline, the NWDAF shall return a zero confidence. | | | | | |

5.1.6.2.35 Type FailureEventInfo

Table 5.1.6.2.35-1: Definition of type FailureEventInfo

| Attribute name | Data type | P | Cardinality | Description | Applicability |
|----------------|------------------|---|-------------|-------------------------------|---------------|
| event | NwdafEvent | M | 1 | Event that is subscribed. | |
| failureCode | NwdafFailureCode | M | 1 | Identifies the failure reason | |

5.1.6.2.36 Type AnalyticsMetadataIndication

Table 5.1.6.2.36-1: Definition of type AnalyticsMetadataIndication

| Attribute name | Data type | P | Cardinality | Description | Applicability |
|----------------|-----------------------------------|---|-------------|--|---------------|
| dataWindow | TimeWindow | O | 0..1 | Data time window of the data samples. | |
| dataStatProps | array(DatasetStatisticalProperty) | O | 1..N | List of dataset statistical properties of the data to be used to generate the analytics. | |
| strategy | OutputStrategy | O | 0..1 | Output strategy to be used for the reporting of the analytics. | |
| aggrNwdafIds | array(NfInstanceId) | O | 1..N | NWDAF identifiers of NWDAF instances used by the NWDAF service consumer when aggregating multiple analytics subscriptions. | |

5.1.6.2.37 Type AnalyticsMetadataInfo

Table 5.1.6.2.37-1: Definition of type AnalyticsMetadataInfo

| Attribute name | Data type | P | Cardinality | Description | Applicability |
|----------------|-----------------------------------|---|-------------|--|---------------|
| numSamples | UInteger | O | 0..1 | Number of data samples used for the generation of the output analytics. | |
| dataWindow | TimeWindow | O | 0..1 | Data time window of the data samples. | |
| dataStatProps | array(DatasetStatisticalProperty) | O | 1..N | List of dataset statistical properties of the data used to generate the analytics. | |
| strategy | OutputStrategy | O | 0..1 | Output strategy used for the reporting of the analytics. | |
| accuracy | Accuracy | O | 0..1 | Level of accuracy reached for the analytics. | |

5.1.6.2.38 Type NumberAverage

Table 5.1.6.2.38-1: Definition of type NumberAverage

| Attribute name | Data type | P | Cardinality | Description | Applicability |
|----------------|-----------|---|-------------|--------------------------|---------------|
| number | Float | M | 1 | The average number. | |
| variance | Float | M | 1 | Identifies the variance. | |
| skewness | Float | O | 0..1 | Contains the skewness. | |

5.1.6.2.39 Type TopApplication

Table 5.1.6.2.39-1: Definition of type TopApplication

| Attribute name | Data type | P | Cardinality | Description | Applicability |
|-----------------|---------------|---|-------------|---|---------------|
| appld | ApplicationId | C | 0..1 | Indicates an application identifier. (NOTE) | |
| ipTrafficFilter | FlowInfo | C | 0..1 | Identifies IP packet filter. (NOTE) | |
| ratio | SamplingRatio | O | 0..1 | The application's throughput as a percentage of the total throughput in the Area of Interest. | |

NOTE: Either "appld" or "ipTrafficFilter" shall be provided.

5.1.6.2.40 Type AnalyticsSubscriptionsTransfer

Table 5.1.6.2.40-1: Definition of type AnalyticsSubscriptionsTransfer

| Attribute name | Data type | P | Cardinality | Description | Applicability |
|-----------------------|---------------------------------|---|-------------|---|-----------------------------|
| subsTransInfos | array(SubscriptionTransferInfo) | M | 1..N | Contains information about the subscription(s) that are requested to be transferred. | |
| failTransEventReports | array(NwdafEvent) | C | 1..N | It contains the event(s) for which the subscription transfer is not successful. It shall be supplied by the Target NWDAF if not all the analytics events in the subscription transfer are accepted. | PartialAnalyticsSubTransfer |

5.1.6.2.41 Type SubscriptionTransferInfo

Table 5.1.6.2.41-1: Definition of type SubscriptionTransferInfo

| Attribute name | Data type | P | Cardinality | Description | Applicability |
|---|----------------------------|---|-------------|--|---------------|
| transReqType | TransferRequestType | M | 1 | Indicates the type of the transfer request (i.e. if it is a request for transfer preparation or transfer execution) | |
| nwdafEvSub | NnwdafEventsSubscription | M | 1 | Contains information about the analytics subscription that is to be transferred. (NOTE) | |
| consumerId | NfInstanceId | M | 1 | NF instance identifier of the consumer of the analytics subscription that is to be transferred. | |
| contextId | AnalyticsContextIdentifier | O | 0..1 | Identifier of analytics context information available at the NF service consumer. | |
| sourceNfIds | array(NfInstanceId) | O | 1..N | NF instance identifier(s) of active data source(s) the NF service consumer is currently using for the analytics of the subscription that is to be transferred. | |
| sourceSetIds | array(NfSetId) | O | 1..N | NF set identifier(s) of active data source(s) the NF service consumer is currently using for the analytics of the subscription that is to be transferred. | |
| modelInfos | array(ModelInfo) | O | 1..N | Contains information identifying the ML model(s) that the NF service consumer is currently using for the analytics. | |
| NOTE: The "nwdafEvSub" attribute shall contain the "notificationURI" attribute. | | | | | |

5.1.6.2.42 Type ModelInfo

Table 5.1.6.2.42-1: Definition of type ModelInfo

| Attribute name | Data type | P | Cardinality | Description | Applicability |
|----------------|--------------------|---|-------------|--|---------------|
| analyticsId | NwdafEvent | M | 1 | Type of analytics for which this ML model is used. | |
| mlModelInfos | array(MLModelInfo) | M | 1..N | The information of the ML models which are applicable to the event indicated by "analyticsId" attribute. | |

5.1.6.2.43 Type AnalyticsContextIdentifier

Table 5.1.6.2.43-1: Definition of type AnalyticsContextIdentifier

| Attribute name | Data type | P | Cardinality | Description | Applicability |
|--|-------------------------------------|---|-------------|--|---------------|
| subscriptionId | string | M | 1 | Identifies a subscription to the Nnwdaf_EventsSubscription Service. | |
| nfAnaCtxts | array(NwdafEvent) | O | 1..N | List of analytics types for which NF related analytics contexts can be retrieved. (NOTE) | |
| ueAnaCtxts | array(UeAnalyticsContextDescriptor) | O | 1..N | List of objects that indicate for which SUPI and analytics types combinations analytics context can be retrieved. (NOTE) | |
| NOTE: At least one of "nfAnaCtxts" and "ueAnaCtxts" shall be provided. | | | | | |

5.1.6.2.44 Type UeAnalyticsContextDescriptor

Table 5.1.6.2.44-1: Definition of type UeAnalyticsContextDescriptor

| Attribute name | Data type | P | Cardinality | Description | Applicability |
|----------------|-------------------|---|-------------|---|---------------|
| supi | Supi | M | 1 | SUPI of the UE for which analytics context can be retrieved. | |
| anaTypes | array(NwdafEvent) | M | 1..N | List of analytics types for which UE related analytics contexts can be retrieved. | |

5.1.6.2.45 Type DnPerfInfo

Table 5.1.6.2.45-1: Definition of type DnPerfInfo

| Attribute name | Data type | P | Cardinality | Description | Applicability |
|--|---------------|---|-------------|---|---------------|
| appld | ApplicationId | C | 0..1 | Indicates an application identifier. Shall be present if the "applds" attribute was provided in the request or subscription. | |
| dnn | Dnn | C | 0..1 | Identifies DNN, a full DNN with both the Network Identifier and Operator Identifier, or a DNN with the Network Identifier only. Shall be present if the "dnns" was provided in the request or subscription. | |
| snssai | Snssai | C | 0..1 | Identifies the network slice information. Shall be present if the "snssais" was provided in the request or subscription. | |
| dnPerf | array(DnPerf) | M | 1..N | List of DN performances for the application. | |
| confidence | UInteger | C | 0..1 | Indicates the confidence of the prediction. (NOTE 1) Shall be present if the analytics result is a prediction. Minimum = 0. Maximum = 100. | |
| NOTE 1: If the requested period identified by the "startTs" and "endTs" attributes in the "EventReportingRequirement" type is a future time period, which means the analytics result is a prediction. If no sufficient data is collected to provide the confidence of the prediction before the time deadline, the NWDAF shall return a zero confidence. | | | | | |

5.1.6.2.46 Type DnPerf

Table 5.1.6.2.46-1: Definition of type DnPerf

| Attribute name | Data type | P | Cardinality | Description | Applicability |
|--|-----------------|---|-------------|---|---------------|
| appServerInsAddr | AddrFqdn | C | 0..1 | Represents the Application Server Instance (IP address/FQDN of the Application Server). Shall be present if the "appServerAddr" attribute was provided in the request or subscription. | |
| upfInfo | UpfInformation | C | 0..1 | Identifies the UPF. Shall be present only if the "upfInfo" attribute was provided in the request or subscription and the identified NF service consumer is not an AF or a NEF. (NOTE 1) | |
| dnai | Dnai | C | 0..1 | Indicates the DN Access Identifier representing location of the service flow. Shall be present if the "dnais" attribute was provided in the request or subscription. | |
| perfData | PerfData | M | 1 | Represents the performance data. | |
| spatialValidCon | NetworkAreaInfo | C | 0..1 | Represents the area where the DN performance analytics applies. Shall be present if "networkArea" attribute was provided in the request or subscription. (NOTE 3) | |
| temporalValidCon | TimeWindow | O | 0..1 | Represents the valid period for the DN performance analytics. (NOTE2) | |
| <p>NOTE 1: This attribute shall not be provided if the NWDAF does not know the NF service consumer type or if the NWDAF knows that the NF service consumer is an AF or a NEF.</p> <p>NOTE 2: If the "temporalGranSize" attribute is provided in the request, the duration indicated by the "temporalValidCon" attribute shall be greater than or equal to the value of the "temporalGranSize" attribute.</p> <p>NOTE 3: If the "spatialGranSizeTa" and/or "spatialGranSizeCell" attributes are provided in the request, the number of TAs or cells contained in "spatialValidCon" attribute shall be smaller than or equal to the values of the "spatialGranSizeTa" and/or "spatialGranSizeCell" attributes.</p> | | | | | |

5.1.6.2.47 Type PerfData

Table 5.1.6.2.47-1: Definition of type PerfData

| Attribute name | Data type | P | Cardinality | Description | Applicability |
|--|-----------------|---|-------------|--|-----------------------|
| avgTrafficRate | BitRate | O | 0..1 | Indicates average traffic rate observed for UEs communicating with the application. | |
| maxTrafficRate | BitRate | O | 0..1 | Indicates maximum traffic rate observed for UEs communicating with the application. | |
| minTrafficRate | BitRate | O | 0..1 | Indicates minimum traffic rate observed for UEs communicating with the application. The minimum traffic rate measurements are only derived from active traffic. | DnPerformanceExt_AIML |
| aggTrafficRate | BitRate | O | 0..1 | Indicates aggregated traffic rate. | DnPerformanceExt_AIML |
| varTrafficRate | Float | O | 0..1 | Indicates variance of traffic rate. | DnPerformanceExt_AIML |
| trafRateUelds | array(Supi) | O | 1..N | Identifies a UE or a list of UEs whose traffic rate is higher or lower than the threshold. Each element identifies a SUPI of an UE. The maximum number of SUPI(s) shall not exceed the subscribed "maxSupiNbr" attribute value if provided. (NOTE) | DnPerformanceExt_AIML |
| avePacketDelay | PacketDelBudget | O | 0..1 | Indicates average Packet Delay. | |
| maxPacketDelay | PacketDelBudget | O | 0..1 | Indicates maximum Packet Delay. | |
| varPacketDelay | Float | O | 0..1 | Indicates variance of Packet Delay. | DnPerformanceExt_AIML |
| packDelayUelds | array(Supi) | O | 1..N | Identifies a UE or a list of UEs whose packet delay is higher or lower than the threshold. Each element identifies a SUPI of an UE. The maximum number of SUPI(s) shall not exceed the subscribed "maxSupiNbr" attribute value if provided. (NOTE) | DnPerformanceExt_AIML |
| avgPacketLossRate | PacketLossRate | O | 0..1 | Indicates average Packet Loss Rate. | |
| maxPacketLossRate | PacketLossRate | O | 0..1 | Indicates maximum Packet Loss Rate. | DnPerformanceExt_AIML |
| varPacketLossRate | Float | O | 0..1 | Indicates variance of Packet Loss Rate. | DnPerformanceExt_AIML |
| packLossUelds | array(Supi) | O | 1..N | Identifies a UE or a list of UEs whose packet loss rate is higher than the threshold. Each element identifies a SUPI of an UE. The maximum number of SUPI(s) shall not exceed the subscribed "maxSupiNbr" attribute value if provided. (NOTE) | DnPerformanceExt_AIML |
| numOfUe | UInteger | O | 0..1 | The number of UEs for the UE group or all UEs (i.e. any UE) communicating with the application in the DNAI. | DnPerformanceExt_eNA |
| NOTE: If these attribute(s) is provided, the analytics target period shall be a past time period (i.e. only statistics is applicable). | | | | | |

5.1.6.2.48 Type ResourceUsage

Table 5.1.6.2.48-1: Definition of type ResourceUsage

| Attribute name | Data type | P | Cardinality | Description | Applicability |
|---|-----------|---|-------------|--|---------------|
| cpuUsage | UInteger | O | 0..1 | Average usage of virtual CPU. (NOTE) Minimum=0. Maximum=100. | |
| memoryUsage | UInteger | O | 0..1 | Average usage of memory. (NOTE) Minimum=0. Maximum=100. | |
| storageUsage | UInteger | O | 0..1 | Average usage of storage. (NOTE) Minimum=0. Maximum=100. | |
| NOTE: The values are percentages which are provided as estimated over a given period. | | | | | |

5.1.6.2.49 Type ConsumerNfInformation

Table 5.1.6.2.49-1: Definition of type ConsumerNfInformation

| Attribute name | Data type | P | Cardinality | Description | Applicability |
|--|--------------|---|-------------|--|---------------|
| nfId | NfInstanceId | C | 0..1 | Identifies the analytics consumer NF instance. (NOTE) | |
| nfSetId | NfSetId | C | 0..1 | Identifies the analytics consumer NF set. (NOTE) | |
| tailList | array(Tai) | C | 1..N | The list of TAls the analytics consumer NF can serve. (NOTE) | |
| NOTE: Either "tailList" or one of "nfId", "nfSetId" shall be provided. | | | | | |

5.1.6.2.50 Type DispersionRequirement

Table 5.1.6.2.50-1: Definition of type DispersionRequirement

| Attribute name | Data type | P | Cardinality | Description | Applicability |
|---|-----------------------------|---|-------------|--|---------------|
| disperType | DispersionType | M | 1 | Indicates the required dispersion analytics type. | |
| classCriters | array(ClassCriterion) | O | 1..N | Indicates the dispersion mobility class criterion for fixed, camper and/or traveller UE, and/or the top-heavy UE dispersion class criterion. | |
| rankCriters | array(RankingCriterion) | O | 1..N | Indicates the usage ranking criterion between the high, medium and low usage UE. | |
| dispOrderCriter | DispersionOrderingCriterion | O | 0..1 | Indicates the ordering criterion for the list of UE Dispersion Analytics information. | |
| order | MatchingDirection | O | 0..1 | Indicate the order: ascending or descending. May be present when the "dispOrderCriter" attribute is included. (NOTE) | |
| NOTE: "CROSSED" value in data type "MatchingDirection" is not applicable for the "order" attribute. | | | | | |

5.1.6.2.51 Type ClassCriterion

Table 5.1.6.2.51-1: Definition of type ClassCriterion

| Attribute name | Data type | P | Cardinality | Description | Applicability |
|--|-------------------|---|-------------|--|---------------|
| disperClass | DispersionClass | M | 1 | Indicates the dispersion class. | |
| classThreshold | SamplingRatio | M | 1 | Indicates the dispersion class threshold. | |
| thresMatch | MatchingDirection | M | 1 | Indicates the dispersion class threshold matching direction. (NOTE) | |
| NOTE: "CROSSED" value in data type "MatchingDirection" is not applicable for the "thresMatch" attribute. | | | | | |

5.1.6.2.52 Type RankingCriterion

Table 5.1.6.2.52-1: Definition of type RankingCriterion

| Attribute name | Data type | P | Cardinality | Description | Applicability |
|---|---------------|---|-------------|--|---------------|
| highBase | SamplingRatio | M | 1 | Indicates the "high" ranking bottom baseline percentage. | |
| lowBase | SamplingRatio | M | 1 | Indicates the "low" ranking top baseline percentage. | |
| NOTE: UE is ranked high (i.e.value 1), medium (2) or low (3) when its data/transactions dispersed during the period of observation at the location/slice, is higher than "highBase" attribute value, within the range between the "highBase" attribute to "lowBase" attribute value or less than "lowBase" value, respectively. | | | | | |

5.1.6.2.53 Type DispersionInfo

Table 5.1.6.2.53-1: Definition of type DispersionInfo

| Attribute name | Data type | P | Cardinality | Description | Applicability |
|---|-----------------------------|---|-------------|---|---------------|
| tsStart | DateTime | M | 1 | Indicates the timestamp when the time slot starts during the Analytics target period. | |
| tsDuration | DurationSec | M | 1 | Indicates the time slot duration. (NOTE) | |
| disperCollects | array(DispersionCollection) | M | 1..N | Dispersion collections on UE location(s) and/or slice(s). | |
| disperType | DispersionType | M | 1 | Indicates the dispersion type. Only applicable to DVDA or TDA value. | |
| NOTE: If the "temporalGranSize" attribute is provided in the request, the duration indicated by the "tsDuration" attribute shall be greater than or equal to the value of the "temporalGranSize" attribute. | | | | | |

5.1.6.2.54 Type DispersionCollection

Table 5.1.6.2.54-1: Definition of type DispersionCollection

| Attribute name | Data type | P | Cardinality | Description | Applicability |
|----------------|---------------------------|---|-------------|---|---------------|
| ueLoc | UserLocation | C | 0..1 | TA or cells where the UE or group of UEs dispersed its transactions and/or data. Shall be present if "networkArea" attribute is included in the event subscription or analytics request. (NOTE 1) | |
| snssai | Snssai | C | 0..1 | Slice where the UE or group of UEs disperse its transactions and/or data. Shall be present if "snssais" attribute is included in the event subscription or analytics request. (NOTE 1) | |
| supis | array(Supi) | C | 1..N | Each element identifies a SUPI of an UE. May only be present if reporting inside 5GC and the event subscription or analytics request applies to more than one UE. (NOTE 2) | |
| gpsis | array(Gpsi) | C | 1..N | Each element identifies a GPSI of an UE. May only be present if reused by the Nnef_AnalyticsExposure service reporting to external AF and the event subscription or analytics request applies to more than one UE. (NOTE 2) | |
| appVolumes | array(Application Volume) | O | 1..N | Application data volumes. May be present if "applds" attribute is included in the event subscription or analytics request (NOTE 6). | |
| disperAmount | UInteger | C | 0..1 | Indicates the dispersion amount of the reported data volume or transaction dispersion type. Shall be present if one of the elements in the "listOfAnaSubsets" attribute was set to DISPER_AMOUNT. (NOTE 3) | |
| disperClass | DispersionClass | C | 0..1 | Indicates the UE dispersion mobility class: fixed, camper, traveller, and/or the top-heavy dispersion class. Shall be present if one of the elements in the "listOfAnaSubsets" attribute was set to DISPER_CLASS. (NOTE 3, NOTE 5). | |
| usageRank | integer | C | 0..1 | Usage ranked high (i.e.value 1), medium (2) or low (3). Shall be present if one of the elements in the "listOfAnaSubsets" attribute was set to RANKING. (NOTE 3, NOTE 6). | |
| percentileRank | SamplingRatio | C | 0..1 | Percentile ranking of the target UE in the Cumulative Distribution Function of data usage for the population of all UEs. Shall be present if one of the elements in the "listOfAnaSubsets" attribute was set to PERCENTILE_RANKING. (NOTE 3, NOTE 6). | |

| | | | | | |
|--|---------------|---|------|---|--|
| ueRatio | SamplingRatio | C | 0..1 | Contains the percentage of UEs with same analytics result in the group or among all UEs. Shall be present if the analytics result applies for a group of UEs or any UE. | |
| confidence | UInteger | C | 0..1 | Indicates the confidence of the prediction. (NOTE 4) Shall be present if the analytics result is a prediction. Minimum = 0. Maximum = 100. | |
| <p>NOTE 1: One of "ueLoc" attribute or "snssai" attribute shall be provided.</p> <p>NOTE 2: When Target of Analytics Reporting is a UE group ID, or "Any UE" and a filter for Top-Heavy UEs, fixed, camper or traveller is included in the subscription, the NWDAF shall include the list of UEs matching the filter. This information element shall not be present when Target of Analytic Reporting is "Any UE" and no filter for Top-Heavy UEs, fixed, camper or traveller is included.</p> <p>NOTE 3: At least one value shall be provided. If the "listofAnaSubsets" attribute with value only applicable to "DISPERSION" event is present in the subscription request, then only the corresponding attribute(s) shall be present.</p> <p>NOTE 4: If the requested period identified by the "startTs" and "endTs" attributes in the EventReportingRequirement type is a future time period, which means the analytics result is a prediction. If no sufficient data is collected to provide the confidence of the prediction before the time deadline, the NWDAF shall return a zero confidence.</p> <p>NOTE 5: This parameter may only be provided when the Target of Analytics Reporting contains the "supis" attribute or the "gpsis" attribute in the "tgtUe" attribute.</p> <p>NOTE 6: This parameter shall not be provided when the "anyUe" attribute in the "tgtUe" attribute for the Target of Analytics Reporting was set to true.</p> <p>NOTE 7: If the "spatialGranSizeTa" and/or "spatialGranSizeCell" attributes are provided in the request, the number of TAs or cells contained in "ueLoc" attribute shall be smaller than or equal to the values of the "spatialGranSizeTa" and/or "spatialGranSizeCell" attributes.</p> | | | | | |

5.1.6.2.55 Type ApplicationVolume

Table 5.1.6.2.55-1: Definition of type ApplicationVolume

| Attribute name | Data type | P | Cardinality | Description | Applicability |
|----------------|---------------|---|-------------|--|---------------|
| appld | ApplicationId | M | 1 | Application where the UE or group of UEs disperse its transactions and/or data. May be present if "applds" attribute is included in the event subscription or analytics request. | |
| appVolume | Volume | M | 1 | Indicates the dispersion data volume per application in units of bytes. | |

5.1.6.2.56 Type RedundantTransmissionExpReq

Table 5.1.6.2.56-1: Definition of type RedundantTransmissionExpReq

| Attribute name | Data type | P | Cardinality | Description | Applicability |
|---|------------------------------|---|-------------|---|---------------|
| redTOrderCriter | RedTransExpOrderingCriterion | O | 0..1 | Indicates the ordering criterion for the list of UE Redundant Transmission Experience Analytics information. (NOTE 1) | |
| order | MatchingDirection | O | 0..1 | Indicate the order: ascending or descending. May be present when the "redTOrderCriter" attribute is included. (NOTE 1) (NOTE 2) | |
| <p>NOTE 1: If no attribute or no value is provided, default ordering may be applied.</p> <p>NOTE 2: "CROSSED" value in data type "MatchingDirection" is not applicable for the "order" attribute.</p> | | | | | |

5.1.6.2.57 Type RedundantTransmissionExplInfo

Table 5.1.6.2.57-1: Definition of type RedundantTransmissionInfo

| Attribute name | Data type | P | Cardinality | Description | Applicability |
|-----------------|--------------------------------------|---|-------------|--|---------------|
| spatialValidCon | NetworkAreaInfo | C | 0..1 | Area where the Redundant Transmission Experience applies. If "networkArea" attribute was provided in the request or subscription, shall be the requested network area. | |
| dnn | Dnn | C | 0..1 | Data Network Name associated for URLLC service. Shall be present if the "dnns" attribute was provided in the request or subscription. | |
| redTransExps | array(RedundantTransmissionExpPerTS) | M | 1..N | Redundant Transmission Experiences. | |

5.1.6.2.58 Type RedundantTransmissionExpPerTS

Table 5.1.6.2.58-1: Definition of type RedundantTransmissionExpPerTS

| Attribute name | Data type | P | Cardinality | Description | Applicability |
|--|---------------------------|---|-------------|--|---------------|
| tsStart | DateTime | M | 1 | Indicates the timestamp when the time slot starts during the Analytics target period. | |
| tsDuration | DurationSec | M | 1 | Indicates the time slot duration. (NOTE 2) | |
| obsvRedTransExp | ObservedRedundantTransExp | M | 1 | Represents the observed Redundant Transmission Experience. | |
| redTransStatus | boolean | O | 0..1 | Redundant Transmission Status. Set to "true" if redundant transmission was activated, otherwise set to "false". Default value is "false" if omitted. | |
| ueRatio | SamplingRatio | O | 0..1 | Percentage on which UE, any UE, or UE group efficiently use the PDU session with redundant transmission. | |
| confidence | UInteger | C | 0..1 | Indicates the confidence of the prediction. (NOTE 1) Shall be present if the analytics result is a prediction. Minimum = 0. Maximum = 100. | |
| NOTE 1: If the requested period identified by the "startTs" and "endTs" attributes in the "EventReportingRequirement" type is a future time period, which means the analytics result is a prediction. If no sufficient data is collected to provide the confidence of the prediction before the time deadline, the NWDAF shall return a zero confidence. | | | | | |
| NOTE 2: If the "temporalGranSize" attribute is provided in the request, the duration indicated by the "tsDuration" attribute shall be greater than or equal to the value of the "temporalGranSize" attribute. | | | | | |

5.1.6.2.59 Type WlanPerformanceReq

Table 5.1.6.2.59-1: Definition of type WlanPerformanceReq

| Attribute name | Data type | P | Cardinality | Description | Applicability |
|---|-----------------------|---|-------------|--|---------------|
| sslds | array(string) | O | 1..N | SSIDs of WLAN access points. | |
| bsslds | array(string) | O | 1..N | BSSIDs of WLAN access points. | |
| wlanOrderCriter | WlanOrderingCriterion | O | 0..1 | Indicates the ordering criterion for the list of WLAN performance information. | |
| order | MatchingDirection | O | 0..1 | Indicate the order: ascending or descending. May be present when the "wlanOrderCriter" attribute is included. (NOTE 1) | |
| NOTE 1: "CROSSED" value in data type "MatchingDirection" is not applicable for the "order" attribute. | | | | | |

5.1.6.2.60 Type WlanPerformanceInfo

Table 5.1.6.2.60-1: Definition of type WlanPerformanceInfo

| Attribute name | Data type | P | Cardinality | Description | Applicability |
|------------------|-----------------------------------|---|-------------|--|-------------------------|
| networkArea | NetworkAreaInfo | C | 0..1 | A list of TAIs or Cell Ids as the Area of Interest where the WLAN performance analytics applies. Shall be present if the "networkArea" attribute is included in the event subscription or analytics request. | |
| wlanPerSsidInfos | array(WlanPerSsidPerformanceInfo) | M | 1..N | WLAN performance information for SSID(s) of WLAN access points deployed in the Area of Interest. | |
| wlanPerUeidInfos | array(WlanPerUeidPerformanceInfo) | O | 1..N | WLAN performance information for UE Id(s) of WLAN access points deployed in the Area of Interest. | WlanPerformanceExt_AIML |

5.1.6.2.61 Type WlanPerSsidPerformanceInfo

Table 5.1.6.2.61-1: Definition of type WlanPerSsidPerformanceInfo

| Attribute name | Data type | P | Cardinality | Description | Applicability |
|----------------|---------------------------------|---|-------------|--|---------------|
| ssid | string | M | 1 | SSID of WLAN access point. | |
| wlanPerTsInfos | array(WlanPerTsPerformanceInfo) | M | 1..N | WLAN performance information per Time Slot during the analytics target period. | |

5.1.6.2.62 Type WlanPerTsPerformanceInfo

Table 5.1.6.2.62-1: Definition of type WlanPerTsPerformanceInfo

| Attribute name | Data type | P | Cardinality | Description | Applicability |
|--|--------------------|---|-------------|--|---------------|
| tsStart | DateTime | M | 1 | Indicates the timestamp when the time slot starts during the Analytics target period. | |
| tsDuration | DurationSec | M | 1 | Indicates the time slot duration. (NOTE 3) | |
| rssI | integer | C | 0..1 | Indicated the RSSI in the unit of dBm. Shall be present if one of the elements in the "listOfAnaSubsets" attribute was set to RSSI. (NOTE 1) | |
| rtt | UInteger | C | 0..1 | Indicates the RTT in the unit of millisecond. Shall be present if one of the elements in the "listOfAnaSubsets" attribute was set to RTT. (NOTE 1) | |
| trafficInfo | TrafficInformation | C | 0..1 | Traffic information including UL/DL data rate and/or Traffic volume. Shall be present if one of the elements in the "listOfAnaSubsets" attribute was set to TRAFFIC_INFO. (NOTE 1) | |
| numberOfUes | UInteger | C | 0..1 | Number of UEs observed for the SSID. Shall be present if one of the elements in the "listOfAnaSubsets" attribute was set to NUMBER_OF_UES. (NOTE 1) | |
| confidence | UInteger | C | 0..1 | Indicates the confidence of the prediction. (NOTE 2) Shall be present if the analytics result is a prediction. Minimum = 0. Maximum = 100. | |
| NOTE 1: At least one value shall be provided. If the "listOfAnaSubsets" attribute with value only applicable to WLAN event is present in the subscription request, then only the corresponding attribute(s) shall be present. | | | | | |
| NOTE 2: If the requested period identified by the "startTs" and "endTs" attributes in the "EventReportingRequirement" type is a future time period, which means the analytics result is a prediction. If no sufficient data is collected to provide the confidence of the prediction before the time deadline, the NWDAF shall return a zero confidence. | | | | | |
| NOTE 3: If the "temporalGranSize" attribute is provided in the request, the duration indicated by the "tsDuration" attribute shall be greater than or equal to the value of the "temporalGranSize" attribute. | | | | | |

5.1.6.2.63 Type TrafficInformation

Table 5.1.6.2.63-1: Definition of type TrafficInformation

| Attribute name | Data type | P | Cardinality | Description | Applicability |
|--|-----------|---|-------------|--|---------------|
| uplinkRate | BitRate | C | 0..1 | Uplink data rate. | |
| downlinkRate | BitRate | C | 0..1 | Downlink data rate. | |
| uplinkVolume | Volume | C | 0..1 | Uplink traffic volume in unit of octet. | |
| downlinkVolume | Volume | C | 0..1 | Downlink traffic volume in unit of octet. | |
| totalVolume | Volume | C | 0..1 | Total data octets for both uplink and downlink traffic volume. | |
| NOTE: At least one of above attributes shall be present. | | | | | |

5.1.6.2.64 Type AppListForUeComm

Table 5.1.6.2.64-1: Definition of type AppListForUeComm

| Attribute name | Data type | P | Cardinality | Description | Applicability |
|-----------------|-----------------|---|-------------|---|---------------|
| appld | ApplicationId | M | 1 | Identification of the application. | |
| startTime | DateTime | O | 0..1 | The time when the UE start to use the application. | |
| appDur | DurationSec | O | 0..1 | The length of time that the UE uses the application. | |
| occurRatio | SamplingRatio | O | 0..1 | In UE Communication Statistics, it represents the proportion of UE using the application in the requested time period. In UE Communication Predictions, it represents the probability that the UE uses the application. | |
| spatialValidity | NetworkAreaInfo | O | 0..1 | The area where the service behavior applies. (NOTE) | |

NOTE: If the "spatialGranSizeTa" and/or "spatialGranSizeCell" attributes are provided in the request, the number of TAs or cells contained in "spatialValidity" attribute shall be smaller than or equal to the values of the "spatialGranSizeTa" and/or "spatialGranSizeCell" attributes.

5.1.6.2.65 Type SessInactTimerForUeComm

Table 5.1.6.2.65-1: Definition of type SessInactTimerForUeComm

| Attribute name | Data type | P | Cardinality | Description | Applicability |
|-------------------|--------------|---|-------------|---|---------------|
| n4SessId | PduSessionId | M | 1 | The identification of the N4 Session. | |
| sessInactiveTimer | DurationSec | M | 1 | The value of the N4 Session inactivity timer. | |

5.1.6.2.66 Type DnPerformanceReq

Table 5.1.6.2.66-1: Definition of type DnPerformanceReq

| Attribute name | Data type | P | Cardinality | Description | Applicability |
|-------------------|-------------------------|---|-------------|--|---------------|
| dnPerfOrderCriter | DnPerfOrderingCriterion | O | 0..1 | Indicates the preferred order criterion of a list of Network Performance analytics results. | |
| order | MatchingDirection | O | 0..1 | Indicate the order: ascending or descending. May be present when the "dnPerfOrderCriter" attribute is included. (NOTE 1) | |
| reportThresholds | array(ThresholdLevel) | C | 1..N | Each of the element represents the reporting threshold of an analytics subset. (NOTE 2) | |

NOTE 1: "CROSSED" value in data type "MatchingDirection" is not applicable for the "order" attribute.

NOTE 2: The value of "reportThresholds" attribute match in sequence with the properties in the "listOfAnaSubsets" attribute. This property shall only be provided if the "notifMethod" in "evtReq" is set to "ON_EVENT_DETECTION" or "notificationMethod" in "eventSubscriptions" is set to "THRESHOLD" or omitted.

5.1.6.2.67 Type: RatFreqInformation

Table 5.1.6.2.67-1: Definition of type RatFreqInformation

| Attribute name | Data type | P | Cardinality | Description | Applicability |
|---|-------------------|---|-------------|--|---------------|
| allFreq | boolean | C | 0..1 | Set to "true" to indicate to handle all the frequencies the NWDAF received, set to "false" to indicate not to handle all the frequencies the NWDAF received. Default value is "false" if omitted. (NOTE 1) | |
| allRat | boolean | C | 0..1 | Set to "true" to indicate to handle all the RAT types the NWDAF received, set to "false" to indicate not to handle all the RAT types the NWDAF received. Default value is "false" if omitted. (NOTE 1) | |
| freq | ArfcnValueNR | C | 0..1 | Identification of the frequency of UE's serving cell(s) where the subscription/request applies. (NOTE 1) | |
| ratType | RatType | C | 0..1 | Identification of the RAT type where the subscription/request applies. (NOTE 1) | |
| svcExpThreshold | ThresholdLevel | C | 0..1 | Service Experience Threshold value. (NOTE 2). | |
| matchingDir | MatchingDirection | O | 0..1 | The matching direction may be provided alongside the service experience threshold. If omitted, the default value is CROSSED. | |
| NOTE 1: The "allFreq" attribute and the "freq" attribute are mutually exclusive. The "allRat" attribute and the "ratType" attribute are mutually exclusive. If both the "allFreq" attribute and the "allRat" attribute are present, then indicate all the RAT type(s) and Frequency(ies) values the NWDAF received. | | | | | |
| NOTE 2: Shall only be present in the subscription request as the service experience threshold value(s) for the RAT Type(s) and/or Frequency value(s) if the "notifMethod" in "evtReq" is set to "ON_EVENT_DETECTION" or "notificationMethod" in "eventSubscriptions" is set to "THRESHOLD" or omitted. | | | | | |

5.1.6.2.68 Type PrevSubInfo

Table 5.1.6.2.68-1: Definition of type PrevSubInfo

| Attribute name | Data type | P | Cardinality | Description | Applicability |
|--|-------------------------------------|---|-------------|---|---------------|
| producerId | NfInstanceId | C | 0..1 | NWDAF instance identifier to which the NF service consumer has established this subscription. (NOTE) | |
| producerSetId | NfSetId | C | 0..1 | NWDAF set identifier to which the NF service consumer has established this subscription. (NOTE) | |
| subscriptionId | string | M | 1 | The identifier of the specific analytics subscription. | |
| nfAnaEvents | array(NwdafEvent) | O | 1..N | List of analytics types for which NF related analytics contexts can be retrieved. | |
| ueAnaEvents | array(UeAnalyticsContextDescriptor) | O | 1..N | List of objects that indicate for which SUPI and analytics types combinations analytics context can be retrieved. | |
| NOTE: One of "producerId" or "producerSetId" attributes shall be provided. | | | | | |

5.1.6.2.69 Type MLModelInfo

Table 5.1.6.2.69-1: Definition of type MLModelInfo

| Attribute name | Data type | P | Cardinality | Description | Applicability |
|--|--------------------|---|-------------|---|---------------|
| mIFileAddr | array(MLModelAddr) | O | 1..N | Addresses of ML model files. May be included only when the source NWDAF itself provides the trained ML model(s) for the analytics subscription(s) being transferred | |
| modelProvd | NfInstanceld | C | 0..1 | NF instance identifier of the ML model provider NWDAF from which the NF service consumer currently subscribes to the ML model information. (NOTE) | |
| modelProvSetId | NfSetId | C | 0..1 | The Set ID of NWDAF(s) to which the current NWDAF subscribe the ML model. (NOTE) | |
| NOTE: One of the "modelProvd" and "modelProvSetId" attributes shall be provided. | | | | | |

5.1.6.2.70 Type ObservedRedundantTransExp

Table 5.1.6.2.70-1: Definition of type ObservedRedundantTransExp

| Attribute name | Data type | P | Cardinality | Description | Applicability |
|------------------|-----------------|---|-------------|--|------------------------------|
| avgPktDropRateUI | PacketLossRate | C | 0..1 | Average uplink packet drop rate on GTP-U path on N3. Shall be present if one of the element in the "listOfAnaSubsets" attribute was set to AVG_UL_PKT_DROP_RATE. | |
| varPktDropRateUI | Float | C | 0..1 | Variance of uplink packet drop rate on GTP-U path on N3. Shall be present if one of the element in the "listOfAnaSubsets" attribute was set to VAR_UL_PKT_DROP_RATE. | |
| avgPktDropRateDI | PacketLossRate | C | 0..1 | Average downlink packet drop rate on GTP-U path on N3. Shall be present if one of the element in the "listOfAnaSubsets" attribute was set to AVG_DL_PKT_DROP_RATE. | |
| varPktDropRateDI | Float | C | 0..1 | Variance of downlink packet drop rate on GTP-U path on N3. Shall be present if one of the element in the "listOfAnaSubsets" attribute was set to VAR_DL_PKT_DROP_RATE. | |
| avgPktDelayUI | PacketDelBudget | C | 0..1 | Average uplink packet delay round trip on GTP-U path on N3. Shall be present if one of the element in the "listOfAnaSubsets" attribute was set to AVG_UL_PKT_DELAY. | |
| varPktDelayUI | Float | C | 0..1 | Variance uplink packet delay round trip on GTP-U path on N3. Shall be present if one of the element in the "listOfAnaSubsets" attribute was set to VAR_UL_PKT_DELAY. | |
| avgPktDelayDI | PacketDelBudget | C | 0..1 | Average downlink packet delay round trip on GTP-U path on N3. Shall be present if one of the element in the "listOfAnaSubsets" attribute was set to AVG_DL_PKT_DELAY. | |
| varPktDelayDI | Float | C | 0..1 | Variance downlink packet delay round trip on GTP-U path on N3. Shall be present if one of the element in the "listOfAnaSubsets" attribute was set to VAR_DL_PKT_DELAY. | |
| avgE2ePktDelayUI | PacketDelBudget | C | 0..1 | Indicates average End-to-End (between UE and UPF) uplink packet delay. Shall be present if one of the element in the "listOfAnaSubsets" attribute was set to AVG_E2E_UL_PKT_DELAY. | RedundantTransExp Ext_eNA |
| varE2ePktDelayUI | Float | C | 0..1 | Indicates the variance of End-to-End (between UE and UPF) uplink packet delay. Shall be present if one of the element in the "listOfAnaSubsets" attribute was set to VAR_E2E_UL_PKT_DELAY. | RedundantTransExp Ext_eNA |

| | | | | | |
|---------------------|-----------------|---|------|---|------------------------------|
| avgE2ePktDelayDI | PacketDelBudget | C | 0..1 | Indicates average End-to-End (between UE and UPF) downlink packet delay. Shall be present if one of the element in the "listOfAnaSubsets" attribute was set to AVG_E2E_DL_PKT_DELAY. | RedundantTransExp Ext_eNA |
| varE2ePktDelayDI | Float | C | 0..1 | Indicates the variance of End-to-End (between UE and UPF) downlink packet delay. Shall be present if one of the element in the "listOfAnaSubsets" attribute was set to VAR_E2E_DL_PKT_DELAY. | RedundantTransExp Ext_eNA |
| avgE2ePktLossRateUI | PacketLossRate | C | 0..1 | Indicates average End-to-End (between UE and UPF) uplink packet loss rate. Shall be present if one of the element in the "listOfAnaSubsets" attribute was set to AVG_E2E_UL_PKT_LOSS_RATE. | RedundantTransExp Ext_eNA |
| varE2ePktLossRateUI | Float | C | 0..1 | Indicates the variance of End-to-End (between UE and UPF) uplink packet loss rate. Shall be present if one of the element in the "listOfAnaSubsets" attribute was set to VAR_E2E_UL_PKT_LOSS_RATE. | RedundantTransExp Ext_eNA |
| avgE2ePktLossRateDI | PacketLossRate | C | 0..1 | Indicates average End-to-End (between UE and UPF) downlink packet loss rate. Shall be present if one of the element in the "listOfAnaSubsets" attribute was set to AVG_E2E_DL_PKT_LOSS_RATE. | RedundantTransExp Ext_eNA |
| varE2ePktLossRateDI | Float | C | 0..1 | Indicates the variance of End-to-End (between UE and UPF) downlink packet loss rate. Shall be present if one of the element in the "listOfAnaSubsets" attribute was set to VAR_E2E_DL_PKT_LOSS_RATE. | RedundantTransExp Ext_eNA |

5.1.6.2.71 Type UeMobilityReq

Table 5.1.6.2.71-1: Definition of type UeMobilityReq

| Attribute name | Data type | P | Cardinality | Description | Applicability |
|--|--------------------------|---|-------------|---|---------------|
| orderCriterion | UeMobilityOrderCriterion | O | 0..1 | The ordering criterion for the list of UE mobility analytics. | |
| orderDirection | MatchingDirection | O | 0..1 | Indicate the order: ascending or descending time slot start. May be present when the "orderCriterion" attribute is included. (NOTE 1) | |
| ueLocOrderInd | boolean | O | 0..1 | UE Location order indication. Set to "true" to indicate the NWDAF to provide UE locations in the UE Mobility analytics in time order, otherwise set to "false" or omitted. (NOTE 2) | |
| distThresholds | array(Uinteger) | O | 1..N | Indicates the linear distance threshold, i.e. if the straight line distance that the UE moves from the previous location to the current location exceeds the threshold, the analytics needs to be reported. | |
| NOTE 1: The "CROSSED" value in "MatchingDirection" data type is not applicable for this attribute. NOTE 2: If this attribute was set to "true", the NWDAF does not aggregate the UE locations in a long duration but provides the UE locations one by one in their own time period, i.e. the "locInfos" contained in UeMobility data type has only one UE location which indicates the UE is located in this location in the duration from the time slot start and the location information in adjacent durations is different from each other. Otherwise, if this attribute is included and set to "false" or omitted, the multiple UE locations will be aggregated. | | | | | |

5.1.6.2.72 Type UeCommReq

Table 5.1.6.2.72-1: Definition of type UeCommReq

| Attribute name | Data type | P | Cardinality | Description | Applicability |
|--|----------------------|---|-------------|---|---------------|
| orderCriterion | UeCommOrderCriterion | O | 0..1 | The ordering criterion for the list of UE communication analytics. | |
| orderDirection | MatchingDirection | O | 0..1 | Indicate the order: ascending or descending. May be present when the "orderCriterion" attribute is included. (NOTE) | |
| NOTE: The "CROSSED" value in "MatchingDirection" data type is not applicable for this attribute. | | | | | |

5.1.6.2.73 Type PfdDeterminationInfo

Table 5.1.6.2.73-1: Definition of type PfdDeterminationInfo

| Attribute name | Data type | P | Cardinality | Description | Applicability |
|-----------------|-------------------------|---|-------------|--|---------------|
| appld | ApplicationId | M | 1 | Represents a known application identifier that refers to the application detection filter. | |
| suggPfdInfoList | array(SuggestedPfdInfo) | M | 1..N | Represents the suggested PFD information for the application identifier. | |

5.1.6.2.74 Type PduSessionInfo

Table 5.1.6.2.74-1: Definition of type PduSessionInfo

| Attribute name | Data type | P | Cardinality | Description | Applicability |
|---|-------------------|---|-------------|---|---------------|
| pduSessType | PduSessionType | O | 0..1 | Represents the PDU Session Type. | |
| sscMode | SscMode | O | 0..1 | Represents the SSC mode of the PDU Session. | |
| accessTypes | array(AccessType) | O | 1..N | Represents the access types. | |
| NOTE: The consumer may provide one of "dnns", "snssais" (contained in EventSubscription data type), "pduSessType", "accessTypes" and "sscMode" attributes or provide a combination of these attributes. | | | | | |

5.1.6.2.75 Type DirectionInfo

Table 5.1.6.2.75-1: Definition of type DirectionInfo

| Attribute name | Data type | P | Cardinality | Description | Applicability |
|---|---------------|---|-------------|---|---------------|
| supi | Supi | C | 0..1 | Identifies a SUPI of a UE. (NOTE 1) | |
| gpsi | Gpsi | C | 0..1 | Identifies a GPSI of a UE. (NOTE 1) | |
| direction | Direction | M | 1 | Indicates the moving direction of the UE in the coverage area. | |
| numOfUe | UInteger | O | 0..1 | Indicate the total number of UEs in the specific direction. (NOTE 2) | |
| avrSpeed | Float | O | 0..1 | Indicate the average speed of users in the specific direction. (NOTE 2) | |
| ratio | SamplingRatio | O | 0..1 | Indicate the ratio of UEs in the specific direction. (NOTE 2) | |
| NOTE 1: The "supi" attribute and the "gpsi" attribute are mutually exclusive and one of them shall be provided by the NWDAF in the case of UE Mobility analytics. | | | | | |
| NOTE 2: This attribute may be provided in the case of Movement Behaviour analytics. | | | | | |

5.1.6.2.76 Type GeoDistributionInfo

Table 5.1.6.2.76-1: Definition of type GeoDistributionInfo

| Attribute name | Data type | P | Cardinality | Description | Applicability |
|---|--------------|---|-------------|---|---------------|
| loc | UserLocation | M | 1 | This attribute contains the detailed location, the ueLocationTimestamp attribute in the 3GPP access type of UserLocation data type shall not be provided. | |
| supis | array(Supi) | C | 1..N | Indicate SUPIs of a list of UE. Each element identifies a UE which is in the location. Shall only be included when used in the Nnwdaf service. (NOTE) | |
| gpsis | array(Gpsi) | C | 1..N | Indicate GPSIs of a list of UE. Each element identifies a UE which is in the location. Shall only be included when used in the Nnef service. (NOTE) | |
| NOTE: The "supis" attribute and the "gpsis" attribute are mutually exclusive. | | | | | |

5.1.6.2.77 Type PduSesTrafficInfo

Table 5.1.6.2.77-1: Definition of type PduSesTrafficInfo

| Attribute name | Data type | P | Cardinality | Description | Applicability |
|--|------------------|---|-------------|--|---------------|
| supis | array(Supi) | C | 1..N | Each element identifies an UE. May only be present if the subscription request applies to one or more UE(s). (NOTE 3) | |
| dnn | Dnn | C | 0..1 | Identifies DNN, a full DNN with both the Network Identifier and Operator Identifier, or a DNN with the Network Identifier only, for which analytics information is provided. Shall be present if the DNN was provided in the request or subscription. (NOTE 1) | |
| snssai | Snssai | C | 0..1 | Identifies the network slice information for which analytics information is provided. Shall be present if the S-NSSAI was provided in the request or subscription. (NOTE 1) | |
| tdMatchTrafs | array(TdTraffic) | C | 1..N | Identifies traffic that matches Traffic Descriptor provided by the consumer in those PDU Sessions identified by the S-NSSAI and DNN above and the volume. Shall be present if one of the elements in the "listOfAnaSubsets" attribute was set to "TRAFFIC_MATCH_TD". (NOTE 2) | |
| tdUnmatchTrafs | array(TdTraffic) | C | 1..N | Identifies traffic that does not match Traffic Descriptor provided by the consumer in those PDU Sessions identified by the S-NSSAI and DNN above and the volume. Shall be present if one of the elements in the "listOfAnaSubsets" attribute was set to "TRAFFIC_UNMATCH_TD". (NOTE 2) | |
| NOTE 1: At least one of the "dnn" and "snssai" attributes shall be provided for the PDU Session traffic statistics of the specific DNN and/or S-NSSAI. | | | | | |
| NOTE 2: At least one of the "tdMatchTrafs" and "tdUnmatchTrafs" attributes shall be provided. | | | | | |
| NOTE 3: When Target of Analytics Reporting is a UE group ID, or "Any UE" in the subscription, the NWDAF shall include the list of UEs matching the filter. | | | | | |

5.1.6.2.78 Type TdTraffic

Table 5.1.6.2.78-1: Definition of type TdTraffic

| Attribute name | Data type | P | Cardinality | Description | Applicability |
|----------------|-------------------------|---|-------------|---|---------------|
| pduSesTrafReqs | array(PduSesTrafficReq) | C | 1..N | Indicates the PDU Session traffic analytics requirements. Shall be present if the "pduSesTrafReqs" attribute was provided in the request or subscription. | |
| ulVol | Volume | O | 0..1 | Indicates the UL data volume exchanged. | |
| dlVol | Volume | O | 0..1 | Indicates the DL data volume exchanged. | |
| allVol | Volume | O | 0..1 | Indicates the overall data volume exchanged. | |
| ulNumOfPkt | UInteger | O | 0..1 | Indicates the number of UL packets exchanged. | |
| dlNumOfPkt | UInteger | O | 0..1 | Indicates the number of DL packets exchanged. | |
| allNumOfPkt | UInteger | O | 0..1 | Indicates the number of overall packets exchanged. | |

5.1.6.2.79 Type PduSesTrafficReq

Table 5.1.6.2.79-1: Definition of type PduSesTrafficReq

| Attribute name | Data type | P | Cardinality | Description | Applicability |
|----------------|------------------------|---|-------------|--|---------------|
| flowDescs | array(FlowDescription) | C | 1..N | Indicates traffic flow filtering description(s) for IP flow(s). | |
| appld | ApplicationId | C | 0..1 | Indicates an application identifier. | |
| domainDescs | array(string) | C | 1..N | FQDN(s) or a regular expression which are used as a domain name matching criteria. | |

NOTE: One of "flowDescs" attribute, "appld" attribute or "domainDescs" attribute shall be provided.

5.1.6.2.80 Type WlanPerUeldPerformanceInfo

Table 5.1.6.2.80-1: Definition of type WlanPerUeldPerformanceInfo

| Attribute name | Data type | P | Cardinality | Description | Applicability |
|----------------|---------------------------------|---|-------------|---|---------------|
| supi | Supi | C | 0..1 | Indicates the SUPI for a UE. (NOTE 1) | |
| gpsi | Gpsi | C | 0..1 | Indicates the GPSI for a UE. (NOTE 1) | |
| wlanPerTsInfos | array(WlanPerTsPerformanceInfo) | M | 1..N | WLAN performance information per Time Slot during the analytics target period. (NOTE 2) | |

NOTE 1: Exactly one of the "supi" and "gpsi" attributes shall be provided. The "supi" attribute is not applicable to the AnalyticsExposure API, the "gpsi" attribute is only applicable to the AnalyticsExposure API and not applicable in the current specification.

NOTE 2: The "numberOfUes" attribute is not applicable for the WlanPerUeldPerformanceInfo data type.

5.1.6.2.81 Type ResourceUsageRequirement

Table 5.1.6.2.81-1: Definition of type ResourceUsageRequirement

| Attribute name | Data type | P | Cardinality | Description | Applicability |
|----------------|------------------|---|-------------|--|---------------|
| tfcDir | TrafficDirection | O | 0..1 | The traffic direction for the resource usage information. If omitted, the value "UL_AND_DL" applies. | |
| valExp | ValueExpression | O | 0..1 | Indicates average or peak value of the resource usage for the network performance type. If omitted, the value "AVERAGE" applies. | |

5.1.6.2.82 Type E2eDataVolTransTimeReq

Table 5.1.6.2.82-1: Definition of type E2eDataVolTransTimeReq

| Attribute name | Data type | P | Cardinality | Description | Applicability |
|--|------------------------------|---|-------------|--|---------------|
| criterion | E2eDataVolTransTimeCriterion | O | 0..1 | Indicates the ordering criterion for the list of E2E data volume transfer time. | |
| order | MatchingDirection | O | 0..1 | Indicate the order: ascending or descending. May be present when the "criterion" attribute is included. (NOTE 1) | |
| highTransTmThr | UInteger | O | 0..1 | Indicates the threshold of high-transfer time in unit of millisecond. If the transfer time is equal to or greater than this threshold, the UEs are classified as high-transfer time. (NOTE 2) | |
| lowTransTmThr | UInteger | O | 0..1 | Indicates the threshold of low-transfer time in unit of millisecond. If the transfer time is equal to or lower than this threshold, the UEs are classified as low-transfer time. (NOTE 2) | |
| repeatDataTrans | UInteger | C | 0..1 | Target repetition number of data transmissions within the Analytics target period. (NOTE 3) | |
| tsIntervalDataTrans | DurationSec | C | 0..1 | Target time interval between data transmissions within the Analytics target period. (NOTE 3) | |
| dataVolume | DataVolume | O | 0..1 | Data Volume UL/DL: indicates a specific data volume per transmission either uplink from UE to AF or downlink from AF to UE when subscribed event is "E2E_DATA_VOL_TRANS_TIME". | |
| maxNumberUes | UInteger | O | 0..1 | The maximum number of UEs. | |
| <p>NOTE 1: "CROSSED" value in data type "MatchingDirection" is not applicable for the "order" attribute.</p> <p>NOTE 2: The value of "highTransTmThr" shall not be less than the value of "lowTransTmThr". If the value of "highTransTmThr" is greater than the value of "lowTransTmThr", then the UEs between "highTransTmThr" and "lowTransTmThr" are ranking as medium-transfer time. If the value of "highTransTmThr" is equal to the value of "lowTransTmThr", then no medium-transfer time class. This property shall only be provided if the "notifMethod" in "evtReq" is set to "ON_EVENT_DETECTION" or "notificationMethod" in "eventSubscriptions" is set to "THRESHOLD" or omitted.</p> <p>NOTE 3: Only one of "repeatDataTrans" or "tsIntervalDataTrans" attribute may be present.</p> | | | | | |

5.1.6.2.83 Type E2eDataVolTransTimeInfo

Table 5.1.6.2.83-1: Definition of type E2eDataVolTransTimeInfo

| Attribute name | Data type | P | Cardinality | Description | Applicability |
|---|----------------------------------|---|-------------|---|---------------|
| e2eDataVolTransTimes | array(E2eDataVolTransTimePerTS) | M | 1..N | List of E2E Data Volume Trans Time for the application per time slot. | |
| e2eDataVolTransTimeUeLists | array(E2eDataVolTransTimeUeList) | C | 1..N | Contains the list of UEs classified based on experience level of E2E Data Volume Transfer Time. Shall be present if one of the elements in the "listOfAnaSubsets" attribute was set to "E2E_DATA_VOL_TRANS_TIME_FOR_UE_LIST". | |
| geoDistrInfos | array(GeoDistributionInfo) | C | 1..N | Indicates the geographical distribution of the UEs per location information. Shall be present if one of the elements in the "listOfAnaSubsets" attribute was set to "UE_GEOG_DIST". | |
| confidence | UInteger | C | 0..1 | Indicates the confidence of the prediction. (NOTE) Shall be present if the analytics result is a prediction. Minimum = 0. Maximum = 100. | |
| NOTE: If the requested period identified by the "tsStart" and "tsDuration" attributes in the "e2eDataVolTransTimes" type leads to future time period, then the analytics result is a prediction. If no sufficient data is collected to provide the confidence of the prediction before the time deadline, the NWDAF shall return a zero confidence. | | | | | |

5.1.6.2.84 Type E2eDataVolTransTimePerTS

Table 5.1.6.2.84-1: Definition of type E2eDataVolTransTimePerTS

| Attribute name | Data type | P | Cardinality | Description | Applicability |
|--------------------------|----------------------------------|---|-------------|---|---------------|
| tsStart | DateTime | M | 1 | Indicates the timestamp when the time slot starts during the Analytics target period. | |
| tsDuration | DurationSec | M | 1 | Indicates the time slot duration of Analytics target period. | |
| e2eDataVolTransTimePerUe | array (E2eDataVolTransTimePerUe) | M | 1..N | Represents the E2E data volume transfer time per UE. | |

5.1.6.2.85 Type DataVolume

Table 5.1.6.2.85-1: Definition of type DataVolume

| Attribute name | Data type | P | Cardinality | Description | Applicability |
|--|-----------|---|-------------|---|---------------|
| uplinkVolume | Volume | C | 0..1 | Uplink traffic volume in unit of octet. | |
| downlinkVolume | Volume | C | 0..1 | Downlink traffic volume in unit of octet. | |
| NOTE: At least one of above attributes shall be present. | | | | | |

5.1.6.2.86 Type E2eDataVolTransTimePerUe

Table 5.1.6.2.86-1: Definition of type E2eDataVolTransTimePerUe

| Attribute name | Data type | P | Cardinality | Description | Applicability |
|------------------|------------------------|---|-------------|---|---------------|
| appld | ApplicationId | C | 0..1 | Indicates an application identifier. Shall be present if the "applds" attribute was provided in the request or subscription. | |
| ueLoc | UserLocation | C | 0..1 | TA or cells where the UE dispersed its transactions and/or data. Shall be present if "networkArea" attribute is included in the event subscription or analytics request. | |
| snssai | Snssai | C | 0..1 | Slice where the UE disperse its transactions and/or data. Shall be present if "snssais" attribute is included in the event subscription or analytics request. | |
| accessType | AccessType | O | 0..1 | The Access Type. | |
| ratTypes | array(RatType) | O | 1..N | The RAT Types. | |
| supi | Supi | C | 0..1 | Identifies the SUPI of an UE. May only be present if reporting inside 5GC. | |
| gpsi | Gpsi | C | 0..1 | Identifies the GPSI of an UE. May only be present if reused by the Nnef_AnalyticsExposure service reporting to external AF. | |
| dnn | Dnn | C | 0..1 | Identifies DNN, a full DNN with both the Network Identifier and Operator Identifier, or a DNN with the Network Identifier only. Shall be present if the "dnns" was provided in the request or subscription. | |
| spatialValid | NetworkAreaInfo | C | 0..1 | Represents the area where the End to End data transfer volume transfer time analytics applies. Shall be present if "networkArea" attribute was provided in the request or subscription. | |
| temporalValid | TimeWindow | O | 0..1 | Represents the valid period for the End to End data transfer volume transfer time analytics. | |
| dataVolTransTime | DataVolumeTransferTime | O | 0..1 | Indicates the E2E data volume transfer time and the data volume used to derive the transfer time. | |

5.1.6.2.87 Type E2eDataVolTransTimeUeList

Table 5.2.6.2.87-1: Definition of type E2eDataVolTransTimeUeList

| Attribute name | Data type | P | Cardinality | Description | Applicability |
|---|-----------------|---|-------------|---|---------------|
| highLevel | array(Supi) | C | 1..N | A list of UEs whose transfer time has reached or greater than the threshold of high level. This attribute may be present if the event subscription includes threshold for high level. (NOTE) | |
| mediumLevel | array(Supi) | C | 1..N | A list of UEs whose transfer time is within the threshold range of medium level. This attribute may be present if the value of "highTransTmThr" is greater than the value of "lowTransTmThr". (NOTE) | |
| lowLevel | array(Supi) | C | 1..N | A list of UEs whose transfer time has reached or lower than the threshold of low level. This attribute may be present if the event subscription includes threshold for low level. (NOTE) | |
| highRatio | SamplingRatio | C | 0..1 | This attribute contains ratio of UEs per E2E data volume transfer time for high level class. Shall be present if the analytics result applies for a group of UEs. | |
| mediumRatio | SamplingRatio | C | 0..1 | This attribute contains ratio of UEs per E2E data volume transfer time for medium level class. Shall be present if the analytics result applies for a group of UEs. | |
| lowRatio | SamplingRatio | C | 0..1 | This attribute contains ratio of UEs per E2E data volume transfer for low level time class. Shall be present if the analytics result applies for a group of UEs. | |
| spatialValidity | NetworkAreaInfo | C | 0..1 | Represents the area where the Classified E2E data volume transfer times for a list of UEs analytics applies. Shall be present if "networkArea" attribute was provided in the request or subscription. | |
| validityPeriod | TimeWindow | O | 0..1 | Represents the validity period for the Classified E2E data volume transfer times for a list of UEs statistics. | |
| NOTE: At least one of "highLevel", "mediumLevel" or "lowLevel" shall be provided. | | | | | |

5.1.6.2.88 Type AccuracyReq

Table 5.1.6.2.88-1: Definition of type AccuracyReq

| Attribute name | Data type | P | Cardinality | Description | Applicability |
|--------------------|-------------|---|-------------|---|---------------|
| accuTimeWin | TimeWindow | O | 0..1 | Indicates the time interval. Only the accuracy information which is generated within this time interval will be considered by the consumer. | |
| accuPeriod | DurationSec | O | 0..1 | The time period for reporting the accuracy information. | |
| accuDevThr | UInteger | O | 0..1 | The reporting threshold of deviation value. Minimum = 0. Maximum = 100. | |
| minNum | UInteger | O | 0..1 | The minimal number of analytics output provided by NWDAF that have to be considered in the determination of the accuracy information. | |
| updatedAnaFlg | boolean | O | 0..1 | Indicates the updated Analytics flag. Set to "true" indicates that the NWDAF can provide the updated analytics if the analytics can be generated within the analytics accuracy information time window, which is specified by "accuTimeWin" attribute. Otherwise set to "false". Default value is "false" if omitted. | |
| correctionInterval | DurationSec | O | 0..1 | The relative time interval with respect to the time when the analytics is provided. It indicates the time interval during which the updated analytics can be accepted by the analytics consumer. | |

5.1.6.2.89 Type AccuracyInfo

Table 5.1.6.2.89-1: Definition of type AccuracyInfo

| Attribute name | Data type | P | Cardinality | Description | Applicability |
|----------------|-----------------------------|---|-------------|---|---------------|
| accuracyVal | UInteger | M | 1 | The accuracy value. Indicates percentage number of correct predictions out of all predictions. Minimum = 0. Maximum = 100. (NOTE) | |
| accuSampleNbr | UInteger | O | 0..1 | Indicates the analytics accuracy checking sampling number. | |
| anaAccuInd | AnalyticsAccuracyIndication | O | 0..1 | Indicates whether the accuracy value meet the analytics accuracy requirement or not. | |

NOTE: The NWDAF containing AnLF determines whether the prediction is correct one is up to implementation.

5.1.6.2.90 Type DataVolumeTransferTime

Table 5.1.6.2.90-1: Definition of type DataVolumeTransferTime

| Attribute name | Data type | P | Cardinality | Description | Applicability |
|----------------|-----------|---|-------------|---|---------------|
| uplinkVolume | Volume | O | 0..1 | Uplink traffic volume in unit of octet. | |
| avgTransTimeUI | UInteger | O | 0..1 | The average time of E2E uplink data volume transfer in unit of millisecond. | |
| varTransTimeUI | Float | O | 0..1 | The E2E uplink data volume transfer time variance. | |
| downlinkVolume | Volume | O | 0..1 | Downlink traffic volume in unit of octet. | |
| avgTransTimeDI | UInteger | O | 0..1 | The average time of E2E downlink data volume transfer in unit of millisecond. | |
| varTransTimeDI | Float | O | 0..1 | The E2E downlink data volume transfer time variance. | |

5.1.6.2.91 Type MovBehavReq

Table 5.1.6.2.91-1: Definition of type MovBehavReq

| Attribute name | Data type | P | Cardinality | Description | Applicability |
|--|--------------------|---|-------------|--|---------------|
| locationGranReq | LocInfoGranularity | O | 0..1 | Indicates the preferred granularity of location information requirement. (NOTE) | |
| reportThresholds | ThresholdLevel | O | 0..1 | Threshold level of speed. | |
| NOTE: Only applicable to the "LON_AND_LAT_LEVEL" value within the "locationGranReq" attribute. | | | | | |

5.1.6.2.92 Type MovBehavInfo

Table 5.1.6.2.92-1: Definition of type MovBehavInfo

| Attribute name | Data type | P | Cardinality | Description | Applicability |
|---|-------------------------|---|-------------|---|---------------|
| geoLoc | GeographicalCoordinates | C | 0..1 | This attribute contains the geographical location (longitude and latitude level). Shall be provided when the "locationGranReq" attribute value "LON_AND_LAT_LEVEL" is subscribed or requested. | |
| movBehavs | array(MovBehav) | O | 1..N | The Movement Behaviour information per time slot. | |
| confidence | UInteger | C | 0..1 | Indicates the confidence of the prediction. (NOTE) Shall be present if the analytics result is a prediction. Minimum = 0. Maximum = 100. | |
| NOTE: If the requested period identified by the "startTs" and "endTs" attributes in the "EventReportingRequirement" type is a future time period, then the analytics result is a prediction. If no sufficient data is collected to provide the confidence of the prediction before the time deadline, the NWDAF shall return a zero confidence. | | | | | |

5.1.6.2.93 Type MovBehav

Table 5.1.6.2.93-1: Definition of type MovBehav

| Attribute name | Data type | P | Cardinality | Description | Applicability |
|------------------|---------------------------|---|-------------|--|---------------|
| tsStart | DateTime | M | 1 | Indicates the timestamp when the time slot starts during the Analytics target period. | |
| tsDuration | DurationSec | M | 1 | Indicates the time slot duration. | |
| numOfUe | UInteger | C | 0..1 | Indicate the total number of users in the area of interest. Shall be present if one of the elements in the "listOfAnaSubsets" attribute was set with value as "NUM_OF_UE". | |
| ratio | SamplingRatio | C | 0..1 | Ratio of moving users in the area of interest. Shall be present if one of the elements in the "listOfAnaSubsets" attribute was set with value as "MOV_UE_RATIO". | |
| avrSpeed | Float | C | 0..1 | Average speed of all users in the area of interest, expressed in kilometres per hour. Shall be present if one of the elements in the "listOfAnaSubsets" attribute was set with value as "AVR_SPEED". | |
| speedThresInfos | array(SpeedThresholdInfo) | C | 1..N | UEs information in the area of interest whose speed is faster than the speed threshold. Shall be present if one of the elements in the "listOfAnaSubsets" attribute was set with value as "SPEED_THRESHOLD". | |
| directionUeInfos | array(DirectionInfo) | C | 1..N | Heading directions information of the UE in the area of interest. Shall be present if one of the elements in the "listOfAnaSubsets" attribute was set with value as "MOV_UE_DIRECTION". | |

5.1.6.2.94 Type SpeedThresholdInfo

Table 5.1.6.2.94-1: Definition of type SpeedThresholdInfo

| Attribute name | Data type | P | Cardinality | Description | Applicability |
|----------------|---------------|---|-------------|--|---------------|
| speedThr | Float | M | 1 | Speed threshold utilized to filter the UEs, expressed in kilometres per hour. | |
| numOfUe | UInteger | O | 0..1 | Indicate the number of UEs whose speed is faster than the speed threshold. | |
| ratio | SamplingRatio | O | 0..1 | Indicate the percentage of UEs whose speed is faster than the speed threshold. | |

5.1.6.2.95 Type GeoLocation

Table 5.1.6.2.95-1: Definition of type GeoLocation

| Attribute name | Data type | P | Cardinality | Description | Applicability |
|--|---------------------------|---|-------------|--|---------------|
| point | Point | C | 0..1 | Horizontal location using geographical coordinates. (NOTE) | |
| pointAlt | PointAltitude | C | 0..1 | Horizontal and vertical location using geographical coordinates. (NOTE) | |
| refPoint | LocalOrigin | C | 0..1 | Reference point for the case of local co-ordinates. (NOTE) | |
| localCoords | RelativeCartesianLocation | C | 0..1 | Local co-ordinates representing horizontal and optionally also vertical distances from a reference point. (NOTE) | |
| NOTE: One of "point", "pointAlt" attribute, or the combination of "refPoint" and "localCoords" attributes shall be provided. | | | | | |

5.1.6.2.96 Type LocAccuracyReq

Table 5.1.6.2.96-1: Definition of type LocAccuracyReq

| Attribute name | Data type | P | Cardinality | Description | Applicability |
|---|-------------------|---|-------------|---|---------------|
| accThres | UInteger | O | 0..1 | The accuracy (percentage) threshold. The NWDAF is requested to report the location accuracy analytics when this threshold is crossed in the direction(s) indicated by the "accThresMatchDir" attribute. Minimum = 1 Maximum = 100 | |
| accThresMatchDir | MatchingDirection | O | 0..1 | Matching direction for the accuracy threshold. It may only be provided if the "accThres" attribute is provided. | |
| inOutThres | UInteger | O | 0..1 | Contains the threshold for the percentage of UEs that are indoors. It may only be provided in the subscription for a network area. The NWDAF is requested to report the location accuracy analytics when this threshold is crossed in the direction(s) indicated by the "inOutThresMatchDir" attribute. Minimum = 1 Maximum = 100 (NOTE) | |
| inOutThresMatchDir | MatchingDirection | O | 0..1 | Matching direction for the indoor/outdoor UEs percentage threshold. It may only be provided if the "inOutThres" attribute is provided. (NOTE) | |
| posMethod | PositioningMethod | O | 1..N | List of used positioning methods for which the NF service consumer wants to receive analytics. | |
| <p>NOTE: The attributes "inOutThres" and "inOutThresMatchDir" can be used to express the threshold and matching direction for the percentage of UEs that are outdoors since the percentage of outdoor UEs is equal to 100 minus the percentage of indoor UEs.</p> | | | | | |

5.1.6.2.97 Type LocAccuracyInfo

Table 5.1.6.2.97-1: Definition of type LocAccuracyInfo

| Attribute name | Data type | P | Cardinality | Description | Applicability |
|--|-----------------------------|---|-------------|--|---------------|
| locAccPerMeths | array(LocAccuracyPerMethod) | M | 1..N | Location accuracy information per positioning method. | |
| inOutUePct | UInteger | C | 0..1 | Contains the percentage of UEs that are indoors in the applicable area. It shall be provided if the subscription was targeting a network area and the "IN_OUT_PERCENT" analytics subset was requested. Minimum value = 0 Maximum value = 100 (NOTE 1)(NOTE 2) | |
| inOutInd | boolean | C | 0..1 | Indicates if the target location is indoors or outdoors. "true" means that the target location is indoors, while "false" means that the target location is outdoors. The default value is "false". It shall be provided if the subscription was targeting a specific location and the "IN_OUT_PERCENT" analytics subset was requested. (NOTE 1) | |
| confidence | UInteger | C | 0..1 | Indicates the confidence of the prediction.(NOTE 3) Shall be present if the analytics result is a prediction. Minimum = 0. Maximum = 100. | |
| <p>NOTE: 1 The attributes "inOutUePct" and "inOutInd" are mutually exclusive.</p> <p>NOTE: 2 The percentage of UEs that are outdoors in the applicable area is equal to 100 minus the value of the "inOutUePct" attribute.</p> <p>NOTE 3: If the requested period identified by the "startTs" and "endTs" attributes in the "EventReportingRequirement" type is a future time period, which means the analytics result is a prediction. If no sufficient data is collected to provide the confidence of the prediction before the time deadline, the NWDAF shall return a zero confidence.</p> | | | | | |

5.1.6.2.98 Type LocAccuracyPerMethod

Table 5.1.6.2.98-1: Definition of type LocAccuracyPerMethod

| Attribute name | Data type | P | Cardinality | Description | Applicability |
|--|-------------------|---|-------------|---|---------------|
| posMethod | PositioningMethod | M | 1 | The used positioning method. | |
| locAcc | UInteger | M | 1 | Location accuracy (percentage) for the given positioning method in the applicable area or location. Minimum value = 0 Maximum value = 100 | |
| losNlosPct | UInteger | O | 0..1 | Percentage of the LOS measurements among the measurements performed using this positioning method. It may be provided if the subscription was targeting a network area. Minimum value = 0 Maximum value = 100 (NOTE 1) | |
| losNlosInd | boolean | O | 0..1 | Indication whether the location is measured with LOS or NLOS using this positioning method: - "true": the location is measured with LOS; - "false"(default): the location is measured with NLOS. It may be provided if the subscription was targeting a specific location. (NOTE 2) | |
| NOTE 1: The percentage of the NLOS measurements is equal to 100 minus the value of the "losNlosPct" attribute. | | | | | |
| NOTE 2: The attributes "losNlosPct" and "losNlosInd" are mutually exclusive. | | | | | |

5.1.6.2.99 Type RelProxReq

Table 5.1.6.2.99-1: Definition of type RelProxReq

| Attribute name | Data type | P | Cardinality | Description | Applicability |
|----------------|---------------------------|---|-------------|---|---------------|
| direction | array(Direction) | O | 1..N | Indicates individual or set of direction(s) of interest. | |
| numOfUe | UInteger | O | 0..1 | Indicates the number of UEs for which one UE may report proximity information. | |
| proximityCrits | array(ProximityCriterion) | O | 1..N | One or several criteria to be considered when computing the relative proximity. | |

5.1.6.2.100 Type RelProxInfo

Table 5.1.6.2.100-1: Definition of type RelProxInfo

| Attribute name | Data type | P | Cardinality | Description | Applicability |
|----------------|---------------------|---|-------------|---|---------------|
| tsStart | DateTime | M | 1 | Indicates the timestamp when the time slot starts during the Analytics target period. | |
| tsDuration | DurationSec | M | 1 | Indicates the time slot duration. | |
| supis | array(Supi) | C | 1..N | Identifies the UE(s) to which the proximity information applies. If omitted, the information applies to all the target UE(s) that were indicated in the subscription/request. If provided, it shall be a subset of the target UE(s) that were indicated in the subscription/request. | |
| gpsis | array(Gpsi) | C | 1..N | Identifies the UE(s) to which the proximity information applies. If omitted, the information applies to all the target UE(s) that were indicated in the subscription/request. If provided, it shall be a subset of the target UE(s) that were indicated in the subscription/request. Not applicable for this API. | |
| ueProximities | array(UeProximity) | M | 1..N | Observed or Predicted proximity information. | |
| ttcInfo | TimeToCollisionInfo | C | 0..1 | Time To Collision (TTC) information. Shall be present if one of the elements in the "listOfAnaSubsets" attribute was set with value as "TIME_TO_COLLISION" and the analytics result is a prediction. | |

5.1.6.2.101 Type UeProximity

Table 5.1.6.2.101-1: Definition of type UeProximity

| Attribute name | Data type | P | Cardinality | Description | Applicability |
|----------------|---------------------|---|-------------|--|---------------|
| ueDistance | integer | O | 0..1 | Distance between two UEs, in centimeters. | |
| ueVelocity | VelocityEstimate | O | 0..1 | UE velocity. May be present if one of the elements in the "proximityCrits" attribute was set to VELOCITY. | |
| avrSpeed | Float | O | 0..1 | Average speed of the users which this proximity information applies to, expressed in kilometres per hour. May be present if one of the elements in the "proximityCrits" attribute was set to AVG_SPD. | |
| locOrientation | LocationOrientation | O | 0..1 | Indicates the preferred orientation of location information. May be present if one of the elements in the "proximityCrits" attribute was set to ORIENTATION. | |
| ueTrajectories | array(UeTrajectory) | O | 1..N | Indicates timestamped UE positions. May be present if one of the elements in the "proximityCrits" attribute was set to TRAJECTORY. | |
| ratio | SamplingRatio | O | 0..1 | Indicate ratio of UEs accounted based on proximity criteria. | |

5.1.6.2.102 Type UeTrajectory

Table 5.1.6.2.102-1: Definition of type UeTrajectory

| Attribute name | Data type | P | Cardinality | Description | Applicability |
|---|-----------------------|---|-------------|--|---------------|
| supi | Supi | C | 0..1 | Identifies a SUPI of a UE for which this trajectory applies. (NOTE) | |
| gpsi | Gpsi | C | 0..1 | Identifies a GPSI of a UE for which this trajectory applies. Not applicable for this API. (NOTE) | |
| timestampedLocs | array(TimestampedLoc) | M | 1..N | The timestamped locations of the trajectory of the UE. | |
| NOTE: One of "supi" or "gpsi" attributes shall be provided. | | | | | |

5.1.6.2.103 Type TimestampedLocation

Table 5.1.6.2.103-1: Definition of type TimestampedLocation

| Attribute name | Data type | P | Cardinality | Description | Applicability |
|----------------|--------------|---|-------------|--|---------------|
| ts | DateTime | M | 1 | Time stamp for the UE location. | |
| locInfo | LocationInfo | M | 1 | This attribute includes the UE location information at the time indicated by "ts" attribute. | |

5.1.6.2.104 Type TimeToCollisionInfo

Table 5.1.6.2.104-1: Definition of type TimeToCollisionInfo

| Attribute name | Data type | P | Cardinality | Description | Applicability |
|---|-----------|---|-------------|--|---------------|
| ttc | DateTime | O | 0..1 | Time until the predicted collision between UEs to which the proximity information applies. | |
| accuracy | UInteger | O | 0..1 | Accuracy of TTC (dependent on both the UE location accuracy and confidence of the prediction). Minimum = 0. Maximum = 100. | |
| confidence | UInteger | O | 0..1 | Indicates the confidence of the prediction. (NOTE) Minimum = 0. Maximum = 100. | |
| NOTE: If the requested period identified by the "startTs" and "endTs" attributes in the "EventReportingRequirement" type is a future time period, then the analytics result is a prediction. If no sufficient data is collected to provide the confidence of the prediction before the time deadline, the NWDAF shall return a zero confidence. | | | | | |

5.1.6.2.105 Type AnalyticsFeedbackInfo

Table 5.1.6.2.105-1: Definition of type AnalyticsFeedbackInfo

| Attribute name | Data type | P | Cardinality | Description | Applicability |
|----------------|-------------------|---|-------------|---|---------------|
| actionTimes | array(DateTime) | M | 1..N | The time(s) at which the NF service consumer took an action(s) influenced by the previously provided analytics, which may or may not affect the ground truth data corresponding to the subscribed analytics event at the time which the prediction refers to, and consequently affect the ML Model accuracy monitoring. | |
| usedAnaTypes | array(NwdafEvent) | O | 1..N | List of analytics types that were used for taking the action(s). | |
| impactInd | boolean | O | 0..1 | If provided and set to "true", it indicates that the action taken by the NF service consumer impacts the ground truth data. If provided and set to "false", it indicates that the action taken by the NF service consumer does not impact the ground truth data. If omitted, there is no information about the action having an impact on the ground truth data or not. | |

5.1.6.2.106 Type RoamingInfo

Table 5.1.6.2.106-1: Definition of type RoamingInfo

| Attribute name | Data type | P | Cardinality | Description | Applicability |
|-----------------|-------------------------|---|-------------|---|---------------|
| plmnId | PlmnIdNid | O | 0..1 | Identifier of the HPLMN (if the analytics are requested by an NF service consumer in the VPLMN) or the VPLMN (if the analytics are requested by an NF service consumer in the HPLMN). | |
| aois | array(GeographicalArea) | O | 1..N | Area of Interest for the analytics in the HPLMN (if the analytics are requested by an NF service consumer in the VPLMN) or the VPLMN (if the analytics are requested by an NF service consumer in the HPLMN). | |
| servingNfIds | array(NfInstanceId) | O | 1..N | NF ID(s) of the NF(s) serving the roaming UE(s) in the VPLMN. | |
| servingNfSetIds | array(NfSetId) | O | 1..N | NF Set ID(s) of the NF Set(s) serving the roaming UE(s) in the VPLMN. | |

5.1.6.2.107 Type SuggestedPfdInfo

Table 5.1.6.2.107-1: Definition of type SuggestedPfdInfo

| Attribute name | Data type | P | Cardinality | Description | Applicability |
|--|--------------------|---|-------------|--|---------------|
| pfdId | string | M | 1 | Identifier of the PFD (i.e., new PFD ID assigned by the NWDAF or the existing PFD ID retrieved from the NEF(PFD) which was generated by NWDAF). (NOTE 2) | |
| ip3TupleList | array(string) | O | 1..N | Represents IP 3-tuple list with protocol, IP address and port number of the application server side. The content of the string has the same encoding as the IPFilterRule AVP value as defined in IETF RFC 6733 [33]. (NOTE 2) | |
| urls | array(string) | O | 1..N | Represents a URL or a regular expression which is used to match the significant parts of the URL. (NOTE 2) | |
| domainNames | array(string) | O | 1..N | Represents an FQDN or a regular expression as a domain name matching criteria. (NOTE 2) | |
| dnProtocol | DomainNameProtocol | C | 0..1 | Represents the additional protocol and protocol field for domain names to be matched, it may only be provided when domainNames attribute is present. | |
| pfdConfidence | UInteger | O | 0..1 | Indicates the confidence on the provided PFD Determination analytics for the known Application identified by the included "appld" attribute. Minimum = 0. Maximum = 100. | |
| NOTE 1: For providing new suggested PFD information, the NWDAF shall assign a new "pfdId" value that is not yet used for this Application ID. | | | | | |
| NOTE 2: At least one of the "ip3TupleList", "urls", and "domainNames" attributes shall be included. If multiple attributes are included, the PFD is only matched when every attribute contained in the PFD has a matching value. | | | | | |

5.1.6.3 Simple data types and enumerations

5.1.6.3.1 Introduction

This clause defines simple data types and enumerations that can be referenced from data structures defined in the previous clauses.

5.1.6.3.2 Simple data types

The simple data types defined in table 5.1.6.3.2-1 shall be supported.

Table 5.1.6.3.2-1: Simple data types

| Type Name | Type Definition | Description | Applicability |
|----------------------|-----------------|--|---------------|
| AnySlice | boolean | "false" represents not applicable for all slices. "true" represents applicable for all slices. | |
| LoadLevelInformation | integer | Load level information of the network slice and the optionally associated network slice instance. Minimum = 0. Maximum = 100. | |

5.1.6.3.3 Enumeration: NotificationMethod

Table 5.1.6.3.3-1: Enumeration NotificationMethod

| Enumeration value | Description | Applicability |
|-------------------|--|---------------|
| PERIODIC | The subscription of NWDAF Event is periodically. The periodic of the notification is identified by repetitionPeriod defined in clause 5.1.6.2.3. | |
| THRESHOLD | The subscription of NWDAF Event is upon threshold exceeded. | |

5.1.6.3.4 Enumeration: NwdafEvent

Table 5.1.6.3.4-1: Enumeration NwdafEvent

| Enumeration value | Description | Applicability |
|-------------------------|--|--------------------------|
| NF_LOAD | Indicates that the event subscribed is NF Load. | NfLoad |
| QOS_SUSTAINABILITY | Indicates that the event subscribed is QoS sustainability. | QoSSustainability |
| SLICE_LOAD_LEVEL | Indicates that the event subscribed is load level information of Network Slice | |
| SERVICE_EXPERIENCE | Indicates that the event subscribed is service experience. | ServiceExperience |
| UE_MOBILITY | Indicates that the event subscribed is UE mobility information. | UeMobility |
| UE_COMM | Indicates that the event subscribed is UE communication information. | UeCommunication |
| ABNORMAL_BEHAVIOUR | Indicates that the event subscribed is abnormal behaviour information. | AbnormalBehaviour |
| USER_DATA_CONGESTION | Indicates that the event subscribed is user data congestion information | UserDataCongestion |
| NETWORK_PERFORMANCE | Indicates that the event subscribed is network performance information | NetworkPerformance |
| NSI_LOAD_LEVEL | Indicates that the event subscribed is load level information of Network Slice and the optionally associated Network Slice Instance | NsiLoad |
| DISPERSION | Indicates that the event subscribed is dispersion information. | Dispersion |
| RED_TRANS_EXP | Indicates that the event subscribed is redundant transmission experience. | RedundantTransmissionExp |
| WLAN_PERFORMANCE | Indicates that the event subscribed is WLAN performance. | WlanPerformance |
| DN_PERFORMANCE | Indicates that the event subscribed is DN performance information. | DnPerformance |
| E2E_DATA_VOL_TRANS_TIME | Indicates that the event subscribed is E2E data volume transfer time | E2eDataVolTransTime |
| SM_CONGESTION | Indicates that the event subscribed is the Session Management Congestion Control Experience information for specific DNN and/or S-NSSAI. | SMCCE |
| PFD_DETERMINATION | Indicates that the event subscribed is the PFD Determination information for known application identifier(s). | PfdDetermination |
| PDU_SESSION_TRAFFIC | Indicates that the event subscribed is the PDU Session traffic information. | PduSesTraffic |
| MOVEMENT_BEHAVIOUR | Indicates that the event subscribed is the Movement Behaviour information. | MovementBehaviour |
| LOC_ACCURACY | Indicates that the event subscribed is the Location Accuracy information. | LocAccuracy |
| RELATIVE_PROXIMITY | Indicates that the event subscribed is the Relative Proximity information. | RelativeProximity |

5.1.6.3.5 Enumeration: Accuracy

Table 5.1.6.3.5-1: Enumeration Accuracy

| Enumeration value | Description | Applicability |
|-------------------|-------------------|---------------|
| LOW | Low accuracy. | |
| MEDIUM | Medium accuracy. | ENAEExt |
| HIGH | High accuracy. | |
| HIGHEST | Highest accuracy. | ENAEExt |

5.1.6.3.6 Enumeration: ExceptionId

Table 5.1.6.3.6-1: Enumeration ExceptionId

| Enumeration value | Description | Applicability |
|--------------------------------|--|---------------|
| UNEXPECTED_UE_LOCATION | Unexpected UE location | |
| UNEXPECTED_LONG_LIVE_FLOW | Unexpected long-live rate flows | |
| UNEXPECTED_LARGE_RATE_FLOW | Unexpected large rate flows | |
| UNEXPECTED_WAKEUP | Unexpected wakeup | |
| SUSPICION_OF_DDoS_ATTACK | Suspicion of DDoS attack | |
| WRONG_DESTINATION_ADDRESS | Wrong destination address | |
| TOO_FREQUENT_SERVICE_ACCESS | Too frequent Service Access | |
| UNEXPECTED_RADIO_LINK_FAILURES | Unexpected radio link failures | |
| PING_PONG_ACROSS_CELLS | Ping-ponging across neighbouring cells | |

5.1.6.3.7 Enumeration: ExceptionTrend

Table 5.1.6.3.7-1: Enumeration ExceptionTrend

| Enumeration value | Description | Applicability |
|-------------------|---------------------------------------|---------------|
| UP | Up trend of the exception level. | |
| DOWN | Down trend of the exception level. | |
| UNKNOWN | Unknown trend of the exception level. | |
| STABLE | Stable trend of the exception level. | |

5.1.6.3.8 Enumeration: CongestionType

Table 5.1.6.3.8-1: Enumeration CongestionType

| Enumeration value | Description | Applicability |
|------------------------|--|---------------|
| USER_PLANE | The congestion analytics type is User Plane. | |
| CONTROL_PLANE | The congestion analytics type is Control Plane. | |
| USER_AND_CONTROL_PLANE | The congestion analytics type is User Plane and Control Plane. | |

5.1.6.3.9 Enumeration: TimeUnit

Table 5.1.6.3.9-1: Enumeration TimeUnit

| Enumeration value | Description | Applicability |
|-------------------|--------------------------|---------------|
| MINUTE | Time unit is per minute. | |
| HOUR | Time unit is per hour. | |
| DAY | Time unit is per day. | |

5.1.6.3.10 Enumeration: NetworkPerfType

Table 5.1.6.3.10-1: Enumeration NetworkPerfType

| Enumeration value | Description | Applicability |
|--------------------------------------|--|----------------------------|
| GNB_ACTIVE_RATIO | Indicates the ratio of gNB active (i.e. up and running) number to the total number of gNB. | |
| GNB_COMPUTING_USAGE | Indicates gNodeB computing resource usage. | |
| GNB_MEMORY_USAGE | Indicates gNodeB memory usage. | |
| GNB_DISK_USAGE | Indicates gNodeB disk usage. | |
| GNB_RSC_USAGE_OVERALL_TRAFFIC | The gNB resource usage. | NetworkPerformanceExt_AIML |
| GNB_RSC_USAGE_GBR_TRAFFIC | The gNB resource usage for GBR traffic. | NetworkPerformanceExt_AIML |
| GNB_RSC_USAGE_DELAY_CRIT_GBR_TRAFFIC | The gNB resource usage for Delay-critical GBR traffic. | NetworkPerformanceExt_AIML |
| NUM_OF_UE | Indicates number of UEs. | |
| SESS_SUCC_RATIO | Indicates ratio of successful setup of PDU sessions to total PDU session setup attempts. | |
| HO_SUCC_RATIO | Indicates Ratio of successful handovers to the total handover attempts. | |

5.1.6.3.11 Enumeration: ExpectedAnalyticsType

Table 5.1.6.3.11-1: Enumeration ExpectedAnalyticsType

| Enumeration value | Description | Applicability |
|---------------------|--|---------------|
| MOBILITY | Mobility related abnormal behaviour analytics is expected by the consumer | |
| COMMUN | Communication related abnormal behaviour analytics is expected by the consumer | |
| MOBILITY_AND_COMMUN | Both mobility and communication related abnormal behaviour analytics is expected by the consumer | |

5.1.6.3.12 Enumeration: MatchingDirection

Table 5.1.6.3.12-1: Enumeration MatchingDirection

| Enumeration value | Description | Applicability |
|-------------------|---|---------------|
| ASCENDING | Threshold is crossed in ascending direction. | |
| DESCENDING | Threshold is crossed in descending direction. | |
| CROSSED | Threshold is crossed either in ascending or descending direction. | |

5.1.6.3.13 Enumeration: NwdafFailureCode

Table 5.1.6.3.13-1: Enumeration NwdafFailureCode

| Enumeration value | Description | Applicability |
|--------------------------------------|---|------------------|
| UNAVAILABLE_DATA | Indicates the requested statistics information for the event is rejected since necessary data to perform the service is unavailable. | |
| BOTH_STAT_PRED_NOT_ALLOWED | Indicates the requested analysis information for the event is rejected since the start time is in the past and the end time is in the future, which means the NF service consumer requested both statistics and prediction for the analytics. | |
| PREDICTION_NOT_ALLOWED | Indicates that the request for the prediction of the analytics event is not allowed. | PredictionError |
| UNSATISFIED_REQUESTED_ANALYTICS_TIME | Indicates that the requested event is rejected since the analytics information is not ready when the time indicated by the "timeAnaNeeded" attribute (as provided during the creation or modification of subscription) is reached. | EneNA |
| NO_ROAMING_SUPPORT | Indicates that the request shall be rejected because roaming analytics or data are required and the NWDAF neither supports roaming exchange capability nor can it forward the request to another NWDAF. | RoamingAnalytics |
| OTHER | Indicates the requested analysis information for the event is rejected due to other reasons. | |

5.1.6.3.14 Enumeration: AnalyticsMetadata

Table 5.1.6.3.14-1: Enumeration AnalyticsMetadata

| Enumeration value | Description | Applicability |
|-------------------|--|---------------|
| NUM_OF_SAMPLES | Number of data samples used for the generation of the output analytics. | |
| DATA_WINDOW | Data time window of the data samples. | |
| DATA_STAT_PROPS | Dataset statistical properties of the data used to generate the analytics. | |
| STRATEGY | Output strategy used for the reporting of the analytics. | |
| ACCURACY | Level of accuracy reached for the analytics. | |

5.1.6.3.15 Enumeration: DatasetStatisticalProperty

Table 5.1.6.3.15-1: Enumeration DatasetStatisticalProperty

| Enumeration value | Description | Applicability |
|-------------------|---|---------------|
| UNIFORM_DIST_DATA | Indicates the use of data samples that are uniformly distributed according to the different aspects of the requested analytics. | |
| NO_OUTLIERS | Indicates that the data samples shall disregard data samples that are at the extreme boundaries of the value range. | |

5.1.6.3.16 Enumeration: OutputStrategy

Table 5.1.6.3.16-1: Enumeration OutputStrategy

| Enumeration value | Description | Applicability |
|-------------------|---|---------------|
| BINARY | Indicates that the analytics shall only be reported when the requested level of accuracy is reached within a cycle of periodic notification as defined in the analytics reporting information (i.e. in the ReportingInformation data type or the EventSubscription data type). | |
| GRADIENT | Indicates that the analytics shall be reported according with the periodicity defined in the analytics reporting information (i.e. in the ReportingInformation data type or the EventSubscription data type) irrespective of whether the requested level of accuracy has been reached or not. | |

5.1.6.3.17 Enumeration: TransferRequestType

Table 5.1.6.3.17-1: Enumeration TransferRequestType

| Enumeration value | Description | Applicability |
|-------------------|--|---------------|
| PREPARE | Indicates that the request is for analytics subscription transfer preparation. | |
| TRANSFER | Indicates that the request is for analytics subscription transfer execution. | |

5.1.6.3.18 Enumeration: AnalyticsSubset

Table 5.1.6.3.18-1: AnalyticsSubset

| Enumeration value | Description | Applicability |
|---|--|-----------------------|
| NUM_OF_UE_REG | The number of UE registered. This value is only applicable to NSI_LOAD_LEVEL event. | |
| NUM_OF_PDU_SESS_ESTBL | The number of PDU sessions established. This value is only applicable to NSI_LOAD_LEVEL event. | |
| RES_USAGE | The current usage of the virtual resources assigned to the NF instances belonging to a particular network slice instance. This value is only applicable to NSI_LOAD_LEVEL event. | |
| NUM_OF_EXCEED_RES_USAGE_LOAD_LEVEL_THR | The number of times the resource usage threshold of the network slice instance is reached or exceeded if a threshold value is provided by the consumer. This value is only applicable to NSI_LOAD_LEVEL event. | |
| PERIOD_OF_EXCEED_RES_USAGE_LOAD_LEVEL_THR | The time interval between each time the threshold being met or exceeded on the network slice (instance). This value is only applicable to NSI_LOAD_LEVEL event. | |
| EXCEED_LOAD_LEVEL_THRESHOLD | Whether the Load Level Threshold is met or exceeded by the statistics value. This value is only applicable to NSI_LOAD_LEVEL event. | |
| LIST_OF_TOP_APP_UL | The list of applications that contribute the most to the traffic in the UL direction. This value is only applicable to USER_DATA_CONGESTION event. | |
| LIST_OF_TOP_APP_DL | The list of applications that contribute the most to the traffic in the DL direction. This value is only applicable to USER_DATA_CONGESTION event. | |
| NF_STATUS | The availability status of the NF on the Analytics target period, expressed as a percentage of time per status value (registered, suspended, undiscoverable). This value is only applicable to NF_LOAD event. | |
| NF_RESOURCE_USAGE | The average usage of assigned resources (CPU, memory, storage). This value is only applicable to NF_LOAD event. | |
| NF_LOAD | The average load of the NF instance over the Analytics target period. This value is only applicable to NF_LOAD event. | |
| NF_PEAK_LOAD | The maximum load of the NF instance over the Analytics target period. This value is only applicable to NF_LOAD event. | |
| NF_LOAD_AVG_IN_AOI | The average load of the NF instances over the area of interest. This value is only applicable to NF_LOAD event. | |
| DISPER_AMOUNT | Indicates the dispersion amount of the reported data volume or transaction dispersion type. This value is only applicable to DISPERSION event. | |
| DISPER_CLASS | Indicates the dispersion mobility class (fixed, camper or traveller) upon set its usage threshold, and/or the top-heavy class upon set its percentile rating threshold. This value is only applicable to DISPERSION event. | |
| RANKING | Data/transaction usage ranked high (i.e.value 1), medium (2) or low (3). This value is only applicable to DISPERSION event. | |
| PERCENTILE_RANKING | Percentile ranking of the target UE in the Cumulative Distribution Function of data usage for the population of all UEs. This value is only applicable to DISPERSION event. | |
| RSSI | Indicated the RSSI in the unit of dBm. This value is only applicable to WLAN_PERFORMANCE event. | |
| RTT | Indicates the RTT in the unit of millisecond. This value is only applicable to WLAN_PERFORMANCE event. | |
| TRAFFIC_INFO | Traffic information including UL/DL data rate and/or Traffic volume. This value is only applicable to WLAN_PERFORMANCE event. | |
| NUMBER_OF_UES | Number of UEs observed for the SSID. This value is only applicable to WLAN_PERFORMANCE event. | |
| APP_LIST_FOR_UE_COMM | The analytics of the application list used by UE. This value is only applicable to UE_COMM event. | |
| N4_SESS_INACT_TIMER_FOR_UE_COMM | The N4 Session inactivity timer. This value is only applicable to UE_COMM event. | |
| AVG_TRAFFIC_RATE | Indicates average traffic rate. This value is only applicable to DN_PERFORMANCE event. | |
| MAX_TRAFFIC_RATE | Indicates maximum traffic rate. This value is only applicable to DN_PERFORMANCE event. | |
| AGG_TRAFFIC_RATE | Indicates aggregated traffic rate. This value is only applicable to DN_PERFORMANCE event. | DnPerformanceExt_AIML |

| | | |
|--------------------------|---|---|
| VAR_TRAFFIC_RATE | Indicates variance of traffic rate. This value is only applicable to DN_PERFORMANCE event. | DnPerformanceExt_AIML |
| AVG_PACKET_DELAY | Indicates average Packet Delay. This value is only applicable to DN_PERFORMANCE event. | |
| MAX_PACKET_DELAY | Indicates maximum Packet Delay. This value is only applicable to DN_PERFORMANCE event. | |
| VAR_PACKET_DELAY | Indicates variance of Packet Delay. This value is only applicable to DN_PERFORMANCE event. | DnPerformanceExt_AIML |
| AVG_PACKET_LOSS_RATE | Indicates average Packet Loss Rate. This value is only applicable to DN_PERFORMANCE event. | |
| MAX_PACKET_LOSS_RATE | Indicates maximum Packet Loss Rate. This value is only applicable to DN_PERFORMANCE event. | DnPerformanceExt_AIML |
| VAR_PACKET_LOSS_RATE | Indicates variance of Packet Loss Rate. This value is only applicable to DN_PERFORMANCE event. | DnPerformanceExt_AIML |
| UE_LOCATION | Indicates UE location information. This value is only applicable to SERVICE_EXPERIENCE event. | |
| LIST_OF_HIGH_EXP_UE | Indicates list of high experienced UE. This value is only applicable to SM_CONGESTION event. | |
| LIST_OF_MEDIUM_EXP_UE | Indicates list of medium experienced UE. This value is only applicable to SM_CONGESTION event. | |
| LIST_OF_LOW_EXP_UE | Indicates list of low experienced UE. This value is only applicable to SM_CONGESTION event. | |
| AVG_UL_PKT_DROP_RATE | Indicates average uplink packet drop rate on GTP-U path on N3. This value is only applicable to RED_TRANS_EXP event. | |
| VAR_UL_PKT_DROP_RATE | Indicates variance of uplink packet drop rate on GTP-U path on N3. This value is only applicable to RED_TRANS_EXP event. | |
| AVG_DL_PKT_DROP_RATE | Indicates average downlink packet drop rate on GTP-U path on N3. This value is only applicable to RED_TRANS_EXP event. | |
| VAR_DL_PKT_DROP_RATE | Indicates variance of downlink packet drop rate on GTP-U path on N3. This value is only applicable to RED_TRANS_EXP event. | |
| TRAFFIC_MATCH_TD | Identifies traffic that matches Traffic Descriptor provided by the consumer. This value is only applicable to PDU_SESSION_TRAFFIC event. | PduSesTraffic |
| TRAFFIC_UNMATCH_TD | Identifies traffic that does not match Traffic Descriptor provided by the consumer. This value is only applicable to PDU_SESSION_TRAFFIC event. | PduSesTraffic |
| NUMBER_OF_UE | Indicates the number of UEs. This value is only applicable to DN_PERFORMANCE event. | DnPerformanceExt_eNA |
| UE_GEOG_DIST | Indicates the geographical distribution of the UEs that can be selected by the AF for application service. This value is only applicable to UE_MOBILITY and E2E_DATA_VOL_TRANS_TIME events. | UeMobilityExt2_eNA E2eDataVolTransTime |
| UE_DIRECTION | Indicates the direction of the UEs. This value is only applicable to UE_MOBILITY event. | UeMobilityExt2_eNA |
| AVG_E2E_UL_PKT_DELAY | Indicates average End-to-End (between UE and UPF) uplink packet delay. This value is only applicable to RED_TRANS_EXP event. | RedundantTransExpExt_eNA |
| VAR_E2E_UL_PKT_DELAY | Indicates the variance of End-to-End (between UE and UPF) uplink packet delay. This value is only applicable to RED_TRANS_EXP event. | RedundantTransExpExt_eNA |
| AVG_E2E_DL_PKT_DELAY | Indicates average End-to-End (between UE and UPF) downlink packet delay. This value is only applicable to RED_TRANS_EXP event. | RedundantTransExpExt_eNA |
| VAR_E2E_DL_PKT_DELAY | Indicates the variance of End-to-End (between UE and UPF) downlink packet delay. This value is only applicable to RED_TRANS_EXP event. | RedundantTransExpExt_eNA |
| AVG_E2E_UL_PKT_LOSS_RATE | Indicates average End-to-End (between UE and UPF) uplink packet loss rate. This value is only applicable to RED_TRANS_EXP event. | RedundantTransExpExt_eNA |
| VAR_E2E_UL_PKT_LOSS_RATE | Indicates the variance of End-to-End (between UE and UPF) uplink packet loss rate. This value is only applicable to RED_TRANS_EXP event. | RedundantTransExpExt_eNA |
| AVG_E2E_DL_PKT_LOSS_RATE | Indicates average End-to-End (between UE and UPF) downlink packet loss rate. This value is only applicable to RED_TRANS_EXP event. | RedundantTransExpExt_eNA |

| | | |
|-------------------------------------|---|--------------------------|
| VAR_E2E_DL_PKT_LOSS_RATE | Indicates the variance of End-to-End (between UE and UPF) downlink packet loss rate. This value is only applicable to RED_TRANS_EXP event. | RedundantTransExpExt_eNA |
| E2E_DATA_VOL_TRANS_TIME_FOR_UE_LIST | Indicates the classified E2E data volume transfer time statistics or predictions for multiple UEs with respect to one or more reporting thresholds. | E2eDataVolTransTime |
| NUM_OF_UE | Indicates the total number of UEs in the area of interest. This value is only applicable to MOVEMENT_BEHAVIOUR event. | MovementBehaviour |
| MOV_UE_RATIO | Indicates the Ratio of moving UEs in the area of interest. This value is only applicable to MOVEMENT_BEHAVIOUR event. | MovementBehaviour |
| AVR_SPEED | Indicates the average speed of all UEs in the area of interest. This value is only applicable to MOVEMENT_BEHAVIOUR event. | MovementBehaviour |
| SPEED_THRESHOLD | Indicates the information on UEs in the area of interest whose speed is faster than the speed threshold. This value is only applicable to MOVEMENT_BEHAVIOUR event. | MovementBehaviour |
| MOV_UE_DIRECTION | Indicates the heading directions of the UE flow in the target area. This value is only applicable to MOVEMENT_BEHAVIOUR event. | MovementBehaviour |
| IN_OUT_PERCENT | Indicates the percentage of UEs that are indoors/outdoors. This value is only applicable to LOC_ACCURACY event. | LocAccuracy |
| TIME_TO_COLLISION | Indicates the time until for a collision with another UE happens. This value is only applicable to RELATIVE_PROXIMITY event prediction. | RelativeProximity |

5.1.6.3.19 Enumeration: DispersionType

Table 5.1.6.3.19-1: Enumeration DispersionType

| Enumeration value | Description | Applicability |
|-------------------|---|---------------|
| DVDA | Data Volume Dispersion Analytics. | |
| TDA | Transactions Dispersion Analytics. | |
| DVDA_AND_TDA | Data Volume Dispersion Analytics and Transactions Dispersion Analytics. | |

5.1.6.3.20 Enumeration: DispersionClass

Table 5.1.6.3.20-1: Enumeration DispersionClass

| Enumeration value | Description | Applicability |
|-------------------|---|---------------|
| FIXED | Dispersion class as fixed UE, its data or transaction usage at a location or a slice, is higher than its class threshold set for its all data or transaction usage. | |
| CAMPER | Dispersion class as camper UE, its data or transaction usage at a location or a slice, is higher than its class threshold and lower than the fixed class threshold set for its all data or transaction usage. | |
| TRAVELLER | Dispersion class as traveller UE, its data or transaction usage at a location or a slice, is lower than the camper class threshold set for its all data or transaction usage. | |
| TOP_HEAVY | Dispersion class as Top_Heavy UE, who's dispersion percentile rating at a location or a slice, is higher than its class threshold. | |

5.1.6.3.21 Enumeration: DispersionOrderingCriterion

Table 5.1.6.3.21-1: Enumeration DispersionOrderingCriterion

| Enumeration value | Description | Applicability |
|--------------------|---|---------------|
| TIME_SLOT_START | Indicates the order of time slot start. | |
| DISPERSION | Indicates the order of data/transaction dispersion. | |
| CLASSIFICATION | Indicates the order of data/transaction classification. | |
| RANKING | Indicates the order of data/transaction ranking. | |
| PERCENTILE_RANKING | Indicates the order of data/transaction percentile ranking. | |

5.1.6.3.22 Enumeration: RedTransExpOrderingCriterion

Table 5.1.6.3.22-1: Enumeration RedTransExpOrderingCriterion

| Enumeration value | Description | Applicability |
|-------------------|---|---------------|
| TIME_SLOT_START | Indicates the order of time slot start. | |
| RED_TRANS_EXP | Indicates the order of Redundant Transmission Experience. | |

5.1.6.3.23 Enumeration: WlanOrderingCriterion

Table 5.1.6.3.23-1: Enumeration WlanOrderingCriterion

| Enumeration value | Description | Applicability |
|-------------------|--|---------------|
| TIME_SLOT_START | Indicates the order of time slot start. | |
| NUMBER_OF_UES | Indicates the order of number of UEs. | |
| RSSI | Indicates the order of RSSI. | |
| RTT | Indicates the order of RTT. | |
| TRAFFIC_INFO | Indicates the order of Traffic Information | |

5.1.6.3.24 Enumeration: ServiceExperienceType

Table 5.1.6.3.24-1: Definition of type ServiceExperienceType

| Enumeration value | Description | Applicability |
|-------------------|---|---------------|
| VOICE | Indicates that the service experience analytics is for voice service. | |
| VIDEO | Indicates that the service experience analytics is for video service. | |
| OTHER | Indicates that the service experience analytics is for other service. | |

5.1.6.3.25 Enumeration: DnPerfOrderingCriterion

Table 5.1.6.3.25-1: Enumeration DnPerfOrderingCriterion

| Enumeration value | Description | Applicability |
|--------------------------|---|---------------|
| AVERAGE_TRAFFIC_RATE | Indicates the average traffic rate. | |
| MAXIMUM_TRAFFIC_RATE | Indicates the maximum traffic rate. | |
| AVERAGE_PACKET_DELAY | Indicates the average packet delay. | |
| MAXIMUM_PACKET_DELAY | Indicates the maximum packet delay. | |
| AVERAGE_PACKET_LOSS_RATE | Indicates the average packet loss rate. | |

5.1.6.3.26 Enumeration: TermCause

Table 5.1.6.3.26-1: Enumeration TermCause

| Enumeration value | Description | Applicability |
|----------------------|---|---------------|
| USER_CONSENT_REVOKED | The user consent has been revoked. | |
| NWDAF_OVERLOAD | The NWDAF is overloaded. | |
| UE_LEFT_AREA | The UE has moved out of the NWDAF serving area. | |

5.1.6.3.27 Enumeration: UserDataConOrderCrit

Table 5.1.6.3.27-1: Enumeration UserDataConOrderCrit

| Enumeration value | Description | Applicability |
|---------------------------|--|---------------|
| APPLICABLE_TIME_WINDOW | The ordering criterion is the Applicable Time Window. | |
| NETWORK_STATUS_INDICATION | The ordering criterion is the network status indication. | |

5.1.6.3.28 Enumeration: UeMobilityOrderCriterion

Table 5.1.6.3.28-1: Enumeration UeMobilityOrderCriterion

| Enumeration value | Description | Applicability |
|-------------------|--|---------------|
| TIME_SLOT | The ordering criterion is the time slot. | |

5.1.6.3.29 Enumeration: UeCommOrderCriterion

Table 5.1.6.3.29-1: Enumeration UeCommOrderCriterion

| Enumeration value | Description | Applicability |
|-------------------|---|---------------|
| START_TIME | The ordering criterion of the analytics is the start time. | |
| DURATION | The ordering criterion of the analytics is the duration of the communication. | |

5.1.6.3.30 Enumeration: NetworkPerfOrderCriterion

Table 5.1.6.3.30-1: Enumeration NetworkPerfOrderCriterion

| Enumeration value | Description | Applicability |
|--------------------|---|---------------|
| NUMBER_OF_UES | The ordering criterion of the analytics is the number of UEs. | |
| COMMUNICATION_PERF | The ordering criterion of the analytics is the communication performance. | |
| MOBILITY_PERF | The ordering criterion of the analytics is the mobility performance. | |

5.1.6.3.31 Enumeration: DeviceType

Table 5.1.6.3.31-1: Enumeration DeviceType

| Enumeration value | Description | Applicability |
|----------------------|----------------------|---------------|
| MOBILE_PHONE | Mobile Phone | |
| SMART_PHONE | Smartphone | |
| TABLET | Tablet | |
| DONGLE | Dongle | |
| MODEM | Modem | |
| WLAN_ROUTER | WLAN Router | |
| IOT_DEVICE | IoT Device | |
| WEARABLE | Wearable | |
| MOBILE_TEST_PLATFORM | Mobile Test Platform | |
| UNDEFINED | Undefined | |

5.1.6.3.32 Enumeration: LocInfoGranularity

Table 5.1.6.3.32-1: Enumeration LocInfoGranularity

| Enumeration value | Description | Applicability |
|-------------------|---|---------------|
| TA_LEVEL | Indicates location granularity of TA level. | |
| CELL_LEVEL | Indicates location granularity of Cell level. | |
| LON_AND_LAT_LEVEL | Indicates location granularity of longitude and latitude level. | |

5.1.6.3.33 Enumeration: TrafficDirection

Table 5.1.6.3.33-1: Enumeration TrafficDirection

| Enumeration value | Description | Applicability |
|-------------------|------------------------------|---------------|
| UL_AND_DL | Uplink and downlink traffic. | |
| UL | Uplink traffic. | |
| DL | Downlink traffic. | |

5.1.6.3.34 Enumeration: ValueExpression

Table 5.1.6.3.34-1: Enumeration ValueExpression

| Enumeration value | Description | Applicability |
|-------------------|--|---------------|
| AVERAGE | Resource usage information in average value. | |
| PEAK | Resource usage information in peak value. | |

5.1.6.3.35 Enumeration: E2eDataVolTransTimeCriterion

Table 5.1.6.3.35-1: Enumeration E2eDataVolTransTimeCriterion

| Enumeration value | Description | Applicability |
|-------------------------|--|---------------|
| E2E_DATA_VOL_TRANS_TIME | The ordering criterion is the E2E data volume transfer time. | |

5.1.6.3.36 Void

5.1.6.3.37 Enumeration: AnalyticsAccuracyIndication

Table 5.1.6.3.37-1: Enumeration AnalyticsAccuracyIndication

| Enumeration value | Description | Applicability |
|-------------------|--|---------------|
| MEET | Indicates meet the analytics accuracy requirement. | |
| NOT_MEET | Indicates not meet the analytics accuracy requirement. | |

5.1.6.3.38 Enumeration: LocationOrientation

Table 5.1.6.3.38-1: Enumeration LocationOrientation

| Enumeration value | Description | Applicability |
|-------------------|---|---------------|
| HORIZONTAL | Indicates horizontal orientation. | |
| VERTICAL | Indicates vertical orientation. | |
| BOTH | Indicates both horizontal and vertical orientation. | |

5.1.6.3.39 Enumeration: Direction

Table 5.1.6.3.39-1: Enumeration Direction

| Enumeration value | Description | Applicability |
|-------------------|----------------------|---------------|
| NORTH | North direction. | |
| SOUTH | South direction. | |
| EAST | East direction. | |
| WEST | West direction. | |
| NORTHWEST | Northwest direction. | |
| NORTHEAST | Northeast direction. | |
| SOUTHWEST | Southwest direction. | |
| SOUTHEAST | Southeast direction. | |

5.1.6.3.40 Enumeration: ProximityCriterion

Table 5.1.6.3.40-1: Enumeration ProximityCriterion

| Enumeration value | Description | Applicability |
|-------------------|----------------------|---------------|
| VELOCITY | Velocity. | |
| AVG_SPD | Average speed. | |
| ORIENTATION | Orientation. | |
| TRAJECTORY | Mobility trajectory. | |

5.1.7 Error handling

5.1.7.1 General

HTTP error handling shall be supported as specified in clause 5.2.4 of 3GPP TS 29.500 [6].

For the Nnwdaf_EventsSubscription API, HTTP error responses shall be supported as specified in clause 4.8 of 3GPP TS 29.501 [7].

Protocol errors and application errors specified in table 5.2.7.2-1 of 3GPP TS 29.500 [6] shall be supported for an HTTP method if the corresponding HTTP status codes are specified as mandatory for that HTTP method in table 5.2.7.1-1 of 3GPP TS 29.500 [6].

In addition, the requirements in the following clauses shall apply.

5.1.7.2 Protocol Errors

In this Release of the specification, there are no additional protocol errors applicable for the Nnwdaf_EventsSubscription API.

5.1.7.3 Application Errors

The application errors defined for the Nnwdaf_EventsSubscription API are listed in table 5.1.7.3-1.

Table 5.1.7.3-1: Application errors

| Application Error | HTTP status code | Description | Applicability |
|----------------------------|--|---|------------------|
| BOTH_STAT_PRED_NOT_ALLOWED | 400 Bad Request | Indicates that the request shall be rejected, because for the requested observation period, the start time is in the past and the end time is in the future, which means the NF service consumer requested both statistics and prediction for the analytics is not allowed. | |
| UE_AGGREGATION_NOT_ALLOWED | 400 Bad Request | For the requested UE location aggregation in UE Mobility analytics is not allowed. | |
| PREDICTION_NOT_ALLOWED | 400 Bad Request | Indicates that the request shall be rejected because the prediction for the analytics event is not allowed. | PredictionError |
| USER_CONSENT_NOT_GRANTED | 403 Forbidden | Indicates that the request shall be rejected because an impacted user has not provided the required user consent. | |
| NO_ROAMING_SUPPORT | 403 Forbidden | Indicates that the request shall be rejected because roaming analytics or data are required and the NWDAF neither supports roaming exchange capability nor can it forward the request to another NWDAF. | RoamingAnalytics |
| UNAVAILABLE_DATA | 500 Internal Server Error | Indicates the requested statistics in the past is rejected since necessary data to perform the service is unavailable. | |
| NOTE: | Including a "ProblemDetails" data structure with the "cause" attribute in the HTTP response is optional unless explicitly mandated in the service operation clauses. | | |

5.1.8 Feature negotiation

The optional features in table 5.1.8-1 are defined for the Nnwdaf_EventsSubscription API. They shall be negotiated using the extensibility mechanism defined in clause 6.6 of 3GPP TS 29.500 [6].

Table 5.1.8-1: Supported Features

| Feature number | Feature Name | Description |
|----------------|--------------------------|--|
| 1 | ServiceExperience | This feature indicates support for the event related to service experience. |
| 2 | UeMobility | This feature indicates the support of analytics based on UE mobility information. |
| 3 | UeCommunication | This feature indicates the support of analytics based on UE communication information. |
| 4 | QoSsustainability | This feature indicates support for the event related to QoS sustainability. |
| 5 | AbnormalBehaviour | This feature indicates support for the event related to abnormal behaviour information. |
| 6 | UserDataCongestion | This feature indicates support for the event related to user data congestion. |
| 7 | NfLoad | This feature indicates the support of the analytics related to the load of NF instances. |
| 8 | NetworkPerformance | This feature indicates the support of analytics based on network performance. |
| 9 | NsiLoad | This feature indicates the support of the event related to the load level of Network Slice and the optionally associated Network Slice Instance. |
| 10 | ES3XX | Extended Support for 3xx redirections. This feature indicates the support of redirection for any service operation, according to Stateless NF procedures as specified in clauses 6.5.3.2 and 6.5.3.3 of 3GPP TS 29.500 [6] and according to HTTP redirection principles for indirect communication, as specified in clause 6.10.9 of 3GPP TS 29.500 [6]. |
| 11 | EneNA | This feature indicates support for the enhancements of network data analytics requirements. |
| 12 | UserDataCongestionExt | This feature indicates support for the extensions to the event related to user data congestion, including support of GPSI and/or list of Top applications. Supporting this feature also requires the support of feature UserDataCongestion. |
| 13 | Aggregation | This feature indicates support for analytics aggregation. |
| 14 | NsiLoadExt | This feature indicates support for the extensions to the event related to the load level of Network Slice and the optionally associated Network Slice Instance, including support of area of interest, NF load information and number of UE or number of PDU Session. Supporting this feature also requires the support of feature NsiLoad. |
| 15 | ServiceExperienceExt | This feature indicates support for the extensions to the event related to service experience, including support of RAT type and/or Frequency. Supporting this feature also requires the support of feature ServiceExperience. |
| 16 | DnPerformance | This feature indicates the support of the analytics related to DN performance. |
| 17 | NfLoadExt | This feature indicates support for the extensions to the event related to the load of NF instances, including NF load over area of interest. Supporting this feature also requires the support of feature NfLoad. |
| 18 | Dispersion | This feature indicates support of the analytics related to dispersion analytics information. |
| 19 | RedundantTransmissionExp | This feature indicates support of the analytics related to redundant transmission experience analytics information. |
| 20 | WlanPerformance | This feature indicates support of the analytics related to WLAN performance information. |
| 21 | UeCommunicationExt | This feature indicates the support for the extensions to the event related to UE communication, including support of reporting the analytics of the application list used by UE, N4 Session inactivity timer, and whether the UE communicates periodically or not. Supporting this feature also requires the support of UeCommunication feature. |
| 22 | UeMobilityExt | This feature indicates support for extensions to the event related to UE mobility, including support of LADN DNN to refer the LADN service area as the AOI. Supporting this feature also requires the support of feature UeMobility. |

| | | |
|----|-----------------------------|---|
| 23 | AnaCtxTransfer | This feature indicates support for functionality related to Analytics Context Transfer. |
| 24 | AnaSubTransfer | This feature indicates support for Analytics Subscription Transfer initiated by the source NWDAF. |
| 25 | UserConsent | Indicates the support of detailed handling of user consent, e.g. error responses related to the lack of user consent. |
| 26 | TermRequest | This feature indicates support for Analytics Subscription termination requests sent by the NWDAF to the NF service consumer. |
| 27 | ENAEExt | This feature indicates support for the general enhancements of network data analytics requirements, including support more level of accuracy and support for use case context sent by the NF service consumer to the NWDAF. |
| 28 | EnAbnormalBehaviour | This feature indicates support for the enhancements of UE Abnormal Behaviour. Supporting this feature also requires the support of AbnormalBehaviour feature. |
| 29 | EnQoSsustainability | This feature indicates support for the enhancements of QoS Sustainability. Supporting this feature also requires the support of QoSsustainability feature. |
| 30 | UserDataCongestionExt2_eNA | This feature indicates support for the enhancements of user data congestion, including support of ordering criterion. Supporting this feature also requires the support of UserDataCongestion and UserDataCongestionExt features. |
| 31 | UeMobilityExt2_eNA | This feature indicates support for the enhancements of UE mobility, including support of ordering criterion and linear distance threshold. Supporting this feature also requires the support of UeMobility and UeMobilityExt features. |
| 32 | UeCommunicationExt_eNA | This feature indicates support for the enhancements of UE Communication, including to indicate the ordering criterion for the list of analytics. Supporting this feature also requires the support of UeCommunication feature. |
| 33 | NetworkPerformanceExt_eNA | This feature indicates support for the enhancements of Network Performance, including support of ordering criterion for the list of analytics and analytics target period subset. Supporting this feature also requires the support of NetworkPerformance feature. |
| 34 | QoSSustainabilityExt_eNA | This feature indicates support for the enhancements of QoS Sustainability, including enhancements of filter information. Supporting this feature also requires the support of QoSSustainability feature. |
| 35 | PartialAnalyticsSubTransfer | This feature indicates support for partial successful analytics subscription transfer. |
| 36 | Void | Void |
| 37 | PfdDetermination | This feature indicates support for functionality related to NWDAF assisted PFD Determination information for known application identifier(s). |
| 38 | ServiceExperienceExt2_eNA | This feature indicates support for the extensions to the event related to service experience supporting eNA, including support for PDU Session parameters information for service experience analytics. Supporting this feature also requires the support of feature ServiceExperience. |
| 39 | DnPerformanceExt_AIML | This feature indicates support for extensions to the event related to DN Performance supporting AIML, including support of extended DN Performance Analytics for group of UEs. Supporting this feature also requires the support of feature DnPerformance. |
| 40 | UeMobilityExt_AIML | This feature indicates support for further extensions to the event related to UE mobility supporting AIML, including UE's geographical distribution and direction analytics. Supporting this feature also requires the support of feature UeMobility. |
| 41 | PduSesTraffic | This feature indicates support of the analytics related to PDU Session traffic information. |
| 42 | E2eDataVolTransTime | This feature indicates support for E2E data volume transfer time analytics |

| | | |
|----|----------------------------|--|
| 43 | DispersionExt_eNA | This feature indicates support for the enhancements of Dispersion, including the support of preferred granularity of UE location. Supporting this feature also requires the support of Dispersion feature. |
| 44 | WlanPerformanceExt_AIML | This feature indicates support for the enhancements of WLAN performance supporting AIML, including support of analytics per UE granularity. Supporting this feature also requires the support of feature WlanPerformance. |
| 45 | NetworkPerformanceExt_AIML | This feature indicates support of the network performance enhancements for AI/ML-based Services. Within this feature the following enhancements are covered: - support of providing gNB resource usage for GBR traffic and Delay-critical GBR traffic. Supporting this feature also requires the support of NetworkPerformance feature. |
| 46 | DnPerformanceExt_eNA | This feature indicates support for extensions to the event related to DN Performance, including support of number of UEs. Supporting this feature also requires the support of feature DnPerformance. |
| 47 | AnalyticsAccuracy | This feature indicates support for the Analytics Accuracy information. |
| 48 | RedundantTransExpExt_eNA | This feature indicates support extensions to the event related to redundant transmission experience analytics information including: - support of providing the E2E UL/DL packet loss rate (average, variance), E2E UL/DL packet delay (average, variance) in the analytics. - support of spatial and temporal granularity size. Supporting this feature also requires the support of feature RedundantTransmissionExp. |
| 49 | WlanPerfExt_eNA | This feature indicates support for the enhancements of WLAN performance supporting AIML, including support of temporal granularity size. Supporting this feature also requires the support of feature WlanPerformance. |
| 50 | MovementBehaviour | This feature indicates support for the Movement Behaviour information. |
| 51 | LocAccuracy | This feature indicates support for the Location Accuracy analytics. |
| 52 | RelativeProximity | This feature indicates support for the Relative Proximity analytics. |
| 53 | StatisticsFailure | This feature indicates support for partial failure report for statistics during event notification. Supporting this feature also requires the support of EneNA feature. |
| 54 | RoamingAnalytics | This feature indicates support for the Roaming analytics. |
| 55 | PredictionError | This feature indicates support for Prediction Error handling. |

5.1.9 Security

As indicated in 3GPP TS 33.501 [13] and 3GPP TS 29.500 [6], the access to the Nnwdaf_EventsSubscription API may be authorized by means of the OAuth2 protocol (see IETF RFC 6749 [14]), based on local configuration, using the "Client Credentials" authorization grant, where the NRF (see 3GPP TS 29.510 [12]) plays the role of the authorization server.

If OAuth2 is used, an NF service consumer, prior to consuming services offered by the Nnwdaf_EventsSubscription API, shall obtain a "token" from the authorization server, by invoking the Access Token Request service, as described in 3GPP TS 29.510 [12], clause 5.4.2.2.

NOTE: When multiple NRFs are deployed in a network, the NRF used as authorization server is the same NRF that the NF service consumer used for discovering the Nnwdaf_EventsSubscription service.

The Nnwdaf_EventsSubscription API defines the following scopes for OAuth2 authorization as described in 3GPP TS 29.501 [7], clause 4.x.

Table 5.1.9-1: OAuth2 scopes defined in Nnwdaf_EventsSubscription API

| Scope | Description |
|--------------------------------------|--|
| "nnwdaf-eventssubscription" | Access to the Nnwdaf_EventsSubscription API |
| "nnwdaf-eventssubscription:transfer" | Access to service operations applying to NWDAF event subscription transfer |

5.2 Nnwdaf_AnalyticsInfo Service API

5.2.1 Introduction

The Nnwdaf_AnalyticsInfo service shall use the Nnwdaf_AnalyticsInfo API.

The API URI of the Nnwdaf_AnalyticsInfo API shall be:

{apiRoot}/<apiName>/<apiVersion>

The request URIs used in each HTTP requests from the NF service consumer towards the NWDAF shall have the Resource URI structure defined in clause 4.4.1 of 3GPP TS 29.501 [7], i.e.:

{apiRoot}/<apiName>/<apiVersion>/<apiSpecificResourceUriPart>

with the following components:

- The {apiRoot} shall be set as described in 3GPP TS 29.501 [7].
- The<apiName> shall be "nnwdaf-analyticsinfo".
- The <apiVersion> shall be "v1".
- The <apiSpecificResourceUriPart> shall be set as described in clause 5.2.3.

5.2.2 Usage of HTTP

5.2.2.1 General

HTTP/2, IETF RFC 9113 [9], shall be used as specified in clause 5 of 3GPP TS 29.500 [6].

HTTP/2 shall be transported as specified in clause 5.3 of 3GPP TS 29.500 [6].

The OpenAPI [11] specification of HTTP messages and content bodies for the Nnwdaf_AnalyticsInfo is contained in Annex A.

5.2.2.2 HTTP standard headers

5.2.2.2.1 General

See clause 5.2.2 of 3GPP TS 29.500 [6] for the usage of HTTP standard headers.

5.2.2.2.2 Content type

JSON, IETF RFC 8259 [10], shall be used as content type of the HTTP bodies specified in the present specification as specified in clause 5.4 of 3GPP TS 29.500 [6]. The use of the JSON format shall be signalled by the content type "application/json".

"Problem Details" JSON object shall be used to indicate additional details of the error in a HTTP response body and shall be signalled by the content type "application/problem+json", as defined in IETF RFC 9457 [15].

5.2.2.3 HTTP custom headers

The Nnwdaf_AnalyticsInfo Service API shall support the mandatory HTTP custom header fields specified in clause 5.2.3.2 of 3GPP TS 29.500 [6] and may support the optional HTTP custom header fields specified in clause 5.2.3.3 of 3GPP TS 29.500 [6].

In this release of the specification, no specific custom headers are defined for the Nnwdaf_AnalyticsInfo Service API.

5.2.3 Resources

5.2.3.1 Resource Structure

This clause describes the structure for the Resource URIs, the resources and methods used for the service.

Figure 5.2.3.1-1 depicts the resource URIs structure for the Nnwdaf_AnalyticsInfo API.

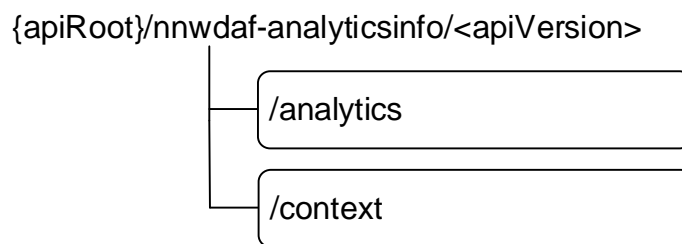

Figure 5.2.3.1-1: Resource URI structure of the Nnwdaf_AnalyticsInfo API

Table 5.2.3.1-1 provides an overview of the resources and applicable HTTP methods.

Table 5.2.3.1-1: Resources and methods overview

| Resource name | Resource URI | HTTP method or custom operation | Description |
|-----------------|--------------|---------------------------------|---|
| NWDAF Analytics | /analytics | GET | Retrieves the NWDAF analytics. |
| NWDAF Context | /context | GET | Retrieves the NWDAF context information related to analytics subscriptions. |

5.2.3.2 Resource: NWDAF Analytics

5.2.3.2.1 Description

The NWDAF Analytics resource represents the analytics to the Nnwdaf_AnalyticsInfo service at a given NWDAF.

5.2.3.2.2 Resource definition

Resource URI: {apiRoot}/nnwdaf-analyticsinfo/<apiVersion>/analytics

The <apiVersion> shall be set as described in clause 5.2.1.

This resource shall support the resource URI variables defined in table 5.2.3.2.2-1.

Table 5.2.3.2.2-1: Resource URI variables for this resource

| Name | Data type | Definition |
|---------|-----------|------------------|
| apiRoot | string | See clause 5.2.1 |

5.2.3.2.3 Resource Standard Methods

5.2.3.2.3.1 GET

This method shall support the URI query parameters specified in table 5.2.3.2.3.1-1.

Table 5.2.3.2.3.1-1: URI query parameters supported by the GET method on this resource

| Name | Data type | P | Cardinality | Description |
|--|---------------------------|---|-------------|--|
| ana-req | EventReportingRequirement | O | 0..1 | Identifies the analytics reporting requirement information. |
| event-id | EventId | M | 1 | Shall be included to identify the analytics. |
| event-filter | EventFilter | C | 0..1 | Shall be included to identify the analytics when filter information is needed for the related event. |
| supported-features | SupportedFeatures | O | 0..1 | To filter irrelevant responses related to unsupported features. |
| tgt-ue | TargetUeInformation | O | 0..1 | Identifies the target UE information. (NOTE) |
| NOTE: All target UE(s) indicated by this attribute shall belong to the same PLMN. When the RoamingAnalytics feature is supported and the target UE(s) indicated by this attribute belong to a PLMN different than the PLMN of the NF service consumer, the request should contain only attributes that are applicable also in the Nnwdaf_RoamingAnalytics service. | | | | |

This method shall support the request data structures specified in table 5.2.3.2.3.1-2 and the response data structures and response codes specified in table 5.2.3.2.3.1-3.

Table 5.2.3.2.3.1-2: Data structures supported by the GET Request Body on this resource

| Data type | P | Cardinality | Description |
|-----------|---|-------------|-------------|
| n/a | | | |

Table 5.2.3.2.3.1-3: Data structures supported by the GET Response Body on this resource

| Data type | P | Cardinality | Response codes | Description |
|--|---|-------------|---------------------------|--|
| AnalyticsData | M | 1 | 200 OK | Containing the analytics with parameters as relevant for the requesting NF service consumer. |
| n/a | | | 204 No Content | If the request NWDAF Analytics data does not exist, the NWDAF shall respond with "204 No Content" |
| ProblemDetails | O | 0..1 | 400 Bad Request | (NOTE 2) |
| ProblemDetails | O | 0..1 | 403 Forbidden | (NOTE 2) |
| ProblemDetailsAnalyticsInfoRequest | O | 0..1 | 500 Internal Server Error | The request is rejected by the NWDAF and more details (not only the ProblemDetails) are returned. (NOTE 2) |
| ProblemDetails | O | 0..1 | 500 Internal Server Error | (NOTE 2) |
| NOTE 1: The mandatory HTTP error status codes for the GET method listed in table 5.2.7.1-1 of 3GPP TS 29.500 [6] also apply. | | | | |
| NOTE 2: Failure cases are described in clause 5.2.7. | | | | |

5.2.3.2.4 Resource Custom Operations

None in this release of the specification.

5.2.3.3 Resource: NWDAF Context

5.2.3.3.1 Description

The NWDAF Context resource represents the context information related to analytics subscriptions at the Nnwdafl_AnalyticsInfo service at a given NWDAF.

5.2.3.3.2 Resource definition

Resource URI: {apiRoot}/nnwdafl-analyticsinfo/<apiVersion>/context

The <apiVersion> shall be set as described in clause 5.2.1.

This resource shall support the resource URI variables defined in table 5.2.3.3.2-1.

Table 5.2.3.3.2-1: Resource URI variables for this resource

| Name | Data type | Definition |
|---------|-----------|------------------|
| apiRoot | string | See clause 5.2.1 |

5.2.3.3.3 Resource Standard Methods

5.2.3.3.3.1 GET

This method shall support the URI query parameters specified in table 5.2.3.3.3.1-1.

Table 5.2.3.3.3.1-1: URI query parameters supported by the GET method on this resource

| Name | Data type | P | Cardinality | Description |
|--------------------|-------------------|---|-------------|---|
| context-ids | ContextIdList | M | 1 | Identifies specific context information related to analytics subscriptions. |
| req-context | RequestedContext | O | 0..1 | Identifies the types of the analytics context information the consumer wishes to receive. Absence of this attribute means that the consumer wishes to receive available context information of all types. |
| supported-features | SupportedFeatures | O | 0..1 | The features supported by the NF service consumer. |

This method shall support the request data structures specified in table 5.2.3.3.3.1-2 and the response data structures and response codes specified in table 5.2.3.3.3.1-3.

Table 5.2.3.3.3.1-2: Data structures supported by the GET Request Body on this resource

| Data type | P | Cardinality | Description |
|-----------|---|-------------|-------------|
| n/a | | | |

Table 5.2.3.3.3.1-3: Data structures supported by the GET Response Body on this resource

| Data type | P | Cardinality | Response codes | Description |
|--|---|-------------|----------------|--|
| ContextData | M | 1 | 200 OK | Contains the context information corresponding with the context identifiers provided in the request. |
| n/a | | | 204 No Content | If the requested context information does not exist, the NWDAF shall respond with "204 No Content". |
| NOTE: The mandatory HTTP error status codes for the GET method listed in table 5.2.7.1-1 of 3GPP TS 29.500 [6] also apply. | | | | |

5.2.4 Custom Operations without associated resources

None in this release of the specification.

5.2.5 Notifications

None in this release of the specification.

5.2.6 Data Model

5.2.6.1 General

This clause specifies the application data model supported by the API.

Table 5.2.6.1-1 specifies the data types defined for the Nnwdaf_AnalyticsInfo service based interface protocol.

Table 5.2.6.1-1: Nnwdaf_AnalyticsInfo specific Data Types

| Data type | Section defined | Description | Applicability |
|------------------------------------|-----------------|---|---------------------------|
| AdditionInfoAnalyticsInfoRequest | 5.2.6.2.5 | Contains more details (not only the ProblemDetails) in case an Nnwdaf_AnalyticsInfo request is rejected. | EneNA |
| AdrfDataType | 5.2.6.3.5 | Represents a type of data that is stored in the ADRF. | AnaCtxTransfer |
| AnalyticsAccuracyInfo | 5.2.6.2.18 | Analytics Accuracy related information needs to be transferred. | EnAnaCtxTransfer |
| AnalyticsData | 5.2.6.2.2 | Describes analytics with parameters indicated in the request. | |
| ContextData | 5.2.6.2.6 | Contains context information related to analytics subscriptions corresponding with one or more context identifiers. | AnaCtxTransfer |
| ContextElement | 5.2.6.2.7 | Contains context information corresponding with a specific context identifier. | AnaCtxTransfer |
| ContextIdList | 5.2.6.2.8 | Contains list of context identifiers of context information of analytics subscriptions. | AnaCtxTransfer |
| ContextType | 5.2.6.3.4 | Identifies the type of analytics context information. | AnaCtxTransfer |
| EventFilter | 5.2.6.2.3 | Represents the event filters used to identify the requested analytics. | |
| EventId | 5.2.6.3.3 | Describes the type of analytics. | |
| GroundTruthInfo | 5.2.6.2.19 | The ground truth information used for the accuracy information computation. | EnAnaCtxTransfer |
| HistoricalData | 5.2.6.2.9 | Contains historical data related to an analytics subscription. | AnaCtxTransfer |
| MIModelAccuracyInfo | 5.2.6.2.20 | The ML Model Accuracy Subscription Information needs to be transferred. | EnAnaCtxTransfer |
| NetworkPerfReq | 5.2.6.2.16 | Represents a network performance requirement. | NetworkPerformanceExt_eNA |
| ProblemDetailsAnalyticsInfoRequest | 5.2.6.4.1 | Data type that extends ProblemDetails. | EneNA |

| | | | |
|--------------------------------|------------|---|----------------------------|
| RequestedContext | 5.2.6.2.11 | Contains types of analytics context information. | AnaCtxTransfer |
| ResourceUsageRequPerNwPerfType | 5.2.6.2.17 | Indicates more requirements per network performance type when providing resource usage information for network performance. | NetworkPerformanceExt_AIML |
| SmcceInfo | 5.2.6.2.12 | Represents the analytics of Session Management congestion control experience information. | SMCCE |
| SmcceUeList | 5.2.6.2.13 | Represents the List of UEs classified based on experience level of Session Management congestion control. | SMCCE |
| SpecificAnalyticsSubscription | 5.2.6.2.10 | Represents an existing subscription for a specific type of analytics to a specific NWDAF. | AnaCtxTransfer |
| SpecificDataSubscription | 5.2.6.2.14 | Represents an existing data collection subscription to a specific data source NF. | AnaCtxTransfer |
| UserDataCongestReq | 5.2.6.2.15 | Represents the user data congestion requirements. | UserDataCongestionExt2_eNA |

Table 5.2.6.1-2 specifies data types re-used by the Nnwdaf_AnalyticsInfo service based interface protocol from other specifications, including a reference to their respective specifications and when needed, a short description of their use within the Nnwdaf service based interface.

Re-used data types of clause 5.1.6 refer here to requests instead of subscriptions.

Table 5.2.6.1-2: Nnwdaf_AnalyticsInfo re-used Data Types

| Data type | Reference | Comments | Applicability |
|----------------------------|---------------------|--|---|
| AbnormalBehaviour | 5.1.6.2.15 | Represents the abnormal behaviour information. | AbnormalBehaviour |
| AccuracyInfo | 5.2.6.2.83 | The analytics accuracy information. | AnalyticsAccuracy |
| AccuracyReq | 5.1.6.2.88 | Represents the analytics accuracy requirement information. | AnalyticsAccuracy |
| AnalyticsContextIdentifier | 5.1.6.2.43 | Contains information about the available analytics contexts. | AnaCtxTransfer |
| AnalyticsMetadataInfo | 5.1.6.2.37 | Contains analytics metadata information required for analytics aggregation. | Aggregation |
| AnalyticsSubset | 5.1.6.3.18 | Contains information about the analytics subsets provided in the subscription request. | EneNA |
| AnySlice | 5.1.6.3.2 | | |
| ApplicationId | 3GPP TS 29.571 [8] | Identifies the application. | ServiceExperience UeCommunication AbnormalBehaviour DnPerformance PfdDetermination E2eDataVolTransTime |
| BwRequirement | 5.1.6.2.25 | | ServiceExperience |
| DataNotification | 3GPP TS 29.575 [27] | Describes Notifications about data collection events that occurred. | EneNA |
| DataSubscription | 3GPP TS 29.575 [27] | Represents data subscription from data source (e.g. AMF, SMF, UDM, NEF, AF). | EneNA EnAnaCtxTransfer |
| DateTime | 3GPP TS 29.571 [8] | Identifies the time. | |
| DispersionRequirement | 5.1.6.2.50 | Dispersion analytics requirement. | Dispersion |
| DispersionInfo | 5.1.6.2.53 | Dispersion analytics information. | Dispersion |
| Dnai | 3GPP TS 29.571 [8] | Identifies a user plane access to one or more DN(s). | ServiceExperience DnPerformance |
| Dnn | 3GPP TS 29.571 [8] | Identifies the DNN. | ServiceExperience AbnormalBehaviour UeCommunication SMCCE DnPerformance PfdDetermination PduSesTraffic E2eDataVolTransTime |
| DnPerfInfo | 5.1.6.2.45 | Represents DN performance information | DnPerformance |
| DnPerformanceReq | 5.1.6.2.66 | Represents the DN performance requirements. | DnPerformance |
| DurationSec | 3GPP TS 29.571 [8] | | |
| EventNotification | 5.1.6.2.5 | Describes Notifications about analytics events that occurred. | AnaCtxTransfer |
| EventReportingRequirement | 5.1.6.2.7 | | |
| ExceptionId | 5.1.6.3.6 | | AbnormalBehaviour |
| ExpectedUeBehaviourData | 3GPP TS 29.503 [23] | | AbnormalBehaviour |
| ExpectedAnalyticsType | 5.1.6.3.11 | | AbnormalBehaviour |

| | | | |
|---------------------------|---------------------|--|---|
| GeographicalArea | 3GPP TS 29.522 [32] | Identifies the geographical location (longitude and latitude level). | UeMobilityExt2_eNA ServiceExperienceExt2_eNA QoSsustainExt_eNA |
| GeoLocation | 5.1.6.2.95 | Represents a geographic location, potentially using local coordinates and optionally including the altitude. | LocAccuracy |
| LocAccuracyInfo | 5.1.6.2.97 | Contains Location Accuracy information. | LocAccuracy |
| LocAccuracyReq | 5.1.6.2.96 | Contains Location Accuracy analytics requirements. | LocAccuracy |
| LocInfoGranularity | 5.1.6.3.32 | Represents the preferred granularity of location information. | ServiceExperienceExt2_eNA UeMobilityExt2_eNA DispersionExt_eNA |
| LocationOrientation | 5.1.6.3.38 | Represent preferred orientation of location information | MovementBehaviour |
| MatchingDirection | 5.1.6.3.12 | The matching direction. | UserDataCongestionExt2_eNA NetworkPerformanceExt |
| MLModelAccuracyInfo | 5.6.6.2.5 | Represents the subscription information for ML model accuracy information. | EnAnaCtxTransfer |
| ModelInfo | 5.1.6.2.42 | The information of the ML models. | AnaCtxTransfer |
| MovBehavInfo | 5.1.6.2.91 | Represents the Movement Behaviour information. | MovementBehaviour |
| MovBehavReq | 5.1.6.2.90 | Represents the Movement Behaviour analytics requirements | MovementBehaviour |
| NetworkAreaInfo | 3GPP TS 29.554 [18] | The network area information. | UeMobility UeCommunication NetworkPerformance QoSsustainability ServiceExperience UserDataCongestion AbnormalBehaviour NsiLoadExt Dispersion RedundantTransmissionExp WlanPerformance DnPerformance NfLoadExt E2eDataVolTransTime MovementBehaviour |
| NetworkPerfInfo | 5.1.6.2.23 | Represents network performance information. | NetworkPerformance |
| NetworkPerfOrderCriterion | 5.1.6.3.30 | Represents a network performance requirement. | NetworkPerformanceExt_eNA |
| NetworkPerfType | 5.1.6.3.10 | Represents the network performance types. | NetworkPerformance |
| NfLoadLevelInformation | 5.1.6.2.31 | Represents load level information of a given NF instance. | NfLoad |
| NfInstanceId | 3GPP TS 29.571 [8] | Identifies an NF instance | NfLoad |
| NfSetId | 3GPP TS 29.571 [8] | Identifies an NF Set instance. | NfLoad |
| NFType | 3GPP TS 29.510 [12] | Identifies a type of NF. | NfLoad |

| | | | |
|------------------------------|--------------------|---|---|
| NsildInfo | 5.1.6.2.33 | Identify the S-NSSAI and the associated Network Slice Instance(s). | ServiceExperience NsiLoad DnPerformance |
| NsiLoadLevellInfo | 5.1.6.2.34 | Represents the load level information for an S-NSSAI and the associated network slice instance. | NsiLoad |
| NnwdafeventsSubscription | 5.1.6.2.2 | Represents an Individual NWDAF Event Subscription resource. | AnaCtxTransfer |
| PfdDeterminationInfo | 5.1.6.2.73 | Represents PFD Determination information. | PfdDetermination |
| ProblemDetails | 3GPP TS 29.571 [8] | Used in error responses to provide more detailed information about an error. | |
| QosRequirement | 5.1.6.2.20 | | QoSsustainability E2eDataVolTransTime |
| QosSustainabilityInfo | 5.1.6.2.19 | | QoSsustainability |
| RatFreqInformation | 5.1.6.2.67 | Represents the RAT type and/or Frequency information | ServiceExperienceExt |
| RedundantTransmissionExpInfo | 5.1.6.2.57 | Redundant transmission experience analytics information. | RedundantTransmissionExp |
| RedundantTransmissionExpReq | 5.1.6.2.56 | Redundant transmission experience analytics requirement. | RedundantTransmissionExp |
| PduSessionInfo | 5.1.6.2.74 | Represents combination of PDU Session parameters. | ServiceExperienceExt2_eNA |
| RelProxInfo | 5.1.6.2.100 | Relative Proximity analytics information. | RelativeProximity |
| RelProxReq | 5.1.6.2.99 | Relative Proximity analytics requirements. | RelativeProximity |
| ResourceUsageRequirement | 5.1.6.2.81 | Indicates more requirements per network performance type when providing resource usage information for network performance. | NetworkPerformanceExt_AIML |
| RoamingInfo | 5.1.6.2.106 | Contains information related to roaming analytics. | RoamingAnalytics |
| ServiceExperienceInfo | 5.1.6.2.24 | | ServiceExperience |
| Supi | 3GPP TS 29.571 [8] | Identifies the UE. | ServiceExperience, NfLoad NetworkPerformance UserDataCongestion UeMobility UeCommunication AbnormalBehaviour SMCCE Dispersion RedundantTransmissionExp WlanPerformance E2eDataVolTransTime |
| SupportedFeatures | 3GPP TS 29.571 [8] | Used to negotiate the applicability of the optional features defined in table 5.2.8-1. | |
| Snsai | 3GPP TS 29.571 [8] | | |

| | | | |
|---------------------------|---------------------|---|--|
| SliceLoadLevelInformation | 5.1.6.2.6 | | |
| TargetUeInformation | 5.1.6.2.8 | Identifies the target UE information. | ServiceExperience NfLoad NetworkPerformance UserDataCongestion UeMobility UeCommunication AbnormalBehaviour QoSsustainability Dispersion RedundantTransmissionExp WlanPerformance SMCCE DnPerformance E2eDataVolTransTime |
| UeCommunication | 5.1.6.2.13 | | UeCommunication |
| UeCommReq | 5.1.6.2.72 | UE communication analytics requirement. | UeCommunicationExt_eNA |
| UeMobility | 5.1.6.2.10 | | UeMobility |
| UeMobilityReq | 5.1.6.2.71 | UE mobility analytics requirement. | UeMobilityExt2_eNA |
| UInteger | 3GPP TS 29.571 [8] | Unsigned Integer, i.e. only value 0 and integers above 0 are permissible. | |
| UpflInformation | 3GPP TS 29.508 [29] | The information of the UPF serving the UE. | ServiceExperienceExt DnPerformance |
| PduSesTrafficInfo | 5.1.6.2.77 | Represents PDU Session traffic analytics information. | PduSesTraffic |
| PduSesTrafficReq | 5.1.6.2.79 | Represents PDU Session traffic analytics requirement. | PduSesTraffic |
| UserDataCongestionInfo | 5.1.6.2.17 | | UserDataCongestion |
| UserDataConOrderCrit | 5.1.6.2.15 | The ordering criterion for the list of User Data Congestion analytics. | UserDataCongestionExt2_eNA |
| WlanPerformanceInfo | 5.1.6.2.60 | WLAN performance analytics information. | WlanPerformance |
| WlanPerformanceReq | 5.1.6.2.59 | WLAN performance analytics requirement. | WlanPerformance |
| E2eDataVolTransTimeInfo | 5.1.6.2.82 | E2E data volume transfer time | E2eDataVolTransTime |
| E2eDataVolTransTimeReq | 5.1.6.2.83 | E2E data volume transfer time requirement | E2eDataVolTransTime |

5.2.6.2 Structured data types

5.2.6.2.1 Introduction

This clause defines the structures to be used in resource representations.

5.2.6.2.2 Type AnalyticsData

Table 5.2.6.2.2-1: Definition of type AnalyticsData

| Attribute name | Data type | P | Cardinality | Description | Applicability |
|---------------------|----------------------------------|---|-------------|---|--------------------|
| start | DateTime | O | 0..1 | It defines the start time of which the statistics analytics information is applicable or predictions analytics information is valid. (NOTE 1) (NOTE 7) | |
| expiry | DateTime | O | 0..1 | It defines the expiration time after which the statistics analytics information is applicable or predictions analytics information is invalid. (NOTE 1) (NOTE 7) | |
| timeStampGen | DateTime | C | 0..1 | It defines the timestamp of analytics generation. (NOTE 3) | |
| anaMetaInfo | AnalyticsMetadataInfo | C | 0..1 | Contains information about analytics metadata required to aggregate the analytics. It shall be present if the "anaMeta" attribute was included in the request, containing the information indicated by the "anaMeta" attribute. | Aggregation |
| sliceLoadLevelInfos | array(SliceLoadLevelInformation) | C | 1..N | The slices and the load level information. Shall be present when the requested event is "LOAD_LEVEL_INFORMATION". | |
| nsiLoadLevelInfos | array(NsiLoadLevelInfo) | C | 1..N | Each element identifies the load level information for an S-NSSAI and the optionally associated network slice instance. Shall be presented when the requested event is "NSI_LOAD_LEVEL" | NsiLoad |
| nwPerfs | array(NetworkPerfInfo) | C | 1..N | The network performance information. Shall be present when the requested event is "NETWORK_PERFORMANCE". | NetworkPerformance |
| nfLoadLevelInfos | array(NfLoadLevelInformation) | C | 1..N | The NF load information. When the requested event is "NF_LOAD", the nfLoadLevelInfos shall be included. | NfLoad |
| qosSustainInfos | array(QosSustainabilityInfo) | C | 1..N | The QoS sustainability informations in the certain geographic areas. It shall be present if the requested event is "QOS_SUSTAINABILITY". (NOTE 2) | QoSSustainability |
| ueMobs | array(UeMobility) | C | 1..N | The UE mobility information. When the requested event is "UE_MOBILITY", the "ueMobs" attribute shall be included. (NOTE 5) (NOTE 8) | UeMobility |
| ueComms | array(UeCommunication) | C | 1..N | The UE communication information. When the requested event is "UE_COMM", the "ueComms" attribute shall be included. (NOTE 9) | UeCommunication |
| userDataConglInfos | array(UserDataCongestionInfo) | C | 1..N | The user data congestion information. Shall be present when the requested event is "USER_DATA_CONGESTION". | UserDataCongestion |

| | | | | | |
|---------------------|-------------------------------------|---|------|--|--------------------------|
| suppFeat | SupportedFeatures | C | 0..1 | List of Supported features used as described in clause 5.2.8. This parameter shall be supplied by NWDAF in the reply of GET request that request the analytics resource, if the consumer includes "supported-features" in the GET request. | |
| svcExps | array(ServiceExperienceInfo) | C | 1..N | The service experience information. Shall be present when the requested event is "SERVICE_EXPERIENCE". | ServiceExperience |
| abnorBehavrs | array(AbnormalBehaviour) | C | 1..N | The abnormal behaviour information. Shall be present when the requested event is "ABNORMAL_BEHAVIOUR". | AbnormalBehaviour |
| smccExps | array(SmccelInfo) | C | 1..N | The Session Management congestion control experience information. Shall be present when the requested event is "SM_CONGESTION". | SMCCE |
| disperInfos | array(DispersionInfo) | C | 1..N | The Dispersion information. Shall be present when the requested event is "DISPERSION". | Dispersion |
| redTransInfos | array(RedundantTransmissionExpInfo) | C | 1..N | The Redundant Transmission Experience analytics information. Shall be present when the requested event is "RED_TRANS_EXP". | RedundantTransmissionExp |
| wlanInfos | array(WlanPerformanceInfo) | C | 1..N | The WLAN performance related information. When requested event is "WLAN_PERFORMANCE", the "wlanInfos" attribute shall be included. (NOTE 6) | WlanPerformance |
| dnPerfInfos | array(DnPerfInfo) | C | 1..N | The DN performance information. Shall be present when the requested event is "DN_PERFORMANCE". (NOTE 4) | DnPerformance |
| pduSesTraffInfos | array(PduSesTrafficInfo) | C | 1..N | The PDU Session traffic related information. Shall be present when the requested event is "PDU_SESSION_TRAFFIC". | PduSesTraffic |
| dataVITransTmlInfos | array(E2eDataVolTransTimeInfo) | C | 1..N | E2E data volume transfer time information. Shall be present when the requested event is "E2E_DATA_VOL_TRANS_TIME". | E2eDataVolTransTime |
| locAccInfos | array(LocAccuracyInfo) | C | 1..N | The Location Accuracy related information. It shall be present when the requested event is "LOC_ACCURACY". | LocAccuracy |

| | | | | | |
|---------------|---------------------|---|------|---|-------------------|
| accuInfo | AccuracyInfo | C | 0..1 | The analytics accuracy information. Shall be provided if the analytics accuracy requirement was requested in the "accuReq" attribute and the "cancelAcculnd" attribute is set to "false" or omitted. (NOTE 10) | AnalyticsAccuracy |
| cancelAcculnd | boolean | O | 0..1 | Indicates cancelled request of the analytics accuracy information. Set to "true" indicates the NWDAF cancelled request of analytics accuracy information as the NWDAF does not support the accuracy checking capability. Otherwise set to "false". Default value is "false" if omitted. | AnalyticsAccuracy |
| movBehavInfos | array(MovBehavInfo) | C | 1..N | The Movement Behaviour information. Shall be present when the requested event is "MOVEMENT_BEHAVIOUR". | MovementBehaviour |
| relProxInfos | array(RelProxInfo) | C | 1..N | The Relative Proximity information. Shall be present when the requested event is "RELATIVE_PROXIMITY", | RelativeProximity |

- NOTE 1: If the "start" attribute and the "expiry" attribute are both provided, the DateTime of the "expiry" attribute shall not be earlier than the DateTime of the "start" attribute.
- NOTE 2: The "qosFlowRetThd" and "ranUeThrouThd" attributes in QoS SustainabilityInfo data type are not applicable.
- NOTE 3: This attribute shall be included when ADRF is deployed.
- NOTE 4: The "minTrafficRate", "aggTrafficRate", "varTrafficRate", "trafRateUelds", "avePacketDelay", "maxPacketDelay", "varPacketDelay", "packDelayUelds", "maxPacketLossRate", "varPacketLossRate" and "packetLossUelds" attribute(s) within the DnPerfInfo data type is applicable only if the "DnPerformanceExt_AIML" feature is supported.
- NOTE 5: The "directionInfos" attribute and the "geoDistrInfos" attribute in the "loclInfos" attribute within the UeMobility data type are applicable only if the "UeMobilityExt_AIML" feature is supported.
- NOTE 6: The "wlanPerUeldInfos" attribute may be included within the "wlanInfos" attribute only if the "WlanPerformanceExt_AIML" feature is supported.
- NOTE 7: The validity period specified by "start" and "expiry" attributes is determined by NWDAF internal logic, and is a subset of the analytics target period indicated by "startTs" and "endTs", or "offsetPeriod" attributes contained in "ana-req" attribute. If the analytics target period refers to the past, the period specified by these two attributes indicate the time period over which the statistics are applicable. If the analytics target period refers to the future, the period specified by these two attributes indicate the time period over which the predictions are valid.
- NOTE 8: If the "UeMobilityExt2_eNA" feature is supported and the "locationGranReq" attribute value "LON_AND_LAT_LEVEL" is requested, the "geoLoc" attribute within the "loclInfos" attribute in the "UeMobility" type shall be provided to report the geographical location (longitude and latitude level).
- NOTE 9: The "perioCommInd", "anaOfAppList" and "sessInactTimer" attributes within the UeCommunication data type are applicable only if the "UeCommunicationExt" feature is supported.
- NOTE 10: Only the "accuracyVal" and "accuSampleNbr" attributes within the AccuracyInfo data type are applicable.

5.2.6.2.3 Type EventFilter

Table 5.2.6.2.3-1: Definition of type EventFilter

| Attribute name | Data type | P | Cardinality | Description | Applicability |
|----------------|----------------------|---|-------------|---|--|
| anySlice | AnySlice | C | 0..1 | Default is "false". (NOTE 1) | |
| applds | array(ApplicationId) | C | 1..N | Represents the Application Identifier(s). The absence of applds means applicable to all applications. (NOTE 4) (NOTE 12) | ServiceExperience UeCommunication AbnormalBehaviour Dispersion DnPerformance E2eDataVolTransTime |
| dnns | array(Dnn) | C | 1..N | Represents the DNN(s). Each DNN is a full DNN with both the Network Identifier and Operator Identifier, or a DNN with the Network Identifier only. The absence of dnns means applicable to all DNNs. (NOTE 4) (NOTE 13) | ServiceExperience UeCommunication AbnormalBehaviour SMCCE DnPerformance RedundantTransmissionExp PduSesTraffic E2eDataVolTransTime RelativeProximity |
| dnais | array(Dnai) | O | 1..N | Represents the Data Network Access Identifier(s) of user plane accesses to DN(s) where applications are deployed. | ServiceExperience DnPerformance |
| ladnDnns | array(Dnn) | O | 1..N | Represents the LADN DNN(s) to indicate the LADN service area(s) as the AoI(s). | UeMobilityExt |
| snssais | array(Snssai) | C | 1..N | Identification(s) of network slice(s). (NOTE 1), (NOTE 4) (NOTE 13) (NOTE 20) | |
| roamingInfo | RoamingInfo | O | 0..1 | Information about roaming analytics. When this attribute is provided, the request should contain only attributes that are applicable also in the Nnwdaf_RoamingAnalytics service. | RoamingAnalytics |
| nfInstancelds | array(NfInstanceId) | O | 1..N | Identification(s) of NF instance(s). | NfLoad |
| nfSetlds | array(NfSetId) | O | 1..N | Identification(s) of NF instance set(s). | NfLoad |
| nfTypes | array(NFType) | O | 1..N | Identification(s) of NF type(s). (NOTE 8) | NfLoad NsiLoadExt |

| | | | | | |
|-------------------|-----------------|---|------|---|--|
| networkArea | NetworkAreaInfo | C | 0..1 | This IE represents the network area where the NF service consumer wants to know the analytics result. (NOTE 2), (NOTE 4) (NOTE 17) (NOTE 18) | UeMobility UeCommunication NetworkPerformance QoSsustainability ServiceExperience UserDataCongestion AbnormalBehaviour NsiLoadExt NfLoadExt Dispersion RedundantTransmissionExp WlanPerformance DnPerformance PduSesTraffic E2eDataVolTransTime MovementBehaviour LocAccuracy RelativeProximity |
| location | GeoLocation | C | 0..1 | A location (i.e. geographical location or location in local coordinates) to which the request applies. (NOTE 18) | LocAccuracy |
| temporalGranSize | DurationSec | O | 0..1 | Indicates the minimum duration of each time slot for which the analytics are provided. (NOTE 15) | NetworkPerformanceExt_eNA UeMobilityExt2_eNA UserDataCongestionExt2_eNA QoSsustainExt_eNA DispersionExt_eNA WlanPerfExt_eNA RedundantTransmissionExpExt_eNA DnPerfExt_eNA |
| spatialGranSizeTa | UInteger | O | 0..1 | Indicates the maximum number of TAs used to define an area for which the analytics are provided. May be included when the "networkArea" attribute in the EventSubscription data type is provided. (NOTE 16) | NetworkPerformanceExt_eNA UeMobilityExt2_eNA UeCommunicationExt_eNA QoSsustainExt_eNA DispersionExt_eNA DnPerfExt_eNA |

| | | | | | |
|---------------------|--------------------------------------|---|------|---|--|
| spatialGranSizeCell | UInteger | O | 0..1 | Indicates the maximum number of cells used to define an area for which the analytics are provided. May be included when the "networkArea" attribute in the EventSubscription data type is provided. (NOTE 16) | NetworkPerformanceExt_eNA UeMobilityExt2_eNA UeCommunicationExt_eNA QoSsustainExt_eNA DispersionExt_eNA DnPerfExt_eNA |
| fineGranAreas | array(GeographicalArea) | O | 1..N | Indicates the fine granularity areas to which the request applies. (i.e. with a finer granularity than cell). (NOTE 2) (NOTE 17) | ServiceExperienceExt2_eNA UeMobilityExt2_eNA QoSsustainExt_eNA MovementBehaviour |
| visitedAreas | array(NetworkAreaInfo) | O | 1..N | Identification(s) of network area(s) which the UEs had previously been in at least one of the Visited Area(s) of Interest. (NOTE 9) | UeMobilityExt |
| maxTopAppUINbr | UInteger | O | 0..1 | Indicates the requested maximum number of top applications that contribute the most to the traffic in Uplink direction. Minimum = 1. May be included when one of the elements in the "listOfAnaSubsets" attribute is set to LIST_OF_TOP_APP_UL. | UserDataCongestionExt |
| maxTopAppDINbr | UInteger | O | 0..1 | Indicates the requested maximum number of top applications that contribute the most to the traffic in Downlink direction. Minimum = 1. May be included when one of the elements in the "listOfAnaSubsets" attribute is set to LIST_OF_TOP_APP_DL. | UserDataCongestionExt |
| nsildInfos | array(NsildInfo) | O | 1..N | Each element identifies the S-NSSAI and the optionally associated network slice instance(s). May be included when the event-id is "NSI_LOAD_LEVEL", "SERVICE_EXPERIENCE" or "DN_PERFORMANCE". (NOTE 1) | ServiceExperience NsiLoad DnPerformance |
| nwPerfReqs | array(NetworkPerformanceReq) | O | 1..N | Represents the network performance requirements. This attribute may be included when the event-id is "NETWORK_PERFORMANCE". | NetworkPerformanceExt_eNA |
| nwPerfTypes | array(NetworkPerformanceType) | C | 1..N | Represents the network performance types. This attribute shall be included when event-id is "NETWORK_PERFORMANCE". | NetworkPerformance |
| addNwPerfReqs | array(ResourceUsageReqPerNwPerfType) | O | 1..N | Each element indicates more requirement for each network performance type (by each element in the "nwPerfTypes" attribute) when providing resource usage information for the network performance type. | NetworkPerformanceExt_AIML |
| userDataConReqs | array(UserDataCongestReq) | O | 1..N | Represents the network performance requirements. This attribute may be included when the event-id is "NETWORK_PERFORMANCE". | UserDataCongestionExt2_eNA |

| | | | | | |
|------------------|------------------------------------|---|------|---|--|
| qosRequ | QoSRequirement | C | 0..1 | Represents the QoS requirements. This attribute shall be included when event-id is "QOS_SUSTAINABILITY" or "E2E_DATA_VOL_TRANS_TIME". | QoSSustainability E2eDataVolTransTime |
| bwRequs | array(BwRequirement) | O | 1..N | Represents the media/application bandwidth requirement for each application. It may only be present if "applds" attribute is provided. | ServiceExperience |
| exceptIds | array(ExceptionId) | C | 1..N | Represents a list of Exception Ids. (NOTE 3), (NOTE 4) | AbnormalBehaviour |
| exptAnaType | ExpectedAnalyticsType | C | 0..1 | Represents expected UE analytics type. (NOTE 3), (NOTE 4) | AbnormalBehaviour |
| exptUeBehav | ExpectedUeBehaviourData | O | 0..1 | Represents expected UE behaviour. | AbnormalBehaviour |
| ratFreqs | array(RatFreqInformation) | O | 1..N | Identification(s) of the RAT type(s) and/or frequency(ies) of UE's serving cell(s) which the request applies. (NOTE 5) | ServiceExperienceExt |
| disperReqs | array(DispersionRequirement) | O | 1..N | Represents the dispersion analytics requirements. | Dispersion |
| redTransReqs | array(RedundantTransmissionExpReq) | O | 1..N | Represents the redundant transmission experience analytics requirements. | RedundantTransmissionExp |
| wlanReqs | array(WlanPerformanceReq) | O | 1..N | Represents other WLAN performance analytics requirements. If the attribute contains no content, may take default handling action. | WlanPerformance |
| listOfAnaSubsets | array(AnalyticsSubset) | O | 1..N | The list of analytics subsets used to indicate the content of the analytics. | EneNA |
| upfInfo | UpfInformation | O | 0..1 | Identifies the UPF. (NOTE 7) | ServiceExperienceExt DnPerformance |
| appServerAdrs | array(AddrFqdn) | C | 1..N | Each element represents the Application Server Instance (IP address/FQDN of the Application Server). (NOTE 6) | ServiceExperienceExt DnPerformance |
| dnPerfReqs | array(DnPerformanceReq) | O | 1..N | Represents the DN performance requirements. This attribute shall be included when event-id is "DN_PERFORMANCE". | DnPerformance |
| dataVITransTmRqs | array(E2eDataVolTransTimeReq) | O | 1..N | Represents the list of E2E data volume transfer time requirement. This attribute may be included when event-id is "E2E_DATA_VOL_TRANS_TIME". | E2eDataVolTransTime |
| ueMobilityReqs | array(UeMobilityReq) | O | 1..N | Represents the UE mobility requirements. This attribute may be included when the event-id is "UE_MOBILITY". | UeMobilityExt2_eNA |
| ueCommReqs | array(UeCommReq) | O | 1..N | Represents the UE communication requirements. This attribute may be included when the event-id is "UE_MOBILITY". | UeCommunicationExt_eNA |
| pduSesInfos | array(PduSessionInfo) | O | 1..N | Represents combination of PDU Session parameters. (NOTE 12) | ServiceExperienceExt2_eNA |
| pduSesTrafReqs | array(PduSesTrafficReq) | C | 1..N | Represents the PDU Session traffic analytics requirements. This attribute shall be included when subscribed event is "PDU_SESSION_TRAFFIC". (NOTE 13) | PduSesTraffic |

| | | | | | |
|----------------|-----------------------|---|------|---|---|
| locAccReqs | array(LocAccuracyReq) | O | 1..N | Represents the Location Accuracy analytics requirements. This attribute may only be included when the subscribed event is "LOC_ACCURACY" and the attributes "accThres", "accThresMatchDir", "inOutThres", and "inOutThresMatchDir" inside it are not applicable for analytics requests. | LocAccuracy |
| locGranularity | LocInfoGranularity | O | 0..1 | The preferred granularity of UE location information.(NOTE 19) | ServiceExperienceExt2_eNA UeMobilityExt2_eNA DispersionExt_eNA MovementBehaviour |
| locOrientation | LocationOrientation | O | 0..1 | Indicates the preferred orientation of location information. | MovementBehaviour UeMobilityExt2_eNA |
| useCaseCxt | string | O | 0..1 | Indicates the context of usage of the analytics. The value and format of this parameter are not standardized. | ENAEExt |
| accuReq | AccuracyReq | O | 0..1 | Represents the analytics accuracy requirement information. May be included as indication to the NWDAF (containing an AnLF supporting Accuracy checking capability) to activate checking the analytics accuracy information of the event. (NOTE 21) | AnalyticsAccuracy |
| movBehavReqs | array(MovBehavReq) | O | 1..N | Represents the Movement Behaviour analytics requirements. | MovementBehaviour |
| relProxReqs | array(RelProxReq) | O | 1..N | Represents the Relative Proximity analytics requirements. | RelativeProximity |

- NOTE 1: The "anySlice" attribute is not applicable to features "UeMobility" and "NetworkPerformance". The "snssais" attribute is not applicable to features "ServiceExperience", "NsiLoad", "UeMobility" and "NetworkPerformance". When event-id in the request is "LOAD_LEVEL_INFORMATION", the identifications of network slices, either information about slice(s) identified by the "snssais" attribute, or "anySlice" set to "true", shall be included. When the requested event-id is "NSI_LOAD_LEVEL" or "SERVICE_EXPERIENCE", either the "nsiIdInfos" attribute or anySlice set to "true" shall be included. When the requested event-id is "QOS_SUSTAINABILITY", "NF_LOAD", "UE_COMM", "ABNORMAL_BEHAVIOUR", "USER_DATA_CONGESTION", "DISPERSION", "RED_TRANS_EXP", "PDU_SESSION_TRAFFIC" or "RELATIVE_PROXIMITY", the identifications of network slices identified by the "snssais" attribute is optional.
- NOTE 2: For different events, the following rules apply:
- For "NETWORK_PERFORMANCE" or "USER_DATA_CONGESTION" event, the "networkArea" attribute shall be provided if the event applied for all UEs (i.e. "anyUe" attribute set to true).
 - For "QOS_SUSTAINABILITY", at least one of "networkArea" and "fineGranAreas" attributes shall be provided.
 - For "E2E_DATA_VOL_TRANS_TIME", the "networkArea" attribute shall be provided.
 - For "MOVEMENT_BEHAVIOUR", at least one of the "networkArea" or "fineGranAreas" attributes shall be provided.
 - For "SERVICE_EXPERIENCE" event, if the event applied for all UEs (i.e. "anyUe" attribute set to "true"): at least one of the "networkArea" and "fineGranAreas" attributes shall be provided.
- NOTE 3: Either "exceptIds" or "exptAnaType" shall be provided if event-id in the request is "ABNORMAL_BEHAVIOUR".
- NOTE 4: For "ABNORMAL_BEHAVIOUR" event with "anyUe" attribute in "tgt-ue" attribute sets to true,
- at least one of the "networkArea" and the "snssais" attribute should be included, if the expected analytics type via the "exptAnaType" attribute or the list of Exception Ids via the "exceptIds" attribute is mobility related;
 - at least one of the "networkArea", "applds", "dnns" and "snssais" attribute should be included, if the expected analytics type via the "exptAnaType" attribute or the list of Exception Ids via the "exceptIds" attribute is communication related;
 - the expected analytics type via the "exptAnaType" attribute or the list of Exception Ids via "exceptIds" attribute shall not be requested for both mobility and communication related analytics at the same time.
- NOTE 5: If both the "allFreq" attribute and the "allRat" attributes in RatFreqInformation data type are present, then the only one instance of the RatFreqInformation data type shall be present to indicate for all the RAT type and Frequency value the NWDAF has received for the application.
- NOTE 6: For service experience analytics, this parameter shall be provided when a consumer requires analytics for an edge application over a UP path.
- NOTE 7: For service experience analytics, this parameter may be provided when a consumer requires analytics for an edge application over a UP path, and it is only needed when the target of the service experience analytics is a specific UPF included in this UP path.
- NOTE 8: When event-id in the request is "NSI_LOAD_LEVEL" and the NsiLoadExt feature is supported, and the NF service consumer provides the "nfTypes" attribute, then the NWDAF accounts only for the resource usage of the NF types included in "nfTypes" to derive the output analytics.
- NOTE 9: If this attribute is provided, the analytics target period shall be a past time period (i.e. only statistics is supported).
- NOTE 10: Void.
- NOTE 11: Void.
- NOTE 12: When the "pduSesInfos" attribute is provided, the associated "applds" attribute shall be provided for the NWDAF to be able to compute the service experience per application.
- NOTE 13: When the subscribed event is "PDU_SESSION_TRAFFIC" and the PduSesTraffic feature is supported, at least one of the "dnns" and/or "snssais" attributes as the route selection descriptor(s) for the URSP rule shall be included.
- NOTE 14: Void.
- NOTE 15: When this attribute is provided, the NWDAF shall provide the analytics per elementary time slot accordingly.
- NOTE 16: When this attribute is provided, the NWDAF shall provide the analytics per group of TAs or cells accordingly.
- NOTE 17: If both "networkArea" and "fineGranAreas" attributes are provided, the Area of Interest is interpreted as the intersection area indicated by these two attributes.
- NOTE 18: When the subscribed event is "LOC_ACCURACY", only one of the "networkArea" or "location" attribute shall be included.
- NOTE 19: The "LON_AND_LAT_LEVEL" value of "locGranularity" attribute is not applicable to features "DispersionExt_eNA". The "TA_LEVEL" or "CELL_LEVEL" value of "locGranularity" attribute is not applicable to features "MovementBehaviour".
- NOTE 20: When the RoamingAnalytics feature is supported, the NF service consumer is in the VPLMN, and the NWDAF determines that the request is for roaming analytics in the HPLMN, this attribute may contain the mapped S-NSSAI(s) of the HPLMN.

NOTE 21: Only the "accuTimeWin" and "minNum" attributes contained in AccuracyReq data type are applicable.

NOTE: Care needs to be taken to avoid excessive signalling.

5.2.6.2.4 Void

5.2.6.2.5 Type AdditionInfoAnalyticsInfoRequest

Table 5.2.6.2.5-1: Definition of type AdditionInfoAnalyticsInfoRequest

| Attribute name | Data type | P | Cardinality | Description | Applicability |
|----------------|-------------|---|-------------|--|---------------|
| rvWaitTime | DurationSec | O | 0..1 | Recommended minimum time interval (in seconds) to be used to determine the time when analytics information is needed in similar future requests. It may only be included if the "cause" attribute within the ProblemDetails data type is set to "UNSATISFIED_REQUESTED_ANALYTICS_TIME". | |

5.2.6.2.6 Type ContextData

Table 5.2.6.2.6-1: Definition of type ContextData

| Attribute name | Data type | P | Cardinality | Description | Applicability |
|----------------|-----------------------|---|-------------|--|---------------|
| contextElems | array(ContextElement) | M | 1..N | List of items that contain context information corresponding with a context identifier. | |
| suppFeat | SupportedFeatures | C | 0..1 | List of Supported features used as described in clause 5.2.8. This parameter shall be supplied by NWDAF in the reply of GET request that request the analytics context information, if the consumer includes "supported-features" in the GET request. | |

5.2.6.2.7 Type ContextElement

Table 5.2.6.2.7-1: Definition of type ContextElement

| Attribute name | Data type | P | Cardinality | Description | Applicability |
|----------------|--|---|-------------|---|---------------|
| contextId | AnalyticsContextId entifier | M | 1 | Context identifier of the context information contained in the rest of the attributes. | |
| pendAnalytics | array(EventNotifica tion) | C | 1..N | Contains output analytics for the analytics subscription this context element is associated with, which have not yet been sent to the analytics consumer. It shall be provided if such analytics are available and the NF service consumer has requested the "PENDING_ANALYTICS" context type. | |
| histAnalytics | array(EventNotifica tion) | C | 1..N | Contains historical output analytics for the analytics subscription this context element is associated with. It shall be provided if such analytics are available and the NF service consumer has requested the "HISTORICAL_ANALYTICS" context type. | |
| lastOutputTime | DateTime | C | 0..1 | Timestamp of the last output analytics provided to the analytics consumer. It shall be provided if output analytics had been provided and the NF service consumer has requested the "PENDING_ANALYTICS" and/or "HISTORICAL_ANALYTICS" context type. Absence of this attribute means that no output analytics had been sent. | |
| aggrSubs | array(SpecificAnaly ticsSubscription) | C | 1..N | Contains analytics subscription aggregation information, i.e. information about analytics subscriptions that the NWDAF has with other NWDAFs that collectively serve an analytics subscription. It shall be provided if such subscriptions exist and the NF service consumer has requested the "AGGR_SUBS" context type. | |
| histData | array(HistoricalDat a) | C | 1..N | Contains historical data related to the analytics subscription this context element is associated with. It shall be provided if such data exists and the NF service consumer has requested the "DATA" context type. | |
| adrfId | NfInstanceId | O | 0..1 | Identifier of the ADRF in which the NWDAF stores analytics context information. | |
| adrfDataTypes | array(AdrfDataTyp e) | C | 1..N | Type(s) of data stored in the ADRF by the NWDAF. It shall be provided if the attribute "adrfId" is provided. | |
| aggrNwdafIds | array(NfInstanceId) | C | 1..N | NWDAF identifiers of NWDAF instances used by the NWDAF service consumer when aggregating multiple analytics subscriptions. It shall be provided if such information is available and the NF service consumer has requested the "AGGR_INFO" context type. | |

| | | | | | |
|----------------|------------------------------|---|------|---|------------------|
| modelInfos | array(ModelInfo) | C | 1..N | Contains information identifying the ML model(s) that the consumer NWDAF is currently subscribing for the analytics. It shall be provided if such information is available and the NF service consumer has requested the "ML_MODELS" context type. | |
| anaAccuInfos | array(AnalyticsAccuracyInfo) | C | 1..N | Contains Analytics Accuracy related information related to the analytics subscription associated with this context element. It shall be provided if such information exists and the NF service consumer has requested the "ANALYTICS_ACCU_INFO" context type. | EnAnaCtxTransfer |
| modelAccuInfos | array(MIModelAccuracyInfo) | C | 1..N | Contains ML Model accuracy related information related to the analytics subscription associated with this context element. It shall be provided if such information exists and the NF service consumer has requested the "ML_MODEL_ACCU_INFO" context type. | EnAnaCtxTransfer |

5.2.6.2.8 Type ContextIdList

Table 5.2.6.2.8-1: Definition of type ContextIdList

| Attribute name | Data type | P | Cardinality | Description | Applicability |
|----------------|-----------------------------------|---|-------------|--|---------------|
| contextIds | array(AnalyticsContextIdentifier) | M | 1..N | List of context identifiers of context information of analytics subscriptions. | |

5.2.6.2.9 Type HistoricalData

Table 5.2.6.2.9-1: Definition of type HistoricalData

| Attribute name | Data type | P | Cardinality | Description | Applicability |
|-----------------|---------------------------------|---|-------------|---|---------------|
| startTime | DateTime | O | 0..1 | Start of the time period during which the data was collected. | |
| endTime | DateTime | O | 0..1 | End of the time period during which the data was collected. | |
| subsWithSources | array(SpecificDataSubscription) | O | 1..N | Information about subscriptions with the data sources. | |
| data | array(DataNotification) | M | 1..N | Historical data related to the analytics. | |

5.2.6.2.10 Type SpecificAnalyticsSubscription

Table 5.2.6.2.10-1: Definition of type SpecificAnalyticsSubscription

| Attribute name | Data type | P | Cardinality | Description | Applicability |
|--|--------------------------|---|-------------|---|---------------|
| subscriptionId | string | M | 1 | The identifier of the specific analytics subscription. | |
| producerId | NfInstanceId | C | 0..1 | NWDAF instance identifier to which the NF service consumer has established this subscription. (NOTE) | |
| producerSetId | NfSetId | C | 0..1 | NWDAF set identifier to which the NF service consumer has established this subscription. (NOTE) | |
| nwdafEvSub | NnwdafEventsSubscription | M | 1 | Contains information about the analytics subscription. | |
| NOTE: Exactly One of "producerId" and "producerSetId" shall be included. | | | | | |

5.2.6.2.11 Type RequestedContext

Table 5.2.6.2.11-1: Definition of type RequestedContext

| Attribute name | Data type | P | Cardinality | Description | Applicability |
|----------------|--------------------|---|-------------|--|------------------|
| contexts | array(ContextType) | M | 1..N | Contains the types of the analytics context information the consumer wishes to receive. | |
| nfConsumerInfo | VendorId | O | 0..1 | Vendor ID of the NF Service Consumer, according to the IANA-assigned "SMI Network Management Private Enterprise Codes" [31]. This attribute may be provided if the requested context type is "ML_MODELS". | EnAnaCtxTransfer |

5.2.6.2.12 Type SmcceleInfo

Table 5.2.6.2.12-1: Definition of type SmcceleInfo

| Attribute name | Data type | P | Cardinality | Description | Applicability |
|----------------|-------------|---|-------------|--|---------------|
| dnn | Dnn | C | 0..1 | Identifies DNN, a full DNN with both the Network Identifier and Operator Identifier, or a DNN with the Network Identifier only. Shall be present if the "dnns" was provided in the event subscription or analytics request. | |
| snssai | Snssai | C | 0..1 | Identifies the network slice information. Shall be present if the "snssais" was provided in the event subscription or analytics request. | |
| smcceUeList | SmcceUeList | M | 1 | Contains the list of UEs classified based on experience level of SM congestion control. | |

5.2.6.2.13 Type SmcceUeList

Table 5.2.6.2.13-1: Definition of type SmcceUeList

| Attribute name | Data type | P | Cardinality | Description | Applicability |
|---|-------------|---|-------------|--|---------------|
| highLevel | array(Supi) | C | 1..N | A list of UEs whose experience level of SMCC for specific DNN and/or S-NSSAI is high. Shall be present if one of the elements in the "listOfAnaSubsets" attribute was set with value as "LIST_OF_HIGH_EXP_UE". (NOTE 1) (NOTE 2) | |
| mediumLevel | array(Supi) | C | 1..N | A list of UEs whose experience level of SMCC for specific DNN and/or S-NSSAI is medium. Shall be present if one of the elements in the "listOfAnaSubsets" attribute was set with value as "LIST_OF_MEDIUM_EXP_UE". (NOTE 1) (NOTE 2) | |
| lowLevel | array(Supi) | C | 1..N | A list of UEs whose experience level of SMCC for specific DNN and/or S-NSSAI is low. Shall be present if one of the elements in the "listOfAnaSubsets" attribute was set with value as "LIST_OF_LOW_EXP_UE". (NOTE 1) (NOTE 2) | |
| NOTE 1: At least one of "highLevel", "mediumLevel" or "lowLevel" shall be provided. | | | | | |
| NOTE 2: If the "listOfAnaSubsets" attribute with value only applicable to SMCCE event is present in the request, then only the corresponding attribute(s) shall be present. | | | | | |

5.2.6.2.14 Type SpecificDataSubscription

Table 5.2.6.2.14-1: Definition of type SpecificDataSubscription

| Attribute name | Data type | P | Cardinality | Description | Applicability |
|--|------------------|---|-------------|---|---------------|
| subscriptionId | string | M | 1 | The identifier of the specific data subscription. | |
| producerId | NfInstanceId | C | 0..1 | NF instance identifier to which the NF service consumer has established this subscription. (NOTE) | |
| producerSetId | NfSetId | C | 0..1 | NF set identifier to which the NF service consumer has established this subscription. (NOTE) | |
| dataSub | DataSubscription | M | 1 | Contains information about the subscription with the data source. | |
| NOTE: One of "producerId" and "producerSetId" shall be included. | | | | | |

5.2.6.2.15 Type UserDataCongestReq

Table 5.2.6.2.15-1: Definition of type UserDataCongestReq

| Attribute name | Data type | P | Cardinality | Description | Applicability |
|---|----------------------|---|-------------|---|---------------|
| orderCriterion | UserDataConOrderCrit | O | 0..1 | The ordering criterion for the list of User Data Congestion analytics. (NOTE 2) | |
| orderDirection | MatchingDirection | O | 0..1 | Indicate the order: ascending or descending. May be present when the "orderCriterion" attribute is included. (NOTE 1) | |
| NOTE 1: The "CROSSED" value in "MatchingDirection" data type is not applicable for this attribute. NOTE 2: If the value of "orderCriterion" attribute is "APPLICABLE_TIME_WINDOW", the "ASCENDING" direction indicates that the list of User Data Congestion analytics are in chronological order and the "DESCENDING" direction indicates that the list of User Data Congestion analytics are in reverse chronological order. | | | | | |

5.2.6.2.16 Type NetworkPerfReq

Table 5.2.6.2.16-1: Definition of type NetworkPerfReq

| Attribute name | Data type | P | Cardinality | Description | Applicability |
|--|---------------------------|---|-------------|---|---------------|
| orderCriterion | NetworkPerfOrderCriterion | O | 0..1 | The ordering criterion for the list of network performance analytics. | |
| orderDirection | MatchingDirection | O | 0..1 | Indicate the order: ascending or descending. May be present when the "orderCriterion" attribute is included. (NOTE) | |
| NOTE: The "CROSSED" value in "MatchingDirection" data type is not applicable for this attribute. | | | | | |

5.2.6.2.17 Type ResourceUsageReqPerNwPerfType

Table 5.2.6.2.17-1: Definition of type ResourceUsageReqPerNwPerfType

| Attribute name | Data type | P | Cardinality | Description | Applicability |
|--|--------------------------|---|-------------|--|---------------|
| nwPerfType | NetworkPerfType | M | 1 | Indicates network performance type. | |
| rscUsgReq | ResourceUsageRequirement | O | 0..1 | Indicates more requirements when providing resource usage information for the network performance type indicated by the "nwPerfType" attribute. (NOTE) | |
| NOTE: The "rscUsgReq" value is only applicable when the "nwPerfType" attribute is set to "GNB_RSC_USAGE_OVERALL_TRAFFIC", "GNB_RSC_USAGE_GBR_TRAFFIC" or "GNB_RSC_USAGE_DELAY_CRIT_GBR_TRAFFIC". | | | | | |

5.2.6.2.18 Type AnalyticsAccuracyInfo

Table 5.2.6.2.18-1: Definition of type AnalyticsAccuracyInfo

| Attribute name | Data type | P | Cardinality | Description | Applicability |
|-----------------|-----------------|---|-------------|---|---------------|
| reportTime | DateTime | O | 0..1 | Indicates the timestamp of the last analytics accuracy information provided to the analytics consumer(s). If no analytics accuracy information had been provided, the value is set to 0. | |
| pauseInd | boolean | O | 0..1 | Indicates whether the analytics subscription has been paused. Set to "true" if it has been paused, otherwise set to "false". | |
| remainTimeWin | TimeWindow | O | 0..1 | The remaining time window of paused analytics subscription. | |
| groundTruthInfo | GroundTruthInfo | O | 0..1 | The ground truth information used for the accuracy information computation. | |

5.2.6.2.19 Type GroundTruthInfo

Table 5.2.6.2.19-1: Definition of type GroundTruthInfo

| Attribute name | Data type | P | Cardinality | Description | Applicability |
|------------------|-------------------------|---|-------------|--|---------------|
| analyticsId | EventId | M | 1 | Indicates the analytics ID. | |
| dataSourceIds | array(NfInstanceId) | O | 1..N | The NF instance ID(s) of the data source for ground truth data. | |
| dataSourceSetIds | array(NfSetId) | O | 1..N | The NF Set ID(s) of the data source for ground truth data. | |
| dataSubs | array(DataSubscription) | O | 1..N | Represents data subscription for ground truth data. | |
| groundTruthDatas | array(DataNotification) | M | 1..N | The actual measured data observed corresponding to the event, i.e. the actual measured data observed at the time which the prediction refers to. | |

5.2.6.2.20 Type MIModelAccuracyInfo

Table 5.2.6.2.20-1: Definition of type MIModelAccuracyInfo

| Attribute name | Data type | P | Cardinality | Description | Applicability |
|----------------|---------------------|---|-------------|--|---------------|
| subscriptionId | string | M | 1 | The identifier of the subscription for the ML Model accuracy information. | |
| sourceId | NfInstanceId | O | 0..1 | The NF instance ID of source NWDAF. | |
| sourceSetId | NfSetId | O | 0..1 | The NF Set ID of source NWDAF. | |
| accuSubInfo | MLModelAccuracyInfo | O | 0..1 | The parameters used for the subscription for ML model accuracy information for the given ML Model. | |

5.2.6.3 Simple data types and enumerations

5.2.6.3.1 Introduction

This clause defines simple data types and enumerations that can be referenced from data structures defined in the previous clauses.

5.2.6.3.2 Simple data types

The simple data types defined in table 5.2.6.3.2-1 shall be supported.

Table 5.2.6.3.2-1: Simple data types

| Type Name | Type Definition | Description | Applicability |
|-----------|-----------------|-------------|---------------|
| n/a | | | |

5.2.6.3.3 Enumeration: EventId

Table 5.2.6.3.3-1: Enumeration EventId

| Enumeration value | Description | Applicability |
|-------------------------|---|--------------------------|
| E2E_DATA_VOL_TRANS_TIME | Represents the analytics of E2E data volume transfer time. | E2eDataVolTransTime |
| LOAD_LEVEL_INFORMATION | Represents the analytics of load level information of corresponding network slice. | |
| NETWORK_PERFORMANCE | Represents the analytics of network performance information | NetworkPerformance |
| NF_LOAD | Represents the analytics of NF Load information. | NfLoad |
| QOS_SUSTAINABILITY | Represents the analytics of QoS sustainability in the certain area. | QoSSustainability |
| SERVICE_EXPERIENCE | Represents the analytics of service experience of corresponding application and/or network slice. | ServiceExperience |
| UE_MOBILITY | Represents the analytics of UE mobility. | UeMobility |
| UE_COMM | Represents the analytics of UE communication. | UeCommunication |
| USER_DATA_CONGESTION | Represents the analytics of the user data congestion in the certain area. | UserDataCongestion |
| ABNORMAL_BEHAVIOUR | Represents the analytics of abnormal behaviour information. | AbnormalBehaviour |
| NSI_LOAD_LEVEL | Represents the analytics of load level information of Network Slice and the optionally associated Network Slice Instance. | NsiLoad |
| SM_CONGESTION | Represents the analytics of Session Management congestion control experience information for specific DNN and/or S-NSSAI. | SMCCE |
| DN_PERFORMANCE | Represents the analytics of DN performance. | DnPerformance |
| DISPERSION | Represents the analytics of dispersion. | Dispersion |
| RED_TRANS_EXP | Represents the analytics of Redundant Transmission Experience. | RedundantTransmissionExp |
| WLAN_PERFORMANCE | Represents the analytics of WLAN performance. | WlanPerformance |
| PDU_SESSION_TRAFFIC | Represents the analytics of PDU Session traffic information. | PduSesTraffic |
| MOVEMENT_BEHAVIOUR | Represents the analytics of Movement Behaviour information. | MovementBehaviour |
| LOC_ACCURACY | Represents the analytics of Location Accuracy. | LocAccuracy |
| RELATIVE_PROXIMITY | Represents the analytics of Relative Proximity information. | RelativeProximity |

5.2.6.3.4 Enumeration: ContextType

Table 5.2.6.3.4-1: Enumeration ContextType

| Enumeration value | Description | Applicability |
|----------------------|---|------------------|
| PENDING_ANALYTICS | Represents context information that relates to pending output analytics. | |
| HISTORICAL_ANALYTICS | Represents context information that relates to historical output analytics. | |
| AGGR_SUBS | Represents context information about the analytics subscriptions that an NWDAF has with other NWDAFs that collectively serve an analytics subscription. | |
| DATA | Represents context information about historical data that is available. | |
| AGGR_INFO | Represents context information that is related to aggregation of analytics from multiple NWDAF subscriptions. | |
| ML_MODELS | Represents context information about used ML models. | |
| ANALYTICS_ACCU_INFO | Represents the Analytics Accuracy related information. | EnAnaCtxTransfer |
| ML_MODEL_ACCU_INFO | Represents the ML Model accuracy related information. | EnAnaCtxTransfer |

5.2.6.3.5 Enumeration: AdrfDataType

Table 5.2.6.3.5-1: Enumeration AdrfDataType

| Enumeration value | Description | Applicability |
|----------------------|---|---------------|
| HISTORICAL_ANALYTICS | Indicates that historical analytics are stored in the ADRF. | |
| HISTORICAL_DATA | Indicates that historical data are stored in the ADRF. | |

5.2.6.4 Data types describing alternative data types or combinations of data types

5.2.6.4.1 Type ProblemDetailsAnalyticsInfoRequest

Table 5.2.6.4.1-1: Definition of type ProblemDetailsAnalyticsInfoRequest as a list of to be combined data types

| Data type | Cardinality | Description | Applicability |
|----------------------------------|-------------|--|---------------|
| ProblemDetails | 1 | Details of the problem as defined in TS 29.571 [8]. | |
| AdditionInfoAnalyticsInfoRequest | 1 | Contains additional information why the analytics request is rejected. | |

5.2.7 Error handling

5.2.7.1 General

HTTP error handling shall be supported as specified in clause 5.2.4 of 3GPP TS 29.500 [6].

For the Nnwdafe_AnalyticsInfo API, HTTP error responses shall be supported as specified in clause 4.8 of 3GPP TS 29.501 [7]. Protocol errors and application errors specified in table 5.2.7.2-1 of 3GPP TS 29.500 [6] shall be supported for an HTTP method if the corresponding HTTP status codes are specified as mandatory for that HTTP method in table 5.2.7.1-1 of 3GPP TS 29.500 [6]. In addition, the requirements in the following clauses shall apply.

5.2.7.2 Protocol Errors

In this Release of the specification, there are no additional protocol errors applicable for the Nnwdaf_AnalyticsInfo API.

5.2.7.3 Application Errors

The application errors defined for the Nnwdaf_AnalyticsInfo API are listed in table 5.2.7.3-1.

Table 5.2.7.3-1: Application errors

| Application Error | HTTP status code | Description | Applicability |
|--------------------------------------|--|---|------------------|
| BOTH_STAT_PRED_NOT_ALLOWED | 400 Bad Request | Indicates that the request shall be rejected, because for the requested observation period, the start time is in the past and the end time is in the future, which means the NF service consumer requested both statistics and prediction for the analytics is not allowed. | |
| PREDICTION_NOT_ALLOWED | 400 Bad Request | Indicates that the request shall be rejected because the prediction for the analytics event is not allowed. | PredictionError |
| USER_CONSENT_NOT_GRANTED | 403 Forbidden | Indicates that the request shall be rejected because an impacted user has not provided the required user consent. | |
| NO_ROAMING_SUPPORT | 403 Forbidden | Indicates that the request shall be rejected because roaming analytics or data are required and the NWDAF neither supports roaming exchange capability nor can it forward the request to another NWDAF. | RoamingAnalytics |
| UNAVAILABLE_DATA | 500 Internal Server Error | Indicates the requested statistics in the past is rejected since necessary data to perform the service is unavailable. | |
| UNSATISFIED_REQUESTED_ANALYTICS_TIME | 500 Internal Server Error | Indicates that the requested event is rejected since the analytics information is not ready when the time indicated by the "timeAnaNeeded" attribute (as provided during the request) is reached. | |
| NOTE: | Including a "ProblemDetails" data structure with the "cause" attribute in the HTTP response is optional unless explicitly mandated in the service operation clauses. | | |

5.2.8 Feature negotiation

The optional features in table 5.2.8-1 are defined for the Nnwdaf_AnalyticsInfo API. They shall be negotiated using the extensibility mechanism defined in clause 6.6 of 3GPP TS 29.500 [6].

Table 5.2.8-1: Supported Features

| Feature number | Feature Name | Description |
|----------------|----------------------------|---|
| 1 | UeMobility | This feature indicates the support of analytics based on UE mobility information. |
| 2 | UeCommunication | This feature indicates the support of analytics based on UE communication information. |
| 3 | NetworkPerformance | This feature indicates the support of analytics based on network performance. |
| 4 | ServiceExperience | This feature indicates support for the event related to service experience. |
| 5 | QoSsustainability | This feature indicates support for the event related to QoS sustainability. |
| 6 | AbnormalBehaviour | This feature indicates support for the event related to abnormal behaviour information. |
| 7 | UserDataCongestion | This feature indicates the support of the analytics related on user data congestion. |
| 8 | NfLoad | This feature indicates the support of the analytics related to the load of NF instances. |
| 9 | NsiLoad | This feature indicates the support of the analytics related to the load level of Network Slice and the optionally associated Network Slice Instance. |
| 10 | EneNA | This feature indicates support for the enhancements of network data analytics requirements. |
| 11 | UserDataCongestionExt | This feature indicates support for the extensions to the event related to user data congestion, including support of GPSI and/or list of Top applications. Supporting this feature also requires the support of feature UserDataCongestion. |
| 12 | Aggregation | This feature indicates support for analytics aggregation. |
| 13 | NsiLoadExt | This feature indicates support for the extensions to the event related to the load level of Network Slice and the optionally associated Network Slice Instance, including support of area of interest, NF load information and number of UE or number of PDU Session. Supporting this feature also requires the support of feature NsiLoad. |
| 14 | ServiceExperienceExt | This feature indicates support for the extensions to the event related to service experience, including support of RAT type and/or Frequency. Supporting this feature also requires the support of feature ServiceExperience. |
| 15 | SMCCE | This feature indicates support for the event related to SM congestion control experience. |
| 16 | NfLoadExt | This feature indicates support for the extensions to the event related to the load of NF instances, including NF load over area of interest. Supporting this feature also required the support of feature NfLoad. |
| 17 | Dispersion | This feature indicates support for the event related to dispersion analytics information. |
| 18 | RedundantTransmissionExp | This feature indicates support for the event related to redundant transmission experience analytics information. |
| 19 | WlanPerformance | This feature indicates support of the event related to WLAN performance analytics information. |
| 20 | UeMobilityExt | This feature indicates support for extensions to the event related to UE mobility, including support of LADN DNN to refer the LADN service area as the AOI. Supporting this feature also requires the support of feature UeMobility. |
| 21 | DnPerformance | This feature indicates the support of the analytics related to DN performance. |
| 22 | AnaCtxTransfer | This feature indicates the support of analytics context transfer. |
| 23 | UserConsent | Indicates the support of detailed handling of user consent, e.g. error responses related to the lack of user consent. |
| 24 | UserDataCongestionExt2_eNA | This feature indicates support for the enhancements of user data congestion, including support of ordering criterion. Supporting this feature also requires the support of UserDataCongestion and UserDataCongestionExt features. |
| 25 | UeMobilityExt2_eNA | This feature indicates support for the enhancements of UE mobility, including support of ordering criterion. Supporting this feature also requires the support of UeMobility and UeMobilityExt features. |

| | | |
|----|----------------------------|---|
| 26 | UeCommunicationExt_eNA | This feature indicates support for the enhancements of UE Communication, including support of ordering criterion. Supporting this feature also requires the support of UeCommunication feature. |
| 27 | NetworkPerformanceExt_eNA | This feature indicates support for the enhancements of Network Performance, including support of ordering criterion for the list of analytics and analytics target period subset. Supporting this feature also requires the support of NetworkPerformance feature. |
| 28 | ServiceExperienceExt2_eNA | This feature indicates extensions to the event related to service experience supporting eNA, including support for PDU Session parameters information for service experience analytics. Supporting this feature also requires the support of feature ServiceExperience. |
| 29 | DnPerformanceExt_AIML | This feature indicates support for extensions to the event related to DN Performance supporting AIML, including support of extended DN Performance Analytics for group of UEs. Supporting this feature also requires the support of feature DnPerformance. |
| 30 | UeMobilityExt_AIML | This feature indicates support for further extensions to the event related to UE mobility supporting AIML, including support of UE's geographical distribution and direction analytics. Supporting this feature also requires the support of feature UeMobility. |
| 31 | PduSesTraffic | This feature indicates support of the analytics related to PDU Session traffic information. |
| 32 | DispersionExt_eNA | This feature indicates support for the enhancements of Dispersion, including the support of preferred granularity of UE location. Supporting this feature also requires the support of Dispersion feature. |
| 33 | WlanPerformanceExt_AIML | This feature indicates support for the enhancements of WLAN performance supporting AIML, including support of analytics per UE granularity. Supporting this feature also requires the support of feature WlanPerformance. |
| 34 | NetworkPerformanceExt_AIML | This feature indicates support of the network performance enhancements for AI/ML-based Services. Within this feature the following enhancements are covered: - support of providing gNB resource usage for GBR traffic and Delay-critical GBR traffic. Supporting this feature also requires the support of NetworkPerformance feature. |
| 35 | E2eDataVolTransTime | This feature indicates support for E2E data volume transfer time analytics |
| 36 | AnalyticsAccuracy | This feature indicates support for the Analytics Accuracy information. |
| 37 | EnAbnormalBehaviour | This feature indicates support for the enhancements of UE Abnormal Behaviour. Supporting this feature also requires the support of AbnormalBehaviour feature. |
| 38 | UeCommunicationExt | This feature indicates the support for the extensions to the event related to UE communication, including support of reporting the analytics of the application list used by UE, N4 Session inactivity timer, and whether the UE communicates periodically or not. Supporting this feature also requires the support of UeCommunication feature. |
| 39 | QoSsustainExt_eNA | This feature indicates support for the enhancements of QoS Sustainability, including: - support of temporal and spatial granularity size. Supporting this feature also requires the support of QoSsustainability feature. |
| 40 | WlanPerfExt_eNA | This feature indicates support for the enhancements of WLAN performance, including: - support of temporal granularity size. Supporting this feature also requires the support of feature WlanPerformance. |

| | | |
|----|-------------------|---|
| 41 | DnPerfExt_eNA | This feature indicates support for extensions to the event related to DN Performance, including support of number of UEs. Supporting this feature also requires the support of feature DnPerformance. |
| 42 | QoSsustainExt_eNA | This feature indicates support for the enhancements of QoS Sustainability, including enhancements of filter information. Supporting this feature also requires the support of QoSsustainability feature. |
| 43 | MovementBehaviour | This feature indicates support for the Movement Behaviour information. |
| 44 | LocAccuracy | This feature indicates support for the Location Accuracy analytics. |
| 45 | RelativeProximity | This feature indicates support for the Relative Proximity analytics. |
| 46 | ENAEExt | This feature indicates support for the general enhancements of network data analytics requirements, including support more level of accuracy and support for use case context sent by the NF service consumer to the NWDAF. |
| 47 | RoamingAnalytics | This feature indicates support for the Roaming analytics. |
| 48 | PredictionError | This feature indicates support for Prediction Error handling. |
| 49 | EnAnaCtxTransfer | This feature indicates the enhancement for the analytics context transfer, including the support of transferring the Analytics Accuracy and ML Model accuracy context types. Supporting this feature also requires the support of feature "AnaCtxTransfer". |

5.2.9 Security

As indicated in 3GPP TS 33.501 [13] and 3GPP TS 29.500 [6], the access to the Nnwdaf_AnalyticsInfo API may be authorized by means of the OAuth2 protocol (see IETF RFC 6749 [14]), based on local configuration, using the "Client Credentials" authorization grant, where the NRF (see 3GPP TS 29.510 [12]) plays the role of the authorization server.

If OAuth2 is used, an NF service consumer, prior to consuming services offered by the Nnwdaf_AnalyticsInfo API, shall obtain a "token" from the authorization server, by invoking the Access Token Request service, as described in 3GPP TS 29.510 [12], clause 5.4.2.2.

NOTE: When multiple NRFs are deployed in a network, the NRF used as authorization server is the same NRF that the NF service consumer used for discovering the Nnwdaf_AnalyticsInfo service.

The Nnwdaf_AnalyticsInfo API defines the following scopes for OAuth2 authorization as described in 3GPP TS 29.501 [7], clause 4.x.

Table 5.2.9-1: OAuth2 scopes defined in Nnwdaf_AnalyticsInfo API

| Scope | Description |
|---------------------------------------|---|
| "nwdaf-analyticsinfo" | Access to the Nnwdaf_AnalyticsInfo API |
| "nwdaf-analyticsinfo:contexttransfer" | Access to service operations applying to NWDAF context transfer related service operations, i.e. ContextTransfer. |

5.3 Nnwdaf_DataManagement Service API

5.3.1 Introduction

The Nnwdaf_DataManagement service shall use the Nnwdaf_DataManagement API.

The API URI of the Nnwdaf_DataManagement API shall be:

{apiRoot}/<apiName>/<apiVersion>

The request URIs used in each HTTP requests from the NF service consumer towards the NWDAF shall have the Resource URI structure defined in clause 4.4.1 of 3GPP TS 29.501 [7], i.e.:

{apiRoot}/<apiName>/<apiVersion>/<apiSpecificResourceUriPart>

with the following components:

- The {apiRoot} shall be set as described in 3GPP TS 29.501 [7].
- The <apiName> shall be "nnwdaf-datamanagement".
- The <apiVersion> shall be "v1".
- The <apiSpecificResourceUriPart> shall be set as described in clause 5.3.3.

5.3.2 Usage of HTTP

5.3.2.1 General

HTTP/2, IETF RFC 9113 [9], shall be used as specified in clause 5 of 3GPP TS 29.500 [6].

HTTP/2 shall be transported as specified in clause 5.3 of 3GPP TS 29.500 [6].

The OpenAPI [11] specification of HTTP messages and content bodies for the Nnwdaf_DataManagement is contained in Annex A.

5.3.2.2 HTTP standard headers

5.3.2.2.1 General

See clause 5.2.2 of 3GPP TS 29.500 [6] for the usage of HTTP standard headers.

5.3.2.2.2 Content type

JSON, IETF RFC 8259 [10], shall be used as content type of the HTTP bodies specified in the present specification as specified in clause 5.4 of 3GPP TS 29.500 [6]. The use of the JSON format shall be signalled by the content type "application/json".

"Problem Details" JSON object shall be used to indicate additional details of the error in a HTTP response body and shall be signalled by the content type "application/problem+json", as defined in IETF RFC 9457 [15].

5.3.2.3 HTTP custom headers

The Nnwdaf_DataManagement service API shall support mandatory HTTP custom header fields specified in clause 5.2.3.2 of 3GPP TS 29.500 [6] and may support HTTP custom header fields specified in clause 5.2.3.3 of 3GPP TS 29.500 [6].

In this release of the specification, no specific custom headers are defined for the Nnwdaf_DataManagement service API.

5.3.3 Resources

5.3.3.1 Resource Structure

This clause describes the structure for the Resource URIs, the resources and methods used for the service.

Figure 5.3.3.1-1 depicts the resource URIs structure for the Nnwdaf_DataManagement API.

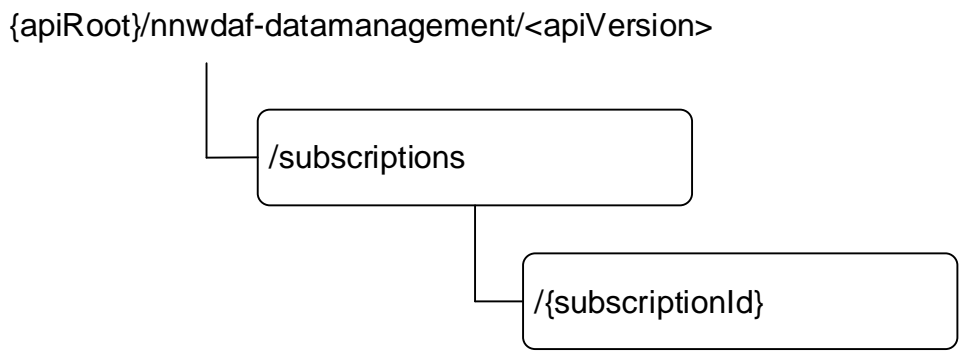

Figure 5.3.3.1-1: Resource URI structure of the Nnwdaf_DataManagement API

Table 5.3.3.1-1 provides an overview of the resources and applicable HTTP methods.

Table 5.3.3.1-1: Resources and methods overview

| Resource name | Resource URI | HTTP method or custom operation | Description |
|---|---------------------------------|---------------------------------|--|
| NWDAF Data Management Subscriptions | /subscriptions | POST | Creates a new Individual NWDAF Data Management Subscription resource. |
| Individual NWDAF Data Management Subscription | /subscriptions/{subscriptionId} | DELETE | Deletes an Individual NWDAF Data Management Subscription identified by subresource {subscriptionId}. |
| | | PUT | Modifies an existing Individual NWDAF Data Management Subscription identified by subresource {subscriptionId}. |

5.3.3.2 Resource: NWDAF Data Management Subscriptions

5.3.3.2.1 Description

The NWDAF Data Management Subscriptions resource represents all subscriptions to the Nnwdaf_DataManagement Service at a given NWDAF. The resource allows an NF service consumer to create a new Individual NWDAF Data Management Subscription resource.

5.3.3.2.2 Resource Definition

Resource URI: **{apiRoot}/nnwdaf-datamanagement/<apiVersion>/subscriptions**

The <apiVersion> shall be set as described in clause 5.3.1.

This resource shall support the resource URI variables defined in table 5.3.3.2.2-1.

Table 5.3.3.2.2-1: Resource URI variables for this resource

| Name | Data type | Definition |
|---------|-----------|------------------|
| apiRoot | string | See clause 5.3.1 |

5.3.3.2.3 Resource Standard Methods

5.3.3.2.3.1 POST

This method shall support the URI query parameters specified in table 5.3.3.2.3.1-1.

Table 5.3.3.2.3.1-1: URI query parameters supported by the POST method on this resource

| Name | Data type | P | Cardinality | Description |
|------|-----------|---|-------------|-------------|
| n/a | | | | |

This method shall support the request data structures specified in table 5.3.3.2.3.1-2 and the response data structures and response codes specified in table 5.3.3.2.3.1-3.

Table 5.3.3.2.3.1-2: Data structures supported by the POST Request Body on this resource

| Data type | P | Cardinality | Description |
|---------------------------|---|-------------|--|
| NnwdafDataManagementSubsc | M | 1 | Create a new Individual NWDAF Data Management Subscription resource. |

Table 5.3.3.2.3.1-3: Data structures supported by the POST Response Body on this resource

| Data type | P | Cardinality | Response codes | Description |
|---------------------------|---|-------------|-----------------|---|
| NnwdafDataManagementSubsc | M | 1 | 201 Created | The creation of an Individual NWDAF Data Management Subscription resource is confirmed and a representation of that resource is returned. |
| ProblemDetails | O | 0..1 | 400 Bad Request | (NOTE 2) |
| ProblemDetails | O | 0..1 | 403 Forbidden | (NOTE 2) |

NOTE 1: The mandatory HTTP error status codes for the POST method listed in table 5.2.7.1-1 of 3GPP TS 29.500 [6] also apply.
NOTE 2: Failure cases are described in clause 5.3.7.

Table 5.3.3.2.3.1-4: Headers supported by the 201 Response Code on this resource

| Name | Data type | P | Cardinality | Description |
|----------|-----------|---|-------------|---|
| Location | string | M | 1 | Contains the URI of the newly created resource, according to the structure: {apiRoot}/nnwdaf-datamanagement/<apiVersion>/subscriptions/{subscriptionId} |

5.3.3.2.4 Resource Custom Operations

None in this release of the specification.

5.3.3.3 Resource: Individual NWDAF Data Management Subscription

5.3.3.3.1 Description

The Individual NWDAF Data Management Subscription resource represents a single subscription to the Nnwdaf_DataManagement Service at a given NWDAF.

5.3.3.3.2 Resource definition

Resource URI: {apiRoot}/nnwdaf-datamanagement/<apiVersion>/subscriptions/{subscriptionId}

The <apiVersion> shall be set as described in clause 5.3.1.

This resource shall support the resource URI variables defined in table 5.3.3.3.2-1.

Table 5.3.3.3.2-1: Resource URI variables for this resource

| Name | Data type | Definition |
|----------------|-----------|--|
| apiRoot | string | See clause 5.3.1 |
| subscriptionId | string | Identifies a subscription to the Nnwdaf_DataManagement Service |

5.3.3.3.3 Resource Standard Methods

5.3.3.3.3.1 PUT

This method shall support the URI query parameters specified in table 5.3.3.3.3.1-1.

Table 5.3.3.3.3.1-1: URI query parameters supported by the PUT method on this resource

| Name | Data type | P | Cardinality | Description |
|------|-----------|---|-------------|-------------|
| n/a | | | | |

This method shall support the request data structures specified in table 5.3.3.3.3.1-2 and the response data structures and response codes specified in table 5.3.3.3.3.1-3.

Table 5.3.3.3.3.1-2: Data structures supported by the PUT Request Body on this resource

| Data type | P | Cardinality | Description |
|---------------------------|---|-------------|--|
| NnwdafDataManagementSubsc | M | 1 | Parameters to replace a subscription to NWDAF Data Management Subscription resource. |

Table 5.3.3.3.3.1-3: Data structures supported by the PUT Response Body on this resource

| Data type | P | Cardinality | Response codes | Description |
|--|---|-------------|------------------------|---|
| NnwdafDataManagementSubsc | M | 1 | 200 OK | The Individual NWDAF Data Management Subscription resource was modified successfully and a representation of that resource is returned. |
| n/a | | | 204 No Content | The Individual NWDAF Data Management Subscription resource was modified successfully. |
| RedirectResponse | O | 0..1 | 307 Temporary Redirect | Temporary redirection, during Individual NWDAF Data Management Subscription modification. (NOTE 3) |
| RedirectResponse | O | 0..1 | 308 Permanent Redirect | Permanent redirection, during Individual NWDAF Data Management Subscription modification. (NOTE 3) |
| ProblemDetails | O | 0..1 | 400 Bad Request | (NOTE 2) |
| ProblemDetails | O | 0..1 | 403 Forbidden | (NOTE 2) |
| NOTE 1: The mandatory HTTP error status codes for the PUT method listed in table 5.2.7.1-1 of 3GPP TS 29.500 [6] also apply. | | | | |
| NOTE 2: Failure cases are described in clause 5.3.7. | | | | |
| NOTE 3: The RedirectResponse data structure may be provided by an SCP (cf. clause 6.10.9.1 of 3GPP TS 29.500 [6]). | | | | |

Table 5.3.3.3.3.1-4: Headers supported by the 307 Response Code on this resource

| Name | Data type | P | Cardinality | Description |
|-----------------------|-----------|---|-------------|---|
| Location | string | M | 1 | Contains an alternative URI of the resource located in an alternative NWDAF (service) instance towards which the request is redirected. For the case where the request is redirected to the same target via a different SCP, refer to clause 6.10.9.1 of 3GPP TS 29.500 [6]. |
| 3gpp-Sbi-Target-Nf-Id | string | O | 0..1 | Identifier of the target NWDAF (service) instance towards which the request is redirected. |

Table 5.3.3.3.3.1-5: Headers supported by the 308 Response Code on this resource

| Name | Data type | P | Cardinality | Description |
|-----------------------|-----------|---|-------------|---|
| Location | string | M | 1 | Contains an alternative URI of the resource located in an alternative NWDAF (service) instance towards which the request is redirected. For the case where the request is redirected to the same target via a different SCP, refer to clause 6.10.9.1 of 3GPP TS 29.500 [6]. |
| 3gpp-Sbi-Target-Nf-Id | string | O | 0..1 | Identifier of the target NWDAF (service) instance towards which the request is redirected. |

5.3.3.3.3.2 DELETE

This method shall support the URI query parameters specified in table 5.3.3.3.3.2-1.

Table 5.3.3.3.3.2-1: URI query parameters supported by the DELETE method on this resource

| Name | Data type | P | Cardinality | Description |
|------|-----------|---|-------------|-------------|
| n/a | | | | |

This method shall support the request data structures specified in table 5.3.3.3.3.2-2 and the response data structures and response codes specified in table 5.3.3.3.3.2-3.

Table 5.3.3.3.3.2-2: Data structures supported by the DELETE Request Body on this resource

| Data type | P | Cardinality | Description |
|-----------|---|-------------|-------------|
| n/a | | | |

Table 5.3.3.3.2-3: Data structures supported by the DELETE Response Body on this resource

| Data type | P | Cardinality | Response codes | Description |
|---|---|-------------|------------------------|---|
| n/a | | | 204 No Content | Successful case: The Individual NWDAF Data Management Subscription resource matching the subscriptionId was deleted. |
| NnwdaDataManagementNotif | C | 0..1 | 200 OK | Successful case: The Individual NWDAF Data Management Subscription resource matching the subscriptionId was deleted and including the stored unsend events in the response. |
| RedirectResponse | O | 0..1 | 307 Temporary Redirect | Temporary redirection, during Individual NWDAF Data Management Subscription deletion. (NOTE 2) |
| RedirectResponse | O | 0..1 | 308 Permanent Redirect | Permanent redirection, during Individual NWDAF Data Management Subscription deletion. (NOTE 2) |
| NOTE 1: The mandatory HTTP error status codes for the DELETE method listed in table 5.2.7.1-1 of 3GPP TS 29.500 [6] also apply. | | | | |
| NOTE 2: The RedirectResponse data structure may be provided by an SCP (cf. clause 6.10.9.1 of 3GPP TS 29.500 [6]). | | | | |

Table 5.3.3.3.2-4: Headers supported by the 307 Response Code on this resource

| Name | Data type | P | Cardinality | Description |
|-----------------------|-----------|---|-------------|---|
| Location | string | M | 1 | Contains an alternative URI of the resource located in an alternative NWDAF (service) instance towards which the request is redirected. For the case where the request is redirected to the same target via a different SCP, refer to clause 6.10.9.1 of 3GPP TS 29.500 [6]. |
| 3gpp-Sbi-Target-Nf-Id | string | O | 0..1 | Identifier of the target NWDAF (service) instance towards which the request is redirected. |

Table 5.3.3.3.2-5: Headers supported by the 308 Response Code on this resource

| Name | Data type | P | Cardinality | Description |
|-----------------------|-----------|---|-------------|--|
| Location | string | M | 1 | Contains an alternative URI of the resource located in an alternative NWDAF (service) instance towards which the request is redirected For the case where the request is redirected to the same target via a different SCP, refer to clause 6.10.9.1 of 3GPP TS 29.500 [6]. |
| 3gpp-Sbi-Target-Nf-Id | string | O | 0..1 | Identifier of the target NWDAF (service) instance towards which the request is redirected. |

5.3.3.3.4 Resource Custom Operations

None in this release of the specification.

5.3.4 Custom Operations without associated resources

None in this release of the specification.

5.3.5 Notifications

5.3.5.1 General

Notifications shall comply with clause 6.2 of 3GPP TS 29.500 [6] and clause 4.6.2.3 of 3GPP TS 29.501 [7].

Table 5.3.5.1-1: Notifications overview

| Notification | Callback URI | HTTP method or custom operation | Description (service operation) |
|--------------------|--------------|---------------------------------|--------------------------------------|
| Event Notification | {notificURI} | POST | Report one or several observed data. |
| Fetch Notification | {fetchUri} | POST | Fetch one or several notified data. |

5.3.5.2 Event Notification

5.3.5.2.1 Description

The Event Notification is used by the NWDAF to report one or several observed data to an NF service consumer that has subscribed to such Notifications.

5.3.5.2.2 Operation Definition

Callback URI: {notificURI}

The operation shall support the callback URI variables defined in Table 5.3.5.2.2-1, the request data structures specified in table 5.3.5.2.2-2 and the response data structure and response codes specified in Table 5.3.5.2.2-3.

Table 5.3.5.2.2-1: Callback URI variables

| Name | Data type | Definition |
|------------|-----------|---|
| notificURI | Uri | The Notification Uri is assigned within the Individual NWDAF Data Management Subscription Resource and described within the NnwdafDataManagementSubsc type (see table 5.3.6.2.2-1). |

Table 5.3.5.2.2-2: Data structures supported by the POST Request Body on this resource

| Data type | P | Cardinality | Description |
|---------------------------|---|-------------|---|
| NnwdafDataManagementNotif | M | 1 | Provides Information about observed data. |

Table 5.3.5.2.2-3: Data structures supported by the POST Response Body on this resource

| Data type | P | Cardinality | Response codes | Description |
|------------------|---|-------------|------------------------|---|
| n/a | | | 204 No Content | The receipt of the Notification is acknowledged. |
| NotifResponse | M | 1 | 200 OK | The receipt of the notification is acknowledged and a response with information about the planned action is provided. |
| RedirectResponse | O | 0..1 | 307 Temporary Redirect | Temporary redirection, during the event notification. (NOTE 2) |
| RedirectResponse | O | 0..1 | 308 Permanent Redirect | Permanent redirection, during the event notification. (NOTE 2) |

NOTE 1: The mandatory HTTP error status codes for the POST method listed in table 5.2.7.1-1 of 3GPP TS 29.500 [6] also apply.

NOTE 2: The RedirectResponse data structure may be provided by an SCP (cf. clause 6.10.9.1 of 3GPP TS 29.500 [6]).

Table 5.3.5.2.2-4: Headers supported by the 307 Response Code on this resource

| Name | Data type | P | Cardinality | Description |
|-----------------------|-----------|---|-------------|--|
| Location | string | M | 1 | Contains an alternative URI representing the end point of an alternative NF consumer (service) instance towards which the notification is redirected. For the case where the notification is redirected to the same target via a different SCP, refer to clause 6.10.9.1 of 3GPP TS 29.500 [6]. |
| 3gpp-Sbi-Target-Nf-Id | string | O | 0..1 | Identifier of the target NF (service) instance towards which the notification request is redirected. |

Table 5.3.5.2.2-5: Headers supported by the 308 Response Code on this resource

| Name | Data type | P | Cardinality | Description |
|-----------------------|-----------|---|-------------|--|
| Location | string | M | 1 | Contains an alternative URI representing the end point of an alternative NF consumer (service) instance towards which the notification is redirected. For the case where the notification is redirected to the same target via a different SCP, refer to clause 6.10.9.1 of 3GPP TS 29.500 [6]. |
| 3gpp-Sbi-Target-Nf-Id | string | O | 0..1 | Identifier of the target NF (service) instance towards which the notification request is redirected. |

5.3.5.3 Fetch Notification

5.3.5.3.1 Description

The Fetch Notification is used by the NF service consumer to retrieve data from the NWDAF.

5.3.5.3.2 Target URI

The Callback URI "{fetchUri}" shall be used with the callback URI variables defined in table 5.3.5.3.2-1.

Table 5.3.5.3.2-1: Callback URI variables

| Name | Data type | Definition |
|----------|-----------|---|
| fetchUri | Uri | Fetch Uri as assigned during the procedure of notification about the subscribed data within the FetchInstruction data type. |

5.3.5.3.3 Standard Methods

5.3.5.3.3.1 POST

This method shall support the URI query parameters specified in table 5.3.5.3.3.1-1.

Table 5.3.5.3.3.1-1: URI query parameters supported by the POST method on this resource

| Name | Data type | P | Cardinality | Description | Applicability |
|------|-----------|---|-------------|-------------|---------------|
| n/a | | | | | |

This method shall support the request data structures specified in table 5.3.5.3.3.1-2 and the response data structures and response codes specified in table 5.3.5.3.3.1-3.

Table 5.3.5.3.3.1-2: Data structures supported by the POST Request Body on this resource

| Data type | P | Cardinality | Description |
|---------------|---|-------------|---|
| array(string) | M | 1..N | Indicate the fetch correlation identifier(s). |

Table 5.3.5.3.3.1-3: Data structures supported by the POST Response Body on this resource

| Data type | P | Cardinality | Response codes | Description |
|--|---|-------------|------------------------|---|
| NnwdafDataManagementNotif | M | 1 | 200 OK | The stored data related to the fetch correlation identifier(s). |
| RedirectResponse | O | 0..1 | 307 Temporary Redirect | Temporary redirection, during subscription retrieval. (NOTE 2) |
| RedirectResponse | O | 0..1 | 308 Permanent Redirect | Permanent redirection, during subscription retrieval. (NOTE 2) |
| NOTE 1: The mandatory HTTP error status code for the POST method listed in Table 5.2.7.1-1 of 3GPP TS 29.500 [6] also apply. | | | | |
| NOTE 2: The RedirectResponse data structure may be provided by an SCP (cf. clause 6.10.9.1 of 3GPP TS 29.500 [6]). | | | | |

Table 5.3.5.3.3.1-4: Headers supported by the by the 307 Response Code on this resource

| Name | Data type | P | Cardinality | Description |
|-----------------------|-----------|---|-------------|--|
| Location | string | M | 1 | Contains an alternative URI of the resource located in an alternative NWDAF towards which the request is redirected. For the case where the request is redirected to the same target via a different SCP, refer to clause 6.10.9.1 of 3GPP TS 29.500 [6]. |
| 3gpp-Sbi-Target-Nf-Id | string | O | 0..1 | Identifier of the target NF (service) instance towards which the request is redirected. |

Table 5.3.5.3.3.1-5: Headers supported by the 308 response code on this resource

| Name | Data type | P | Cardinality | Description |
|-----------------------|-----------|---|-------------|--|
| Location | string | M | 1 | Contains an alternative URI of the resource located in an alternative NWDAF towards which the request is redirected. For the case where the request is redirected to the same target via a different SCP, refer to clause 6.10.9.1 of 3GPP TS 29.500 [6]. |
| 3gpp-Sbi-Target-Nf-Id | string | O | 0..1 | Identifier of the target NF (service) instance towards which the request is redirected. |

5.3.6 Data Model

5.3.6.1 General

This clause specifies the application data model supported by the API.

Table 5.3.6.1-1 specifies the data types defined for the Nnwdaf_DataManagement service based interface protocol.

Table 5.3.6.1-1: Nnwdaf_DataManagement specific Data Types

| Data type | Clause defined | Description | Applicability |
|---------------------------|----------------|--|---------------|
| NnwdafDataManagementSubsc | 5.3.6.2.2 | Represents an Individual NWDAF Data Management Subscription resource. | |
| NnwdafDataManagementNotif | 5.3.6.2.3 | Represents a notification that corresponds with an Individual NWDAF Data Management Subscription resource. | |
| PendingNotificationCause | 5.3.6.3.3 | Represents the Pending Notification Cause for the stored unsend events. | EnhDataMgmt |

Table 5.3.6.1-2 specifies data types re-used by the Nnwdaf_DataManagement service based interface protocol from other specifications, including a reference to their respective specifications and when needed, a short description of their use within the Nnwdaf_DataManagement service based interface.

Table 5.3.6.1-2: Nnwdaf_DataManagement re-used Data Types

| Data type | Reference | Comments | Applicability |
|----------------------------|---------------------|---|----------------|
| DataCollectionPurpose | 3GPP TS 29.574 [26] | Represents the purpose for data collection, e.g. analytics or model training. | |
| DataNotification | 3GPP TS 29.575 [27] | Represents data subscription notification from data source (e.g. AMF, SMF, UDM, NEF, AF). | |
| DataSubscription | 3GPP TS 29.575 [27] | Represents data subscription from data source (e.g. AMF, SMF, UDM, NEF, AF). | |
| DateTime | 3GPP TS 29.571 [8] | Identifies the time. | |
| DeletionAlert | 3GPP TS 29.574 [26] | Contains information about data that are about to be deleted. | EnhDataMgmt |
| FormattingInstruction | 3GPP TS 29.574 [26] | DCCF formatting Instructions. | |
| FetchInstruction | 3GPP TS 29.576 [28] | The fetch instruction indicates whether the data can be fetched by the consumer. | |
| NfInstanceId | 3GPP TS 29.571 [8] | NF instance identifier. | |
| NfSetId | 3GPP TS 29.571 [8] | NF set identifier. | |
| NnwdafEventsSubscription | 5.1.6.2.2 | Represents an NWDAF analytics subscription. | |
| NotifSummaryReport | 3GPP TS 29.574 [26] | Contains a summary report of processed notifications. | |
| NotifyEndpoint | 3GPP TS 29.574 [26] | The information of notification endpoint. | DataAnaCollect |
| NotifResponse | 3GPP TS 29.574 [26] | Contains information about the planned action upon receiving a notification. | EnhDataMgmt |
| ProcessingInstruction | 3GPP TS 29.574 [26] | DCCF processing Instructions. | |
| StorageHandlingInformation | 3GPP TS 29.574 [26] | Contains storage handling information for data or analytics. | EnhDataMgmt |
| SupportedFeatures | 3GPP TS 29.571 [8] | | |
| TimeWindow | 3GPP TS 29.122 [19] | Represents a time window. | |
| Uri | 3GPP TS 29.571 [8] | URI. | |

5.3.6.2 Structured data types

5.3.6.2.1 Introduction

This clause defines the structures to be used in resource representations.

5.3.6.2.2 Type NnwdafDataManagementSubsc

Table 5.3.6.2.2-1: Definition of type NnwdafDataManagementSubsc

| Attribute name | Data type | P | Cardinality | Description | Applicability |
|---------------------|------------------------------|---|-------------|---|---------------|
| adrfId | NfInstanceld | O | 0..1 | Identifier of the ADRF to be used by the NWDAF. If the subscription is for runtime data (i.e. the "timePeriod" attribute is either absent or contains a time window in the future) then the NWDAF shall store the notifications in this ADRF. If the subscription is for historical data (i.e. the "timePeriod" attribute contains a time window in the past) then the NWDAF shall retrieve the data from this ADRF. (NOTE 2) | |
| adrfSetId | NfSetId | O | 0..1 | Identifier of the ADRF Set to be used by the NWDAF. If the subscription is for runtime data (i.e. the "timePeriod" attribute is either absent or contains a time window in the future) then the NWDAF shall store the notifications in this ADRF Set. If the subscription is for historical data (i.e. the "timePeriod" attribute contains a time window in the past) then the NWDAF shall retrieve the data from this ADRF Set. (NOTE 2) | |
| anaSub | NnwdafEventsSubscription | C | 0..1 | Analytics subscription information to be used by the NWDAF to determine the data that is relevant to these analytics and shall thus be collected and reported, i.e. the "anaSub" attribute may be provided when the consumer requests from the NWDAF data that it needs in order to compute the analytics that is specified by the "anaSub" attribute. (NOTE 1) | |
| checkedConsentInd | boolean | O | 0..1 | If set to "true", it indicates that the NF service consumer has already checked the user consent. The default value is "false". | UserConsent |
| dataCollectPurposes | array(DataCollectionPurpose) | O | 1..N | The purpose of data collection. This attribute may only be provided if user consent is required depending on local policy and regulations, and the consumer has not checked user consent. | |
| dataSub | DataSubscription | C | 0..1 | Subscribed data events. (NOTE 1) (NOTE 6) (NOTE 7) | |

| | | | | | |
|--------------------|----------------------------------|---|------|---|----------------------------|
| formatInstruct | FormattingInstr uction | O | 0..1 | Formatting instructions to be used for sending event notifications. If provided, they take precedence over any potentially conflicting requirements provided within the "dataSub" attribute. | |
| notifCorrld | string | M | 1 | Notification correlation identifier. | |
| notificURI | Uri | M | 1 | Notification target address. | |
| notifEndpoints | array(NotifyEnd point) | O | 1..N | The additional information of notification target address and correlation identifier. | DataAnaCollect |
| proclnstruct | ProcessingInstr uction | O | 0..1 | Processing instructions to be used for sending event notifications. This attribute may only be provided if the "dataSub" attribute is provided. (NOTE 4) | |
| multiProclnstructs | array(Processin gInstruction) | O | 1..N | Processing instructions to be used for sending event notifications. This attribute may only be provided if the "dataSub" attribute is provided. (NOTE 4) | MultiProcessingInstruction |
| suppFeat | SupportedFeatu res | C | 0..1 | This IE represents a list of Supported features as described in clause 5.3.8. (NOTE 5) | |
| targetNfld | NfInstanceld | O | 0..1 | NF instance identifier to which the NWDAF shall create the requested subscription. (NOTE 2) | |
| targetNfSetld | NfSetld | O | 0..1 | NF set identifier to which the NWDAF shall create the requested subscription. (NOTE 2) | |
| timePeriod | TimeWindow | O | 0..1 | Represents a start time and a stop time during which data was collected or is requested to be collected. If this attribute is included, then the internal attributes of the data subscription that indicate a subscription duration (e.g. the "targetPeriod" attribute of an "eventSubs" attribute of an "smfDataSub" attribute, or the "monDur" attribute of the ReportingInformation data type) shall not be provided. (NOTE 3) | |
| immReport | NnwdafDataMa nagementNotif | O | 0..1 | Immediate report including available NWDAF data management notification. May only be present in the response to a subscription request and only if the immediate reporting indication and formatting or processing instructions were included in the subscription request. | DataAnaCollect |

| | | | | | |
|--|--------------------------------|---|------|--|-------------|
| storeHandl | StorageHandlin gInformation | O | 0..1 | Contains storage handling information for the data that will be collected and stored in an ADRF based on the requested subscription. | EnhDataMgmt |
| <p>NOTE 1: Exactly one of these attributes shall be provided.</p> <p>NOTE 2: "targetNfld" and "targetNfSetId" are mutually exclusive. "adrfld" and "adrSetId" are also mutually exclusive.</p> <p>NOTE 3: It includes the time period either in the past or in the future (i.e., start time as past time and stop time as future time is not allowed).</p> <p>NOTE 4: The "multiProclnstructs" attribute shall be used instead of the "proclnstruct" attribute when the "MultiProcessingInstruction" feature is supported.</p> <p>NOTE 5: It shall be present in the POST request if at least one feature defined in clause 5.3.8 is supported, and it shall be present in the POST response if the NF service consumer includes the "suppFeat" attribute in the POST request.</p> <p>NOTE 6: The event reporting information within the "dataSub" attribute (e.g. "eventsRepInfo" attribute in the case of AF events) may include muting instructions (e.g. within the "notifFlagInstruct" attribute in the case of AF events) and/or muting notifications settings (e.g. within the "mutingSetting" attribute in the case of AF events) only if the EnhDataMgmt feature is supported.</p> <p>NOTE 7: The "upfDataSub" attribute within the "dataSub" attribute is applicable only if the "UpEvents" feature is supported. The "gmlcDataSub" attribute within the "dataSub" attribute is applicable only if the "LocEvents" feature is supported.</p> | | | | | |

5.3.6.2.3 Type NnwdafDataManagementNotif

Table 5.3.6.2.3-1: Definition of type NnwdafDataManagementNotif

| Attribute name | Data type | P | Cardinality | Description | Applicability |
|---|---------------------------|---|-------------|---|---------------|
| dataNotification | DataNotification | C | 0..1 | List of data subscription notifications. (NOTE 1, NOTE 3, NOTE 4) | |
| dataReports | array(NotifSummaryReport) | C | 1..N | List of reports with summarized data from multiple notifications received from data producer. (NOTE 1) (NOTE 2) | |
| delAlert | DeletionAlert | C | 0..1 | Information about data that is about to be deleted. This attribute may not be present in the response of a Fetch request. (NOTE 1) | EnhDataMgmt |
| notifCorrId | string | M | 1 | Notification correlation identifier. | |
| terminationReq | string | O | 0..1 | If set to "true", it indicates that the termination of the data management subscription is requested by the NWDAF, i.e. NWDAF will not provide further notifications related to this subscription. If absent, no termination is requested. | |
| fetchInstruct | FetchInstruction | C | 0..1 | The fetch instruction indicates whether the data are to be fetched by the Consumer. This attribute may not be present in the response of a Fetch request. (NOTE 1) | |
| notifTimestamp | DateTime | M | 1 | It represents time when NWDAF completes preparation of the requested data. | |
| pendNotifCause | PendingNotificationCause | O | 0..1 | Represents the Pending Notification Cause for the stored unsent data. | EnhDataMgmt |
| <p>NOTE 1: One of these attributes shall be provided.</p> <p>NOTE 2: For every entry of the array, the "eventId" attribute shall not contain the "nwdafEvent" attribute.</p> <p>NOTE 3: If the NWDAF has received the notifications from another source without a timestamp, then the NWDAF adds itself a timestamp based on the time it received the notification in "timeStamp" attribute contained in "dataNotification" attribute.</p> <p>NOTE 4: The "upfEventNotifs" attribute within the "dataNotification" attribute is applicable only if the "UpEvents" feature is supported. The "gmlcEventNotifs" attribute within the "dataNotification" attribute is applicable only if the "LocEvents" feature is supported.</p> | | | | | |

5.3.6.3 Simple data types and enumerations

5.3.6.3.1 Introduction

This clause defines simple data types and enumerations that can be referenced from data structures defined in the previous clauses.

5.3.6.3.2 Simple data types

The simple data types defined in table 5.3.6.3.2-1 shall be supported.

Table 5.3.6.3.2-1: Simple data types

| Type Name | Type Definition | Description | Applicability |
|-----------|-----------------|-------------|---------------|
| n/a | | | |

5.3.6.3.3 Enumeration: PendingNotificationCause

Table 5.3.6.3.3-1: Enumeration PendingNotificationCause

| Enumeration value | Description | Applicability |
|---------------------------|---|---------------|
| UE_OUT_OF_NF_SERVING_AREA | Represents the UE moved out of the NF serving area. | |
| OTHER | Represents the other cause. | |

5.3.7 Error handling

5.3.7.1 General

HTTP error handling shall be supported as specified in clause 5.2.4 of TS 29.500 [6].

For the Nnwdaf_DataManagement API, HTTP error responses shall be supported as specified in clause 4.8 of TS 29.501 [7]. Protocol errors and application errors specified in table 5.2.7.2-1 of TS 29.500 [6] shall be supported for an HTTP method if the corresponding HTTP status codes are specified as mandatory for that HTTP method in table 5.2.7.1-1 of TS 29.500 [6]. In addition, the requirements in the following clauses shall apply.

5.3.7.2 Protocol Errors

In this Release of the specification, there are no additional protocol errors applicable for the Nnwdaf_DataManagement API.

5.3.7.3 Application Errors

The application errors defined for the Nnwdaf_DataManagement API are listed in table 5.3.7.3-1.

Table 5.3.7.3-1: Application errors

| Application Error | HTTP status code | Description |
|-------------------------------|--|--|
| SUBSCRIPTION_CANNOT_BE_SERVED | 400 Bad Request | Indicates that the NWDAF cannot use the contents of the request to either a) determine whether the subscription can already be served or interactions with the ADRF and/or data sources are required or b) determine what interactions with the ADRF and/or data sources are required (if it has determined that they are required). |
| USER_CONSENT_NOT_GRANTED | 403 Forbidden | Indicates that the request shall be rejected because an impacted user has not provided the required user consent. |
| MUTING_INSTR_NOT_ACCEPTED | 403 Forbidden | Indicates that the muting instructions received by the NF service consumer cannot be accepted. |
| NOTE: | Including a "ProblemDetails" data structure with the "cause" attribute in the HTTP response is optional unless explicitly mandated in the service operation clauses. | |

5.3.8 Feature negotiation

The optional features in table 5.3.8-1 are defined for the Nnwdaf_DataManagement API. They shall be negotiated using the extensibility mechanism defined in clause 6.6 of 3GPP TS 29.500 [6].

Table 5.3.8-1: Supported Features

| Feature number | Feature Name | Description |
|----------------|----------------------------|--|
| 1 | MultiProcessingInstruction | Indicates the support of multiple processing instructions. |
| 2 | UserConsent | Indicates the support of detailed handling of user consent, e.g. indications that user consent has been checked and error responses related to the lack of user consent. |
| 3 | DataAnaCollect | This feature indicates support for the enhancement of data and analytics collection. |
| 4 | EnhDataMgmt | Indicates the support of enhanced data management mechanisms, including supporting of pending notification, muting and storage handling. |
| 5 | UpEvents | Indicates the support of UPF events. |
| 6 | LocEvents | Indicates the support of location events. |

5.3.9 Security

As indicated in TS 33.501 [13] and TS 29.500 [6], the access to the Nnwdaf_DataManagement API may be authorized by means of the OAuth2 protocol (see IETF RFC 6749 [14]), based on local configuration, using the "Client Credentials" authorization grant, where the NRF (see TS 29.510 [12]) plays the role of the authorization server.

If OAuth2 is used, an NF service consumer, prior to consuming services offered by the Nnwdaf_DataManagement API, shall obtain a "token" from the authorization server, by invoking the Access Token Request service, as described in TS 29.510 [12], clause 5.4.2.2.

NOTE: When multiple NRFs are deployed in a network, the NRF used as authorization server is the same NRF that the NF service consumer used for discovering the Nnwdaf_DataManagement service.

The Nnwdaf_DataManagement API defines a single scope "nnwdaf-datamanagement" for the entire service, and it does not define any additional scopes at resource or operation level.

5.4 Nnwdaf_MLModelProvision Service API

5.4.1 Introduction

The Nnwdaf_MLModelProvision service shall use the Nnwdaf_MLModelProvision API.

The API URI of the Nnwdaf_MLModelProvision API shall be:

{apiRoot}/<apiName>/<apiVersion>

The request URIs used in each HTTP requests from the NF service consumer towards the NWDAF shall have the Resource URI structure defined in clause 4.4.1 of 3GPP TS 29.501 [7], i.e.:

{apiRoot}/<apiName>/<apiVersion>/<apiSpecificResourceUriPart>

with the following components:

- The {apiRoot} shall be set as described in 3GPP TS 29.501 [7].
- The <apiName> shall be "nnwdaf-mlmodelprovision".
- The <apiVersion> shall be "v1".
- The <apiSpecificResourceUriPart> shall be set as described in clause 5.4.3.

5.4.2 Usage of HTTP

5.4.2.1 General

HTTP/2, IETF RFC 9113 [9], shall be used as specified in clause 5 of 3GPP TS 29.500 [6].

HTTP/2 shall be transported as specified in clause 5.3 of 3GPP TS 29.500 [6].

The OpenAPI [11] specification of HTTP messages and content bodies for the Nnwdaf_MLModelProvision is contained in Annex A.

5.4.2.2 HTTP standard headers

5.4.2.2.1 General

See clause 5.2.2 of 3GPP TS 29.500 [6] for the usage of HTTP standard headers.

5.4.2.2.2 Content type

JSON, IETF RFC 8259 [10], shall be used as content type of the HTTP bodies specified in the present specification as specified in clause 5.4 of 3GPP TS 29.500 [6]. The use of the JSON format shall be signalled by the content type "application/json".

"Problem Details" JSON object shall be used to indicate additional details of the error in a HTTP response body and shall be signalled by the content type "application/problem+json", as defined in IETF RFC 9457 [15].

5.4.2.3 HTTP custom headers

The Nnwdaf_MLModelProvision service API shall support mandatory HTTP custom header fields specified in clause 5.2.3.2 of 3GPP TS 29.500 [6] and may support HTTP custom header fields specified in clause 5.2.3.3 of 3GPP TS 29.500 [6].

In this release of the specification, no specific custom headers are defined for the Nnwdaf_MLModelProvision service API.

5.4.3 Resources

5.4.3.1 Resource Structure

This clause describes the structure for the Resource URIs and the resources and methods used for the service.

Figure 5.4.3.1-1 depicts the resource URIs structure for the Nnwdaf_MLModelProvision API.

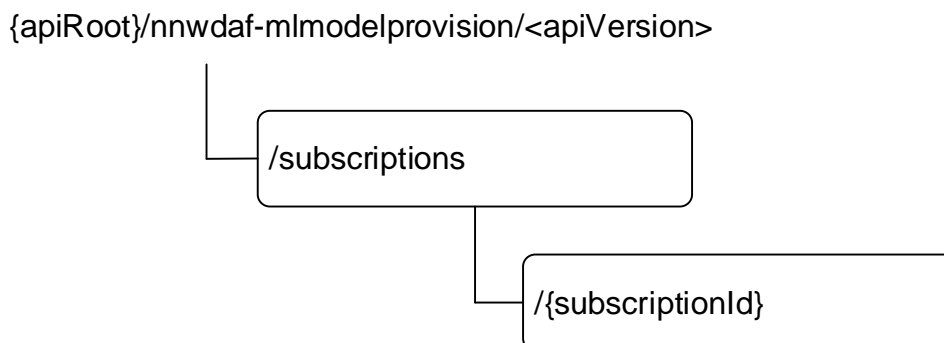

Figure 5.4.3.1-1: Resource URI structure of the Nnwdaf_MLModelProvision API

Table 5.4.3.1-1 provides an overview of the resources and applicable HTTP methods.

Table 5.4.3.1-1: Resources and methods overview

| Resource name | Resource URI | HTTP method or custom operation | Description |
|--|---------------------------------|---------------------------------|---|
| NWDAF ML Model Provision Subscriptions | /subscriptions | POST | Creates a new Individual NWDAF ML Model Provision Subscription resource. |
| Individual NWDAF ML Model Provision Subscription | /subscriptions/{subscriptionId} | DELETE | Deletes an Individual NWDAF ML Model Provision Subscription identified by subresource {subscriptionId}. |
| | | PUT | Modifies an existing Individual NWDAF ML Model Provision Subscription identified by subresource {subscriptionId}. |

5.4.3.2 Resource: NWDAF ML Model Provision Subscriptions

5.4.3.2.1 Description

The NWDAF ML Model Provision Subscriptions resource represents all subscriptions to the Nnwdaf_MLModelProvision service at a given NWDAF. The resource allows an NF service consumer to create a new Individual NWDAF ML Model Provision Subscription resource.

5.4.3.2.2 Resource definition

Resource URI: {apiRoot}/nnwdaf-mlmodelprovision/<apiVersion>/subscriptions

This resource shall support the resource URI variables defined in table 5.4.3.2.2-1.

Table 5.4.3.2.2-1: Resource URI variables for this resource

| Name | Data type | Definition |
|---------|-----------|------------------|
| apiRoot | string | See clause 5.4.1 |

5.4.3.2.3 Resource Standard Methods

5.4.3.2.3.1 POST

This method shall support the URI query parameters specified in table 5.4.3.2.3.1-1.

Table 5.4.3.2.3.1-1: URI query parameters supported by the POST method on this resource

| Name | Data type | P | Cardinality | Description |
|------|-----------|---|-------------|-------------|
| n/a | | | | |

This method shall support the request data structures specified in table 5.4.3.2.3.1-2 and the response data structures and response codes specified in table 5.4.3.2.3.1-3.

Table 5.4.3.2.3.1-2: Data structures supported by the POST Request Body on this resource

| Data type | P | Cardinality | Description |
|----------------------------|---|-------------|--|
| NwdafMLModelProvisionSubsc | M | 1 | Creates a new Individual NWDAF ML Model Provision Subscription resource. |

Table 5.4.3.2.3.1-3: Data structures supported by the POST Response Body on this resource

| Data type | P | Cardinality | Response codes | Description |
|----------------------------|---|-------------|---------------------------|--|
| NwdafMLModelProvisionSubsc | M | 1 | 201 Created | The creation of an Individual NWDAF ML Model Provision Subscription resource is confirmed and a representation of that resource is returned. |
| ProblemDetails | O | 0..1 | 500 Internal Server Error | (NOTE 2) |

NOTE 1: The mandatory HTTP error status codes for the POST method listed in table 5.2.7.1-1 of 3GPP TS 29.500 [6] also apply.
NOTE 2: Failure causes are described in subclause 5.4.7.3.

Table 5.4.3.2.3.1-4: Headers supported by the 201 Response Code on this resource

| Name | Data type | P | Cardinality | Description |
|----------|-----------|---|-------------|--|
| Location | string | M | 1 | Contains the URI of the newly created resource, according to the structure: {apiRoot}/nwdaf-mlmodelprovision/<apiVersion>/subscriptions/{subscriptionId} |

5.4.3.2.4 Resource Custom Operations

None in this release of the specification.

5.4.3.3 Resource: Individual NWDAF ML Model Provision Subscription

5.4.3.3.1 Description

The Individual NWDAF ML Model Provision Subscription resource represents a single subscription to the Nwdaf_MLModelProvision service at a given NWDAF.

5.4.3.3.2 Resource definition

Resource URI: {apiRoot}/nwdaf-mlmodelprovision/<apiVersion>/subscriptions/{subscriptionId}

The <apiVersion> shall be set as described in clause 5.4.1.

This resource shall support the resource URI variables defined in table 5.4.3.3.2-1.

Table 5.4.3.3.2-1: Resource URI variables for this resource

| Name | Data type | Definition |
|----------------|-----------|--|
| apiRoot | string | See clause 5.4.1. |
| subscriptionId | string | Identifies a subscription to the Nwdaf_MLModelProvision service. |

5.4.3.3.3 Resource Standard Methods

5.4.3.3.3.1 PUT

This method shall support the URI query parameters specified in table 5.4.3.3.3.1-1.

Table 5.4.3.3.1-1: URI query parameters supported by the PUT method on this resource

| Name | Data type | P | Cardinality | Description |
|------|-----------|---|-------------|-------------|
| n/a | | | | |

This method shall support the request data structures specified in table 5.4.3.3.1-2 and the response data structures and response codes specified in table 5.4.3.3.1-3.

Table 5.4.3.3.1-2: Data structures supported by the PUT Request Body on this resource

| Data type | P | Cardinality | Description |
|-----------------------|---|-------------|---|
| NwdafMLModelProvSubsc | M | 1 | Parameters to replace a subscription to NWDAF ML Model Provision Subscription resource. |

Table 5.4.3.3.1-3: Data structures supported by the PUT Response Body on this resource

| Data type | P | Cardinality | Response codes | Description |
|--|---|-------------|---------------------------|--|
| NwdafMLModelProvSubsc | M | 1 | 200 OK | The Individual NWDAF ML Model Provision Subscription resource was modified successfully and a representation of that resource is returned. |
| n/a | | | 204 No Content | The Individual NWDAF ML Model Provision Subscription resource was modified successfully. |
| RedirectResponse | O | 0..1 | 307 Temporary Redirect | Temporary redirection, during Individual NWDAF ML Model Provision Subscription modification. (NOTE 3) |
| RedirectResponse | O | 0..1 | 308 Permanent Redirect | Permanent redirection, during Individual NWDAF ML Model Provision Subscription modification. (NOTE 3) |
| ProblemDetails | O | 0..1 | 500 Internal Server Error | (NOTE 2) |
| NOTE 1: The mandatory HTTP error status codes for the PUT method listed in table 5.2.7.1-1 of 3GPP TS 29.500 [6] also apply. | | | | |
| NOTE 2: Failure causes are described in subclause 5.4.7.3. | | | | |
| NOTE 3: The RedirectResponse data structure may be provided by an SCP (cf. clause 6.10.9.1 of 3GPP TS 29.500 [6]). | | | | |

Table 5.4.3.3.1-4: Headers supported by the 307 Response Code on this resource

| Name | Data type | P | Cardinality | Description |
|-----------------------|-----------|---|-------------|---|
| Location | string | M | 1 | Contains an alternative URI of the resource located in an alternative NWDAF (service) instance towards which the request is redirected. For the case where the request is redirected to the same target via a different SCP, refer to clause 6.10.9.1 of 3GPP TS 29.500 [6]. |
| 3gpp-Sbi-Target-Nf-Id | string | O | 0..1 | Identifier of the target NWDAF (service) instance towards which the request is redirected. |

Table 5.4.3.3.1-5: Headers supported by the 308 Response Code on this resource

| Name | Data type | P | Cardinality | Description |
|-----------------------|-----------|---|-------------|---|
| Location | string | M | 1 | Contains an alternative URI of the resource located in an alternative NWDAF (service) instance towards which the request is redirected. For the case where the request is redirected to the same target via a different SCP, refer to clause 6.10.9.1 of 3GPP TS 29.500 [6]. |
| 3gpp-Sbi-Target-Nf-Id | string | O | 0..1 | Identifier of the target NWDAF (service) instance towards which the request is redirected. |

5.4.3.3.2 DELETE

This method shall support the URI query parameters specified in table 5.4.3.3.2-1.

Table 5.4.3.3.2-1: URI query parameters supported by the DELETE method on this resource

| Name | Data type | P | Cardinality | Description |
|------|-----------|---|-------------|-------------|
| n/a | | | | |

This method shall support the request data structures specified in table 5.4.3.3.2-2 and the response data structures and response codes specified in table 5.4.3.3.2-3.

Table 5.4.3.3.2-2: Data structures supported by the DELETE Request Body on this resource

| Data type | P | Cardinality | Description |
|-----------|---|-------------|-------------|
| n/a | | | |

Table 5.4.3.3.2-3: Data structures supported by the DELETE Response Body on this resource

| Data type | P | Cardinality | Response codes | Description |
|---|---|-------------|------------------------|---|
| n/a | | | 204 No Content | Successful case: The Individual NWDAF ML Model Provision Subscription resource matching the subscriptionId was deleted. |
| RedirectResponse | O | 0..1 | 307 Temporary Redirect | Temporary redirection, during Individual NWDAF ML Model Provision Subscription deletion. (NOTE 2) |
| RedirectResponse | O | 0..1 | 308 Permanent Redirect | Permanent redirection, during Individual NWDAF ML Model Provision Subscription deletion. (NOTE 2) |
| NOTE 1: The mandatory HTTP error status codes for the DELETE method listed in table 5.2.7.1-1 of 3GPP TS 29.500 [6] also apply. | | | | |
| NOTE 2: The RedirectResponse data structure may be provided by an SCP (cf. clause 6.10.9.1 of 3GPP TS 29.500 [6]). | | | | |

Table 5.4.3.3.2-4: Headers supported by the 307 Response Code on this resource

| Name | Data type | P | Cardinality | Description |
|-----------------------|-----------|---|-------------|---|
| Location | string | M | 1 | Contains an alternative URI of the resource located in an alternative NWDAF (service) instance towards which the request is redirected. For the case where the request is redirected to the same target via a different SCP, refer to clause 6.10.9.1 of 3GPP TS 29.500 [6]. |
| 3gpp-Sbi-Target-Nf-Id | string | O | 0..1 | Identifier of the target NWDAF (service) instance towards which the request is redirected. |

Table 5.4.3.3.2-5: Headers supported by the 308 Response Code on this resource

| Name | Data type | P | Cardinality | Description |
|-----------------------|-----------|---|-------------|---|
| Location | string | M | 1 | Contains an alternative URI of the resource located in an alternative NWDAF (service) instance towards which the request is redirected. For the case where the request is redirected to the same target via a different SCP, refer to clause 6.10.9.1 of 3GPP TS 29.500 [6]. |
| 3gpp-Sbi-Target-Nf-Id | string | O | 0..1 | Identifier of the target NWDAF (service) instance towards which the request is redirected. |

5.4.3.3.4 Resource Custom Operations

None in this release of the specification.

5.4.4 Custom Operations without associated resources

None in this release of the specification.

5.4.5 Notifications

5.4.5.1 General

Notifications shall comply with clause 6.2 of 3GPP TS 29.500 [6] and clause 4.6.2.3 of 3GPP TS 29.501 [7].

Table 5.4.3.4.1-1: Notifications overview

| Notification | Callback URI | HTTP method or custom operation | Description (service operation) |
|--------------------|--------------|---------------------------------|--|
| Event Notification | {notifUri} | POST | Report one or several observed Events. |

5.4.5.2 Event Notification

5.4.5.2.1 Description

The Event Notification is used by the NWDAF to report one or several observed Events to a NF service consumer that has subscribed to such Notifications via the Individual NWDAF ML Model Provision Subscription Resource.

5.4.5.2.2 Operation Definition

Callback URI: {notifUri}

The operation shall support the callback URI variables defined in table 5.4.5.2.2-1, the request data structures specified in table 5.4.5.2.2-2 and the response data structure and response codes specified in table 5.4.5.2.2-3.

Table 5.4.5.2.2-1: Callback URI variables

| Name | Data type | Definition |
|----------|-----------|---|
| notifUri | Uri | The Notification Uri as assigned within the Individual NWDAF ML Model Provision Subscription and described within the NwdafMLModelProvSubsc type (see table 5.4.6.2.2-1). |

Table 5.4.5.2.2-2: Data structures supported by the POST Request Body on this resource

| Data type | P | Cardinality | Description |
|------------------------------|---|-------------|---|
| array(NwdafMLModelProvNotif) | M | 1..N | Provides Information about observed events. |

Table 5.4.5.2.2-3: Data structures supported by the POST Response Body on this resource

| Data type | P | Cardinality | Response codes | Description |
|---|---|-------------|------------------------|---|
| n/a | | | 204 No Content | The receipt of the Notification is acknowledged. |
| RedirectResponse | O | 0..1 | 307 Temporary Redirect | Temporary redirection, during the event notification. (NOTE 2) |
| RedirectResponse | O | 0..1 | 308 Permanent Redirect | Permanent redirection, during the event notification. (NOTE 2) |
| NOTE 1: The mandatory HTTP error status codes for the POST method listed in table 5.2.7.1-1 of 3GPP TS 29.500 [6] also apply. | | | | |
| NOTE 2: The RedirectResponse data structure may be provided by an SCP (cf. clause 6.10.9.1 of 3GPP TS 29.500 [6]). | | | | |

Table 5.4.5.2.2-4: Headers supported by the 307 Response Code on this resource

| Name | Data type | P | Cardinality | Description |
|-----------------------|-----------|---|-------------|--|
| Location | string | M | 1 | Contains an alternative URI representing the end point of an alternative NF consumer (service) instance towards which the notification is redirected. For the case where the notification is redirected to the same target via a different SCP, refer to clause 6.10.9.1 of 3GPP TS 29.500 [6]. |
| 3gpp-Sbi-Target-Nf-Id | string | O | 0..1 | Identifier of the target NF (service) instance towards which the notification request is redirected. |

Table 5.4.5.2.2-5: Headers supported by the 308 Response Code on this resource

| Name | Data type | P | Cardinality | Description |
|-----------------------|-----------|---|-------------|--|
| Location | string | M | 1 | Contains an alternative URI representing the end point of an alternative NF consumer (service) instance towards which the notification is redirected. For the case where the notification is redirected to the same target via a different SCP, refer to clause 6.10.9.1 of 3GPP TS 29.500 [6]. |
| 3gpp-Sbi-Target-Nf-Id | string | O | 0..1 | Identifier of the target NF (service) instance towards which the notification request is redirected |

5.4.6 Data Model

5.4.6.1 General

This clause specifies the application data model supported by the API.

Table 5.4.6.1-1 specifies the data types defined for the Nnwdaf_MLModelProvision service based interface protocol.

Table 5.4.6.1-1: Nnwdaf_MLModelProvision specific Data Types

| Data type | Section defined | Description | Applicability |
|------------------------------|-----------------|--|--|
| AdditionalMLModelInformation | 5.4.6.2.14 | Represents the additional ML Model Information | ModelProvisionExt |
| FailureEventInfoForMLModel | 5.4.6.2.7 | | |
| InputDataInfo | 5.4.6.2.12 | Represents the metrics of the input data. | ModelProvisionExt |
| InferenceDataForModelTrain | 5.4.6.2.17 | Indicates the inference data stored in ADRF. | ModelProvisionExt |
| MLEventNotif | 5.4.6.2.6 | | |
| MLEventSubscription | 5.4.6.2.3 | | |
| MLModelAddr | 5.4.6.2.8 | | |
| MLModelAdrf | 5.4.6.2.15 | Represents the ADRF (Set) information of ML Model. | ModelProvisionExt |
| MLModelMetric | 5.4.6.2.9 | Indicates the ML model metric. | FederatedLearning ModelProvisionExt |
| MLModelStatus | 5.4.6.2.10 | Indicates the pre-determined status of the ML model or training. | FederatedLearning |
| MLRepEventCondition | 5.4.6.2.11 | Indicates the ML event reporting condition. | FederatedLearning ModelProvisionExt |
| ModelProvisionParamsExt | 5.4.6.2.13 | Represents extended model provision parameters. | ModelProvisionExt |
| NnwdafMLModelProvNotif | 5.4.6.2.5 | | |
| NnwdafMLModelProvSubsc | 5.4.6.2.2 | | |
| TrainInputDataInfo | 5.4.6.2.16 | Represents training input data information. | ModelProvisionExt |

Table 5.4.6.1-2 specifies data types re-used by the Nnwdaf_MLModelProvision service based interface protocol from other specifications, including a reference to their respective specifications and when needed, a short description of their use within the Nnwdaf_MLModelProvision service based interface.

Table 5.4.6.1-2: Nnwdaf_MLModelProvision re-used Data Types

| Data type | Reference | Comments | Applicability |
|----------------------|---------------------|---|-------------------|
| Accuracy | 5.1.6.3.5 | Represents accuracy levels of interest for ML models | ModelProvisionExt |
| DateTime | 3GPP TS 29.571 [8] | Identifies the time. | |
| DccfEvent | 3GPP TS 29.574 [26] | Identifies the input data event. | ModelProvisionExt |
| EventFilter | 5.2.6.2.3 | Identifies the filter for the subscribed event. | |
| NetworkAreaInfo | 3GPP TS 29.554 [18] | Identifies the network area. | |
| NwdafEvent | 5.1.6.3.4 | | |
| NfInstancelId | 3GPP TS 29.571 [8] | Identifies an NF instance. | ModelProvisionExt |
| NfSetId | 3GPP TS 29.571 [8] | Identifies an NF Set. | ModelProvisionExt |
| RedirectResponse | 3GPP TS 29.571 [8] | | |
| ReportingInformation | 3GPP TS 29.523 [20] | Represents the requirements of reporting the subscription. | |
| SupportedFeatures | 3GPP TS 29.571 [8] | | |
| TargetUeInformation | 5.1.6.2.8 | | |
| TimeWindow | 3GPP TS 29.122 [19] | | |
| UInteger | 3GPP TS 29.571 [8] | Unsigned Integer, i.e. only value 0 and integers above 0 are permissible. | ModelProvisionExt |
| Uri | 3GPP TS 29.571 [8] | | |
| VendorId | 3GPP TS 29.510 [12] | Represents the Vendor ID. | ModelSharing |

5.4.6.2 Structured data types

5.4.6.2.1 Introduction

This clause defines the structures to be used in resource representations.

5.4.6.2.2 Type NwdafMLModelProvSubsc

Table 5.4.6.2.2-1: Definition of type NwdafMLModelProvSubsc

| Attribute name | Data type | P | Cardinality | Description | Applicability |
|------------------|------------------------------------|---|-------------|--|---------------|
| mLEventSubscs | array(MLEventSubscription) | M | 1..N | Each element identifies the subscription for each event. | |
| notifUri | Uri | M | 1 | Identifies the recipient of Notifications sent by the NWDAF. | |
| mLEventNotifs | array(MLEventNotif) | C | 1..N | Notifications about Individual Events. Shall only be present if the immediate reporting indication in the "immRep" attribute within the "eventReq" attribute sets to true in the event subscription, and the reports are available. | |
| suppFeats | SupportedFeatures | C | 0..1 | List of Supported features used as described in clause 5.4.8. It shall be supplied by NF service consumer in the POST requests that request the creation of an NWDAF ML Model Provision Subscriptions resource, and shall be supplied by the NWDAF in the reply of corresponding request. | |
| notifCorrelId | string | O | 0..1 | The value of Notification Correlation ID in the corresponding notification. | |
| eventReq | ReportingInformation | O | 0..1 | Reporting requirement information of the subscription. If omitted, the default values within the ReportingInformation data type apply. | |
| failEventReports | array(FailureEventInfoForML Model) | O | 1..N | Supplied by the NWDAF containing MTLF when available, shall contain the event(s) that the subscription is not successful including the failure reason(s). | |

5.4.6.2.3 Type MLEventSubscription

Table 5.4.6.2.3-1: Definition of type MLEventSubscription

| Attribute name | Data type | P | Cardinality | Description | Applicability |
|-------------------|----------------------------|---|-------------|--|--|
| mLEvent | NwdafEvent | M | 1 | Identifies the subscribed event. | |
| mLEventFilter | EventFilter | M | 1 | Identifies the analytics filter for the subscribed event. | |
| tgtUe | TargetUeInformation | O | 0..1 | Identifies target UE information | |
| mLTargetPeriod | TimeWindow | O | 0..1 | Indicates the time interval for which the ML model for the analytics is requested. | |
| timeModelNeeded | DateTime | O | 0..1 | UTC time indicating the time when the ML model is needed. | ModelProvisionExt FederatedLearning |
| expiryTime | DateTime | O | 0..1 | Indicates the time when the subscription expired. | |
| mLEvRepCon | MLRepEventCondition | O | 0..1 | Indicates the ML event reporting condition. This attribute can be provided when the "notifMethod" attribute within the ReportingInformation structure is set to "ON_EVENT_DETECTION" in the "eventReq" attribute within the NwdafMLModelProvSubsc data type. | FederatedLearning ModelProvisionExt |
| modelInterInfo | string | O | 0..1 | Represents the ML Model Interoperability Information. This is vendor-specific information and is agreed between vendors, if necessary for sharing purposes. The format of value is out of 3GPP. | ModelSharing |
| nfConsumerInfo | VendorId | O | 0..1 | Identifies a vendor. Vendor ID of the NF Service Consumer instance, according to the IANA-assigned "SMI Network Management Private Enterprise Codes" [31]. | ModelSharing |
| modelProvExt | ModelProvisionParamsExt | O | 0..1 | Extended ML model provisioning parameters. | ModelProvisionExt |
| useCaseCxt | string | O | 0..1 | Indicates the context of usage of the analytics. The value and format of this parameter are not standardized. | ENAEExt |
| inferDataForModel | InferenceDataForModelTrain | O | 0..1 | Indicates the inference data stored in ADRF which can be used by MTLF to retrain or reprovision of the ML model. | ModelProvisionExt |
| modelId | UInteger | O | 0..1 | The ML model Identifier. This attribute may be included when the consumer knows which model it wants to request, e.g., due to Analytics Context Transfer. | EnAnaCtxTransfer |

5.4.6.2.4 Void

5.4.6.2.5 Type NwdafMLModelProvNotif

Table 5.4.6.2.5-1: Definition of type NwdafMLModelProvNotif

| Attribute name | Data type | P | Cardinality | Description | Applicability |
|----------------|---------------------|---|-------------|--|---------------|
| eventNotifs | array(MLEventNotif) | M | 1..N | Notifications about Individual Events | |
| subscriptionId | string | M | 1 | String identifying a subscription to the Nnwdaf_MLModelProvision Service | |

5.4.6.2.6 Type MLEventNotif

Table 5.4.6.2.6-1: Definition of type MLEventNotif

| Attribute name | Data type | P | Cardinality | Description | Applicability |
|-----------------|-------------------------------------|---|-------------|--|-------------------|
| event | NwdafEvent | M | 1 | Identifies the subscribed event. | |
| notifCorreld | string | O | 0..1 | Notification correlation ID used to identify the subscription to which the notification relates. It shall be set to the same value as the "notifCorreld" attribute of NwdafMLModelProvSubsc data type. | |
| mLFile | string | O | 0..1 | Indicates the ML model file. The format of its value is out of 3GPP scope. This attribute is not applicable in the Nnwdaf_MLModelProvision API. | |
| mLFileAddr | MLModelAddr | C | 0..1 | Indicates the address (e.g. a URL or an FQDN) of the ML model file. (NOTE 1, NOTE 2) | |
| mLModelAdrf | MLModelAdrf | C | 0..1 | Indicates the ADRF (Set) information of the ML Model. (NOTE 2) | ModelProvisionExt |
| modelUniqueld | UInteger | C | 0..1 | Unique identifier for an ML model. The identifier shall be unique within 5GC scope. It shall be provided only if the ModelProvisionExt feature is supported. | ModelProvisionExt |
| validityPeriod | TimeWindow | O | 0..1 | Indicates the time period when the provided ML model applies. (NOTE 1) | |
| spatialValidity | NetworkAreaInfo | O | 0..1 | Indicates the area where the provided ML model applies. (NOTE 1) | |
| addModelInfo | array(AdditionalMLModelInformation) | O | 1..N | Indicates the additional ML Model Information. (NOTE 1) | ModelProvisionExt |
| useCaseCxt | string | O | 0..1 | Indicates the context of the ML model. The value and format of this parameter are not standardized. This attribute is not applicable in the Nnwdaf_MLModelProvision API. | ENAEExt |
| mLEventFilter | EventFilter | O | 0..1 | Identifies the analytics filter for the subscribed event. May be present if multiple ML Models with the same analytics ID are provided in the notification. (NOTE 3) | ModelProvisionExt |
| tgtUe | TargetUeInformation | O | 0..1 | Identifies target UE information. May be present if multiple ML Models with the same analytics ID are provided in the notification. (NOTE 3) | ModelProvisionExt |

| |
|---|
| NOTE 1: If the "addModelInfo" attribute is provided, then the attributes "validityPeriod" and "spatialValidity" shall not be provided and the value of the "mlFileAddr" attribute and "mlModelAddr" attribute and "modelUniqueid" attribute of the MLEventNotif data type shall be ignored. |
| NOTE 2: If the "ModelProvisionExt" feature is supported, one of the "mlFileAddr" or "mlModelAddr" attribute shall be provided. |
| NOTE 3: The "mLEventFilter" and/or "tgtUe" attributes may be present when the ML Model provisioning request includes the same Analytics ID but with different ML Model filter information and/or different targets of ML Model reporting. |

5.4.6.2.7 Type FailureEventInfoForMLModel

Table 5.1.6.2.7-1: Definition of type FailureEventInfoForMLModel

| Attribute name | Data type | P | Cardinality | Description | Applicability |
|----------------|-------------|---|-------------|--------------------------------|---------------|
| event | NwdafEvent | M | 1 | Event that is subscribed. | |
| failureCode | FailureCode | M | 1 | Identifies the failure reason. | |

5.4.6.2.8 Type MLModelAddr

Table 5.4.6.2.8-1: Definition of type MLModelAddr

| Attribute name | Data type | P | Cardinality | Description | Applicability |
|--|-----------|---|-------------|--|---------------|
| mlModelUrl | Uri | C | 0..1 | The URL of the ML Model file. (NOTE) | |
| mlFileFqdn | string | C | 0..1 | The FQDN of the ML Model file. (NOTE) | |
| NOTE: One of the "mlModelUrl" and "mlFileFqdn" attributes shall be provided. | | | | | |

5.4.6.2.9 Void

5.4.6.2.10 Void

5.4.6.2.11 Type MLRepEventCondition

Table 5.4.6.2.11-1: Definition of type MLRepEventCondition

| Attribute name | Data type | P | Cardinality | Description | Applicability |
|---------------------|---------------|---|-------------|---|---------------|
| mlTrainRound | UInteger | O | 0..1 | Indicates the report shall occur when the number of training round is a multiple of the value set for the attribute. | |
| mlTrainRepTime | TimeWindow | O | 0..1 | Indicates the report shall occur when every training time interval is achieved. | |
| mlAccuracyThreshold | UInteger | O | 0..1 | Indicates the report shall occur when the ML model accuracy is crossing the ML Model Accuracy threshold of the value set for the attribute, i.e., the accuracy either becomes higher or lower than the value set for the attribute. | |
| modelMetric | MLModelMetric | O | 0..1 | Indicates the ML model metric. | |

5.4.6.2.12 Type InputDataInfo

Table 5.4.6.2.12-1: Definition of type InputDataInfo

| Attribute name | Data type | P | Cardinality | Description | Applicability |
|-----------------|---------------------|---|-------------|--|---------------|
| inpEvent | DccfEvent | M | 1 | Identifies the input data event to which the information applies. | |
| maxNumSamples | UInteger | O | 0..1 | Maximum number of samples that have been taken to train an ML model. | |
| maxTimeInterval | UInteger | O | 0..1 | Maximum time interval between samples that are used to train an ML model. | |
| nfInstanceIds | array(NfInstanceId) | O | 1..N | NF instance identifiers of the used data sources. | |
| nfSetIds | array(NfSetId) | O | 1..N | NF set identifiers of the used data sources. | |
| ratio | UInteger | O | 0..1 | Sampling ratio, indicates the percentage of the available data values that are used by this ML model (for training or inference). Minimum = 0. Maximum = 100. | |

5.4.6.2.13 Type ModelProvisionParamsExt

Table 5.4.6.2.13-1: Definition of type ModelProvisionParamsExt

| Attribute name | Data type | P | Cardinality | Description | Applicability |
|-------------------|----------------------|---|-------------|---|---------------|
| modelInterInfo | string | O | 0..1 | Represents the ML Model Interoperability Information. This is vendor-specific information and is agreed between vendors, if necessary for sharing purposes. The format of value is out of 3GPP. | |
| reqRepRatio | UInteger | O | 0..1 | Minimum percentage of UEs whose data is used for training an ML model when the target of ML model reporting is a group of UEs. Minimum = 0. Maximum = 100. | |
| inferInpDataInfos | array(InputDataInfo) | O | 1..N | The metrics of input data that are expected to be used by NWDAF containing AnLF during inference. | |
| multModelsInd | boolean | O | 0..1 | If provided and set to "true", it indicates that the NF service consumer supports receiving multiple ML models. If omitted or set to "false" the NF service consumer does not support multiple ML models. The default value is false. | |
| numModels | UInteger | O | 0..1 | Maximum number of ML models that the consumer supports to receive for a specific analytics ID. It may only be provided if the "multModelsInd" attribute is provided and set to "true". | |
| accuLevels | array(Accuracy) | O | 1..N | Provided accuracy levels of interest for ML models. | |

5.4.6.2.14 Type AdditionalMLModelInformation

Table 5.4.6.2.14-1: Definition of type AdditionalMLModelInformation

| Attribute name | Data type | P | Cardinality | Description | Applicability |
|---|---------------------------|---|-------------|---|---------------|
| mLFileAddr | MLModelAddr | C | 0..1 | Indicates the address (e.g. a URL or an FQDN) of the ML model file. (NOTE) | |
| mLModelAdrf | MLModelAdrf | C | 0..1 | Indicates the ADRF (Set) information of the ML Model. (NOTE) | |
| validityPeriod | TimeWindow | O | 0..1 | Indicates the time period when the provided ML model applies. | |
| spatialValidity | NetworkAreaInfo | O | 0..1 | Indicates the area where the provided ML model applies. | |
| modelUniqueld | UInteger | M | 1 | Unique identifier for an ML model. The identifier shall be unique within 5GC scope. | |
| modelRepRatio | UInteger | O | 0..1 | Indicating the percentage of UEs in the group that is used to train an ML model when target of ML model reporting is a group of UEs. | |
| mlDegradInd | boolean | O | 0..1 | Set to "true" to indicate that the ML model is degraded. Set to "false" to indicate that the ML model is not degraded. Default value is "false" if omitted. | |
| trainInpInfos | array(TrainInputDataInfo) | O | 1..N | Training input data information that is used by NWDAF containing MTLF during training. | |
| modelMetric | MLModelMetric | O | 0..1 | Indicates the ML model metric. | |
| accMLModel | UInteger | O | 0..1 | Indicates the accuracy value of the ML model. Minimum = 0. Maximum = 100. | |
| NOTE: Exactly one of the "mLFileAddr" or "mLModelAdrf" attribute shall be provided. | | | | | |

5.4.6.2.15 Type MLModelAdrf

Table 5.4.6.2.15-1: Definition of type MLModelAdrf

| Attribute name | Data type | P | Cardinality | Description | Applicability |
|--|--------------|---|-------------|---------------------------------------|---------------|
| adrflid | NfInstanceId | C | 0..1 | Identifier of the ADRF. (NOTE) | |
| adrfSetId | NfSetId | C | 0..1 | Identifier of the ADRF Set. (NOTE) | |
| storTransId | string | O | 0..1 | Indicates the Storage Transaction ID. | |
| NOTE: One of "adrflid" and "adrfSetId" attributes shall be provided. | | | | | |

5.4.6.2.16 Type TrainInputDataInfo

Table 5.4.6.2.16-1: Definition of type TrainInputDataInfo

| Attribute name | Data type | P | Cardinality | Description | Applicability |
|---------------------|---------------|---|-------------|--|---------------|
| dataInfo | InputDataInfo | O | 0..1 | The metrics of input data that has been used by NWDAF containing MTLF during training. | |
| time | TimeWindow | O | 0..1 | Indicates the time interval during which the data was obtained from the data source NFs. | |
| dataStatisticsInfos | string | O | 0..1 | Indicates the statistics information of the data identified by "dataInfo" attribute, i.e. data range including maximum and minimum values, mean and standard deviation and data distribution when applicable. May be present when the "dataInfo" attribute is included. The format of the value of this attribute is up to implementation. | |

5.4.6.2.17 Type InferenceDataForModelTrain

Table 5.4.6.2.17-1: Definition of type InferenceDataForModelTrain

| Attribute name | Data type | P | Cardinality | Description | Applicability |
|----------------|--------------|---|-------------|--|---------------|
| adrflid | NfInstanceId | C | 0..1 | Identifier of the ADRF. (NOTE) | |
| adrfSetId | NfSetId | C | 0..1 | Identifier of the ADRF Set. (NOTE) | |
| dataSetTag | DataSetTag | O | 0..1 | Data set tag of the data stored in ADRF which can be used by MTLF. | |
| modelId | UInteger | O | 0..1 | ML model Identifier. Indicates the model that the data corresponding to the DataSetTag is related to. This attribute may be present only in a subscription modification request. | |

NOTE: One of "adrflid" and "adrfSetId" attributes shall be provided.

5.4.6.3 Simple data types and enumerations

5.4.6.3.1 Introduction

This clause defines simple data types and enumerations that can be referenced from data structures defined in the previous clauses.

5.4.6.3.2 Simple data types

The simple data types defined in table 5.1.6.3.2-1 shall be supported.

Table 5.4.6.3.2-1: Simple data types

| Type Name | Type Definition | Description | Applicability |
|-----------|-----------------|-------------|---------------|
| | | | |

5.4.6.3.3 Enumeration: FailureCode

Table 5.4.6.3.3-1: Enumeration FailureCode

| Enumeration value | Description | Applicability |
|--------------------------|--|---------------|
| UNAVAILABLE_ML_MO DEL | Indicates the requested ML model for the event is unavailable. | |

5.4.6.3.4 Enumeration: MLModelMetric

Table 5.4.6.3.4-1: Enumeration MLModelMetric

| Enumeration value | Description | Applicability |
|-------------------|---------------------------|---------------|
| ACCURACY | ML Model Accuracy metric. | |

5.4.7 Error handling

5.4.7.1 General

HTTP error handling shall be supported as specified in clause 5.2.4 of 3GPP TS 29.500 [6].

For the Nnwdaf_MLModelProvision API, HTTP error responses shall be supported as specified in clause 4.8 of 3GPP TS 29.501 [7].

Protocol errors and application errors specified in table 5.2.7.2-1 of 3GPP TS 29.500 [6] shall be supported for an HTTP method if the corresponding HTTP status codes are specified as mandatory for that HTTP method in table 5.2.7.1-1 of 3GPP TS 29.500 [6].

Protocol errors and application errors specified in table 5.2.7.2-1 of 3GPP TS 29.500 [6] for HTTP redirections shall be supported.

In addition, the requirements in the following clauses shall apply.

5.4.7.2 Protocol Errors

In this Release of the specification, there are no additional protocol errors applicable for the Nnwdaf_MLModelProvision API.

5.4.7.3 Application Errors

The application errors defined for the Nnwdaf_MLModelProvision API are listed in table 5.4.7.3-1.

Table 5.4.7.3-1: Application errors

| Application Error | HTTP status code | Description |
|--|------------------------------|--|
| UNAVAILABLE_ML_MODEL_FOR_ALLEVE NTS | 500 Internal Server Error | Indicates the requested all events ML model is unavailable. |
| NOTE: Including a "ProblemDetails" data structure with the "cause" attribute in the HTTP response is optional unless explicitly mandated in the service operation clauses. | | |

5.4.8 Feature negotiation

The optional features in table 5.4.8-1 are defined for the Nnwdaf_MLModelProvision API. They shall be negotiated using the extensibility mechanism defined in clause 6.6 of 3GPP TS 29.500 [6].

Table 5.4.8-1: Supported Features

| Feature number | Feature Name | Description |
|----------------|-------------------|--|
| 1 | FederatedLearning | Indicates the support of Federated Learning. |
| 2 | ModelSharing | This feature indicates the support of ML model sharing. |
| 3 | ENAEExt | This feature indicates support for the general enhancements of network data analytics requirements, including support for use case context sent by the NF service consumer to the NWDAF. |
| 4 | ModelProvisionExt | This feature indicates support for the Model Provision Extension, including support for provisioning the ML model file address (e.g. URL or FQDN) or ADRF (Set) ID and additional ML Model Information to the NF service consumer. |

5.4.9 Security

As indicated in 3GPP TS 33.501 [13] and 3GPP TS 29.500 [6], the access to the Nnwdaf_MLModelProvision API may be authorized by means of the OAuth2 protocol (see IETF RFC 6749 [14]), based on local configuration, using the "Client Credentials" authorization grant, where the NRF (see 3GPP TS 29.510 [12]) plays the role of the authorization server.

If OAuth2 is used, a n NF Service Consumer, prior to consuming services offered by the Nnwdaf_MLModelProvision API, shall obtain a "token" from the authorization server, by invoking the Access Token Request service, as described in 3GPP TS 29.510 [12], clause 5.4.2.2.

NOTE: When multiple NRFs are deployed in a network, the NRF used as authorization server is the same NRF that the NF Service Consumer used for discovering the Nnwdaf_MLModelProvision service.

The Nnwdaf_MLModelProvision API defines a single scope "nnwdaf-mlmodelprovision" for the entire service, and it does not define any additional scopes at resource or operation level.

5.5 Nnwdaf_MLModelTraining Service API

5.5.1 Introduction

The Nnwdaf_MLModelTraining service shall use the Nnwdaf_MLModelTraining API.

The API URI of the Nnwdaf_MLModelTraining API shall be:

{apiRoot}/<apiName>/<apiVersion>

The request URIs used in each HTTP requests from the NF service consumer towards the NWDAF shall have the Resource URI structure defined in clause 4.4.1 of 3GPP TS 29.501 [7], i.e.:

{apiRoot}/<apiName>/<apiVersion>/<apiSpecificResourceUriPart>

with the following components:

- The {apiRoot} shall be set as described in 3GPP TS 29.501 [7].
- The<apiName> shall be "nnwdaf-mlmodeltraining".
- The <apiVersion> shall be "v1".
- The <apiSpecificResourceUriPart> shall be set as described in clause 5.5.3.

5.5.2 Usage of HTTP

5.5.2.1 General

HTTP/2, IETF RFC 9113 [9], shall be used as specified in clause 5 of 3GPP TS 29.500 [6].

HTTP/2 shall be transported as specified in clause 5.3 of 3GPP TS 29.500 [6].

The OpenAPI [11] specification of HTTP messages and content bodies for the Nnwdaf_MLModelTraining is contained in Annex A.

5.5.2.2 HTTP standard headers

5.5.2.2.1 General

See clause 5.2.2 of 3GPP TS 29.500 [6] for the usage of HTTP standard headers.

5.5.2.2.2 Content type

JSON, IETF RFC 8259 [10], shall be used as content type of the HTTP bodies specified in the present specification as specified in clause 5.4 of 3GPP TS 29.500 [6]. The use of the JSON format shall be signalled by the content type "application/json".

"Problem Details" JSON object shall be used to indicate additional details of the error in a HTTP response body and shall be signalled by the content type "application/problem+json", as defined in IETF RFC 9457 [15].

5.5.2.3 HTTP custom headers

The Nnwdaf_MLModelTraining service API shall support mandatory HTTP custom header fields specified in clause 5.2.3.2 of 3GPP TS 29.500 [6] and may support HTTP custom header fields specified in clause 5.2.3.3 of 3GPP TS 29.500 [6].

In this release of the specification, no specific custom headers are defined for the Nnwdaf_MLModelTraining service API.

5.5.3 Resources

5.5.3.1 Resource Structure

This clause describes the structure for the Resource URIs and the resources and methods used for the service.

Figure 5.5.3.1-1 depicts the resource URIs structure for the Nnwdaf_MLModelTraining API.

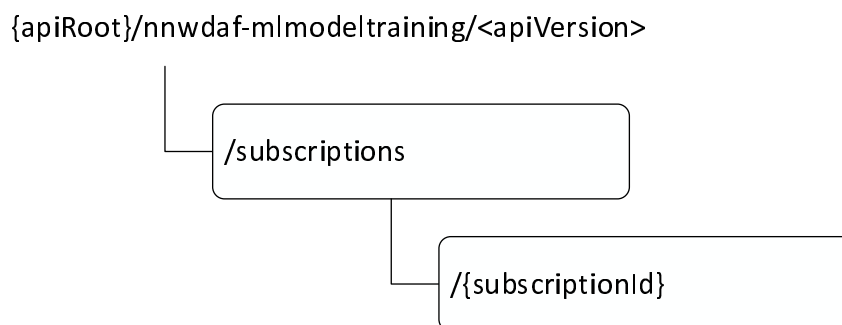

Figure 5.5.3.1-1: Resource URI structure of the Nnwdaf_MLModelTraining API

Table 5.5.3.1-1 provides an overview of the resources and applicable HTTP methods.

Table 5.5.3.1-1: Resources and methods overview

| Resource name | Resource URI | HTTP method or custom operation | Description |
|---|---------------------------------|---------------------------------|---|
| NWDAF ML Model Training Subscriptions | /subscriptions | POST | Creates a new Individual NWDAF ML Model Training Subscription resource. |
| Individual NWDAF ML Model Training Subscription | /subscriptions/{subscriptionId} | DELETE | Deletes an Individual NWDAF ML Model Training Subscription identified by subresource {subscriptionId}. |
| | | PUT | Modifies an existing Individual NWDAF ML Model Training Subscription identified by subresource {subscriptionId}. |
| | | PATCH | Partial update of an existing Individual NWDAF ML Model Training Subscription identified by subresource {subscriptionId}. |

5.5.3.2 Resource: NWDAF ML Model Training Subscriptions

5.5.3.2.1 Description

The NWDAF ML Model Training Subscriptions resource represents all subscriptions to the NnwdaflMLModelTraining service at a given NWDAF. The resource allows an NF service consumer to create a new Individual NWDAF ML Model Training Subscription resource.

5.5.3.2.2 Resource definition

Resource URI: {apiRoot}/nnwdaflmlmodeltraining/<apiVersion>/subscriptions

This resource shall support the resource URI variables defined in table 5.5.3.2.2-1.

Table 5.5.3.2.2-1: Resource URI variables for this resource

| Name | Data type | Definition |
|---------|-----------|------------------|
| apiRoot | string | See clause 5.5.1 |

5.5.3.2.3 Resource Standard Methods

5.5.3.2.3.1 POST

This method shall support the URI query parameters specified in table 5.5.3.2.3.1-1.

Table 5.5.3.2.3.1-1: URI query parameters supported by the POST method on this resource

| Name | Data type | P | Cardinality | Description |
|------|-----------|---|-------------|-------------|
| n/a | | | | |

This method shall support the request data structures specified in table 5.5.3.2.3.1-2 and the response data structures and response codes specified in table 5.5.3.2.3.1-3.

Table 5.5.3.2.3.1-2: Data structures supported by the POST Request Body on this resource

| Data type | P | Cardinality | Description |
|------------------------|---|-------------|---|
| NwdafMLModelTrainSubsc | M | 1 | Creates a new Individual NWDAF ML Model Training Subscription resource. |

Table 5.5.3.2.3.1-3: Data structures supported by the POST Response Body on this resource

| Data type | P | Cardinality | Response codes | Description |
|------------------------|---|-------------|---------------------------|---|
| NwdafMLModelTrainSubsc | M | 1 | 201 Created | The creation of an Individual NWDAF ML Model Training Subscription resource is confirmed and a representation of that resource is returned. |
| ProblemDetails | O | 0..1 | 403 Forbidden | (NOTE 2) |
| ProblemDetails | O | 0..1 | 500 Internal Server Error | (NOTE 2) |

NOTE 1: The mandatory HTTP error status codes for the POST method listed in table 5.2.7.1-1 of 3GPP TS 29.500 [6] also apply.

NOTE 2: Failure causes are described in subclause 5.5.7.3.

Table 5.5.3.2.3.1-4: Headers supported by the 201 Response Code on this resource

| Name | Data type | P | Cardinality | Description |
|----------|-----------|---|-------------|--|
| Location | string | M | 1 | Contains the URI of the newly created resource, according to the structure: {apiRoot}/nnwdaf-mlmodeltraining/<apiVersion>/subscriptions/{subscriptionId} |

5.5.3.2.4 Resource Custom Operations

None in this release of the specification.

5.5.3.3 Resource: Individual NWDAF ML Model Training Subscription

5.5.3.3.1 Description

The Individual NWDAF ML Model Training Subscription resource represents a single subscription to the Nnwdaf_MLModelTraining service at a given NWDAF.

5.5.3.3.2 Resource definition

Resource URI: {apiRoot}/nnwdaf-mlmodeltraining/<apiVersion>/subscriptions/{subscriptionId}

The <apiVersion> shall be set as described in clause 5.5.1.

This resource shall support the resource URI variables defined in table 5.5.3.3.2-1.

Table 5.5.3.3.2-1: Resource URI variables for this resource

| Name | Data type | Definition |
|----------------|-----------|--|
| apiRoot | string | See clause 5.5.1. |
| subscriptionId | string | Identifies a subscription to the Nnwdaf_MLModelTraining service. |

5.5.3.3.3 Resource Standard Methods

5.5.3.3.3.1 PUT

This method shall support the URI query parameters specified in table 5.5.3.3.3.1-1.

Table 5.5.3.3.3.1-1: URI query parameters supported by the PUT method on this resource

| Name | Data type | P | Cardinality | Description |
|------|-----------|---|-------------|-------------|
| n/a | | | | |

This method shall support the request data structures specified in table 5.5.3.3.3.1-2 and the response data structures and response codes specified in table 5.5.3.3.3.1-3.

Table 5.5.3.3.3.1-2: Data structures supported by the PUT Request Body on this resource

| Data type | P | Cardinality | Description |
|------------------------|---|-------------|--|
| NwdafMLModelTrainSubsc | M | 1 | Parameters to replace a subscription to NWDAF ML Model Training Subscription resource. |

Table 5.5.3.3.3.1-3: Data structures supported by the PUT Response Body on this resource

| Data type | P | Cardinality | Response codes | Description |
|--|---|-------------|---------------------------|--|
| NwdafMLModelTrainSubsc | M | 1 | 200 OK | The Individual NWDAF ML Model Training Subscription resource was modified successfully, and a representation of that resource is returned. |
| n/a | | | 204 No Content | The Individual NWDAF ML Model Training Subscription resource was modified successfully. |
| RedirectResponse | O | 0..1 | 307 Temporary Redirect | Temporary redirection, during Individual NWDAF ML Model Training Subscription modification. The response shall include a Location header field containing an alternative URI of the resource located in an alternative NWDAF (service) instance. |
| RedirectResponse | O | 0..1 | 308 Permanent Redirect | Permanent redirection, during Individual NWDAF ML Model Trainin Subscription modification. The response shall include a Location header field containing an alternative URI of the resource located in an alternative NWDAF (service) instance. |
| ProblemDetails | O | 0..1 | 403 Forbidden | (NOTE 2) |
| ProblemDetails | O | 0..1 | 500 Internal Server Error | (NOTE 2) |
| NOTE 1: The mandatory HTTP error status codes for the PUT method listed in table 5.2.7.1-1 of 3GPP TS 29.500 [6] also apply. | | | | |
| NOTE 2: Failure causes are described in subclause 5.5.7.3. | | | | |

Table 5.5.3.3.3.1-4: Headers supported by the 307 Response Code on this resource

| Name | Data type | P | Cardinality | Description |
|-----------------------|-----------|---|-------------|--|
| Location | string | M | 1 | An alternative URI of the resource located in an alternative NWDAF (service) instance. |
| 3gpp-Sbi-Target-Nf-Id | string | O | 0..1 | Identifier of the target NF (service) instance towards which the request is redirected |

Table 5.5.3.3.3.1-5: Headers supported by the 308 Response Code on this resource

| Name | Data type | P | Cardinality | Description |
|-----------------------|-----------|---|-------------|--|
| Location | string | M | 1 | An alternative URI of the resource located in an alternative NWDAF (service) instance. |
| 3gpp-Sbi-Target-Nf-Id | string | O | 0..1 | Identifier of the target NF (service) instance towards which the request is redirected |

5.5.3.3.3.2 PATCH

This method shall support the URI query parameters specified in table 5.5.3.3.3.2-1.

Table 5.5.3.3.3.2-1: URI query parameters supported by the PATCH method on this resource

| Name | Data type | P | Cardinality | Description |
|------|-----------|---|-------------|-------------|
| n/a | | | | |

This method shall support the request data structures specified in table 5.5.3.3.3.2-2 and the response data structures and response codes specified in table 5.5.3.3.3.2-3.

Table 5.5.3.3.3.2-2: Data structures supported by the PATCH Request Body on this resource

| Data type | P | Cardinality | Description |
|-----------------------------|---|-------------|--|
| NwdafMLModelTrainSubscPatch | M | 1 | Partial update of parameters to a subscription to NWDAF ML Model Training Subscription resource. |

Table 5.5.3.3.3.2-3: Data structures supported by the PATCH Response Body on this resource

| Data type | P | Cardinality | Response codes | Description |
|------------------------|---|-------------|---------------------------|--|
| NwdafMLModelTrainSubsc | M | 1 | 200 OK | The Individual NWDAF ML Model Training Subscription resource was partial modified successfully and a representation of that resource is returned. |
| n/a | | | 204 No Content | The Individual NWDAF ML Model Training Subscription resource was partial modified successfully. |
| RedirectResponse | O | 0..1 | 307 Temporary Redirect | Temporary redirection, during Individual NWDAF ML Model Training Subscription modification. The response shall include a Location header field containing an alternative URI of the resource located in an alternative NWDAF (service) instance. |
| RedirectResponse | O | 0..1 | 308 Permanent Redirect | Permanent redirection, during Individual NWDAF ML Model Trainin Subscription modification. The response shall include a Location header field containing an alternative URI of the resource located in an alternative NWDAF (service) instance. |
| ProblemDetails | O | 0..1 | 403 Forbidden | (NOTE 2) |
| ProblemDetails | O | 0..1 | 500 Internal Server Error | (NOTE 2) |

NOTE 1: The mandatory HTTP error status codes for the PATCH method listed in table 5.2.7.1-1 of 3GPP TS 29.500 [6] also apply.

NOTE 2: Failure causes are described in subclause 5.5.7.3.

Table 5.5.3.3.3.2-4: Headers supported by the 307 Response Code on this resource

| Name | Data type | P | Cardinality | Description |
|-----------------------|-----------|---|-------------|--|
| Location | string | M | 1 | An alternative URI of the resource located in an alternative NWDAF (service) instance. |
| 3gpp-Sbi-Target-Nf-Id | string | O | 0..1 | Identifier of the target NF (service) instance towards which the request is redirected |

Table 5.5.3.3.2-5: Headers supported by the 308 Response Code on this resource

| Name | Data type | P | Cardinality | Description |
|-----------------------|-----------|---|-------------|--|
| Location | string | M | 1 | An alternative URI of the resource located in an alternative NWDAF (service) instance. |
| 3gpp-Sbi-Target-Nf-Id | string | O | 0..1 | Identifier of the target NF (service) instance towards which the request is redirected |

5.5.3.3.3.3 DELETE

This method shall support the URI query parameters specified in table 5.5.3.3.3.3-1.

Table 5.5.3.3.3.3-1: URI query parameters supported by the DELETE method on this resource

| Name | Data type | P | Cardinality | Description |
|------|-----------|---|-------------|-------------|
| n/a | | | | |

This method shall support the request data structures specified in table 5.5.3.3.3.3-2 and the response data structures and response codes specified in table 5.5.3.3.3.3-3.

Table 5.5.3.3.3.2-2: Data structures supported by the DELETE Request Body on this resource

| Data type | P | Cardinality | Description |
|-----------|---|-------------|-------------|
| | | | |

Table 5.5.3.3.3.3-3: Data structures supported by the DELETE Response Body on this resource

| Data type | P | Cardinality | Response codes | Description |
|---|---|-------------|------------------------|--|
| n/a | | | 204 No Content | Successful case: The Individual NWDAF ML Model Training Subscription resource matching the subscriptionId was deleted. |
| RedirectResponse | O | 0..1 | 307 Temporary Redirect | Temporary redirection, during Individual NWDAF ML Model Training Subscription deletion. The response shall include a Location header field containing an alternative URI of the resource located in an alternative NWDAF (service) instance. |
| RedirectResponse | O | 0..1 | 308 Permanent Redirect | Permanent redirection, during Individual NWDAF ML Model Training Subscription deletion. The response shall include a Location header field containing an alternative URI of the resource located in an alternative NWDAF (service) instance. |
| NOTE: The mandatory HTTP error status codes for the DELETE method listed in table 5.2.7.1-1 of 3GPP TS 29.500 [6] also apply. | | | | |

Table 5.5.3.3.3.3-4: Headers supported by the 307 Response Code on this resource

| Name | Data type | P | Cardinality | Description |
|-----------------------|-----------|---|-------------|--|
| Location | string | M | 1 | An alternative URI of the resource located in an alternative NWDAF (service) instance. |
| 3gpp-Sbi-Target-Nf-Id | string | O | 0..1 | Identifier of the target NF (service) instance towards which the request is redirected |

Table 5.5.3.3.3.3-5: Headers supported by the 308 Response Code on this resource

| Name | Data type | P | Cardinality | Description |
|-----------------------|-----------|---|-------------|--|
| Location | string | M | 1 | An alternative URI of the resource located in an alternative NWDAF (service) instance. |
| 3gpp-Sbi-Target-Nf-Id | string | O | 0..1 | Identifier of the target NF (service) instance towards which the request is redirected |

5.5.3.3.4 Resource Custom Operations

None in this release of the specification.

5.5.4 Custom Operations without associated resources

None in this release of the specification.

5.5.5 Notifications

5.5.5.1 General

Notifications shall comply with clause 6.2 of 3GPP TS 29.500 [6] and clause 4.6.2.3 of 3GPP TS 29.501 [7].

Table 5.5.3.4.1-1: Notifications overview

| Notification | Callback URI | HTTP method or custom operation | Description (service operation) |
|--------------------|--------------|---------------------------------|--|
| Event Notification | {notifUri} | POST | Report one or several observed Events. |

5.5.5.2 Event Notification

5.5.5.2.1 Description

The Event Notification is used by the NWDAF to report one or several observed Events to a NF service consumer that has subscribed to such Notifications via the Individual NWDAF ML Model Training Subscription Resource.

5.5.5.2.2 Operation Definition

Callback URI: {**notifUri**}

The operation shall support the callback URI variables defined in table 5.5.5.2.2-1, the request data structures specified in table 5.5.5.2.2-2 and the response data structure and response codes specified in table 5.5.5.2.2-3.

Table 5.5.5.2.2-1: Callback URI variables

| Name | Data type | Definition |
|----------|-----------|--|
| notifUri | Uri | The Notification Uri as assigned within the Individual NWDAF ML Model Training Subscription and described within the NwdafMLModelTrainSubsc/NwdafMLModelTrainSubscPatch data types (see tables 5.5.6.2.2-1 and 5.5.6.2.3-1). |

Table 5.5.5.2.2-2: Data structures supported by the POST Request Body on this resource

| Data type | P | Cardinality | Description |
|------------------------|---|-------------|---|
| NwdafMLModelTrainNotif | M | 1 | Provides Information about observed events. |

Table 5.5.5.2.2-3: Data structures supported by the POST Response Body on this resource

| Data type | P | Cardinality | Response codes | Description |
|---|---|-------------|------------------------|---|
| n/a | | | 204 No Content | The receipt of the Notification is acknowledged. |
| RedirectResponse | O | 0..1 | 307 Temporary Redirect | Temporary redirection, during the event notification. The response shall include a Location header field containing an alternative URI representing the end point of an alternative NF consumer (service) instance where the notification should be sent. |
| RedirectResponse | O | 0..1 | 308 Permanent Redirect | Permanent redirection, during the event notification. The response shall include a Location header field containing an alternative URI representing the end point of an alternative NF consumer (service) instance where the notification should be sent. |
| NOTE: The mandatory HTTP error status codes for the POST method listed in table 5.2.7.1-1 of 3GPP TS 29.500 [6] also apply. | | | | |

Table 5.5.5.2.2-4: Headers supported by the 307 Response Code on this resource

| Name | Data type | P | Cardinality | Description |
|-----------------------|-----------|---|-------------|---|
| Location | string | M | 1 | An alternative URI representing the end point of an alternative NF consumer (service) instance towards which the notification should be redirected. |
| 3gpp-Sbi-Target-Nf-Id | string | O | 0..1 | Identifier of the target NF (service) instance towards which the notification request is redirected. |

Table 5.5.5.2.2-5: Headers supported by the 308 Response Code on this resource

| Name | Data type | P | Cardinality | Description |
|-----------------------|-----------|---|-------------|---|
| Location | string | M | 1 | An alternative URI representing the end point of an alternative NF consumer (service) instance towards which the notification should be redirected. |
| 3gpp-Sbi-Target-Nf-Id | string | O | 0..1 | Identifier of the target NF (service) instance towards which the notification request is redirected |

5.5.6 Data Model

5.5.6.1 General

This clause specifies the application data model supported by the API.

Table 5.5.6.1-1 specifies the data types defined for the Nnwdaf_MLModelTraining service-based interface protocol.

Table 5.5.6.1-1: Nnwdaf_MLModelTraining specific Data Types

| Data type | Section defined | Description | Applicability |
|---------------------------------|---------------------|--|---------------|
| DataAvReq | 5.5.6.2.10 | Represents the requirement on available data for the ML model training. | |
| DelayEventNotif | 5.5.6.2.11 | Indicates that the NWDAF containing MTLF is not able to complete the training of ML model within the maximum response time, the cause code, and the expected time complete the training. | |
| FailureCodeTrain | 5.5.6.3.3 | Identifies the failure reason. | |
| FailureEventInfoForMLModelTrain | 5.5.6.2.7 | Represents the failure event information for a ML Model Training subscription. | |
| NwdafMLModelTrainSubsc | 5.5.6.2.2 | Represents a ML Model Training subscription. | |
| NwdafMLModelTrainSubscPatch | 5.5.6.2.3 | Represents parameters to request the modification of a ML Model Training subscription. | |
| MLModelInfo | 5.5.6.2.4 | Represents the ML Model information. | |
| MLModelTrainInfo | 5.5.6.2.5 | Represents the ML Model training information, include requirement on data availability and time availability, training filter information. | |
| NetworkAreaInfo | 3GPP TS 29.554 [18] | Identifies the network area. | |
| NwdafMLModelTrainNotif | 5.5.6.2.8 | Represents notification of a ML Model Training subscription. | |
| MLTrainReportInfo | 5.5.6.2.6 | Indicates the training reporting information. | |
| StatusReportInfo | 5.5.6.2.12 | Indicates status information generated by the NWDAF containing MTLF during ML model training. | |
| TermTrainCause | 5.5.6.3.4 | Represents the reasons that the ML Model Training to be terminated. | |
| TrainDataInfo | 5.5.6.2.13 | Represents the training input data information. | |

Table 5.5.6.1-2 specifies data types re-used by the Nnwdaf_MLModelTraining service-based interface protocol from other specifications, including a reference to their respective specifications and when needed, a short description of their use within the Nnwdaf_MLModelTraining service-based interface.

Table 5.5.6.1-2: Nnwdaf_MLModelTraining re-used Data Types

| Data type | Reference | Comments | Applicability |
|----------------------------|---------------------|---|---------------|
| Accuracy | 5.1.6.3.5 | Represents the accuracy level of the ML model. | |
| DatasetStatisticalProperty | 5.1.6.3.15 | Dataset statistical properties of the data used for ML model training. | |
| DccfEvent | 3GPP TS 29.574 [26] | Identifies the input data event. | |
| Dnn | 3GPP TS 29.571 [8] | Identifies the DNN. | |
| DurationSec | 3GPP TS 29.571 [8] | Represents the duration time in second(s). | |
| Float | 3GPP TS 29.571 [8] | | |
| MLEventSubscription | 5.4.6.2.3 | Represents an Individual NWDAF Event Subscription resource. | |
| MLEventNotif | 5.4.6.2.6 | Represents notifications about Individual Events. | |
| NwdafEvent | 5.1.6.3.4 | Describes the NWDAF Events. | |
| RedirectResponse | 3GPP TS 29.571 [8] | | |
| ReportingInformation | 3GPP TS 29.523 [20] | Represents the requirements of reporting the subscription. | |
| Snsai | 3GPP TS 29.571 [8] | Identifies the S-NSSAI (Single Network Slice Selection Assistance Information). | |
| SupportedFeatures | 3GPP TS 29.571 [8] | | |
| TargetUeInformation | 5.1.6.2.8 | Identifies the target UE information. | |
| TimeWindow | 3GPP TS 29.122 [19] | | |
| Uri | 3GPP TS 29.571 [8] | | |

5.5.6.2 Structured data types

5.5.6.2.1 Introduction

This clause defines the structures to be used in resource representations.

5.5.6.2.2 Type NwdafMLModelTrainSubsc

Table 5.5.6.2.2-1: Definition of type NwdafMLModelTrainSubsc

| Attribute name | Data type | P | Cardinality | Description | Applicability |
|-------------------|--|---|-------------|---|---------------|
| eventReq | ReportingInformation | O | 0..1 | Reporting requirement information of the subscription. If omitted, the default values within the ReportingInformation data type apply. | |
| failEventReports | array(FailureEventInfoForMLModelTrain) | O | 1..N | Supplied by the NWDAF containing MTLF when available, shall contain the event(s) that the subscription is not successful including the failure reason(s). | |
| mlCorreId | string | C | 0..1 | Identifies the Machine Learning procedure for training the ML model. It shall be present when the service is for Federated Learning. | |
| mLEventSubscs | array(MLEventSubscription) | M | 1..N | Each element identifies the subscription for each event. The "modelInterInfo" attribute within the MLEventSubscription data type shall be provided. (NOTE 3) | |
| mLModelInfos | array(MLEventNotif) | O | 1..N | Each element contains ML Model information for a specific analytics type. (NOTE 1) (NOTE 2) | |
| immReport | NwdafMLModelTrainNotif | O | 0..1 | Immediately reported ML Model Training notifications. It may only be provided in the response of a subscription creation/update and only if the immediate reporting flag was set to "true" in the corresponding request. | |
| mLModelTrainInfos | array(MLModelTrainInfo) | O | 1..N | Each element represents the ML Model training information for each event, include requirement on data availability and time availability. | |
| mLPreFlag | boolean | C | 0..1 | Indicates whether the subscription is for preparation of ML Model training. Set to "true" if it is for ML training preparation, otherwise set to "false". Default value is "false" if omitted. It shall be present when the service is for preparation of Federated Learning. | |
| mLAccChkFlg | boolean | O | 0..1 | Indicates whether request using the local training data as the testing dataset to calculate the Model Accuracy of the global ML model provided by the consumer. Set to "true" if it is requested, otherwise set to "false". Default value is "false" if omitted. | |

| | | | | | |
|---|---------------------|---|------|---|--|
| mLTrainRepInfo | MLTrainReportInfo | O | 0..1 | Indicates the training reporting information. This attribute can be provided when the "notifMethod" attribute within the ReportingInformation structure is set to "ON_EVENT_DETECTION" in the "eventReq" attribute. | |
| notifCorreld | string | M | 1 | The value of Notification Correlation ID in the corresponding notification. | |
| notifUri | Uri | M | 1 | URI at which the NF service consumer requests to receive notifications. | |
| roundInd | UInteger | O | 0..1 | Indicates the round number of the training in a multi-round training process. | |
| suppFeats | SupportedFeatures | C | 0..1 | List of Supported features used as described in clause 5.5.8. It shall be supplied by NF service consumer in the POST requests that request the creation of an NWDAF ML Model Training Subscriptions resource and shall be supplied by the NWDAF in the reply of corresponding request. | |
| tgtRepUe | TargetUeInformation | O | 0..1 | Indicates the UE(s) information for which data for ML model training is requested. | |
| skipFlInd | boolean | O | 0..1 | Indicates whether to skip the current FL round or not. Set to "true": Skipping the current FL round. Set to "false": Not skipping the current FL round. Default value is "false" if omitted. | |
| NOTE 1: It is up to implementation to determine whether to include the "mlFile" attribute in the "MLEventNotif" data structure considering ML Model file size, etc. | | | | | |
| NOTE 2: Only the "event", "mlFile", "mlFileAddr", "mlModelAddr", "modelUniqueId" and "useCaseCxt" attributes contained in MLEventNotif data type are applicable. | | | | | |
| NOTE 3: The "useCaseCxt" attribute contained in MLEventSubscription data type is not applicable. | | | | | |

5.5.6.2.3 Type NwdafMLModelTrainSubscPatch

Table 5.5.6.2.3-1: Definition of type NwdafMLModelTrainSubscPatch

| Attribute name | Data type | P | Cardinality | Description | Applicability |
|---|-------------------------|---|-------------|---|---------------|
| eventReq | ReportingInformation | O | 0..1 | Reporting requirement information of the subscription. If omitted, the default values within the ReportingInformation data type apply. | |
| mLModelInfos | array(MLEventNotif) | O | 1..N | Each element contains ML Model information for a specific analytics type. (NOTE 1) (NOTE 2) | |
| mLModelTrainInfos | array(MLModelTrainInfo) | O | 1..N | Each element represents the ML Model training information, include requirement on data availability and time availability, training filter information. | |
| mLPreFlag | boolean | O | 0..1 | Indicates whether the subscription is for preparation of ML Model training. Set to "true" if it is for ML training preparation, otherwise set to "false". | |
| mLAccChkFig | boolean | O | 0..1 | Indicates whether request using the local training data as the testing dataset to calculate the Model Accuracy of the global ML model provided by the consumer. Set to "true" if it is requested, otherwise set to "false". | |
| mLTrainRepInfo | MLTrainReportInfo | O | 0..1 | Indicates the training reporting information. This attribute can be provided when the "notifMethod" attribute within the ReportingInformation structure is set to "ON_EVENT_DETECTION" in the "eventReq" attribute. | |
| notifUri | Uri | O | 0..1 | URI at which the NF service consumer requests to receive notifications. | |
| roundInd | UInteger | O | 0..1 | Indicates the round number of the training in a multi-round training process. | |
| tgtRepUe | TargetUeInformation | O | 0..1 | Indicates the UE(s) information for which data for ML model training is requested. | |
| skipFlInd | boolean | O | 0..1 | Indicates whether to skip the current FL round or not. Set to "true": Skipping the current FL round. Set to "false": Not skipping the current FL round. | |
| NOTE 1: It is up to implementation to determine whether to include the "mlFile" attribute in the "MLEventNotif" data structure considering ML Model file size, etc. | | | | | |
| NOTE 2: Only the "event", "mlFile", "mlFileAddr", "mLModelAddr", "modelUniqueId" and "useCaseCxt" attributes contained in MLEventNotif data type are applicable. | | | | | |

5.5.6.2.4 Void

5.5.6.2.5 Type MLModelTrainInfo

Table 5.5.6.2.5-1: Definition of type MLModelTrainInfo

| Attribute name | Data type | P | Cardinality | Description | Applicability |
|----------------|-----------|---|-------------|--|---------------|
| dataAvReq | DataAvReq | C | 0..1 | Represents the requirement on available data for the ML model training. Shall be provided when the "mLPreFlag" attribute in data type "NwdafMLModelTrainSubsc"/ "NwdafMLModelTrainSubscP atch" is set to "true". | |
| timeAvReq | string | C | 0..1 | Represents the requirement on available time for the ML model training. Shall be provided when the "mLPreFlag" attribute in data type "NwdafMLModelTrainSubsc"/ "NwdafMLModelTrainSubscP atch" is set to "true". | |

5.5.6.2.6 Type MLTrainReportInfo

Table 5.5.6.2.6-1: Definition of type MLTrainReportInfo

| Attribute name | Data type | P | Cardinality | Description | Applicability |
|----------------|-------------|---|-------------|---|---------------|
| maxResTime | DurationSec | O | 0..1 | Indicates the maximum time for waiting notifications. | |

5.5.6.2.7 Type FailureEventInfoForMLModelTrain

Table 5.5.6.2.7-1: Definition of type FailureEventInfoForMLModelTrain

| Attribute name | Data type | P | Cardinality | Description | Applicability |
|------------------|------------------|---|-------------|--------------------------------|---------------|
| mLTrainEvent | NwdafEvent | M | 1 | Event that is subscribed. | |
| failureCodeTrain | FailureCodeTrain | M | 1 | Identifies the failure reason. | |

5.5.6.2.8 Type NwdafMLModelTrainNotif

Table 5.5.6.2.8-1: Definition of type NwdafMLModelTrainNotif

| Attribute name | Data type | P | Cardinality | Description | Applicability |
|--|---------------------|---|-------------|---|---------------|
| delayEventNotif | DelayEventNotif | C | 0..1 | Indicates that the NWDAF containing MTLF is not able to complete the training of ML model within the maximum response time, the cause code, and the expected time complete the training. May be provided for Federated Learning training. (NOTE 1) | |
| mlCorreId | string | C | 0..1 | Identifies the Machine Learning procedure for training the ML model. It shall be present when the service is for Federated Learning. | |
| mLModelInfos | array(MLEventNotif) | C | 1..N | Represents the ML Model information. (NOTE 1) (NOTE 2) | |
| notifCorreId | string | M | 1 | Notification correlation ID used to identify the subscription to which the notification relates. It shall be set to the same value as the "notifCorreId" attribute of NwdafMLModelTrainSubsc data type. | |
| roundInd | UInteger | O | 0..1 | Indicates the round number of the training in a multi-round training process. | |
| statusReport | StatusReportInfo | O | 0..1 | Indicates status information generated by the NWDAF containing MTLF during ML model training. May be provided for Federated Learning training. | |
| termTrainReq | TermTrainCause | C | 0..1 | If provided, it indicates that the subscription is requested to be terminated (i.e. no further notifications related to this subscription will be provided) and it contains the reason why the subscription is requested to be terminated. (NOTE 1) | |
| NOTE 1: At least one of the "delayEventNotif", "mLModelInfos" or "termTrainReq" attribute shall be provided. The "delayEventNotif" attribute and "mLModelInfos" attribute are mutually exclusive. The "delayEventNotif" attribute and "termTrainReq" attribute are mutually exclusive. | | | | | |
| NOTE 2: Only the "event", "mLFileAddr", "mLModelAddr", "modelUniquelId" and "useCaseCxt" attributes contained in MLEventNotif data type are applicable. | | | | | |

5.5.6.2.9 Void

5.5.6.2.10 Type DataAvReq

Table 5.5.6.2.10-1: Definition of type DataAvReq

| Attribute name | Data type | P | Cardinality | Description | Applicability |
|----------------|-----------------------------------|---|-------------|--|---------------|
| dataStatProps | array(DatasetStatisticalProperty) | O | 1..N | List of dataset statistical properties of the data to be used for ML model training. | |
| inpEvents | array(DccfEvent) | M | 1..N | Event ID list of the data to be collected for ML model training. | |
| minNumSamples | UInteger | O | 0..1 | Minimum number of samples that be taken to train an ML model. | |
| timeWindows | array(TimeWindow) | O | 1..N | The time periods of the data samples. | |

5.5.6.2.11 Type DelayEventNotif

Table 5.5.6.2.11-1: Definition of type DelayEventNotif

| Attribute name | Data type | P | Cardinality | Description | Applicability |
|----------------|-------------|---|-------------|--|---------------|
| delayEventInd | boolean | M | 1 | Indicates the NWDAF containing MTLF is not able to complete the training of the ML model within the maximum response time provided by the "maxResTime" attribute in the "MLTrainReportInfo" data type. Set to "true" if not able to complete the ML model training on time, otherwise set to "false". | |
| delayCause | DelayCause | O | 0..1 | Represents the reasons for the ML Model training delay. | |
| expCompTime | DurationSec | O | 0..1 | Indicates the expected remaining training time. | |

5.5.6.2.12 Type StatusReportInfo

Table 5.5.6.2.12-1: Definition of type StatusReportInfo

| Attribute name | Data type | P | Cardinality | Description | Applicability |
|-----------------|---------------|---|-------------|---|---------------|
| mIModelAcc | UInteger | O | 0..1 | Indicates the accuracy of the ML model in percent. Minimum = 0. Maximum = 100. | |
| trainInDataInfo | TrainDataInfo | O | 0..1 | Represents the training input data information. | |

5.5.6.2.13 Type TrainDataInfo

Table 5.5.6.2.13-1: Definition of type TrainDataInfo

| Attribute name | Data type | P | Cardinality | Description | Applicability |
|----------------|-----------------|---|-------------|---|---------------|
| areaInfo | NetworkAreaInfo | O | 0..1 | Indicates the areas covered by the data set. | |
| maxValues | array(string) | O | 1..N | Each element represents the maximum value of one dimension of data. The format of its value is out of 3GPP scope. | |
| minValues | array(string) | O | 1..N | Each element represents the minimum value of one dimension of data. The format of its value is out of 3GPP scope. | |
| sampIRatio | UInteger | O | 0..1 | Sampling ratio, indicates the percentage of the available data that are taken to train an ML model. Minimum = 0. Maximum = 100. | |

5.5.6.3 Simple data types and enumerations

5.5.6.3.1 Introduction

This clause defines simple data types and enumerations that can be referenced from data structures defined in the previous clauses.

5.5.6.3.2 Simple data types

The simple data types defined in table 5.1.6.3.2-1 shall be supported.

Table 5.5.6.3.2-1: Simple data types

| Type Name | Type Definition | Description | Applicability |
|-----------|-----------------|-------------|---------------|
| | | | |

5.5.6.3.3 Enumeration: FailureCodeTrain

Table 5.5.6.3.3-1: Enumeration FailureCodeTrain

| Enumeration value | Description | Applicability |
|----------------------------|---|---------------|
| UNAVAILABLE_ML_MODEL_TRAIN | Indicates the requested ML model training is unavailable. | |

5.5.6.3.4 Enumeration: TermTrainCause

Table 5.5.6.3.4-1: Enumeration TermTrainCause

| Enumeration value | Description | Applicability |
|------------------------|--|---------------|
| NWDAF_OVERLOAD | Indicates the NWDAF is overload, e.g. in computation and/or communication capability, for the ML model training. | |
| NOT_AVAILABLE_ML_TRAIN | Indicates the ML model training process is not available anymore. | |
| OTHERS | Indicates other cause. | |

5.5.6.3.5 Enumeration: DelayCause

Table 5.5.6.3.5-1: Enumeration DelayCause

| Enumeration value | Description | Applicability |
|-----------------------|---|---------------|
| ML_MODEL_TRAIN_FAILED | Indicates the ML model training is failed. | |
| NEED_MORE_TIME | Indicates that more time is needed for the ML model training. | |
| OTHERS | Indicates other cause. | |

5.5.7 Error handling

5.5.7.1 General

HTTP error handling shall be supported as specified in clause 5.2.4 of 3GPP TS 29.500 [6].

For the Nnwdaf_MLModelTraining API, HTTP error responses shall be supported as specified in clause 4.8 of 3GPP TS 29.501 [7].

Protocol errors and application errors specified in table 5.2.7.2-1 of 3GPP TS 29.500 [6] shall be supported for an HTTP method if the corresponding HTTP status codes are specified as mandatory for that HTTP method in table 5.2.7.1-1 of 3GPP TS 29.500 [6].

Protocol errors and application errors specified in table 5.2.7.2-1 of 3GPP TS 29.500 [6] for HTTP redirections shall be supported.

In addition, the requirements in the following clauses shall apply.

5.5.7.2 Protocol Errors

In this Release of the specification, there are no additional protocol errors applicable for the Nnwdaf_MLModelTraining API.

5.5.7.3 Application Errors

The application errors defined for the Nnwdaf_MLModelTraining API are listed in table 5.5.7.3-1.

Table 5.5.7.3-1: Application errors

| Application Error | HTTP status code | Description |
|---|---|--|
| UNAVAILABLE_ML_MODEL_TRAINING_F OR_ALLEVENTS | 500 Internal Server Error | Indicates the requested all events ML model training is unavailable. |
| ML_MODEL_TRAINING_REQS_NOT_MET | 403 Forbidden | Indicates the ML model training requirements are not met. The "ProblemDetails" data structure shall contain the attribute(s) that do not meet the ML model training requirements within the "invalidParams" attribute. |
| ML_TRAINING_NOT_COMPLETE | 403 Forbidden | Indicates the ML training is not complete. |
| OVERLOAD | 403 Forbidden | Indicates the NWDaf is overload. |
| NOT_AVAILABLE_FOR_FL_PROCESS_AN YMORE | 403 Forbidden | Indicates the NWDaf is not available for the FL process anymore. |
| NOTE: | Including a "ProblemDetails" data structure with the "cause" attribute in the HTTP response is optional unless explicitly mandated in the service operation clauses. | |

5.5.8 Feature negotiation

The optional features in table 5.5.8-1 are defined for the Nnwdaf_MLModelTraining API. They shall be negotiated using the extensibility mechanism defined in clause 6.6 of 3GPP TS 29.500 [6].

Table 5.5.8-1: Supported Features

| Feature number | Feature Name | Description |
|----------------|--------------|-------------|
| | | |

5.5.9 Security

As indicated in 3GPP TS 33.501 [13] and 3GPP TS 29.500 [6], the access to the Nnwdaf_MLModelTraining API may be authorized by means of the OAuth2 protocol (see IETF RFC 6749 [14]), based on local configuration, using the "Client Credentials" authorization grant, where the NRF (see 3GPP TS 29.510 [12]) plays the role of the authorization server.

If OAuth2 is used, a n NF Service Consumer, prior to consuming services offered by the Nnwdaf_MLModelTraining API, shall obtain a "token" from the authorization server, by invoking the Access Token Request service, as described in 3GPP TS 29.510 [12], clause 5.4.2.2.

NOTE: When multiple NRFs are deployed in a network, the NRF used as authorization server is the same NRF that the NF Service Consumer used for discovering the Nnwdaf_MLModelTraining service.

The Nnwdaf_MLModelTraining API defines a single scope "nnwdaf-mlmodeltraining" for the entire service, and it does not define any additional scopes at resource or operation level.

5.6 Nnwdaf_MLModelMonitor Service API

5.6.1 Introduction

The Nnwdaf_MLModelMonitor service shall use the Nnwdaf_MLModelMonitor API.

The API URI of the Nnwdaf_MLModelMonitor API shall be:

{apiRoot}/<apiName>/<apiVersion>

The request URIs used in each HTTP requests from the NF service consumer towards the NWDaf shall have the Resource URI structure defined in clause 4.4.1 of 3GPP TS 29.501 [7], i.e.:

{apiRoot}/<apiName>/<apiVersion>/<apiSpecificResourceUriPart>

with the following components:

- The {apiRoot} shall be set as described in 3GPP TS 29.501 [7].
- The <apiName> shall be "nnwdaf-mlmodelmonitor".
- The <apiVersion> shall be "v1".
- The <apiSpecificResourceUriPart> shall be set as described in clause 5.6.3.

5.6.2 Usage of HTTP

5.6.2.1 General

HTTP/2, IETF RFC 9113 [9], shall be used as specified in clause 5 of 3GPP TS 29.500 [6].

HTTP/2 shall be transported as specified in clause 5.3 of 3GPP TS 29.500 [6].

The OpenAPI [11] specification of HTTP messages and content bodies for the Nnwdaf_MLModelMonitor is contained in Annex A.

5.6.2.2 HTTP standard headers

5.6.2.2.1 General

See clause 5.2.2 of 3GPP TS 29.500 [6] for the usage of HTTP standard headers.

5.6.2.2.2 Content type

JSON, IETF RFC 8259 [10], shall be used as content type of the HTTP bodies specified in the present specification as specified in clause 5.4 of 3GPP TS 29.500 [6]. The use of the JSON format shall be signalled by the content type "application/json".

"Problem Details" JSON object shall be used to indicate additional details of the error in a HTTP response body and shall be signalled by the content type "application/problem+json", as defined in IETF RFC 9457 [15].

5.6.2.3 HTTP custom headers

The Nnwdaf_MLModelMonitor service API shall support mandatory HTTP custom header fields specified in clause 5.2.3.2 of 3GPP TS 29.500 [6] and may support HTTP custom header fields specified in clause 5.2.3.3 of 3GPP TS 29.500 [6].

In this release of the specification, no specific custom headers are defined for the Nnwdaf_MLModelMonitor service API.

5.6.3 Resources

5.6.3.1 Resource Structure

This clause describes the structure for the Resource URIs, the resources and methods used for the service.

Figure 5.6.3.1-1 depicts the resource URIs structure for the Nnwdaf_MLModelMonitor API.

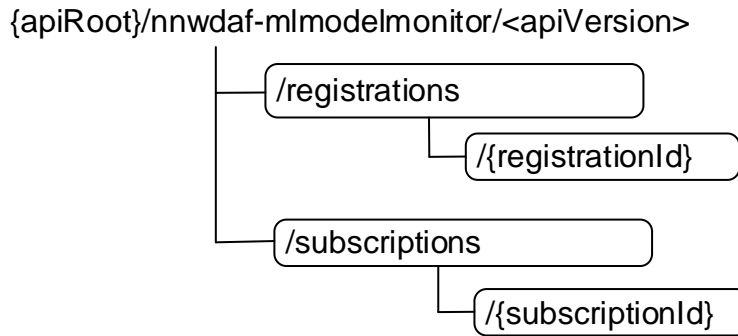

Figure 5.6.3.1-1: Resource URI structure of the Nnwdaf_MLModelMonitor API

Table 5.6.3.1-1 provides an overview of the resources and applicable HTTP methods.

Table 5.6.3.1-1: Resources and methods overview

| Resource name | Resource URI | HTTP method or custom operation | Description |
|---|---------------------------------|---------------------------------|--|
| NWDAF ML model monitoring registrations | /registrations | POST | Create a new Individual ML model monitoring registration resource on the NWDAF containing MTLF. |
| Individual NWDAF ML model monitoring registration | /registrations/{registrationId} | DELETE | Delete an Individual ML model monitoring registration resource by {registrationId} on the NWDAF containing MTLF. |
| NWDAF ML model monitoring Subscriptions | /subscriptions | POST | Create a new Individual ML model monitoring Subscription resource on the NWDAF containing AnLF. |
| Individual NWDAF ML model monitoring Subscription | /subscriptions/{subscriptionId} | PUT | Modifies an existing ML model monitoring Subscription resource on the NWDAF containing AnLF. |
| | | DELETE | Delete an individual ML model monitoring Subscription identified by {subscriptionId} on the NWDAF containing AnLF. |

5.6.3.2 Resource: NWDAF ML model monitoring registrations

5.6.3.2.1 Description

The NWDAF ML model monitoring registrations resource represents all registrations to the Nnwdaf_MLModelMonitor Service at a given NWDAF containing MTLF. The resource allows an NF service consumer to create a new Individual NWDAF ML model monitoring registration resource.

5.6.3.2.2 Resource Definition

Resource URI: **{apiRoot}/nnwdaf-mlmodelmonitor/<apiVersion>/registrations**

The <apiVersion> shall be set as described in clause 5.6.1.

This resource shall support the resource URI variables defined in table 5.6.3.2.2-1.

Table 5.6.3.2.2-1: Resource URI variables for this resource

| Name | Data type | Definition |
|---------|-----------|------------------|
| apiRoot | string | See clause 5.6.1 |

5.6.3.2.3 Resource Standard Methods

5.6.3.2.3.1 POST

This method shall support the URI query parameters specified in table 5.6.3.2.3.1-1.

Table 5.6.3.2.3.1-1: URI query parameters supported by the POST method on this resource

| Name | Data type | P | Cardinality | Description |
|------|-----------|---|-------------|-------------|
| n/a | | | | |

This method shall support the request data structures specified in table 5.6.3.2.3.1-2 and the response data structures and response codes specified in table 5.6.3.2.3.1-3.

Table 5.6.3.2.3.1-2: Data structures supported by the POST Request Body on this resource

| Data type | P | Cardinality | Description |
|-------------------|---|-------------|--|
| MLModelMonitorReg | M | 1 | Create a new Individual NWDAF ML model monitoring registration resource. |

Table 5.6.3.2.3.1-3: Data structures supported by the POST Response Body on this resource

| Data type | P | Cardinality | Response codes | Description |
|---|---|-------------|----------------|---|
| MLModelMonitorReg | M | 1 | 201 Created | The creation of an Individual NWDAF ML model monitoring registration resource is confirmed and a representation of that resource is returned. |
| NOTE 1: The mandatory HTTP error status codes for the POST method listed in table 5.2.7.1-1 of 3GPP TS 29.500 [6] also apply. | | | | |
| NOTE 2: Failure cases are described in clause 5.6.7. | | | | |

Table 5.6.3.2.3.1-4: Headers supported by the 201 Response Code on this resource

| Name | Data type | P | Cardinality | Description |
|----------|-----------|---|-------------|---|
| Location | string | M | 1 | Contains the URI of the newly created resource, according to the structure: {apiRoot}/nnwdaf-mlmodelmonitor/<apiVersion>/registrations/{registrationId} |

5.6.3.2.4 Resource Custom Operations

None in this release of the specification.

5.6.3.3 Resource: Individual NWDAF ML model monitoring registration

5.6.3.3.1 Description

The Individual NWDAF ML model monitoring registration resource represents a single registration to the Nnwdaf_MLModelMonitor Service at a given NWDAF containing MTLF.

5.6.3.3.2 Resource definition

Resource URI: {apiRoot}/nnwdaf-mlmodelmonitor/<apiVersion>/registrations/{registrationId}

The <apiVersion> shall be set as described in clause 5.6.1.

This resource shall support the resource URI variables defined in table 5.6.3.3.2-1.

Table 5.6.3.3.2-1: Resource URI variables for this resource

| Name | Data type | Definition |
|----------------|-----------|---|
| apiRoot | string | See clause 5.6.1. |
| registrationId | string | Identifies a registration to the Nnwdaf_MLModelMonitor Service. |

5.6.3.3.3 Resource Standard Methods

5.6.3.3.3.1 DELETE

This method shall support the URI query parameters specified in table 5.6.3.3.3.1-1.

Table 5.6.3.3.3.1-1: URI query parameters supported by the DELETE method on this resource

| Name | Data type | P | Cardinality | Description |
|------|-----------|---|-------------|-------------|
| n/a | | | | |

This method shall support the request data structures specified in table 5.6.3.3.3.1-2 and the response data structures and response codes specified in table 5.6.3.3.3.1-3.

Table 5.6.3.3.3.1-2: Data structures supported by the DELETE Request Body on this resource

| Data type | P | Cardinality | Description |
|-----------|---|-------------|-------------|
| n/a | | | |

Table 5.6.3.3.3.1-3: Data structures supported by the DELETE Response Body on this resource

| Data type | P | Cardinality | Response codes | Description |
|---|---|-------------|------------------------|--|
| n/a | | | 204 No Content | Successful case: The Individual NWDAF ML model monitoring registration resource matching the registrationId was deleted. |
| RedirectResponse | O | 0..1 | 307 Temporary Redirect | Temporary redirection, during Individual ML model monitoring registration deletion. (NOTE 2) |
| RedirectResponse | O | 0..1 | 308 Permanent Redirect | Permanent redirection, during Individual ML model monitoring registration deletion. (NOTE 2) |
| NOTE 1: The mandatory HTTP error status codes for the DELETE method listed in table 5.2.7.1-1 of 3GPP TS 29.500 [6] also apply. | | | | |
| NOTE 2: The RedirectResponse data structure may be provided by an SCP (cf. clause 6.10.9.1 of 3GPP TS 29.500 [6]). | | | | |

Table 5.6.3.3.3.1-4: Headers supported by the 307 Response Code on this resource

| Name | Data type | P | Cardinality | Description |
|-----------------------|-----------|---|-------------|---|
| Location | string | M | 1 | Contains an alternative URI of the resource located in an alternative NWDAF (service) instance towards which the request is redirected. For the case where the request is redirected to the same target via a different SCP, refer to clause 6.10.9.1 of 3GPP TS 29.500 [6]. |
| 3gpp-Sbi-Target-Nf-Id | string | O | 0..1 | Identifier of the target NWDAF (service) instance towards which the request is redirected. |

Table 5.6.3.3.3.1-5: Headers supported by the 308 Response Code on this resource

| Name | Data type | P | Cardinality | Description |
|-----------------------|-----------|---|-------------|--|
| Location | string | M | 1 | Contains an alternative URI of the resource located in an alternative NWDAF (service) instance towards which the request is redirected For the case where the request is redirected to the same target via a different SCP, refer to clause 6.10.9.1 of 3GPP TS 29.500 [6]. |
| 3gpp-Sbi-Target-Nf-Id | string | O | 0..1 | Identifier of the target NWDAF (service) instance towards which the request is redirected. |

5.6.3.3.4 Resource Custom Operations

None in this release of the specification.

5.6.3.4 Resource: NWDAF ML model monitoring Subscriptions

5.6.3.4.1 Description

The NWDAF ML model monitoring Subscriptions resource represents all subscriptions to the NnwdaflMLModelMonitor Service at a given NWDAF containing AnLF. The resource allows an NF service consumer to create a new Individual NWDAF ML model monitoring subscription resource.

5.6.3.4.2 Resource Definition

Resource URI: {apiRoot}/nnwdaflmlmodelmonitor/<apiVersion>/subscriptions

The <apiVersion> shall be set as described in clause 5.6.1.

This resource shall support the resource URI variables defined in table 5.6.3.4.2-1.

Table 5.6.3.4.2-1: Resource URI variables for this resource

| Name | Data type | Definition |
|---------|-----------|------------------|
| apiRoot | string | See clause 5.6.1 |

5.6.3.4.3 Resource Standard Methods

5.6.3.4.3.1 POST

This method shall support the URI query parameters specified in table 5.6.3.4.3.1-1.

Table 5.6.3.4.3.1-1: URI query parameters supported by the POST method on this resource

| Name | Data type | P | Cardinality | Description |
|------|-----------|---|-------------|-------------|
| n/a | | | | |

This method shall support the request data structures specified in table 5.6.3.4.3.1-2 and the response data structures and response codes specified in table 5.6.3.4.3.1-3.

Table 5.6.3.4.3.1-2: Data structures supported by the POST Request Body on this resource

| Data type | P | Cardinality | Description |
|-------------------|---|-------------|--|
| MLModelMonitorSub | M | 1 | Create a new Individual NWDAF ML model monitoring subscription resource. |

Table 5.6.3.4.3.1-3: Data structures supported by the POST Response Body on this resource

| Data type | P | Cardinality | Response codes | Description |
|---|---|-------------|----------------|---|
| MLModelMonitorSub | M | 1 | 201 Created | The creation of an Individual NWDAF ML model monitoring subscription resource is confirmed and a representation of that resource is returned. |
| NOTE 1: The mandatory HTTP error status codes for the POST method listed in table 5.2.7.1-1 of 3GPP TS 29.500 [6] also apply. | | | | |
| NOTE 2: Failure cases are described in clause 5.6.7. | | | | |

Table 5.6.3.4.3.1-4: Headers supported by the 201 Response Code on this resource

| Name | Data type | P | Cardinality | Description |
|----------|-----------|---|-------------|---|
| Location | string | M | 1 | Contains the URI of the newly created resource, according to the structure: {apiRoot}/nnwdaf-mlmodelmonitor/<apiVersion>/subscriptions/{subscriptionId} |

5.6.3.4.4 Resource Custom Operations

None in this release of the specification.

5.6.3.5 Resource: Individual NWDAF ML model monitoring Subscription

5.6.3.5.1 Description

The Individual NWDAF ML model monitoring Subscription resource represents a single subscription to the Nnwdaf_MLModelMonitor Service at a given NWDAF containing AnLF.

5.6.3.5.2 Resource definition

Resource URI: {apiRoot}/nnwdaf-mlmodelmonitor/<apiVersion>/subscriptions/{subscriptionId}

The <apiVersion> shall be set as described in clause 5.6.1.

This resource shall support the resource URI variables defined in table 5.6.3.5.2-1.

Table 5.6.3.5.2-1: Resource URI variables for this resource

| Name | Data type | Definition |
|----------------|-----------|---|
| apiRoot | string | See clause 5.6.1. |
| subscriptionId | string | Identifies a subscription to the Nnwdaf_MLModelMonitor Service. |

5.6.3.5.3 Resource Standard Methods

5.6.3.5.3.1 PUT

This method shall support the URI query parameters specified in table 5.6.3.5.3.1-1.

Table 5.6.3.5.3.1-1: URI query parameters supported by the PUT method on this resource

| Name | Data type | P | Cardinality | Description |
|------|-----------|---|-------------|-------------|
| n/a | | | | |

This method shall support the request data structures specified in table 5.6.3.5.3.1-2 and the response data structures and response codes specified in table 5.6.3.5.3.1-3.

Table 5.6.3.5.3.1-2: Data structures supported by the PUT Request Body on this resource

| Data type | P | Cardinality | Description |
|-------------------|---|-------------|--|
| MLModelMonitorSub | M | 1 | Parameters to replace a subscription to NWDAF ML model monitoring subscription resource. |

Table 5.6.3.5.3.1-3: Data structures supported by the PUT Response Body on this resource

| Data type | P | Cardinality | Response codes | Description |
|--|---|-------------|------------------------|---|
| MLModelMonitorSub | M | 1 | 200 OK | The Individual NWDAF ML model monitoring subscription resource was modified successfully and a representation of that resource is returned. |
| n/a | | | 204 No Content | The Individual NWDAF ML model monitoring subscription resource was modified successfully. |
| RedirectResponse | O | 0..1 | 307 Temporary Redirect | Temporary redirection, during Individual NWDAF ML model monitoring subscription modification. (NOTE 3) |
| RedirectResponse | O | 0..1 | 308 Permanent Redirect | Permanent redirection, during Individual NWDAF ML model monitoring subscription modification. (NOTE 3) |
| NOTE 1: The mandatory HTTP error status codes for the PUT method listed in table 5.2.7.1-1 of 3GPP TS 29.500 [6] also apply. | | | | |
| NOTE 2: Failure cases are described in clause 5.6.7. | | | | |
| NOTE 3: The RedirectResponse data structure may be provided by an SCP (cf. clause 6.10.9.1 of 3GPP TS 29.500 [6]). | | | | |

Table 5.6.3.5.3.1-4: Headers supported by the 307 Response Code on this resource

| Name | Data type | P | Cardinality | Description |
|-----------------------|-----------|---|-------------|---|
| Location | string | M | 1 | Contains an alternative URI of the resource located in an alternative NWDAF (service) instance towards which the request is redirected. For the case where the request is redirected to the same target via a different SCP, refer to clause 6.10.9.1 of 3GPP TS 29.500 [6]. |
| 3gpp-Sbi-Target-Nf-Id | string | O | 0..1 | Identifier of the target NWDAF (service) instance towards which the request is redirected. |

Table 5.6.3.5.3.1-5: Headers supported by the 308 Response Code on this resource

| Name | Data type | P | Cardinality | Description |
|-----------------------|-----------|---|-------------|---|
| Location | string | M | 1 | Contains an alternative URI of the resource located in an alternative NWDAF (service) instance towards which the request is redirected. For the case where the request is redirected to the same target via a different SCP, refer to clause 6.10.9.1 of 3GPP TS 29.500 [6]. |
| 3gpp-Sbi-Target-Nf-Id | string | O | 0..1 | Identifier of the target NWDAF (service) instance towards which the request is redirected. |

5.6.3.5.3.2 DELETE

This method shall support the URI query parameters specified in table 5.6.3.5.3.2-1.

Table 5.6.3.5.3.2-1: URI query parameters supported by the DELETE method on this resource

| Name | Data type | P | Cardinality | Description |
|------|-----------|---|-------------|-------------|
| n/a | | | | |

This method shall support the request data structures specified in table 5.6.3.5.3.2-2 and the response data structures and response codes specified in table 5.6.3.5.3.2-3.

Table 5.6.3.5.3.2-2: Data structures supported by the DELETE Request Body on this resource

| Data type | P | Cardinality | Description |
|-----------|---|-------------|-------------|
| n/a | | | |

Table 5.6.3.5.3.2-3: Data structures supported by the DELETE Response Body on this resource

| Data type | P | Cardinality | Response codes | Description |
|---|---|-------------|------------------------|--|
| n/a | | | 204 No Content | Successful case: The Individual NWDAF ML model monitoring subscription resource matching the subscriptionId was deleted. |
| RedirectResponse | O | 0..1 | 307 Temporary Redirect | Temporary redirection, during Individual ML model monitoring subscription deletion. (NOTE 2) |
| RedirectResponse | O | 0..1 | 308 Permanent Redirect | Permanent redirection, during Individual ML model monitoring subscription deletion. (NOTE 2) |
| NOTE 1: The mandatory HTTP error status codes for the DELETE method listed in table 5.2.7.1-1 of 3GPP TS 29.500 [6] also apply. | | | | |
| NOTE 2: The RedirectResponse data structure may be provided by an SCP (cf. clause 6.10.9.1 of 3GPP TS 29.500 [6]). | | | | |

Table 5.6.3.5.3.2-4: Headers supported by the 307 Response Code on this resource

| Name | Data type | P | Cardinality | Description |
|-----------------------|-----------|---|-------------|---|
| Location | string | M | 1 | Contains an alternative URI of the resource located in an alternative NWDAF (service) instance towards which the request is redirected. For the case where the request is redirected to the same target via a different SCP, refer to clause 6.10.9.1 of 3GPP TS 29.500 [6]. |
| 3gpp-Sbi-Target-Nf-Id | string | O | 0..1 | Identifier of the target NWDAF (service) instance towards which the request is redirected. |

Table 5.6.3.5.3.2-5: Headers supported by the 308 Response Code on this resource

| Name | Data type | P | Cardinality | Description |
|-----------------------|-----------|---|-------------|---|
| Location | string | M | 1 | Contains an alternative URI of the resource located in an alternative NWDAF (service) instance towards which the request is redirected. For the case where the request is redirected to the same target via a different SCP, refer to clause 6.10.9.1 of 3GPP TS 29.500 [6]. |
| 3gpp-Sbi-Target-Nf-Id | string | O | 0..1 | Identifier of the target NWDAF (service) instance towards which the request is redirected. |

5.6.3.5.4 Resource Custom Operations

None in this release of the specification.

5.6.4 Custom Operations without associated resources

None in this release of the specification.

5.6.5 Notifications

5.6.5.1 General

Notifications shall comply with clause 6.2 of 3GPP TS 29.500 [6] and clause 4.6.2.3 of 3GPP TS 29.501 [7].

Table 5.6.5.1-1: Notifications overview

| Notification | Callback URI | HTTP method or custom operation | Description (service operation) |
|--------------------|-------------------|---------------------------------|--|
| Event Notification | {notificationUri} | POST | Report analytics feedback information. |

5.6.5.2 Event Notification

5.6.5.2.1 Description

The Event Notification is used by the NWDAF containing AnLF to report analytics feedback information to the NF service consumer that has subscribed to such Notifications.

5.6.5.2.2 Operation Definition

Callback URI: {notificationUri}

The operation shall support the callback URI variables defined in Table 5.6.5.2.2-1, the request data structures specified in table 5.6.5.2.2-2 and the response data structure and response codes specified in Table 5.6.5.2.2-3.

Table 5.6.5.2.2-1: Callback URI variables

| Name | Data type | Definition |
|-----------------|-----------|--|
| notificationUri | Uri | The Notification Uri is assigned within the Individual NWDAF ML model monitoring Subscription Resource and described within the MLModelMonitorSub data type (see table 5.6.6.2.3-1). |

Table 5.6.5.2.2-2: Data structures supported by the POST Request Body on this resource

| Data type | P | Cardinality | Description |
|----------------------|---|-------------|--|
| MLModelMonitorNotify | M | 1 | Provides analytics feedback information. |

Table 5.6.5.2.2-3: Data structures supported by the POST Response Body on this resource

| Data type | P | Cardinality | Response codes | Description |
|---|---|-------------|------------------------|---|
| n/a | | | 204 No Content | The receipt of the Notification is acknowledged. |
| RedirectResponse | O | 0..1 | 307 Temporary Redirect | Temporary redirection, during the event notification. (NOTE 2) |
| RedirectResponse | O | 0..1 | 308 Permanent Redirect | Permanent redirection, during the event notification. (NOTE 2) |
| NOTE 1: The mandatory HTTP error status codes for the POST method listed in table 5.2.7.1-1 of 3GPP TS 29.500 [6] also apply. | | | | |
| NOTE 2: The RedirectResponse data structure may be provided by an SCP (cf. clause 6.10.9.1 of 3GPP TS 29.500 [6]). | | | | |

Table 5.6.5.2.2-4: Headers supported by the 307 Response Code on this resource

| Name | Data type | P | Cardinality | Description |
|-----------------------|-----------|---|-------------|--|
| Location | string | M | 1 | Contains an alternative URI representing the end point of an alternative NF consumer (service) instance towards which the notification is redirected. For the case where the notification is redirected to the same target via a different SCP, refer to clause 6.10.9.1 of 3GPP TS 29.500 [6]. |
| 3gpp-Sbi-Target-Nf-Id | string | O | 0..1 | Identifier of the target NF (service) instance towards which the notification request is redirected. |

Table 5.6.5.2.2-5: Headers supported by the 308 Response Code on this resource

| Name | Data type | P | Cardinality | Description |
|-----------------------|-----------|---|-------------|--|
| Location | string | M | 1 | Contains an alternative URI representing the end point of an alternative NF consumer (service) instance towards which the notification is redirected. For the case where the notification is redirected to the same target via a different SCP, refer to clause 6.10.9.1 of 3GPP TS 29.500 [6]. |
| 3gpp-Sbi-Target-Nf-Id | string | O | 0..1 | Identifier of the target NF (service) instance towards which the notification request is redirected. |

5.6.6 Data Model

5.6.6.1 General

This clause specifies the application data model supported by the API.

Table 5.6.6.1-1 specifies the data types defined for the Nnwdaf_MLModelMonitor service based interface protocol.

Table 5.6.6.1-1: Nnwdaf_MLModelMonitor specific Data Types

| Data type | Clause defined | Description | Applicability |
|----------------------|----------------|-------------|---------------|
| AnalyticsFeedback | 5.6.6.2.6 | | |
| MLModelAccuracyInfo | 5.6.6.2.5 | | |
| MLModelMonitorNotify | 5.6.6.2.4 | | |
| MLModelMonitorReg | 5.6.6.2.2 | | |
| MLModelMonitorSub | 5.6.6.2.3 | | |

Table 5.6.6.1-2 specifies data types re-used by the Nnwdaf_MLModelMonitor service based interface protocol from other specifications, including a reference to their respective specifications and when needed, a short description of their use within the Nnwdaf_MLModelMonitor service based interface.

Table 5.6.6.1-2: Nnwdaf_MLModelMonitor re-used Data Types

| Data type | Reference | Comments | Applicability |
|----------------------|---------------------|--|---------------|
| DataSetTag | 3GPP TS 29.575 [27] | Contains an identifier and a description of associated data or analytics records. | |
| DateTime | 3GPP TS 29.571 [8] | Identifies the time. | |
| EventFilter | 5.2.6.2.3 | Represents the event filters used to identify the requested analytics. | |
| Float | 3GPP TS 29.571 [8] | Number with format "float" as defined in OpenAPI Specification [11]. | |
| MLModelMetric | 5.4.6.3.4 | Indicates the ML Model Metric. | |
| NfInstanceId | 3GPP TS 29.571 [8] | Identifies an NF instance | |
| NfSetId | 3GPP TS 29.571 [8] | Identifies an NF Set instance. | |
| NwdafEvent | 5.1.6.3.4 | Indicates the NWDAF events. | |
| ReportingInformation | 3GPP TS 29.523 [20] | Represents the type of reporting the subscription requires. | |
| SupportedFeatures | 3GPP TS 29.571 [8] | Used to negotiate the applicability of the optional features defined in table 5.1.8-1. | |
| TargetUeInformation | 5.1.6.2.8 | Identifies the target UE information. | |
| UInteger | 3GPP TS 29.571 [8] | Unsigned Integer, i.e. only value 0 and integers above 0 are permissible. | |
| Uri | 3GPP TS 29.571 [8] | Indicates the URI. | |

5.6.6.2 Structured data types

5.6.6.2.1 Introduction

This clause defines the structures to be used in resource representations.

5.6.6.2.2 Type MLModelMonitorReg

Table 5.6.6.2.2-1: Definition of type MLModelMonitorReg

| Attribute name | Data type | P | Cardinality | Description | Applicability |
|---|---------------------|---|-------------|---|---------------|
| consumerId | NfInstanceId | C | 0..1 | Indicates the NF instance ID of the consumer. (NOTE) | |
| consumerSetId | NfSetId | C | 0..1 | Indicates the NF set ID of the consumer. (NOTE) | |
| modelId | UInteger | M | 1 | The ML model ID. | |
| modelAccuInd | boolean | O | 0..1 | Indicates the ML Model accuracy transfer indication. Set to "true": The monitoring of the accuracy of the ML model shall be transferred. Set to "false": The monitoring of the accuracy of the ML model shall not be transferred. Default value is "false" if omitted. | |
| mLEvent | NwdafEvent | O | 0..1 | Identifies the analytics for which this ML model is used. | |
| mLEventFilter | EventFilter | O | 0..1 | Identifies the analytics filter for the subscribed event. | |
| suppFeat | SupportedFeatures | C | 0..1 | List of Supported features used as described in clause 5.6.8. It shall be present in the POST request if at least one feature defined in clause 5.6.8 is supported, and it shall be present in the POST response if the NF service consumer included the "suppFeat" attribute in the POST request. | |
| tgtUe | TargetUeInformation | O | 0..1 | Identifies target UE information. | |
| NOTE: One of "consumerId" and "consumerSetId" attributes shall be provided. | | | | | |

5.6.6.2.3 Type MLModelMonitorSub

Table 5.6.6.2.3-1: Definition of type MLModelMonitorSub

| Attribute name | Data type | P | Cardinality | Description | Applicability |
|-----------------|----------------------|---|-------------|---|---------------|
| modelIds | array(Uinteger) | M | 1..N | The ML model IDs. | |
| notificationUri | Uri | M | 1 | Notification target address. | |
| notifCorrId | string | M | 1 | Notification correlation identifier. | |
| modelMetric | MLModelMetric | O | 0..1 | The ML model metrics to calculate the accuracy information. | |
| accuThreshold | Uinteger | O | 0..1 | Accuracy reporting threshold. Indicates the threshold upon the crossing of which (in either ascending or descending direction) the accuracy information needs to be reported. | |
| eventReportReq | ReportingInformation | O | 0..1 | Represents the reporting requirements of the event subscription. If omitted, the default values within the ReportingInformation data type apply. | |
| immReport | MLModelMonitorNotify | O | 0..1 | Immediately reported ML model Monitoring notifications. It may only be provided in the response of a subscription creation/update and only if the immediate reporting flag was set to "true" in the corresponding request. | |
| suppFeat | SupportedFeatures | C | 0..1 | List of Supported features used as described in clause 5.6.8. It shall be present in the POST request if at least one feature defined in clause 5.6.8 is supported, and it shall be present in the POST response if the NF service consumer included the "suppFeat" attribute in the POST request. | |

5.6.6.2.4 Type MLModelMonitorNotify

Table 5.6.6.2.4-1: Definition of type MLModelMonitorNotify

| Attribute name | Data type | P | Cardinality | Description | Applicability |
|---|----------------------------|---|-------------|--|---------------|
| notifCorrId | string | M | 1 | Notification correlation identifier. | |
| modelAccuInfos | array(MLModelAccuracyInfo) | C | 1..N | The monitored accuracy information of the ML model. (NOTE) | |
| anaFeedbacks | array(AnalyticsFeedback) | C | 1..N | The analytics feedback information. (NOTE) | |
| accuMeetInd | boolean | O | 0..1 | Set to "true" to indicate that the analytics accuracy of the ML model meet the requirement of accuracy for the ML model. Otherwise, default value is "false" if omitted. | |
| mLEvent | NwdafEvent | O | 0..1 | Identifies the analytics for which this ML model is used. | |
| mLEventFilter | EventFilter | O | 0..1 | Identifies the analytics filter for the subscribed event. | |
| tgtUe | TargetUeInformation | O | 0..1 | Identifies target UE information. | |
| NOTE: At least one of "modelAccuInfos" and "anaFeedbacks" attributes shall be provided. | | | | | |

5.6.6.2.5 Type MLModelAccuracyInfo

Table 5.6.6.2.5-1: Definition of type MLModelAccuracyInfo

| Attribute name | Data type | P | Cardinality | Description | Applicability |
|--|---------------|---|-------------|--|---------------|
| modelId | UInteger | M | 1 | The ML model ID. | |
| mlModelAcc | UInteger | O | 0..1 | Indicates the accuracy of the ML model in percent. Minimum = 0. Maximum = 100. | |
| deviation | Float | O | 0..1 | Indicates the deviation value of the predictions generated using the ML model from the ground truth data. | |
| inferenceNum | UInteger | O | 0..1 | The number of inferences that were performed during the time interval between Nnwdaf_MLModelMonitor_R register request and the Notify request or between the time of last Notification message and the time of the current Notification message. | |
| adrfId | NfInstanceId | O | 0..1 | Identifier of the ADRF. (NOTE) | |
| adrfSetId | NfSetId | O | 0..1 | Identifier of the ADRF Set. (NOTE) | |
| dataSetTag | DataSetTag | O | 0..1 | Data set tag of the data stored in ADRF which can be used by MTLF. This attribute may be present if the "adrfId" or "adrfSetId" attribute is present. | |
| modelMetric | MLModelMetric | O | 0..1 | The ML model metrics to calculate the accuracy information. | |
| monitorInterval | TimeWindow | O | 0..1 | Represents the time interval during which the ML model accuracy monitoring was conducted. | |
| NOTE: "adrfId" and "adrfSetId" are mutually exclusive. | | | | | |

5.6.6.2.6 Type AnalyticsFeedback

Table 5.6.6.2.6-1: Definition of type AnalyticsFeedback

| Attribute name | Data type | P | Cardinality | Description | Applicability |
|---------------------|-------------------|---|-------------|---|---------------|
| events | array(NwdafEvent) | M | 1..N | Each element indicates the Analytics ID that was used to take this action. | |
| modelIds | array(UInteger) | M | 1..N | Each element indicate the ML Model identifier that was used to take this action. | |
| groundDataImpactInd | boolean | O | 0..1 | Indication whether the action will affect on ground truth data. Set to "true" to indicate that the action will affect on ground truth data. Otherwise, default value is "false" if omitted. | |
| timeStamp | DateTime | O | 0..1 | Time stamp when the action was taken. | |

5.6.7 Error handling

5.6.7.1 General

HTTP error handling shall be supported as specified in clause 5.2.4 of TS 29.500 [6].

For the Nnwdaf_MLModelMonitor API, HTTP error responses shall be supported as specified in clause 4.8 of TS 29.501 [7]. Protocol errors and application errors specified in table 5.2.7.2-1 of TS 29.500 [6] shall be supported for an HTTP method if the corresponding HTTP status codes are specified as mandatory for that HTTP method in table 5.2.7.1-1 of TS 29.500 [6]. In addition, the requirements in the following clauses shall apply.

5.6.7.2 Protocol Errors

In this Release of the specification, there are no additional protocol errors applicable for the Nnwdaf_MLModelMonitor API.

5.6.7.3 Application Errors

The application errors defined for the Nnwdaf_MLModelMonitor API are listed in table 5.6.7.3-1.

Table 5.6.7.3-1: Application errors

| Application Error | HTTP status code | Description |
|-------------------|------------------|-------------|
| | | |

5.6.8 Feature negotiation

The optional features in table 5.6.8-1 are defined for the Nnwdaf_MLModelMonitor API. They shall be negotiated using the extensibility mechanism defined in clause 6.6 of 3GPP TS 29.500 [6].

Table 5.6.8-1: Supported Features

| Feature number | Feature Name | Description |
|----------------|--------------|-------------|
| | | |

5.6.9 Security

As indicated in TS 33.501 [13] and TS 29.500 [6], the access to the Nnwdaf_MLModelMonitor API may be authorized by means of the OAuth2 protocol (see IETF RFC 6749 [14]), based on local configuration, using the "Client Credentials" authorization grant, where the NRF (see TS 29.510 [12]) plays the role of the authorization server.

If OAuth2 is used, an NF service consumer, prior to consuming services offered by the Nnwdaf_MLModelMonitor API, shall obtain a "token" from the authorization server, by invoking the Access Token Request service, as described in TS 29.510 [12], clause 5.4.2.2.

NOTE: When multiple NRFs are deployed in a network, the NRF used as authorization server is the same NRF that the NF service consumer used for discovering the Nnwdaf_MLModelMonitor service.

The Nnwdaf_MLModelMonitor API defines a single scope "nnwdaf-mlmodelmonitor" for the entire service, and it does not define any additional scopes at resource or operation level.

5.7 Nnwdaf_RoamingData Service API

5.7.1 Introduction

The Nnwdaf_RoamingData service shall use the Nnwdaf_RoamingData API.

The API URI of the Nnwdaf_RoamingData API shall be:

{apiRoot}/<apiName>/<apiVersion>

The request URIs used in each HTTP requests from the NF service consumer towards the RE-NWDAF shall have the Resource URI structure defined in clause 4.4.1 of 3GPP TS 29.501 [7], i.e.:

{apiRoot}/<apiName>/<apiVersion>/<apiSpecificResourceUriPart>

with the following components:

- The {apiRoot} shall be set as described in 3GPP TS 29.501 [7].
- The<apiName> shall be "nnwdaf-roamingdata".
- The <apiVersion> shall be "v1".
- The <apiSpecificResourceUriPart> shall be set as described in clause 5.7.3.

5.7.2 Usage of HTTP

5.7.2.1 General

HTTP/2, IETF RFC 9113 [9], shall be used as specified in clause 5 of 3GPP TS 29.500 [6].

HTTP/2 shall be transported as specified in clause 5.3 of 3GPP TS 29.500 [6].

The OpenAPI [11] specification of HTTP messages and content bodies for the Nnwdaf_RoamingData is contained in Annex A.

5.7.2.2 HTTP standard headers

5.7.2.2.1 General

See clause 5.2.2 of 3GPP TS 29.500 [6] for the usage of HTTP standard headers.

5.7.2.2.2 Content type

JSON, IETF RFC 8259 [10], shall be used as content type of the HTTP bodies specified in the present specification as specified in clause 5.4 of 3GPP TS 29.500 [6]. The use of the JSON format shall be signalled by the content type "application/json".

"Problem Details" JSON object shall be used to indicate additional details of the error in a HTTP response body and shall be signalled by the content type "application/problem+json", as defined in IETF RFC 9457 [15].

5.7.2.3 HTTP custom headers

The Nnwdaf_RoamingData service API shall support mandatory HTTP custom header fields specified in clause 5.2.3.2 of 3GPP TS 29.500 [6] and may support HTTP custom header fields specified in clause 5.2.3.3 of 3GPP TS 29.500 [6].

In this release of the specification, no specific custom headers are defined for the Nnwdaf_RoamingData service API.

5.7.3 Resources

5.7.3.1 Resource Structure

This clause describes the structure for the Resource URIs, the resources and methods used for the service.

Figure 5.7.3.1-1 depicts the resource URIs structure for the Nnwdaf_RoamingData API.

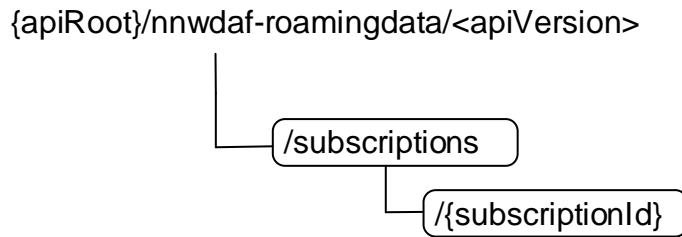

Figure 5.7.3.1-1: Resource URI structure of the NnwdaF_RoamingData API

Table 5.7.3.1-1 provides an overview of the resources and applicable HTTP methods.

Table 5.7.3.1-1: Resources and methods overview

| Resource name | Resource URI | HTTP method or custom operation | Description |
|--|---------------------------------|---------------------------------|---|
| NWDAF Roaming Data Subscriptions | /subscriptions | POST | Create a new Individual NWDAF Roaming Data Subscription resource on the NWDAF. |
| Individual NWDAF Roaming Data Subscription | /subscriptions/{subscriptionId} | PUT | Modifies an existing Roaming Data Subscription resource on the NWDAF. |
| | | DELETE | Delete an Individual NWDAF Roaming Data Subscription identified by {subscriptionId} on the NWDAF. |

5.7.3.2 Resource: NWDAF Roaming Data Subscriptions

5.7.3.2.1 Description

The NWDAF Roaming Data Subscriptions resource represents all subscriptions to the NnwdaF_RoamingData Service at a given RE-NWDAF. The resource allows an NF service consumer to create a new Individual NWDAF Roaming Data Subscription resource.

5.7.3.2.2 Resource Definition

Resource URI: **{apiRoot}/nnwdaF-roamingdata/<apiVersion>/subscriptions**

The <apiVersion> shall be set as described in clause 5.7.1.

This resource shall support the resource URI variables defined in table 5.7.3.2.2-1.

Table 5.7.3.2.2-1: Resource URI variables for this resource

| Name | Data type | Definition |
|---------|-----------|------------------|
| apiRoot | string | See clause 5.7.1 |

5.7.3.2.3 Resource Standard Methods

5.7.3.2.3.1 POST

This method shall support the URI query parameters specified in table 5.7.3.2.3.1-1.

Table 5.7.3.2.3.1-1: URI query parameters supported by the POST method on this resource

| Name | Data type | P | Cardinality | Description |
|------|-----------|---|-------------|-------------|
| n/a | | | | |

This method shall support the request data structures specified in table 5.7.3.2.3.1-2 and the response data structures and response codes specified in table 5.7.3.2.3.1-3.

Table 5.7.3.2.3.1-2: Data structures supported by the POST Request Body on this resource

| Data type | P | Cardinality | Description |
|----------------|---|-------------|---|
| RoamingDataSub | M | 1 | Create a new Individual NWDAF Roaming Data Subscription resource. |

Table 5.7.3.2.3.1-3: Data structures supported by the POST Response Body on this resource

| Data type | P | Cardinality | Response codes | Description |
|---|---|-------------|----------------|--|
| RoamingDataSub | M | 1 | 201 Created | The creation of an Individual NWDAF Roaming Data Subscription resource is confirmed and a representation of that resource is returned. |
| ProblemDetails | O | 0..1 | 403 Forbidden | (NOTE 2) |
| NOTE 1: The mandatory HTTP error status codes for the POST method listed in table 5.2.7.1-1 of 3GPP TS 29.500 [6] also apply. | | | | |
| NOTE 2: Failure cases are described in clause 5.7.7. | | | | |

Table 5.7.3.2.3.1-4: Headers supported by the 201 Response Code on this resource

| Name | Data type | P | Cardinality | Description |
|----------|-----------|---|-------------|--|
| Location | string | M | 1 | Contains the URI of the newly created resource, according to the structure: {apiRoot}/nnwdaf-roamingdata/<apiVersion>/subscriptions/{subscriptionId} |

5.7.3.2.4 Resource Custom Operations

None in this release of the specification.

5.7.3.3 Resource: Individual NWDAF Roaming Data Subscription

5.7.3.3.1 Description

The Individual NWDAF Roaming Data Subscription resource represents a single subscription to the Nnwdaf_RoamingData Service at a given RE-NWDAF.

5.7.3.3.2 Resource definition

Resource URI: {apiRoot}/nnwdaf-roamingdata/<apiVersion>/subscriptions/{subscriptionId}

The <apiVersion> shall be set as described in clause 5.7.1.

This resource shall support the resource URI variables defined in table 5.7.3.3.2-1.

Table 5.7.3.3.2-1: Resource URI variables for this resource

| Name | Data type | Definition |
|----------------|-----------|--|
| apiRoot | string | See clause 5.7.1. |
| subscriptionId | string | Identifies a subscription to the Nnwdaf_RoamingData Service. |

5.7.3.3.3 Resource Standard Methods

5.7.3.3.3.1 PUT

This method shall support the URI query parameters specified in table 5.7.3.3.3.1-1.

Table 5.7.3.3.3.1-1: URI query parameters supported by the PUT method on this resource

| Name | Data type | P | Cardinality | Description |
|------|-----------|---|-------------|-------------|
| n/a | | | | |

This method shall support the request data structures specified in table 5.7.3.3.3.1-2 and the response data structures and response codes specified in table 5.7.3.3.3.1-3.

Table 5.7.3.3.3.1-2: Data structures supported by the PUT Request Body on this resource

| Data type | P | Cardinality | Description |
|----------------|---|-------------|---|
| RoamingDataSub | M | 1 | Parameters to replace a subscription to NWDAF Roaming Data Subscription resource. |

Table 5.7.3.3.3.1-3: Data structures supported by the PUT Response Body on this resource

| Data type | P | Cardinality | Response codes | Description |
|--|---|-------------|------------------------|--|
| RoamingDataSub | M | 1 | 200 OK | The Individual NWDAF Roaming Data Subscription resource was modified successfully and a representation of that resource is returned. |
| n/a | | | 204 No Content | The Individual NWDAF Roaming Data Subscription resource was modified successfully. |
| RedirectResponse | O | 0..1 | 307 Temporary Redirect | Temporary redirection, during Individual NWDAF Roaming Data Subscription modification. (NOTE 3) |
| RedirectResponse | O | 0..1 | 308 Permanent Redirect | Permanent redirection, during Individual NWDAF Roaming Data subscription modification. (NOTE 3) |
| ProblemDetails | O | 0..1 | 403 Forbidden | (NOTE 2) |
| NOTE 1: The mandatory HTTP error status codes for the PUT method listed in table 5.2.7.1-1 of 3GPP TS 29.500 [6] also apply. | | | | |
| NOTE 2: Failure cases are described in clause 5.7.7. | | | | |
| NOTE 3: The RedirectResponse data structure may be provided by an SEPP or SCP (cf. clause 6.10.9.1 of 3GPP TS 29.500 [6]). | | | | |

Table 5.7.3.3.3.1-4: Headers supported by the 307 Response Code on this resource

| Name | Data type | P | Cardinality | Description |
|-----------------------|-----------|---|-------------|--|
| Location | string | M | 1 | Contains an alternative URI of the resource located in an alternative RE-NWDAF (service) instance towards which the request is redirected. For the case where the request is redirected to the same target via a different SEPP or SCP, refer to clause 6.10.9.1 of 3GPP TS 29.500 [6]. |
| 3gpp-Sbi-Target-Nf-Id | string | O | 0..1 | Identifier of the target NWDAF (service) instance towards which the request is redirected. |

Table 5.7.3.3.3.1-5: Headers supported by the 308 Response Code on this resource

| Name | Data type | P | Cardinality | Description |
|-----------------------|-----------|---|-------------|--|
| Location | string | M | 1 | Contains an alternative URI of the resource located in an alternative RE-NWDAF (service) instance towards which the request is redirected. For the case where the request is redirected to the same target via a different SEPP or SCP, refer to clause 6.10.9.1 of 3GPP TS 29.500 [6]. |
| 3gpp-Sbi-Target-Nf-Id | string | O | 0..1 | Identifier of the target RE-NWDAF (service) instance towards which the request is redirected. |

5.7.3.3.3.2 DELETE

This method shall support the URI query parameters specified in table 5.7.3.3.3.2-1.

Table 5.7.3.3.3.2-1: URI query parameters supported by the DELETE method on this resource

| Name | Data type | P | Cardinality | Description |
|------|-----------|---|-------------|-------------|
| n/a | | | | |

This method shall support the request data structures specified in table 5.7.3.3.3.2-2 and the response data structures and response codes specified in table 5.7.3.3.3.2-3.

Table 5.7.3.3.3.2-2: Data structures supported by the DELETE Request Body on this resource

| Data type | P | Cardinality | Description |
|-----------|---|-------------|-------------|
| n/a | | | |

Table 5.7.3.3.3.2-3: Data structures supported by the DELETE Response Body on this resource

| Data type | P | Cardinality | Response codes | Description |
|---|---|-------------|------------------------|---|
| n/a | | | 204 No Content | Successful case: The Individual NWDAF Roaming Data Subscription resource matching the subscriptionId was deleted. |
| RedirectResponse | O | 0..1 | 307 Temporary Redirect | Temporary redirection, during Individual Roaming Data Subscription deletion. (NOTE 2) |
| RedirectResponse | O | 0..1 | 308 Permanent Redirect | Permanent redirection, during Individual Roaming Data Subscription deletion. (NOTE 2) |
| NOTE 1: The mandatory HTTP error status codes for the DELETE method listed in table 5.2.7.1-1 of 3GPP TS 29.500 [6] also apply. | | | | |
| NOTE 2: The RedirectResponse data structure may be provided by an SEPP or SCP (cf. clause 6.10.9.1 of 3GPP TS 29.500 [6]). | | | | |

Table 5.7.3.3.2-4: Headers supported by the 307 Response Code on this resource

| Name | Data type | P | Cardinality | Description |
|-----------------------|-----------|---|-------------|--|
| Location | string | M | 1 | Contains an alternative URI of the resource located in an alternative RE-NWDAF (service) instance towards which the request is redirected. For the case where the request is redirected to the same target via a different SEPP or SCP, refer to clause 6.10.9.1 of 3GPP TS 29.500 [6]. |
| 3gpp-Sbi-Target-Nf-Id | string | O | 0..1 | Identifier of the target RE-NWDAF (service) instance towards which the request is redirected. |

Table 5.7.3.3.2-5: Headers supported by the 308 Response Code on this resource

| Name | Data type | P | Cardinality | Description |
|-----------------------|-----------|---|-------------|---|
| Location | string | M | 1 | Contains an alternative URI of the resource located in an alternative RE-NWDAF (service) instance towards which the request is redirected For the case where the request is redirected to the same target via a different SEPP or SCP, refer to clause 6.10.9.1 of 3GPP TS 29.500 [6]. |
| 3gpp-Sbi-Target-Nf-Id | string | O | 0..1 | Identifier of the target RE-NWDAF (service) instance towards which the request is redirected. |

5.7.3.3.4 Resource Custom Operations

None in this release of the specification.

5.7.4 Custom Operations without associated resources

None in this release of the specification.

5.7.5 Notifications

5.7.5.1 General

Notifications shall comply with clause 6.2 of 3GPP TS 29.500 [6] and clause 4.6.2.3 of 3GPP TS 29.501 [7].

Table 5.7.5.1-1: Notifications overview

| Notification | Callback URI | HTTP method or custom operation | Description (service operation) |
|--------------------|-------------------|---------------------------------|---|
| Event Notification | {notificationUri} | POST | Report data information related to roaming UE(s). |

5.7.5.2 Event Notification

5.7.5.2.1 Description

The Event Notification is used by the RE-NWDAF to report data information to the NF service consumer that has subscribed to such Notifications.

5.7.5.2.2 Operation Definition

Callback URI: {notificationUri}

The operation shall support the callback URI variables defined in Table 5.7.5.2.2-1, the request data structures specified in table 5.7.5.2.2-2 and the response data structure and response codes specified in Table 5.7.5.2.2-3.

Table 5.7.5.2.2-1: Callback URI variables

| Name | Data type | Definition |
|-----------------|-----------|--|
| notificationUri | Uri | The Notification Uri is assigned within the Individual NWDAF Roaming Data Subscription Resource and described within the RoamingDataSub data type (see table 5.7.6.2.3-1). |

Table 5.7.5.2.2-2: Data structures supported by the POST Request Body on this resource

| Data type | P | Cardinality | Description |
|--------------------------|---|-------------|---|
| NnwdaDataManagementNotif | M | 1 | Provides data related to roaming UE(s). |

Table 5.7.5.2.2-3: Data structures supported by the POST Response Body on this resource

| Data type | P | Cardinality | Response codes | Description |
|---|---|-------------|------------------------|---|
| n/a | | | 204 No Content | The receipt of the Notification is acknowledged. |
| RedirectResponse | O | 0..1 | 307 Temporary Redirect | Temporary redirection, during the event notification. (NOTE 2) |
| RedirectResponse | O | 0..1 | 308 Permanent Redirect | Permanent redirection, during the event notification. (NOTE 2) |
| NOTE 1: The mandatory HTTP error status codes for the POST method listed in table 5.2.7.1-1 of 3GPP TS 29.500 [6] also apply. | | | | |
| NOTE 2: The RedirectResponse data structure may be provided by an SEPP or SCP (cf. clause 6.10.9.1 of 3GPP TS 29.500 [6]). | | | | |

Table 5.7.5.2.2-4: Headers supported by the 307 Response Code on this resource

| Name | Data type | P | Cardinality | Description |
|-----------------------|-----------|---|-------------|--|
| Location | string | M | 1 | Contains an alternative URI representing the end point of an alternative NF consumer (service) instance towards which the notification is redirected. For the case where the notification is redirected to the same target via a different SEPP or SCP, refer to clause 6.10.9.1 of 3GPP TS 29.500 [6]. |
| 3gpp-Sbi-Target-Nf-Id | string | O | 0..1 | Identifier of the target NF (service) instance towards which the notification request is redirected. |

Table 5.7.5.2.2-5: Headers supported by the 308 Response Code on this resource

| Name | Data type | P | Cardinality | Description |
|-----------------------|-----------|---|-------------|--|
| Location | string | M | 1 | Contains an alternative URI representing the end point of an alternative NF consumer (service) instance towards which the notification is redirected. For the case where the notification is redirected to the same target via a different SEPP or SCP, refer to clause 6.10.9.1 of 3GPP TS 29.500 [6]. |
| 3gpp-Sbi-Target-Nf-Id | string | O | 0..1 | Identifier of the target NF (service) instance towards which the notification request is redirected. |

5.7.6 Data Model

5.7.6.1 General

This clause specifies the application data model supported by the API.

Table 5.7.6.1-1 specifies the data types defined for the Nnwdaf_RoamingData service based interface protocol.

Table 5.7.6.1-1: Nnwdaf_RoamingData specific Data Types

| Data type | Clause defined | Description | Applicability |
|----------------|----------------|---|---------------|
| RoamingDataSub | 5.7.6.2.2 | Represents roaming data subscription information. | |

Table 5.7.6.1-2 specifies data types re-used by the Nnwdaf_RoamingData service based interface protocol from other specifications, including a reference to their respective specifications and when needed, a short description of their use within the Nnwdaf_RoamingData service based interface.

Table 5.7.6.1-2: Nnwdaf_RoamingData re-used Data Types

| Data type | Reference | Comments | Applicability |
|---------------------------|---------------------|--|---------------|
| DataSubscription | 3GPP TS 29.575 [27] | Subscription information for data retrieval from data source. | |
| DateTime | 3GPP TS 29.571 [8] | Identifies the time. | |
| FormattingInstruction | 3GPP TS 29.574 [26] | DCCF formatting Instructions. | |
| NfInstanceId | 3GPP TS 29.571 [8] | Identifies an NF instance | |
| NfSetId | 3GPP TS 29.571 [8] | Identifies an NF Set instance. | |
| NnwdafDataManagementNotif | 5.3.6.2.3 | The data notification. | |
| NwdafEvent | 5.1.6.3.4 | Indicates the NWDAF events. | |
| NnwdafEventsSubscription | 5.1.6.2.2 | Represents an NWDAF analytics subscription information. | |
| PlmnId | 3GPP TS 29.571 [8] | Identifies a PLMN Identifier. | |
| ProcessingInstruction | 3GPP TS 29.574 [26] | DCCF processing Instructions. | |
| SupportedFeatures | 3GPP TS 29.571 [8] | Used to negotiate the applicability of the optional features defined in table 5.7.8-1. | |
| TimeWindow | 3GPP TS 29.122 [19] | Represents a time window. | |
| UInteger | 3GPP TS 29.571 [8] | Unsigned Integer, i.e. only value 0 and integers above 0 are permissible. | |
| Uri | 3GPP TS 29.571 [8] | Indicates the URI. | |

5.7.6.2 Structured data types

5.7.6.2.1 Introduction

This clause defines the structures to be used in resource representations.

5.7.6.2.2 Type RoamingDataSub

Table 5.7.6.2.2-1: Definition of type RoamingDataSub

| Attribute name | Data type | P | Cardinality | Description | Applicability |
|-----------------|------------------------------|---|-------------|--|---------------|
| notificationUri | Uri | M | 1 | Notification target address. | |
| notifCorrId | string | M | 1 | Notification correlation identifier. | |
| plmnlId | PlmnlId | M | 1 | PLMN ID of the consumer. | |
| dataSub | DataSubscription | C | 0..1 | Subscribed data events. (NOTE 1) | |
| anaSub | NnwdafEventsSubscription | C | 0..1 | Analytics subscription information to be used by the NWDAF to determine the data that can be used to generate these analytics, specified by the "anaSub" attribute. (NOTE 1) | |
| formatInstruct | FormattingInstruction | O | 0..1 | Formatting instructions to be used for sending event notifications. If provided, they take precedence over any potentially conflicting event reporting requirements provided within the "dataSub" attribute. | |
| procInstructs | array(ProcessingInstruction) | O | 1..N | Processing instructions to be used for sending event notifications. | |
| timePeriod | TimeWindow | O | 0..1 | Represents a start time and a stop time during which the data was collected or is requested to be collected. If provided, the time period related attributes contained in "dataSub" attribute shall be ignored. (NOTE 2) | |
| targetNfId | NfInstanceId | O | 0..1 | The NF instance identifier from which the NWDAF may collect the requested data. (NOTE 3) | |
| targetNfSetId | NfSetId | O | 0..1 | NF set identifier from which the NWDAF may collect the requested data. (NOTE 3) | |
| immReport | NnwdafDataManagementNotif | O | 0..1 | Immediately reported roaming data notifications. It may only be provided in the HTTP POST response of a subscription creation/update and only if the immediate reporting flag was set to "true" in the HTTP POST request. | |
| suppFeat | SupportedFeatures | C | 0..1 | List of Supported features used as described in clause 5.7.8. It shall be present in the POST request if at least one feature defined in clause 5.7.8 is supported, and it shall be present in the POST response if the NF service consumer included the "suppFeat" attribute in the POST request. | |

NOTE 1: One of these attributes shall be provided.
 NOTE 2: It includes the time period either in the past or in the future (i.e., start time as past time and stop time as future time is not allowed).
 NOTE 3: The "targetNfId" and "targetNfSetId" attributes are mutually exclusive.

5.7.7 Error handling

5.7.7.1 General

HTTP error handling shall be supported as specified in clause 5.2.4 of TS 29.500 [6].

For the Nnwdaf_RoamingData API, HTTP error responses shall be supported as specified in clause 4.8 of TS 29.501 [7]. Protocol errors and application errors specified in table 5.2.7.2-1 of TS 29.500 [6] shall be supported for an HTTP method if the corresponding HTTP status codes are specified as mandatory for that HTTP method in table 5.2.7.1-1 of TS 29.500 [6]. In addition, the requirements in the following clauses shall apply.

5.7.7.2 Protocol Errors

In this Release of the specification, there are no additional protocol errors applicable for the Nnwdaf_RoamingData API.

5.7.7.3 Application Errors

The application errors defined for the Nnwdaf_RoamingData API are listed in table 5.7.7.3-1.

Table 5.7.7.3-1: Application errors

| Application Error | HTTP status code | Description | Applicability |
|---------------------------|------------------|---|---------------|
| MISSING_ROAMING_AGREEMENT | 403 Forbidden | Missing the corresponding roaming agreement to satisfy the request. | |

5.7.8 Feature negotiation

The optional features in table 5.7.8-1 are defined for the Nnwdaf_RoamingData API. They shall be negotiated using the extensibility mechanism defined in clause 6.6 of 3GPP TS 29.500 [6].

Table 5.7.8-1: Supported Features

| Feature number | Feature Name | Description |
|----------------|--------------|-------------|
| | | |

5.7.9 Security

As indicated in TS 33.501 [13] and TS 29.500 [6], the access to the Nnwdaf_RoamingData API may be authorized by means of the OAuth2 protocol (see IETF RFC 6749 [14]), based on local configuration, using the "Client Credentials" authorization grant, where the NRF (see TS 29.510 [12]) plays the role of the authorization server.

If OAuth2 is used, an NF service consumer, prior to consuming services offered by the Nnwdaf_RoamingData API, shall obtain a "token" from the authorization server, by invoking the Access Token Request service, as described in TS 29.510 [12], clause 5.4.2.2.

NOTE: When multiple NRFs are deployed in a network, the NRF used as authorization server is the same NRF that the NF service consumer used for discovering the Nnwdaf_RoamingData service.

The Nnwdaf_RoamingData API defines a single scope "nnwdaf-roamingdata" for the entire service, and it does not define any additional scopes at resource or operation level.

5.8 Nnwdaf_RoamingAnalytics Service API

5.8.1 Introduction

The Nnwdaf_RoamingAnalytics service shall use the Nnwdaf_RoamingAnalytics API.

The API URI of the Nnwdaf_RoamingAnalytics API shall be:

`{apiRoot}/<apiName>/<apiVersion>`

The request URIs used in each HTTP requests from the NF service consumer towards the RE-NWDAF shall have the Resource URI structure defined in clause 4.4.1 of 3GPP TS 29.501 [7], i.e.:

`{apiRoot}/<apiName>/<apiVersion>/<apiSpecificResourceUriPart>`

with the following components:

- The {apiRoot} shall be set as described in 3GPP TS 29.501 [7].
- The <apiName> shall be "nnwdaf-roaminganalytics".
- The <apiVersion> shall be "v1".
- The <apiSpecificResourceUriPart> shall be set as described in clause 5.8.3.

5.8.2 Usage of HTTP

5.8.2.1 General

HTTP/2, IETF RFC 9113 [9], shall be used as specified in clause 5 of 3GPP TS 29.500 [6].

HTTP/2 shall be transported as specified in clause 5.3 of 3GPP TS 29.500 [6].

The OpenAPI [11] specification of HTTP messages and content bodies for the Nnwdaf_RoamingAnalytics API is contained in Annex A.9.

5.8.2.2 HTTP standard headers

5.8.2.2.1 General

See clause 5.2.2 of 3GPP TS 29.500 [6] for the usage of HTTP standard headers.

5.8.2.2.2 Content type

JSON, IETF RFC 8259 [10], shall be used as content type of the HTTP bodies specified in the present specification as specified in clause 5.4 of 3GPP TS 29.500 [6]. The use of the JSON format shall be signalled by the content type "application/json".

"Problem Details" JSON object shall be used to indicate additional details of the error in an HTTP response body and shall be signalled by the content type "application/problem+json", as defined in IETF RFC 9457 [15].

5.8.2.3 HTTP custom headers

The Nnwdaf_RoamingAnalytics service API shall support mandatory HTTP custom header fields specified in clause 5.2.3.2 of 3GPP TS 29.500 [6] and may support HTTP custom header fields specified in clause 5.2.3.3 of 3GPP TS 29.500 [6].

In this release of the specification, no specific custom headers are defined for the Nnwdaf_RoamingAnalytics service API.

5.8.3 Resources

5.8.3.1 Resource Structure

This clause describes the structure for the Resource URIs, the resources and methods used for the service.

Figure 5.8.3.1-1 depicts the resource URIs structure for the Nnwdaf_RoamingAnalytics API.

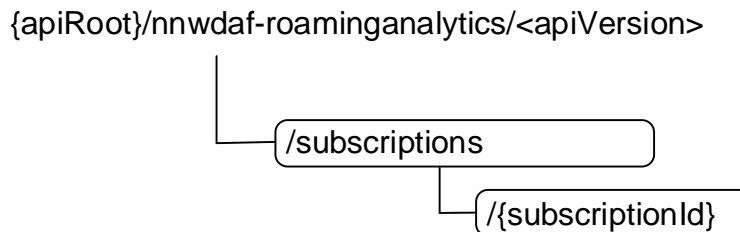

Figure 5.8.3.1-1: Resource URI structure of the Nnwdaf_RoamingAnalytics API

Table 5.8.3.1-1 provides an overview of the resources and applicable HTTP methods.

Table 5.8.3.1-1: Resources and methods overview

| Resource name | Resource URI | HTTP method or custom operation | Description |
|---|---------------------------------|---------------------------------|---|
| NWDAF Roaming Analytics Subscriptions | /subscriptions | POST | Create a new Individual NWDAF Roaming Analytics Subscription resource on the NWDAF with roaming exchange capability. |
| Individual NWDAF Roaming Analytics Subscription | /subscriptions/{subscriptionId} | PUT | Modifies an existing Individual NWDAF Roaming Analytics Subscription resource on the NWDAF with roaming exchange capability. |
| | | DELETE | Delete the Individual NWDAF Roaming Analytics Subscription resource identified by {subscriptionId} on the NWDAF with roaming exchange capability. |

5.8.3.2 Resource: NWDAF Roaming Analytics Subscriptions

5.8.3.2.1 Description

The NWDAF Roaming Analytics Subscriptions resource represents all subscriptions to the Nnwdaf_RoamingAnalytics Service at a given RE-NWDAF. The resource allows an NF service consumer to create a new Individual NWDAF Roaming Analytics Subscription resource.

5.8.3.2.2 Resource Definition

Resource URI: **{apiRoot}/nnwdaf-roaminganalytics/<apiVersion>/subscriptions**

The <apiVersion> shall be set as described in clause 5.8.1.

This resource shall support the resource URI variables defined in table 5.8.3.2.2-1.

Table 5.8.3.2.2-1: Resource URI variables for this resource

| Name | Data type | Definition |
|---------|-----------|------------------|
| apiRoot | string | See clause 5.8.1 |

5.8.3.2.3 Resource Standard Methods

5.8.3.2.3.1 POST

This method shall support the URI query parameters specified in table 5.8.3.2.3.1-1.

Table 5.8.3.2.3.1-1: URI query parameters supported by the POST method on this resource

| Name | Data type | P | Cardinality | Description |
|------|-----------|---|-------------|-------------|
| n/a | | | | |

This method shall support the request data structures specified in table 5.8.3.2.3.1-2 and the response data structures and response codes specified in table 5.8.3.2.3.1-3.

Table 5.8.3.2.3.1-2: Data structures supported by the POST Request Body on this resource

| Data type | P | Cardinality | Description |
|------------------------------|---|-------------|--|
| RoamingAnalyticsSubscription | M | 1 | Create a new Individual NWDAF Roaming Analytics subscription resource. |

Table 5.8.3.2.3.1-3: Data structures supported by the POST Response Body on this resource

| Data type | P | Cardinality | Response codes | Description |
|------------------------------|---|-------------|---------------------------|---|
| RoamingAnalyticsSubscription | M | 1 | 201 Created | The creation of an Individual NWDAF Roaming Analytics subscription resource is confirmed and a representation of that resource is returned. |
| ProblemDetails | O | 0..1 | 400 Bad Request | (NOTE 2) |
| ProblemDetails | O | 0..1 | 403 Forbidden | (NOTE 2) |
| ProblemDetails | O | 0..1 | 500 Internal Server Error | (NOTE 2) |

NOTE 1: The mandatory HTTP error status codes for the POST method listed in table 5.2.7.1-1 of 3GPP TS 29.500 [6] also apply.

NOTE 2: Failure cases are described in clause 5.8.7.

Table 5.8.3.2.3.1-4: Headers supported by the 201 Response Code on this resource

| Name | Data type | P | Cardinality | Description |
|----------|-----------|---|-------------|---|
| Location | string | M | 1 | Contains the URI of the newly created resource, according to the structure: {apiRoot}/nnwdaf-roaminganalytics/<apiVersion>/subscriptions/{subscriptionId} |

5.8.3.2.4 Resource Custom Operations

None in this release of the specification.

5.8.3.3 Resource: Individual NWDAF Roaming Analytics Subscription

5.8.3.3.1 Description

The Individual NWDAF Roaming Analytics Subscription resource represents a single subscription to the NnwdaF_RoamingAnalytics Service at a given RE-NWDAF.

5.8.3.3.2 Resource definition

Resource URI: **{apiRoot}/nnwdaF-roaminganalytics/<apiVersion>/subscriptions/{subscriptionId}**

The <apiVersion> shall be set as described in clause 5.8.1.

This resource shall support the resource URI variables defined in table 5.8.3.3.2-1.

Table 5.8.3.3.2-1: Resource URI variables for this resource

| Name | Data type | Definition |
|----------------|-----------|---|
| apiRoot | string | See clause 5.8.1. |
| subscriptionId | string | Identifies a subscription to the NnwdaF_RoamingAnalytics Service. |

5.8.3.3.3 Resource Standard Methods

5.8.3.3.3.1 PUT

This method shall support the URI query parameters specified in table 5.8.3.3.3.1-1.

Table 5.8.3.3.3.1-1: URI query parameters supported by the PUT method on this resource

| Name | Data type | P | Cardinality | Description |
|------|-----------|---|-------------|-------------|
| n/a | | | | |

This method shall support the request data structures specified in table 5.8.3.3.3.1-2 and the response data structures and response codes specified in table 5.8.3.3.3.1-3.

Table 5.8.3.3.3.1-2: Data structures supported by the PUT Request Body on this resource

| Data type | P | Cardinality | Description |
|------------------------------|---|-------------|--|
| RoamingAnalyticsSubscription | M | 1 | Parameters to replace a subscription to NWDAF Roaming Analytics. |

Table 5.8.3.3.1-3: Data structures supported by the PUT Response Body on this resource

| Data type | P | Cardinality | Response codes | Description |
|--|---|-------------|---------------------------|---|
| RoamingAnalyticsSubscription | M | 1 | 200 OK | The Individual NWDAF Roaming Analytics subscription resource was modified successfully and a representation of that resource is returned. |
| n/a | | | 204 No Content | The Individual NWDAF Roaming Analytics subscription resource was modified successfully. |
| RedirectResponse | O | 0..1 | 307 Temporary Redirect | Temporary redirection, during Individual NWDAF Roaming Analytics subscription modification. (NOTE 3) |
| RedirectResponse | O | 0..1 | 308 Permanent Redirect | Permanent redirection, during Individual NWDAF Roaming Analytics subscription modification. (NOTE 3) |
| ProblemDetails | O | 0..1 | 400 Bad Request | (NOTE 2) |
| ProblemDetails | O | 0..1 | 403 Forbidden | (NOTE 2) |
| ProblemDetails | O | 0..1 | 500 Internal Server Error | (NOTE 2) |
| NOTE 1: The mandatory HTTP error status codes for the PUT method listed in table 5.2.7.1-1 of 3GPP TS 29.500 [6] also apply. | | | | |
| NOTE 2: Failure cases are described in clause 5.8.7. | | | | |
| NOTE 3: The RedirectResponse data structure may be provided by an SCP or a SEPP (cf. clause 6.10.9.1 of 3GPP TS 29.500 [6]). | | | | |

Table 5.8.3.3.1-4: Headers supported by the 307 Response Code on this resource

| Name | Data type | P | Cardinality | Description |
|-----------------------|-----------|---|-------------|--|
| Location | string | M | 1 | Contains an alternative URI of the resource located in an alternative RE-NWDAF (service) instance towards which the request is redirected. For the case where the request is redirected to the same target via a different SCP or SEPP, refer to clause 6.10.9.1 of 3GPP TS 29.500 [6]. |
| 3gpp-Sbi-Target-Nf-Id | string | O | 0..1 | Identifier of the target RE-NWDAF (service) instance towards which the request is redirected. |

Table 5.8.3.3.1-5: Headers supported by the 308 Response Code on this resource

| Name | Data type | P | Cardinality | Description |
|-----------------------|-----------|---|-------------|--|
| Location | string | M | 1 | Contains an alternative URI of the resource located in an alternative RE-NWDAF (service) instance towards which the request is redirected. For the case where the request is redirected to the same target via a different SCP or SEPP, refer to clause 6.10.9.1 of 3GPP TS 29.500 [6]. |
| 3gpp-Sbi-Target-Nf-Id | string | O | 0..1 | Identifier of the target RE-NWDAF (service) instance towards which the request is redirected. |

5.8.3.3.2 DELETE

This method shall support the URI query parameters specified in table 5.8.3.3.2-1.

Table 5.8.3.3.3.2-1: URI query parameters supported by the DELETE method on this resource

| Name | Data type | P | Cardinality | Description |
|------|-----------|---|-------------|-------------|
| n/a | | | | |

This method shall support the request data structures specified in table 5.8.3.3.3.2-2 and the response data structures and response codes specified in table 5.8.3.3.3.2-3.

Table 5.8.3.3.3.2-2: Data structures supported by the DELETE Request Body on this resource

| Data type | P | Cardinality | Description |
|-----------|---|-------------|-------------|
| n/a | | | |

Table 5.8.3.3.3.2-3: Data structures supported by the DELETE Response Body on this resource

| Data type | P | Cardinality | Response codes | Description |
|---|---|-------------|------------------------|--|
| n/a | | | 204 No Content | Successful case: The Individual NWDAF Roaming Analytics subscription resource matching the subscriptionId was deleted. |
| RedirectResponse | O | 0..1 | 307 Temporary Redirect | Temporary redirection, during Individual Roaming Analytics subscription deletion. (NOTE 2) |
| RedirectResponse | O | 0..1 | 308 Permanent Redirect | Permanent redirection, during Individual Roaming Analytics subscription deletion. (NOTE 2) |
| NOTE 1: The mandatory HTTP error status codes for the DELETE method listed in table 5.2.7.1-1 of 3GPP TS 29.500 [6] also apply. | | | | |
| NOTE 2: The RedirectResponse data structure may be provided by an SCP or a SEPP (cf. clause 6.10.9.1 of 3GPP TS 29.500 [6]). | | | | |

Table 5.8.3.3.3.2-4: Headers supported by the 307 Response Code on this resource

| Name | Data type | P | Cardinality | Description |
|-----------------------|-----------|---|-------------|--|
| Location | string | M | 1 | Contains an alternative URI of the resource located in an alternative RE-NWDAF (service) instance towards which the request is redirected. For the case where the request is redirected to the same target via a different SCP or SEPP, refer to clause 6.10.9.1 of 3GPP TS 29.500 [6]. |
| 3gpp-Sbi-Target-Nf-Id | string | O | 0..1 | Identifier of the target RE-NWDAF (service) instance towards which the request is redirected. |

Table 5.8.3.3.3.2-5: Headers supported by the 308 Response Code on this resource

| Name | Data type | P | Cardinality | Description |
|-----------------------|-----------|---|-------------|--|
| Location | string | M | 1 | Contains an alternative URI of the resource located in an alternative RE-NWDAF (service) instance towards which the request is redirected. For the case where the request is redirected to the same target via a different SCP or SEPP, refer to clause 6.10.9.1 of 3GPP TS 29.500 [6]. |
| 3gpp-Sbi-Target-Nf-Id | string | O | 0..1 | Identifier of the target RE-NWDAF (service) instance towards which the request is redirected. |

5.8.3.3.4 Resource Custom Operations

None in this release of the specification.

5.8.4 Custom Operations without associated resources

None in this release of the specification.

5.8.5 Notifications

5.8.5.1 General

Notifications shall comply with clause 6.2 of 3GPP TS 29.500 [6] and clause 4.6.2.3 of 3GPP TS 29.501 [7].

Table 5.8.5.1-1: Notifications overview

| Notification | Callback URI | HTTP method or custom operation | Description (service operation) |
|--------------------------------|--------------|---------------------------------|--|
| Roaming Analytics Notification | {notifUri} | POST | Report analytics related to roaming UE(s). |

5.8.5.2 Roaming Analytics Notification

5.8.5.2.1 Description

The Roaming Analytics Notification is used by the RE-NWDAF to report analytics related to roaming UE(s) to the NF service consumer that has subscribed to such notifications.

5.8.5.2.2 Operation Definition

Callback URI: {**notifUri**}

The operation shall support the callback URI variables defined in Table 5.8.5.2.2-1, the request data structures specified in table 5.8.5.2.2-2 and the response data structure and response codes specified in Table 5.8.5.2.2-3.

Table 5.8.5.2.2-1: Callback URI variables

| Name | Data type | Definition |
|----------|-----------|---|
| notifUri | Uri | The Notification Uri is assigned within the Individual NWDAF Roaming Analytics Subscription Resource and described within the RoamingAnalyticsSubscription data type. |

Table 5.8.5.2.2-2: Data structures supported by the POST Request Body on this resource

| Data type | P | Cardinality | Description |
|------------------------------|---|-------------|--|
| RoamingAnalyticsNotification | M | 1 | Provides analytics related to roaming UE(s). |

Table 5.8.5.2.2-3: Data structures supported by the POST Response Body on this resource

| Data type | P | Cardinality | Response codes | Description |
|---|---|-------------|------------------------|---|
| n/a | | | 204 No Content | The receipt of the Notification is acknowledged. |
| RedirectResponse | O | 0..1 | 307 Temporary Redirect | Temporary redirection, during the event notification. (NOTE 2) |
| RedirectResponse | O | 0..1 | 308 Permanent Redirect | Permanent redirection, during the event notification. (NOTE 2) |
| NOTE 1: The mandatory HTTP error status codes for the POST method listed in table 5.2.7.1-1 of 3GPP TS 29.500 [6] also apply. | | | | |
| NOTE 2: The RedirectResponse data structure may be provided by an SCP or a SEPP (cf. clause 6.10.9.1 of 3GPP TS 29.500 [6]). | | | | |

Table 5.8.5.2.2-4: Headers supported by the 307 Response Code on this resource

| Name | Data type | P | Cardinality | Description |
|-----------------------|-----------|---|-------------|--|
| Location | string | M | 1 | Contains an alternative URI representing the end point of an alternative NF consumer (service) instance towards which the notification is redirected. For the case where the notification is redirected to the same target via a different SCP or SEPP, refer to clause 6.10.9.1 of 3GPP TS 29.500 [6]. |
| 3gpp-Sbi-Target-Nf-Id | string | O | 0..1 | Identifier of the target NF (service) instance towards which the notification request is redirected. |

Table 5.8.5.2.2-5: Headers supported by the 308 Response Code on this resource

| Name | Data type | P | Cardinality | Description |
|-----------------------|-----------|---|-------------|--|
| Location | string | M | 1 | Contains an alternative URI representing the end point of an alternative NF consumer (service) instance towards which the notification is redirected. For the case where the notification is redirected to the same target via a different SCP or SEPP, refer to clause 6.10.9.1 of 3GPP TS 29.500 [6]. |
| 3gpp-Sbi-Target-Nf-Id | string | O | 0..1 | Identifier of the target NF (service) instance towards which the notification request is redirected. |

5.8.6 Data Model

5.8.6.1 General

This clause specifies the application data model supported by the API.

Table 5.8.6.1-1 specifies the data types defined for the Nnwdaf_RoamingAnalytics service based interface protocol.

Table 5.8.6.1-1: Nnwdaf_RoamingAnalytics specific Data Types

| Data type | Clause defined | Description | Applicability |
|------------------------------|----------------|---------------------------------|---------------|
| RoamingAnalyticsSubscription | 5.8.6.2.2 | Roaming Analytics Subscription. | |
| RoamingAnalyticsNotification | 5.8.6.2.3 | Roaming Analytics Notification. | |

Table 5.8.6.1-2 specifies data types re-used by the Nnwdaf_RoamingAnalytics service based interface protocol from other specifications, including a reference to their respective specifications and when needed, a short description of their use within the Nnwdaf_RoamingAnalytics service based interface.

Table 5.8.6.1-2: Nnwdaf_RoamingAnalytics re-used Data Types

| Data type | Reference | Comments | Applicability |
|----------------------|---------------------|--|----------------------|
| EventNotification | 5.1.6.2.5 | Contains NWDAF events that are being notified. | |
| EventSubscription | 5.1.6.2.3 | Contains NWDAF events to be subscribed. | |
| FailureEventInfo | 5.1.6.2.35 | Information about events for which the subscription failed. | |
| PlmnId | 3GPP TS 29.571 [8] | PLMN identifier. | |
| ReportingInformation | 3GPP TS 29.523 [20] | Represents the type of reporting the subscription requires. | |
| SupportedFeatures | 3GPP TS 29.571 [8] | Used to negotiate the applicability of the optional features defined in table 5.7.8-1. | |
| TermCause | 5.1.6.3.26 | Cause of termination of an analytics subscription. | |
| Uri | 3GPP TS 29.571 [8] | Indicates the URI. | |

5.8.6.2 Structured data types

5.8.6.2.1 Introduction

This clause defines the structures to be used in resource representations.

5.8.6.2.2 Type RoamingAnalyticsSubscription

Table 5.8.6.2.2-1: Definition of type RoamingAnalyticsSubscription

| Attribute name | Data type | P | Cardinality | Description | Applicability |
|--|--------------------------|---|-------------|--|---------------|
| roamEventSubs | array(EventSubscription) | M | 1..N | Subscribed events. (NOTE 1) | |
| evtReq | ReportingInformation | O | 0..1 | Represents the reporting requirements of the event subscription. (NOTE 2, NOTE 3) If omitted, the default values within the ReportingInformation data type apply. | |
| notifUri | Uri | M | 1 | Identifies the recipient of Notifications sent by the NWDAF. | |
| notifCorrId | string | M | 1 | Notification correlation identifier. | |
| consPlmnId | PlmnId | M | 1 | The PLMN ID of the NF service consumer. | |
| roamEventNotifs | array(EventNotification) | C | 1..N | Notifications about Individual Events. Shall only be present in the response to a subscription creation or modification if the immediate reporting indication in the "immRep" attribute within the "evtReq" attribute was set to true in the request and the reports are available. (NOTE 4) | |
| failEventReports | array(FailureEventInfo) | O | 1..N | It may be supplied by the NWDAF in the response to a subscription creation or modification. When available, it contains the event(s) for which the subscription was not successful including the failure reason(s). | |
| suppFeat | SupportedFeatures | C | 0..1 | List of Supported features used as described in clause 5.8.8. This parameter shall be included in the response to the subscription creation or modification if it was included in the request. | |
| NOTE 1: The attributes "useCaseCxt", "accuReq", "pauseFlg", "resumeFlg", as well as the attributes "anaMeta" and "anaMetaInd" within the "extraReportReq" attribute, are not applicable here. | | | | | |
| NOTE 2: If the "evtReq" attribute (of data type ReportingInformation) is provided and contains the "notifMethod" attribute, the notification method indicated by the "notifMethod" attribute within the ReportingInformation data type takes precedence over the notification method indicated by the "notificationMethod" attribute within the EventSubscription data type. | | | | | |
| NOTE 3: If the "evtReq" attribute (of data type ReportingInformation) is provided and contains the "repPeriod" attribute, the periodic reporting time indicated by the "repPeriod" attribute in the ReportingInformation data type takes precedence over the periodic reporting time indicated by the "repetitionPeriod" attribute in the EventSubscription data type. | | | | | |
| NOTE 4: The attributes "anaMetaInfo", "accuInfo", "cancelAccuInd", "pauseInd", and "resumeInd" are not applicable here. | | | | | |

5.8.6.2.3 Type RoamingAnalyticsNotification

Table 5.8.6.2.3-1: Definition of type RoamingAnalyticsNotification

| Attribute name | Data type | P | Cardinality | Description | Applicability |
|-----------------|---|---|-------------|---|---------------|
| roamEventNotifs | array(EventNotification) | M | 1..N | Notifications about Individual Events. (NOTE) | |
| notifCorrId | string | M | 1 | Notification correlation identifier. | |
| termCause | TermCause | O | 0..1 | A cause for which the NWDAF will send no further notifications for this subscription. Its presence indicates that the NWDAF requests the termination of the subscription. | |
| NOTE: | The attributes "anaMetaInfo", "accuInfo", "cancelAccuInd", "pauseInd", and "resumeInd" are not applicable here. | | | | |

5.8.7 Error handling

5.8.7.1 General

HTTP error handling shall be supported as specified in clause 5.2.4 of TS 29.500 [6].

For the Nnwdaf_RoamingAnalytics API, HTTP error responses shall be supported as specified in clause 4.8 of TS 29.501 [7]. Protocol errors and application errors specified in table 5.2.7.2-1 of TS 29.500 [6] shall be supported for an HTTP method if the corresponding HTTP status codes are specified as mandatory for that HTTP method in table 5.2.7.1-1 of TS 29.500 [6]. In addition, the requirements in the following clauses shall apply.

5.8.7.2 Protocol Errors

In this Release of the specification, there are no additional protocol errors applicable for the Nnwdaf_RoamingAnalytics API.

5.8.7.3 Application Errors

The application errors defined for the Nnwdaf_RoamingAnalytics API are listed in table 5.8.7.3-1.

Table 5.8.7.3-1: Application errors

| Application Error | HTTP status code | Description | Applicability |
|----------------------------|--|--|---------------|
| BOTH_STAT_PRED_NOT_ALLOWED | 400 Bad Request | For the requested observation period, the start time is in the past and the end time is in the future, which means the NF service consumer requested both statistics and prediction for the analytics. | |
| MISSING_ROAMING_AGREEMENT | 403 Forbidden | Missing the corresponding roaming agreement to satisfy the request. | |
| UNAVAILABLE_DATA | 500 Internal Server Error | Indicates the requested statistics in the past is rejected since necessary data to perform the service is unavailable. | |
| NOTE: | Including a "ProblemDetails" data structure with the "cause" attribute in the HTTP response is optional unless explicitly mandated in the service operation clauses. | | |

5.8.8 Feature negotiation

The optional features in table 5.8.8-1 are defined for the Nnwdaf_RoamingAnalytics API. They shall be negotiated using the extensibility mechanism defined in clause 6.6 of 3GPP TS 29.500 [6].

Table 5.8.8-1: Supported Features

| Feature number | Feature Name | Description |
|----------------|--------------|-------------|
| | | |

5.8.9 Security

As indicated in TS 33.501 [13] and TS 29.500 [6], the access to the Nnwdaf_RoamingAnalytics API may be authorized by means of the OAuth2 protocol (see IETF RFC 6749 [14]), based on local configuration, using the "Client Credentials" authorization grant, where the NRF (see TS 29.510 [12]) plays the role of the authorization server.

If OAuth2 is used, an NF service consumer, prior to consuming services offered by the Nnwdaf_RoamingAnalytics API, shall obtain a "token" from the authorization server, by invoking the Access Token Request service, as described in TS 29.510 [12], clause 5.4.2.2.

NOTE: When multiple NRFs are deployed in a network, the NRF used as authorization server is the same NRF that the NF service consumer used for discovering the Nnwdaf_RoamingAnalytics service.

The Nnwdaf_RoamingAnalytics API defines a single scope "nnwdaf-roaminganalytics" for the entire service, and it does not define any additional scopes at resource or operation level.

Annex A (normative): OpenAPI specification

A.1 General

The present Annex contains an OpenAPI [11] specification of HTTP messages and content bodies used by the Nnwdaf_EventsSubscription, the Nnwdaf_AnalyticsInfo, Nnwdaf_DataManagement, Nnwdaf_MLModelProvision, and Nnwdaf_MLModelTraining APIs.

This Annex shall take precedence when being discrepant to other parts of the specification with respect to the encoding of information elements and methods within the API(s).

NOTE: The semantics and procedures, as well as conditions, e.g. for the applicability and allowed combinations of attributes or values, not expressed in the OpenAPI definitions but defined in other parts of the specification also apply.

Informative copies of the OpenAPI specification files contained in this 3GPP Technical Specification are available on a Git-based repository, that uses the GitLab software version control system (see clause 5B of the 3GPP TR 21.900 [16] and clause 5.3.1 of the 3GPP TS 29.501 [7] for further information).

A.2 Nnwdaf_EventsSubscription API

openapi: 3.0.0

info:

```
version: 1.3.1
title: Nnwdaf_EventsSubscription
description: |
  Nnwdaf_EventsSubscription Service API.
  © 2024, 3GPP Organizational Partners (ARIB, ATIS, CCSA, ETSI, TSDSI, TTA, TTC).
  All rights reserved.
```

externalDocs:

```
description: 3GPP TS 29.520 V18.7.0; 5G System; Network Data Analytics Services.
url: 'https://www.3gpp.org/ftp/Specs/archive/29_series/29.520/'
```

security:

```
- {}
- oAuth2ClientCredentials:
  - nnwdaf-eventssubscription
```

servers:

```
- url: '{apiRoot}/nnwdaf-eventssubscription/v1'
  variables:
    apiRoot:
      default: https://example.com
      description: apiRoot as defined in clause 4.4 of 3GPP TS 29.501.
```

paths:

```
/subscriptions:
  post:
    summary: Create a new Individual NWDAF Events Subscription
    operationId: CreateNWDAFEventsSubscription
    tags:
      - NWDAF Events Subscriptions (Collection)
    requestBody:
      required: true
      content:
        application/json:
          schema:
            $ref: '#/components/schemas/NnwdafEventsSubscription'
    responses:
      '201':
        description: Create a new Individual NWDAF Event Subscription resource.
        headers:
          Location:
            description: >
```

```

    Contains the URI of the newly created resource, according to the structure
    {apiRoot}/nnwdaf-eventssubscription/<apiVersion>/subscriptions/{subscriptionId}
    required: true
    schema:
      type: string
    content:
      application/json:
        schema:
          $ref: '#/components/schemas/NnwdafEventsSubscription'
  '400':
    $ref: 'TS29571_CommonData.yaml#/components/responses/400'
  '401':
    $ref: 'TS29571_CommonData.yaml#/components/responses/401'
  '403':
    $ref: 'TS29571_CommonData.yaml#/components/responses/403'
  '404':
    $ref: 'TS29571_CommonData.yaml#/components/responses/404'
  '411':
    $ref: 'TS29571_CommonData.yaml#/components/responses/411'
  '413':
    $ref: 'TS29571_CommonData.yaml#/components/responses/413'
  '415':
    $ref: 'TS29571_CommonData.yaml#/components/responses/415'
  '429':
    $ref: 'TS29571_CommonData.yaml#/components/responses/429'
  '500':
    $ref: 'TS29571_CommonData.yaml#/components/responses/500'
  '502':
    $ref: 'TS29571_CommonData.yaml#/components/responses/502'
  '503':
    $ref: 'TS29571_CommonData.yaml#/components/responses/503'
  default:
    $ref: 'TS29571_CommonData.yaml#/components/responses/default'
callbacks:
  myNotification:
    '{$request.body#/notificationURI}':
      post:
        requestBody:
          required: true
          content:
            application/json:
              schema:
                type: array
                items:
                  $ref: '#/components/schemas/NnwdafEventsSubscriptionNotification'
                minItems: 1
  responses:
    '204':
      description: The receipt of the Notification is acknowledged.
    '307':
      $ref: 'TS29571_CommonData.yaml#/components/responses/307'
    '308':
      $ref: 'TS29571_CommonData.yaml#/components/responses/308'
    '400':
      $ref: 'TS29571_CommonData.yaml#/components/responses/400'
    '401':
      $ref: 'TS29571_CommonData.yaml#/components/responses/401'
    '403':
      $ref: 'TS29571_CommonData.yaml#/components/responses/403'
    '404':
      $ref: 'TS29571_CommonData.yaml#/components/responses/404'
    '411':
      $ref: 'TS29571_CommonData.yaml#/components/responses/411'
    '413':
      $ref: 'TS29571_CommonData.yaml#/components/responses/413'
    '415':
      $ref: 'TS29571_CommonData.yaml#/components/responses/415'
    '429':
      $ref: 'TS29571_CommonData.yaml#/components/responses/429'
    '500':
      $ref: 'TS29571_CommonData.yaml#/components/responses/500'
    '502':
      $ref: 'TS29571_CommonData.yaml#/components/responses/502'
    '503':
      $ref: 'TS29571_CommonData.yaml#/components/responses/503'
  default:
    $ref: 'TS29571_CommonData.yaml#/components/responses/default'

```

```
/subscriptions/{subscriptionId}:
delete:
  summary: Delete an existing Individual NWDAF Events Subscription
  operationId: DeleteNWDAFEventsSubscription
  tags:
    - Individual NWDAF Events Subscription (Document)
  parameters:
    - name: subscriptionId
      in: path
      description: String identifying a subscription to the Nnwdaf_EventsSubscription Service
      required: true
      schema:
        type: string
  responses:
    '204':
      description: >
        No Content. The Individual NWDAF Event Subscription resource matching the subscriptionId
        was deleted.
    '307':
      $ref: 'TS29571_CommonData.yaml#/components/responses/307'
    '308':
      $ref: 'TS29571_CommonData.yaml#/components/responses/308'
    '400':
      $ref: 'TS29571_CommonData.yaml#/components/responses/400'
    '401':
      $ref: 'TS29571_CommonData.yaml#/components/responses/401'
    '403':
      $ref: 'TS29571_CommonData.yaml#/components/responses/403'
    '404':
      $ref: 'TS29571_CommonData.yaml#/components/responses/404'
    '429':
      $ref: 'TS29571_CommonData.yaml#/components/responses/429'
    '500':
      $ref: 'TS29571_CommonData.yaml#/components/responses/500'
    '501':
      $ref: 'TS29571_CommonData.yaml#/components/responses/501'
    '502':
      $ref: 'TS29571_CommonData.yaml#/components/responses/502'
    '503':
      $ref: 'TS29571_CommonData.yaml#/components/responses/503'
    default:
      $ref: 'TS29571_CommonData.yaml#/components/responses/default'
put:
  summary: Update an existing Individual NWDAF Events Subscription
  operationId: UpdateNWDAFEventsSubscription
  tags:
    - Individual NWDAF Events Subscription (Document)
  requestBody:
    required: true
    content:
      application/json:
        schema:
          $ref: '#/components/schemas/NnwdafEventsSubscription'
  parameters:
    - name: subscriptionId
      in: path
      description: String identifying a subscription to the Nnwdaf_EventsSubscription Service.
      required: true
      schema:
        type: string
  responses:
    '200':
      description: >
        The Individual NWDAF Event Subscription resource was modified successfully and a
        representation of that resource is returned.
      content:
        application/json:
          schema:
            $ref: '#/components/schemas/NnwdafEventsSubscription'
    '204':
      description: The Individual NWDAF Event Subscription resource was modified successfully.
    '307':
      $ref: 'TS29571_CommonData.yaml#/components/responses/307'
    '308':
      $ref: 'TS29571_CommonData.yaml#/components/responses/308'
    '400':
      $ref: 'TS29571_CommonData.yaml#/components/responses/400'
    '401':
```

```

    $ref: 'TS29571_CommonData.yaml#/components/responses/401'
  '403':
    $ref: 'TS29571_CommonData.yaml#/components/responses/403'
  '404':
    $ref: 'TS29571_CommonData.yaml#/components/responses/404'
  '411':
    $ref: 'TS29571_CommonData.yaml#/components/responses/411'
  '413':
    $ref: 'TS29571_CommonData.yaml#/components/responses/413'
  '415':
    $ref: 'TS29571_CommonData.yaml#/components/responses/415'
  '429':
    $ref: 'TS29571_CommonData.yaml#/components/responses/429'
  '500':
    $ref: 'TS29571_CommonData.yaml#/components/responses/500'
  '501':
    $ref: 'TS29571_CommonData.yaml#/components/responses/501'
  '502':
    $ref: 'TS29571_CommonData.yaml#/components/responses/502'
  '503':
    $ref: 'TS29571_CommonData.yaml#/components/responses/503'
  default:
    $ref: 'TS29571_CommonData.yaml#/components/responses/default'

/transfers:
  post:
    summary: Provide information about requested analytics subscriptions transfer and potentially
    create a new Individual NWDAF Event Subscription Transfer resource.
    operationId: CreateNWDAFEventSubscriptionTransfer
    tags:
      - NWDAF Event Subscription Transfers (Collection)
    security:
      - {}
      - oAuth2ClientCredentials:
          - nnwdaf-eventssubscription
      - oAuth2ClientCredentials:
          - nnwdaf-eventssubscription:transfer
    requestBody:
      required: true
      content:
        application/json:
          schema:
            $ref: '#/components/schemas/AnalyticsSubscriptionsTransfer'
    responses:
      '201':
        description: Create a new Individual NWDAF Event Subscription Transfer resource.
        headers:
          Location:
            description: >
              Contains the URI of the newly created resource, according to the structure
              {apiRoot}/nnwdaf-eventssubscription/<apiVersion>/transfers/{transferId}
            required: true
            schema:
              type: string
      '204':
        description: >
          No Content. The receipt of the information about analytics subscription(s) that are
          requested to be transferred and the ability to handle this information (e.g. execute the
          steps required to transfer an analytics subscription directly) is confirmed.
      '400':
        $ref: 'TS29571_CommonData.yaml#/components/responses/400'
      '401':
        $ref: 'TS29571_CommonData.yaml#/components/responses/401'
      '403':
        $ref: 'TS29571_CommonData.yaml#/components/responses/403'
      '404':
        $ref: 'TS29571_CommonData.yaml#/components/responses/404'
      '411':
        $ref: 'TS29571_CommonData.yaml#/components/responses/411'
      '413':
        $ref: 'TS29571_CommonData.yaml#/components/responses/413'
      '415':
        $ref: 'TS29571_CommonData.yaml#/components/responses/415'
      '429':
        $ref: 'TS29571_CommonData.yaml#/components/responses/429'
      '500':
        $ref: 'TS29571_CommonData.yaml#/components/responses/500'

```

```

'502':
  $ref: 'TS29571_CommonData.yaml#/components/responses/502'
'503':
  $ref: 'TS29571_CommonData.yaml#/components/responses/503'
default:
  $ref: 'TS29571_CommonData.yaml#/components/responses/default'

/transfers/{transferId}:
  delete:
    summary: Delete an existing Individual NWDAF Event Subscription Transfer
    operationId: DeleteNWDAFEventSubscriptionTransfer
    tags:
      - Individual NWDAF Event Subscription Transfer (Document)
    security:
      - {}
      - oAuth2ClientCredentials:
          - nnwdaf-eventsubscription
      - oAuth2ClientCredentials:
          - nnwdaf-eventsubscription
          - nnwdaf-eventsubscription:transfer
    parameters:
      - name: transferId
        in: path
        description: >
          String identifying a request for an analytics subscription transfer to the
          Nnwdaf_EventsSubscription Service.
        required: true
        schema:
          type: string
    responses:
      '204':
        description: >
          No Content. The Individual NWDAF Event Subscription Transfer resource matching the
          transferId was deleted.
      '307':
        $ref: 'TS29571_CommonData.yaml#/components/responses/307'
      '308':
        $ref: 'TS29571_CommonData.yaml#/components/responses/308'
      '400':
        $ref: 'TS29571_CommonData.yaml#/components/responses/400'
      '401':
        $ref: 'TS29571_CommonData.yaml#/components/responses/401'
      '403':
        $ref: 'TS29571_CommonData.yaml#/components/responses/403'
      '404':
        $ref: 'TS29571_CommonData.yaml#/components/responses/404'
      '429':
        $ref: 'TS29571_CommonData.yaml#/components/responses/429'
      '500':
        $ref: 'TS29571_CommonData.yaml#/components/responses/500'
      '501':
        $ref: 'TS29571_CommonData.yaml#/components/responses/501'
      '502':
        $ref: 'TS29571_CommonData.yaml#/components/responses/502'
      '503':
        $ref: 'TS29571_CommonData.yaml#/components/responses/503'
      default:
        $ref: 'TS29571_CommonData.yaml#/components/responses/default'
    put:
      summary: Update an existing Individual NWDAF Event Subscription Transfer
      operationId: UpdateNWDAFEventSubscriptionTransfer
      tags:
        - Individual NWDAF Event Subscription Transfer (Document)
      security:
        - {}
        - oAuth2ClientCredentials:
            - nnwdaf-eventsubscription
        - oAuth2ClientCredentials:
            - nnwdaf-eventsubscription
            - nnwdaf-eventsubscription:transfer
      requestBody:
        required: true
        content:
          application/json:
            schema:
              $ref: '#/components/schemas/AnalyticsSubscriptionsTransfer'
      parameters:
        - name: transferId

```

```

    in: path
    description: >
      String identifying a request for an analytics subscription transfer to the
      Nnwdaf_EventsSubscription Service
    required: true
    schema:
      type: string
  responses:
    '204':
      description: >
        The Individual NWDAF Event Subscription Transfer resource was modified successfully.
    '307':
      $ref: 'TS29571_CommonData.yaml#/components/responses/307'
    '308':
      $ref: 'TS29571_CommonData.yaml#/components/responses/308'
    '400':
      $ref: 'TS29571_CommonData.yaml#/components/responses/400'
    '401':
      $ref: 'TS29571_CommonData.yaml#/components/responses/401'
    '403':
      $ref: 'TS29571_CommonData.yaml#/components/responses/403'
    '404':
      $ref: 'TS29571_CommonData.yaml#/components/responses/404'
    '411':
      $ref: 'TS29571_CommonData.yaml#/components/responses/411'
    '413':
      $ref: 'TS29571_CommonData.yaml#/components/responses/413'
    '415':
      $ref: 'TS29571_CommonData.yaml#/components/responses/415'
    '429':
      $ref: 'TS29571_CommonData.yaml#/components/responses/429'
    '500':
      $ref: 'TS29571_CommonData.yaml#/components/responses/500'
    '501':
      $ref: 'TS29571_CommonData.yaml#/components/responses/501'
    '502':
      $ref: 'TS29571_CommonData.yaml#/components/responses/502'
    '503':
      $ref: 'TS29571_CommonData.yaml#/components/responses/503'
  default:
    $ref: 'TS29571_CommonData.yaml#/components/responses/default'

components:

  securitySchemes:
    oAuth2ClientCredentials:
      type: oauth2
      flows:
        clientCredentials:
          tokenUrl: '{nrfApiRoot}/oauth2/token'
          scopes:
            nwdaf-eventssubscription: Access to the Nnwdaf_EventsSubscription API
            nwdaf-eventssubscription:transfer: >
              Access to service operations applying to NWDAF event subscription transfer.

  schemas:

    NnwdafEventsSubscription:
      description: Represents an Individual NWDAF Event Subscription resource.
      type: object
      properties:
        eventSubscriptions:
          type: array
          items:
            $ref: '#/components/schemas/EventSubscription'
          minItems: 1
          description: Subscribed events
        evtReq:
          $ref: 'TS29523_Npcf_EventExposure.yaml#/components/schemas/ReportingInformation'
        notificationURI:
          $ref: 'TS29571_CommonData.yaml#/components/schemas/Uri'
        notifCorrId:
          type: string
          description: Notification correlation identifier.
        supportedFeatures:
          $ref: 'TS29571_CommonData.yaml#/components/schemas/SupportedFeatures'
        eventNotifications:
          type: array

```

```

    items:
      $ref: '#/components/schemas/EventNotification'
    minItems: 1
  failEventReports:
    type: array
    items:
      $ref: '#/components/schemas/FailureEventInfo'
    minItems: 1
  prevSub:
    $ref: '#/components/schemas/PrevSubInfo'
  consNfInfo:
    $ref: '#/components/schemas/ConsumerNfInformation'
  required:
    - eventSubscriptions

EventSubscription:
  description: Represents a subscription to a single event.
  type: object
  properties:
    anySlice:
      $ref: '#/components/schemas/AnySlice'
    appIds:
      type: array
      items:
        $ref: 'TS29571_CommonData.yaml#/components/schemas/ApplicationId'
      minItems: 1
      description: Identification(s) of application to which the subscription applies.
    deviations:
      type: array
      items:
        $ref: 'TS29571_CommonData.yaml#/components/schemas/UInteger'
      minItems: 1
    dnns:
      type: array
      items:
        $ref: 'TS29571_CommonData.yaml#/components/schemas/Dnn'
      minItems: 1
      description: Identification(s) of DNN to which the subscription applies.
    dnais:
      type: array
      items:
        $ref: 'TS29571_CommonData.yaml#/components/schemas/Dnai'
      minItems: 1
    event:
      $ref: '#/components/schemas/NwdafEvent'
    extraReportReq:
      $ref: '#/components/schemas/EventReportingRequirement'
    ladnDnns:
      type: array
      items:
        $ref: 'TS29571_CommonData.yaml#/components/schemas/Dnn'
      minItems: 1
      description: Identification(s) of LADN DNN to indicate the LADN service area as the AOI.
    loadLevelThreshold:
      type: integer
      description: >
        Indicates that the NWDAF shall report the corresponding network slice load level to the
        NF service consumer where the load level of the network slice identified by snssais is
        reached.
    notificationMethod:
      $ref: '#/components/schemas/NotificationMethod'
    matchingDir:
      $ref: '#/components/schemas/MatchingDirection'
    nfLoadLvlThds:
      type: array
      items:
        $ref: '#/components/schemas/ThresholdLevel'
      minItems: 1
      description: >
        Shall be supplied in order to start reporting when an average load level is reached.
    nfInstanceIds:
      type: array
      items:
        $ref: 'TS29571_CommonData.yaml#/components/schemas/NfInstanceId'
      minItems: 1
    nfSetIds:
      type: array
      items:

```

```

    $ref: 'TS29571_CommonData.yaml#/components/schemas/NfSetId'
  minItems: 1
  nfTypes:
    type: array
    items:
      $ref: 'TS29510_Nnrf_NFManagement.yaml#/components/schemas/NFType'
  minItems: 1
  networkArea:
    $ref: 'TS29554_Npcf_BDTPolicyControl.yaml#/components/schemas/NetworkAreaInfo'
  location:
    $ref: '#/components/schemas/GeoLocation'
  temporalGranSize:
    $ref: 'TS29571_CommonData.yaml#/components/schemas/DurationSec'
  spatialGranSizeTa:
    $ref: 'TS29571_CommonData.yaml#/components/schemas/UInteger'
  spatialGranSizeCell:
    $ref: 'TS29571_CommonData.yaml#/components/schemas/UInteger'
  fineGranAreas:
    type: array
    items:
      $ref: 'TS29522_AMPolicyAuthorization.yaml#/components/schemas/GeographicalArea'
    minItems: 1
  description: Indicates the fine granularity areas to which the subscription applies.
  visitedAreas:
    type: array
    items:
      $ref: 'TS29554_Npcf_BDTPolicyControl.yaml#/components/schemas/NetworkAreaInfo'
    minItems: 1
  maxTopAppUlNbr:
    $ref: 'TS29571_CommonData.yaml#/components/schemas/UInteger'
  maxTopAppDlNbr:
    $ref: 'TS29571_CommonData.yaml#/components/schemas/UInteger'
  nsiIdInfos:
    type: array
    items:
      $ref: '#/components/schemas/NsiIdInfo'
    minItems: 1
  nsiLevelThrds:
    type: array
    items:
      $ref: 'TS29571_CommonData.yaml#/components/schemas/UInteger'
    minItems: 1
  qosRequ:
    $ref: '#/components/schemas/QosRequirement'
  qosFlowRetThds:
    type: array
    items:
      $ref: '#/components/schemas/RetainabilityThreshold'
    minItems: 1
  ranUeThrouThds:
    type: array
    items:
      $ref: 'TS29571_CommonData.yaml#/components/schemas/BitRate'
    minItems: 1
  repetitionPeriod:
    $ref: 'TS29571_CommonData.yaml#/components/schemas/DurationSec'
  snssaia:
    type: array
    items:
      $ref: 'TS29571_CommonData.yaml#/components/schemas/Snssai'
    minItems: 1
  description: >
    Identification(s) of network slice to which the subscription applies. It corresponds to
    snssais in the data model definition of 3GPP TS 29.520.
  tgtUe:
    $ref: '#/components/schemas/TargetUeInformation'
  roamingInfo:
    $ref: '#/components/schemas/RoamingInfo'
  congThresholds:
    type: array
    items:
      $ref: '#/components/schemas/ThresholdLevel'
    minItems: 1
  nwPerfRequs:
    type: array
    items:
      $ref: '#/components/schemas/NetworkPerfRequirement'
    minItems: 1

```



```

ueCommReqs:
  type: array
  items:
    $ref: '#/components/schemas/UeCommReq'
  minItems: 1
ueMobilityReqs:
  type: array
  items:
    $ref: '#/components/schemas/UeMobilityReq'
  minItems: 1
userDataConOrderCri:
  $ref: '#/components/schemas/UserDataConOrderCrit'
bwReqs:
  type: array
  items:
    $ref: '#/components/schemas/BwRequirement'
  minItems: 1
exceptReqs:
  type: array
  items:
    $ref: '#/components/schemas/Exception'
  minItems: 1
exptAnaType:
  $ref: '#/components/schemas/ExpectedAnalyticsType'
exptUeBehav:
  $ref: 'TS29503_Nudm_SDM.yaml#/components/schemas/ExpectedUeBehaviourData'
ratFreqs:
  type: array
  items:
    $ref: '#/components/schemas/RatFreqInformation'
  minItems: 1
listOfAnaSubsets:
  type: array
  items:
    $ref: '#/components/schemas/AnalyticsSubset'
  minItems: 1
disperReqs:
  type: array
  items:
    $ref: '#/components/schemas/DispersionRequirement'
  minItems: 1
redTransReqs:
  type: array
  items:
    $ref: '#/components/schemas/RedundantTransmissionExpReq'
  minItems: 1
wlanReqs:
  type: array
  items:
    $ref: '#/components/schemas/WlanPerformanceReq'
  minItems: 1
upfInfo:
  $ref: 'TS29508_Nsmf_EventExposure.yaml#/components/schemas/UpfInformation'
appServerAddrs:
  type: array
  items:
    $ref: 'TS29517_Naf_EventExposure.yaml#/components/schemas/AddrFqdn'
  minItems: 1
dnPerfReqs:
  type: array
  items:
    $ref: '#/components/schemas/DnPerformanceReq'
  minItems: 1
pduSesInfos:
  type: array
  items:
    $ref: '#/components/schemas/PduSessionInfo'
  minItems: 1
useCaseCxt:
  type: string
  description: >
    Indicates the context of usage of the analytics. The value and format of this parameter
    are not standardized.
pduSesTrafReqs:
  type: array
  items:
    $ref: '#/components/schemas/PduSesTrafficReq'
  minItems: 1

```

```

locAccReqs:
  type: array
  items:
    $ref: '#/components/schemas/LocAccuracyReq'
  minItems: 1
locGranularity:
  $ref: '#/components/schemas/LocInfoGranularity'
locOrientation:
  $ref: '#/components/schemas/LocationOrientation'
dataVlTrnsTmRqs:
  type: array
  items:
    $ref: '#/components/schemas/E2eDataVolTransTimeReq'
  minItems: 1
accuReq:
  $ref: '#/components/schemas/AccuracyReq'
pauseFlg:
  type: boolean
  description: >
    Pause analytics consumption flag. Set to "true" to indicate the NWDAF to stop sending
    the notifications of analytics. Default value is "false" if omitted.
resumeFlg:
  type: boolean
  description: >
    Resume analytics consumption flag. Set to "true" to indicate the NWDAF to resume sending
    the notifications of analytics. Default value is "false" if omitted.
movBehavReqs:
  type: array
  items:
    $ref: '#/components/schemas/MovBehavReq'
  minItems: 1
relProxReqs:
  type: array
  items:
    $ref: '#/components/schemas/RelProxReq'
  minItems: 1
feedback:
  $ref: '#/components/schemas/AnalyticsFeedbackInfo'
required:
  - event
not:
  required: [excepRequs, exptAnaType]

NnwdafEventsSubscriptionNotification:
description: Represents an Individual NWDAF Event Subscription Notification resource.
type: object
properties:
  eventNotifications:
    type: array
    items:
      $ref: '#/components/schemas/EventNotification'
    minItems: 1
    description: Notifications about Individual Events
  subscriptionId:
    type: string
    description: String identifying a subscription to the Nnwdaf_EventsSubscription Service
  notifCorrId:
    type: string
    description: Notification correlation identifier.
  oldSubscriptionId:
    type: string
    description: >
      Subscription ID which was allocated by the source NWDAF. This parameter shall be present
      if the notification is for informing the assignment of a new Subscription ID by the
      target NWDAF.
  resourceUri:
    $ref: 'TS29571_CommonData.yaml#/components/schemas/Uri'
  termCause:
    $ref: '#/components/schemas/TermCause'
  transEvents:
    type: array
    items:
      $ref: '#/components/schemas/NwdafEvent'
    minItems: 1
required:
  - subscriptionId
oneOf:
  - required: [eventNotifications]

```

- allOf:
- required: [resourceUri]
- required: [oldSubscriptionId]

EventNotification:

```

description: Represents a notification on events that occurred.
type: object
properties:
  event:
    $ref: '#/components/schemas/NwdafEvent'
  start:
    $ref: 'TS29571_CommonData.yaml#/components/schemas/DateTime'
  expiry:
    $ref: 'TS29571_CommonData.yaml#/components/schemas/DateTime'
  timeStampGen:
    $ref: 'TS29571_CommonData.yaml#/components/schemas/DateTime'
  failNotifyCode:
    $ref: '#/components/schemas/NwdafFailureCode'
  rvWaitTime:
    $ref: 'TS29571_CommonData.yaml#/components/schemas/DurationSec'
  anaMetaInfo:
    $ref: '#/components/schemas/AnalyticsMetadataInfo'
  nfLoadLevelInfos:
    type: array
    items:
      $ref: '#/components/schemas/NfLoadLevelInformation'
    minItems: 1
  nsiLoadLevelInfos:
    type: array
    items:
      $ref: '#/components/schemas/NsiLoadLevelInfo'
    minItems: 1
  pfdDetermInfos:
    type: array
    items:
      $ref: '#/components/schemas/PfdDeterminationInfo'
    minItems: 1
  sliceLoadLevelInfo:
    $ref: '#/components/schemas/SliceLoadLevelInformation'
  svcExps:
    type: array
    items:
      $ref: '#/components/schemas/ServiceExperienceInfo'
    minItems: 1
  qosSustainInfos:
    type: array
    items:
      $ref: '#/components/schemas/QosSustainabilityInfo'
    minItems: 1
  ueComms:
    type: array
    items:
      $ref: '#/components/schemas/UeCommunication'
    minItems: 1
  ueMobs:
    type: array
    items:
      $ref: '#/components/schemas/UeMobility'
    minItems: 1
  userDataCongInfos:
    type: array
    items:
      $ref: '#/components/schemas/UserDataCongestionInfo'
    minItems: 1
  abnorBehavrs:
    type: array
    items:
      $ref: '#/components/schemas/AbnormalBehaviour'
    minItems: 1
  nwPerfs:
    type: array
    items:
      $ref: '#/components/schemas/NetworkPerfInfo'
    minItems: 1
  dnPerfInfos:
    type: array
    items:
      $ref: '#/components/schemas/DnPerfInfo'

```

```

    minItems: 1
  disperInfos:
    type: array
    items:
      $ref: '#/components/schemas/DispersionInfo'
    minItems: 1
  redTransInfos:
    type: array
    items:
      $ref: '#/components/schemas/RedundantTransmissionExpInfo'
    minItems: 1
  wlanInfos:
    type: array
    items:
      $ref: '#/components/schemas/WlanPerformanceInfo'
    minItems: 1
  smccExps:
    type: array
    items:
      $ref: 'TS29520_Nnwdaf_AnalyticsInfo.yaml#/components/schemas/SmcceInfo'
    minItems: 1
  pduSesTrafInfos:
    type: array
    items:
      $ref: '#/components/schemas/PduSesTrafficInfo'
    minItems: 1
  dataVlTrnsTmInfos:
    type: array
    items:
      $ref: '#/components/schemas/E2eDataVolTransTimeInfo'
    minItems: 1
  accuInfo:
    $ref: '#/components/schemas/AccuracyInfo'
  cancelAccuInd:
    type: boolean
    description: >
      Indicates cancelled subscription of the analytics accuracy information.
      Set to "true" indicates the NWDAF cancelled subscription of analytics accuracy
      information as the NWDAF does not support the accuracy checking capability.
      Otherwise set to "false". Default value is "false" if omitted.
  pauseInd:
    type: boolean
    description: >
      Pause analytics consumption indication. Set to "true" to indicate the consumer to stop
      the consumption of the analytics. Default value is "false" if omitted.
  resumeInd:
    type: boolean
    description: >
      Resume analytics consumption indication. Set to "true" to indicate the consumer to
      resume the consumption of the analytics. Default value is "false" if omitted.
  movBehavInfos:
    type: array
    items:
      $ref: '#/components/schemas/MovBehavInfo'
    minItems: 1
  locAccInfos:
    type: array
    items:
      $ref: '#/components/schemas/LocAccuracyInfo'
    minItems: 1
  relProxInfos:
    type: array
    items:
      $ref: '#/components/schemas/RelProxInfo'
    minItems: 1
  required:
    - event

ServiceExperienceInfo:
  description: Represents service experience information.
  type: object
  properties:
    svcExprc:
      $ref: 'TS29517_Naf_EventExposure.yaml#/components/schemas/SvcExperience'
    svcExprcVariance:
      $ref: 'TS29571_CommonData.yaml#/components/schemas/Float'
    supis:
      type: array

```

```

    items:
      $ref: 'TS29571_CommonData.yaml#/components/schemas/Supi'
    minItems: 1
  snssai:
    $ref: 'TS29571_CommonData.yaml#/components/schemas/Snssai'
  appId:
    $ref: 'TS29571_CommonData.yaml#/components/schemas/ApplicationId'
  srvExpcType:
    $ref: '#/components/schemas/ServiceExperienceType'
  ueLocs:
    type: array
    items:
      $ref: '#/components/schemas/LocationInfo'
    minItems: 1
  upfInfo:
    $ref: 'TS29508_Nsmf_EventExposure.yaml#/components/schemas/UpfInformation'
  dnai:
    $ref: 'TS29571_CommonData.yaml#/components/schemas/Dnai'
  appServerInst:
    $ref: 'TS29517_Naf_EventExposure.yaml#/components/schemas/AddrFqdn'
  confidence:
    $ref: 'TS29571_CommonData.yaml#/components/schemas/UInteger'
  dnn:
    $ref: 'TS29571_CommonData.yaml#/components/schemas/Dnn'
  networkArea:
    $ref: 'TS29554_Npcf_BDTPolicyControl.yaml#/components/schemas/NetworkAreaInfo'
  nsiId:
    $ref: 'TS29531_Nnssf_NSSelection.yaml#/components/schemas/NsiId'
  ratio:
    $ref: 'TS29571_CommonData.yaml#/components/schemas/SamplingRatio'
  ratFreq:
    $ref: '#/components/schemas/RatFreqInformation'
  pduSesInfo:
    $ref: '#/components/schemas/PduSessionInfo'
  required:
    - svcExprc

BwRequirement:
  description: Represents bandwidth requirements.
  type: object
  properties:
    appId:
      $ref: 'TS29571_CommonData.yaml#/components/schemas/ApplicationId'
    marBwDl:
      $ref: 'TS29571_CommonData.yaml#/components/schemas/BitRate'
    marBwUl:
      $ref: 'TS29571_CommonData.yaml#/components/schemas/BitRate'
    mirBwDl:
      $ref: 'TS29571_CommonData.yaml#/components/schemas/BitRate'
    mirBwUl:
      $ref: 'TS29571_CommonData.yaml#/components/schemas/BitRate'
  required:
    - appId

SliceLoadLevelInformation:
  description: Contains load level information applicable for one or several slices.
  type: object
  properties:
    loadLevelInformation:
      $ref: '#/components/schemas/LoadLevelInformation'
    snssais:
      type: array
      items:
        $ref: 'TS29571_CommonData.yaml#/components/schemas/Snssai'
      minItems: 1
      description: Identification(s) of network slice to which the subscription applies.
  required:
    - loadLevelInformation
    - snssais

NsiLoadLevelInfo:
  description: >
    Represents the network slice and optionally the associated network slice instance and the
    load level information.
  type: object
  properties:
    loadLevelInformation:
      $ref: '#/components/schemas/LoadLevelInformation'

```

```

snssai:
  $ref: 'TS29571_CommonData.yaml#/components/schemas/Snssai'
nsiId:
  $ref: 'TS29531_Nnssf_NSSElection.yaml#/components/schemas/NsiId'
resUsage:
  $ref: '#/components/schemas/ResourceUsage'
numOfExceedLoadLevelThr:
  $ref: 'TS29571_CommonData.yaml#/components/schemas/UInteger'
exceedLoadLevelThrInd:
  type: boolean
  description: >
    Indicates whether the Load Level Threshold is met or exceeded by the statistics value.
    Set to "true" if the Load Level Threshold is met or exceeded, otherwise set to "false".
    Shall be present if one of the element in the "listOfAnaSubsets" attribute was set to
    EXCEED_LOAD_LEVEL_THR_IND.
networkArea:
  $ref: 'TS29554_Npcf_BDTPolicyControl.yaml#/components/schemas/NetworkAreaInfo'
timePeriod:
  $ref: 'TS29122_CommonData.yaml#/components/schemas/TimeWindow'
resUsgThrCrossTimePeriod:
  type: array
  items:
    $ref: 'TS29122_CommonData.yaml#/components/schemas/TimeWindow'
  minItems: 1
  description: >
    Each element indicates the time elapsed between times each threshold is met or exceeded
    or crossed. The start time and end time are the exact time stamps of the resource usage
    threshold is reached or exceeded. May be present if the "listOfAnaSubsets" attribute is
    provided and the maximum number of instances shall not exceed the value provided in the
    "numOfExceedLoadLevelThr" attribute.
numOfUes:
  $ref: '#/components/schemas/NumberAverage'
numOfPduSess:
  $ref: '#/components/schemas/NumberAverage'
confidence:
  $ref: 'TS29571_CommonData.yaml#/components/schemas/UInteger'
required:
  - loadLevelInformation
  - snssai

NsiIdInfo:
  description: Represents the S-NSSAI and the optionally associated Network Slice Instance(s).
  type: object
  properties:
    snssai:
      $ref: 'TS29571_CommonData.yaml#/components/schemas/Snssai'
    nsiIds:
      type: array
      items:
        $ref: 'TS29531_Nnssf_NSSElection.yaml#/components/schemas/NsiId'
      minItems: 1
  required:
    - snssai

EventReportingRequirement:
  description: Represents the type of reporting that the subscription requires.
  type: object
  properties:
    accuracy:
      $ref: '#/components/schemas/Accuracy'
    accPerSubset:
      type: array
      items:
        $ref: '#/components/schemas/Accuracy'
      minItems: 1
    description: >
      Each element indicates the preferred accuracy level per analytics subset. It may be
      present if the "listOfAnaSubsets" attribute is present in the subscription request.
    startTs:
      $ref: 'TS29571_CommonData.yaml#/components/schemas/DateTime'
    endTs:
      $ref: 'TS29571_CommonData.yaml#/components/schemas/DateTime'
    offsetPeriod:
      type: integer
      description: >
        Offset period in units of seconds to the reporting time, if the value is negative means
        statistics in the past offset period, otherwise a positive value means prediction in the
        future offset period. May be present if the "repPeriod" attribute is included within the

```

```

    "evtReq" attribute or the "repetitionPeriod" attribute is included within the
    EventSubscription type.
  sampRatio:
    $ref: 'TS29571_CommonData.yaml#/components/schemas/SamplingRatio'
  maxObjectNbr:
    $ref: 'TS29571_CommonData.yaml#/components/schemas/UInteger'
  maxSupiNbr:
    $ref: 'TS29571_CommonData.yaml#/components/schemas/UInteger'
  timeAnaNeeded:
    $ref: 'TS29571_CommonData.yaml#/components/schemas/DateTime'
  anaMeta:
    type: array
    items:
      $ref: '#/components/schemas/AnalyticsMetadata'
    minItems: 1
  anaMetaInd:
    $ref: '#/components/schemas/AnalyticsMetadataIndication'
  histAnaTimePeriod:
    $ref: 'TS29122_CommonData.yaml#/components/schemas/TimeWindow'

TargetUeInformation:
  description: Identifies the target UE information.
  type: object
  properties:
    anyUe:
      type: boolean
      description: >
        Identifies any UE when setting to "true". Default value is "false" if omitted.
    supis:
      type: array
      items:
        $ref: 'TS29571_CommonData.yaml#/components/schemas/Supi'
      minItems: 1
    gpsis:
      type: array
      items:
        $ref: 'TS29571_CommonData.yaml#/components/schemas/Gpsi'
      minItems: 1
    intGroupIds:
      type: array
      items:
        $ref: 'TS29571_CommonData.yaml#/components/schemas/GroupId'
      minItems: 1

UeMobility:
  description: Represents UE mobility information.
  type: object
  properties:
    ts:
      $ref: 'TS29571_CommonData.yaml#/components/schemas/DateTime'
    recurringTime:
      $ref: 'TS29122_CpProvisioning.yaml#/components/schemas/ScheduledCommunicationTime'
    duration:
      $ref: 'TS29571_CommonData.yaml#/components/schemas/DurationSec'
    durationVariance:
      $ref: 'TS29571_CommonData.yaml#/components/schemas/Float'
    locInfos:
      type: array
      items:
        $ref: '#/components/schemas/LocationInfo'
      minItems: 1
    directionInfos:
      type: array
      items:
        $ref: '#/components/schemas/DirectionInfo'
      minItems: 1
  allOf:
    - required: [duration]
    - required: [locInfos]
    - oneOf:
      - required: [ts]
      - required: [recurringTime]

LocationInfo:
  description: Represents UE location information.
  type: object
  properties:
    loc:

```

```

    $ref: 'TS29571_CommonData.yaml#/components/schemas/UserLocation'
  geoLoc:
    $ref: 'TS29522_AMPolicyAuthorization.yaml#/components/schemas/GeographicalArea'
  ratio:
    $ref: 'TS29571_CommonData.yaml#/components/schemas/SamplingRatio'
  confidence:
    $ref: 'TS29571_CommonData.yaml#/components/schemas/Uinteger'
  geoDistrInfos:
    type: array
    items:
      $ref: '#/components/schemas/GeoDistributionInfo'
    minItems: 1
  distThreshold:
    $ref: 'TS29571_CommonData.yaml#/components/schemas/Uinteger'
  required:
    - loc

DirectionInfo:
  description: Represents the UE direction information.
  type: object
  properties:
    supi:
      $ref: 'TS29571_CommonData.yaml#/components/schemas/Supi'
    gpsi:
      $ref: 'TS29571_CommonData.yaml#/components/schemas/Gpsi'
    numOfUe:
      $ref: 'TS29571_CommonData.yaml#/components/schemas/Uinteger'
    avrSpeed:
      $ref: 'TS29571_CommonData.yaml#/components/schemas/Float'
    ratio:
      $ref: 'TS29571_CommonData.yaml#/components/schemas/SamplingRatio'
    direction:
      $ref: '#/components/schemas/Direction'
  required:
    - direction
  oneOf:
    - required: [supi]
    - required: [gpsi]

GeoDistributionInfo:
  description: Represents the geographical distribution of the UEs.
  type: object
  properties:
    loc:
      $ref: 'TS29571_CommonData.yaml#/components/schemas/UserLocation'
    supis:
      type: array
      items:
        $ref: 'TS29571_CommonData.yaml#/components/schemas/Supi'
      minItems: 1
    gpsis:
      type: array
      items:
        $ref: 'TS29571_CommonData.yaml#/components/schemas/Gpsi'
      minItems: 1
  required:
    - loc
  oneOf:
    - required: [supis]
    - required: [gpsis]

UeCommunication:
  description: Represents UE communication information.
  type: object
  properties:
    commDur:
      $ref: 'TS29571_CommonData.yaml#/components/schemas/DurationSec'
    commDurVariance:
      $ref: 'TS29571_CommonData.yaml#/components/schemas/Float'
    perioTime:
      $ref: 'TS29571_CommonData.yaml#/components/schemas/DurationSec'
    perioTimeVariance:
      $ref: 'TS29571_CommonData.yaml#/components/schemas/Float'
    ts:
      $ref: 'TS29571_CommonData.yaml#/components/schemas/DateTime'
    tsVariance:
      $ref: 'TS29571_CommonData.yaml#/components/schemas/Float'
    recurringTime:

```



```

    $ref: 'TS29122_CpProvisioning.yaml#/components/schemas/ScheduledCommunicationTime'
  trafChar:
    $ref: '#/components/schemas/TrafficCharacterization'
  ratio:
    $ref: 'TS29571_CommonData.yaml#/components/schemas/SamplingRatio'
  perioCommInd:
    type: boolean
    description: >
      This attribute indicates whether the UE communicates periodically or not. Set to "true"
      to indicate the UE communicates periodically, otherwise set to "false" or omitted.
  confidence:
    $ref: 'TS29571_CommonData.yaml#/components/schemas/Uinteger'
  anaOfAppList:
    $ref: '#/components/schemas/AppListForUeComm'
  sessInactTimer:
    $ref: '#/components/schemas/SessInactTimerForUeComm'
  allOf:
    - required: [commDur]
    - required: [trafChar]
    - oneOf:
      - required: [ts]
      - required: [recurringTime]
TrafficCharacterization:
  description: Identifies the detailed traffic characterization.
  type: object
  properties:
    dnn:
      $ref: 'TS29571_CommonData.yaml#/components/schemas/Dnn'
    snssai:
      $ref: 'TS29571_CommonData.yaml#/components/schemas/Snssai'
    appId:
      $ref: 'TS29571_CommonData.yaml#/components/schemas/ApplicationId'
    fDescs:
      type: array
      items:
        $ref: '#/components/schemas/IpEthFlowDescription'
      minItems: 1
      maxItems: 2
    ulVol:
      $ref: 'TS29122_CommonData.yaml#/components/schemas/Volume'
    ulVolVariance:
      $ref: 'TS29571_CommonData.yaml#/components/schemas/Float'
    dlVol:
      $ref: 'TS29122_CommonData.yaml#/components/schemas/Volume'
    dlVolVariance:
      $ref: 'TS29571_CommonData.yaml#/components/schemas/Float'
  anyOf:
    - required: [ulVol]
    - required: [dlVol]

UserDataCongestionInfo:
  description: Represents the user data congestion information.
  type: object
  properties:
    networkArea:
      $ref: 'TS29554_Npcf_BDTPolicyControl.yaml#/components/schemas/NetworkAreaInfo'
    congestionInfo:
      $ref: '#/components/schemas/CongestionInfo'
    snssai:
      $ref: 'TS29571_CommonData.yaml#/components/schemas/Snssai'
  required:
    - networkArea
    - congestionInfo

CongestionInfo:
  description: Represents the congestion information.
  type: object
  properties:
    congType:
      $ref: '#/components/schemas/CongestionType'
    timeIntev:
      $ref: 'TS29122_CommonData.yaml#/components/schemas/TimeWindow'
    nsi:
      $ref: '#/components/schemas/ThresholdLevel'
    confidence:
      $ref: 'TS29571_CommonData.yaml#/components/schemas/Uinteger'
    topAppListUl:
      type: array

```

```

    items:
      $ref: '#/components/schemas/TopApplication'
    minItems: 1
  topAppListDl:
    type: array
    items:
      $ref: '#/components/schemas/TopApplication'
    minItems: 1
  required:
    - congType
    - timeIntev
    - nsi

TopApplication:
  description: Top application that contributes the most to the traffic.
  type: object
  properties:
    appId:
      $ref: 'TS29571_CommonData.yaml#/components/schemas/ApplicationId'
    ipTrafficFilter:
      $ref: 'TS29122_CommonData.yaml#/components/schemas/FlowInfo'
    ratio:
      $ref: 'TS29571_CommonData.yaml#/components/schemas/SamplingRatio'
  oneOf:
    - required: [appId]
    - required: [ipTrafficFilter]

QoS Sustainability Info:
  description: Represents the QoS Sustainability information.
  type: object
  properties:
    areaInfo:
      $ref: 'TS29554_Npcf_BDTPolicyControl.yaml#/components/schemas/NetworkAreaInfo'
    fineAreaInfos:
      type: array
      items:
        $ref: 'TS29522_AMPolicyAuthorization.yaml#/components/schemas/GeographicalArea'
      minItems: 1
      description: >
        This attribute contains the geographical locations in a fine granularity.
    startTs:
      $ref: 'TS29571_CommonData.yaml#/components/schemas/DateTime'
    endTs:
      $ref: 'TS29571_CommonData.yaml#/components/schemas/DateTime'
    qosFlowRetThd:
      $ref: '#/components/schemas/RetainabilityThreshold'
    ranUeThrouThd:
      $ref: 'TS29571_CommonData.yaml#/components/schemas/BitRate'
    snssai:
      $ref: 'TS29571_CommonData.yaml#/components/schemas/Snssai'
    confidence:
      $ref: 'TS29571_CommonData.yaml#/components/schemas/Uinteger'
  oneOf:
    - required: [qosFlowRetThd]
    - required: [ranUeThrouThd]

QoS Requirement:
  description: Represents the QoS requirements.
  type: object
  properties:
    5qi:
      $ref: 'TS29571_CommonData.yaml#/components/schemas/5Qi'
    gfbrUl:
      $ref: 'TS29571_CommonData.yaml#/components/schemas/BitRate'
    gfbrDl:
      $ref: 'TS29571_CommonData.yaml#/components/schemas/BitRate'
    resType:
      $ref: 'TS29571_CommonData.yaml#/components/schemas/QoSResourceType'
    pdb:
      $ref: 'TS29571_CommonData.yaml#/components/schemas/PacketDelBudget'
    per:
      $ref: 'TS29571_CommonData.yaml#/components/schemas/PacketErrRate'
    deviceSpeed:
      $ref: 'TS29572_Nlmf_Location.yaml#/components/schemas/VelocityEstimate'
    deviceType:
      $ref: '#/components/schemas/DeviceType'
  oneOf:
    - required: [5qi]

```

```

- required: [resType]

ThresholdLevel:
  description: Represents a threshold level.
  type: object
  properties:
    congLevel:
      type: integer
    nfLoadLevel:
      type: integer
    nfCpuUsage:
      type: integer
    nfMemoryUsage:
      type: integer
    nfStorageUsage:
      type: integer
    avgTrafficRate:
      $ref: 'TS29571_CommonData.yaml#/components/schemas/BitRate'
    maxTrafficRate:
      $ref: 'TS29571_CommonData.yaml#/components/schemas/BitRate'
    minTrafficRate:
      $ref: 'TS29571_CommonData.yaml#/components/schemas/BitRate'
    aggTrafficRate:
      $ref: 'TS29571_CommonData.yaml#/components/schemas/BitRate'
    varTrafficRate:
      $ref: 'TS29571_CommonData.yaml#/components/schemas/Float'
    avgPacketDelay:
      $ref: 'TS29571_CommonData.yaml#/components/schemas/PacketDelBudget'
    maxPacketDelay:
      $ref: 'TS29571_CommonData.yaml#/components/schemas/PacketDelBudget'
    varPacketDelay:
      $ref: 'TS29571_CommonData.yaml#/components/schemas/Float'
    avgPacketLossRate:
      $ref: 'TS29571_CommonData.yaml#/components/schemas/PacketLossRate'
    maxPacketLossRate:
      $ref: 'TS29571_CommonData.yaml#/components/schemas/PacketLossRate'
    varPacketLossRate:
      $ref: 'TS29571_CommonData.yaml#/components/schemas/Float'
    svcExpLevel:
      $ref: 'TS29571_CommonData.yaml#/components/schemas/Float'
    speed:
      $ref: 'TS29571_CommonData.yaml#/components/schemas/Float'

NfLoadLevelInformation:
  description: Represents load level information of a given NF instance.
  type: object
  properties:
    nfType:
      $ref: 'TS29510_Nnrf_NFManagement.yaml#/components/schemas/NFType'
    nfInstanceId:
      $ref: 'TS29571_CommonData.yaml#/components/schemas/NfInstanceId'
    nfSetId:
      $ref: 'TS29571_CommonData.yaml#/components/schemas/NfSetId'
    nfStatus:
      $ref: '#/components/schemas/NfStatus'
    nfCpuUsage:
      type: integer
    nfMemoryUsage:
      type: integer
    nfStorageUsage:
      type: integer
    nfLoadLevelAverage:
      type: integer
    nfLoadLevelpeak:
      type: integer
    nfLoadAvgInAoi:
      type: integer
    snssai:
      $ref: 'TS29571_CommonData.yaml#/components/schemas/Snssai'
    confidence:
      $ref: 'TS29571_CommonData.yaml#/components/schemas/UInteger'
  allOf:
    - required: [nfType]
    - required: [nfInstanceId]
    - anyOf:
      - required: [nfStatus]
      - required: [nfCpuUsage]
      - required: [nfMemoryUsage]

```

- required: [nfStorageUsage]
- required: [nfLoadLevelAverage]
- required: [nfLoadLevelPeak]

NfStatus:

description: Contains the percentage of time spent on various NF states.

type: object

properties:

statusRegistered:

\$ref: 'TS29571_CommonData.yaml#/components/schemas/SamplingRatio'

statusUnregistered:

\$ref: 'TS29571_CommonData.yaml#/components/schemas/SamplingRatio'

statusUndiscoverable:

\$ref: 'TS29571_CommonData.yaml#/components/schemas/SamplingRatio'

anyOf:

- required: [statusRegistered]
- required: [statusUnregistered]
- required: [statusUndiscoverable]

AnySlice:

type: boolean

description: >

"false" represents not applicable for all slices. "true" represents applicable for all slices.

LoadLevelInformation:

type: integer

description: >

Load level information of the network slice and the optionally associated network slice instance.

AbnormalBehaviour:

description: Represents the abnormal behaviour information.

type: object

properties:

supis:

type: array

items:

\$ref: 'TS29571_CommonData.yaml#/components/schemas/Supi'

minItems: 1

except:

\$ref: '#/components/schemas/Exception'

dnn:

\$ref: 'TS29571_CommonData.yaml#/components/schemas/Dnn'

snsai:

\$ref: 'TS29571_CommonData.yaml#/components/schemas/Snsai'

ratio:

\$ref: 'TS29571_CommonData.yaml#/components/schemas/SamplingRatio'

confidence:

\$ref: 'TS29571_CommonData.yaml#/components/schemas/Uinteger'

addtMeasInfo:

\$ref: '#/components/schemas/AdditionalMeasurement'

required:

- except

Exception:

description: Represents the Exception information.

type: object

properties:

exceptId:

\$ref: '#/components/schemas/ExceptionId'

exceptLevel:

type: integer

exceptTrend:

\$ref: '#/components/schemas/ExceptionTrend'

required:

- exceptId

AdditionalMeasurement:

description: Represents additional measurement information.

type: object

properties:

unexpLoc:

\$ref: 'TS29554_Npcf_BDTPolicyControl.yaml#/components/schemas/NetworkAreaInfo'

unexpFlowTeps:

type: array

items:

\$ref: '#/components/schemas/IpEthFlowDescription'

```

    minItems: 1
  unexpWakes:
    type: array
    items:
      $ref: 'TS29571_CommonData.yaml#/components/schemas/DateTime'
    minItems: 1
  ddosAttack:
    $ref: '#/components/schemas/AddressList'
  wrgDest:
    $ref: '#/components/schemas/AddressList'
  circums:
    type: array
    items:
      $ref: '#/components/schemas/CircumstanceDescription'
    minItems: 1

IpEthFlowDescription:
  description: Contains the description of an Uplink and/or Downlink Ethernet flow.
  type: object
  properties:
    ipTrafficFilter:
      $ref: 'TS29514_Npcf_PolicyAuthorization.yaml#/components/schemas/FlowDescription'
    ethTrafficFilter:
      $ref: 'TS29514_Npcf_PolicyAuthorization.yaml#/components/schemas/EthFlowDescription'
  oneOf:
    - required: [ipTrafficFilter]
    - required: [ethTrafficFilter]

AddressList:
  description: Represents a list of IPv4 and/or IPv6 addresses.
  type: object
  properties:
    ipv4Addrs:
      type: array
      items:
        $ref: 'TS29571_CommonData.yaml#/components/schemas/Ipv4Addr'
      minItems: 1
    ipv6Addrs:
      type: array
      items:
        $ref: 'TS29571_CommonData.yaml#/components/schemas/Ipv6Addr'
      minItems: 1

CircumstanceDescription:
  description: Contains the description of a circumstance.
  type: object
  properties:
    freq:
      $ref: 'TS29571_CommonData.yaml#/components/schemas/Float'
    tm:
      $ref: 'TS29571_CommonData.yaml#/components/schemas/DateTime'
    locArea:
      $ref: 'TS29554_Npcf_BDTPolicyControl.yaml#/components/schemas/NetworkAreaInfo'
    vol:
      $ref: 'TS29122_CommonData.yaml#/components/schemas/Volume'

RetainabilityThreshold:
  description: Represents a QoS flow retainability threshold.
  type: object
  properties:
    relFlowNum:
      $ref: 'TS29571_CommonData.yaml#/components/schemas/Uinteger'
    relTimeUnit:
      $ref: '#/components/schemas/TimeUnit'
    relFlowRatio:
      $ref: 'TS29571_CommonData.yaml#/components/schemas/SamplingRatio'
  oneOf:
    - allof:
      - required: [relFlowNum]
      - required: [relTimeUnit]
      - required: [relFlowRatio]

NetworkPerfRequirement:
  description: Represents a network performance requirement.
  type: object
  properties:
    nwPerfType:
      $ref: '#/components/schemas/NetworkPerfType'

```

```

    relativeRatio:
      $ref: 'TS29571_CommonData.yaml#/components/schemas/SamplingRatio'
    absoluteNum:
      $ref: 'TS29571_CommonData.yaml#/components/schemas/UInteger'
    orderCriterion:
      $ref: '#/components/schemas/NetworkPerfOrderCriterion'
    rscUsgReq:
      $ref: '#/components/schemas/ResourceUsageRequirement'
  required:
    - nwPerfType
  not:
    required: [relativeRatio, absoluteNum]

NetworkPerfInfo:
  description: Represents the network performance information.
  type: object
  properties:
    networkArea:
      $ref: 'TS29554_Npcf_BDTPolicyControl.yaml#/components/schemas/NetworkAreaInfo'
    nwPerfType:
      $ref: '#/components/schemas/NetworkPerfType'
    anaPeriod:
      $ref: 'TS29122_CommonData.yaml#/components/schemas/TimeWindow'
    relativeRatio:
      $ref: 'TS29571_CommonData.yaml#/components/schemas/SamplingRatio'
    absoluteNum:
      $ref: 'TS29571_CommonData.yaml#/components/schemas/UInteger'
    rscUsgReq:
      $ref: '#/components/schemas/ResourceUsageRequirement'
    confidence:
      $ref: 'TS29571_CommonData.yaml#/components/schemas/UInteger'
  allOf:
    - required: [networkArea]
    - required: [nwPerfType]
    - oneOf:
      - required: [relativeRatio]
      - required: [absoluteNum]

FailureEventInfo:
  description: Contains information on the event for which the subscription is not successful.
  type: object
  properties:
    event:
      $ref: '#/components/schemas/NwdafEvent'
    failureCode:
      $ref: '#/components/schemas/NwdafFailureCode'
  required:
    - event
    - failureCode

AnalyticsMetadataIndication:
  description: >
    Contains analytics metadata information requested to be used during analytics generation.
  type: object
  properties:
    dataWindow:
      $ref: 'TS29122_CommonData.yaml#/components/schemas/TimeWindow'
    dataStatProps:
      type: array
      items:
        $ref: '#/components/schemas/DatasetStatisticalProperty'
      minItems: 1
    strategy:
      $ref: '#/components/schemas/OutputStrategy'
    aggrNwdafIds:
      type: array
      items:
        $ref: 'TS29571_CommonData.yaml#/components/schemas/NfInstanceId'
      minItems: 1

AnalyticsMetadataInfo:
  description: Contains analytics metadata information required for analytics aggregation.
  type: object
  properties:
    numSamples:
      $ref: 'TS29571_CommonData.yaml#/components/schemas/UInteger'
    dataWindow:
      $ref: 'TS29122_CommonData.yaml#/components/schemas/TimeWindow'

```

```

    dataStatProps:
      type: array
      items:
        $ref: '#/components/schemas/DatasetStatisticalProperty'
      minItems: 1
    strategy:
      $ref: '#/components/schemas/OutputStrategy'
    accuracy:
      $ref: '#/components/schemas/Accuracy'
NumberAverage:
  description: Represents average and variance information.
  type: object
  properties:
    number:
      $ref: 'TS29571_CommonData.yaml#/components/schemas/Float'
    variance:
      $ref: 'TS29571_CommonData.yaml#/components/schemas/Float'
    skewness:
      $ref: 'TS29571_CommonData.yaml#/components/schemas/Float'
  required:
    - number
    - variance

AnalyticsSubscriptionsTransfer:
  description: Contains information about a request to transfer analytics subscriptions.
  type: object
  properties:
    subsTransInfos:
      type: array
      items:
        $ref: '#/components/schemas/SubscriptionTransferInfo'
      minItems: 1
    failTransEventReports:
      type: array
      items:
        $ref: '#/components/schemas/NwdafEvent'
      minItems: 1
  required:
    - subsTransInfos

SubscriptionTransferInfo:
  description: Contains information about subscriptions that are requested to be transferred.
  type: object
  properties:
    transReqType:
      $ref: '#/components/schemas/TransferRequestType'
    nwdafEvSub:
      $ref: '#/components/schemas/NnwdafEventsSubscription'
    consumerId:
      $ref: 'TS29571_CommonData.yaml#/components/schemas/NfInstanceId'
    contextId:
      $ref: '#/components/schemas/AnalyticsContextIdentifier'
    sourceNfIds:
      type: array
      items:
        $ref: 'TS29571_CommonData.yaml#/components/schemas/NfInstanceId'
      minItems: 1
    sourceSetIds:
      type: array
      items:
        $ref: 'TS29571_CommonData.yaml#/components/schemas/NfSetId'
      minItems: 1
    modelInfo:
      type: array
      items:
        $ref: '#/components/schemas/ModelInfo'
      minItems: 1
  required:
    - transReqType
    - nwdafEvSub
    - consumerId

ModelInfo:
  description: Contains information about an ML model.
  type: object
  properties:
    analyticsId:
      $ref: '#/components/schemas/NwdafEvent'

```

```

    mlModelInfos:
      type: array
      items:
        $ref: '#/components/schemas/MLModelInfo'
      minItems: 1
    required:
      - analyticsId
      - mlModelInfos
  MLModelInfo:
    description: Contains information about an ML models.
    type: object
    properties:
      mlFileAdrrs:
        type: array
        items:
          $ref: 'TS29520_NnwdaF_MLModelProvision.yaml#/components/schemas/MLModelAddr'
        minItems: 1
      modelProvId:
        $ref: 'TS29571_CommonData.yaml#/components/schemas/NfInstanceId'
      modelProvSetId:
        $ref: 'TS29571_CommonData.yaml#/components/schemas/NfSetId'
    oneOf:
      - required: [modelProvId]
      - required: [modelProvSetId]

  AnalyticsContextIdentifier:
    description: Contains information about available analytics contexts.
    type: object
    properties:
      subscriptionId:
        type: string
        description: The identifier of a subscription.
      nfAnaCtxts:
        type: array
        items:
          $ref: '#/components/schemas/NwdafEvent'
        minItems: 1
        description: >
          List of analytics types for which NF related analytics contexts can be retrieved.
      ueAnaCtxts:
        type: array
        items:
          $ref: '#/components/schemas/UeAnalyticsContextDescriptor'
        minItems: 1
        description: >
          List of objects that indicate for which SUPI and analytics types combinations analytics
          context can be retrieved.
    allOf:
      - anyOf:
          - required: [nfAnaCtxts]
          - required: [ueAnaCtxts]
      - required: [subscriptionId]

  UeAnalyticsContextDescriptor:
    description: Contains information about available UE related analytics contexts.
    type: object
    properties:
      supi:
        $ref: 'TS29571_CommonData.yaml#/components/schemas/Supi'
      anaTypes:
        type: array
        items:
          $ref: '#/components/schemas/NwdafEvent'
        minItems: 1
        description: >
          List of analytics types for which UE related analytics contexts can be retrieved.
    required:
      - supi
      - anaTypes

  DnPerfInfo:
    description: Represents DN performance information.
    type: object
    properties:
      appId:
        $ref: 'TS29571_CommonData.yaml#/components/schemas/ApplicationId'
      dnn:
        $ref: 'TS29571_CommonData.yaml#/components/schemas/Dnn'

```



```

snssai:
  $ref: 'TS29571_CommonData.yaml#/components/schemas/Snssai'
dnPerf:
  type: array
  items:
    $ref: '#/components/schemas/DnPerf'
  minItems: 1
confidence:
  $ref: 'TS29571_CommonData.yaml#/components/schemas/UInteger'
required:
  - dnPerf

DnPerf:
description: Represents DN performance for the application.
type: object
properties:
  appServerInsAddr:
    $ref: 'TS29517_Naf_EventExposure.yaml#/components/schemas/AddrFqdn'
  upfInfo:
    $ref: 'TS29508_Nsmf_EventExposure.yaml#/components/schemas/UpfInformation'
  dnai:
    $ref: 'TS29571_CommonData.yaml#/components/schemas/Dnai'
  perfData:
    $ref: '#/components/schemas/PerfData'
  spatialValidCon:
    $ref: 'TS29554_Npcf_BDTPolicyControl.yaml#/components/schemas/NetworkAreaInfo'
  temporalValidCon:
    $ref: 'TS29122_CommonData.yaml#/components/schemas/TimeWindow'
required:
  - perfData

PerfData:
description: Represents DN performance data.
type: object
properties:
  avgTrafficRate:
    $ref: 'TS29571_CommonData.yaml#/components/schemas/BitRate'
  maxTrafficRate:
    $ref: 'TS29571_CommonData.yaml#/components/schemas/BitRate'
  minTrafficRate:
    $ref: 'TS29571_CommonData.yaml#/components/schemas/BitRate'
  aggTrafficRate:
    $ref: 'TS29571_CommonData.yaml#/components/schemas/BitRate'
  varTrafficRate:
    $ref: 'TS29571_CommonData.yaml#/components/schemas/Float'
  trafRateUeIds:
    type: array
    items:
      $ref: 'TS29571_CommonData.yaml#/components/schemas/Supi'
    minItems: 1
  avePacketDelay:
    $ref: 'TS29571_CommonData.yaml#/components/schemas/PacketDelBudget'
  maxPacketDelay:
    $ref: 'TS29571_CommonData.yaml#/components/schemas/PacketDelBudget'
  varPacketDelay:
    $ref: 'TS29571_CommonData.yaml#/components/schemas/Float'
  packDelayUeIds:
    type: array
    items:
      $ref: 'TS29571_CommonData.yaml#/components/schemas/Supi'
    minItems: 1
  avgPacketLossRate:
    $ref: 'TS29571_CommonData.yaml#/components/schemas/PacketLossRate'
  maxPacketLossRate:
    $ref: 'TS29571_CommonData.yaml#/components/schemas/PacketLossRate'
  varPacketLossRate:
    $ref: 'TS29571_CommonData.yaml#/components/schemas/Float'
  packLossUeIds:
    type: array
    items:
      $ref: 'TS29571_CommonData.yaml#/components/schemas/Supi'
    minItems: 1
  numOfUe:
    $ref: 'TS29571_CommonData.yaml#/components/schemas/UInteger'

DispersionRequirement:
description: Represents the dispersion analytics requirements.
type: object

```

```

properties:
  disperType:
    $ref: '#/components/schemas/DispersionType'
  classCriters:
    type: array
    items:
      $ref: '#/components/schemas/ClassCriterion'
    minItems: 1
  rankCriters:
    type: array
    items:
      $ref: '#/components/schemas/RankingCriterion'
    minItems: 1
  dispOrderCriter:
    $ref: '#/components/schemas/DispersionOrderingCriterion'
  order:
    $ref: '#/components/schemas/MatchingDirection'
required:
  - disperType

ClassCriterion:
description: >
  Indicates the dispersion class criterion for fixed, camper and/or traveller UE, and/or the
  top-heavy UE dispersion class criterion.
type: object
properties:
  disperClass:
    $ref: '#/components/schemas/DispersionClass'
  classThreshold:
    $ref: 'TS29571_CommonData.yaml#/components/schemas/SamplingRatio'
  thresMatch:
    $ref: '#/components/schemas/MatchingDirection'
required:
  - disperClass
  - classThreshold
  - thresMatch

RankingCriterion:
description: Indicates the usage ranking criterion between the high, medium and low usage UE.
type: object
properties:
  highBase:
    $ref: 'TS29571_CommonData.yaml#/components/schemas/SamplingRatio'
  lowBase:
    $ref: 'TS29571_CommonData.yaml#/components/schemas/SamplingRatio'
required:
  - highBase
  - lowBase

DispersionInfo:
description: >
  Represents the Dispersion information. When subscribed event is "DISPERSION", the
  "disperInfos" attribute shall be included.
type: object
properties:
  tsStart:
    $ref: 'TS29571_CommonData.yaml#/components/schemas/DateTime'
  tsDuration:
    $ref: 'TS29571_CommonData.yaml#/components/schemas/DurationSec'
  disperCollects:
    type: array
    items:
      $ref: '#/components/schemas/DispersionCollection'
    minItems: 1
  disperType:
    $ref: '#/components/schemas/DispersionType'
required:
  - tsStart
  - tsDuration
  - disperCollects
  - disperType

DispersionCollection:
description: Dispersion collection per UE location or per slice.
type: object
properties:
  ueLoc:
    $ref: 'TS29571_CommonData.yaml#/components/schemas/UserLocation'

```

```

snssai:
  $ref: 'TS29571_CommonData.yaml#/components/schemas/Snssai'
supis:
  type: array
  items:
    $ref: 'TS29571_CommonData.yaml#/components/schemas/Supi'
  minItems: 1
gpsis:
  type: array
  items:
    $ref: 'TS29571_CommonData.yaml#/components/schemas/Gpsi'
  minItems: 1
appVolumes:
  type: array
  items:
    $ref: '#/components/schemas/ApplicationVolume'
  minItems: 1
disperAmount:
  $ref: 'TS29571_CommonData.yaml#/components/schemas/Uinteger'
disperClass:
  $ref: '#/components/schemas/DispersionClass'
usageRank:
  type: integer
  description: Integer where the allowed values correspond to 1, 2, 3 only.
  minimum: 1
  maximum: 3
percentileRank:
  $ref: 'TS29571_CommonData.yaml#/components/schemas/SamplingRatio'
ueRatio:
  $ref: 'TS29571_CommonData.yaml#/components/schemas/SamplingRatio'
confidence:
  $ref: 'TS29571_CommonData.yaml#/components/schemas/Uinteger'
allof:
  - oneOf:
    - required: [ueLoc]
    - required: [snssai]
  - anyOf:
    - required: [disperAmount]
    - required: [disperClass]
    - required: [usageRank]
    - required: [percentileRank]

ApplicationVolume:
  description: Application data volume per Application Id.
  type: object
  properties:
    appId:
      $ref: 'TS29571_CommonData.yaml#/components/schemas/ApplicationId'
    appVolume:
      $ref: 'TS29122_CommonData.yaml#/components/schemas/Volume'
  required:
    - appId
    - appVolume

RedundantTransmissionExpReq:
  description: Represents other redundant transmission experience analytics requirements.
  type: object
  properties:
    redTOrderCriter:
      $ref: '#/components/schemas/RedTransExpOrderingCriterion'
    order:
      $ref: '#/components/schemas/MatchingDirection'

RedundantTransmissionExpInfo:
  description: >
  The redundant transmission experience related information. When subscribed event is
  "RED_TRANS_EXP", the "redTransInfos" attribute shall be included.
  type: object
  properties:
    spatialValidCon:
      $ref: 'TS29554_Npcf_BDTPolicyControl.yaml#/components/schemas/NetworkAreaInfo'
    dnn:
      $ref: 'TS29571_CommonData.yaml#/components/schemas/Dnn'
    redTransExps:
      type: array
      items:
        $ref: '#/components/schemas/RedundantTransmissionExpPerTS'
      minItems: 1

```

```

required:
  - redTransExps

RedundantTransmissionExpPerTS:
description: The redundant transmission experience per Time Slot.
type: object
properties:
  tsStart:
    $ref: 'TS29571_CommonData.yaml#/components/schemas/DateTime'
  tsDuration:
    $ref: 'TS29571_CommonData.yaml#/components/schemas/DurationSec'
  obsvRedTransExp:
    $ref: '#/components/schemas/ObservedRedundantTransExp'
  redTransStatus:
    type: boolean
    description: >
      Redundant Transmission Status. Set to "true" if redundant transmission was activated,
      otherwise set to "false". Default value is "false" if omitted.
  ueRatio:
    $ref: 'TS29571_CommonData.yaml#/components/schemas/SamplingRatio'
  confidence:
    $ref: 'TS29571_CommonData.yaml#/components/schemas/UInteger'
required:
  - tsStart
  - tsDuration
  - obsvRedTransExp

ObservedRedundantTransExp:
description: Represents the observed redundant transmission experience related information.
type: object
properties:
  avgPktDropRateUl:
    $ref: 'TS29571_CommonData.yaml#/components/schemas/PacketLossRate'
  varPktDropRateUl:
    $ref: 'TS29571_CommonData.yaml#/components/schemas/Float'
  avgPktDropRateDl:
    $ref: 'TS29571_CommonData.yaml#/components/schemas/PacketLossRate'
  varPktDropRateDl:
    $ref: 'TS29571_CommonData.yaml#/components/schemas/Float'
  avgPktDelayUl:
    $ref: 'TS29571_CommonData.yaml#/components/schemas/PacketDelBudget'
  varPktDelayUl:
    $ref: 'TS29571_CommonData.yaml#/components/schemas/Float'
  avgPktDelayDl:
    $ref: 'TS29571_CommonData.yaml#/components/schemas/PacketDelBudget'
  varPktDelayDl:
    $ref: 'TS29571_CommonData.yaml#/components/schemas/Float'
  avgE2ePktDelayUl:
    $ref: 'TS29571_CommonData.yaml#/components/schemas/PacketDelBudget'
  varE2ePktDelayUl:
    $ref: 'TS29571_CommonData.yaml#/components/schemas/Float'
  avgE2ePktDelayDl:
    $ref: 'TS29571_CommonData.yaml#/components/schemas/PacketDelBudget'
  varE2ePktDelayDl:
    $ref: 'TS29571_CommonData.yaml#/components/schemas/Float'
  avgE2ePktLossRateUl:
    $ref: 'TS29571_CommonData.yaml#/components/schemas/PacketLossRate'
  varE2ePktLossRateUl:
    $ref: 'TS29571_CommonData.yaml#/components/schemas/Float'
  avgE2ePktLossRateDl:
    $ref: 'TS29571_CommonData.yaml#/components/schemas/PacketLossRate'
  varE2ePktLossRateDl:
    $ref: 'TS29571_CommonData.yaml#/components/schemas/Float'

WlanPerformanceReq:
description: Represents other WLAN performance analytics requirements.
type: object
properties:
  ssIds:
    type: array
    items:
      type: string
    minItems: 1
  bssIds:
    type: array
    items:
      type: string
    minItems: 1
  wlanOrderCriter:

```

```

    $ref: '#/components/schemas/WlanOrderingCriterion'
  order:
    $ref: '#/components/schemas/MatchingDirection'

WlanPerformanceInfo:
  description: The WLAN performance related information.
  type: object
  properties:
    networkArea:
      $ref: 'TS29554_Npcf_BDTPolicyControl.yaml#/components/schemas/NetworkAreaInfo'
    wlanPerSsidInfos:
      type: array
      items:
        $ref: '#/components/schemas/WlanPerSsidPerformanceInfo'
      minItems: 1
    wlanPerUeIdInfos:
      type: array
      items:
        $ref: '#/components/schemas/WlanPerUeIdPerformanceInfo'
      minItems: 1
      description: >
        WLAN performance information for UE Id(s) of WLAN access points deployed in the Area
        of Interest.
  required:
    - wlanPerSsidInfos

WlanPerSsidPerformanceInfo:
  description: The WLAN performance per SSID.
  type: object
  properties:
    ssid:
      type: string
    wlanPerTsInfos:
      type: array
      items:
        $ref: '#/components/schemas/WlanPerTsPerformanceInfo'
      minItems: 1
  required:
    - ssid
    - wlanPerTsInfos

WlanPerUeIdPerformanceInfo:
  description: The WLAN performance per UE ID.
  type: object
  properties:
    supi:
      $ref: 'TS29571_CommonData.yaml#/components/schemas/Supi'
    gpsi:
      $ref: 'TS29571_CommonData.yaml#/components/schemas/Gpsi'
    wlanPerTsInfos:
      type: array
      items:
        $ref: '#/components/schemas/WlanPerTsPerformanceInfo'
      minItems: 1
      description: >
        WLAN performance information per Time Slot during the analytics target period.
  required:
    - wlanPerTsInfos
  oneOf:
    - required: [supi]
    - required: [gpsi]

WlanPerTsPerformanceInfo:
  description: WLAN performance information per Time Slot during the analytics target period.
  type: object
  properties:
    tsStart:
      $ref: 'TS29571_CommonData.yaml#/components/schemas/DateTime'
    tsDuration:
      $ref: 'TS29571_CommonData.yaml#/components/schemas/DurationSec'
    rssi:
      type: integer
    rtt:
      $ref: 'TS29571_CommonData.yaml#/components/schemas/Uinteger'
    trafficInfo:
      $ref: '#/components/schemas/TrafficInformation'
    numberOfUes:
      $ref: 'TS29571_CommonData.yaml#/components/schemas/Uinteger'

```

```

    confidence:
      $ref: 'TS29571_CommonData.yaml#/components/schemas/UInteger'
  required:
    - tsStart
    - tsDuration
  anyOf:
    - required: [rssi]
    - required: [rtt]
    - required: [trafficInfo]
    - required: [numberOfUes]

TrafficInformation:
  description: Traffic information including UL/DL data rate and/or Traffic volume.
  type: object
  properties:
    uplinkRate:
      $ref: 'TS29571_CommonData.yaml#/components/schemas/BitRate'
    downlinkRate:
      $ref: 'TS29571_CommonData.yaml#/components/schemas/BitRate'
    uplinkVolume:
      $ref: 'TS29122_CommonData.yaml#/components/schemas/Volume'
    downlinkVolume:
      $ref: 'TS29122_CommonData.yaml#/components/schemas/Volume'
    totalVolume:
      $ref: 'TS29122_CommonData.yaml#/components/schemas/Volume'
  anyOf:
    - required: [uplinkRate]
    - required: [downlinkRate]
    - required: [uplinkVolume]
    - required: [downlinkVolume]
    - required: [totalVolume]

AppListForUeComm:
  description: Represents the analytics of the application list used by UE.
  type: object
  properties:
    appId:
      $ref: 'TS29571_CommonData.yaml#/components/schemas/ApplicationId'
    startTime:
      $ref: 'TS29571_CommonData.yaml#/components/schemas/DateTime'
    appDur:
      $ref: 'TS29571_CommonData.yaml#/components/schemas/DurationSec'
    occurRatio:
      $ref: 'TS29571_CommonData.yaml#/components/schemas/SamplingRatio'
    spatialValidity:
      $ref: 'TS29554_Npcf_BDTPolicyControl.yaml#/components/schemas/NetworkAreaInfo'
  required:
    - appId

SessInactTimerForUeComm:
  description: Represents the N4 Session inactivity timer.
  type: object
  properties:
    n4SessId:
      $ref: 'TS29571_CommonData.yaml#/components/schemas/PduSessionId'
    sessInactiveTimer:
      $ref: 'TS29571_CommonData.yaml#/components/schemas/DurationSec'
  required:
    - n4SessId
    - sessInactiveTimer

DnPerformanceReq:
  description: Represents other DN performance analytics requirements.
  type: object
  properties:
    dnPerfOrderCriter:
      $ref: '#/components/schemas/DnPerfOrderingCriterion'
    order:
      $ref: '#/components/schemas/MatchingDirection'
    reportThresholds:
      type: array
      items:
        $ref: '#/components/schemas/ThresholdLevel'
    minItems: 1

RatFreqInformation:
  description: Represents the RAT type and/or Frequency information.
  type: object

```

```

properties:
  allFreq:
    type: boolean
    description: >
      Set to "true" to indicate to handle all the frequencies the NWDAF received, otherwise
      set to "false" or omit. The "allFreq" attribute and the "freq" attribute are mutually
      exclusive.
  allRat:
    type: boolean
    description: >
      Set to "true" to indicate to handle all the RAT Types the NWDAF received, otherwise
      set to "false" or omit. The "allRat" attribute and the "ratType" attribute are mutually
      exclusive.
  freq:
    $ref: 'TS29571_CommonData.yaml#/components/schemas/ArfcnValueNR'
  ratType:
    $ref: 'TS29571_CommonData.yaml#/components/schemas/RatType'
  svcExpThreshold:
    $ref: '#/components/schemas/ThresholdLevel'
  matchingDir:
    $ref: '#/components/schemas/MatchingDirection'

PrevSubInfo:
  description: Information of the previous subscription.
  type: object
  properties:
    producerId:
      $ref: 'TS29571_CommonData.yaml#/components/schemas/NfInstanceId'
    producerSetId:
      $ref: 'TS29571_CommonData.yaml#/components/schemas/NfSetId'
    subscriptionId:
      type: string
      description: The identifier of a subscription.
    nfAnaEvents:
      type: array
      items:
        $ref: '#/components/schemas/NwdafEvent'
      minItems: 1
    ueAnaEvents:
      type: array
      items:
        $ref: '#/components/schemas/UeAnalyticsContextDescriptor'
      minItems: 1
  required:
  - subscriptionId
  oneOf:
  - required: [producerId]
  - required: [producerSetId]

ResourceUsage:
  description: >
    The current usage of the virtual resources assigned to the NF instances belonging to a
    particular network slice instance.
  type: object
  properties:
    cpuUsage:
      $ref: 'TS29571_CommonData.yaml#/components/schemas/Uinteger'
    memoryUsage:
      $ref: 'TS29571_CommonData.yaml#/components/schemas/Uinteger'
    storageUsage:
      $ref: 'TS29571_CommonData.yaml#/components/schemas/Uinteger'

ConsumerNfInformation:
  description: Represents the analytics consumer NF Information.
  type: object
  properties:
    nfId:
      $ref: 'TS29571_CommonData.yaml#/components/schemas/NfInstanceId'
    nfSetId:
      $ref: 'TS29571_CommonData.yaml#/components/schemas/NfSetId'
    taiList:
      type: array
      items:
        $ref: 'TS29571_CommonData.yaml#/components/schemas/Tai'
      minItems: 1
  oneOf:
  - oneOf:
    - required: [nfId]

```

```

    - required: [nfSetId]
    - required: [taiList]

UeCommReq:
  description: UE communication analytics requirement.
  type: object
  properties:
    orderCriterion:
      $ref: '#/components/schemas/UeCommOrderCriterion'
    orderDirection:
      $ref: '#/components/schemas/MatchingDirection'
UeMobilityReq:
  description: UE mobility analytics requirement.
  type: object
  properties:
    orderCriterion:
      $ref: '#/components/schemas/UeMobilityOrderCriterion'
    orderDirection:
      $ref: '#/components/schemas/MatchingDirection'
    ueLocOrderInd:
      type: boolean
      description: >
        UE Location order indication. Set to "true" to indicate the NWDAF to provide UE
        locations in the UE Mobility analytics in time order, otherwise set to "false" or
        omitted.
    distThresholds:
      type: array
      items:
        $ref: 'TS29571_CommonData.yaml#/components/schemas/UInteger'
      minItems: 1
      description: Indicates the linear distance threshold.

PduSessionInfo:
  description: Represents combination of PDU Session parameter(s) information.
  type: object
  properties:
    pduSessType:
      $ref: 'TS29571_CommonData.yaml#/components/schemas/PduSessionType'
    sscMode:
      $ref: 'TS29571_CommonData.yaml#/components/schemas/ScsMode'
    accessTypes:
      type: array
      items:
        $ref: 'TS29571_CommonData.yaml#/components/schemas/AccessType'
      minItems: 1

PfdDeterminationInfo:
  description: Represents the PFD Determination information for a known application identifier.
  type: object
  properties:
    appId:
      $ref: 'TS29571_CommonData.yaml#/components/schemas/ApplicationId'
    suggPfdInfoList:
      type: array
      items:
        $ref: '#/components/schemas/SuggestedPfdInfo'
      minItems: 1
  required:
    - appId
    - suggPfdInfoList

SuggestedPfdInfo:
  description: Represents the suggested PFD information for the application identifier.
  type: object
  properties:
    pfdId:
      type: string
      description: >
        Identifier of the PFD (i.e. new PFD ID assigned by NWDAF or existing PFD ID retrieved
        from UDR which was generated by NWDAF).
    ip3TupleList:
      type: array
      items:
        type: string
      minItems: 1
      description: >
        Represents a 3-tuple with protocol, server ip and server port for UL/DL
        application traffic. The content of the string has the same encoding as the IPFilterRule

```



```

    AVP value as defined in IETF RFC 6733.
  urls:
    type: array
    items:
      type: string
    minItems: 1
    description: Represents the significant parts of the URL to be matched, e.g. host name.
  domainNames:
    type: array
    items:
      type: string
    minItems: 1
    description: Represents Domain name matching criteria.
  dnProtocol:
    $ref: 'TS29122_PfdManagement.yaml#/components/schemas/DomainNameProtocol'
  pfdConfidence:
    $ref: 'TS29571_CommonData.yaml#/components/schemas/UInteger'
  required:
    - pfdId

PduSesTrafficInfo:
  description: Represents the PDU Set traffic analytics information.
  type: object
  properties:
    supis:
      type: array
      items:
        $ref: 'TS29571_CommonData.yaml#/components/schemas/Supi'
      minItems: 1
    dnn:
      $ref: 'TS29571_CommonData.yaml#/components/schemas/Dnn'
    snssai:
      $ref: 'TS29571_CommonData.yaml#/components/schemas/Snssai'
    tdMatchTrafs:
      type: array
      items:
        $ref: '#/components/schemas/TdTraffic'
      minItems: 1
    tdUnmatchTrafs:
      type: array
      items:
        $ref: '#/components/schemas/TdTraffic'
      minItems: 1
  allOf:
    - anyOf:
      - required: [dnn]
      - required: [snssai]
    - anyOf:
      - required: [tdMatchTrafs]
      - required: [tdUnmatchTrafs]

TdTraffic:
  description: Represents traffic that matches or unmatches Traffic Descriptor of URSP rule.
  type: object
  properties:
    pduSesTrafReqs:
      type: array
      items:
        $ref: '#/components/schemas/PduSesTrafficReq'
      minItems: 1
    ulVol:
      $ref: 'TS29122_CommonData.yaml#/components/schemas/Volume'
    dlVol:
      $ref: 'TS29122_CommonData.yaml#/components/schemas/Volume'
    allVol:
      $ref: 'TS29122_CommonData.yaml#/components/schemas/Volume'
    ulNumOfPkt:
      $ref: 'TS29571_CommonData.yaml#/components/schemas/UInteger'
    dlNumOfPkt:
      $ref: 'TS29571_CommonData.yaml#/components/schemas/UInteger'
    allNumOfPkt:
      $ref: 'TS29571_CommonData.yaml#/components/schemas/UInteger'

PduSesTrafficReq:
  description: Represents the PDU Session traffic analytics requirements.
  type: object
  properties:
    flowDescs:

```

```

    type: array
    items:
      $ref: 'TS29514_Npcf_PolicyAuthorization.yaml#/components/schemas/FlowDescription'
    minItems: 1
    description: >
      Indicates traffic flow filtering description(s) for IP flow(s).
  appId:
    $ref: 'TS29571_CommonData.yaml#/components/schemas/ApplicationId'
  domainDescs:
    type: array
    items:
      type: string
    minItems: 1
    description: >
      FQDN(s) or a regular expression which are used as a domain name matching criteria.
  oneOf:
    - required: [flowDescs]
    - required: [appId]
    - required: [domainDescs]

ResourceUsageRequirement:
  description: resource usage requirement.
  type: object
  properties:
    tfcDir:
      $ref: '#/components/schemas/TrafficDirection'
    valExp:
      $ref: '#/components/schemas/ValueExpression'

E2eDataVolTransTimeReq:
  description: Represents other E2E data volume transfer time analytics requirements.
  type: object
  properties:
    criterion:
      $ref: '#/components/schemas/E2eDataVolTransTimeCriterion'
    order:
      $ref: '#/components/schemas/MatchingDirection'
    highTransTmThr:
      $ref: 'TS29571_CommonData.yaml#/components/schemas/UInteger'
    lowTransTmThr:
      $ref: 'TS29571_CommonData.yaml#/components/schemas/UInteger'
    repeatDataTrans:
      $ref: 'TS29571_CommonData.yaml#/components/schemas/UInteger'
    tsIntervalDataTrans:
      $ref: 'TS29571_CommonData.yaml#/components/schemas/DurationSec'
    dataVolume:
      $ref: '#/components/schemas/DataVolume'
    maxNumberUes:
      $ref: 'TS29571_CommonData.yaml#/components/schemas/UInteger'
  oneOf:
    - required: [repeatDataTrans]
    - required: [tsIntervalDataTrans]

DataVolume:
  description: Data Volume including UL/DL.
  type: object
  properties:
    uplinkVolume:
      $ref: 'TS29122_CommonData.yaml#/components/schemas/Volume'
    downlinkVolume:
      $ref: 'TS29122_CommonData.yaml#/components/schemas/Volume'
  anyOf:
    - required: [uplinkVolume]
    - required: [downlinkVolume]

E2eDataVolTransTimeInfo:
  description: >
    Represents the E2E data volume transfer time analytics information when subscribed event is
    "E2E_DATA_VOL_TRANS_TIME", the "dataVlTrnsTmInfos" attribute shall be included.
  type: object
  properties:
    e2eDataVolTransTimes:
      type: array
      items:
        $ref: '#/components/schemas/E2eDataVolTransTimePerTS'
      minItems: 1
    e2eDataVolTransTimeUeLists:
      type: array

```

```

    items:
      $ref: '#/components/schemas/E2eDataVolTransTimeUeList'
    minItems: 1
  geoDistrInfos:
    type: array
    items:
      $ref: '#/components/schemas/GeoDistributionInfo'
    minItems: 1
  confidence:
    $ref: 'TS29571_CommonData.yaml#/components/schemas/UInteger'
  required:
    - e2eDataVolTransTimes

E2eDataVolTransTimePerTS:
  description: Represents the E2E data volume transfer time analytics per Time Slot.
  type: object
  properties:
    tsStart:
      $ref: 'TS29571_CommonData.yaml#/components/schemas/DateTime'
    tsDuration:
      $ref: 'TS29571_CommonData.yaml#/components/schemas/DurationSec'
    e2eDataVolTransTimePerUe:
      type: array
      items:
        $ref: '#/components/schemas/E2eDataVolTransTimePerUe'
      minItems: 1
  required:
    - tsStart
    - tsDuration
    - e2eDataVolTransTimePerUe

E2eDataVolTransTimePerUe:
  description: Represents the E2E data volume transfer time per UE.
  type: object
  properties:
    supi:
      $ref: 'TS29571_CommonData.yaml#/components/schemas/Supi'
    gpsi:
      $ref: 'TS29571_CommonData.yaml#/components/schemas/Gpsi'
    snssai:
      $ref: 'TS29571_CommonData.yaml#/components/schemas/Snssai'
    accessType:
      $ref: 'TS29571_CommonData.yaml#/components/schemas/AccessType'
    ratTypes:
      type: array
      items:
        $ref: 'TS29571_CommonData.yaml#/components/schemas/RatType'
      minItems: 1
      description: The RAT types.
    appId:
      $ref: 'TS29571_CommonData.yaml#/components/schemas/ApplicationId'
    ueLoc:
      $ref: 'TS29571_CommonData.yaml#/components/schemas/UserLocation'
    dnn:
      $ref: 'TS29571_CommonData.yaml#/components/schemas/Dnn'
    spatialValidity:
      $ref: 'TS29554_Npcf_BDTPolicyControl.yaml#/components/schemas/NetworkAreaInfo'
    validityPeriod:
      $ref: 'TS29122_CommonData.yaml#/components/schemas/TimeWindow'
    dataVolTransTime:
      $ref: '#/components/schemas/DataVolumeTransferTime'
  oneOf:
    - required: [ueLoc]
    - required: [snssai]

E2eDataVolTransTimeUeList:
  description: >
    Contains the list of UEs classified based on experience level of E2E Data Volume Transfer
    Time
  type: object
  properties:
    highLevel:
      type: array
      items:
        $ref: 'TS29571_CommonData.yaml#/components/schemas/Supi'
      minItems: 1
    mediumLevel:
      type: array

```

```

    items:
      $ref: 'TS29571_CommonData.yaml#/components/schemas/Supi'
    minItems: 1
  lowLevel:
    type: array
    items:
      $ref: 'TS29571_CommonData.yaml#/components/schemas/Supi'
    minItems: 1
  lowRatio:
    $ref: 'TS29571_CommonData.yaml#/components/schemas/SamplingRatio'
  mediumRatio:
    $ref: 'TS29571_CommonData.yaml#/components/schemas/SamplingRatio'
  highRatio:
    $ref: 'TS29571_CommonData.yaml#/components/schemas/SamplingRatio'
  spatialValidity:
    $ref: 'TS29554_Npcf_BDTPolicyControl.yaml#/components/schemas/NetworkAreaInfo'
  validityPeriod:
    $ref: 'TS29122_CommonData.yaml#/components/schemas/TimeWindow'
  anyOf:
    - required: [highLevel]
    - required: [mediumLevel]
    - required: [lowLevel]

DataVolumeTransferTime:
  description: >
    Indicates the E2E data volume transfer time and the data volume used to derive the transfer
    time.
  type: object
  properties:
    uplinkVolume:
      $ref: 'TS29122_CommonData.yaml#/components/schemas/Volume'
    avgTransTimeUl:
      $ref: 'TS29571_CommonData.yaml#/components/schemas/Uinteger'
    varTransTimeUl:
      $ref: 'TS29571_CommonData.yaml#/components/schemas/Float'
    downlinkVolume:
      $ref: 'TS29122_CommonData.yaml#/components/schemas/Volume'
    avgTransTimeDl:
      $ref: 'TS29571_CommonData.yaml#/components/schemas/Uinteger'
    varTransTimeDl:
      $ref: 'TS29571_CommonData.yaml#/components/schemas/Float'

GeoLocation:
  description: >
    Represents a horizontal and optionally vertical location using either geographic
    or local coordinates.
  type: object
  properties:
    point:
      $ref: 'TS29572_Nlmf_Location.yaml#/components/schemas/Point'
    pointAlt:
      $ref: 'TS29572_Nlmf_Location.yaml#/components/schemas/PointAltitude'
    refPoint:
      $ref: 'TS29572_Nlmf_Location.yaml#/components/schemas/LocalOrigin'
    localCoords:
      $ref: 'TS29572_Nlmf_Location.yaml#/components/schemas/RelativeCartesianLocation'
  anyOf:
    - required: [point]
    - required: [pointAlt]
    - allOf:
      - required: [refPoint]
      - required: [localCoords]

LocAccuracyReq:
  description: >
    Contains location accuracy analytics requirements.
  type: object
  properties:
    accThres:
      $ref: 'TS29571_CommonData.yaml#/components/schemas/Uinteger'
    accThresMatchDir:
      $ref: '#/components/schemas/MatchingDirection'
    inOutThres:
      $ref: 'TS29571_CommonData.yaml#/components/schemas/Uinteger'
    inOutThresMatchDir:
      $ref: '#/components/schemas/MatchingDirection'
    posMethod:
      $ref: 'TS29572_Nlmf_Location.yaml#/components/schemas/PositioningMethod'

```

```

LocAccuracyInfo:
  description: >
    Contains location accuracy analytics.
  type: object
  properties:
    locAccPerMeths:
      type: array
      items:
        $ref: '#/components/schemas/LocAccuracyPerMethod'
      minItems: 1
      description: Location accuracy information per positioning method.
    inOutUePct:
      $ref: 'TS29571_CommonData.yaml#/components/schemas/UInteger'
    inOutInd:
      type: boolean
      description: Indicates if the target location is indoors or outdoors.
    confidence:
      $ref: 'TS29571_CommonData.yaml#/components/schemas/UInteger'
  required:
    - locAccPerMeths
  not:
    required: [inOutUePct, inOutInd]

LocAccuracyPerMethod:
  description: >
    Contains location accuracy analytics per positioning method.
  type: object
  properties:
    posMethod:
      $ref: 'TS29572_Nlmf_Location.yaml#/components/schemas/PositioningMethod'
    locAcc:
      $ref: 'TS29571_CommonData.yaml#/components/schemas/UInteger'
    losNlosPct:
      $ref: 'TS29571_CommonData.yaml#/components/schemas/UInteger'
    losNlosInd:
      type: boolean
      description: Indicates whether the target location is measured with LOS or NLOS.
  required:
    - posMethod
    - locAcc

AccuracyReq:
  description: Represents the analytics accuracy requirement information.
  type: object
  properties:
    accuTimeWin:
      $ref: 'TS29122_CommonData.yaml#/components/schemas/TimeWindow'
    accuPeriod:
      $ref: 'TS29571_CommonData.yaml#/components/schemas/DurationSec'
    accuDevThr:
      $ref: 'TS29571_CommonData.yaml#/components/schemas/UInteger'
    minNum:
      $ref: 'TS29571_CommonData.yaml#/components/schemas/UInteger'
    updatedAnaFlg:
      type: boolean
      description: >
        Indicates the updated Analytics flag. Set to "true" indicates that the NWDAF can provide
        the updated analytics if the analytics can be generated within the analytics accuracy
        information time window, which is specified by "accuTimeWin" attribute.
        Otherwise set to "false". Default value is "false" if omitted.
    correctionInterval:
      $ref: 'TS29571_CommonData.yaml#/components/schemas/DurationSec'

AccuracyInfo:
  description: The analytics accuracy information.
  type: object
  properties:
    accuracyVal:
      $ref: 'TS29571_CommonData.yaml#/components/schemas/UInteger'
    accuSampleNbr:
      $ref: 'TS29571_CommonData.yaml#/components/schemas/UInteger'
    anaAccuInd:
      $ref: '#/components/schemas/AnalyticsAccuracyIndication'
  required:
    - accuracyVal

```

```
MovBehavReq:
  description: Represents the Movement Behaviour analytics requirements.
  type: object
  properties:
    locationGranReq:
      $ref: '#/components/schemas/LocInfoGranularity'
    reportThresholds:
      $ref: '#/components/schemas/ThresholdLevel'

MovBehavInfo:
  description: Represents the Movement Behaviour information.
  type: object
  properties:
    geoLoc:
      $ref: 'TS29572_Nlmf_Location.yaml#/components/schemas/GeographicalCoordinates'
    movBehavs:
      type: array
      items:
        $ref: '#/components/schemas/MovBehav'
      minItems: 1
    confidence:
      $ref: 'TS29571_CommonData.yaml#/components/schemas/UInteger'

MovBehav:
  description: Represents the Movement Behaviour information per time slot.
  type: object
  properties:
    tsStart:
      $ref: 'TS29571_CommonData.yaml#/components/schemas/DateTime'
    tsDuration:
      $ref: 'TS29571_CommonData.yaml#/components/schemas/DurationSec'
    numOfUe:
      $ref: 'TS29571_CommonData.yaml#/components/schemas/UInteger'
    ratio:
      $ref: 'TS29571_CommonData.yaml#/components/schemas/SamplingRatio'
    avrSpeed:
      $ref: 'TS29571_CommonData.yaml#/components/schemas/Float'
    speedThresdInfos:
      type: array
      items:
        $ref: '#/components/schemas/SpeedThresholdInfo'
      minItems: 1
    directionUeInfos:
      type: array
      items:
        $ref: '#/components/schemas/DirectionInfo'
      minItems: 1
  required:
    - tsStart
    - tsDuration

SpeedThresholdInfo:
  description: UEs information whose speed is faster than the speed threshold.
  type: object
  properties:
    speedThr:
      $ref: 'TS29571_CommonData.yaml#/components/schemas/Float'
    numOfUe:
      $ref: 'TS29571_CommonData.yaml#/components/schemas/UInteger'
    ratio:
      $ref: 'TS29571_CommonData.yaml#/components/schemas/SamplingRatio'

RelProxReq:
  description: Represents the Relative Proximity analytics requirements.
  type: object
  properties:
    direction:
      type: array
      items:
        $ref: '#/components/schemas/Direction'
      minItems: 1
    numOfUe:
      $ref: 'TS29571_CommonData.yaml#/components/schemas/UInteger'
    proximityCrits:
      type: array
      items:
        $ref: '#/components/schemas/ProximityCriterion'
      minItems: 1
```

```
RelProxInfo:
  description: Represents the Relative Proximity information.
  type: object
  properties:
    tsStart:
      $ref: 'TS29571_CommonData.yaml#/components/schemas/DateTime'
    tsDuration:
      $ref: 'TS29571_CommonData.yaml#/components/schemas/DurationSec'
    supis:
      type: array
      items:
        $ref: 'TS29571_CommonData.yaml#/components/schemas/Supi'
      minItems: 1
    gpsis:
      type: array
      items:
        $ref: 'TS29571_CommonData.yaml#/components/schemas/Gpsi'
      minItems: 1
    ueProximities:
      type: array
      items:
        $ref: '#/components/schemas/UeProximity'
      minItems: 1
    ttcInfo:
      $ref: '#/components/schemas/TimeToCollisionInfo'
  required:
    - tsStart
    - tsDuration
    - ueProximities

UeProximity:
  description: Represents the Observed or Predicted proximity information.
  type: object
  properties:
    ueDistance:
      type: integer
    ueVelocity:
      $ref: 'TS29572_Nlmf_Location.yaml#/components/schemas/VelocityEstimate'
    avrSpeed:
      $ref: 'TS29571_CommonData.yaml#/components/schemas/Float'
    locOrientation:
      $ref: '#/components/schemas/LocationOrientation'
    ueTrajectories:
      type: array
      items:
        $ref: '#/components/schemas/UeTrajectory'
      minItems: 1
    ratio:
      $ref: 'TS29571_CommonData.yaml#/components/schemas/SamplingRatio'

UeTrajectory:
  description: Represents timestamped UE positions.
  type: object
  properties:
    supi:
      $ref: 'TS29571_CommonData.yaml#/components/schemas/Supi'
    gpsi:
      $ref: 'TS29571_CommonData.yaml#/components/schemas/Gpsi'
    timestampedLocs:
      type: array
      items:
        $ref: '#/components/schemas/TimestampedLocation'
      minItems: 1
  required:
    - timestampedLocs
  oneOf:
    - required: [supi]
    - required: [gpsi]

TimestampedLocation:
  description: The timestamped locations of the trajectory of the UE.
  type: object
  properties:
    ts:
      $ref: 'TS29571_CommonData.yaml#/components/schemas/DateTime'
    locInfo:
      items:
```

```
    $ref: '#/components/schemas/LocationInfo'
  required:
    - ts
    - locInfo

TimeToCollisionInfo:
  description: Represents Time To Collision (TTC) information.
  type: object
  properties:
    ttc:
      $ref: 'TS29571_CommonData.yaml#/components/schemas/DateTime'
    accuracy:
      $ref: 'TS29571_CommonData.yaml#/components/schemas/UInteger'
    confidence:
      $ref: 'TS29571_CommonData.yaml#/components/schemas/UInteger'

AnalyticsFeedbackInfo:
  description: Analytics feedback information.
  type: object
  properties:
    actionTimes:
      type: array
      items:
        $ref: 'TS29571_CommonData.yaml#/components/schemas/DateTime'
      minItems: 1
      description: The times at which an action was taken.
    usedAnaTypes:
      type: array
      items:
        $ref: '#/components/schemas/NwdafEvent'
      minItems: 1
      description: The analytics types that were used to take the action.
    impactInd:
      type: boolean
      description: Indication about the impact of an action on the ground truth data.
  required:
    - actionTimes

RoamingInfo:
  description: Information related to roaming analytics.
  type: object
  properties:
    plmnId:
      $ref: 'TS29571_CommonData.yaml#/components/schemas/PlmnIdNid'
    aois:
      type: array
      items:
        $ref: 'TS29522_AMPolicyAuthorization.yaml#/components/schemas/GeographicalArea'
      minItems: 1
      description: Areas of Interest in the HPLMN or the VPLMN.
    servingNfIds:
      type: array
      items:
        $ref: 'TS29571_CommonData.yaml#/components/schemas/NfInstanceId'
      minItems: 1
      description: NF ID(s) of the NF(s) serving the roaming UE(s) in the VPLMN.
    servingNfSetIds:
      type: array
      items:
        $ref: 'TS29571_CommonData.yaml#/components/schemas/NfSetId'
      minItems: 1
      description: NF Set ID(s) of the NF Set(s) serving the roaming UE(s) in the VPLMN.

#
# ENUMERATIONS DATA TYPES
#

NotificationMethod:
  anyOf:
    - type: string
      enum:
        - PERIODIC
        - THRESHOLD
    - type: string
      description: >
        This string provides forward-compatibility with future
        extensions to the enumeration but is not used to encode
        content defined in the present version of this API.
  description: |
```

Represents the notification methods for the subscribed events.

Possible values are:

- PERIODIC: The notification of the subscribed NWDAF Event is periodical. The period between the notifications is identified by repetitionPeriod and represents time in seconds.
- THRESHOLD: The subscribe of NWDAF Event is upon threshold exceeded.

NwdafEvent:

anyOf:

- type: string

enum:

- SLICE_LOAD_LEVEL
- NETWORK_PERFORMANCE
- NF_LOAD
- SERVICE_EXPERIENCE
- UE_MOBILITY
- UE_COMMUNICATION
- QOS_SUSTAINABILITY
- ABNORMAL_BEHAVIOUR
- USER_DATA_CONGESTION
- NSI_LOAD_LEVEL
- DN_PERFORMANCE
- DISPERSION
- RED_TRANS_EXP
- WLAN_PERFORMANCE
- SM_CONGESTION
- PFD_DETERMINATION
- PDU_SESSION_TRAFFIC
- E2E_DATA_VOL_TRANS_TIME
- MOVEMENT_BEHAVIOUR
- NUM_OF_UE
- MOV_UE_RATIO
- AVR_SPEED
- SPEED_THRESHOLD
- MOV_UE_DIRECTION
- LOC_ACCURACY
- RELATIVE_PROXIMITY

- type: string

description: >

This string provides forward-compatibility with future extensions to the enumeration but is not used to encode content defined in the present version of this API.

description: |

Describes the NWDAF Events.

Possible values are:

- SLICE_LOAD_LEVEL: Indicates that the event subscribed is load level information of Network Slice.
- NETWORK_PERFORMANCE: Indicates that the event subscribed is network performance information.
- NF_LOAD: Indicates that the event subscribed is load level and status of one or several Network Functions.
- SERVICE_EXPERIENCE: Indicates that the event subscribed is service experience.
- UE_MOBILITY: Indicates that the event subscribed is UE mobility information.
- UE_COMMUNICATION: Indicates that the event subscribed is UE communication information.
- QOS_SUSTAINABILITY: Indicates that the event subscribed is QoS sustainability.
- ABNORMAL_BEHAVIOUR: Indicates that the event subscribed is abnormal behaviour.
- USER_DATA_CONGESTION: Indicates that the event subscribed is user data congestion information.
- NSI_LOAD_LEVEL: Indicates that the event subscribed is load level information of Network Slice and the optionally associated Network Slice Instance.
- DN_PERFORMANCE: Indicates that the event subscribed is DN performance information.
- DISPERSION: Indicates that the event subscribed is dispersion information.
- RED_TRANS_EXP: Indicates that the event subscribed is redundant transmission experience.
- WLAN_PERFORMANCE: Indicates that the event subscribed is WLAN performance.
- SM_CONGESTION: Indicates the Session Management Congestion Control Experience information for specific DNN and/or S-NSSAI.
- PFD_DETERMINATION: Indicates that the event subscribed is the PFD Determination information for known application identifier(s).
- PDU_SESSION_TRAFFIC: Indicates that the event subscribed is the PDU Session traffic information.
- E2E_DATA_VOL_TRANS_TIME: Indicates that the event subscribed is of E2E data volume transfer time.
- MOVEMENT_BEHAVIOUR: Indicates that the event subscribed is the Movement Behaviour information.
- LOC_ACCURACY: Indicates that the event subscribed is of location accuracy.
- RELATIVE_PROXIMITY: Indicates that the event subscribed is the Relative Proximity information.

Accuracy:
anyOf:
- type: string
enum:
- LOW
- MEDIUM
- HIGH
- HIGHEST
- type: string
description: >
This string provides forward-compatibility with future extensions to the enumeration but is not used to encode content defined in the present version of this API.
description: |
Represents the preferred level of accuracy of the analytics.
Possible values are:
- LOW: Low accuracy.
- MEDIUM: Medium accuracy.
- HIGH: High accuracy.
- HIGHEST: Highest accuracy.

CongestionType:
anyOf:
- type: string
enum:
- USER_PLANE
- CONTROL_PLANE
- USER_AND_CONTROL_PLANE
- type: string
description: >
This string provides forward-compatibility with future extensions to the enumeration but is not used to encode content defined in the present version of this API.
description: |
Indicates the congestion analytics type.
Possible values are:
- USER_PLANE: The congestion analytics type is User Plane.
- CONTROL_PLANE: The congestion analytics type is Control Plane.
- USER_AND_CONTROL_PLANE: The congestion analytics type is User Plane and Control Plane.

ExceptionId:
anyOf:
- type: string
enum:
- UNEXPECTED_UE_LOCATION
- UNEXPECTED_LONG_LIVE_FLOW
- UNEXPECTED_LARGE_RATE_FLOW
- UNEXPECTED_WAKEUP
- SUSPICION_OF_DDOS_ATTACK
- WRONG_DESTINATION_ADDRESS
- TOO_FREQUENT_SERVICE_ACCESS
- UNEXPECTED_RADIO_LINK_FAILURES
- PING_PONG_ACROSS_CELLS
- type: string
description: >
This string provides forward-compatibility with future extensions to the enumeration but is not used to encode content defined in the present version of this API.
description: |
Describes the Exception Id.
Possible values are:
- UNEXPECTED_UE_LOCATION: Unexpected UE location.
- UNEXPECTED_LONG_LIVE_FLOW: Unexpected long-live rate flows.
- UNEXPECTED_LARGE_RATE_FLOW: Unexpected large rate flows.
- UNEXPECTED_WAKEUP: Unexpected wakeup.
- SUSPICION_OF_DDOS_ATTACK: Suspicion of DDoS attack.
- WRONG_DESTINATION_ADDRESS: Wrong destination address.
- TOO_FREQUENT_SERVICE_ACCESS: Too frequent Service Access.
- UNEXPECTED_RADIO_LINK_FAILURES: Unexpected radio link failures.
- PING_PONG_ACROSS_CELLS: Ping-ponging across neighbouring cells.

ExceptionTrend:
anyOf:
- type: string
enum:
- UP
- DOWN
- UNKNOWN

```

- STABLE
- type: string
description: >
  This string provides forward-compatibility with future
  extensions to the enumeration but is not used to encode
  content defined in the present version of this API.
description: |
  Represents the Exception Trend.
  Possible values are:
- UP: Up trend of the exception level.
- DOWN: Down trend of the exception level.
- UNKNOW: Unknown trend of the exception level.
- STABLE: Stable trend of the exception level.

TimeUnit:
anyOf:
- type: string
enum:
- MINUTE
- HOUR
- DAY
- type: string
description: >
  This string provides forward-compatibility with future
  extensions to the enumeration but is not used to encode
  content defined in the present version of this API.
description: |
  Represents the unit for the session active time.
  Possible values are:
- MINUTE: Time unit is per minute.
- HOUR: Time unit is per hour.
- DAY: Time unit is per day.

NetworkPerfType:
anyOf:
- type: string
enum:
- GNB_ACTIVE_RATIO
- GNB_COMPUTING_USAGE
- GNB_MEMORY_USAGE
- GNB_DISK_USAGE
- GNB_RSC_USAGE_OVERALL_TRAFFIC
- GNB_RSC_USAGE_GBR_TRAFFIC
- GNB_RSC_USAGE_DELAY_CRIT_GBR_TRAFFIC
- NUM_OF_UE
- SESS_SUCC_RATIO
- HO_SUCC_RATIO
- type: string
description: >
  This string provides forward-compatibility with future
  extensions to the enumeration but is not used to encode
  content defined in the present version of this API.
description: |
  Represents the network performance types.
  Possible values are:
- GNB_ACTIVE_RATIO: Indicates that the network performance requirement is gNodeB active
  (i.e. up and running) rate. Indicates the ratio of gNB active (i.e. up and running) number
  to the total number of gNB.
- GNB_COMPUTING_USAGE: Indicates gNodeB computing resource usage.
- GNB_MEMORY_USAGE: Indicates gNodeB memory usage.
- GNB_DISK_USAGE: Indicates gNodeB disk usage.
- GNB_RSC_USAGE_OVERALL_TRAFFIC: The gNB resource usage.
- GNB_RSC_USAGE_GBR_TRAFFIC: The gNB resource usage for GBR traffic.
- GNB_RSC_USAGE_DELAY_CRIT_GBR_TRAFFIC: The gNB resource usage for Delay-critical GBR
  traffic.
- NUM_OF_UE: Indicates number of UEs.
- SESS_SUCC_RATIO: Indicates ratio of successful setup of PDU sessions to total PDU
  session setup attempts.
- HO_SUCC_RATIO: Indicates Ratio of successful handovers to the total handover attempts.

ExpectedAnalyticsType:
anyOf:
- type: string
enum:
- MOBILITY
- COMMUN
- MOBILITY_AND_COMMUN
- type: string

```

```
description: >
  This string provides forward-compatibility with future
  extensions to the enumeration but is not used to encode
  content defined in the present version of this API.
description: |
  Represents the expected UE analytics type.
  Possible values are:
  - MOBILITY: Mobility related abnormal behaviour analytics is expected by the consumer.
  - COMMUN: Communication related abnormal behaviour analytics is expected by the consumer.
  - MOBILITY_AND_COMMUN: Both mobility and communication related abnormal behaviour analytics
    is expected by the consumer.

MatchingDirection:
  anyOf:
  - type: string
    enum:
    - ASCENDING
    - DESCENDING
    - CROSSED
  - type: string
    description: >
      This string provides forward-compatibility with future
      extensions to the enumeration but is not used to encode
      content defined in the present version of this API.
description: |
  Represents the matching direction when crossing a threshold.
  Possible values are:
  - ASCENDING: Threshold is crossed in ascending direction.
  - DESCENDING: Threshold is crossed in descending direction.
  - CROSSED: Threshold is crossed either in ascending or descending direction.

NwdafFailureCode:
  anyOf:
  - type: string
    enum:
    - UNAVAILABLE_DATA
    - BOTH_STAT_PRED_NOT_ALLOWED
    - PREDICTION_NOT_ALLOWED
    - UNSATISFIED_REQUESTED_ANALYTICS_TIME
    - NO_ROAMING_SUPPORT
    - OTHER
  - type: string
    description: >
      This string provides forward-compatibility with future
      extensions to the enumeration but is not used to encode
      content defined in the present version of this API.
description: |
  Represents the failure reason.
  Possible values are:
  - UNAVAILABLE_DATA: Indicates the requested statistics information for the event is rejected
    since necessary data to perform the service is unavailable.
  - BOTH_STAT_PRED_NOT_ALLOWED: Indicates the requested analysis information for the event is
    rejected since the start time is in the past and the end time is in the future, which
    means the NF service consumer requested both statistics and prediction for the analytics.
  - PREDICTION_NOT_ALLOWED: Indicates that the request for the prediction of the analytics
    event is not allowed.
  - UNSATISFIED_REQUESTED_ANALYTICS_TIME: Indicates that the requested event is rejected since
    the analytics information is not ready when the time indicated by the "timeAnaNeeded"
    attribute (as provided during the creation or modification of subscription) is reached.
  - NO_ROAMING_SUPPORT: Indicates that the request shall be rejected because roaming analytics
    or data are required and the NWDaf neither supports roaming exchange capability nor can
    it forward the request to another NWDaf.
  - OTHER: Indicates the requested analysis information for the event is rejected due to other
    reasons.

AnalyticsMetadata:
  anyOf:
  - type: string
    enum:
    - NUM_OF_SAMPLES
    - DATA_WINDOW
    - DATA_STAT_PROPS
    - STRATEGY
    - ACCURACY
  - type: string
    description: >
      This string provides forward-compatibility with future
      extensions to the enumeration but is not used to encode
```

content defined in the present version of this API.

description: |

Represents the types of analytics metadata information that can be requested.

Possible values are:

- NUM_OF_SAMPLES: Number of data samples used for the generation of the output analytics.
- DATA_WINDOW: Data time window of the data samples.
- DATA_STAT_PROPS: Dataset statistical properties of the data used to generate the analytics.
- STRATEGY: Output strategy used for the reporting of the analytics.
- ACCURACY: Level of accuracy reached for the analytics.

DatasetStatisticalProperty:

anyOf:

- type: string

enum:

- UNIFORM_DIST_DATA
- NO_OUTLIERS

- type: string

description: >

This string provides forward-compatibility with future extensions to the enumeration but is not used to encode content defined in the present version of this API.

description: |

Represents the dataset statistical properties.

Possible values are:

- UNIFORM_DIST_DATA: Indicates the use of data samples that are uniformly distributed according to the different aspects of the requested analytics.
- NO_OUTLIERS: Indicates that the data samples shall disregard data samples that are at the extreme boundaries of the value range.

OutputStrategy:

anyOf:

- type: string

enum:

- BINARY
- GRADIENT

- type: string

description: >

This string provides forward-compatibility with future extensions to the enumeration but is not used to encode content defined in the present version of this API.

description: |

Represents the output strategy used for the analytics reporting.

Possible values are:

- BINARY: Indicates that the analytics shall only be reported when the requested level of accuracy is reached within a cycle of periodic notification.
- GRADIENT: Indicates that the analytics shall be reported according with the periodicity irrespective of whether the requested level of accuracy has been reached or not.

TransferRequestType:

anyOf:

- type: string

enum:

- PREPARE
- TRANSFER

- type: string

description: >

This string provides forward-compatibility with future extensions to the enumeration but is not used to encode content defined in the present version of this API.

description: |

Represents the request type for the analytics subscription transfer.

Possible values are:

- PREPARE: Indicates that the request is for analytics subscription transfer preparation.
- TRANSFER: Indicates that the request is for analytics subscription transfer execution.

AnalyticsSubset:

anyOf:

- type: string

enum:

- NUM_OF_UE_REG
- NUM_OF_PDU_SESS_ESTBL
- RES_USAGE
- NUM_OF_EXCEED_RES_USAGE_LOAD_LEVEL_THR
- PERIOD_OF_EXCEED_RES_USAGE_LOAD_LEVEL_THR
- EXCEED_LOAD_LEVEL_THR_IND
- LIST_OF_TOP_APP_UL
- LIST_OF_TOP_APP_DL

```

- NF_STATUS
- NF_RESOURCE_USAGE
- NF_LOAD
- NF_PEAK_LOAD
- NF_LOAD_AVG_IN_AOI
- DISPER_AMOUNT
- DISPER_CLASS
- RANKING
- PERCENTILE_RANKING
- RSSI
- RTT
- TRAFFIC_INFO
- NUMBER_OF_UES
- APP_LIST_FOR_UE_COMM
- N4_SESS_INACT_TIMER_FOR_UE_COMM
- AVG_TRAFFIC_RATE
- MAX_TRAFFIC_RATE
- AGG_TRAFFIC_RATE
- VAR_TRAFFIC_RATE
- AVG_PACKET_DELAY
- MAX_PACKET_DELAY
- VAR_PACKET_DELAY
- AVG_PACKET_LOSS_RATE
- MAX_PACKET_LOSS_RATE
- VAR_PACKET_LOSS_RATE
- UE_LOCATION
- LIST_OF_HIGH_EXP_UE
- LIST_OF_MEDIUM_EXP_UE
- LIST_OF_LOW_EXP_UE
- AVG_UL_PKT_DROP_RATE
- VAR_UL_PKT_DROP_RATE
- AVG_DL_PKT_DROP_RATE
- VAR_DL_PKT_DROP_RATE
- AVG_UL_PKT_DELAY
- VAR_UL_PKT_DELAY
- AVG_DL_PKT_DELAY
- VAR_DL_PKT_DELAY
- TRAFFIC_MATCH_TD
- TRAFFIC_UNMATCH_TD
- NUMBER_OF_UE
- UE_GEOG_DIST
- UE_DIRECTION
- AVG_E2E_UL_PKT_DELAY
- VAR_E2E_UL_PKT_DELAY
- AVG_E2E_DL_PKT_DELAY
- VAR_E2E_DL_PKT_DELAY
- AVG_E2E_UL_PKT_LOSS_RATE
- VAR_E2E_UL_PKT_LOSS_RATE
- AVG_E2E_DL_PKT_LOSS_RATE
- VAR_E2E_DL_PKT_LOSS_RATE
- E2E_DATA_VOL_TRANS_TIME_FOR_UE_LIST
- IN_OUT_PERCENT
- TIME_TO_COLLISION
- type: string
description: >
  This string provides forward-compatibility with future
  extensions to the enumeration but is not used to encode
  content defined in the present version of this API.
description: |
  Represents the analytics subset.
  Possible values are:
- NUM_OF_UE_REG: The number of UE registered. This value is only applicable to
  NSI_LOAD_LEVEL event.
- NUM_OF_PDU_SESS_ESTBL: The number of PDU sessions established. This value is only
  applicable to NSI_LOAD_LEVEL event.
- RES_USAGE: The current usage of the virtual resources assigned to the NF instances
  belonging to a particular network slice instance. This value is only applicable to
  NSI_LOAD_LEVEL event.
- NUM_OF_EXCEED_RES_USAGE_LOAD_LEVEL_THR: The number of times the resource usage threshold
  of the network slice instance is reached or exceeded if a threshold value is provided by
  the consumer. This value is only applicable to NSI_LOAD_LEVEL event.
- PERIOD_OF_EXCEED_RES_USAGE_LOAD_LEVEL_THR: The time interval between each time the
  threshold being met or exceeded on the network slice (instance). This value is only
  applicable to NSI_LOAD_LEVEL event.
- EXCEED_LOAD_LEVEL_THR_IND: Whether the Load Level Threshold is met or exceeded by the
  statistics value. This value is only applicable to NSI_LOAD_LEVEL event.
- LIST_OF_TOP_APP_UL: The list of applications that contribute the most to the traffic in
  the UL direction. This value is only applicable to USER_DATA_CONGESTION event.

```

- LIST_OF_TOP_APP_DL: The list of applications that contribute the most to the traffic in the DL direction. This value is only applicable to USER_DATA_CONGESTION event.
- NF_STATUS: The availability status of the NF on the Analytics target period, expressed as a percentage of time per status value (registered, suspended, undiscoverable). This value is only applicable to NF_LOAD event.
- NF_RESOURCE_USAGE: The average usage of assigned resources (CPU, memory, storage). This value is only applicable to NF_LOAD event.
- NF_LOAD: The average load of the NF instance over the Analytics target period. This value is only applicable to NF_LOAD event.
- NF_PEAK_LOAD: The maximum load of the NF instance over the Analytics target period. This value is only applicable to NF_LOAD event.
- NF_LOAD_AVG_IN_AOI: The average load of the NF instances over the area of interest. This value is only applicable to NF_LOAD event.
- DISPER_AMOUNT: Indicates the dispersion amount of the reported data volume or transaction dispersion type. This value is only applicable to DISPERSION event.
- DISPER_CLASS: Indicates the dispersion mobility class: fixed, camper, traveller upon set its usage threshold, and/or the top-heavy class upon set its percentile rating threshold. This value is only applicable to DISPERSION event.
- RANKING: Data/transaction usage ranking high (i.e.value 1), medium (2) or low (3). This value is only applicable to DISPERSION event.
- PERCENTILE_RANKING: Percentile ranking of the target UE in the Cumulative Distribution Function of data usage for the population of all UEs. This value is only applicable to DISPERSION event.
- RSSI: Indicated the RSSI in the unit of dBm. This value is only applicable to WLAN_PERFORMANCE event.
- RTT: Indicates the RTT in the unit of millisecond. This value is only applicable to WLAN_PERFORMANCE event.
- TRAFFIC_INFO: Traffic information including UL/DL data rate and/or Traffic volume. This value is only applicable to WLAN_PERFORMANCE event.
- NUMBER_OF_UES: Number of UEs observed for the SSID. This value is only applicable to WLAN_PERFORMANCE event.
- APP_LIST_FOR_UE_COMM: The analytics of the application list used by UE. This value is only applicable to UE_COMM event.
- N4_SESS_INACT_TIMER_FOR_UE_COMM: The N4 Session inactivity timer. This value is only applicable to UE_COMM event.
- AVG_TRAFFIC_RATE: Indicates average traffic rate. This value is only applicable to DN_PERFORMANCE event.
- MAX_TRAFFIC_RATE: Indicates maximum traffic rate. This value is only applicable to DN_PERFORMANCE event.
- AGG_TRAFFIC_RATE: Indicates aggregated traffic rate. This value is only applicable to DN_PERFORMANCE event.
- VAR_TRAFFIC_RATE: Indicates variance traffic rate. This value is only applicable to DN_PERFORMANCE event.
- AVG_PACKET_DELAY: Indicates average Packet Delay. This value is only applicable to DN_PERFORMANCE event.
- MAX_PACKET_DELAY: Indicates maximum Packet Delay. This value is only applicable to DN_PERFORMANCE event.
- VAR_PACKET_DELAY: Indicates variance Packet Delay. This value is only applicable to DN_PERFORMANCE event.
- AVG_PACKET_LOSS_RATE: Indicates average Loss Rate. This value is only applicable to DN_PERFORMANCE event.
- MAX_PACKET_LOSS_RATE: Indicates maximum Packet Loss Rate. This value is only applicable to DN_PERFORMANCE event.
- VAR_PACKET_LOSS_RATE: Indicates variance Packet Loss Rate. This value is only applicable to DN_PERFORMANCE event.
- UE_LOCATION: Indicates UE location information. This value is only applicable to SERVICE_EXPERIENCE event.
- LIST_OF_HIGH_EXP_UE: Indicates list of high experienced UE. This value is only applicable to SM_CONGESTION event.
- LIST_OF_MEDIUM_EXP_UE: Indicates list of medium experienced UE. This value is only applicable to SM_CONGESTION event.
- LIST_OF_LOW_EXP_UE: Indicates list of low experienced UE. This value is only applicable to SM_CONGESTION event.
- AVG_UL_PKT_DROP_RATE: Indicates average uplink packet drop rate on GTP-U path on N3. This value is only applicable to RED_TRANS_EXP event.
- VAR_UL_PKT_DROP_RATE: Indicates variance of uplink packet drop rate on GTP-U path on N3. This value is only applicable to RED_TRANS_EXP event.
- AVG_DL_PKT_DROP_RATE: Indicates average downlink packet drop rate on GTP-U path on N3. This value is only applicable to RED_TRANS_EXP event.
- VAR_DL_PKT_DROP_RATE: Indicates variance of downlink packet drop rate on GTP-U path on N3. This value is only applicable to RED_TRANS_EXP event.
- AVG_UL_PKT_DELAY: Indicates average uplink packet delay round trip on GTP-U path on N3. This value is only applicable to RED_TRANS_EXP event.
- VAR_UL_PKT_DELAY: Indicates variance uplink packet delay round trip on GTP-U path on N3. This value is only applicable to RED_TRANS_EXP event.
- AVG_DL_PKT_DELAY: Indicates average downlink packet delay round trip on GTP-U path on N3. This value is only applicable to RED_TRANS_EXP event.
- VAR_DL_PKT_DELAY: Indicates variance downlink packet delay round trip on GTP-U path on N3.

- This value is only applicable to RED_TRANS_EXP event.
- TRAFFIC_MATCH_TD: Identifies traffic that matches Traffic Descriptor provided by the consumer.
 - TRAFFIC_UNMATCH_TD: Identifies traffic that does not match Traffic Descriptor provided by the consumer.
 - NUMBER_OF_UE: Indicates the number of UEs. This value is only applicable to DN_PERFORMANCE event.
 - UE_GEOG_DIST: Indicates the geographical distribution of the UEs that can be selected by the AF for application service. This value is only applicable to UE_MOBILITY event.
 - UE_DIRECTION: Indicates the direction of the UEs. This value is only applicable to UE_MOBILITY event.
 - AVG_E2E_UL_PKT_DELAY: Indicates average End-to-End (between UE and UPF) uplink packet delay. This value is only applicable to RED_TRANS_EXP event.
 - VAR_E2E_UL_PKT_DELAY: Indicates the variance of End-to-End (between UE and UPF) uplink packet delay. This value is only applicable to RED_TRANS_EXP event.
 - AVG_E2E_DL_PKT_DELAY: Indicates average End-to-End (between UE and UPF) downlink packet delay. This value is only applicable to RED_TRANS_EXP event.
 - VAR_E2E_DL_PKT_DELAY: Indicates the variance of End-to-End (between UE and UPF) downlink packet delay. This value is only applicable to RED_TRANS_EXP event.
 - AVG_E2E_UL_PKT_LOSS_RATE: Indicates average End-to-End (between UE and UPF) uplink packet loss rate. This value is only applicable to RED_TRANS_EXP event.
 - VAR_E2E_UL_PKT_LOSS_RATE: Indicates the variance of End-to-End (between UE and UPF) uplink packet loss rate. This value is only applicable to RED_TRANS_EXP event.
 - AVG_E2E_DL_PKT_LOSS_RATE: Indicates average End-to-End (between UE and UPF) downlink packet loss rate. This value is only applicable to RED_TRANS_EXP event.
 - VAR_E2E_DL_PKT_LOSS_RATE: Indicates the variance of End-to-End (between UE and UPF) downlink packet loss rate. This value is only applicable to RED_TRANS_EXP event.
 - E2E_DATA_VOL_TRANS_TIME_FOR_UE_LIST: Indicates the classified E2E data volume transfer time statistics or predictions for multiple UEs with respect to one or more reporting thresholds.
 - NUM_OF_UE: Indicates the total number of users in the area of interest. This value is only applicable to MOVEMENT_BEHAVIOUR event.
 - MOV_UE_RATIO: Indicates the Ratio of moving UEs in the area of interest. This value is only applicable to MOVEMENT_BEHAVIOUR event.
 - AVR_SPEED: Indicates the average speed of all UEs in the area of interest. This value is only applicable to MOVEMENT_BEHAVIOUR event.
 - SPEED_THRESHOLD: Indicates the information on UEs in the area of interest whose speed is faster than the speed threshold. This value is only applicable to MOVEMENT_BEHAVIOUR event.
 - MOV_UE_DIRECTION: Indicates the heading directions of the UE flow in the target area. This value is only applicable to MOVEMENT_BEHAVIOUR event.
 - IN_OUT_PERCENT: Indicates the percentage of indoor/outdoor UEs at a location. The value is only applicable to the LOC_ACCURACY event.
 - TIME_TO_COLLISION: Indicates the time until for a collision with another UE happens. This value is only applicable to RELATIVE_PROXIMITY event prediction.

DispersionType:

anyOf:

- type: string

enum:

- DVDA
- TDA
- DVDA_AND_TDA
- type: string

description: >

This string provides forward-compatibility with future extensions to the enumeration but is not used to encode content defined in the present version of this API.

description: |

Represents the dispersion type.

Possible values are:

- DVDA: Data Volume Dispersion Analytics.
- TDA: Transactions Dispersion Analytics.
- DVDA_AND_TDA: Data Volume Dispersion Analytics and Transactions Dispersion Analytics.

DispersionClass:

anyOf:

- type: string

enum:

- FIXED
- CAMPER
- TRAVELLER
- TOP_HEAVY
- type: string

description: >

This string provides forward-compatibility with future extensions to the enumeration but is not used to encode content defined in the present version of this API.

```
description: |
  Represents the dispersion class.
  Possible values are:
  - FIXED: Dispersion class as fixed UE its data or transaction usage at a location or
    a slice, is higher than its class threshold set for its all data or transaction usage.
  - CAMPER: Dispersion class as camper UE, its data or transaction usage at a location or
    a slice, is higher than its class threshold and lower than the fixed class threshold set
    for its all data or transaction usage.
  - TRAVELLER: Dispersion class as traveller UE, its data or transaction usage at a location
    or a slice, is lower than the camper class threshold set for its all data or transaction
    usage.
  - TOP_HEAVY: Dispersion class as Top_Heavy UE, who's dispersion percentile rating at a
    location or a slice, is higher than its class threshold.

DispersionOrderingCriterion:
  anyOf:
  - type: string
    enum:
      - TIME_SLOT_START
      - DISPERSION
      - CLASSIFICATION
      - RANKING
      - PERCENTILE_RANKING
  - type: string
    description: >
      This string provides forward-compatibility with future
      extensions to the enumeration but is not used to encode
      content defined in the present version of this API.
  description: |
    Represents the order criterion for the list of dispersion.
    Possible values are:
    - TIME_SLOT_START: Indicates the order of time slot start.
    - DISPERSION: Indicates the order of data/transaction dispersion.
    - CLASSIFICATION: Indicates the order of data/transaction classification.
    - RANKING: Indicates the order of data/transaction ranking.
    - PERCENTILE_RANKING: Indicates the order of data/transaction percentile ranking.

DeviceType:
  anyOf:
  - type: string
    enum:
      - MOBILE_PHONE
      - SMART_PHONE
      - TABLET
      - DONGLE
      - MODEM
      - WLAN_ROUTER
      - IOT_DEVICE
      - WEARABLE
      - MOBILE_TEST_PLATFORM
      - UNDEFINED
  - type: string
    description: >
      This string provides forward-compatibility with future extensions to the enumeration but
      is not used to encode content defined in the present version of this API.
  description: |
    Represents the device type.
    Possible values are:
    - MOBILE_PHONE: Mobile Phone.
    - SMART_PHONE: Smartphone.
    - TABLET: Tablet.
    - DONGLE: Dongle.
    - MODEM: Modem.
    - WLAN_ROUTER: WLAN Router.
    - IOT_DEVICE: IoT Device.
    - WEARABLE: Wearable.
    - MOBILE_TEST_PLATFORM: Mobile Test Platform.
    - UNDEFINED: Undefined.

RedTransExpOrderingCriterion:
  anyOf:
  - type: string
    enum:
      - TIME_SLOT_START
      - RED_TRANS_EXP
  - type: string
    description: >
      This string provides forward-compatibility with future
```

extensions to the enumeration but is not used to encode content defined in the present version of this API.

description: |
Represents the order criterion for the list of Redundant Transmission Experience.
Possible values are:
- TIME_SLOT_START: Indicates the order of time slot start.
- RED_TRANS_EXP: Indicates the order of Redundant Transmission Experience.

WlanOrderingCriterion:
anyOf:
- type: string
enum:
- TIME_SLOT_START
- NUMBER_OF_UES
- RSSI
- RTT
- TRAFFIC_INFO
- type: string
description: >
This string provides forward-compatibility with future extensions to the enumeration but is not used to encode content defined in the present version of this API.

description: |
Represents the order criterion for the list of WLAN performance information.
Possible values are:
- TIME_SLOT_START: Indicates the order of time slot start.
- NUMBER_OF_UES: Indicates the order of number of UEs.
- RSSI: Indicates the order of RSSI.
- RTT: Indicates the order of RTT.
- TRAFFIC_INFO: Indicates the order of Traffic information.

ServiceExperienceType:
anyOf:
- type: string
enum:
- VOICE
- VIDEO
- OTHER
- type: string
description: >
This string provides forward-compatibility with future extensions to the enumeration but is not used to encode content defined in the present version of this API.

description: |
Represents the type of the service experience analytics.
Possible values are:
- VOICE: Indicates that the service experience analytics is for voice service.
- VIDEO: Indicates that the service experience analytics is for video service.
- OTHER: Indicates that the service experience analytics is for other service.

DnPerfOrderingCriterion:
anyOf:
- type: string
enum:
- AVERAGE_TRAFFIC_RATE
- MAXIMUM_TRAFFIC_RATE
- AVERAGE_PACKET_DELAY
- MAXIMUM_PACKET_DELAY
- AVERAGE_PACKET_LOSS_RATE
- type: string
description: >
This string provides forward-compatibility with future extensions to the enumeration but is not used to encode content defined in the present version of this API.

description: |
Represents the order criterion for the list of DN performance analytics.
Possible values are:
- AVERAGE_TRAFFIC_RATE: Indicates the average traffic rate.
- MAXIMUM_TRAFFIC_RATE: Indicates the maximum traffic rate.
- AVERAGE_PACKET_DELAY: Indicates the average packet delay.
- MAXIMUM_PACKET_DELAY: Indicates the maximum packet delay.
- AVERAGE_PACKET_LOSS_RATE: Indicates the average packet loss rate.

TermCause:
anyOf:
- type: string
enum:
- USER_CONSENT_REVOKED
- NWDAF_OVERLOAD
- UE_LEFT_AREA

```
- type: string
  description: >
    This string provides forward-compatibility with future extensions to the enumeration but
    is not used to encode content defined in the present version of this API.
description: |
  Represents the cause for the analytics subscription termination request.
  Possible values are:
  - USER_CONSENT_REVOKED: The user consent has been revoked.
  - NWDAF_OVERLOAD: The NWDAF is overloaded.
  - UE_LEFT_AREA: The UE has moved out of the NWDAF serving area.
UserDataConOrderCrit:
  anyOf:
  - type: string
    enum:
    - APPLICABLE_TIME_WINDOW
    - NETWORK_STATUS_INDICATION
  - type: string
    description: >
      This string provides forward-compatibility with future extensions to the enumeration but
      is not used to encode content defined in the present version of this API.
description: |
  Represents the cause for requesting to terminate an analytics subscription.
  Possible values are:
  - APPLICABLE_TIME_WINDOW: The ordering criterion is the Applicable Time Window.
  - NETWORK_STATUS_INDICATION: The ordering criterion is the network status indication.

UeMobilityOrderCriterion:
  anyOf:
  - type: string
    enum:
    - TIME_SLOT
  - type: string
    description: >
      This string provides forward-compatibility with future extensions to the enumeration but
      is not used to encode content defined in the present version of this API.
description: |
  Represents the ordering criterion for the list of UE mobility analytics.
  Possible values are:
  - TIME_SLOT: The ordering criterion is the time slot.

UeCommOrderCriterion:
  anyOf:
  - type: string
    enum:
    - START_TIME
    - DURATION
  - type: string
    description: >
      This string provides forward-compatibility with future extensions to the enumeration but
      is not used to encode content defined in the present version of this API.
description: |
  Represents the ordering criterion for the list of UE communication analytics.
  Possible values are:
  - START_TIME: The ordering criterion of the analytics is the start time.
  - DURATION: The ordering criterion of the analytics is the duration of the communication.

NetworkPerfOrderCriterion:
  anyOf:
  - type: string
    enum:
    - NUMBER_OF_UES
    - COMMUNICATION_PERF
    - MOBILITY_PERF
  - type: string
    description: >
      This string provides forward-compatibility with future extensions to the enumeration but
      is not used to encode content defined in the present version of this API.
description: |
  Represents the ordering criterion for the list of network performance analytics.
  Possible values are:
  - NUMBER_OF_UES: The ordering criterion of the analytics is the number of UEs.
  - COMMUNICATION_PERF: The ordering criterion of the analytics is the communication
performance.
  - MOBILITY_PERF: The ordering criterion of the analytics is themobility performance.

LocInfoGranularity:
  anyOf:
  - type: string
```

```
enum:
  - TA_LEVEL
  - CELL_LEVEL
  - LON_AND_LAT_LEVEL
- type: string
  description: >
    This string provides forward-compatibility with future extensions to the enumeration but
    is not used to encode content defined in the present version of this API.
description: |
  Represents the preferred granularity of location information.
  Possible values are:
  - TA_LEVEL: Indicates location granularity of TA level.
  - CELL_LEVEL: Indicates location granularity of Cell level.
  - LON_AND_LAT_LEVEL: Indicates location granularity of longitude and latitude level.

TrafficDirection:
  anyOf:
  - type: string
    enum:
      - UL_AND_DL
      - UL
      - DL
  - type: string
    description: >
      This string provides forward-compatibility with future extensions to the enumeration but
      is not used to encode content defined in the present version of this API.
description: |
  Represents the traffic direction for the resource usage information.
  Possible values are:
  - UL_AND_DL: Uplink and downlink traffic.
  - UL: Uplink traffic.
  - DL: Downlink traffic.

ValueExpression:
  anyOf:
  - type: string
    enum:
      - AVERAGE
      - PEAK
  - type: string
    description: >
      This string provides forward-compatibility with future extensions to the enumeration but
      is not used to encode content defined in the present version of this API.
description: |
  Represents the average or peak value of the resource usage for the network performance type.
  Possible values are:
  - AVERAGE: Resource usage information in average value.
  - PEAK: Resource usage information in peak value.

E2eDataVolTransTimeCriterion:
  anyOf:
  - type: string
    enum:
      - E2E_DATA_VOL_TRANS_TIME
  - type: string
    description: >
      This string provides forward-compatibility with future extensions to the enumeration but
      is not used to encode content defined in the present version of this API.
description: |
  Represents the ordering criterion for the list of E2E data volume transfer time.
  Possible values are:
  - E2E_DATA_VOL_TRANS_TIME: The ordering criterion is the E2E data volume transfer time.

AnalyticsAccuracyIndication:
  anyOf:
  - type: string
    enum:
      - MEET
      - NOT_MEET
  - type: string
    description: >
      This string provides forward-compatibility with future
      extensions to the enumeration but is not used to encode
      content defined in the present version of this API.
description: |
  Represents the notification methods for the subscribed events.
  Possible values are:
  - MEET: Indicates meet the analytics accuracy requirement.
```

- NOT_MEET: Indicates not meet the analytics accuracy requirement.

LocationOrientation:

anyOf:

- type: string

enum:

- HORIZONTAL
- VERTICAL
- HOR_AND_VER

- type: string

description: >

This string provides forward-compatibility with future extensions to the enumeration but is not used to encode content defined in the present version of this API.

description: |

Possible values are:

- HORIZONTAL: Indicates horizontal orientation.
- VERTICAL: Indicates vertical orientation.
- HOR_AND_VER: Indicates both horizontal and vertical orientation.

Direction:

anyOf:

- type: string

enum:

- NORTH
- SOUTH
- EAST
- WEST
- NORTHWEST
- NORTHEAST
- SOUTHWEST
- SOUTHEAST

- type: string

description: >

This string provides forward-compatibility with future extensions to the enumeration but is not used to encode content defined in the present version of this API.

description: |

Possible values are:

- NORTH: North direction.
- SOUTH: South direction.
- EAST: EAST direction.
- WEST: WEST direction.
- NORTHWEST: Northwest direction.
- NORTHEAST: Northeast direction.
- SOUTHWEST: Southwest direction.
- SOUTHEAST: Southeast direction.

ProximityCriterion:

anyOf:

- type: string

enum:

- VELOCITY
- AVG_SPD
- ORIENTATION
- TRAJECTORY

- type: string

description: >

This string provides forward-compatibility with future extensions to the enumeration but is not used to encode content defined in the present version of this API.

description: |

Possible values are:

- VELOCITY: Velocity.
- AVG_SPD: Average speed.
- ORIENTATION: Orientation.
- TRAJECTORY: Mobility trajectory.

A.3 Nnwdaf_AnalyticsInfo API

openapi: 3.0.0

info:

version: 1.3.1

title: Nnwdaf_AnalyticsInfo

description: |

Nnwdaf_AnalyticsInfo Service API.

© 2024, 3GPP Organizational Partners (ARIB, ATIS, CCSA, ETSI, TSDSI, TTA, TTC).

All rights reserved.

```

externalDocs:
  description: 3GPP TS 29.520 V18.7.0; 5G System; Network Data Analytics Services.
  url: 'https://www.3gpp.org/ftp/Specs/archive/29_series/29.520/'

security:
- {}
- oAuth2ClientCredentials:
  - nnwdaf-analyticsinfo

servers:
- url: '{apiRoot}/nnwdaf-analyticsinfo/v1'
  variables:
    apiRoot:
      default: https://example.com
      description: apiRoot as defined in clause 4.4 of 3GPP TS 29.501.

paths:
  /analytics:
    get:
      summary: Read a NWDAF Analytics
      operationId: GetNWDAFAnalytics
      tags:
        - NWDAF Analytics (Document)
      parameters:
        - name: event-id
          in: query
          description: Identify the analytics.
          required: true
          schema:
            $ref: '#/components/schemas/EventId'
        - name: ana-req
          in: query
          description: Identifies the analytics reporting requirement information.
          required: false
          content:
            application/json:
              schema:
                $ref: 'TS29520_Nnwdaf_EventsSubscription.yaml#/components/schemas/EventReportingRequirement'
        - name: event-filter
          in: query
          description: Identify the analytics.
          required: false
          content:
            application/json:
              schema:
                $ref: '#/components/schemas/EventFilter'
        - name: supported-features
          in: query
          description: To filter irrelevant responses related to unsupported features.
          schema:
            $ref: 'TS29571_CommonData.yaml#/components/schemas/SupportedFeatures'
        - name: tgt-ue
          in: query
          description: Identify the target UE information.
          required: false
          content:
            application/json:
              schema:
                $ref: 'TS29520_Nnwdaf_EventsSubscription.yaml#/components/schemas/TargetUeInformation'
      responses:
        '200':
          description: >
            Containing the analytics with parameters as relevant for the requesting NF service consumer.
          content:
            application/json:
              schema:
                $ref: '#/components/schemas/AnalyticsData'
        '204':
          description: No Content. The requested NWDAF Analytics data does not exist.
        '400':
          $ref: 'TS29571_CommonData.yaml#/components/responses/400'
        '401':
          $ref: 'TS29571_CommonData.yaml#/components/responses/401'
        '403':

```

```

    $ref: 'TS29571_CommonData.yaml#/components/responses/403'
  '404':
    description: Indicates that the NWDAF Analytics resource does not exist.
    content:
      application/problem+json:
        schema:
          $ref: 'TS29571_CommonData.yaml#/components/schemas/ProblemDetails'
  '406':
    $ref: 'TS29571_CommonData.yaml#/components/responses/406'
  '414':
    $ref: 'TS29571_CommonData.yaml#/components/responses/414'
  '429':
    $ref: 'TS29571_CommonData.yaml#/components/responses/429'
  '500':
    description: >
      The request is rejected by the NWDAF and more details (not only the ProblemDetails) are
      returned.
    content:
      application/problem+json:
        schema:
          $ref: '#/components/schemas/ProblemDetailsAnalyticsInfoRequest'
  '502':
    $ref: 'TS29571_CommonData.yaml#/components/responses/502'
  '503':
    $ref: 'TS29571_CommonData.yaml#/components/responses/503'
  default:
    $ref: 'TS29571_CommonData.yaml#/components/responses/default'

```

/context:

get:

```

summary: Get context information related to analytics subscriptions.
operationId: GetNwdafContext
tags:
  - NWDAF Context (Document)
security:
  - {}
  - oAuth2ClientCredentials:
    - nnwdaF-analyticsinfo
  - oAuth2ClientCredentials:
    - nnwdaF-analyticsinfo
    - nnwdaF-analyticsinfo:contextttransfer
parameters:
  - name: context-ids
    in: query
    description: Identifies specific context information related to analytics subscriptions.
    required: true
    content:
      application/json:
        schema:
          $ref: '#/components/schemas/ContextIdList'
  - name: req-context
    in: query
    description: >
      Identifies the type(s) of the analytics context information the consumer wishes
      to receive.
    required: false
    content:
      application/json:
        schema:
          $ref: '#/components/schemas/RequestedContext'
  - name: supported-features
    in: query
    description: The features supported by the NF service consumer.
    schema:
      $ref: 'TS29571_CommonData.yaml#/components/schemas/SupportedFeatures'
    required: false
responses:
  '200':
    description: >
      Contains context information related to analytics subscriptions corresponding with
      one or more context identifiers.
    content:
      application/json:
        schema:
          $ref: '#/components/schemas/ContextData'
  '204':
    description: >
      No Content. No context information could be retrieved for the requested context

```

```

    Identifiers.
  '400':
    $ref: 'TS29571_CommonData.yaml#/components/responses/400'
  '401':
    $ref: 'TS29571_CommonData.yaml#/components/responses/401'
  '403':
    $ref: 'TS29571_CommonData.yaml#/components/responses/403'
  '404':
    $ref: 'TS29571_CommonData.yaml#/components/responses/404'
  '406':
    $ref: 'TS29571_CommonData.yaml#/components/responses/406'
  '414':
    $ref: 'TS29571_CommonData.yaml#/components/responses/414'
  '429':
    $ref: 'TS29571_CommonData.yaml#/components/responses/429'
  '500':
    $ref: 'TS29571_CommonData.yaml#/components/responses/500'
  '502':
    $ref: 'TS29571_CommonData.yaml#/components/responses/502'
  '503':
    $ref: 'TS29571_CommonData.yaml#/components/responses/503'
  default:
    $ref: 'TS29571_CommonData.yaml#/components/responses/default'

```

components:

```

securitySchemes:
  oAuth2ClientCredentials:
    type: oauth2
    flows:
      clientCredentials:
        tokenUrl: '{nrfApiRoot}/oauth2/token'
        scopes:
          nnwdaf-analyticsinfo: Access to the Nnwdaf_AnalyticsInfo API
          nnwdaf-analyticsinfo:contexttransfer: >
            Access to service operations applying to NWDAF context transfer related service
            operations, i.e. ContextTransfer.

```

schemas:

```

AnalyticsData:
  description: >
    Represents the description of analytics with parameters as relevant for the requesting NF
    service consumer.
  type: object
  properties:
    start:
      $ref: 'TS29571_CommonData.yaml#/components/schemas/DateTime'
    expiry:
      $ref: 'TS29571_CommonData.yaml#/components/schemas/DateTime'
    timeStampGen:
      $ref: 'TS29571_CommonData.yaml#/components/schemas/DateTime'
    anaMetaInfo:
      $ref: 'TS29520_Nnwdaf_EventsSubscription.yaml#/components/schemas/AnalyticsMetadataInfo'
    sliceLoadLevelInfos:
      type: array
      items:
        $ref:
          'TS29520_Nnwdaf_EventsSubscription.yaml#/components/schemas/SliceLoadLevelInformation'
      minItems: 1
      description: The slices and their load level information.
    nsiLoadLevelInfos:
      type: array
      items:
        $ref: 'TS29520_Nnwdaf_EventsSubscription.yaml#/components/schemas/NsiLoadLevelInfo'
      minItems: 1
    nfLoadLevelInfos:
      type: array
      items:
        $ref:
          'TS29520_Nnwdaf_EventsSubscription.yaml#/components/schemas/NfLoadLevelInformation'
      minItems: 1
    nwPerfs:
      type: array
      items:
        $ref: 'TS29520_Nnwdaf_EventsSubscription.yaml#/components/schemas/NetworkPerfInfo'
      minItems: 1
    svcExps:

```



```

    type: array
    items:
      $ref: 'TS29520_Nnwdaf_EventsSubscription.yaml#/components/schemas/ServiceExperienceInfo'
    minItems: 1
  qosSustainInfos:
    type: array
    items:
      $ref: 'TS29520_Nnwdaf_EventsSubscription.yaml#/components/schemas/QosSustainabilityInfo'
    minItems: 1
  ueMobs:
    type: array
    items:
      $ref: 'TS29520_Nnwdaf_EventsSubscription.yaml#/components/schemas/UeMobility'
    minItems: 1
  ueComms:
    type: array
    items:
      $ref: 'TS29520_Nnwdaf_EventsSubscription.yaml#/components/schemas/UeCommunication'
    minItems: 1
  userDataCongInfos:
    type: array
    items:
      $ref:
'TS29520_Nnwdaf_EventsSubscription.yaml#/components/schemas/UserDataCongestionInfo'
    minItems: 1
  abnorBehavrs:
    type: array
    items:
      $ref: 'TS29520_Nnwdaf_EventsSubscription.yaml#/components/schemas/AbnormalBehaviour'
    minItems: 1
  smccExps:
    type: array
    items:
      $ref: '#/components/schemas/SmcceInfo'
    minItems: 1
  disperInfos:
    type: array
    items:
      $ref: 'TS29520_Nnwdaf_EventsSubscription.yaml#/components/schemas/DispersionInfo'
    minItems: 1
  redTransInfos:
    type: array
    items:
      $ref:
'TS29520_Nnwdaf_EventsSubscription.yaml#/components/schemas/RedundantTransmissionExpInfo'
    minItems: 1
  wlanInfos:
    type: array
    items:
      $ref: 'TS29520_Nnwdaf_EventsSubscription.yaml#/components/schemas/WlanPerformanceInfo'
    minItems: 1
  dnPerfInfos:
    type: array
    items:
      $ref: 'TS29520_Nnwdaf_EventsSubscription.yaml#/components/schemas/DnPerfInfo'
    minItems: 1
  pduSesTrafInfos:
    type: array
    items:
      $ref: 'TS29520_Nnwdaf_EventsSubscription.yaml#/components/schemas/PduSesTrafficInfo'
    minItems: 1
  dataVlTrnsTmInfos:
    type: array
    items:
      $ref:
'TS29520_Nnwdaf_EventsSubscription.yaml#/components/schemas/E2eDataVolTransTimeInfo'
    minItems: 1
  locAccInfos:
    type: array
    items:
      $ref: 'TS29520_Nnwdaf_EventsSubscription.yaml#/components/schemas/LocAccuracyInfo'
    minItems: 1
  accuInfo:
    $ref: 'TS29520_Nnwdaf_EventsSubscription.yaml#/components/schemas/AccuracyInfo'
  cancelAccuInd:
    type: boolean
    description: >
      Indicates cancelled request of the analytics accuracy information.

```

Set to "true" indicates the NWDAF cancelled request of analytics accuracy information as the NWDAF does not support the accuracy checking capability. Otherwise set to "false". Default value is "false" if omitted.

```

movBehavInfos:
  type: array
  items:
    $ref: 'TS29520_Nnwdaf_EventsSubscription.yaml#/components/schemas/MovBehavInfo'
  minItems: 1
relProxInfos:
  type: array
  items:
    $ref: 'TS29520_Nnwdaf_EventsSubscription.yaml#/components/schemas/RelProxInfo'
  minItems: 1
suppFeat:
  $ref: 'TS29571_CommonData.yaml#/components/schemas/SupportedFeatures'

EventFilter:
description: Represents the event filters used to identify the requested analytics.
type: object
properties:
  anySlice:
    $ref: 'TS29520_Nnwdaf_EventsSubscription.yaml#/components/schemas/AnySlice'
  snssais:
    type: array
    items:
      $ref: 'TS29571_CommonData.yaml#/components/schemas/Snssai'
    minItems: 1
    description: Identification(s) of network slice.
  roamingInfo:
    $ref: 'TS29520_Nnwdaf_EventsSubscription.yaml#/components/schemas/RoamingInfo'
  appIds:
    type: array
    items:
      $ref: 'TS29571_CommonData.yaml#/components/schemas/ApplicationId'
    minItems: 1
  dnns:
    type: array
    items:
      $ref: 'TS29571_CommonData.yaml#/components/schemas/Dnn'
    minItems: 1
  dnais:
    type: array
    items:
      $ref: 'TS29571_CommonData.yaml#/components/schemas/Dnai'
    minItems: 1
  ladmDnns:
    type: array
    items:
      $ref: 'TS29571_CommonData.yaml#/components/schemas/Dnn'
    minItems: 1
    description: Identification(s) of LADN DNN to indicate the LADN service area as the AOI.
  location:
    $ref: 'TS29520_Nnwdaf_EventsSubscription.yaml#/components/schemas/GeoLocation'
  networkArea:
    $ref: 'TS29554_Npcf_BDTPolicyControl.yaml#/components/schemas/NetworkAreaInfo'
  temporalGranSize:
    $ref: 'TS29571_CommonData.yaml#/components/schemas/DurationSec'
  spatialGranSizeTa:
    $ref: 'TS29571_CommonData.yaml#/components/schemas/Uinteger'
  spatialGranSizeCell:
    $ref: 'TS29571_CommonData.yaml#/components/schemas/Uinteger'
  fineGranAreas:
    type: array
    items:
      $ref: 'TS29522_AMPolicyAuthorization.yaml#/components/schemas/GeographicalArea'
    minItems: 1
    description: Indicates the fine granularity areas to which the request applies.
  visitedAreas:
    type: array
    items:
      $ref: 'TS29554_Npcf_BDTPolicyControl.yaml#/components/schemas/NetworkAreaInfo'
    minItems: 1
  maxTopAppUlNbr:
    $ref: 'TS29571_CommonData.yaml#/components/schemas/Uinteger'
  maxTopAppDlNbr:
    $ref: 'TS29571_CommonData.yaml#/components/schemas/Uinteger'
  nfInstanceIds:
    type: array

```

```

    items:
      $ref: 'TS29571_CommonData.yaml#/components/schemas/NfInstanceId'
    minItems: 1
  nfSetIds:
    type: array
    items:
      $ref: 'TS29571_CommonData.yaml#/components/schemas/NfSetId'
    minItems: 1
  nfTypes:
    type: array
    items:
      $ref: 'TS29510_Nnrf_NFManagement.yaml#/components/schemas/NFType'
    minItems: 1
  nsiIdInfos:
    type: array
    items:
      $ref: 'TS29520_Nnwdaf_EventsSubscription.yaml#/components/schemas/NsiIdInfo'
    minItems: 1
  qosRequ:
    $ref: 'TS29520_Nnwdaf_EventsSubscription.yaml#/components/schemas/QosRequirement'
  nwPerfReqs:
    type: array
    items:
      $ref: '#/components/schemas/NetworkPerfReq'
    minItems: 1
  nwPerfTypes:
    type: array
    items:
      $ref: 'TS29520_Nnwdaf_EventsSubscription.yaml#/components/schemas/NetworkPerfType'
    minItems: 1
  addNwPerfReqs:
    type: array
    items:
      $ref: '#/components/schemas/ResourceUsageReqPerNwPerfType'
    minItems: 1
  userDataConReqs:
    type: array
    items:
      $ref: '#/components/schemas/UserDataCongestReq'
    minItems: 1
  bwRequ:
    type: array
    items:
      $ref: 'TS29520_Nnwdaf_EventsSubscription.yaml#/components/schemas/BwRequirement'
    minItems: 1
  excepIds:
    type: array
    items:
      $ref: 'TS29520_Nnwdaf_EventsSubscription.yaml#/components/schemas/ExceptionId'
    minItems: 1
  exptAnaType:
    $ref: 'TS29520_Nnwdaf_EventsSubscription.yaml#/components/schemas/ExpectedAnalyticsType'
  exptUeBehav:
    $ref: 'TS29503_Nudm_SDM.yaml#/components/schemas/ExpectedUeBehaviourData'
  ratFreqs:
    type: array
    items:
      $ref: 'TS29520_Nnwdaf_EventsSubscription.yaml#/components/schemas/RatFreqInformation'
    minItems: 1
  disperReqs:
    type: array
    items:
      $ref: 'TS29520_Nnwdaf_EventsSubscription.yaml#/components/schemas/DispersionRequirement'
    minItems: 1
  redTransReqs:
    type: array
    items:
      $ref:
'TS29520_Nnwdaf_EventsSubscription.yaml#/components/schemas/RedundantTransmissionExpReq'
    minItems: 1
  wlanReqs:
    type: array
    items:
      $ref: 'TS29520_Nnwdaf_EventsSubscription.yaml#/components/schemas/WlanPerformanceReq'
    minItems: 1
  listOfAnaSubsets:
    type: array
    items:

```

```

    $ref: 'TS29520_Nnwdaf_EventsSubscription.yaml#/components/schemas/AnalyticsSubset'
    minItems: 1
  upfInfo:
    $ref: 'TS29508_Nsmf_EventExposure.yaml#/components/schemas/UpfInformation'
  appServerAddr:
    type: array
    items:
      $ref: 'TS29517_Naf_EventExposure.yaml#/components/schemas/AddrFqdn'
    minItems: 1
  dnPerfReqs:
    type: array
    items:
      $ref: 'TS29520_Nnwdaf_EventsSubscription.yaml#/components/schemas/DnPerformanceReq'
    minItems: 1
  ueMobilityReqs:
    type: array
    items:
      $ref: 'TS29520_Nnwdaf_EventsSubscription.yaml#/components/schemas/UeMobilityReq'
    minItems: 1
  ueCommReqs:
    type: array
    items:
      $ref: 'TS29520_Nnwdaf_EventsSubscription.yaml#/components/schemas/UeCommReq'
    minItems: 1
  pduSesInfos:
    type: array
    items:
      $ref: 'TS29520_Nnwdaf_EventsSubscription.yaml#/components/schemas/PduSessionInfo'
    minItems: 1
  pduSesTraffReqs:
    type: array
    items:
      $ref: 'TS29520_Nnwdaf_EventsSubscription.yaml#/components/schemas/PduSesTrafficReq'
    minItems: 1
  locAccReqs:
    type: array
    items:
      $ref: 'TS29520_Nnwdaf_EventsSubscription.yaml#/components/schemas/LocAccuracyReq'
    minItems: 1
  locGranularity:
    $ref: 'TS29520_Nnwdaf_EventsSubscription.yaml#/components/schemas/LocInfoGranularity'
  locOrientation:
    $ref: 'TS29520_Nnwdaf_EventsSubscription.yaml#/components/schemas/LocationOrientation'
  useCaseCxt:
    type: string
    description: >
      Indicates the context of usage of the analytics. The value and format of this parameter
      are not standardized.
  dataVlTrnsTmRqs:
    type: array
    items:
      $ref:
'TS29520_Nnwdaf_EventsSubscription.yaml#/components/schemas/E2eDataVolTransTimeReq'
    minItems: 1
  accuReq:
    $ref: 'TS29520_Nnwdaf_EventsSubscription.yaml#/components/schemas/AccuracyReq'
  movBehavReqs:
    type: array
    items:
      $ref: 'TS29520_Nnwdaf_EventsSubscription.yaml#/components/schemas/MovBehavReq'
    minItems: 1
  relProxReqs:
    type: array
    items:
      $ref: 'TS29520_Nnwdaf_EventsSubscription.yaml#/components/schemas/RelProxReq'
    minItems: 1
  not:
    required: [anySlice, snssais]

ProblemDetailsAnalyticsInfoRequest:
  description: >
    Extends ProblemDetails to indicate more details why the analytics request is rejected.
  allOf:
    - $ref: 'TS29571_CommonData.yaml#/components/schemas/ProblemDetails'
    - $ref: '#/components/schemas/AdditionInfoAnalyticsInfoRequest'

AdditionInfoAnalyticsInfoRequest:
  description: Indicates additional information why the analytics request is rejected.

```

```

    type: object
    properties:
      rvWaitTime:
        $ref: 'TS29571_CommonData.yaml#/components/schemas/DurationSec'

ContextData:
  description: >
    Contains context information related to analytics subscriptions corresponding with one or
    more context identifiers.
  type: object
  properties:
    contextElems:
      type: array
      items:
        $ref: '#/components/schemas/ContextElement'
      minItems: 1
      description: >
        List of items that contain context information corresponding with a context identifier.
    suppFeat:
      $ref: 'TS29571_CommonData.yaml#/components/schemas/SupportedFeatures'
  required:
    - contextElems

ContextElement:
  description: Contains context information corresponding with a specific context identifier.
  type: object
  properties:
    contextId:
      $ref:
'TS29520_Nnwdaf_EventsSubscription.yaml#/components/schemas/AnalyticsContextIdentifier'
    pendAnalytics:
      type: array
      items:
        $ref: 'TS29520_Nnwdaf_EventsSubscription.yaml#/components/schemas/EventNotification'
      minItems: 1
      description: >
        Output analytics for the analytics subscription which have not yet been sent to the
        analytics consumer.
    histAnalytics:
      type: array
      items:
        $ref: 'TS29520_Nnwdaf_EventsSubscription.yaml#/components/schemas/EventNotification'
      minItems: 1
      description: Historical output analytics.
    lastOutputTime:
      $ref: 'TS29571_CommonData.yaml#/components/schemas/DateTime'
    agrSubs:
      type: array
      items:
        $ref: '#/components/schemas/SpecificAnalyticsSubscription'
      minItems: 1
      description: >
        Information about analytics subscriptions that the NWDAF has with other NWDAFs to
        perform aggregation.
    histData:
      type: array
      items:
        $ref: '#/components/schemas/HistoricalData'
      minItems: 1
      description: Historical data related to the analytics subscription.
    adrfId:
      $ref: 'TS29571_CommonData.yaml#/components/schemas/NfInstanceId'
    adrfDataTypes:
      type: array
      items:
        $ref: '#/components/schemas/AdrfDataType'
      minItems: 1
      description: Type(s) of data stored in the ADRF by the NWDAF.
    agrNwdafIds:
      type: array
      items:
        $ref: 'TS29571_CommonData.yaml#/components/schemas/NfInstanceId'
      minItems: 1
      description: >
        NWDAF identifiers of NWDAF instances used by the NWDAF service consumer when aggregating
        multiple analytics subscriptions.
    modelInfo:
      type: array

```

```

    items:
      $ref: 'TS29520_Nnwdaf_EventsSubscription.yaml#/components/schemas/ModelInfo'
    minItems: 1
    description: >
      Contains information identifying the ML model(s) that the consumer NWDAF is currently
      subscribing for the analytics.
  anaAccuInfos:
    type: array
    items:
      $ref: '#/components/schemas/AnalyticsAccuracyInfo'
    minItems: 1
    description: The Analytics Accuracy related information.
  modelAccuInfos:
    type: array
    items:
      $ref: '#/components/schemas/MLModelAccuracyInfo'
    minItems: 1
    description: The ML Model accuracy related information.
  required:
    - contextId

ContextIdList:
  description: >
    Contains a list of context identifiers of context information of analytics
    subscriptions.
  type: object
  properties:
    contextIds:
      type: array
      items:
        $ref:
'TS29520_Nnwdaf_EventsSubscription.yaml#/components/schemas/AnalyticsContextIdentifier'
      minItems: 1
  required:
    - contextIds

HistoricalData:
  description: Contains historical data related to an analytics subscription.
  type: object
  properties:
    startTime:
      $ref: 'TS29571_CommonData.yaml#/components/schemas/DateTime'
    endTime:
      $ref: 'TS29571_CommonData.yaml#/components/schemas/DateTime'
    subsWithSources:
      type: array
      items:
        $ref: '#/components/schemas/SpecificDataSubscription'
      minItems: 1
      description: Information about subscriptions with the data sources.
    data:
      type: array
      items:
        $ref: 'TS29575_Nadrf_DataManagement.yaml#/components/schemas/DataNotification'
      minItems: 1
      description: Historical data related to the analytics.
  required:
    - data

NetworkPerfReq:
  description: Represents a network performance requirement.
  type: object
  properties:
    orderCriterion:
      $ref:
'TS29520_Nnwdaf_EventsSubscription.yaml#/components/schemas/NetworkPerfOrderCriterion'
    orderDirection:
      $ref: 'TS29520_Nnwdaf_EventsSubscription.yaml#/components/schemas/MatchingDirection'

SpecificAnalyticsSubscription:
  description: >
    Represents an existing subscription for a specific type of analytics to a specific NWDAF.
  type: object
  properties:
    subscriptionId:
      type: string
    producerId:
      $ref: 'TS29571_CommonData.yaml#/components/schemas/NfInstanceId'

```

```

    producerSetId:
      $ref: 'TS29571_CommonData.yaml#/components/schemas/NfSetId'
    nwdafEvSub:
      $ref:
'TS29520_Nnwdaf_EventsSubscription.yaml#/components/schemas/NnwdafEventsSubscription'
  allOf:
    - oneOf:
      - required: [producerId]
      - required: [producerSetId]
      - required: [subscriptionId]
      - required: [nwdafEvSub]

RequestedContext:
  description: Contains types of analytics context information.
  type: object
  properties:
    contexts:
      type: array
      items:
        $ref: '#/components/schemas/ContextType'
      minItems: 1
      description: List of analytics context types.
    nfConsumerInfo:
      $ref: 'TS29510_Nnrf_NFManagement.yaml#/components/schemas/VendorId'
  required:
    - contexts

SmcceInfo:
  description: Represents the Session Management congestion control experience information.
  type: object
  properties:
    dnn:
      $ref: 'TS29571_CommonData.yaml#/components/schemas/Dnn'
    snssai:
      $ref: 'TS29571_CommonData.yaml#/components/schemas/Snssai'
    smcceUeList:
      $ref: '#/components/schemas/SmcceUeList'
  required:
    - smcceUeList

SmcceUeList:
  description: >
    Represents the List of UEs classified based on experience level of Session Management
    congestion control.
  type: object
  properties:
    highLevel:
      type: array
      items:
        $ref: 'TS29571_CommonData.yaml#/components/schemas/Supi'
      minItems: 1
    mediumLevel:
      type: array
      items:
        $ref: 'TS29571_CommonData.yaml#/components/schemas/Supi'
      minItems: 1
    lowLevel:
      type: array
      items:
        $ref: 'TS29571_CommonData.yaml#/components/schemas/Supi'
      minItems: 1
  anyOf:
    - required: [highLevel]
    - required: [mediumLevel]
    - required: [lowLevel]

SpecificDataSubscription:
  description: >
    Represents an existing subscription for data collection to a specific data source NF.
  type: object
  properties:
    subscriptionId:
      type: string
    producerId:
      $ref: 'TS29571_CommonData.yaml#/components/schemas/NfInstanceId'
    producerSetId:
      $ref: 'TS29571_CommonData.yaml#/components/schemas/NfSetId'
    dataSub:

```

```

    $ref: 'TS29575_Nadrf_DataManagement.yaml#/components/schemas/DataSubscription'
  allOf:
    - oneOf:
      - required: [producerId]
      - required: [producerSetId]
      - required: [subscriptionId]
      - required: [dataSub]

UserDataCongestReq:
  description: >
    Represents a user data congestion requirement.
  type: object
  properties:
    orderCriterion:
      $ref: 'TS29520_Nnwdaf_EventsSubscription.yaml#/components/schemas/UserDataConOrderCrit'
    orderDirection:
      $ref: 'TS29520_Nnwdaf_EventsSubscription.yaml#/components/schemas/MatchingDirection'

ResourceUsageRequPerNwPerfType:
  description: More requirement for each network performance type.
  type: object
  properties:
    nwPerfType:
      $ref: 'TS29520_Nnwdaf_EventsSubscription.yaml#/components/schemas/NetworkPerfType'
    rscUsgReq:
      $ref:
' TS29520_Nnwdaf_EventsSubscription.yaml#/components/schemas/ResourceUsageRequirement'
  required:
    - nwPerfType

AnalyticsAccuracyInfo:
  description: Analytics Accuracy related information needs to be transferred.
  type: object
  properties:
    reportTime:
      $ref: 'TS29571_CommonData.yaml#/components/schemas/DateTime'
    pauseInd:
      type: boolean
      description: >
        Indicates whether the analytics subscription has been paused. Set to "true" if it has
        been paused, otherwise set to "false".
    remainTimeWin:
      $ref: 'TS29122_CommonData.yaml#/components/schemas/TimeWindow'
    groundTruthInfo:
      $ref: '#/components/schemas/GroundTruthInfo'

GroundTruthInfo:
  description: The ground truth information used for the accuracy information computation.
  type: object
  properties:
    analyticsId:
      $ref: '#/components/schemas/EventId'
    dataSourceIds:
      type: array
      items:
        $ref: 'TS29571_CommonData.yaml#/components/schemas/NfInstanceId'
      minItems: 1
      description: The NF instance ID(s) of the data source for ground truth data.
    dataSourceSetIds:
      type: array
      items:
        $ref: 'TS29571_CommonData.yaml#/components/schemas/NfSetId'
      minItems: 1
      description: The NF Set ID(s) of the data source for ground truth data.
    dataSubs:
      type: array
      items:
        $ref: 'TS29575_Nadrf_DataManagement.yaml#/components/schemas/DataSubscription'
      minItems: 1
    groundTruthDatas:
      type: array
      items:
        $ref: 'TS29575_Nadrf_DataManagement.yaml#/components/schemas/DataNotification'
      minItems: 1
  required:
    - analyticsId
    - groundTruthDatas

```



```

MLModelAccuracyInfo:
  description: The ML Model Accuracy Subscription Information needs to be transferred.
  type: object
  properties:
    subscriptionId:
      type: string
      description: The identifier of the subscription for the ML Model accuracy information.
    sourceId:
      $ref: 'TS29571_CommonData.yaml#/components/schemas/NfInstanceId'
    sourceSetId:
      $ref: 'TS29571_CommonData.yaml#/components/schemas/NfSetId'
    accuSubInfo:
      $ref: 'TS29520_Nnwdaf_MLModelMonitor.yaml#/components/schemas/MLModelAccuracyInfo'
  required:
    - subscriptionId

```

```

#
# ENUMERATIONS DATA TYPES
#

```

```

EventId:
  anyOf:
    - type: string
      enum:
        - LOAD_LEVEL_INFORMATION
        - NETWORK_PERFORMANCE
        - NF_LOAD
        - SERVICE_EXPERIENCE
        - UE_MOBILITY
        - UE_COMMUNICATION
        - QOS_SUSTAINABILITY
        - ABNORMAL_BEHAVIOUR
        - USER_DATA_CONGESTION
        - NSI_LOAD_LEVEL
        - SM_CONGESTION
        - DISPERSION
        - RED_TRANS_EXP
        - WLAN_PERFORMANCE
        - DN_PERFORMANCE
        - PDU_SESSION_TRAFFIC
        - E2E_DATA_VOL_TRANS_TIME
        - MOVEMENT_BEHAVIOUR
        - LOC_ACCURACY
        - RELATIVE_PROXIMITY
    - type: string
      description: >
        This string provides forward-compatibility with future
        extensions to the enumeration but is not used to encode
        content defined in the present version of this API.
  description: |
    Represents the analytics type.
    Possible values are:
    - LOAD_LEVEL_INFORMATION: Represent the analytics of load level information of corresponding
      network slice.
    - NETWORK_PERFORMANCE: Represent the analytics of network performance information.
    - NF_LOAD: Indicates that the event subscribed is NF Load.
    - SERVICE_EXPERIENCE: Represent the analytics of service experience information of the
      specific applications.
    - UE_MOBILITY: Represent the analytics of UE mobility.
    - UE_COMMUNICATION: Represent the analytics of UE communication.
    - QOS_SUSTAINABILITY: Represent the analytics of QoS sustainability information in the
      certain area.
    - ABNORMAL_BEHAVIOUR: Indicates that the event subscribed is abnormal behaviour information.
    - USER_DATA_CONGESTION: Represent the analytics of the user data congestion in the certain
      area.
    - NSI_LOAD_LEVEL: Represent the analytics of Network Slice and the optionally associated
      Network Slice Instance.
    - SM_CONGESTION: Represent the analytics of Session Management congestion control experience
      information for specific DNN and/or S-NSSAI.
    - DISPERSION: Represents the analytics of dispersion.
    - RED_TRANS_EXP: Represents the analytics of Redundant Transmission Experience.
    - WLAN_PERFORMANCE: Represents the analytics of WLAN performance.
    - DN_PERFORMANCE: Represents the analytics of DN performance.
    - PDU_SESSION_TRAFFIC: Represents the analytics of PDU Session traffic.
    - E2E_DATA_VOL_TRANS_TIME: Represents the analytics of E2E data volume transfer time.
    - MOVEMENT_BEHAVIOUR: Represents the analytics of the Movement Behaviour information.
    - LOC_ACCURACY: Represents the analytics of location accuracy.
    - RELATIVE_PROXIMITY: Represents the analytics of Relative Proximity information.

```

```

ContextType:
  anyOf:
  - type: string
    enum:
      - PENDING_ANALYTICS
      - HISTORICAL_ANALYTICS
      - AGGR_SUBS
      - DATA
      - AGGR_INFO
      - ML_MODELS
      - ANALYTICS_ACCU_INFO
      - ML_MODEL_ACCU_INFO
  - type: string
    description: >
      This string provides forward-compatibility with future
      extensions to the enumeration but is not used to encode
      content defined in the present version of this API.
    description: |
      Represents the analytics context information type.
      Possible values are:
      - PENDING_ANALYTICS: Represents context information that relates to pending output
        analytics.
      - HISTORICAL_ANALYTICS: Represents context information that relates to historical output
        analytics.
      - AGGR_SUBS: Represents context information about the analytics subscriptions that an NWDAF
        has with other NWDAFs that collectively serve an analytics subscription.
      - DATA: Represents context information about historical data that is available.
      - AGGR_INFO: Represents context information that is related to aggregation of analytics
        from multiple NWDAF subscriptions.
      - ML_MODELS: Represents context information about used ML models.
      - ANALYTICS_ACCU_INFO: Represents the Analytics Accuracy related information.
      - ML_MODEL_ACCU_INFO: Represents the ML Model accuracy related information.

AdrfDataType:
  anyOf:
  - type: string
    enum:
      - HISTORICAL_ANALYTICS
      - HISTORICAL_DATA
  - type: string
    description: >
      This string provides forward-compatibility with future
      extensions to the enumeration but is not used to encode
      content defined in the present version of this API.
    description: |
      Represents a type of data that is stored in the ADRF.
      Possible values are:
      - HISTORICAL_ANALYTICS: Indicates that historical analytics are stored in the ADRF.
      - HISTORICAL_DATA: Indicates that historical data are stored in the ADRF.

```

A.4 Nnwdaf_DataManagement API

openapi: 3.0.0

```

info:
  title: Nnwdaf_DataManagement
  version: 1.1.1
  description: |
    Nnwdaf_DataManagement API Service.
    © 2024, 3GPP Organizational Partners (ARIB, ATIS, CCSA, ETSI, TSDSI, TTA, TTC).
    All rights reserved.

externalDocs:
  description: 3GPP TS 29.520 V18.7.0; 5G System; Network Data Analytics Services.
  url: 'https://www.3gpp.org/ftp/Specs/archive/29_series/29.520/'

servers:
  - url: '{apiRoot}/nnwdaf-datamanagement/v1'
    variables:
      apiRoot:
        default: https://example.com
        description: apiRoot as defined in clause 4.4 of 3GPP TS 29.501

security:

```

- {}
- oAuth2ClientCredentials:
 - nnwdaf-datamanagement

paths:

```

/subscriptions:
  post:
    summary: subscribe to notifications
    operationId: CreateIndividualSubscription
    tags:
      - Subscriptions (Collection)
    requestBody:
      required: true
      content:
        application/json:
          schema:
            $ref: '#/components/schemas/NnwdafDataManagementSubsc'
    responses:
      '201':
        description: Success
        content:
          application/json:
            schema:
              $ref: '#/components/schemas/NnwdafDataManagementSubsc'
        headers:
          Location:
            description: >
              Contains the URI of the newly created resource, according to the structure
              {apiRoot}/nnwdaf-datamanagement/<apiVersion>/subscriptions/{subscriptionId}.
            required: true
            schema:
              type: string
      '400':
        $ref: 'TS29571_CommonData.yaml#/components/responses/400'
      '401':
        $ref: 'TS29571_CommonData.yaml#/components/responses/401'
      '403':
        $ref: 'TS29571_CommonData.yaml#/components/responses/403'
      '404':
        $ref: 'TS29571_CommonData.yaml#/components/responses/404'
      '411':
        $ref: 'TS29571_CommonData.yaml#/components/responses/411'
      '413':
        $ref: 'TS29571_CommonData.yaml#/components/responses/413'
      '415':
        $ref: 'TS29571_CommonData.yaml#/components/responses/415'
      '429':
        $ref: 'TS29571_CommonData.yaml#/components/responses/429'
      '500':
        $ref: 'TS29571_CommonData.yaml#/components/responses/500'
      '502':
        $ref: 'TS29571_CommonData.yaml#/components/responses/502'
      '503':
        $ref: 'TS29571_CommonData.yaml#/components/responses/503'
      default:
        $ref: 'TS29571_CommonData.yaml#/components/responses/default'
    callbacks:
      myNotification:
        '{$request.body#/notificURI}':
          post:
            requestBody:
              required: true
              content:
                application/json:
                  schema:
                    $ref: '#/components/schemas/NnwdafDataManagementNotif'
            responses:
              '200':
                description: The notification is acknowledged and a planned action is provided.
                content:
                  application/json:
                    schema:
                      $ref: 'TS29574_Ndccf_DataManagement.yaml#/components/schemas/NotifResponse'
              '204':
                description: No Content, Notification was succesfull
              '307':
                $ref: 'TS29571_CommonData.yaml#/components/responses/307'
              '308':

```

```

    $ref: 'TS29571_CommonData.yaml#/components/responses/308'
  '400':
    $ref: 'TS29571_CommonData.yaml#/components/responses/400'
  '401':
    $ref: 'TS29571_CommonData.yaml#/components/responses/401'
  '403':
    $ref: 'TS29571_CommonData.yaml#/components/responses/403'
  '404':
    $ref: 'TS29571_CommonData.yaml#/components/responses/404'
  '411':
    $ref: 'TS29571_CommonData.yaml#/components/responses/411'
  '413':
    $ref: 'TS29571_CommonData.yaml#/components/responses/413'
  '415':
    $ref: 'TS29571_CommonData.yaml#/components/responses/415'
  '429':
    $ref: 'TS29571_CommonData.yaml#/components/responses/429'
  '500':
    $ref: 'TS29571_CommonData.yaml#/components/responses/500'
  '502':
    $ref: 'TS29571_CommonData.yaml#/components/responses/502'
  '503':
    $ref: 'TS29571_CommonData.yaml#/components/responses/503'
  default:
    $ref: 'TS29571_CommonData.yaml#/components/responses/default'
callbacks:
  Fetch:
    '{$request.body#/fetchInstruct/fetchUri}':
      post:
        requestBody:
          required: true
          content:
            application/json:
              schema:
                type: array
                items:
                  type: string
                  minItems: 1
                description: Indicate the fetch correlation identifier.
        responses:
          '200':
            description: Expected response to a valid request
            content:
              application/json:
                schema:
                  $ref: '#/components/schemas/NnwdafDataManagementNotif'
          '307':
            $ref: 'TS29571_CommonData.yaml#/components/responses/307'
          '308':
            $ref: 'TS29571_CommonData.yaml#/components/responses/308'
          '400':
            $ref: 'TS29571_CommonData.yaml#/components/responses/400'
          '401':
            $ref: 'TS29571_CommonData.yaml#/components/responses/401'
          '403':
            $ref: 'TS29571_CommonData.yaml#/components/responses/403'
          '404':
            $ref: 'TS29571_CommonData.yaml#/components/responses/404'
          '406':
            $ref: 'TS29571_CommonData.yaml#/components/responses/406'
          '411':
            $ref: 'TS29571_CommonData.yaml#/components/responses/411'
          '413':
            $ref: 'TS29571_CommonData.yaml#/components/responses/413'
          '415':
            $ref: 'TS29571_CommonData.yaml#/components/responses/415'
          '429':
            $ref: 'TS29571_CommonData.yaml#/components/responses/429'
          '500':
            $ref: 'TS29571_CommonData.yaml#/components/responses/500'
          '502':
            $ref: 'TS29571_CommonData.yaml#/components/responses/502'
          '503':
            $ref: 'TS29571_CommonData.yaml#/components/responses/503'
          default:
            $ref: 'TS29571_CommonData.yaml#/components/responses/default'
/subscriptions/{subscriptionId}:
  put:

```

```

summary: Update an existing Individual NWDAF Data Subscription.
operationId: UpdateNWDAFDataSubscription
tags:
  - Individual NWDAF Data Management Subscription (Document)
requestBody:
  required: true
  content:
    application/json:
      schema:
        $ref: '#/components/schemas/NnwdafDataManagementSubsc'
parameters:
  - name: subscriptionId
    in: path
    description: Event Subscription ID
    required: true
    schema:
      type: string
responses:
  '200':
    description: OK. Resource was succesfully modified and representation is returned
    content:
      application/json:
        schema:
          $ref: '#/components/schemas/NnwdafDataManagementSubsc'
  '204':
    description: No Content. Resource was succesfully modified
  '307':
    $ref: 'TS29571_CommonData.yaml#/components/responses/307'
  '308':
    $ref: 'TS29571_CommonData.yaml#/components/responses/308'
  '400':
    $ref: 'TS29571_CommonData.yaml#/components/responses/400'
  '401':
    $ref: 'TS29571_CommonData.yaml#/components/responses/401'
  '403':
    $ref: 'TS29571_CommonData.yaml#/components/responses/403'
  '404':
    $ref: 'TS29571_CommonData.yaml#/components/responses/404'
  '411':
    $ref: 'TS29571_CommonData.yaml#/components/responses/411'
  '413':
    $ref: 'TS29571_CommonData.yaml#/components/responses/413'
  '415':
    $ref: 'TS29571_CommonData.yaml#/components/responses/415'
  '429':
    $ref: 'TS29571_CommonData.yaml#/components/responses/429'
  '500':
    $ref: 'TS29571_CommonData.yaml#/components/responses/500'
  '502':
    $ref: 'TS29571_CommonData.yaml#/components/responses/502'
  '503':
    $ref: 'TS29571_CommonData.yaml#/components/responses/503'
  default:
    $ref: 'TS29571_CommonData.yaml#/components/responses/default'
delete:
  summary: unsubscribe from notifications
  operationId: DeleteNWDAFDataSubscription
  tags:
    - Individual NWDAF Data Management Subscription (Document)
  parameters:
    - name: subscriptionId
      in: path
      description: Event Subscription ID
      required: true
      schema:
        type: string
  responses:
    '204':
      description: No Content. Resource was succesfully deleted
    '200':
      description: >
        Resource was succesfully deleted and including the stored unsend events in the response.
      content:
        application/json:
          schema:
            $ref: '#/components/schemas/NwdafDataManagementNotif'
    '307':
      $ref: 'TS29571_CommonData.yaml#/components/responses/307'

```

```

'308':
  $ref: 'TS29571_CommonData.yaml#/components/responses/308'
'400':
  $ref: 'TS29571_CommonData.yaml#/components/responses/400'
'401':
  $ref: 'TS29571_CommonData.yaml#/components/responses/401'
'403':
  $ref: 'TS29571_CommonData.yaml#/components/responses/403'
'404':
  $ref: 'TS29571_CommonData.yaml#/components/responses/404'
'429':
  $ref: 'TS29571_CommonData.yaml#/components/responses/429'
'500':
  $ref: 'TS29571_CommonData.yaml#/components/responses/500'
'502':
  $ref: 'TS29571_CommonData.yaml#/components/responses/502'
'503':
  $ref: 'TS29571_CommonData.yaml#/components/responses/503'
default:
  $ref: 'TS29571_CommonData.yaml#/components/responses/default'

```

components:

```

securitySchemes:
  oAuth2ClientCredentials:
    type: oauth2
    flows:
      clientCredentials:
        tokenUrl: '{nrfApiRoot}/oauth2/token'
        scopes:
          nnwdaf-datamanagement: Access to the Nnwdaf_DataManagement API

```

schemas:

```

NnwdafDataManagementSubsc:
  description: Represents an Individual NWDAF Data Management Subscription resource.
  type: object
  properties:
    adrfId:
      $ref: 'TS29571_CommonData.yaml#/components/schemas/NfInstanceId'
    adrfSetId:
      $ref: 'TS29571_CommonData.yaml#/components/schemas/NfSetId'
    anaSub:
      $ref: 'TS29520_Nnwdaf_EventsSubscription.yaml#/components/schemas/NnwdafEventsSubscription'
    dataCollectPurposes:
      type: array
      items:
        $ref: 'TS29574_Ndccf_DataManagement.yaml#/components/schemas/DataCollectionPurpose'
      minItems: 1
      description: >
        The purposes of data collection. This attribute may only be provided if user consent
        is required depending on local policy and regulations and the consumer has
        not checked user consent.
    checkedConsentInd:
      type: boolean
      description: Indication that the NF service consumer has already checked the user consent.
    dataSub:
      $ref: 'TS29575_Ndrf_DataManagement.yaml#/components/schemas/DataSubscription'
    formatInstruct:
      $ref: 'TS29574_Ndccf_DataManagement.yaml#/components/schemas/FormattingInstruction'
    notifCorrId:
      type: string
      description: Notification correlation identifier.
    notificURI:
      $ref: 'TS29571_CommonData.yaml#/components/schemas/Uri'
    notifEndpoints:
      type: array
      items:
        $ref: 'TS29574_Ndccf_DataManagement.yaml#/components/schemas/NotifyEndpoint'
      minItems: 1
      description: The information of notification endpoints.
    procInstruct:
      $ref: 'TS29574_Ndccf_DataManagement.yaml#/components/schemas/ProcessingInstruction'
    multiProcInstructs:
      type: array
      items:
        $ref: 'TS29574_Ndccf_DataManagement.yaml#/components/schemas/ProcessingInstruction'
      minItems: 1
      description: Processing instructions to be used for sending event notifications.

```

```

    suppFeat:
      $ref: 'TS29571_CommonData.yaml#/components/schemas/SupportedFeatures'
    targetNfId:
      $ref: 'TS29571_CommonData.yaml#/components/schemas/NfInstanceId'
    targetNfSetId:
      $ref: 'TS29571_CommonData.yaml#/components/schemas/NfSetId'
    timePeriod:
      $ref: 'TS29122_CommonData.yaml#/components/schemas/TimeWindow'
    immReport:
      $ref: '#/components/schemas/NnwdafDataManagementNotif'
    storeHandl:
      $ref: 'TS29574_Ndccf_DataManagement.yaml#/components/schemas/StorageHandlingInformation'
  required:
    - notifCorrId
    - notificURI
  oneOf:
    - required: [anaSub]
    - required: [dataSub]

NnwdafDataManagementNotif:
  description: Represents an Individual Notification.
  type: object
  properties:
    dataNotification:
      $ref: 'TS29575_Ndrf_DataManagement.yaml#/components/schemas/DataNotification'
    dataReports:
      type: array
      items:
        $ref: 'TS29574_Ndccf_DataManagement.yaml#/components/schemas/NotifSummaryReport'
      minItems: 1
      description: List of summary reports of processed notifications.
    delAlert:
      $ref: 'TS29574_Ndccf_DataManagement.yaml#/components/schemas/DeletionAlert'
    notifCorrId:
      type: string
      description: Notification correlation identifier.
    terminationReq:
      type: string
      description: >
        It indicates that the termination of the data management subscription
        is requested by the NWDAF.
    fetchInstruct:
      $ref: 'TS29576_Nmfaf_3caDataManagement.yaml#/components/schemas/FetchInstruction'
    notifTimestamp:
      $ref: 'TS29571_CommonData.yaml#/components/schemas/DateTime'
    pendNotifCause:
      $ref: '#/components/schemas/PendingNotificationCause'
  required:
    - notifCorrId
    - notifTimestamp
  oneOf:
    - required: [dataNotification]
    - required: [dataReports]
    - required: [fetchInstruct]

#
# ENUMERATIONS DATA TYPES
#
PendingNotificationCause:
  anyOf:
    - type: string
      enum:
        - UE_OUT_OF_NF_SERVING_AREA
        - OTHER
    - type: string
      description: >
        This string provides forward-compatibility with future extensions to the enumeration but
        is not used to encode content defined in the present version of this API.
  description: |
    Represents the Pending Notification Cause for the stored unsent data.
    Possible values are:
    - UE_OUT_OF_NF_SERVING_AREA: The UE moved out of the NF serving area.
    - OTHER: Other cause.

```

A.5 Nnwdaf_MLModelProvision API

openapi: 3.0.0

info:

```
title: Nnwdaf_MLModelProvision
version: 1.1.1
description: |
  Nnwdaf_MLModelProvision API Service.
  © 2024, 3GPP Organizational Partners (ARIB, ATIS, CCSA, ETSI, TSDSI, TTA, TTC).
  All rights reserved.
```

externalDocs:

```
description: 3GPP TS 29.520 V18.7.0; 5G System; Network Data Analytics Services.
url: https://www.3gpp.org/ftp/Specs/archive/29_series/29.520/
```

servers:

```
- url: '{apiRoot}/nnwdaf-mlmodelprovision/v1'
  variables:
    apiRoot:
      default: https://example.com
      description: apiRoot as defined in clause 4.4 of 3GPP TS 29.501
```

security:

```
- {}
- oAuth2ClientCredentials:
  - nnwdaf-mlmodelprovision
```

paths:

```
/subscriptions:
  post:
    summary: Create a new Individual NWDAF ML Model Provision Subscription resource.
    operationId: CreateNWDAFMLModelProvisionSubscription
    tags:
      - Subscriptions (Collection)
    requestBody:
      required: true
      content:
        application/json:
          schema:
            $ref: '#/components/schemas/NwdafMLModelProvSubsc'
    responses:
      '201':
        description: Create a new Individual NWDAF ML Model Provision Subscription resource.
        content:
          application/json:
            schema:
              $ref: '#/components/schemas/NwdafMLModelProvSubsc'
        headers:
          Location:
            description: >
              Contains the URI of the newly created resource, according to the structure
              {apiRoot}/nnwdaf-mlmodelprovision/v1/subscriptions/{subscriptionId}.
            required: true
            schema:
              type: string
      '400':
        $ref: 'TS29571_CommonData.yaml#/components/responses/400'
      '401':
        $ref: 'TS29571_CommonData.yaml#/components/responses/401'
      '403':
        $ref: 'TS29571_CommonData.yaml#/components/responses/403'
      '404':
        $ref: 'TS29571_CommonData.yaml#/components/responses/404'
      '411':
        $ref: 'TS29571_CommonData.yaml#/components/responses/411'
      '413':
        $ref: 'TS29571_CommonData.yaml#/components/responses/413'
      '415':
        $ref: 'TS29571_CommonData.yaml#/components/responses/415'
      '429':
        $ref: 'TS29571_CommonData.yaml#/components/responses/429'
      '500':
        $ref: 'TS29571_CommonData.yaml#/components/responses/500'
      '502':
        $ref: 'TS29571_CommonData.yaml#/components/responses/502'
      '503':
```



```

    $ref: 'TS29571_CommonData.yaml#/components/responses/503'
  default:
    $ref: 'TS29571_CommonData.yaml#/components/responses/default'
  callbacks:
    myNotification:
      '{$request.body#/notifUri}':
        post:
          requestBody:
            required: true
            content:
              application/json:
                schema:
                  type: array
                  items:
                    $ref: '#/components/schemas/NwdafMLModelProvNotif'
                  minItems: 1
          responses:
            '204':
              description: No Content, Notification was succesfull
            '307':
              $ref: 'TS29571_CommonData.yaml#/components/responses/307'
            '308':
              $ref: 'TS29571_CommonData.yaml#/components/responses/308'
            '400':
              $ref: 'TS29571_CommonData.yaml#/components/responses/400'
            '401':
              $ref: 'TS29571_CommonData.yaml#/components/responses/401'
            '403':
              $ref: 'TS29571_CommonData.yaml#/components/responses/403'
            '404':
              $ref: 'TS29571_CommonData.yaml#/components/responses/404'
            '411':
              $ref: 'TS29571_CommonData.yaml#/components/responses/411'
            '413':
              $ref: 'TS29571_CommonData.yaml#/components/responses/413'
            '415':
              $ref: 'TS29571_CommonData.yaml#/components/responses/415'
            '429':
              $ref: 'TS29571_CommonData.yaml#/components/responses/429'
            '500':
              $ref: 'TS29571_CommonData.yaml#/components/responses/500'
            '502':
              $ref: 'TS29571_CommonData.yaml#/components/responses/502'
            '503':
              $ref: 'TS29571_CommonData.yaml#/components/responses/503'
          default:
            $ref: 'TS29571_CommonData.yaml#/components/responses/default'
/subscriptions/{subscriptionId}:
  put:
    summary: update an existing Individual NWDAF ML Model Provision Subscription
    operationId: UpdateNWDAFMLModelProvisionSubscription
    tags:
      - Individual NWDAF ML Model Provision Subscription (Document)
    requestBody:
      required: true
      content:
        application/json:
          schema:
            $ref: '#/components/schemas/NwdafMLModelProvSubsc'
    parameters:
      - name: subscriptionId
        in: path
        description: String identifying a subscription to the Nnwdaf_MLModelProvision Service.
        required: true
        schema:
          type: string
    responses:
      '200':
        description: >
          The Individual NWDAF ML Model Provision Subscription resource was modified successfully
          and a representation of that resource is returned.
        content:
          application/json:
            schema:
              $ref: '#/components/schemas/NwdafMLModelProvSubsc'
      '204':
        description: >
          The Individual NWDAF ML Model Provision Subscription resource was modified successfully.

```

```

'307':
  $ref: 'TS29571_CommonData.yaml#/components/responses/307'
'308':
  $ref: 'TS29571_CommonData.yaml#/components/responses/308'
'400':
  $ref: 'TS29571_CommonData.yaml#/components/responses/400'
'401':
  $ref: 'TS29571_CommonData.yaml#/components/responses/401'
'403':
  $ref: 'TS29571_CommonData.yaml#/components/responses/403'
'404':
  $ref: 'TS29571_CommonData.yaml#/components/responses/404'
'411':
  $ref: 'TS29571_CommonData.yaml#/components/responses/411'
'413':
  $ref: 'TS29571_CommonData.yaml#/components/responses/413'
'415':
  $ref: 'TS29571_CommonData.yaml#/components/responses/415'
'429':
  $ref: 'TS29571_CommonData.yaml#/components/responses/429'
'500':
  $ref: 'TS29571_CommonData.yaml#/components/responses/500'
'502':
  $ref: 'TS29571_CommonData.yaml#/components/responses/502'
'503':
  $ref: 'TS29571_CommonData.yaml#/components/responses/503'
default:
  $ref: 'TS29571_CommonData.yaml#/components/responses/default'
delete:
  summary: Delete an existing Individual NWDAF ML Model Provision Subscription.
  operationId: DeleteNWDAFMLModelProvisionSubscription
  tags:
    - Individual NWDAF ML Model Provision Subscription (Document)
  parameters:
    - name: subscriptionId
      in: path
      description: String identifying a subscription to the Nnwdaf_MLModelProvision Service.
      required: true
      schema:
        type: string
  responses:
    '204':
      description: >
        No Content. The Individual NWDAF ML Model Provision Subscription matching the
        subscriptionId was deleted.
    '307':
      $ref: 'TS29571_CommonData.yaml#/components/responses/307'
    '308':
      $ref: 'TS29571_CommonData.yaml#/components/responses/308'
    '400':
      $ref: 'TS29571_CommonData.yaml#/components/responses/400'
    '401':
      $ref: 'TS29571_CommonData.yaml#/components/responses/401'
    '403':
      $ref: 'TS29571_CommonData.yaml#/components/responses/403'
    '404':
      $ref: 'TS29571_CommonData.yaml#/components/responses/404'
    '429':
      $ref: 'TS29571_CommonData.yaml#/components/responses/429'
    '500':
      $ref: 'TS29571_CommonData.yaml#/components/responses/500'
    '502':
      $ref: 'TS29571_CommonData.yaml#/components/responses/502'
    '503':
      $ref: 'TS29571_CommonData.yaml#/components/responses/503'
    default:
      $ref: 'TS29571_CommonData.yaml#/components/responses/default'

components:
  securitySchemes:
    oAuth2ClientCredentials:
      type: oauth2
      flows:
        clientCredentials:
          tokenUrl: '{nrfApiRoot}/oauth2/token'
          scopes:
            nnwdaf-mlmodelprovision: Access to the Nnwdaf_MLModelProvision API

```

```

schemas:
  NwdafMLModelProvSubsc:
    description: Represents NWDAF Event Subscription resources.
    type: object
    properties:
      mLEventSubscs:
        type: array
        items:
          $ref: '#/components/schemas/MLEventSubscription'
        minItems: 1
        description: Subscribed events
      notifUri:
        $ref: 'TS29571_CommonData.yaml#/components/schemas/Uri'
      mLEventNotifs:
        type: array
        items:
          $ref: '#/components/schemas/MLEventNotif'
        minItems: 1
        description: >
          Notifications about Individual Events. Shall only be present if the immediate reporting
          indication in the "immRep" attribute within the "eventReq" attribute sets to true in the
          event subscription, and the reports are available.
      suppFeats:
        $ref: 'TS29571_CommonData.yaml#/components/schemas/SupportedFeatures'
      notifCorreId:
        type: string
      eventReq:
        $ref: 'TS29523_Npcf_EventExposure.yaml#/components/schemas/ReportingInformation'
      failEventReports:
        type: array
        items:
          $ref: '#/components/schemas/FailureEventInfoForMLModel'
        minItems: 1
        description: >
          Supplied by the NWDAF containing MTLF when available, shall contain the event(s) that
          the subscription is not successful including the failure reason(s).
    required:
      - mLEventSubscs
      - notifUri

  ModelProvisionParamsExt:
    description: >
      Extended parameters for ML model provisioning which can optionally be set by a service
      consumer NF.
    type: object
    properties:
      modelInterInfo:
        type: string
        description: String representing the ML Model Interoperability Information.
      reqRepRatio:
        $ref: 'TS29571_CommonData.yaml#/components/schemas/UInteger'
      inferInpDataInfos:
        type: array
        items:
          $ref: '#/components/schemas/InputDataInfo'
        minItems: 1
        description: >
          Inference information that is used by NWDAF containing AnLF during inference.
      multModelsInd:
        type: boolean
        description: Indicates if the NF service consumer supports multiple models.
      numModels:
        $ref: 'TS29571_CommonData.yaml#/components/schemas/UInteger'
      accuLevels:
        type: array
        items:
          $ref: 'TS29520_Nnwdaf_EventsSubscription.yaml#/components/schemas/Accuracy'
        minItems: 1
        description: >
          Provided accuracy levels of interest for ML models.

  InputDataInfo:
    description: Contains information about inference that is used by NWDAF containing AnLF.
    type: object
    properties:
      ratio:
        $ref: 'TS29571_CommonData.yaml#/components/schemas/UInteger'
      maxNumSamples:

```

```

    $ref: 'TS29571_CommonData.yaml#/components/schemas/UInteger'
  maxTimeInterval:
    $ref: 'TS29571_CommonData.yaml#/components/schemas/UInteger'
  inpEvent:
    $ref: 'TS29574_Ndccf_DataManagement.yaml#/components/schemas/DccfEvent'
  nfInstanceIds:
    type: array
    items:
      $ref: 'TS29571_CommonData.yaml#/components/schemas/NfInstanceId'
    minItems: 1
  nfSetIds:
    type: array
    items:
      $ref: 'TS29571_CommonData.yaml#/components/schemas/NfSetId'
    minItems: 1
  required:
    - inpEvent

```

MLEventSubscription:

```

description: Represents a subscription to a single event.
type: object
properties:
  mLEvent:
    $ref: 'TS29520_Nnwdaf_EventsSubscription.yaml#/components/schemas/NwdafEvent'
  mLEventFilter:
    $ref: 'TS29520_Nnwdaf_AnalyticsInfo.yaml#/components/schemas/EventFilter'
  tgtUe:
    $ref: 'TS29520_Nnwdaf_EventsSubscription.yaml#/components/schemas/TargetUeInformation'
  mLTargetPeriod:
    $ref: 'TS29122_CommonData.yaml#/components/schemas/TimeWindow'
  expiryTime:
    $ref: 'TS29571_CommonData.yaml#/components/schemas/DateTime'
  timeModelNeeded:
    $ref: 'TS29571_CommonData.yaml#/components/schemas/DateTime'
  mLvEvRepCon:
    $ref: '#/components/schemas/MLRepEventCondition'
  modelInterInfo:
    type: string
    description: String representing the ML Model Interoperability Information.
  nfConsumerInfo:
    $ref: 'TS29510_Nnrf_NFManagement.yaml#/components/schemas/VendorId'
  modelProvExt:
    $ref: '#/components/schemas/ModelProvisionParamsExt'
  useCaseCxt:
    type: string
    description: >
      Indicates the context of usage of the analytics. The value and format of this parameter
      are not standardized.
  inferDataForModel:
    $ref: '#/components/schemas/InferenceDataForModelTrain'
  modelId:
    $ref: 'TS29571_CommonData.yaml#/components/schemas/UInteger'
  required:
    - mLEvent
    - mLEventFilter

```

NwdafMLModelProvNotif:

```

description: Represents notifications on events that occurred.
type: object
properties:
  eventNotifs:
    type: array
    items:
      $ref: '#/components/schemas/MLEventNotif'
    minItems: 1
    description: Notifications about Individual Events.
  subscriptionId:
    type: string
    description: String identifying a subscription to the Nnwdaf_MLModelProvision Service.
  required:
    - eventNotifs
    - subscriptionId

```

MLEventNotif:

```

description: Represents a notification related to a single event that occurred.
type: object
properties:

```

```

event:
  $ref: 'TS29520_Nnwdaf_EventsSubscription.yaml#/components/schemas/NwdafEvent'
notifCorreId:
  type: string
  description: >
    Contains notification correlation ID used to identify the subscription to which the
    notification relates. It shall be set to the same value as the "notifCorreId" attribute
    of NwdafMLModelProvSubsc data type.
mlFile:
  type: string
  description: Contains the ML model file.
mlFileAddr:
  $ref: '#/components/schemas/MLModelAddr'
mlModelAdrf:
  $ref: '#/components/schemas/MLModelAdrf'
validityPeriod:
  $ref: 'TS29122_CommonData.yaml#/components/schemas/TimeWindow'
spatialValidity:
  $ref: 'TS29554_Npcf_BDTPolicyControl.yaml#/components/schemas/NetworkAreaInfo'
addModelInfo:
  type: array
  items:
    $ref: '#/components/schemas/AdditionalMLModelInformation'
  minItems: 1
  description: Contains the additional ML Model Information besides the ML Model Address
modelUniqueId:
  $ref: 'TS29571_CommonData.yaml#/components/schemas/Uinteger'
useCaseCxt:
  type: string
  description: >
    String identifying the context of use of ML model. The value and format of this
    parameter are not standardized.
mlEventFilter:
  $ref: 'TS29520_Nnwdaf_AnalyticsInfo.yaml#/components/schemas/EventFilter'
tgtUe:
  $ref: 'TS29520_Nnwdaf_EventsSubscription.yaml#/components/schemas/TargetUeInformation'
allOf:
  - required: [event]
  - oneOf:
    - required: [mlFileAddr]
    - required: [mlModelAdrf]

FailureEventInfoForMLModel:
  description: >
    Represents the event(s) that the subscription is not successful including the failure
    reason(s).
  type: object
  properties:
    event:
      $ref: 'TS29520_Nnwdaf_EventsSubscription.yaml#/components/schemas/NwdafEvent'
    failureCode:
      $ref: '#/components/schemas/FailureCode'
  required:
    - event
    - failureCode

MLModelAddr:
  description: Addresses of ML model files.
  type: object
  properties:
    mlModelUrl:
      $ref: 'TS29571_CommonData.yaml#/components/schemas/Uri'
    mlFileFqdn:
      type: string
      description: The FQDN of the ML Model file.
  oneOf:
    - required: [mlModelUrl]
    - required: [mlFileFqdn]

MLRepEventCondition:
  description: Indicates the ML event reporting condition.
  type: object
  properties:
    mlTrainRound:
      $ref: 'TS29571_CommonData.yaml#/components/schemas/Uinteger'
    mlTrainRepTime:
      $ref: 'TS29122_CommonData.yaml#/components/schemas/TimeWindow'

```

```

mlAccuracyThreshold:
  $ref: 'TS29571_CommonData.yaml#/components/schemas/Uinteger'
modelMetric:
  $ref: '#/components/schemas/MLModelMetric'

AdditionalMLModelInformation:
  description: Represents the additional ML Model Information.
  type: object
  properties:
    mlFileAddr:
      $ref: '#/components/schemas/MLModelAddr'
    mlModelAdrf:
      $ref: '#/components/schemas/MLModelAdrf'
    validityPeriod:
      $ref: 'TS29122_CommonData.yaml#/components/schemas/TimeWindow'
    spatialValidity:
      $ref: 'TS29554_Npcf_BDTPolicyControl.yaml#/components/schemas/NetworkAreaInfo'
    modelUniqueId:
      $ref: 'TS29571_CommonData.yaml#/components/schemas/Uinteger'
    modelRepRatio:
      $ref: 'TS29571_CommonData.yaml#/components/schemas/Uinteger'
    mlDegradInd:
      type: boolean
      description: >
        Set to "true" to indicate support degradation of an ML model. Set to "false" to indicate
        not support degradation of an ML model. Default value is "false" if omitted.
    trainInpInfos:
      type: array
      items:
        $ref: '#/components/schemas/TrainInputDataInfo'
      minItems: 1
      description: >
        Training information that is used by NWDAF containing MTLF during training.
    modelMetric:
      $ref: '#/components/schemas/MLModelMetric'
    accMLModel:
      $ref: 'TS29571_CommonData.yaml#/components/schemas/Uinteger'
  oneOf:
    - required: [mlFileAddr]
    - required: [mlModelAdrf]
  required:
    - modelUniqueId

MLModelAdrf:
  description: ADRF (Set) information of the ML Model.
  type: object
  properties:
    adrfId:
      $ref: 'TS29571_CommonData.yaml#/components/schemas/NfInstanceId'
    adrfSetId:
      $ref: 'TS29571_CommonData.yaml#/components/schemas/NfSetId'
    storTransId:
      type: string
      description: String identifying a Storage Transaction ID.
  oneOf:
    - required: [adrfId]
    - required: [adrfSetId]

TrainInputDataInfo:
  description: Contains Training input data information that is used by NWDAF containing MTLF.
  type: object
  properties:
    dataInfo:
      $ref: '#/components/schemas/InputDataInfo'
    time:
      $ref: 'TS29122_CommonData.yaml#/components/schemas/TimeWindow'
    dataStatisticsInfos:
      type: string

InferenceDataForModelTrain:
  description: >
    Indicates the inference data stored in ADRF which can be used by MTLF to retrain or
    reprovision of the ML model.
  type: object
  properties:
    adrfId:
      $ref: 'TS29571_CommonData.yaml#/components/schemas/NfInstanceId'

```

```

    adrfSetId:
      $ref: 'TS29571_CommonData.yaml#/components/schemas/NfSetId'
    dataSetTag:
      $ref: 'TS29575_Nadrf_DataManagement.yaml#/components/schemas/DataSetTag'
    modelId:
      $ref: 'TS29571_CommonData.yaml#/components/schemas/UInteger'
  oneOf:
    - required: [adrfId]
    - required: [adrfSetId]

#
# ENUMERATIONS DATA TYPES
#
FailureCode:
  anyOf:
    - type: string
      enum:
        - UNAVAILABLE_ML_MODEL
    - type: string
      description: >
        This string provides forward-compatibility with future extensions to the enumeration but
        is not used to encode content defined in the present version of this API.
      description: |
        Represents the failure code.
        Possible values are:
        - UNAVAILABLE_ML_MODEL: Indicates the requested ML model for the event is unavailable.

MLModelMetric:
  anyOf:
    - type: string
      enum:
        - ACCURACY
    - type: string
      description: >
        This string provides forward-compatibility with future extensions to the enumeration but
        is not used to encode content defined in the present version of this API.
      description: |
        Represents the metric of the ML model.
        Possible values are:
        - ACCURACY: ML Model Accuracy metric.

```

A.6 Nnwdaf_MLModelTraining API

openapi: 3.0.0

info:

```

title: Nnwdaf_MLModelTraining
version: 1.0.1
description: |
  Nnwdaf_MLModelTraining API Service.
  © 2024, 3GPP Organizational Partners (ARIB, ATIS, CCSA, ETSI, TSDSI, TTA, TTC).
  All rights reserved.

```

externalDocs:

```

description: 3GPP TS 29.520 V18.7.0; 5G System; Network Data Analytics Services.
url: https://www.3gpp.org/ftp/Specs/archive/29_series/29.520/

```

servers:

```

- url: '{apiRoot}/nnwdaf-mlmodeltraining/v1'
  variables:
    apiRoot:
      default: https://example.com
      description: apiRoot as defined in clause 4.4 of 3GPP TS 29.501

```

security:

```

- {}
- oAuth2ClientCredentials:
  - nnwdaf-mlmodeltraining

```

paths:

```

/subscriptions:
  post:
    summary: Create a new Individual NWDAF ML Model Training Subscription resource.
    operationId: CreateNWDAFMLModelTrainingSubscription
    tags:

```

```

- Subscriptions (Collection)
requestBody:
  required: true
  content:
    application/json:
      schema:
        $ref: '#/components/schemas/NwdafMLModelTrainSubsc'
responses:
  '201':
    description: Create a new Individual NWDaf ML Model Training Subscription resource.
    content:
      application/json:
        schema:
          $ref: '#/components/schemas/NwdafMLModelTrainSubsc'
    headers:
      Location:
        description: >
          Contains the URI of the newly created resource, according to the structure
          {apiRoot}/nnwdaf-mlmodeltraining/v1/subscriptions/{subscriptionId}.
        required: true
        schema:
          type: string
  '400':
    $ref: 'TS29571_CommonData.yaml#/components/responses/400'
  '401':
    $ref: 'TS29571_CommonData.yaml#/components/responses/401'
  '403':
    $ref: 'TS29571_CommonData.yaml#/components/responses/403'
  '404':
    $ref: 'TS29571_CommonData.yaml#/components/responses/404'
  '411':
    $ref: 'TS29571_CommonData.yaml#/components/responses/411'
  '413':
    $ref: 'TS29571_CommonData.yaml#/components/responses/413'
  '415':
    $ref: 'TS29571_CommonData.yaml#/components/responses/415'
  '429':
    $ref: 'TS29571_CommonData.yaml#/components/responses/429'
  '500':
    $ref: 'TS29571_CommonData.yaml#/components/responses/500'
  '502':
    $ref: 'TS29571_CommonData.yaml#/components/responses/502'
  '503':
    $ref: 'TS29571_CommonData.yaml#/components/responses/503'
  default:
    $ref: 'TS29571_CommonData.yaml#/components/responses/default'
callbacks:
  myNotification:
    '{$request.body#/notifUri}':
      post:
        requestBody:
          required: true
          content:
            application/json:
              schema:
                $ref: '#/components/schemas/NwdafMLModelTrainNotif'
        responses:
          '204':
            description: No Content, Notification was succesfull
          '307':
            $ref: 'TS29571_CommonData.yaml#/components/responses/307'
          '308':
            $ref: 'TS29571_CommonData.yaml#/components/responses/308'
          '400':
            $ref: 'TS29571_CommonData.yaml#/components/responses/400'
          '401':
            $ref: 'TS29571_CommonData.yaml#/components/responses/401'
          '403':
            $ref: 'TS29571_CommonData.yaml#/components/responses/403'
          '404':
            $ref: 'TS29571_CommonData.yaml#/components/responses/404'
          '411':
            $ref: 'TS29571_CommonData.yaml#/components/responses/411'
          '413':
            $ref: 'TS29571_CommonData.yaml#/components/responses/413'
          '415':
            $ref: 'TS29571_CommonData.yaml#/components/responses/415'
          '429':

```



```

    $ref: 'TS29571_CommonData.yaml#/components/responses/429'
  '500':
    $ref: 'TS29571_CommonData.yaml#/components/responses/500'
  '502':
    $ref: 'TS29571_CommonData.yaml#/components/responses/502'
  '503':
    $ref: 'TS29571_CommonData.yaml#/components/responses/503'
  default:
    $ref: 'TS29571_CommonData.yaml#/components/responses/default'
/subscriptions/{subscriptionId}:
  put:
    summary: update an existing Individual NWDAF ML Model Training Subscription
    operationId: UpdateNWDAFMLModelTrainingSubscription
    tags:
      - Individual NWDAF ML Model Training Subscription (Document)
    requestBody:
      required: true
      content:
        application/json:
          schema:
            $ref: '#/components/schemas/NwdafMLModelTrainSubsc'
    parameters:
      - name: subscriptionId
        in: path
        description: String identifying a subscription to the Nnwdaf_MLModelTraining Service.
        required: true
        schema:
          type: string
    responses:
      '200':
        description: >
          The Individual NWDAF ML Model Training Subscription resource was modified successfully
          and a representation of that resource is returned.
        content:
          application/json:
            schema:
              $ref: '#/components/schemas/NwdafMLModelTrainSubsc'
      '204':
        description: >
          The Individual NWDAF ML Model Training Subscription resource was modified successfully.
      '307':
        $ref: 'TS29571_CommonData.yaml#/components/responses/307'
      '308':
        $ref: 'TS29571_CommonData.yaml#/components/responses/308'
      '400':
        $ref: 'TS29571_CommonData.yaml#/components/responses/400'
      '401':
        $ref: 'TS29571_CommonData.yaml#/components/responses/401'
      '403':
        $ref: 'TS29571_CommonData.yaml#/components/responses/403'
      '404':
        $ref: 'TS29571_CommonData.yaml#/components/responses/404'
      '411':
        $ref: 'TS29571_CommonData.yaml#/components/responses/411'
      '413':
        $ref: 'TS29571_CommonData.yaml#/components/responses/413'
      '415':
        $ref: 'TS29571_CommonData.yaml#/components/responses/415'
      '429':
        $ref: 'TS29571_CommonData.yaml#/components/responses/429'
      '500':
        $ref: 'TS29571_CommonData.yaml#/components/responses/500'
      '502':
        $ref: 'TS29571_CommonData.yaml#/components/responses/502'
      '503':
        $ref: 'TS29571_CommonData.yaml#/components/responses/503'
      default:
        $ref: 'TS29571_CommonData.yaml#/components/responses/default'
  patch:
    summary: partial update an existing Individual NWDAF ML Model Training Subscription
    operationId: PartialUpdateNWDAFMLModelTrainingSubscription
    tags:
      - Individual NWDAF ML Model Training Subscription (Document)
    requestBody:
      required: true
      content:
        application/merge-patch+json:
          schema:

```

```

    $ref: '#/components/schemas/NwdafMLModelTrainSubscPatch'
parameters:
  - name: subscriptionId
    in: path
    description: String identifying a subscription to the Nnwdaf_MLModelTraining Service.
    required: true
    schema:
      type: string
responses:
  '200':
    description: >
      The Individual NWDAF ML Model Training Subscription resource was partial modified
      successfully and a representation of that resource is returned.
    content:
      application/json:
        schema:
          $ref: '#/components/schemas/NwdafMLModelTrainSubsc'
  '204':
    description: >
      The Individual NWDAF ML Model Training Subscription resource was partial modified
      successfully.
  '307':
    $ref: 'TS29571_CommonData.yaml#/components/responses/307'
  '308':
    $ref: 'TS29571_CommonData.yaml#/components/responses/308'
  '400':
    $ref: 'TS29571_CommonData.yaml#/components/responses/400'
  '401':
    $ref: 'TS29571_CommonData.yaml#/components/responses/401'
  '403':
    $ref: 'TS29571_CommonData.yaml#/components/responses/403'
  '404':
    $ref: 'TS29571_CommonData.yaml#/components/responses/404'
  '411':
    $ref: 'TS29571_CommonData.yaml#/components/responses/411'
  '413':
    $ref: 'TS29571_CommonData.yaml#/components/responses/413'
  '415':
    $ref: 'TS29571_CommonData.yaml#/components/responses/415'
  '429':
    $ref: 'TS29571_CommonData.yaml#/components/responses/429'
  '500':
    $ref: 'TS29571_CommonData.yaml#/components/responses/500'
  '502':
    $ref: 'TS29571_CommonData.yaml#/components/responses/502'
  '503':
    $ref: 'TS29571_CommonData.yaml#/components/responses/503'
  default:
    $ref: 'TS29571_CommonData.yaml#/components/responses/default'
delete:
  summary: Delete an existing Individual NWDAF ML Model Training Subscription.
  operationId: DeleteNWDAFMLModelTrainingSubscription
  tags:
    - Individual NWDAF ML Model Training Subscription (Document)
  parameters:
    - name: subscriptionId
      in: path
      description: String identifying a subscription to the Nnwdaf_MLModelTraining Service.
      required: true
      schema:
        type: string
  responses:
    '204':
      description: >
        No Content. The Individual NWDAF ML Model Training Subscription matching the
        subscriptionId was deleted.
    '307':
      $ref: 'TS29571_CommonData.yaml#/components/responses/307'
    '308':
      $ref: 'TS29571_CommonData.yaml#/components/responses/308'
    '400':
      $ref: 'TS29571_CommonData.yaml#/components/responses/400'
    '401':
      $ref: 'TS29571_CommonData.yaml#/components/responses/401'
    '403':
      $ref: 'TS29571_CommonData.yaml#/components/responses/403'
    '404':
      $ref: 'TS29571_CommonData.yaml#/components/responses/404'

```

```

'429':
  $ref: 'TS29571_CommonData.yaml#/components/responses/429'
'500':
  $ref: 'TS29571_CommonData.yaml#/components/responses/500'
'502':
  $ref: 'TS29571_CommonData.yaml#/components/responses/502'
'503':
  $ref: 'TS29571_CommonData.yaml#/components/responses/503'
default:
  $ref: 'TS29571_CommonData.yaml#/components/responses/default'

```

components:

```

securitySchemes:
  oAuth2ClientCredentials:
    type: oauth2
    flows:
      clientCredentials:
        tokenUrl: '{nrfApiRoot}/oauth2/token'
        scopes:
          nnwdaf-mlmodeltraining: Access to the Nnwdaf_MLModelTraining API

```

schemas:

```

NwdafMLModelTrainSubsc:
  description: Represents a ML Model Training subscription.
  type: object
  properties:
    mLEventSubscs:
      type: array
      items:
        $ref: 'TS29520_Nnwdaf_MLModelProvision.yaml#/components/schemas/MLEventSubscription'
      minItems: 1
      description: Subscribed events
    notifUri:
      $ref: 'TS29571_CommonData.yaml#/components/schemas/Uri'
    suppFeats:
      $ref: 'TS29571_CommonData.yaml#/components/schemas/SupportedFeatures'
    eventReq:
      $ref: 'TS29523_Npcf_EventExposure.yaml#/components/schemas/ReportingInformation'
    failEventReports:
      type: array
      items:
        $ref: '#/components/schemas/FailureEventInfoForMLModelTrain'
      minItems: 1
      description: >
        Supplied by the NWDAF containing MTLF when available, shall contain the event(s) that
        the subscription is not successful including the failure reason(s).
    mlCorreId:
      type: string
      description: String identifying the subscription is for a Federated Learning procedure.
    mLModelInfos:
      type: array
      items:
        $ref: 'TS29520_Nnwdaf_MLModelProvision.yaml#/components/schemas/MLEventNotif'
      minItems: 1
      description: Represents the ML Model information.
    immReport:
      $ref: '#/components/schemas/NwdafMLModelTrainNotif'
      description: Immediately reported ML Model Training notifications.
    mLModelTrainInfos:
      type: array
      items:
        $ref: '#/components/schemas/MLModelTrainInfo'
      minItems: 1
      description: Represents the ML Model training information.
    mLPreFlag:
      type: boolean
      description: >
        Indicates whether the subscription is for preparation of ML Model training. Set to
        "true" if it is for ML training preparation, otherwise set to "false".
    mLAccChkFlg:
      type: boolean
      description: >
        Indicates whether request using the local training data as the testing dataset to
        calculate the Model Accuracy of the global ML model provided by the consumer. Set to
        "true" if it is requested, otherwise set to "false".
    mLTrainRepInfo:
      $ref: '#/components/schemas/MLTrainReportInfo'
    notifCorreId:

```

```

    type: string
    description: >
      String identifying the Notification Correlation ID in the corresponding notification.
  roundInd:
    $ref: 'TS29571_CommonData.yaml#/components/schemas/UInteger'
  tgtRepUe:
    $ref: 'TS29520_Nnwdaf_EventsSubscription.yaml#/components/schemas/TargetUeInformation'
  skipFlInd:
    type: boolean
    description: Indicates whether to skip the current FL round or not.
  required:
    - mLEventSubscs
    - notifUri
    - notifCorreId

NwdafMLModelTrainSubscPatch:
  description: >
    Represents parameters to request the modification of a ML Model Training subscription.
  type: object
  properties:
    notifUri:
      $ref: 'TS29571_CommonData.yaml#/components/schemas/Uri'
    eventReq:
      $ref: 'TS29523_Npcf_EventExposure.yaml#/components/schemas/ReportingInformation'
    mLModelInfos:
      type: array
      items:
        $ref: 'TS29520_Nnwdaf_MLModelProvision.yaml#/components/schemas/MLEventNotif'
      minItems: 1
      description: Represents the ML Model information.
    mLModelTrainInfos:
      type: array
      items:
        $ref: '#/components/schemas/MLModelTrainInfo'
      minItems: 1
      description: Represents the ML Model training information.
    mLPreFlag:
      type: boolean
      description: >
        Indicates whether the subscription is for preparation of ML Model training. Set to
        "true" if it is for ML training preparation, otherwise set to "false".
    mLAccChkFlg:
      type: boolean
      description: >
        Indicates whether request using the local training data as the testing dataset to
        Calculate the Model Accuracy of the global ML model provided by the consumer. Set to
        "true" if it is requested, otherwise set to "false".
    mLTrainRepInfo:
      $ref: '#/components/schemas/MLTrainReportInfo'
  roundInd:
    $ref: 'TS29571_CommonData.yaml#/components/schemas/UInteger'
  tgtRepUe:
    $ref: 'TS29520_Nnwdaf_EventsSubscription.yaml#/components/schemas/TargetUeInformation'
  skipFlInd:
    type: boolean
    description: Indicates whether to skip the current FL round or not.

NwdafMLModelTrainNotif:
  description: Represents notifications on events that occurred.
  type: object
  properties:
    delayEventNotif:
      $ref: '#/components/schemas/DelayEventNotif'
    mLCorreId:
      type: string
      description: String identifying the subscription is for a Federated Learning procedure.
    mLModelInfos:
      type: array
      items:
        $ref: 'TS29520_Nnwdaf_MLModelProvision.yaml#/components/schemas/MLEventNotif'
      minItems: 1
      description: Represents the ML Model information.
    notifCorreId:
      type: string
      description: >
        String identifying the Notification Correlation ID in the corresponding notification.
  roundInd:
    $ref: 'TS29571_CommonData.yaml#/components/schemas/UInteger'

```

```

    statusReport:
      $ref: '#/components/schemas/StatusReportInfo'
    termTrainReq:
      $ref: '#/components/schemas/TermTrainCause'
  required:
    - notifCorreId
  oneOf:
    - required: [delayEventNotif]
    - required: [mLModelInfos]
    - required: [termTrainReq]
    - required: [mLModelInfos, termTrainReq]

MLModelTrainInfo:
  description: >
    Represents the ML Model training information, include requirement on data availability and
    time availability, training filter information.
  type: object
  properties:
    dataAvReq:
      $ref: '#/components/schemas/DataAvReq'
    timeAvReq:
      type: string
      description: >
        String representing the requirement on available time for the ML model training.

MLTrainReportInfo:
  description: Represents the ML Model training reporting information.
  type: object
  properties:
    maxResTime:
      $ref: 'TS29571_CommonData.yaml#/components/schemas/DurationSec'

FailureEventInfoForMLModelTrain:
  description: Represents the failure event information for a ML Model Training subscription.
  type: object
  properties:
    mLTrainEvent:
      $ref: 'TS29520_Nnwdaf_EventsSubscription.yaml#/components/schemas/NwdafEvent'
    failureCodeTrain:
      $ref: '#/components/schemas/FailureCodeTrain'
  required:
    - mLTrainEvent
    - failureCodeTrain

DataAvReq:
  description: Represents the requirement on available data for the ML model training.
  type: object
  properties:
    dataStatProps:
      type: array
      items:
        $ref:
'TS29520_Nnwdaf_EventsSubscription.yaml#/components/schemas/DatasetStatisticalProperty'
      minItems: 1
    inpEvents:
      type: array
      items:
        $ref: 'TS29574_Ndccf_DataManagement.yaml#/components/schemas/DccfEvent'
      minItems: 1
    minNumSamples:
      $ref: 'TS29571_CommonData.yaml#/components/schemas/UInteger'
    timeWindows:
      type: array
      items:
        $ref: 'TS29122_CommonData.yaml#/components/schemas/TimeWindow'
      minItems: 1
  required:
    - inpEvents

DelayEventNotif:
  description: >
    Indicating that the NWDAF containing MTLF is not able to complete the training of ML model
    within the maximum response time, the cause code, and the expected time complete the
    training.
  type: object
  properties:
    delayEventInd:
      type: boolean

```

```

    description: >
      Indicates that the NWDAF containing MTLF is not able to complete the training of ML
      model within the maximum response time. Set to "true" if not able to complete the ML
      model training on time, otherwise set to "false".
  delayCause:
    $ref: '#/components/schemas/DelayCause'
  expCompTime:
    $ref: 'TS29571_CommonData.yaml#/components/schemas/DurationSec'
  required:
    - delayEventInd

StatusReportInfo:
  description: >
    Indicating status information generated by the NWDAF containing MTLF during ML model
    training.
  type: object
  properties:
    mlModelAcc:
      $ref: 'TS29571_CommonData.yaml#/components/schemas/Uinteger'
    trainInDataInfo:
      $ref: '#/components/schemas/TrainDataInfo'

TrainDataInfo:
  description: Represents the training input data information.
  type: object
  properties:
    areaInfo:
      $ref: 'TS29554_Npcf_BDTPolicyControl.yaml#/components/schemas/NetworkAreaInfo'
    maxValues:
      type: array
      items:
        type: string
      minItems: 1
      description: >
        Represents the maximum value of one dimension of data. The format of its value is out of
        3GPP scope.
    minValues:
      type: array
      items:
        type: string
      minItems: 1
      description: >
        Represents the minimum value of one dimension of data. The format of its value is out of
        3GPP scope.
    samplRatio:
      $ref: 'TS29571_CommonData.yaml#/components/schemas/Uinteger'

#
# ENUMERATIONS DATA TYPES
#
FailureCodeTrain:
  anyOf:
    - type: string
      enum:
        - UNAVAILABLE_ML_MODEL_TRAIN
    - type: string
      description: >
        This string provides forward-compatibility with future extensions to the enumeration but
        is not used to encode content defined in the present version of this API.
      description: |
        Represents the failure reason.
        Possible values are:
        - UNAVAILABLE_ML_MODEL_TRAIN: The ML model training is unavailable.

TermTrainCause:
  anyOf:
    - type: string
      enum:
        - NWDAF_OVERLOAD
        - NOT_AVAILABLE_ML_TRAIN
        - OTHERS
    - type: string
      description: >
        This string provides forward-compatibility with future extensions to the enumeration but
        is not used to encode content defined in the present version of this API.
      description: |
        Represents the reasons that ML Model Training to be terminated.
        Possible values are:
        - NWDAF_OVERLOAD: The NWDAF is overloaded for the ML model training.

```

- NOT_AVAILABLE_ML_TRAIN: The ML model training process is not available.
- OTHERS: Other cause.

```

DelayCause:
  anyOf:
  - type: string
    enum:
      - ML_MODEL_TRAIN_FAILURE
      - NEED_MORE_TIME
      - OTHERS
  - type: string
    description: >
      This string provides forward-compatibility with future extensions to the enumeration but
      is not used to encode content defined in the present version of this API.
  description: |
    Represents the reasons for ML Model training delay.
    Possible values are:
    - ML_MODEL_TRAIN_FAILURE: The ML model training is failure.
    - NEED_MORE_TIME: The ML model training needs more time.
    - OTHERS: Other cause.

```

A.7 Nnwdaf_MLModelMonitor API

openapi: 3.0.0

```

info:
  title: Nnwdaf_MLModelMonitor
  version: 1.0.0
  description: |
    Nnwdaf_MLModelMonitor API Service.
    © 2024, 3GPP Organizational Partners (ARIB, ATIS, CCSA, ETSI, TSDSI, TTA, TTC).
    All rights reserved.

```

```

externalDocs:
  description: 3GPP TS 29.520 V18.6.0; 5G System; Network Data Analytics Services.
  url: https://www.3gpp.org/ftp/Specs/archive/29_series/29.520/

```

```

servers:
  - url: '{apiRoot}/nnwdaf-mlmodelmonitor/v1'
    variables:
      apiRoot:
        default: https://example.com
        description: apiRoot as defined in clause 4.4 of 3GPP TS 29.501

```

```

security:
  - {}
  - oAuth2ClientCredentials:
      - nnwdaf-mlmodelmonitor

```

```

paths:
  /registrations:
    post:
      summary: Create a new Individual NWDAF ML Model monitoring registration resource.
      operationId: CreateNWDAFMLModelMonitoringRegistration
      tags:
        - registrations (Collection)
      requestBody:
        required: true
        content:
          application/json:
            schema:
              $ref: '#/components/schemas/MLModelMonitorReg'
      responses:
        '201':
          description: Create a new Individual NWDAF ML Model monitoring registration resource.
          content:
            application/json:
              schema:
                $ref: '#/components/schemas/MLModelMonitorReg'
          headers:
            Location:
              description: >
                Contains the URI of the newly created resource, according to the structure
                {apiRoot}/nnwdaf-mlmodelmonitor/<apiVersion>/registrations/{registrationId}.

```

```

    required: true
    schema:
      type: string
  '400':
    $ref: 'TS29571_CommonData.yaml#/components/responses/400'
  '401':
    $ref: 'TS29571_CommonData.yaml#/components/responses/401'
  '403':
    $ref: 'TS29571_CommonData.yaml#/components/responses/403'
  '404':
    $ref: 'TS29571_CommonData.yaml#/components/responses/404'
  '411':
    $ref: 'TS29571_CommonData.yaml#/components/responses/411'
  '413':
    $ref: 'TS29571_CommonData.yaml#/components/responses/413'
  '415':
    $ref: 'TS29571_CommonData.yaml#/components/responses/415'
  '429':
    $ref: 'TS29571_CommonData.yaml#/components/responses/429'
  '500':
    $ref: 'TS29571_CommonData.yaml#/components/responses/500'
  '502':
    $ref: 'TS29571_CommonData.yaml#/components/responses/502'
  '503':
    $ref: 'TS29571_CommonData.yaml#/components/responses/503'
  default:
    $ref: 'TS29571_CommonData.yaml#/components/responses/default'

/registrations/{registrationId}:
  delete:
    summary: Delete an existing Individual NWDAF ML model monitoring registration.
    operationId: DeleteNWDAFMLModelMonitoringRegistration
    tags:
      - Individual NWDAF ML model monitoring registration (Document)
    parameters:
      - name: registrationId
        in: path
        description: String identifying a registration to the Nnwdaf_MLModelMonitor Service.
        required: true
        schema:
          type: string
    responses:
      '204':
        description: >
          No Content. The Individual NWDAF ML Model monitoring registration matching the
          registrationId was deleted.
      '307':
        $ref: 'TS29571_CommonData.yaml#/components/responses/307'
      '308':
        $ref: 'TS29571_CommonData.yaml#/components/responses/308'
      '400':
        $ref: 'TS29571_CommonData.yaml#/components/responses/400'
      '401':
        $ref: 'TS29571_CommonData.yaml#/components/responses/401'
      '403':
        $ref: 'TS29571_CommonData.yaml#/components/responses/403'
      '404':
        $ref: 'TS29571_CommonData.yaml#/components/responses/404'
      '429':
        $ref: 'TS29571_CommonData.yaml#/components/responses/429'
      '500':
        $ref: 'TS29571_CommonData.yaml#/components/responses/500'
      '502':
        $ref: 'TS29571_CommonData.yaml#/components/responses/502'
      '503':
        $ref: 'TS29571_CommonData.yaml#/components/responses/503'
      default:
        $ref: 'TS29571_CommonData.yaml#/components/responses/default'

/subscriptions:
  post:
    summary: Create a new Individual NWDAF ML model monitoring Subscription.
    operationId: CreateNWDAFMLModelMonitoringSubscription
    tags:
      - NWDAF ML model monitoring Subscriptions (Collection)
    requestBody:
      required: true
      content:

```



```

    application/json:
      schema:
        $ref: '#/components/schemas/MModelMonitorSub'
  responses:
    '201':
      description: Create a new Individual NWDAF ML model monitoring Subscription resource.
      headers:
        Location:
          description: >
            Contains the URI of the newly created resource, according to the structure
            {apiRoot}/nnwdaflmodelmonitor/<apiVersion>/subscriptions/{subscriptionId}
          required: true
          schema:
            type: string
      content:
        application/json:
          schema:
            $ref: '#/components/schemas/MModelMonitorSub'
    '400':
      $ref: 'TS29571_CommonData.yaml#/components/responses/400'
    '401':
      $ref: 'TS29571_CommonData.yaml#/components/responses/401'
    '403':
      $ref: 'TS29571_CommonData.yaml#/components/responses/403'
    '404':
      $ref: 'TS29571_CommonData.yaml#/components/responses/404'
    '411':
      $ref: 'TS29571_CommonData.yaml#/components/responses/411'
    '413':
      $ref: 'TS29571_CommonData.yaml#/components/responses/413'
    '415':
      $ref: 'TS29571_CommonData.yaml#/components/responses/415'
    '429':
      $ref: 'TS29571_CommonData.yaml#/components/responses/429'
    '500':
      $ref: 'TS29571_CommonData.yaml#/components/responses/500'
    '502':
      $ref: 'TS29571_CommonData.yaml#/components/responses/502'
    '503':
      $ref: 'TS29571_CommonData.yaml#/components/responses/503'
  default:
    $ref: 'TS29571_CommonData.yaml#/components/responses/default'
  callbacks:
    myNotification:
      '{$request.body#/notificationUri}':
        post:
          requestBody:
            required: true
            content:
              application/json:
                schema:
                  $ref: '#/components/schemas/MModelMonitorNotify'
  responses:
    '204':
      description: The receipt of the Notification is acknowledged.
    '307':
      $ref: 'TS29571_CommonData.yaml#/components/responses/307'
    '308':
      $ref: 'TS29571_CommonData.yaml#/components/responses/308'
    '400':
      $ref: 'TS29571_CommonData.yaml#/components/responses/400'
    '401':
      $ref: 'TS29571_CommonData.yaml#/components/responses/401'
    '403':
      $ref: 'TS29571_CommonData.yaml#/components/responses/403'
    '404':
      $ref: 'TS29571_CommonData.yaml#/components/responses/404'
    '411':
      $ref: 'TS29571_CommonData.yaml#/components/responses/411'
    '413':
      $ref: 'TS29571_CommonData.yaml#/components/responses/413'
    '415':
      $ref: 'TS29571_CommonData.yaml#/components/responses/415'
    '429':
      $ref: 'TS29571_CommonData.yaml#/components/responses/429'
    '500':
      $ref: 'TS29571_CommonData.yaml#/components/responses/500'
    '502':

```

```

    $ref: 'TS29571_CommonData.yaml#/components/responses/502'
  '503':
    $ref: 'TS29571_CommonData.yaml#/components/responses/503'
  default:
    $ref: 'TS29571_CommonData.yaml#/components/responses/default'

/subscriptions/{subscriptionId}:
  put:
    summary: Update an existing Individual NWDAF ML model monitoring Subscription resource.
    operationId: UpdateNWDAFMLModelMonitoringSubscription
    tags:
      - Individual NWDAF ML model monitoring Subscription resource (Document)
    requestBody:
      required: true
      content:
        application/json:
          schema:
            $ref: '#/components/schemas/MLModelMonitorSub'
    parameters:
      - name: subscriptionId
        in: path
        description: String identifying a subscription to the Nnwdaf_MLModelMonitor Service.
        required: true
        schema:
          type: string
    responses:
      '200':
        description: >
          The Individual NWDAF ML model monitoring Subscription resource was modified successfully
          and a representation of that resource is returned.
        content:
          application/json:
            schema:
              $ref: '#/components/schemas/MLModelMonitorSub'
      '204':
        description: >
          The Individual NWDAF ML model monitoring Subscription resource was modified
          successfully.
      '307':
        $ref: 'TS29571_CommonData.yaml#/components/responses/307'
      '308':
        $ref: 'TS29571_CommonData.yaml#/components/responses/308'
      '400':
        $ref: 'TS29571_CommonData.yaml#/components/responses/400'
      '401':
        $ref: 'TS29571_CommonData.yaml#/components/responses/401'
      '403':
        $ref: 'TS29571_CommonData.yaml#/components/responses/403'
      '404':
        $ref: 'TS29571_CommonData.yaml#/components/responses/404'
      '411':
        $ref: 'TS29571_CommonData.yaml#/components/responses/411'
      '413':
        $ref: 'TS29571_CommonData.yaml#/components/responses/413'
      '415':
        $ref: 'TS29571_CommonData.yaml#/components/responses/415'
      '429':
        $ref: 'TS29571_CommonData.yaml#/components/responses/429'
      '500':
        $ref: 'TS29571_CommonData.yaml#/components/responses/500'
      '501':
        $ref: 'TS29571_CommonData.yaml#/components/responses/501'
      '502':
        $ref: 'TS29571_CommonData.yaml#/components/responses/502'
      '503':
        $ref: 'TS29571_CommonData.yaml#/components/responses/503'
      default:
        $ref: 'TS29571_CommonData.yaml#/components/responses/default'
    delete:
      summary: Delete an existing Individual NWDAF ML model monitoring Subscription.
      operationId: DeleteNWDAFMLModelMonitoringSubscription
      tags:
        - Individual NWDAF ML model monitoring Subscription (Document)
      parameters:
        - name: subscriptionId
          in: path
          description: String identifying a subscription to the Nnwdaf_MLModelMonitor Service
          required: true

```

```

    schema:
      type: string
  responses:
    '204':
      description: >
        No Content. The Individual NWDAF ML model monitoring Subscription resource matching the
        subscriptionId was deleted.
    '307':
      $ref: 'TS29571_CommonData.yaml#/components/responses/307'
    '308':
      $ref: 'TS29571_CommonData.yaml#/components/responses/308'
    '400':
      $ref: 'TS29571_CommonData.yaml#/components/responses/400'
    '401':
      $ref: 'TS29571_CommonData.yaml#/components/responses/401'
    '403':
      $ref: 'TS29571_CommonData.yaml#/components/responses/403'
    '404':
      $ref: 'TS29571_CommonData.yaml#/components/responses/404'
    '429':
      $ref: 'TS29571_CommonData.yaml#/components/responses/429'
    '500':
      $ref: 'TS29571_CommonData.yaml#/components/responses/500'
    '501':
      $ref: 'TS29571_CommonData.yaml#/components/responses/501'
    '502':
      $ref: 'TS29571_CommonData.yaml#/components/responses/502'
    '503':
      $ref: 'TS29571_CommonData.yaml#/components/responses/503'
  default:
    $ref: 'TS29571_CommonData.yaml#/components/responses/default'

```

```

components:
  securitySchemes:
    oAuth2ClientCredentials:
      type: oauth2
      flows:
        clientCredentials:
          tokenUrl: '{nrfApiRoot}/oauth2/token'
          scopes:
            nnwdaf-mlmodelmonitor: Access to the Nnwdaf_MLModelMonitor API

```

```

schemas:
  MLModelMonitorReg:
    description: Represents a ML Model monitoring registration.
    type: object
    properties:
      consumerId:
        $ref: 'TS29571_CommonData.yaml#/components/schemas/NfInstanceId'
      consumerSetId:
        $ref: 'TS29571_CommonData.yaml#/components/schemas/NfSetId'
      modelId:
        $ref: 'TS29571_CommonData.yaml#/components/schemas/Uinteger'
      modelAccuInd:
        type: boolean
        description: >
          Indicates the ML Model accuracy transfer indication.
      mLEvent:
        $ref: 'TS29520_Nnwdaf_EventsSubscription.yaml#/components/schemas/NwdafEvent'
      mLEventFilter:
        $ref: 'TS29520_Nnwdaf_AnalyticsInfo.yaml#/components/schemas/EventFilter'
      tgtUe:
        $ref: 'TS29520_Nnwdaf_EventsSubscription.yaml#/components/schemas/TargetUeInformation'
    required:
      - modelId
    oneOf:
      - required: [consumerId]
      - required: [consumerSetId]

```

```

MLModelMonitorSub:
  description: >
    Represents parameters to request the modification of a ML Model monitoring registration.
  type: object
  properties:
    modelIds:
      type: array
      items:
        $ref: 'TS29571_CommonData.yaml#/components/schemas/Uinteger'

```

```

    minItems: 1
    description: Represents the ML Model IDs.
  notificationUri:
    $ref: 'TS29571_CommonData.yaml#/components/schemas/Uri'
  notifCorrId:
    type: string
    description: Notification correlation identifier.
  modelMetric:
    $ref: 'TS29520_Nnwdaf_MLModelProvision.yaml#/components/schemas/MLModelMetric'
  accuThreshold:
    $ref: 'TS29571_CommonData.yaml#/components/schemas/UInteger'
  eventReportReq:
    $ref: 'TS29523_Npcf_EventExposure.yaml#/components/schemas/ReportingInformation'
  immReport:
    $ref: '#/components/schemas/MLModelMonitorNotify'
  mLEvent:
    $ref: 'TS29520_Nnwdaf_EventsSubscription.yaml#/components/schemas/NwdafEvent'
  mLEventFilter:
    $ref: 'TS29520_Nnwdaf_AnalyticsInfo.yaml#/components/schemas/EventFilter'
  tgtUe:
    $ref: 'TS29520_Nnwdaf_EventsSubscription.yaml#/components/schemas/TargetUeInformation'
  suppFeat:
    $ref: 'TS29571_CommonData.yaml#/components/schemas/SupportedFeatures'
  required:
    - modelIds
    - notificationUri
    - notifCorrId

MLModelMonitorNotify:
  description: Represents notifications on events that occurred.
  type: object
  properties:
    notifCorrId:
      type: string
      description: Notification correlation identifier.
    modelAccuInfos:
      type: array
      items:
        $ref: '#/components/schemas/MLModelAccuracyInfo'
      minItems: 1
      description: The accuracy related information of the ML model.
    anaFeedbacks:
      type: array
      items:
        $ref: '#/components/schemas/AnalyticsFeedback'
      minItems: 1
      description: The analytics feedback information.
    accuMeetInd:
      type: boolean
      description: >
        Set to "true" to indicate that the analytics accuracy of the ML model meet the
        requirement of accuracy for the ML model. Otherwise, default value is "false" if
        omitted.
    mLEvent:
      $ref: 'TS29520_Nnwdaf_EventsSubscription.yaml#/components/schemas/NwdafEvent'
    mLEventFilter:
      $ref: 'TS29520_Nnwdaf_AnalyticsInfo.yaml#/components/schemas/EventFilter'
    tgtUe:
      $ref: 'TS29520_Nnwdaf_EventsSubscription.yaml#/components/schemas/TargetUeInformation'
  required:
    - notifCorrId
  anyOf:
    - required: [modelAccuInfos]
    - required: [anaFeedbacks]

MLModelAccuracyInfo:
  description: Represents the ML Model accuracy information.
  type: object
  properties:
    modelId:
      $ref: 'TS29571_CommonData.yaml#/components/schemas/UInteger'
    deviation:
      $ref: 'TS29571_CommonData.yaml#/components/schemas/Float'
    inferenceNum:
      $ref: 'TS29571_CommonData.yaml#/components/schemas/UInteger'
    adrfId:
      $ref: 'TS29571_CommonData.yaml#/components/schemas/NfInstanceId'
    adrfSetId:

```

```

    $ref: 'TS29571_CommonData.yaml#/components/schemas/NfSetId'
  dataSetTag:
    $ref: 'TS29575_Nadrf_DataManagement.yaml#/components/schemas/DataSetTag'
  modelMetric:
    $ref: 'TS29520_Nnwdaf_MLModelProvision.yaml#/components/schemas/MLModelMetric'
  mlModelAcc:
    $ref: 'TS29571_CommonData.yaml#/components/schemas/UInteger'
  monitorInterval:
    $ref: 'TS29122_CommonData.yaml#/components/schemas/TimeWindow'
  required:
    - modelId

AnalyticsFeedback:
  description: Represents the analytics feedback.
  type: object
  properties:
    events:
      type: array
      items:
        $ref: 'TS29520_Nnwdaf_EventsSubscription.yaml#/components/schemas/NwdafEvent'
      minItems: 1
      description: Indicates the Analytics IDs that were used to take this action.
    modelIds:
      type: array
      items:
        $ref: 'TS29571_CommonData.yaml#/components/schemas/UInteger'
      minItems: 1
      description: Indicates the ML Model identifier that were used to take this action.
    groundDataImpactInd:
      type: boolean
      description: >
        Indication whether the action will affect on ground truth data. Set to "true" to
        indicate that the action will affect on ground truth data. Otherwise set to "false",
        default value is "false" if omitted.
    timeStamp:
      $ref: 'TS29571_CommonData.yaml#/components/schemas/DateTime'
  required:
    - events
    - modelIds

```

A.8 Nnwdaf_RoamingData API

openapi: 3.0.0

```

info:
  title: Nnwdaf_RoamingData
  version: 1.0.0
  description: |
    Nnwdaf_RoamingData API Service.
    © 2024, 3GPP Organizational Partners (ARIB, ATIS, CCSA, ETSI, TSDSI, TTA, TTC).
    All rights reserved.

```

```

externalDocs:
  description: 3GPP TS 29.520 V18.6.0; 5G System; Network Data Analytics Services.
  url: https://www.3gpp.org/ftp/Specs/archive/29_series/29.520/

```

```

servers:
  - url: '{apiRoot}/nnwdaf-roamingdata/v1'
    variables:
      apiRoot:
        default: https://example.com
        description: apiRoot as defined in clause 4.4 of 3GPP TS 29.501

```

```

security:
  - {}
  - oAuth2ClientCredentials:
    - nnwdaf-roamingdata

```

```

paths:
  /subscriptions:
    post:
      summary: Create a new Individual NWDAF Roaming Data Subscription
      operationId: CreateNWDAFRoamingDataSubscription
      tags:
        - NWDAF Roaming Data Subscriptions (Collection)

```

```

requestBody:
  required: true
  content:
    application/json:
      schema:
        $ref: '#/components/schemas/RoamingDataSub'
responses:
  '201':
    description: Create a new Individual NWDaf Roaming Data Subscription resource.
    headers:
      Location:
        description: >
          Contains the URI of the newly created resource, according to the structure
          {apiRoot}/nnwdaf-roamingdata/<apiVersion>/subscriptions/{subscriptionId}
        required: true
        schema:
          type: string
    content:
      application/json:
        schema:
          $ref: '#/components/schemas/RoamingDataSub'
  '400':
    $ref: 'TS29571_CommonData.yaml#/components/responses/400'
  '401':
    $ref: 'TS29571_CommonData.yaml#/components/responses/401'
  '403':
    $ref: 'TS29571_CommonData.yaml#/components/responses/403'
  '404':
    $ref: 'TS29571_CommonData.yaml#/components/responses/404'
  '411':
    $ref: 'TS29571_CommonData.yaml#/components/responses/411'
  '413':
    $ref: 'TS29571_CommonData.yaml#/components/responses/413'
  '415':
    $ref: 'TS29571_CommonData.yaml#/components/responses/415'
  '429':
    $ref: 'TS29571_CommonData.yaml#/components/responses/429'
  '500':
    $ref: 'TS29571_CommonData.yaml#/components/responses/500'
  '502':
    $ref: 'TS29571_CommonData.yaml#/components/responses/502'
  '503':
    $ref: 'TS29571_CommonData.yaml#/components/responses/503'
  default:
    $ref: 'TS29571_CommonData.yaml#/components/responses/default'
callbacks:
  myNotification:
    '{$request.body#/notificationUri}':
      post:
        requestBody:
          required: true
          content:
            application/json:
              schema:
                $ref:
'TS29520_Nnwdaf_DataManagement.yaml#/components/schemas/NnwdafDataManagementNotif'
      responses:
        '204':
          description: The receipt of the Notification is acknowledged.
        '307':
          $ref: 'TS29571_CommonData.yaml#/components/responses/307'
        '308':
          $ref: 'TS29571_CommonData.yaml#/components/responses/308'
        '400':
          $ref: 'TS29571_CommonData.yaml#/components/responses/400'
        '401':
          $ref: 'TS29571_CommonData.yaml#/components/responses/401'
        '403':
          $ref: 'TS29571_CommonData.yaml#/components/responses/403'
        '404':
          $ref: 'TS29571_CommonData.yaml#/components/responses/404'
        '411':
          $ref: 'TS29571_CommonData.yaml#/components/responses/411'
        '413':
          $ref: 'TS29571_CommonData.yaml#/components/responses/413'
        '415':
          $ref: 'TS29571_CommonData.yaml#/components/responses/415'
        '429':

```

```

    $ref: 'TS29571_CommonData.yaml#/components/responses/429'
  '500':
    $ref: 'TS29571_CommonData.yaml#/components/responses/500'
  '502':
    $ref: 'TS29571_CommonData.yaml#/components/responses/502'
  '503':
    $ref: 'TS29571_CommonData.yaml#/components/responses/503'
  default:
    $ref: 'TS29571_CommonData.yaml#/components/responses/default'

/subscriptions/{subscriptionId}:
  put:
    summary: Update an existing Individual NWDAF Roaming Data Subscription resource.
    operationId: UpdateNWDAFRoamingDataSubscription
    tags:
      - Individual NWDAF Roaming Data Subscription resource (Document)
    requestBody:
      required: true
      content:
        application/json:
          schema:
            $ref: '#/components/schemas/RoamingDataSub'
    parameters:
      - name: subscriptionId
        in: path
        description: String identifying a subscription to the Nnwdaf_RoamingData Service.
        required: true
        schema:
          type: string
    responses:
      '200':
        description: >
          The Individual NWDAF Roaming Data Subscription resource was modified successfully
          and a representation of that resource is returned.
        content:
          application/json:
            schema:
              $ref: '#/components/schemas/RoamingDataSub'
      '204':
        description: >
          The Individual NWDAF Roaming Data Subscription resource was modified successfully.
      '307':
        $ref: 'TS29571_CommonData.yaml#/components/responses/307'
      '308':
        $ref: 'TS29571_CommonData.yaml#/components/responses/308'
      '400':
        $ref: 'TS29571_CommonData.yaml#/components/responses/400'
      '401':
        $ref: 'TS29571_CommonData.yaml#/components/responses/401'
      '403':
        $ref: 'TS29571_CommonData.yaml#/components/responses/403'
      '404':
        $ref: 'TS29571_CommonData.yaml#/components/responses/404'
      '411':
        $ref: 'TS29571_CommonData.yaml#/components/responses/411'
      '413':
        $ref: 'TS29571_CommonData.yaml#/components/responses/413'
      '415':
        $ref: 'TS29571_CommonData.yaml#/components/responses/415'
      '429':
        $ref: 'TS29571_CommonData.yaml#/components/responses/429'
      '500':
        $ref: 'TS29571_CommonData.yaml#/components/responses/500'
      '501':
        $ref: 'TS29571_CommonData.yaml#/components/responses/501'
      '502':
        $ref: 'TS29571_CommonData.yaml#/components/responses/502'
      '503':
        $ref: 'TS29571_CommonData.yaml#/components/responses/503'
      default:
        $ref: 'TS29571_CommonData.yaml#/components/responses/default'
    delete:
      summary: Delete an existing Individual NWDAF Roaming Data Subscription.
      operationId: DeleteNWDAFRoamingDataSubscription
      tags:
        - Individual NWDAF Roaming Data Subscription (Document)
      parameters:
        - name: subscriptionId

```

```

    in: path
    description: String identifying a subscription to the Nnwdaf_RoamingData Service
    required: true
    schema:
      type: string
  responses:
    '204':
      description: >
        No Content. The Individual NWDAF Roaming Data Subscription resource matching the
        subscriptionId was deleted.
    '307':
      $ref: 'TS29571_CommonData.yaml#/components/responses/307'
    '308':
      $ref: 'TS29571_CommonData.yaml#/components/responses/308'
    '400':
      $ref: 'TS29571_CommonData.yaml#/components/responses/400'
    '401':
      $ref: 'TS29571_CommonData.yaml#/components/responses/401'
    '403':
      $ref: 'TS29571_CommonData.yaml#/components/responses/403'
    '404':
      $ref: 'TS29571_CommonData.yaml#/components/responses/404'
    '429':
      $ref: 'TS29571_CommonData.yaml#/components/responses/429'
    '500':
      $ref: 'TS29571_CommonData.yaml#/components/responses/500'
    '501':
      $ref: 'TS29571_CommonData.yaml#/components/responses/501'
    '502':
      $ref: 'TS29571_CommonData.yaml#/components/responses/502'
    '503':
      $ref: 'TS29571_CommonData.yaml#/components/responses/503'
    default:
      $ref: 'TS29571_CommonData.yaml#/components/responses/default'

components:
  securitySchemes:
    oAuth2ClientCredentials:
      type: oauth2
      flows:
        clientCredentials:
          tokenUrl: '{nrfApiRoot}/oauth2/token'
          scopes:
            nnwdaf-roamingdata: Access to the Nnwdaf_RoamingData API

schemas:
  RoamingDataSub:
    description: >
      Represents roaming data subscription information.
    type: object
    properties:
      notificationUri:
        $ref: 'TS29571_CommonData.yaml#/components/schemas/Uri'
      notifCorrId:
        type: string
        description: Notification correlation identifier.
      plmnId:
        $ref: 'TS29571_CommonData.yaml#/components/schemas/PlmnId'
      dataSub:
        $ref: 'TS29575_Ndrf_DataManagement.yaml#/components/schemas/DataSubscription'
      anaSub:
        $ref: 'TS29520_Nnwdaf_EventsSubscription.yaml#/components/schemas/NnwdafEventsSubscription'
      formatInstruct:
        $ref: 'TS29574_Ndccf_DataManagement.yaml#/components/schemas/FormattingInstruction'
      procInstructs:
        type: array
        items:
          $ref: 'TS29574_Ndccf_DataManagement.yaml#/components/schemas/ProcessingInstruction'
        minItems: 1
        description: Processing instructions to be used for sending event notifications.
      timePeriod:
        $ref: 'TS29122_CommonData.yaml#/components/schemas/TimeWindow'
      targetNfId:
        $ref: 'TS29571_CommonData.yaml#/components/schemas/NfInstanceId'
      targetNfSetId:
        $ref: 'TS29571_CommonData.yaml#/components/schemas/NfSetId'
      immReport:

```



```

    $ref: 'TS29520_Nnwdaf_DataManagement.yaml#/components/schemas/NnwdafDataManagementNotif'
  suppFeat:
    $ref: 'TS29571_CommonData.yaml#/components/schemas/SupportedFeatures'
  required:
    - notificationUri
    - notifCorrId
    - plmnId
  oneOf:
    - required: [anaSub]
    - required: [dataSub]

```

A.9 Nnwdaf_RoamingAnalytics API

openapi: 3.0.0

info:

```

title: Nnwdaf_RoamingAnalytics
version: 1.0.0
description: |
  Nnwdaf_RoamingAnalytics API Service.
  © 2024, 3GPP Organizational Partners (ARIB, ATIS, CCSA, ETSI, TSDSI, TTA, TTC).
  All rights reserved.

```

externalDocs:

```

description: 3GPP TS 29.520 V18.6.0; 5G System; Network Data Analytics Services.
url: https://www.3gpp.org/ftp/Specs/archive/29_series/29.520/

```

servers:

```

- url: '{apiRoot}/nnwdaf-roaminganalytics/v1'
  variables:
    apiRoot:
      default: https://example.com
      description: apiRoot as defined in clause 4.4 of 3GPP TS 29.501

```

security:

```

- {}
- oAuth2ClientCredentials:
  - nnwdaf-roaminganalytics

```

paths:

```

/subscriptions:
  post:
    summary: Create a new Individual NWDAF Roaming Analytics Subscription
    operationId: CreateNwdafRoamingAnalyticsSubscription
    tags:
      - NWDAF Roaming Analytics Subscriptions (Collection)
    requestBody:
      required: true
      content:
        application/json:
          schema:
            $ref: '#/components/schemas/RoamingAnalyticsSubscription'
    responses:
      '201':
        description: Create a new Individual Roaming Analytics Subscription resource.
        headers:
          Location:
            description: >
              Contains the URI of the newly created resource.
            required: true
            schema:
              type: string
        content:
          application/json:
            schema:
              $ref: '#/components/schemas/RoamingAnalyticsSubscription'
      '400':
        $ref: 'TS29571_CommonData.yaml#/components/responses/400'
      '401':
        $ref: 'TS29571_CommonData.yaml#/components/responses/401'
      '403':
        $ref: 'TS29571_CommonData.yaml#/components/responses/403'
      '404':
        $ref: 'TS29571_CommonData.yaml#/components/responses/404'

```

```

'411':
  $ref: 'TS29571_CommonData.yaml#/components/responses/411'
'413':
  $ref: 'TS29571_CommonData.yaml#/components/responses/413'
'415':
  $ref: 'TS29571_CommonData.yaml#/components/responses/415'
'429':
  $ref: 'TS29571_CommonData.yaml#/components/responses/429'
'500':
  $ref: 'TS29571_CommonData.yaml#/components/responses/500'
'502':
  $ref: 'TS29571_CommonData.yaml#/components/responses/502'
'503':
  $ref: 'TS29571_CommonData.yaml#/components/responses/503'
default:
  $ref: 'TS29571_CommonData.yaml#/components/responses/default'
callbacks:
  myNotification:
    '{$request.body#/notifUri}':
      post:
        requestBody:
          required: true
          content:
            application/json:
              schema:
                type: array
                items:
                  $ref: '#/components/schemas/RoamingAnalyticsNotification'
                minItems: 1
        responses:
          '204':
            description: The receipt of the Notification is acknowledged.
          '307':
            $ref: 'TS29571_CommonData.yaml#/components/responses/307'
          '308':
            $ref: 'TS29571_CommonData.yaml#/components/responses/308'
          '400':
            $ref: 'TS29571_CommonData.yaml#/components/responses/400'
          '401':
            $ref: 'TS29571_CommonData.yaml#/components/responses/401'
          '403':
            $ref: 'TS29571_CommonData.yaml#/components/responses/403'
          '404':
            $ref: 'TS29571_CommonData.yaml#/components/responses/404'
          '411':
            $ref: 'TS29571_CommonData.yaml#/components/responses/411'
          '413':
            $ref: 'TS29571_CommonData.yaml#/components/responses/413'
          '415':
            $ref: 'TS29571_CommonData.yaml#/components/responses/415'
          '429':
            $ref: 'TS29571_CommonData.yaml#/components/responses/429'
          '500':
            $ref: 'TS29571_CommonData.yaml#/components/responses/500'
          '502':
            $ref: 'TS29571_CommonData.yaml#/components/responses/502'
          '503':
            $ref: 'TS29571_CommonData.yaml#/components/responses/503'
          default:
            $ref: 'TS29571_CommonData.yaml#/components/responses/default'

/subscriptions/{subscriptionId}:
  put:
    summary: Update an existing Individual Roaming Analytics Subscription resource.
    operationId: UpdateNwdafRoamingAnalyticsSubscription
    tags:
      - Individual NWDAF Roaming Analytics Subscription resource (Document)
    requestBody:
      required: true
      content:
        application/json:
          schema:
            $ref: '#/components/schemas/RoamingAnalyticsSubscription'
    parameters:
      - name: subscriptionId
        in: path
        description: String identifying a subscription to the Nnwdaf_RoamingAnalytics service.
        required: true

```

```

    schema:
      type: string
  responses:
    '200':
      description: >
        The Individual NWDAF Roaming Analytics Subscription resource was modified successfully
        and a representation of that resource is returned.
      content:
        application/json:
          schema:
            $ref: '#/components/schemas/RoamingAnalyticsSubscription'
    '204':
      description: >
        The Individual NWDAF Roaming Analytics Subscription resource was modified
        successfully.
    '307':
      $ref: 'TS29571_CommonData.yaml#/components/responses/307'
    '308':
      $ref: 'TS29571_CommonData.yaml#/components/responses/308'
    '400':
      $ref: 'TS29571_CommonData.yaml#/components/responses/400'
    '401':
      $ref: 'TS29571_CommonData.yaml#/components/responses/401'
    '403':
      $ref: 'TS29571_CommonData.yaml#/components/responses/403'
    '404':
      $ref: 'TS29571_CommonData.yaml#/components/responses/404'
    '411':
      $ref: 'TS29571_CommonData.yaml#/components/responses/411'
    '413':
      $ref: 'TS29571_CommonData.yaml#/components/responses/413'
    '415':
      $ref: 'TS29571_CommonData.yaml#/components/responses/415'
    '429':
      $ref: 'TS29571_CommonData.yaml#/components/responses/429'
    '500':
      $ref: 'TS29571_CommonData.yaml#/components/responses/500'
    '501':
      $ref: 'TS29571_CommonData.yaml#/components/responses/501'
    '502':
      $ref: 'TS29571_CommonData.yaml#/components/responses/502'
    '503':
      $ref: 'TS29571_CommonData.yaml#/components/responses/503'
    default:
      $ref: 'TS29571_CommonData.yaml#/components/responses/default'
  delete:
    summary: Delete an existing Individual NWDAF Roaming Analytics Subscription.
    operationId: DeleteNwdafRoamingAnalyticsSubscription
    tags:
      - Individual NWDAF Roaming Analytics Subscription (Document)
    parameters:
      - name: subscriptionId
        in: path
        description: String identifying a subscription to the Nnwdaf_RoamingAnalytics service
        required: true
        schema:
          type: string
    responses:
      '204':
        description: >
          No Content. The Individual NWDAF Roaming Analytics Subscription resource matching the
          subscriptionId was deleted.
      '307':
        $ref: 'TS29571_CommonData.yaml#/components/responses/307'
      '308':
        $ref: 'TS29571_CommonData.yaml#/components/responses/308'
      '400':
        $ref: 'TS29571_CommonData.yaml#/components/responses/400'
      '401':
        $ref: 'TS29571_CommonData.yaml#/components/responses/401'
      '403':
        $ref: 'TS29571_CommonData.yaml#/components/responses/403'
      '404':
        $ref: 'TS29571_CommonData.yaml#/components/responses/404'
      '429':
        $ref: 'TS29571_CommonData.yaml#/components/responses/429'
      '500':
        $ref: 'TS29571_CommonData.yaml#/components/responses/500'

```

```

'501':
  $ref: 'TS29571_CommonData.yaml#/components/responses/501'
'502':
  $ref: 'TS29571_CommonData.yaml#/components/responses/502'
'503':
  $ref: 'TS29571_CommonData.yaml#/components/responses/503'
default:
  $ref: 'TS29571_CommonData.yaml#/components/responses/default'

```

```

components:
  securitySchemes:
    oAuth2ClientCredentials:
      type: oauth2
      flows:
        clientCredentials:
          tokenUrl: '{nrfApiRoot}/oauth2/token'
          scopes:
            nnwdaf-roaminganalytics: Access to the Nnwdaf_RoamingAnalytics API

```

```

schemas:
  RoamingAnalyticsSubscription:
    description: Represents a Roaming Analytics subscription.
    type: object
    properties:
      roamEventSubs:
        type: array
        items:
          $ref: 'TS29520_Nnwdaf_EventsSubscription.yaml#/components/schemas/EventSubscription'
        minItems: 1
        description: Represents Roaming Analytics subscription for a specific event.
      evtReq:
        $ref: 'TS29523_Npcf_EventExposure.yaml#/components/schemas/ReportingInformation'
      notifUri:
        $ref: 'TS29571_CommonData.yaml#/components/schemas/Uri'
      notifCorrId:
        type: string
        description: Notification correlation identifier.
      consPlmnId:
        $ref: 'TS29571_CommonData.yaml#/components/schemas/PlmnId'
      roamEventNotifs:
        type: array
        items:
          $ref: 'TS29520_Nnwdaf_EventsSubscription.yaml#/components/schemas/EventNotification'
        minItems: 1
        description: Contains immediate reports for Roaming Analytics.
      failEventReports:
        type: array
        items:
          $ref: 'TS29520_Nnwdaf_EventsSubscription.yaml#/components/schemas/FailureEventInfo'
        minItems: 1
        description: Contains information about failed events.
      suppFeat:
        $ref: 'TS29571_CommonData.yaml#/components/schemas/SupportedFeatures'
    required:
      - roamEventSubs
      - notifUri
      - notifCorrId
      - consPlmnId

  RoamingAnalyticsNotification:
    description: Represents a Roaming Analytics notification.
    type: object
    properties:
      roamEventNotifs:
        type: array
        items:
          $ref: 'TS29520_Nnwdaf_EventsSubscription.yaml#/components/schemas/EventNotification'
        minItems: 1
        description: Contains Roaming Analytics notification for a specific event.
      notifCorrId:
        type: string
        description: Notification correlation identifier.
      termCause:
        $ref: 'TS29520_Nnwdaf_EventsSubscription.yaml#/components/schemas/TermCause'
    required:
      - roamEventNotifs
      - notifCorrId

```

Annex B (informative): Change history

| Change history | | | | | | | |
|----------------|---------|-----------|------|-----|-----|---|-------------|
| Date | Meeting | TDoc | CR | Rev | Cat | Subject/Comment | New version |
| 2017-10 | | | | | | TS skeleton of Network Data Analytics Services. | 0.0.0 |
| 2017-11 | CT3#92 | | | | | Inclusion of documents agreed in CT3#92 C3-175356. | 0.1.0 |
| 2017-12 | CT3#93 | | | | | Inclusion of documents agreed in CT3#93 C3-176166, C3-176260, C3-176324, C3-176325, C3-176326, and C3-176327. | 0.2.0 |
| 2018-01 | CT3#94 | | | | | Inclusion of documents agreed in CT3#94 C3-180252, C3-180253, C3-180254, C3-180255, C3-180256, C3-180257, C3-180344, C3-180345, C3-180346, C3-180323 and C3-180347. | 0.3.0 |
| 2018-03 | CT3#95 | | | | | Inclusion of documents agreed in CT3#95 C3-181253, C3-181255, C3-181256, C3-181257, C3-181260, C3-181312, C3-181342 and C3-181343. | 0.4.0 |
| 2018-03 | CT3#96 | | | | | Inclusion of documents agreed in CT3#96 C3-182379 and C3-182380. | 0.5.0 |
| 2018-05 | CT3#97 | | | | | Inclusion of documents agreed in CT3#97 C3-183285, C3-183532, C3-183533, C3-183534 and C3-183535. | 0.6.0 |
| 2018-06 | CT#80 | CP-181032 | | | | TS sent to plenary for approval | 1.0.0 |
| 2018-06 | CT#80 | CP-181032 | | | | TS approved by plenary | 15.0.0 |
| 2018-09 | CT#81 | CP-182015 | 0001 | 3 | F | Clarification on mandatory HTTP error status codes | 15.1.0 |
| 2018-09 | CT#81 | CP-182209 | 0002 | 4 | B | OpenAPI for TS 29.520 | 15.1.0 |
| 2018-09 | CT#81 | CP-182015 | 0003 | 1 | F | Description of Structured data types | 15.1.0 |
| 2018-09 | CT#81 | CP-182015 | 0004 | 1 | F | Resource structure presentation | 15.1.0 |
| 2018-12 | CT#82 | CP-183205 | 0006 | | F | Default value for apiRoot | 15.2.0 |
| 2018-12 | CT#82 | CP-183205 | 0007 | 2 | F | Correct Nnwdaf service | 15.2.0 |
| 2018-12 | CT#82 | CP-183205 | 0008 | 1 | F | Cardinality | 15.2.0 |
| 2018-12 | CT#82 | CP-183205 | 0009 | | F | API version | 15.2.0 |
| 2018-12 | CT#82 | CP-183205 | 0010 | | F | ExternalDocs OpenAPI field | 15.2.0 |
| 2018-12 | CT#82 | CP-183205 | 0011 | 1 | F | Security | 15.2.0 |
| 2018-12 | CT#82 | CP-183205 | 0012 | 1 | F | Supported content types | 15.2.0 |
| 2018-12 | CT#82 | CP-183205 | 0013 | 2 | F | HTTP Error responses | 15.2.0 |
| 2018-12 | CT#82 | CP-183205 | 0014 | 2 | F | Correct NWDAF resource | 15.2.0 |
| 2018-12 | CT#82 | CP-183205 | 0016 | 1 | F | Adding HTTP status code "204 No Content" | 15.2.0 |
| 2018-12 | CT#82 | CP-183205 | 0019 | | F | Location header field in OpenAPI | 15.2.0 |
| 2019-03 | CT#83 | CP-190113 | 0020 | | F | Support of NSSF as the service consumer | 15.3.0 |
| 2019-03 | CT#83 | CP-190113 | 0021 | 1 | F | Formatting of structured data types in query | 15.3.0 |
| 2019-03 | CT#83 | CP-190113 | 0022 | | F | OpenAPI info version update | 15.3.0 |
| 2019-03 | CT#83 | CP-190213 | 0023 | 1 | F | Correction of Location header in Nnwdaf_EventsSubscription OpenAPI | 15.3.0 |
| 2019-06 | CT#84 | CP-191078 | 0024 | 1 | F | Correction of Nnwdaf_EventsSubscription OpenAPI | 15.4.0 |
| 2019-06 | CT#84 | CP-191078 | 0029 | 7 | F | Corrections on TS 29.520 | 15.4.0 |
| 2019-06 | CT#84 | CP-191078 | 0035 | 1 | F | Precedence of OpenAPI file | 15.4.0 |
| 2019-06 | CT#84 | CP-191078 | 0037 | 1 | F | Copyright Note in YAML files | 15.4.0 |
| 2019-06 | CT#84 | CP-191090 | 0025 | 1 | B | Reference update and service representation | 16.0.0 |
| 2019-06 | CT#84 | CP-191090 | 0027 | 3 | B | Support of more consumers | 16.0.0 |
| 2019-06 | CT#84 | CP-191090 | 0028 | 1 | B | Support of more analytic events | 16.0.0 |
| 2019-06 | CT#84 | CP-191225 | 0031 | 9 | B | Subscribing of service experience for the application | 16.0.0 |
| 2019-06 | CT#84 | CP-191090 | 0033 | 2 | B | Delete the subscription of service experience for the application | 16.0.0 |
| 2019-06 | CT#84 | CP-191090 | 0034 | 5 | B | Notification of service experience for the application | 16.0.0 |
| 2019-06 | CT#84 | CP-191090 | 0039 | 2 | F | Copyright Note in YAML files | 16.0.0 |
| 2019-09 | CT#85 | CP-192146 | 0041 | 2 | F | Correct cardinality in NnwdafEventsSubscription | 16.1.0 |
| 2019-09 | CT#85 | CP-192157 | 0042 | 4 | B | UE mobility and communication analytics | 16.1.0 |
| 2019-09 | CT#85 | CP-192157 | 0043 | 2 | B | Support of network performance analytics in Nnwdaf_AnalyticsInfo_Request | 16.1.0 |
| 2019-09 | CT#85 | CP-192157 | 0047 | 1 | B | OAM as service consumer | 16.1.0 |
| 2019-09 | CT#85 | CP-192157 | 0048 | 1 | B | Update Nnwdaf_EventSubscription service for service experience | 16.1.0 |
| 2019-09 | CT#85 | CP-192261 | 0049 | 1 | B | Enhance the Nnwdaf_AnalyticsInfo service to support service experience | 16.1.0 |
| 2019-09 | CT#85 | CP-192177 | 0050 | 2 | B | Enhance the Nnwdaf_EventsSubscription service to support QoS sustainability | 16.1.0 |
| 2019-09 | CT#85 | CP-192177 | 0051 | 2 | B | Enhance the Nnwdaf_AnalyticsInfo service to support QoS sustainability | 16.1.0 |
| 2019-09 | CT#85 | CP-192173 | 0054 | 2 | F | OpenAPI version update TS 29.520 Rel-16 | 16.1.0 |
| 2019-12 | CT#86 | CP-193198 | 0055 | 3 | B | Abnormal behaviour analytics | 16.2.0 |
| 2019-12 | CT#86 | CP-193198 | 0056 | 4 | B | Enhance the Nnwdaf_EventsSubscription service to support User Data Congestion | 16.2.0 |
| 2019-12 | CT#86 | CP-193198 | 0057 | 2 | B | Enhance the Nnwdaf_AnalyticsInfo service to support user data congestion | 16.2.0 |
| 2019-12 | CT#86 | CP-193198 | 0058 | 1 | B | Defination of QoS sustainability information | 16.2.0 |
| 2019-12 | CT#86 | CP-193198 | 0059 | 4 | B | Inclusion of QoS requirements and thresholds for QoS Sustainability | 16.2.0 |
| 2019-12 | CT#86 | CP-193198 | 0062 | 2 | F | Clarify references to QoS sustainability analytics | 16.2.0 |

| | | | | | | | |
|---------|--------|-----------|------|---|---|---|--------|
| 2019-12 | CT#86 | CP-193198 | 0063 | 2 | F | Clarifications on NWDAF generalities | 16.2.0 |
| 2019-12 | CT#86 | CP-193267 | 0102 | 3 | B | OpenAPI file Update for Nnwdaf_EventsSubscription API | 16.2.0 |
| 2019-12 | CT#86 | CP-193198 | 0103 | | B | OpenAPI file Update for Nnwdaf_AnalyticsInfo API | 16.2.0 |
| 2019-12 | CT#86 | CP-193198 | 0104 | 1 | B | Slice identification for all analytics types | 16.2.0 |
| 2019-12 | CT#86 | CP-193234 | 0106 | 2 | B | NF Load analytics generalities | 16.2.0 |
| 2019-12 | CT#86 | CP-193212 | 0107 | 1 | F | Update of API version and TS version in OpenAPI file | 16.2.0 |
| 2020-03 | CT#87e | CP-200208 | 0109 | 1 | B | Definition of QoS Requirement | 16.3.0 |
| 2020-03 | CT#87e | CP-200208 | 0110 | 1 | B | Description of consumer functionalities | 16.3.0 |
| 2020-03 | CT#87e | CP-200208 | 0111 | 1 | B | Update the types of analytics events | 16.3.0 |
| 2020-03 | CT#87e | CP-200207 | 0114 | | B | DNN Clarification | 16.3.0 |
| 2020-03 | CT#87e | CP-200208 | 0115 | 1 | F | Update Feature applicability for Rel-16 new data types | 16.3.0 |
| 2020-03 | CT#87e | CP-200208 | 0118 | 2 | D | Corrections in TS29.520 | 16.3.0 |
| 2020-03 | CT#87e | CP-200208 | 0120 | 1 | F | Clarify start time and end time | 16.3.0 |
| 2020-03 | CT#87e | CP-200182 | 0121 | 2 | F | Correct QoS sustainability | 16.3.0 |
| 2020-03 | CT#87e | CP-200232 | 0122 | 1 | F | Correct UE mobility and communication | 16.3.0 |
| 2020-03 | CT#87e | CP-200208 | 0123 | 1 | B | Support network performance analytics | 16.3.0 |
| 2020-03 | CT#87e | CP-200208 | 0124 | 1 | F | Correcting QoS sustainability information | 16.3.0 |
| 2020-03 | CT#87e | CP-200214 | 0125 | | F | OpenAPI: usage of the "tags" keyword | 16.3.0 |
| 2020-03 | CT#87e | CP-200208 | 0126 | 1 | F | Corrections on resource name | 16.3.0 |
| 2020-03 | CT#87e | CP-200208 | 0127 | 1 | F | Data used for area of interest | 16.3.0 |
| 2020-03 | CT#87e | CP-200208 | 0128 | 1 | F | Any UE possibility for UE mobility and UE communication | 16.3.0 |
| 2020-03 | CT#87e | CP-200208 | 0129 | 1 | B | Nnwdaf_EventsSubscription API, Support of Service experience | 16.3.0 |
| 2020-03 | CT#87e | CP-200208 | 0130 | 1 | B | Nnwdaf_EventsSubscription API, Support of Service experience | 16.3.0 |
| 2020-03 | CT#87e | CP-200236 | 0131 | 2 | B | Nnwdaf_EventsSubscription API, Support of abnormal behaviour | 16.3.0 |
| 2020-03 | CT#87e | CP-200224 | 0132 | 1 | B | Nnwdaf_AnalyticsInfo API, Support of abnormal behaviour | 16.3.0 |
| 2020-03 | CT#87e | CP-200228 | 0136 | 2 | B | Support of NF Load analytics | 16.3.0 |
| 2020-03 | CT#87e | CP-200216 | 0140 | | F | Update of OpenAPI version and TS version in externalDocs field | 16.3.0 |
| 2020-06 | CT#88e | CP-201234 | 0142 | 1 | F | Condition description for threshold related attributes | 16.4.0 |
| 2020-06 | CT#88e | CP-201234 | 0143 | 1 | F | Some corrections to Nnwdaf_AnalyticsInfo Service | 16.4.0 |
| 2020-06 | CT#88e | CP-201234 | 0144 | 1 | F | Clarification on applicability for network slice information | 16.4.0 |
| 2020-06 | CT#88e | CP-201234 | 0145 | 1 | F | Analytics result per DNN | 16.4.0 |
| 2020-06 | CT#88e | CP-201234 | 0146 | 3 | F | Maximum number of SUPIs | 16.4.0 |
| 2020-06 | CT#88e | CP-201234 | 0147 | 1 | F | Correction on FlowDescription | 16.4.0 |
| 2020-06 | CT#88e | CP-201234 | 0149 | 3 | F | Support of Abnormal Behaviour | 16.4.0 |
| 2020-06 | CT#88e | CP-201234 | 0150 | 2 | F | Confidence for User Data Congestion Information. | 16.4.0 |
| 2020-06 | CT#88e | CP-201234 | 0151 | 1 | F | Data types used for NWDAF services | 16.4.0 |
| 2020-06 | CT#88e | CP-201234 | 0153 | 2 | F | Adding maxObjectNbr attribute in related feature of NWDAF analytics service | 16.4.0 |
| 2020-06 | CT#88e | CP-201234 | 0154 | 1 | F | Adding UDM as consumer of services provided by NWDAF | 16.4.0 |
| 2020-06 | CT#88e | CP-201234 | 0155 | | F | Corrections on descriptions of NF service consumers offered by NWDAF | 16.4.0 |
| 2020-06 | CT#88e | CP-201234 | 0157 | 1 | D | Updates to Abbreviations | 16.4.0 |
| 2020-06 | CT#88e | CP-201234 | 0158 | 2 | B | Support NSI ID | 16.4.0 |
| 2020-06 | CT#88e | CP-201234 | 0163 | 3 | B | Support Service Experience Variance | 16.4.0 |
| 2020-06 | CT#88e | CP-201234 | 0165 | 1 | F | Correction to Service Description | 16.4.0 |
| 2020-06 | CT#88e | CP-201234 | 0166 | 1 | F | Correction to description of consumer functionalities | 16.4.0 |
| 2020-06 | CT#88e | CP-201234 | 0167 | 1 | F | Correction to variance of Start time in UE Communication | 16.4.0 |
| 2020-06 | CT#88e | CP-201234 | 0169 | 1 | B | Correct supported feature in AnalyticsData | 16.4.0 |
| 2020-06 | CT#88e | CP-201234 | 0170 | 1 | F | Clarify service experience data | 16.4.0 |
| 2020-06 | CT#88e | CP-201234 | 0171 | | F | Correct threshold | 16.4.0 |
| 2020-06 | CT#88e | CP-201234 | 0172 | 1 | F | Resource type in QoS requirement | 16.4.0 |
| 2020-06 | CT#88e | CP-201244 | 0173 | 1 | F | Storage of YAML files in ETSI Forge | 16.4.0 |
| 2020-06 | CT#88e | CP-201234 | 0176 | 2 | F | Analytics result per S-NSSAI | 16.4.0 |
| 2020-06 | CT#88e | CP-201234 | 0177 | 1 | F | Corrections on confidence for other NWDAF events | 16.4.0 |
| 2020-06 | CT#88e | CP-201256 | 0179 | 1 | F | URI of the Nnwdaf services | 16.4.0 |
| 2020-06 | CT#88e | CP-201234 | 0180 | 1 | F | Default value for matching direction | 16.4.0 |
| 2020-06 | CT#88e | CP-201234 | 0181 | | F | Support of immediate reporting | 16.4.0 |
| 2020-06 | CT#88e | CP-201244 | 0182 | 1 | F | Optionality of ProblemDetails | 16.4.0 |
| 2020-06 | CT#88e | CP-201234 | 0183 | 1 | F | Correction to abnormal traffic volume | 16.4.0 |
| 2020-06 | CT#88e | CP-201234 | 0186 | 2 | F | Corrections on ratio of UEs in NWDAF event reports | 16.4.0 |
| 2020-06 | CT#88e | CP-201234 | 0187 | 1 | F | Corrections to TargetUeInformation | 16.4.0 |
| 2020-06 | CT#88e | CP-201234 | 0188 | | F | Corrections on AbnormalBehaviour | 16.4.0 |
| 2020-06 | CT#88e | CP-201234 | 0189 | | F | Plural of NF load level information related attribute | 16.4.0 |
| 2020-06 | CT#88e | CP-201234 | 0190 | 1 | F | locInfo attribute within the UeMobility data | 16.4.0 |
| 2020-06 | CT#88e | CP-201234 | 0191 | | F | Corrections on NfLoadLevelInformation | 16.4.0 |
| 2020-06 | CT#88e | CP-201244 | 0192 | 1 | F | Supported headers, Resource Data type, Operation Name and yaml mapping | 16.4.0 |
| 2020-06 | CT#88e | CP-201255 | 0193 | | F | Update of OpenAPI version and TS version in externalDocs field | 16.4.0 |
| 2020-09 | CT#89e | CP-202066 | 0196 | 1 | F | Description for NWDAF services | 16.5.0 |
| 2020-09 | CT#89e | CP-202066 | 0197 | 1 | F | Zero confidence | 16.5.0 |
| 2020-09 | CT#89e | CP-202066 | 0199 | | F | Correct QoS sustainability requirement | 16.5.0 |

| | | | | | | | |
|---------|--------|-----------|------|---|---|--|--------|
| 2020-09 | CT#89e | CP-202066 | 0200 | | F | Validity period for analytics information | 16.5.0 |
| 2020-09 | CT#89e | CP-202066 | 0201 | 1 | F | Timestamp of analytics generation | 16.5.0 |
| 2020-09 | CT#89e | CP-202066 | 0202 | | F | Notification about subscribed event | 16.5.0 |
| 2020-09 | CT#89e | CP-202066 | 0204 | 1 | F | Omitted event reporting information | 16.5.0 |
| 2020-09 | CT#89e | CP-202066 | 0205 | | F | Optional network slice identification | 16.5.0 |
| 2020-09 | CT#89e | CP-202066 | 0206 | | F | Slice load level information | 16.5.0 |
| 2020-09 | CT#89e | CP-202066 | 0207 | 1 | F | Matching direction | 16.5.0 |
| 2020-09 | CT#89e | CP-202066 | 0208 | | F | Time when analytics information is needed | 16.5.0 |
| 2020-09 | CT#89e | CP-202066 | 0209 | 1 | F | Confidence for UE mobility | 16.5.0 |
| 2020-09 | CT#89e | CP-202066 | 0210 | | F | Supported feature in Nnwdaf_AnalyticsInfo API | 16.5.0 |
| 2020-09 | CT#89e | CP-202066 | 0211 | | F | Target UE identification | 16.5.0 |
| 2020-09 | CT#89e | CP-202066 | 0212 | | F | Correction on NetworkPerfType | 16.5.0 |
| 2020-09 | CT#89e | CP-202066 | 0214 | | F | Corrections on applds and dnns | 16.5.0 |
| 2020-09 | CT#89e | CP-202066 | 0215 | 1 | F | Corrections to networkArea with anyUE | 16.5.0 |
| 2020-09 | CT#89e | CP-202066 | 0216 | 1 | F | Corrections to abnormal behaviour for any UE | 16.5.0 |
| 2020-09 | CT#89e | CP-202054 | 0218 | | A | ResourceURI correction during subscription update | 16.5.0 |
| 2020-09 | CT#89e | CP-202084 | 0221 | 1 | F | Update of OpenAPI version and TS version in externalDocs field | 16.5.0 |
| 2020-09 | CT#89e | CP-202073 | 0198 | | F | Reference to enumeration Accuracy | 17.0.0 |
| 2020-09 | CT#89e | CP-202085 | 0220 | 1 | F | Update of OpenAPI version and TS version in externalDocs field | 17.0.0 |
| 2020-12 | CT#90e | CP-203139 | 0223 | 1 | A | Essential corrections and alignments | 17.1.0 |
| 2020-12 | CT#90e | CP-203117 | 0226 | 1 | A | Correction to notificationURI attribute | 17.1.0 |
| 2020-12 | CT#90e | CP-203129 | 0228 | | A | Mapping of expected analytics types and exception Ids | 17.1.0 |
| 2020-12 | CT#90e | CP-203129 | 0230 | 1 | A | Analytics report correction | 17.1.0 |
| 2020-12 | CT#90e | CP-203129 | 0232 | 1 | A | Error response for statistics request | 17.1.0 |
| 2020-12 | CT#90e | CP-203129 | 0234 | | A | S-NSSAI applicability | 17.1.0 |
| 2020-12 | CT#90e | CP-203129 | 0236 | 1 | A | Revomal of Service Experience feature for nsiLevelThrds attribute | 17.1.0 |
| 2020-12 | CT#90e | CP-203129 | 0238 | 1 | A | Correction to supis of Service Experience Analytics | 17.1.0 |
| 2020-12 | CT#90e | CP-203155 | 0240 | 1 | A | Updates CEF as NWDAF consumer of Nnwdaf_EventsSubscription service | 17.1.0 |
| 2020-12 | CT#90e | CP-203130 | 0242 | 1 | F | Corrections to Validity Period | 17.1.0 |
| 2020-12 | CT#90e | CP-203129 | 0244 | 1 | A | Corrections to Threshold | 17.1.0 |
| 2020-12 | CT#90e | CP-203153 | 0246 | | F | Update of OpenAPI version and TS version in externalDocs field | 17.1.0 |
| 2021-03 | CT#91e | CP-210191 | 0248 | 1 | F | Support of stateless NFs | 17.2.0 |
| 2021-03 | CT#91e | CP-210217 | 0250 | | A | Storage of YAML files in ETSI Forge | 17.2.0 |
| 2021-03 | CT#91e | CP-210218 | 0251 | | F | OpenAPI reference | 17.2.0 |
| 2021-03 | CT#91e | CP-210206 | 0253 | 1 | A | Correction to S-NSSAI applicability | 17.2.0 |
| 2021-03 | CT#91e | CP-210206 | 0255 | 1 | A | Adding network slice instance load level information | 17.2.0 |
| 2021-03 | CT#91e | CP-210219 | 0256 | | F | Adding some missing description fields to data type definitions in OpenAPI specification files | 17.2.0 |
| 2021-03 | CT#91e | CP-210219 | 0257 | | F | Removal of the NnwdafFailureCode data type from the Nnwdaf_AnalyticsInfo API | 17.2.0 |
| 2021-03 | CT#91e | CP-210230 | 0258 | | F | Missing data type in the Nnwdaf_EventsSubscription specific Data Types table | 17.2.0 |
| 2021-03 | CT#91e | CP-210230 | 0259 | | F | Wrong description of the EventFilter data type in the Nnwdaf_AnalyticsInfo specific Data Types table | 17.2.0 |
| 2021-03 | CT#91e | CP-210206 | 0261 | | A | Any Slice applicability | 17.2.0 |
| 2021-03 | CT#91e | CP-210206 | 0263 | 1 | A | Partial failure during event subscription | 17.2.0 |
| 2021-03 | CT#91e | CP-210206 | 0265 | | A | Supported feature | 17.2.0 |
| 2021-03 | CT#91e | CP-210240 | 0267 | | F | Update of OpenAPI version and TS version in externalDocs field | 17.2.0 |
| 2021-06 | CT#92e | CP-211220 | 0269 | 3 | A | Adding missing description for partial failure operation | 17.3.0 |
| 2021-06 | CT#92e | CP-211221 | 0270 | 4 | B | Adding time when analytics needed and revised time to analytics subscriptions | 17.3.0 |
| 2021-06 | CT#92e | CP-211221 | 0271 | 2 | B | Adding NWDAF as NWDAF services consumer due to analytics aggregation | 17.3.0 |
| 2021-06 | CT#92e | CP-211234 | 0272 | 1 | F | Support of optional HTTP custom header fields | 17.3.0 |
| 2021-06 | CT#92e | CP-211206 | 0278 | 1 | A | Correction on 404 Not Found | 17.3.0 |
| 2021-06 | CT#92e | CP-211220 | 0280 | | A | Missing attributes in subscription procedure | 17.3.0 |
| 2021-06 | CT#92e | CP-211220 | 0282 | 1 | A | Correction on the value of confidence | 17.3.0 |
| 2021-06 | CT#92e | CP-211206 | 0285 | 1 | A | Correction to Load Level Information | 17.3.0 |
| 2021-06 | CT#92e | CP-211220 | 0287 | 1 | A | Correction to NSI Load Level Information | 17.3.0 |
| 2021-06 | CT#92e | CP-211221 | 0288 | 1 | B | Service introduction of Nnwdaf_DataManagement service | 17.3.0 |
| 2021-06 | CT#92e | CP-211221 | 0289 | 1 | B | Service operations for Nnwdaf_DataManagement | 17.3.0 |
| 2021-06 | CT#92e | CP-211221 | 0290 | 1 | B | Nnwdaf_DataManagement Service API | 17.3.0 |
| 2021-06 | CT#92e | CP-211221 | 0291 | 1 | B | Service introduction of Nnwdaf_MLModelProvision service | 17.3.0 |
| 2021-06 | CT#92e | CP-211221 | 0292 | 1 | B | Service operations for Nnwdaf_MLModelProvision service | 17.3.0 |
| 2021-06 | CT#92e | CP-211221 | 0293 | 1 | B | Nnwdaf_MLModelProvision Service API | 17.3.0 |
| 2021-06 | CT#92e | CP-211221 | 0294 | 2 | B | Partitioning criteria for applying sampling in specific UE partitions in NWDAF event exposure | 17.3.0 |
| 2021-06 | CT#92e | CP-211221 | 0295 | 1 | B | Complete definition of the Nnwdaf_MLModelProvision API | 17.3.0 |
| 2021-06 | CT#92e | CP-211200 | 0297 | 1 | A | Redirect responses with "application/json" media type | 17.3.0 |
| 2021-06 | CT#92e | CP-211251 | 0298 | 1 | F | analytics for a specific time | 17.3.0 |
| 2021-06 | CT#92e | CP-211221 | 0299 | 1 | B | Service operations of Nnwdaf_MLModelProvision service | 17.3.0 |

| | | | | | | | |
|---------|--------|---------------------------|------|---|---|--|--------|
| 2021-06 | CT#92e | CP-211221 | 0300 | 1 | B | Service description of Nnwdaf_MLModelProvision service | 17.3.0 |
| 2021-06 | CT#92e | CP-211275 | 0301 | 1 | B | Extension to User Data Congestion Analytics with GPSI | 17.3.0 |
| 2021-06 | CT#92e | CP-211221 | 0302 | 1 | F | Correction of the description of the snssaia attribute | 17.3.0 |
| 2021-06 | CT#92e | CP-211265 | 0305 | | F | Update of OpenAPI version and TS version in externalDocs field | 17.3.0 |
| 2021-09 | CT#93e | CP-212203 | 0306 | 1 | B | Aggregation support in analytics requests | 17.4.0 |
| 2021-09 | CT#93e | CP-212203 | 0307 | 1 | B | Aggregation support in analytics subscriptions | 17.4.0 |
| 2021-09 | CT#93e | CP-212203 | 0310 | | F | Small corrections in NWDAF APIs | 17.4.0 |
| 2021-09 | CT#93e | CP-212232 | 0311 | 1 | B | Extensions of Slice load level related network data analytics | 17.4.0 |
| 2021-09 | CT#93e | CP-212203 | 0312 | | F | Extend General for OpenAPI specification | 17.4.0 |
| 2021-09 | CT#93e | CP-212203 | 0313 | | B | Redirection handling for Nnwdaf_MLModelProvision Service | 17.4.0 |
| 2021-09 | CT#93e | CP-212203 | 0314 | 2 | B | Extension to User Data Congestion Analytics in Nnwdaf_EventsSubscription API | 17.4.0 |
| 2021-09 | CT#93e | CP-212203 | 0315 | 1 | B | Extension to User Data Congestion Analytics in Nnwdaf_AnalyticsInfo API | 17.4.0 |
| 2021-09 | CT#93e | CP-212202 | 0317 | | A | Removal of NSI ID from PCF as consumer of NWDAF | 17.4.0 |
| 2021-09 | CT#93e | CP-212223 | 0318 | | F | Update of OpenAPI version and TS version in externalDocs field | 17.4.0 |
| 2021-12 | CT#94e | CP-213228 | 0322 | 3 | F | Extension to Observed Service Experience in Nnwdaf_EventsSubscription Service API | 17.5.0 |
| 2021-12 | CT#94e | CP-213228 | 0323 | 3 | F | Extension to Observed Service Experience in Nnwdaf_AnalyticsInfo Service API | 17.5.0 |
| 2021-12 | CT#94e | CP-213227 | 0324 | 1 | B | Addition of network analytics for the PCF | 17.5.0 |
| 2021-12 | CT#94e | CP-213228 | 0325 | 2 | B | Updates to User Data Congestion Extension in Nnwdaf_EventsSubscription API | 17.5.0 |
| 2021-12 | CT#94e | CP-213228 | 0326 | 1 | B | Updates to User Data Congestion Extension in Nnwdaf_AnalyticsInfo API | 17.5.0 |
| 2021-12 | CT#94e | CP-213227 | 0327 | 1 | B | Analytics info context transfer operation descriptions | 17.5.0 |
| 2021-12 | CT#94e | CP-213228 | 0328 | 2 | B | Analytics info context transfer operation data model and OpenAPI | 17.5.0 |
| 2021-12 | CT#94e | CP-213227 | 0329 | 1 | B | Analytics info context transfer operation overview | 17.5.0 |
| 2021-12 | CT#94e | CP-213227 | 0330 | 1 | B | Analytics info context transfer operation resources | 17.5.0 |
| 2021-12 | CT#94e | CP-213227 | 0331 | 1 | B | Analytics subscription transfer operation descriptions | 17.5.0 |
| 2021-12 | CT#94e | CP-213228 | 0332 | 2 | B | Analytics subscription transfer operation data model and OpenAPI | 17.5.0 |
| 2021-12 | CT#94e | CP-213227 | 0333 | | B | Analytics subscription transfer operation overview | 17.5.0 |
| 2021-12 | CT#94e | CP-213227 | 0334 | 1 | B | Analytics subscription transfer operation resources | 17.5.0 |
| 2021-12 | CT#94e | CP-213227 | 0335 | 1 | B | Extending analytics subscription to enable context transfer | 17.5.0 |
| 2021-12 | CT#94e | CP-213227 | 0336 | 1 | B | Subscription modification procedure of Nnwdaf_MLModelProvision service | 17.5.0 |
| 2021-12 | CT#94e | CP-213227 | 0337 | 1 | B | Support of Nnwdaf_MLModelInfo Service | 17.5.0 |
| 2021-12 | CT#94e | CP-213227 | 0338 | | B | The OpenAPI file for Nnwdaf_MLModelProvision | 17.5.0 |
| 2021-12 | CT#94e | CP-213227 | 0339 | 1 | B | Update of procedures and data type definition for Nnwdaf_MLModelProvision | 17.5.0 |
| 2021-12 | CT#94e | CP-213239 | 0340 | 1 | F | Aligning API URI with SBI template | 17.5.0 |
| 2021-12 | CT#94e | CP-213228 | 0341 | 3 | B | Support of SM congestion control experience analytics by Nnwdaf_AnalyticsInfo service | 17.5.0 |
| 2021-12 | CT#94e | CP-213228 | 0342 | | B | Adding DCCF as NWDAF events subscription NF service consumer | 17.5.0 |
| 2021-12 | CT#94e | CP-213226 | 0344 | | A | Remove QoS sustainability as analytics for PCF | 17.5.0 |
| 2021-12 | CT#94e | CP-213228 | 0347 | 1 | B | Support of DN performance analytics | 17.5.0 |
| 2021-12 | CT#94e | CP-213228 | 0348 | 1 | B | Define the list of analytics subsets in the request | 17.5.0 |
| 2021-12 | CT#94e | CP-213228 | 0349 | 1 | B | Add load level related information for NSI_LOAD_LEVEL event | 17.5.0 |
| 2021-12 | CT#94e | CP-213228 | 0350 | | B | Add load level related information for LOAD_LEVEL_INFORMATION event | 17.5.0 |
| 2021-12 | CT#94e | CP-213244 | 0352 | 1 | F | Corrections to EventReportingRequirement | 17.5.0 |
| 2021-12 | CT#94e | CP-213228 | 0353 | 1 | B | Add consumer NF information in Subscription | 17.5.0 |
| 2021-12 | CT#94e | CP-213228 | 0354 | | B | Updates geenrak description to analytics subscription transfer operation | 17.5.0 |
| 2021-12 | CT#94e | CP-213246 | 0355 | | F | Update of OpenAPI version and TS version in externalDocs field | 17.5.0 |
| 2022-03 | CT#95e | CP-220190 | 0357 | 1 | B | Resolve Editor's Note on Slice load level related network data analytics | 17.6.0 |
| 2022-03 | CT#95e | CP-220190 | 0358 | 1 | F | Clarification about conditional descriptions for Slice load level related network data analytics | 17.6.0 |
| 2022-03 | CT#95e | CP-220189 | 0359 | | F | Correction of DN performance analytics | 17.6.0 |
| 2022-03 | CT#95e | CP-220189 | 0360 | | F | Update the Nnwdaf_AnalyticsInfo Service API specific data types table | 17.6.0 |
| 2022-03 | CT#95e | CP-220189 | 0362 | | F | Editorial correction of offsetPeriod attribute for Nnwdaf_EventsSubscription API | 17.6.0 |
| 2022-03 | CT#95e | CP-220189 | 0365 | 1 | B | NF Load analytics extensions in Nnwdaf_EventsSubscription API | 17.6.0 |
| 2022-03 | CT#95e | CP-220189 | 0366 | 1 | B | NF Load analytics extensions in Nnwdaf_AnalyticsInfo API | 17.6.0 |
| 2022-03 | CT#95e | CP-220191 | 0367 | 3 | B | Support Dispersion Analytics in Nnwdaf_EventsSubscription API | 17.6.0 |
| 2022-03 | CT#95e | CP-220190 | 0368 | 2 | B | Support Dispersion Analytics in Nnwdaf_AnalyticsInfo API | 17.6.0 |
| 2022-03 | CT#95e | CP-220189 | 0369 | 1 | B | Support Redundant Transmission Experience Analytics in Nnwdaf_EventsSubscription API | 17.6.0 |
| 2022-03 | CT#95e | CP-220189 | 0370 | | B | Support Redundant Transmission Experience Analytics in Nnwdaf_AnalyticsInfo API | 17.6.0 |

| | | | | | | | |
|---------|--------|-----------|------|---|---|--|--------|
| 2022-03 | CT#95e | CP-220191 | 0371 | 2 | B | Support WLAN performance analytics in Nnwdaf_EventsSubscription API | 17.6.0 |
| 2022-03 | CT#95e | CP-220189 | 0372 | 1 | B | Support WLAN performance analytics in Nnwdaf_AnalyticsInfo API | 17.6.0 |
| 2022-03 | CT#95e | CP-220189 | 0373 | | F | Corrections to DN Performance Events | 17.6.0 |
| 2022-03 | CT#95e | CP-220189 | 0374 | 1 | B | Update extended features description and analytics events applicability | 17.6.0 |
| 2022-03 | CT#95e | CP-220189 | 0375 | 1 | F | Corrections to Nnwdaf_AnalyticsInfo Service | 17.6.0 |
| 2022-03 | CT#95e | CP-220190 | 0376 | 1 | F | Clarification on GPSI for UserDataCongestionExt | 17.6.0 |
| 2022-03 | CT#95e | CP-220190 | 0377 | 1 | F | Features in the applicability section | 17.6.0 |
| 2022-03 | CT#95e | CP-220190 | 0378 | 1 | F | Update of 5.1.6.1 | 17.6.0 |
| 2022-03 | CT#95e | CP-220190 | 0379 | 1 | F | Adding ADRF as a consumer of Nnwdaf_DataManagement Service | 17.6.0 |
| 2022-03 | CT#95e | CP-220176 | 0381 | 2 | A | Alignment of "Application Errors" clauses with SBI TS template | 17.6.0 |
| 2022-03 | CT#95e | CP-220189 | 0382 | | B | Adding DCCF as Nnwdaf_AnalyticsInfo service consumer | 17.6.0 |
| 2022-03 | CT#95e | CP-220190 | 0383 | 1 | B | Service Description of Nnwdaf_DataManagement Service | 17.6.0 |
| 2022-03 | CT#95e | CP-220189 | 0384 | | F | Clarification on NF consumer of Nnwdaf_MLModelProvision Service | 17.6.0 |
| 2022-03 | CT#95e | CP-220189 | 0385 | | F | Corrections to Nnwdaf_MLModelProvision Service | 17.6.0 |
| 2022-03 | CT#95e | CP-220189 | 0386 | 1 | B | Support reporting the analytics of the application list used by UE in the UE communication analytics | 17.6.0 |
| 2022-03 | CT#95e | CP-220190 | 0387 | 1 | B | Support reporting N4 session inactivity timer in the UE communication analytics | 17.6.0 |
| 2022-03 | CT#95e | CP-220189 | 0388 | 1 | B | Support list of analytics subsets for Nnwdaf_AnalyticsInfo Service | 17.6.0 |
| 2022-03 | CT#95e | CP-220189 | 0389 | | B | Resolve the Editor's Note for partial failure events handling in ML model subscription procedure | 17.6.0 |
| 2022-03 | CT#95e | CP-220191 | 0390 | 2 | B | Resolve the Editor's Note for ML model filter information | 17.6.0 |
| 2022-03 | CT#95e | CP-220190 | 0391 | 1 | B | Add visited AOI(s) to analytics filter for UE mobility analytics | 17.6.0 |
| 2022-03 | CT#95e | CP-220192 | 0392 | 2 | B | Add UPF ID to analytics filter for Service Experience analytics | 17.6.0 |
| 2022-03 | CT#95e | CP-220190 | 0393 | 1 | B | Add the periodic communication indicator to UeCommunication data type | 17.6.0 |
| 2022-03 | CT#95e | CP-220190 | 0394 | 1 | B | Add Service Experience Type to Service Experience analytics | 17.6.0 |
| 2022-03 | CT#95e | CP-220192 | 0395 | 3 | B | Add Application Server Address(es) to analytics filter for Service Experience analytics | 17.6.0 |
| 2022-03 | CT#95e | CP-220190 | 0400 | | B | Extension of UE Mobility Analytics to support LADN DNN | 17.6.0 |
| 2022-03 | CT#95e | CP-220191 | 0401 | 1 | F | References to apiSpecificResourceUriPart for Nnwdaf_DataManagement and Nnwdaf_MLModelProvision APIs | 17.6.0 |
| 2022-03 | CT#95e | CP-220191 | 0402 | 1 | D | Editorial modifications | 17.6.0 |
| 2022-03 | CT#95e | CP-220191 | 0403 | 1 | B | Add load level related information to analytics subset | 17.6.0 |
| 2022-03 | CT#95e | CP-220191 | 0404 | 1 | B | Add missing attribute to SM congestion control experience analytics | 17.6.0 |
| 2022-03 | CT#95e | CP-220191 | 0405 | 1 | F | Correction on freqs attribute for Nnwdaf_EventsSubscription API | 17.6.0 |
| 2022-03 | CT#95e | CP-220191 | 0406 | 1 | B | Add missing attributes to DN Performance analytics | 17.6.0 |
| 2022-03 | CT#95e | CP-220191 | 0407 | 1 | B | Add service description and operations to DN Performance analytics | 17.6.0 |
| 2022-03 | CT#95e | CP-220173 | 0409 | 1 | A | Correction of the description of end time | 17.6.0 |
| 2022-03 | CT#95e | CP-220192 | 0410 | 1 | F | Incorrect response code of PUT method for Event Subscription Transfer | 17.6.0 |
| 2022-03 | CT#95e | CP-220196 | 0411 | | F | Correction to descriptions in OpenAPI file | 17.6.0 |
| 2022-03 | CT#95e | CP-220191 | 0412 | 1 | B | Service Operation of Nnwdaf_DataManagement_Subscribe Service | 17.6.0 |
| 2022-03 | CT#95e | CP-220191 | 0413 | 1 | B | Service Operation of Nnwdaf_DataManagement_Unsubscribe Service | 17.6.0 |
| 2022-03 | CT#95e | CP-220191 | 0414 | 1 | B | Nnwdaf_DataManagement Service Resources | 17.6.0 |
| 2022-03 | CT#95e | CP-220191 | 0415 | 1 | B | Nnwdaf_DataManagement Service Data Model | 17.6.0 |
| 2022-03 | CT#95e | CP-220192 | 0417 | 1 | B | Add accuracy per analytics subset for the specific events | 17.6.0 |
| 2022-03 | CT#95e | CP-220192 | 0418 | 1 | B | Add list of analytics subsets to the Nnwdaf_AnalyticsInfo_Request procedure | 17.6.0 |
| 2022-03 | CT#95e | CP-220191 | 0419 | | B | Add list of analytics subsets to the subscription procedure | 17.6.0 |
| 2022-03 | CT#95e | CP-220192 | 0420 | 1 | B | Add requirement for DN performance analytics | 17.6.0 |
| 2022-03 | CT#95e | CP-220192 | 0421 | 1 | B | Add the missing data structure to the specific Data Types table | 17.6.0 |
| 2022-03 | CT#95e | CP-220191 | 0422 | | B | Solve the Editor's Note for ML model filter information | 17.6.0 |
| 2022-03 | CT#95e | CP-220194 | 0423 | | F | Update of info and externalDocs fields | 17.6.0 |
| 2022-06 | CT#96 | CP-221130 | 0426 | 1 | B | Correction of DN Performance Analytics | 17.7.0 |
| 2022-06 | CT#96 | CP-221130 | 0427 | 1 | B | Update Observed Service Experience Analytics | 17.7.0 |
| 2022-06 | CT#96 | CP-221131 | 0429 | 1 | F | Resolving ENs about references in the Transfer procedures | 17.7.0 |
| 2022-06 | CT#96 | CP-221131 | 0430 | 1 | B | Resolving ENs about subscriptions with data sources in ContextTransfer | 17.7.0 |
| 2022-06 | CT#96 | CP-221132 | 0431 | 1 | F | Resolving EN about the definition of previous subscription | 17.7.0 |
| 2022-06 | CT#96 | CP-221129 | 0432 | | F | Removing inapplicable feature ES3XX in Transfer operation | 17.7.0 |
| 2022-06 | CT#96 | CP-221129 | 0433 | | F | Removing inapplicable feature ES3XX in ML provisioning | 17.7.0 |
| 2022-06 | CT#96 | CP-221129 | 0434 | | F | Resolving EN about partitioning criteria | 17.7.0 |
| 2022-06 | CT#96 | CP-221129 | 0435 | | B | Resolving ENs about how to implement NF ID in NF consumer information | 17.7.0 |

| | | | | | | | |
|---------|-------|-----------|------|---|---|---|--------|
| 2022-06 | CT#96 | CP-221129 | 0436 | | F | Resolving EN about CANCEL type in Transfer request | 17.7.0 |
| 2022-06 | CT#96 | CP-221129 | 0437 | | F | Resolving EN about redirection codes in Context Transfer | 17.7.0 |
| 2022-06 | CT#96 | CP-221132 | 0438 | 1 | B | Fixing the data type for historial data | 17.7.0 |
| 2022-06 | CT#96 | CP-221131 | 0439 | 1 | B | Add clarifications for analytics subsets of some attributes | 17.7.0 |
| 2022-06 | CT#96 | CP-221132 | 0440 | 1 | B | Clarification for the presence of some attributes in the request | 17.7.0 |
| 2022-06 | CT#96 | CP-221131 | 0441 | 1 | F | Correct the Cardinality of some attributes | 17.7.0 |
| 2022-06 | CT#96 | CP-221129 | 0442 | | B | Define Error Handling and Security for Nnwdaf_DataManagement Service | 17.7.0 |
| 2022-06 | CT#96 | CP-221134 | 0443 | 2 | B | Update the Service Experience Analytics for Nnwdaf_EventsSubscription service | 17.7.0 |
| 2022-06 | CT#96 | CP-221131 | 0444 | 1 | F | Update the Nnwdaf_MLModelProvision OpenAPI and related data types | 17.7.0 |
| 2022-06 | CT#96 | CP-221131 | 0445 | 1 | F | Correction to topAppListUI and topAppListDI attributes | 17.7.0 |
| 2022-06 | CT#96 | CP-221129 | 0446 | | F | replace NnwdafEventsSubscription with NnwdafEventsSubscription | 17.7.0 |
| 2022-06 | CT#96 | CP-221129 | 0447 | | F | Incorrect definition of smcceUeList in openAPI file | 17.7.0 |
| 2022-06 | CT#96 | CP-221154 | 0453 | | F | Nnwdaf_EventsSubscription API: n4SessId and lowBase properties | 17.7.0 |
| 2022-06 | CT#96 | CP-221154 | 0454 | 1 | F | Nnwdaf_EventsSubscription API: removal of sibling elements | 17.7.0 |
| 2022-06 | CT#96 | CP-221154 | 0455 | | F | Nnwdaf_AnalyticsInfo API: removal of sibling elements | 17.7.0 |
| 2022-06 | CT#96 | CP-221130 | 0456 | 1 | B | Updates on Dispersion Analytics | 17.7.0 |
| 2022-06 | CT#96 | CP-221136 | 0457 | 3 | B | Update RAT types and Frequencies in Service Experience Analytics in Nnwdaf_EventsSubscription API | 17.7.0 |
| 2022-06 | CT#96 | CP-221131 | 0458 | 1 | B | Update RAT types and Frequencies in Service Experience Analytics in Nnwdaf_AnalyticsInfo API | 17.7.0 |
| 2022-06 | CT#96 | CP-221131 | 0459 | 1 | B | Updates UE location in Service Experience Analytics | 17.7.0 |
| 2022-06 | CT#96 | CP-221136 | 0460 | 2 | B | Resolve editor's note for Analytics Subscription Transfer | 17.7.0 |
| 2022-06 | CT#96 | CP-221130 | 0464 | 1 | B | Updates to SMCCE | 17.7.0 |
| 2022-06 | CT#96 | CP-221131 | 0465 | 1 | B | Updates to Service Experience Type | 17.7.0 |
| 2022-06 | CT#96 | CP-221130 | 0468 | | B | Supplement the missing events and remove the ENs for ML model subscription | 17.7.0 |
| 2022-06 | CT#96 | CP-221131 | 0469 | 1 | B | Remove the Editor's Note for Nnwdaf_MLModelInfo service | 17.7.0 |
| 2022-06 | CT#96 | CP-221133 | 0470 | 2 | B | Define SMCCE event for Nnwdaf_EventsSubscription service | 17.7.0 |
| 2022-06 | CT#96 | CP-221136 | 0471 | 3 | B | Define Nnwdaf_DataManagement API | 17.7.0 |
| 2022-06 | CT#96 | CP-221154 | 0472 | 1 | F | Formatting of description fields of Nnwdaf_MLModelProvision API | 17.7.0 |
| 2022-06 | CT#96 | CP-221131 | 0473 | 1 | F | Correction to MLEventNotif data type | 17.7.0 |
| 2022-06 | CT#96 | CP-221134 | 0474 | 1 | B | Adding NF load over AOI to analytics subset | 17.7.0 |
| 2022-06 | CT#96 | CP-221128 | 0476 | | A | Removing UDM from the list of service consumers for Analytics Subscription | 17.7.0 |
| 2022-06 | CT#96 | CP-221128 | 0478 | | A | Removing UDM from the list of service consumers for Analytics Information | 17.7.0 |
| 2022-06 | CT#96 | CP-221133 | 0479 | | F | Feature handling corrections in EventsSubscription | 17.7.0 |
| 2022-06 | CT#96 | CP-221136 | 0480 | 1 | F | Feature for Analytics Subsets in EventsSubscription | 17.7.0 |
| 2022-06 | CT#96 | CP-221136 | 0481 | 1 | F | Feature for ContextTransfer in EventsSubscription | 17.7.0 |
| 2022-06 | CT#96 | CP-221136 | 0483 | 1 | B | Separate feature for Slice Load Level analytics extensions in EventsSubscription | 17.7.0 |
| 2022-06 | CT#96 | CP-221133 | 0484 | | F | Removing EneNA dependency from the Aggregation feature in AnalyticsInfo | 17.7.0 |
| 2022-06 | CT#96 | CP-221136 | 0485 | 1 | F | Feature for Analytics Subsets in AnalyticsInfo | 17.7.0 |
| 2022-06 | CT#96 | CP-221136 | 0486 | 1 | F | Correcting the usage of features in AnalyticsInfo | 17.7.0 |
| 2022-06 | CT#96 | CP-221136 | 0487 | 1 | F | Correcting the definition and usage of features in MLModelProvision | 17.7.0 |
| 2022-06 | CT#96 | CP-221136 | 0488 | 1 | B | Corrections for the ML model related information in Transfer and ContextTransfer | 17.7.0 |
| 2022-06 | CT#96 | CP-221133 | 0491 | | B | Muting notifications | 17.7.0 |
| 2022-06 | CT#96 | CP-221135 | 0492 | 1 | B | Service Operation of Nnwdaf_DataManagement_Notify | 17.7.0 |
| 2022-06 | CT#96 | CP-221136 | 0493 | 1 | B | Nnwdaf_DataManagement Data Model | 17.7.0 |
| 2022-06 | CT#96 | CP-221135 | 0494 | 1 | B | Service Operation of Nnwdaf_DataManagement_Fetch | 17.7.0 |
| 2022-06 | CT#96 | CP-221135 | 0495 | 1 | B | Nnwdaf_DataManagement Service Notifications | 17.7.0 |
| 2022-06 | CT#96 | CP-221135 | 0496 | 1 | F | Removal of repetition in HTTP error response | 17.7.0 |
| 2022-06 | CT#96 | CP-221136 | 0498 | 1 | F | Analytics subscription data model sync for events | 17.7.0 |
| 2022-06 | CT#96 | CP-221155 | 0499 | 1 | F | Nnwdaf_EventsSubscription API: formatting of description fields | 17.7.0 |
| 2022-06 | CT#96 | CP-221154 | 0500 | | F | Nnwdaf_AnalyticsInfo: formatting of description fields | 17.7.0 |
| 2022-06 | CT#96 | CP-221135 | 0501 | 1 | B | Add Notification Correlation ID to Nnwdaf_EventsSubscription service | 17.7.0 |
| 2022-06 | CT#96 | CP-221135 | 0503 | 1 | F | Add the missing required fields in the OpenAPI for SMCCE | 17.7.0 |
| 2022-06 | CT#96 | CP-221133 | 0504 | | F | Add the missing status codes for Nnwdaf_EventsSubscription and Nnwdaf_MLModelProvision service | 17.7.0 |
| 2022-06 | CT#96 | CP-221133 | 0505 | | F | Corrections on ML model data structure and Nnwdaf_MLModelProvision API | 17.7.0 |
| 2022-06 | CT#96 | CP-221133 | 0506 | | F | Corrections on the data type of the revised waiting time | 17.7.0 |
| 2022-06 | CT#96 | CP-221135 | 0507 | 1 | F | Presence condition on consumer NF information data types | 17.7.0 |
| 2022-06 | CT#96 | CP-221238 | 0509 | 2 | A | Presence condition on data types of UE related analytics | 17.7.0 |

| | | | | | | | |
|---------|--------|-----------|------|---|---|--|--------|
| 2022-06 | CT#96 | CP-221237 | 0510 | 3 | F | Presence condition on Dispersion data types | 17.7.0 |
| 2022-06 | CT#96 | CP-221128 | 0512 | 1 | A | Presence condition on Network Performance and Flow Description data types | 17.7.0 |
| 2022-06 | CT#96 | CP-221239 | 0514 | 2 | A | Presence condition on NF load data types | 17.7.0 |
| 2022-06 | CT#96 | CP-221240 | 0516 | 2 | A | Presence condition on QoS Sustainability data types | 17.7.0 |
| 2022-06 | CT#96 | CP-221135 | 0517 | 1 | F | Presence condition on SpecificAnalyticsSubscription data type | 17.7.0 |
| 2022-06 | CT#96 | CP-221135 | 0518 | 1 | B | Solve the ENs for exposing the network topology to the untrusted AF | 17.7.0 |
| 2022-06 | CT#96 | CP-221135 | 0519 | 1 | B | Update the analytics subscription transfer procedure | 17.7.0 |
| 2022-06 | CT#96 | CP-221135 | 0520 | 1 | B | Update the ML model related information | 17.7.0 |
| 2022-06 | CT#96 | CP-221134 | 0521 | | F | Update the OpenAPI of DN performance and User data congestion | 17.7.0 |
| 2022-06 | CT#96 | CP-221134 | 0522 | | B | Update the UPF information for Service Experience and DN performance | 17.7.0 |
| 2022-06 | CT#96 | CP-221255 | 0523 | 1 | F | Corrections related to confidence | 17.7.0 |
| 2022-06 | CT#96 | CP-221135 | 0524 | 1 | F | Remove inapplicable event for EXCEED_LOAD_LEVEL_THR_IND | 17.7.0 |
| 2022-06 | CT#96 | CP-221135 | 0525 | 1 | F | Correct common attributes in analytics result for subscription and analytics request | 17.7.0 |
| 2022-06 | CT#96 | CP-221135 | 0526 | 1 | B | Support of Time Window in Nnwdaf_DataManagement_Subscribe service operation | 17.7.0 |
| 2022-06 | CT#96 | CP-221128 | 0528 | 1 | A | Correction to Threshold value in QoS SustainabilityInfo | 17.7.0 |
| 2022-06 | CT#96 | CP-221128 | 0530 | | A | Correction to time period in CongestionInfo | 17.7.0 |
| 2022-06 | CT#96 | CP-221119 | 0536 | 1 | A | Correction to the re-used data types for the re-using Nnwdaf_AnalyticsInfo API | 17.7.0 |
| 2022-06 | CT#96 | CP-221155 | 0537 | 1 | F | Update the apiVersion placeholder 29.520 Rel-17 | 17.7.0 |
| 2022-06 | CT#96 | CP-221151 | 0538 | | F | Update of info and externalDocs fields | 17.7.0 |
| 2022-09 | CT#97e | CP-222103 | 0463 | 4 | F | Updates on analytics target period | 17.8.0 |
| 2022-09 | CT#97e | CP-222103 | 0541 | 1 | F | ML Model Application Error code addition | 17.8.0 |
| 2022-09 | CT#97e | CP-222103 | 0542 | 2 | F | Correction of UPF information for Service Experience and DN performance | 17.8.0 |
| 2022-09 | CT#97e | CP-222102 | 0543 | 1 | B | Update Dispersion Analytics for missing conditional descriptions | 17.8.0 |
| 2022-09 | CT#97e | CP-222101 | 0544 | | F | Update re-used data type for Nnwdaf_AnalyticsInfo Service API | 17.8.0 |
| 2022-09 | CT#97e | CP-222101 | 0545 | | F | Update re-used data types for Nnwdaf_EventsSubscription Service API | 17.8.0 |
| 2022-09 | CT#97e | CP-222104 | 0546 | 1 | F | Update inputs of Nnwdaf_DataManagement service | 17.8.0 |
| 2022-09 | CT#97e | CP-222102 | 0547 | 1 | F | Removal of repetition in HTTP error response | 17.8.0 |
| 2022-09 | CT#97e | CP-222101 | 0548 | | F | Remove EN about further information in previous subscription information | 17.8.0 |
| 2022-09 | CT#97e | CP-222101 | 0549 | | F | Specifying the applicability of event subscription attributes to NSI load analytics | 17.8.0 |
| 2022-09 | CT#97e | CP-222101 | 0551 | | F | Corrections in the NumberAverage data type | 17.8.0 |
| 2022-09 | CT#97e | CP-222104 | 0552 | 1 | F | Aligning the NWDAF hosting DCCF with the DCCF - service descriptions | 17.8.0 |
| 2022-09 | CT#97e | CP-222104 | 0553 | 1 | F | Aligning the NWDAF hosting DCCF with the DCCF - resources and errors | 17.8.0 |
| 2022-09 | CT#97e | CP-222104 | 0555 | 1 | F | Aligning the NWDAF hosting DCCF with the DCCF - OpenAPI | 17.8.0 |
| 2022-09 | CT#97e | CP-222101 | 0556 | | F | Nnwdaf_EventsSubscription API: required n4SessId property | 17.8.0 |
| 2022-09 | CT#97e | CP-222101 | 0557 | | F | Correction of the name of appServerAddr attribute | 17.8.0 |
| 2022-09 | CT#97e | CP-222101 | 0558 | | F | Incorrect data type name | 17.8.0 |
| 2022-09 | CT#97e | CP-222101 | 0559 | | F | missing presence condition for some conditional attributes | 17.8.0 |
| 2022-09 | CT#97e | CP-222101 | 0560 | | F | Clarification for SM_CONGESTION | 17.8.0 |
| 2022-09 | CT#97e | CP-222103 | 0561 | 1 | F | Clarification on notificationURI transferred by source NWDAF | 17.8.0 |
| 2022-09 | CT#97e | CP-222101 | 0562 | | F | Incorrect attribute name in AnalyticsContextIdentifier data type | 17.8.0 |
| 2022-09 | CT#97e | CP-222101 | 0563 | | F | Corrections in the error handling of NWDAF Analytics | 17.8.0 |
| 2022-09 | CT#97e | CP-222103 | 0564 | 1 | F | Update of Scope and Overview and Service Architecture | 17.8.0 |
| 2022-09 | CT#97e | CP-222103 | 0565 | 1 | F | Applicability corrections | 17.8.0 |
| 2022-09 | CT#97e | CP-222102 | 0567 | 1 | F | Correct the errors of the cardinality and data type in the data structures | 17.8.0 |
| 2022-09 | CT#97e | CP-222102 | 0568 | 1 | F | Remove the Editor's Note for analytics subset | 17.8.0 |
| 2022-09 | CT#97e | CP-222102 | 0569 | 1 | F | Remove the Editor's Note for ML model | 17.8.0 |
| 2022-09 | CT#97e | CP-222104 | 0571 | 1 | F | Update Nnwdaf_DataManagement_Fetch service operation | 17.8.0 |
| 2022-09 | CT#97e | CP-222103 | 0572 | 1 | F | Update Resource usage threshold crossings time period for NSI load | 17.8.0 |
| 2022-09 | CT#97e | CP-222210 | 0573 | 1 | F | Update the redundant transmission analytics | 17.8.0 |
| 2022-09 | CT#97e | CP-222101 | 0574 | | F | Updates to any UE for Dispersion | 17.8.0 |
| 2022-09 | CT#97e | CP-222102 | 0575 | 1 | F | Corrections to EventSubscription | 17.8.0 |
| 2022-09 | CT#97e | CP-222102 | 0577 | | F | Corrections on percentage value range | 17.8.0 |
| 2022-09 | CT#97e | CP-222102 | 0578 | | F | Correction to ConsumerNfInformation | 17.8.0 |
| 2022-09 | CT#97e | CP-222102 | 0579 | | F | Corrections to EventFilter | 17.8.0 |
| 2022-09 | CT#97e | CP-222102 | 0580 | 1 | F | Miscellaneous corrections on NWDAF services | 17.8.0 |
| 2022-09 | CT#97e | CP-222121 | 0581 | | F | Update of info and externalDocs fields | 17.8.0 |
| 2022-12 | CT#98e | CP-223173 | 0582 | 1 | F | Missing data reports for processed data notifications | 17.9.0 |

| | | | | | | | |
|---------|--------|-----------|------|---|---|--|--------|
| 2022-12 | CT#98e | CP-223172 | 0583 | | F | Correcting the role of analytics subscription information for data collection | 17.9.0 |
| 2022-12 | CT#98e | CP-223173 | 0584 | 1 | F | User consent corrections for NWDAF data management | 17.9.0 |
| 2022-12 | CT#98e | CP-223173 | 0587 | 1 | F | Analytics output restrictions | 17.9.0 |
| 2022-12 | CT#98e | CP-223172 | 0591 | 1 | F | Corrections for time stamp in NWDAF | 17.9.0 |
| 2022-12 | CT#98e | CP-223172 | 0594 | | F | Corrections for Nnwdaf_AnalyticsInfo_Request procedure | 17.9.0 |
| 2022-12 | CT#98e | CP-223172 | 0595 | | F | Corrections related to analytics subscription transfer | 17.9.0 |
| 2022-12 | CT#98e | CP-223173 | 0596 | 1 | F | Corrections to NnwdafDataManagementNotif | 17.9.0 |
| 2022-12 | CT#98e | CP-223172 | 0597 | | F | Correction to visitedAreas attribute | 17.9.0 |
| 2022-12 | CT#98e | CP-223172 | 0598 | | F | Incorrect attribute name referenced in DnPerformanceReq data type | 17.9.0 |
| 2022-12 | CT#98e | CP-223172 | 0599 | | F | Incorrect attribute name referenced in NnwdafMLModelProvSubsc data type | 17.9.0 |
| 2022-12 | CT#98e | CP-223172 | 0600 | | F | Aligning the notifications of Nnwdaf_DataManagement API with service description | 17.9.0 |
| 2022-12 | CT#98e | CP-223172 | 0602 | | F | features in Nnwdaf_MLModelProvision Service API | 17.9.0 |
| 2022-12 | CT#98e | CP-223173 | 0603 | 2 | F | Correction of data type of terminationReq | 17.9.0 |
| 2022-12 | CT#98e | CP-223224 | 0604 | 1 | F | adding resourceUri for analytics subscription transfer notification | 17.9.0 |
| 2022-12 | CT#98e | CP-223173 | 0608 | 2 | F | Correction to Event Notification in Nnwdaf_MLModelProvision API | 17.9.0 |
| 2022-12 | CT#98e | CP-223173 | 0610 | 1 | F | Corrections to NF Service Consumers | 17.9.0 |
| 2022-12 | CT#98e | CP-223174 | 0613 | 1 | F | Corrections to Slice Load level Analytics | 17.9.0 |
| 2022-12 | CT#98e | CP-223173 | 0616 | 1 | F | Corrections for DispersionCollection data type and MLEventSubscription data type | 17.9.0 |
| 2022-12 | CT#98e | CP-223173 | 0619 | 1 | F | Miscellaneous corrections | 17.9.0 |
| 2022-12 | CT#98e | CP-223188 | 0621 | | F | Update of info and externalDocs fields | 17.9.0 |
| 2022-12 | CT#98e | CP-223176 | 0585 | 1 | B | User consent enhancements for NWDAF analytics subscriptions | 18.0.0 |
| 2022-12 | CT#98e | CP-223176 | 0586 | 1 | B | User consent enhancements for NWDAF analytics info | 18.0.0 |
| 2022-12 | CT#98e | CP-223176 | 0588 | 1 | B | Analytics subscription termination request | 18.0.0 |
| 2022-12 | CT#98e | CP-223191 | 0590 | | F | Adding the mandatory error code 502 Bad Gateway | 18.0.0 |
| 2022-12 | CT#98e | CP-223176 | 0605 | 1 | B | Correction of data type of proclnstruct | 18.0.0 |
| 2022-12 | CT#98e | CP-223176 | 0606 | 1 | F | Corrections in ServiceExperienceInfo data type | 18.0.0 |
| 2022-12 | CT#98e | CP-223176 | 0611 | 1 | F | Corrections to service operation procedures in Nnwdaf_EventsSubscription API | 18.0.0 |
| 2022-12 | CT#98e | CP-223176 | 0612 | 1 | F | Corrections to service operation procedures in Nnwdaf_AnalyticsInfo API | 18.0.0 |
| 2022-12 | CT#98e | CP-223176 | 0618 | 1 | F | Correct the presence and add the missing feature of some attributes | 18.0.0 |
| 2022-12 | CT#98e | CP-223176 | 0620 | | B | User consent enhancements for NWDAF data management | 18.0.0 |
| 2022-12 | CT#98e | CP-223189 | 0622 | | F | Update of info and externalDocs fields | 18.0.0 |
| 2023-03 | CT#99 | CP-230291 | 0624 | 2 | B | PFD Determination Analytics for Nnwdaf_AnalyticsInfo API | 18.1.0 |
| 2023-03 | CT#99 | CP-230148 | 0625 | | F | Update abbreviations clause and table of NWDAF services | 18.1.0 |
| 2023-03 | CT#99 | CP-230167 | 0632 | 1 | B | OAuth2 scopes in Nnwdaf_AnalyticsInfo API | 18.1.0 |
| 2023-03 | CT#99 | CP-230167 | 0633 | 1 | B | OAuth2 scopes in Nnwdaf_EventsSubscription API | 18.1.0 |
| 2023-03 | CT#99 | CP-230149 | 0635 | 1 | F | Corrections on offsetPeriod | 18.1.0 |
| 2023-03 | CT#99 | CP-230149 | 0637 | 1 | F | Corrections on list of analytics subsets in Network Performance Analytics | 18.1.0 |
| 2023-03 | CT#99 | CP-230149 | 0638 | 1 | B | Updates on analytics target period subset in Network Performance Analytics | 18.1.0 |
| 2023-03 | CT#99 | CP-230166 | 0639 | 1 | F | Correction of the description fields in enumerations | 18.1.0 |
| 2023-03 | CT#99 | CP-230145 | 0641 | | A | Correction to DnPerformanceReq for Nnwdaf_AnalyticsInfo API | 18.1.0 |
| 2023-03 | CT#99 | CP-230145 | 0643 | 1 | A | Corrections related to ServiceExperienceExt | 18.1.0 |
| 2023-03 | CT#99 | CP-230145 | 0645 | | A | misplaced description and useless NOTE | 18.1.0 |
| 2023-03 | CT#99 | CP-230145 | 0647 | 2 | A | definition of the value for boolean data type | 18.1.0 |
| 2023-03 | CT#99 | CP-230148 | 0648 | 1 | F | Handling of fetch Instruction | 18.1.0 |
| 2023-03 | CT#99 | CP-230148 | 0649 | | B | Partial failure during analytics subscription transfer | 18.1.0 |
| 2023-03 | CT#99 | CP-230148 | 0650 | | F | Update of 5.1.6.1 and 5.2.6.1 | 18.1.0 |
| 2023-03 | CT#99 | CP-230167 | 0651 | 1 | F | Fix the description formatting issue | 18.1.0 |
| 2023-03 | CT#99 | CP-230129 | 0655 | 1 | A | Invalid JSON value | 18.1.0 |
| 2023-03 | CT#99 | CP-230145 | 0657 | 1 | A | Corrections for historical analytics exposure procedures | 18.1.0 |
| 2023-03 | CT#99 | CP-230147 | 0659 | 1 | B | QoS sustainability analytics with fine granularity | 18.1.0 |
| 2023-03 | CT#99 | CP-230148 | 0660 | 1 | F | Clarification for Analytics Specification in Nnwdaf_DataManagement Service | 18.1.0 |
| 2023-03 | CT#99 | CP-230148 | 0661 | 1 | F | Corrections for descriptions of boolean data types | 18.1.0 |
| 2023-03 | CT#99 | CP-230149 | 0662 | 1 | B | Enhancement of network performance for AnalyticsInfo Service | 18.1.0 |
| 2023-03 | CT#99 | CP-230148 | 0663 | 1 | F | Corrections for MLModelProvision | 18.1.0 |
| 2023-03 | CT#99 | CP-230149 | 0664 | 1 | B | Enhancement of UE communication for AnalyticsInfo Service | 18.1.0 |
| 2023-03 | CT#99 | CP-230149 | 0665 | 1 | B | Enhancement of UE mobility for AnalyticsInfo Service | 18.1.0 |
| 2023-03 | CT#99 | CP-230149 | 0666 | 1 | B | Enhancement of user data congestion for AnalyticsInfo Service | 18.1.0 |
| 2023-03 | CT#99 | CP-230148 | 0667 | | B | Support of multiple notification endpoints | 18.1.0 |
| 2023-03 | CT#99 | CP-230148 | 0668 | | B | Support of ordering criterion for network performance | 18.1.0 |
| 2023-03 | CT#99 | CP-230148 | 0669 | | B | Support of ordering criterion for UE communication | 18.1.0 |
| 2023-03 | CT#99 | CP-230149 | 0670 | 1 | B | Support of ordering criterion for UE mobility | 18.1.0 |

| | | | | | | | |
|---------|--------|-----------|------|---|---|--|--------|
| 2023-03 | CT#99 | CP-230149 | 0671 | 1 | B | Support of ordering criterion for user data congestion | 18.1.0 |
| 2023-03 | CT#99 | CP-230148 | 0672 | | B | Support of the acceptable deviation from the threshold for QoS Sustainability | 18.1.0 |
| 2023-03 | CT#99 | CP-230148 | 0673 | | B | Support of the amount information in the notification for Abnormal behaviour | 18.1.0 |
| 2023-03 | CT#99 | CP-230149 | 0674 | 1 | B | Update the enumeration value of preferred level of accuracy | 18.1.0 |
| 2023-03 | CT#99 | CP-230161 | 0687 | | F | Update of info and externalDocs fields | 18.1.0 |
| 2023-06 | CT#100 | CP-231127 | 0626 | 3 | B | Updates for DN performance of Group UEs in Nnwdaf_EventsSubscription API | 18.2.0 |
| 2023-06 | CT#100 | CP-231127 | 0627 | 2 | B | Updates for DN performance of Group UEs in Nnwdaf_AnalyticsInfo API | 18.2.0 |
| 2023-06 | CT#100 | CP-231127 | 0628 | 2 | B | Updates to UE Mobility support FL in Nnwdaf_EventsSubscription API | 18.2.0 |
| 2023-06 | CT#100 | CP-231127 | 0629 | 2 | B | Update for UE Mobility support FL in Nnwdaf_AnalyticsInfo API | 18.2.0 |
| 2023-06 | CT#100 | CP-231124 | 0675 | 2 | B | Support NWDAF assisted URSPs in Service Experience in Nnwdaf_EventsSubscription API | 18.2.0 |
| 2023-06 | CT#100 | CP-231124 | 0676 | 2 | B | Support NWDAF assisted URSPs in Service Experience in Nnwdaf_AnalyticsInfo API | 18.2.0 |
| 2023-06 | CT#100 | CP-231124 | 0677 | 1 | B | Support use case context in Nnwdaf_EventsSubscription API | 18.2.0 |
| 2023-06 | CT#100 | CP-231126 | 0678 | 2 | B | Support use case context in Nnwdaf_AnalyticsInfo API | 18.2.0 |
| 2023-06 | CT#100 | CP-231126 | 0679 | 2 | B | Support use case context in Nnwdaf_MLModelProvision API | 18.2.0 |
| 2023-06 | CT#100 | CP-231124 | 0680 | 3 | B | Support PFD Determination Analytics in Nnwdaf_EventsSubscription API | 18.2.0 |
| 2023-06 | CT#100 | CP-231124 | 0682 | 2 | B | Update to Nnwdaf_MLModelProvision Service API for Federated Learning | 18.2.0 |
| 2023-06 | CT#100 | CP-231125 | 0683 | 4 | B | Update to Nnwdaf_MLModelProvision Service API for Model Sharing | 18.2.0 |
| 2023-06 | CT#100 | CP-231125 | 0688 | 1 | B | Event muting enhancements for Analytics Subscriptions | 18.2.0 |
| 2023-06 | CT#100 | CP-231125 | 0689 | 1 | B | Event muting enhancements for ML Model Provisioning | 18.2.0 |
| 2023-06 | CT#100 | CP-231137 | 0690 | 1 | B | Implementing immediate reports for NWDAF Data Management subscriptions | 18.2.0 |
| 2023-06 | CT#100 | CP-231137 | 0691 | 3 | F | Adding missing presence conditions | 18.2.0 |
| 2023-06 | CT#100 | CP-231124 | 0692 | | B | Update PFD Determination Analytics for Nnwdaf_AnalyticsInfo API | 18.2.0 |
| 2023-06 | CT#100 | CP-231314 | 0693 | 4 | B | PDU Session traffic analytics for Nnwdaf_EventsSubscription API | 18.2.0 |
| 2023-06 | CT#100 | CP-231145 | 0694 | 2 | B | PDU Session traffic analytics for Nnwdaf_AnalyticsInfo Service API | 18.2.0 |
| 2023-06 | CT#100 | CP-231338 | 0695 | 4 | B | Support Nnwdaf_MLModelTraining Service | 18.2.0 |
| 2023-06 | CT#100 | CP-231127 | 0696 | 1 | B | End-to-end data volume transfer time analytics for Nnwdaf_EventsSubscription Service | 18.2.0 |
| 2023-06 | CT#100 | CP-231127 | 0697 | 1 | B | End-to-end data volume transfer time analytics for Nnwdaf_AnalyticsInfo Service | 18.2.0 |
| 2023-06 | CT#100 | CP-231316 | 0698 | 2 | B | End-to-end data volume transfer time analytics for Nnwdaf_MLModelProvision Service | 18.2.0 |
| 2023-06 | CT#100 | CP-231125 | 0699 | 3 | B | Update to support extended parameters for ML model provisioning | 18.2.0 |
| 2023-06 | CT#100 | CP-231137 | 0700 | 1 | F | Addition of network analytics for the SMF | 18.2.0 |
| 2023-06 | CT#100 | CP-231137 | 0701 | 1 | F | Addition of network analytics for the PCF | 18.2.0 |
| 2023-06 | CT#100 | CP-231131 | 0702 | | F | Correction of the DnPerfOrderingCriterion enumeration | 18.2.0 |
| 2023-06 | CT#100 | CP-231137 | 0703 | 1 | B | Support of preferred granularity of location for EventsSubscription service | 18.2.0 |
| 2023-06 | CT#100 | CP-231137 | 0704 | 1 | B | Support of preferred granularity of location for AnalyticsInfo service | 18.2.0 |
| 2023-06 | CT#100 | CP-231124 | 0707 | 1 | B | Enhancements on UE Mobility analytics | 18.2.0 |
| 2023-06 | CT#100 | CP-231127 | 0708 | 1 | B | Enhancements to WLAN performance analytics for Nnwdaf_EventsSubscription API | 18.2.0 |
| 2023-06 | CT#100 | CP-231127 | 0709 | 1 | B | Enhancements to WLAN performance analytics for Nnwdaf_AnalyticsInfo API | 18.2.0 |
| 2023-06 | CT#100 | CP-231127 | 0710 | 1 | B | Enhancements to Network performance in Nnwdaf_EventsSubscription API | 18.2.0 |
| 2023-06 | CT#100 | CP-231127 | 0711 | 1 | B | Enhancements to Network performance in Nnwdaf_AnalyticsInfo API | 18.2.0 |
| 2023-06 | CT#100 | CP-231126 | 0712 | 1 | B | Adding Storage Handling Information in NWDAF Data Management subscriptions | 18.2.0 |
| 2023-06 | CT#100 | CP-231126 | 0713 | 1 | B | Sending NWDAF Deletion Alerts | 18.2.0 |
| 2023-06 | CT#100 | CP-231126 | 0714 | 1 | B | Event muting enhancements for NWDAF Data Management subscriptions | 18.2.0 |
| 2023-06 | CT#100 | CP-231157 | 0715 | 1 | B | Usage of the upfInfo attribute | 18.2.0 |
| 2023-06 | CT#100 | CP-231157 | 0716 | 1 | B | Adding support of UPF events by the NWDAF | 18.2.0 |
| 2023-06 | CT#100 | CP-231125 | 0717 | 1 | B | Support of analytics subset and accuracy per analytics subset for UE mobility for Nnwdaf_AnalyticsInfo API | 18.2.0 |
| 2023-06 | CT#100 | CP-231303 | 0718 | 2 | B | End-to-end data volume transfer time analytics for Nnwdaf_EventsSubscription Service API | 18.2.0 |
| 2023-06 | CT#100 | CP-231128 | 0719 | 1 | B | End-to-end data volume transfer time analytics for Nnwdaf_AnalyticsInfo Service API | 18.2.0 |
| 2023-06 | CT#100 | CP-231125 | 0720 | 1 | B | Update to Nnwdaf_MLModelProvision API for Supporting ML Model Retrieval with ADRF | 18.2.0 |

| | | | | | | | |
|---------|--------|-----------|------|---|---|---|--------|
| 2023-06 | CT#100 | CP-231159 | 0722 | 1 | A | Corrections on the validity period in the analytics | 18.2.0 |
| 2023-06 | CT#100 | CP-231125 | 0723 | 1 | B | Enhancement of DN Performance Analytics | 18.2.0 |
| 2023-06 | CT#100 | CP-231126 | 0724 | 1 | B | Support of analytics accuracy information for Nnwdaf_AnalyticsInfo API | 18.2.0 |
| 2023-06 | CT#100 | CP-231126 | 0725 | 1 | B | Support of analytics accuracy information for Nnwdaf_EventsSubscription API | 18.2.0 |
| 2023-06 | CT#100 | CP-231126 | 0726 | 1 | B | Support of analytics subset and accuracy per analytics subset for UE mobility for Nnwdaf_EventsSubscription API | 18.2.0 |
| 2023-06 | CT#100 | CP-231138 | 0727 | 1 | F | Removal of the redundant descriptions for ML model service | 18.2.0 |
| 2023-06 | CT#100 | CP-231125 | 0728 | 1 | B | Updates for UE mobility analytics using fine granularity | 18.2.0 |
| 2023-06 | CT#100 | CP-231138 | 0730 | 1 | F | misplaced attributes | 18.2.0 |
| 2023-06 | CT#100 | CP-231138 | 0731 | 1 | F | Correction to EnAbnormalBehaviour feature | 18.2.0 |
| 2023-06 | CT#100 | CP-231138 | 0733 | 1 | F | Missing attributes in procedure description for NsiLoadExt feature | 18.2.0 |
| 2023-06 | CT#100 | CP-231159 | 0735 | 1 | A | Correction to UeCommunicationExt feature | 18.2.0 |
| 2023-06 | CT#100 | CP-231132 | 0736 | 1 | F | Corrections to the redirection mechanism description | 18.2.0 |
| 2023-06 | CT#100 | CP-231141 | 0737 | | F | Update of info and externalDocs fields | 18.2.0 |
| 2023-09 | CT#101 | CP-232082 | 0738 | 1 | B | Immediate reporting in the MLModelTraining API | 18.3.0 |
| 2023-09 | CT#101 | CP-232082 | 0739 | 1 | B | Applicabilities and restrictions in the MLModelProvision and MLModelTraining APIs | 18.3.0 |
| 2023-09 | CT#101 | CP-232082 | 0740 | 1 | F | Redundancies in the MLModelTraining service | 18.3.0 |
| 2023-09 | CT#101 | CP-232081 | 0741 | | F | Procedure descriptions corrections | 18.3.0 |
| 2023-09 | CT#101 | CP-232082 | 0742 | 1 | B | Location Accuracy Analytics for subscriptions | 18.3.0 |
| 2023-09 | CT#101 | CP-232082 | 0743 | 1 | B | Location Accuracy Analytics for requests | 18.3.0 |
| 2023-09 | CT#101 | CP-232081 | 0746 | 1 | B | Movement Behaviour analytics for Nnwdaf_EventsSubscription API | 18.3.0 |
| 2023-09 | CT#101 | CP-232081 | 0747 | 1 | B | Movement Behaviour analytics for Nnwdaf_AnalyticsInfo Service API | 18.3.0 |
| 2023-09 | CT#101 | CP-232081 | 0749 | | B | Update UE Mobility analytics | 18.3.0 |
| 2023-09 | CT#101 | CP-232087 | 0750 | 2 | B | Update End-to-end data volume transfer time analytics | 18.3.0 |
| 2023-09 | CT#101 | CP-232255 | 0751 | 2 | B | Update to Nnwdaf_MLModelTraining Service API | 18.3.0 |
| 2023-09 | CT#101 | CP-232087 | 0752 | 1 | B | Update for adding NEF as Consumer of Multiple Analytics IDs | 18.3.0 |
| 2023-09 | CT#101 | CP-232082 | 0753 | 1 | D | Corrections to Nnwdaf_MLModelProvision Service API | 18.3.0 |
| 2023-09 | CT#101 | CP-232097 | 0754 | 1 | F | Corrections to Nnwdaf_EventsSubscription Service API | 18.3.0 |
| 2023-09 | CT#101 | CP-232097 | 0755 | 1 | F | Corrections to Nnwdaf_AnalyticsInfo Service API | 18.3.0 |
| 2023-09 | CT#101 | CP-232087 | 0756 | 1 | B | Resolve the Editor's Note for the analytics subset of E2E data volume transfer time | 18.3.0 |
| 2023-09 | CT#101 | CP-232087 | 0757 | 1 | B | Support of reporting the E2E data volume transfer time and the corresponding volume | 18.3.0 |
| 2023-09 | CT#101 | CP-232081 | 0758 | 1 | B | Enhancement of Redundant Transmission Experience analytics for NWDaf-assisted URSP | 18.3.0 |
| 2023-09 | CT#101 | CP-232081 | 0759 | 1 | B | Enhancements of the QoS sustainability analytics request | 18.3.0 |
| 2023-09 | CT#101 | CP-232081 | 0760 | 1 | B | Enhancements of the QoS sustainability subscription | 18.3.0 |
| 2023-09 | CT#101 | CP-232081 | 0761 | 1 | B | Miscellaneous corrections for analytics | 18.3.0 |
| 2023-09 | CT#101 | CP-232081 | 0762 | 1 | B | Support for stopping and resuming the consumption of the analytics | 18.3.0 |
| 2023-09 | CT#101 | CP-232082 | 0763 | 1 | B | Support of spatial granularity size and temporal granularity size of the analytics request | 18.3.0 |
| 2023-09 | CT#101 | CP-232082 | 0764 | 1 | B | Support of spatial granularity size and temporal granularity size of the analytics subscription | 18.3.0 |
| 2023-09 | CT#101 | CP-232082 | 0765 | 1 | B | Support of the analytics subsets of PDU session traffic | 18.3.0 |
| 2023-09 | CT#101 | CP-232082 | 0766 | 1 | B | New ML Model Provisioning parameter | 18.3.0 |
| 2023-09 | CT#101 | CP-232097 | 0767 | | F | Merging two NetworkPerformanceExt_eNA features | 18.3.0 |
| 2023-09 | CT#101 | CP-232097 | 0768 | | F | misalignment of transEvents attribute | 18.3.0 |
| 2023-09 | CT#101 | CP-232087 | 0769 | 1 | F | Editors Note removal for E2E Data Volume Transfer Time analytics | 18.3.0 |
| 2023-09 | CT#101 | CP-232081 | 0770 | 1 | B | Corrections to PDU Session Traffic Analytics | 18.3.0 |
| 2023-09 | CT#101 | CP-232082 | 0771 | 1 | B | Updates to Analytics Accuracy Monitoring in Nnwdaf_EventsSubscription API | 18.3.0 |
| 2023-09 | CT#101 | CP-232081 | 0772 | | B | Updates to Analytics Accuracy Monitoring in Nnwdaf_AnalyticsInfo API | 18.3.0 |
| 2023-09 | CT#101 | CP-232082 | 0773 | 1 | B | Updates ML Model Provisioning supporting ML model accuracy monitoring | 18.3.0 |
| 2023-09 | CT#101 | CP-232085 | 0775 | | F | Update of info and externalDocs fields | 18.3.0 |
| 2023-09 | CT#101 | CP-232097 | 0777 | | B | Support of providing the number of impacted UE for Abnormal Behaviour analytics | 18.3.0 |
| 2023-12 | CT#102 | CP-233235 | 0778 | 1 | F | Corrections on End-to-end data volume transfer time analytics | 18.4.0 |
| 2023-12 | CT#102 | CP-233235 | 0779 | 1 | B | Resolve the Editor's Note of UE mobility analytics | 18.4.0 |
| 2023-12 | CT#102 | CP-233235 | 0780 | 1 | B | Support of End-to-end data volume transfer time for list of UEs | 18.4.0 |
| 2023-12 | CT#102 | CP-233224 | 0781 | 1 | B | Clarifications for UE Location order indicator in UE mobility analytics request | 18.4.0 |
| 2023-12 | CT#102 | CP-233224 | 0782 | 1 | F | Corrections on ML model provisioning | 18.4.0 |
| 2023-12 | CT#102 | CP-233225 | 0783 | 2 | B | Define Nnwdaf_MLModelMonitor API | 18.4.0 |
| 2023-12 | CT#102 | CP-233224 | 0784 | 1 | B | Define the linear distance threshold for the UE mobility analytics | 18.4.0 |
| 2023-12 | CT#102 | CP-233225 | 0785 | 2 | B | Enhancements on the inference input data and training input data | 18.4.0 |

| | | | | | | | |
|---------|--------|-----------|------|---|---|---|--------|
| 2023-12 | CT#102 | CP-233224 | 0786 | 1 | B | Support list of Access Types in the Service Experience analytics | 18.4.0 |
| 2023-12 | CT#102 | CP-233224 | 0787 | 1 | B | Support the consumer to provide the inference data stored in ADRF for model training | 18.4.0 |
| 2023-12 | CT#102 | CP-233224 | 0788 | 1 | B | Support the consumer to provide the time when the ML model is needed | 18.4.0 |
| 2023-12 | CT#102 | CP-233224 | 0789 | 1 | B | Relative Proximity analytics for Nnwdaf_EventsSubscription API | 18.4.0 |
| 2023-12 | CT#102 | CP-233224 | 0790 | | B | Relative Proximity analytics for Nnwdaf_AnalyticsInfo API | 18.4.0 |
| 2023-12 | CT#102 | CP-233224 | 0791 | | B | Adding confidence attributes to PFD Determination Analytics | 18.4.0 |
| 2023-12 | CT#102 | CP-233224 | 0792 | | B | Update conditional description to locGranularity attribute. | 18.4.0 |
| 2023-12 | CT#102 | CP-233224 | 0793 | | B | Update direction data type | 18.4.0 |
| 2023-12 | CT#102 | CP-233224 | 0794 | | B | Update the description of accPerSubset attribute | 18.4.0 |
| 2023-12 | CT#102 | CP-233258 | 0796 | | A | Correcting a contradiction in the meaning of expiry | 18.4.0 |
| 2023-12 | CT#102 | CP-233224 | 0797 | 1 | B | Analytics feedback information in Subscriptions | 18.4.0 |
| 2023-12 | CT#102 | CP-233246 | 0798 | | F | add ENAExt feature for Nnwdaf_AnalyticsInfo Service | 18.4.0 |
| 2023-12 | CT#102 | CP-233225 | 0801 | 1 | B | Pending Notification in Nnwdaf_DataManagement API | 18.4.0 |
| 2023-12 | CT#102 | CP-233225 | 0802 | 1 | B | Updates to MLEventNotif in Nnwdaf_MLModelProvision API | 18.4.0 |
| 2023-12 | CT#102 | CP-233235 | 0803 | 1 | B | Adding confidence attribute to E2E data volume transfer time analytics | 18.4.0 |
| 2023-12 | CT#102 | CP-233246 | 0805 | 1 | B | Applicability of UNAVAILABLE_DATA failure code | 18.4.0 |
| 2023-12 | CT#102 | CP-233258 | 0807 | | A | Corrections on attribute names | 18.4.0 |
| 2023-12 | CT#102 | CP-233226 | 0808 | 1 | F | Corrections for UE mobility analytics | 18.4.0 |
| 2023-12 | CT#102 | CP-233226 | 0809 | 1 | B | Define service descriptions of Nnwdaf_MLModelMonitor API | 18.4.0 |
| 2023-12 | CT#102 | CP-233225 | 0810 | | B | Define OpenAPI of Nnwdaf_MLModelMonitor API | 18.4.0 |
| 2023-12 | CT#102 | CP-233225 | 0811 | | B | Define Nnwdaf_RoamingData API | 18.4.0 |
| 2023-12 | CT#102 | CP-233226 | 0812 | 1 | B | Define service descriptions of Nnwdaf_RoamingData API | 18.4.0 |
| 2023-12 | CT#102 | CP-233136 | 0813 | 1 | B | Define OpenAPI of Nnwdaf_RoamingData API | 18.4.0 |
| 2023-12 | CT#102 | CP-233246 | 0814 | | F | Corrections on the presence and description of dnais attribute | 18.4.0 |
| 2023-12 | CT#102 | CP-233226 | 0815 | 1 | B | Roaming Analytics service definition | 18.4.0 |
| 2023-12 | CT#102 | CP-233226 | 0816 | 1 | B | Roaming Analytics service data model | 18.4.0 |
| 2023-12 | CT#102 | CP-233226 | 0817 | 1 | B | Roaming Analytics service OpenAPI | 18.4.0 |
| 2023-12 | CT#102 | CP-233226 | 0818 | 1 | B | Analytics subscription extensions to support analytics for roaming UEs | 18.4.0 |
| 2023-12 | CT#102 | CP-233225 | 0819 | | B | Analytics info extensions to support analytics for roaming UEs | 18.4.0 |
| 2023-12 | CT#102 | CP-233227 | 0820 | 1 | F | Applicability of muting exception instructions | 18.4.0 |
| 2023-12 | CT#102 | CP-233246 | 0821 | 1 | F | Wrong feature and service operation names | 18.4.0 |
| 2023-12 | CT#102 | CP-233246 | 0822 | | F | Data fetching correction | 18.4.0 |
| 2023-12 | CT#102 | CP-233246 | 0824 | 1 | F | Corrections to boolean type definitions | 18.4.0 |
| 2023-12 | CT#102 | CP-233246 | 0825 | 1 | B | Updates to error handling | 18.4.0 |
| 2023-12 | CT#102 | CP-233226 | 0826 | 1 | B | Updates for the Support of Nnwdaf_MLModelTraining_Subscribe Service Operation | 18.4.0 |
| 2023-12 | CT#102 | CP-233226 | 0827 | 1 | F | Update to the NwdafMLModelTrainNotif Data Type | 18.4.0 |
| 2023-12 | CT#102 | CP-233226 | 0828 | | B | Updates for Application Error Handling | 18.4.0 |
| 2023-12 | CT#102 | CP-233246 | 0829 | 1 | F | Updates to the Data Model for Nnwdaf_EventsSubscription Service API | 18.4.0 |
| 2023-12 | CT#102 | CP-233226 | 0830 | | F | Updates to Nnwdaf_AnalyticsInfo Service API | 18.4.0 |
| 2023-12 | CT#102 | CP-233246 | 0831 | | F | Updates to NnwdafEventsSubscriptionNotification Data Type | 18.4.0 |
| 2023-12 | CT#102 | CP-233229 | 0832 | 1 | F | IETF RFC 7540, RFC 7807 obsoleted by RFC 9113 and RFC 9457 respectively | 18.4.0 |
| 2023-12 | CT#102 | CP-233237 | 0833 | | F | Update of info and externalDocs fields | 18.4.0 |
| 2024-03 | CT#103 | CP-240162 | 0834 | 2 | B | Update Location accuracy analytics | 18.5.0 |
| 2024-03 | CT#103 | CP-240162 | 0836 | 2 | F | Correction for Network Performance analytics | 18.5.0 |
| 2024-03 | CT#103 | CP-240162 | 0837 | 2 | F | Correction for Dispersion analytics | 18.5.0 |
| 2024-03 | CT#103 | CP-240161 | 0838 | 1 | B | Update WLAN performance analytics | 18.5.0 |
| 2024-03 | CT#103 | CP-240161 | 0839 | | F | Misplaced locAcclInfos attribute | 18.5.0 |
| 2024-03 | CT#103 | CP-240162 | 0840 | 1 | B | Missing LosNlos indication in LocAccuracyPerMethod | 18.5.0 |
| 2024-03 | CT#103 | CP-240162 | 0841 | 1 | F | Incorrect figures in notification procedures | 18.5.0 |
| 2024-03 | CT#103 | CP-240161 | 0842 | | F | Missing HTTP response code 200 for notification POST | 18.5.0 |
| 2024-03 | CT#103 | CP-240161 | 0843 | | F | Wrong description of MLEventNotif data type | 18.5.0 |
| 2024-03 | CT#103 | CP-240162 | 0844 | 1 | F | Correction of AdditionalMLModelInformation data type | 18.5.0 |
| 2024-03 | CT#103 | CP-240162 | 0845 | 1 | B | Adding model identifier to MLEventNotif | 18.5.0 |
| 2024-03 | CT#103 | CP-240161 | 0846 | | F | Correction of mLModelInfos attribute | 18.5.0 |
| 2024-03 | CT#103 | CP-240162 | 0847 | 1 | B | Roaming-related errors in Analytics Suscriptions | 18.5.0 |
| 2024-03 | CT#103 | CP-240161 | 0848 | | B | Roaming-related errors in Analytics Info requests | 18.5.0 |
| 2024-03 | CT#103 | CP-240162 | 0849 | 1 | B | Error handling in RoamingAnalytics and RoamingData | 18.5.0 |
| 2024-03 | CT#103 | CP-240161 | 0850 | | F | Missing statements in the OpenAPI of the Events Subscription API | 18.5.0 |
| 2024-03 | CT#103 | CP-240162 | 0851 | 1 | F | Wrong attribute names in RoamingData | 18.5.0 |
| 2024-03 | CT#103 | CP-240161 | 0852 | | F | Missing response code | 18.5.0 |
| 2024-03 | CT#103 | CP-240162 | 0853 | 1 | F | MLModelTraining errors | 18.5.0 |
| 2024-03 | CT#103 | CP-240177 | 0854 | 1 | F | Missing provisions related to User Consent | 18.5.0 |
| 2024-03 | CT#103 | CP-240161 | 0855 | 1 | B | Enhancement of Nnwdaf_AnalyticsInfo_ContextTransfer service operation to support Analytics context transfer | 18.5.0 |

| | | | | | | | |
|---------|--------|-----------|------|---|---|--|--------|
| 2024-03 | CT#103 | CP-240161 | 0856 | | B | Enhancement of Nnwdaf_MLModelProvision API to support Analytics context transfer | 18.5.0 |
| 2024-03 | CT#103 | CP-240161 | 0857 | | B | Enhancement of Nnwdaf_MLModelMonitor service | 18.5.0 |
| 2024-03 | CT#103 | CP-240162 | 0858 | 1 | B | Enhancement of PFD Determination analytics | 18.5.0 |
| 2024-03 | CT#103 | CP-240161 | 0859 | | F | Removal of the EN for distance thresholds | 18.5.0 |
| 2024-03 | CT#103 | CP-240162 | 0860 | 1 | F | Resolve the Editor's Note for DN performance analytics | 18.5.0 |
| 2024-03 | CT#103 | CP-240161 | 0861 | | F | Resolve the Editor's Note for accuracy request in Nnwdaf_AnalyticsInfo service | 18.5.0 |
| 2024-03 | CT#103 | CP-240162 | 0862 | 1 | B | Support of analytics and ML model accuracy context transfer | 18.5.0 |
| 2024-03 | CT#103 | CP-240177 | 0865 | 1 | F | Corrections to boolean type definitions | 18.5.0 |
| 2024-03 | CT#103 | CP-240177 | 0866 | 1 | B | Clarification for user consent for retrieving data stored in the NWDAF | 18.5.0 |
| 2024-03 | CT#103 | CP-240174 | 0868 | 1 | B | Updates to E2E data volume transfer time analytics | 18.5.0 |
| 2024-03 | CT#103 | CP-240174 | 0869 | 1 | B | Updates to PFD Determination Analytics | 18.5.0 |
| 2024-03 | CT#103 | CP-240174 | 0870 | 1 | B | Remove DNAI Parameter from E2E Data Volume Transfer Time Analytics | 18.5.0 |
| 2024-03 | CT#103 | CP-240161 | 0871 | | F | Updates to the Service Architecture of Nnwdaf_MLModelProvision Service | 18.5.0 |
| 2024-03 | CT#103 | CP-240166 | 0872 | | F | Update of info and externalDocs fields | 18.5.0 |
| 2024-04 | CT#103 | | | | | Correction of TS29520_Nnwdaf_EventsSubscription.yaml | 18.5.1 |
| 2024-06 | CT#104 | CP-241077 | 0873 | | F | Update PFD Determination analytics | 18.6.0 |
| 2024-06 | CT#104 | CP-241077 | 0874 | 1 | F | ML file usage corrections | 18.6.0 |
| 2024-06 | CT#104 | CP-241077 | 0875 | | F | Roaming Data notification correction | 18.6.0 |
| 2024-06 | CT#104 | CP-241077 | 0876 | | F | Muting resolution | 18.6.0 |
| 2024-06 | CT#104 | CP-241101 | 0877 | 1 | F | Analytics Subscription Transfer corrections | 18.6.0 |
| 2024-06 | CT#104 | CP-241101 | 0878 | | F | Callback correction | 18.6.0 |
| 2024-06 | CT#104 | CP-241077 | 0879 | | F | AnLF as consumer of the Nnwdaf_MLModelMonitor service | 18.6.0 |
| 2024-06 | CT#104 | CP-241077 | 0880 | | F | Corrections related to immReports | 18.6.0 |
| 2024-06 | CT#104 | CP-241077 | 0881 | 1 | F | Completion of analytics events for Nnwdaf_MLModelProvision service | 18.6.0 |
| 2024-06 | CT#104 | CP-241077 | 0882 | | F | correction to MLModelTrainInfo | 18.6.0 |
| 2024-06 | CT#104 | CP-241078 | 0883 | 2 | F | Support of model level use case context | 18.6.0 |
| 2024-06 | CT#104 | CP-241078 | 0884 | 1 | F | alignment of MLModelMonitorNotify | 18.6.0 |
| 2024-06 | CT#104 | CP-241078 | 0885 | 1 | F | MLModel Training Notification correction | 18.6.0 |
| 2024-06 | CT#104 | CP-241105 | 0887 | | A | Incorrect description in NnwdafDataManagementSubsc data type | 18.6.0 |
| 2024-06 | CT#104 | CP-241091 | 0888 | | B | Support of request for geographical distribution of the UEs | 18.6.0 |
| 2024-06 | CT#104 | CP-241093 | 0891 | | F | RFC 7807 obsoleted by RFC 9457 | 18.6.0 |
| 2024-06 | CT#104 | CP-241078 | 0892 | 2 | F | Clarification on Analytics/ML Model Accuracy Information | 18.6.0 |
| 2024-06 | CT#104 | CP-241078 | 0893 | 2 | F | Adding Analytics Information in Nnwdaf_MLModelMonitor service | 18.6.0 |
| 2024-06 | CT#104 | CP-241078 | 0895 | 1 | B | Add skip current FL round indication in NWDAF ML Model Training API | 18.6.0 |
| 2024-06 | CT#104 | CP-241077 | 0896 | | F | Corrections on ML model monitor and provisioning APIs | 18.6.0 |
| 2024-06 | CT#104 | CP-241077 | 0897 | | F | Corrections on roaming data and analytics APIs | 18.6.0 |
| 2024-06 | CT#104 | CP-241077 | 0898 | 1 | B | Resolve the Editor's Note of training data | 18.6.0 |
| 2024-06 | CT#104 | CP-241077 | 0899 | | B | Solve EN and Updates to MIModelAccuracyInfo for Nnwdaf_AnalyticsInfo API | 18.6.0 |
| 2024-06 | CT#104 | CP-241077 | 0900 | 1 | F | Correction of OpenAPI syntax errors | 18.6.0 |
| 2024-06 | CT#104 | CP-241101 | 0901 | | F | Corrections in Nnwdaf_EventsSubscription API | 18.6.0 |
| 2024-06 | CT#104 | CP-241078 | 0903 | 1 | B | Resolve EN for GroundTruthInfo | 18.6.0 |
| 2024-06 | CT#104 | CP-241078 | 0905 | 1 | B | Resolve EN for TrainInputDataInfo | 18.6.0 |
| 2024-06 | CT#104 | CP-241078 | 0906 | 1 | F | Presence condition correction in AccuracyInfo data type | 18.6.0 |
| 2024-06 | CT#104 | CP-241079 | 0907 | 1 | F | Corrections related to anaAcculnd attribute | 18.6.0 |
| 2024-06 | CT#104 | CP-241079 | 0908 | 1 | F | Correction for accuracy information notification | 18.6.0 |
| 2024-06 | CT#104 | CP-241101 | 0909 | 1 | F | Corrections to NF Service Consumers descriptions | 18.6.0 |
| 2024-06 | CT#104 | CP-241079 | 0910 | 1 | F | Corrections on Nnwdaf_RoamingData and Nnwdaf_RoamingAnalytics services | 18.6.0 |
| 2024-06 | CT#104 | CP-241092 | 0912 | 1 | B | Support of RAT type and access type in the E2E data volume transmission time analytics | 18.6.0 |
| 2024-06 | CT#104 | CP-241101 | 0913 | | F | Corrections on the Nnwdaf_DataManagement_Fetch service operation | 18.6.0 |
| 2024-06 | CT#104 | CP-241101 | 0914 | | B | Support of target UE and filter information in ML model notification | 18.6.0 |
| 2024-06 | CT#104 | CP-241079 | 0915 | 1 | F | Corrections on Nnwdaf_RoamingAnalytics API | 18.6.0 |
| 2024-06 | CT#104 | CP-241078 | 0917 | | B | Support of providing threshold in the movement behaviour analytics | 18.6.0 |
| 2024-06 | CT#104 | CP-241085 | 0918 | | F | Update of info and externalDocs fields | 18.6.0 |
| 2024-09 | CT#105 | CP-242125 | 0919 | | F | Fix the misalignment for Nnwdaf_EventsSubscription API | 18.7.0 |
| 2024-09 | CT#105 | CP-242128 | 0924 | | A | Support of feature negotiation at analytics context retrieval from source NWDAF | 18.7.0 |
| 2024-09 | CT#105 | CP-242128 | 0927 | | A | Corrections on the resource URI in the Nnwdaf_DataManagement API | 18.7.0 |
| 2024-09 | CT#105 | CP-242119 | 0928 | 1 | F | Fix the misalignment and resolve the Editor's Note for Nnwdaf_MLModelTraining API | 18.7.0 |

| | | | | | | | |
|---------|--------|-----------|------|---|---|---|--------|
| 2024-09 | CT#105 | CP-242155 | 0929 | | F | Corrections on target UE and filter provided in the ML model notification | 18.7.0 |
| 2024-09 | CT#105 | CP-242119 | 0930 | 1 | F | Corrections to Movement Behaviour Analytics | 18.7.0 |
| 2024-09 | CT#105 | CP-242125 | 0931 | 1 | F | Corrections to E2E data volume transfer time analytics | 18.7.0 |
| 2024-09 | CT#105 | CP-242120 | 0934 | | F | Update of info and externalDocs fields | 18.7.0 |

History

| Document history | | |
|-------------------------|----------------|-------------|
| V18.5.1 | April 2024 | Publication |
| V18.6.0 | July 2024 | Publication |
| V18.7.0 | September 2024 | Publication |
| | | |
| | | |