

# ETSI TS 129 532 V18.5.0 (2024-07)



**5G;  
5G System;  
5G Multicast-Broadcast Session Management Services;  
Stage 3  
(3GPP TS 29.532 version 18.5.0 Release 18)**



---

**Reference**

RTS/TSGC-0429532vi50

---

**Keywords**

5G

**ETSI**

650 Route des Lucioles  
F-06921 Sophia Antipolis Cedex - FRANCE

---

Tel.: +33 4 92 94 42 00 Fax: +33 4 93 65 47 16

Siret N° 348 623 562 00017 - APE 7112B  
Association à but non lucratif enregistrée à la  
Sous-Préfecture de Grasse (06) N° w061004871

---

**Important notice**

The present document can be downloaded from the  
ETSI [Search & Browse Standards application](#).

The present document may be made available in electronic versions and/or in print. The content of any electronic and/or print versions of the present document shall not be modified without the prior written authorization of ETSI. In case of any existing or perceived difference in contents between such versions and/or in print, the prevailing version of an ETSI deliverable is the one made publicly available in PDF format on [ETSI deliver](#).

Users should be aware that the present document may be revised or have its status changed,  
this information is available in the [Milestones listing](#).

If you find errors in the present document, please send your comments to  
the relevant service listed under [Committee Support Staff](#).

If you find a security vulnerability in the present document, please report it through our  
[Coordinated Vulnerability Disclosure \(CVD\)](#) program.

---

**Notice of disclaimer & limitation of liability**

The information provided in the present deliverable is directed solely to professionals who have the appropriate degree of experience to understand and interpret its content in accordance with generally accepted engineering or other professional standard and applicable regulations.

No recommendation as to products and services or vendors is made or should be implied.

No representation or warranty is made that this deliverable is technically accurate or sufficient or conforms to any law and/or governmental rule and/or regulation and further, no representation or warranty is made of merchantability or fitness for any particular purpose or against infringement of intellectual property rights.

In no event shall ETSI be held liable for loss of profits or any other incidental or consequential damages.

Any software contained in this deliverable is provided "AS IS" with no warranties, express or implied, including but not limited to, the warranties of merchantability, fitness for a particular purpose and non-infringement of intellectual property rights and ETSI shall not be held liable in any event for any damages whatsoever (including, without limitation, damages for loss of profits, business interruption, loss of information, or any other pecuniary loss) arising out of or related to the use of or inability to use the software.

---

**Copyright Notification**

No part may be reproduced or utilized in any form or by any means, electronic or mechanical, including photocopying and microfilm except as authorized by written permission of ETSI.

The content of the PDF version shall not be modified without the written authorization of ETSI.

The copyright and the foregoing restriction extend to reproduction in all media.

© ETSI 2024.  
All rights reserved.

---

# Intellectual Property Rights

## Essential patents

IPRs essential or potentially essential to normative deliverables may have been declared to ETSI. The declarations pertaining to these essential IPRs, if any, are publicly available for **ETSI members and non-members**, and can be found in ETSI SR 000 314: "*Intellectual Property Rights (IPRs); Essential, or potentially Essential, IPRs notified to ETSI in respect of ETSI standards*", which is available from the ETSI Secretariat. Latest updates are available on the ETSI Web server (<https://ipr.etsi.org/>).

Pursuant to the ETSI Directives including the ETSI IPR Policy, no investigation regarding the essentiality of IPRs, including IPR searches, has been carried out by ETSI. No guarantee can be given as to the existence of other IPRs not referenced in ETSI SR 000 314 (or the updates on the ETSI Web server) which are, or may be, or may become, essential to the present document.

## Trademarks

The present document may include trademarks and/or tradenames which are asserted and/or registered by their owners. ETSI claims no ownership of these except for any which are indicated as being the property of ETSI, and conveys no right to use or reproduce any trademark and/or tradename. Mention of those trademarks in the present document does not constitute an endorsement by ETSI of products, services or organizations associated with those trademarks.

**DECT™**, **PLUGTESTS™**, **UMTS™** and the ETSI logo are trademarks of ETSI registered for the benefit of its Members. **3GPP™** and **LTE™** are trademarks of ETSI registered for the benefit of its Members and of the 3GPP Organizational Partners. **oneM2M™** logo is a trademark of ETSI registered for the benefit of its Members and of the oneM2M Partners. **GSM®** and the GSM logo are trademarks registered and owned by the GSM Association.

---

# Legal Notice

This Technical Specification (TS) has been produced by ETSI 3rd Generation Partnership Project (3GPP).

The present document may refer to technical specifications or reports using their 3GPP identities. These shall be interpreted as being references to the corresponding ETSI deliverables.

The cross reference between 3GPP and ETSI identities can be found under <https://webapp.etsi.org/key/queryform.asp>.

---

# Modal verbs terminology

In the present document "**shall**", "**shall not**", "**should**", "**should not**", "**may**", "**need not**", "**will**", "**will not**", "**can**" and "**cannot**" are to be interpreted as described in clause 3.2 of the [ETSI Drafting Rules](#) (Verbal forms for the expression of provisions).

"**must**" and "**must not**" are **NOT** allowed in ETSI deliverables except when used in direct citation.

# Contents

Intellectual Property Rights .....	2
Legal Notice .....	2
Modal verbs terminology.....	2
Foreword.....	7
1 Scope .....	9
2 References .....	9
3 Definitions, symbols and abbreviations .....	10
3.1 Definitions .....	10
3.2 Abbreviations .....	10
4 Overview .....	11
4.1 Introduction .....	11
5 Services offered by the MB-SMF .....	11
5.1 Introduction .....	11
5.2 Nmbsmf_TMGI Service .....	12
5.2.1 Service Description.....	12
5.2.2 Service Operations.....	13
5.2.2.1 Introduction.....	13
5.2.2.2 TMGI Allocate service operation.....	13
5.2.2.2.1 General .....	13
5.2.2.3 TMGI Deallocate service operation .....	13
5.2.2.3.1 General .....	13
5.3 Nmbsmf_MBSSession Service .....	14
5.3.1 Service Description.....	14
5.3.2 Service Operations.....	15
5.3.2.1 Introduction.....	15
5.3.2.2 Create .....	15
5.3.2.2.1 General .....	15
5.3.2.3 Update .....	17
5.3.2.3.1 General .....	17
5.3.2.4 Release .....	18
5.3.2.4.1 General .....	18
5.3.2.5 ContextUpdate .....	19
5.3.2.5.1 General .....	19
5.3.2.6 StatusSubscribe service operation.....	21
5.3.2.6.1 General .....	21
5.3.2.6.2 Subscription creation .....	21
5.3.2.6.3 Subscription update .....	22
5.3.2.7 StatusUnsubscribe.....	23
5.3.2.7.1 General .....	23
5.3.2.8 StatusNotify .....	23
5.3.2.8.1 General .....	23
5.3.2.9 ContextStatusSubscribe.....	24
5.3.2.9.1 General .....	24
5.3.2.9.2 Creation of a subscription.....	24
5.3.2.9.3 Modification of a Subscription .....	26
5.3.2.10 ContextStatusUnSubscribe.....	27
5.3.2.10.1 General .....	27
5.3.2.11 ContextStatusNotify .....	27
5.3.2.11.1 General .....	27
6 API Definitions .....	28
6.1 Nmbsmf_TMGI Service API .....	28
6.1.1 Introduction.....	28

6.1.2	Usage of HTTP .....	29
6.1.2.1	General .....	29
6.1.2.2	HTTP standard headers .....	29
6.1.2.2.1	General .....	29
6.1.2.2.2	Content type .....	29
6.1.2.3	HTTP custom headers .....	29
6.1.3	Resources .....	29
6.1.3.1	Overview .....	29
6.1.3.2	Resource: TMGI collection .....	30
6.1.3.2.1	Description .....	30
6.1.3.2.2	Resource Definition .....	30
6.1.3.2.3	Resource Standard Methods .....	30
6.1.3.2.4	Resource Custom Operations .....	33
6.1.4	Custom Operations without associated resources .....	33
6.1.5	Notifications .....	33
6.1.6	Data Model .....	33
6.1.6.1	General .....	33
6.1.6.2	Structured data types .....	34
6.1.6.2.1	Introduction .....	34
6.1.6.2.2	Type: TmgiAllocate .....	34
6.1.6.2.3	Type: TmgiAllocated .....	34
6.1.6.3	Simple data types and enumerations .....	35
6.1.6.3.1	Introduction .....	35
6.1.6.3.2	Simple data types .....	35
6.1.6.3.3	Enumeration: <EnumType1> .....	35
6.1.6.3.4	Void .....	35
6.1.6.4	Data types describing alternative data types or combinations of data types .....	35
6.1.6.5	Binary data .....	35
6.1.7	Error Handling .....	35
6.1.7.1	General .....	35
6.1.7.2	Protocol Errors .....	35
6.1.7.3	Application Errors .....	35
6.1.8	Feature negotiation .....	36
6.1.9	Security .....	36
6.1.10	HTTP redirection .....	36
6.2	Nmbsmf_MBSSession Service API .....	36
6.2.1	Introduction .....	36
6.2.2	Usage of HTTP .....	37
6.2.2.1	General .....	37
6.2.2.2	HTTP standard headers .....	37
6.2.2.2.1	General .....	37
6.2.2.2.2	Content type .....	37
6.2.2.3	HTTP custom headers .....	37
6.2.2.4	HTTP multipart messages .....	37
6.2.3	Resources .....	38
6.2.3.1	Overview .....	38
6.2.3.2	Resource: MBS sessions collection (Collection) .....	39
6.2.3.2.1	Description .....	39
6.2.3.2.2	Resource Definition .....	39
6.2.3.2.3	Resource Standard Methods .....	39
6.2.3.2.4	Resource Custom Operations .....	44
6.2.3.3	Resource: Individual MBS session (Document) .....	45
6.2.3.3.1	Description .....	45
6.2.3.3.2	Resource Definition .....	45
6.2.3.3.3	Resource Standard Methods .....	45
6.2.3.3.4	Resource Custom Operations .....	49
6.2.3.4	Resource: Subscriptions collection for MBS sessions (Collection) .....	49
6.2.3.4.1	Description .....	49
6.2.3.4.2	Resource Definition .....	49
6.2.3.4.3	Resource Standard Methods .....	50
6.2.3.4.4	Resource Custom Operations .....	51
6.2.3.5	Resource: Individual subscription for an MBS session (Document) .....	51

6.2.3.5.1	Description .....	51
6.2.3.5.2	Resource Definition .....	51
6.2.3.5.3	Resource Standard Methods .....	52
6.2.3.5.4	Resource Custom Operations .....	54
6.2.3.6	Resource: Subscriptions collection for MBS contexts (Collection) .....	54
6.2.3.6.1	Description .....	54
6.2.3.6.2	Resource Definition .....	54
6.2.3.6.3	Resource Standard Methods .....	54
6.2.3.6.4	Resource Custom Operations .....	56
6.2.3.7	Resource: Individual subscription for an MBS context (Document) .....	56
6.2.3.7.1	Description .....	56
6.2.3.7.2	Resource Definition .....	56
6.2.3.7.3	Resource Standard Methods .....	56
6.2.3.7.4	Resource Custom Operations .....	58
6.2.4	Custom Operations without associated resources .....	59
6.2.5	Notifications .....	59
6.2.5.1	General .....	59
6.2.5.2	StatusNotify .....	59
6.2.5.2.1	Description .....	59
6.2.5.2.2	Target URI .....	59
6.2.5.2.3	Standard Methods .....	59
6.2.5.3	ContextStatusNotify .....	60
6.2.5.3.1	Description .....	60
6.2.5.3.2	Target URI .....	60
6.2.5.3.3	Standard Methods .....	60
6.2.6	Data Model .....	61
6.2.6.1	General .....	61
6.2.6.2	Structured data types .....	63
6.2.6.2.1	Introduction .....	63
6.2.6.2.2	Type: CreateReqData .....	63
6.2.6.2.3	Type: CreateRspData .....	64
6.2.6.2.4	Type: MbsSessionExtension .....	64
6.2.6.2.5	Type: ContextUpdateReqData .....	65
6.2.6.2.6	Type: ContextUpdateRspData .....	65
6.2.6.2.7	Type: StatusSubscribeReqData .....	66
6.2.6.2.8	Type: StatusSubscribeRspData .....	66
6.2.6.2.9	Type: N2MbsSmInfo .....	66
6.2.6.2.10	Type: ContextStatusNotifyReqData .....	66
6.2.6.2.11	Type: StatusNotifyReqData .....	66
6.2.6.2.12	Type: ContextStatusSubscribeReqData .....	67
6.2.6.2.13	Type: ContextStatusSubscription .....	67
6.2.6.2.14	Type: ContextStatusEvent .....	67
6.2.6.2.15	Type: ContextStatusSubscribeRspData .....	68
6.2.6.2.16	Type: MbsContextInfo .....	68
6.2.6.2.17	Type: ContextStatusEventReport .....	69
6.2.6.2.18	Type: MulticastTransportAddressChangeInfo .....	69
6.2.6.2.19	Type: QosInfo .....	70
6.2.6.2.20	Type: QosFlowAddModifyRequestItem .....	70
6.2.6.2.21	Type: QosFlowProfile .....	70
6.2.6.2.22	Type: GbrQosFlowInformation .....	71
6.2.6.2.23	Type: ProblemDetailsExtension .....	71
6.2.6.2.24	Type: UpdateRspData .....	71
6.2.6.3	Simple data types and enumerations .....	71
6.2.6.3.1	Introduction .....	71
6.2.6.3.2	Simple data types .....	71
6.2.6.3.3	Enumeration: ContextUpdateAction .....	71
6.2.6.3.4	Enumeration: ContextStatusEventType .....	72
6.2.6.3.5	Enumeration: ReportingMode .....	72
6.2.6.3.6	Enumeration: NgapIeType .....	72
6.2.6.4	Data types describing alternative data types or combinations of data types .....	72
6.2.6.4.1	Type: ExtMbsSession .....	72
6.2.6.4.2	Type: ExtProblemDetails .....	73

6.2.6.5	Binary data .....	73
6.2.6.5.1	Introduction .....	73
6.2.6.5.2	N2 MBS Session Management Information .....	73
6.2.6.5.3	Void .....	73
6.2.7	Error Handling .....	73
6.2.7.1	General .....	73
6.2.7.2	Protocol Errors .....	74
6.2.7.3	Application Errors .....	74
6.2.8	Feature negotiation .....	74
6.2.9	Security .....	75
6.2.10	HTTP redirection .....	75
<b>Annex A (normative):    OpenAPI specification.....</b>		<b>76</b>
A.1	General .....	76
A.2	Nmbsmf_TMGI API .....	76
A.3	Nmbsmf_MBSSession API .....	78
<b>Annex B (informative):    Change history .....</b>		<b>94</b>
History .....		97

---

# Foreword

This Technical Specification has been produced by the 3rd Generation Partnership Project (3GPP).

The contents of the present document are subject to continuing work within the TSG and may change following formal TSG approval. Should the TSG modify the contents of the present document, it will be re-released by the TSG with an identifying change of release date and an increase in version number as follows:

Version x.y.z

where:

- x the first digit:
  - 1 presented to TSG for information;
  - 2 presented to TSG for approval;
  - 3 or greater indicates TSG approved document under change control.
- y the second digit is incremented for all changes of substance, i.e. technical enhancements, corrections, updates, etc.
- z the third digit is incremented when editorial only changes have been incorporated in the document.

In the present document, modal verbs have the following meanings:

- shall** indicates a mandatory requirement to do something
- shall not** indicates an interdiction (prohibition) to do something

The constructions "shall" and "shall not" are confined to the context of normative provisions, and do not appear in Technical Reports.

The constructions "must" and "must not" are not used as substitutes for "shall" and "shall not". Their use is avoided insofar as possible, and they are not used in a normative context except in a direct citation from an external, referenced, non-3GPP document, or so as to maintain continuity of style when extending or modifying the provisions of such a referenced document.

- should** indicates a recommendation to do something
- should not** indicates a recommendation not to do something
- may** indicates permission to do something
- need not** indicates permission not to do something

The construction "may not" is ambiguous and is not used in normative elements. The unambiguous constructions "might not" or "shall not" are used instead, depending upon the meaning intended.

- can** indicates that something is possible
- cannot** indicates that something is impossible

The constructions "can" and "cannot" are not substitutes for "may" and "need not".

- will** indicates that something is certain or expected to happen as a result of action taken by an agency the behaviour of which is outside the scope of the present document
- will not** indicates that something is certain or expected not to happen as a result of action taken by an agency the behaviour of which is outside the scope of the present document
- might** indicates a likelihood that something will happen as a result of action taken by some agency the behaviour of which is outside the scope of the present document



**might not** indicates a likelihood that something will not happen as a result of action taken by some agency the behaviour of which is outside the scope of the present document

In addition:

**is** (or any other verb in the indicative mood) indicates a statement of fact

**is not** (or any other negative verb in the indicative mood) indicates a statement of fact

The constructions "is" and "is not" do not indicate requirements.

---

# 1 Scope

The present document specifies the stage 3 protocol and data model for the Nmb-smf Service Based Interface. It provides stage 3 protocol definitions and message flows, and specifies the API for each service offered by the MB-SMF with the exception of the MB-SMF Event Exposure service.

The 5G System stage 2 architecture and procedures are specified in 3GPP TS 23.501 [2] and 3GPP TS 23.502 [3]. The 5G Multicast-Broadcast Session Management Services for 5G System is specified in 3GPP TS 23.247 [14].

The Technical Realization of the Service Based Architecture and the Principles and Guidelines for Services Definition are specified in 3GPP TS 29.500 [4] and 3GPP TS 29.501 [5].

---

# 2 References

The following documents contain provisions which, through reference in this text, constitute provisions of the present document.

- References are either specific (identified by date of publication, edition number, version number, etc.) or non-specific.
- For a specific reference, subsequent revisions do not apply.
- For a non-specific reference, the latest version applies. In the case of a reference to a 3GPP document (including a GSM document), a non-specific reference implicitly refers to the latest version of that document *in the same Release as the present document*.

- [1] 3GPP TR 21.905: "Vocabulary for 3GPP Specifications".
- [2] 3GPP TS 23.501: "System Architecture for the 5G System; Stage 2".
- [3] 3GPP TS 23.502: "Procedures for the 5G System; Stage 2".
- [4] 3GPP TS 29.500: "5G System; Technical Realization of Service Based Architecture; Stage 3".
- [5] 3GPP TS 29.501: "5G System; Principles and Guidelines for Services Definition; Stage 3".
- [6] OpenAPI: "OpenAPI Specification Version 3.0.0", <https://spec.openapis.org/oas/v3.0.0>.
- [7] 3GPP TR 21.900: "Technical Specification Group working methods".
- [8] 3GPP TS 33.501: "Security architecture and procedures for 5G system".
- [9] IETF RFC 6749: "The OAuth 2.0 Authorization Framework".
- [10] 3GPP TS 29.510: "5G System; Network Function Repository Services; Stage 3".
- [11] IETF RFC 9113: "HTTP/2".
- [12] IETF RFC 8259: "The JavaScript Object Notation (JSON) Data Interchange Format".
- [13] IETF RFC 9457: "Problem Details for HTTP APIs".
- [14] 3GPP TS 23.247: "Architectural enhancements for 5G multicast-broadcast services; Stage 2".
- [16] IETF RFC 6902: "JavaScript Object Notation (JSON) Patch".
- [17] 3GPP TS 29.281: "General Packet Radio System (GPRS) Tunnelling Protocol User Plane (GTPv1-U)".
- [18] 3GPP TS 29.571: "5G System; Common Data Types for Service Based Interfaces; Stage 3".
- [19] 3GPP TS 29.274: "3GPP Evolved Packet System (EPS); Evolved General Packet Radio Service (GPRS) Tunnelling Protocol for Control plane (GTPv2-C); Stage 3".

- [20] 3GPP TS 38.413: "NG Radio Access Network (NG-RAN); NG Application Protocol (NGAP)".
- [21] IETF RFC 2387: "The MIME Multipart/Related Content-type".
- [22] IETF RFC 2045: "Multipurpose Internet Mail Extensions (MIME) Part One: Format of Internet Message Bodies".
- [23] 3GPP TS 29.537: "5G System; Multicast/Broadcast Policy Control Services; Stage 3".
- [24] 3GPP TS 29.214: "Policy and Charging Control over Rx reference point".

---

## 3 Definitions, symbols and abbreviations

### 3.1 Definitions

For the purposes of the present document, the terms and definitions given in 3GPP TR 21.905 [1] and in clause 3.1 of 3GPP TS 23.247 [14] apply. A term defined in the present document takes precedence over the definition of the same term, if any, in 3GPP TR 21.905 [1].

For the definitions of the basic SBI notions (e.g. apiRoot, API URI, Callback URI, etc.), SBI specific abbreviations (e.g. CRUD, YAML, etc.), special characters, operators and delimiters that are used by SBI specifications, see clause 3 in 3GPP TS 29.501 [5].

### 3.2 Abbreviations

For the purposes of the present document, the abbreviations given in 3GPP TR 21.905 [1] and the following apply. An abbreviation defined in the present document takes precedence over the definition of the same abbreviation, if any, in 3GPP TR 21.905 [1].

5MBS	5G Multicast-Broadcast Services
AF/AS	Application Function / Application server
AMF	Access and Mobility Management Function
C-TEID	Common Tunnel Endpoint IDentifier
DNN	Data Network Name
FSA	Frequency Selection Area
F-TEID	Fully Qualified TEID (i.e. IP address and TEID)
GTP-U	GTP User plane
MBS	Multicast/Broadcast Service
MBSF	Multicast/Broadcast Service Function
MBSTF	Multicast/Broadcast Service Transport Function
MB-SMF	Multicast/Broadcast Session Management Function
MB-UPF	Multicast/Broadcast User Plane Function
NEF	Network Exposure Function
NF	Network Function
NG-RAN	Next Generation (5G) RAN
SMF	Session Management Function
S-NSSAI	Single Network Slice Selection Assistance Information
TEID	Tunnel Endpoint IDentifier
TMGI	Temporary Mobile Group Identity
UPF	User Plane Function
URI	Uniform Resource Identifier

## 4 Overview

### 4.1 Introduction

Within the 5GC, the MB-SMF offers services to the SMF, AMF, AF/AS, MBSF and NEF via the Nmbsmf service based interface (see 3GPP TS 23.501 [2], 3GPP TS 23.502 [3] and 3GPP TS 23.247 [14]).

Figure 4.1-1 provides the reference model (in service based interface representation and in reference point representation), with focus on the MB-SMF and the scope of the present specification.

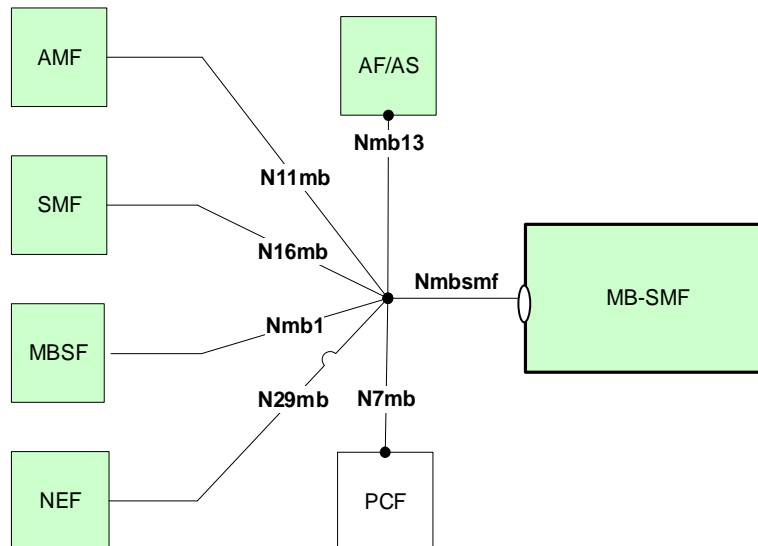

**Figure 4.1-1: Reference model – MB-SMF**

N11mb is the reference point between MB-SMF and AMF.

N16mb is the reference point between MB-SMF and SMF.

N29mb is the reference point between MB-SMF and NEF.

Nmb1 is the reference point between MB-SMF and MBSF.

Nmb13 is the reference point between MB-SMF and AF/AS.

The functionalities supported by the MB-SMF are listed in clause 5.3.2.2 of 3GPP TS 23.247 [14].

## 5 Services offered by the MB-SMF

### 5.1 Introduction

Table 5.1-1 summarizes the SBI services produced by an MB-SMF.

**Table 5.1-1: NF Services provided by MB-SMF**

Service Name	Description	Example Consumers
Nmbsmf_TMGI	This service enables to request the allocation or release of TMGI(s). Applicable to both Broadcast and Multicast services.	NEF, MBSF, AF
Nmbsmf_MBSSession	This service enables: <ul style="list-style-type: none"> <li>- to create, modify, activate, deactivate and release a multicast MBS session</li> <li>- create, modify and release a broadcast MBS session</li> <li>- request the start or termination of MBS data reception for a multicast MBS session</li> <li>- query information (e.g. QoS information) about a multicast MBS session and subscribe and unsubscribe to notifications of events about the multicast MBS session context and notify corresponding events to the subscribed NFs</li> <li>- subscribe and unsubscribe to notifications of events about status change of a broadcast or multicast MBS session and notify corresponding events to the subscribed NFs</li> </ul>	NEF, MBSF, AF  NEF, MBSF, AF  SMF, AMF  SMF  NEF, MBSF, AF

Table 5.1-2 summarizes the corresponding MB-SMF APIs defined in this specification (see Annex A).

**Table 5.1-2: MB-SMF API Descriptions**

Service Name	Clause	Description	OpenAPI Specification File	apiName	Annex
Nmbsmf_TMGI	5.2	MB-SMF TMGI Service	TS29532_Nmbsmf_TMGI.yaml	nmbsmf_tmgi	A.2
Nmbsmf_MBSSession	5.3	MB-SMF MBSSession Service	TS29532_Nmbsmf_MBSSession.yaml	nmbsmf_mbssession	A.3

## 5.2 Nmbsmf\_TMGI Service

### 5.2.1 Service Description

The Nmbsmf\_TMGI service operates on TMGI resources. It is applicable to both Broadcast and Multicast services. The service operations exposed by this service allow other NFs to request the allocation and release of TMGIs. The following are the key functionalities of this NF service, as specified in clause 9.1.2 of 3GPP TS23.247 [14]:

- Requesting the allocation of one or more TMGI values, or requesting to refresh the expiration time of the previous allocated TMGI(s);
- Requesting the deallocation of one or more TMGI values.

Table 5.2.1-1 lists the service operations that are supported by the Nmbsmf\_TMGI service.

**Table 5.2.1-1: Service operations supported by the Nmbsmf\_TMGI service**

Service Operations	Description	Operation Semantics	Example Consumers
Allocate	Request the allocation of one or more TMGI values, or refresh the expiration time of the previously allocated TMGI(s).	Request / Response	NEF, MBSF, AF
Deallocate	Request the deallocation of one or more TMGI values.	Request / Response	NEF, MBSF, AF

## 5.2.2 Service Operations

### 5.2.2.1 Introduction

See Table 5.2.1-1 for an overview of the service operations supported by the Nmbsmf\_TMGI service.

### 5.2.2.2 TMGI Allocate service operation

#### 5.2.2.2.1 General

The TMGI Allocate service operation (Nmbsmf\_TMGI\_Allocate) shall be used by NF Service Consumers to request the allocation of TMGI(s). The TMGI Allocate service operation shall also be used to refresh the expiration time of the previously allocated TMGI(s).

It is used in the following procedures:

- MBS Session Creation with and without PCC (see clauses 7.1.1.2 and 7.1.1.3 in 3GPP TS 23.247 [14]).

The NF Service Consumer (e.g. NEF, MBSF and AF) shall trigger the allocation of one or more TMGIs by using the HTTP POST method on the TMGI collection resource (/tmgi), as shown in Figure 5.2.2.2.1-1.

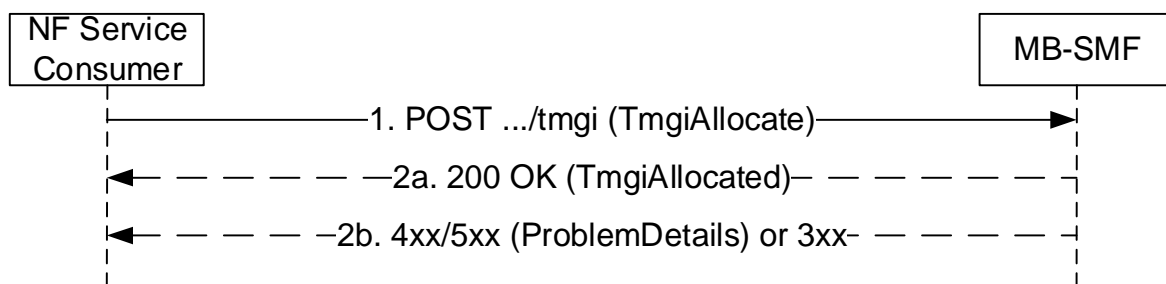

**Figure 5.2.2.2.1-1: TMGI allocation and TMGI refresh operations**

1. The NF Service Consumer shall send a POST request to the resource representing the TMGI collection resource (/tmgi) of the MB-SMF. The content (TmgiAllocate data structure) of the POST request shall contain:
  - the number of TMGIs to be allocated, if TMGI allocation is requested;
  - one or more TMGIs, if the expiration time of the previously allocated TMGI(s) needs to be refreshed.
- 2a. On success, the MB-SMF shall return a 200 OK response with a content (TmgiAllocated data structure), which contains the allocated TMGI(s) and their expiration time, i.e. one expiration time for all TMGIs.
- 2b. On failure, or redirection, one of the HTTP status codes listed in Table 6.1.3.2.3.1-3 shall be returned. For a 4xx/5xx response, the message body may contain a ProblemDetails data structure with ProblemDetails structure with the "cause" attribute set to one of the application error listed in Table 6.1.3.2.3.1-3.

### 5.2.2.3 TMGI Deallocate service operation

#### 5.2.2.3.1 General

The TMGI Deallocate service operation (Nmbsmf\_TMGI\_Deallocate) shall be used by NF Service Consumers to request the deallocation of one or more TMGI(s).

It is used in the following procedures:

- MBS Session Deletion with and without PCC (see clauses 7.1.1.4 and 7.1.1.5 in 3GPP TS 23.247 [14]);
- MBS Session Release for Broadcast (see clause 7.3.2 in 3GPP TS 23.247 [14]).

The NF Service Consumer (e.g. NEF, MBSF and AF) shall trigger the deallocation of one or more TMGIs by using the HTTP DELETE method on the TMGI collection resource (/tmgi), as shown in Figure 5.2.2.3.1-1.

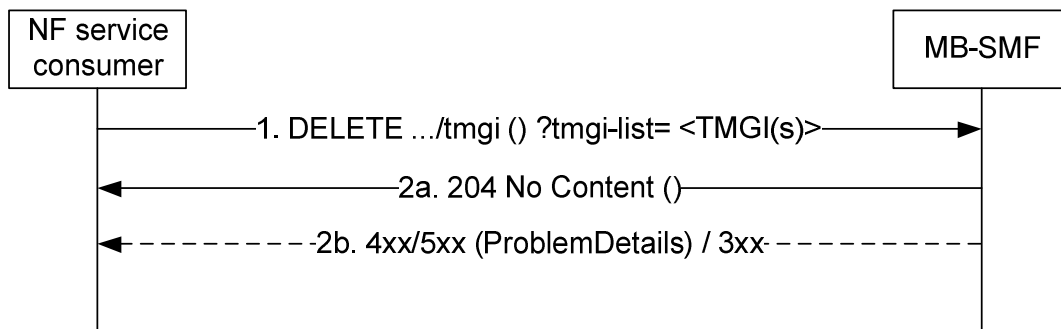

**Figure 5.2.2.3.1-1: TMGI deallocation**

1. The NF Service Consumer shall send a DELETE request to the resource representing the TMGIs collection. Query parameters shall be used to indicate the TMGI(s) to be deallocated. The NF Service Consumer may request to deallocate all previously allocated TMGIs, or one or more specific TMGIs previously allocated.
- 2a. On success, "204 No Content" shall be returned with empty message body.
- 2b. On failure or redirection, one of the HTTP status code listed in Table 6.1.3.2.3.2-3 shall be returned. For a 4xx/5xx response, the message body may contain a ProblemDetails structure with the "cause" attribute set to one of the application errors listed in Table 6.1.3.2.3.2-3.

## 5.3 Nmbsmf\_MBSSession Service

### 5.3.1 Service Description

The Nmbsmf\_MBSSession service operates on MBS Sessions. It is applicable to both Broadcast and Multicast services. The service operations exposed by this service allow other NFs to create, update and release MBS sessions. The following are the key functionalities of this NF service, as specified in clause 9.1.3 of 3GPP TS23.247 [14]:

- Creation, modification and release of MBS contexts for MBS Sessions;
- Requesting the start or termination of MBS data reception for a multicast MBS session;
- Subscribing to or unsubscribing from notifications of status change of multicast MBS session context;
- Subscribing to or unsubscribing from notifications of status change of a broadcast or multicast MBS session.

Table 5.3.1-1 lists the service operations that are supported by Nmbsmf\_MBSSession service.

**Table 5.3.1-1: Service operations supported by the Nmbsmf\_MBSSession service**

Service Operations	Description	Operation Semantics	Example Consumers
Create	Create a multicast or broadcast MBS session	Request / Response	NEF, MBSF, AF
Update	Update a multicast or broadcast MBS session	Request / Response	NEF, MBSF, AF
Delete	Delete a multicast or broadcast MBS session	Request / Response	NEF, MBSF, AF
ContextUpdate	Request the start or termination of MBS data reception for a multicast MBS session	Request / Response	AMF, SMF
ContextStatusSubscribe	Request information (e.g. QoS information) about a multicast MBS session and subscribe to notification of events about the multicast MBS session context	Subscribe/ Notify	SMF
ContextStatusUnsubscribe	Unsubscribe to notification of events about the multicast MBS session context		SMF
ContextStatusNotify	Notify events about the multicast MBS session context		SMF
StatusSubscribe	Subscribe to notifications of status change of a broadcast or multicast MBS session	Subscribe/ Notify	NEF, MBSF, AF
StatusUnsubscribe	Unsubscribe to notifications of status change of a broadcast or multicast MBS session		NEF, MBSF, AF
StatusNotify	Notify status changes of a multicast or broadcast or multicast MBS session		NEF, MBSF, AF

## 5.3.2 Service Operations

### 5.3.2.1 Introduction

See Table 5.3.1-1 for an overview of the service operations supported by the Nmbsmf\_MBSSession service.

### 5.3.2.2 Create

#### 5.3.2.2.1 General

The Create service operation shall be used to create a multicast or a broadcast MBS session, or for a location dependent MBS session, the part of an MBS Session within an MBS service area.

NOTE 1: For a location dependent MBS service, the Create service operation is performed per MBS service area of the MBS session.

It is used in the following procedures:

- MBS Session Creation with or without PCC (see clauses 7.1.1.2 and 7.1.1.3 of 3GPP TS 23.247 [14]); and
- MBS Session Start for Broadcast (see clause 7.3.1 of 3GPP TS 23.247 [14]).

For a location dependent MBS service, TMGI shall be used to identify the MBS Session within 5GS. Different MBS Service Areas shall use different SSM (source specific IP multicast) addresses if multicast transport is used over N6mb.

For a location dependent broadcast MBS session, based on operator's policy, the MB-SMF shall accept a TMGI value allocated by another MB-SMF.

NOTE 2: Different MB-SMFs can be assigned for different MBS service areas belonging to different MB-SMF service areas for a location dependent broadcast MBS session (see clause 7.3.4 of 3GPP TS 23.247 [14]).

The NF Service Consumer (e.g. NEF, MBSF or AF) shall create an MBS session, or for a location dependent MBS session, the part of an MBS Session within an MBS service area, by using the HTTP POST method as shown in Figure 5.3.2.2.1-1.



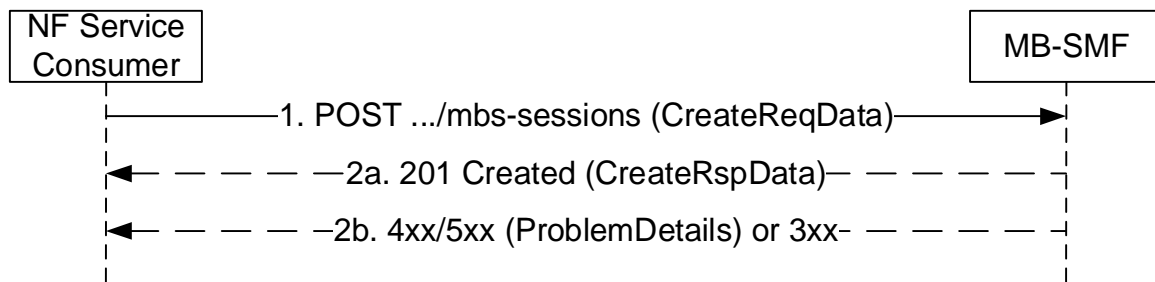

**Figure 5.3.2.2.1-1: MBS session creation**

1. The NF Service Consumer shall send a POST request (CreateReqData structure) targeting the MBS Sessions collection resource of the MB-SMF. The content of the POST request shall contain the following information:
  - MBS Session ID (source specific IP multicast address or TMGI) and/or TMGI allocation request indication;
  - MBS service type (either multicast or broadcast service);
  - the locationDependent IE set to true, for a location dependent MBS service;
  - MBS Service Area, for a location dependent MBS service or for a Local MBS service;
  - Area Session Policy ID, for a location dependent MBS service, if the AF/NEF/MBSF has obtained the Area Session Policy ID from the PCF (see clause 7.1.1.3 of 3GPP TS 23.247 [14]).

The content of the POST request may further contain the following parameters:

- for a multicast or a broadcast MBS session:
  - ingress transport address request indication, if the allocation of an ingress transport address is requested;
  - DNN;
  - S-NSSAI;
  - MBS start time;
  - MBS termination time;
  - MBS service information;
  - an MBS session status subscription request, including the list of MBS session events requested to be subscribed, a Notify Correlation ID, the Notification URI where to receive MBS session status notifications and the NF instance ID of the subscribing NF, for subscribing to notifications of events about the MBS session.
- for a multicast MBS session:
  - session activity status (active/inactive);
  - indication that any UE may join the MBS session, for a multicast MBS session;
  - if security protection is applied, the multicast session security context containing MBS Service Key (MSK), MBS Traffic Key (MTK) and the corresponding key IDs.
- for a broadcast MBS session:
  - list of MBS FSA IDs;
  - Associated Session ID to enable NG-RAN to identify multiple MBS sessions delivering the same content when an AF creates multiple broadcast MBS Sessions via different Core Networks in network sharing scenarios;

- NR RedCap UE information to indicate whether the broadcast MBS session is intended only for NR RedCap UEs, for both NR RedCap UEs and non-RedCap UEs or only for non-RedCap UEs.
- 2a. On success, the MB-SMF shall reserve ingress resources for the MBS session and shall return a "201 Created" response. The "Location" header shall be present and shall contain the URI of the created resource. The content of the POST response (CreateRspData structure) shall contain a representation of the created MBS session, including the following parameters:
- the TMGI allocated to the MBS session and its expiration time, if the request included a TMGI allocation request;
  - the Area Session ID allocated by the MB-SMF for the MBS session and MBS service area, for a location-dependent MBS session;
  - MB-UPF tunnel information used between MB-UPF and MBSTF over Nmb9, or between MB-UPF and AF/AS if unicast transport is used over N6mb;
  - list of MBS FSA IDs, if any, for a broadcast MBS session; and
  - a representation of the created MBS session status subscription, including the list of MBS session events successfully subscribed, the URI of the created subscription and the expiry time after which the subscription becomes invalid, if the Create request includes the subscription to events about the MBS session and the subscription was created successfully.

The POST response may also contain:

- a list of event reports, if corresponding information is available.

For a location dependent MBS service, the MB-SMF shall allocate a unique Area Session ID within the MBS session for the MBS Service Area.

If the MBS service area received in the request cannot be entirely covered by the MB-SMF service area, the MB-SMF shall reduce the MBS service area to be within the MB-SMF service area and continue the Create service operation using the reduced MBS service area. In this case, the MB-SMF shall indicate in the response the reduced MBS service area in the redMbsServArea attribute set to the part of the requested MBS service area that is within the MB-SMF service area in which the MBS session has been created.

- 2b. On failure or redirection, one of the HTTP status code listed in Table 6.2.3.2.3.1-3 shall be returned. For a 4xx/5xx response, the message body may contain a ProblemDetails structure with the "cause" attribute set to one of the application errors listed in Table 6.2.3.2.3.1-3.

### 5.3.2.3 Update

#### 5.3.2.3.1 General

The Update service operation shall be used to update a multicast or a broadcast MBS session, or for a location dependent MBS session, the part of an MBS Session within an MBS service area.

NOTE: For a location dependent MBS service, the Update service operation is performed per MBS service area of the MBS session.

It is used in the following procedures:

- MBS Session Update with or without PCC (see clauses 7.1.1.6 and 7.1.1.7 of 3GPP TS 23.247 [14]); and
- MBS Session Update for Broadcast (see clause 7.3.3 of 3GPP TS 23.247 [14]).

The NF Service Consumer (e.g. NEF, MBSF or AF) shall update an MBS session by using the HTTP PATCH method with the URI of the individual MBS session as shown in Figure 5.3.2.3.1-1.

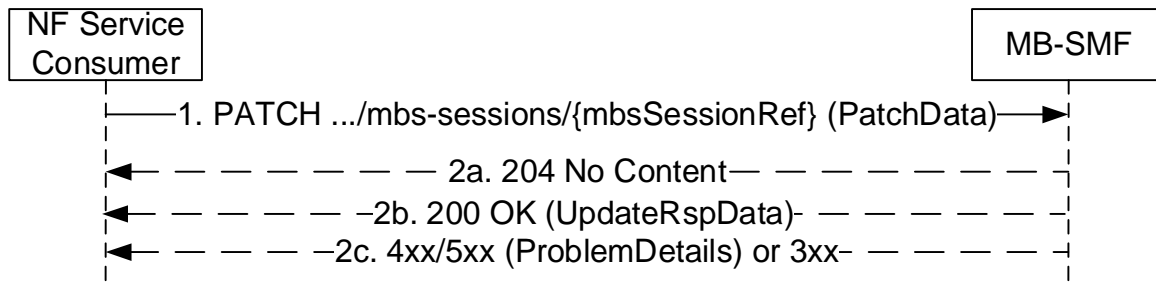

**Figure 5.3.2.3.1-1: MBS session update**

1. The NF Service Consumer shall send a PATCH request (PatchData) to update the MBS session. The following parameters may be modified:
  - for a multicast or a broadcast MBS session:
    - MBS Service Area and/or;
    - MBS service information.
  - for a multicast MBS session:
    - session activity status (active/inactive) to activate or deactivate an MBS session; and/or
    - if security protection is applied, the multicast session security context containing MBS Service Key (MSK), MBS Traffic Key (MTK) and the corresponding key IDs.
  - for a broadcast MBS session:
    - list of MBS FSA IDs;
    - NR RedCap UE information to indicate whether the broadcast MBS session is intended only for NR RedCap UEs, for both NR RedCap UEs and non-RedCap UEs or only for non-RedCap UEs.

If the "indication that the PCF has to be contacted" shall be conveyed in the update request as defined in 3GPP TS 23.247 [14], the NF service consumer shall include the corresponding "contactPcfInd" attribute within the set of requested modifications.

- 2a. On success, the MB-SMF shall return a "204 No Content" response.
- 2b. If the MBS service area received in the request cannot be entirely covered by the MB-SMF service area, the MB-SMF shall reduce the MBS service area to be within the MB-SMF service area and continue the Update service operation using the reduced MBS service area. In this case, the MB-SMF shall return a "200 OK" response and provide in the response the representation of the updated MBS session including the reduced MBS service area in the redMbsServArea attribute set to the part of the requested MBS service area that is within the MB-SMF service area in which the MBS session has been updated.
- 2c. On failure or redirection, one of the HTTP status code listed in Table 6.2.3.3.1-3 shall be returned. For a 4xx/5xx response, the message body may contain a ProblemDetails structure with the "cause" attribute set to one of the application errors listed in Table 6.2.3.3.1-3.

## 5.3.2.4 Release

### 5.3.2.4.1 General

The Release service operation shall be used to delete a multicast or broadcast MBS session, or for a location dependent MBS session, the part of an MBS Session within an MBS service area.

NOTE: For a location dependent MBS service, the Release service operation is performed per MBS service area of the MBS session.

It is used in the following procedures:

- MBS Session Deletion with or without PCC (see clauses 7.1.1.4 and 7.1.1.5 of 3GPP TS 23.247 [14]); and
- MBS Session Release for Broadcast (see clause 7.3.2 of 3GPP TS 23.247 [14]).

The NF Service Consumer (e.g. NEF, MBSF or AF) shall release an MBS session by using the HTTP DELETE method with the URI of the individual MBS session as shown in Figure 5.3.2.4.1-1.

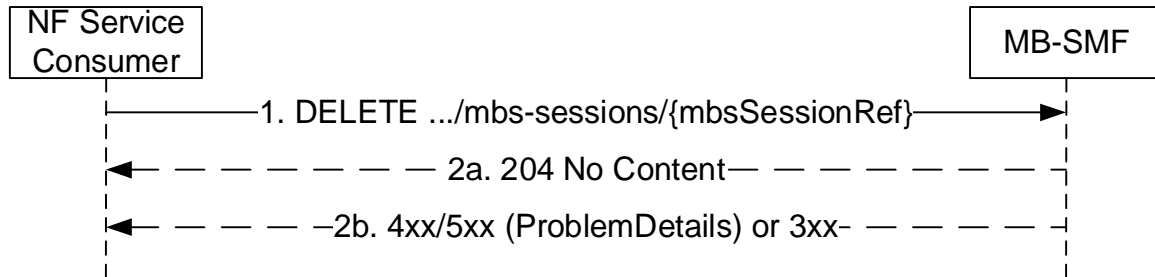

**Figure 5.3.2.4.1-1: MBS session release**

1. The NF Service Consumer shall send a DELETE request (mbsSessionRef) to release the MBS session.
- 2a. On success, the MB-SMF shall release ingress resource for the MBS session and return a "204 No Content" response.
- 2b. On failure or redirection, one of the HTTP status code listed in Table 6.2.3.3.3.2-3 shall be returned. For a 4xx/5xx response, the message body may contain a ProblemDetails structure with the "cause" attribute set to one of the application errors listed in Table 6.2.3.3.3.2-3.

## 5.3.2.5 ContextUpdate

### 5.3.2.5.1 General

The ContextUpdate service operation shall be used to start or terminate MBS data reception of a multicast MBS session, or for a location dependent multicast MBS session, for the part of an MBS session within an MBS service area.

**NOTE:** For a location dependent multicast MBS service, the ContextUpdate service operation is performed per MBS service area of the MBS session.

It is used in the following procedures:

- to start MBS data reception:
  - Multicast session join and session establishment procedure (see clause 7.2.1.3 of 3GPP TS 23.247 [14])
  - Establishment of shared delivery toward RAN node (see clause 7.2.1.4 of 3GPP TS 23.247 [14])
  - Xn based handover from MBS supporting NG-RAN node (see clause 7.2.3.2 of 3GPP TS 23.247 [14])
  - N2 based handover from MBS supporting NG-RAN node (see clause 7.2.3.3 of 3GPP TS 23.247 [14])
  - MBS session activation procedure (see clause 7.2.5.2 of 3GPP TS 23.247 [14])
- to terminate MBS data reception:
  - MBS session Leave (see clause 7.2.2.2 of 3GPP TS 23.247 [14])
  - SMF removing joined UEs from MBS session (see clause 7.2.2.3 of 3GPP TS 23.247 [14])
  - Release of shared delivery toward RAN node (see clause 7.2.2.4 of 3GPP TS 23.247 [14])
  - MBS session deactivation procedure (see clause 7.2.5.3 of 3GPP TS 23.247 [14])

The NF Service Consumer (e.g. AMF or SMF) shall update the MBS session context to start or terminate the MBS data reception of an MBS session by using the HTTP POST method as shown in Figure 5.3.2.5.1-1.

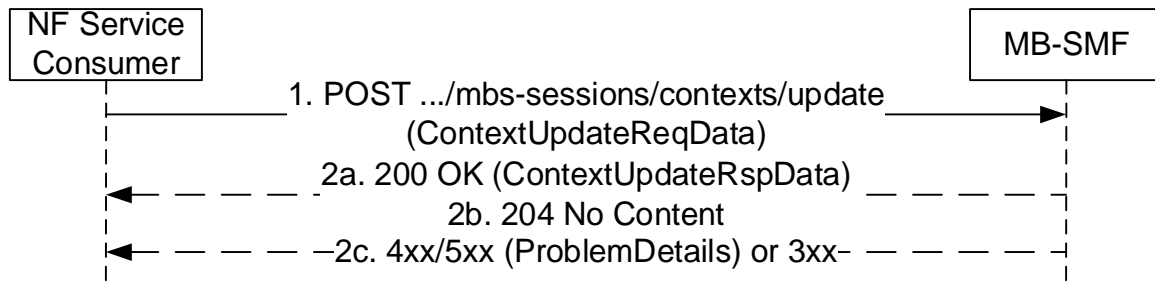

**Figure 5.3.2.5.1-1: Multicast MBS session Context Update**

1. The NF Service Consumer shall send a POST request targeting the /mbs-sessions/contexts/update resource. The content of the POST request (ContextUpdateReqData structure) shall contain the following information:
  - NF Instance ID of the NF Service Consumer;
  - MBS Session ID;
  - Area Session ID, for a location dependent MBS session;
  - if the NF Service Consumer is the SMF:
    - requested action (i.e. Start or terminate MBS data reception);
    - the (UPF) DL GTP-U F-TEID, to be used for starting or terminating MBS data reception, if unicast transport is used over N19mb.
  - if the NF Service Consumer is the AMF:
    - RAN Node ID;
    - N2 MBS Session Management Container (see MBS Distribution Setup Request Transfer IE and MBS Distribution Release Request Transfer IE specified in clauses 9.3.5.7 and 9.3.5.10 of 3GPP TS 38.413 [20]), if an N2 MBS Session Management Container has been received from the NG-RAN;
    - a Leave Indication, if it is the last NG-RAN controlled by the AMF serving the multicast MBS session.
- 2a. On success, a "200 OK" response shall be returned, if additional information needs to be returned in the response. The content of the POST response (ContextUpdateRspData structure) may contain the following parameters:
  - if the NF Service Consumer is the SMF and it was requested to start MBS data reception:
    - the GTP-U Common TEID (C-TEID, see 3GPP TS 29.281 [17]) and the related IP multicast source address of the MB-UPF, for data reception over N19mb using multicast transport, if no DL GTP-U F-TEID was received in the request for unicast transport;
  - if the NF Service Consumer is the AMF:
    - N2 MBS Session Management Container (see MBS Distribution Setup Response Transfer IE or MBS Distribution Setup Unsuccessful Transfer IE specified in clauses 9.3.5.8 and 9.3.5.9 of 3GPP TS 38.413 [20]), if an N2 MBS Session Management Container needs to be sent to the NG-RAN.

If the MB-SMF supports a deployment where NG-U termination can be shared by multiple NG-RAN nodes, the MB-SMF shall check the information (e.g. NG-RAN Node ID, NG-U DL F-TEID, etc.) carried in the N2 MBS Session Management Container in step 1, and accordingly determine whether to maintain the existing shared NG-U tunnel or request the MB-UPF to establish new shared NG-U tunnel or release the existing shared NG-U tunnel, as specified in clause 7.2.1.4 and clause 7.2.2.4 of 3GPP TS 23.247 [14].

If the Leave indication was received in the request, the MB-SMF shall remove the information of the AMF from the context of the multicast MBS session.

NOTE: The user plane from the MB-UPF to NG-RAN (for 5GC Shared MBS traffic delivery) and the user plane from MB-UPF to UPFs (5GC Individual MBS traffic delivery) may use multicast transport via a common GTP-U tunnel per MBS session or use unicast transport via separate GTP-U tunnels at NG-RAN or at UPF per MBS session.

2b. Otherwise, the MB-SMF shall return a "204 No Content" response if no additional information needs to be returned in the response

2c. On failure or redirection, one of the HTTP status code listed in Table 6.2.3.2.4.2.2-2 shall be returned. For a 4xx/5xx response, the message body may contain a ProblemDetails structure with the "cause" attribute set to one of the application errors listed in Table 6.2.3.2.4.2.2-2.

## 5.3.2.6 StatusSubscribe service operation

### 5.3.2.6.1 General

The StatusSubscribe service operation shall be used by an NF Service Consumer (e.g. NEF, MBSF or AF) to create or to update a subscription to the MB-SMF notifications related to the status of an MBS session or, for a location dependent MBS session, the part of an MBS session within an MBS service area.

NOTE: For a location dependent MBS service, one StatusSubscribe service operation is performed per MBS Service Area of the MBS session.

### 5.3.2.6.2 Subscription creation

When the StatusSubscribe service operation is used for creating a subscription, the NF Service Consumer (e.g. NEF, MBSF or AF) shall subscribe to MB-SMF service notifications by using the HTTP POST method as shown in Figure 5.3.2.6.2-1.

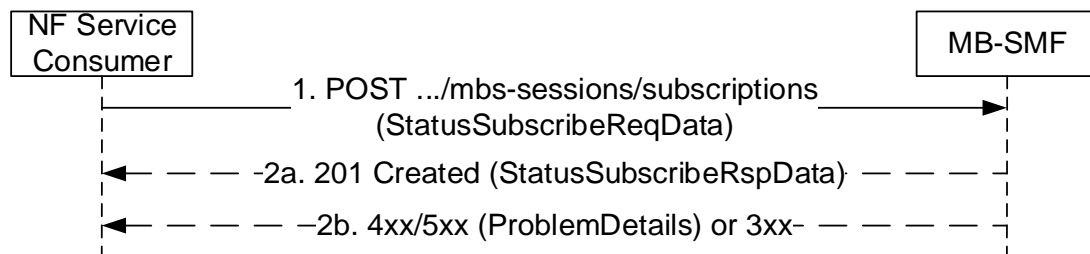

**Figure 5.3.2.6.2-1: Subscribing to MB-SMF notifications**

1. The NF Service Consumer shall send a POST request to the resource URI representing the "/subscriptions" collection resource in the MB-SMF (/mbs-sessions/subscriptions). The request body shall include the data indicating the type of notifications that the NF Service Consumer is interested in receiving. The content of the POST request (StatusSubscribeReqData data structure, see clause 6.2.6.2.7) shall contain:

- the MBS Session ID (source specific IP multicast address or TMGI);
- Area Session ID, for a location dependent MBS session;
- the list of MBS session events requested to be subscribed.
- the Notification URI, indicating the address where the MB-SMF shall send the MBS session status notifications; and
- the NF instance ID of the subscribing NF, if available.

The request body may also contain:

- an expiry time suggested by the NF Service Consumer, representing the time span during which the subscription is desired to be kept active; and

- a Notification Correlation ID indicating the correlation identity to be carried in event notifications generated by the subscription.
- 2a. On success, the MB-SMF shall return a "201 Created" response. The "Location" header shall be present and shall contain the URI of the created resource. The content of the POST response shall include a representation of the created subscription (StatusSubscribeRspData data structure, see clause 6.2.6.2.8), with the following parameters:
- MBS Session ID (source specific IP multicast address or TMGI);
  - Area Session ID, for a location dependent MBS session;
  - the list of MBS session events successfully subscribed; and
  - the expiry time after which the subscription becomes invalid.
- The POST response may also contain:
- a list of event reports, if corresponding information is available.
- 2b. On failure or redirection, one of the HTTP status code listed in Table 6.2.3.4.3.1-3 shall be returned. For a 4xx/5xx response, the message body may contain a ProblemDetails structure with the "cause" attribute set to one of the application error listed in the same Table 6.2.3.4.3.1-3).

### 5.3.2.6.3 Subscription update

When the StatusSubscribe service operation is used for updating a subscription, the NF Service Consumer (e.g. NEF, MBSF or AF) shall update its subscription to MB-SMF notifications by using the HTTP PATCH method as shown in Figure 5.3.2.6.3-1.

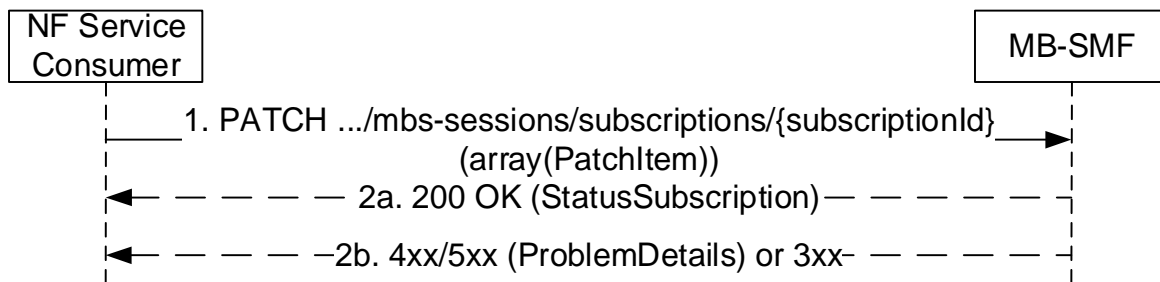

**Figure 5.3.2.6.2-1: Updating a subscription to MB-SMF notifications**

1. The NF Service Consumer shall send a PATCH request to update the individual subscription resource at the MB-SMF (/mbs-sessions/subscriptions/{subscriptionId}). The message body contains an array(PatchItem), where each PatchItem type indicates a requested change to the MbsSessionSubscriptiondata (see clause 5.2.4.3 in 3GPP TS 29.571 [18]). The following information may be requested to be modified with array(PatchItem) structure (see Table 6.2.3.5.3.1-2):
  - Notification URI (callback URI), indicating the address where the MB-SMF shall send the notifications;
  - Notification Correlation ID, indicating the correlation identity to be carried in event notifications generated by the subscription;
  - New expiration time; and/or
  - List of MBS Session events.
- 2a. On success, the MB-SMF shall return a "200 Ok" response with a representation of the modified subscription (MbsSessionSubscription data structure, see clause 5.2.4.3 in 3GPP TS 29.571 [18]).
- 2b. On failure or redirection, one of the HTTP status code listed in Table 6.2.3.5.3.1-3 shall be returned. For a 4xx/5xx response, the message body may contain a ProblemDetails structure with the "cause" attribute set to one of the application error listed in the same Table 6.2.3.5.3.1-3.

### 5.3.2.7 StatusUnsubscribe

#### 5.3.2.7.1 General

The StatusUnsubscribe service operation shall be used by an NF Service Consumer (e.g. NEF, MBSF or AF) to unsubscribe from the MB-SMF notifications related to the status of the MBS session, or for a location dependent MBS session, of the part of an MBS session within an MBS service area.

NOTE: For a location dependent multicast MBS service, the StatusUnsubscribe service operation is performed per MBS service area of the MBS session.

The NF Service Consumer (e.g. NEF, MBSF or AF) shall unsubscribe from MB-SMF service notifications by using the HTTP DELETE method as shown in Figure 5.3.2.7.1-1.

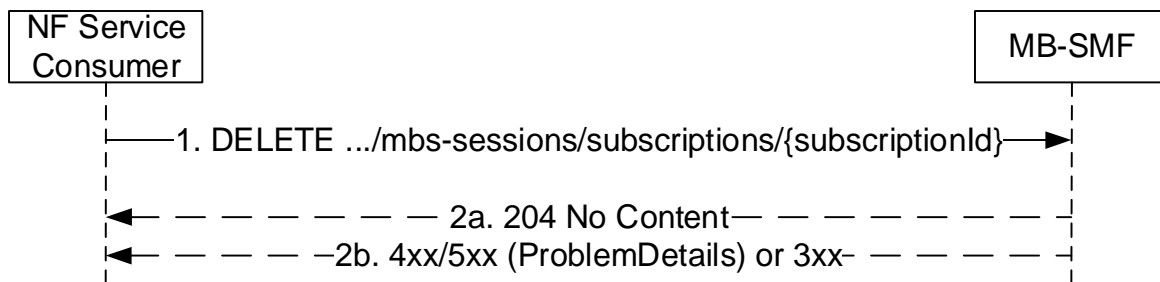

Figure 5.3.2.7.1-1: Unsubscribing from MB-SMF notifications

1. The NF Service Consumer shall send a DELETE request to the resource URI representing the individual subscription document resource in the MB-SMF (/subscriptions/{subscriptionID}).
2. On success, the MB-SMF shall return a "204 No Content" response.
- 2b. On failure or redirection, one of the HTTP status code listed in Table 6.2.3.5.3.2-3 shall be returned. For a 4xx/5xx response, the message body may contain a ProblemDetails structure with the "cause" attribute set to one of the application error listed in the same Table 6.2.3.5.3.2-3.

### 5.3.2.8 StatusNotify

#### 5.3.2.8.1 General

The StatusNotify service operation shall be used by the MB-SMF to notify a subscribed NF Service Consumer (e.g. NEF, MBSF or AF) about the change in the status of the MBS session, or for a location dependent MBS session, of the part of an MBS session within an MBS service area.

NOTE: For a location dependent multicast MBS service, the StatusNotify service operation is performed per MBS service area of the MBS session.

The MB-SMF shall notify the NF Service Consumer (e.g. NEF, MBSF or AF) by using the HTTP POST method to the callback URI received earlier in the subscription as shown in Figure 5.3.2.8.1-1.

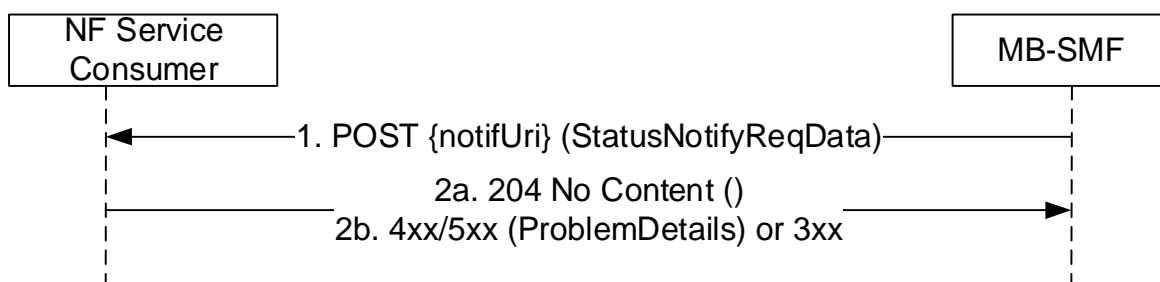

Figure 5.3.2.8.1-1: MB-SMF notifications



1. The MB-SMF shall send a POST request to the callback URI ({notifUri}) of the subscribed NF Service Consumer. The content of the POST request (StatusNotifyReqData data structure) shall contain:
  - Notification Correlation ID, if this information is available in the MBS session status subscription;
  - the list of MBS session events to be reported;
  - When reporting a BROADCAST\_DELIVERY\_STATUS event:
    - the new broadcast delivery status (e.g. the MBS session has been STARTED or TERMINATED);
  - When reporting a INGRESS\_TUNNEL\_ADD\_CHANGE event:
    - new ingress tunnel address used over the N6mb/Nmb9 reference point.
- 2a. On success, the MB-SMF shall return a "204 No Content" response.
- 2b. On failure or redirection, one of the HTTP status code listed in Table 6.2.5.2.3.1-2 shall be returned. For a 4xx/5xx response, the message body may contain a ProblemDetails structure with the "cause" attribute set to one of the application error listed in the same Table 6.2.5.2.3.1-2).

### 5.3.2.9 ContextStatusSubscribe

#### 5.3.2.9.1 General

The ContextStatusSubscribe service operation enables to create and modify a subscription to notifications of events about a multicast MBS session context.

NOTE: For a location dependent MBS service, the ContextStatusSubscribe service operation is performed per MBS session.

#### 5.3.2.9.2 Creation of a subscription

The ContextStatusSubscribe service operation shall be used to request information (e.g. QoS information) about a multicast MBS session and subscribe to notifications of events about the multicast MBS session context.

It is used in the following procedures:

- Multicast session join and session establishment procedure (see clause 7.2.1.3 of 3GPP TS 23.247 [14]).

The NF Service Consumer may subscribe to multiple events in a subscription. A subscription shall be specific to a multicast MBS session context.

The NF Service Consumer (e.g. SMF) shall request information (e.g. QoS information) about a multicast MBS session and create a subscription to notification of events about the multicast MBS session context by using the HTTP POST method with the URI of the Subscriptions collection for MBS contexts resource as shown in Figure 5.3.2.9.2-1.

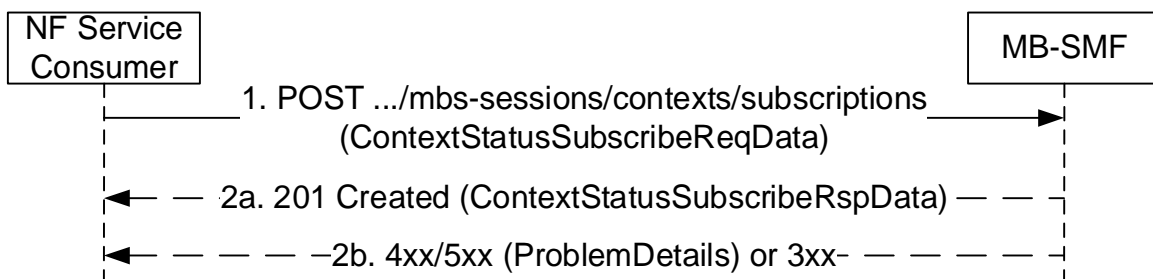

**Figure 5.3.2.9.2-1: Creation of a subscription for a multicast MBS session context**

1. The NF Service Consumer shall send a POST request. The content of the POST request (ContextStatusSubscribeReqData structure) shall contain the description of the subscription requested to be created:
  - NF Instance ID of the NF Service Consumer creating the subscription;

- MBS Session ID (i.e. TMGI or source specific multicast address) being the target of the subscription;
- Event ID(s) of the events to which the NF service consumer requests to subscribe; and
- Notification URI, indicating the address where to send the events notifications generated by the subscription;

The content of the POST request may further contain the following parameters:

- Notification Correlation ID, indicating the correlation identity to be carried in event notifications generated by the subscription.
- For each subscribed event:
  - Immediate Report Indication, to request to receive an immediate report in the response with the current event status;
  - Reporting Mode, to indicate how event shall be reported (One-time Reporting or Continuous);
- Expiry time, indicating the time up to which the subscription is desired to be kept active and after which the subscribed events shall stop generating notifications.

In this release of the specification, the SMF shall subscribe to the "QOS\_INFO", "STATUS\_INFO", "SERVICE\_AREA\_INFO", "SESSION\_RELEASE", "SECURITY\_INFO" and "MULT\_TRANS\_ADD\_CHANGE" events, with the Reporting Mode set to "Continuous event reporting".

- 2a. On success, the MB-SMF shall return a "201 Created" response, with an HTTP Location header providing the URI of the newly created resource.

The content of the POST response (ContextStatusSubscribeRspData structure) shall include a representation of the created subscription. If the NF Service Consumer has included more than one event in the subscription creation request and some of the events cannot be subscribed, the MB-SMF shall accept the request and indicate the successfully subscribed event(s) in the response.

If the NF Service Consumer has requested an Immediate Report, the MB-SMF shall include the current status of the events subscribed in the response, if available:

- list of MBS QoS flows to set up (in the qosFlowsAddModRequestList IE) for the multicast MBS session;
- multicast MBS session's status (activated/deactivated);
- multicast MBS session service area for local multicast service; and
- if security protection is applied, the multicast session security context containing MBS Service Key (MSK), MBS Traffic Key (MTK) and the corresponding key IDs.

NOTE: No immediate report is generated for the MULT\_TRANS\_ADD\_CHANGE event type.

If the NF Service Consumer has requested One-time Reporting and if the MB-SMF has included the current status of the events subscribed in the response, then the MB-SMF shall not do any subsequent event notification for the subscribed events.

The content of the POST response shall also contain the following parameters:

- the MBS Service Areas and their respective Area Session IDs, for a location dependent MBS session; or
- the MBS Service Area, for a local MBS session.

The content of the POST response may also contain the following parameters:

- start time of the multicast MBS session;
- the GTP-U Common TEID (C-TEID, see 3GPP TS 29.281 [17]) and the related IP multicast source address of the MB-UPF, for data reception over N19mb using multicast transport, if IP multicast transport may apply over N19mb;
- MBS session authorization information (i.e. indication whether the multicast MBS session allows any UE to join);

- Expiry time after which the subscription becomes invalid, determined based on operator policies and taking into account the expiry time included in the request if any. If an expiry time was included in the request, then the expiry time returned in the response should be less than or equal to that value. The NF Service Consumer may update the subscription before the Expiry time to extend the subscription lifetime. Once the subscription expires, if the NF Service Consumer wants to keep receiving notifications, it shall create a new subscription in the MB-SMF. If the expiry time is not included in the response, the NF Service Consumer shall consider the subscription to be valid without an expiry time.

2b. On failure or redirection, one of the HTTP status code listed in Table 6.2.3.6.3.1-3 shall be returned. For a 4xx/5xx response, the message body may contain a ProblemDetails structure with the "cause" attribute set to one of the application errors listed in Table 6.2.3.6.3.1-3.

### 5.3.2.9.3 Modification of a Subscription

The ContextStatusSubscribe service operation shall be used to modify an existing subscription or extends the lifetime of an existing subscription to notifications of events about a multicast MBS session context.

The NF Service Consumer shall modify the subscription by using HTTP method PATCH with the URI of the individual subscription resource to be modified as shown in Figure 5.3.2.9.3-1.

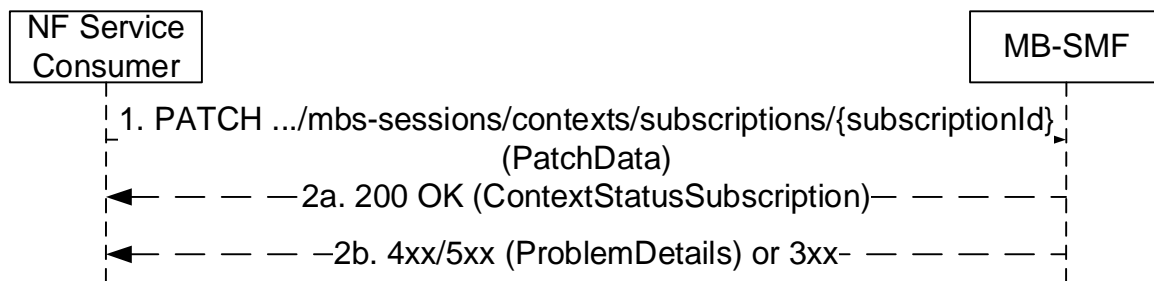

**Figure 5.3.2.9.3-1: Modification of a subscription for a multicast MBS session context**

1. The NF Service Consumer shall send a PATCH request (PatchData) targeting the URI of the individual subscription resource to be modified. The content of the PATCH request shall contain the description of the modifications to apply to the subscription. The following information may be requested to be modified:
  - NF Instance ID of the NF Service Consumer;
  - Notification URI, indicating the address where to send the events notifications generated by the subscription;
  - Event ID(s) of the events to which the NF service consumer requests to subscribe;
  - Notification Correlation ID, indicating the correlation identity to be carried in event notifications generated by the subscription.
  - Expiry time, indicating the time up to which the subscription is desired to be kept active and after which the subscribed events shall stop generating notifications.

NOTE: A subscription can be modified e.g. when it is taken over by another SMF in the same SMF set, or before the Expiry time expires.

2a. On success, the MB-SMF shall return a "200 OK" response, with the content (ContextStatusSubscription) containing a representation of the modified subscription.

2b. On failure or redirection, one of the HTTP status code listed in Table 6.2.3.7.3.1-3 shall be returned. For a 4xx/5xx response, the message body may contain a ProblemDetails structure with the "cause" attribute set to one of the application errors listed in Table 6.2.3.7.3.1-3.

### 5.3.2.10 ContextStatusUnSubscribe

#### 5.3.2.10.1 General

The ContextStatusUnSubscribe service operation shall be used to unsubscribe to notifications of events about a multicast MBS session context.

NOTE: For a location dependent MBS service, the ContextStatusUnSubscribe service operation is performed per MBS session.

The NF Service Consumer (e.g. SMF) shall unsubscribe to notification of events about a multicast MBS session context by using the HTTP DELETE method as shown in Figure 5.3.2.10.1-1.

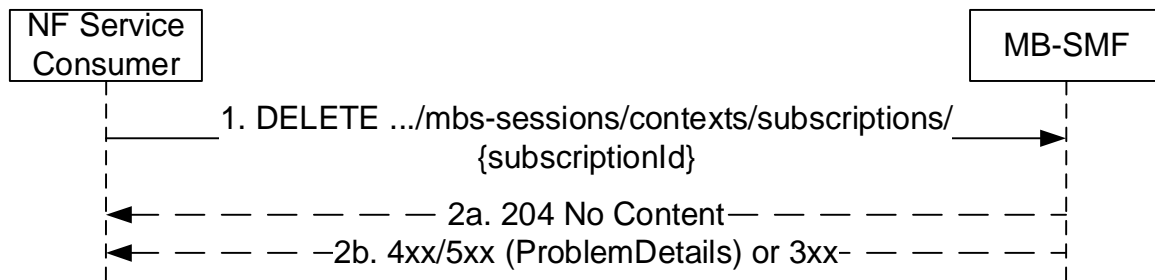

**Figure 5.3.2.10.1-1: Deletion of a subscription for a multicast MBS session context**

1. The NF Service Consumer shall send a DELETE request (subscriptionId) targeting the subscription resource to be deleted.
- 2a. On success, the MB-SMF shall return a "204 No Content" response.
- 2b. On failure or redirection, one of the HTTP status code listed in Table 6.2.3.7.3.2-3 shall be returned. For a 4xx/5xx response, the message body may contain a ProblemDetails structure with the "cause" attribute set to one of the application errors listed in Table 6.2.3.7.3.2-3.

### 5.3.2.11 ContextStatusNotify

#### 5.3.2.11.1 General

The ContextStatusNotify service operation shall be invoked by the MB-SMF to send a notification about event(s), when events about the multicast MBS session context included in the subscription occur.

NOTE: For a location dependent MBS service, the ContextStatusNotify service operation is performed per MBS session.

It is used in the following procedures:

- Multicast session leave requested by the network or MBS session release (see clause 7.2.2.3 of 3GPP TS 23.247 [14]);
- MBS session activation procedure (see clause 7.2.5.2 of 3GPP TS 23.247 [14]);
- MBS session deactivation procedure (see clause 7.2.5.3 of 3GPP TS 23.247 [14]); and
- Multicast session update procedure (see clause 7.2.6 of 3GPP TS 23.247 [14]).

The MB-SMF shall notify event(s) about the multicast MBS session context by using the HTTP POST method targeting the notification URI received in the subscription as shown in Figure 5.3.2.11.1-1.

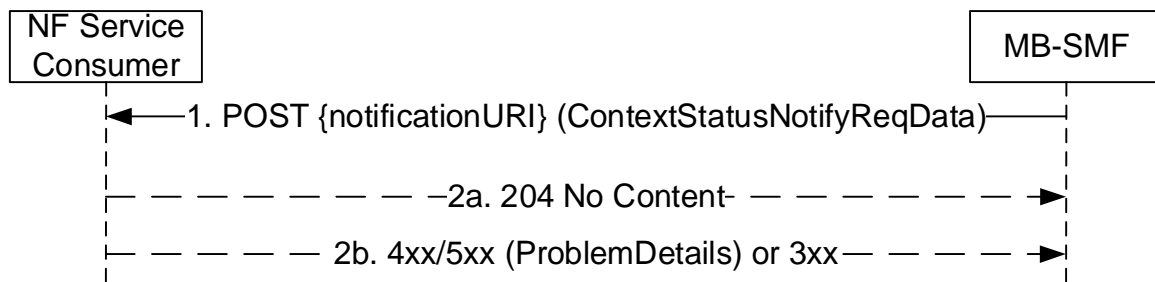

**Figure 5.3.2.11.1-1: Notification of a multicast MBS session context event**

1. The MB-SMF shall send a POST request targeting the notification URI. The notification, i.e. the content of the POST request (ContextStatusNotifyReqData structure) shall contain the following information:
  - Notification Correlation ID, if available in the subscription;
  - List of event(s) which occurred;
  - When reporting a MULT\_TRANS\_ADD\_CHANGE event:
    - new multicast transport address (Low Layer SSM and C-TEID) used over the N19mb reference point;
    - area session Id of the part of the location dependent MBS session for which the new multicast transport address is provided, for a location dependent MBS session;
  - When reporting a QOS\_INFO event:
    - list of MBS QoS flows to add, modify and/or release (in the qosFlowsAddModRequestList IE and/or qosFlowsRelRequestList) for the multicast MBS session.
  - When reporting a SECURITY\_INFO event:
    - if security protection is applied, the multicast session security context containing MBS Service Key (MSK), MBS Traffic Key (MTK) and the corresponding key IDs.
- 2a. On success, a "204 No Content" response shall be returned.
- 2b. On failure or redirection, one of the HTTP status code listed in Table 6.2.5.3.3.1-2 shall be returned. For a 4xx/5xx response, the message body may contain a ProblemDetails structure with the "cause" attribute set to one of the application errors listed in Table 6.2.5.3.3.1-2.

## 6 API Definitions

### 6.1 Nmbsmf\_TMGI Service API

#### 6.1.1 Introduction

The Nmbsmf\_TMGI service shall use the Nmbsmf\_TMGI API.

The API URI of the Nmbsmf\_TMGI API shall be:

**{apiRoot}/<apiName>/<apiVersion>**

The request URIs used in HTTP requests from the NF service consumer towards the NF service producer shall have the Resource URI structure defined in clause 4.4.1 of 3GPP TS 29.501 [5], i.e.:

**{apiRoot}/<apiName>/<apiVersion>/<apiSpecificResourceUriPart>**

with the following components:

- The {apiRoot} shall be set as described in 3GPP TS 29.501 [5].
- The <apiName> shall be "nmbsmf-tmgi".
- The <apiVersion> shall be "v1".
- The <apiSpecificResourceUriPart> shall be set as described in clause 6.1.3.

## 6.1.2 Usage of HTTP

### 6.1.2.1 General

HTTP/2, IETF RFC 9113 [11], shall be used as specified in clause 5 of 3GPP TS 29.500 [4].

HTTP/2 shall be transported as specified in clause 5.3 of 3GPP TS 29.500 [4].

The OpenAPI [6] specification of HTTP messages and content bodies for the Nmbsmf\_TMGI API is contained in Annex A.

### 6.1.2.2 HTTP standard headers

#### 6.1.2.2.1 General

See clause 5.2.2 of 3GPP TS 29.500 [4] for the usage of HTTP standard headers.

#### 6.1.2.2.2 Content type

JSON, IETF RFC 8259 [12], shall be used as content type of the HTTP bodies specified in the present specification as specified in clause 5.4 of 3GPP TS 29.500 [4]. The use of the JSON format shall be signalled by the content type "application/json".

"Problem Details" JSON object shall be used to indicate additional details of the error in a HTTP response body and shall be signalled by the content type "application/problem+json", as defined in IETF RFC 9457 [13].

### 6.1.2.3 HTTP custom headers

The mandatory HTTP custom header fields specified in clause 5.2.3.2 of 3GPP TS 29.500 [4] shall be supported, and the optional HTTP custom header fields specified in clause 5.2.3.3 of 3GPP TS 29.500 [4] may be supported.

## 6.1.3 Resources

### 6.1.3.1 Overview

Figure 6.1.3.1-1 describes the resource URI structure of the Nmbsmf\_TMGI API.

{apiRoot}/Nmbsmf-tmgi/<apiVersion>



**Figure 6.1.3.1-1: Resource URI structure of the Nmbsmf\_TMGI API**

Table 6.1.3.1-1 provides an overview of the resources and applicable HTTP methods.

**Table 6.1.3.1-1: Resources and methods overview**

Resource purpose/name	Resource URI (relative path after API URI)	HTTP method or custom operation	Description (service operation)	
TMGI collection	/tmgi	POST	Allocate	
		DELETE	Deallocate	

### 6.1.3.2 Resource: TMGI collection

#### 6.1.3.2.1 Description

This resource represents the collection of the individual TMGI values that can be assigned by the MB-SMF.

This resource is modelled with the Collection resource archetype (see clause C.2 of 3GPP TS 29.501 [5]).

#### 6.1.3.2.2 Resource Definition

Resource URI: {apiRoot}/nmbsmf-tmgi/<apiVersion>/tmgi

This resource shall support the resource URI variables defined in table 6.1.3.2.2-1.

**Table 6.1.3.2.2-1: Resource URI variables for this resource**

Name	Data type	Definition
apiRoot	string	See clause 6.1.1

#### 6.1.3.2.3 Resource Standard Methods

##### 6.1.3.2.3.1 POST

This method requests the MB-SMF to allocate one or more TMGIs with Nmbsmf\_TMGI\_Allocate service operation.

This method shall support the URI query parameters specified in table 6.1.3.2.3.1-1.

**Table 6.1.3.2.3.1-1: URI query parameters supported by the POST method on this resource**

Name	Data type	P	Cardinality	Description	Applicability
n/a					

This method shall support the request data structures specified in table 6.1.3.2.3.1-2 and the response data structures and response codes specified in table 6.1.3.2.3.1-3.

**Table 6.1.3.2.3.1-2: Data structures supported by the POST Request Body on this resource**

Data type	P	Cardinality	Description
TmgiAllocate	M	1	Representation of one or more TMGIs to be allocated by the MB-SMF. The Request Body shall contain: - the requested number of TMGIs (one or more), if TMGIs are requested to be allocated; or - a list of TMGIs, if the expiration time of previously allocated TMGI(s) needs to be refreshed.

**Table 6.1.3.2.3.1-3: Data structures supported by the POST Response Body on this resource**

Data type	P	Cardinality	Response codes	Description
TmgiAllocated	C	1	200 OK	Successful allocation of one or more TMGI(s) and their expiration time. Alternatively, if the expiration time of the previously allocated TMGI(s) needs to be refreshed, the Response Body shall contain the list of the TMGI(s) and their new expiration time.
ProblemDetails	O	0..1	403 Forbidden	When used to represent an unsuccessful TMGI allocation or TMGI refreshment, the "cause" attribute of the "ProblemDetails" may be used to include one of the following application error codes: - MANDATORY_IE_INCORRECT, if the required TMGI number for TMGI allocation is not valid.
ProblemDetails	O	0..1	404 Not Found	When used to represent an unsuccessful TMGI allocation or TMGI refreshment, the "cause" attribute of the "ProblemDetails" may be used to include one of the following application error codes: - UNKNOWN_TMGI, if the TMGI to be refreshed is expired or not found in the MB-SMF.
RedirectResponse	O	0..1	307 Temporary Redirect	Temporary redirection. (NOTE 2)
RedirectResponse	O	0..1	308 Permanent Redirect	Permanent redirection. (NOTE 2)
NOTE 1: The mandatory HTTP error status code for the POST method listed in Table 5.2.7.1-1 of 3GPP TS 29.500 [4] also apply.				
NOTE 2: RedirectResponse may be inserted by an SCP, see clause 6.10.9.1 of 3GPP TS 29.500 [4].				

**Table 6.1.3.2.3.1-4: Headers supported by the POST method on this resource**

Name	Data type	P	Cardinality	Description

**Table 6.1.3.2.3.1-5: Headers supported by the 200 response code on this resource**

Name	Data type	P	Cardinality	Description

**Table 6.1.3.2.3.1-6: Links supported by the 200 Response Code on this endpoint**

Name	Resource name	HTTP method or custom operation	Link parameter(s)	Description

**Table 6.1.3.2.3.1-7: Headers supported by the 307 Response Code on this resource**

Name	Data type	P	Cardinality	Description
Location	string	M	1	An alternative URI of the resource located on an alternative service instance within the same MB-SMF or MB-SMF (service) set. For the case when a request is redirected to the same target resource via a different SCP, see clause 6.10.9.1 in 3GPP TS 29.500 [4].
3gpp-Sbi-Target-Nf-Id	string	O	0..1	Identifier of the target MB-SMF (service) instance ID towards which the request is redirected



**Table 6.1.3.2.3.1-8: Headers supported by the 308 Response Code on this resource**

Name	Data type	P	Cardinality	Description
Location	string	M	1	An alternative URI of the resource located on an alternative service instance within the same MB-SMF or MB-SMF (service) set. For the case when a request is redirected to the same target resource via a different SCP, see clause 6.10.9.1 in 3GPP TS 29.500 [4].
3gpp-Sbi-Target-Nf-Id	string	O	0..1	Identifier of the target MB-SMF (service) instance ID towards which the request is redirected

**6.1.3.2.3.2 DELETE**

This method deallocates one or more of the previously allocated individual TMGIs in the MB-SMF with Nmbsmf\_TMGI\_Deallocate service operation.

This method shall support the URI query parameters specified in table 6.1.3.2.3.2-1.

**Table 6.1.3.2.3.2-1: URI query parameters supported by the DELETE method on this resource**

Name	Data type	P	Cardinality	Description	Applicability
tmgi-list	array(Tmgi)	M	1..N	The list of the TMGIs, which shall be deallocated by MB-SMF.	

This method shall support the request data structures specified in table 6.1.3.3.2-2 and the response data structures and response codes specified in table 6.1.3.2.3.2-3.

**Table 6.1.3.3.2-2: Data structures supported by the DELETE Request Body on this resource**

Data type	P	Cardinality	Description
n/a			

**Table 6.1.3.2.3.2-3: Data structures supported by the DELETE Response Body on this resource**

Data type	P	Cardinality	Response codes	Description
n/a			204 No Content	This case represents a successful deletion of TMGI list.
RedirectResponse	O	0..1	307 Temporary Redirect	Temporary redirection. (NOTE 2)
RedirectResponse	O	0..1	308 Permanent Redirect	Permanent redirection. (NOTE 2)
ProblemDetails	O	0..1	404 Not Found	When used to represent an unsuccessful deletion of TMGI, the "cause" attribute of the "ProblemDetails" may be used to include one of the following application error codes: - UNKNOWN_TMGI, if the TMGI to be deleted is not found in MB-SMF.

NOTE 1: The mandatory HTTP error status codes for the DELETE method listed in Table 5.2.7.1-1 of 3GPP TS 29.500 [4] also apply.

NOTE 2: RedirectResponse may be inserted by an SCP, see clause 6.10.9.1 of 3GPP TS 29.500 [4].

**Table 6.1.3.2.3.2-4: Headers supported by the DELETE method on this resource**

Name	Data type	P	Cardinality	Description

**Table 6.1.3.2.3.2-5: Headers supported by the 307 Response Code on this resource**

Name	Data type	P	Cardinality	Description
Location	string	M	1	An alternative URI of the resource located on an alternative service instance within the same MB-SMF or MB-SMF (service) set. For the case when a request is redirected to the same target resource via a different SCP, see clause 6.10.9.1 in 3GPP TS 29.500 [4].
3gpp-Sbi-Target-Nf-Id	string	O	0..1	Identifier of the target NF (service) instance ID towards which the request is redirected

**Table 6.1.3.2.3.2-6: Headers supported by the 308 Response Code on this resource**

Name	Data type	P	Cardinality	Description
Location	string	M	1	An alternative URI of the resource located on an alternative service instance within the same MB-SMF or MB-SMF (service) set. For the case when a request is redirected to the same target resource via a different SCP, see clause 6.10.9.1 in 3GPP TS 29.500 [4].
3gpp-Sbi-Target-Nf-Id	string	O	0..1	Identifier of the target NF (service) instance ID towards which the request is redirected

#### 6.1.3.2.4 Resource Custom Operations

None.

#### 6.1.4 Custom Operations without associated resources

None.

#### 6.1.5 Notifications

None.

#### 6.1.6 Data Model

##### 6.1.6.1 General

This clause specifies the application data model supported by the API.

Table 6.1.6.1-1 specifies the data types defined for the Nmbsmf\_TMGI service based interface protocol.

**Table 6.1.6.1-1: Nmbsmf\_TMGI specific Data Types**

Data type	Clause defined	Description	Applicability
TmgiAllocate	6.1.6.2.2	TMGI Allocation Request Content.	
TmgiAllocated	6.1.6.2.3	TMGI Allocation Response Content.	

Table 6.1.6.1-2 specifies data types re-used by the Nmbsmf\_TMGI service based interface protocol from other specifications, including a reference to their respective specifications and when needed, a short description of their use within the Nmbsmf service based interface.

**Table 6.1.6.1-2: Nmbsmf\_TMGI re-used Data Types**

Data type	Reference	Comments	Applicability
Tmgi	3GPP TS 29.571 [18]	TMGI	
DateTime	3GPP TS 29.571 [18]	Date and time	
Nid	3GPP TS 29.571 [18]	NID, which is used in SNPN scenarios	

## 6.1.6.2 Structured data types

### 6.1.6.2.1 Introduction

This clause defines the structures to be used in resource representations.

### 6.1.6.2.2 Type: TmgiAllocate

**Table 6.1.6.2.2-1: Definition of type TmgiAllocate**

Attribute name	Data type	P	Cardinality	Description	Applicability
tmgjNumber	integer	C	0..1	This IE shall be present if TMGI allocation is requested. When present, this IE shall indicate the number of TMGIs requested to be allocated. Minimum: 1. Maximum: 255.	
tmgjList	array(Tmgi)	C	1..N	This IE shall be present if the expiration time of previously allocated TMGIs needs to be refreshed. When present, this IE shall contain the list of TMGI(s) to be refreshed.	

### 6.1.6.2.3 Type: TmgiAllocated

**Table 6.1.6.2.3-1: Definition of type TmgiAllocated**

Attribute name	Data type	P	Cardinality	Description	Applicability
tmgjList	array(Tmgi)	M	1..N	One or more TMGIs allocated by MB-SMF. (NOTE)	
expirationTime	DateTime	M	1	Expiration time (in UTC) for the allocated TMGI(s). (NOTE)	
nid	Nid	O	0..1	When present, this IE shall contain the NID, which together with the PLMN ID included in the TMGIs, identifies the SNPN which allocated the TMGIs. (see 3GPP TS 23.003 [7] and 3GPP TS 23.501 [8] clause 5.30.2.1).	
NOTE: This attribute is necessary if the MB-SMF allocates TMGI(s) and also if the MB-SMF refreshes the expiration time of earlier allocated TMGIs.					

### 6.1.6.3 Simple data types and enumerations

#### 6.1.6.3.1 Introduction

This clause defines simple data types and enumerations that can be referenced from data structures defined in the previous clauses.

#### 6.1.6.3.2 Simple data types

The Nmbsmf\_TMGI API does not define any simple data types in this release of the specification.

**Table 6.1.6.3.2-1: Simple data types**

Type Name	Type Definition	Description	Applicability

#### 6.1.6.3.3 Enumeration: <EnumType1>

The Nmbsmf\_TMGI API does not define any enumerations in this release of the specification.

#### 6.1.6.3.4 Void

#### 6.1.6.4 Data types describing alternative data types or combinations of data types

None.

#### 6.1.6.5 Binary data

None.

### 6.1.7 Error Handling

#### 6.1.7.1 General

For the Nmbsmf\_TMGI API, HTTP error responses shall be supported as specified in clause 4.8 of 3GPP TS 29.501 [5]. Protocol errors and application errors specified in table 5.2.7.2-1 of 3GPP TS 29.500 [4] shall be supported for an HTTP method if the corresponding HTTP status codes are specified as mandatory for that HTTP method in table 5.2.7.1-1 of 3GPP TS 29.500 [4].

In addition, the requirements in the following clauses are applicable for the Nmbsmf\_TMGI API.

#### 6.1.7.2 Protocol Errors

No specific procedures for the Nmbsmf\_TMGI service are specified.

#### 6.1.7.3 Application Errors

The application errors defined for the Nmbsmf\_TMGI service are listed in Table 6.1.7.3-1.

**Table 6.1.7.3-1: Application errors**

Application Error	HTTP status code	Description
UNKNOWN_TMGI	404 Not Found	The requested TMGI Allocate or TMGI Deallocate service operation failed, because requested TMGI expired or cannot be found.

## 6.1.8 Feature negotiation

The optional features in table 6.1.8-1 are defined for the Nmbsmf\_TMGI API. They shall be negotiated using the extensibility mechanism defined in clause 6.6 of 3GPP TS 29.500 [4].

**Table 6.1.8-1: Supported Features**

Feature number	Feature Name	Description

## 6.1.9 Security

As indicated in 3GPP TS 33.501 [8] and 3GPP TS 29.500 [4], the access to the Nmbsmf\_TMGI API may be authorized by means of the OAuth2 protocol (see IETF RFC 6749 [9]), based on local configuration, using the "Client Credentials" authorization grant, where the NRF (see 3GPP TS 29.510 [10]) plays the role of the authorization server.

If OAuth2 is used, an NF Service Consumer, prior to consuming services offered by the Nmbsmf\_TMGI API, shall obtain a "token" from the authorization server, by invoking the Access Token Request service, as described in 3GPP TS 29.510 [10], clause 5.4.2.2.

**NOTE:** When multiple NRFs are deployed in a network, the NRF used as authorization server is the same NRF that the NF Service Consumer used for discovering the Nmbsmf\_TMGI service.

The Nmbsmf\_TMGI API defines a single scope "nmbsmf-tmgi" for the entire service, and it does not define any additional scopes at resource or operation level.

## 6.1.10 HTTP redirection

An HTTP request may be redirected to a different MB-SMF service instance, within the same MB-SMF or a different MB-SMF of an MB-SMF set, e.g. when an MB-SMF service instance is part of an MB-SMF (service) set or when using indirect communications (see 3GPP TS 29.500 [4]).

An SCP that reselects a different MB-SMF producer instance will return the NF Instance ID of the new MB-SMF producer instance in the 3gpp-Sbi-Producer-Id header, as specified in clause 6.10.3.4 of 3GPP TS 29.500 [4].

If an MB-SMF within an MB-SMF set redirects a service request to a different MB-SMF of the set using an 307 Temporary Redirect or 308 Permanent Redirect status code, the identity of the new MB-SMF towards which the service request is redirected shall be indicated in the 3gpp-Sbi-Target-Nf-Id header of the 307 Temporary Redirect or 308 Permanent Redirect response as specified in clause 6.10.9.1 of 3GPP TS 29.500 [4].

## 6.2 Nmbsmf\_MBSSession Service API

### 6.2.1 Introduction

The Nmbsmf\_MBSSession shall use the Nmbsmf\_MBSSession API.

The API URI of the Nmbsmf\_MBSSession API shall be:

**{apiRoot}/<apiName>/<apiVersion>/**

The request URIs used in HTTP requests from the NF service consumer towards the NF service producer shall have the Resource URI structure defined in clause 4.4.1 of 3GPP TS 29.501 [5], i.e.:

**{apiRoot}/<apiName>/<apiVersion>/<apiSpecificResourceUriPart>**

with the following components:

- The {apiRoot} shall be set as described in 3GPP TS 29.501 [5].
- The <apiName> shall be "nmbsmf\_mbssession".

- The <apiVersion> shall be "v1".
- The <apiSpecificResourceUriPart> shall be set as described in clause 5.3.

## 6.2.2 Usage of HTTP

### 6.2.2.1 General

HTTP/2, IETF RFC 9113 [11], shall be used as specified in clause 5 of 3GPP TS 29.500 [4].

HTTP/2 shall be transported as specified in clause 5.3 of 3GPP TS 29.500 [4].

The OpenAPI [6] specification of HTTP messages and content bodies for the Nmbsmf\_MBSSession API is contained in Annex A.

### 6.2.2.2 HTTP standard headers

#### 6.2.2.2.1 General

See clause 5.2.2 of 3GPP TS 29.500 [4] for the usage of HTTP standard headers.

#### 6.2.2.2.2 Content type

The following content types shall be supported:

- JSON, as defined in IETF RFC 8259 [12], shall be used as content type of the HTTP bodies specified in the present specification as specified in clause 5.4 of 3GPP TS 29.500 [4]. The use of the JSON format shall be signalled by the content type "application/json".
- The "Problem Details" JSON object, as defined in IETF RFC 9457 [13], shall be used to indicate additional details of the error in a HTTP response body and shall be signalled by the content type "application/problem+json".

Multipart messages shall also be supported (see clause 6.2.2.4) using the content type "multipart/related", comprising:

- one JSON body part with the "application/json" content type; and
- one binary body part with 3gpp vendor specific content subtypes.

The 3gpp vendor specific content subtypes defined in Table 6.5.2.2.2-1 shall be supported.

**Table 6.2.2.2-1: 3GPP vendor specific content subtypes**

content subtype	Description
vnd.3gpp.ngap	Binary encoded content, encoding NG Application Protocol (NGAP) IEs, as specified in clause 9.3 of 3GPP TS 38.413 [20] (ASN.1 encoded).
NOTE:	Using 3GPP vendor content subtypes allows to describe the nature of the opaque content (i.e. NGAP information) without having to rely on metadata in the JSON content.

See clause 6.2.2.4 for the binary content supported in the binary body part of multipart messages.

### 6.2.2.3 HTTP custom headers

The mandatory HTTP custom header fields specified in clause 5.2.3.2 of 3GPP TS 29.500 [4] shall be supported, and the optional HTTP custom header fields specified in clause 5.2.3.3 of 3GPP TS 29.500 [4] may be supported.

### 6.2.2.4 HTTP multipart messages

HTTP multipart messages shall be supported, to transfer opaque N2 Information in the following service operations (and HTTP messages):

- ContextUpdate Request and Response (POST).

HTTP multipart messages shall include one JSON body part and one binary body parts comprising:

- N2 MBS Session Management information (see clause 6.2.6.5).

The JSON body part shall be the "root" body part of the multipart message. It shall be encoded as the first body part of the multipart message. The "Start" parameter does not need to be included.

The multipart message shall include a "type" parameter (see IETF RFC 2387 [21]) specifying the media type of the root body part, i.e. "application/json".

NOTE: The "root" body part (or "root" object) is the first body part the application processes when receiving a multipart/related message, see IETF RFC 2387 [21]. The default root is the first body within the multipart/related message. The "Start" parameter indicates the root body part, e.g. when this is not the first body part in the message.

For each binary body part in a HTTP multipart message, the binary body part shall include a Content-ID header (see IETF RFC 2045 [22]), and the JSON body part shall include an attribute, defined with the RefToBinaryData type, that contains the value of the Content-ID header field of the referenced binary body part.

## 6.2.3 Resources

### 6.2.3.1 Overview

Figure 6.2.3.1-1 describes the resource URI structure of the Nmbsmf\_MBSSession API.

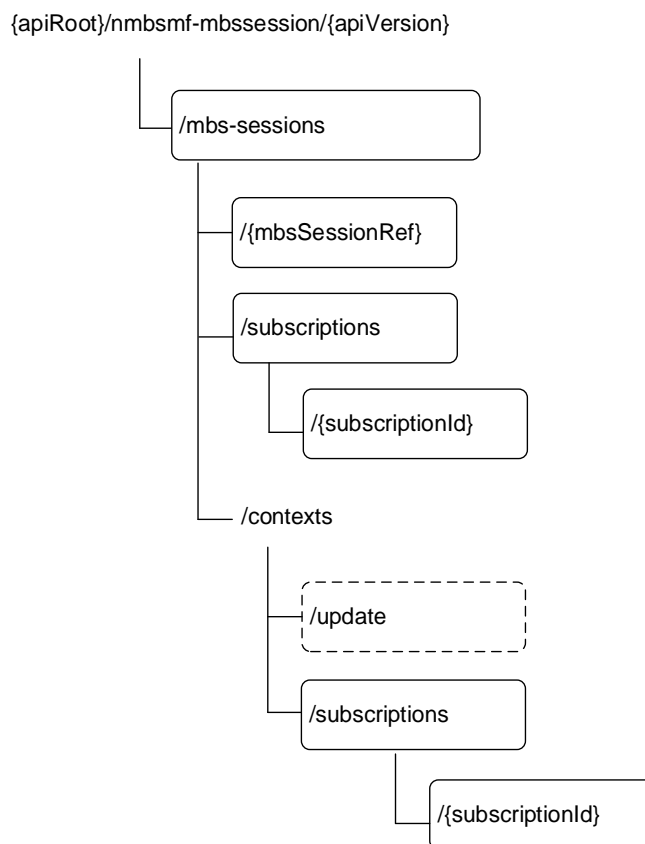

Figure 6.2.3.1-1: Resource URI structure of the Nmbsmf\_MBSSession API

Table 6.2.3.1-1 provides an overview of the resources and applicable HTTP methods.

**Table 6.2.3.1-1: Resources and methods overview**

Resource name	Resource URI (relative path under API URI)	HTTP method or custom operation	Description (service operation)
MBS sessions collection	/mbs-sessions	POST	Create
	/mbs-sessions/contexts/update	update (POST)	ContextUpdate
Individual MBS session	/mbs-sessions/{mbsSessionRef}	PATCH	Update
		DELETE	Delete
Subscriptions collection for MBS sessions	/mbs-sessions/subscriptions	POST	StatusSubscribe (to create a subscription) (NOTE 1, NOTE 2)
Individual subscription for an MBS session	/mbs-sessions/subscriptions/{subscriptionId}	PATCH	StatusSubscribe (to update or renew a subscription)
		DELETE	StatusUnsubscribe
Subscriptions collection for MBS contexts	/mbs-sessions/contexts/subscriptions	POST	ContextStatusSubscribe (to create a subscription) (NOTE 2)
Individual subscription for an MBS context	/mbs-sessions/contexts/subscriptions/{subscriptionId}	PATCH	ContextStatusSubscribe (to update or renew a subscription)
		DELETE	ContextStatusUnsubscribe
NOTE 1: A subscription to an MBS session may be performed after the MBS session is created using the POST method on this resource, or alternatively during the creation of the MBS session.			
NOTE 2: The StatusNotify and ContextStatusNotify service operations are defined in clause 6.2.6.1.			

### 6.2.3.2 Resource: MBS sessions collection (Collection)

#### 6.2.3.2.1 Description

This resource represents the collection of the individual MBS sessions created in the MB-SMF.

This resource is modelled with the Collection resource archetype (see clause C.2 of 3GPP TS 29.501 [5]).

#### 6.2.3.2.2 Resource Definition

Resource URI: {apiRoot}/nmbsmf-mbssession/<apiVersion>/mbs-sessions

This resource shall support the resource URI variables defined in table 6.2.3.2.2-1.

**Table 6.2.3.2.2-1: Resource URI variables for this resource**

Name	Data type	Definition
apiRoot	string	See clause 6.2.1

#### 6.2.3.2.3 Resource Standard Methods

##### 6.2.3.2.3.1 POST

This method creates an individual MBS session resource in the MB-SMF.

This method shall support the URI query parameters specified in table 6.2.3.2.3.1-1.



**Table 6.2.3.2.3.1-1: URI query parameters supported by the POST method on this resource**

Name	Data type	P	Cardinality	Description	Applicability
n/a					

This method shall support the request data structures specified in table 6.2.3.2.3.1-2 and the response data structures and response codes specified in table 6.2.3.2.3.1-3.

**Table 6.2.3.2.3.1-2: Data structures supported by the POST Request Body on this resource**

Data type	P	Cardinality	Description
CreateReqData	M	1	Representation of the MBS session to be created in the MB-SMF

**Table 6.2.3.2.3.1-3: Data structures supported by the POST Response Body on this resource**

Data type	P	Cardinality	Response codes	Description
CreateRspData	M	1	201 Created	Successful creation of an MBS session
RedirectResponse	O	0..1	307 Temporary Redirect	Temporary redirection. (NOTE 2)
RedirectResponse	O	0..1	308 Permanent Redirect	Permanent redirection. (NOTE 2)
ProblemDetails	O	0..1	400 Bad Request	When used to represent an unsuccessful MBS session creation, the "cause" attribute of the "ProblemDetails" may be used to include one of the following application error codes: <ul style="list-style-type: none"> <li>- INVALID_MBS_SERVICE_INFO, if the provided MBS Service Information is invalid (e.g. invalid QoS reference), incorrect or insufficient to perform MBS policy authorization, e.g. if the PCF rejected the creation or update of an MBS Policy Association with the same error (see 3GPP TS 29.537 [23])</li> <li>- FILTER_RESTRICTIONS_NOT_RESPECTED, if the MBS IP flow(s) description provided within the MBS Service Information cannot be handled due to the restrictions defined in clause 5.3.8 of 3GPP TS 29.214 [24] not being respected, e.g. if the PCF rejected the creation or update of an MBS Policy Association with the same error (see 3GPP TS 29.537 [23])</li> <li>- ERROR_INPUT_PARAMETERS, if the provided set of input parameters are incomplete, erroneous or missing necessary information to perform MBS policy control, e.g. if the PCF rejected the creation or update of an MBS Policy Association with the same error (see 3GPP TS 29.537 [23])</li> </ul>
ExtProblemDetails	O	0..1	403 Forbidden	When used to represent an unsuccessful MBS session creation, the "cause" attribute of the "ProblemDetails" may be used to include one of the following application error codes: <ul style="list-style-type: none"> <li>- MBS_SESSION_ALREADY_CREATED, if MBS session to be created has already been created in the MB-SMF.</li> <li>- OVERLAPPING_MBS_SERVICE_AREA, if the new MBS service area overlaps with the service area of any MBS session with the same MBS session identifier.</li> <li>- MBS_SERVICE_INFO_NOT_AUTHORIZED, if the provided MBS Service Information is not authorized to perform MBS policy authorization, e.g. if the PCF rejected the creation or update of an MBS Policy Association with the same error (see 3GPP TS 29.537 [23])</li> <li>- MBS_POLICY_CONTEXT_DENIED, if the request is rejected due to operator policies and/or local configuration, e.g. if the PCF rejected the creation or update of an MBS Policy Association with the same error (see 3GPP TS 29.537 [23])</li> </ul>

ProblemDetails	O	0..1	404 Not Found	When used to represent an unsuccessful MBS session creation, the "cause" attribute of the "ProblemDetails" may be used to include one of the following application error codes: - UNKNOWN_TMGI, if the TMGI indicated in the mbsSessionId IE is not found in the MB-SMF. This application error shall not apply to a location dependent broadcast MBS session if, based on operator's policy, the MB-SMF shall accept a TMGI value allocated by another MB-SMF.
NOTE 1: The mandatory HTTP error status code for the POST method listed in Table 5.2.7.1-1 of 3GPP TS 29.500 [4] also apply.				
NOTE 2: RedirectResponse may be inserted by an SCP, see clause 6.10.9.1 of 3GPP TS 29.500 [4].				

**Table 6.2.3.2.3.1-4: Headers supported by the POST method on this resource**

Name	Data type	P	Cardinality	Description

**Table 6.2.3.2.3.1-5: Headers supported by the 201 response code on this resource**

Name	Data type	P	Cardinality	Description
Location	string	M	1	Contains the URI of the newly created resource, according to the structure: {apiRoot}/nmb-smf-mb-session/<apiVersion>/mbs-sessions/{mbsSessionRef}

**Table 6.2.3.2.3.1-6: Headers supported by the 307 Response Code on this resource**

Name	Data type	P	Cardinality	Description
Location	string	M	1	An alternative URI of the resource located on an alternative service instance within the same MB-SMF or MB-SMF (service) set. For the case when a request is redirected to the same target resource via a different SCP, see clause 6.10.9.1 in 3GPP TS 29.500 [4].
3gpp-Sbi-Target-Nf-Id	string	O	0..1	Identifier of the target MB-SMF (service) instance ID towards which the request is redirected

**Table 6.2.3.2.3.1-7: Headers supported by the 308 Response Code on this resource**

Name	Data type	P	Cardinality	Description
Location	string	M	1	An alternative URI of the resource located on an alternative service instance within the same MB-SMF or MB-SMF (service) set. For the case when a request is redirected to the same target resource via a different SCP, see clause 6.10.9.1 in 3GPP TS 29.500 [4].
3gpp-Sbi-Target-Nf-Id	string	O	0..1	Identifier of the target MB-SMF (service) instance ID towards which the request is redirected

## 6.2.3.2.4 Resource Custom Operations

## 6.2.3.2.4.1 Overview

**Table 6.2.3.2.4.1-1: Custom operations**

Operation name	Custom operation URI	Mapped HTTP method	Description
update	/mbs-sessions/contexts/update	POST	ContextUpdate service operation

## 6.2.3.2.4.2 Operation: update

## 6.2.3.2.4.2.1 Description

See clause 5.3.2.5.1.

## 6.2.3.2.4.2.2 Operation Definition

This operation shall support the request data structures specified in table 6.2.3.2.4.2.2-1 and the response data structure and response codes specified in table 6.2.3.2.4.2.2-2.

**Table 6.2.3.2.4.2.2-1: Data structures supported by the POST Request Body on this resource**

Data type	P	Cardinality	Description
ContextUpdateReqData	M	1	Data within the ContextUpdate Request

**Table 6.2.3.2.4.2.2-2: Data structures supported by the POST Response Body on this resource**

Data type	P	Cardinality	Response codes	Description
ContextUpdateRspData	M	1	200 OK	Data in the ContextUpdate Response
n/a			204 No Content	
RedirectResponse	O	0..1	307 Temporary Redirect	Temporary redirection. (NOTE 2)
RedirectResponse	O	0..1	308 Permanent Redirect	Permanent redirection. (NOTE 2)
ProblemDetails	O	0..1	404 Not Found	When used to represent an unsuccessful MBS session context update, the "cause" attribute of the "ProblemDetails" may be used to include one of the following application error codes: - UNKNOWN_TMGI, if the TMGI provided in the request does not exist in the MB-SMF. - UNKNOWN_MBS_SESSION, if the indicated MBS session is not found in the MB-SMF. - UNKNOWN_MBS_SERVICE_AREA, if the MBS Area Session ID in the request cannot be found for a location dependent MBS session.

NOTE 1: The mandatory HTTP error status code for the POST method listed in Table 5.2.7.1-1 of 3GPP TS 29.500 [4] also apply.

NOTE 2: RedirectResponse may be inserted by an SCP, see clause 6.10.9.1 of 3GPP TS 29.500 [4].

**Table 6.2.3.2.4.2.2-3: Headers supported by the 307 Response Code on this resource**

Name	Data type	P	Cardinality	Description
Location	string	M	1	An alternative URI of the resource located on an alternative service instance within the same MB-SMF or MB-SMF (service) set. For the case when a request is redirected to the same target resource via a different SCP, see clause 6.10.9.1 in 3GPP TS 29.500 [4].
3gpp-Sbi-Target-Nf-Id	string	O	0..1	Identifier of the target MB-SMF (service) instance ID towards which the request is redirected

**Table 6.2.3.2.4.2.2-4: Headers supported by the 308 Response Code on this resource**

Name	Data type	P	Cardinality	Description
Location	string	M	1	An alternative URI of the resource located on an alternative service instance within the same MB-SMF or MB-SMF (service) set. For the case when a request is redirected to the same target resource via a different SCP, see clause 6.10.9.1 in 3GPP TS 29.500 [4].
3gpp-Sbi-Target-Nf-Id	string	O	0..1	Identifier of the target MB-SMF (service) instance ID towards which the request is redirected

### 6.2.3.3 Resource: Individual MBS session (Document)

#### 6.2.3.3.1 Description

This resource represents an individual MBS session created in the MB-SMF.

This resource is modelled with the Document resource archetype (see clause C.1 of 3GPP TS 29.501 [5]).

#### 6.2.3.3.2 Resource Definition

Resource URI: {apiRoot}/nmb-smf-mb-session/<apiVersion>/mbs-sessions/{mbsSessionRef}

This resource shall support the resource URI variables defined in table 6.2.3.3.2-1.

**Table 6.2.3.3.2-1: Resource URI variables for this resource**

Name	Data type	Definition
apiRoot	string	See clause 6.2.1
mbsSessionRef	string	MBS session reference assigned by the MB-SMF during the Create service operation

#### 6.2.3.3.3 Resource Standard Methods

##### 6.2.3.3.3.1 PATCH

This method updates an individual MBS session resource in the MB-SMF.

This method shall support the URI query parameters specified in table 6.2.3.3.3.1-1.

**Table 6.2.3.3.3.1-1: URI query parameters supported by the PATCH method on this resource**

Name	Data type	P	Cardinality	Description	Applicability
n/a					

This method shall support the request data structures specified in table 6.2.3.3.3.1-2 and the response data structures and response codes specified in table 6.2.3.3.3.1-3.

**Table 6.2.3.3.3.1-2: Data structures supported by the PATCH Request Body on this resource**

<b>Data type</b>	<b>P</b>	<b>Cardinality</b>	<b>Description</b>
array(PatchItem)	M	1	List of changes to be made to the MBS session resource (i.e. ExtMbsSession data type), according to the JSON PATCH format specified in IETF RFC 6902 [16].

Table 6.2.3.3.1-3: Data structures supported by the PATCH Response Body on this resource

Data type	P	Cardinality	Response codes	Description
n/a			204 No Content	Successful response
UpdateRspData	M	1	200 OK	Successful update of the MBS session if additional information needs to be returned in the response.
RedirectResponse	O	0..1	307 Temporary Redirect	Temporary redirection. (NOTE 2)
RedirectResponse	O	0..1	308 Permanent Redirect	Permanent redirection. (NOTE 2)
ProblemDetails	O	0..1	400 Bad Request	When used to represent an unsuccessful MBS session update, the "cause" attribute of the "ProblemDetails" may be used to include one of the following application error codes: <ul style="list-style-type: none"> <li>- INVALID_MBS_SERVICE_INFO, if the provided MBS Service Information is invalid (e.g. invalid QoS reference), incorrect or insufficient to perform MBS policy authorization, e.g if the PCF rejected the creation or update of an MBS Policy Association with the same error (see 3GPP TS 29.537 [23])</li> <li>- FILTER_RESTRICTIONS_NOT_RESPECTED, if the MBS IP flow(s) description provided within the MBS Service Information cannot be handled due to the restrictions defined in clause 5.3.8 of 3GPP TS 29.214 [24] not being respected, e.g. if the PCF rejected the creation or update of an MBS Policy Association with the same error (see 3GPP TS 29.537 [23])</li> <li>- ERROR_INPUT_PARAMETERS, if the provided set of input parameters are incomplete, erroneous or missing necessary information to perform MBS policy control, e.g. if the PCF rejected the creation or update of an MBS Policy Association with the same error (see 3GPP TS 29.537 [23])</li> </ul>
ExtProblemDetails	O	0..1	403 Forbidden	When used to represent an unsuccessful MBS session update, the "cause" attribute of the "ProblemDetails" may be used to include one of the following application error codes: <ul style="list-style-type: none"> <li>- MBS_SERVICE_INFO_NOT_AUTHORIZED, if the provided MBS Service Information is not authorized to perform MBS policy authorization, e.g. if the PCF rejected the creation or update of an MBS Policy Association with the same error (see 3GPP TS 29.537 [23])</li> <li>- MBS_POLICY_CONTEXT_DENIED, if the request is rejected due to operator policies and/or local configuration, e.g. if the PCF rejected the creation or update of an MBS Policy Association with the same error (see 3GPP TS 29.537 [23])</li> </ul>
ProblemDetails	O	0..1	404 Not Found	When used to represent an unsuccessful MBS session update, the "cause" attribute of the "ProblemDetails" may be used to include one of the following application error codes: <ul style="list-style-type: none"> <li>- UNKNOWN_MBS_SESSION, if the indicated MBS session is not found in the MB-SMF.</li> <li>- UNKNOWN_MBS_SERVICE_AREA, if the indicated MBS Area Session ID is not found for a location dependent MBS session.</li> </ul>

NOTE 1: The mandatory HTTP error status code for the PATCH method listed in Table 5.2.7.1-1 of 3GPP TS 29.500 [4] also apply.

NOTE 2: RedirectResponse may be inserted by an SCP, see clause 6.10.9.1 of 3GPP TS 29.500 [4].



**Table 6.2.3.3.3.1-4: Headers supported by the 307 Response Code on this resource**

Name	Data type	P	Cardinality	Description
Location	string	M	1	An alternative URI of the resource located on an alternative service instance within the same MB-SMF or MB-SMF (service) set. For the case when a request is redirected to the same target resource via a different SCP, see clause 6.10.9.1 in 3GPP TS 29.500 [4].
3gpp-Sbi-Target-Nf-Id	string	O	0..1	Identifier of the target MB-SMF (service) instance ID towards which the request is redirected

**Table 6.2.3.3.3.1-5: Headers supported by the 308 Response Code on this resource**

Name	Data type	P	Cardinality	Description
Location	string	M	1	An alternative URI of the resource located on an alternative service instance within the same MB-SMF or MB-SMF (service) set. For the case when a request is redirected to the same target resource via a different SCP, see clause 6.10.9.1 in 3GPP TS 29.500 [4].
3gpp-Sbi-Target-Nf-Id	string	O	0..1	Identifier of the target MB-SMF (service) instance ID towards which the request is redirected

#### 6.2.3.3.3.2 DELETE

This method deletes an individual MBS session resource in the MB-SMF.

This method shall support the URI query parameters specified in table 6.2.3.2.3.2-1.

**Table 6.2.3.3.3.2-1: URI query parameters supported by the DELETE method on this resource**

Name	Data type	P	Cardinality	Description	Applicability
n/a					

This method shall support the request data structures specified in table 6.2.3.3.3.2-2 and the response data structures and response codes specified in table 6.2.3.3.3.2-3.

**Table 6.2.3.3.3.2-2: Data structures supported by the DELETE Request Body on this resource**

Data type	P	Cardinality	Description
n/a			

**Table 6.2.3.3.2-3: Data structures supported by the DELETE Response Body on this resource**

Data type	P	Cardinality	Response codes	Description
n/a			204 No Content	Successful response
RedirectResponse	O	0..1	307 Temporary Redirect	Temporary redirection. (NOTE 2)
RedirectResponse	O	0..1	308 Permanent Redirect	Permanent redirection. (NOTE 2)
ProblemDetails	O	0..1	404 Not Found	When used to represent an unsuccessful MBS session delete, the "cause" attribute of the "ProblemDetails" may be used to include one of the following application error codes: - UNKNOWN_MBS_SESSION, if the indicated MBS session is not found in the MB-SMF.

NOTE 1: The mandatory HTTP error status code for the DELETE method listed in Table 5.2.7.1-1 of 3GPP TS 29.500 [4] also apply.

NOTE 2: RedirectResponse may be inserted by an SCP, see clause 6.10.9.1 of 3GPP TS 29.500 [4].

**Table 6.2.3.3.2-4: Headers supported by the 307 Response Code on this resource**

Name	Data type	P	Cardinality	Description
Location	string	M	1	An alternative URI of the resource located on an alternative service instance within the same MB-SMF or MB-SMF (service) set. For the case when a request is redirected to the same target resource via a different SCP, see clause 6.10.9.1 in 3GPP TS 29.500 [4].
3gpp-Sbi-Target-Nf-Id	string	O	0..1	Identifier of the target MB-SMF (service) instance ID towards which the request is redirected

**Table 6.2.3.3.2-5: Headers supported by the 308 Response Code on this resource**

Name	Data type	P	Cardinality	Description
Location	string	M	1	An alternative URI of the resource located on an alternative service instance within the same MB-SMF or MB-SMF (service) set. For the case when a request is redirected to the same target resource via a different SCP, see clause 6.10.9.1 in 3GPP TS 29.500 [4].
3gpp-Sbi-Target-Nf-Id	string	O	0..1	Identifier of the target MB-SMF (service) instance ID towards which the request is redirected

#### 6.2.3.3.4 Resource Custom Operations

None.

#### 6.2.3.4 Resource: Subscriptions collection for MBS sessions (Collection)

##### 6.2.3.4.1 Description

This resource represents the collection of the individual subscriptions for MBS sessions that are created in the MB-SMF with StatusSubscribe service operation.

This resource is modelled with the Collection resource archetype (see clause C.2 of 3GPP TS 29.501 [5]).

##### 6.2.3.4.2 Resource Definition

Resource URI: {apiRoot}/nbsmf-mbssession/<apiVersion>/mbs-sessions/subscriptions

This resource shall support the resource URI variables defined in table 6.2.3.4.2-1.

**Table 6.2.3.4.2-1: Resource URI variables for this resource**

Name	Data type	Definition
apiRoot	string	See clause 6.2.1

### 6.2.3.4.3 Resource Standard Methods

#### 6.2.3.4.3.1 POST

This method creates an individual subscription resource for an MBS session in the MB-SMF with StatusSubscribe service operation.

This method shall support the URI query parameters specified in table 6.2.3.4.3.1-1.

**Table 6.2.3.4.3.1-1: URI query parameters supported by the POST method on this resource**

Name	Data type	P	Cardinality	Description	Applicability
n/a					

This method shall support the request data structures specified in table 6.2.3.4.3.1-2 and the response data structures and response codes specified in table 6.2.3.4.3.1-3.

**Table 6.2.3.4.3.1-2: Data structures supported by the POST Request Body on this resource**

Data type	P	Cardinality	Description
StatusSubscribeReqData	M	1	Data within the StatusSubscribe Request

**Table 6.2.3.4.3.1-3: Data structures supported by the POST Response Body on this resource**

Data type	P	Cardinality	Response codes	Description
StatusSubscribeRspData	M	1	201 Created	Data within the StatusSubscribe Response
RedirectResponse	O	0..1	307 Temporary Redirect	Temporary redirection. (NOTE 2)
RedirectResponse	O	0..1	308 Permanent Redirect	Permanent redirection. (NOTE 2)
ProblemDetails	O	0..1	404 Not Found	When used to represent an unsuccessful subscription to MBS session, the "cause" attribute of the "ProblemDetails" may be used to include one of the following application error codes: - UNKNOWN_MBS_SESSION, if the indicated MBS session is not found in the MB-SMF. - UNKNOWN_MBS_SERVICE_AREA, if the requested MBS Area Session ID is not found for a location dependent MBS session.

NOTE 1: The mandatory HTTP error status code for the POST method listed in Table 5.2.7.1-1 of 3GPP TS 29.500 [4] also apply.

NOTE 2: RedirectResponse may be inserted by an SCP, see clause 6.10.9.1 of 3GPP TS 29.500 [4].

**Table 6.2.3.4.3.1-4: Headers supported by the POST method on this resource**

Name	Data type	P	Cardinality	Description

**Table 6.2.3.4.3.1-5: Headers supported by the 201 response code on this resource**

Name	Data type	P	Cardinality	Description
Location	string	M	1	Contains the URI of the newly created resource, according to the structure: {apiRoot}/nmbsmf-mbssession/<apiVersion>/mbs-sessions/subscriptions/{subscriptionId}

**Table 6.2.3.4.3.1-6: Headers supported by the 307 Response Code on this resource**

Name	Data type	P	Cardinality	Description
Location	string	M	1	An alternative URI of the resource located on an alternative service instance within the same MB-SMF or MB-SMF (service) set. For the case when a request is redirected to the same target resource via a different SCP, see clause 6.10.9.1 in 3GPP TS 29.500 [4].
3gpp-Sbi-Target-Nf-Id	string	O	0..1	Identifier of the target MB-SMF (service) instance ID towards which the request is redirected

**Table 6.2.3.4.3.1-7: Headers supported by the 308 Response Code on this resource**

Name	Data type	P	Cardinality	Description
Location	string	M	1	An alternative URI of the resource located on an alternative service instance within the same MB-SMF or MB-SMF (service) set. For the case when a request is redirected to the same target resource via a different SCP, see clause 6.10.9.1 in 3GPP TS 29.500 [4].
3gpp-Sbi-Target-Nf-Id	string	O	0..1	Identifier of the target MB-SMF (service) instance ID towards which the request is redirected

#### 6.2.3.4.4 Resource Custom Operations

None.

#### 6.2.3.5 Resource: Individual subscription for an MBS session (Document)

##### 6.2.3.5.1 Description

This resource represents an individual subscription for an MBS session in the MB-SMF, which are updated with StatusSubscribe service operation, or are deleted with StatusUnsubscribe service operation.

This resource is modelled with the Document resource archetype (see clause C.1 of 3GPP TS 29.501 [5]).

##### 6.2.3.5.2 Resource Definition

Resource URI: {apiRoot}/nmbsmf-mbssession/<apiVersion>/mbs-sessions/subscriptions/{subscriptionId}

This resource shall support the resource URI variables defined in table 6.2.3.5.2-1.

**Table 6.2.3.5.2-1: Resource URI variables for this resource**

Name	Data type	Definition
apiRoot	string	See clause 6.2.1
subscriptionId	string	Subscription identifier assigned by the MB-SMF during the creation of the subscription

## 6.2.3.5.3 Resource Standard Methods

## 6.2.3.5.3.1 PATCH

This method updates an individual subscription resource for an MBS session in the MB-SMF with StatusSubscribe service operation for the subscription update (see clause 5.3.2.6.3).

This method shall support the URI query parameters specified in table 6.2.3.5.3.1-1.

**Table 6.2.3.5.3.1-1: URI query parameters supported by the PATCH method on this resource**

Name	Data type	P	Cardinality	Description	Applicability
n/a					

This method shall support the request data structures specified in table 6.2.3.5.3.1-2 and the response data structures and response codes specified in table 6.2.3.5.3.1-3.

**Table 6.2.3.5.3.1-2: Data structures supported by the PATCH Request Body on this resource**

Data type	P	Cardinality	Description
array(PatchItem)	M	1	It shall contain the list of changes to be made to the Status Subscription (i.e. MbsSessionSubscription data type), according to the JSON PATCH format specified in IETF RFC 6902 [16].

**Table 6.2.3.5.3.1-3: Data structures supported by the PATCH Response Body on this resource**

Data type	P	Cardinality	Response codes	Description
MbsSessionSubscription	M	1	200 OK	Upon success, a response body shall be returned containing the updated Status Subscription.
RedirectResponse	O	0..1	307 Temporary Redirect	Temporary redirection. (NOTE 2)
RedirectResponse	O	0..1	308 Permanent Redirect	Permanent redirection. (NOTE 2)
NOTE 1: The mandatory HTTP error status code for the PATCH method listed in Table 5.2.7.1-1 of 3GPP TS 29.500 [4] also apply.				
NOTE 2: RedirectResponse may be inserted by an SCP, see clause 6.10.9.1 of 3GPP TS 29.500 [4].				

**Table 6.2.3.5.3.1-4: Headers supported by the PATCH method on this resource**

Name	Data type	P	Cardinality	Description

**Table 6.2.3.5.3.1-5: Headers supported by the 200 response code on this resource**

Name	Data type	P	Cardinality	Description

**Table 6.2.3.5.3.1-6: Headers supported by the 307 Response Code on this resource**

Name	Data type	P	Cardinality	Description
Location	string	M	1	An alternative URI of the resource located on an alternative service instance within the same MB-SMF or MB-SMF (service) set. For the case when a request is redirected to the same target resource via a different SCP, see clause 6.10.9.1 in 3GPP TS 29.500 [4].
3gpp-Sbi-Target-Nf-Id	string	O	0..1	Identifier of the target MB-SMF (service) instance ID towards which the request is redirected

**Table 6.2.3.5.3.1-7: Headers supported by the 308 Response Code on this resource**

Name	Data type	P	Cardinality	Description
Location	string	M	1	An alternative URI of the resource located on an alternative service instance within the same MB-SMF or MB-SMF (service) set. For the case when a request is redirected to the same target resource via a different SCP, see clause 6.10.9.1 in 3GPP TS 29.500 [4].
3gpp-Sbi-Target-Nf-Id	string	O	0..1	Identifier of the target MB-SMF (service) instance ID towards which the request is redirected

### 6.2.3.5.3.2 DELETE

This method deletes an individual subscription resource for an MBS session in the MB-SMF with StatusUnsubscribe service operation.

This method shall support the URI query parameters specified in table 6.2.3.5.3.2-1.

**Table 6.2.3.5.3.2-1: URI query parameters supported by the DELETE method on this resource**

Name	Data type	P	Cardinality	Description	Applicability
n/a					

This method shall support the request data structures specified in table 6.2.3.5.3.2-2 and the response data structures and response codes specified in table 6.2.3.5.3.2-3.

**Table 6.2.3.5.3.2-2: Data structures supported by the DELETE Request Body on this resource**

Data type	P	Cardinality	Description
n/a			

**Table 6.2.3.5.3.2-3: Data structures supported by the DELETE Response Body on this resource**

Data type	P	Cardinality	Response codes	Description
n/a			204 No Content	Successful deletion
RedirectResponse	O	0..1	307 Temporary Redirect	Temporary redirection. (NOTE 2)
RedirectResponse	O	0..1	308 Permanent Redirect	Permanent redirection. (NOTE 2)

NOTE 1: The mandatory HTTP error status code for the DELETE method listed in Table 5.2.7.1-1 of 3GPP TS 29.500 [4] also apply.

NOTE 2: RedirectResponse may be inserted by an SCP, see clause 6.10.9.1 of 3GPP TS 29.500 [4].

**Table 6.2.3.5.3.2-4: Headers supported by the 307 Response Code on this resource**

Name	Data type	P	Cardinality	Description
Location	string	M	1	An alternative URI of the resource located on an alternative service instance within the same MB-SMF or MB-SMF (service) set. For the case when a request is redirected to the same target resource via a different SCP, see clause 6.10.9.1 in 3GPP TS 29.500 [4].
3gpp-Sbi-Target-Nf-Id	string	O	0..1	Identifier of the target MB-SMF (service) instance ID towards which the request is redirected

**Table 6.2.3.5.3.2-5: Headers supported by the 308 Response Code on this resource**

Name	Data type	P	Cardinality	Description
Location	string	M	1	An alternative URI of the resource located on an alternative service instance within the same MB-SMF or MB-SMF (service) set. For the case when a request is redirected to the same target resource via a different SCP, see clause 6.10.9.1 in 3GPP TS 29.500 [4].
3gpp-Sbi-Target-Nf-Id	string	O	0..1	Identifier of the target MB-SMF (service) instance ID towards which the request is redirected

#### 6.2.3.5.4 Resource Custom Operations

None.

#### 6.2.3.6 Resource: Subscriptions collection for MBS contexts (Collection)

##### 6.2.3.6.1 Description

This resource represents the collection of the individual subscriptions for MBS contexts created in the MB-SMF.

This resource is modelled with the Collection resource archetype (see clause C.2 of 3GPP TS 29.501 [5]).

##### 6.2.3.6.2 Resource Definition

Resource URI: {apiRoot}/nbsmf-mbssession/<apiVersion>/mbs-sessions/contexts/subscriptions

This resource shall support the resource URI variables defined in table 6.2.3.6.2-1.

**Table 6.2.3.6.2-1: Resource URI variables for this resource**

Name	Data type	Definition
apiRoot	string	See clause 6.2.1

##### 6.2.3.6.3 Resource Standard Methods

###### 6.2.3.6.3.1 POST

This method creates an individual subscription resource for an MBS context in the MB-SMF.

This method shall support the URI query parameters specified in table 6.2.3.6.3.1-1.

**Table 6.2.3.6.3.1-1: URI query parameters supported by the POST method on this resource**

Name	Data type	P	Cardinality	Description	Applicability
n/a					

This method shall support the request data structures specified in table 6.2.3.6.3.1-2 and the response data structures and response codes specified in table 6.2.3.6.3.1-3.

**Table 6.2.3.6.3.1-2: Data structures supported by the POST Request Body on this resource**

Data type	P	Cardinality	Description
ContextStatusSubscribeReq Data	M	1	Data within the ContextStatusSubscribe Request

**Table 6.2.3.6.3.1-3: Data structures supported by the POST Response Body on this resource**

Data type	P	Cardinality	Response codes	Description
ContextStatusSubscribeResp Data	M	1	201 Created	Data within the ContextStatusSubscribe Response
RedirectResponse	O	0..1	307 Temporary Redirect	Temporary redirection. (NOTE 2)
RedirectResponse	O	0..1	308 Permanent Redirect	Permanent redirection. (NOTE 2)
ProblemDetails	O	0..1	404 Not Found	When used to represent an unsuccessful subscription to MBS session context, the "cause" attribute of the "ProblemDetails" may be used to include one of the following application error codes: - UNKNOWN_MBS_SESSION, if indicated the MBS session is not found in the MB-SMF.

NOTE 1: The mandatory HTTP error status code for the POST method listed in Table 5.2.7.1-1 of 3GPP TS 29.500 [4] also apply.

NOTE 2: RedirectResponse may be inserted by an SCP, see clause 6.10.9.1 of 3GPP TS 29.500 [4].

**Table 6.2.3.6.3.1-4: Headers supported by the POST method on this resource**

Name	Data type	P	Cardinality	Description

**Table 6.2.3.6.3.1-5: Headers supported by the 201 response code on this resource**

Name	Data type	P	Cardinality	Description
Location	string	M	1	Contains the URI of the newly created resource, according to the structure: {apiRoot}/nmb-smf-mb-session/<apiVersion>/mb-sessions/contexts/subscriptions/{subscriptionId}

**Table 6.2.3.6.3.1-6: Headers supported by the 307 Response Code on this resource**

Name	Data type	P	Cardinality	Description
Location	string	M	1	An alternative URI of the resource located on an alternative service instance within the same MB-SMF or MB-SMF (service) set. For the case when a request is redirected to the same target resource via a different SCP, see clause 6.10.9.1 in 3GPP TS 29.500 [4].
3gpp-Sbi-Target-Nf-Id	string	O	0..1	Identifier of the target MB-SMF (service) instance ID towards which the request is redirected



**Table 6.2.3.6.3.1-7: Headers supported by the 308 Response Code on this resource**

Name	Data type	P	Cardinality	Description
Location	string	M	1	An alternative URI of the resource located on an alternative service instance within the same MB-SMF or MB-SMF (service) set. For the case when a request is redirected to the same target resource via a different SCP, see clause 6.10.9.1 in 3GPP TS 29.500 [4].
3gpp-Sbi-Target-Nf-Id	string	O	0..1	Identifier of the target MB-SMF (service) instance ID towards which the request is redirected

#### 6.2.3.6.4 Resource Custom Operations

None.

#### 6.2.3.7 Resource: Individual subscription for an MBS context (Document)

##### 6.2.3.7.1 Description

This resource represents an individual subscription for an MBS context created in the MB-SMF.

This resource is modelled with the Document resource archetype (see clause C.1 of 3GPP TS 29.501 [5]).

##### 6.2.3.7.2 Resource Definition

Resource URI: {apiRoot}/nbsmf-mbssession/<apiVersion>/mbs-sessions/contexts/subscriptions/{subscriptionId}

This resource shall support the resource URI variables defined in table 6.2.3.7.2-1.

**Table 6.2.3.7.2-1: Resource URI variables for this resource**

Name	Data type	Definition
apiRoot	string	See clause 6.2.1
subscriptionId	string	Subscription identifier assigned by the MB-SMF during the creation of the subscription

#### 6.2.3.7.3 Resource Standard Methods

##### 6.2.3.7.3.1 PATCH

This method modifies an individual subscription resource for an MBS context in the MB-SMF.

This method shall support the URI query parameters specified in table 6.2.3.7.3.1-1.

**Table 6.2.3.7.3.1-1: URI query parameters supported by the PATCH method on this resource**

Name	Data type	P	Cardinality	Description	Applicability
n/a					

This method shall support the request data structures specified in table 6.2.3.7.3.1-2 and the response data structures and response codes specified in table 6.2.3.7.3.1-3.

**Table 6.2.3.7.3.1-2: Data structures supported by the PATCH Request Body on this resource**

Data type	P	Cardinality	Description
array(PatchItem)	M	1	It shall contain the list of changes to be made to the Context Status Subscription (i.e. ContextStatusSubscription data type), according to the JSON PATCH format specified in IETF RFC 6902 [16].

**Table 6.2.3.7.3.1-3: Data structures supported by the PATCH Response Body on this resource**

Data type	P	Cardinality	Response codes	Description
ContextStatusSubscription	M	1	200 OK	Upon success, a response body shall be returned containing the updated Context Status Subscription.
RedirectResponse	O	0..1	307 Temporary Redirect	Temporary redirection. (NOTE 2)
RedirectResponse	O	0..1	308 Permanent Redirect	Permanent redirection. (NOTE 2)
NOTE 1: The mandatory HTTP error status code for the PATCH method listed in Table 5.2.7.1-1 of 3GPP TS 29.500 [4] also apply.				
NOTE 2: RedirectResponse may be inserted by an SCP, see clause 6.10.9.1 of 3GPP TS 29.500 [4].				

**Table 6.2.3.7.3.1-4: Headers supported by the PATCH method on this resource**

Name	Data type	P	Cardinality	Description

**Table 6.2.3.7.3.1-5: Headers supported by the 200 response code on this resource**

Name	Data type	P	Cardinality	Description

**Table 6.2.3.7.3.1-6: Headers supported by the 307 Response Code on this resource**

Name	Data type	P	Cardinality	Description
Location	string	M	1	An alternative URI of the resource located on an alternative service instance within the same MB-SMF or MB-SMF (service) set. For the case when a request is redirected to the same target resource via a different SCP, see clause 6.10.9.1 in 3GPP TS 29.500 [4].
3gpp-Sbi-Target-Nf-Id	string	O	0..1	Identifier of the target MB-SMF (service) instance ID towards which the request is redirected

**Table 6.2.3.7.3.1-7: Headers supported by the 308 Response Code on this resource**

Name	Data type	P	Cardinality	Description
Location	string	M	1	An alternative URI of the resource located on an alternative service instance within the same MB-SMF or MB-SMF (service) set. For the case when a request is redirected to the same target resource via a different SCP, see clause 6.10.9.1 in 3GPP TS 29.500 [4].
3gpp-Sbi-Target-Nf-Id	string	O	0..1	Identifier of the target MB-SMF (service) instance ID towards which the request is redirected

### 6.2.3.7.3.2 DELETE

This method deletes an individual subscription resource for an MBS context in the MB-SMF.

This method shall support the URI query parameters specified in table 6.2.3.7.3.1-1.

**Table 6.2.3.7.3.2-1: URI query parameters supported by the DELETE method on this resource**

Name	Data type	P	Cardinality	Description	Applicability
n/a					

This method shall support the request data structures specified in table 6.2.3.7.3.1-2 and the response data structures and response codes specified in table 6.2.3.7.3.1-3.

**Table 6.2.3.7.3.2-2: Data structures supported by the DELETE Request Body on this resource**

Data type	P	Cardinality	Description
n/a			

**Table 6.2.3.7.3.2-3: Data structures supported by the DELETE Response Body on this resource**

Data type	P	Cardinality	Response codes	Description
n/a			204 No Content	Successful deletion
RedirectResponse	O	0..1	307 Temporary Redirect	Temporary redirection. (NOTE 2)
RedirectResponse	O	0..1	308 Permanent Redirect	Permanent redirection. (NOTE 2)

NOTE 1: The mandatory HTTP error status code for the DELETE method listed in Table 5.2.7.1-1 of 3GPP TS 29.500 [4] also apply.

NOTE 2: RedirectResponse may be inserted by an SCP, see clause 6.10.9.1 of 3GPP TS 29.500 [4].

**Table 6.2.3.7.3.2-4: Headers supported by the 307 Response Code on this resource**

Name	Data type	P	Cardinality	Description
Location	string	M	1	An alternative URI of the resource located on an alternative service instance within the same MB-SMF or MB-SMF (service) set. For the case when a request is redirected to the same target resource via a different SCP, see clause 6.10.9.1 in 3GPP TS 29.500 [4].
3gpp-Sbi-Target-Nf-Id	string	O	0..1	Identifier of the target MB-SMF (service) instance ID towards which the request is redirected

**Table 6.2.3.7.3.2-5: Headers supported by the 308 Response Code on this resource**

Name	Data type	P	Cardinality	Description
Location	string	M	1	An alternative URI of the resource located on an alternative service instance within the same MB-SMF or MB-SMF (service) set. For the case when a request is redirected to the same target resource via a different SCP, see clause 6.10.9.1 in 3GPP TS 29.500 [4].
3gpp-Sbi-Target-Nf-Id	string	O	0..1	Identifier of the target MB-SMF (service) instance ID towards which the request is redirected

#### 6.2.3.7.4 Resource Custom Operations

None.

## 6.2.4 Custom Operations without associated resources

None

## 6.2.5 Notifications

### 6.2.5.1 General

Notifications shall comply to clause 6.2 of 3GPP TS 29.500 [4] and clause 4.6.2.3 of 3GPP TS 29.501 [5].

**Table 6.2.5.1-1: Notifications overview**

Notification	Callback URI	HTTP method or custom operation	Description (service operation)
Status Notification	{notifUri}	POST	StatusNotify
Context Status Notification	{notifUri}	POST	ContextStatusNotify

### 6.2.5.2 StatusNotify

#### 6.2.5.2.1 Description

The Event Notification is used by the MB-SMF to report one or several observed Events to a NF service consumer that has subscribed to such Notifications.

#### 6.2.5.2.2 Target URI

The Callback URI "{**notifUri**}" shall be used with the callback URI variables defined in table 6.2.5.2.2-1.

**Table 6.2.5.2.2-1: Callback URI variables**

Name	Definition
notifUri	String formatted as URI with the Callback Uri

### 6.2.5.2.3 Standard Methods

#### 6.2.5.2.3.1 POST

This method shall support the request data structures specified in table 6.2.5.2.3.1-1 and the response data structures and response codes specified in table 6.2.5.2.3.1-2.

**Table 6.2.5.2.3.1-1: Data structures supported by the POST Request Body**

Data type	P	Cardinality	Description
StatusNotifyReqData	M	1	Data within the StatusNotify Request

**Table 6.2.5.2.3.1-2: Data structures supported by the POST Response Body**

Data type	P	Cardinality	Response codes	Description
n/a			204 No Content	Successful response
RedirectResponse	O	0..1	307 Temporary Redirect	Temporary redirection.
RedirectResponse	O	0..1	308 Permanent Redirect	Permanent redirection.

NOTE: The mandatory HTTP error status codes for the POST method listed in Table 5.2.7.1-1 of 3GPP TS 29.500 [4] also apply.

**Table 6.2.5.2.3.1-3: Headers supported by the 307 Response Code on this resource**

Name	Data type	P	Cardinality	Description
Location	string	M	1	A URI pointing to the endpoint of the NF service consumer to which the notification should be sent. For the case when a request is redirected to the same target resource via a different SCP, see clause 6.10.9.1 in 3GPP TS 29.500 [4].
3gpp-Sbi-Target-Nf-Id	string	O	0..1	Identifier of the target NF (service) instance ID towards which the request is redirected

**Table 6.2.5.2.3.1-4: Headers supported by the 308 Response Code on this resource**

Name	Data type	P	Cardinality	Description
Location	string	M	1	A URI pointing to the endpoint of the NF service consumer to which the notification should be sent. For the case when a request is redirected to the same target resource via a different SCP, see clause 6.10.9.1 in 3GPP TS 29.500 [4].
3gpp-Sbi-Target-Nf-Id	string	O	0..1	Identifier of the target NF (service) instance ID towards which the request is redirected

### 6.2.5.3 ContextStatusNotify

#### 6.2.5.3.1 Description

The Event Notification is used by the MB-SMF to report one or several observed Events to a NF Service Consumer that has subscribed to such notifications.

#### 6.2.5.3.2 Target URI

The Callback URI "{notifUri}" shall be used with the callback URI variables defined in table 6.2.5.3.2-1.

**Table 6.2.5.3.2-1: Callback URI variables**

Name	Definition
notifUri	String formatted as URI with the Callback URI

#### 6.2.5.3.3 Standard Methods

##### 6.2.5.3.3.1 POST

This method shall support the request data structures specified in table 6.2.5.3.3.1-1 and the response data structures and response codes specified in table 6.2.5.3.3.1-2.

**Table 6.2.5.3.3.1-1: Data structures supported by the POST Request Body**

Data type	P	Cardinality	Description
ContextStatusNotifyReqData	M	1	Data within the ContextStatusNotify Request

**Table 6.2.5.3.3.1-2: Data structures supported by the POST Response Body**

Data type	P	Cardinality	Response codes	Description
n/a			204 No Content	Successful response
RedirectResponse	O	0..1	307 Temporary Redirect	Temporary redirection.
RedirectResponse	O	0..1	308 Permanent Redirect	Permanent redirection.
NOTE: The mandatory HTTP error status codes for the POST method listed in Table 5.2.7.1-1 of 3GPP TS 29.500 [4] also apply.				

**Table 6.2.5.3.3.1-3: Headers supported by the 307 Response Code on this resource**

Name	Data type	P	Cardinality	Description
Location	string	M	1	A URI pointing to the endpoint of the NF service consumer to which the notification should be sent. For the case when a request is redirected to the same target resource via a different SCP, see clause 6.10.9.1 in 3GPP TS 29.500 [4].
3gpp-Sbi-Target-Nf-Id	string	O	0..1	Identifier of the target NF (service) instance ID towards which the request is redirected

**Table 6.2.5.3.3.1-4: Headers supported by the 308 Response Code on this resource**

Name	Data type	P	Cardinality	Description
Location	string	M	1	A URI pointing to the endpoint of the NF service consumer to which the notification should be sent. For the case when a request is redirected to the same target resource via a different SCP, see clause 6.10.9.1 in 3GPP TS 29.500 [4].
3gpp-Sbi-Target-Nf-Id	string	O	0..1	Identifier of the target NF (service) instance ID towards which the request is redirected

## 6.2.6 Data Model

### 6.2.6.1 General

This clause specifies the application data model supported by the API.

Table 6.2.6.1-1 specifies the data types defined for the Nmb-smf\_MBSSession service based interface protocol.

Table 6.2.6.1-1: Nmbsmf\_MBSSession specific Data Types

Data type	Clause defined	Description	Applicability
CreateReqData	6.2.6.2.2	Data within the Create Request	
CreateRspData	6.2.6.2.3	Data within the Create Response	
MbsSessionExtension	6.2.6.2.4	MB-SMF API specific MbsSession data type extensions	
ContextUpdateReqData	6.2.6.2.5	Data within the ContextUpdate Request	
ContextUpdateRspData	6.2.6.2.6	Data within the ContextUpdate Response	
StatusSubscribeReqData	6.2.6.2.7	Data within the Create Subscription Request for the collection of MBS Session subscriptions (StatusSubscribe service operation).	
StatusSubscribeRspData	6.2.6.2.8	Data within the Create Subscription Response (StatusSubscribe service operation).	
N2MbsSmlInfo	6.2.6.2.9	N2 MBS Session Management Information	
ContextStatusNotifyReqData	6.2.6.2.10	Data within ContextStatusNotify Request	
StatusNotifyReqData	6.2.6.2.11	Data within StatusNotify Request	
ContextStatusSubscribeReqData	6.2.6.2.12	Data within ContextStatusSubscribe Request	
ContextStatusSubscription	6.2.6.2.13	Context Status Subscription	
ContextStatusEvent	6.2.6.2.14	Context Status Event	
ContextStatusSubscribeRspData	6.2.6.2.15	Data within ContextStatusSubscribe Response	
MbsContextInfo	6.2.6.2.16	MBS Context Information	
ContextStatusEventReport	6.2.6.2.17	Context Status Event Report	
MulticastTransportAddressChangeInfo	6.2.6.2.18	Multicast Transport Address Change Information	
QosInfo	6.2.6.2.19	QoS Information	
QosFlowAddModifyRequestItem	6.2.6.2.20	Individual MBS QoS flow requested to be created or modified	
QosFlowProfile	6.2.6.2.21	MBS QoS flow profile	
GbrQosFlowInformation	6.2.6.2.22	GBR MBS QoS flow information	
ProblemDetailsExtension	6.2.6.2.23	Extensions to the ProblemDetails common data	
UpdateRspData	6.2.6.2.24	Data within the Update Response	
ContextUpdateAction	6.2.6.3.3	The requested action for the MBS session context	
ContextStatusEventType	6.2.6.3.4	Context Status Event Type	
ReportingMode	6.2.6.3.5	Reporting Mode	
NgapleType	6.2.6.3.6	NGAP Information Element Type	
ExtMbsSession	6.2.6.4.1	MbsSession common data type extended with MB-SMF API specific extensions	
ExtProblemDetails	6.2.6.4.2	ProblemDetails common data type with extensions	

Table 6.2.6.1-2 specifies data types re-used by the Nmbsmf\_MBSSession service based interface protocol from other specifications, including a reference to their respective specifications and when needed, a short description of their use within the Nmbsmf\_MBSSession service based interface.

Table 6.2.6.1-2: Nmbsmf\_MBSsession re-used Data Types

Data type	Reference	Comments	Applicability
MbsSession	3GPP TS 29.571 [18]	MBS session	
Tmgi	3GPP TS 29.571 [18]	TMGI	
TunnelAddress	3GPP TS 29.571 [18]	Tunnel Address (UDP/IP)	
MbsSessionId	3GPP TS 29.571 [18]	MBS Session Identifier	
AreaSessionId	3GPP TS 29.571 [18]	Area Session Identifier used for MBS session with location dependent content	
AreaSessionPolicyId	3GPP TS 29.571 [18]	Area Session Policy Identifier used for MBS session with location dependent content	
Ssm	3GPP TS 29.571 [18]	Source specific IP multicast address	
UInt32	3GPP TS 29.571 [18]	Unsigned 32-bit integer	
NfInstanceId	3GPP TS 29.571 [18]	NF Instance Identifier	
Bytes	3GPP TS 29.571 [18]	Base64-encoded characters	
RefToBinaryData	3GPP TS 29.571 [18]	Cross-Reference to binary data encoded within a binary body part in an HTTP multipart message	
GlobalRanNodeId	3GPP TS 29.571 [18]	Global RAN Node Identity	
DateTime	3GPP TS 29.571 [18]	Date and time	
Uri	3GPP TS 29.571 [18]	URI	
MbsSessionActivityStatus	3GPP TS 29.571 [18]	MBS Session Activity Status	
MbsServiceArea	3GPP TS 29.571 [18]	MBS Service Area	
MbsServiceAreaInfo	3GPP TS 29.571 [18]	MBS Service Area Information for a location dependent MBS session	
MbsSessionSubscription	3GPP TS 29.571 [18]	MBS Session Subscription	
MbsSessionEventReportList	3GPP TS 29.571 [18]	MBS Session Event Report List	
Qfi	3GPP TS 29.571 [18]	QoS Flow Identifier	
Arp	3GPP TS 29.571 [18]	Allocation and Retention Priority	
Dynamic5Qi	3GPP TS 29.571 [18]	QoS characteristics for a 5QI that is neither standardized nor pre-configured.	
NonDynamic5Qi	3GPP TS 29.571 [18]	QoS characteristics that replace the default QoS characteristics for a standardized or pre-configured 5QI.	
5Qi	3GPP TS 29.571 [18]	5G QoS Identifier	
BitRate	3GPP TS 29.571 [18]	Bit rate	
PacketLossRate	3GPP TS 29.571 [18]	Packet loss rate	
MbsSecurityContext	3GPP TS 29.571 [18]	MBS Security Context	
SupportedFeatures	3GPP TS 29.571 [18]	Represents the list of supported features	
AcceptableMbsServInfo	3GPP TS 29.537 [23]	MBS Service Information that can be accepted by the PCF	

## 6.2.6.2 Structured data types

### 6.2.6.2.1 Introduction

This clause defines the structures to be used in resource representations.

#### 6.2.6.2.2 Type: CreateReqData

Table 6.2.6.2.2-1: Definition of type CreateReqData

Attribute name	Data type	P	Cardinality	Description	Applicability
mbsSession	ExtMbsSession	M	1	MBS session to be created	
supportedFeatures	SupportedFeatures	C	0..1	This IE shall be present if at least one optional feature defined in clause 6.2.8 is supported.	



## 6.2.6.2.3 Type: CreateRspData

Table 6.2.6.2.3-1: Definition of type CreateRspData

Attribute name	Data type	P	Cardinality	Description	Applicability
mbsSession	ExtMbsSession	M	1	Representation of the created MBS session	
eventList	MbsSessionEventReportList	C	0..1	Event reports, if corresponding information is available.	
supportedFeatures	SupportedFeatures	C	0..1	This IE shall be present if at least one optional feature defined in clause 6.2.8 is supported.	

## 6.2.6.2.4 Type: MbsSessionExtension

Table 6.2.6.2.4-1: Definition of type MbsSessionExtension

Attribute name	Data type	P	Cardinality	Description	Applicability
mbsSecurityContext	MbsSecurityContext	O	0..1	This IE may be present if security protection is applied to the MBS Session. When present, it shall contain the MBS Service Key (MSK), MBS Traffic Key (MTK) and the corresponding key IDs.	
contactPcfInd	boolean	O	0..1	Indicates whether the PCF shall be contacted or not, i.e.: - "true" means that the PCF shall be contacted; and - "false" means that the PCF shall not be contacted. When this attribute is not present, the default value is "false".  This attribute may only be present in an MBS Session update request.	
areaSessionPolicyId	AreaSessionPolicyId	C	0..1	This IE shall be present for a location-dependent MBS session if the AF/NEF/MBSF has obtained the Area Session Policy ID from the PCF (see clause 7.1.1.3 of 3GPP TS 23.247 [14]). When present, it shall contain the Area Session Policy ID assigned by the PCF to the location-dependent MBS session.	

## 6.2.6.2.5 Type: ContextUpdateReqData

Table 6.2.6.2.5-1: Definition of type ContextUpdateReqData

Attribute name	Data type	P	Cardinality	Description	Applicability
nfInstanceId	NfInstanceId	M	1	NF Instance ID of the NF Service Consumer (e.g. AMF or SMF)	
mbsSessionId	MbsSessionId	M	1	MBS session identifier (TMGI and/or SSM, and NID for an SNPN)	
areaSessionId	AreaSessionId	C	0..1	This IE shall be present if this is a location dependent multicast MBS session.	
requestedAction	ContextUpdateAction	C	0..1	This IE shall be set by an SMF. When present, this IE shall indicate whether to start or terminate MBS data reception.	
dlTunnelInfo	Bytes	C	0..1	This IE shall be included by the SMF if the mbsSessionId IE is present and unicast transport is used over N19mb. When present, it shall contain Base64-encoded characters, encoding the DL F-TEID of the UPF as specified in Figure 8.22-1 of 3GPP TS 29.274 [19] (starting from octet 1). (NOTE)	
n2MbsSmlInfo	N2MbsSmlInfo	C	0..1	This IE shall be included by the AMF if N2 MBS Session Management Information (container) needs to be sent to the MB-SMF.	
ranNodeid	GlobalRanNodeid	C	0..1	This IE shall be included by the AMF. When present, it shall indicate the RAN Node ID of the RAN having sent the N2 information.	
leaveInd	boolean	C	0..1	Leave Indication This IE shall be included by the AMF and set to true during a Release of shared delivery toward RAN node procedure, if it is the last NG-RAN controlled by the AMF serving the multicast MBS session.  - true: the AMF does not control any more NG-RAN node for the multicast MBS session.	
NOTE: The SMF shall set the Interface Type in octet 5 indicating N19mb as specified in clause 8.22 of 3GPP TS 29.274 [19].					

## 6.2.6.2.6 Type: ContextUpdateRspData

Table 6.2.6.2.6-1: Definition of type ContextUpdateRspData

Attribute name	Data type	P	Cardinality	Description	Applicability
lISsm	Ssm	C	0..1	This IE shall be present if the n2Info IE is absent and multicast transport is used over N19mb. When present, it shall contain the Low Layer Source Specific Multicast Address allocated by the MB-UPF.	
cTeid	Uint32	C	0..1	This IE shall be present if the n2Info IE is absent and multicast transport is used over N19mb. When present, it shall contain the Common TEID allocated by the MB-UPF.	
n2MbsSmlInfo	N2MbsSmlInfo	C	0..1	This IE shall be present if N2 MBS Session Management Information (container) needs to be sent to the NF Service Consumer.	

## 6.2.6.2.7 Type: StatusSubscribeReqData

**Table 6.2.6.2.7-1: Definition of type StatusSubscribeReqData**

Attribute name	Data type	P	Cardinality	Description	Applicability
subscription	MbsSessionSubscription	M	1	MbsSession Status subscription to be created	

## 6.2.6.2.8 Type: StatusSubscribeRspData

**Table 6.2.6.2.8-1: Definition of type StatusSubscribeRspData**

Attribute name	Data type	P	Cardinality	Description	Applicability
subscription	MbsSessionSubscription	M	1	MBS Session Status subscription created	
eventList	MbsSessionEventReportList	C	0..1	Event reports if corresponding information is available.	

## 6.2.6.2.9 Type: N2MbsSmInfo

**Table 6.2.6.2.9-1: Definition of type N2MbsSmInfo**

Attribute name	Data type	P	Cardinality	Description	Applicability
ngapleType	NgapleType	M	1	This IE shall indicate the NGAP IE type of the ngapData as specified in clause 6.2.6.3.6.	
ngapData	RefToBinaryData	M	1	This IE shall contain the reference to the binary data part carrying the NGAP data. See clause 6.2.6.5.2 for details.	

## 6.2.6.2.10 Type: ContextStatusNotifyReqData

**Table 6.2.6.2.10-1: Definition of type ContextStatusNotifyReqData**

Attribute name	Data type	P	Cardinality	Description	Applicability
reportList	array(ContextStatusEventReport)	M	1..N	Events to be reported	
notifyCorrelationId	string	C	0..1	Notification Correlation ID. This IE shall be present if a Notification Correlation ID is available in the subscription.	

## 6.2.6.2.11 Type: StatusNotifyReqData

**Table 6.2.6.2.11-1: Definition of type StatusNotifyReqData**

Attribute name	Data type	P	Cardinality	Description	Applicability
eventList	MbsSessionEventReportList	M	1	Reported MBS session events	

## 6.2.6.2.12 Type: ContextStatusSubscribeReqData

**Table 6.2.6.2.12-1: Definition of type ContextStatusSubscribeReqData**

Attribute name	Data type	P	Cardinality	Description	Applicability
subscription	ContextStatusSubscription	M	1	Context Status subscription to be created	

## 6.2.6.2.13 Type: ContextStatusSubscription

**Table 6.2.6.2.13-1: Definition of type ContextStatusSubscription**

Attribute name	Data type	P	Cardinality	Description	Applicability
nfInstanceId	NfInstanceId	M	1	NF Instance ID of the NF Service Consumer	
mbsSessionId	MbsSessionId	M	1	MBS Session Identifier (i.e. TMGI or source specific IP multicast address)	
eventList	array(ContextStatusEvent)	M	1..N	Events subscribed	
notifyUri	Uri	M	1	URI where to send event notifications	
notifyCorrelationId	string	O	0..1	Notification Correlation ID	
expiryTime	DateTime	O	0..1	When present in a subscription creation or modification request, it shall indicate the time (in UTC) up to which the subscription is desired to be kept active and after which the subscribed events shall stop generating notifications.  When present in a subscription or modification response, it shall indicate the expiry time after which the subscription becomes invalid.	

## 6.2.6.2.14 Type: ContextStatusEvent

**Table 6.2.6.2.14-1: Definition of type ContextStatusEvent**

Attribute name	Data type	P	Cardinality	Description	Applicability
eventType	ContextStatusEventType	M	1	MBS session context status event type (NOTE)	
immediateReportInd	boolean	O	0..1	Immediate Report Indication When present, it shall be set as follows: - true: an immediate report is requested  - false (default): no immediate report is requested	
reportingMode	ReportingMode	O	0..1	When present, it shall indicate whether the events shall be reported continuously or one time only. (NOTE)	

NOTE: In this release of the specification, the SMF shall subscribe to the "QOS\_INFO", "STATUS\_INFO", "SERVICE\_AREA\_INFO", "SECURITY\_INFO", "SESSION\_RELEASE" and "MULT\_TRANS\_ADD\_CHANGE" events, with the Reporting Mode set to "Continuous event reporting".

## 6.2.6.2.15 Type: ContextStatusSubscribeRspData

Table 6.2.6.2.15-1: Definition of type ContextStatusSubscribeRspData

Attribute name	Data type	P	Cardinality	Description	Applicability
subscription	ContextStatusSubscription	M	1	Representation of the Context Status Subscription resource that has been created.	
reportList	Array(ContextStatusEventReport)	C	1..N	Immediate event reports, if requested in the request and if corresponding information is available.	
mbsContextInfo	MbsContextInfo	O	0..1	MBS context information	

## 6.2.6.2.16 Type: MbsContextInfo

Table 6.2.6.2.16-1: Definition of type MbsContextInfo

Attribute name	Data type	P	Cardinality	Description	Applicability
startTime	DateTime	O	0..1	Start time (in UTC) of the multicast MBS session	
anyUeInd	boolean	O	0..1	Indication that the multicast MBS session allows any UE to join. When present, it shall be set as follows: - true: any UE may join  - false (default): the MBS session is not open to any UE	
lISsm	Ssm	O	0..1	This IE may be present if multicast transport may be used over N19mb. When present, it shall contain the Low Layer Source Specific Multicast Address allocated by the MB-UPF.	
cTeid	Uint32	O	0..1	This IE may be present if multicast transport may be used over N19mb. When present, it shall contain the Common TEID allocated by the MB-UPF.	
mbsServiceArea	MbsServiceArea	C	0..1	This IE shall be present for a Local MBS session.	
mbsServiceAreaInfoList	map(MbsServiceAreaInfo)	C	1..N	This IE shall be present for a location dependent MBS service. When present, one map entry shall be provided for each MBS Service Area served by the MBS session. The key of the map shall be the areaSessionId.	

## 6.2.6.2.17 Type: ContextStatusEventReport

**Table 6.2.6.2.17-1: Definition of type ContextStatusEventReport**

Attribute name	Data type	P	Cardinality	Description	Applicability
eventType	ContextStatusEventType	M	1	MBS session context status event type	
timeStamp	DateTime	M	1	This IE shall contain the time (in UTC) at which the event is generated.	
qosInfo	QosInfo	C	0..1	This IE shall be present if the eventType IE indicates "QOS_INFO".	
statusInfo	MbsSessionActivityStatus	C	0..1	This IE shall be present if the eventType IE indicates "STATUS_INFO".	
mbsServiceArea	MbsServiceArea	C	0..1	This IE shall be present for a Local MBS session if the eventType IE indicates "SERVICE_AREA_INFO". The receiver of this IE shall overwrite any previously stored value with the value received in this IE.	
mbsServiceAreaInfoList	map(MbsServiceAreaInfo)	C	1..N	This IE shall be present for a location dependent MBS service if the eventType IE indicates "SERVICE_AREA_INFO". When present, one map entry shall be provided for each MBS Service Area served by the MBS session. The key of the map shall be the areaSessionId. The receiver of this IE shall overwrite any previously stored value with the value received in this IE.	
multicastTransAddInfo	MulticastTransportAddressChangeInfo	C	0..1	Multicast Transport Address Change Information This IE shall be present if the eventType IE indicates "MULT_TRANS_ADD_CHANGE".	
mbsSecurityContext	MbsSecurityContext	C	0..1	This IE shall be present in the eventType IE indicates "SECURITY_INFO". The receiver of this IE shall overwrite any previously stored value with the value received in this IE.	

## 6.2.6.2.18 Type: MulticastTransportAddressChangeInfo

**Table 6.2.6.2.18-1: Definition of type MulticastTransportAddressChangeInfo**

Attribute name	Data type	P	Cardinality	Description	Applicability
IIsm	Ssm	M	1	This IE shall indicate the new multicast transport address (i.e. source IP address and destination multicast address) allocated by the MB-UPF to receive the MBS session data over the N19mb reference point.	
cTeid	Uint32	M	1	This IE shall contain the new Common TEID allocated by the MB-UPF to receive the MBS session data over the N19mb reference point.	
areaSessionId	AreaSessionId	C	0..1	This IE shall be present for a location dependent MBS session. When present, it shall indicate the Area Session ID of the part of the location dependent MBS session for which the new multicast transport address is provided.	

## 6.2.6.2.19 Type: QosInfo

Table 6.2.6.2.19-1: Definition of type QosInfo

Attribute name	Data type	P	Cardinality	Description	Applicability
qosFlowsAddModReqList	array(QosFlowAddModifyRequestItem)	C	1..N	This IE shall be present if the eventType IE indicates "QOS_INFO" and MBS QoS flows are requested to be established or modified.	
qosFlowsRelRequestList	array(Qfi)	C	1..N	This IE shall be present if the eventType IE indicates "QOS_INFO" and MBS QoS flows are requested to be released. When present, it shall indicate the MBS QoS flows to be released.	

## 6.2.6.2.20 Type: QosFlowAddModifyRequestItem

Table 6.2.6.2.20-1: Definition of type QosFlowAddModifyRequestItem

Attribute name	Data type	P	Cardinality	Description	Applicability
qfi	Qfi	M	1	This IE shall contain the MBS QoS Flow Identifier.	
qosFlowProfile	QosFlowProfile	O	0..1	When present, this IE shall contain the description of the MBS QoS Flow level QoS parameters. When modifying an MBS QoS flow, the IE shall only contain the MBS QoS Flow profile's attributes which are modified.	

## 6.2.6.2.21 Type: QosFlowProfile

Table 6.2.6.2.21-1: Definition of type QosFlowProfile

Attribute name	Data type	P	Cardinality	Description
5qi	5Qi	M	1	This IE shall contain the 5G QoS Identifier (5QI) of the MBS QoS flow.
nonDynamic5Qi	NonDynamic5Qi	C	0..1	When present, this IE shall indicate the QoS Characteristics for a standardized or pre-configured 5QI for downlink. (NOTE)
dynamic5Qi	Dynamic5Qi	C	0..1	When present, this IE shall indicate the QoS Characteristics for a Non-standardised or not pre-configured 5QI for downlink. (NOTE)
arp	Arp	C	0..1	This IE shall be present when establishing an MBS QoS flow; it may be present when modifying an MBS QoS flow. When present, this IE shall contain the Allocation and Retention Priority (ARP) assigned to the MBS QoS flow.
gbrQosFlowInfo	GbrQosFlowInformation	C	0..1	This IE shall be present when establishing a GBR MBS QoS flow or if the GBR MBS QoS flow information is modified.
NOTE:	Either the nonDynamic5Qi IE or the dynamic5Qi IE may be present when establishing a QoS flow. Either the nonDynamic5Qi IE or the dynamic5Qi IE may be present when modifying a QoS flow; when present, the received nonDynamic5Qi IE or dynamic5Qi IE shall replace any value received previously for this IE.			

## 6.2.6.2.22 Type: GbrQosFlowInformation

**Table 6.2.6.2.22-1: Definition of type GbrQosFlowInformation**

Attribute name	Data type	P	Cardinality	Description
maxFbrDI	BitRate	M	1	Maximum Bit Rate in Downlink. See 3GPP TS 23.501 [2].
guaFbrDI	BitRate	M	1	Guaranteed Bit Rate in Downlink. See 3GPP TS 23.501 [2].
maxPacketLossRateDI	PacketLossRate	O	0..1	Maximum rate for lost packets that can be tolerated in the downlink direction. See 3GPP TS 23.501 [2].

## 6.2.6.2.23 Type: ProblemDetailsExtension

**Table 6.2.6.2.23-1: Definition of type ProblemDetailsExtension**

Attribute name	Data type	P	Cardinality	Description	Applicability
accMbsServiceInfo	AcceptableMbsServInfo	O	0..1	MBS Service Information that can be accepted by the PCF	

## 6.2.6.2.24 Type: UpdateRspData

**Table 6.2.6.2.24-1: Definition of type UpdateRspData**

Attribute name	Data type	P	Cardinality	Description	Applicability
mbsSession	ExtMbsSession	M	1	Representation of the updated MBS session  if the MB-SMF has reduced the MBS service area to be within the MB-SMF service area (see clause 5.3.2.3.1), the MB-SMF shall provide in the response the representation of the updated MBS session including the reduced MBS service area in the redMbsServArea attribute.	

## 6.2.6.3 Simple data types and enumerations

## 6.2.6.3.1 Introduction

This clause defines simple data types and enumerations that can be referenced from data structures defined in the previous clauses.

## 6.2.6.3.2 Simple data types

The Nmbsmf\_MBSSession API does not define any simple data type in this release of the specification.

## 6.2.6.3.3 Enumeration: ContextUpdateAction

The enumeration ContextUpdateAction indicates the requested action for the MBS session context. It shall comply with the provisions defined in table 6.2.6.3.3-1.



**Table 6.2.6.3.3-1: Enumeration ContextUpdateAction**

Enumeration value	Description	Applicability
"START"	Start MBS data reception	
"TERMINATE"	Terminate MBS data reception	

## 6.2.6.3.4 Enumeration: ContextStatusEventType

**Table 6.2.6.3.4-1: Enumeration ContextStatusEventType**

Enumeration value	Description	Applicability
"QOS_INFO"	Subscription to be notified about the current MBS Session's QoS information and/or change of this information (e.g. addition, modification or removal of QoS flows)	
"STATUS_INFO"	Subscription to be notified about the current MBS Session's status (activated or deactivated) and/or change of this information.	
"SERVICE_AREA_INFO"	Subscription to be notified about the current MBS Service Area and/or change of this information.	
"SESSION_RELEASE"	Subscription to be notified when the MBS session is released.	
"MULT_TRANS_ADD_CHANGE"	Subscription to be notified about change of the N19mb multicast transport address.	
"SECURITY_INFO"	Subscription to be notified about the current MBS Session's Security Context information and/or change of this information	

## 6.2.6.3.5 Enumeration: ReportingMode

**Table 6.2.6.3.5-1: Enumeration ReportingMode**

Enumeration value	Description	Applicability
"CONTINUOUS"	Continuous event reporting	
"ONE_TIME"	One-time event reporting	

## 6.2.6.3.6 Enumeration: NgapleType

**Table 6.5.6.3.6-1: Enumeration NgapleType**

Enumeration value	Description
"MBS_DIS_SETUP_REQ"	MBS Distribution Setup Request Transfer
"MBS_DIS_SETUP_RSP"	MBS Distribution Setup Response Transfer
"MBS_DIS_SETUP_FAIL"	MBS Distribution Setup Unsuccessful Transfer
"MBS_DIS_REL_REQ"	MBS Distribution Release Request Transfer

## 6.2.6.4 Data types describing alternative data types or combinations of data types

## 6.2.6.4.1 Type: ExtMbsSession

**6.2.6.4.1-1: Definition of type ExtMbsSession as a list of to be combined data types**

Data type	Cardinality	Description
MbsSession	1	MbsSession common data type
MbsSessionExtension	1	Extensions to the MbsSession common data type

## 6.2.6.4.2 Type: ExtProblemDetails

**6.2.6.4.2-1: Definition of type ExtProblemDetails as a list of to be combined data types**

Data type	Cardinality	Description
ProblemDetails	1	Details of the encountered problem, as defined in 3GPP TS 29.571 [18].
ProblemDetailsExtension	1	Extensions to the ProblemDetails common data type

## 6.2.6.5 Binary data

## 6.2.6.5.1 Introduction

This clause defines the binary data that shall be supported in a binary body part in an HTTP multipart message (see clauses 6.2.2.2.2 and 6.2.2.4).

**Table 6.2.6.5.1-1: Binary Data Types**

Name	Clause defined	Content type
N2 MBS Session Management Information	6.2.6.5.2	vnd.3gpp.ngap

## 6.2.6.5.2 N2 MBS Session Management Information

N2 MBS Session Management Information shall encode NG Application Protocol (NGAP) IEs, as specified in clause 9.3.5 of 3GPP TS 38.413 [20] (ASN.1 encoded), using the vnd.3gpp.ngap content-type.

N2 MBS Session Management Information may encode following NGAP IE related to MBS Session Management specified in in clause 9.3.5 of 3GPP TS 38.413 [20], as summarized in Table 6.5.6.4.2-1.

**Table 6.5.6.4.2-1: N2 MBS Session Management Information content**

NGAP IE	Reference (3GPP TS 38.413 [20])	Related NGAP message
MBS Distribution Setup Request Transfer	9.3.5.7	DISTRIBUTION SETUP REQUEST
MBS Distribution Setup Response Transfer	9.3.5.8	DISTRIBUTION SETUP RESPONSE
MBS Distribution Setup Unsuccessful Transfer	9.3.5.9	DISTRIBUTION SETUP FAILURE
MBS Distribution Release Request Transfer	9.3.5.10	DISTRIBUTION RELEASE REQUEST

## 6.2.6.5.3 Void

## 6.2.7 Error Handling

## 6.2.7.1 General

For the Nmbsmf\_MBSSession API, HTTP error responses shall be supported as specified in clause 4.8 of 3GPP TS 29.501 [5]. Protocol errors and application errors specified in table 5.2.7.2-1 of 3GPP TS 29.500 [4] shall be supported for an HTTP method if the corresponding HTTP status codes are specified as mandatory for that HTTP method in table 5.2.7.1-1 of 3GPP TS 29.500 [4].

In addition, the requirements in the following clauses are applicable for the Nmbsmf\_MBSSession API.

### 6.2.7.2 Protocol Errors

No specific procedures for the NmbSMF\_MBSSession service are specified.

### 6.2.7.3 Application Errors

The application errors defined for the NmbSMF\_MBSSession service are listed in Table 6.2.7.3-1.

**Table 6.2.7.3-1: Application errors**

Application Error	HTTP status code	Description
INVALID_MBS_SERVICE_INFO	400 Bad Request	The HTTP request is rejected because the provided MBS Service Information is invalid (e.g. invalid QoS reference), incorrect or insufficient to perform MBS policy authorization.
FILTER_RESTRICTIONS_NOT_RESPECTED	400 Bad Request	The HTTP request is rejected because the MBS IP flow(s) description provided within the MBS Service Information cannot be handled due to the restrictions defined in clause 5.3.8 of 3GPP TS 29.214 [24] not being respected.
ERROR_INPUT_PARAMETERS	400 Bad Request	The HTTP request is rejected because the provided set of input parameters are incomplete, erroneous or missing necessary information to perform MBS policy control.
MBS_SERVICE_INFO_NOT_AUTHORIZED	403 Forbidden	The HTTP request is rejected because the provided MBS Service Information is not authorized to perform MBS policy authorization.
MBS_POLICY_CONTEXT_DENIED	403 Forbidden	The HTTP request is rejected due to operator policies and/or local configuration.
MBS_SESSION_ALREADY_CREATED	403 Forbidden	This error indicates an unsuccessful of MBS session creation, if the MBS session to be created has already been created in the MB-SMF. For a location dependent MBS session, this error shall be used if the MBS session associated to the indicated MBS session identifier and MBS service area has already been created in the MB-SMF. For non location dependent MBS session, this error shall be used if the MBS session indicated by the MBS session identifier has been created in the MB-SMF.
OVERLAPPING_MBS_SERVICE_AREA	403 Forbidden	This error indicates an unsuccessful of MBS session creation, if the new MBS service area overlaps with the service area of any MBS session with the same MBS session identifier.
UNKNOWN_TMGI	404 Not Found	This error indicates an unsuccessful of MBS session creation, if the TMGI provided in the request does not exist in the MB-SMF. This application error shall not apply to a location dependent broadcast MBS session if, based on operator's policy, the MB-SMF shall accept a TMGI value allocated by another MB-SMF.
UNKNOWN_MBS_SESSION	404 Not Found	This error indicates an unsuccessful MBS session update or release, if the MBS session to be updated or deleted is not found in the MB-SMF.
UNKNOWN_MBS_SERVICE_AREA	404 Not Found	This error indicates an unsuccessful MBS session update, context update or status subscribe procedure for a location dependent MBS session, if the requested MBS Area Session ID cannot be found.

### 6.2.8 Feature negotiation

The optional features in table 6.2.8-1 are defined for the NmbSMF\_MBSSession API. They shall be negotiated using the extensibility mechanism defined in clause 6.6 of 3GPP TS 29.500 [4].

**Table 6.2.8-1: Supported Features**

Feature number	Feature Name	Description
1	MOCNS	<p>Multiple Operators Core Network Support</p> <p>This feature indicates that the MB-SMF supports the resource sharing across broadcast MBS Sessions during network sharing as specified in clauses 6.18 and 7.3.7 of 3GPP TS 23.247 [14].</p> <p>The NF service consumer may use the feature for selecting an MB-SMF supporting MOCN function, e.g. support of receiving the associatedSessionId attribute in the MbsSession data type (as defined in 3GPP TS 29.571 [18]) and communicating the same to the NG-RAN.</p>
2	REDCAP	<p>REDuced CAPability</p> <p>This feature indicates that the MB-SMF supports indicating whether a broadcast MBS session is intended for NR RedCap UEs, for both NR RedCap UEs and non-RedCap UEs, or only for non-RedCap UEs as specified in clause 6.19 of 3GPP TS 23.247 [14].</p> <p>The NF service consumer may use the feature for selecting an MB-SMF supporting the NrRedCapUeInfo (as defined in 3GPP TS 29.571 [18]) and communicating the same to the NG-RAN.</p>

## 6.2.9 Security

As indicated in 3GPP TS 33.501 [8] and 3GPP TS 29.500 [4], the access to the Nmbsmf\_MBSSession API may be authorized by means of the OAuth2 protocol (see IETF RFC 6749 [9]), based on local configuration, using the "Client Credentials" authorization grant, where the NRF (see 3GPP TS 29.510 [10]) plays the role of the authorization server.

If OAuth2 is used, an NF Service Consumer, prior to consuming services offered by the Nmbsmf\_MBSSession API, shall obtain a "token" from the authorization server, by invoking the Access Token Request service, as described in 3GPP TS 29.510 [10], clause 5.4.2.2.

**NOTE:** When multiple NRFs are deployed in a network, the NRF used as authorization server is the same NRF that the NF Service Consumer used for discovering the Nmbsmf\_MBSSession service.

The Nmbsmf\_MBSSession API defines the following scopes for OAuth2 authorization.

**Table 6.2.9-1: OAuth2 scopes defined in Nmbsmf\_MBSSession API**

Scope	Description
"nmbsmf-mbssession"	Access to the Nmbsmf_MBSSession API
"nmbsmf-mbssession:mbs-sessions"	Access to service operations applying to MBS session resources, i.e. Create, Update, Delete, StatusSubscribe, StatusUnsubscribe
"nmbsmf-mbssession:mbs-contexts"	Access to service operations applying to MBS session context resources, i.e. ContextUpdate, ContextStatusSubscribe, ContextStatusUnsubscribe

## 6.2.10 HTTP redirection

An HTTP request may be redirected to a different MB-SMF service instance, within the same MB-SMF or a different MB-SMF of an MB-SMF set, e.g. when an MB-SMF service instance is part of an MB-SMF (service) set or when using indirect communications (see 3GPP TS 29.500 [4]).

An SCP that reselects a different MB-SMF producer instance will return the NF Instance ID of the new MB-SMF producer instance in the 3gpp-Sbi-Producer-Id header, as specified in clause 6.10.3.4 of 3GPP TS 29.500 [4].

If an MB-SMF within an MB-SMF set redirects a service request to a different MB-SMF of the set using an 307 Temporary Redirect or 308 Permanent Redirect status code, the identity of the new MB-SMF towards which the service

request is redirected shall be indicated in the 3gpp-Sbi-Target-Nf-Id header of the 307 Temporary Redirect or 308 Permanent Redirect response as specified in clause 6.10.9.1 of 3GPP TS 29.500 [4].

---

# Annex A (normative): OpenAPI specification

## A.1 General

This Annex specifies the formal definition of the MB-SMF Service APIs defined in the present specification - Nmbsmf\_TMGI and Nmbsmf\_MBSSession APIs. This Annex consists of OpenAPI specifications in YAML format.

This Annex takes precedence when being discrepant to other parts of the specification with respect to the encoding of information elements and methods within the API(s).

**NOTE:** The semantics and procedures, as well as conditions, e.g. for the applicability and allowed combinations of attributes or values, not expressed in the OpenAPI definitions but defined in other parts of the specification also apply.

Informative copies of the OpenAPI specification files contained in this 3GPP Technical Specification are available on a Git-based repository that uses the GitLab software version control system (see 3GPP TS 29.501 [5] clause 5.3.1 and 3GPP TR 21.900 [7] clause 5B).

---

## A.2 Nmbsmf\_TMGI API

openapi: 3.0.0

```
info:
  title: 'Nmbsmf_TMGI'
  version: 1.0.1
  description: |
    MB-SMF TMGI Service.
    © 2022, 3GPP Organizational Partners (ARIB, ATIS, CCSA, ETSI, TSDSI, TTA, TTC).
    All rights reserved.

externalDocs:
  description: >
    3GPP TS 29.532 V17.3.0; 5G System; 5G Multicast-Broadcast Session Management Services;
    Stage 3.
  url: https://www.3gpp.org/ftp/Specs/archive/29_series/29.532/

servers:
  - url: '{apiRoot}/nmbsmf-tmgi/v1'
    variables:
      apiRoot:
        default: https://example.com
        description: apiRoot as defined in clause 4.4 of 3GPP TS 29.501

security:
  - {}
  - oAuth2ClientCredentials:
    - nmbsmf-tmgi

paths:
  /tmgi:
    post:
      summary: Allocate TMGIs
      tags:
        - TMGI collection
      operationId: AllocateTmgi
      requestBody:
        description: representation of the TMGIs to be created in the MB-SMF
        required: true
        content:
          application/json:
            schema:
```

```

    $ref: '#/components/schemas/TmgiAllocate'
responses:
  '200':
    description: successful allocation of TMGIs
    content:
      application/json:
        schema:
          $ref: '#/components/schemas/TmgiAllocated'
  '307':
    $ref: 'TS29571_CommonData.yaml#/components/responses/307'
  '308':
    $ref: 'TS29571_CommonData.yaml#/components/responses/308'
  '400':
    $ref: 'TS29571_CommonData.yaml#/components/responses/400'
  '401':
    $ref: 'TS29571_CommonData.yaml#/components/responses/401'
  '403':
    $ref: 'TS29571_CommonData.yaml#/components/responses/403'
  '404':
    $ref: 'TS29571_CommonData.yaml#/components/responses/404'
  '411':
    $ref: 'TS29571_CommonData.yaml#/components/responses/411'
  '413':
    $ref: 'TS29571_CommonData.yaml#/components/responses/413'
  '415':
    $ref: 'TS29571_CommonData.yaml#/components/responses/415'
  '429':
    $ref: 'TS29571_CommonData.yaml#/components/responses/429'
  '500':
    $ref: 'TS29571_CommonData.yaml#/components/responses/500'
  '502':
    $ref: 'TS29571_CommonData.yaml#/components/responses/502'
  '503':
    $ref: 'TS29571_CommonData.yaml#/components/responses/503'
  default:
    $ref: 'TS29571_CommonData.yaml#/components/responses/default'
delete:
  summary: Deallocate one or more TMGIs
  operationId: TMGIDeallocate
  tags:
    - TMGI collection
  parameters:
    - name: tmgi-list
      in: query
      description: One or more TMGIs to be deallocated
      content:
        application/json:
          schema:
            type: array
            items:
              $ref: 'TS29571_CommonData.yaml#/components/schemas/Tmgi'
            minItems: 1
  responses:
    '204':
      description: successful deallocation of TMGIs
    '307':
      $ref: 'TS29571_CommonData.yaml#/components/responses/307'
    '308':
      $ref: 'TS29571_CommonData.yaml#/components/responses/308'
    '400':
      $ref: 'TS29571_CommonData.yaml#/components/responses/400'
    '401':
      $ref: 'TS29571_CommonData.yaml#/components/responses/401'
    '403':
      $ref: 'TS29571_CommonData.yaml#/components/responses/403'
    '404':
      $ref: 'TS29571_CommonData.yaml#/components/responses/404'
    '429':
      $ref: 'TS29571_CommonData.yaml#/components/responses/429'
    '500':
      $ref: 'TS29571_CommonData.yaml#/components/responses/500'
    '502':
      $ref: 'TS29571_CommonData.yaml#/components/responses/502'
    '503':
      $ref: 'TS29571_CommonData.yaml#/components/responses/503'
    default:
      $ref: 'TS29571_CommonData.yaml#/components/responses/default'

```

```

components:
  securitySchemes:
    oAuth2ClientCredentials:
      type: oauth2
      flows:
        clientCredentials:
          tokenUrl: '{nrfApiRoot}/oauth2/token'
          scopes:
            nmbsmf-tmgi: Access to the nmbsmf-tmgi API

  schemas:
    # API specific definitions
#
# STRUCTURED DATA TYPES
#
  TmgiAllocate:
    description: Data within TMGI Allocate Request
    type: object
    properties:
      tmgiNumber:
        description: The number of requested TMGIs
        type: integer
        minimum: 1
        maximum: 255
      tmgiList:
        description: The list of TMGIs to be refreshed
        type: array
        items:
          $ref: 'TS29571_CommonData.yaml#/components/schemas/Tmgi'
        minItems: 1

  TmgiAllocated:
    description: Data within TMGI Allocate Response
    type: object
    properties:
      tmgiList:
        description: One or more TMGI values
        type: array
        items:
          $ref: 'TS29571_CommonData.yaml#/components/schemas/Tmgi'
        minItems: 1
      expirationTime:
        $ref: 'TS29571_CommonData.yaml#/components/schemas/DateTime'
      nid:
        $ref: 'TS29571_CommonData.yaml#/components/schemas/Nid'
    required:
      - tmgiList
      - expirationTime

#
# SIMPLE DATA TYPES
#

#
# ENUMERATIONS
#

```

---

## A.3 Nmbsmf\_MBSSession API

openapi: 3.0.0

```

info:
  title: 'Nmbsmf-MBSSession'
  version: 1.2.0
  description: |
    MB-SMF MBSSession Service.
    © 2024, 3GPP Organizational Partners (ARIB, ATIS, CCSA, ETSI, TSDSI, TTA, TTC).
    All rights reserved.

```

```

externalDocs:
  description: >
    3GPP TS 29.532 V18.5.0; 5G System; 5G Multicast-Broadcast Session Management Services;
    Stage 3.
  url: https://www.3gpp.org/ftp/Specs/archive/29_series/29.532/

```

```

servers:
  - url: '{apiRoot}/nmbsmf-mbssession/v1'
    variables:
      apiRoot:
        default: https://example.com
        description: apiRoot as defined in clause 4.4 of 3GPP TS 29.501

security:
  - {}
  - oAuth2ClientCredentials:
    - nmbsmf-mbssession

paths:
  /mbs-sessions:
    post:
      summary: Create
      tags:
        - MBS sessions collection
      operationId: Create
      security:
        - {}
        - oAuth2ClientCredentials:
          - nmbsmf-mbssession
        - oAuth2ClientCredentials:
          - nmbsmf-mbssession
        - nmbsmf-mbssession:mbs-sessions
      requestBody:
        description: >
          Representation of the MBS session to be created in the MB-SMF
          Creates an individual MBS session resource in the MB-SMF.
        required: true
        content:
          application/json:
            schema:
              $ref: '#/components/schemas/CreateReqData'
      responses:
        '201':
          description: >
            Successful creation of an MBS session
          content:
            application/json:
              schema:
                $ref: '#/components/schemas/CreateRspData'
          headers:
            Location:
              description: >
                'Contains the URI of the newly created resource, according to the structure:
                {apiRoot}/nmbsmf-mbssession/<apiVersion>/mbs-sessions/{mbsSessionRef}'
              required: true
              schema:
                type: string
        '307':
          $ref: 'TS29571_CommonData.yaml#/components/responses/307'
        '308':
          $ref: 'TS29571_CommonData.yaml#/components/responses/308'
        '400':
          $ref: 'TS29571_CommonData.yaml#/components/responses/400'
        '401':
          $ref: 'TS29571_CommonData.yaml#/components/responses/401'
        '403':
          description: Forbidden.
          content:
            application/problem+json:
              schema:
                $ref: '#/components/schemas/ExtProblemDetails'
        '404':
          $ref: 'TS29571_CommonData.yaml#/components/responses/404'
        '411':
          $ref: 'TS29571_CommonData.yaml#/components/responses/411'
        '413':
          $ref: 'TS29571_CommonData.yaml#/components/responses/413'
        '415':
          $ref: 'TS29571_CommonData.yaml#/components/responses/415'
        '429':
          $ref: 'TS29571_CommonData.yaml#/components/responses/429'
        '500':
          $ref: 'TS29571_CommonData.yaml#/components/responses/500'

```



```

'502':
  $ref: 'TS29571_CommonData.yaml#/components/responses/502'
'503':
  $ref: 'TS29571_CommonData.yaml#/components/responses/503'
default:
  $ref: 'TS29571_CommonData.yaml#/components/responses/default'

/mbs-sessions/{mbsSessionRef}:
  patch:
    summary: Updates an individual MBS session resource in the MB-SMF.
    tags:
      - Individual MBS session
    operationId: Update
    security:
      - {}
      - oAuth2ClientCredentials:
          - nmbsmf-mbssession
      - oAuth2ClientCredentials:
          - nmbsmf-mbssession
          - nmbsmf-mbssession:mbs-sessions
    parameters:
      - name: mbsSessionRef
        in: path
        required: true
        description: Unique ID of the MBS session to be modified
        schema:
          type: string
    requestBody:
      description: Data within the Update Request
      required: true
      content:
        application/json-patch+json:
          schema:
            type: array
            items:
              $ref: 'TS29571_CommonData.yaml#/components/schemas/PatchItem'
            minItems: 1
    responses:
      '204':
        description: >
          Successful modification of the MBS session without content in the response.
      '200':
        description: >
          Successful modification of the MBS session with content in the response
        content:
          application/json:
            schema:
              $ref: '#/components/schemas/UpdateRspData'
      '307':
        $ref: 'TS29571_CommonData.yaml#/components/responses/307'
      '308':
        $ref: 'TS29571_CommonData.yaml#/components/responses/308'
      '400':
        $ref: 'TS29571_CommonData.yaml#/components/responses/400'
      '401':
        $ref: 'TS29571_CommonData.yaml#/components/responses/401'
      '403':
        description: Forbidden.
        content:
          application/problem+json:
            schema:
              $ref: '#/components/schemas/ExtProblemDetails'
      '404':
        $ref: 'TS29571_CommonData.yaml#/components/responses/404'
      '411':
        $ref: 'TS29571_CommonData.yaml#/components/responses/411'
      '413':
        $ref: 'TS29571_CommonData.yaml#/components/responses/413'
      '415':
        $ref: 'TS29571_CommonData.yaml#/components/responses/415'
      '429':
        $ref: 'TS29571_CommonData.yaml#/components/responses/429'
      '500':
        $ref: 'TS29571_CommonData.yaml#/components/responses/500'
      '502':
        $ref: 'TS29571_CommonData.yaml#/components/responses/502'
      '503':
        $ref: 'TS29571_CommonData.yaml#/components/responses/503'

```

```

    default:
      $ref: 'TS29571_CommonData.yaml#/components/responses/default'

delete:
  summary: Deletes an individual MBS session resource in the MB-SMF.
  tags:
    - Individual MBS session
  operationId: Release
  security:
    - {}
    - OAuth2ClientCredentials:
      - nmbsmf-mbssession
    - OAuth2ClientCredentials:
      - nmbsmf-mbssession
      - nmbsmf-mbssession:mbs-sessions
  parameters:
    - name: mbsSessionRef
      in: path
      required: true
      description: Unique ID of the MBS session to be released
      schema:
        type: string
  responses:
    '204':
      description: >
        Successful release of the MBS session without content in the response.
    '307':
      $ref: 'TS29571_CommonData.yaml#/components/responses/307'
    '308':
      $ref: 'TS29571_CommonData.yaml#/components/responses/308'
    '400':
      $ref: 'TS29571_CommonData.yaml#/components/responses/400'
    '401':
      $ref: 'TS29571_CommonData.yaml#/components/responses/401'
    '403':
      $ref: 'TS29571_CommonData.yaml#/components/responses/403'
    '404':
      $ref: 'TS29571_CommonData.yaml#/components/responses/404'
    '429':
      $ref: 'TS29571_CommonData.yaml#/components/responses/429'
    '500':
      $ref: 'TS29571_CommonData.yaml#/components/responses/500'
    '502':
      $ref: 'TS29571_CommonData.yaml#/components/responses/502'
    '503':
      $ref: 'TS29571_CommonData.yaml#/components/responses/503'
    default:
      $ref: 'TS29571_CommonData.yaml#/components/responses/default'

/mbs-sessions/contexts/update:
  post:
    summary: ContextUpdate
    tags:
      - MBS sessions collection
    operationId: ContextUpdate
    security:
      - {}
      - OAuth2ClientCredentials:
        - nmbsmf-mbssession
      - OAuth2ClientCredentials:
        - nmbsmf-mbssession
        - nmbsmf-mbssession:mbs-contexts
    requestBody:
      description: Data within the ContextUpdate Request
      required: true
      content:
        application/json: # message without binary body part
          schema:
            $ref: '#/components/schemas/ContextUpdateReqData'
        multipart/related: # message with binary body part
          schema:
            type: object
            properties: # Request parts
              jsonData:
                $ref: '#/components/schemas/ContextUpdateReqData'
              binaryDataN2Information:
                type: string
                format: binary

```

```

    encoding:
      jsonData:
        contentType: application/json
      binaryDataN2Information:
        contentType: application/vnd.3gpp.ngap
      headers:
        Content-Id:
          schema:
            type: string
responses:
  '200':
    description: Successful response with content in the response
    content:
      application/json: # message without binary body part
        schema:
          $ref: '#/components/schemas/ContextUpdateRspData'
      multipart/related: # message with binary body part
        schema:
          type: object
          properties:
            jsonData:
              $ref: '#/components/schemas/ContextUpdateRspData'
            binaryDataN2Information:
              type: string
              format: binary
          encoding:
            jsonData:
              contentType: application/json
            binaryDataN2Information:
              contentType: application/vnd.3gpp.ngap
            headers:
              Content-Id:
                schema:
                  type: string
  '204':
    description: Successful response without content in the response
  '307':
    $ref: 'TS29571_CommonData.yaml#/components/responses/307'
  '308':
    $ref: 'TS29571_CommonData.yaml#/components/responses/308'
  '400':
    $ref: 'TS29571_CommonData.yaml#/components/responses/400'
  '401':
    $ref: 'TS29571_CommonData.yaml#/components/responses/401'
  '403':
    $ref: 'TS29571_CommonData.yaml#/components/responses/403'
  '404':
    $ref: 'TS29571_CommonData.yaml#/components/responses/404'
  '411':
    $ref: 'TS29571_CommonData.yaml#/components/responses/411'
  '413':
    $ref: 'TS29571_CommonData.yaml#/components/responses/413'
  '415':
    $ref: 'TS29571_CommonData.yaml#/components/responses/415'
  '429':
    $ref: 'TS29571_CommonData.yaml#/components/responses/429'
  '500':
    $ref: 'TS29571_CommonData.yaml#/components/responses/500'
  '502':
    $ref: 'TS29571_CommonData.yaml#/components/responses/502'
  '503':
    $ref: 'TS29571_CommonData.yaml#/components/responses/503'
  default:
    $ref: 'TS29571_CommonData.yaml#/components/responses/default'

/mbs-sessions/subscriptions:
  post:
    summary: StatusSubscribe creating a subscription
    tags:
      - Subscriptions collection for MBS sessions
    operationId: StatusSubscribe
    security:
      - {}
      - oAuth2ClientCredentials:
          - nmbsmf-mbssession
      - oAuth2ClientCredentials:
          - nmbsmf-mbssession
      - nmbsmf-mbssession:mbs-sessions

```

```

requestBody:
  description: Data within the StatusSubscribe Request
  required: true
  content:
    application/json:
      schema:
        $ref: '#/components/schemas/StatusSubscribeReqData'
responses:
  '201':
    description: Data within a successful StatusSubscribe Response
    content:
      application/json:
        schema:
          $ref: '#/components/schemas/StatusSubscribeRspData'
  '204':
    description: Successful response without content in the response
  '307':
    $ref: 'TS29571_CommonData.yaml#/components/responses/307'
  '308':
    $ref: 'TS29571_CommonData.yaml#/components/responses/308'
  '400':
    $ref: 'TS29571_CommonData.yaml#/components/responses/400'
  '401':
    $ref: 'TS29571_CommonData.yaml#/components/responses/401'
  '403':
    $ref: 'TS29571_CommonData.yaml#/components/responses/403'
  '404':
    $ref: 'TS29571_CommonData.yaml#/components/responses/404'
  '411':
    $ref: 'TS29571_CommonData.yaml#/components/responses/411'
  '413':
    $ref: 'TS29571_CommonData.yaml#/components/responses/413'
  '415':
    $ref: 'TS29571_CommonData.yaml#/components/responses/415'
  '429':
    $ref: 'TS29571_CommonData.yaml#/components/responses/429'
  '500':
    $ref: 'TS29571_CommonData.yaml#/components/responses/500'
  '502':
    $ref: 'TS29571_CommonData.yaml#/components/responses/502'
  '503':
    $ref: 'TS29571_CommonData.yaml#/components/responses/503'
  default:
    $ref: 'TS29571_CommonData.yaml#/components/responses/default'

callbacks:
  statusNotification:
    '{$request.body#/notifUri}':
      post:
        parameters:
          - name: Content-Encoding
            in: header
            description: Content-Encoding, described in IETF RFC 9110
            schema:
              type: string
        requestBody:
          description: Notification Content
          content:
            application/json:
              schema:
                $ref: '#/components/schemas/StatusNotifyReqData'
        responses:
          '204':
            description: Expected response to a successful callback processing
            headers:
              Accept-Encoding:
                description: Accept-Encoding, described in IETF RFC 9110
                schema:
                  type: string
          '307':
            $ref: 'TS29571_CommonData.yaml#/components/responses/307'
          '308':
            $ref: 'TS29571_CommonData.yaml#/components/responses/308'
          '400':
            $ref: 'TS29571_CommonData.yaml#/components/responses/400'
          '401':
            $ref: 'TS29571_CommonData.yaml#/components/responses/401'
          '403':

```

```

    $ref: 'TS29571_CommonData.yaml#/components/responses/403'
  '404':
    $ref: 'TS29571_CommonData.yaml#/components/responses/404'
  '411':
    $ref: 'TS29571_CommonData.yaml#/components/responses/411'
  '413':
    $ref: 'TS29571_CommonData.yaml#/components/responses/413'
  '415':
    $ref: 'TS29571_CommonData.yaml#/components/responses/415'
  '429':
    $ref: 'TS29571_CommonData.yaml#/components/responses/429'
  '500':
    $ref: 'TS29571_CommonData.yaml#/components/responses/500'
  '501':
    $ref: 'TS29571_CommonData.yaml#/components/responses/501'
  '502':
    $ref: 'TS29571_CommonData.yaml#/components/responses/502'
  '503':
    $ref: 'TS29571_CommonData.yaml#/components/responses/503'
  default:
    $ref: 'TS29571_CommonData.yaml#/components/responses/default'

/mbs-sessions/subscriptions/{subscriptionId}:
  patch:
    summary: StatusSubscribe to modify (update or renew) an individual subscription
    tags:
      - Individual Subscription for an MBS session
    operationId: StatusSubscribeMod
    security:
      - {}
      - OAuth2ClientCredentials:
          - nmbsmf-mbssession
      - OAuth2ClientCredentials:
          - nmbsmf-mbssession
          - nmbsmf-mbssession:mbs-sessions
    parameters:
      - name: subscriptionId
        in: path
        required: true
        description: Unique ID of the individual subscription to be modified
        schema:
          type: string
    requestBody:
      description: Data to be modified in the MBSsessionSubscription
      required: true
      content:
        application/json-patch+json:
          schema:
            type: array
            items:
              $ref: 'TS29571_CommonData.yaml#/components/schemas/PatchItem'
            minItems: 1
    responses:
      '200':
        description: Successful modification of the individual Status Subscription
        content:
          application/json:
            schema:
              $ref: 'TS29571_CommonData.yaml#/components/schemas/MbsSessionSubscription'
      '307':
        $ref: 'TS29571_CommonData.yaml#/components/responses/307'
      '308':
        $ref: 'TS29571_CommonData.yaml#/components/responses/308'
      '400':
        $ref: 'TS29571_CommonData.yaml#/components/responses/400'
      '401':
        $ref: 'TS29571_CommonData.yaml#/components/responses/401'
      '403':
        $ref: 'TS29571_CommonData.yaml#/components/responses/403'
      '404':
        $ref: 'TS29571_CommonData.yaml#/components/responses/404'
      '411':
        $ref: 'TS29571_CommonData.yaml#/components/responses/411'
      '413':
        $ref: 'TS29571_CommonData.yaml#/components/responses/413'
      '415':
        $ref: 'TS29571_CommonData.yaml#/components/responses/415'
      '429':

```

```

    $ref: 'TS29571_CommonData.yaml#/components/responses/429'
  '500':
    $ref: 'TS29571_CommonData.yaml#/components/responses/500'
  '502':
    $ref: 'TS29571_CommonData.yaml#/components/responses/502'
  '503':
    $ref: 'TS29571_CommonData.yaml#/components/responses/503'
  default:
    $ref: 'TS29571_CommonData.yaml#/components/responses/default'

```

## delete:

```

summary: StatusUnSubscribe to unsubscribe from the Status Subscription
tags:

```

```

  - Individual Subscription for an MBS session

```

```

operationId: StatusUnSubscribe

```

```

security:

```

```

  - {}
  - oAuth2ClientCredentials:
    - nmbsmf-mbssession
  - oAuth2ClientCredentials:
    - nmbsmf-mbssession
    - nmbsmf-mbssession:mbs-sessions

```

```

parameters:

```

```

  - name: subscriptionId
    in: path
    required: true
    description: Unique ID of the subscription to be deleted
    schema:
      type: string

```

```

responses:

```

```

  '204':
    description: Successful deletion of the subscription
  '307':
    $ref: 'TS29571_CommonData.yaml#/components/responses/307'
  '308':
    $ref: 'TS29571_CommonData.yaml#/components/responses/308'
  '400':
    $ref: 'TS29571_CommonData.yaml#/components/responses/400'
  '401':
    $ref: 'TS29571_CommonData.yaml#/components/responses/401'
  '403':
    $ref: 'TS29571_CommonData.yaml#/components/responses/403'
  '404':
    $ref: 'TS29571_CommonData.yaml#/components/responses/404'
  '429':
    $ref: 'TS29571_CommonData.yaml#/components/responses/429'
  '500':
    $ref: 'TS29571_CommonData.yaml#/components/responses/500'
  '502':
    $ref: 'TS29571_CommonData.yaml#/components/responses/502'
  '503':
    $ref: 'TS29571_CommonData.yaml#/components/responses/503'
  default:
    $ref: 'TS29571_CommonData.yaml#/components/responses/default'

```

## /mbs-sessions/contexts/subscriptions:

```

post:

```

```

summary: ContextStatusSubscribe creating a subscription

```

```

tags:

```

```

  - Subscriptions collection for MBS contexts

```

```

operationId: ContextStatusSubscribe

```

```

security:

```

```

  - {}
  - oAuth2ClientCredentials:
    - nmbsmf-mbssession
  - oAuth2ClientCredentials:
    - nmbsmf-mbssession
    - nmbsmf-mbssession:mbs-contexts

```

```

requestBody:

```

```

  description: Data within the ContextStatusSubscribe Request

```

```

  required: true

```

```

  content:

```

```

    application/json:

```

```

      schema:

```

```

        $ref: '#/components/schemas/ContextStatusSubscribeReqData'

```

```

responses:

```

```

  '201':

```

```

    description: successful creation of a Context Status Subscription

```

```

    content:
      application/json:
        schema:
          $ref: '#/components/schemas/ContextStatusSubscriberRspData'
    '204':
      description: Successful response without content in the response
    '307':
      $ref: 'TS29571_CommonData.yaml#/components/responses/307'
    '308':
      $ref: 'TS29571_CommonData.yaml#/components/responses/308'
    '400':
      $ref: 'TS29571_CommonData.yaml#/components/responses/400'
    '401':
      $ref: 'TS29571_CommonData.yaml#/components/responses/401'
    '403':
      $ref: 'TS29571_CommonData.yaml#/components/responses/403'
    '404':
      $ref: 'TS29571_CommonData.yaml#/components/responses/404'
    '411':
      $ref: 'TS29571_CommonData.yaml#/components/responses/411'
    '413':
      $ref: 'TS29571_CommonData.yaml#/components/responses/413'
    '415':
      $ref: 'TS29571_CommonData.yaml#/components/responses/415'
    '429':
      $ref: 'TS29571_CommonData.yaml#/components/responses/429'
    '500':
      $ref: 'TS29571_CommonData.yaml#/components/responses/500'
    '502':
      $ref: 'TS29571_CommonData.yaml#/components/responses/502'
    '503':
      $ref: 'TS29571_CommonData.yaml#/components/responses/503'
    default:
      $ref: 'TS29571_CommonData.yaml#/components/responses/default'

callbacks:
  contextStatusNotification:
    '{$request.body#/subscription/notifUri}':
      post:
        parameters:
          - name: Content-Encoding
            in: header
            description: Content-Encoding, described in IETF RFC 9110
            schema:
              type: string
        requestBody:
          description: Notification Content
          content:
            application/json:
              schema:
                $ref: '#/components/schemas/ContextStatusNotifyReqData'
        responses:
          '204':
            description: Expected response to a successful callback processing
            headers:
              Accept-Encoding:
                description: Accept-Encoding, described in IETF RFC 9110
                schema:
                  type: string
          '307':
            $ref: 'TS29571_CommonData.yaml#/components/responses/307'
          '308':
            $ref: 'TS29571_CommonData.yaml#/components/responses/308'
          '400':
            $ref: 'TS29571_CommonData.yaml#/components/responses/400'
          '401':
            $ref: 'TS29571_CommonData.yaml#/components/responses/401'
          '403':
            $ref: 'TS29571_CommonData.yaml#/components/responses/403'
          '404':
            $ref: 'TS29571_CommonData.yaml#/components/responses/404'
          '411':
            $ref: 'TS29571_CommonData.yaml#/components/responses/411'
          '413':
            $ref: 'TS29571_CommonData.yaml#/components/responses/413'
          '415':
            $ref: 'TS29571_CommonData.yaml#/components/responses/415'
          '429':

```

```

    $ref: 'TS29571_CommonData.yaml#/components/responses/429'
  '500':
    $ref: 'TS29571_CommonData.yaml#/components/responses/500'
  '501':
    $ref: 'TS29571_CommonData.yaml#/components/responses/501'
  '502':
    $ref: 'TS29571_CommonData.yaml#/components/responses/502'
  '503':
    $ref: 'TS29571_CommonData.yaml#/components/responses/503'
  default:
    $ref: 'TS29571_CommonData.yaml#/components/responses/default'

/mbs-sessions/contexts/subscriptions/{subscriptionId}:
  patch:
    summary: ContextStatusSubscribe modifying an individual subscription
    tags:
      - Individual Subscription for an MBS context
    operationId: ContextStatusSubscribeMod
    security:
      - {}
      - oAuth2ClientCredentials:
          - nmbsmf-mbssession
      - oAuth2ClientCredentials:
          - nmbsmf-mbssession
          - nmbsmf-mbssession:mbs-contexts
    parameters:
      - name: subscriptionId
        in: path
        required: true
        description: Unique ID of the subscription to be modified
        schema:
          type: string
    requestBody:
      description: Data to be modified in the ContextStatusSubscription
      required: true
      content:
        application/json-patch+json:
          schema:
            type: array
            items:
              $ref: 'TS29571_CommonData.yaml#/components/schemas/PatchItem'
            minItems: 1
    responses:
      '200':
        description: Successful modification of a Context Status Subscription
        content:
          application/json:
            schema:
              $ref: '#/components/schemas/ContextStatusSubscription'
      '307':
        $ref: 'TS29571_CommonData.yaml#/components/responses/307'
      '308':
        $ref: 'TS29571_CommonData.yaml#/components/responses/308'
      '400':
        $ref: 'TS29571_CommonData.yaml#/components/responses/400'
      '401':
        $ref: 'TS29571_CommonData.yaml#/components/responses/401'
      '403':
        $ref: 'TS29571_CommonData.yaml#/components/responses/403'
      '404':
        $ref: 'TS29571_CommonData.yaml#/components/responses/404'
      '411':
        $ref: 'TS29571_CommonData.yaml#/components/responses/411'
      '413':
        $ref: 'TS29571_CommonData.yaml#/components/responses/413'
      '415':
        $ref: 'TS29571_CommonData.yaml#/components/responses/415'
      '429':
        $ref: 'TS29571_CommonData.yaml#/components/responses/429'
      '500':
        $ref: 'TS29571_CommonData.yaml#/components/responses/500'
      '502':
        $ref: 'TS29571_CommonData.yaml#/components/responses/502'
      '503':
        $ref: 'TS29571_CommonData.yaml#/components/responses/503'
      default:
        $ref: 'TS29571_CommonData.yaml#/components/responses/default'

```



```

delete:
  summary: ContextStatusUnSubscribe
  tags:
    - Individual Subscription for an MBS context
  operationId: ContextStatusUnSubscribe
  security:
    - {}
    - oAuth2ClientCredentials:
      - nmbsmf-mbssession
    - oAuth2ClientCredentials:
      - nmbsmf-mbssession
      - nmbsmf-mbssession:mbs-contexts
  parameters:
    - name: subscriptionId
      in: path
      required: true
      description: Unique ID of the subscription to be deleted
      schema:
        type: string
  responses:
    '204':
      description: Successful deletion
    '307':
      $ref: 'TS29571_CommonData.yaml#/components/responses/307'
    '308':
      $ref: 'TS29571_CommonData.yaml#/components/responses/308'
    '400':
      $ref: 'TS29571_CommonData.yaml#/components/responses/400'
    '401':
      $ref: 'TS29571_CommonData.yaml#/components/responses/401'
    '403':
      $ref: 'TS29571_CommonData.yaml#/components/responses/403'
    '404':
      $ref: 'TS29571_CommonData.yaml#/components/responses/404'
    '429':
      $ref: 'TS29571_CommonData.yaml#/components/responses/429'
    '500':
      $ref: 'TS29571_CommonData.yaml#/components/responses/500'
    '502':
      $ref: 'TS29571_CommonData.yaml#/components/responses/502'
    '503':
      $ref: 'TS29571_CommonData.yaml#/components/responses/503'
    default:
      $ref: 'TS29571_CommonData.yaml#/components/responses/default'

components:
  securitySchemes:
    oAuth2ClientCredentials:
      type: oauth2
      flows:
        clientCredentials:
          tokenUrl: '{nrfApiRoot}/oauth2/token'
          scopes:
            nmbsmf-mbssession: Access to the Nmbsmf-MBSSession API
            nmbsmf-mbssession:mbs-sessions: >
              Access to service operations applying to MBS session resources, i.e. Create, Update,
              Delete, StatusSubscribe, StatusUnsubscribe
            nmbsmf-mbssession:mbs-contexts: >
              Access to service operations applying to MBS session context resources, i.e.
              ContextUpdate, ContextStatusSubscribe and ContextStatusUnsubscribe

  schemas:
    #
    # STRUCTURED DATA TYPES
    #
    CreateReqData:
      description: Data within Create Request
      type: object
      properties:
        mbsSession:
          $ref: '#/components/schemas/ExtMbsSession'
        supportedFeatures:
          $ref: 'TS29571_CommonData.yaml#/components/schemas/SupportedFeatures'

      required:
        - mbsSession

    CreateRspData:

```

```

description: Data within Create Response
type: object
properties:
  mbsSession:
    $ref: '#/components/schemas/ExtMbsSession'
  eventList:
    $ref: 'TS29571_CommonData.yaml#/components/schemas/MbsSessionEventReportList'
  supportedFeatures:
    $ref: 'TS29571_CommonData.yaml#/components/schemas/SupportedFeatures'

required:
  - mbsSession

ExtMbsSession:
description: MbsSession common data type with MB-SMF API specific extensions
allOf:
  - $ref: 'TS29571_CommonData.yaml#/components/schemas/MbsSession'
  - $ref: '#/components/schemas/MbsSessionExtension'

MbsSessionExtension:
description: MB-SMF API specific extensions to the MbsSession common data type
type: object
properties:
  mbsSecurityContext:
    $ref: 'TS29571_CommonData.yaml#/components/schemas/MbsSecurityContext'
  contactPcfInd:
    type: boolean
    default: false
  areaSessionPolicyId:
    $ref: 'TS29571_CommonData.yaml#/components/schemas/AreaSessionPolicyId'

ContextUpdateReqData:
description: Data within ContextUpdate Request
type: object
properties:
  nfcInstanceId:
    $ref: 'TS29571_CommonData.yaml#/components/schemas/NfInstanceId'
  mbsSessionId:
    $ref: 'TS29571_CommonData.yaml#/components/schemas/MbsSessionId'
  areaSessionId:
    $ref: 'TS29571_CommonData.yaml#/components/schemas/AreaSessionId'
  requestedAction:
    $ref: '#/components/schemas/ContextUpdateAction'
  dlTunnelInfo:
    $ref: 'TS29571_CommonData.yaml#/components/schemas/Bytes'
  n2MbsSmInfo:
    $ref: '#/components/schemas/N2MbsSmInfo'
  ranNodeId:
    $ref: 'TS29571_CommonData.yaml#/components/schemas/GlobalRanNodeId'
  leaveInd:
    type: boolean
    enum:
      - true
required:
  - nfcInstanceId
  - mbsSessionId

ContextUpdateRspData:
description: Data within ContextUpdate Response
type: object
properties:
  llSsm:
    $ref: 'TS29571_CommonData.yaml#/components/schemas/Ssm'
  cTeid:
    $ref: 'TS29571_CommonData.yaml#/components/schemas/Uint32'
  n2MbsSmInfo:
    $ref: '#/components/schemas/N2MbsSmInfo'

ContextStatusSubscribeReqData:
description: Data within ContextStatusSubscribe Request
type: object
properties:
  subscription:
    $ref: '#/components/schemas/ContextStatusSubscription'
required:
  - subscription

```

```

ContextStatusSubscription:
  description: Context Status Subscription
  type: object
  properties:
    nfcInstanceId:
      $ref: 'TS29571_CommonData.yaml#/components/schemas/NfInstanceId'
    mbsSessionId:
      $ref: 'TS29571_CommonData.yaml#/components/schemas/MbsSessionId'
    eventList:
      type: array
      items:
        $ref: '#/components/schemas/ContextStatusEvent'
      minItems: 1
    notifyUri:
      $ref: 'TS29571_CommonData.yaml#/components/schemas/Uri'
    notifyCorrelationId:
      type: string
    expiryTime:
      $ref: 'TS29571_CommonData.yaml#/components/schemas/DateTime'
  required:
    - nfcInstanceId
    - mbsSessionId
    - eventList
    - notifyUri

ContextStatusEvent:
  description: Context Status Event
  type: object
  properties:
    eventType:
      $ref: '#/components/schemas/ContextStatusEventType'
    immediateReportInd:
      type: boolean
      default: false
    reportingMode:
      $ref: '#/components/schemas/ReportingMode'
  required:
    - eventType

ContextStatusSubscribeRspData:
  description: Data within ContextStatusSubscribe Response
  type: object
  properties:
    subscription:
      $ref: '#/components/schemas/ContextStatusSubscription'
    reportList:
      type: array
      items:
        $ref: '#/components/schemas/ContextStatusEventReport'
      minItems: 1
    mbsContextInfo:
      $ref: '#/components/schemas/MbsContextInfo'
  required:
    - subscription

MbsContextInfo:
  description: MBS context information
  type: object
  properties:
    startTime:
      $ref: 'TS29571_CommonData.yaml#/components/schemas/DateTime'
    anyUeInd:
      type: boolean
      default: false
    llSsm:
      $ref: 'TS29571_CommonData.yaml#/components/schemas/Ssm'
    cTeid:
      $ref: 'TS29571_CommonData.yaml#/components/schemas/Uint32'
    mbsServiceArea:
      $ref: 'TS29571_CommonData.yaml#/components/schemas/MbsServiceArea'
    mbsServiceAreaInfoList:
      description: >
        A map (list of key-value pairs) where the key identifies an areaSessionId
      additionalProperties:
        $ref: 'TS29571_CommonData.yaml#/components/schemas/MbsServiceAreaInfo'
      minProperties: 1

```

```
ContextStatusEventReport:
  description: Context Status Event Report
  type: object
  properties:
    eventType:
      $ref: '#/components/schemas/ContextStatusEventType'
    timeStamp:
      $ref: 'TS29571_CommonData.yaml#/components/schemas/DateTime'
    qosInfo:
      $ref: '#/components/schemas/QosInfo'
    statusInfo:
      $ref: 'TS29571_CommonData.yaml#/components/schemas/MbsSessionActivityStatus'
    mbsServiceArea:
      $ref: 'TS29571_CommonData.yaml#/components/schemas/MbsServiceArea'
    mbsServiceAreaInfoList:
      description: >
        A map (list of key-value pairs) where the key identifies an areaSessionId
        additionalProperties:
          $ref: 'TS29571_CommonData.yaml#/components/schemas/MbsServiceAreaInfo'
          minProperties: 1
      multicastTransAddInfo:
        $ref: '#/components/schemas/MulticastTransportAddressChangeInfo'
      mbsSecurityContext:
        $ref: 'TS29571_CommonData.yaml#/components/schemas/MbsSecurityContext'
    required:
      - eventType
      - timeStamp

ContextStatusNotifyReqData:
  description: Context Status Notification
  type: object
  properties:
    reportList:
      type: array
      items:
        $ref: '#/components/schemas/ContextStatusEventReport'
      minItems: 1
    notifyCorrelationId:
      type: string
  required:
    - reportList

StatusSubscribeReqData:
  description: Data within the StatusSubscribe Request
  type: object
  properties:
    subscription:
      $ref: 'TS29571_CommonData.yaml#/components/schemas/MbsSessionSubscription'
  required:
    - subscription

StatusSubscribeRspData:
  description: Data within StatusSubscribe Response
  type: object
  properties:
    subscription:
      $ref: 'TS29571_CommonData.yaml#/components/schemas/MbsSessionSubscription'
    eventList:
      $ref: 'TS29571_CommonData.yaml#/components/schemas/MbsSessionEventReportList'
  required:
    - subscription

StatusNotifyReqData:
  description: Status Notification
  type: object
  properties:
    eventList:
      $ref: 'TS29571_CommonData.yaml#/components/schemas/MbsSessionEventReportList'
  required:
    - eventList

N2MbsSmInfo:
  description: N2 MBS Session Management information
  type: object
  properties:
```

```

    ngapIeType:
      $ref: '#/components/schemas/NgapIeType'
    ngapData:
      $ref: 'TS29571_CommonData.yaml#/components/schemas/RefToBinaryData'
  required:
    - ngapIeType
    - ngapData

MulticastTransportAddressChangeInfo:
  description: Multicast Transport Address Change Information
  type: object
  properties:
    llSsm:
      $ref: 'TS29571_CommonData.yaml#/components/schemas/Ssm'
    cTeid:
      $ref: 'TS29571_CommonData.yaml#/components/schemas/Uint32'
    areaSessionId:
      $ref: 'TS29571_CommonData.yaml#/components/schemas/AreaSessionId'
  required:
    - llSsm
    - cTeid

QosInfo:
  description: QoS Information
  type: object
  properties:
    qosFlowsAddModRequestList:
      type: array
      items:
        $ref: '#/components/schemas/QosFlowAddModifyRequestItem'
      minItems: 1
    qosFlowsRelRequestList:
      type: array
      items:
        $ref: 'TS29571_CommonData.yaml#/components/schemas/Qfi'
      minItems: 1

QosFlowAddModifyRequestItem:
  description: Individual MBS QoS flow requested to be created or modified
  type: object
  properties:
    qfi:
      $ref: 'TS29571_CommonData.yaml#/components/schemas/Qfi'
    qosFlowProfile:
      $ref: '#/components/schemas/QosFlowProfile'
  required:
    - qfi

QosFlowProfile:
  description: MBS QoS flow profile
  type: object
  properties:
    5qi:
      $ref: 'TS29571_CommonData.yaml#/components/schemas/5Qi'
    nonDynamic5Qi:
      $ref: 'TS29571_CommonData.yaml#/components/schemas/NonDynamic5Qi'
    dynamic5Qi:
      $ref: 'TS29571_CommonData.yaml#/components/schemas/Dynamic5Qi'
    arp:
      $ref: 'TS29571_CommonData.yaml#/components/schemas/Arp'
    gbrQosFlowInfo:
      $ref: '#/components/schemas/GbrQosFlowInformation'
  required:
    - 5qi

GbrQosFlowInformation:
  description: GBR MBS QoS flow information
  type: object
  properties:
    maxFbrDl:
      $ref: 'TS29571_CommonData.yaml#/components/schemas/BitRate'
    guaFbrDl:
      $ref: 'TS29571_CommonData.yaml#/components/schemas/BitRate'
    maxPacketLossRateDl:
      $ref: 'TS29571_CommonData.yaml#/components/schemas/PacketLossRate'
  required:
    - maxFbrDl

```

```
- guaFbrDl
ExtProblemDetails:
  description: Extended Problem Details data structure
  allOf:
    - $ref: 'TS29571_CommonData.yaml#/components/schemas/ProblemDetails'
    - $ref: '#/components/schemas/ProblemDetailsExtension'

ProblemDetailsExtension:
  description: Extensions to ProblemDetails
  type: object
  properties:
    accMbsServiceInfo:
      $ref: 'TS29537_Npcf_MBSPolicyAuthorization.yaml#/components/schemas/AcceptableMbsServInfo'

UpdateRspData:
  description: Data within Update Response
  type: object
  properties:
    mbsSession:
      $ref: '#/components/schemas/ExtMbsSession'
  required:
    - mbsSession

#
# SIMPLE DATA TYPES
#

#
# ENUMERATIONS
#

ContextUpdateAction:
  description: Start or Terminate MBS data reception
  anyOf:
    - type: string
      enum:
        - START
        - TERMINATE
    - type: string

ContextStatusEventType:
  description: Context Status Event Type
  anyOf:
    - type: string
      enum:
        - QOS_INFO
        - STATUS_INFO
        - SERVICE_AREA_INFO
        - SESSION_RELEASE
        - MULT_TRANS_ADD_CHANGE
        - SECURITY_INFO
    - type: string

ReportingMode:
  description: Reporting Mode
  anyOf:
    - type: string
      enum:
        - CONTINUOUS
        - ONE_TIME
    - type: string

NgapIeType:
  description: NGAP Information Element Type
  anyOf:
    - type: string
      enum:
        - MBS_DIS_SETUP_REQ
        - MBS_DIS_SETUP_RSP
        - MBS_DIS_SETUP_FAIL
        - MBS_DIS_REL_REQ
    - type: string
```

## Annex B (informative): Change history

Change history							
Date	Meeting	TDoc	CR	Rev	Cat	Subject/Comment	New version
2021-08	CT4#105e	C4-214755				Following pCRs are implemented into the skeleton of the TS 29.532 v0.0.0 (C4-214118): C4-214026, C4-214032, C4-214188, C4-214190, C4-214191, C4-214236, C4-214237, C4-214238, C4-214239, C4-214547, C4-214549, C4-214551, C4-214554, C4-214683, C4-214684, C4-214685 and C4-214686.	0.1.0
2021-10	CT4#106e	C4-215519				Following pCRs are implemented: C4-21-5015, C4-21-5017, C4-21-5071, C4-21-5075, C4-21-5076, C4-21-5077, C4-21-5078, C4-21-5079, C4-21-5080, C4-21-5081, C4-21-5083, C4-21-5335, C4-21-5337, C4-21-5338, C4-21-5339, C4-21-5340, C4-21-5341, C4-21-5374, C4-21-5375, C4-21-5376, C4-21-5377, C4-21-5498, C4-21-5500.	0.2.0
2021-11	CT4#107e	C4-216472				Following pCRs are implemented: C4-216019, C4-216139, C4-216210, C4-216424, C4-216425, C4-216601, C4-216604, C4-216605.	0.3.0
2021-12	CT#94	CP-213158				V1.0.0 presented for information	1.0.0
2022-01	CT4#107e-bis	CP-220454				Following pCRs are implemented: C4-220097, C4-220098, C4-220327, C4-220352, C4-220416, C4-220417 and C4-220418.	1.1.0
2022-02	CT4#108e	C4-221592				Following pCRs are implemented: C4-221123, C4-221138, C4-221140, C4-221147, C4-221380, C4-221419, C4-221420, C4-221531, C4-221546.	1.2.0
2022-03	CT#95e	CP-220107				TS presented for approval	2.0.0
2022-03	CT#95e					TS approved	17.0.0
2022-06	CT#96	CP-221023	0006		F	Nmbsmf miscellaneous corrections	17.1.0
2022-06	CT#96	CP-221023	0008		B	MBS Frequency Selection Area Identifier	17.1.0
2022-06	CT#96	CP-221023	0010		F	MBS Service Area Information for Location dependent MBS session	17.1.0
2022-06	CT#96	CP-221023	0011		F	Granularity of MBSsession service operations for Location dependent MBS session	17.1.0
2022-06	CT#96	CP-221023	0012		B	Broadcast Delivery Status event	17.1.0
2022-06	CT#96	CP-221023	0013		B	Ingress Tunnel Address Change Status Event	17.1.0
2022-06	CT#96	CP-221023	0007	1	F	NGAP MB-SMF related IEs	17.1.0
2022-06	CT#96	CP-221023	0002	2	F	Simple data types and enumerations for Nmbsmf_TMGI Service	17.1.0
2022-06	CT#96	CP-221023	0004	2	F	Simple data types for Nmbsmf_MBSsession Service	17.1.0
2022-06	CT#96	CP-221023	0005	1	F	Corrections to Nmbsmf data models	17.1.0
2022-06	CT#96	CP-221024	0014	1	B	Multicast Transport Address Change Context Status event	17.1.0
2022-06	CT#96	CP-221236	0009	3	B	QoS information in Context Status Event Report	17.1.0
2022-06	CT#96	CP-221024	0001	3	B	MBS Security Context Delivery	17.1.0
2022-06	CT#96	CP-221024	0017	1	F	Updates to Service Description	17.1.0
2022-06	CT#96	CP-221024	0020	1	F	Corrections on HTTP Response	17.1.0
2022-06	CT#96	CP-221024	0018	2	F	Application Error for TMGI Service	17.1.0
2022-06	CT#96	CP-221024	0019	2	F	Application Error for MBS Session Service	17.1.0
2022-06	CT#96	CP-221051	0025		F	29.532 Rel-17 API version and External doc update	17.1.0
2022-09	CT#97e	CP-222031	0029		F	Event reports in Create response and Status Subscribe Response	17.2.0
2022-09	CT#97e	CP-222058	0033		F	29.532 0033 Rel-17 API version and External doc update	17.2.0
2022-09	CT#97e	CP-222031	0027	2	F	Change of MBS session authorization	17.2.0
2022-09	CT#97e	CP-222031	0031	1	F	Clarification on the tunnel information	17.2.0
2022-09	CT#97e	CP-222031	0034		B	Defining the "indication that the PCF has to be contacted"	17.2.0
2022-12	CT#98e	CP-223036	0037		F	Complete the applicable procedure for the ContextStatusNotify service operation	17.3.0
2022-12	CT#98e	CP-223036	0042		F	Corrections for MBS session with PCC	17.3.0
2022-12	CT#98e	CP-223036	0043	1	F	Miscellaneous corrections (OpenAPI errors, incorrect IEs and references, etc)	17.3.0
2022-12	CT#98e	CP-223036	0044	1	F	Corrections to N2 MBS Session Management Information	17.3.0
2022-12	CT#98e	CP-223042	0041	1	F	Missing mandatory status codes and 307/308 codes in OpenAPI	17.3.0
2022-12	CT#98e	CP-223225	0039	3	F	Adding NID to TmgiAllocated type	17.3.0
2022-12	CT#98e	CP-223225	0036	2	F	Complete the description for ProblemDetails in the Nmbsmf_MBSsession API	17.3.0
2022-12	CT#98e	CP-223066	0046		F	29.532 0046 Rel-17 API version and External doc update	17.3.0
2022-12	CT#98e	CP-223036	0045	2	F	Clarification on MB-SMF behaviour on handling shared NG-U tunnel	17.3.0
2023-03	CT#99	CP-230029	0048		F	OAuth2 scopes in the MBSsession API	18.0.0
2023-03	CT#99	CP-230049	0049	1	F	Correct string datatype and StatusNotify service operation description	18.0.0
2023-03	CT#99	CP-230071	0052		F	29.532 Rel18 API version and External doc update	18.0.0
2023-06	CT#100	CP-231026	0050	2	F	Location header description	18.1.0
2023-06	CT#100	CP-231037	0054	1	B	Adding Associated Session ID to Nmbsmf_MBSsession_Create Request	18.1.0



2023-06	CT#100	CP-231076	0057	1	A	Essential Correction for the usage of the cause "UNKNOWN_MBS_SERVICE_AREA"	18.1.0
2023-09	CT#101	CP-232065	0063	1	F	Correct callback URI for mbsSession service	18.2.0
2023-09	CT#101	CP-232058	0064		F	EventType attribute correction	18.2.0
2023-12	CT#102	CP-233044	0067		F	Editorial corrections and DateTime clarification	18.3.0
2023-12	CT#102	CP-233027	0068		F	Update and replace obsoleted HTTP RFCs	18.3.0
2023-12	CT#102	CP-233063	0073	1	A	Area Session Policy ID in Nmbsmf_MBSSession_Create request	18.3.0
2023-12	CT#102	CP-233063	0075	1	A	MBS Service Area not contained within the MB-SMF service area	18.3.0
2023-12	CT#102	CP-233063	0077	2	A	Location Dependent MBS broadcast session with multiple MB-SMFs	18.3.0
2023-12	CT#102	CP-233030	0079		F	29.532: Replacing obsoleted HTTP RFC 7807 with 9457	18.3.0
2023-12	CT#102	CP-233060	0082		F	29.532 Rel-18 API version and External doc update	18.3.0
2024-03	CT#103	CP-240035	0085	2	B	RedCap UEs Information for a broadcast MBS session	18.4.0
2024-03	CT#103	CP-240035	0086	2	B	New feature for Nmbsmf_MBSSession to support MOCN	18.4.0
2024-03	CT#103	CP-240236	0088		F	29.532 Rel-18 API version and External doc update	18.4.0
2024-06	CT#104	CP-241050	0089	1	F	Definition of MBS related terms	18.5.0
2024-06	CT#104	CP-241033	0090		F	Supported Features in MBS Session Create request and response	18.5.0
2024-06	CT#104	CP-241033	0091	1	F	Correction of enumeration description and editorial mistake	18.5.0
2024-06	CT#104	CP-241052	0092		F	29.532 Rel-18 API version and External doc update	18.5.0

---

# History

<b>Document history</b>		
V18.4.0	May 2024	Publication
V18.5.0	July 2024	Publication