

# ETSI TS 129 536 V18.6.0 (2024-07)



**5G;  
5G System;  
Network Slice Admission Control Services;  
Stage 3  
(3GPP TS 29.536 version 18.6.0 Release 18)**



---

**Reference**

RTS/TSGC-0429536vi60

---

**Keywords**

5G

**ETSI**

---

650 Route des Lucioles  
F-06921 Sophia Antipolis Cedex - FRANCE

Tel.: +33 4 92 94 42 00 Fax: +33 4 93 65 47 16

Siret N° 348 623 562 00017 - APE 7112B  
Association à but non lucratif enregistrée à la  
Sous-Préfecture de Grasse (06) N° w061004871

---

**Important notice**

The present document can be downloaded from the  
ETSI [Search & Browse Standards application](#).

The present document may be made available in electronic versions and/or in print. The content of any electronic and/or print versions of the present document shall not be modified without the prior written authorization of ETSI. In case of any existing or perceived difference in contents between such versions and/or in print, the prevailing version of an ETSI deliverable is the one made publicly available in PDF format on [ETSI deliver](#).

Users should be aware that the present document may be revised or have its status changed,  
this information is available in the [Milestones listing](#).

If you find errors in the present document, please send your comments to  
the relevant service listed under [Committee Support Staff](#).

If you find a security vulnerability in the present document, please report it through our  
[Coordinated Vulnerability Disclosure \(CVD\)](#) program.

---

**Notice of disclaimer & limitation of liability**

The information provided in the present deliverable is directed solely to professionals who have the appropriate degree of experience to understand and interpret its content in accordance with generally accepted engineering or other professional standard and applicable regulations.

No recommendation as to products and services or vendors is made or should be implied.

No representation or warranty is made that this deliverable is technically accurate or sufficient or conforms to any law and/or governmental rule and/or regulation and further, no representation or warranty is made of merchantability or fitness for any particular purpose or against infringement of intellectual property rights.

In no event shall ETSI be held liable for loss of profits or any other incidental or consequential damages.

Any software contained in this deliverable is provided "AS IS" with no warranties, express or implied, including but not limited to, the warranties of merchantability, fitness for a particular purpose and non-infringement of intellectual property rights and ETSI shall not be held liable in any event for any damages whatsoever (including, without limitation, damages for loss of profits, business interruption, loss of information, or any other pecuniary loss) arising out of or related to the use of or inability to use the software.

---

**Copyright Notification**

No part may be reproduced or utilized in any form or by any means, electronic or mechanical, including photocopying and microfilm except as authorized by written permission of ETSI.

The content of the PDF version shall not be modified without the written authorization of ETSI.

The copyright and the foregoing restriction extend to reproduction in all media.

© ETSI 2024.  
All rights reserved.

---

# Intellectual Property Rights

## Essential patents

IPRs essential or potentially essential to normative deliverables may have been declared to ETSI. The declarations pertaining to these essential IPRs, if any, are publicly available for **ETSI members and non-members**, and can be found in ETSI SR 000 314: "*Intellectual Property Rights (IPRs); Essential, or potentially Essential, IPRs notified to ETSI in respect of ETSI standards*", which is available from the ETSI Secretariat. Latest updates are available on the ETSI Web server (<https://ipr.etsi.org/>).

Pursuant to the ETSI Directives including the ETSI IPR Policy, no investigation regarding the essentiality of IPRs, including IPR searches, has been carried out by ETSI. No guarantee can be given as to the existence of other IPRs not referenced in ETSI SR 000 314 (or the updates on the ETSI Web server) which are, or may be, or may become, essential to the present document.

## Trademarks

The present document may include trademarks and/or tradenames which are asserted and/or registered by their owners. ETSI claims no ownership of these except for any which are indicated as being the property of ETSI, and conveys no right to use or reproduce any trademark and/or tradename. Mention of those trademarks in the present document does not constitute an endorsement by ETSI of products, services or organizations associated with those trademarks.

**DECT™**, **PLUGTESTS™**, **UMTS™** and the ETSI logo are trademarks of ETSI registered for the benefit of its Members. **3GPP™** and **LTE™** are trademarks of ETSI registered for the benefit of its Members and of the 3GPP Organizational Partners. **oneM2M™** logo is a trademark of ETSI registered for the benefit of its Members and of the oneM2M Partners. **GSM®** and the GSM logo are trademarks registered and owned by the GSM Association.

---

# Legal Notice

This Technical Specification (TS) has been produced by ETSI 3rd Generation Partnership Project (3GPP).

The present document may refer to technical specifications or reports using their 3GPP identities. These shall be interpreted as being references to the corresponding ETSI deliverables.

The cross reference between 3GPP and ETSI identities can be found under <https://webapp.etsi.org/key/queryform.asp>.

---

# Modal verbs terminology

In the present document "**shall**", "**shall not**", "**should**", "**should not**", "**may**", "**need not**", "**will**", "**will not**", "**can**" and "**cannot**" are to be interpreted as described in clause 3.2 of the [ETSI Drafting Rules](#) (Verbal forms for the expression of provisions).

"**must**" and "**must not**" are **NOT** allowed in ETSI deliverables except when used in direct citation.

# Contents

Intellectual Property Rights .....	2
Legal Notice .....	2
Modal verbs terminology.....	2
Foreword.....	7
1 Scope .....	9
2 References .....	9
3 Definitions, abbreviations .....	10
3.1 Definitions .....	10
3.2 Abbreviations .....	10
4 Overview .....	10
4.1 General .....	10
4.1A NSAC Architecture Options.....	11
4.2 NSAC support in roaming.....	12
4.3 Interaction between NSACFs .....	12
5 Services offered by the NSACF .....	12
5.1 Introduction .....	12
5.2 Nnsacf_NSAC Service .....	13
5.2.1 Service Description.....	13
5.2.2 Service Operations.....	14
5.2.2.1 Introduction.....	14
5.2.2.2 NumOfUEsUpdate .....	14
5.2.2.2.1 General .....	14
5.2.2.2.2 NSAC for controlling the number of UEs .....	15
5.2.2.2.3 NSAC for controlling the number of UEs in hierarchical NSACF architecture.....	17
5.2.2.2.4 NSAC for controlling the number of UEs with at least one PDU session/PDN connection .....	19
5.2.2.2.5 NSAC for controlling the number of UEs in case of VPLMN with HPLMN assistance NSAC mode .....	20
5.2.2.3 EACNotify .....	21
5.2.2.3.1 General .....	21
5.2.2.3.2 NSACF initiated EAC mode configuration.....	21
5.2.2.4 NumOfPDUsUpdate .....	22
5.2.2.4.1 General .....	22
5.2.2.4.2 NSAC for controlling the number of PDU sessions .....	22
5.2.2.4.3 NSAC for controlling the number of PDU sessions in hierarchical NSACF architecture.....	25
5.2.2.4.4 NSAC for controlling the number of UEs with at least one PDU session/PDN connection per network slice.....	26
5.2.2.4.5 NSAC for controlling the number of LBO PDU Sessions in case of VPLMN with HPLMN assistance NSAC mode.....	27
5.2.2.5 LocalNumberUpdate .....	28
5.2.2.5.1 General .....	28
5.2.2.5.2 Update of local maximum number of UEs or PDU sessions.....	29
5.2.2.6 QuotaUpdate .....	29
5.2.2.6.1 General .....	29
5.2.2.6.2 Update of maximum number of UEs and/or PDU sessions.....	30
5.3 Nnsacf_SliceEventExposure Service .....	30
5.3.1 Service Description.....	30
5.3.2 Service Operations.....	31
5.3.2.1 Introduction.....	31
5.3.2.2 Subscribe.....	31
5.3.2.2.1 General .....	31
5.3.2.2.2 Creation of a subscription.....	31
5.3.2.2.3 Modification of a subscription.....	33
5.3.2.2.4 Creation of a one time and immediate reporting subscription .....	34

5.3.2.3	Unsubscribe.....	35
5.3.2.3.1	General .....	35
5.3.2.4	Notify .....	35
5.3.2.4.1	General .....	35
6	API Definitions .....	37
6.1	Nnsacf_NSAC Service API.....	37
6.1.1	Introduction.....	37
6.1.2	Usage of HTTP.....	37
6.1.2.1	General .....	37
6.1.2.2	HTTP standard headers .....	37
6.1.2.2.1	General .....	37
6.1.2.2.2	Content type .....	37
6.1.2.3	HTTP custom headers .....	37
6.1.3	Resources.....	38
6.1.3.1	Overview.....	38
6.1.3.2	Resource: Slice Collection Subject to NSAC for UEs .....	39
6.1.3.2.1	Description .....	39
6.1.3.2.2	Resource Definition.....	39
6.1.3.2.3	Resource Standard Methods .....	39
6.1.3.2.4	Resource Custom Operations .....	41
6.1.3.3	Resource: Slice Collection Subject to NSAC for PDU sessions .....	41
6.1.3.3.1	Description .....	41
6.1.3.3.2	Resource Definition.....	41
6.1.3.3.3	Resource Standard Methods .....	41
6.1.3.3.4	Resource Custom Operations .....	42
6.1.3.4	Resource: Slice Collection Configurations .....	43
6.1.3.4.1	Description .....	43
6.1.3.4.2	Resource Definition.....	43
6.1.3.4.3	Resource Standard Methods .....	43
6.1.3.4.4	Resource Custom Operations .....	43
6.1.3.4.4.2.1	Description .....	43
6.1.3.4.4.2.2	Operation Definition .....	43
6.1.3.5	Resource: Slice Collection Roaming Quotas .....	44
6.1.3.5.1	Description .....	44
6.1.3.5.2	Resource Definition.....	44
6.1.3.5.3	Resource Standard Methods .....	45
6.1.3.5.4	Resource Custom Operations .....	45
6.1.3.5.4.2.1	Description .....	45
6.1.3.5.4.2.2	Operation Definition .....	45
6.1.4	Custom Operations without associated resources .....	46
6.1.5	Notifications .....	46
6.1.5.1	General .....	46
6.1.5.2	EAC Mode Notification .....	47
6.1.5.2.1	Description .....	47
6.1.5.2.2	Target URI.....	47
6.1.5.2.3	Standard Methods .....	47
6.1.6	Data Model .....	47
6.1.6.1	General .....	47
6.1.6.2	Structured data types .....	49
6.1.6.2.1	Introduction .....	49
6.1.6.2.2	Type: UeACRequestData .....	49
6.1.6.2.3	Type: UeACResponseData.....	50
6.1.6.2.4	Type: EACNotification .....	50
6.1.6.2.5	Type: AcuOperationItem.....	51
6.1.6.2.6	Type: AcuFailureItem .....	52
6.1.6.2.7	Type: PduACRequestData.....	52
6.1.6.2.8	Type: PduACResponseData .....	53
6.1.6.2.9	Type: UeACRequestInfo .....	53
6.1.6.2.10	Type: PduACRequestInfo.....	54
6.1.6.2.11	Type: UeAdmissionValue .....	54
6.1.6.2.12	Type: PduAdmissionValue.....	55

6.1.6.2.13	Type: ACUpdateData .....	55
6.1.6.2.14	Type: QuotaUpdateRequestData .....	55
6.1.6.2.15	Type: QuotaUpdateResponseData .....	55
6.1.6.3	Simple data types and enumerations .....	56
6.1.6.3.1	Introduction .....	56
6.1.6.3.2	Simple data types.....	56
6.1.6.3.3	Enumeration: EACMode .....	56
6.1.6.3.4	Enumeration: AcuFlag.....	56
6.1.6.3.5	Enumeration: AcuFailureReason.....	56
6.1.6.3.6	Enumeration: SliceQuotaType .....	57
6.1.6.3.7	Enumeration: NsacAdmissionMode.....	57
6.1.6.4	Data types describing alternative data types or combinations of data types .....	58
6.1.6.5	Binary data .....	58
6.1.7	Error Handling .....	58
6.1.7.1	General .....	58
6.1.7.2	Protocol Errors .....	58
6.1.7.3	Application Errors .....	58
6.1.8	Feature negotiation .....	59
6.1.9	Security .....	59
6.1.10	HTTP redirection .....	60
6.2	Nnsacf_SliceEventExposure Service API .....	60
6.2.1	Introduction.....	60
6.2.2	Usage of HTTP .....	60
6.2.2.1	General .....	60
6.2.2.2	HTTP standard headers .....	60
6.2.2.2.1	General .....	60
6.2.2.2.2	Content type .....	61
6.2.2.3	HTTP custom headers .....	61
6.2.3	Resources .....	61
6.2.3.1	Overview .....	61
6.2.3.2	Resource: Subscriptions collection .....	61
6.2.3.2.1	Description .....	61
6.2.3.2.2	Resource Definition.....	62
6.2.3.2.3	Resource Standard Methods .....	62
6.2.3.2.4	Resource Custom Operations .....	63
6.2.3.3	Resource: Individual subscription .....	63
6.2.3.3.1	Description .....	63
6.2.3.3.2	Resource Definition.....	63
6.2.3.3.3	Resource Standard Methods .....	64
6.2.3.3.4	Resource Custom Operations .....	67
6.2.4	Custom Operations without associated resources .....	68
6.2.5	Notifications .....	68
6.2.5.1	General .....	68
6.2.5.2	NSACF Event Notification .....	68
6.2.5.2.1	Notification Definition .....	68
6.2.5.2.2	Notification Standard Methods.....	68
6.2.6	Data Model .....	69
6.2.6.1	General .....	69
6.2.6.2	Structured data types .....	70
6.2.6.2.1	Introduction .....	70
6.2.6.2.2	Type: SACEventSubscription.....	71
6.2.6.2.3	Type: CreatedSACEventSubscription .....	72
6.2.6.2.4	Type: SACEventReport.....	72
6.2.6.2.5	Type: SACEvent.....	73
6.2.6.2.6	Type: SACEventReportItem.....	73
6.2.6.2.7	Type: SACEventState.....	74
6.2.6.3	Simple data types and enumerations .....	74
6.2.6.3.1	Introduction .....	74
6.2.6.3.2	Simple data types.....	74
6.2.6.3.3	Enumeration: SACEventType .....	74
6.2.6.3.4	Enumeration: SACEventTrigger .....	74
6.2.6.4	Data types describing alternative data types or combinations of data types .....	75

6.2.6.5	Binary data .....	75
6.2.7	Error Handling .....	75
6.2.7.1	General .....	75
6.2.7.2	Protocol Errors .....	75
6.2.7.3	Application Errors .....	75
6.2.8	Feature negotiation .....	75
6.2.9	Security .....	76
6.2.10	HTTP redirection .....	76
<b>Annex A (normative):</b>	<b>OpenAPI specification.....</b>	<b>77</b>
A.1	General .....	77
A.2	Nnsacf_NSAC API .....	77
A.3	Nnsacf_SliceEventExposure API.....	85
<b>Annex B (informative):</b>	<b>Change history .....</b>	<b>92</b>
History .....		95

---

# Foreword

This Technical Specification has been produced by the 3rd Generation Partnership Project (3GPP).

The contents of the present document are subject to continuing work within the TSG and may change following formal TSG approval. Should the TSG modify the contents of the present document, it will be re-released by the TSG with an identifying change of release date and an increase in version number as follows:

Version x.y.z

where:

- x the first digit:
  - 1 presented to TSG for information;
  - 2 presented to TSG for approval;
  - 3 or greater indicates TSG approved document under change control.
- y the second digit is incremented for all changes of substance, i.e. technical enhancements, corrections, updates, etc.
- z the third digit is incremented when editorial only changes have been incorporated in the document.

In the present document, modal verbs have the following meanings:

- shall** indicates a mandatory requirement to do something
- shall not** indicates an interdiction (prohibition) to do something

The constructions "shall" and "shall not" are confined to the context of normative provisions, and do not appear in Technical Reports.

The constructions "must" and "must not" are not used as substitutes for "shall" and "shall not". Their use is avoided insofar as possible, and they are not used in a normative context except in a direct citation from an external, referenced, non-3GPP document, or so as to maintain continuity of style when extending or modifying the provisions of such a referenced document.

- should** indicates a recommendation to do something
- should not** indicates a recommendation not to do something
- may** indicates permission to do something
- need not** indicates permission not to do something

The construction "may not" is ambiguous and is not used in normative elements. The unambiguous constructions "might not" or "shall not" are used instead, depending upon the meaning intended.

- can** indicates that something is possible
- cannot** indicates that something is impossible

The constructions "can" and "cannot" are not substitutes for "may" and "need not".

- will** indicates that something is certain or expected to happen as a result of action taken by an agency the behaviour of which is outside the scope of the present document
- will not** indicates that something is certain or expected not to happen as a result of action taken by an agency the behaviour of which is outside the scope of the present document
- might** indicates a likelihood that something will happen as a result of action taken by some agency the behaviour of which is outside the scope of the present document



**might not** indicates a likelihood that something will not happen as a result of action taken by some agency the behaviour of which is outside the scope of the present document

In addition:

**is** (or any other verb in the indicative mood) indicates a statement of fact

**is not** (or any other negative verb in the indicative mood) indicates a statement of fact

The constructions "is" and "is not" do not indicate requirements.

---

# 1 Scope

The present document specifies the stage 3 protocol and data model for the Nnsacf Service Based Interface. It provides stage 3 protocol definitions and message flows, and specifies the API for each service offered by the NSACF.

The 5G System stage 2 architecture and procedures are specified in 3GPP TS 23.501 [2] and 3GPP TS 23.502 [3].

The Technical Realization of the Service Based Architecture and the Principles and Guidelines for Services Definition are specified in 3GPP TS 29.500 [4] and 3GPP TS 29.501 [5].

---

# 2 References

The following documents contain provisions which, through reference in this text, constitute provisions of the present document.

- References are either specific (identified by date of publication, edition number, version number, etc.) or non-specific.
- For a specific reference, subsequent revisions do not apply.
- For a non-specific reference, the latest version applies. In the case of a reference to a 3GPP document (including a GSM document), a non-specific reference implicitly refers to the latest version of that document *in the same Release as the present document*.

- [1] 3GPP TR 21.905: "Vocabulary for 3GPP Specifications".
- [2] 3GPP TS 23.501: "System Architecture for the 5G System; Stage 2".
- [3] 3GPP TS 23.502: "Procedures for the 5G System; Stage 2".
- [4] 3GPP TS 29.500: "5G System; Technical Realization of Service Based Architecture; Stage 3".
- [5] 3GPP TS 29.501: "5G System; Principles and Guidelines for Services Definition; Stage 3".
- [6] OpenAPI: "OpenAPI Specification Version 3.0.0", <https://spec.openapis.org/oas/v3.0.0>.
- [7] 3GPP TR 21.900: "Technical Specification Group working methods".
- [8] 3GPP TS 33.501: "Security architecture and procedures for 5G system".
- [9] IETF RFC 6749: "The OAuth 2.0 Authorization Framework".
- [10] 3GPP TS 29.510: "5G System; Network Function Repository Services; Stage 3".
- [11] IETF RFC 9113: "HTTP/2".
- [12] IETF RFC 8259: "The JavaScript Object Notation (JSON) Data Interchange Format".
- [13] IETF RFC 9457: "Problem Details for HTTP APIs".
- [14] IETF RFC 6902: "JavaScript Object Notation (JSON) Patch".
- [15] 3GPP TS 29.518: "5G System; Access and Mobility Management Service; Stage 3".
- [16] 3GPP TS 29.571: "5G System; Common Data Types for Service Based Interfaces Stage 3".
- [17] 3GPP TS 29.510: "5G System; Network Function Repository Services; Stage 3".
- [18] 3GPP TS 23.288: "Architecture enhancements for 5G System (5GS) to support network data analytics services".

---

## 3 Definitions, abbreviations

### 3.1 Definitions

For the purposes of the present document, the terms and definitions given in 3GPP TR 21.905 [1] and the following apply. A term defined in the present document takes precedence over the definition of the same term, if any, in 3GPP TR 21.905 [1].

### 3.2 Abbreviations

For the purposes of the present document, the abbreviations given in 3GPP TR 21.905 [1] and the following apply. An abbreviation defined in the present document takes precedence over the definition of the same abbreviation, if any, in 3GPP TR 21.905 [1].

AF	Application Function
5GC	5G Core Network
AMF	Access Management Function
DCCF	Data Collection Coordination Function
EAC	Early Admission Control
MCX	Mission Critical Service
MPS	Multimedia Priority Service
NEF	Network Exposure Function
NID	Network identifier
NSAC	Network Slice Admission Control
NSACF	Network Slice Admission Control Function
NSCE	Network Slice Capability Enablement
NWDAF	Network Data Analytics Function
SMF	Session Management Function
SNPN	Standalone Non-Public Network

---

## 4 Overview

### 4.1 General

Within the 5GC of a PLMN or a SNPN, the NSACF offers services to the AMF, SMF (or combined SMF+PGW-C), NWDAF, NEF, DCCF, NSCE and NSACF via the Nnsacf service based interface (see 3GPP TS 23.501 [2] and 3GPP TS 23.502 [3]).

Figure 4.1 provides the reference model (in service based interface representation and in reference point representation), with focus on the NSACF and the scope of the present specification.

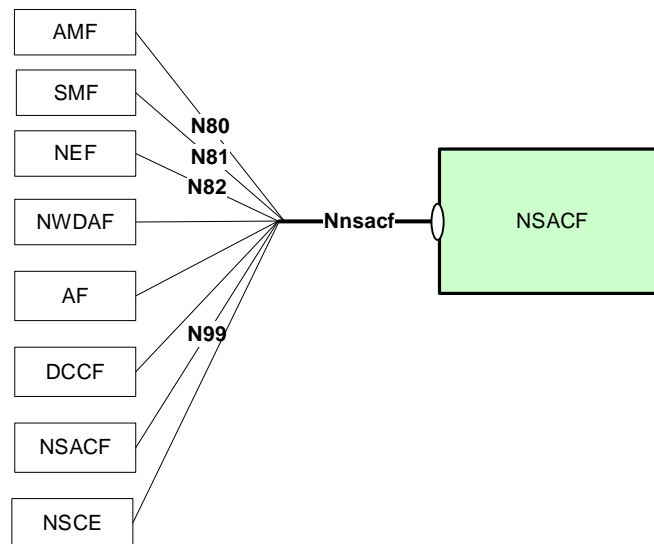

**Figure 4-1: Reference model – NSACF**

The functionalities supported by the NSACF are listed in clause 6.2.28 of 3GPP TS 23.501 [2].

The services and service operations provided by the Nnsacf interface are listed in clause 5.2.21 of 3GPP TS 23.502 [3].

When the UE connects to EPS and EPS counting is required, it is the combined SMF+PGW-C invokes NSACF services to perform network slice admission control, during PDN connection establishment procedure and PDN connection release procedure, as specified in clause 5.15.11.5 of 3GPP TS 23.501 [2].

**NOTE:** A trusted AF can access NSACF services either via NEF to NSACF or directly to NSACF. An untrusted AF shall only be allowed to access NSACF services via NEF. If multiple NSACFs are deployed in the network and the trusted AF is interested in the aggregated report, then the trusted AF collects the report from NEF, instead of contacting multiple NSACFs directly.

## 4.1A NSAC Architecture Options

If the network is configured with a single NSAC service area, there is a single NSACF deployed to handle the admissions for an S-NSSAI.

If the network is configured with multiple NSAC service areas, one of the three NSAC architecture options, i.e. non-hierarchical NSAC architecture, centralized NSAC architecture and hierarchical NSAC architecture (as specified in clause 5.15.11.0 of 3GPP TS 23.501 [2]), may be selected to handle the admissions for an S-NSSAI based on operator's policy.

In different NSAC architectures, there are different roles of NSACFs as:

- independent NSACFs are deployed in each NSAC service area in non-hierarchical NSAC architecture;
- a single centralized NSACF is deployed in the whole network in centralized NSAC architecture; and
- a primary NSACF and several distributed NSACFs are deployed in hierarchical NSAC architecture.

For the hierarchical NSAC architecture, the NSACF role (i.e. primary NSACF or distributed NSACF) is configured in the NSACF per S-NSSAI (e.g. a NSACF may act as primary NSACF for a first S-NSSAI and as a distributed NSACF for a second S-NSSAI). For the same S-NSSAI, the role of primary and distributed NSACFs can be co-located at the same NSACF instance. A NSACF acting as a Primary NSACF for a given S-NSSAI handles overall NSAC for the S-NSSAI at the global level (i.e. it is ultimately responsible for the NSAC for an S-NSSAI). See clause 5.15.11 of 3GPP TS 23.501 [2].

## 4.2 NSAC support in roaming

In the roaming scenario, depending on operator's policy and roaming agreement, a specific NSAC admission mode (i.e. VPLMN NSAC admission, VPLMN with HPLMN assistance admission or HPLMN NSAC admission) is determined for the NSAC procedure for roaming UEs (see clause 5.15.11.3 of 3GPP TS 23.501 [2]).

For roaming UEs with LBO PDU session:

- if VPLMN NSAC admission (with or without HPLMN assistance) is determined, the vNSACF offers service to the NF in the VPLMN (e.g. AMF and SMF in VPLMN);
- if HPLMN NSAC admission is determined, the hNSACF offers service to the NF in the VPLMN (e.g. AMF and SMF in VPLMN). The AMF and SMF in VPLMN interact with hNSACF to perform NSAC procedure.

For roaming UEs with HR PDU session:

- the hNSACF offers service to the SMF in the HPLMN;
- if HPLMN NSAC admission is determined, the hNSACF offers service to the AMF in the VPLMN. Otherwise, the vNSACF offers services to the AMF in the VPLMN.

## 4.3 Interaction between NSACFs

NSACF interactions may exist in the following cases:

- for roaming case, if VPLMN with HPLMN assistance NSAC admission mode is determined, the NSACF in VPLMN may interact with the NSACF in HPLMN to fetch the quota for number of UEs or number of PDU sessions, and the NSACF in HPLMN may interact with the NSACF in VPLMN to provide the updated number of UEs or number of PDU sessions;
- for roaming case, if VPLMN NSAC admission mode is determined, the NSACF in VPLMN may interact with the NSACF in HPLMN to fetch the maximum number of registered UEs to be enforced and the maximum number of LBO PDU sessions to be enforced;
- in hierarchical NSAC architecture, a distributed NSACF may interact with the primary NSACF to fetch the quota for number of UEs or number of PDU sessions, and the primary NSACF may interact with the distributed NSACF to provide the updated number of UEs or number of PDU sessions, as specified in clause 5.15.11 of 3GPP TS 23.501 [2].

---

# 5 Services offered by the NSACF

## 5.1 Introduction

The NSACF supports the following services.

**Table 5.1-1: NF Services provided by NSACF**

Service Name	Description	Example Consumer
Nnsacf_NSAC	This service allows the NF service consumer to: - request the NSACF to perform per slice admission control for the number of UEs / PDU sessions, or the number of UEs with at least one PDU session/PDN connection in case EPS counting is required; - request the NSACF to send or update the local maximum number of UEs / PDU sessions, in hierarchical NSAC architecture scenario; - retrieve slice roaming quotas (i.e. the maximum number of UEs and/or PDU sessions) from the NSACF in HPLMN, in roaming scenario.	AMF, SMF, NSACF
Nnsacf_SliceEventExposure	This service provides event based notifications to the NF service consumer related to the number of UEs registered to a network slice or the number of PDU sessions established to a network slice.	NEF, AF, NWDAF, DCCF, NSACF, NSCE

Table 5.1-2 summarizes the corresponding APIs defined for this specification.

**Table 5.1-2: API Descriptions**

Service Name	Clause	Description	OpenAPI Specification File	apiName	Annex
Nnsacf_NSAC	6.1	Per slice admission control service to control the number of UEs / PDU sessions or the combination, or configure the local maximum number of UEs / PDU sessions in a distributed NSACF in hierarchical NSAC architecture, or retrieve slice roaming quotas from HPLMN NSACF in roaming scenario.	TS29536_Nnsacf_NSAC.yaml	nnsacf-nsac	A.2
Nnsacf_SliceEvent Exposure	6.2	Slice related event subscription and notification	TS29536_Nnsacf_SliceEventExposure.yaml	nnsacf-slice-ee	A.3

## 5.2 Nnsacf\_NSAC Service

### 5.2.1 Service Description

The Nnsacf\_NSAC service provides the service capability for the NF Service Consumer (e.g. AMF, SMF or primary NSACF) to request admission control for UEs accessing a specific network slice, or for PDU sessions to be established to a specific network slice. The following are the key functionalities of this NF service:

- Request the NSACF to control the number of UEs registered to a specific network slice, e.g. perform availability check and update the number of UEs registered to a specific network slice;
- Request the NSACF to control the number of PDU sessions established to a specific network slice, e.g. perform availability check and update the number of PDU sessions established to a specific network slice;
- Request the NSACF to control the number of UEs with at least one PDU session/PDN connection established on a network slice if EPS counting is required;
- Notify the NF Service Consumer (e.g. AMF) of the activation/deactivation of EAC (Early Admission Control) mode for NSAC procedure;
- Request the NSACF to configure or update the local maximum number of registered UEs and/or number of PDU sessions of the network slice at a distributed NSACF, in hierarchical NSAC architecture.

- Request the NSACF in HPLMN to provide slice roaming quotas (i.e. the maximum number of UEs / PDU session in NSACF in VPLMN), in roaming scenario.

The Nnsacf\_NSAC service supports the following service operations.

**Table 5.2.1-1: Service operations supported by the Nnsacf\_NSAC service**

Service Operations	Description	Operation Semantics	Example Consumer(s)
NumOfUEsUpdate	Request the NSACF to perform admission control for the number of registered UEs, or the number of UEs with at least one PDU session/PDN connection in case EPS counting is required.	Request/Response	AMF, combined SMF+PGW-C, NSACF
NumOfPDUsUpdate	Request the NSACF to perform admission control for the number of PDU sessions, or the number of UEs with at least one PDU session/PDN connection in case EPS counting is required.	Request/Response	SMF, combined SMF+PGW-C, NSACF
EACNotify	Notify the NF Service Consumer of the activation/deactivation of EAC mode.	Subscribe/Notify	AMF
LocalNumberUpdate	Request the distributed NSACF to update its local maximum number of registered UEs and/or PDU sessions of the network slice, in hierarchical NSAC architecture.	Request/Response	primary NSACF
QuotaUpdate	Request the primary or central NSACF at HPLMN to update the slice roaming quotas (i.e. the maximum number of registered UEs and/or the maximum number of PDU sessions of a network slice) at the primary or central NSACF of VPLMN.	Request/Response	V-NSACF

When the UE connects to EPS and EPS counting is required for the S-NSSAI subjected to NSAC, only one of the configurations shall be applied as specified in clause 5.15.11.5 of 3GPP TS 23.501 [2]:

- Maximum number of registered UEs and/or maximum number of PDU session. In that case the combined SMF+PGW-C shall invoke the NumOfUEsUpdate and NumOfPDUsUpdate service operations in sequence. If the NumOfUEsUpdate returns failure, the combined SMF+PGW-C shall not continue invoking the NumOfPDUsUpdate. If the NumOfPDUsUpdate returns failure then the combined SMF+PGW-C shall invoke the NumOfUEUpdate to decrease the UE count. Or,
- Maximum number of UEs with at least one PDU session/PDN Connection and/or maximum number of PDU session. In that case the combined SMF+PGW-C shall be configured with option 1 and shall invoke the NumOfUEsUpdate service operation or with option 2 and shall invoke NumOfPDUsUpdate service operation to NSACF to perform admission control for the number of UEs with at least one PDU session/PDN connection and/or maximum number of PDU session as specified in clause 5.15.11.5a of 3GPP TS 23.501 [2].

## 5.2.2 Service Operations

### 5.2.2.1 Introduction

This clause introduces the related procedures using Nnsacf\_NSAC service operations to request the NSACF to control the number of UEs registered to a specific network slice.

### 5.2.2.2 NumOfUEsUpdate

#### 5.2.2.2.1 General

The NumOfUEsUpdate service operation shall be used by the NF Service Consumer (e.g. AMF, combined SMF+PGW-C, or NSACF) to request the NSACF to control the number of UEs registered to a specific network slice, e.g. perform availability check and update the number of UEs registered to a network slice. It is used in the following procedures:

- AMF initiated network slice admission control procedure related to control the number of UEs registered to a network slice (see clause 4.2.11.2 of 3GPP TS 23.502 [3]).
- AMF initiated network slice admission control procedure related to control the number of roaming UEs registered to a network slice (see clauses 4.2.11.5.1 and 4.2.11.5.2.3 of 3GPP TS 23.502 [3]).
- Combined SMF+PGW-C initiated network slice admission control procedure related to control the number of UEs registered to a network slice, in the case of EPS interworking (see clause 5.15.11.5 of 3GPP TS 23.501 [2]).
- Combined SMF+PGW-C initiated network slice admission control procedure related to control the number of UEs with at least one PDU session/PDN connection (see clause 5.15.11.5a of 3GPP TS 23.501 [2]).
- Hierarchical NSACF-based network slice admission control procedure related to control the number of UEs registered to a network slice (see clause 4.2.11.2a of 3GPP TS 23.502 [3]).

The operation may also be used to update the number of existing registered UEs in the NSACF when NSAC is enabled or disabled for a slice which is already live in the network.

#### 5.2.2.2.2 NSAC for controlling the number of UEs

The NF Service Consumer (e.g. AMF, combined SMF+PGW-C) shall invoke the NumOfUEsUpdate service operation to request the NSACF to perform network slice admission control procedure related to the number of UEs, by using the HTTP POST method as shown in Figure 5.2.2.2-1.

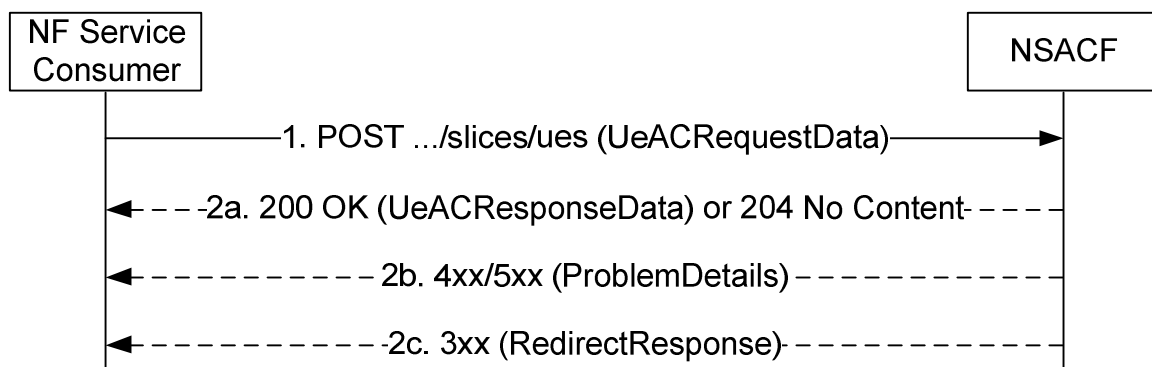

**Figure 5.2.2.2-1: NSAC procedure for controlling the number of UEs**

1. The NF Service Consumer (e.g. AMF, combined SMF+PGW-C) shall send a POST request to the resource representing the network slice admission control related to the number of UEs (i.e. .../slices/ues) in the NSACF.

The content of the POST request shall contain the input data structure (i.e. UeACRequestData) for network slice admission control, which shall contain the following information:

- the SUPI(s) of the UE(s);
- the access type, over which the UE registers to the network or deregisters from the network;
- a list of S-NSSAIs which are subject to NSAC, and for each S-NSSAI an update flag that indicates the operation to that S-NSSAI;
- the NF Instance ID, identifying the requester NF.
- the NSAC Service Area of the NF consumer, if it is configured in the NF consumer.
- the NSAC admission mode of each S-NSSAI for inbound roamer, i.e. VPLMN NSAC admission mode or VPLMN with HPLMN assistance NSAC admission mode;
- the serving PLMN ID of the inbound roamer.

In addition, the POST request may also contain:



- the EAC notification callback URI. The AMF may provide the EAC notification callback URI at the first interaction with the NSACF, or may provide an updated one in later interactions when it changes. If the EAC notification callback URI is set to null value by the AMF in later interactions, it means the AMF unsubscribes the EAC notification from the NSACF;
- the additional access type, if the UE deregisters from the network over both 3GPP access and Non-3GPP access.

The update flag shall be set to "INCREASE" for a UE to be registered to a specific slice, and shall be set to "DECREASE" for a UE to be deregistered from a specific slice.

For NSAC of roaming UEs with VPLMN NSAC admission with or without HPLMN assistance, the NF Service Consumer (e.g. AMF) shall provide the S-NSSAI in serving PLMN, and the corresponding mapped S-NSSAI in home PLMN to the NSACF in serving PLMN. For NSAC of roaming UEs with HPLMN NSAC admission, the NF Service Consumer (e.g. AMF) shall provide the S-NSSAI in home PLMN to the NSACF in home PLMN (corresponding to the S-NSSAI in the VPLMN).

NOTE 1: When multiple S-NSSAIs are supported by a NSACF and multiple S-NSSAIs are required for NSAC for a given UE where EAC mode is active for at least one S-NSSAI, how the AMF triggers NSAC procedure to this NSACF is implementation specific, e.g. the AMF triggers NSAC procedure for all these supported S-NSSAIs before the Registration Accept message or the UE Configuration Update message.

2a. For each S-NSSAI included in UeACRequestData, the NSACF shall perform the following actions:

- if the update flag is set to "INCREASE", the NSACF shall check whether the UE is already in the UE registration list stored in the NSACF and whether the total number of UEs to this slice will exceed the maximum number of UEs allowed to be registered to this slice:
  - if the UE ID is already recorded in the UE registration list but the requester NF is not recorded in the UE registration list, the NSACF shall create a new entry for the UE registration associated with the requester NF and shall also maintain the existing UE registration entries. The total number of UEs registered to this slice is not updated;
  - if the UE ID is not recorded in the UE registration list and the total number of UEs (including the UEs indicated in the request and the UEs already stored in the NSACF) does not exceed the maximum number of UEs allowed to be registered to this slice, the NSACF records the indicated UEs to the UE registration list stored in the NSACF, and updates the total number of UEs registered to this slice accordingly;
  - if the UE ID is not recorded in the UE registration list and if the total number of UEs will exceed the maximum number of UEs allowed to be registered to this slice, the NSACF shall not record the UE into the UE registration list stored in the NSACF, and shall not update the total number of UEs. Instead, the NSACF shall record this S-NSSAI in the failed list of S-NSSAI in the response message, together with an appropriate value of AcuFailureReason (e.g. "EXCEED\_MAX\_UE\_NUM" as specified in clause 6.1.6.3.5);
- if the update flag is set to "DECREASE" and if the UE is recorded in the UE registration list, the NSACF shall remove the indicated UEs from the UE registration list stored in the NSACF. If there are two or more UE registration entries associated with the UE ID, the NSACF shall only remove the entry associated with the requester NF. After removal, if a UE is no longer recorded in the UE registration list, the NSACF shall decrease the total number of UEs registered to this slice.
- if the update flag is set to "DECREASE" and if the UE is not recorded in the UE registration list, the NSACF shall not decrease the total number of UEs registered to this slice and shall return successful handling for this UE registration.

The NSACF may be configured to perform per access type network slice admission control. In this case, the NSACF shall check whether the access type provided by the NF Service Consumer is configured for NSAC for the indicated S-NSSAI to control the number of UEs. If the access type is not configured for NSAC for the indicated S-NSSAI, the NSACF shall skip the above handling for increasing/decreasing the number of UEs and return successful handling for this S-NSSAI. If the access type is configured for NSAC for the indicated S-NSSAI, the NSACF shall perform the above handling taking the access type into account and record/remove the UE registration associated with the access type. If the total number of UEs will exceed the maximum number of UEs allowed to be registered to this slice, the NSACF shall record this S-NSSAI in the failed list of S-NSSAI in

the response message, together with an appropriate value of `AcuFailureReason` (e.g. "EXCEED\_MAX\_UE\_NUM" as specified in clause 6.1.6.3.5).

If the NSACF is not configured to perform per access type network slice admission control, the NSACF may perform network slice admission control without taking access type into account. For example, the NSACF is configured with a total quota for the PLMN, but the network slice admission control is not specific to one access type. The NSACF shall record the access type(s) associated with the UE registration. The NSACF shall remove the corresponding UE registration entry when the UE deregisters from all access types.

NOTE 2: For each S-NSSAI that is applicable for NSAC, the NSACF is configured with a total quota for the PLMN. However, the network slice admission control may be configured to apply for one specific access type or both access types.

If in above NSACF handling not all S-NSSAIs are successful, "200 OK" shall be returned, with necessary response data indicating the failed S-NSSAI and the failure reason, e.g. "EXCEED\_MAX\_UE\_NUM".

If in above NSACF handling all S-NSSAIs are successful, "204 No Content" shall be returned which could represent the maximum number of UEs for the S-NSSAI not reached.

If the NSACF is configured with multiple NSAC Service Areas and is further configured to perform NSAC admission on a per NSAC service area granularity, the NSACF shall perform the NSAC admission against the received NSAC service area in the request.

NOTE 3: If the PLMN has multiple NSAC service areas and there are multiple NSACFs deployed for the network slice, each NSACF may be configured with the maximum number of UEs of the network slice within its service area, e.g. as per operator policy. If hierarchical NSAC architecture is deployed, how to synchronize the threshold among the primary NSACF and distributed NSACFs is specified in clause 5.2.2.2.3 and clause 5.2.2.5.2. Otherwise, how to split or synchronize the threshold in multiple NSACFs is left to implementation, and how to guarantee session continuity when a UE moves to new NSAC service area with a different NSACF is also left to implementation.

NOTE 4: If the NF Service Consumer is AMF, the NSACF may subscribe to AMF Status Change Notifications (e.g. AMF unavailability) via the NRF and update the NF ID accordingly, as described in clause 4.2.11.2 of 3GPP TS 23.502 [3].

When the NF Service Consumer subscribes to the EAC Notification for the first time, the NSACF shall immediately send an EAC notification (see clause 5.2.2.3.2) towards the NF consumer including the most recent EAC Modes for the subscribed S-NSSAIs.

2b. On failure, the appropriate HTTP status code (e.g. "403 Forbidden") indicating the error shall be returned.

A `ProblemDetails` IE shall be included in the content of POST response, with the "cause" attribute of `ProblemDetails` set to application error codes specified in table 6.1.3.2.3.1-1.

NOTE 5: If the NF Service Consumer provided the EAC notification callback URI, the NSACF can handle the EAC notification implicit subscription independently of the result of the UE NSAC activities, i.e. even the NSAC actions for all the S-NSSAIs are failed for the UE(s) and negative response is sent to the AMF, the NSACF can still store the EAC notification subscription and send EAC notification(s) to the AMF.

2c. On redirection, "307 Temporary Redirect" or "308 Permanent Redirect" shall be returned. A `RedirectResponse` IE shall be included in the content of POST response.

When the procedure is used to perform admission control for a number of UEs, when e.g. NSAC is enabled or disabled for an already live slice, then based on operator policy AMF may allow or disallow sessions for which NSACF returned a reject.

### 5.2.2.2.3 NSAC for controlling the number of UEs in hierarchical NSACF architecture

When the hierarchical NSACF architecture is deployed in the network, the NF Service Consumer (e.g. AMF, combined SMF+PGW-C) shall invoke the `NumOfUEsUpdate` service operation to request the NSACF to perform network slice admission control procedure based on UE admission quota or UE admission threshold to control the number of UEs. In this procedure, the NSACF may delegate the request to the primary NSACF for further processing in specific cases.

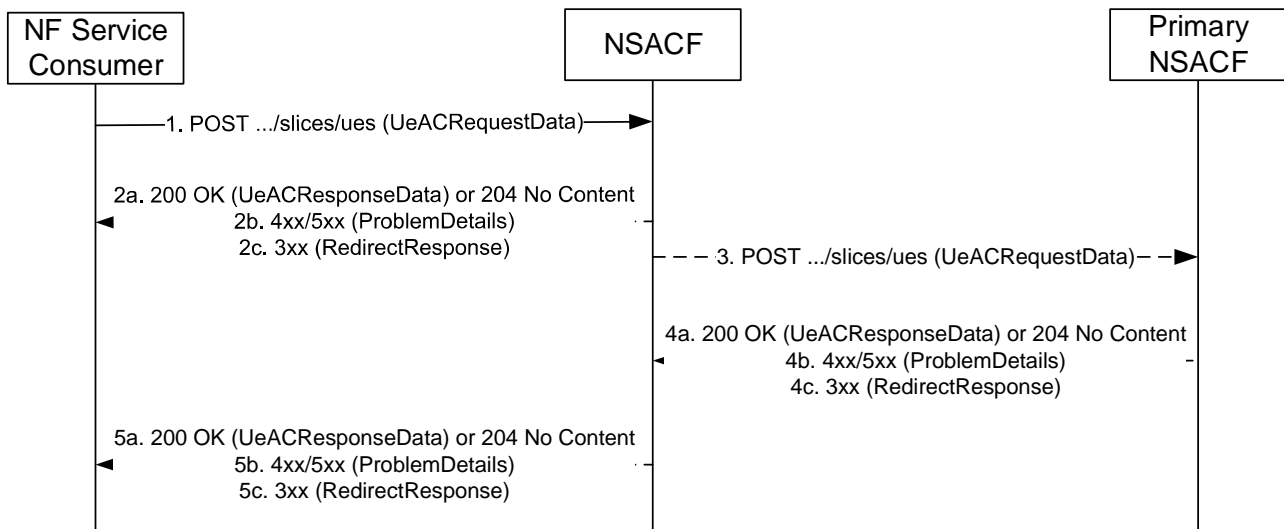

**Figure 5.2.2.2.3-1: NSAC procedure for controlling the number of UEs in hierarchical NSACF architecture**

1. Same as step 1 of Figure 5.2.2.2.2-1, with the following modifications.

The POST request may contain:

- the UE already registered indication, if the UE has been registered with the associated S-NSSAI in another NSAC service area before.

**NOTE:** During inter-AMF mobility or EPS to 5GS mobility, the target AMF determines the UE already registered indication based on the allowed NSSAI information received from the source AMF or the combined SMF+PGW-C, as specified in clause 5.15.11.1.2 of 3GPP TS 23.501 [2].

- 2a. For each S-NSSAI included in UeACRequestData, the NSACF shall perform the actions to control the number of UEs.

- if the update flag is set to "INCREASE" or "DECREASE", the NSACF shall behave as described in clause 5.15.11.1.2 of 3GPP TS 23.501 [2] and clause 4.2.11.2a of 3GPP TS 23.502 [3].

- 2b and 2c. Same as step 2b and 2c of Figure 5.2.2.2.2-1.

3. If the NSAC processing involves the primary NSACF based on the mechanism defined in clause 4.2.11.2a of 3GPP TS 23.502 [3], the NF Service Consumer (e.g. NSACF) shall send a POST request to the resource representing the network slice admission control related to the number of UEs (i.e. .../slices/ues) in the primary NSACF. If the primary NSACF is not discovered, the NSACF shall discover the primary NSACF according to clause 6.3.22 of 3GPP TS 23.501 [2].

The content of the POST request shall contain the input data structure (i.e. UeACRequestData) for network slice admission control, which shall contain the information received in step 1. The UE already registered indication may be included if it is received in step 1 and the UE admission type is quota-based.

- 4a. For each S-NSSAI included in UeACRequestData, the primary NSACF shall check the global maximum number of UEs and determine whether to accept or reject the request to update the local maximum number of UEs and/or the UE admission threshold configurations of NSACF.

- if the update flag is set to "INCREASE" or "DECREASE", the primary NSACF shall behave as described in clause 5.15.11.1.2 of 3GPP TS 23.501 [2] and clause 4.2.11.2a of 3GPP TS 23.502 [3]. If in above primary NSACF handling not all S-NSSAIs are successful, "200 OK" shall be returned, with necessary response data indicating the failed S-NSSAI and the failure reason, e.g. "EXCEED\_MAX\_UE\_NUM".

If in above primary NSACF handling all S-NSSAIs are successful, "204 No Content" shall be returned which could represent the maximum number of UEs for the S-NSSAI not reached.

- 4b. On failure, the appropriate HTTP status code (e.g. "403 Forbidden") indicating the error shall be returned.

A ProblemDetails IE shall be included in the content of POST response, with the "cause" attribute of ProblemDetails set to application error codes specified in table 6.1.3.2.3.1-3.

4c. On redirection, "307 Temporary Redirect" or "308 Permanent Redirect" shall be returned. A RedirectResponse IE shall be included in the content of POST response.

5a. If the response message includes the updated local maximum number of UEs and/or the updated UE admission threshold, the NSACF shall replace the local maximum number of UEs and/or the local UE admission threshold with the received updated values respectively. The NSACF shall execute the same action as step 2a of Figure 5.2.2.2.2-1 based on the updated values;

If the response does not include the updated local maximum number of UEs and/or the updated UE admission threshold, the NSACF shall return the response to NF service consumer based on the received NSAC response from Primary NSACF.

5b and 5c. Same as step 2b and 2c of Figure 5.2.2.2.2-1.

#### 5.2.2.2.4 NSAC for controlling the number of UEs with at least one PDU session/PDN connection

The NumOfUEsUpdate service operation may be invoked to control the number of UEs with at least one PDU session/PDN connection, by a combined SMF+PGW-C under the following conditions:

- EPS interworking is supported;
- EPS counting is required for the network slice identified by an S-NSSAI;
- the network (i.e., combined SMF+PGW-C, NSACF) is configured to perform NSAC for the number of UEs with at least one PDU session/PDN Connection.

The combined SMF+PGW-C shall only invoke the NumOfUEsUpdate in the following cases:

- when the UE establishes the first PDU session/PDN connection associated with the network slice in the combined SMF+PGW-C;
- when the last PDU session/PDN connection associated with the network slice is released.

The procedure specified in clause 5.2.2.2.2 is applied, with the following difference:

- Step 2a:

- for each S-NSSAI, the NSACF checks if the S-NSSAI is subject to counting the number of UEs with at least one PDU session/PDN connection. If no, the NSACF shall perform the existing NSAC handling as per clause 5.2.2.2.2. Otherwise, the NSACF shall perform the following steps:
  - if the update flag is set to "INCREASE"/"DECREASE", perform "INCREASE"/"DECREASE" operation similarly as clause 5.2.2.2.2, by replacing the number of UEs to the number of UEs with at least one PDU session/PDN connection.
  - if the update flag is set to "INCREASE" and the counted UE number exceeds the configured maximum number of UEs with at least one PDU session/PDN connection, the NSACF shall record this S-NSSAI in the failed list of S-NSSAI in the response message, together with an appropriate value of AcuFailureReason (e.g. "EXCEED\_MAX\_UE\_NUM " as specified in clause 6.1.6.3.5).
  - if the update flag is set to "UPDATE", behave as described in clause 4.11.5.9a of 3GPP TS 23.502 [3].
- For the hierarchical NSAC architecture, the NSACF shall behave as specified in clause 5.2.2.2.3.
- If the local maximum number of UEs with at least one PDU session/PDN connection or local threshold is reached, the NSACF may interact with the Primary NSACF before it returns the response back to the SMF+PGW-C. For more details on handling between the NSACF and Primary NSACF see clause 4.2.11.2a of 3GPP TS 23.502 [3].

The EAC mode shall not be applicable for the NSAC for controlling the number of UEs with at least one PDU session/PDN connection option 1 and option 2.

### 5.2.2.2.5 NSAC for controlling the number of UEs in case of VPLMN with HPLMN assistance NSAC mode

For controlling of maximum number of UEs in roaming case, the NF Service Consumer (e.g. AMF, vNSACF in Hierarchical NSAC architecture) shall invoke the NumOfUEsUpdate service operation to request the NSACF in Serving PLMN (e.g. Central or Primary NSACF in VPLMN) to perform network slice admission control procedure based on UE admission quota or UE admission threshold to control the number of UEs. In this procedure, the NSACF in Serving PLMN shall delegate the request to the NSACF in HPLMN for further processing in specific cases.

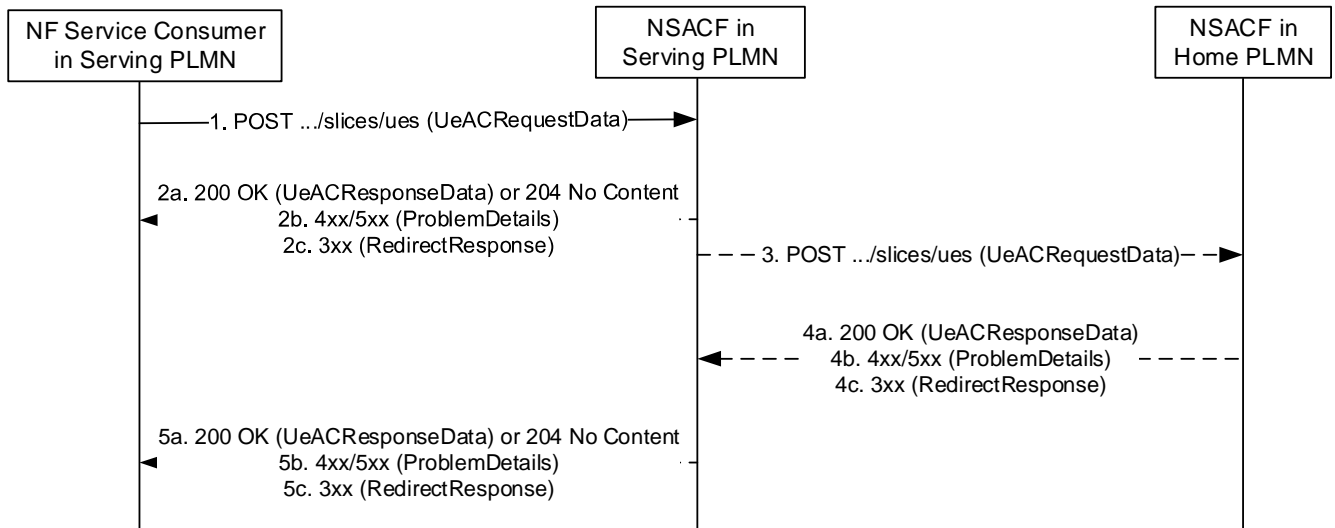

**Figure 5.2.2.2.5-1: HPLMN Delegated NSAC procedure for controlling the number of UEs**

1. Same as step 1 of Figure 5.2.2.2-1, with the value of NSAC admission mode set to VPLMN with HPLMN assistance NSAC admission mode.
- 2a. For each S-NSSAI included in UeACRequestData, the NSACF in serving PLMN shall perform the actions to control the number of UEs.
  - if centralized NSAC architecture is deployed in the VPLMN, same as step 2a of Figure 5.2.2.2-1; or
  - if Hierarchical NSAC architecture is deployed in the VPLMN, same as step 4a of Figure 5.2.2.2-1.

2b and 2c. Same as step 2b and 2c of Figure 5.2.2.2-1.

3. If there is no allocated maximum number of UEs from HPLMN or the allocated maximum number of registered UEs has been reached, the NSACF in serving PLMN shall send a POST request to the resource representing the network slice admission control related to the number of UEs (i.e. ../slices/ues) in the NSACF in HPLMN.

The content of the POST request shall contain the input data structure (i.e. UeACRequestData) for network slice admission control, which shall contain the information received in step 1.

- 4a. For each S-NSSAI included in UeACRequestData, the NSACF in HPLMN shall check the global maximum number of UEs and determine whether to accept or reject the request to update the local maximum number of UEs and/or the UE admission threshold configurations of NSACF in serving PLMN.

The NSACF in HPLMN shall send allocated maximum number or admission threshold of registered UEs for the mapped S-NSSAI in HPLMN for inbound roamers as described in clause 4.2.11.5.2.3 of 3GPP TS 23.502 [3]. If in above NSACF in HPLMN handling not all S-NSSAIs are successful, "200 OK" shall be returned, with necessary response data indicating the failed S-NSSAI and the failure reason, e.g. "EXCEED\_MAX\_UE\_NUM".

- 4b. On failure, the appropriate HTTP status code (e.g. "403 Forbidden") indicating the error shall be returned.

A ProblemDetails IE shall be included in the content of POST response, with the "cause" attribute of ProblemDetails set to application error codes specified in table 6.1.3.2.3.1-3.

4c. On redirection, "307 Temporary Redirect" or "308 Permanent Redirect" shall be returned. A RedirectResponse IE shall be included in the content of POST response.

5a. If the response message includes the allocated maximum number of UEs and/or UE admission threshold for the mapped S-NSSAI in HPLMN for inbound roamers, the NSACF in serving PLMN shall replace the local maximum number of UEs and/or the local UE admission threshold with the received updated values respectively. The NSACF in serving PLMN shall execute the same action as step 2a of this procedure based on the updated values;

If the response does not include the allocated maximum number of UEs and/or UE admission threshold, the NSACF in serving PLMN shall return the response to NF service consumer based on the received NSAC response from NSACF in HPLMN.

5b and 5c. Same as step 2b and 2c of Figure 5.2.2.2-1.

### 5.2.2.3 EACNotify

#### 5.2.2.3.1 General

The EACNotify service operation shall be used by the NSACF to inform the NF Service Consumer (e.g. AMF) of the activation/deactivation of EAC mode. It is used in the following procedures:

- NSACF initiated configuration on EAC mode procedure (see clause 4.2.11.3 of 3GPP TS 23.502 [3]).

#### 5.2.2.3.2 NSACF initiated EAC mode configuration

The EACNotify service operation shall be used by the NSACF to configure the EAC mode(s) for S-NSSAI(s) to the NF Service Consumer (e.g. AMF). The EACNotify service operation shall be triggered when the NSACF decides to set the EAC mode for an S-NSSAI to "ACTIVE" if the number of UEs registered to an S-NSSAI is above certain threshold, or set the EAC mode for an S-NSSAI to "DEACTIVE" if the number of UEs registered to an S-NSSAI is below certain threshold. The activation threshold and the deactivation threshold may be same or different.

If NF Service Consumer has implicitly subscribed to receive EAC notification, the NSACF shall notify the NF Service Consumer (e.g. AMF) to configure the EAC mode by using the HTTP POST method as shown in Figure 5.2.2.3.2-1.

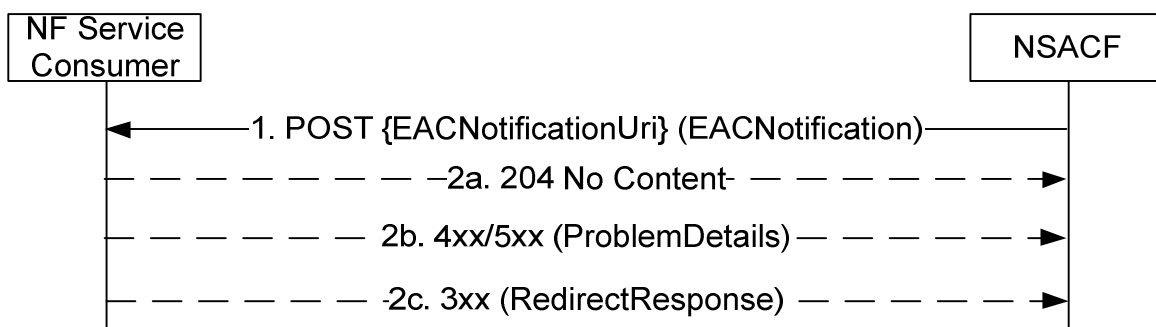

**Figure 5.2.2.3.2-1: NSACF initiated EAC mode configuration procedure**

1. The NSACF shall send a POST request to the EAC Notification callback URI provided by the NF Service Consumer (e.g. AMF).

The content of the POST request shall contain the notification content (i.e. EACNotification), which shall contain the following information:

- S-NSSAI(s);
- the EAC mode for each S-NSSAI.

The callback URI may be provided by the AMF in the first interaction with the NSACF, or in later interactions when the callback URI is changed.

- 2a. On success, "204 No Content" shall be returned and the content of the POST response shall be empty.
- 2b. On failure, one of the HTTP status code listed in Table 6.1.5.2.3.1-2 shall be returned. For a 4xx/5xx response, the message body shall contain a ProblemDetails structure with the "cause" attribute set to one of the application error listed in Table 6.1.5.2.3.1-2.
- 2c. On redirection, "307 Temporary Redirect" or "308 Permanent Redirect" shall be returned. A RedirectResponse IE shall be included in the content of POST response.

The EAC mode configuration shall be access type independent, i.e. applied to both 3GPP access and Non-3GPP access.

The NSACF may try several times to send EAC notification to the AMF, if no response is received from the AMF e.g. AMF is out of service. If the subsequent try still fails, the NSACF should stop sending EAC notification, unless the AMF becomes available.

## 5.2.2.4 NumOfPDUsUpdate

### 5.2.2.4.1 General

The NumOfPDUsUpdate service operation shall be used by the NF Service Consumer (e.g. SMF or NSACF) to request the NSACF to control the number of PDU sessions registered to a specific slice, e.g. perform availability check and update the number of PDU sessions registered to a slice. It is used in the following procedures:

- SMF initiated network slice admission control procedure for controlling the number of PDU sessions registered to a network slice (see clause 4.2.11.4 of 3GPP TS 23.502 [3]).
- SMF initiated network slice admission control procedure for controlling the number of LBO PDU sessions registered to a network slice (see clauses 4.2.11.5.1 and 4.2.11.5.2.4 of 3GPP TS 23.502 [3]).
- Combined SMF+PGW-C initiated network slice admission control procedure for controlling the number of PDU sessions registered to a network slice, in the case of EPS interworking (see clause 5.15.11.5 of 3GPP TS 23.501 [2], and clause 4.2.11.4 of 3GPP TS 23.502 [3]).
- Combined SMF+PGW-C initiated network slice admission control procedure related to control the number of UEs with at least one PDU session/PDN connection (see clause 5.15.11.5a of 3GPP TS 23.501 [2]).
- Hierarchical NSAC-based network slice admission control procedure for controlling the number of PDU sessions registered to a network slice (see clause 4.2.11.4a of 3GPP TS 23.502 [3]).

The operation may also be used to update the number of existing PDU Sessions in the NSACF when NSAC is enabled or disabled for a slice which is already live in the network.

### 5.2.2.4.2 NSAC for controlling the number of PDU sessions

The NF Service Consumer (e.g. SMF, combined SMF+PGW-C) shall invoke the NumOfPDUsUpdate service operation to request the NSACF to perform network slice admission control procedure related to the number of PDU sessions, by using the HTTP POST method as shown in Figure 5.2.2.4.2-1.

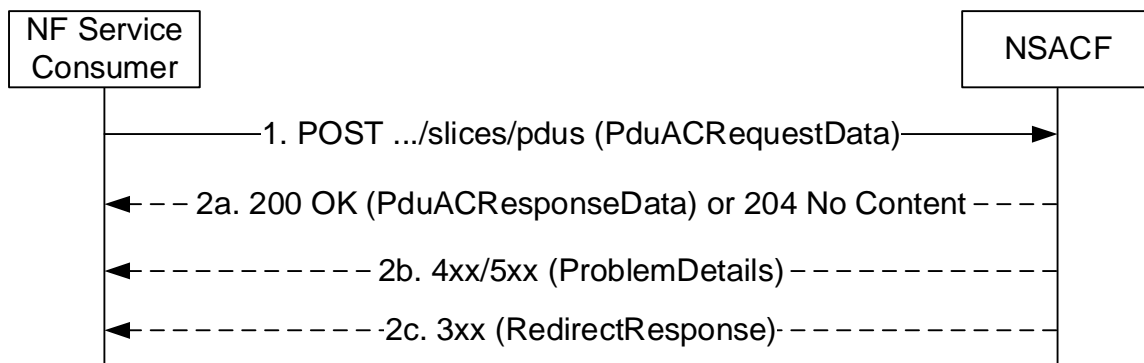

**Figure 5.2.2.4.2-1: NSAC procedure for controlling the number of PDU sessions**

1. The NF Service Consumer (e.g. SMF) shall send a POST request to the resource representing the network slice admission control related to the number of PDU sessions (i.e. .../slices/pdus) in the NSACF.

The content of the POST request shall contain the input data structure (i.e. PduACRequestData) for network slice admission control, which shall contain the following information:

- the SUPI of the UE;
- the access type, over which the PDU session is to be established or released;
- the PDU session ID(s);
- a list of S-NSSAIs which are subject to NSAC, and for each S-NSSAI an update flag that indicates the operation to that S-NSSAI.
- the NSAC Service Area of the NF consumer, if it is configured in the NF consumer.
- the NSAC admission mode of each S-NSSAI for inbound roamer, i.e. VPLMN NSAC admission mode or VPLMN with HPLMN assistance NSAC admission mode;
- the serving PLMN ID of the inbound roamer.

In addition, the POST request may also contain:

- the NF Instance ID of the requester NF (i.e. SMF);
- the PGW-C FQDN, if the request is sent by a combined SMF+PGW-C in EPS interworking case.
- the additional access type, for an Multi-Access PDU session, if the PDU session is to be established over both 3GPP access and Non-3GPP access, or if the PDU session is to be released from both 3GPP access and Non-3GPP access.

The update flag within the PduACRequestData shall be set to the value as following:

- "INCREASE" for a Single-Access PDU session which is to be established, or for an Multi-Access PDU session when new access leg(s) is to be established;
- "DECREASE" for a Single-Access PDU session which is to be released, or for an Multi-Access PDU session when existing access leg(s) is to be removed;
- "UPDATE" for a Single-Access PDU session when the access type is to be replaced with a new access type during inter access mobility.

For LBO cases with VPLMN NSAC admission with or without HPLMN assistance, the NF Service Consumer in serving PLMN (e.g. vSMF) shall provide the S-NSSAI in serving PLMN, and the corresponding mapped S-NSSAI in home PLMN to the NSACF in serving PLMN. For LBO cases with HPLMN NSAC admission, the NF Service Consumer in serving PLMN (e.g. vSMF) shall provide the S-NSSAI in home PLMN (corresponding to the S-NSSAI in the VPLMN) to the NSACF in home PLMN. For



PDU sessions in the home-routed roaming case, the NF Service Consumer in home PLMN (e.g. hSMF) shall provide S-NSSAI(s) in home PLMN to the NSACF in the home PLMN.

If an S-NSSAI of the PDU session is temporarily replaced by an alternative S-NSSAI when the S-NSSAI becomes unavailable or congested, based on operator policy, the SMF may perform NSAC procedure towards the NSACF indicating the replaced S-NSSAI and/or the Alternative S-NSSAI. If the replaced S-NSSAI and alternative S-NSSAI are served by the same NSACF, both the replaced S-NSSAI and the alternative S-NSSAI may be sent in the acuOperationList (i.e. At the beginning of the Network Slice Replacement, one AcuOperationItem indicates the replaced S-NSSAI with the updateFlag set to "DECREASE", and another AcuOperationItem indicates the alternative S-NSSAI with the updateFlag set to "INCREASE". At the end of the Network Slice Replacement, one AcuOperationItem indicates the replaced S-NSSAI with the updateFlag set to "INCREASE" and another AcuOperationItem indicates the alternative S-NSSAI with the updateFlag set to "DECREASE").

2a. For each S-NSSAI included in PduACRequestData, the NSACF shall perform the following actions:

- if the update flag is set to "INCREASE", the NSACF shall check whether the PDU session is already recorded in the PDU registration list in the NSACF and whether the total number of PDU sessions to this slice will exceed the maximum number of PDU sessions allowed to be registered to this slice:
  - if the PDU session (identified by the UE ID and the PDU session ID) is already recorded in the PDU registration list, the NSACF shall skip recording this PDU session and shall not increase the total number of PDU sessions established to this network slice;
  - if the PDU session is not recorded in the PDU registration list and the total number of PDU sessions (including the PDU session indicated in the request and the PDU sessions already stored in the NSACF) does not exceed the maximum number of PDU sessions allowed to be registered to this slice, the NSACF records the PDU session to the PDU registration list stored in the NSACF, and updates the total number of PDU sessions registered to this slice accordingly;
  - if the PDU session is not recorded in the PDU registration list and if the total number of PDU sessions will exceed the maximum number of PDU sessions allowed to be registered to this slice, the NSACF shall not record the PDU session into the PDU registration list stored in the NSACF, and shall not update the total number of PDU sessions. Instead, the NSACF shall record this S-NSSAI in the failed list of S-NSSAI in the response message, together with an appropriate value of AcuFailureReason (e.g. "EXCEED\_MAX\_PDU\_NUM" as specified in clause 6.1.6.3.5);
- if the update flag is set to "DECREASE" and if the PDU session is recorded in the PDU registration list, the NSACF decreases the total number of PDU sessions registered to this slice, and removes the indicated PDU session from the PDU registration list stored in the NSACF.
- if the update flag is set to "DECREASE" and if the PDU session is not recorded in the PDU registration list, the NSACF shall not decrease the total number of PDU sessions registered to this slice and shall return successful handling for this PDU registration.
- if the update flag is set to "UPDATE", the NSACF shall locate the existing entry in the PDU registration list and update the access type associated to the PDU session to which indicated in the request message.

The NSACF may be configured to perform per access type network slice admission control. In this case, the NSACF shall check whether the access type provided by the NF Service Consumer is configured for NSAC for the indicated S-NSSAI to control the number of PDU sessions. If the access type is not configured for NSAC for the indicated S-NSSAI, the NSACF shall skip the above handling for increasing/decreasing the number of PDU sessions and shall return successful handling for this S-NSSAI. If the access type is configured for NSAC for the indicated S-NSSAI, the NSACF shall perform the above handling taking the access type into account. If the update flag is set to "UPDATE", the NSACF shall first increase the number of PDU sessions for the new access type, and if successful then decrease the number of PDU sessions for the old access type. If the total number of PDU sessions will exceed the maximum number of PDU sessions allowed to be registered to this slice, the AcuFailureReason shall indicate the applied access type (e.g. "EXCEED\_MAX\_PDU\_NUM\_3GPP" or "EXCEED\_MAX\_PDU\_NUM\_N3GPP" as specified in clause 6.1.6.3.5).

If the NSACF is not configured to perform per access type network slice admission control, the NSACF may perform network slice admission control without taking access type into account. For example, the NSACF is configured with a total quota for the PLMN, but the network slice admission control is not specific to one access

type. The NSACF shall record the access type(s) associated with the PDU registration. The NSACF shall remove the PDU registration entry when the PDU session is released from all access types.

NOTE 1: For each S-NSSAI that is applicable for NSAC, the NSACF is configured with a total quota for the PLMN. However, the network slice admission control may be configured to apply for one specific access type or both access types.

If in above NSACF handling not all S-NSSAIs are successful, "200 OK" shall be returned, with necessary response data, e.g. indicating the failed S-NSSAI(s).

If in above NSACF handling all S-NSSAIs are successful, "204 No Content" shall be returned.

If the NSACF is configured with multiple NSAC Service Areas and is further configured to perform NSAC admission on a per NSAC service area granularity, the NSACF shall perform the NSAC admission against the received NSAC service area in the request.

NOTE 2: If the PLMN has NSAC multiple service areas and there are multiple NSACFs deployed for the network slice, each NSACF may be configured with the maximum number of PDU Sessions of the network slice within its service area, e.g. as per operator policy. If hierarchical NSAC architecture is deployed, how to synchronize the threshold among the primary NSACF and distributed NSACFs is specified in clause 5.2.2.4.3 and clause 5.2.2.5.2. Otherwise, how to split or synchronize the threshold in multiple NSACFs is left to implementation, and how to guarantee session continuity when a UE moves to new NSAC service area with a different NSACF is also left to implementation.

2b. On failure, the appropriate HTTP status code (e.g. "403 Forbidden") indicating the error shall be returned.

A ProblemDetails IE shall be included in the content of POST response, with the "cause" attribute of ProblemDetails set to application error codes specified in table 6.1.3.3.3.1-3.

2c. On redirection, "307 Temporary Redirect" or "308 Permanent Redirect" shall be returned. A RedirectResponse shall be included in the content of POST response.

When the procedure is used to perform admission control for a number of PDU sessions, when e.g. NSAC is enabled or disabled for an already live slice, then based on operator policy, SMF may allow or disallow sessions for which NSACF returned a reject.

### 5.2.2.4.3 NSAC for controlling the number of PDU sessions in hierarchical NSACF architecture

When hierarchical NSACF architecture is deployed in the network, the NF Service Consumer (e.g. SMF, combined SMF+PGW-C) shall invoke the NumOfPDUsUpdate service operation to request the NSACF to perform network slice admission control procedure related to the number of PDU sessions. In this procedure, the NSACF may delegate the request to the primary NSACF for further processing.

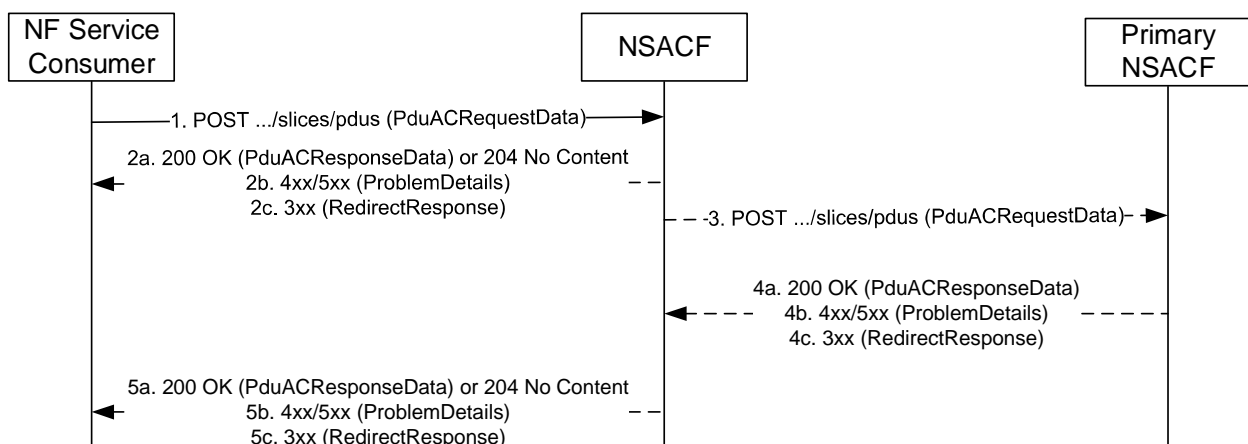

Figure 5.2.2.4.3-1: NSAC procedure for controlling the number of PDU sessions in hierarchical NSACF architecture

1. Same as step 1 of Figure 5.2.2.4.2-1.

- 2a. For each S-NSSAI included in PduACRequestData, the NSACF shall perform action to control the number of PDU session.

If the local maximum number of PDU sessions is reached, the NSACF may interact with the Primary NSACF to request an update of the local maximum number of PDU sessions before it returns a response to the NF Service Consumer.

2b and 2c. Same as step 2b and 2c of Figure 5.2.2.4.2-1.

3. If the NSAC processing involves the primary NSACF based on the mechanism defined in clause 4.2.11.4a of 3GPP TS 23.502 [3], the NF Service Consumer (e.g. NSACF) shall send a POST request to the resource representing the network slice admission control related to the number of PDU sessions (i.e. .../slices/pdus) in the primary NSACF. If the primary NSACF is not discovered, the NSACF shall discover the primary NSACF according to clause 6.3.22 of 3GPP TS 23.501 [2].

The content of the POST request shall contain the input data structure (i.e. PduACRequestData) for network slice admission control, which shall contain the information received in step 1.

- 4a. For each S-NSSAI included in PduACRequestData, the primary NSACF shall check the global maximum PDU session number and determine whether to accept or reject the request to update the local maximum PDU session number from NSACF.

The primary NSACF shall include the S-NSSAI in the failed list of S-NSSAI in the response message, together with an appropriate value of AcuFailureReason (e.g. "EXCEED\_MAX\_PDU\_NUM" as specified in clause 6.1.6.3.5), if the request to update the local maximum PDU session number is rejected.

The primary NSACF shall include a new allocated local maximum PDU sessions number in the response message, if the request to update the local maximum PDU session number is accepted.

- 4b. On failure, the appropriate HTTP status code (e.g. "403 Forbidden") indicating the error shall be returned.

A ProblemDetails IE shall be included in the content of POST response, with the "cause" attribute of ProblemDetails set to application error codes specified in table 6.1.3.3.3.1-3.

- 4c. On redirection, "307 Temporary Redirect" or "308 Permanent Redirect" shall be returned. A RedirectResponse shall be included in the content of POST response.

- 5a. If the response message includes the updated the local maximum number, the NSACF shall replaces the existing local maximum number with the received updated value, and the NSACF shall execute the same action as step 2a of Figure 5.2.2.4.2-1 based on the updated value;

If the response does not include the updated local maximum number of PDU sessions, the NSACF shall returns the response to NF service consumer based on the received NSAC response from Primary NSACF.

5b and 5c. Same as step 2b and 2c of Figure 5.2.2.4.2-1.

#### 5.2.2.4.4 NSAC for controlling the number of UEs with at least one PDU session/PDN connection per network slice

The NumOfPDUsUpdate service operation may be invoked to control the number of UEs with at least one PDU session/PDN connection, by the combined SMF+PGW-C under the following conditions:

- EPS interworking is supported;
- EPS counting is required for the network slice identified by an S-NSSAI;
- the network (e.g. combined SMF+PGW-C, NSACF) is configured to perform NSAC for the number of UEs with at least one PDU Session/PDN Connection.

The combined SMF+PGW-C shall invoke the NumOfPDUsUpdate in the following cases:

- when the UE establishes PDU session/PDN connection associated with the network slice in the combined SMF+PGW-C;
- when the PDU session/PDN connection associated with the network slice is released.

When invoking NumOfPDUsUpdate, the procedure specified in clause 5.2.2.4.2 is applied, with the following differences:

- Step 2a:
  - for each S-NSSAI, the NSACF checks if the S-NSSAI is subject to counting the number of UEs with at least one PDU session/PDN connection. If no, the NSACF shall perform the existing NSAC handling as per clause 5.2.2.4.2. Otherwise, the NSACF shall perform the following steps:
    - if the update flag is set to "INCREASE", the NSACF, shall behave as specified in clause 5.15.11.5a of 3GPP TS 23.501 [2] and clause 4.11.5.9a of 3GPP TS 23.502 [3].
      - if the counted UE number exceeds the configured maximum number of UEs with at least one PDU session/PDN connection, the NSACF shall record this S-NSSAI in the failed list of S-NSSAI in the response message, together with an appropriate value of AcuFailureReason (e.g. "EXCEED\_MAX\_UE\_NUM" as specified in clause 6.1.6.3.5).
    - if the update flag is set to "UPDATE", the NSACF performs necessary check and updates the stored information in the UE entry (e.g. access type), as specified in clause 4.11.5.9a of 3GPP TS 23.502 [3].
    - if the update flag is set to "DECREASE", the NSACF shall behave as specified in clause 5.15.11.5a of 3GPP TS 23.501 [2] and clause 4.11.5.9a of 3GPP TS 23.502 [3].
  - For the hierarchical NSAC architecture, the NSACF shall behave as specified in clause 5.2.2.4.3.
    - If the local maximum number of UEs with at least one PDU session/PDN connection or local threshold is reached, the NSACF may interact with the Primary NSACF before it returns the response back to the SMF+PGW-C. For more details on handling between the NSACF and Primary NSACF see clause 4.2.11.4a of 3GPP TS 23.502 [3].

**5.2.2.4.5 NSAC for controlling the number of LBO PDU Sessions in case of VPLMN with HPLMN assistance NSAC mode**

For controlling of maximum number of LBO PDU sessions for inbound roamers, the NF Service Consumer (e.g. SMF, vNSACF in Hierarchical NSAC architecture) shall invoke the NumOfPDUsUpdate service operation to request the NSACF in Serving PLMN (e.g. Central or Primary NSACF in VPLMN) to perform network slice admission control procedure related to the number of LBO PDU sessions. In this procedure, the NSACF in Serving PLMN shall delegate the request to the NSACF in HPLMN for further processing in specific cases.

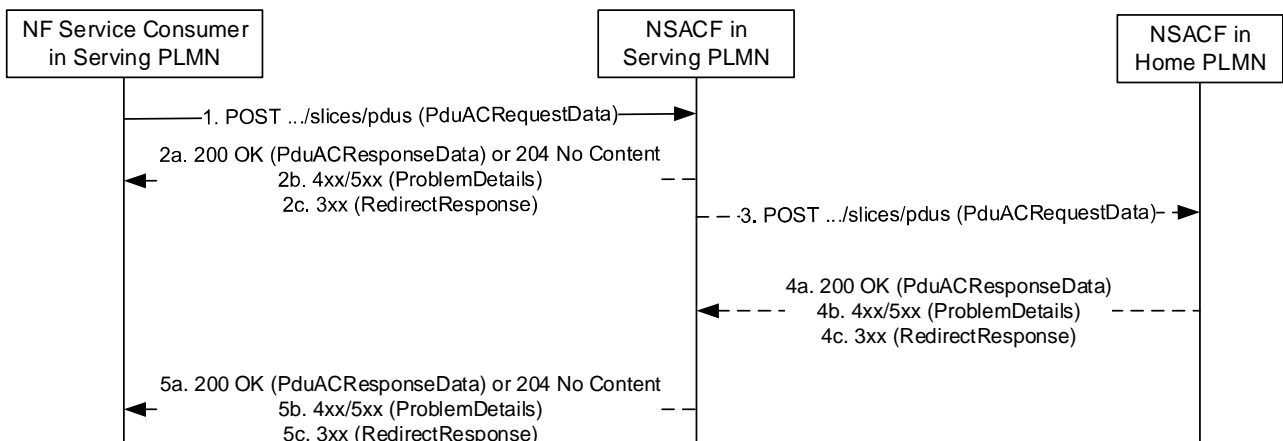

**Figure 5.2.2.4.5-1: HPLMN Delegated NSAC procedure for controlling the number of LBO PDU sessions**

1. Same as step 1 of Figure 5.2.2.4.2-1, with the value of NSAC admission mode set to VPLMN with HPLMN assistance NSAC admission mode.
- 2a. For each S-NSSAI included in PduACRequestData, the NSACF in serving PLMN shall perform actions to control the number of PDU session.

- if centralized NSAC architecture is deployed in the VPLMN, same as step 2a of Figure 5.2.2.4.2-1; or
- if Hierarchical NSAC architecture is deployed in the VPLMN, same as step 4a of Figure 5.2.2.4.3-1.

2b and 2c. Same as step 2b and 2c of Figure 5.2.2.4.2-1.

3. If the maximum number of PDU session is not available or the maximum number of PDU sessions has been reached at the NSACF in serving PLMN, the NSACF in serving PLMN shall send a POST request to the resource representing the network slice admission control related to the number of PDU sessions (i.e. .../slices/pdus) in the NSACF in HPLMN.

The content of the POST request shall contain the input data structure (i.e. PduACRequestData) for network slice admission control, which shall contain the information received in step 1.

- 4a. For each S-NSSAI included in PduACRequestData, the NSACF in HPLMN shall check the global maximum PDU session number and determine whether to accept or reject the request to update the local maximum PDU session number configurations of NSACF in serving PLMN.

The NSACF in HPLMN shall include the S-NSSAI in the failed list of S-NSSAI in the response message, together with an appropriate value of AcuFailureReason (e.g. "EXCEED\_MAX\_PDU\_NUM" as specified in clause 6.1.6.3.5), if the request is rejected.

The NSACF in HPLMN shall send allocated maximum number of LBO PDU sessions for the mapped S-NSSAI in HPLMN for inbound roamers in the response message, if the request to update the local maximum PDU session number is accepted, as described in clause 4.2.11.5.2.4 of 3GPP TS 23.502 [3].

- 4b. On failure, the appropriate HTTP status code (e.g. "403 Forbidden") indicating the error shall be returned.

A ProblemDetails IE shall be included in the content of POST response, with the "cause" attribute of ProblemDetails set to application error codes specified in table 6.1.3.3.3.1-3.

- 4c. On redirection, "307 Temporary Redirect" or "308 Permanent Redirect" shall be returned. A RedirectResponse shall be included in the content of POST response.

- 5a. If the response message includes the allocated maximum number of LBO PDU sessions, the NSACF in serving PLMN shall replace the existing local maximum number with the received updated value, and the NSACF in serving PLMN shall execute the same action as step 2a of this procedure based on the updated value;

If the response does not include the allocated maximum number of LBO PDU sessions, the NSACF in serving PLMN shall return the response to NF service consumer based on the received NSAC response from NSACF in HPLMN.

5b and 5c. Same as step 2b and 2c of Figure 5.2.2.4.2-1.

## 5.2.2.5 LocalNumberUpdate

### 5.2.2.5.1 General

The LocalNumberUpdate service operation shall be used by the NF service consumer (e.g., primary NSACF) to update the local maximum number of registered UEs and/or PDU sessions of a network slice at the NSACF. It is used in the following procedures:

- Update of local maximum number in Hierarchical NSAC Architecture (see clause 4.2.11.6 of 3GPP TS 23.502 [3]).

The LocalNumberUpdate service operation shall also be used by the NF service consumer (e.g. primary or central NSACF in HPLMN) to update the local maximum number of registered roaming UEs and/or LBO PDU sessions of a network slice at the primary or central NSACF in VPLMN. It is used in the following procedures:

- VPLMN with HPLMN assistance NSAC Admission mode for number of registered roaming UEs and number of LBO PDU sessions (see clause 4.2.11.5.2.2 of 3GPP TS 23.502 [3]).

### 5.2.2.5.2 Update of local maximum number of UEs or PDU sessions

The LocalNumberUpdate service operation shall be used by the NF service consumer to update the local maximum number of registered UEs and/or PDU sessions of the network slice at the NSACF by using the HTTP POST method as shown in Figure 5.2.2.5.2-1.

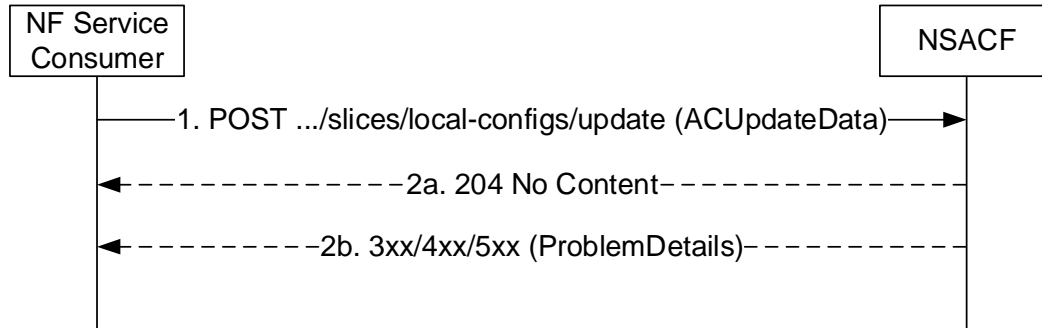

**Figure 5.2.2.5.2-1: NSAC procedure for updating the numbers of UEs and/or PDU sessions**

1. The NF Service Consumer (i.e., primary NSACF or central NSACF) shall send a POST request to the resource representing the network slice admission control configurations (i.e., `.../slices/local-configs-update`) in the NSACF.

The content of the POST request shall contain the input data structure (i.e., `ACUpdateData`), which shall contain the following information to update the local maximum number of registered UEs and/or (LBO) PDU sessions in the Hierarchical NSAC Architecture:

- the S-NSSAIs subject to NSAC for which an updated number of maximum number of UEs or PDU sessions needs to be provided;
- the updated local maximum number of registered UEs, if this information is changed; and
- the updated local maximum number of PDU sessions if this information is changed.

Or it shall contain the following information in VPLMN with HPLMN assistance NSAC Admission mode:

- the S-NSSAIs mapped in HPLMN subject to NSAC for which an update of the maximum number of registered roaming UEs or LBO PDU sessions needs to be provided;
- the updated local maximum number of registered roaming UEs, if this information is changed; and
- the updated local maximum number of LBO PDU sessions if this information is changed.

- 2a. On success, "204 No Content" shall be returned and the content of the POST response shall be empty. The updated values of the local maximum number of registered UEs and/or PDU sessions may directly apply to current NSAC pending requests in NSACF and they shall be used for all future requests as specified in clause 5.15.11.1.2 of 3GPP TS 23.501 [2].

- 2b. On failure, one of the HTTP status codes listed in Table 6.1.3.4.3.1-3 shall be returned.

### 5.2.2.6 QuotaUpdate

#### 5.2.2.6.1 General

The QuotaUpdate service operation shall be used to request the primary or central NSACF at HPLMN to return the maximum number of registered UEs and/or the maximum number of LBO PDU sessions of a network slice to the primary or central NSACF of VPLMN for inbound roamers when the VPLMN NSAC admission mode is determined.

It is used in the following procedures:

- Network Slice Admission Control Support for Roaming by VPLMN (see clause 4.2.11.5.1 of 3GPP TS 23.502 [3]).

### 5.2.2.6.2 Update of maximum number of UEs and/or PDU sessions

The QuotaUpdate service operation shall be used by the NF service consumer to fetch the maximum number of registered UEs and/or the maximum number of LBO PDU sessions of a network slice at the primary or central NSACF at HPLMN for inbound roamers by using the HTTP POST method as shown in Figure 5.2.2.6.2-1.

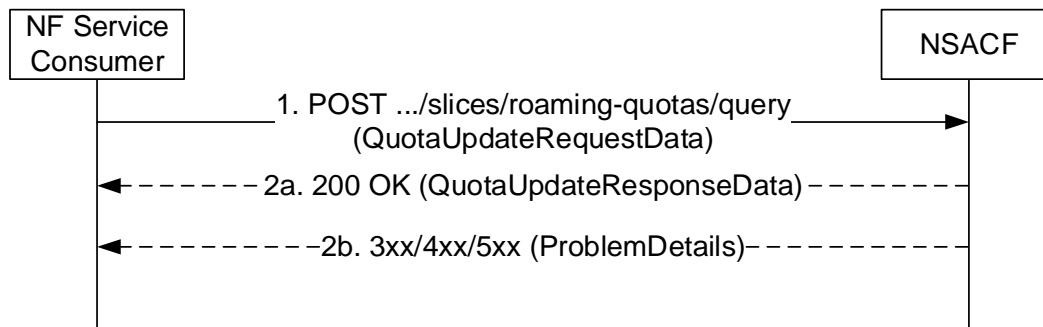

**Figure 5.2.2.6.2-1: NSAC procedure for fetching the quota of the number of UEs and/or LBO PDU sessions at the HPLMN NSACF for inbound roamers**

1. The NF Service Consumer (i.e., primary or central NSACF at VPLMN) shall send a POST request to the resource representing the network slice admission control related to the quota update (i.e., .../slice/roaming-quotas/query) in the primary or central HPLMN NSACF.

The content of the POST request shall contain the input data structure (i.e., QuotaUpdateRequestData), which shall contain the following information:

- the S-NSSAI mapped in HPLMN subject to NSAC for which the available quota for the maximum number of inbound roaming UEs and/or LBO PDU sessions needs to be provided;
- the serving PLMN ID of the UE for which quotas are requested; and
- the requested quota type indicating if the requested quota is for the maximum number of registered inbound roaming UEs and/or the maximum number of LBO PDU sessions.

- 2a. On success, "200 OK" shall be returned and the content of the POST response shall contain input data structure (i.e., QuotaUpdateResponseData), which shall contain the following information:

- The updated maximum number of registered inbound roaming UEs and/or the maximum number of LBO PDU sessions.

- 2b. On failure, one of the HTTP status codes listed in Table 6.1.3.5.4.2.2-2 shall be returned.

## 5.3 Nnsacf\_SliceEventExposure Service

### 5.3.1 Service Description

The Nnsacf\_SliceEventExposure services provide event based notifications to the consumer NF (e.g. to NEF, AF, DCCF or NWDAF) related to the number of UEs registered to a network slice or the number of PDU Sessions established to a network slice.

If, in accordance with operator policy and national/regional regulations, the NF Service Consumer (i.e. the AMF or the SMF) needs to exempt UEs/PDU Sessions that are used for emergency, mission critical and/or priority services (e.g.

MCS, MPS) from NSAC, then the NF service consumer may send a request to NSACF and ignore the NSACF response. Therefore, if a UE/PDU session is rejected by NSACF, then the reports generated by the NSACF would not have counts of those UEs/PDU-Sessions, despite the UEs accessing the corresponding slice(s). Alternatively, the NF Service Consumer (i.e. the AMF or the SMF) may not invoke the corresponding NSAC procedure for the exempted UE/PDU Session, i.e. those UEs/PDU Sessions are not counted towards the maximum number of UEs/PDU Sessions (see clause 5.15.11.0 of 3GPP TS 23.501 [2]).

## 5.3.2 Service Operations

### 5.3.2.1 Introduction

For the Nnsacf\_SliceEventExposure service the following service operations are defined:

- Subscribe, including creation or modification of a subscription;
- Unsubscribe;
- Notify.

### 5.3.2.2 Subscribe

#### 5.3.2.2.1 General

This service operation is used by the consumer NF (e.g. NEF, AF, DCCF, NSACF or NWDAF) to subscribe or modify a subscription with the NSACF for event based notifications for: the number of UEs registered to a network slice, or the number of PDU Sessions established to a network slice.

**NOTE:** In notifications reporting the number of UEs registered to a network slice, the NSACF can indicate whether the reported number of UEs correspond to UEs with at least one PDU session/PDN connection. See clause 5.3.2.4.1.

#### 5.3.2.2.2 Creation of a subscription

The Subscribe service operation is invoked by a NF Service Consumer (e.g. NEF, AF, DCCF or NWDAF) towards the NSACF, when it needs to create a subscription to monitor the event relevant to the NSACF.

The NF Service Consumer shall request to create a new subscription by using HTTP method POST with URI of the subscriptions collection, see clause 6.2.3.1.

The NF Service Consumer shall include the following information in the HTTP message body:

- NF ID, indicates the identity of the network function instance initiating the subscription;
- Notification URI, indicates the address to deliver the event notifications generated by the subscription;
- Notification Correlation ID, indicates the correlation identity to be carried in the event notifications, the value of this IE shall be unique per subscription for a given NF service consumer receiving the notification;
- SAC Event Type, defines which type of events to notify (e.g. the number of UEs registered to a network slice, or the number of PDU Sessions established on a network slice);
- Event Filter, indicate the S-NSSAI(s) in serving PLMN and/or mapped S-NSSAI(s) in home PLMN to be monitored and reported.
- SAC Event Report Triggers, defines whether the notification is threshold triggered (e.g. the notification is triggered when the current number of UEs or PDU Sessions with a network slice reaches a defined threshold value) or the notification is periodic triggered (e.g. the notification is triggered at expiry of a periodic timer).
- Notification threshold if the SAC Event Report Triggers is threshold triggered, defines a numeric value or a percentage of the maximum number of the UEs or PDU Sessions per network slice;
- Notification periodicity if the SAC Event Report Triggers is periodic triggered, defines the time between the notification periodicity;



- a notification flag as "notifFlag" attribute if the EEMM feature is supported; and/or
- Muting Exception Instructions, which specify instructions to apply to the subscription and the stored events when an exception occurs at the NSACF while the event is muted (e.g. the buffer of stored event reports is full, or the number of stored event reports exceeds a certain number), if the EEMM feature is supported (see clause 6.2.8).

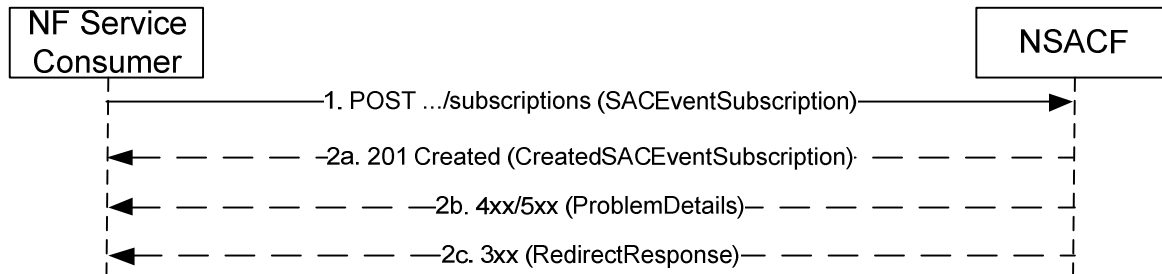

**Figure 5.4.2.2.2-1 Subscribe for Creation**

1. The NF Service Consumer (e.g. NEF, AF, DCCF or NWDAF) shall send a POST request to create a subscription resource in the NSACF. The content of the POST request shall contain a representation of the individual subscription resource to be created. The request may contain an expiry time, suggested by the NF Service Consumer, representing the time up to which the subscription is desired to be kept active and the time after which the subscribed event(s) shall stop generating report.
- 2a. On success, the request is accepted, the NSACF shall include a HTTP Location header to provide the location of a newly created resource (subscription) together with the status code 201 indicating the requested resource is created in the response message.

The response, based on operator policy and taking into account the expiry time included in the request, may contain the expiry time, as determined by the NSACF, after which the subscription becomes invalid. Once the subscription expires, if the NF Service Consumer wants to keep receiving notifications, it shall create a new subscription in the NSACF. The NSACF shall not provide the same expiry time for many subscriptions in order to avoid all of them expiring and recreating the subscription at the same time. If the expiry time is not included in the response, the NF Service Consumer shall consider the subscription to be valid without an expiry time.

If the immediateFlag attribute is set to "true" in the request message, the NSACF shall include the current number of UEs or PDU Sessions per network slice in the response immediately.

If the NSACF supports the EEMM feature and the "notifFlag" attribute is included and set to "DEACTIVATE" in the request by e.g. the NWDAF or DCCF, the NSACF shall mute the event notification and store the available events. Additionally, if the NF service consumer also included event muting instructions in the request, the NSACF should evaluate the received event muting instructions against to local actions (if configured) and, if the subscription creation request is accepted, the NSACF may indicate the following information to the NF service consumer in the response:

- the maximum number of notifications that the NSACF expects to be able to store for the subscription;
- an estimate of the duration for which notifications can be buffered.

- 2b. On failure, the appropriate HTTP status code (e.g. "403 Forbidden") shall be returned.

A ProblemDetails IE shall be included in the content of POST response, with the "cause" attribute of ProblemDetails set to application error codes specified in table 6.2.3.2.3.1-3.

- 2c. On redirection, "307 Temporary Redirect" or "308 Permanent Redirect" shall be returned. A RedirectResponse IE shall be included in the content of POST response.

If the NSACF supports the EEMM features (see clause 6.2.8), the NF service consumer sets the "notifFlag" attribute to "DEACTIVATE" and event muting instructions in the request, but the NSACF cannot accept the received instructions, the NSACF may reject the request with a 403 Forbidden response and the application error "MUTING\_EXC\_INSTR\_NOT\_ACCEPTED".

### 5.3.2.2.3 Modification of a subscription

The Subscribe service operation is invoked by a NF Service Consumer (e.g. NEF, AF, DCCF or NWDAF) towards the NSACF, when it needs to modify an existing subscription previously created by itself at the NSACF.

When the subscription is to be expired, the NF service consumer may request the NSACF to update the subscription by indicating a new expiry time. The NSACF may return a new expiry time based on local policy, taking into account of the NF service consumer provided expiry time.

To perform a partial update of the subscription of a given subscription Id, the NF Service Consumer shall issue an HTTP PATCH request, as shown in Figure 5.3.2.2.3-1. This partial update shall be used to add, delete and/or replace individual parameters of the subscription.

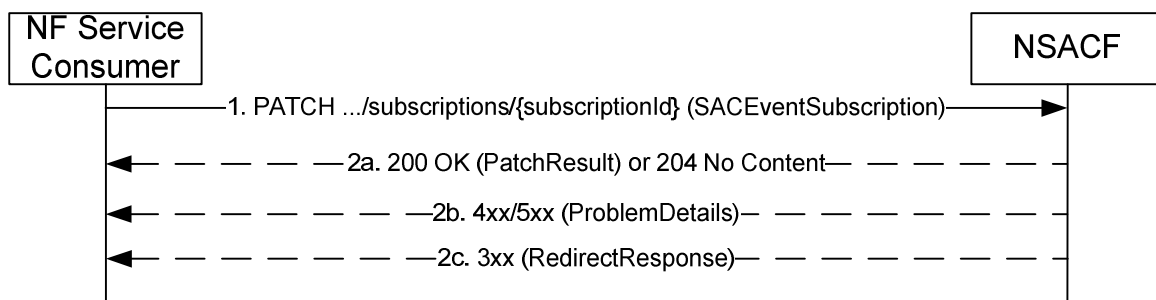

**Figure 5.3.2.2.3-1 Subscription partial modification**

1. The NF Service Consumer (e.g. NEF, AF, DCCF or NWDAF) shall send a PATCH request to the resource URI representing the individual subscription, identified by the {subscriptionId}. The content of the PATCH request shall contain the list of operations (add/delete/replace) to be applied to parameters in the individual subscription.
- 2a. On success, the request is accepted, the NSACF shall return the representation of the updated subscription resource with the status code "200 OK", or "204 No Content" shall be returned.
 

"204 No Content" may be returned, if the NF Service Producer accepts entirely the resource representation provided by the NF Service Consumer in the request. For example, the request contained a proposed expiry time and it is accepted by the NF Service Producer as the expiration time for the subscription, or the request did not contain a proposed expiry time and no expiration time is set by the NF Service Producer for the subscription.
- 2b. On failure, the appropriate HTTP status code (e.g. "403 Forbidden") shall be returned.
 

A ProblemDetails IE shall be included in the content of PATCH response, with the "cause" attribute of ProblemDetails set to application error codes specified in table 6.2.3.3.3.1-3.
- 2c. On redirection, "307 Temporary Redirect" or "308 Permanent Redirect" shall be returned. A RedirectResponse IE shall be included in the content of PATCH response.

To perform a complete replacement of the subscription of a given subscription Id, the NF Service Consumer shall issue an HTTP PUT request, as shown in Figure 5.3.2.2.3-2:

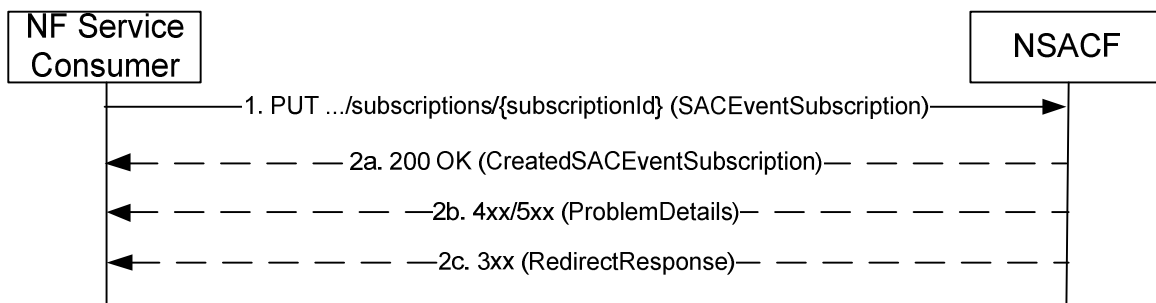

**Figure 5.3.2.2.3-2 Subscription Complete Replacement**

1. The NF service consumer (e.g. NEF, AF, DCCF or NWDAF) shall send a PUT request to the resource URI representing the individual subscription, identified by the {subscriptionId}. The content of the PUT request shall contain a representation of the individual subscription to be completely replaced in the NSACF.
- 2a. On success, the request is accepted, the NSACF shall include the resource (subscription) after replacement together with the status code "200 OK" indicating the requested resource is updated in the response message.  
  
The response, based on operator policy and taking into account the expiry time included in the request if any, may contain the expiry time as defined in 5.3.2.2.2.  
  
If the immediateFlag attribute is set to "true" in the request message, the NSACF shall include the current number of UEs or PDU sessions per network slice in the response immediately.
- 2b. On failure, the appropriate HTTP status code (e.g. "403 Forbidden") shall be returned.  
  
A ProblemDetails IE shall be included in the content of PUT response, with the "cause" attribute of ProblemDetails set to application error codes specified in table 6.2.3.3.3.2-3.
- 2c. On redirection, "307 Temporary Redirect" or "308 Permanent Redirect" shall be returned. A RedirectResponse IE shall be included in the content of PUT response.

#### 5.3.2.2.4 Creation of a one time and immediate reporting subscription

The NF Service Consumer (e.g. NEF, AF, DCCF or NWDAF) may request the NSACF to immediately provide the current network slice status information (e.g. the number of UEs registered to a network slice, the current number of PDU Sessions established to a network slice). In this case, the NF Service Consumer (e.g. NEF, AF, DCCF or NWDAF) shall request the NSACF to create a temporary subscription and response with immediate report, as follows.

1. The NF Service Consumer shall send a POST request as specified in step 1 of clause 5.3.2.2.2, with the following additional information:
  - the maxReports attribute set to 1 and the immediateFlag attribute set to "true".
- 2a. The NSACF shall send a POST response as specified in step 2a of clause 5.3.2.2.2, with the following additional information:
  - the NSACF shall include the current number of UEs or PDU Sessions per network slice in the response immediately and shall terminate the subscription of the event.

The NSACF shall terminate the subscription of the event after sending response to the NF Service Consumer.
- 2b. Same as step 2b of figure 5.3.2.2.2-1.
- 2c. Same as step 2c of figure 5.3.2.2.2-1.

### 5.3.2.3 Unsubscribe

#### 5.3.2.3.1 General

This service operation is used by the consumer NF (e.g. NEF, AF, DCCF or NWDAF) to unsubscribe from the event notification.

The NF Service Consumer (e.g. NEF, AF, DCCF or NWDAF) shall unsubscribe to the subscription by using HTTP method DELETE.

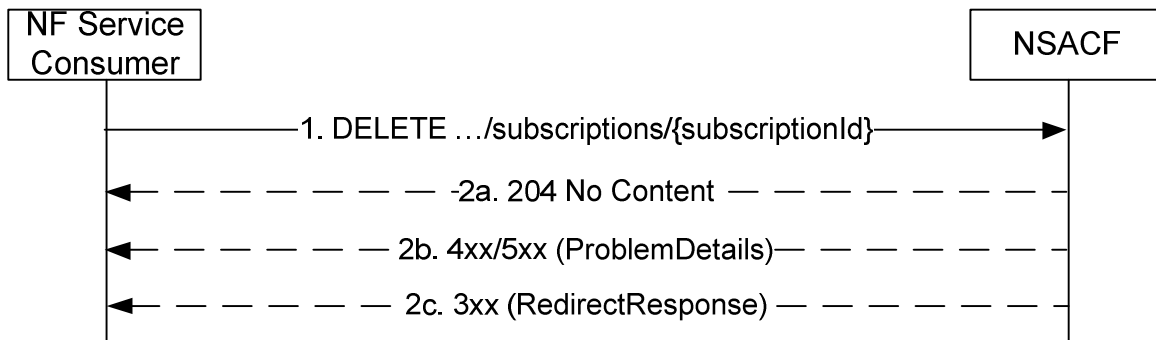

**Figure 5.3.2.3.1-1: Unsubscribe a subscription**

1. The NF Service Consumer (e.g. NEF, AF, DCCF or NWDAF) shall send a DELETE request to delete an existing subscription resource in the NSACF.
- 2a. On success, the request is accepted, the NSACF shall reply with the status code 204 indicating the resource identified by subscription ID is successfully deleted in the response message.
- 2b. On failure, the appropriate HTTP status code (e.g. "403 Forbidden") shall be returned.  
 A ProblemDetails IE shall be included in the content of DELETE response, with the "cause" attribute of ProblemDetails set to application error codes specified in table 6.2.3.3.3-3.
- 2c. On redirection, "307 Temporary Redirect" or "308 Permanent Redirect" shall be returned. A RedirectResponse IE shall be included in the content of DELETE response.

### 5.3.2.4 Notify

#### 5.3.2.4.1 General

This service operation is used by the NSACF to report the current status of certain network slice (e.g. the number of UEs registered to a network slice, or the current number of PDU Sessions established on a network slice in numbers or in percentage from the maximum allowed numbers).

While counting the number of UEs registered to a network slice, or counting the number of UEs registered to a network slice with at least one PDU session/PDN connection, the NSACF shall not count twice the UE Ids stored temporarily due to the AMF mobility scenario.

When reporting the number of UEs registered to a network slice, the NSACF may indicate whether the reported number of UEs correspond to UEs with at least one PDU session/PDN connection.

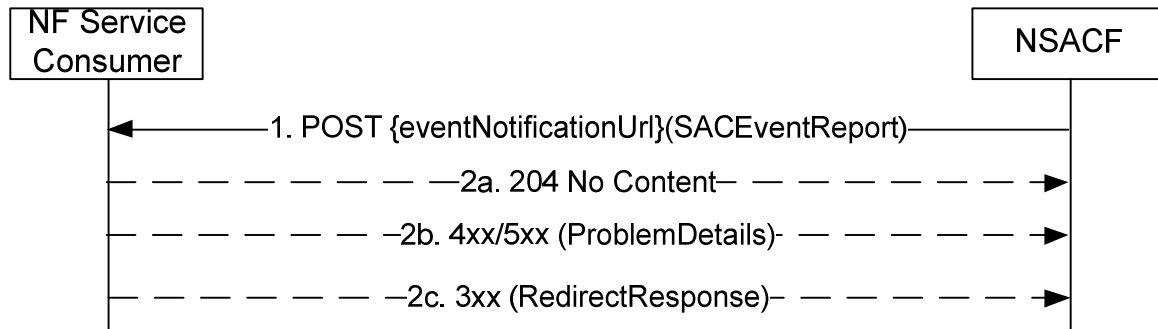

**Figure 5.3.2.4.1-1: Notify**

1. The NSACF shall send a POST request to send a notification.

If the notification is threshold triggered, the NSACF shall send the notification every time if there is a change from being below the threshold to reach the threshold, or from reaching the threshold to coming down below the threshold (see clause 4.15.3.2.10 of 3GPP TS 23.502 [3]). When a subscription is created and the current number of UEs or number of PDU sessions reaches the threshold, the NSACF shall send the notification immediately.

**EXAMPLE:**

If the threshold for the reporting of the number of registered UEs is 100, the behaviour of the NSACF as below:

- the current number of registered UEs is 100 when the subscription is created, the NSACF shall send a notification to the NF service consumer, then
- the current number of registered UEs is changed to 99, the NSACF shall send a notification to the NF service consumer, then
- the current number of registered UEs is changed to 90, the NSACF shall not send notification, then
- the current number of registered UEs is changed to 100, the NSACF shall send a notification to the NF service consumer, then
- the current number of registered UEs is changed to 110, the NSACF shall not send notification.

For periodic reporting, the NSACF shall contain the current number of registered UEs in the concerned network slice or the current number of established PDU sessions in the concerned network slice expressed in percentage and in numerical to the NF Service Consumer.

- 2a. On success, "204 No content" shall be returned by the NF Service Consumer (e.g. NEF, AF, DCCF or NWDAF).
- 2b. On failure, the appropriate HTTP status code (e.g. "404 Not Found") shall be returned and appropriate additional information should be returned.

A ProblemDetails IE shall be included in the content of POST response, with the "cause" attribute of ProblemDetails set to application error codes specified in table 6.2.5.2.2.1-3.

- 2c. On redirection, "307 Temporary Redirect" or "308 Permanent Redirect" shall be returned. A RedirectResponse IE shall be included in the content of POST response.

---

## 6 API Definitions

### 6.1 Nnsacf\_NSAC Service API

#### 6.1.1 Introduction

The Nnsacf\_NSAC shall use the Nnsacf\_NSAC API.

The API URI of the Nnsacf\_NSAC API shall be:

**{apiRoot}/<apiName>/<apiVersion>**

The request URIs used in HTTP requests from the NF service consumer towards the NF service producer shall have the Resource URI structure defined in clause 4.4.1 of 3GPP TS 29.501 [5], i.e.:

**{apiRoot}/<apiName>/<apiVersion>/<apiSpecificResourceUriPart>**

with the following components:

- The {apiRoot} shall be set as described in 3GPP TS 29.501 [5].
- The <apiName> shall be "nnsacf-nsac".
- The <apiVersion> shall be "v1".
- The <apiSpecificResourceUriPart> shall be set as described in clause 5.3.

#### 6.1.2 Usage of HTTP

##### 6.1.2.1 General

HTTP/2, IETF RFC 7540 [11], shall be used as specified in clause 5 of 3GPP TS 29.500 [4].

HTTP/2 shall be transported as specified in clause 5.3 of 3GPP TS 29.500 [4].

The OpenAPI [6] specification of HTTP messages and content bodies for the Nnsacf\_NSAC API is contained in Annex A.

##### 6.1.2.2 HTTP standard headers

###### 6.1.2.2.1 General

See clause 5.2.2 of 3GPP TS 29.500 [4] for the usage of HTTP standard headers.

###### 6.1.2.2.2 Content type

JSON, IETF RFC 8259 [12], shall be used as content type of the HTTP bodies specified in the present specification as specified in clause 5.4 of 3GPP TS 29.500 [4]. The use of the JSON format shall be signalled by the content type "application/json".

"Problem Details" JSON object shall be used to indicate additional details of the error in a HTTP response body and shall be signalled by the content type "application/problem+json", as defined in IETF RFC 9457 [13].

##### 6.1.2.3 HTTP custom headers

The mandatory HTTP custom header fields specified in clause 5.2.3.2 of 3GPP TS 29.500 [4] shall be supported, and the optional HTTP custom header fields specified in clause 5.2.3.3 of 3GPP TS 29.500 [4] may be supported.

## 6.1.3 Resources

### 6.1.3.1 Overview

This clause describes the structure for the Resource URIs and the resources and methods used for the service.

The figure 6.1.3.1-1 describes the resource URI structure of the Nnsacf-NSAC API.

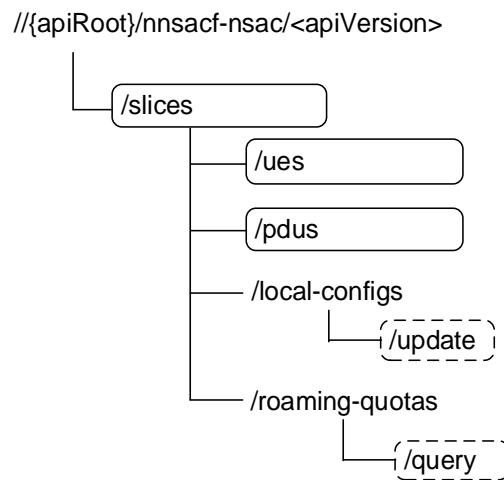

**Figure 6.1.3.1-1: Resource URI structure of the Nnsacf\_NSAC API**

Table 6.1.3.1-1 provides an overview of the resources and applicable HTTP methods.

Table 6.1.3.1-1: Resources and methods overview

Resource name	Resource URI	HTTP method or custom operation	Description
Slice Collection Subject to NSAC for UEs (Collection)	/slices/ues	POST	Request the NSACF to perform network slice admission control related to the number of UEs registered to a network slice, or a group of network slices.
Slice Collection Subject to NSAC for PDU sessions (Collection)	/slices/pdus	POST	Request the NSACF to perform network slice admission control related to the number of PDU sessions established to a network slice, or a group of network slices.
Slice Collection Configurations	/slices/local-configs/update	update (POST)	Request the NSACF to update the Network slice local configurations for NSAC procedure, i.e., to update the local maximum number of registered UEs and/or the local maximum number of PDU sessions established per Network slice.
Slice Collection Roaming Quotas	/slices/roaming-quotas/query	query (POST)	Request the NSACF at HPLMN to update the maximum number of registered UEs and/or number of LBO PDU sessions of the network slice at the NSACF of VPLMN for inbound roamers for VPLMN NSAC admission mode.

### 6.1.3.2 Resource: Slice Collection Subject to NSAC for UEs

#### 6.1.3.2.1 Description

This resource represents the collection of slice subject to NSAC for UEs.

This resource is modelled with the Store resource archetype (see clause C.2 of 3GPP TS 29.501 [5]).

#### 6.1.3.2.2 Resource Definition

Resource URI: **{apiRoot}/<apiName>/<apiVersion>/slices/ues**

This resource shall support the resource URI variables defined in table 6.1.3.2.2-1.

Table 6.1.3.2.2-1: Resource URI variables for this resource

Name	Data type	Definition
apiRoot	string	See clause 6.1.1

#### 6.1.3.2.3 Resource Standard Methods

##### 6.1.3.2.3.1 POST

This method shall support the URI query parameters specified in table 6.1.3.2.3.1-1.



**Table 6.1.3.2.3.1-1: URI query parameters supported by the POST method on this resource**

Name	Data type	P	Cardinality	Description	Applicability

This method shall support the request data structures specified in table 6.1.3.2.3.1-2 and the response data structures and response codes specified in table 6.1.3.2.3.1-3.

**Table 6.1.3.2.3.1-2: Data structures supported by the POST Request Body on this resource**

Data type	P	Cardinality	Description
UeACRequestData	M	1	Request data for NSAC procedure related to the number of UEs per slice.

**Table 6.1.3.2.3.1-3: Data structures supported by the POST Response Body on this resource**

Data type	P	Cardinality	Response codes	Description
UeACResponseData	M	1	200 OK	Response data for NSAC procedure related to the number of UEs per slice, in the case of not all S-NSSAIs are successful in the NSAC procedure.
n/a			204 No Content	Upon success. Indicates all S-NSSAIs are successful in the NSAC procedure.
RedirectResponse	O	0..1	307 Temporary Redirect	Temporary redirection. (NOTE 2)
RedirectResponse	O	0..1	308 Permanent Redirect	Permanent redirection, during a NSAC procedure. (NOTE 2)
ProblemDetails	O	0..1	403 Forbidden	When used to represent the failure of NSAC procedure, the "cause" attribute of the "ProblemDetails" shall be set to one of the following application error codes: <ul style="list-style-type: none"> <li>- SLICE_NOT_FOUND, if all S-NSSAIs provided in the request are not found from the NSSAI which are subject to NSAC procedure;</li> <li>- ALL_SLICE_FAILED, if the list of S-NSSAIs is fully failed in the NSAC procedure;</li> <li>- NSAC_SERVICE_AREA_NOT_SUPPORT, if the NSAC Service Area included in the request is not supported by the NSACF.</li> <li>- NSAC_SERVICE_AREA_REQUIRED, if the NSACF has been configured with multiple NSAC Service Areas to perform NSAC admission on a per NSAC Service Area, and there is no NSAC Service Area received in the request.</li> </ul>

NOTE 1: The mandatory HTTP error status code for the POST method listed in Table 5.2.7.1-1 of 3GPP TS 29.500 [4] also apply.

NOTE 2: RedirectResponse may be inserted by an SCP, see clause 6.10.9.1 of 3GPP TS 29.500 [4].

**Table 6.1.3.2.3.1-4: Headers supported by the 307 Response Code on this resource**

Name	Data type	P	Cardinality	Description
Location	string	M	1	An alternative URI of the resource located on an alternative service instance within the same NSACF or NSACF (service) set. For the case, when a request is redirected to the same target resource via a different SCP, see clause 6.10.9.1 in 3GPP TS 29.500 [4].
3gpp-Sbi-Target-Nf-Id	string	O	0..1	Identifier of the target NF (service) instance ID towards which the request is redirected

**Table 6.1.3.2.3.1-5: Headers supported by the 308 Response Code on this resource**

Name	Data type	P	Cardinality	Description
Location	string	M	1	An alternative URI of the resource located on an alternative service instance within the same NSACF or NSACF (service) set. For the case, when a request is redirected to the same target resource via a different SCP, see clause 6.10.9.1 in 3GPP TS 29.500 [4].
3gpp-Sbi-Target-Nf-Id	string	O	0..1	Identifier of the target NF (service) instance ID towards which the request is redirected

#### 6.1.3.2.4 Resource Custom Operations

In this release of this specification, no custom operations associated to this resource is defined.

### 6.1.3.3 Resource: Slice Collection Subject to NSAC for PDU sessions

#### 6.1.3.3.1 Description

This resource represents the collection of slice subject to NSAC for PDU sessions.

This resource is modelled with the Store resource archetype (see clause C.2 of 3GPP TS 29.501 [5]).

#### 6.1.3.3.2 Resource Definition

Resource URI: {apiRoot}/<apiName>/<apiVersion>/slices/pdus

This resource shall support the resource URI variables defined in table 6.1.3.3.2-1.

**Table 6.1.3.3.2-1: Resource URI variables for this resource**

Name	Data type	Definition
apiRoot	string	See clause 6.1.1

#### 6.1.3.3.3 Resource Standard Methods

##### 6.1.3.3.3.1 POST

This method shall support the URI query parameters specified in table 6.1.3.3.3.1-1.

**Table 6.1.3.3.3.1-1: URI query parameters supported by the POST method on this resource**

Name	Data type	P	Cardinality	Description	Applicability

This method shall support the request data structures specified in table 6.1.3.3.3.1-2 and the response data structures and response codes specified in table 6.1.3.3.3.1-3.

**Table 6.1.3.3.3.1-2: Data structures supported by the POST Request Body on this resource**

Data type	P	Cardinality	Description
PduACRequestData	M	1	Request data for NSAC procedure related to the number of PDU sessions per slice.

**Table 6.1.3.3.3.1-3: Data structures supported by the POST Response Body on this resource**

Data type	P	Cardinality	Response codes	Description
PduACResponseData	M	1	200 OK	Response data for NSAC procedure related to the number of PDU sessions per slice, in the case of not all S-NSSAIs are successful in the NSAC procedure.
n/a			204 No Content	Upon success. Indicates all S-NSSAIs are successful in the NSAC procedure.
RedirectResponse	O	0..1	307 Temporary Redirect	Temporary redirection.
RedirectResponse	O	0..1	308 Permanent Redirect	Permanent redirection. (NOTE 2)
ProblemDetails	O	0..1	403 Forbidden	When used to represent the failure of NSAC procedure, the "cause" attribute of the "ProblemDetails" shall be set to one of the following application error codes: - SLICE_NOT_FOUND, if all S-NSSAIs provided in the request are not found from the NSSAI which are subject to NSAC procedure; - ALL_SLICE_FAILED, if the list of S-NSSAIs is fully failed in the NSAC procedure; - NSAC_SERVICE_AREA_NOT_SUPPORT, if the NSAC Service Area included in the request is not supported by the NSACF. - NSAC_SERVICE_AREA_REQUIRED, if the NSACF has been configured with multiple NSAC Service Areas to perform NSAC admission on a per NSAC Service Area, and there is no NSAC Service Area received in the request.
NOTE 1: The mandatory HTTP error status code for the POST method listed in Table 5.2.7.1-1 of 3GPP TS 29.500 [4] also apply.				
NOTE 2: RedirectResponses may be inserted by an SCP, see clause 6.10.9.1 of 3GPP TS 29.500 [4].				

**Table 6.1.3.3.3.1-4: Headers supported by the 307 Response Code on this resource**

Name	Data type	P	Cardinality	Description
Location	string	M	1	An alternative URI of the resource located on an alternative service instance within the same NSACF or NSACF (service) set. For the case, when a request is redirected to the same target resource via a different SCP, see clause 6.10.9.1 in 3GPP TS 29.500 [4].
3gpp-Sbi-Target-Nf-Id	string	O	0..1	Identifier of the target NF (service) instance ID towards which the request is redirected

**Table 6.1.3.3.3.1-5: Headers supported by the 308 Response Code on this resource**

Name	Data type	P	Cardinality	Description
Location	string	M	1	An alternative URI of the resource located on an alternative service instance within the same NSACF or NSACF (service) set. For the case, when a request is redirected to the same target resource via a different SCP, see clause 6.10.9.1 in 3GPP TS 29.500 [4].
3gpp-Sbi-Target-Nf-Id	string	O	0..1	Identifier of the target NF (service) instance ID towards which the request is redirected

#### 6.1.3.3.4 Resource Custom Operations

In this release of this specification, no custom operations associated to this resource is defined.

### 6.1.3.4 Resource: Slice Collection Configurations

#### 6.1.3.4.1 Description

This resource represents the Slice Collection configurations, i.e. local configurations of the maximum number of registered UEs and/or maximum number of PDU sessions established at a network slice.

#### 6.1.3.4.2 Resource Definition

Resource URI: {apiRoot}/<apiName>/<apiVersion>/slices/configs

This resource shall support the resource URI variables defined in table 6.1.3.w.2-1.

**Table 6.1.3.4.2-1: Resource URI variables for this resource**

Name	Data type	Definition
apiRoot	string	See clause 6.1.1

#### 6.1.3.4.3 Resource Standard Methods

In this release of this specification, no standard operations associated to this resource is defined.

#### 6.1.3.4.4 Resource Custom Operations

##### 6.1.3.4.4.1 Overview

**Table 6.1.3.4.4.1-1: Custom operations**

Operation Name	Custom operation URI	Mapped HTTP method	Description
update	/slices/local-configs/update	POST	Request the NSACF to update the network slice local configurations for NSAC procedure, i.e., to update the local maximum number of registered UEs and/or the local maximum number of PDU sessions established per Network slice.

##### 6.1.3.4.4.2 Operation: update (POST)

###### 6.1.3.4.4.2.1 Description

This custom operation is used to update the Slice Collection configurations, i.e. local configurations of the maximum number of registered UEs and/or maximum number of PDU sessions established at a network slice.

###### 6.1.3.4.4.2.2 Operation Definition

This operation shall support the request data structures specified in table 6.1.3.4.4.2.2-1 and the response data structure and response codes specified in table 6.1.3.4.4.2.2-2.

**Table 6.1.3.4.4.2.2-1: Data structures supported by the POST Request Body on this resource**

Data type	P	Cardinality	Description
ACUpdateData	M	1	Provide the local configuration data for NSAC procedure related to update the local maximum number of registered UEs and/or the local maximum number of PDU sessions of the network slice at a NSACF.

**Table 6.1.3.4.4.2.2-2: Data structures supported by the POST Response Body on this resource**

Data type	P	Cardinality	Response codes	Description
n/a			204 No Content	Indicates successful processing of the request to update the local configuration for NSAC procedure, i.e., the local maximum number of registered UEs and/or the local maximum number of PDU sessions per network slice.
RedirectResponse	O	0..1	307 Temporary Redirect	Temporary redirection. (NOTE 2)
RedirectResponse	O	0..1	308 Permanent Redirect	Permanent redirection, (NOTE 2)
ProblemDetails	O	0..1	404 Not Found	Indicates the network slice with which the updated local maximum number of registered UEs and/or PDU sessions relates is not found. The "cause" attribute may be used to indicate one of the following application errors: - LOCAL_CONFIG_NOT_FOUND
NOTE 1: The mandatory HTTP error status code for the POST method listed in Table 5.2.7.1-1 of 3GPP TS 29.500 [4] also apply.				
NOTE 2: RedirectResponse may be inserted by an SCP, see clause 6.10.9.1 of 3GPP TS 29.500 [4].				

**Table 6.1.3.4.4.2.2-3: Headers supported by the 307 Response Code on this resource**

Name	Data type	P	Cardinality	Description
Location	string	M	1	An alternative URI of the resource located on an alternative service instance within the same NSACF or NSACF (service) set. For the case when a request is redirected to the same target resource via a different SCP, see clause 6.10.9.1 in 3GPP TS 29.500 [4].
3gpp-Sbi-Target-Nf-Id	string	O	0..1	Identifier of the target NF (service) instance ID towards which the request is redirected

**Table 6.1.3.4.4.2.2-4: Headers supported by the 308 Response Code on this resource**

Name	Data type	P	Cardinality	Description
Location	string	M	1	An alternative URI of the resource located on an alternative service instance within the same NSACF or NSACF (service) set. For the case when a request is redirected to the same target resource via a different SCP, see clause 6.10.9.1 in 3GPP TS 29.500 [4].
3gpp-Sbi-Target-Nf-Id	string	O	0..1	Identifier of the target NF (service) instance ID towards which the request is redirected

## 6.1.3.5 Resource: Slice Collection Roaming Quotas

### 6.1.3.5.1 Description

This resource represents the Slice Collection subject to roaming quotas update, i.e. quota update of the maximum number of registered UEs and/or maximum number of PDU sessions established at a network slice in a primary or central VPLMN NSACF for inbound roamers for VPLMN NSAC admission mode.

### 6.1.3.5.2 Resource Definition

Resource URI: {apiRoot}/<apiName>/<apiVersion>/slices/roaming-quotas

This resource shall support the resource URI variables defined in table 6.1.3.5.2-1.

**Table 6.1.3.5.2-1: Resource URI variables for this resource**

Name	Data type	Definition
apiRoot	string	See clause 6.1.1

### 6.1.3.5.3 Resource Standard Methods

None.

### 6.1.3.5.4 Resource Custom Operations

#### 6.1.3.5.4.1 Overview

**Table 6.1.3.5.4.1-1: Custom operations**

Operation Name	Custom operation URI	Mapped HTTP method	Description
query	/slices/roaming-quotas/query	POST	Request the NSACF at HPLMN to update the maximum number of registered UEs and/or maximum number of LBO PDU sessions of the network slice at the NSACF of VPLMN for inbound roamers for VPLMN NSAC admission mode.

#### 6.1.3.5.4.2 Operation: query

##### 6.1.3.5.4.2.1 Description

This custom operation is used to request the central or primary NSACF at HPLMN to update the maximum number of registered UEs and/or number of LBO PDU sessions of the network slice at the central or primary NSACF at VPLMN for inbound roamers for VPLMN NSAC admission mode.

##### 6.1.3.5.4.2.2 Operation Definition

This operation shall support the request data structures specified in table 6.1.3.5.4.2.2-1 and the response data structure and response codes specified in table 6.1.3.5.4.2.2-2.

**Table 6.1.3.5.4.2.2-1: Data structures supported by the POST Request Body on this resource**

Data type	P	Cardinality	Description
QuotaUpdateRequestData	M	1	Provide the data for NSAC procedure related to quota update of the maximum number of registered UEs and/or number of LBO PDU sessions of the network slice at the primary or central NSACF in a VPLMN for inbound roamers for VPLMN NSAC admission mode.

**Table 6.1.3.5.4.2.2-2: Data structures supported by the POST Response Body on this resource**

Data type	P	Cardinality	Response codes	Description
QuotaUpdateResponseData	M	1	200 OK	Response data for NSAC procedure related to the quota update of the number of UEs and/or number of LBO PDU sessions of the network slice in VPLMN for inbound roamers for VPLMN NSAC admission mode.
RedirectResponse	O	0..1	307 Temporary Redirect	Temporary redirection. (NOTE 2)
RedirectResponse	O	0..1	308 Permanent Redirect	Permanent redirection, during a NSAC procedure. (NOTE 2)
NOTE 1: The mandatory HTTP error status code for the POST method listed in Table 5.2.7.1-1 of 3GPP TS 29.500 [4] also apply.				
NOTE 2: RedirectResponse may be inserted by an SCP or SEPP, see clause 6.10.9.1 of 3GPP TS 29.500 [4].				

**Table 6.1.3.5.4.2.2-3: Headers supported by the 307 Response Code on this resource**

Name	Data type	P	Cardinality	Description
Location	string	M	1	An alternative URI of the resource located on an alternative service instance within the same NSACF or NSACF (service) set. For the case when a request is redirected to the same target resource via a different SCP, see clause 6.10.9.1 in 3GPP TS 29.500 [4].
3gpp-Sbi-Target-Nf-Id	string	O	0..1	Identifier of the target NF (service) instance ID towards which the request is redirected

**Table 6.1.3.5.4.2.2-4: Headers supported by the 308 Response Code on this resource**

Name	Data type	P	Cardinality	Description
Location	string	M	1	An alternative URI of the resource located on an alternative service instance within the same NSACF or NSACF (service) set. For the case when a request is redirected to the same target resource via a different SCP, see clause 6.10.9.1 in 3GPP TS 29.500 [4].
3gpp-Sbi-Target-Nf-Id	string	O	0..1	Identifier of the target NF (service) instance ID towards which the request is redirected

## 6.1.4 Custom Operations without associated resources

In this release of this specification, no custom operations without associated resources are defined.

## 6.1.5 Notifications

### 6.1.5.1 General

Notifications shall comply to clause 6.2 of 3GPP TS 29.500 [4] and clause 4.6.2.3 of 3GPP TS 29.501 [5].

**Table 6.1.5.1-1: Notifications overview**

Notification	Callback URI	HTTP method or custom operation	Description (service operation)
EAC Mode Notification	{EACNotificationUri}	POST	Notify the NF Service Customer (e.g. AMF) of the activation/deactivation of EAC mode.

## 6.1.5.2 EAC Mode Notification

### 6.1.5.2.1 Description

The EAC Mode Notification is used by the NSACF to inform the NF Service Consumer (e.g. AMF) of the activation/deactivation of EAC mode.

### 6.1.5.2.2 Target URI

The Callback URI "{EACNotificationUri}" shall be used with the callback URI variables defined in table 6.1.5.2.2-1.

**Table 6.1.5.2.2-1: Callback URI variables**

Name	Definition
eacNotificationUri	Notification URI for receiving EAC mode notification.

### 6.1.5.2.3 Standard Methods

#### 6.1.5.2.3.1 POST

This method shall support the request data structures specified in table 6.1.5.2.3.1-1 and the response data structures and response codes specified in table 6.1.5.2.3.1-1.

**Table 6.1.5.2.3.1-1: Data structures supported by the POST Request Body**

Data type	P	Cardinality	Description
EACNotification	M	1	EAC mode notification

**Table 6.1.5.2.3.1-2: Data structures supported by the POST Response Body**

Data type	P	Cardinality	Response codes	Description
NOTE: The mandatory HTTP error status codes for the POST method listed in Table 5.2.7.1-1 of 3GPP TS 29.500 [4] also apply.				

## 6.1.6 Data Model

### 6.1.6.1 General

This clause specifies the application data model supported by the API.

Table 6.1.6.1-1 specifies the data types defined for the Nnsacf\_NSAC service based interface protocol.



**Table 6.1.6.1-1: Nnsacf\_NSAC specific Data Types**

Data type	Clause defined	Description	Applicability
UeACRequestData	6.1.6.2.2	Input data for NSAC procedure related to the number of UEs per slice.	
UeACResponseData	6.1.6.2.3	Response data of NSAC procedure for controlling the number of UEs.	
EACNotification	6.1.6.2.4	EAC mode notification	
AcuOperationItem	6.1.6.2.5	An operation item for NSAC procedure, indicating an S-NSSAI subject to NSAC and the associated operation.	
AcuFailureItem	6.1.6.2.6	A failure item which indicates the failed S-NSSAI and the failure reason.	
PduACRequestData	6.1.6.2.7	Input data for NSAC procedure related to the number of PDUs per slice.	
PduACResponseData	6.1.6.2.8	Response data of NSAC procedure for controlling the number of PDU sessions.	
EACMode	6.1.6.3.3	EAC mode	
AcuFlag	6.1.6.3.4	Update Flag for NSAC procedure	
AcuFailureReason	6.1.6.3.5	Indicates the failure reason for an S-NSSAI in the NSAC procedure	
UeACRequestInfo	6.1.6.2.9	One item of a UE and associated NSAC action.	
PduACRequestInfo	6.1.6.2.10	One item of a PDU session and associated NSAC action.	
UeAdmissionValue	6.1.6.2.11	Local maximum number of UEs	HNSAC
PduAdmissionValue	6.1.6.2.12	Local maximum number of PDUs	HNSAC
ACUpdateData	6.1.6.2.13	Input data for NSAC procedure to update the local maximum number of registered UEs and the local maximum number of PDU sessions.	HNSAC
QuotaUpdateRequestData	6.1.6.2.14	Input data for NSAC procedure to fetch the maximum number of registered UEs and/or the maximum number of PDU sessions.	
QuotaUpdateResponseData	6.1.6.2.15	Input data for NSAC procedure to update the maximum number of registered UEs and/or the maximum number of PDU sessions.	
SliceQuotaType	6.1.6.3.6	Type of quota update for NSAC procedure.	
NsacAdmissionMode	6.1.6.3.7	NSAC admission mode	

Table 6.1.6.1-2 specifies data types re-used by the Nnsacf\_NSAC service based interface protocol from other specifications, including a reference to their respective specifications and when needed, a short description of their use within the Nnsacf\_NSAC service based interface.

**Table 6.1.6.1-2: Nnsacf\_NSAC re-used Data Types**

Data type	Reference	Comments	Applicability
ProblemDetails	3GPP TS 29.571 [16]	Problem Details	
RedirectResponse	3GPP TS 29.571 [16]	Redirect Response	
SupportedFeatures	3GPP TS 29.571 [16]	Supported Features	
Supi	3GPP TS 29.571 [16]	Subscription Permanent Identifier	
Snssai	3GPP TS 29.571 [16]	Single NSSAI	
NfInstanceId	3GPP TS 29.571 [16]	NF Instance ID	
Uri	3GPP TS 29.571 [16]	Resource or callback URI	
AccessType	3GPP TS 29.571 [16]	Access Type	
NFType	3GPP TS 29.510 [17]	NF Type	
Fqdn	3GPP TS 29.571 [16]	FQDN	
PduSessionId	3GPP TS 29.571 [16]	PDU Session Identifier	
PlmnId	3GPP TS 29.571 [16]	PLMN ID	
PlmnIdNid	3GPP TS 29.571 [16]	The combination of a PLMN ID and a NID identifies an SNPN.	
UInteger	3GPP TS 29.571 [16]	Unsigned Integer	
NsacSai	3GPP TS 29.571 [16]	NSAC Service Area ID	

## 6.1.6.2 Structured data types

### 6.1.6.2.1 Introduction

This clause defines the structures to be used in resource representations.

### 6.1.6.2.2 Type: UeACRequestData

**Table 6.1.6.2.2-1: Definition of type UeACRequestData**

Attribute name	Data type	P	Cardinality	Description	Applicability
ueACRequestInfo	array(UeACRequestInfo)	M	1..N	List of UEs and their associated NSAC action details	
nflid	NflInstanceid	M	1	Indicates the NF Instance ID. When present, it shall carry one of the following values: - the AMF Instance ID, if the request is from an AMF; - the SMF Instance ID, if the request is from a combined SMF+PGW-C in EPS interworking case.	
nfType	NFType	O	0..1	Indicates the NF type of the requester NF. When present, it shall carry one of the following values: - NFType=AMF, if the request is from an AMF; - NFType=SMF, if the request is from a combined SMF+PGW-C in EPS interworking case.	
eacNotificationUri	Uri	O	0..1	Indicates the EAC notification callback URI. If the EAC notification callback URI is present, the AMF Instance ID shall also be present.	
nsacServiceArea	NsacSai	C	0..1	This IE shall be present if the NF consumer has been configured with NSAC service area it belongs to.  When present, this IE shall indicate the identity of the NSAC Service Area of the NF consumer.	
supportedFeatures	SupportedFeatures	C	0..1	This IE shall be present if at least one optional feature defined in clause 6.1.8 is supported.	
<b>NOTE:</b> If the NF consumer is combined SMF+PGW-C, the combined SMF+PGW-C determines the Access Type based on the RAT type parameter in the PMIP or GTP message received from the ePDG; or alternatively it can internally determine the Access Type based on the source node (e.g. SGW) sending the request for the PDN Connection establishment.					

## 6.1.6.2.3 Type: UeACResponseData

**Table 6.1.6.2.3-1: Definition of type UeACResponseData**

Attribute name	Data type	P	Cardinality	Description	Applicability
acuFailureList	map(array(AcuFailureItem))	C	1..N(1..M)	Indicates a list of S-NSSAI which is failed in the NSAC procedure, and the reasons for each S-NSSAI. Key of the map is the SUPI of the UE.	
ueAdmissionList	array(UeAdmissionValue)	C	1..N	Indicates a list of S-NSSAI to delegate the NSAC handling to the NSACF, and the updated local maximum number of UEs and/or the updated UE admission threshold for each S-NSSAI, as defined in clause 4.2.11.2a or clause 4.2.11.5.2.3 of 3GPP TS 23.502 [3].	HNSAC VHNSAC
supportedFeatures	SupportedFeatures	C	0..1	This IE shall be present if at least one optional feature defined in clause 6.1.8 is supported.	

## 6.1.6.2.4 Type: EACNotification

**Table 6.1.6.2.4-1: Definition of type EACNotification**

Attribute name	Data type	P	Cardinality	Description	Applicability
eacModeList	map(EACMode)	O	1..N	a map of EAC Mode where the S-NSSAI serves as the key.	

## 6.1.6.2.5 Type: AcuOperationItem

Table 6.1.6.2.5-1: Definition of type AcuOperationItem

Attribute name	Data type	P	Cardinality	Description	Applicability
updateFlag	AcuFlag	M	1	Indicates the operation (i.e. increase or decrease) to the impacted S-NSSAI.	
snssai	Snssai	M	1	Indicates the S-NSSAI for the increase or decrease operation. It shall contain S-NSSAI in serving PLMN or the mapped S-NSSAI in home PLMN.	
plmnId	PlmnId	C	0..1	Indicates the PLMN ID associated to the S-NSSAI for increase or decrease operation. It shall be present in the NSAC procedure for the HR or LBO roaming case, or if the NSACF serves multiple PLMNs.	
plmnIdNid	PlmnIdNid	C	0..1	This IE shall be present when the S-NSSAI is associated with a SNPN for increase or decrease operation. When present, it shall contain the combination of a PLMN ID and a NID associated to the S-NSSAI.	
ueRegInd	boolean	C	0..1	This IE shall be present and set to true if the UE has been registered with the associated S-NSSAI in another NSAC service area before, in hierarchical NSAC architecture.  Presence of this IE with false value shall be prohibited.	HNSAC
servingPlmnId	PlmnId	C	0..1	It shall be present in the NSAC procedure for the HR or LBO roaming case, and if the mapped S-NSSAI in home PLMN is included in snssai attribute. When present, it shall contain the serving PLMN ID of the UE.	
nsacMode	NsacAdmission Mode	C	0..1	This IE shall be present for inbound roamer, indicating VPLMN NSAC admission mode or VPLMN with HPLMN assistance NSAC admission mode.	

## 6.1.6.2.6 Type: AcuFailureItem

Table 6.1.6.2.6-1: Definition of type AcuFailureItem

Attribute name	Data type	P	Cardinality	Description	Applicability
snssai	Snssai	M	1	Indicates the S-NSSAI which is failed in the NSAC procedure. It shall contain S-NSSAI in serving PLMN or the mapped S-NSSAI in home PLMN.	
reason	AcuFailureReason	M	1	Indicates the reason of an S-NSSAI which is failed in the NSAC procedure.	
pduSessionId	PduSessionId	C	0..1	The PDU session Identifier, shall be present when response is for pduAC.	
plmnId	PlmnId	C	0..1	Indicates the PLMN ID associated to the S-NSSAI which is failed in the NSAC procedure. It shall be present in the NSAC procedure for the HR or LBO roaming case, or if the NSACF serves multiple PLMN.	
plmnIdNid	PlmnIdNid	C	0..1	This IE shall be present when the S-NSSAI is associated with a SNPN for NSAC procedure failure. When present, it shall contain the combination of a PLMN ID and a NID associated to the S-NSSAI.	

## 6.1.6.2.7 Type: PduACRequestData

Table 6.1.6.2.7-1: Definition of type PduACRequestData

Attribute name	Data type	P	Cardinality	Description	Applicability
pduACRequestInfo	array(PduACRequestInfo)	M	1..N	List of UEs and their associated NSAC action details	
nfId	NfInstanceId	O	0..1	Indicates the SMF Instance ID.	
pgwFqdn	Fqdn	O	0..1	Indicates the PGW-C FQDN, if the request is from a combined SMF+PGW-C, in EPS interworking case.	
nsacServiceArea	NsacSai	C	0..1	This IE shall be present if the NF consumer has been configured with NSAC service area it belongs to.  When present, this IE shall indicate the identity of the NSAC Service Area of the NF consumer.	
supportedFeatures	SupportedFeatures	C	0..1	This IE shall be present if at least one optional feature defined in clause 6.1.8 is supported.	

## 6.1.6.2.8 Type: PduACResponseData

**Table 6.1.6.2.8-1: Definition of type PduACResponseData**

Attribute name	Data type	P	Cardinality	Description	Applicability
acuFailureList	map(array(AcuFailureItem))	C	1..N(1..2)	Indicates a list of S-NSSAIs which are failed in the NSAC procedure, and the reasons for each S-NSSAI. Key of the map is the SUPI of the UE.	
pduAdmissionList	array(PduAdmissionValue)	C	1..N	Indicates a list of S-NSSAI to delegate the NSAC handling to the NSACF, and the updated local maximum number of PDU sessions for each S-NSSAI, as defined in clause 4.2.11.4a or clause 4.2.11.5.2.4 of 3GPP TS 23.502 [3].	HNSAC VHNSAC
supportedFeatures	SupportedFeatures	C	0..1	This IE shall be present if at least one optional feature defined in clause 6.1.8 is supported.	

## 6.1.6.2.9 Type: UeACRequestInfo

**Table 6.1.6.2.9-1: Definition of type UeACRequestInfo**

Attribute name	Data type	P	Cardinality	Description	Applicability
supi	Supi	M	1	Supi	
anType	AccessType	M	1	Indicates the access type over which the UE registers to the network or deregisters from the network.	
acuOperationList	array(AcuOperationItem)	M	1..N	A list of S-NSSAI to which the UE is to be registered or from which the UE is to be de-registered.	
additionalAnType	AccessType	O	0..1	Indicates the additional access type, when the UE deregisters from the network, if the UE previously registered to the network over 3GPP access and Non-3GPP access	

## 6.1.6.2.10 Type: PduACRequestInfo

Table 6.1.6.2.7-1: Definition of type PduACRequestInfo

Attribute name	Data type	P	Cardinality	Description	Applicability
supi	Supi	M	1	Supi	
anType	AccessType	M	1	Indicates the access type over which the PDU session is to be established or released.	
pduSessionId	PduSessionId	M	1	Indicates the PDU session Identifier.  During PDU session establishment or release in 5GC, this IE shall indicate the PDU session ID of the PDU session to be established or to be released;  During PDN connection establishment or release in EPC, this IE shall indicate the EPS pre-allocated PDU session ID for the corresponding PDU session in 5GC.	
acuOperationList	array(AcuOperationItem)	M	1..2	A list of S-NSSAI to which the PDU session is to be established or from which the PDU session is to be released.	
additionalAnType	AccessType	O	0..1	Indicates the additional access type, for a Multiple-Access PDU session, if the PDU session is to be established over both 3GPP access and Non-3GPP access, or if the PDU session is to be released from both 3GPP access and Non-3GPP access.	

## 6.1.6.2.11 Type: UeAdmissionValue

Table 6.1.6.2.11-1: Definition of type UeAdmissionValue

Attribute name	Data type	P	Cardinality	Description	Applicability
snsai	Snsai	M	1	Indicates the S-NSSAI to delegate the NSAC handling to the NSACF. It shall contain the S-NSSAI in serving PLMN or the mapped S-NSSAI in home PLMN.	
maxNumUes	UInteger	C	0..1	This IE shall be present to include the maximum number of registered UEs, if the primary NSACF or the NSACF in HPLMN determines to update the maximum number of UEs.  See clause 4.2.11.2a or clause 4.2.11.5.2.3 of 3GPP TS 23.502 [3].	
ueAdmissionThreshold	integer	C	0..1	This IE shall be present if the maxNumUes attribute is present and the primary NSACF or the NSACF in HPLMN determines to update the UE admission threshold for NSACF which supports UE admission threshold-based control. When present it shall indicate the threshold expressed as a percentage of the local maximum number of UEs in NSACF.  See clause 4.2.11.2a or clause 4.2.11.5.2.3 of 3GPP TS 23.502 [3].  Minimum = 0. Maximum = 100.	

## 6.1.6.2.12 Type: PduAdmissionValue

**Table 6.1.6.2.12-1: Definition of type PduAdmissionValue**

Attribute name	Data type	P	Cardinality	Description	Applicability
snssai	Snssai	M	1	Indicates the S-NSSAI to delegate the NSAC handling to the NSACF. It shall contain S-NSSAI in serving PLMN or the mapped S-NSSAI in home PLMN.	
maxNumPdus	UInteger	M	1	This attribute shall be present to include the maximum number of (LBO) PDU sessions.	

## 6.1.6.2.13 Type: ACUpdateData

**Table 6.1.6.2.13-1: Definition of type ACUpdateData**

Attribute name	Data type	P	Cardinality	Description	Applicability
snssai	Snssai	M	1	Indicates the Network slice for which the NSACF shall update the maximum number of registered UEs number and/or the maximum number of PDU sessions. It shall indicate S-NSSAI in serving PLMN or the mapped S-NSSAI in home PLMN.	
maxUesNumber	integer	O	0..1	Indicates the updated maximum number of registered UEs of the S-NSSAI, that the NSACF can use.	
maxPdusNumber	integer	O	0..1	Indicates the updated maximum number of PDU Sessions of the S-NSSAI, that the NSACF can use.	

## 6.1.6.2.14 Type: QuotaUpdateRequestData

**Table 6.1.6.2.14-1: Definition of type QuotaUpdateRequestData**

Attribute name	Data type	P	Cardinality	Description	Applicability
snssai	Snssai	M	1	Indicates the Network slice for which the NSACF shall provide the maximum number of registered inbound roaming UEs and/or the maximum number of LBO PDU sessions. It shall indicate the mapped S-NSSAI in home PLMN.	
plmnId	PlmnId	M	1	Indicates the serving PLMN ID of UE.	
quotaType	SliceQuotaType	M	1	Indicates the type of the requested quota (i.e., maximum number of registered inbound roaming UEs and/or maximum number of LBO PDU sessions).	

## 6.1.6.2.15 Type: QuotaUpdateResponseData

**Table 6.1.6.2.15-1: Definition of type QuotaUpdateResponseData**

Attribute name	Data type	P	Cardinality	Description	Applicability
snssai	Snssai	M	1	Indicates the Network slice for which the NSACF shall update the maximum number of registered inbound roaming UEs number and/or the maximum number of LBO PDU sessions. It shall indicate the mapped S-NSSAI in home PLMN.	



maxUesNumber	integer	O	0..1	Indicates the updated maximum number of registered inbound roaming UEs of the S-NSSAI.	
maxPduNumber	integer	O	0..1	Indicates the updated maximum number of LBO PDU Sessions of the S-NSSAI	

### 6.1.6.3 Simple data types and enumerations

#### 6.1.6.3.1 Introduction

This clause defines simple data types and enumerations that can be referenced from data structures defined in the previous clauses.

#### 6.1.6.3.2 Simple data types

The simple data types defined in table 6.1.6.3.2-1 shall be supported.

**Table 6.1.6.3.2-1: Simple data types**

Type Name	Type Definition	Description	Applicability

#### 6.1.6.3.3 Enumeration: EACMode

The enumeration EACMode represents the mode of Early Admission Control. It shall comply with the provisions defined in table 6.1.6.3.3-1.

**Table 6.1.6.3.3-1: Enumeration EACMode**

Enumeration value	Description	Applicability
"ACTIVE"	EAC mode is enabled.	
"DEACTIVE"	EAC mode is disabled.	

#### 6.1.6.3.4 Enumeration: AcuFlag

The enumeration AcuFlag indicates the operation (i.e. increase or decrease) applied to a list of S-NSSAI during the NSAC procedure. It shall comply with the provisions defined in table 6.1.6.3.4-1.

**Table 6.1.6.3.4-1: Enumeration AcuFlag**

Enumeration value	Description	Applicability
"INCREASE"	Indicates the impacted list of S-NSSAI is to be added to the NSACF for a UE (or a PDU session).	
"DECREASE"	Indicates the impacted list of S-NSSAI is to be removed from the NSACF for a UE (or a PDU session).	
"UPDATE"	Indicates for the impacted S-NSSAIs the access type of a PDU session is to be replaced; or Indicates for the impacted S-NSSAIs the access type of a UE with at least one PDU session/PDN connection is to be replaced.	

#### 6.1.6.3.5 Enumeration: AcuFailureReason

The enumeration AcuFailureReason indicates the operation result of the NSAC procedure for an individual S-NSSAI. It shall comply with the provisions defined in table 6.1.6.3.5-1.

**Table 6.1.6.3.5-1: Enumeration AcuFailureReason**

Enumeration value	Description	Applicability
"SLICE_NOT_FOUND"	Indicates that an S-NSSAI is not found by the NSACF from the list of S-NSSAIs which are subject to NSAC procedure.	
"EXCEED_MAX_UE_NUM"	Indicates for an S-NSSAI the number of UEs has exceeded the configured maximum number of UEs, if network slice admission control is not specific to one access type. (NOTE 2)	
"EXCEED_MAX_UE_NUM_3GPP"	Indicates for an S-NSSAI the number of UEs has exceeded the configured maximum number of UEs, if network slice admission control is required for 3GPP access. (NOTE 1, NOTE 2)	
"EXCEED_MAX_UE_NUM_N3GPP"	Indicates for an S-NSSAI the number of UEs has exceeded the configured maximum number of UEs, if network slice admission control is required for Non-3GPP access. (NOTE 1, NOTE 2)	
"EXCEED_MAX_PDU_NUM"	Indicates for an S-NSSAI the number of PDU sessions has exceeded the configured maximum number of PDU sessions if network slice admission control is not specific to one access type.	
"EXCEED_MAX_PDU_NUM_3GPP"	Indicates for an S-NSSAI the number of PDU sessions has exceeded the configured maximum number of PDU sessions, if network slice admission control is required for 3GPP access. (NOTE 1)	
"EXCEED_MAX_PDU_NUM_N3GPP"	Indicates for an S-NSSAI the number of PDU sessions has exceeded the configured maximum number of PDU sessions, if network slice admission control is required for Non-3GPP access. (NOTE 1)	
NOTE 1: If this value is returned in the NSAC response message, how the NF service consumer (e.g. AMF) utilizes the access information carried in the AcuFailureReason value is implementation specific.		
NOTE 2: For one S-NSSAI, if the network is configured to perform NSAC for the number of UEs with at least one PDU session/PDN connection, these values returned in the NSAC response message indicate the excess of the configured maximum number of UEs with at least one PDU session/PDN connection.		

#### 6.1.6.3.6 Enumeration: SliceQuotaType

The enumeration SliceQuotaType indicates the type of the quota (i.e. maximum number of registered UEs and/or maximum number of PDU sessions) for an S-NSSAI for which the fetching of the available quota is performed during the NSAC procedure. It shall comply with the provisions defined in table 6.1.6.3.6-1.

**Table 6.1.6.3.6-1: Enumeration SliceQuotaType**

Enumeration value	Description	Applicability
"MAX_UE_NUM"	Indicates that quota type for update relates to maximum number of registered inbound roaming UEs.	
"MAX_PDU_NUM"	Indicates that quota type for update relates to maximum number of LBO PDU sessions.	
"BOTH"	Indicates that quota type for update relates to both maximum number of registered inbound roaming UEs and maximum number of LBO PDU sessions.	

#### 6.1.6.3.7 Enumeration: NsacAdmissionMode

The enumeration NsacAdmissionMode indicates the mode (i.e. VPLMN NSAC admission mode or VPLMN with HPLMN assistance NSAC admission mode) applied to an S-NSSAI during the NSAC procedure. It shall comply with the provisions defined in table 6.1.6.3.7-1.

**Table 6.1.6.3.7-1: Enumeration NsacAdmissionMode**

Enumeration value	Description	Applicability
"VPLMN_ADMISSION"	VPLMN NSAC admission mode	
"VPLMN_WITH_HPLMN_ASSISTANCE"	VPLMN with HPLMN assistance NSAC Admission mode	

#### 6.1.6.4 Data types describing alternative data types or combinations of data types

In this release, no alternative data types or combinations of data types are defined in this specification.

#### 6.1.6.5 Binary data

In this release, no binary data types are defined in this specification.

### 6.1.7 Error Handling

#### 6.1.7.1 General

For the Nnsacf\_NSAC API, HTTP error responses shall be supported as specified in clause 4.8 of 3GPP TS 29.501 [5]. Protocol errors and application errors specified in table 5.2.7.2-1 of 3GPP TS 29.500 [4] shall be supported for an HTTP method if the corresponding HTTP status codes are specified as mandatory for that HTTP method in table 5.2.7.1-1 of 3GPP TS 29.500 [4].

In addition, the requirements in the following clauses are applicable for the Nnsacf\_NSAC API.

#### 6.1.7.2 Protocol Errors

No specific procedures for the Nnsacf\_NSAC service are specified.

#### 6.1.7.3 Application Errors

The application errors defined for the Nnsacf\_NSAC service are listed in Table 6.1.7.3-1.

**Table 6.1.7.3-1: Application errors**

Application Error	HTTP status code	Description
SLICE_NOT_FOUND	403 Forbidden	All S-NSSAIs provided in the request are not found by the NSACF from the list of S-NSSAIs which are subjected to NSAC procedure.
ALL_SLICE_FAILED	403 Forbidden	All S-NSSAIs are failed in the NSAC procedure, e.g. due to exceed the configured maximum number of UEs, PDU sessions or UEs with at least one PDU session/PDN connection.
NSAC_SERVICE_AREA_NOT_SUPPORT	403 Forbidden	The NSAC Service Area included in the request is not supported by the NSACF.
NSAC_SERVICE_AREA_REQUIRED	403 Forbidden	The NSACF has been configured with multiple NSAC Service Areas to perform NSAC admission on a per NSAC Service Area, and there is no NSAC Service Area received in the request.
LOCAL_CONFIG_NOT_FOUND	404 Not Found	All S-NSSAIs provided in the request are not found by the receiving NSACF during the network slice local configuration update procedure (i.e. to update the local maximum number of UEs and/or PDU session).

## 6.1.8 Feature negotiation

The optional features in table 6.1.8-1 are defined for the Nnsacf\_NSAC API. They shall be negotiated using the extensibility mechanism defined in clause 6.6 of 3GPP TS 29.500 [4].

The syntax of the supportedFeatures attribute is defined in clause 5.2.2 of 3GPP TS 29.571 [16].

The following features are defined for the Nnsacf\_NSAC service.

**Table 6.1.8-1: Supported Features**

Feature number	Feature Name	M/O	Description
1	HNSAC	O	Hierarchical Network Slice Admission Control  An NF Service Consumer and the NSACF support this feature shall support handling of Hierarchical NSACF procedures as specified in clause 4.2.11.2a and clause 4.2.11.4a of 3GPP TS 23.502 [3].
2	VHNSAC	O	VPLMN with HPLMN assistance NSAC Admission mode  An NF Service Consumer and the NSACF support this feature shall support handling of VPLMN with HPLMN assistance NSAC Admission procedures as specified in clause 4.2.11.5.2.3 and clause 4.2.11.5.2.4 of 3GPP TS 23.502 [3].
Feature number: The order number of the feature within the supportedFeatures attribute (starting with 1). Feature: A short name that can be used to refer to the bit and to the feature. M/O: Defines if the implementation of the feature is mandatory ("M") or optional ("O"). Description: A clear textual description of the feature.			

## 6.1.9 Security

As indicated in 3GPP TS 33.501 [8] and 3GPP TS 29.500 [4], the access to the Nnsacf\_NSAC API may be authorized by means of the OAuth2 protocol (see IETF RFC 6749 [9]), based on local configuration, using the "Client Credentials" authorization grant, where the NRF (see 3GPP TS 29.510 [10]) plays the role of the authorization server.

If OAuth2 is used, an NF Service Consumer, prior to consuming services offered by the Nnsacf\_NSAC API, shall obtain a "token" from the authorization server, by invoking the Access Token Request service, as described in 3GPP TS 29.510 [10], clause 5.4.2.2.

**NOTE:** When multiple NRFs are deployed in a network, the NRF used as authorization server is the same NRF that the NF Service Consumer used for discovering the Nnsacf\_NSAC service.

The Nnsacf\_NSAC API defines the following scopes for OAuth2 authorization:

**Table 6.1.9-X: OAuth2 scopes defined in Nnsacf\_NSAC API**

Scope	Description
"nnsacf-nsac"	Access to the Nnsacf_NSAC API.
"nnsacf-nsac:slice-ues"	Access to service operations applying to the collection of slice subject to NSAC for UEs.
"nnsacf-nsac:slice-pdus"	Access to service operations applying to the collection of slice subject to NSAC for PDU sessions.
"nnsacf-nsac:local-configs-update"	Access (from a primary NSACF) to update the network slice local configuration (i.e., the maximum number of registered UEs and/or the maximum number of PDU sessions) of a network slice at a distributed NSACF, in hierarchical NSAC architecture.
"nnsacf-nsac:roaming-quotas-query"	Access (from a primary or central VPLMN NSACF) to request the primary or central HPLMN NSACF the maximum number of registered UEs and/or the maximum number of PDU sessions of a network slice for inbound roamers for VPLMN NSAC admission mode.

## 6.1.10 HTTP redirection

An HTTP request may be redirected to a different NSACF service instance within the same NSACF, or to a different NSACF of an NSACF set, when using direct or indirect communications (see 3GPP TS 29.500 [4]).

An SCP that reselects a different NSACF producer instance will return the NF Instance ID of the new NSACF producer instance in the 3gpp-Sbi-Producer-Id header, as specified in clause 6.10.3.4 of 3GPP TS 29.500 [4].

If an NSACF redirects a service request to a different NSACF using an 307 Temporary Redirect or 308 Permanent Redirect status code, the identity of the new NSACF towards which the service request is redirected shall be indicated in the 3gpp-Sbi-Target-Nf-Id header of the 307 Temporary Redirect or 308 Permanent Redirect response as specified in clause 6.10.9.1 of 3GPP TS 29.500 [4].

## 6.2 Nnsacf\_SliceEventExposure Service API

### 6.2.1 Introduction

The Nnsacf\_SliceEventExposure shall use the Nnsacf\_SliceEventExposure API.

The API URI of the Nnsacf\_SliceEventExposure API shall be:

**{apiRoot}/<apiName>/<apiVersion>**

The request URIs used in HTTP requests from the NF service consumer towards the NF service producer shall have the Resource URI structure defined in clause 4.4.1 of 3GPP TS 29.501 [5], i.e.:

**{apiRoot}/<apiName>/<apiVersion>/<apiSpecificResourceUriPart>**

with the following components:

- The {apiRoot} shall be set as described in 3GPP TS 29.501 [5].
- The <apiName> shall be "nnsacf-slice-ee".
- The <apiVersion> shall be "v1".
- The <apiSpecificResourceUriPart> shall be set as described in clause 6.2.3.

### 6.2.2 Usage of HTTP

#### 6.2.2.1 General

HTTP/2, IETF RFC 7540 [11], shall be used as specified in clause 5 of 3GPP TS 29.500 [4].

HTTP/2 shall be transported as specified in clause 5.3 of 3GPP TS 29.500 [4].

The OpenAPI [6] specification of HTTP messages and content bodies for the Nnsacf\_SliceEventExposure API is contained in Annex A.

#### 6.2.2.2 HTTP standard headers

##### 6.2.2.2.1 General

See clause 5.2.2 of 3GPP TS 29.500 [4] for the usage of HTTP standard headers.

### 6.2.2.2.2 Content type

JSON, IETF RFC 8259 [12], shall be used as content type of the HTTP bodies specified in the present specification as specified in clause 5.4 of 3GPP TS 29.500 [4]. The use of the JSON format shall be signalled by the content type "application/json".

"Problem Details" JSON object shall be used to indicate additional details of the error in a HTTP response body and shall be signalled by the content type "application/problem+json", as defined in IETF RFC 9457 [13].

### 6.2.2.3 HTTP custom headers

The mandatory HTTP custom header fields specified in clause 5.2.3.2 of 3GPP TS 29.500 [4] shall be supported, and the optional HTTP custom header fields specified in clause 5.2.3.3 of 3GPP TS 29.500 [4] may be supported.

## 6.2.3 Resources

### 6.2.3.1 Overview

The figure 6.2.3.1-1 describes the resource URI structure of the Nnsacf\_SliceEventExposure API.

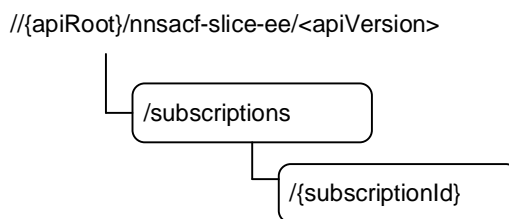

**Figure 6.2.3.1-1: Resource URI structure of the Nnsacf\_SliceEventExposure API**

Table 6.2.3.1-1 provides an overview of the resources and applicable HTTP methods.

**Table 6.2.3.1-1: Resources and methods overview**

Resource name	Resource URI	HTTP method or custom operation	Description
Subscriptions Collection (Collection)	/subscriptions	POST	Mapped to the service operation Subscribe, when to create a subscription
Individual subscription	/subscriptions/{subscriptionId}	PATCH	Mapped to the service operation Subscribe, when to modify the subscription partially
		PUT	Mapped to the service operation Subscribe, when to modify the subscription completely
		DELETE	Mapped to the service operation Unsubscribe

### 6.2.3.2 Resource: Subscriptions collection

#### 6.2.3.2.1 Description

This resource represents a collection of subscriptions created by NF service consumers of Nnsacf\_SliceEventExposure service.

This resource is modelled as the Collection resource archetype (see clause C.2 of 3GPP TS 29.501 [5]).

### 6.2.3.2.2 Resource Definition

Resource URI: {apiRoot}/nnsacf-slice-ee/<apiVersion>/subscriptions

This resource shall support the resource URI variables defined in table 6.2.3.2.2-1.

**Table 6.2.3.2.2-1: Resource URI variables for this resource**

Name	Data type	Definition
apiRoot	string	See clause 6.2.1
apiVersion	string	See clause 6.2.1.

### 6.2.3.2.3 Resource Standard Methods

#### 6.2.3.2.3.1 POST

This method shall support the URI query parameters specified in table 6.2.3.2.3.1-1.

**Table 6.2.3.2.3.1-1: URI query parameters supported by the POST method on this resource**

Name	Data type	P	Cardinality	Description
n/a				

This method shall support the request data structures specified in table 6.2.3.2.3.1-2 and the response data structures and response codes specified in table 6.2.3.2.3.1-3.

**Table 6.2.3.2.3.1-2: Data structures supported by the POST Request Body on this resource**

Data type	P	Cardinality	Description
SACEventSubscription	M	1	Represents the subscription to the events for slice admission control

**Table 6.2.3.2.3.1-3: Data structures supported by the POST Response Body on this resource**

Data type	P	Cardinality	Response codes	Description
CreatedSACEventSubscription	M	1	201 Created	Represents successful creation of the events subscription for slice admission control
RedirectResponse	O	0..1	307 Temporary Redirect	Temporary redirection.
RedirectResponse	O	0..1	308 Permanent Redirect	Permanent redirection.
ProblemDetails	O	0..1	403 Forbidden	Indicates the creation of subscription has failed due to application error.  The "cause" attribute may be used to indicate one of the following application errors: - SLICE_NOT_FOUND - MUTING_EXC_INSTR_NOT_ACCEPTED
NOTE: The mandatory HTTP error status code for the POST method listed in Table 5.2.7.1-1 of 3GPP TS 29.500 [4] also apply.				

**Table 6.2.3.2.3.1-4: Headers supported by the 201 Response Code on this resource**

Name	Data type	P	Cardinality	Description
Location	string	M	1	Contains the URI of the newly created resource, according to the structure: {apiRoot}/nnsacf-slice-ee/<apiVersion>/subscriptions/{subscriptionId}

**Table 6.2.3.2.3.1-5: Headers supported by the 307 Response Code on this resource**

Name	Data type	P	Cardinality	Description
Location	string	M	1	An alternative URI of the resource located on an alternative service instance within the same NSACF or NSACF (service) set. For the case, when a request is redirected to the same target resource via a different SCP, see clause 6.10.9.1 in 3GPP TS 29.500 [4].
3gpp-Sbi-Target-Nf-Id	string	O	0..1	Identifier of the target NF (service) instance ID towards which the request is redirected

**Table 6.2.3.2.3.1-6: Headers supported by the 308 Response Code on this resource**

Name	Data type	P	Cardinality	Description
Location	string	M	1	An alternative URI of the resource located on an alternative service instance within the same NSACF or NSACF (service) set. For the case, when a request is redirected to the same target resource via a different SCP, see clause 6.10.9.1 in 3GPP TS 29.500 [4].
3gpp-Sbi-Target-Nf-Id	string	O	0..1	Identifier of the target NF (service) instance ID towards which the request is redirected

#### 6.2.3.2.4 Resource Custom Operations

In this release of this specification, no custom operations associated to this resource is defined.

#### 6.2.3.3 Resource: Individual subscription

##### 6.2.3.3.1 Description

This resource represents an individual of subscription created by NF service consumers of Nnsacf\_SliceEventExposure service.

This resource is modelled as the Document resource archetype (see clause C.1 of 3GPP TS 29.501 [5]).

##### 6.2.3.3.2 Resource Definition

Resource URI: {apiRoot}/nnsacf-slice-ee/<apiVersion>/subscriptions/{subscriptionId}

This resource shall support the resource URI variables defined in table 6.2.3.3.2-1.

**Table 6.2.3.3.2-1: Resource URI variables for this resource**

Name	Data type	Definition
apiRoot	string	See clause 6.2.1
apiVersion	string	See clause 6.2.1.
subscriptionId	string	String identifies an individual subscription to the NSACF event exposure service



## 6.2.3.3.3 Resource Standard Methods

## 6.2.3.3.3.1 PATCH

This method shall support the URI query parameters specified in table 6.2.3.3.3.1-1.

**Table 6.2.3.3.3.1-1: URI query parameters supported by the PATCH method on this resource**

Name	Data type	P	Cardinality	Description
n/a				

This method shall support the request data structures specified in table 6.2.3.3.3.1-2 and the response data structures and response codes specified in table 6.2.3.3.3.1-3.

**Table 6.2.3.3.3.1-2: Data structures supported by the PATCH Request Body on this resource**

Data type	P	Cardinality	Description
array(PatchItem)	M	1..N	It contains the list of changes to be made to the subscription, according to the JSON PATCH format specified in IETF RFC 6902 [14].

**Table 6.2.3.3.3.1-3: Data structures supported by the PATCH Response Body on this resource**

Data type	P	Cardinality	Response codes	Description
CreatedSACEventSubscription	M	1	200 OK	Represents successful update of the events subscription for slice admission control
n/a			204 No Content	Represents a successful update of the events subscription for slice admission control, and no information needs to be returned to the NF service consumer.
RedirectResponse	O	0..1	307 Temporary Redirect	Temporary redirection.
RedirectResponse	O	0..1	308 Permanent Redirect	Permanent redirection.
ProblemDetails	O	0..1	403 Forbidden	Indicates the modification of subscription has failed due to application error.  The "cause" attribute may be used to indicate one of the following application errors: - SLICE_NOT_FOUND - MUTING_EXC_INSTR_NOT_ACCEPTED
ProblemDetails	O	0..1	404 Not Found	Indicates the modification of subscription has failed due to application error.  The "cause" attribute may be used to indicate one of the following application errors: - SUBSCRIPTION_NOT_FOUND
NOTE:	The mandatory HTTP error status code for the PATCH method listed in Table 5.2.7.1-1 of 3GPP TS 29.500 [4] also apply.			

**Table 6.2.3.3.3.1-4: Headers supported by the 307 Response Code on this resource**

Name	Data type	P	Cardinality	Description
Location	string	M	1	An alternative URI of the resource located on an alternative service instance within the same NSACF or NSACF (service) set. For the case, when a request is redirected to the same target resource via a different SCP, see clause 6.10.9.1 in 3GPP TS 29.500 [4].
3gpp-Sbi-Target-Nf-Id	string	O	0..1	Identifier of the target NF (service) instance ID towards which the request is redirected

**Table 6.2.3.3.3.1-5: Headers supported by the 308 Response Code on this resource**

Name	Data type	P	Cardinality	Description
Location	string	M	1	An alternative URI of the resource located on an alternative service instance within the same NSACF or NSACF (service) set. For the case, when a request is redirected to the same target resource via a different SCP, see clause 6.10.9.1 in 3GPP TS 29.500 [4].
3gpp-Sbi-Target-Nf-Id	string	O	0..1	Identifier of the target NF (service) instance ID towards which the request is redirected

#### 6.2.3.3.3.2 PUT

This method shall support the URI query parameters specified in table 6.2.3.3.3.2-1.

**Table 6.2.3.3.3.2-1: URI query parameters supported by the PUT method on this resource**

Name	Data type	P	Cardinality	Description
n/a				

This method shall support the request data structures specified in table 6.2.3.3.3.2-2 and the response data structures and response codes specified in table 6.2.3.3.3.2-3.

**Table 6.2.3.3.3.2-2: Data structures supported by the PUT Request Body on this resource**

Data type	P	Cardinality	Description
SACEventSubscription	M	1	Represents the events subscription for slice admission control to be completely replaced.

**Table 6.2.3.3.2-3: Data structures supported by the PUT Response Body on this resource**

Data type	P	Cardinality	Response codes	Description
CreatedSACEventSubscription	M	1	200 OK	Represents successful update of the events subscription for slice admission control.
n/a			204 No Content	Represents the events subscription modification provided by the NF Service Consumer is accepted entirely.
RedirectResponse	O	0..1	307 Temporary Redirect	Temporary redirection.
RedirectResponse	O	0..1	308 Permanent Redirect	Permanent redirection.
ProblemDetails	O	0..1	403 Forbidden	Indicates the creation of subscription has failed due to application error.  The "cause" attribute may be used to indicate one of the following application errors: - SLICE_NOT_FOUND - MUTING_EXC_INSTR_NOT_ACCEPTED
ProblemDetails	O	0..1	404 Not Found	Indicates the modification of subscription has failed due to application error.  The "cause" attribute may be used to indicate one of the following application errors: - SUBSCRIPTION_NOT_FOUND
NOTE: The mandatory HTTP error status code for the PUT method listed in Table 5.2.7.1-1 of 3GPP TS 29.500 [4] also apply.				

**Table 6.2.3.3.2-4: Headers supported by the 307 Response Code on this resource**

Name	Data type	P	Cardinality	Description
Location	string	M	1	An alternative URI of the resource located on an alternative service instance within the same NSACF or NSACF (service) set. For the case, when a request is redirected to the same target resource via a different SCP, see clause 6.10.9.1 in 3GPP TS 29.500 [4].
3gpp-Sbi-Target-Nf-Id	string	O	0..1	Identifier of the target NF (service) instance ID towards which the request is redirected

**Table 6.2.3.3.2-5: Headers supported by the 308 Response Code on this resource**

Name	Data type	P	Cardinality	Description
Location	string	M	1	An alternative URI of the resource located on an alternative service instance within the same NSACF or NSACF (service) set. For the case, when a request is redirected to the same target resource via a different SCP, see clause 6.10.9.1 in 3GPP TS 29.500 [4].
3gpp-Sbi-Target-Nf-Id	string	O	0..1	Identifier of the target NF (service) instance ID towards which the request is redirected

### 6.2.3.3.3 DELETE

This method shall support the URI query parameters specified in table 6.2.3.3.3-1.

**Table 6.2.3.3.3.3-1: URI query parameters supported by the DELETE method on this resource**

Name	Data type	P	Cardinality	Description
n/a				

This method shall support the request data structures specified in table 6.2.3.3.3.3-2 and the response data structures and response codes specified in table 6.2.3.3.3.3-3.

**Table 6.2.3.3.3.3-2: Data structures supported by the DELETE Request Body on this resource**

Data type	P	Cardinality	Description
n/a			

**Table 6.2.3.3.3.3-3: Data structures supported by the DELETE Response Body on this resource**

Data type	P	Cardinality	Response codes	Description
n/a			204 No Content	Upon success, an empty response body shall be returned.
RedirectResponse	O	0..1	307 Temporary Redirect	Temporary redirection.
RedirectResponse	O	0..1	308 Permanent Redirect	Permanent redirection.
ProblemDetails	O	0..1	404 Not Found	Indicates the modification of subscription has failed due to application error.  The "cause" attribute may be used to indicate one of the following application errors: - SUBSCRIPTION_NOT_FOUND.
NOTE: The mandatory HTTP error status code for the DELETE method listed in Table 5.2.7.1-1 of 3GPP TS 29.500 [4] also apply.				

**Table 6.2.3.3.3.3-4: Headers supported by the 307 Response Code on this resource**

Name	Data type	P	Cardinality	Description
Location	string	M	1	A URI pointing to the endpoint of another NF service consumer to which the notification should be sent. For the case, when a request is redirected to the same target resource via a different SCP, see clause 6.10.9.1 in 3GPP TS 29.500 [4].
3gpp-Sbi-Target-Nf-Id	string	O	0..1	Identifier of the target NF (service) instance ID towards which the request is redirected

**Table 6.2.3.3.3.3-5: Headers supported by the 308 Response Code on this resource**

Name	Data type	P	Cardinality	Description
Location	string	M	1	A URI pointing to the endpoint of another NF service consumer to which the notification should be sent. For the case, when a request is redirected to the same target resource via a different SCP, see clause 6.10.9.1 in 3GPP TS 29.500 [4].
3gpp-Sbi-Target-Nf-Id	string	O	0..1	Identifier of the target NF (service) instance ID towards which the request is redirected

#### 6.2.3.3.4 Resource Custom Operations

In this release of this specification, no custom operations associated to this resource is defined.

## 6.2.4 Custom Operations without associated resources

In this release of this specification, no custom operations without associated resources are defined.

## 6.2.5 Notifications

### 6.2.5.1 General

This clause specifies the notifications provided by the Nnsacf\_SliceEventExposure service.

**Table 6.2.5.1-1: Notifications overview**

Notification	Callback URI	HTTP method or custom operation	Description (service operation)
NSACF Event Notification	{eventNotifyUri}	POST	

### 6.2.5.2 NSACF Event Notification

If a NF service consumer has subscribed to an event(s) supported by Nnsacf\_SliceEventExposure service, when NSACF aware of a state change of the event, NSACF shall create a notification including the event state report, and shall deliver the notification to the call-back URI, following Subscribe/Notify mechanism defined in 3GPP TS 29.501 [5].

#### 6.2.5.2.1 Notification Definition

Call-back URI: {callbackUri}

Call-back URI is "eventNotifyUri" provided by NF Service Consumer during creation of the subscription.

#### 6.2.5.2.2 Notification Standard Methods

##### 6.2.5.2.2.1 POST

This method shall support the request data structures specified in table 6.2.5.2.2.1-1 and the response data structures and response codes specified in table 6.2.5.2.2.1-2.

**Table 6.2.5.2.2.1-2: Data structures supported by the POST Request Body**

Data type	P	Cardinality	Description
SACEventReport	M	1	Represents the notification to be delivered

**Table 6.2.5.2.2.1-3: Data structures supported by the POST Response Body**

Data type	P	Cardinality	Response codes	Description
n/a			204 No Content	Upon success, an empty response body shall be returned.
RedirectResponse	O	0..1	307 Temporary Redirect	Temporary redirection.
RedirectResponse	O	0..1	308 Permanent Redirect	Permanent redirection.

NOTE: The mandatory HTTP error status code for the POST method listed in Table 5.2.7.1-1 of 3GPP TS 29.500 [4] also apply.

**Table 6.2.5.2.2.1-4: Headers supported by the 307 Response Code on this resource**

Name	Data type	P	Cardinality	Description
Location	string	M	1	A URI pointing to the endpoint of another NF service consumer to which the notification should be sent. For the case, when a request is redirected to the same target resource via a different SCP, see clause 6.10.9.1 in 3GPP TS 29.500 [4].
3gpp-Sbi-Target-Nf-Id	string	O	0..1	Identifier of the target NF (service) instance ID towards which the request is redirected

**Table 6.2.5.2.2.1-5: Headers supported by the 308 Response Code on this resource**

Name	Data type	P	Cardinality	Description
Location	string	M	1	A URI pointing to the endpoint of another NF service consumer to which the notification should be sent. For the case, when a request is redirected to the same target resource via a different SCP, see clause 6.10.9.1 in 3GPP TS 29.500 [4].
3gpp-Sbi-Target-Nf-Id	string	O	0..1	Identifier of the target NF (service) instance ID towards which the request is redirected

## 6.2.6 Data Model

### 6.2.6.1 General

This clause specifies the application data model supported by the API.

Table 6.2.6.1-1 specifies the data types defined for the Nnsacf\_SliceEventExposure service based interface protocol.

**Table 6.2.6.1-1: Nnsacf\_SliceEventExposure specific Data Types**

Data type	Clause defined	Description	Applicability
SACEventSubscription	6.2.6.2.2	Request data to create the event subscription	
CreatedSACEventSubscription	6.2.6.2.3	Response data on created event subscription	
SACEventReport	6.2.6.2.4	Event notification	
SACEvent	6.2.6.2.5	Describes an event to be subscribed	
SACEventReportItem	6.2.6.2.6	Represents a report triggered by a subscribed event type	
SACEventState	6.2.6.2.7	Represents the state of a subscribed event	
SACEventType	6.2.6.3.3	Describes the supported event types	
SACEventTrigger	6.2.6.3.4	Describes how NSACF should generate the report for the event	

Table 6.2.6.1-2 specifies data types re-used by the Nnsacf\_SliceEventExposure service based interface protocol from other specifications, including a reference to their respective specifications and when needed, a short description of their use within the Nnsacf\_SliceEventExposure service based interface.

**Table 6.2.6.1-2: Nnsacf\_SliceEventExposure re-used Data Types**

<b>Data type</b>	<b>Reference</b>	<b>Comments</b>	<b>Applicability</b>
PatchItem	3GPP TS 29.571 [16]		
Uri	3GPP TS 29.571 [16]	Callback URI	
NfInstanceId	3GPP TS 29.571 [16]	NF Instance Id	
DurationSec	3GPP TS 29.571 [16]	Time value in seconds	
SACInfo	3GPP TS 29.571 [16]	SAC Information	
DateTime	3GPP TS 29.571 [16]	UTC time	
SupportedFeatures	3GPP TS 29.571 [16]	Supported Features	
Snsai	3GPP TS 29.571 [16]	S-NSSAI	
SACEventStatus	3GPP TS 29.571 [16]	SAC Event Status	
VarRepPeriod	3GPP TS 29.571 [16]	Variable Reporting Periodicity	
NotificationFlag	3GPP TS 29.571 [16]	Notification flag	
MutingExceptionInstructions	3GPP TS 29.571 [16]	Muting exception instructions	
MutingNotificationsSettings	3GPP TS 29.571 [16]	Muting notifications settings	

## 6.2.6.2 Structured data types

### 6.2.6.2.1 Introduction

This clause defines the structures to be used in resource representations.

## 6.2.6.2.2 Type: SACEventSubscription

Table 6.2.6.2.2-1: Definition of type SACEventSubscription

Attribute name	Data type	P	Cardinality	Description	Applicability
event	SACEvent	M	1	Describes the event to be subscribed in subscription request.	
eventNotifyUri	Uri	M	1	Identifies the recipient of notifications sent by NSACF for this subscription.	
nfId	NfInstanceId	M	1	Indicates the instance identity of the network function creating the subscription.	
notifyCorrelationId	string	C	0..1	This IE shall be present if available.  If present, this IE identifies the notification correlation ID. The NSACF shall include this ID in the notifications. The value of this IE shall be unique per subscription for a given NF service consumer.	
maxReports	integer	C	0..1	This IE shall be present if available.  If present, this IE contains the maximum number of reports that can be generated by each subscribed event in the subscription.	
expiry	DateTime	C	0..1	This IE shall be included in an event subscription response, if, based on operator policy and taking into account the expiry time included in the request, the NSACF needs to include an expiry time.  This IE may be included in an event subscription request.  When present, this IE shall represent the time after which the subscribed event(s) shall stop generating report and the subscription becomes invalid.  This IE shall be absent in the response for one time and immediate reporting (see clause 5.3.2.2.4).	
notifFlag	NotificationFlag	O	0..1	Indicates the notification flag by NWDAF or DCCF, which is used to mute/unmute notifications and to retrieve events stored during a period of muted notifications.	EEMM
mutingExclInstructions	MutingExceptionInstructions	O	0..1	This IE may be included by NWDAF or DCCF in the event subscription request, if the notifFlag IE is present and set to "DEACTIVATE".  When present, it shall indicate the instructions for the subscription and stored events when an exception (e.g. the buffer of stored event reports is full, or the number of stored event reports exceeds a certain number) occurs at NSACF while the events are muted. See 3GPP TS 23.288 [18], clause 6.2.7.2. Write-Only: true	EEMM
mutingNotSettings	MutingNotificationsSettings	O	0..1	This IE may be included in the event subscription response if the event notifications muting is activated. This IE Indicates the NSACF muting notification settings. See 3GPP TS 23.288 [18], clause 6.2.7.2. Read-Only: true	EEMM
supportedFeatures	SupportedFeatures	C	0..1	This IE shall be present if at least one optional feature defined in clause 6.2.8 is supported.	



## 6.2.6.2.3 Type: CreatedSACEventSubscription

**Table 6.2.6.2.3-1: Definition of type CreatedSACEventSubscription**

Attribute name	Data type	P	Cardinality	Description	Applicability
subscription	SACEventSubscription	M	1	Represents the newly created SAC Event Subscription resource.	
subscriptionId	string	M	1	Represents the subscription Id of the newly created SAC Event Subscription resource.	
report	SACEventReportItem	C	0..1	This IE shall be present if available and if the immediateFlag attribute is set to "true" in subscription request. When present, this IE represents the immediate event report (i.e. the current value of the event subscribed).	
supportedFeatures	SupportedFeatures	C	0..1	This IE shall be present if at least one optional feature defined in clause 6.3.8 is supported.	

## 6.2.6.2.4 Type: SACEventReport

**Table 6.2.6.2.4-1: Definition of type SACEventReport**

Attribute name	Data type	P	Cardinality	Description	Applicability
report	SACEventReportItem	M	1	This IE represents the event report to be delivered.	
notifyCorrelationId	string	C	0..1	This IE shall be present if available.  If present, this IE indicate the notification correlation Id provided by the NF service consumer during event subscription. This parameter can be useful if the NF service consumer uses a common call-back URI for multiple subscriptions.	

## 6.2.6.2.5 Type: SACEvent

Table 6.2.6.2.5-1: Definition of type SACEvent

Attribute name	Data type	P	Cardinality	Description	Applicability
eventType	SACEventType	M	1	Describes the event type to be reported.	
eventTrigger	SACEventTrigger	C	0..1	Describes how the reports are triggered. (See NOTE 1)	
eventFilter	array(Snssai)	M	1..N	This IE shall indicate the S-NSSAI list to be applied.	
notificationPeriod	DurationSec	C	0..1	This IE shall be present if the eventTrigger is set to "PERIODIC". When present, this IE contains the time period for the event reports. (See NOTE 3)	
notifThreshold	SACInfo	C	0..1	This IE shall be present if the eventTrigger is set to "THRESHOLD". When present, this IE Indicates the monitoring threshold value, upon which event notification(s) are triggered.	
immediateFlag	boolean	O	0..1	This attribute shall be set to "true" to indicate an immediate event report in the subscription response is requested. The report contains the current value of the event stored at the time of the subscription in the NSACF. (See NOTE 2)	
varRepPeriodInfo	array(VarRepPeriod)	O	1..N	This IE may be present if the trigger is set to "PERIODIC". This IE Indicates the variable reporting periodicity information. See 3GPP TS 23.502 [4], clause 4.15.1. (See NOTE 3)	ENAPH3
NOTE 1: The eventTrigger shall not be present if the maxReports attribute in the SACEventSubscription is set to 1. Otherwise, the eventTrigger shall be present.					
NOTE 2: If the immediateFlag flag is absent or set to "false", then the immediate reporting shall not be done.					
NOTE 3: If both notificationPeriod and varRepPeriodInfo attributes are present, the notificationPeriod shall be applied if non of the conditions trigger the variable reporting is met.					

## 6.2.6.2.6 Type: SACEventReportItem

Table 6.2.6.2.6-1: Definition of type SACEventReportItem

Attribute name	Data type	P	Cardinality	Description	Applicability
eventType	SACEventType	M	1	Describes the type of the event which triggers the report	
eventState	SACEventState	M	1	Describes the state of the event which triggered the report.	
timeStamp	DateTime	M	1	This IE shall contain the time at which the event is generated.	
eventFilter	Snssai	M	1	This IE shall indicate the S-NSSAI to be applied.	
sliceStautsInfo	SACEventStatus	C	0..1	If the "eventType" attribute is set to "NUM_OF_REGD_UES" or "NUM_OF_ESTD_PDU_SESSIONS", this parameter shall be included to indicate the current network slice status information for the concerned network slice. (NOTE)	
NOTE: For periodic reporting, both of the values expressed in percentage and in numerical shall be included.					

## 6.2.6.2.7 Type: SACEventState

Table 6.2.6.2.7-1: Definition of type SACEventState

Attribute name	Data type	P	Cardinality	Description	Applicability
active	boolean	M	1	Represents the active state of the subscribe event. "TRUE" value indicates the event will continue generating reports; "FALSE" value indicates the event will not generate further report.	
remainReports	integer	O	0..1	Represents the number of remain reports to be generated by the subscribed event.	
remainDuration	DurationSec	O	0..1	Represents how long the subscribed event will continue generating reports.	

## 6.2.6.3 Simple data types and enumerations

## 6.2.6.3.1 Introduction

This clause defines simple data types and enumerations that can be referenced from data structures defined in the previous clauses.

## 6.2.6.3.2 Simple data types

The simple data types defined in table 6.2.6.3.2-1 shall be supported.

Table 6.2.6.3.2-1: Simple data types

Type Name	Type Definition	Description	Applicability

## 6.2.6.3.3 Enumeration: SACEventType

Table 6.2.6.3.3-1: Enumeration SACEventType

Enumeration value	Description	Applicability
"NUM_OF_REGD_UES"	A NF subscribes to this event to receive the current number of registered UEs for a network slice.	
"NUM_OF_ESTD_PDU_SESSIONS"	A NF subscribes to this event to receive the current number of established PDU Sessions for a network slice.	

## 6.2.6.3.4 Enumeration: SACEventTrigger

Table 6.2.6.3.4-1: Enumeration SACEventTrigger

Enumeration value	Description	Applicability
"THRESHOLD"	Defines that the NSACF should generate reports for the event when the defined threshold value is reached, until the subscription to this event ends: - due to end of report duration or - up to the maximum number of reports or - the event being unsubscribed explicitly.	
"PERIODIC"	Defines that the NSACF should periodically generate reports for the event, until the subscription to this event ends: - due to end of report duration or - up to the maximum number of reports or - the event being unsubscribed explicitly.	

#### 6.2.6.4 Data types describing alternative data types or combinations of data types

In this release, no alternative data types or combinations of data types are defined in this specification.

#### 6.2.6.5 Binary data

In this release, no binary data types are defined in this specification.

### 6.2.7 Error Handling

#### 6.2.7.1 General

For the Nnsacf\_SliceEventExposure API, HTTP error responses shall be supported as specified in clause 4.8 of 3GPP TS 29.501 [5]. Protocol errors and application errors specified in table 5.2.7.2-1 of 3GPP TS 29.500 [4] shall be supported for an HTTP method if the corresponding HTTP status codes are specified as mandatory for that HTTP method in table 5.2.7.1-1 of 3GPP TS 29.500 [4].

In addition, the requirements in the following clauses are applicable for the Nnsacf\_SliceEventExposure API.

#### 6.2.7.2 Protocol Errors

No specific procedures for the Nnsacf\_SliceEventExposure service are specified.

#### 6.2.7.3 Application Errors

The application errors defined for the Nnsacf\_SliceEventExposure service are listed in Table 6.2.7.3-1.

**Table 6.2.7.3-1: Application errors**

Application Error	HTTP status code	Description
SLICE_NOT_FOUND	403 Forbidden	The given S-NSSAI is not found by the NSACF in the list of S-NSSAIs which are subjected to NSAC procedure.
MUTING_EXC_INSTR_NOT_ACCEPTED	403 Forbidden	Indicates the NSACF does not accept the received muting exception instructions.
UNSPECIFIED	403 Forbidden	The request is rejected due to unspecified reasons.
UNSUPPORTED_EVENT_TYPE	501 Not Implemented	The request for creation of a subscription is rejected because none of the events is supported by the NSACF.

### 6.2.8 Feature negotiation

The optional features in table 6.3.8-1 are defined for the Nnsacf\_SliceEventExposure API. They shall be negotiated using the extensibility mechanism defined in clause 6.6 of 3GPP TS 29.500 [4].

**Table 6.2.8-1: Supported Features**

Feature number	Feature Name	M/O	Description
1	ENAPH3	O	Enhanced Network Automation Phase 3 defined in 3GPP Rel-18.  An NSACF supporting this feature shall support the handling of variable reporting periodicity information as specified in clause 4.15.1 of 3GPP TS 23.502 [4].
2	EEMM	O	Event Exposure Muting Mechanism  An NSACF supporting this feature shall support the handling of event muting mechanism as specified in clause 6.2.7.2 of 3GPP TS 23.288 [18].
Feature number: The order number of the feature within the supportedFeatures attribute (starting with 1). Feature: A short name that can be used to refer to the bit and to the feature. M/O: Defines if the implementation of the feature is mandatory ("M") or optional ("O"). Description: A clear textual description of the feature.			

## 6.2.9 Security

As indicated in 3GPP TS 33.501 [8] and 3GPP TS 29.500 [4], the access to the Nnsacf\_SliceEventExposure API may be authorized by means of the OAuth2 protocol (see IETF RFC 6749 [9]), based on local configuration, using the "Client Credentials" authorization grant, where the NRF (see 3GPP TS 29.510 [10]) plays the role of the authorization server.

If OAuth2 is used, an NF Service Consumer, prior to consuming services offered by the Nnsacf\_SliceEventExposure API, shall obtain a "token" from the authorization server, by invoking the Access Token Request service, as described in 3GPP TS 29.510 [10], clause 5.4.2.2.

**NOTE:** When multiple NRFs are deployed in a network, the NRF used as authorization server is the same NRF that the NF Service Consumer used for discovering the Nnsacf\_SliceEventExposure service.

The Nnsacf\_SliceEventExposure API defines a single scope "nnsacf-slice-ee" for the entire service, and it does not define any additional scopes at resource or operation level.

### 6.2.10 HTTP redirection

An HTTP request may be redirected to a different NSACF service instance within the same NSACF, or to a different NSACF of an NSACF set, when using direct or indirect communications (see 3GPP TS 29.500 [4]).

An SCP that reselects a different NSACF producer instance will return the NF Instance ID of the new NSACF producer instance in the 3gpp-Sbi-Producer-Id header, as specified in clause 6.10.3.4 of 3GPP TS 29.500 [4].

If an NSACF redirects a service request to a different NSACF using an 307 Temporary Redirect or 308 Permanent Redirect status code, the identity of the new NSACF towards which the service request is redirected shall be indicated in the 3gpp-Sbi-Target-Nf-Id header of the 307 Temporary Redirect or 308 Permanent Redirect response as specified in clause 6.10.9.1 of 3GPP TS 29.500 [4].

---

# Annex A (normative): OpenAPI specification

## A.1 General

This Annex specifies the formal definition of the API(s) defined in the present specification. It consists of OpenAPI specifications in YAML format.

This Annex takes precedence when being discrepant to other parts of the specification with respect to the encoding of information elements and methods within the API(s).

NOTE 1: The semantics and procedures, as well as conditions, e.g. for the applicability and allowed combinations of attributes or values, not expressed in the OpenAPI definitions but defined in other parts of the specification also apply.

Informative copies of the OpenAPI specification files contained in this 3GPP Technical Specification are available on a Git-based repository that uses the GitLab software version control system (see 3GPP TS 29.501 [5] clause 5.3.1 and 3GPP TR 21.900 [7] clause 5B).

---

## A.2 Nnsacf\_NSAC API

```
openapi: 3.0.0

info:
  title: Nnsacf_NSAC
  version: 1.1.0
  description: |
    Nnsacf_NSAC Service.
    © 2024, 3GPP Organizational Partners (ARIB, ATIS, CCSA, ETSI, TSDSI, TTA, TTC).
    All rights reserved.

externalDocs:
  description: 3GPP TS 29.536 V18.6.0; 5G System; Network Slice Admission Control Services; Stage 3.
  url: https://www.3gpp.org/ftp/Specs/archive/29_series/29.536/

servers:
  - url: '{apiRoot}/nnsacf-nsac/v1'
    variables:
      apiRoot:
        default: https://example.com
        description: apiRoot as defined in clause 4.4 of 3GPP TS 29.501

security:
  - {}
  - oAuth2ClientCredentials:
    - nnsacf-nsac

paths:
  /slices/ues:
    post:
      summary: Network Slice Admission Control on the Number of UEs
      operationId: NumOfUEsUpdate
      tags:
        - slice collection
      security:
        - {}
        - oAuth2ClientCredentials:
          - nnsacf-nsac
        - oAuth2ClientCredentials:
          - nnsacf-nsac
          - nnsacf-nsac:slice-ues
      requestBody:
        content:
          application/json:
            schema:
              $ref: '#/components/schemas/UeACRequestData'
            required: true
```

```

responses:
  '200':
    description: Partial successful ACU operation
    content:
      application/json:
        schema:
          $ref: '#/components/schemas/UeACResponseData'
  '204':
    description: Successful ACU operation
  '307':
    $ref: 'TS29571_CommonData.yaml#/components/responses/307'
  '308':
    $ref: 'TS29571_CommonData.yaml#/components/responses/308'
  '400':
    description: Unsuccessful ACU operation - Bad Request
    content:
      application/problem+json:
        schema:
          $ref: 'TS29571_CommonData.yaml#/components/schemas/ProblemDetails'
  '401':
    $ref: 'TS29571_CommonData.yaml#/components/responses/401'
  '403':
    description: Unsuccessful ACU operation - Slice Not Subject to NSAC
    content:
      application/problem+json:
        schema:
          $ref: 'TS29571_CommonData.yaml#/components/schemas/ProblemDetails'
  '404':
    description: Unsuccessful ACU operation - Slice Not Found
    content:
      application/problem+json:
        schema:
          $ref: 'TS29571_CommonData.yaml#/components/schemas/ProblemDetails'
  '500':
    $ref: 'TS29571_CommonData.yaml#/components/responses/500'
  '502':
    $ref: 'TS29571_CommonData.yaml#/components/responses/502'
  '503':
    $ref: 'TS29571_CommonData.yaml#/components/responses/503'
  '504':
    $ref: 'TS29571_CommonData.yaml#/components/responses/504'
callbacks:
  eacNotification:
    '{$request.body#/eacNotificationUri}':
      post:
        requestBody:
          required: true
          content:
            application/json:
              schema:
                $ref: '#/components/schemas/EacNotification'
        responses:
          '204':
            description: slice re-authentication notification response
          '307':
            $ref: 'TS29571_CommonData.yaml#/components/responses/307'
          '308':
            $ref: 'TS29571_CommonData.yaml#/components/responses/308'
          '400':
            $ref: 'TS29571_CommonData.yaml#/components/responses/400'
          '404':
            $ref: 'TS29571_CommonData.yaml#/components/responses/404'
          '500':
            $ref: 'TS29571_CommonData.yaml#/components/responses/500'
          '503':
            $ref: 'TS29571_CommonData.yaml#/components/responses/503'
          default:
            description: Unexpected error

/slices/pdus:
  post:
    summary: Network Slice Admission Control on the number of PDU Sessions
    operationId: NumOfPDUsUpdate
    tags:
      - slice collection
    security:
      - {}
      - oAuth2ClientCredentials:

```

```

- nnsacf-nsac
- oAuth2ClientCredentials:
- nnsacf-nsac
- nnsacf-nsac:slice-pdus
requestBody:
content:
  application/json:
    schema:
      $ref: '#/components/schemas/PduACRequestData'
required: true
responses:
'200':
  description: Partial successful ACU operation
  content:
    application/json:
      schema:
        $ref: '#/components/schemas/PduACResponseData'
'204':
  description: Successful ACU operation
'307':
  $ref: 'TS29571_CommonData.yaml#/components/responses/307'
'308':
  $ref: 'TS29571_CommonData.yaml#/components/responses/308'
'400':
  description: Unsuccessful ACU operation - Bad Request
  content:
    application/problem+json:
      schema:
        $ref: 'TS29571_CommonData.yaml#/components/schemas/ProblemDetails'
'401':
  $ref: 'TS29571_CommonData.yaml#/components/responses/401'
'403':
  description: Unsuccessful ACU operation - Slice Not Subject to NSAC
  content:
    application/problem+json:
      schema:
        $ref: 'TS29571_CommonData.yaml#/components/schemas/ProblemDetails'
'404':
  description: Unsuccessful ACU operation - Slice Not Found
  content:
    application/problem+json:
      schema:
        $ref: 'TS29571_CommonData.yaml#/components/schemas/ProblemDetails'
'500':
  $ref: 'TS29571_CommonData.yaml#/components/responses/500'
'502':
  $ref: 'TS29571_CommonData.yaml#/components/responses/502'
'503':
  $ref: 'TS29571_CommonData.yaml#/components/responses/503'
'504':
  $ref: 'TS29571_CommonData.yaml#/components/responses/504'

/slices/local-configs/update:
post:
  summary: >
    Network Slice Admission Control update of the local maximum number of registered UEs and/or
    PDU sessions of the network slice at NSACF.
  operationId: LocalNumberUpdate
  tags:
  - slice collection
  security:
  - {}
  - oAuth2ClientCredentials:
    - nnsacf-nsac
  - oAuth2ClientCredentials:
    - nnsacf-nsac
    - nnsacf-nsac:local-configs-update
  requestBody:
  content:
    application/json:
      schema:
        $ref: '#/components/schemas/ACUpdateData'
  required: true
  responses:
  '204':
    description: Successful ACU operation
  '307':
    $ref: 'TS29571_CommonData.yaml#/components/responses/307'

```



```

'308':
  $ref: 'TS29571_CommonData.yaml#/components/responses/308'
'400':
  $ref: 'TS29571_CommonData.yaml#/components/responses/400'
'401':
  $ref: 'TS29571_CommonData.yaml#/components/responses/401'
'403':
  $ref: 'TS29571_CommonData.yaml#/components/responses/403'
'404':
  $ref: 'TS29571_CommonData.yaml#/components/responses/404'
'500':
  $ref: 'TS29571_CommonData.yaml#/components/responses/500'
'502':
  $ref: 'TS29571_CommonData.yaml#/components/responses/502'
'503':
  $ref: 'TS29571_CommonData.yaml#/components/responses/503'
'504':
  $ref: 'TS29571_CommonData.yaml#/components/responses/504'

```

/slices/roaming-quotas/query:

```

post:
  summary: >
    Network Slice Admission Control fetching of the maximum number of registered UEs and/or
    number of PDU sessions of the network slice at NSACF.
  operationId: QuotaUpdate
  tags:
  - slice collection
  security:
  - {}
  - oAuth2ClientCredentials:
    - nnsacf-nsac
  - oAuth2ClientCredentials:
    - nnsacf-nsac
    - nnsacf-nsac:roaming-quotas-query
  requestBody:
    content:
      application/json:
        schema:
          $ref: '#/components/schemas/QuotaUpdateRequestData'
    required: true
  responses:
    '200':
      description: Successful operation
      content:
        application/json:
          schema:
            $ref: '#/components/schemas/QuotaUpdateResponseData'
    '307':
      $ref: 'TS29571_CommonData.yaml#/components/responses/307'
    '308':
      $ref: 'TS29571_CommonData.yaml#/components/responses/308'
    '400':
      $ref: 'TS29571_CommonData.yaml#/components/responses/400'
    '401':
      $ref: 'TS29571_CommonData.yaml#/components/responses/401'
    '403':
      $ref: 'TS29571_CommonData.yaml#/components/responses/403'
    '404':
      $ref: 'TS29571_CommonData.yaml#/components/responses/404'
    '500':
      $ref: 'TS29571_CommonData.yaml#/components/responses/500'
    '502':
      $ref: 'TS29571_CommonData.yaml#/components/responses/502'
    '503':
      $ref: 'TS29571_CommonData.yaml#/components/responses/503'
    '504':
      $ref: 'TS29571_CommonData.yaml#/components/responses/504'

```

components:

```

securitySchemes:
  oAuth2ClientCredentials:
    type: oauth2
    flows:
      clientCredentials:
        tokenUrl: '{nrfApiRoot}/oauth2/token'
        scopes:

```

```

nnsacf-nsac: Access to the Nnsacf_NSAC API
nnsacf-nsac:slice-ues: >
  Access to service operations applying to the collection of slice subject to NSAC for
  UEs
nnsacf-nsac:slice-pdus: >
  Access to service operations applying to the collection of slice subject to NSAC for
  PDU sessions
nnsacf-nsac:local-configs-update: >
  Access to the NSAC update of the local maximum number of registered UEs and/or
  PDU sessions of the network slice at NSACF

```

schemas:

```

#
# STRUCTURED DATA TYPES:
#

```

```

UeACRequestData:
  type: object
  properties:
    ueACRequestInfo:
      type: array
      items:
        $ref: '#/components/schemas/UeACRequestInfo'
      minItems: 1
    nfId:
      $ref: 'TS29571_CommonData.yaml#/components/schemas/NfInstanceId'
    nfType:
      $ref: 'TS29510_Nnrf_NFManagement.yaml#/components/schemas/NFType'
    eacNotificationUri:
      $ref: 'TS29571_CommonData.yaml#/components/schemas/Uri'
    nsacServiceArea:
      $ref: 'TS29571_CommonData.yaml#/components/schemas/NsacSai'
    supportedFeatures:
      $ref: 'TS29571_CommonData.yaml#/components/schemas/SupportedFeatures'
  required:
    - ueACRequestInfo
    - nfId

```

```

UeACRequestInfo:
  type: object
  properties:
    supi:
      $ref: 'TS29571_CommonData.yaml#/components/schemas/Supi'
    anType:
      $ref: 'TS29571_CommonData.yaml#/components/schemas/AccessType'
    acuOperationList:
      type: array
      items:
        $ref: '#/components/schemas/AcuOperationItem'
      minItems: 1
    additionalAnType:
      $ref: 'TS29571_CommonData.yaml#/components/schemas/AccessType'
  required:
    - supi
    - anType
    - acuOperationList

```

```

UeACResponseData:
  type: object
  properties:
    acuFailureList:
      description: A map (list of key-value pairs) where the key of the map shall be UE's supi
      type: object
      additionalProperties:
        type: array
        items:
          $ref: '#/components/schemas/AcuFailureItem'
      minItems: 1
      minProperties: 1
    ueAdmissionList:
      type: array
      items:
        $ref: '#/components/schemas/UeAdmissionValue'
      minItems: 1
    supportedFeatures:
      $ref: 'TS29571_CommonData.yaml#/components/schemas/SupportedFeatures'

```

```

AcuOperationItem:
  type: object
  properties:
    updateFlag:
      $ref: '#/components/schemas/AcuFlag'
    snssai:
      $ref: 'TS29571_CommonData.yaml#/components/schemas/Snssai'
    plmnId:
      $ref: 'TS29571_CommonData.yaml#/components/schemas/PlmnId'
    plmnIdNid:
      $ref: 'TS29571_CommonData.yaml#/components/schemas/PlmnIdNid'
    ueRegInd:
      type: boolean
      enum:
        - true
    servingPlmnId:
      $ref: 'TS29571_CommonData.yaml#/components/schemas/PlmnId'
    nsacMode:
      $ref: '#/components/schemas/NsacAdmissionMode'
  required:
    - updateFlag
    - snssai

AcuFailureItem:
  type: object
  properties:
    snssai:
      $ref: 'TS29571_CommonData.yaml#/components/schemas/Snssai'
    reason:
      $ref: '#/components/schemas/AcuFailureReason'
    plmnId:
      $ref: 'TS29571_CommonData.yaml#/components/schemas/PlmnId'
    plmnIdNid:
      $ref: 'TS29571_CommonData.yaml#/components/schemas/PlmnIdNid'
    pduSessionId:
      $ref: 'TS29571_CommonData.yaml#/components/schemas/PduSessionId'
  required:
    - snssai
    - reason

EacNotification:
  description: A map (list of key-value pairs) where Snssai converted to a string serves as key
  type: object
  additionalProperties:
    $ref: '#/components/schemas/EACMode'
  minProperties: 1

PduACRequestData:
  type: object
  properties:
    pduACRequestInfo:
      type: array
      items:
        $ref: '#/components/schemas/PduACRequestInfo'
      minItems: 1
    nfId:
      $ref: 'TS29571_CommonData.yaml#/components/schemas/NfInstanceId'
    pgwFqdn:
      $ref: 'TS29571_CommonData.yaml#/components/schemas/Fqdn'
    nsacServiceArea:
      $ref: 'TS29571_CommonData.yaml#/components/schemas/NsacSai'
    supportedFeatures:
      $ref: 'TS29571_CommonData.yaml#/components/schemas/SupportedFeatures'
  required:
    - pduACRequestInfo

PduACRequestInfo:
  type: object
  properties:
    supi:
      $ref: 'TS29571_CommonData.yaml#/components/schemas/Supi'
    anType:
      $ref: 'TS29571_CommonData.yaml#/components/schemas/AccessType'
    pduSessionId:
      $ref: 'TS29571_CommonData.yaml#/components/schemas/PduSessionId'
    acuOperationList:
      type: array
      items:

```

```

    $ref: '#/components/schemas/AcuOperationItem'
    minItems: 1
    maxItems: 2
    additionalAnType:
      $ref: 'TS29571_CommonData.yaml#/components/schemas/AccessType'
  required:
    - supi
    - anType
    - pduSessionId
    - acuOperationList

PduACResponseData:
  type: object
  properties:
    acuFailureList:
      description: A map (list of key-value pairs) where the key of the map shall be UE's supi
      type: object
      additionalProperties:
        type: array
        items:
          $ref: '#/components/schemas/AcuFailureItem'
          minItems: 1
          maxItems: 2
      minProperties: 1
    pduAdmissionList:
      type: array
      items:
        $ref: '#/components/schemas/PduAdmissionValue'
      minItems: 1
    supportedFeatures:
      $ref: 'TS29571_CommonData.yaml#/components/schemas/SupportedFeatures'

UeAdmissionValue:
  type: object
  properties:
    properties:
      snssai:
        $ref: 'TS29571_CommonData.yaml#/components/schemas/Snssai'
      maxNumUes:
        $ref: 'TS29571_CommonData.yaml#/components/schemas/Uinteger'
      ueAdmissionThreshold:
        type: integer
        minimum: 0
        maximum: 100
  required:
    - snssai

PduAdmissionValue:
  type: object
  properties:
    snssai:
      $ref: 'TS29571_CommonData.yaml#/components/schemas/Snssai'
    maxNumPdus:
      $ref: 'TS29571_CommonData.yaml#/components/schemas/Uinteger'
  required:
    - snssai
    - maxNumPdus

ACUpdateData:
  type: object
  properties:
    snssai:
      $ref: 'TS29571_CommonData.yaml#/components/schemas/Snssai'
    maxUesNumber:
      type: integer
    maxPdusNumber:
      type: integer
  required:
    - snssai

QuotaUpdateRequestData:
  type: object
  properties:
    snssai:
      $ref: 'TS29571_CommonData.yaml#/components/schemas/Snssai'
    plmnId:
      $ref: 'TS29571_CommonData.yaml#/components/schemas/PlmnId'
    quotaType:
      $ref: '#/components/schemas/SliceQuotaType'

```

```
    required:
      - snssai
      - plmnID
      - quotaType

QuotaUpdateResponseData:
  type: object
  properties:
    snssai:
      $ref: 'TS29571_CommonData.yaml#/components/schemas/Snssai'
    maxUesNumber:
      type: integer
    maxPdusNumber:
      type: integer
  required:
    - snssai

#
# SIMPLE DATA TYPES
#

#
# ENUMERATIONS
#

EACMode:
  anyOf:
    - type: string
      enum:
        - ACTIVE
        - DEACTIVE
    - type: string
      description: >
        This string provides forward-compatibility with future
        extensions to the enumeration but is not used to encode
        content defined in the present version of this API.
  description: >
    EAC mode. Possible values are
    - ACTIVE
    - DEACTIVE

AcuFlag:
  anyOf:
    - type: string
      enum:
        - INCREASE
        - DECREASE
        - UPDATE
    - type: string
      description: >
        This string provides forward-compatibility with future
        extensions to the enumeration but is not used to encode
        content defined in the present version of this API.
  description: >
    Update Flag of ACU operation. Possible values are
    - INCREASE
    - DECREASE
    - UPDATE

AcuFailureReason:
  anyOf:
    - type: string
      enum:
        - SLICE_NOT_FOUND
        - EXCEED_MAX_UE_NUM
        - EXCEED_MAX_UE_NUM_3GPP
        - EXCEED_MAX_UE_NUM_N3GPP
        - EXCEED_MAX_PDU_NUM
        - EXCEED_MAX_PDU_NUM_3GPP
        - EXCEED_MAX_PDU_NUM_N3GPP
    - type: string
      description: >
        This string provides forward-compatibility with future
        extensions to the enumeration but is not used to encode
        content defined in the present version of this API.
  description: >
```

```
Failure Reason of ACU operation to an S-NSSAI. Possible values are
- SLICE_NOT_FOUND
- EXCEED_MAX_UE_NUM
- EXCEED_MAX_UE_NUM_3GPP
- EXCEED_MAX_UE_NUM_N3GPP
- EXCEED_MAX_PDU_NUM
- EXCEED_MAX_PDU_NUM_3GPP
- EXCEED_MAX_PDU_NUM_N3GPP

SliceQuotaType:
anyOf:
- type: string
  enum:
    - MAX_UE_NUM
    - MAX_PDU_NUM
    - BOTH
- type: string
  description: >
    This string provides forward-compatibility with future
    extensions to the enumeration but is not used to encode
    content defined in the present version of this API.
description: >
  Slice quota type. Possible values are
  - MAX_UE_NUM
  - MAX_PDU_NUM
  - BOTH

NsacAdmissionMode:
description: >
  Indicates the NSAC admission mode applied in roaming case.
anyOf:
- type: string
  enum:
    - VPLMN_ADMISSION
    - VPLMN_WITH_HPLMN_ASSISTANCE
- type: string
  description: >
    This string provides forward-compatibility with future
    extensions to the enumeration but is not used to encode
    content defined in the present version of this API.
    - VPLMN_ADMISSION
    - VPLMN_WITH_HPLMN_ASSISTANCE
```

---

## A.3 Nnsacf\_SliceEventExposure API

openapi: 3.0.0

info:

```
title: Nnsacf_SliceEventExposure
version: 1.1.0
description: |
  Nnsacf_SliceEventExposure Service.
  © 2024, 3GPP Organizational Partners (ARIB, ATIS, CCSA, ETSI, TSDSI, TTA, TTC).
  All rights reserved.
```

externalDocs:

```
description: 3GPP TS 29.536 V18.6.0; 5G System; Network Slice Admission Control Services; Stage 3.
url: https://www.3gpp.org/ftp/Specs/archive/29_series/29.536/
```

servers:

```
- url: '{apiRoot}/nnsacf-slice-ee/v1'
  variables:
    apiRoot:
      default: https://example.com
      description: apiRoot as defined in clause 4.4 of 3GPP TS 29.501
```

security:

```
- {}
- oAuth2ClientCredentials:
  - nnsacf-slice-ee
```

paths:

```
/subscriptions:
  post:
    summary: Nnsacf_SliceEventExposure Subscribe service Operation
```

```

tags:
  - Subscriptions collection (Collection)
operationId: CreateSubscription
requestBody:
  content:
    application/json:
      schema:
        $ref: '#/components/schemas/SACEventSubscription'
      required: true
responses:
  '201':
    description: Subscription Created
    headers:
      Location:
        description: 'Contains the URI of the newly created resource, according to the
structure: {apiRoot}/nnsacf-slice-ee/<apiVersion>/subscriptions/{subscriptionId}'
        required: true
        schema:
          type: string
    content:
      application/json:
        schema:
          $ref: '#/components/schemas/CreatedSACEventSubscription'
  '307':
    $ref: 'TS29571_CommonData.yaml#/components/responses/307'
  '308':
    $ref: 'TS29571_CommonData.yaml#/components/responses/308'
  '400':
    $ref: 'TS29571_CommonData.yaml#/components/responses/400'
  '401':
    $ref: 'TS29571_CommonData.yaml#/components/responses/401'
  '403':
    $ref: 'TS29571_CommonData.yaml#/components/responses/403'
  '404':
    $ref: 'TS29571_CommonData.yaml#/components/responses/404'
  '411':
    $ref: 'TS29571_CommonData.yaml#/components/responses/411'
  '413':
    $ref: 'TS29571_CommonData.yaml#/components/responses/413'
  '415':
    $ref: 'TS29571_CommonData.yaml#/components/responses/415'
  '429':
    $ref: 'TS29571_CommonData.yaml#/components/responses/429'
  '500':
    $ref: 'TS29571_CommonData.yaml#/components/responses/500'
  '501':
    $ref: 'TS29571_CommonData.yaml#/components/responses/501'
  '502':
    $ref: 'TS29571_CommonData.yaml#/components/responses/502'
  '503':
    $ref: 'TS29571_CommonData.yaml#/components/responses/503'
default:
  description: Unexpected error
callbacks:
  eventReport:
    '{$request.body#/subscription/eventNotifyUri}':
      post:
        summary: Event Notificaiton Delivery
        requestBody:
          content:
            application/json:
              schema:
                $ref: '#/components/schemas/SACEventReport'
              required: true
        responses:
          '204':
            description: Successful acknowledgement
          '307':
            $ref: 'TS29571_CommonData.yaml#/components/responses/307'
          '308':
            $ref: 'TS29571_CommonData.yaml#/components/responses/308'
          '400':
            $ref: 'TS29571_CommonData.yaml#/components/responses/400'
          '401':
            $ref: 'TS29571_CommonData.yaml#/components/responses/401'
          '403':
            $ref: 'TS29571_CommonData.yaml#/components/responses/403'
          '404':
            $ref: 'TS29571_CommonData.yaml#/components/responses/403'

```

```

    $ref: 'TS29571_CommonData.yaml#/components/responses/404'
  '411':
    $ref: 'TS29571_CommonData.yaml#/components/responses/411'
  '413':
    $ref: 'TS29571_CommonData.yaml#/components/responses/413'
  '415':
    $ref: 'TS29571_CommonData.yaml#/components/responses/415'
  '429':
    $ref: 'TS29571_CommonData.yaml#/components/responses/429'
  '500':
    $ref: 'TS29571_CommonData.yaml#/components/responses/500'
  '502':
    $ref: 'TS29571_CommonData.yaml#/components/responses/502'
  '503':
    $ref: 'TS29571_CommonData.yaml#/components/responses/503'
  default:
    description: Unexpected error

/subscriptions/{subscriptionId}:
  patch:
    summary: Nnsacf_SliceEventExposure Subscribe partial modify service Operation
    tags:
      - Individual subscription (Document)
    operationId: PartialModifySubscription
    parameters:
      - name: subscriptionId
        in: path
        required: true
        description: Unique ID of the subscription to be modified
        schema:
          type: string
    requestBody:
      content:
        application/json-patch+json:
          schema:
            type: array
            items:
              $ref: 'TS29571_CommonData.yaml#/components/schemas/PatchItem'
            minItems: 1
      required: true
    responses:
      '200':
        description: Subsription modified successfully
        content:
          application/json:
            schema:
              $ref: '#/components/schemas/CreatedSACEventSubscription'
      '307':
        $ref: 'TS29571_CommonData.yaml#/components/responses/307'
      '308':
        $ref: 'TS29571_CommonData.yaml#/components/responses/308'
      '400':
        $ref: 'TS29571_CommonData.yaml#/components/responses/400'
      '401':
        $ref: 'TS29571_CommonData.yaml#/components/responses/401'
      '403':
        $ref: 'TS29571_CommonData.yaml#/components/responses/403'
      '404':
        $ref: 'TS29571_CommonData.yaml#/components/responses/404'
      '411':
        $ref: 'TS29571_CommonData.yaml#/components/responses/411'
      '413':
        $ref: 'TS29571_CommonData.yaml#/components/responses/413'
      '415':
        $ref: 'TS29571_CommonData.yaml#/components/responses/415'
      '429':
        $ref: 'TS29571_CommonData.yaml#/components/responses/429'
      '500':
        $ref: 'TS29571_CommonData.yaml#/components/responses/500'
      '502':
        $ref: 'TS29571_CommonData.yaml#/components/responses/502'
      '503':
        $ref: 'TS29571_CommonData.yaml#/components/responses/503'
      default:
        description: Unexpected error
    put:
      summary: Nnsacf_SliceEventExposure Subscribe complete modify service Operation
      tags:

```



```

- Individual subscription (Document)
operationId: CompleteModifySubscription
parameters:
- name: subscriptionId
  in: path
  required: true
  description: Unique ID of the subscription to be modified
  schema:
    type: string
requestBody:
  content:
    application/json:
      schema:
        $ref: '#/components/schemas/SACEventSubscription'
      required: true
responses:
'200':
  description: Subscription modified successfully
  content:
    application/json:
      schema:
        $ref: '#/components/schemas/CreatedSACEventSubscription'
'204':
  description: Events subscription modification is accepted entirely
'307':
  $ref: 'TS29571_CommonData.yaml#/components/responses/307'
'308':
  $ref: 'TS29571_CommonData.yaml#/components/responses/308'
'400':
  $ref: 'TS29571_CommonData.yaml#/components/responses/400'
'401':
  $ref: 'TS29571_CommonData.yaml#/components/responses/401'
'403':
  $ref: 'TS29571_CommonData.yaml#/components/responses/403'
'404':
  $ref: 'TS29571_CommonData.yaml#/components/responses/404'
'411':
  $ref: 'TS29571_CommonData.yaml#/components/responses/411'
'413':
  $ref: 'TS29571_CommonData.yaml#/components/responses/413'
'415':
  $ref: 'TS29571_CommonData.yaml#/components/responses/415'
'429':
  $ref: 'TS29571_CommonData.yaml#/components/responses/429'
'500':
  $ref: 'TS29571_CommonData.yaml#/components/responses/500'
'502':
  $ref: 'TS29571_CommonData.yaml#/components/responses/502'
'503':
  $ref: 'TS29571_CommonData.yaml#/components/responses/503'
default:
  description: Unexpected error
delete:
  summary: Nnsacf_SliceEventExposure Unsubscribe service Operation
  tags:
- Individual subscription (Document)
operationId: DeleteSubscription
parameters:
- name: subscriptionId
  in: path
  required: true
  description: Unique ID of the subscription to be deleted
  schema:
    type: string
responses:
'204':
  description: Subscription deleted successfully
'307':
  $ref: 'TS29571_CommonData.yaml#/components/responses/307'
'308':
  $ref: 'TS29571_CommonData.yaml#/components/responses/308'
'400':
  $ref: 'TS29571_CommonData.yaml#/components/responses/400'
'401':
  $ref: 'TS29571_CommonData.yaml#/components/responses/401'
'403':
  $ref: 'TS29571_CommonData.yaml#/components/responses/403'
'404':

```

```

    $ref: 'TS29571_CommonData.yaml#/components/responses/404'
  '411':
    $ref: 'TS29571_CommonData.yaml#/components/responses/411'
  '413':
    $ref: 'TS29571_CommonData.yaml#/components/responses/413'
  '415':
    $ref: 'TS29571_CommonData.yaml#/components/responses/415'
  '429':
    $ref: 'TS29571_CommonData.yaml#/components/responses/429'
  '500':
    $ref: 'TS29571_CommonData.yaml#/components/responses/500'
  '502':
    $ref: 'TS29571_CommonData.yaml#/components/responses/502'
  '503':
    $ref: 'TS29571_CommonData.yaml#/components/responses/503'
  default:
    description: Unexpected error

```

components:

```

securitySchemes:
  oAuth2ClientCredentials:
    type: oauth2
    flows:
      clientCredentials:
        tokenUrl: '{nrfApiRoot}/oauth2/token'
        scopes:
          nnsacf-slice-ee: Access to the Nnsacf_SliceEventExposure API

```

schemas:

```

#
# STRUCTURED DATA TYPES
#

```

```

SACEventSubscription:
  description: Request data to create the event subscription
  type: object
  required:
    - event
    - eventNotifyUri
    - nfId
  properties:
    event:
      $ref: '#/components/schemas/SACEvent'
    eventNotifyUri:
      $ref: 'TS29571_CommonData.yaml#/components/schemas/Uri'
    nfId:
      $ref: 'TS29571_CommonData.yaml#/components/schemas/NfInstanceId'
    notifyCorrelationId:
      type: string
    maxReports:
      type: integer
    expiry:
      $ref: 'TS29571_CommonData.yaml#/components/schemas/DateTime'
    notifFlag:
      $ref: 'TS29571_CommonData.yaml#/components/schemas/NotificationFlag'
    mutingExcInstructions:
      writeOnly: true
      allOf:
        - $ref: 'TS29571_CommonData.yaml#/components/schemas/MutingExceptionInstructions'
    mutingNotSettings:
      readOnly: true
      allOf:
        - $ref: 'TS29571_CommonData.yaml#/components/schemas/MutingNotificationsSettings'
    supportedFeatures:
      $ref: 'TS29571_CommonData.yaml#/components/schemas/SupportedFeatures'

```

```

CreatedSACEventSubscription:
  description: Response data on created event subscription
  type: object
  required:
    - subscription
    - subscriptionId
  properties:
    subscription:
      $ref: '#/components/schemas/SACEventSubscription'
    subscriptionId:

```

```

    type: string
  report:
    $ref: '#/components/schemas/SACEventReportItem'
  supportedFeatures:
    $ref: 'TS29571_CommonData.yaml#/components/schemas/SupportedFeatures'

SACEventReport:
  description: Event notification
  type: object
  required:
    - report
  properties:
    report:
      $ref: '#/components/schemas/SACEventReportItem'
    notifyCorrelationId:
      type: string

SACEvent:
  description: Describes an event to be subscribed
  type: object
  required:
    - eventType
    - eventFilter
  properties:
    eventType:
      $ref: '#/components/schemas/SACEventType'
    eventTrigger:
      $ref: '#/components/schemas/SACEventTrigger'
    eventFilter:
      type: array
      items:
        $ref: 'TS29571_CommonData.yaml#/components/schemas/Snssai'
      minItems: 1
    notificationPeriod:
      $ref: 'TS29571_CommonData.yaml#/components/schemas/DurationSec'
    notifThreshold:
      $ref: 'TS29571_CommonData.yaml#/components/schemas/SACInfo'
    immediateFlag:
      type: boolean
      default: false
    varRepPeriodInfo:
      type: array
      items:
        $ref: 'TS29571_CommonData.yaml#/components/schemas/VarRepPeriod'
      minItems: 1

SACEventReportItem:
  description: Represents a report triggered by a subscribed event type
  type: object
  required:
    - eventType
    - eventState
    - timeStamp
    - eventFilter
  properties:
    eventType:
      $ref: '#/components/schemas/SACEventType'
    eventState:
      $ref: '#/components/schemas/SACEventState'
    timeStamp:
      $ref: 'TS29571_CommonData.yaml#/components/schemas/DateTime'
    eventFilter:
      $ref: 'TS29571_CommonData.yaml#/components/schemas/Snssai'
    sliceStatusInfo:
      $ref: 'TS29571_CommonData.yaml#/components/schemas/SACEventStatus'

SACEventState:
  description: Represents the state of a subscribed event
  type: object
  required:
    - active
  properties:
    active:
      type: boolean
    remainReports:
      type: integer
    remainDuration:
      $ref: 'TS29571_CommonData.yaml#/components/schemas/DurationSec'

```

```
#  
# SIMPLE DATA TYPES  
#
```

```
#  
# ENUMERATIONS  
#
```

```
SACEventType:  
  description: Describes the supported event types  
  anyOf:  
  - type: string  
    enum:  
      - NUM_OF_REGD_UES  
      - NUM_OF_ESTD_PDU_SESSIONS  
  - type: string
```

```
SACEventTrigger:  
  description: Describes how NSACF should generate the report for the event  
  anyOf:  
  - type: string  
    enum:  
      - THRESHOLD  
      - PERIODIC  
  - type: string
```

## Annex B (informative): Change history

Change history							
Date	Meeting	TDoc	CR	Rev	Cat	Subject/Comment	New version
2021-04	CT4#103E	C4-212108				TS skeleton	0.0.1
2021-04	CT4#103E	C4-212430, etc.				Implementation of pCRs agreed in CT4#103E (C4-212430, C4-212610, C4-212432, C4-212112)	0.1.0
2021-06	CT4#104E	C4-213440, etc.				Implementation of pCRs agreed in CT4#104E (C4-213440, C4-213441, C4-213442, C4-213443, C4-213444, C4-213445, C4-213446, C4-213435, C4-213436, C4-213437, C4-213438)	0.2.0
2021-09	CT4#105E	C4-214694, etc.				Implementation of pCRs agreed in CT4#105E (C4-214694, C4-214695, C4-214645, C4-214646, C4-214647, C4-214098, C4-214610, C4-214611, C4-214107, C4-214292, C4-214593, C4-214594, C4-214595, C4-214317, C4-214318, C4-214729, C4-214730, C4-214337)	0.3.0
2021-10	CT4#106E	C4-215382, etc.				Implementation of pCRs agreed in CT4#106E (C4-215382, C4-215116, C4-215470, C4-215383, C4-215385, C4-215386, C4-215388, C4-215389, C4-215390, C4-215391, C4-215392, C4-215393, C4-215394, C4-215395, C4-215525, C4-215415, C4-215416, C4-215264)	0.4.0
2021-11	CT4#107E	C4-216052, etc.				Implementation of pCRs agreed in CT4#107E (C4-216052, C4-216240, C4-216241, C4-216414, C4-216415, C4-216416, C4-216429, C4-216446, C4-216516)	0.5.0
2021-12	CT#94e	CP-213155				V1.0.0 presented for information	1.0.0
2022-01	CT4#107bis-E	C4-220378, etc.				Implementation of pCRs agreed in CT4#107bis-E (C4-220379, C4-220357, C4-220459, C4-220070, C4-220389, C4-220345, C4-220346, C4-220348, C4-220372, C4-220411, C4-220413, C4-220284)	1.1.0
2022-03	CT4#108-E	C4-221040, etc.				Implementation of pCRs agreed in CT4#108-E (C4-221040, C4-221046, C4-221450, C4-221505, C4-221302)	1.2.0
2022-03	CT#95e	CP-220104				TS presented for approval	2.0.0
2022-03	CT#95e					TS approved	17.0.0
2022-06	CT#96	CP-221033	0003	1	F	NSAC for emergency and priority sessions alignment	17.1.0
2022-06	CT#96	CP-221033	0005	1	F	Session continuity guarantee with multiple NSACFs deployment	17.1.0
2022-06	CT#96	CP-221038	0008	-	F	Consumers of NSACF event exposure service	17.1.0
2022-06	CT#96	CP-221028	0010	1	F	Reuse of type Fqdn from 29.571	17.1.0
2022-06	CT#96	CP-221033	0011	1	F	Clarification on Per Access NSAC	17.1.0
2022-06	CT#96	CP-221033	0012	1	F	Removal of NSACF from HPLMN in LBO Model	17.1.0
2022-06	CT#96	CP-221051	0013	-	F	API version and External doc update	17.1.0
2022-09	CT#97	CP-222028	0014	1	F	Clarification on per access failure reason	17.2.0
2022-12	CT#98	CP-223095	0016	2	F	Missing mandatory status codes in OpenAPI	18.0.0
2022-12	CT#98	CP-223033	0017	-	F	29.536 Rel-18 API version and External doc update	18.0.0
2023-03	CT#99	CP-230047	0018	-	B	Different NSAC Admission Mode in Roaming Scenario	18.1.0
2023-03	CT#99	CP-230070	0019	-	F	Add DCCF to the NF service consumers list	18.1.0
2023-06	CT#100	CP-231027	0021	4	F	Location header and missing Redirection clause	18.2.0
2023-06	CT#100	CP-231048	0023	1	B	Interaction between two NSACFs	18.2.0
2023-06	CT#100	CP-231025	0027	-	B	OAuth2 scopes in the Nnsacf_NSAC API	18.2.0
2023-06	CT#100	CP-231048	0028	1	B	Network Slice status notifications and reports to Primary NSACF	18.2.0
2023-06	CT#100	CP-231048	0029	2	B	NSAC Service Area Support during NSAC Admission Control	18.2.0
2023-06	CT#100	CP-231047	0034	1	B	Variable reporting periodicity	18.2.0
2023-06	CT#100	CP-231048	0035	-	F	NSAC in roaming	18.2.0
2023-06	CT#100	CP-231048	0040	2	B	Update NumOfUEsUpdate service operation for hierarchical NSACF architecture	18.2.0
2023-06	CT#100	CP-231048	0041	2	B	Update NumOfPDUsUpdate service operation for hierarchical NSACF architecture	18.2.0
2023-06	CT#100	CP-231028	0042	-	F	Removal of apiVersion from resource URI variables tables	18.2.0
2023-06	CT#100	CP-231048	0043	2	B	Add LocalNumberUpdate service operation	18.2.0
2023-06	CT#100	CP-231069	0044	1	F	Remove undefined Note in the table and correct the figure number	18.2.0
2023-06	CT#100	CP-231048	0046	1	B	Update OpenApis for the primary NSACF communication	18.2.0
2023-06	CT#100	CP-231096	0049	-	A	Correction on the cardinality of acuFailureList	18.2.0
2023-06	CT#100	CP-231070	0047	-	F	29.536 Rel-18 API version and External doc update	18.2.0
2023-09	CT#101	CP-232037	0051	2	B	Option 1: Enhance NumOfUEsUpdate to count the number of UEs with at least one PDU session/PDN connection	18.3.0
2023-09	CT#101	CP-232037	0052	2	B	Option 2: Enhance NumOfPDUsUpdate to count the number of UEs with at least one PDU session/PDN connection	18.3.0
2023-09	CT#101	CP-232043	0054	3	B	NSAC Architecture Options and Role of NSACF	18.3.0
2023-09	CT#101	CP-232043	0057	1	F	Update LocalNumberUpdate service operation	18.3.0
2023-09	CT#101	CP-232043	0058	1	F	Corrections to modification of slice event subscription	18.3.0
2023-09	CT#101	CP-232043	0059	1	F	Miscellaneous Updates and Corrections	18.3.0
2023-09	CT#101	CP-232058	0060	-	F	Correct the reference for supportedFeatures	18.3.0

2023-09	CT#101	CP-232058	0061	-	F	Correct the resource in the figures of NumOfPDUsUpdate procedure	18.3.0
2023-09	CT#101	CP-232058	0062	-	F	Correct the reference for LocalNumberUpdate	18.3.0
2023-09	CT#101	CP-232043	0063	-	B	UE admission threshold	18.3.0
2023-09	CT#101	CP-232043	0064	1	B	VPLMN with HPLMN assistance NSAC admission	18.3.0
2023-09	CT#101	CP-232043	0065	1	B	EN removal for NSACF and Primary NSACF interaction in a hierarchical NSACF deployment	18.3.0
2023-09	CT#101	CP-232043	0066	1	B	NSACF NSAC Quota Update service operation	18.3.0
2023-09	CT#101	CP-232043	0067	2	B	Resource and Data types of NSACF NSAC Quota Update service operation	18.3.0
2023-09	CT#101	CP-232037	0070	1	F	Removal of description for AF/NEF subscription to the number of UEs with at least one PDU session/PDN connection	18.3.0
2023-09	CT#101	CP-232033	0071	2	F	EAC Mode Subscription and Notification	18.3.0
2023-09	CT#101	CP-232037	0072	1	B	Service introduction update for counting of UEs with at least one PDU sessions	18.3.0
2023-09	CT#101	CP-232043	0076	1	B	NSAC admission mode	18.3.0
2023-09	CT#101	CP-232060	0080	-	F	Rel18 API version and External doc update	18.3.0
2023-12	CT#102	CP-233045	0081	2	B	Muting mechanism	18.4.0
2023-12	CT#102	CP-233046	0082	-	F	Correction on hierarchical NSACF architecture	18.4.0
2023-12	CT#102	CP-233046	0083	1	F	Correction on Update operation for controlling the number of UEs with at least one PDU session/PDN connection	18.4.0
2023-12	CT#102	CP-233046	0084	2	F	LocalNumberUpdate in VPLMN with HPLMN assistance NSAC admission mode	18.4.0
2023-12	CT#102	CP-233046	0085	1	F	QuotaUpdate service operation Update	18.4.0
2023-12	CT#102	CP-233046	0086	-	F	Update the procedures to support the NumOfUEsUpdate and NumOfPDUsUpdate service operations for roaming UEs	18.4.0
2023-12	CT#102	CP-233046	0087	1	B	VPLMN with HPLMN assistance NSAC Admission mode for number of LBO PDU Sessions	18.4.0
2023-12	CT#102	CP-233046	0088	1	B	VPLMN with HPLMN assistance NSAC Admission mode for number of Registered UEs	18.4.0
2023-12	CT#102	CP-233027	0089	-	F	Obsoleted HTTP/2 RFCs	18.4.0
2023-12	CT#102	CP-233046	0092	-	F	Remove EN on PDU Session ID in Clause 5.2.4.2.4	18.4.0
2023-12	CT#102	CP-233046	0093	1	F	Updates to general description of NSAC service operations	18.4.0
2023-12	CT#102	CP-233046	0094	2	F	Update to Resource Structure of Slice Collection Configurations	18.4.0
2023-12	CT#102	CP-233046	0095	1	F	Corrections to Slice Collection Roaming Quotas	18.4.0
2023-12	CT#102	CP-233027	0097	-	F	ProblemDetails RFC 7807 obsoleted by 9457	18.4.0
2023-12	CT#102	CP-233039	0098	2	B	Finding and delegating an NSAC request to the primary NSACF	18.4.0
2023-12	CT#102	CP-233039	0099	4	B	NSACF role clarification	18.4.0
2023-12	CT#102	CP-233039	0100	2	B	Handling UE number with at least one PDU Session in the Hierarchical NSAC architecture	18.4.0
2023-12	CT#102	CP-233039	0101	1	B	Controlling the number of UEs with at least one PDU session/PDN connection	18.4.0
2023-12	CT#102	CP-233046	0102	2	B	NSAC Service Area data type definition	18.4.0
2023-12	CT#102	CP-233046	0103	1	F	Clarification on UE already registered indication	18.4.0
2023-12	CT#102	CP-233046	0104	1	F	Clarification on threshold synchronization among multiple NSACFs	18.4.0
2023-12	CT#102	CP-233046	0105	2	F	Threshold based UE admission control	18.4.0
2023-12	CT#102	CP-233046	0107	1	F	Clarification on the LocalNumberUpdate procedure	18.4.0
2023-12	CT#102	CP-233039	0108	1	F	EAC mode is not applicable for NSAC for UEs with at least PDU session/PDN connection	18.4.0
2023-12	CT#102	CP-233060	0109	-	F	API version and External doc update	18.4.0
2024-03	CT#103	CP-240053	0112	1	F	Applicability of EAC Mode Configuration	18.5.0
2024-03	CT#103	CP-240032	0113	1	F	Corrections on NSACF NumberOfPDUsUpdate service operation	18.5.0
2024-03	CT#103	CP-240032	0114	-	F	Corrections on NSACF NumOfUEsUpdate service operation and NSACF Service description	18.5.0
2024-03	CT#103	CP-240032	0115	-	F	Further clarification on the NSACF behavior for maximum number of UEs with at least one PDU Session/PDN connection	18.5.0
2024-03	CT#103	CP-240059	0116	1	A	Supporting NSAC in SNPN	18.5.0
2024-03	CT#103	CP-240051	0117	1	B	Add the NSCE server as NF consumer to NSACF	18.5.0
2024-03	CT#103	CP-240056	0119	-	F	29.536 Rel-18 API version and External doc update	18.5.0
2024-06	CT#104	CP-241028	0122	1	F	Callbacks	18.6.0
2024-06	CT#104	CP-241042	0123	-	F	Correct the feature name VHNSAC in structured datatypes	18.6.0
2024-06	CT#104	CP-241042	0124	-	F	Correction of QuotaUpdateRequestData and QuotaUpdateResponseData references	18.6.0
2024-06	CT#104	CP-241042	0125	4	B	NSAC optimization for network slice replacement	18.6.0
2024-06	CT#104	CP-241028	0128	1	B	Returning UNSUPPORTED_EVENT_TYPE	18.6.0
2024-06	CT#104	CP-241050	0129	-	F	Miscellaneous corrections	18.6.0
2024-06	CT#104	CP-241052	0130	-	F	29.536 Rel-18 API version and External doc update	18.6.0

---

# History

<b>Document history</b>		
V18.5.0	May 2024	Publication
V18.6.0	July 2024	Publication